



# Liebert® APS™ MBC

## Rack-mount Maintenance Bypass Cabinet

Installer/User Guide

### **Technical Support Site**

If you encounter any installation or operational issues with your product, check the pertinent section of this manual to see if the issue can be resolved by following outlined procedures. For additional assistance, visit <https://www.VertivCo.com/en-us/support/>

# TABLE OF CONTENTS

---

<b>1 Important Safety Precautions</b> .....	<b>5</b>
<b>2 Product Description</b> .....	<b>9</b>
2.1 Features .....	9
2.2 Appearance and Components .....	9
2.2.1 Bypass Indicator LED .....	10
2.2.2 UPS Indicator LED .....	10
2.2.3 Output Indicator LED .....	10
2.3 Operating Modes .....	11
2.3.1 UPS Mode .....	11
2.3.2 Maintenance Bypass Mode .....	12
<b>3 Installation</b> .....	<b>15</b>
3.1 Unpacking Inspection .....	15
3.2 Installation Environment .....	15
3.3 Installation Procedures .....	15
3.4 Selecting and Connecting Cables .....	17
3.4.1 Cable Selection .....	17
3.4.2 Removing the Conduit Boxes .....	18
3.4.3 Connections for Liebert APS UPS 200 to 240-V input/output .....	19
3.4.4 Connections for Liebert APS UPS 200 to 240-V Input / 200/100 to 240/120-V Output with Integral Output Transformer .....	21
3.4.5 Connections for Liebert APS UPS 200/100 to 240/120-V Input/Output .....	24
<b>4 Operation</b> .....	<b>25</b>
4.1 Starting Up .....	25
4.2 Shutting Down (with Loss of All Power) .....	25
4.3 Transferring from UPS to Maintenance Bypass .....	25
4.4 Transferring from Maintenance Bypass to UPS .....	26
<b>5 Troubleshooting</b> .....	<b>27</b>
<b>6 POD—Optional</b> .....	<b>29</b>
6.1 Introduction .....	29
6.2 Installing the POD .....	30
<b>7 Specifications</b> .....	<b>32</b>



# 1 IMPORTANT SAFETY PRECAUTIONS

## Save These Instructions

This manual contains important safety instructions. Read all safety, installation and operating instructions before operating the Liebert APS MBC and parallel UPS system. Adhere to all warnings on the unit and in this manual. Follow all operating and user instructions. Individuals must fully understand this equipment to install and operate it.

The Liebert APS MBC (maintenance bypass cabinet) is designed for commercial/industrial use only. It is not intended for use with life-support or other designated critical devices. Maximum load must not exceed that shown on the rating label. Install and operate the unit only in a clean indoor environment, free of conductive contaminants, moisture, flammable liquids, gases and corrosive substances. The Liebert APS MBC contains no user-serviceable parts. Refer all faults to your local dealer, local Vertiv™ representative or Vertiv™ Technical Support.

The Liebert APS MBC UPS system is designed for use on a properly earthed (grounded) 200-240 VAC, 50 or 60 Hz supply. The system must be installed by qualified personnel. A qualified electrician must review and approve customer supplied wiring, circuit breakers, and intended loads and verify correct input, output, and earth connections to ensure compliance with the technical standards and local electrical codes of practice.



**WARNING! Risk of electric shock. Can cause equipment damage, injury and death. A battery can present a risk of electrical shock and high short-circuit current.**

The following precautions must be observed before replacing the battery pack:

- Wear rubber gloves and boots
- Remove rings, watches and other metal objects.
- Use tools with insulated handles.
- Do not lay tools or other metal objects on the batteries.
- If the battery kit is damaged in any way or shows signs of leakage, contact your local Vertiv™ representative immediately.
- Do not dispose of batteries in a fire. The batteries may explode.
- Handle, transport and recycle batteries in accordance with local regulations.

The Liebert APS MBC is designed and manufactured to ensure personal safety, but improper use can result in electrical shock or fire. To ensure safety, observe the following precautions:

- Turn Off and unplug the Liebert APS MBC before cleaning it.
- Clean the unit with a dry cloth. Do not use liquid or aerosol cleaners.
- Never block or insert any objects into the ventilation holes or other openings of the Liebert APS MBC.
- Do not place the Liebert APS MBC power cord where it might be damaged.

This LiebertAPS MBC contains no user-serviceable parts except the internal battery pack. The unit's On/Off push buttons do not electrically isolate internal parts. Under no circumstances attempt to gain access internally, due to the risk of electric shock or burn.

**ELECTROMAGNETIC COMPATIBILITY**—The Liebert APS MBC complies with the limits of Category C2, pursuant to IEC/EN/AS 62040-2, and for a Class A digital device, pursuant to Part 15 of FCC rules. Operation is subject to the following conditions:

- The output cables must be no longer than 10 m (32 ft).
- This device may not cause harmful interference.
- This device must accept any interference received, including interference that may cause undesired operation. Operating this device in a residential area is likely to cause harmful interference that users must correct at their own expense.

The Liebert APS MBC complies with the requirements of EMC Directive 2004/108/EC and the published technical standards. Continued compliance requires installation in accordance with these instructions and use of accessories approved by Vertiv™.

## NOTICE

This is a Category C2 UPS product. In a residential environment, this product may cause radio interference, in which case the user may be required to take additional measures.

Operate the unit in an indoor environment only in an ambient temperature range of 0-40°C (32-104°F). Install it in a clean environment, free from moisture, flammable liquids, gases and corrosive substances.

Do not continue to use the Liebert APS MBC if the front panel indications are not in accordance with these operating instructions or the performance alters in use. Refer all faults to your Vertiv™ representative or Technical Support.

Servicing of batteries must be performed or supervised by properly-trained and qualified personnel knowledgeable of batteries and the required precautions. Keep unauthorized personnel away from the batteries. Proper disposal of batteries is required. Refer to your local laws and regulations for disposal requirements.

Never block or insert any object into the ventilation holes or other openings.

DO NOT CONNECT equipment that could overload the UPS or demand DC current from the Liebert APS MBC, for example: electric drills, vacuum cleaners, laser printers, hair dryers or any appliance using half-wave rectification.

Storing magnetic media on top of the Liebert APS MBC may result in data loss or corruption.

Turn Off and isolate the Liebert APS MBC before cleaning it. Use only a soft cloth, never liquid or aerosol cleaners.

## Information for the Protection of the Environment

**UPS SERVICING**—This unit makes use of components dangerous for the environment (electronic cards, electronic components). The components removed must be taken to specialized collection and disposal centers.







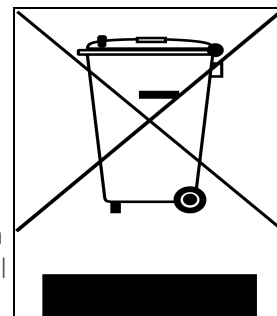

**NOTICE TO EUROPEAN UNION CUSTOMERS: DISPOSAL OF OLD APPLIANCES**—This product has been supplied from an environmentally aware manufacturer that complies with the Waste Electrical and Electronic Equipment (WEEE) Directive 2002/96/CE.

The symbol at right is placed on this product to encourage recycling wherever possible. Recycle this product through a recycling facility at the end of its service life. Do not dispose of this product as unsorted municipal waste. Follow local municipal waste ordinances for proper disposal provisions to reduce the environmental impact of waste electrical and electronic equipment (WEEE).

For information regarding the disposing of this equipment, visit [www.VertivCo.com](http://www.VertivCo.com) or contact Vertiv™ technical support. Refer to the inside front cover of this manual for contact information.



**Table 1.1 Glossary of Symbols**

SYMBOL	DESCRIPTION
	Risk of electrical shock
	Indicates caution followed by important instructions
	AC input
	AC output
	Requests the user to consult the manual
	Recycle
	Equipment grounding conductor
	Bonded to ground
	AC voltage

This page intentionally left blank.



## 2 PRODUCT DESCRIPTION

The rack-mountable MBC is intended for use with the Liebert APS, Liebert GXT3 8 to 10 kVA or other UPS with equivalent specifications. Typical applications include supporting workstations, servers, network, telecommunications or other sensitive electronic equipment.

The Liebert APS MBC provides maximum system availability to business-critical equipment allowing the transfer of connected equipment to an alternate power path for full isolation of the UPS for maintenance. The UPS can be turned Off and removed from service with no interruption of power to connected equipment.

### 2.1 Features

- Supports 8, 10, 15 or 20 kVA power, depending on model
- High-speed transfer switch
- Compact design
- Multiple power-path indicators
- Easily accessible terminal blocks
- Rack-mountable or tower orientation
- Integral output distribution options via optional PODs

### 2.2 Appearance and Components

Figure 2.1 Front Panel with Plastic Bezel in Place

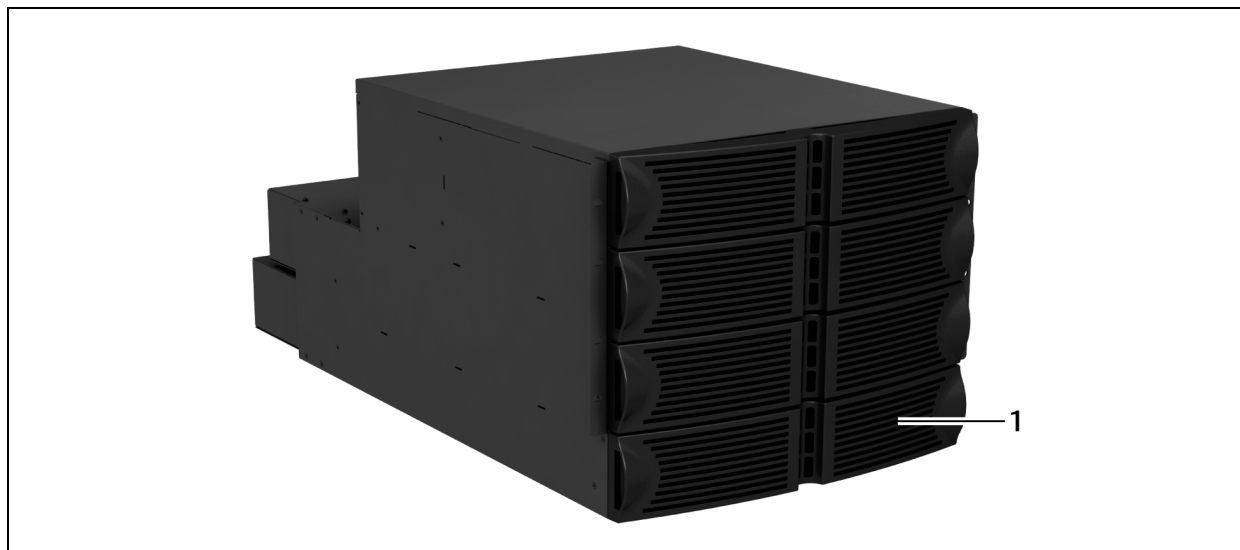

ITEM	DESCRIPTION
1	Plastic Bezel

Figure 2.2 Components on Front with Bezel Removed

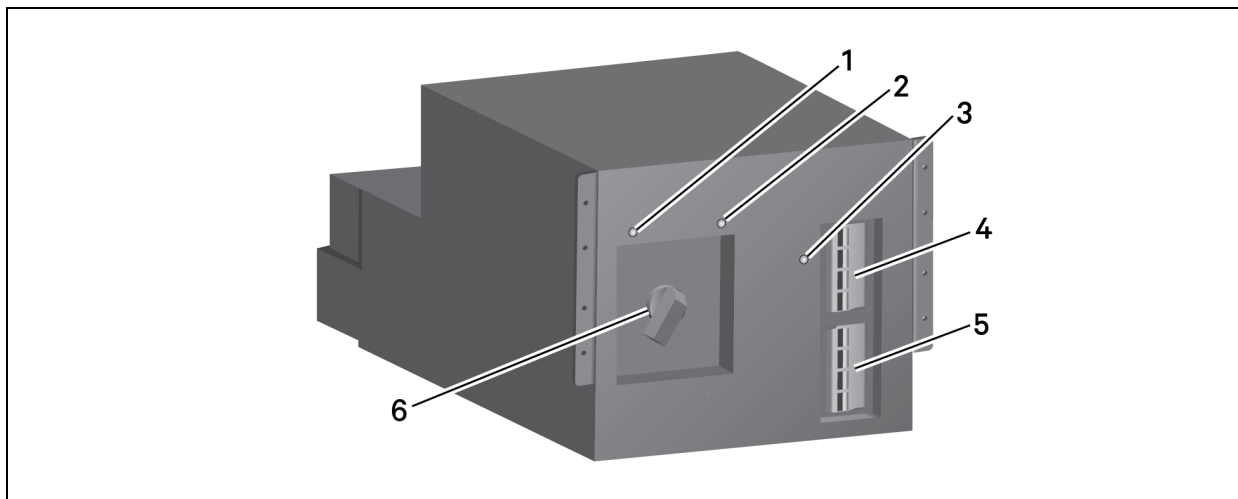

ITEM	DESCRIPTION	ITEM	DESCRIPTION
1	Bypass LED indicator (amber)	4	MBC output breaker
2	UPS LED indicator (green)	5	UPS input breaker
3	Output LED indicator (amber)	6	Maintenance bypass switch

### 2.2.1 Bypass Indicator LED

The amber Bypass Indicator illuminates when the maintenance-bypass source is available. When the Bypass Indicator is illuminated, you can connect the equipment to Maintenance Bypass mode by rotating the switch (see [Components on Front with Bezel Removed](#) on page 10). When the Bypass Indicator is not illuminated, the maintenance bypass source is not ready or available and transfers should not occur.

**NOTE: When the switch is in the Maintenance Bypass position, the connected equipment is not protected by the UPS and is susceptible to any AC mains/utility anomalies and outages.**

### 2.2.2 UPS Indicator LED

The green UPS Indicator shows when UPS output power is available. When the UPS Indicator is illuminated, UPS output power is available to the Liebert APS MBC and it is permissible to transfer the rotary switch to the UPS Mode (see [Components on Front with Bezel Removed](#) on page 10). When the UPS indicator is not illuminated, the UPS output power is not ready/available and transfers should not occur.

### 2.2.3 Output Indicator LED

The amber Output Indicator lets you know when the Liebert APS MBC main output breaker is closed and power is available on the main output terminal block. When the Output Indicator is not illuminated, output power is not available.

The POD ports, POD breakers and input/output terminal blocks are on the rear of the Liebert APS MBC, as shown in [Parts on the rear of APS MBC](#) on page 11.

Figure 2.3 Parts on the rear of APS MBC



NO.	DESCRIPTION
1	Pod port (with cover)
2	Input/Output terminal block
3	POD breaker

## 2.3 Operating Modes

The Liebert APS MBC permits maintaining power to all connected equipment during maintenance of the Liebert APS. The APS MBC operates in two modes, UPS Mode and Maintenance Bypass Mode.

### 2.3.1 UPS Mode

The diagram below illustrates the Liebert APS MBC operating in UPS Mode.

While in UPS Mode, the UPS supplies continuous, high-quality AC power. In this operating mode, the connected equipment is protected by the UPS. The maintenance-bypass switch is rotated toward the UPS indicator (green) in this mode.

Figure 2.4 Operation in UPS Mode

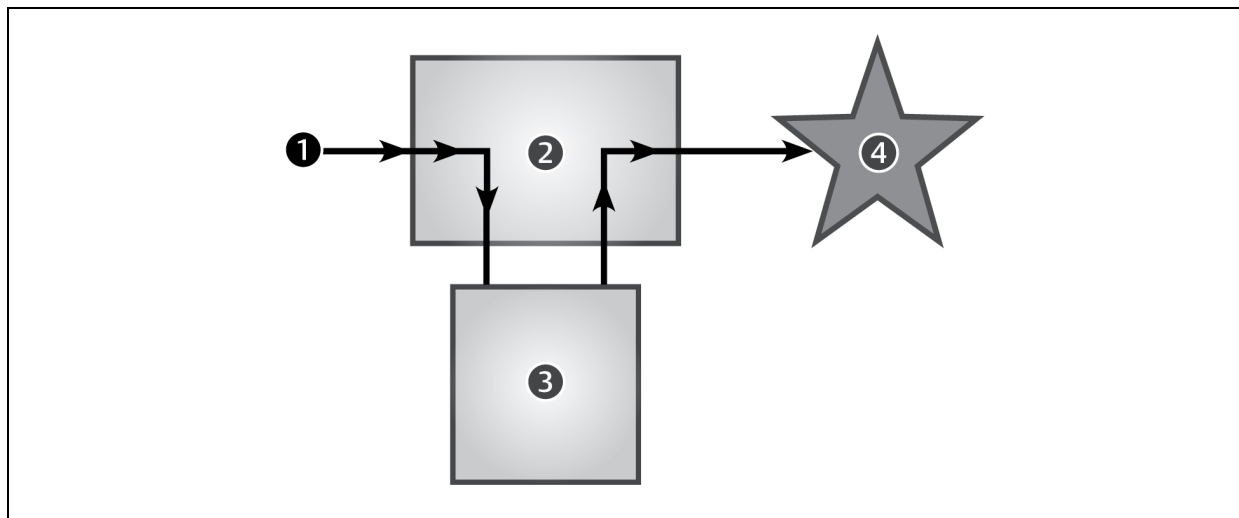

NO.	DESCRIPTION
1	AC input
2	MBC
3	Liebert APS
4	Connected load

### 2.3.2 Maintenance Bypass Mode

The diagram below illustrates the Liebert APS MBC operating in Maintenance Bypass Mode.

While in the Maintenance Bypass mode, the MBC provides an alternate path for power to the connected equipment. If the UPS must be taken out of service for limited maintenance or repair, manual activation of the bypass immediately transfers the equipment from the UPS inverter to the bypass source. In this mode, the connected equipment is not protected from utility/mains power abnormalities or outages. The maintenance bypass switch is rotated toward the Bypass Indicator (amber) in this mode.

Figure 2.5 Operation in Maintenance Bypass Mode

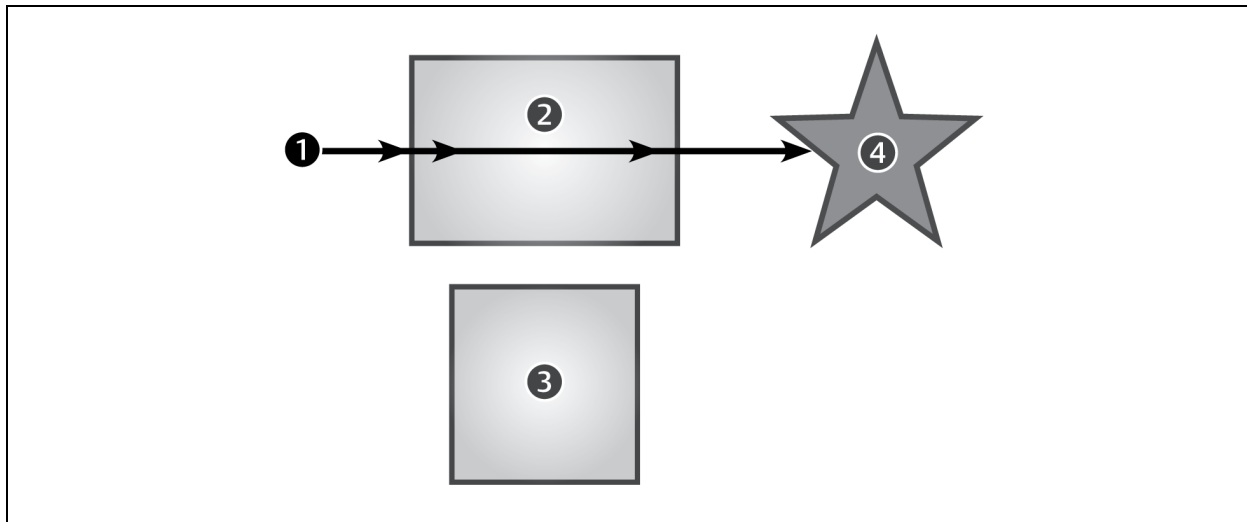

NO.	DESCRIPTION
1	AC input
2	MBC
3	Liebert APS
4	Connected load

This page intentionally left blank.

## 3 INSTALLATION

### 3.1 Unpacking Inspection

Upon receipt, unpack the Liebert APS MBC and conduct the following checks:

- Inspect the unit for shipping damage. If any shipping damage is founded, report it to the carrier.
- Check against the delivery list to verify that the types of the accessories are complete and correct. If there is any discrepancy, contact the carrier and your Vertiv™ representative immediately.

### 3.2 Installation Environment

The environment must be free of conductive contaminants and excessive moisture (water and condensation), flammable vapors, chemical fumes, corrosive gases and liquids.

### 3.3 Installation Procedures

#### Installation Tools

The following tools are required to properly set up your APS MBC:

- 13-mm (1/2 in) wrench or socket
- #1 and #2 Phillips screwdrivers
- Torque wrench

If the Liebert APS MBC will be installed in a rack enclosure, see the following for the installation procedures:

**NOTE: The MBC is rack-mountable. If the Liebert APS UPS will be rack mounted and there is no UPS in the rack, install the UPS before installing the MBC. If there is a UPS in the rack and the UPS is operating, turn off the UPS, disconnect the local input breaker and loads, and remove the UPS Input/Output cables according to the corresponding UPS user manual.**

1. Locate the rack-mount rails from the APS MBC packaging and review the following procedures to install the rails onto the vertical pole of the rack.
2. Install the cage nuts in the middle square holes of the 1U and 2U height space, the upper square holes of the 3U and 6U height spaces and in the lower square holes of the 5U and 8U height spaces.

**NOTE: The height space indicates the whole U-height space counted from the top of the Liebert APS UPS. The 1U and 2U height spaces are used to install the guide rails. The 3U, 6U, 5U and 8U height spaces are used to install the securing brackets of the Liebert APS MBC.**

3. Using the hook on the rear flange of the rack-mount rail, clip it onto the rear vertical pole and use the provided four M6 x 16 screws to secure them, as shown in [Attaching the rear of the rack-mount rail kit](#) on page 16.

Figure 3.1 Attaching the rear of the rack-mount rail kit

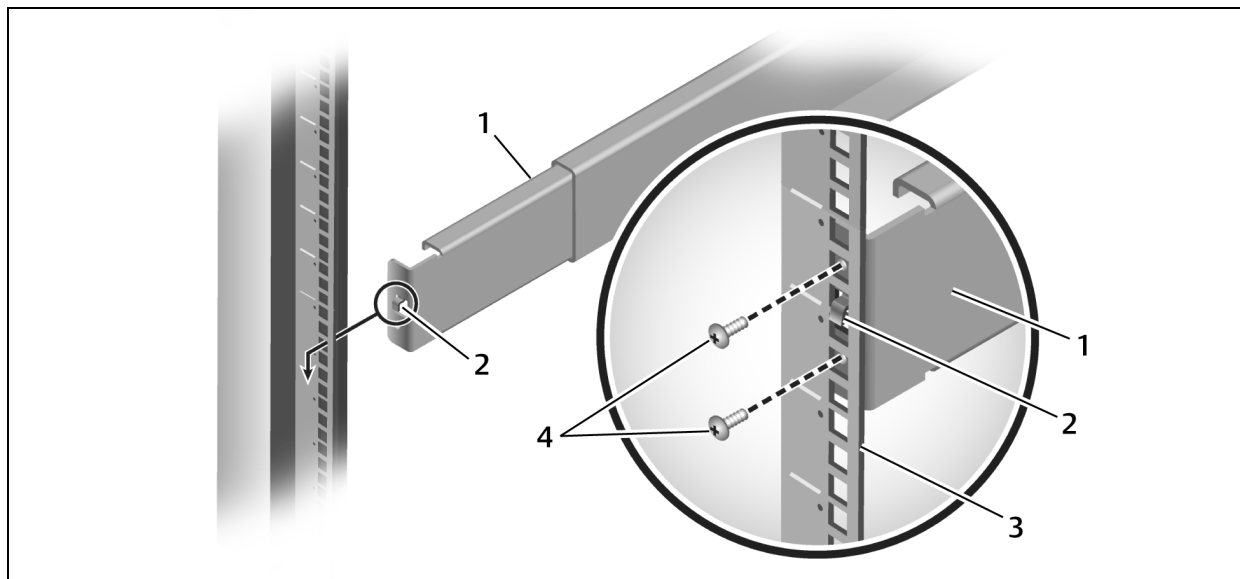

NO.	DESCRIPTION
1	Guide rail
2	Hook
3	Vertical rail
4	M6 x 16 screws (4 places)

4. Using the provided four M6 x 16 screws, secure the front of the rack-mount rails onto the vertical pole.
5. Remove the MBC from the shipping carton, lift and place it on the guide rails, then slide it into the rack as shown in [Installing the Liebert APS MBC](#) on page 17.

**NOTE: The Liebert APS MBC weighs 30 kg (66 lb). Please be careful when lifting it. Lifting may require two people.**



Figure 3.2 Installing the Liebert APS MBC

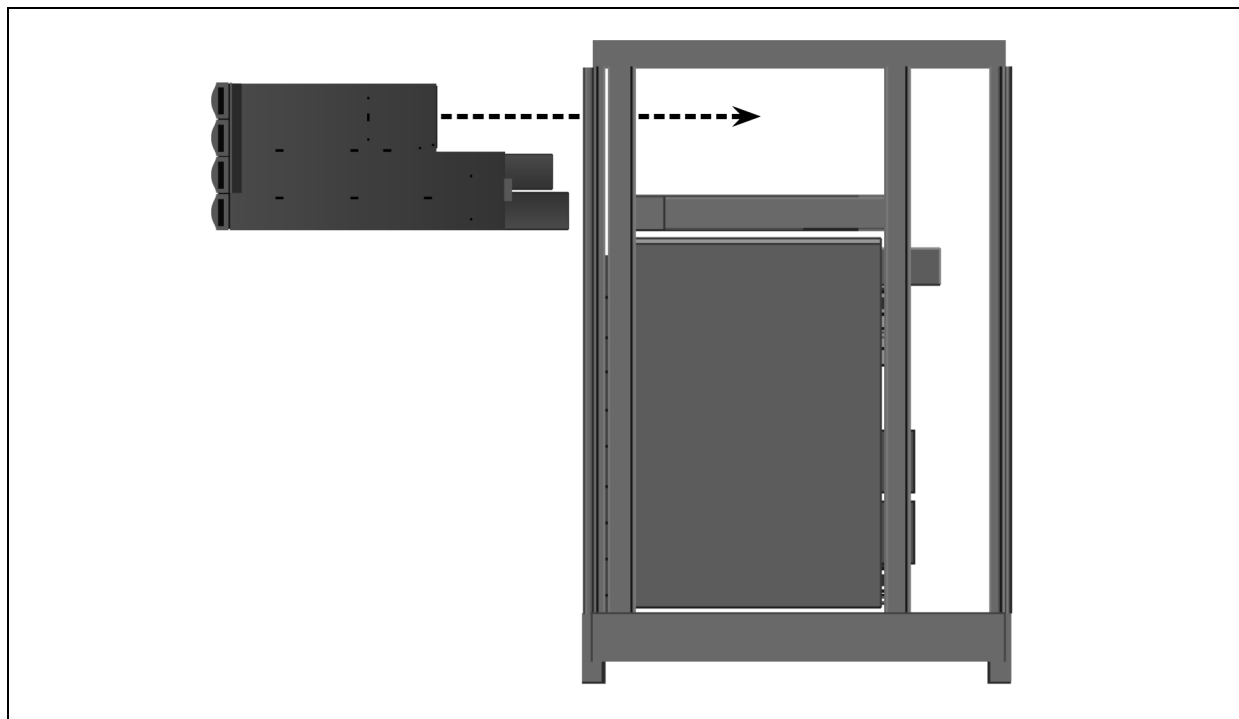

6. Refer to [Selecting and Connecting Cables](#) on page 17 for wiring connections.
7. Refer to [POD—Optional](#) on page 29 for installing any integral output-distribution PODs.

### 3.4 Selecting and Connecting Cables

#### Installation Tools

The following tools are required to properly set up your UPS:

- 13-mm (1/2 in) wrench or socket
- #1 and #2 Phillips screwdrivers
- Torque wrench

#### 3.4.1 Cable Selection

Select proper cable size/amperage based on the Liebert APS MBC model. The models have different circuit-breaker ratings. See Table 3.1 below for the amperages for proper cable selection.

Table 3.1 Cables and protection grade

ITEM	MODEL			
	ASMBCR2 SERIES	ASMBCR1 SERIES	ASMBCRG SERIES	ASMBCRW SERIES
Maximum Input Current	125A	100A	63A	50A
Input Protection	125A	100A	63A	50A
Maximum Output Current	125A	100A	63A	50A

**Table 3.1 Cables and protection grade (continued)**

ITEM	MODEL			
	ASMBCR2 SERIES	ASMBCR1 SERIES	ASMBRCR SERIES	ASMBRCR SERIES
Terminal Block				
Wire Size Range			Maximum: 2/0 (60mm <sup>2</sup> )	Minimum: 6 AWG (22mm <sup>2</sup> )

90°C rated copper wire is recommended

Terminal block torque requirements are 4.52Nm (40 in-lb)

The Liebert APS unit model number determines the section to follow for the installation of the APS MBC.

**Table 3.2 Cable Installation Reference**

UPS MODEL NUMBER DIGITS 1-3	UPS SYSTEM VOLTAGE AND FRAME TYPE	SEE MANUAL SECTION
AS1 or ASA	200-240V Input / Output; Transformer-Free	<a href="#">Connections for Liebert APS UPS 200 to 240-V input/output on page 19</a>
AS2 or ASB	200-240V input / output; transformer-free	<a href="#">Connections for Liebert APS UPS 200 to 240-V input/output on page 19</a>
AS3 or ASC	200-240 Input - 200/100-240/120 Output; Transformer-Based	<a href="#">Connections for Liebert APS UPS 200 to 240-V input/output on page 19</a>
AS4 or ASD	200-240 Input - 200/100-240/120 Output; Transformer-Based	<a href="#">Connections for Liebert APS UPS 200 to 240-V input/output on page 19</a>
AS5 or ASE	200/100-240/120 Input / Output; Transformer-Free	<a href="#">Connections for Liebert APS UPS 200/100 to 240/120-V Input/Output on page 24</a>
AS6 or ASF	200/100-240/120 Input / Output; Transformer-Free	<a href="#">Connections for Liebert APS UPS 200/100 to 240/120-V Input/Output on page 24</a>

### 3.4.2 Removing the Conduit Boxes

1. Referring to [Remove the conduit boxes](#) on page 19, remove the knockouts on the conduit boxes and pull the cables through them.
2. Connect the cables to the corresponding input/output terminals, and using a torque wrench, turn the screws clockwise until tightened.

**NOTE:** The upper terminal block connects with the UPS; The lower terminal block connects with the local power input and loads.

Figure 3.3 Remove the conduit boxes



NO.	DESCRIPTION
1	Cover
2	Retaining screws
3	Knockouts
4	Upper box, connects to UPS
5	Lower box, connects to input power and to the load

### 3.4.3 Connections for Liebert APS UPS 200 to 240-V input/output

Refer to [MBC upper terminal block \(to/from UPS unit\)](#) on page 20 and [MBC lower terminal block \(from main AC source/to main distribution panel\)](#) on page 20 for the cable connections when the Liebert APS UPS will be connected and wired for single-phase input, either L-N-PE (50-Hz voltages) or L-L-G (60-Hz voltages).

Figure 3.4 MBC upper terminal block (to/from UPS unit)

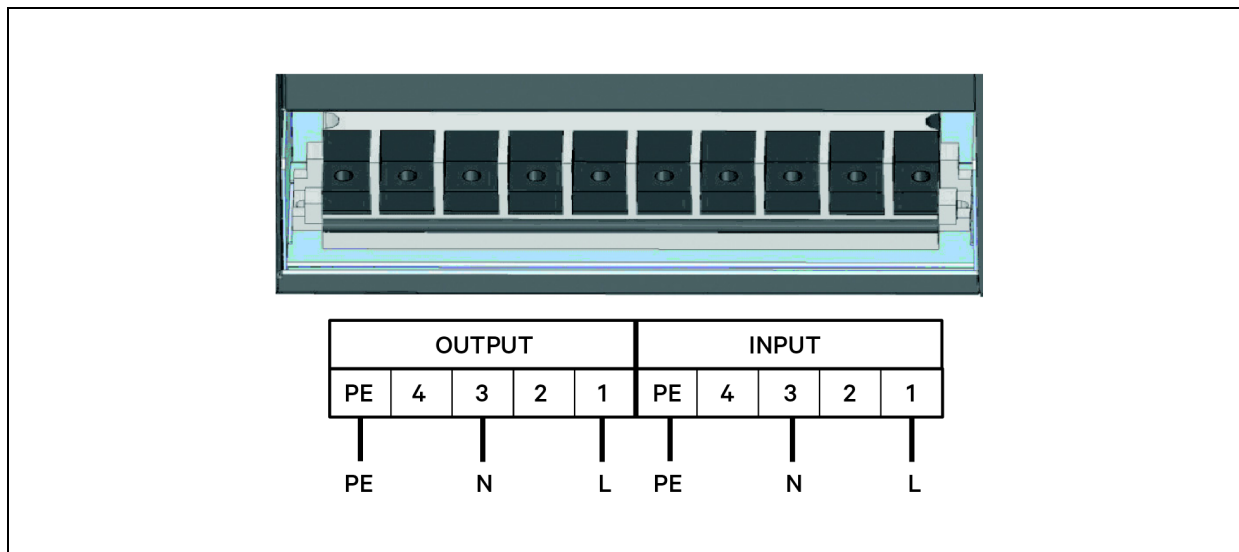
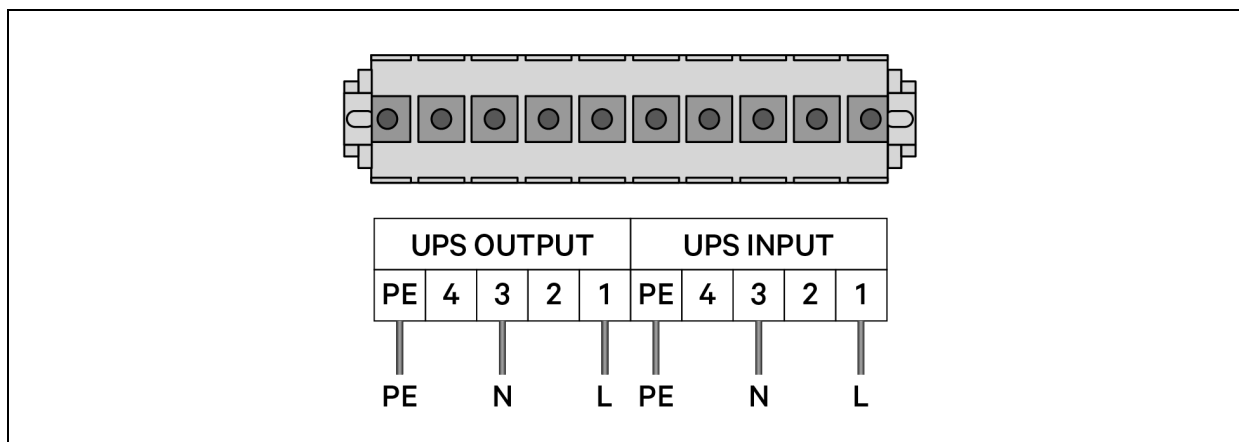
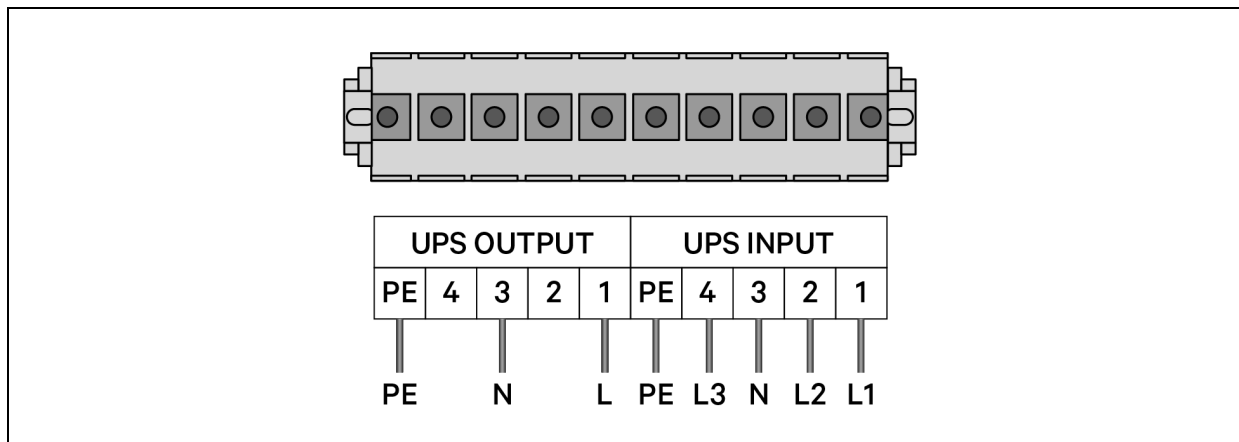

Figure 3.5 MBC lower terminal block (from main AC source/to main distribution panel)



Refer to [MBC upper terminal block \(to/from UPS unit\)](#) on page 21 and [MBC lower terminal block \(from main AC source/to main distribution panel\)](#) on page 21 for the cable connections when the Liebert APS UPS will be connected and wired for 3-phase input, L1-L2-L3-N-PE (50-Hz voltages only).

**Figure 3.6** MBC upper terminal block (to/from UPS unit)



**Figure 3.7** MBC lower terminal block (from main AC source/to main distribution panel)

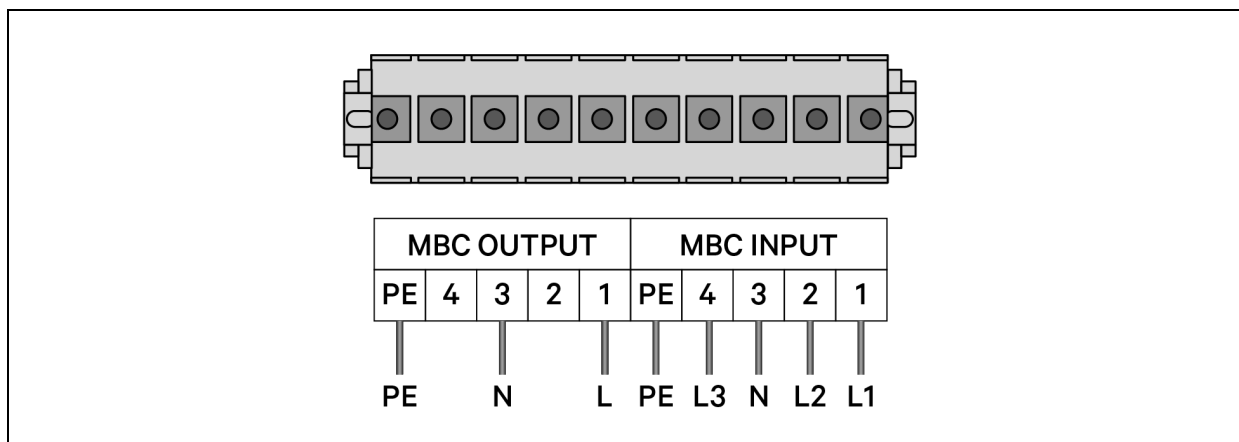

### 3.4.4 Connections for Liebert APS UPS 200 to 240-V Input / 200/100 to 240/120-V Output with Integral Output Transformer

Refer to [MBC upper terminal block \(to/from UPS unit\)](#) on page 22 and [MBC lower terminal block \(from main AC source/to main distribution panel\)](#) on page 23 for the cable connections when the Liebert APS UPS will be connected and wired for single-phase input, either L-N-PE (50-Hz voltages) or L-L-G (60-Hz voltages).

Figure 3.8 MBC upper terminal block (to/from UPS unit)

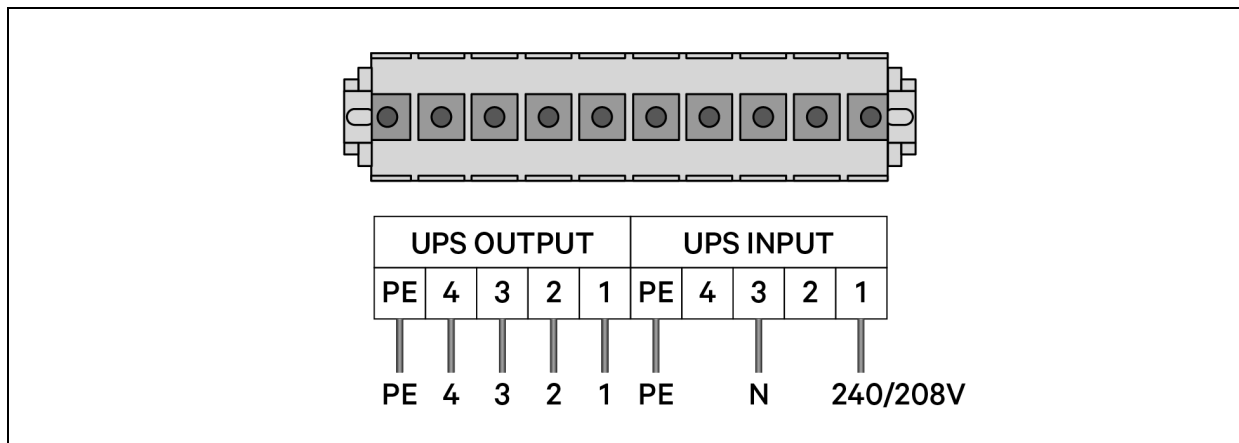

Table 3.3 Connections, upper terminal block, single-phase input, L-N-PE (50 Hz) or L-L-G (60 Hz)

INPUT VOLTAGE	INPUT TERMINAL WIRING			
	1	2	3	4
200/100	L1	Do Not Use	L2/N	Do Not Use
220/110	L1	Do Not Use	L2/N	Do Not Use
230/115	L1	Do Not Use	L2/N	Do Not Use
220/127	L1	Do Not Use	L2/N	Do Not Use
240/120	L1	Do Not Use	L2/N	Do Not Use
208/120	L1	Do Not Use	L2/N	Do Not Use
Output Voltage Needed	Output Voltage (Between Terminals)			
	1-4	3-4	2-3	1-3
200/100	100	100	173 (Do Not Use)	200
220/110	110	110	190 (Do Not Use)	220
230/115	115	115	199 (Do Not Use)	230
220/127	127	127	220	254 (Do Not Use)
240/120	120	120	208	240
208/120	120	120	208	240

Figure 3.9 MBC lower terminal block (from main AC source/to main distribution panel)

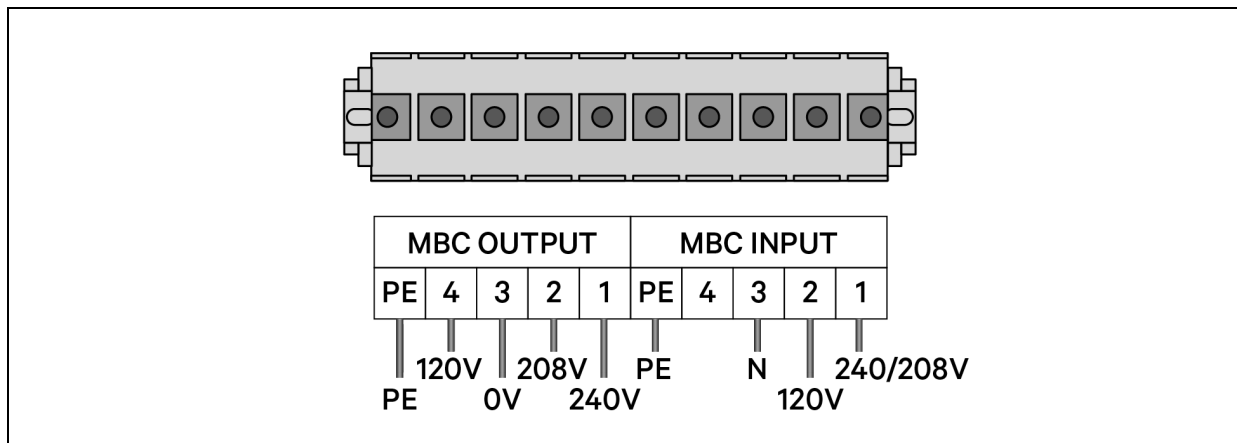

Table 3.4 Connections, lower terminal block, single-phase input, L-N-PE (50 Hz) or L-L-G (60 Hz)

INPUT VOLTAGE	INPUT VOLTAGE (BETWEEN TERMINALS)			
	1-4	1-2	2-3	1-3
200/100	Do Not Use	100	100	200
220/110	Do Not Use	110	110	220
230/115	Do Not Use	115	115	230
220/127	Do Not Use	127	127	254 (Do Not Use)
240/120	Do Not Use	120	120	240
208/120	Do Not Use	120	120	240
Output Voltage Needed	Output Voltage (Between Terminals)			
	1-4	3-4	2-3	1-3
200/100	100	100	173 (Do Not Use)	200
220/110	110	110	190 (Do Not Use)	220
230/115	115	115	199 (Do Not Use)	230
220/127	127	127	220	254 (Do Not Use)
240/120	120	120	208	240
208/120	120	120	208	240

- To connect a 120-V load between Terminal 3 and Terminal 4 of the APS MBC OUTPUT, make sure that there is 120-V voltage between Terminal 2 and Terminal 3 of the APS MBC input.
- To connect a 208-V load between Terminal 2 and Terminal 3 of the APS MBC output, make sure that there is 208-V voltage between terminal 1 and terminal 3 of the MBC input.
- To connect a 240-V load between Terminal 1 and Terminal 3 of the APS MBC output, make sure that there is 240-V voltage between Terminal 1 and Terminal 3 of the MBC input.
- To connect a 120-V load between Terminal 3 and Terminal 4 of the APS MBC output, simultaneously connect a 208-V load between Terminal 2 and Terminal 3 of MBC output or a 240-V load between Terminal 1 and Terminal 3 of MBC output, make sure that there is 120-V voltage between Terminal 2 and Terminal 3 of the MBC input, at the same time, there is 208-V voltage between Terminal 1 and Terminal 3 of the MBC input or 240-V voltage between Terminal 1 and Terminal 3 of the MBC input.

### 3.4.5 Connections for Liebert APS UPS 200/100 to 240/120-V Input/Output

Refer to [MBC upper terminal block \(to/from UPS unit\)](#) on page 24 and [MBC lower terminal block \(from main AC source/to main distribution panel\)](#) on page 24 for the cable connections when the Liebert APS UPS will be connected and wired for single-phase input, L-L-N-G (50/60-Hz voltages).

**Figure 3.10** MBC upper terminal block (to/from UPS unit)

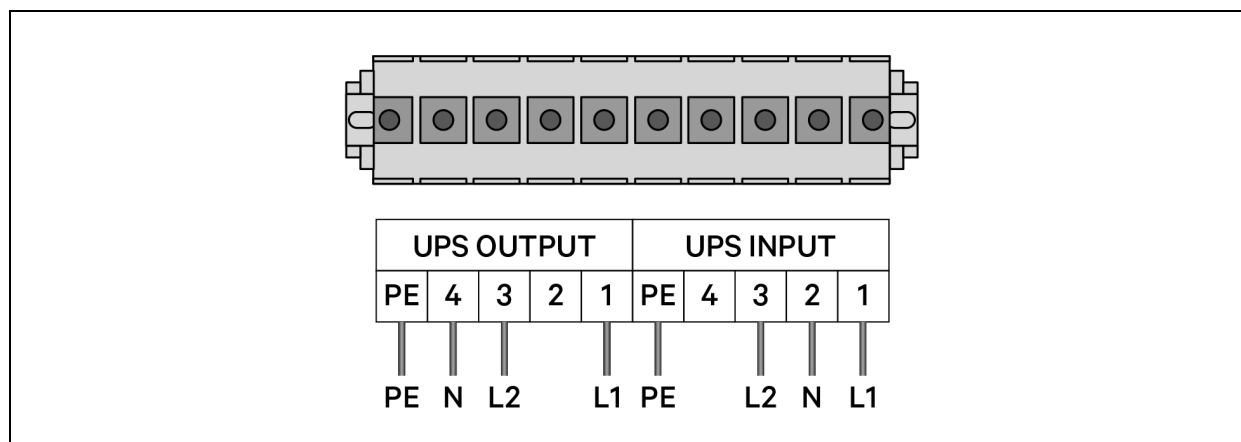

**Figure 3.11** MBC lower terminal block (from main AC source/to main distribution panel)

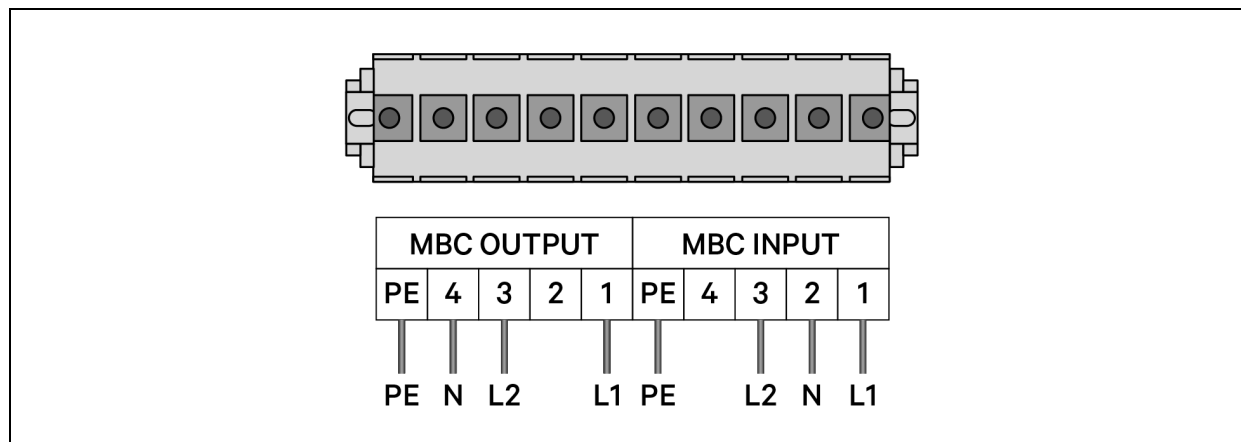



## 4 OPERATION



**WARNING! Risk of electric shock. Can cause equipment damage, injury or death. Observe all cautions and warnings in this manual. Failure to do so may result in serious injury or death. Refer all UPS and battery service to properly trained and qualified service personnel. Do not attempt to service this product yourself. Opening or removing the cover may expose you to lethal voltages within this unit even when it is apparently not operating and the input wiring is disconnected from the electrical source. Never work alone.**

### 4.1 Starting Up

To start the UPS while connected to the Maintenance Bypass:

1. Set the rotary, maintenance-bypass switch to the UPS position on the front of the Liebert APS MBC.
2. Close the UPS input breaker and the MBC output breaker on the front of the MBC.
3. Close the input breaker located in the local AC-power panel that provides power to the UPS system.
4. Start the Liebert APS UPS according to its user manual (see SL-25510, which shipped with the UPS).
5. The load is now supplied with conditioned power through the UPS.
6. Close the corresponding POD breaker, if any PODs are installed.

### 4.2 Shutting Down (with Loss of All Power)

To power off the system:

1. Shut down the UPS according to its user manual and open the UPS's input breaker and any breakers on each connected external battery cabinet.
2. Open the remote input breaker in the local power panel and any POD breakers on the rear of the Liebert APS MBC.
3. Open the UPS input breaker and the MBC output breaker on front of the APS MBC.

### 4.3 Transferring from UPS to Maintenance Bypass

1. Remove the 4 plastic bezels from the front of the Liebert APS MBC by pulling equally on each side of one bezel at a time.
2. Verify that the Bypass Indicator (amber) on the front of the MBC is illuminated.
  - If the Bypass indicator is not illuminated, do not proceed and refer to [Troubleshooting](#) on page 27.
  - If the Bypass Indicator is illuminated, refer to the Liebert APS user manual to transfer the UPS to internal bypass.
3. Using the rotary, maintenance-bypass switch on the front of the APS MBC, transfer it from UPS to Bypass.
4. Turn the UPS Off using the LCD display, then open any breakers on any connected external battery cabinets.

5. Open the UPS input breaker on the front of the APS MBC.
6. Open both the input and output breakers on the Liebert APS UPS.  
The UPS is now electrically isolated and may be transferred to maintenance bypass.

#### 4.4 Transferring from Maintenance Bypass to UPS

1. Close the UPS input and output breaker on the Liebert APS UPS.
2. Close the UPS input breaker on the front of the Liebert APS MBC.
3. Start the UPS according to its user manual and leave it in internal bypass mode.
4. Verify that the UPS Indicator (green) on the APS MBC is illuminated.
  - If the UPS Indicator does not illuminate, do not proceed and refer to [Troubleshooting](#) on page 27.
  - If the UPS Indicator is illuminated, transfer the rotary, maintenance-bypass switch from Bypass to UPS.
5. Transfer the UPS from internal bypass to inverter.  
Conditioned power is now being supplied through the UPS.

## 5 TROUBLESHOOTING

Table 5.1 Troubleshooting—Possible Causes and Solutions

PROBLEM	CAUSE	SOLUTION
Bypass Indicator (amber) not illuminated	Bypass not present	Call qualified service personnel to restore power to local power
	APS MBC input cable is not connected to bypass.	Refer to <a href="#">Cable Selection</a> on page 17
UPS Indicator (green) not illuminated	UPS output power not present	Turn on UPS, refer to UPS user manual.
	UPS input and/or output cable is not connected to the APS MBC.	Refer to <a href="#">Cable Selection</a> on page 17
Output Indicator (amber) not illuminated	The output breaker is not closed.	Close MBC output breaker (see <a href="#">Components on Front with Bezel Removed</a> on page 10 for its position)
	The load cable is not connected to the APS MBC.	Refer to <a href="#">Cable Selection</a> on page 17
Liebert APS MBC will not start some/all connected loads	The MBC output breaker and/or POD breaker is open.	Close MBC output breaker and/or POD breakers, refer to <a href="#">Components on Front with Bezel Removed</a> on page 10 and <a href="#">Parts on the rear of APS MBC</a> on page 11 for their positions
	Overload on APS MBC.	Recalculate load requirement and choose a proper version.

This page intentionally left blank.

## 6 POD—OPTIONAL

### 6.1 Introduction

Power Output Distribution (PODs) are optional, integral distribution units that may be attached on a UPS or a Maintenance Bypass Cabinet. PODs provide safe and reliable power-distribution function to directly connect equipment that is to be protected by the UPS. The POD's technical specifications are listed in Table 6.1 below through Table 6.3 on the next page.

**Table 6.1 Technical specifications of the POD (PD2-101 ~ PD2-105)**

PARAMETER	POD MODEL				
	PD2-101	PD2-102	PD2-103	PD2-104	PD2-105
<b>Dimension, W x D x H, in (mm)</b>					
Unit	7.4 × 5.7 (188 × 145)				
Shipping	11.9 × 20.6 × 8.7 (302 × 522 × 220)				
<b>Weight, lb (kg)</b>					
Unit	4.4 (2)	6.6 (3)	—	6.6 (3)	4.4 (2)
Shipping	6.6 (3)	8.8 (4)	—	8.8 (4)	6.6 (3)
<b>Electrical Specification</b>					
Rating Amp.	63 A 2-pole input breaker				
Output Power Connection	L6-30 (2 pcs) 5-15/20R (8 pcs)	L6-20R (4 pcs) 5-15/20R (4 pcs)	L6-30R (4 pcs) 5-15/20R (4 pcs)	5-15/20R (4 pcs) L6-30R (2 pcs) L6-20R (2 pcs)	5-15/20R (4 pcs) L5-30R (2 pcs) L5-20R (2 pcs)

**Table 6.2 Technical specifications of the POD (PD2-106 ~ PD2-109)**

PARAMETER	POD MODEL			
	PD2-106	PD2-107	PD2-108	PD2-109
<b>Dimension, W x D x H, in (mm)</b>				
Unit	7.4 × 5.7 (188 × 145)			
Shipping	11.9 × 20.6 × 8.7 (302 × 522 × 220)			
<b>Weight, lb (kg)</b>				
Unit	6.6 (3)	4.4 (2)	4.4 (2)	4.4 (2)
Shipping	8.8 (4)	6.6 (3)	6.6 (3)	6.6 (3)
<b>Electrical Specification</b>				
Rating Amp.	63A 2-pole input breaker			
Output Power Connection	L6-20R (4 pcs) L5-20R (4 pcs)	L5-20R (4 pcs) L5-20R (4 pcs)	L6-30R (2 pcs) L6-20R (2 pcs)	L14-30R (2 pcs)

**Table 6.3 Technical specifications of the POD (PD2-200 ~ PD2-204)**

PARAMETER	POD MODEL			
	PD2-200	PD2-201	PD2-202	PD2-204
<b>Dimensions, W x D x H, in (mm)</b>				
Unit	7.4 × 5.7 (188 × 145)			
Shipping	11.9 × 20.6 × 8.7 (302 × 522 × 220)			
<b>Weight, lb (kg)</b>				
Unit	4.4 (2)	4.4 (2)	4.4 (2)	4.4 (2)
Shipping	6.6 (3)	6.6 (3)	6.6 (3)	6.6 (3)
<b>Electrical Specification</b>				
Rating Amp.	63A 2-pole input breaker			
Output Power Connection	IEC320-C19 (4 pcs)	IEC320-C19 (2 pcs)	IEC320-C13 (12 pcs)	IEC309-32 (2 pcs)
	IEC320-C13 (4 pcs)	IEC320-C13 (8 pcs)		IEC320-C13 (4 pcs)

## 6.2 Installing the POD

To connect the POD:

1. Unscrew the 2 screws from the cover of the POD port and remove the cover, as shown in [Remove Cover and Attach the POD](#) on page 31.
2. Insert the PP75 terminals of the POD into the POD port of the Liebert APS MBC.

### NOTICE

Risk of improper connections. Can cause improper operation.

When inserting, make sure that the colors of the PP75 terminals correspond to the colors of the POD port.

3. Align the installation holes of the POD with those on the MBC, and attach the POD as shown in [Remove Cover and Attach the POD](#) on page 31.

Figure 6.1 Remove Cover and Attach the POD

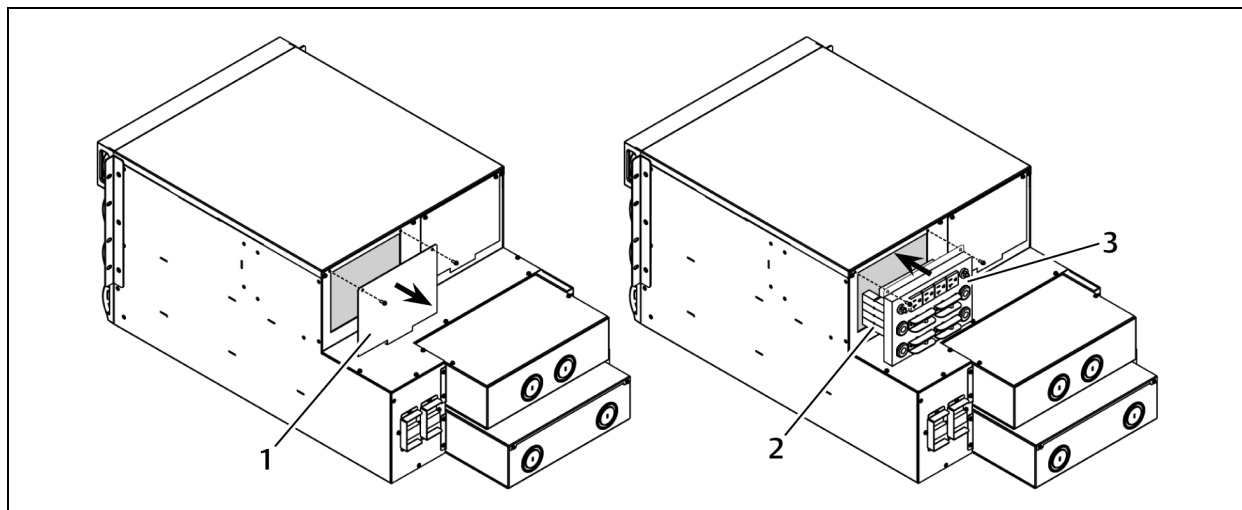

NO.	DESCRIPTION
1	POD port cover
2	PP75 terminals
3	POD

## 7 SPECIFICATIONS

Table 6.4 Specifications

ITEM	SPECIFICATION
<b>General</b>	
Unit Rating	ASMBCR2 Series: 125A max
	ASMBCR1 Series: 100A max
	ASMBCRG Series: 63A max
	ASMBCRW Series: 50A max
Compliant Safety Standards	UL 1778-4th Edition, CSA C22.2 No. 107.3, IEC62040-1:2008
<b>Mechanical</b>	
Dimensions, W x D x H, mm (In)	440 × 862 × 355 (17.3 x 33.9 x 14.3)
Weight, kg (Lb)	30 (66.1)
<b>Environmental</b>	
Operating Ambient Temperature	0°C to +40°C (32°F to 104°F)
Storage Ambient Temperature	-20°C to +60°C (-4°F to +140°F)
Humidity	0 to 95% non-condensing
Agency/standards	ISTA Procedure 1A
<b>Input Parameters</b>	
Nominal Input Voltage	200/208/220/230/240V ~ L + N + PE
	220/380V ~ 240/415V ~ L1 + L2 +L3 + N + PE
	100/200V ~ 120/240V ~ L1 + L2 +N + PE
Nominal Input Frequency	50/60Hz
Input Frequency Range	40Hz ~ 70Hz
<b>Output Parameters</b>	
Output Voltage	200/208/220/230/240V ~ L + N + PE
	100/100/173/200 - 120/120/208/240V ~
	100/200 110/220 115/230 120/208 120/240 127/220 ~ L1 + L2 +N + PE
Transfer Time, milliseconds	<6
Output Frequency	50/60Hz







---

VertivCo.com | Vertiv Headquarters, 1050 Dearborn Drive, Columbus, OH, 43085, USA

© 2017 Vertiv Co. All rights reserved. Vertiv and the Vertiv logo are trademarks or registered trademarks of Vertiv Co. All other names and logos referred to are trade names, trademarks or registered trademarks of their respective owners. While every precaution has been taken to ensure accuracy and completeness herein, Vertiv Co. assumes no responsibility, and disclaims all liability, for damages resulting from use of this information or for any errors or omissions. Specifications are subject to change without notice.

SL-55015\_REV2\_6-17/590-1435-501A