

ASRock®

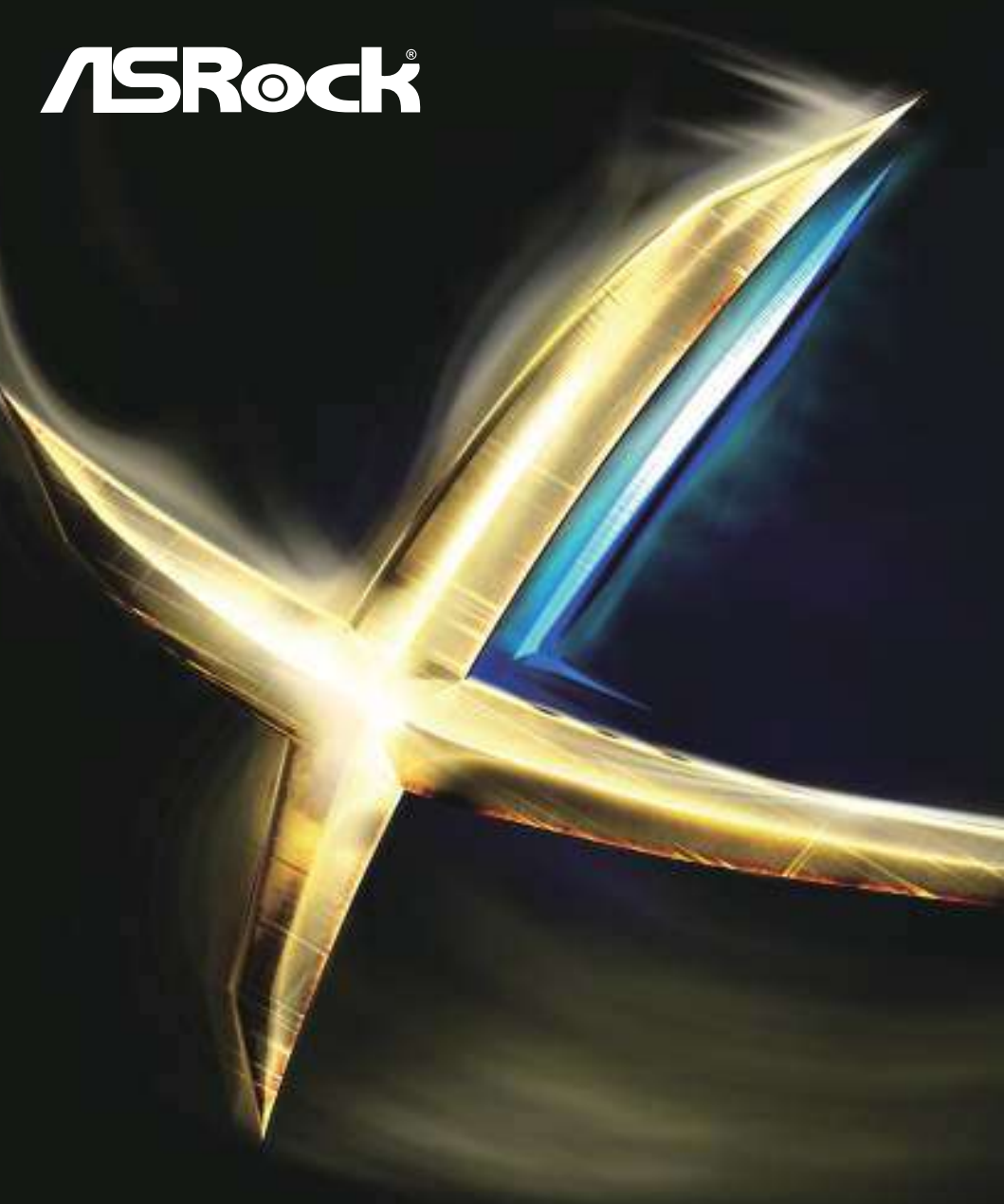

B95M-DGS

User Manual

Version 1.1

Published October 2014

Copyright©2014 ASRock INC. All rights reserved.

Copyright Notice:

No part of this documentation may be reproduced, transcribed, transmitted, or translated in any language, in any form or by any means, except duplication of documentation by the purchaser for backup purpose, without written consent of ASRock Inc.

Products and corporate names appearing in this documentation may or may not be registered trademarks or copyrights of their respective companies, and are used only for identification or explanation and to the owners' benefit, without intent to infringe.

Disclaimer:

Specifications and information contained in this documentation are furnished for informational use only and subject to change without notice, and should not be constructed as a commitment by ASRock. ASRock assumes no responsibility for any errors or omissions that may appear in this documentation.

With respect to the contents of this documentation, ASRock does not provide warranty of any kind, either expressed or implied, including but not limited to the implied warranties or conditions of merchantability or fitness for a particular purpose.

In no event shall ASRock, its directors, officers, employees, or agents be liable for any indirect, special, incidental, or consequential damages (including damages for loss of profits, loss of business, loss of data, interruption of business and the like), even if ASRock has been advised of the possibility of such damages arising from any defect or error in the documentation or product.



This device complies with Part 15 of the FCC Rules. Operation is subject to the following two conditions:

- (1) this device may not cause harmful interference, and
- (2) this device must accept any interference received, including interference that may cause undesired operation.

CALIFORNIA, USA ONLY

The Lithium battery adopted on this motherboard contains Perchlorate, a toxic substance controlled in Perchlorate Best Management Practices (BMP) regulations passed by the California Legislature. When you discard the Lithium battery in California, USA, please follow the related regulations in advance.

“Perchlorate Material-special handling may apply, see www.dtsc.ca.gov/hazardouswaste/perchlorate”

ASRock Website: <http://www.asrock.com>

Contents

Chapter 1 Introduction	1
1.1 Package Contents	1
1.2 Specifications	2
1.3 Motherboard Layout	5
1.4 I/O Panel	7
Chapter 2 Installation	8
2.1 Installing the CPU	9
2.2 Installing the CPU Fan and Heatsink	12
2.3 Installing Memory Modules (DIMM)	13
2.4 Expansion Slots (PCI Express Slots)	15
2.5 Jumpers Setup	16
2.6 Onboard Headers and Connectors	17
Chapter 3 Software and Utilities Operation	22
3.1 Installing Drivers	22
3.2 A-Tuning	23
3.3 Intel® Rapid Start Technology	29
3.4 Intel® Smart Connect Technology	34
3.5 ASRock APP Shop	39
3.5.1 UI Overview	39
3.5.2 Apps	40
3.5.3 BIOS & Drivers	43
3.5.4 Setting	44

3.6	Start8	45
-----	--------	----

Chapter 4	UEFI SETUP UTILITY	48
------------------	---------------------------	-----------

4.1	Introduction	48
4.1.1	UEFI Menu Bar	48
4.1.2	Navigation Keys	49
4.2	Main Screen	50
4.3	OC Tweaker Screen	51
4.4	Advanced Screen	59
4.4.1	CPU Configuration	60
4.4.2	Chipset Configuration	62
4.4.3	Storage Configuration	64
4.4.4	Intel® Rapid Start Technology	65
4.4.5	Intel® Smart Connect Technology	66
4.4.6	Super IO Configuration	67
4.4.7	ACPI Configuration	68
4.4.8	USB Configuration	70
4.4.9	Trusted Computing	72
4.5	Tools	73
4.6	Hardware Health Event Monitoring Screen	76
4.7	Boot Screen	77
4.8	Security Screen	80
4.9	Exit Screen	81

Chapter 1 Introduction

Thank you for purchasing ASRock B95M-DGS motherboard, a reliable motherboard produced under ASRock's consistently stringent quality control. It delivers excellent performance with robust design conforming to ASRock's commitment to quality and endurance.

In this manual, Chapter 1 and 2 contains the introduction of the motherboard and step-by-step installation guides. Chapter 3 contains the operation guide of the software and utilities. Chapter 4 contains the configuration guide of the BIOS setup.



Because the motherboard specifications and the BIOS software might be updated, the content of this documentation will be subject to change without notice. In case any modifications of this documentation occur, the updated version will be available on ASRock's website without further notice. If you require technical support related to this motherboard, please visit our website for specific information about the model you are using. You may find the latest VGA cards and CPU support list on ASRock's website as well. ASRock website <http://www.asrock.com>.

1.1 Package Contents

- ASRock B95M-DGS Motherboard (Micro ATX Form Factor)
- ASRock B95M-DGS Quick Installation Guide
- ASRock B95M-DGS Support CD
- 2 x Serial ATA (SATA) Data Cables (Optional)
- 1 x I/O Panel Shield

1.2 Specifications

- Platform**
- Micro ATX Form Factor
 - Solid Capacitor design
 - High Density Glass Fabric PCB

- CPU**
- Supports New 4th and 4th Generation Intel® Core™ i7/i5/i3/ Xeon®/Pentium®/Celeron® Processors (Socket 1150)
 - Supports Intel® Turbo Boost 2.0 Technology

- Chipset**
- Intel® B85

- Memory**
- Dual Channel DDR3 Memory Technology
 - 2 x DDR3 DIMM Slots
 - Supports DDR3 1600/1333/1066 non-ECC, un-buffered memory
 - Max. capacity of system memory: 16GB (see CAUTION)
 - Supports Intel® Extreme Memory Profile (XMP) 1.3 / 1.2

- Expansion Slot**
- 1 x PCI Express 3.0 x16 Slot (PCI-E: x16 mode)
 - 1 x PCI Express 2.0 x1 Slot

- Graphics**
- Intel® HD Graphics Built-in Visuals and the VGA outputs can be supported only with processors which are GPU integrated.
 - Supports Intel® HD Graphics Built-in Visuals : Intel® Quick Sync Video with AVC, MVC (S3D) and MPEG-2 Full HW Encode1, Intel® InTru™ 3D, Intel® Clear Video HD Technology, Intel® Insider™, Intel® HD Graphics 4400/4600
 - Pixel Shader 5.0, DirectX 11.1
 - Max. shared memory 1792MB
 - Dual graphics output: support DVI-D and D-Sub by independent display controllers
 - Supports DVI-D with max. resolution up to 1920x1200 @ 60Hz
 - Supports D-Sub with max. resolution up to 1920x1200 @ 60Hz
 - Supports HDCP with DVI-D Port
 - Supports Full HD 1080p Blu-ray (BD) playback with DVI-D Port

Audio

- 5.1 CH HD Audio (Realtek ALC662 Audio Codec)
- Supports Surge Protection (ASRock Full Spike Protection)
- ELNA Audio Caps

LAN

- PCIE x1 Gigabit LAN 10/100/1000 Mb/s
- Realtek RTL8111GR
- Supports Wake-On-WAN
- Supports Wake-On-LAN
- Supports Lightning/ESD Protection (ASRock Full Spike Protection)
- Supports LAN Cable Detection
- Supports Energy Efficient Ethernet 802.3az
- Supports PXE

Rear Panel I/O

- 1 x PS/2 Mouse/Keyboard Port
- 1 x D-Sub Port
- 1 x DVI-D Port
- 4 x USB 2.0 Ports (Supports ESD Protection (ASRock Full Spike Protection))
- 2 x USB 3.0 Ports (Supports ESD Protection (ASRock Full Spike Protection))
- 1 x RJ-45 LAN Port with LED (ACT/LINK LED and SPEED LED)
- HD Audio Jacks: Line in / Front Speaker / Microphone

Storage

- 4 x SATA3 6.0 Gb/s Connectors, support NCQ, AHCI and Hot Plug

Connector

- 1 x Print Port Header
- 1 x COM Port Header
- 1 x Chassis Intrusion Header
- 1 x TPM Header
- 1 x CPU Fan Connector (4-pin)
- 1 x Chassis Fan Connector (4-pin)
- 1 x Power Fan Connector (3-pin)
- 1 x 24 pin ATX Power Connector
- 1 x 4 pin 12V Power Connector
- 1 x Front Panel Audio Connector

- 2 x USB 2.0 Headers (Support 4 USB 2.0 ports) (Supports ESD Protection (ASRock Full Spike Protection))
- 1 x USB 3.0 Header (Supports 2 USB 3.0 ports) (Supports ESD Protection (ASRock Full Spike Protection))

**BIOS
Feature**

- 32Mb AMI UEFI Legal BIOS with multilingual GUI support
- ACPI 1.1 Compliant wake up events
- SMBIOS 2.3.1 support
- CPU, DRAM, PCH 1.05V, PCH 1.5V Voltage multi-adjustment

**Hardware
Monitor**

- CPU/Chassis temperature sensing
- CPU/Chassis/Power Fan Tachometer
- CPU/Chassis Quiet Fan (Auto adjust chassis fan speed by CPU temperature)
- CPU/Chassis Fan multi-speed control
- CASE OPEN detection
- Voltage monitoring: +12V, +5V, +3.3V, CPU Vcore

OS

- Microsoft® Windows® 8.1 32-bit / 8.1 64-bit / 8 32-bit / 8 64-bit / 7 32-bit / 7 64-bit

**Certifica-
tions**

- FCC, CE, WHQL
- ErP/EuP ready (ErP/EuP ready power supply is required)

* For detailed product information, please visit our website: <http://www.asrock.com>



Please realize that there is a certain risk involved with overclocking, including adjusting the setting in the BIOS, applying Untied Overclocking Technology, or using third-party overclocking tools. Overclocking may affect your system's stability, or even cause damage to the components and devices of your system. It should be done at your own risk and expense. We are not responsible for possible damage caused by overclocking.



Due to limitation, the actual memory size may be less than 4GB for the reservation for system usage under Windows® 32-bit operating systems. Windows® 64-bit operating systems do not have such limitations. You can use ASRock XFast RAM to utilize the memory that Windows® cannot use.

1.3 Motherboard Layout

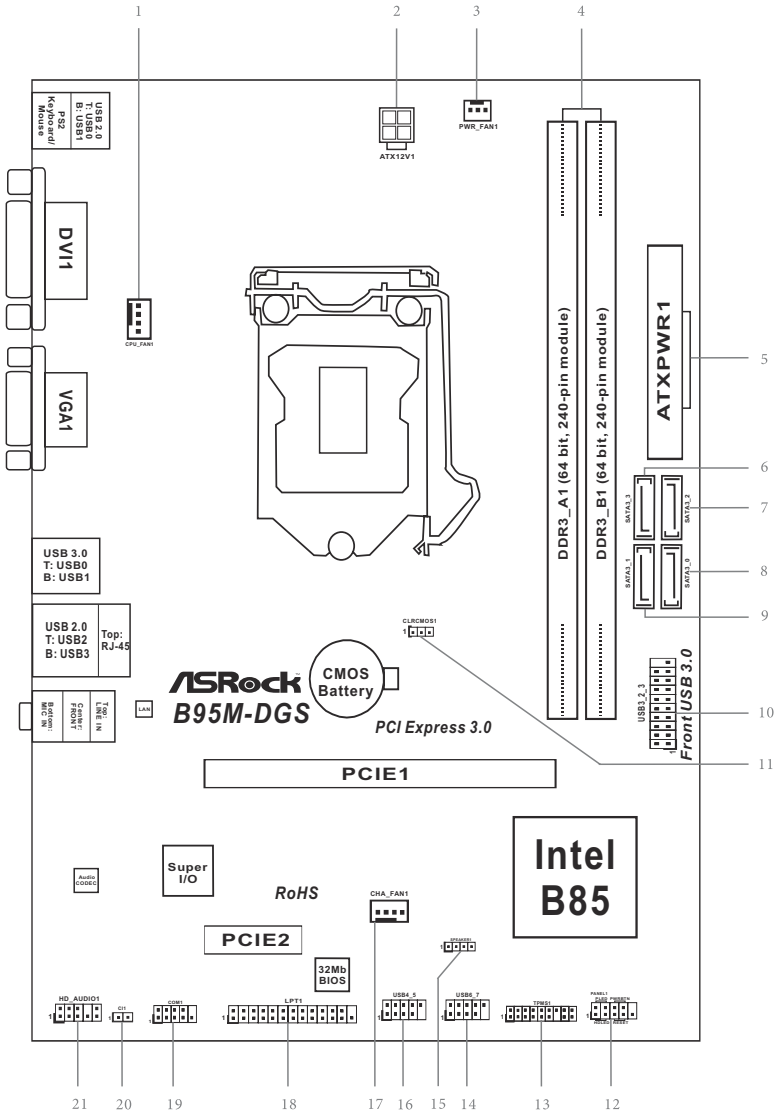

No.	Description
1	CPU Fan Connector (CPU_FAN1)
2	ATX 12V Power Connector (ATX12V1)
3	Power Fan Connector (PWR_FAN1)
4	2 x 240-pin DDR3 DIMM Slots (DDR3_A1, DDR3_B1)
5	ATX Power Connector (ATXPWR1)
6	SATA3 Connector (SATA3_3)
7	SATA3 Connector (SATA3_2)
8	SATA3 Connector (SATA3_0)
9	SATA3 Connector (SATA3_1)
10	USB 3.0 Header (USB3_2_3)
11	Clear CMOS Jumper (CLRCMOS1)
12	System Panel Header (PANEL1)
13	TPM Header (TPMS1)
14	USB 2.0 Header (USB6_7)
15	Chassis Speaker Header (SPEAKER1)
16	USB 2.0 Header (USB4_5)
17	Chassis Fan Connector (CHA_FAN1)
18	Print Port Header (LPT1)
19	COM Port Header (COM1)
20	Chassis Intrusion Header (CI1)
21	Front Panel Audio Header (HD_AUDIO1)

1.4 I/O Panel

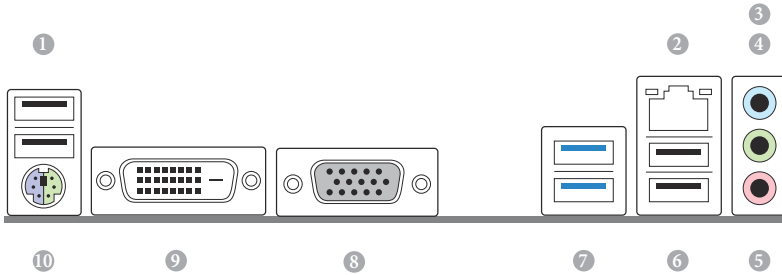

No.	Description	No.	Description
1	USB 2.0 Ports (USB01)	6	USB 2.0 Ports (USB23)
2	LAN RJ-45 Port*	7	USB 3.0 Ports (USB3_01)
3	Line In (Light Blue)	8	D-Sub Port
4	Front Speaker (Lime)	9	DVI-D Port
5	Microphone (Pink)	10	PS/2 Mouse/Keyboard Port

* There are two LEDs on each LAN port. Please refer to the table below for the LAN port LED indications.

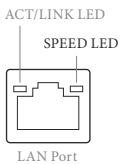

Activity / Link LED		Speed LED	
Status	Description	Status	Description
Off	No Link	Off	10Mbps connection
Blinking	Data Activity	Orange	100Mbps connection
On	Link	Green	1Gbps connection

Chapter 2 Installation

This is a Micro ATX form factor motherboard. Before you install the motherboard, study the configuration of your chassis to ensure that the motherboard fits into it.

Pre-installation Precautions

Take note of the following precautions before you install motherboard components or change any motherboard settings.

- Make sure to unplug the power cord before installing or removing the motherboard components. Failure to do so may cause physical injuries and damages to motherboard components.
- In order to avoid damage from static electricity to the motherboard's components, NEVER place your motherboard directly on a carpet. Also remember to use a grounded wrist strap or touch a safety grounded object before you handle the components.
- Hold components by the edges and do not touch the ICs.
- Whenever you uninstall any components, place them on a grounded anti-static pad or in the bag that comes with the components.
- When placing screws to secure the motherboard to the chassis, please do not over-tighten the screws! Doing so may damage the motherboard.

2.1 Installing the CPU



1. Before you insert the 1150-Pin CPU into the socket, please check if the **PnP cap** is on the socket, if the CPU surface is unclean, or if there are any **bent pins** in the socket. Do not force to insert the CPU into the socket if above situation is found. Otherwise, the CPU will be seriously damaged.
2. Unplug all power cables before installing the CPU.

1

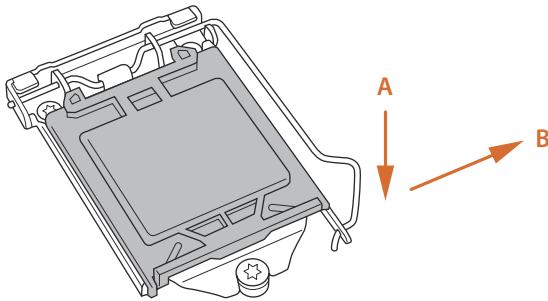

2

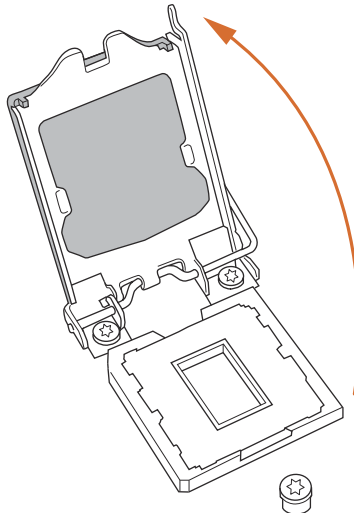

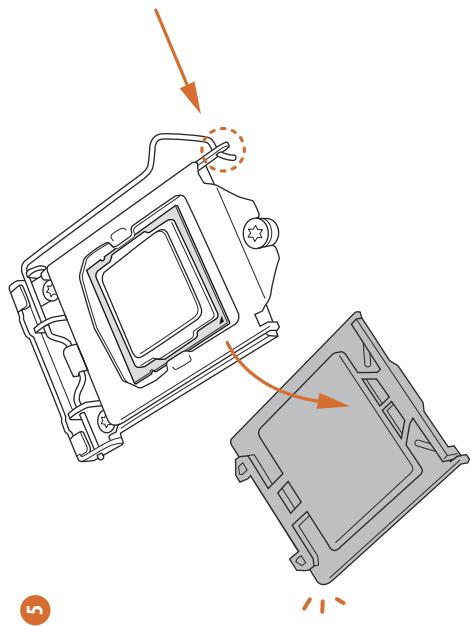
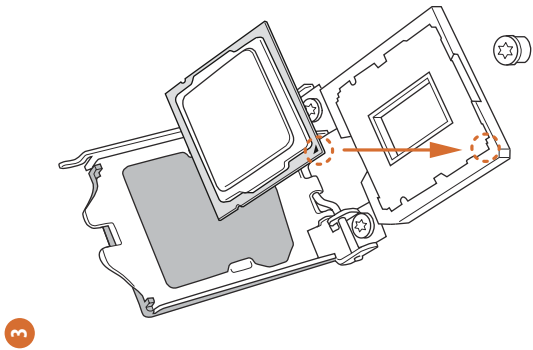
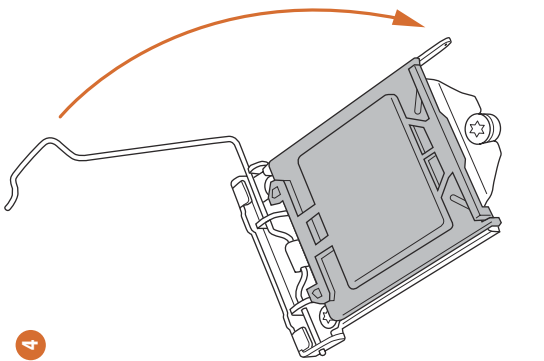



Please save and replace the cover if the processor is removed. The cover must be placed if you wish to return the motherboard for after service.

2.2 Installing the CPU Fan and Heatsink

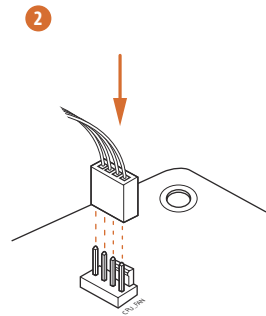
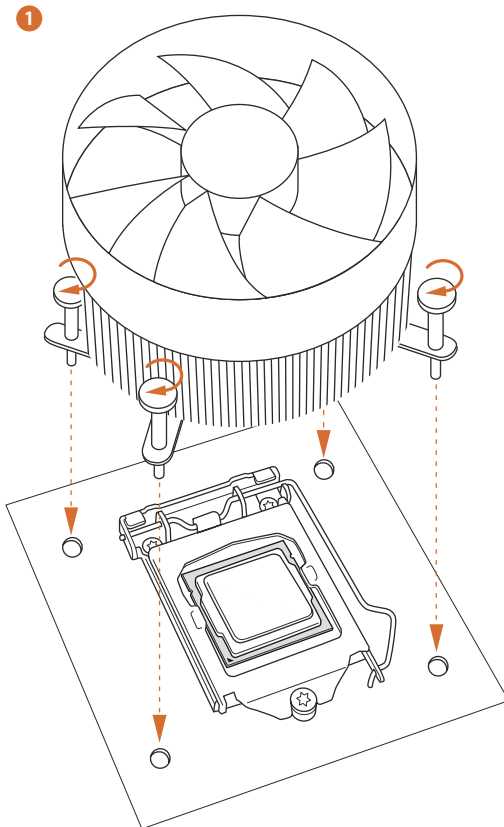
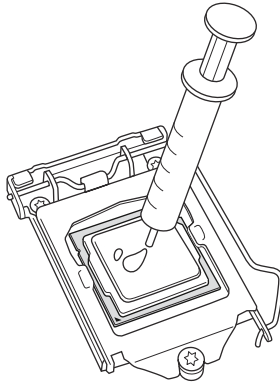

2.3 Installing Memory Modules (DIMM)

This motherboard provides two 240-pin DDR3 (Double Data Rate 3) DIMM slots, and supports Dual Channel Memory Technology.



- 1. For dual channel configuration, you always need to install identical (the same brand, speed, size and chip-type) DDR3 DIMM pairs.*
- 2. It is unable to activate Dual Channel Memory Technology with only one memory module installed.*
- 3. It is not allowed to install a DDR or DDR2 memory module into a DDR3 slot; otherwise, this motherboard and DIMM may be damaged.*



The DIMM only fits in one correct orientation. It will cause permanent damage to the motherboard and the DIMM if you force the DIMM into the slot at incorrect orientation.

1

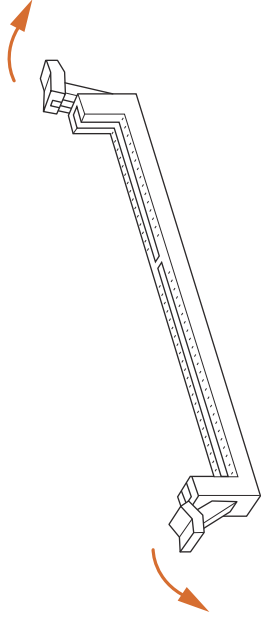

2

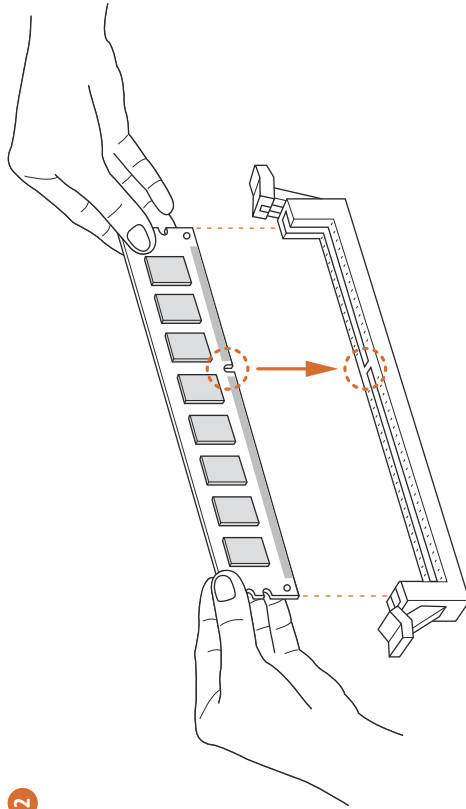

3

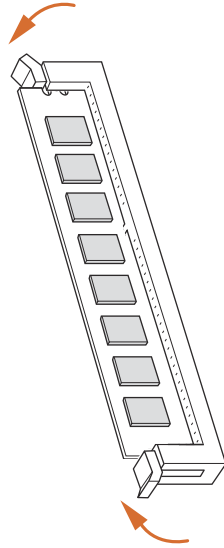

2.4 Expansion Slots (PCI Express Slots)

There are 2 PCI Express slots on the motherboard.



Before installing an expansion card, please make sure that the power supply is switched off or the power cord is unplugged. Please read the documentation of the expansion card and make necessary hardware settings for the card before you start the installation.

PCIe slots:

PCIE1 (PCIe 3.0 x16 slot) is used for PCI Express x16 lane width graphics cards.

PCIE2 (PCIe 2.0 x1 slot) is used for PCI Express x1 lane width graphics cards.

2.5 Jumpers Setup

The illustration shows how jumpers are setup. When the jumper cap is placed on the pins, the jumper is “Short”. If no jumper cap is placed on the pins, the jumper is “Open”. The illustration shows a 3-pin jumper whose pin1 and pin2 are “Short” when a jumper cap is placed on these 2 pins.



Clear CMOS Jumper
(CLRCMOS1)
(see p.5, No. 11)

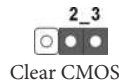

CLRCMOS1 allows you to clear the data in CMOS. To clear and reset the system parameters to default setup, please turn off the computer and unplug the power cord from the power supply. After waiting for 15 seconds, use a jumper cap to short pin2 and pin3 on CLRCMOS1 for 5 seconds. However, please do not clear the CMOS right after you update the BIOS. If you need to clear the CMOS when you just finish updating the BIOS, you must boot up the system first, and then shut it down before you do the clear-CMOS action. Please be noted that the password, date, time, and user default profile will be cleared only if the CMOS battery is removed.



If you clear the CMOS, the case open may be detected. Please adjust the BIOS option “Clear Status” to clear the record of previous chassis intrusion status.

2.6 Onboard Headers and Connectors



Onboard headers and connectors are NOT jumpers. Do NOT place jumper caps over these headers and connectors. Placing jumper caps over the headers and connectors will cause permanent damage to the motherboard.

System Panel Header
(9-pin PANEL1)
(see p.5, No. 12)

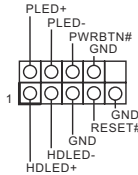

Connect the power switch, reset switch and system status indicator on the chassis to this header according to the pin assignments below. Note the positive and negative pins before connecting the cables.



PWRBTN (Power Switch):

Connect to the power switch on the chassis front panel. You may configure the way to turn off your system using the power switch.

RESET (Reset Switch):

Connect to the reset switch on the chassis front panel. Press the reset switch to restart the computer if the computer freezes and fails to perform a normal restart.

PLED (System Power LED):

Connect to the power status indicator on the chassis front panel. The LED is on when the system is operating. The LED keeps blinking when the system is in S1/S3 sleep state. The LED is off when the system is in S4 sleep state or powered off (S5).

HDLED (Hard Drive Activity LED):

Connect to the hard drive activity LED on the chassis front panel. The LED is on when the hard drive is reading or writing data.

The front panel design may differ by chassis. A front panel module mainly consists of power switch, reset switch, power LED, hard drive activity LED, speaker and etc. When connecting your chassis front panel module to this header, make sure the wire assignments and the pin assignments are matched correctly.

Serial ATA3 Connectors

(SATA3_0:
see p.5, No. 8)
(SATA3_1:
see p.5, No. 9)
(SATA3_2:
see p.5, No. 7)
(SATA3_3:
see p.5, No. 6)

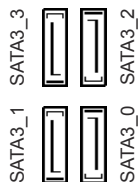

These four SATA3 connectors support SATA data cables for internal storage devices with up to 6.0 Gb/s data transfer rate.

USB 2.0 Headers

(9-pin USB4_5)
(see p.5, No. 16)
(9-pin USB6_7)
(see p.5, No. 14)

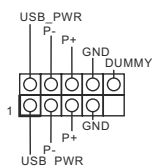

Besides four USB 2.0 ports on the I/O panel, there are two headers on this motherboard. Each USB 2.0 header can support two ports.

USB 3.0 Header

(19-pin USB3_2_3)
(see p.5, No. 10)

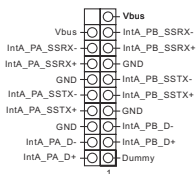

Besides two USB 3.0 ports on the I/O panel, there is one header on this motherboard. Each USB 3.0 header can support two ports.

Front Panel Audio Header

(9-pin HD_AUDIO1)
(see p.5, No. 21)

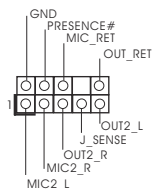

This header is for connecting audio devices to the front audio panel.



1. High Definition Audio supports Jack Sensing, but the panel wire on the chassis must support HDA to function correctly. Please follow the instructions in our manual and chassis manual to install your system.
2. If you use an AC'97 audio panel, please install it to the front panel audio header by the steps below:
 - A. Connect Mic_IN (MIC) to MIC2_L.
 - B. Connect Audio_R (RIN) to OUT2_R and Audio_L (LIN) to OUT2_L.
 - C. Connect Ground (GND) to Ground (GND).
 - D. MIC_RET and OUT_RET are for the HD audio panel only. You don't need to connect them for the AC'97 audio panel.
 - E. To activate the front mic, go to the "FrontMic" Tab in the Realtek Control panel and adjust "Recording Volume".

Chassis Speaker Header
(4-pin SPEAKER1)
(see p.5, No. 15)

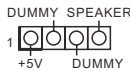

Please connect the chassis speaker to this header.

Chassis and Power Fan Connectors
(4-pin CHA_FAN1)
(see p.5, No. 17)

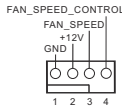

Please connect fan cables to the fan connectors and match the black wire to the ground pin.

(3-pin PWR_FAN1)
(see p.5, No. 3)



CPU Fan Connector
(4-pin CPU_FAN1)
(see p.5, No. 1)

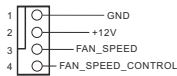

This motherboard provides a 4-Pin CPU fan (Quiet Fan) connector. If you plan to connect a 3-Pin CPU fan, please connect it to Pin 1-3.

ATX Power Connector
(24-pin ATXPWR1)
(see p.5, No. 5)

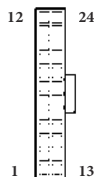

This motherboard provides a 24-pin ATX power connector. To use a 20-pin ATX power supply, please plug it along Pin 1 and Pin 13.

ATX 12V Power Connector
(4-pin ATX12V1)
(see p.5, No. 2)



Please connect an ATX 12V power supply to this connector.

Serial Port Header
(9-pin COM1)
(see p.5, No. 19)

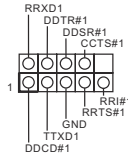

This COM1 header supports a serial port module.

Chassis Intrusion Header
(2-pin CI1)
(see p.5, No. 20)



This motherboard supports CASE OPEN detection feature that detects if the chassis cover has been removed. This feature requires a chassis with chassis intrusion detection design.

TPM Header
(17-pin TPMS1)
(see p.5, No. 13)

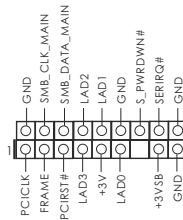

This connector supports Trusted Platform Module (TPM) system, which can securely store keys, digital certificates, passwords, and data. A TPM system also helps enhance network security, protects digital identities, and ensures platform integrity.

Print Port Header
(25-pin LPT1)
(see p.5, No. 18)

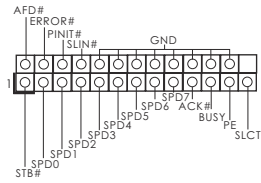

This is an interface for print port cable that allows convenient connection of printer devices.

Chapter 3 Software and Utilities Operation

3.1 Installing Drivers

The Support CD that comes with the motherboard contains necessary drivers and useful utilities that enhance the motherboard's features.

Running The Support CD

To begin using the support CD, insert the CD into your CD-ROM drive. The CD automatically displays the Main Menu if "AUTORUN" is enabled in your computer. If the Main Menu does not appear automatically, locate and double click on the file "ASRSETUP.EXE" in the Support CD to display the menu.

Drivers Menu

The drivers compatible to your system will be auto-detected and listed on the support CD driver page. Please click **Install All** or follow the order from top to bottom to install those required drivers. Therefore, the drivers you install can work properly.

Utilities Menu

The Utilities Menu shows the application software that the motherboard supports. Click on a specific item then follow the installation wizard to install it.



*To improve Windows 7 compatibility, please download and install the following hot fix provided by Microsoft.
"KB2720599": <http://support.microsoft.com/kb/2720599/en-us>*

3.2 A-Tuning

A-Tuning is ASRock's multi purpose software suite with a new interface, more new features and improved utilities, including XFast RAM, Dehumidifier, Good Night LED, FAN-Tastic Tuning, OC Tweaker and a whole lot more.

3.2.1 Installing A-Tuning

When you install the all-in-one driver to your system from ASRock's support CD, A-Tuning will be auto-installed as well. After the installation, you will find the icon "A-Tuning" on your desktop. Double-click the "A-Tuning"  icon, A-Tuning main menu will pop up.

3.2.2 Using A-Tuning

There are six sections in A-Tuning main menu: Operation Mode, Tools, OC Tweaker, System Info, Live Update, Tech Service and Settings.

Operation Mode

Choose an operation mode for your computer.

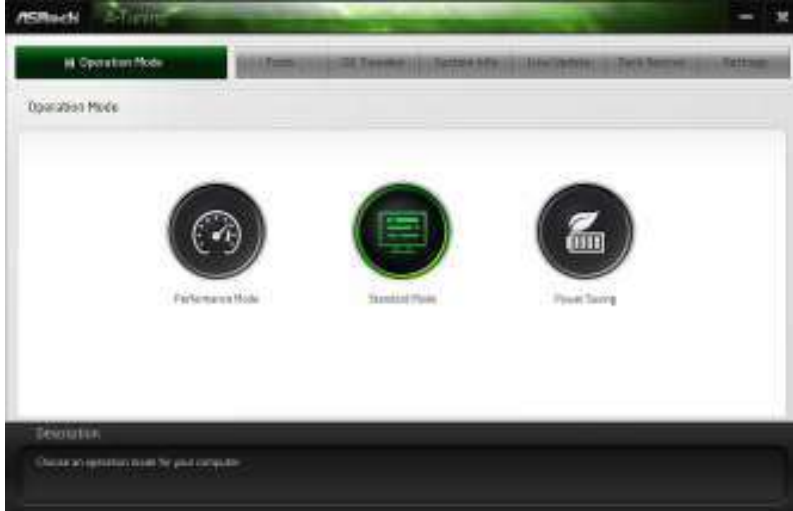

Tools

Various tools and utilities.



XFast RAM

Boost the system's performance and extend the HDD's or SSD's lifespan! Create a hidden partition, then assign which files should be stored in the RAM drive.

XFast LAN

Boost the speed of your internet connection! Select a specific mode for making the designated program's priority highest.

Fast Boot

Fast Boot minimizes your computer's boot time. Please note that Ultra Fast mode is only supported by Windows 8.1/8 and the VBIOS must support UEFI GOP if you are using an external graphics card.

Good Night LED

Switch off the Power/HDD LEDs when the system is on, and automatically switch off the Power and Keyboard LEDs when the system enters into Standby/Hibernation mode.

FAN-Tastic Tuning

Configure up to five different fan speeds using the graph. The fans will automatically shift to the next speed level when the assigned temperature is met.

Dehumidifier

Prevent motherboard damages due to dampness. Enable this function and configure the period of time until the computer powers on, and the duration of the dehumidifying process.

USB Key

Plug in the USB Key and let your computer log in to windows automatically!

Disk Health Report

Disk Health Report is a hard disk health monitoring utility that displays detailed HDD information, such as hard disk model, serial number, firmware, power on count, power on hours, S.M.A.R.T. values, current temperature, etc. HDD, SSD and optical disk drives are all supported. The health status block displays Good (in green color), Caution (in yellow color) or Bad (in red color). Click on the health status icon to configure settings for an alert to be triggered.

OC Tweaker

Configurations for overclocking the system.



System Info

View information about the system.

*The System Browser tab may not appear for certain models.

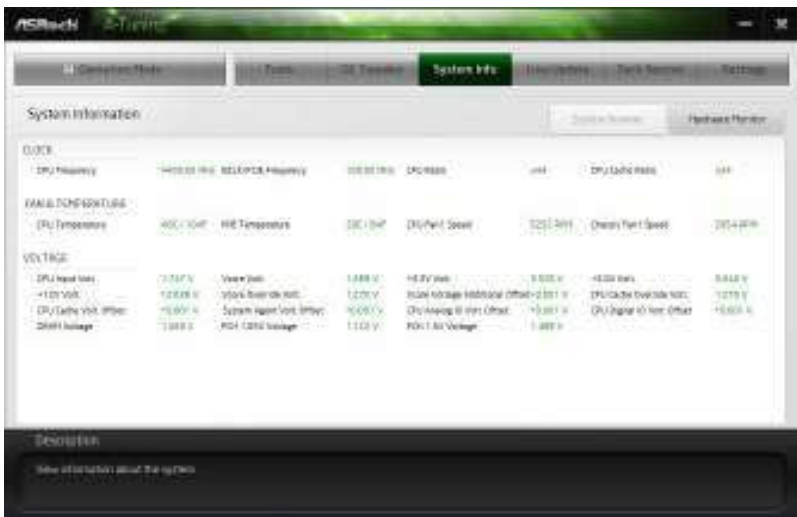

Settings

Configure ASRock A-Tuning. Click to select "Auto run at Windows Startup" if you want A-Tuning to be launched when you start up the Windows operating system.

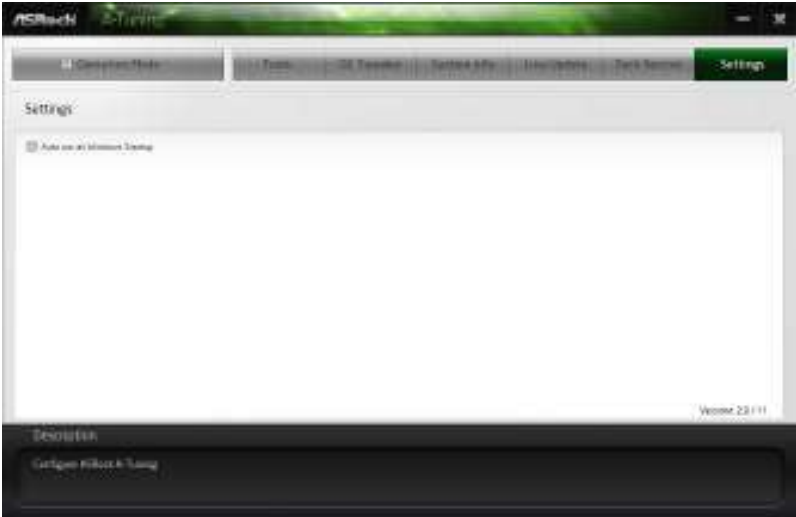

3.3 Intel® Rapid Start Technology

Intel® Rapid Start Technology enables your system to wake up faster from deep sleep, saving time and power consumption. Feel secure to know that your system will resume to working condition even if an unexpected power loss happens while the PC is in sleep mode.

3.3.1 System Requirements

- Confirm whether your motherboard supports this feature.
- Operating system: Microsoft Windows 8.1/8/7 (32- or 64-bit edition)
- Set the SATA mode to AHCI. If Windows 8.1/8/7 is already installed under IDE mode, directly changing the SATA mode to AHCI may cause Windows 8/7 to crash while booting. If your system is not in AHCI mode, please follow the instructions below.



There are certain risks. Please backup any important data before operating to avoid loss.

1. Press **Win + R** simultaneously in Windows 8/7, type "Regedit" into the word box then click **OK**.

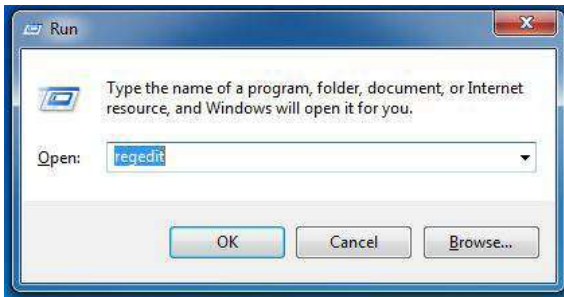

2. Enter into **HKEY_LOCAL_MACHINE\SYSTEM\CurrentControlSet\services\msahci** in Windows Registry Editor. Double click on the value **Start** and change the value from **3** into **0**. Click on **OK**.

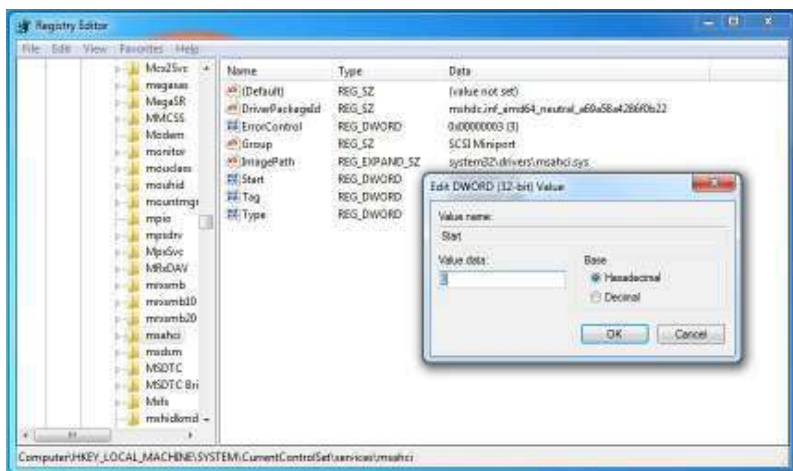

3. Exit the Registry Editor window and restart the computer.
4. Press **F2** to enter BIOS, then go to **Advanced** -> **Storage Configuration** and change SATA Mode to AHCI. Press **F10** to save changes and exit.
5. Enter Windows 8/7. Windows will discover the new device and install AHCI drivers automatically.

3.3.2 Setup Guide

Configuring Rapid Start

Step 1

Run ASRock Rapid Start utility from **Start** -> **All Programs** -> **ASRock Utility**.

Step 2

If you have more than one hard drives in your system, you must select one, then choose the **Partition Size** desired for your hidden partition and click on **Create**. The system will automatically create a hidden partition according to your settings. If there are SSD's installed into your system, it is recommended to create the partition on the SSD.



Step 3

When prompted to restart after the setup, click Yes to reboot.



Step 4

Double-click the Intel® Rapid Start Technology Manager icon  in the Windows system tray.

Step 5

Make sure Rapid Start is on. Drag the slider to configure the time. For example, if the timer value is set to ten minutes, the system will enable Rapid Start mode after entering sleep state for ten minutes. If the timer is set to 0 minutes, Windows will immediately enable Rapid Start mode as it enters sleep state.



Using Rapid Start

1. You may shut down the computer without terminating the applications or files you are executing currently. Click on Windows Start -> the arrow next to Shut down, and click on **Sleep**.

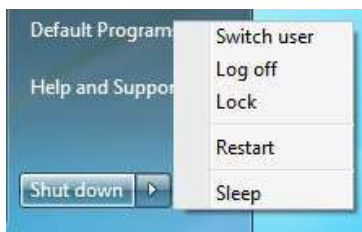

2. Windows system will enter sleep state.
3. According to your settings in Rapid Start Technology Manager, the system will automatically wake up and enable Rapid Start mode after entering sleep

state for a period of time. The power of the computer in Rapid Start mode can be cut off, it will not cause data loss of the programs or files you were executing before entering sleep state.

4. When you wish to continue to use the computer just hit the power button, the system will rapidly return to Windows, the programs and files which you were using before entering sleep state will be accessible immediately.

3.4 Intel® Smart Connect Technology

Intel® Smart Connect Technology is a feature that periodically wakes your computer from Windows® sleep state to refresh email or social networking applications. It saves your waiting time and keeps the content always up-to-date.

3.4.1 System Requirements

- Confirm whether your motherboard supports this feature.
- Operating system: Microsoft Windows 8.1/8/7 (32- or 64-bit edition)
- Set the SATA mode to AHCI. If Windows 8.1/8/7 is already installed under IDE mode, directly changing the SATA mode to AHCI may cause Windows 8/7 to crash while booting. If your system is not in AHCI mode, please follow the instructions below.



There are certain risks. Please backup any important data before operating to avoid loss.

1. Press **Win + R** simultaneously in Windows 8.1/8/7, type "Regedit" into the word box then click **OK**.

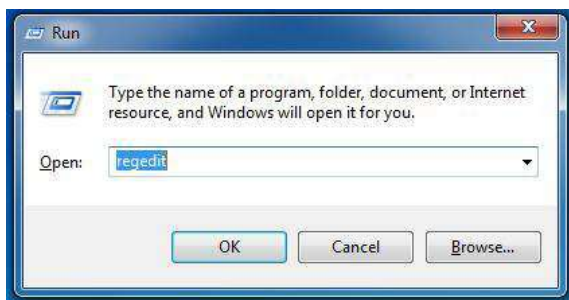

2. Enter into **HKEY_LOCAL_MACHINE\SYSTEM\CurrentControlSet\services\msahci** in Windows Registry Editor. Double click on the value **Start** and change the value from **3** into **0**. Click on **OK**.

3.4.2 Setup Guide

Installing ASRock Smart Connect Utility

Step 1

Install **ASRock Smart Connect Utility**, which is located in the folder at the following path of the Support CD: \ **ASRock Utility** > **Smart Connect**.

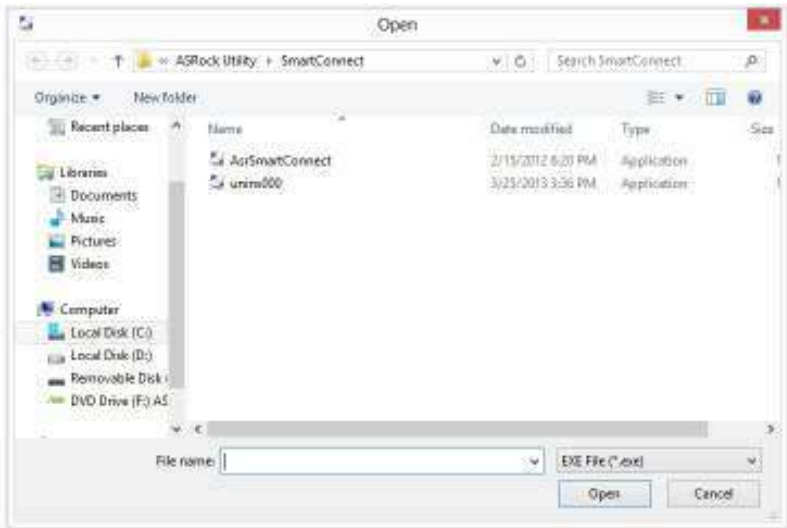

Step 2

Once installed, run ASRock Smart Connect from your desktop or go to Windows **Start** -> **All Programs** -> **ASRock Utility**.



Step 3

Click the **Add** button. Take Foxmail as an example, add Foxmail to the Application list.

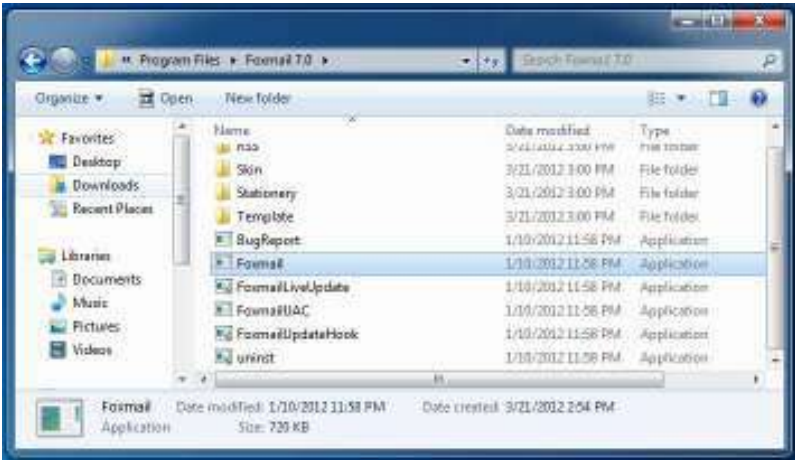

Step 4

Select Foxmail from the **Application List**, then click the arrow pointing right to add this application to the **Smart Connect List**.



Step 5

Click **Apply** to enable Smart Connect.

Step 6

Double-click the Intel® Smart Connect Technology Manager icon  in the Windows system tray.

Step 7

Drag the slider to configure how often the system will connect to the network to download updates. Shorter durations will provide more frequent updates, but may cause more power consumption.

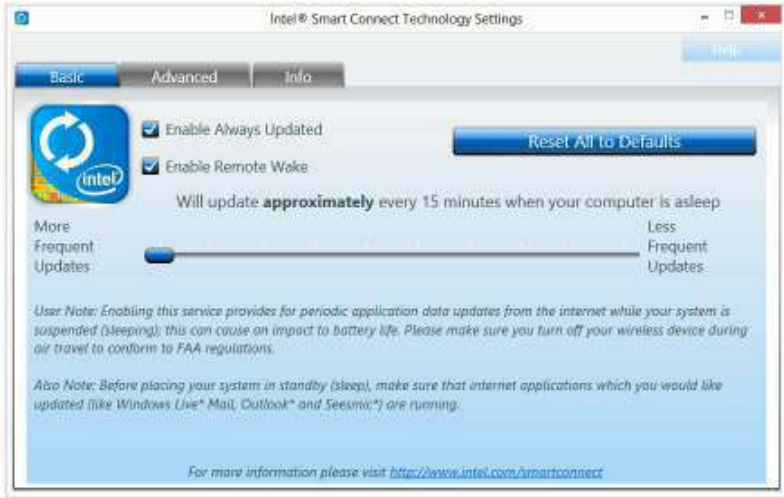
**Using Smart Connect**

1. Keep the applications which you wish to connect to the internet and receive updates while the system is in sleep state running. Foxmail for instance, keep Foxmail running.
2. Click on Windows Start -> the arrow next to Shut down, and click on **Sleep**.



3. Windows system will enter sleep state.

4. The system will wake up from sleep state periodically, and then start to update Foxmail. The screen will not display anything so the computer can maintain minimum power usage. Afterwards, the system will automatically return to sleep state again.
5. Upon waking up the system, you will find the new mail that were sent to you during sleep state are already updated and ready to be read in Foxmail.

3.5 ASRock APP Shop

The ASRock APP Shop is an online store for purchasing and downloading software applications for your ASRock computer. You can install various apps and support utilities quickly and easily, and optimize your system and keep your motherboard up to date simply with a few clicks.

Double-click  on your desktop to access ASRock APP Shop utility.

**You need to be connected to the Internet to download apps from the ASRock APP Shop.*

3.5.1 UI Overview



Category Panel: The category panel contains several category tabs or buttons that when selected the information panel below displays the relative information.

Information Panel: The information panel in the center displays data about the currently selected category and allows users to perform job-related tasks.

Hot News: The hot news section displays the various latest news. Click on the image to visit the website of the selected news and know more.

3.5.2 Apps

When the "Apps" tab is selected, you will see all the available apps on screen for you to download.

Installing an App

Step 1

Find the app you want to install.



The most recommended app appears on the left side of the screen. The other various apps are shown on the right. Please scroll up and down to see more apps listed.

You can check the price of the app and whether you have already installed it or not.

Free - The red icon displays the price or "Free" if the app is free of charge.

Installed - The green "Installed" icon means the app is installed on your computer.

Step 2

Click on the app icon to see more details about the selected app.

Step 3

If you want to install the app, click on the red icon  to start downloading.

**Step 4**

When installation completes, you can find the green "Installed" icon appears on the upper right corner.



To uninstall it, simply click on the trash can icon .

*The trash icon may not appear for certain apps.

Upgrading an App

You can only upgrade the apps you have already installed. When there is an available new version for your app, you will find the mark of "New Version"  appears below the installed app icon.



Step 1

Click on the app icon to see more details.

Step 2

Click on the yellow icon  to start upgrading.

3.5.3 BIOS & Drivers

Installing BIOS or Drivers

When the "BIOS & Drivers" tab is selected, you will see a list of recommended or critical updates for the BIOS or drivers. Please update them all soon.

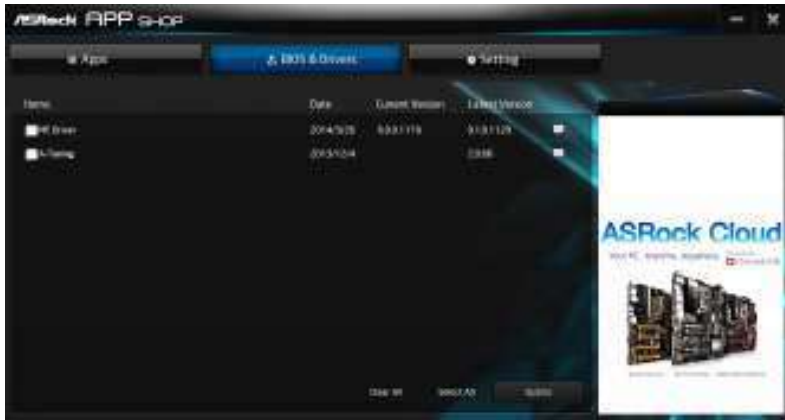

Step 1

Please check the item information before update. Click on ⓘ to see more details.

Step 2

Click to select one or more items you want to update.

Step 3

Click Update to start the update process.

3.5.4 Setting

In the "Setting" page, you can change the language, select the server location, and determine if you want to automatically run the ASRock APP Shop on Windows startup.



3.6 Start8

For those Windows 8 users who miss the Start Menu, Start8 is an ideal solution that brings back the familiar Start Menu along with added customizations for greater efficiency.

3.6.1 Installing Start8

Install **Start8**, which is located in the folder at the following path of the Support CD:
 \ASRock Utility > Start8.

3.6.2 Configuring Start8

Style

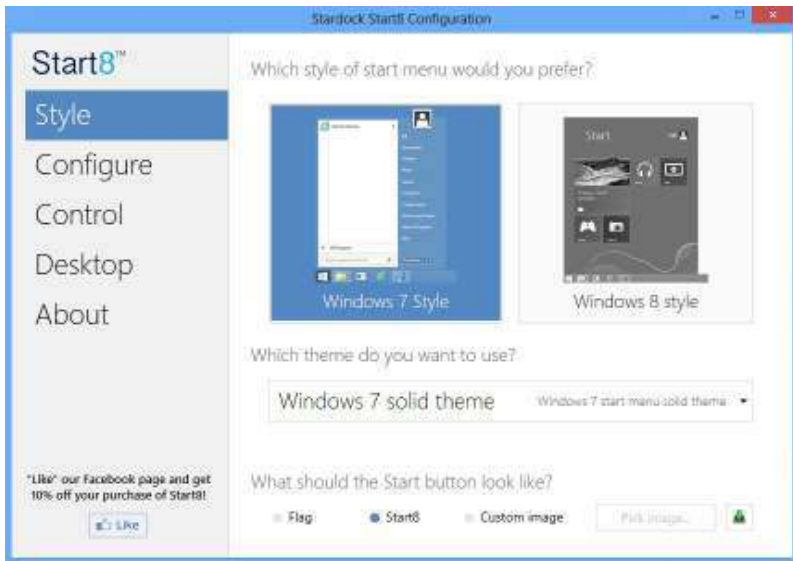

Select between the Windows 7 style and Windows 8 style Start Menu. Then select the theme of the Start Menu and customize the style of the Start icon.

Configure

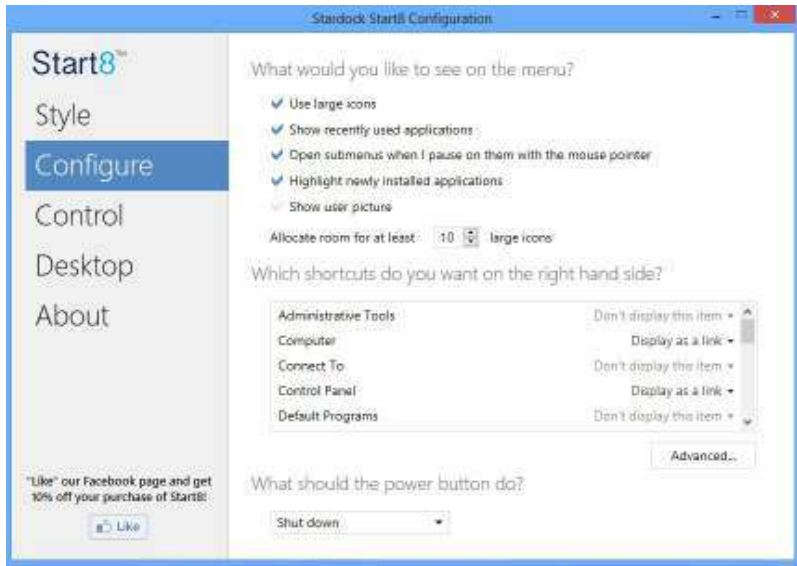

Configure provides configuration options, including icon sizes, which shortcuts you want Start Menu to display, quick access to recently used apps, the functionality of the power button, and more.

Control

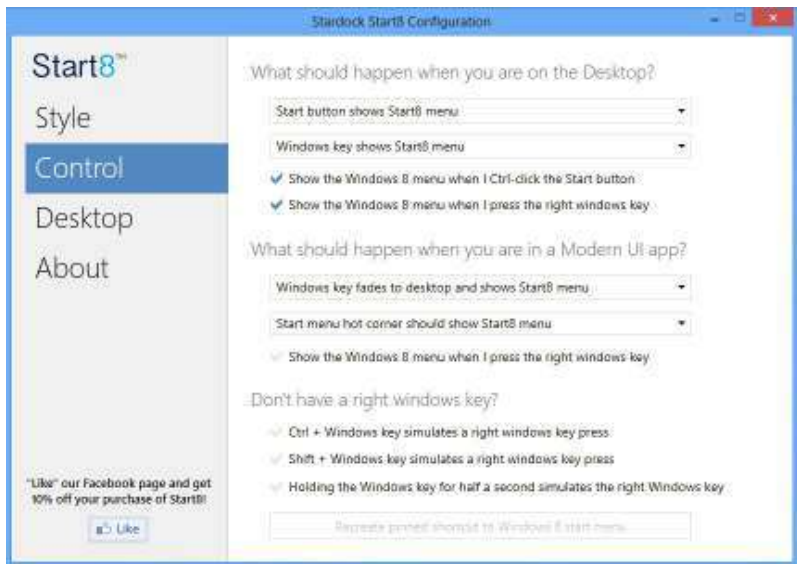

Control lets you configure what a click on the start button or a press on the Windows key does.

Desktop

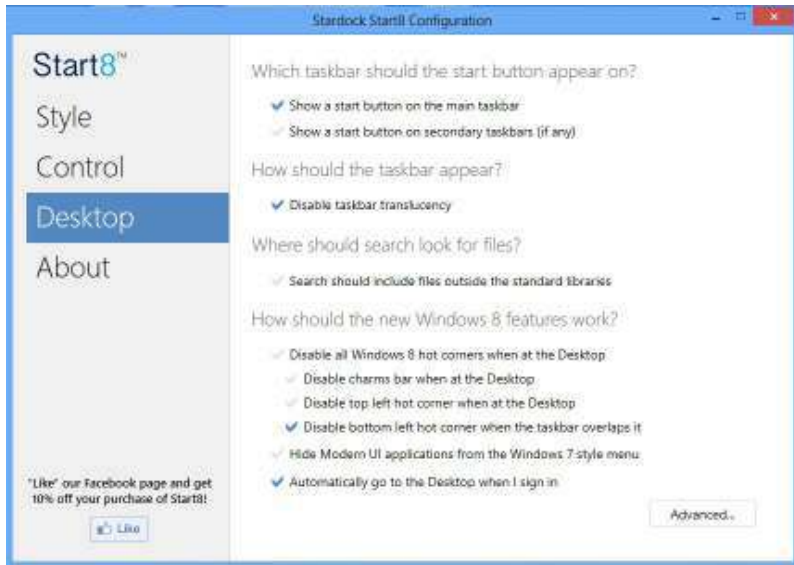

Desktop allows you to disable the hot corners when you are working on the desktop. It also lets you choose whether or not the system boots directly into desktop mode and bypass the Metro user interface.

About

Displays information about Start8.

Chapter 4 UEFI SETUP UTILITY

4.1 Introduction

ASRock Interactive UEFI is a blend of system configuration tools, cool sound effects and stunning visuals. Not only will it make BIOS setup less difficult but also a lot more amusing. This section explains how to use the UEFI SETUP UTILITY to configure your system. You may run the UEFI SETUP UTILITY by pressing <F2> or right after you power on the computer, otherwise, the Power-On-Self-Test (POST) will continue with its test routines. If you wish to enter the UEFI SETUP UTILITY after POST, restart the system by pressing <Ctl> + <Alt> + <Delete>, or by pressing the reset button on the system chassis. You may also restart by turning the system off and then back on.



Because the UEFI software is constantly being updated, the following UEFI setup screens and descriptions are for reference purpose only, and they may not exactly match what you see on your screen.

4.1.1 UEFI Menu Bar

The top of the screen has a menu bar with the following selections:

Main	For setting system time/date information
OC Tweaker	For overclocking configurations
Advanced	For advanced system configurations
Tool	Useful tools
H/W Monitor	Displays current hardware status
Boot	For configuring boot settings and boot priority
Security	For security settings
Exit	Exit the current screen or the UEFI Setup Utility

4.1.2 Navigation Keys

Use <←> key or <→> key to choose among the selections on the menu bar, and use <↑> key or <↓> key to move the cursor up or down to select items, then press <Enter> to get into the sub screen. You can also use the mouse to click your required item.

Please check the following table for the descriptions of each navigation key.

Navigation Key(s)	Description
+ / -	To change option for the selected items
<Tab>	Switch to next function
<PGUP>	Go to the previous page
<PGDN>	Go to the next page
<HOME>	Go to the top of the screen
<END>	Go to the bottom of the screen
<F1>	To display the General Help Screen
<F4>	Toggle sound on/off
<F7>	Discard changes and exit the SETUP UTILITY
<F9>	Load optimal default values for all the settings
<F10>	Save changes and exit the SETUP UTILITY
<F12>	Print screen
<ESC>	Jump to the Exit Screen or exit the current screen

4.2 Main Screen

When you enter the UEFI SETUP UTILITY, the Main screen will appear and display the system overview.



Active Page on Entry

Select the default page when entering the UEFI setup utility.

UEFI Guide

UEFI Guide is a quick tutorial for ASRock's UEFI setup Utility. You may abort the tutorial by pressing "esc".

4.3 OC Tweaker Screen

In the OC Tweaker screen, you can set up overclocking features.



Because the UEFI software is constantly being updated, the following UEFI setup screens and descriptions are for reference purpose only, and they may not exactly match what you see on your screen.

Advanced Turbo

Load optimized CPU and GPU OC settings. Please note that overclocking may cause damage to your CPU and motherboard. It should be done at your own risk and expense.

Non-Z OC

Non-Z OC allows users with a K-Series Haswell processor to overclock their non Z87 chipset motherboards.

Load Optimized GPU OC Setting

Please note that overclocking may cause damage to your GPU and motherboard. It should be done at your own risk and expense.

CPU Configuration

Multi core enhancement

Improve the system's performance by forcing the CPU to perform the highest frequency on all CPU cores simultaneously. Disable to reduce power consumption.

CPU Ratio

The CPU speed is determined by the CPU Ratio multiplied with the BCLK. Increasing the CPU Ratio will increase the internal CPU clock speed without affecting the clock speed of other components.

CPU Cache Ratio

The CPU Internal Bus Speed Ratio. The maximum should be the same as the CPU Ratio.

CPU OC Fixed Mode

CPU OC fix mode allows you to keep the max CPU ratio as your setting without throttling. Please note that overclocking may cause damage to your CPU and motherboard. It should be done at your own risk and expense.

Intel SpeedStep Technology

Intel SpeedStep technology allows processors to switch between multiple frequencies and voltage points for better power saving and heat dissipation.

Intel Turbo Boost Technology

Intel Turbo Boost Technology enables the processor to run above its base operating frequency when the operating system requests the highest performance state.

Filter PLL Frequency

CPU BCLK Filter Frequency. Choose 1.6 for better overclocking capabilities.

Long Duration Power Limit

Configure Package Power Limit 1 in watts. When the limit is exceeded, the CPU ratio will be lowered after a period of time. A lower limit can protect the CPU and save power, while a higher limit may improve performance.

Long Duration Maintained

Configure the period of time until the CPU ratio is lowered when the Long Duration Power Limit is exceeded.

Short Duration Power Limit

Configure Package Power Limit 2 in watts. When the limit is exceeded, the CPU ratio will be lowered immediately. A lower limit can protect the CPU and save power, while a higher limit may improve performance.

Primary Plane Current Limit

Configure the current limit of the CPU under Turbo Mode in ampere. A lower limit can protect the CPU and save power, while a higher limit may improve performance.

GT Frequency

Configure the frequency of the integrated GPU.

GT Voltage Mode

Auto: For optimized settings.

Adaptive: Add voltage to the integrated GPU when the system is under heavy load.

Override: The voltage is fixed.

GT Adaptive Voltage

Configure the fixed voltage added to the integrated GPU.

GT Voltage Offset

Configure the voltage added to the integrated GPU when the system is under heavy load.

DRAM Timing Configuration

Load XMP Setting

Load XMP settings to overclock the DDR3 memory and perform beyond standard specifications.

DRAM Frequency

If [Auto] is selected, the motherboard will detect the memory module(s) inserted and assign the appropriate frequency automatically.

Refresh Cycle Time (tRFC)

The number of clocks from a Refresh command until the first Activate command to the same rank.

RAS to RAS Delay (tRRD)

The number of clocks between two rows activated in different banks of the same rank.

Write to Read Delay (tWTR)

The number of clocks between the last valid write operation and the next read command to the same internal bank.

Read to Precharge (tRTP)

The number of clocks that are inserted between a read command to a row precharge command to the same rank.

Four Activate Window (tFAW)

The time window in which four activates are allowed the same rank.

CAS Write Latency (tCWL)

Configure CAS Write Latency.

tREFI

Configure refresh cycles at an average periodic interval.

tCKE

Configure the period of time the DDR3 initiates a minimum of one refresh command internally once it enters Self-Refresh mode.

tRDRD

Configure between module read to read delay.

tRDRDDR

Configure between module read to read delay from different ranks.

tRDRDDD

Use this to change DRAM tRWSR Auto/Manual settings. The default is [Auto].

tWRRD

Configure between module write to read delay.

tWRRDDR

Configure between module write to read delay from different ranks.

tWRRDDD

Use this to change DRAM tRRSR Auto/Manual settings. The default is [Auto].

Configure between module write to read delay from different DIMMs.

tWRWR

Configure between module write to write delay.

tWRWRDR

Configure between module write to write delay from different ranks.

tWRWRDD

Configure between module write to write delay from different DIMMs.

tRDWR

Configure between module read to write delay.

tRDWRDR

Configure between module read to write delay from different ranks.

tRDWRDD

Configure between module read to write delay from different DIMMs.

RTL (CHA)

Configure round trip latency for channel A.

RTL (CHB)

Configure round trip latency for channel B.

IO-L (CHA)

Configure IO latency for channel A.

IO-L (CHB)

Configure IO latency for channel B.

ODT WR (CHA)

Configure the memory on die termination resistors' WR for channel A.

ODT WR (CHB)

Configure the memory on die termination resistors' WR for channel B.

ODT NOM (CHA)

Use this to change ODT (CHA) Auto/Manual settings. The default is [Auto].

ODT NOM (CHB)

Use this to change ODT (CHB) Auto/Manual settings. The default is [Auto].

Command Tri State

Enable for DRAM power saving.

MRC Fast Boot

Enable Memory Fast Boot to skip DRAM memory training for booting faster.

DIMM Exit Mode

Select Slow Exit to reduce power consumption, or Fast Exit for better performance.

FIVR Configuration

FIVR Switch Frequency Signature

Select whether to boost or lower the FIVR Switch Frequency.

FIVR Switch Frequency Offset

Configure the percentage of frequency boost or deduction.

Vcore Override Voltage

Configure the voltage added to the Vcore when the system is under heavy load.

Vcore Voltage Additional Offset

Configure the dynamic Vcore voltage added to the Vcore.

CPU Cache Override Voltage

Add voltage to the CPU Cache when the system is under heavy load.

CPU Cache Voltage Offset

Configure the voltage for the CPU Cache. Setting the voltage higher may increase system stability when overclocking.

System Agent Voltage Offset

Configure the voltage for the System Agent. Setting the voltage higher may increase system stability when overclocking.

CPU Analog IO Voltage Offset

CPU I/O Analog Voltage.

CPU Digital IO Voltage Offset

CPU I/O Digital Voltage.

CPU Integrated VR Faults

Disable FIVR Faults to raise the threshold to trigger CPU over current protection and over voltage protection for better overclocking capabilities.

CPU Integrated VR Efficiency Mode

Enable FIVR Efficiency Management for power saving. Disable for better performance and overclocking capabilities.

Voltage Configuration

DRAM Voltage

Use this to configure DRAM Voltage. The default value is [Auto].

PCH 1.05V Voltage

Chipset 1.05V Voltage. Use default settings for best performance.

PCH 1.5V Voltage

I/O 1.5V Voltage. Use default settings for best performance.

4.4 Advanced Screen

In this section, you may set the configurations for the following items: CPU Configuration, Chipset Configuration, Storage Configuration, Intel® Rapid Start Technology, Intel® Smart Connect Technology, Super IO Configuration, ACPI Configuration, USB Configuration and Trusted Computing.



Setting wrong values in this section may cause the system to malfunction.

4.4.1 CPU Configuration



Intel Hyper Threading Technology

Intel Hyper Threading Technology allows multiple threads to run on each core, so that the overall performance on threaded software is improved.

Active Processor Cores

Select the number of cores to enable in each processor package.

CPU C States Support

Enable CPU C States Support for power saving. It is recommended to keep C3, C6 and C7 all enabled for better power saving.

Enhanced Halt State (C1E)

Enable Enhanced Halt State (C1E) for lower power consumption.

CPU C3 State Support

Enable C3 sleep state for lower power consumption.

CPU C6 State Support

Enable C6 deep sleep state for lower power consumption.

CPU C7 State Support

Enable C7 deep sleep state for lower power consumption.

Package C State Support

Enable CPU, PCIe, Memory, Graphics C State Support for power saving.

CPU Thermal Throttling

Enable CPU internal thermal control mechanisms to keep the CPU from overheating.

No-Execute Memory Protection

Processors with No-Execution Memory Protection Technology may prevent certain classes of malicious buffer overflow attacks.

Intel Virtualization Technology

Intel Virtualization Technology allows a platform to run multiple operating systems and applications in independent partitions, so that one computer system can function as multiple virtual systems.

Hardware Prefetcher

Automatically prefetch data and code for the processor. Enable for better performance.

Adjacent Cache Line Prefetch

Automatically prefetch the subsequent cache line while retrieving the currently requested cache line. Enable for better performance.

4.4.2 Chipset Configuration



Primary Graphics Adapter

Select a primary VGA.

VT-d

Intel® Virtualization Technology for Directed I/O helps your virtual machine monitor better utilize hardware by improving application compatibility and reliability, and providing additional levels of manageability, security, isolation, and I/O performance.

PCIe1 Link Speed

Select the link speed for PCIe1.

Share Memory

Configure the size of memory that is allocated to the integrated graphics processor when the system boots up.

IGPU Multi-Monitor

Select disable to disable the integrated graphics when an external graphics card is installed. Select enable to keep the integrated graphics enabled at all times.

Render Standby

Power down the render unit when the GPU is idle for lower power consumption.

Onboard HD Audio

Enable/disable onboard HD audio. Set to Auto to enable onboard HD audio and automatically disable it when a sound card is installed.

iCafe Audio

Select to enable iCafe Audio and the headphone amplifier for rear audio jack line-out. If you would like to plug headphone to rear line-out, it is recommended to enable iCafe Audio for better acoustic experience. If you disable iCafe Audio, the headphone amplifier for rear audio jack line-out will also be disabled.

Front Panel

Enable/disable front panel HD audio.

Onboard HDMI HD Audio

Enable audio for the onboard digital outputs.

Onboard LAN

Enable or disable the onboard network interface controller.

Deep Sleep

Configure deep sleep mode for power saving when the computer is shut down.

Restore on AC/Power Loss

Select the power state after a power failure. If [Power Off] is selected, the power will remain off when the power recovers. If [Power On] is selected, the system will start to boot up when the power recovers.

Good Night LED

By enabling Good Night LED, the Power/HDD LEDs will be switched off when the system is on. It will also automatically switch off the Power and Keyboard LEDs when the system enters into Standby/Hibernation mode.

4.4.3 Storage Configuration



SATA Controller(s)

Enable/disable the SATA controllers.

SATA Mode Selection

IDE: For better compatibility.

AHCI: Supports new features that improve performance.



AHCI (Advanced Host Controller Interface) supports NCQ and other new features that will improve SATA disk performance but IDE mode does not have these advantages.

SATA Aggressive Link Power Management

SATA Aggressive Link Power Management allows SATA devices to enter a low power state during periods of inactivity to save power. It is only supported by AHCI mode.

Hard Disk S.M.A.R.T.

S.M.A.R.T stands for Self-Monitoring, Analysis, and Reporting Technology. It is a monitoring system for computer hard disk drives to detect and report on various indicators of reliability.

4.4.4 Intel® Rapid Start Technology



Intel® Rapid Start Technology

Intel® Rapid Start Technology is a new zero power hibernation mode which allows users to resume in just 5-6 seconds.

4.4.5 Intel® Smart Connect Technology



Intel® Smart Connect Technology

Intel® Smart Connect Technology automatically updates your email and social networks, such as Twitter, Facebook, etc. while the computer is in sleep mode.

4.4.6 Super IO Configuration



PS2 Y-Cable

Enable the PS2 Y-Cable or set this option to Auto.

Serial Port

Enable or disable the Serial port.

Serial Port Address

Select the address of the Serial port.

Parallel Port

Enable or disable the Parallel port.

Change Settings

Select the address of the Parallel port.

Device Mode

Select the device mode according to your connected device.

4.4.7 ACPI Configuration



Suspend to RAM

Select disable for ACPI suspend type S1. It is recommended to select auto for ACPI S3 power saving.

Check Ready Bit

Enable to enter the operating system after S3 only when the hard disk is ready, this is recommended for better system stability.

ACPI HPET Table

Enable the High Precision Event Timer for better performance and to pass WHQL tests.

PS/2 Keyboard Power On

Allow the system to be waked up by a PS/2 Keyboard.

PCIe Devices Power On

Allow the system to be waked up by a PCIe device and enable wake on LAN.

Ring-In Power On

Allow the system to be waked up by onboard COM port modem Ring-In signals.

RTC Alarm Power On

Allow the system to be waked up by the real time clock alarm. Set it to By OS to let it be handled by your operating system.

USB Keyboard/Remote Power On

Allow the system to be waked up by an USB keyboard or remote controller.

USB Mouse Power On

Allow the system to be waked up by an USB mouse.

4.4.8 USB Configuration



USB Controller

Enable or disable all the USB ports.

Intel USB 3.0 Mode

Select Intel® USB 3.0 controller mode. Set [Smart Auto] to keep the USB 3.0 driver enabled after rebooting (USB 3.0 is enabled in BIOS). Set [Auto] to automatically enable the USB 3.0 driver after entering the OS (USB 3.0 is disabled in BIOS). Set [Enabled] to keep the USB 3.0 driver enabled (Must install driver to use USB devices under Windows® 7). Set [Disabled] to disable the USB 3.0 ports.

Legacy USB Support

Enable or disable Legacy OS Support for USB 2.0 devices. If you encounter USB compatibility issues it is recommended to disable legacy USB support. Select UEFI Setup Only to support USB devices under the UEFI setup and Windows/Linux operating systems only.

Legacy USB 3.0 Support

Enable or disable Legacy OS Support for USB 3.0 devices. If you encounter USB compatibility issues it is recommended to disable legacy USB support. Select UEFI Setup Only to support USB devices under the UEFI setup and Windows/Linux operating systems only.

USB Compatibility Patch

If your USB devices (i.e. USB mouse or storage) encounter compatibility problems, please enable this option to fix it. Please note that after enabling this option, it is normal that the system will postpone booting up after pressing the power button.

4.4.9 Trusted Computing



Security Device Support

Enable to activate Trusted Platform Module (TPM) security for your hard disk drives.

4.5 Tools



UEFI Tech Service

Contact ASRock Tech Service if you are having trouble with your PC. Please setup network configuration before using UEFI Tech Service.

Easy Driver Installer

For users that don't have an optical disk drive to install the drivers from our support CD, Easy Driver Installer is a handy tool in the UEFI that installs the LAN driver to your system via an USB storage device, then downloads and installs the other required drivers automatically.

Instant Flash

Save UEFI files in your USB storage device and run Instant Flash to update your UEFI.

Internet Flash

ASRock Internet Flash downloads and updates the latest UEFI firmware version from our servers for you. Please setup network configuration before using Internet Flash.

*For BIOS backup and recovery purpose, it is recommended to plug in your USB pen drive before using this function.

Network Configuration

Use this to configure internet connection settings for Internet Flash.



Internet Setting

Enable or disable sound effects in the setup utility.

UEFI Download Server

Select a server to download the UEFI firmware.

Dehumidifier Function

If Dehumidifier Function is enabled, the computer will power on automatically to dehumidify the system after entering S4/S5 state.

Dehumidifier Period

Configure the period of time until the computer powers on and enables Dehumidifier after entering S4/S5 state.

Dehumidifier Duration

Configure the duration of the dehumidifying process before it returns to S4/S5 state.

Dehumidifier CPU Fan Setting

Configure the speed of the CPU fan while Dehumidifier is enabled. The higher the value, the faster the fan speed.

Max: 255

Min: 1

Save User Default

Type a profile name and press enter to save your settings as user default.

Load User Default

Load previously saved user defaults.

4.7 Boot Screen

This section displays the available devices on your system for you to configure the boot settings and the boot priority.



Fast Boot

Fast Boot minimizes your computer's boot time. In fast mode you may not boot from an USB storage device. Ultra Fast mode is only supported by Windows 8.1/8 and the VBIOS must support UEFI GOP if you are using an external graphics card. Please notice that Ultra Fast mode will boot so fast that the only way to enter this UEFI Setup Utility is to Clear CMOS or run the Restart to UEFI utility in Windows.

Boot From Onboard LAN

Allow the system to be waked up by the onboard LAN.

Setup Prompt Timeout

Configure the number of seconds to wait for the setup hot key.

Bootup Num-Lock

Select whether Num Lock should be turned on or off when the system boots up.

Boot Beep

Select whether the Boot Beep should be turned on or off when the system boots up. Please note that a buzzer is needed.

Full Screen Logo

Enable to display the boot logo or disable to show normal POST messages.

AddOn ROM Display

Enable AddOn ROM Display to see the AddOn ROM messages or configure the AddOn ROM if you've enabled Full Screen Logo. Disable for faster boot speed.

Boot Failure Guard

If the computer fails to boot for a number of times the system automatically restores the default settings.

Boot Failure Guard Count

Configure the number of attempts to boot until the system automatically restores the default settings.

CSM (Compatibility Support Module)



CSM

Enable to launch the Compatibility Support Module. Please do not disable unless you're running a WHCK test. If you are using Windows 8.1/8 64-bit and all of your devices support UEFI, you may also disable CSM for faster boot speed.

Launch PXE OpROM Policy

Select UEFI only to run those that support UEFI option ROM only. Select Legacy only to run those that support legacy option ROM only.

Launch Storage OpROM Policy

Select UEFI only to run those that support UEFI option ROM only. Select Legacy only to run those that support legacy option ROM only.

Launch Video OpROM Policy

Select UEFI only to run those that support UEFI option ROM only. Select Legacy only to run those that support legacy option ROM only.

4.8 Security Screen

In this section you may set or change the supervisor/user password for the system. You may also clear the user password.



Supervisor Password

Set or change the password for the administrator account. Only the administrator has authority to change the settings in the UEFI Setup Utility. Leave it blank and press enter to remove the password.

User Password

Set or change the password for the user account. Users are unable to change the settings in the UEFI Setup Utility. Leave it blank and press enter to remove the password.

Secure Boot

Enable to support Windows 8.1 / 8 Secure Boot.

4.9 Exit Screen



Save Changes and Exit

When you select this option the following message, “Save configuration changes and exit setup?” will pop out. Select [OK] to save changes and exit the UEFI SETUP UTILITY.

Discard Changes and Exit

When you select this option the following message, “Discard changes and exit setup?” will pop out. Select [OK] to exit the UEFI SETUP UTILITY without saving any changes.

Discard Changes

When you select this option the following message, “Discard changes?” will pop out. Select [OK] to discard all changes.

Load UEFI Defaults

Load UEFI default values for all options. The F9 key can be used for this operation.

Launch EFI Shell from filesystem device

Copy shellx64.efi to the root directory to launch EFI Shell.

Contact Information

If you need to contact ASRock or want to know more about ASRock, you're welcome to visit ASRock's website at <http://www.asrock.com>; or you may contact your dealer for further information. For technical questions, please submit a support request form at <http://www.asrock.com/support/tsd.asp>

ASRock Incorporation

2F., No.37, Sec. 2, Jhongyang S. Rd., Beitou District,

Taipei City 112, Taiwan (R.O.C.)

ASRock EUROPE B.V.

Bijsterhuizen 3151

6604 LV Wijchen

The Netherlands

Phone: +31-24-345-44-33

Fax: +31-24-345-44-38

ASRock America, Inc.

13848 Magnolia Ave, Chino, CA91710

U.S.A.

Phone: +1-909-590-8308

Fax: +1-909-590-1026