



LIPPERT
COMPONENTS

HAPPIJAC

Kimro



DREW

INDUSTRIES INCORPORATED

2010-2011
RV Product Catalog

*Michiana
Mattress*

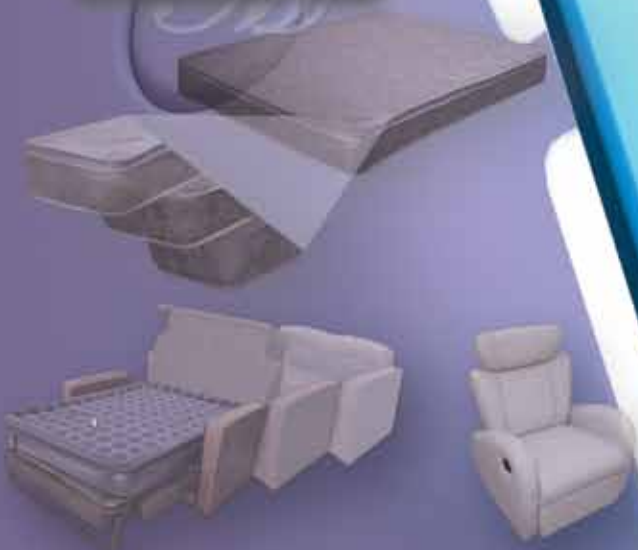

SLATECH

Seating Technology, Inc.



Kimro Composites

Drew Industries Inc Family of Companies
2010-2011 RV Product Guide
Table of Contents

Lippert Components Inc.....	LCI-1
Axles and Suspension.....	LCI-2-6
Towable Axles.....	LCI-2
Sealed Bearing System.....	LCI-3
Super Lube by LCI.....	LCI-3
Self Adjusting Break Systems.....	LCI-3
Equaflex Rubber Suspension System.....	LCI-4
Centerpoint Air Ride Suspension System.....	LCI-5
Standard Suspension Kits.....	LCI-6
Shock Kits.....	LCI-6
Axle Components.....	LCI-7-10
Brake Hub Assemblies.....	LCI-7
Brake/Idler Hub Drums.....	LCI-7
Brake Assemblies/Disc Brakes.....	LCI-8
Bearings.....	LCI-9
Grease Seals.....	LCI-9
Dust Caps.....	LCI-9
Axle Leaf Springs.....	LCI-10
Chassis.....	LCI-11
Doors.....	LCI-12-17
Entry Door Series/Options.....	LCI-12-13
Secure Lock Tent Doors.....	LCI-14
Access/Baggage Doors.....	LCI-15
Bus Doors.....	LCI-16
Cargo Doors.....	LCI-16
Ramp Doors.....	LCI-17
Vapor Doors.....	LCI-17
5th Wheel Hitches/Pin Boxes.....	LCI-18-19
Tri-Glide Air Ride Pin Box.....	LCI-18
Standard Air Ride Pin Boxes.....	LCI-18
Rota Flex Rubberized Pin Box.....	LCI-19
Lippert Standard Pin Boxes.....	LCI-19
Pin Box Accessories	
Hitch/Pin Box Covers.....	LCI-20
Hitch Helper Rear Assistance Device.....	LCI-20
Pin Box Stabilizer Systems.....	LCI-20
Coach Leveling and Stabilization.....	LCI-21-25
Jacks	
Electric Stabilizer Jacks.....	LCI-21
Manual Scissor Jacks.....	LCI-22
PT2 Power Tongue Jack.....	LCI-22
Manual Sidewinder Jack.....	LCI-22
Landing Gear	
Hydraulic Landing Gear.....	LCI-23
Electric Landing Gear (Universal Fit).....	LCI-23
Quick Release Pull Pin.....	LCI-23
Aluminum Leveling Systems	
NEW! Level-Up Automatic Leveling System!....	LCI-24
.....	LCI-25
LP Tanks,Trays & Regulators.....	LCI-26
Quickbite® Dual Jaw Locking Coupler.....	LCI-27
Sewer Management System.....	LCI-28

Drew Industries Inc Family of Companies
2010-2011 RV Product Guide
Table of Contents Cont.

Slide-Out Systems & Accessories.....	LCI-29-31
Total Control 1 In Wall Slide System.....	LCI-29
Hydraulic/Electric Slide-Out Systems.....	LCI-30
Flex Guard.....	LCI-31
Slide-Out Slicker.....	LCI-31
Steps.....	LCI-32
Radius Entry Steps.....	LCI-32
Motorized Entry Steps.....	LCI-32
Storage Solutions.....	LCI-33-35
Quick Draw Storage Trays.....	LCI-33
Battery Trays.....	LCI-33
LP Racks.....	LCI-33
Bike Racks.....	LCI-34
Spare Tire Carriers/Winchess.....	LCI-34
Underchassis Storage Compartments.....	LCI-35
Tow-N-Stow® Cargo Trailer and Storage Unit.....	LCI-36
Touch Audio Multimedia Player.....	LCI-37
Toylok® Antitheft Device.....	LCI-38
TV Lifts.....	LCI-39
Electric TV Lifts.....	LCI-39
Manual TV Lifts.....	LCI-39
TV Brackets.....	LCI-39
Wireless Remote Systems.....	LCI-40
Late 2010 Additions.....	LCI-41
Power Cord Reel.....	LCI-41
Folding Dinette Table.....	LCI-41
Welded Hitch Receiver.....	LCI-41
Happijac Inc®, a Division of Lippert Components.....	H-1-10
Camper Jacks.....	H-2
Qwik-Load® Lever-Action Turnbuckles.....	H-3
Camper Tiedown Systems.....	H-4-5
JT's Strong Arm Jack Stabilizers and Accessories.....	H-6-7
JT's Strong Arm Jack Stabilizers.....	H-6
Elephant Foot Pads.....	H-7
Wireless Digital Leveling.....	H-7
Happijac® Vertical Bed Lift Systems.....	H-8
Secure Trac™ Above Floor Slide-Out Systems.....	H-9
Quick-Draw® Sliding Tool Box Systems.....	H-10-11
Happijac® Contact Information.....	H-12

Drew Industries Inc Family of Companies

2010-2011 RV Product Guide

Table of Contents Cont.

Kinro.....	K-1
RV Radius Windows.....	K-2
2000 Series SV Radius Window.....	K-2
2000 Series SVS Radius Window.....	K-2
2800 Series Euro-Style Window.....	K-2
3000 Series Bonded Window.....	K-3
8500/8600 Series Sliding Radius Window.....	K-3
8700 Series Bus Window.....	K-3
Rock Guard Windows.....	K-4
Vented Exit Picture Escape Window.....	K-4
RV Patio Doors.....	K-5
7500 Series Aluminum Patio Sliding Door.....	K-5
Contact Information.....	K-6
Kinro Composites™.....	KC-1
Permalux Plus™.....	KC-2
RV Bath Tubs.....	KC-3
RV Shower Surrounds & Pans.....	KC-3
RV Sinks.....	KC-4
Large Thermoformed RV Parts.....	KC-5
Kinro Composites™ Contact Information.....	KC-6
Michiana Mattress.....	M-1
Innerspring Mattresses.....	M-2
Bunk Matts and Futons.....	M-3
New! Heated Bunk Matt.....	M-4
The Evergreen Performance Core.....	M-5
Coil Counts, Specs and Contact Information.....	M-6
Seating Technology Inc.....	ST-1
Traditional Furniture.....	ST-2-3
Dinette Systems.....	ST-4
Flip Sofas.....	ST-5
Rollover Sofas.....	ST-5
Hide-A-Beds.....	ST-6-7
Magic Air Bed.....	ST-6
Comfort Air Bed.....	ST-7
Mechanized Air Beds.....	ST-7
Picnic Table Lift System.....	ST-8
Sit-N-Sleep.....	ST-9
Unique Furniture Concepts.....	ST-10
Sit-N-Play.....	ST-10
Custom Interiors by Design Time.....	ST-11
Tents & Awnings.....	ST-12
Tire Covers.....	ST-12
Contact Information.....	ST-13



LIPPERT COMPONENTS

**2010-2011
PRODUCT GUIDE**

VISIT US AT WWW.LCI1.COM
SHOP OUR STORE AT STORE.LCI1.COM



Sealed Bearing System (SBS)

Available in drum and discs
4,000-7,000 Capacities



Spring Axles

2,000-10,000 Capacities



Torsion Axles

2,000-7,000 Capacities



Idler Axles

Torsion and Spring
2,000-7,000 Capacities

LippertComponents, Inc Trailer Axle Solutions

Feature Benefit

- **Powder coated axle tube**
Better aesthetics and corrosion protection.
- **Zinc plated mounting**
Prevents rusting and corrosion.
- **Waterproof 3M connectors in all brake wiring**
Prevents wire separation/prevents corrosion at connection.
- **CSA certified 2K-7K spring/torsion axles**
Extensive testing and approval process ensures that axles perform to standards.
- **CSA approved 7K 12 X 2 electric brake assembly**
Competitors are only approved up to 6K.
- **State of the art camber and toe process**
Consistent and repeatable process controls toe and camber.
- **One piece integrated spindle/brake flange**
Provides precise brake mounting and maximizes brake performance.
- **Robotically welded spindles and spring seats**
Competitor relies on operator's rotary welds. Welds are not traceable to production run.
- **Extensive weld approval**
Approved weld etch coupon can be traced to the final axle serial number.
- **DC electric nut runners used for accurate torque**
Competitors use non-repeatable air guns that do not guarantee proper u-bolt nut torque.
- **Electrical checks on 100% of all axles built.**
Ensures functional wiring and brakes.
- **Brakes adjusted to drums 100%**
Maximizes brake performance. Lippert adjusts brakes like a professional service shop.

[Click here to download Product Literature or go to www.lci1.com](http://www.lci1.com)



Trailer Axle Options

Sealed Bearing System Features:

- Automotive style cartridge system.
- No bearing maintenance.
- Lower maintenance cost
- Sealed for life.
- Preset bearing adjustment reduces human error.
- No need to replace seals during brake inspection.

Super Lube Hubs and Bearing Lubrication System Features:

- Changing grease is easy and clean.
- Lubrication system requires no disassembly of wheels or hubs.
- Better protection over standard systems.
- Grease fills entire bearing cavity allowing complete submersion.

Self Adjusting Brake Systems

- Improved stopping time - over 50% in some situations.
- No need to worry about improperly adjusted brakes.
- Peace of mind knowing your towing a safer trailer.
- Lower maintenance cost due to elimination of routine adjustments.

[Click here to download Product Literature or go to www.lci1.com](http://www.lci1.com)



SBS

Sealed Bearing System



SUPER LUBE
Hubs & Bearing Lubrication System



**Self-Adjusting
Brake Systems**

EQUA-FLEX™

Because You Are Riding On Our Reputation...



7-8K Tandem & Triple Applications



3-6K Tandem & Triple Applications



2-3.5K Single Applications

Road shock should be absorbed by suspension, not transferred. The Equa-Flex™ rubber equalizer system completes this task with flying colors. Equa-Flex™ virtually eliminates damage caused by vibration from road bumps, holes and cracks. A specialized rubber suspension system was formulated to absorb the vibrations and protect your precious cargo. Equa-Flex™ also helps reduce chucking allowing for a stress free traveling experience. The rougher the road, the better Equa-Flex™ performs. Protect your investment today with Equa-Flex™.

Available Options:

- Greasable Wet bolts
- Single, Tandem & Triple Applications
- Retrofits with Existing Cast Equalizers

Standard:

- Reduces cost from torsion but preserves the ride.
- Reduces shock and vibration
- Reduces fore to aft movement, otherwise known as "chucking."
- Reduces wear and tear on trailer.
- Increases relaxation while towing.

Click below to download product flyer:

[Equa-Flex™ Sales Flyer](#)

Trailair
The Comfort of Air

Trailair® is a division of Lippert Components

CENTERPOINT AIR RIDE SUSPENSION SYSTEM

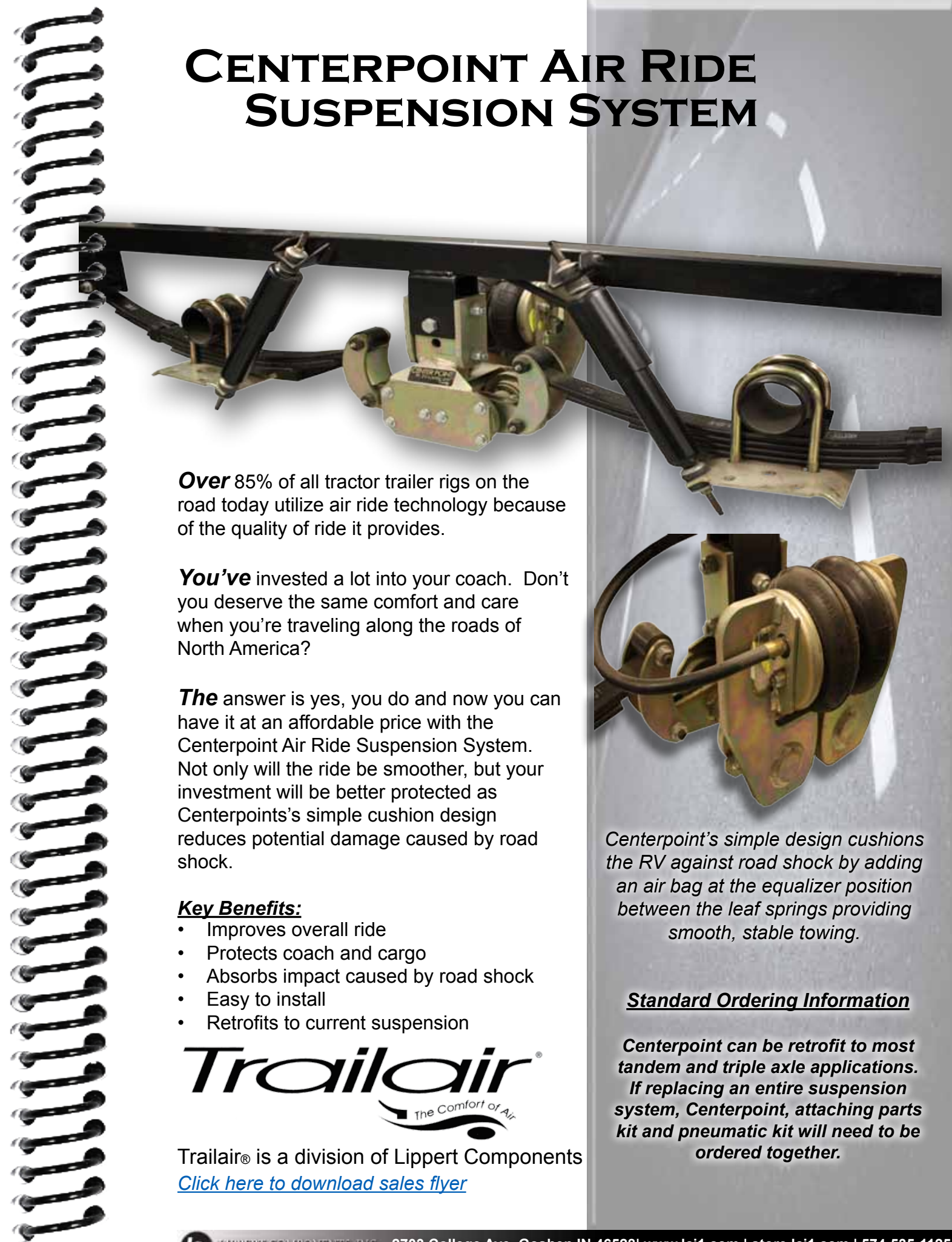

Over 85% of all tractor trailer rigs on the road today utilize air ride technology because of the quality of ride it provides.

You've invested a lot into your coach. Don't you deserve the same comfort and care when you're traveling along the roads of North America?

The answer is yes, you do and now you can have it at an affordable price with the Centerpoint Air Ride Suspension System. Not only will the ride be smoother, but your investment will be better protected as Centerpoint's simple cushion design reduces potential damage caused by road shock.

Key Benefits:

- Improves overall ride
- Protects coach and cargo
- Absorbs impact caused by road shock
- Easy to install
- Retrofits to current suspension

Trailair
The Comfort of Air

Trailair® is a division of Lippert Components

[Click here to download sales flyer](#)

Centerpoint's simple design cushions the RV against road shock by adding an air bag at the equalizer position between the leaf springs providing smooth, stable towing.

Standard Ordering Information

Centerpoint can be retrofit to most tandem and triple axle applications. If replacing an entire suspension system, Centerpoint, attaching parts kit and pneumatic kit will need to be ordered together.

Standard Suspension Kits



Standard Leaf Spring Tandem Attaching Parts Kit



Standard Leaf Spring Triple Attaching Parts Kit

**Standard AP Kit
Ordering Information**

Axle Config	Spring Type	SKU#
Single-Torsion	Leaf	132019
Single-Standard	Leaf	121101
Tandem-Standard	Leaf	121097
Tandem-Tall	Leaf	121098
Tandem-Long	Leaf	121099
Tandem-HD	Leaf	126359
Triple-Standard	Leaf	121100
Triple-Long	Leaf	132698
Tandem-Standard	Slipper	128877
Triple-Standard	Slipper	137383

Need it today? Order online:

[Click here to buy product](#)

...or visit our store at:

<http://store.lci1.com>

**Note that all hardware, u-bolts, fasteners and equalizers are available for individual sale online.*

Upgrade to LCI Shocks

Upgrade your standard suspension with Lippert Component's standard shock system. Shocks provide a smoother ride and reduce tire wear by better managing spring movement. Many of the most popular RV models on the road today are riding on Lippert shock systems. Help protect your investment today!

Need it today? Order online:

[Click here to buy product](#)

...or visit our store at:

<http://store.lci1.com>



SKU# 122108

Lippert Components, Inc is dedicated to providing a complete line of axles and replacement parts. Quick and easy, LCI makes ordering your axle parts a breeze.

Capacity	Bolt Pattern	Stud Size	SKU#
2200#	5-4.5"	1/2"	141282
3500#	5-4.5"	1/2"	122460
3500#	6-5.5"	1/2"	141286
5200#	6-5.5"	1/2"	122462
6000#	6-5.5"	1/2"	122463
6000#	8-6.5"	1/2"	122464
7000#	8-6.5"	1/2"	122465
7000#	8-6.5"	9/16"	141290

Need it today? Order online:

[Click here to buy product](#)

or go to <http://store.lci1.com>

Complete Brake Hub Assemblies



Each hub assembly comes standard with hub drum, inner and outer bearings, bolts, caps and grease seals. Hubs come greased.

Brake/Idler Hub Drums



Brake Hubs (only)



Idler Hubs (only)

Capacity	Bolt Pattern	Stud Size	SKU#
2000#	4-4.0"	1/2"	134574
2000# (6.5" HFD)	5-4.5"	1/2"	158529
2000# (5.5" HFD)	5-4.5"	1/2"	134332
3500#	5-4.5"	1/2"	122098
3500#	5-5.0"	1/2"	137860
3500#	6-5.5"	1/2"	144603
6000#	6-5.5"	1/2"	137859
7000#	8-6.5"	1/2"	137830

Don't need the whole hub? No problem - Lippert can ship out any axle component need you might have.

Brake/Idler Hub Drums

Capacity	Bolt Pattern	Stud Size	SKU#
2200#	5-4.5"	1/2"	134206
3500#	5-4.5"	1/2"	126003
3500#	5-4.75"	1/2"	136368
3500#	5-5.0"	1/2"	136367
3500#	5-5.5"	1/2"	137514
3500#	6-5.5"	1/2"	136214
5200#	6-5.5"	1/2"	122093
6000#	6-5.5"	1/2"	122094
6000#	8-6.5"	1/2"	122095
6000#	6-5.5"	9/16"	129122
6K 42MM SBS	6-5.5"	1/2"	142221
7000#	8-6.5"	1/2"	122096
7000#	8-6.5"	9/16"	134543
7K 49MM SBS	8-6.5"	9/16"	134847
8000#	8-6.5"	5/8"	148626

Standard Electric Brake Assembly



Self-Adjusting Electric Brake Assembly

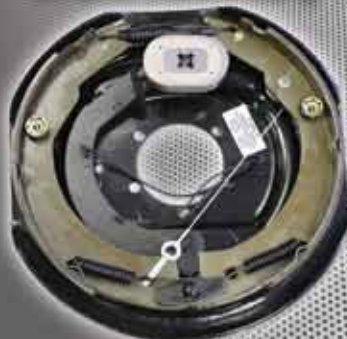

NEW!!

All new Self Adjusting Brakes bring added safety and security to your trip.

- Improved stopping time.
- No worrying over improperly adjusted brakes.
- Peace of mind.
- Lower maintenance costs - no adjustments!

Electric Brake Assembly Ordering Guide

Capacity	Size	LH SKU/ RH SKU	Note
2200#	7" x 1.25"	139700/ 139701	Standard
3500#	10" x 2.25"	122258/ 122450	Standard
3500#	10" x 2.25"	139380/ 139381	w/ Park
7000#	12" x 2"	139383/ 139384	Standard
8000#	12.25" x 3.38"	156443/ 156444	Standard
3500#	10" x 2.25"	1222583/ 1224503	Self-Adjusting
4-7000#	12" x 2"	1222593/ 1224513	Self-Adjusting

[Click here to buy product or go to store.lci1.com](http://store.lci1.com)

Hydraulic Brake Assembly Ordering Guide

Capacity	Size	LH SKU/ RH SKU	Note
3500#	10" x 2.25"	132048/ 132047	Underslung
3500#	10" x 2.25"	192325/ 192324	Underslung w/ Park
3500#	10" x 2.25"	179869/ 179868	Free Backing
7000#	12" x 2"	138754/ 138755	Underslung
7000#	12" x 2"	139419/ 139420	Free Backing
7000#	12" x 2"	139516/ 139517	Free Back & Park

Disk Brake Components Ordering Guide

System	Hub Rotor-Caliper-Bracket
13" Rotor; 50MM SBS; 9/16" Studs	167616-134221-161345
13" Rotor; 50MM SBS; 5/8" Studs	167617-134221-161345

Hydraulic Brake Assembly



Disc Brakes (Hub Rotors/Brake Calipers/Caliper Brackets)



Need a replacement part fast? Lippert Components online ordering system makes ordering parts a breeze. Check us out online at: <http://store.lci1.com>

Bearing Cones

Manufacturer #	Lippert #	Inner/ Outer	Capacity
L44649	122089	Outer	3500#
L68149	122092	Inner	3500#
LM67048	122090	Outer	5200#
25580	122066	Inner	5.2-7000#
15123	122091	Outer	6000#
14125A	127009	Outer	7000#

[Click here to buy product or go to store.lci1.com](http://store.lci1.com)

Double Lip Grease Seals

Capacity	Lippert SKU#
2200#	139514
2800#-3500#	122087
4000#-8000#	122088

[Click here to buy product or go to store.lci1.com](http://store.lci1.com)

Inner/Outer Bearing Cones



Grease Seals

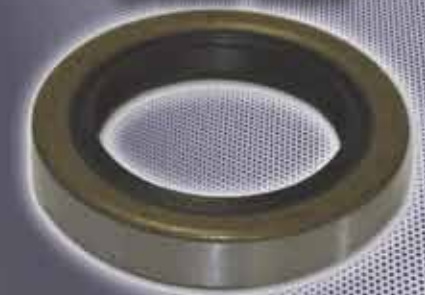

Nonlubed Dust Caps



Lubed Dust Caps



Sealed Bearing System (SBS) Dust Caps



Dust Caps

Capacity	Lubed/Non-lubed	Lippert SKU#
2000#-3500#	Lubed	122067
2000#-3500#	Nonlubed	122099
5200#-6000#	Lubed	122064
5200#-6000#	Nonlubed	122071
6000# 42MM SBS	SBS	166814
7000#	Lubed	127300
7000#	Nonlubed	127206
7000# SBS	SBS	142143

[Click here to buy product or go to store.lci1.com](http://store.lci1.com)





Double Eye Leaf Springs

Standens #	Capacity	Loaded Length	Leaves	Eye-to-Eye Length	Loaded Arch Height	LCI SKU#
72-17	1000#	21"	3	20.375"	2.12"	127094
72-06	1250#	24"	3	23.125"	2.5"	127103
72-13	1400#	21"	4	25.5"	2.38"	125269
72-09	1750#	24"	3	23.2"	2.5"	125215
72-42	1750#	26"	4	25.25"	1.5"	124903
72-18	2000#	24"	4	23.125"	2.5"	125799
72-24	2000#	26"	3	25.25"	1.75"	125797
72-78	2200#	26"	4	25.25"	2"	129745
72-25	2600#	26"	4	25.25"	1.75"	124886
72-40	3000#	26"	1	25.25"	1.75"	125259
72-26	3000#	26"	4	25.25"	1.75"	122111
75-27	3500#	26"	6	24.875"	1.75"	122113
72-79	4000#	26"	7	24.875"	1.75"	132887

[Click here to buy product online or go to store.lci1.com](http://store.lci1.com)

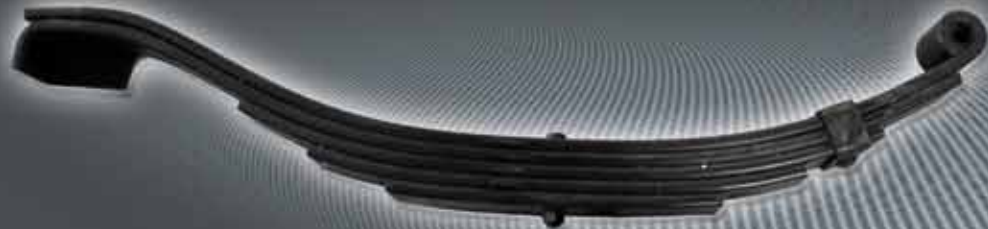

Slipper Springs

Standens #	Capacity	Loaded Length	Leaves	Eye-to-Eye Length	Loaded Arch Height	LCI SKU#
NA	400#	25"	2	24.25"	4"	196770
NA	700#	25"	2	25"	5.25"	194616
72-2	1000#	25"	2	24.75" +/- 1/8	4"	132819
NA	1750#	25"	3	25"	4.5"	157739
072-030-00	2000#	25"	4	26.5"	2"	136527
072-031-00	2500#	25"	4	26.5"	2"	125250
072-032-00	3500#	25"	5	26.5"	2"	125203
072-033-00	4000#	25"	7	26.5"	NA	156446



LIPPERT COMPONENTS, INC.
LEADING SUPPLIER TO THE RECREATIONAL VEHICLE INDUSTRY
Towable RV Chassis

LONG the industry leader in towable chassis, Lippert Components provides a quality product with unmatched service. There is no other way that LCI could have obtained the market share in towable chassis they have today without this being true. LCI has continually helped their customers push the envelope and imagination of what can be towed down the roads of this great country. With continuing development of peripheral items like slide-out systems, steps, stabilization equipment and other items that can be welded to a chassis, Lippert has become a one-stop-shop for all RV component needs. Lippert Components is dedicated to having the best quality and service in the industry because in the end, YOU'RE RIDING ON OUR REPUTATION!

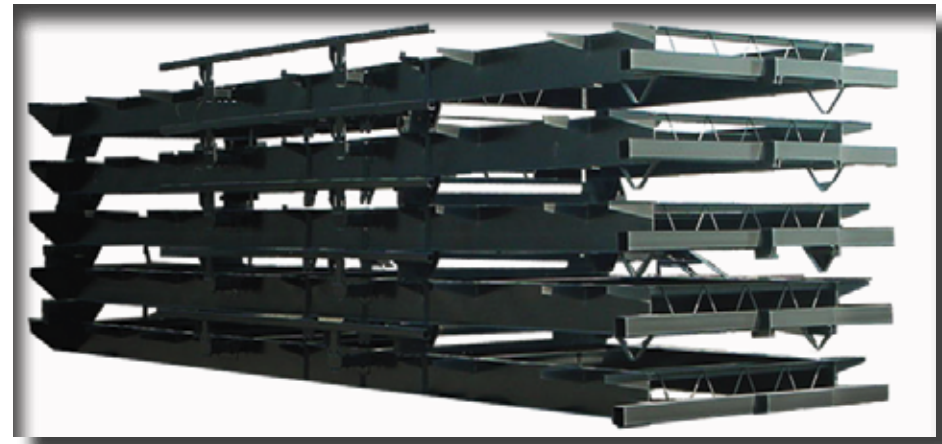

At LCI, innovation is leading to new chassis design concepts:

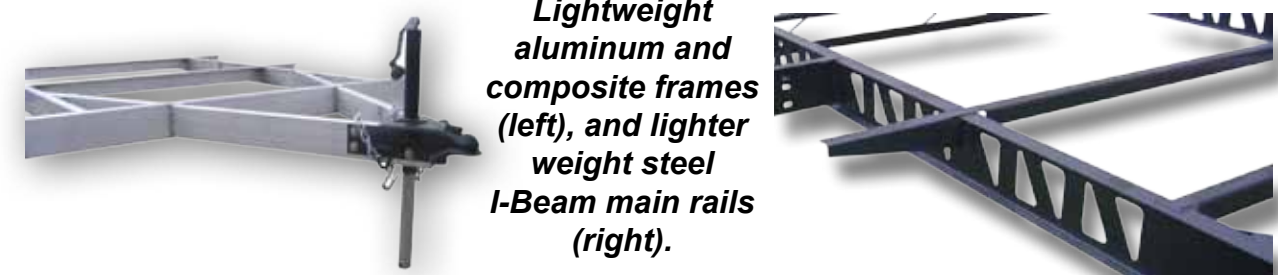

Lightweight aluminum and composite frames (left), and lighter weight steel I-Beam main rails (right).



Every Lippert chassis is ran through one of our state-of-the-art powder coat booths.



Features

Series 8000 Radius Entry Door

Optional keyless entry

10% lighter construction than standard door

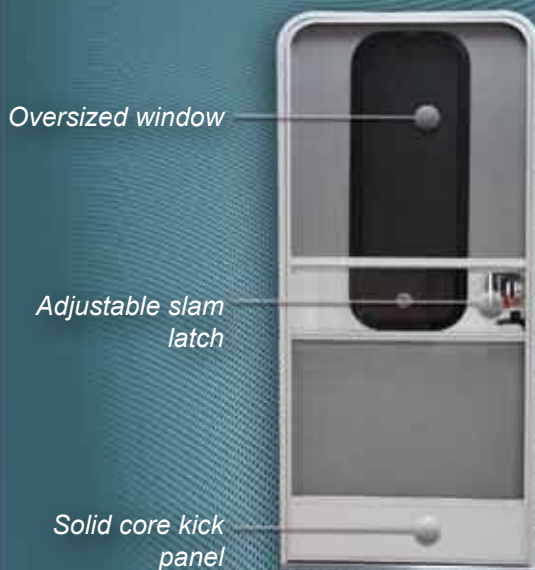

Oversized window

Adjustable slam latch

Solid core kick panel



Thicker gauge frame

Optional storm windows

Clear slider

Optional lighted threshold

Entry Door Series



The RV entry door has remained virtually unchanged since its conception. Listening to the needs of our customers, LCI offers more features and value, not COST. We offer the most diverse radius door lineup in the market at the same cost as a square door. This is how LCI has grabbed more than 50% of the market share in RV entry doors in only one year. With over **ONE MILLION** cycle tests completed with no issues, LCI's entry door series ensures trouble free camping for years to come.

Feature Benefit

- **Low Profile Drip Cap**
No more raw cut edges.
 - **Fully bonded and cambered core**
Leverages strength of lamination plus ensures seal in interior and exterior. Solid mounting surface for strut and NO flex.
 - **Rigid "I" beam threshold**
Eliminates bending or flexing.
 - **Adjustable vs. fixed screen door catch**
Allows adjustments so screen closes properly.
 - **30% thicker screen frame than competition**
Strength added where you need it most - screen is closed more than the main door.
 - **Solid core kick panel**
Eliminates rattle and ensures strength in day to day abuse.
 - **Aluminum snap finish trim**
Insert molding yellows in time and loses integrity due to expansion.
 - **Full wrap soft finishing trim option**
One seamless piece that offers the same pleasing appearance as the aluminum snap trim.
 - **Self piercing rivets vs. screws (competition)**
Rivets ensure a secure connection for the life of the door. Screws become lose from vibration.
 - **Clear view slider panels in screen door**
Screen doors are for sun, not shade.
- [Click here to download product literature](#)
[or go to www.lci1.com](http://www.lci1.com)



Entry Door Options



Innovation sets LCI aside from the rest. With never seen options like the 8100 Lighted Threshold Entry Door, the 8200 Keyless Entry Door and the 8300 Security Alarm Equipped Entry Door, LCI is heads and tails above the competition.

Options Available

Fiberglass

- LCI can accommodate virtually any fiberglass option available to the market. Want to use your own design? No problem. LCI's "U-Skin-It" program lets you supply us.

Hardware

Extrusion Color

- LCI can match any extrusion color that can be imagined.

Latch

- LCI carries standard white, black and chrome latches, but any latch on the market can be applied.

Window Options

Obscure Glass Window

- Standard for entry door series.
- Plastic frame

Full View Window

- White or Black Frame Color
- Obscure or tinted (GL-20) glass color
- Virtually any radius window (slider, etc) can be applied

Other Options

Lighted Threshold

- Lighted threshold activated upon opening entry door,
- Takes the guesswork out of step location.
- Durable, protective cover strong enough to withstand heavy traffic.
- Delivered pre-wired - easy to install.

Keyless Entry

- No more broken keys!
- No more fumbling around with door locks and keys.
- Most autos have this feature, why shouldn't your coach?

Security Alarm Equipped Door

- Protect your precious cargo.
- Leave your cargo behind and stop worrying.
- Alarm is tripped when door is locked and opened from the inside.

Trim Kit

- Snap trim, drip cap and threshold included with door and shipped loose.

Storm Window Package Available

Series 8100 Lighted Threshold Radius Entry Door



Series 8200 Keyless Entry Radius Entry Door



Series 8300 Security Alarm Equipped Radius Entry Door



SECURE-LOCK TENT DOORS

Preassembled bed door and expandable tent package

Patent Pending



1st product of its kind to combine tent and door!



At Lippert Components, we're always looking out for our customers. The Secure-Lock Tent Door system provides several advantages for the customer:

1. The preassembled bed door and tent combination eliminates multiple SKU's simplifying the ordering process.
2. Less SKU's means less inventory to manage. This will save you time and money.
3. A preassembled package equals instant labor savings.

Need more reasons to buy into the Secure-Lock concept? No problem!

- Secure-Lock's patent pending integrated track provides a tight seal that solidly and securely fastens the tent to the door.
- Extruded hinge design eliminates seal voids while the door is open.
- Interior trim ring provides a cleaner look.
- Multiple exterior trim options: hard/soft screw track, include/exclude drip pan.
- Custom embossing, graphics, & interior decor.

[Clicker here to download product literature or go to **www.lci1.com**](#)



Secure-Lock track provides added security

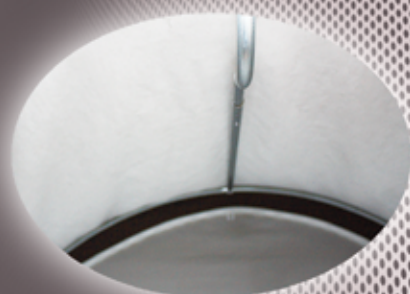

Raised bow increases interior space



RV Access and Baggage Doors

LCI offers a full line of baggage and access doors for RV's. LCI's access door features include standard extruded aluminum inner and outer frames, foam core construction, piano hinges and internal weep systems. Other options include:

- Radius or square corners
- Fiberglass or aluminum construction
- Smooth or embossed finish (white or gray)
- Screw covers
- Painted frames
- Key locks and thumb locks
- Finger pulls

Series Lineup:

Series	Shape	Core	Frame	Finish	Mount
8500	Square	1/2"	1"	WH/MILL	Ext/Surface
8500	Radius	1/2"	1"	WH/MILL	Ext/Surface
9700	Radius	1/2"	1"	WHITE	Interior
07	Radius	1/2"	1 3/8"	WHITE	Interior
9600	Radius	5/8"	2'	WHITE	Interior
08	Radius	1"	2'	WHITE	Interior
08 Slam	Radius	1"	2'	WHITE	Interior

Also Available:

- LPG Doors
- Generator Doors
- Battery Doors
- Double Doors
- Cable Hatch Doors
- No Sill Doors
- Dryer Vent Doors
- Angled Doors

New for 2010...

SLAM-LATCH



Line of Bus Style Luggage Doors
SLAM IT...AND FORGET IT!

- No easy to bend latches
- Bus style latch system provides excellent security.
- Frameless option coming Q2 2010.

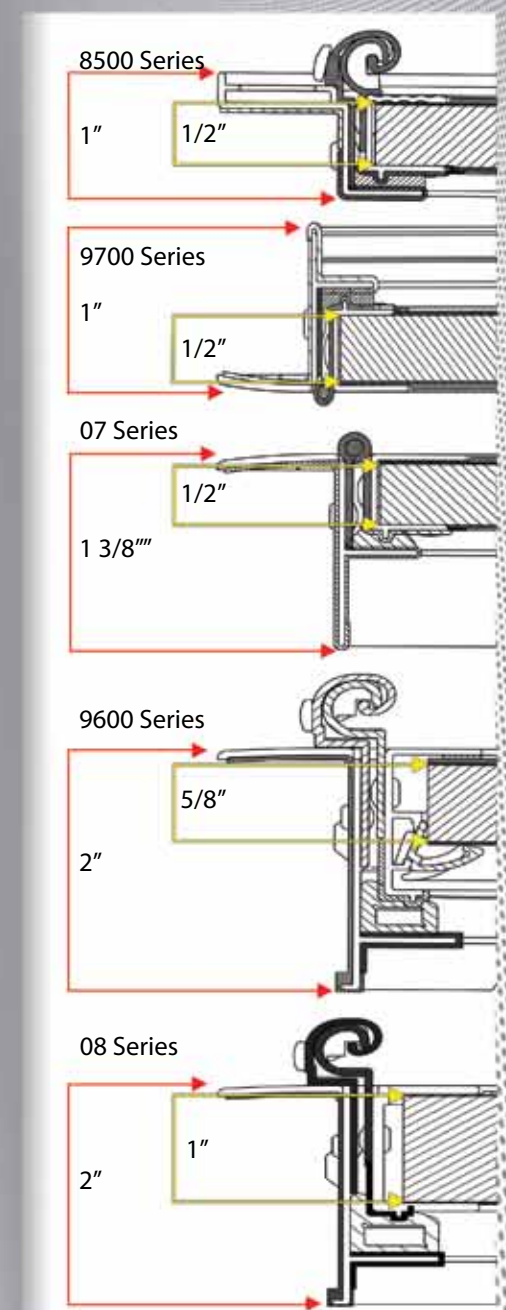
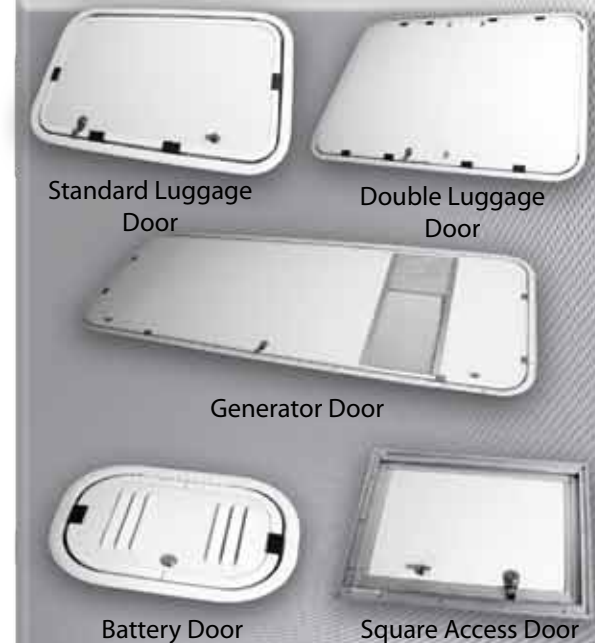



Series 11000
Bus Door

"Bus" Style Doors

Lippert Components offers a durable and affordable bus style escape door. Standard features include:

- Bonded construction
- Durable aluminum snap trim (eliminates yellowing caused by insert molding)
- Multiple handle options available
- "U-Skin-It" program allows customer to choose the skin color or bring their own door in of their choice.



Escape latch

Radius Cargo Doors



"U-Skin-It" program:
Choose from our pre-laminated doors or choose your own design by bringing it to us. This can help keep your inventory low!

LCI ups the bar on the Cargo Entry Door - here's why:

- **Feature:** Solid expanded polystyrene laminated core construction (EPS).
Benefit: One piece of laminated core is lighter and provides superior strength and quality.
- **Feature:** Pre-cambered inner door with automotive "D" seal
Benefit: The pre-camber on the door provides a tight, weather proof seal around the entire door parameter.
- **Feature:** Integrated, pre-mounted hinge
Benefit: Decreases installation time. Promotes cost savings by not needing additional components to complete installation.
- **Feature:** Radius Corners
Benefit: Sleeker than unsightly mitered corners found on traditional doors. Eliminates possible awning damage when using awnings in conjunction with new radius design.
- **Feature:** Aluminum snap trim and low profile drip rail design
Benefit: Cover unsightly installation screws with color matched trim that won't fade or discolor over time.

LCI Ramp Doors

Why has LCI once again upped the bar against the competition?

- Optional side compression latch.
- Improved seal.
- Vacuum bonded construction weighs 20% lighter than the competition.
- 3000 LB loading capacity.
- Standard slotted hinge makes installation easier.

And saving the best feature for last...

Power Ramp Door

- Open and close the ramp door with a touch of a button.
- Easily installs to any rear ramp door.
- Load sensing technology stops expansion/retraction if obstruction is sensed.
- Easy to use manual override in case of power failure.

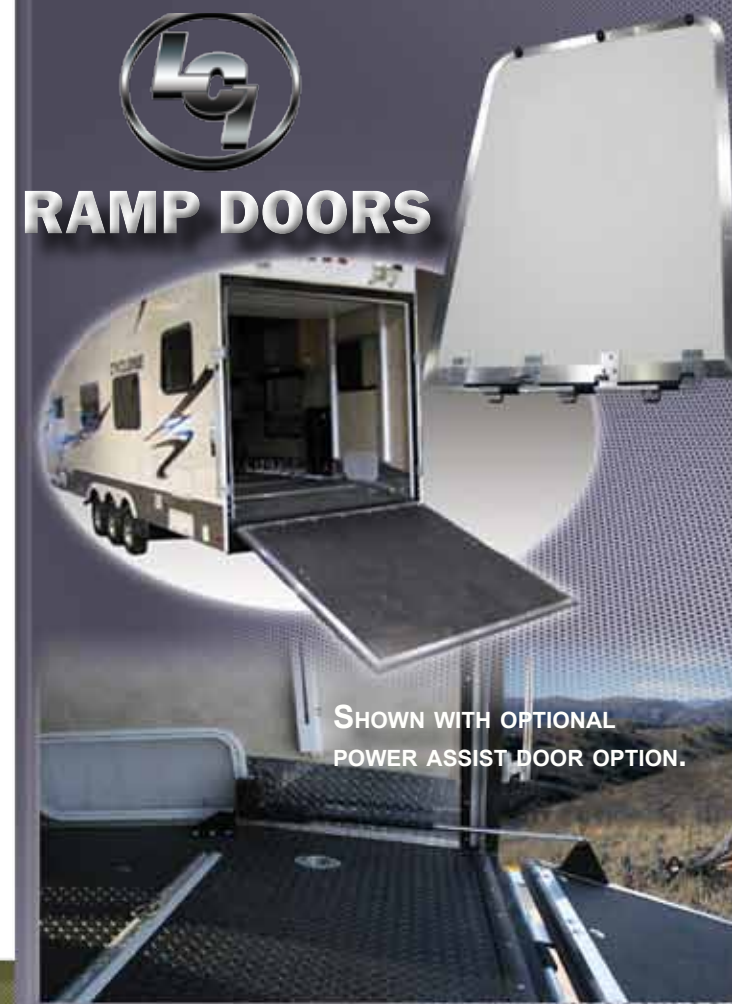

RAMP DOORS

SHOWN WITH OPTIONAL POWER ASSIST DOOR OPTION.



[Click here to download product information.](#)



Vapor Doors

Functional & Economical

LCI's full line of RV doors include our Vapor Door. Keep garage odors where they belong and do it affordably. Standard features include:

- Snap trim keeps vapors out of living quarters.
- "U-Skin-It" program lets you have your own custom finish or let LCI do it for you.



NEW!!! TRI-GLIDE AIR RIDE PIN BOX



Trailair
a division of LIPPERT COMPONENTS, INC.

TRAIL AIR'S TRI-GLIDE SYSTEM IS THE FIRST AIR SPRING SYSTEM TO BOTH REDUCE "CHUCKING" AND CONTROL VERTICAL PUSH-PULL COACH MOVEMENT. CONSIDER THESE ADVANTAGES:

- THE TRI-GLIDE SYSTEM CAN RETROFIT TO ANY LONG OR MEDIUM STYLE PIN BOX ON THE MARKET.
- SIGNIFICANTLY DAMPENS ROAD SHOCK PROVIDING A SMOOTHER RIDE.
- GIVES YOU THE PROTECTION YOUR INVESTMENT DESERVES!
- SAVES YOU MONEY! SHOCK ABSORPTION POTENTIALLY CUTS COSTS OF REPAIRING OR REPLACING INTERIOR/ EXTERIOR COACH PARTS.

STANDARD AIR RIDE PIN BOXES

THE QUALITY OF RIDE HAS BECOME A RELATIVELY FORGOTTEN ASPECT OF THE CAMPING EXPERIENCE. 75% OF ALL TRACTOR TRAILER RIGS ON THE ROAD TODAY UTILIZE SOME KIND OF AIR RIDE TECHNOLOGY, SO SHOULDN'T YOUR COACH DESERVE THE SAME TREATMENT? THE ANSWER IS, "YES," IT SHOULD AND NOW YOU CAN GET IT AFFORDABLY WITH THE AIR RIDE PIN BOX. AIR RIDE CAN BE RETROFIT TO VIRTUALLY ANY EXISTING PIN BOX ON THE MARKET TODAY. DOWNLOAD OUR CATALOG TODAY FOR MORE INFORMATION ON THIS GREAT PRODUCT!

[CLICK TO DOWNLOAD BROCHURE:](#)



**LONG STYLE AIR
RIDE PIN BOX**

- UNIQUE COUPLER DESIGN TRANSFERS ROAD SHOCK TO THE AIR BAG.



**MEDIUM STYLE AIR
RIDE PIN BOX**

- IMPROVES RIDE BY DAMPENING ROAD SHOCK TO REDUCE "CHUCKING."



**TELESCOPING 45°
AIR RIDE PIN BOX**

- SHOCK ABSORBER DECOMPRESSES AIR BAG, REMOVING BOUNCE EFFECT.

- EASY INSTALLATION - RETROFITS TO MOST PIN BOXES ON THE MARKET TODAY.



ROTA FLEX™ FLEXIBLE PIN BOX

ROTA-FLEX™ IS A PIVOTING HEAD PIN BOX THAT UTILIZES A PROPRIETARY RUBBER COMPOUND IN A COMPRESSION APPLICATION TO ABSORB THE TRANSFER OF FORE TO AFT MOTION, OTHERWISE KNOWN AS "CHUCKING." THIS INNOVATIVE DESIGN ALLOWS THE FIFTH WHEEL AND KING PIN PLATE TO REMAIN IN A HORIZONTAL POSITION WHILE THE VEHICLE AND TRAILER PIVOT INDEPENDENTLY OF EACH OTHER. CONSIDER THESE ADVANTAGES:

- IMPROVES RIDE WHILE PROTECTING COACH.
- ABSORBS IMPACT CAUSED BY ROAD SHOCK.
- GREAT UPGRADE TO ANY STANDARD PIN BOX.
- SAVES YOU \$\$\$ ON COSTLY REPAIRS CAUSED BY ROAD SHOCK.

[BUY THIS PRODUCT](#)
[DOWNLOAD LITERATURE](#)

UPGRADE YOUR RIDE AFFORDABLY WITH THE PIVOTING HEAD ROTA-FLEX™ PIN BOX

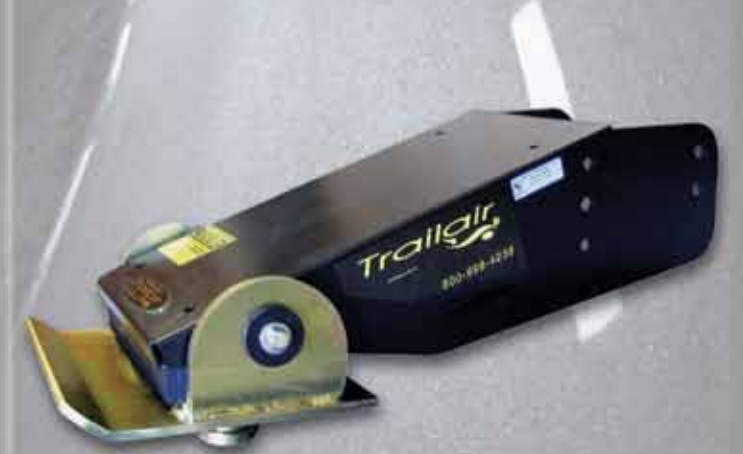

Trailair
a division of LIPPERT COMPONENTS, INC.

LIPPERT COMPONENTS INC

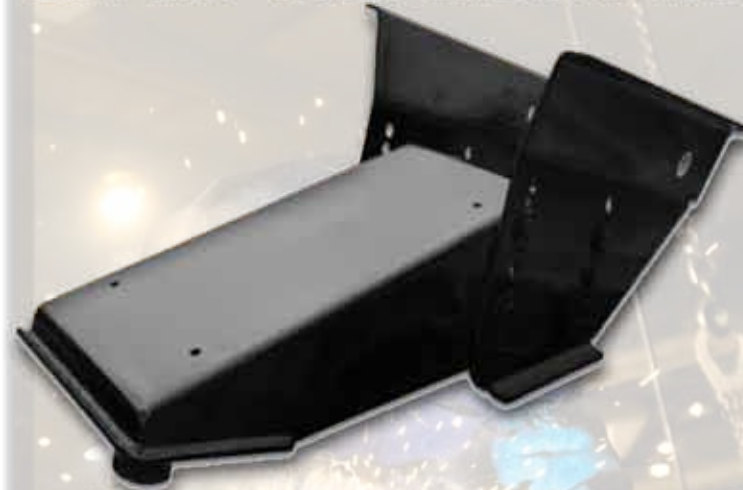

PINBOX

15,500# CAP.
CSA//Z240.1.2-M99

Lippert Components, Inc has been producing quality pin boxes for over a decade. Lippert's diverse pin box line is sure to meet any hitch need at an affordable price. To see exact dimensions, click on the links below.

- Lippert Model 0719 Extended Pin Box. [Click link to view print:](#)
- Lippert Model 0719 Retracted Pin Box. [Click link to view print:](#)
- Lippert Model 1116 Extended Pin Box. [Click link to view print:](#)
- Lippert Model 1116 Retracted Pin Box. [Click link to view print:](#)
- Lippert Model 1621 Pin Box. [Click link to view print:](#)
- Lippert Model 1621 HD 18K Pin Box. [Click link to view print:](#)
- Lippert Model 1621 Retracted Pin Box. [Click link to view print:](#)
- Lippert Model 1716 Extended Pin Box. [Click link to view print:](#)
- Lippert Model 1716 Retracted Pin Box. [Click link to view print:](#)

[Click here to buy products online](#)



HITCH COVERS

PUT THE FINISHING TOUCH ON YOUR COACH



Pin Box Stabilizers

LCI Hitch Covers

Put the finishing touches on your coach with a stylish LCI hitch cover. Consider these advantages that an LCI hitch cover provides.

- Stylish upgrade to any fifth wheel hitch.
- Quick and easy installation.
- Custom grills, colors and other options.
- Hides unsightly rust.
- Compatible with all popular LCI pin boxes.

[Click here to buy product online](#)
or go to store.lci1.com

[Click here to download product literature](#)

Hitch Helper Assistance Device

- Patent pending design provides direct line of sight from rear view mirror to hitch.
- Convex mirror for full hitch view.
- Easy to install - 2 minutes or less.
- Models available to fit all major hitches.

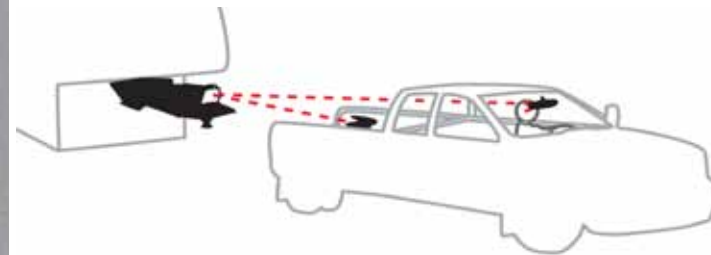

Simply use your vehicle's rear view mirror to find your hitch in the patent pending Hitch Helper mirror. Line up the center of your hitch with the "Center Finder" and back into a perfect hookup every time.

Pin Box Stabilizer

Side-to-side rocking can be bothersome when a fifth wheel coach is parked. The LCI pin box stabilizer eliminates that issue with flying colors.

- Permanently mounts to pin box sleeve so it sets up in seconds - no tools required.
- Stores underneath upper deck when not in use - no additional storage needed.
- Multi-position legs adjust to any terrain.
- Durable zinc and powder coat finish withstands the elements.
- Turnbuckles adjust by hand - no tools required.

[Click here to buy product online](#)

[Click here to download product literature](#)

LIPPERT COMPONENTS, INC.

ELECTRIC STABILIZER JACK



The last thing you want to do after a long day on the road is to manually adjust your stabilizer jacks. This task can become especially tedious if your jacks are old and weathered. It can be a dirty, unpleasant experience. Lippert Component's Electric Stabilizer Jack Systems makes this job a breeze with the flip of a switch. Here's why Lippert's Electric Stabilizer Jack Systems outshine the rest:

- Jacks automatically adjust to the terrain with both legs having equal pressure.
- An external control panel expands and retracts your jacks to achieve a stabilized coach in less than one minute.
- Lippert's patented design utilizes one motor to activate both legs independently.
- Constructed of heavy gauge steel and precision fabricated parts.

[Click here to buy product online](#)
or go to store.lci1.com

[Click here to download product literature](#)



Jacks in retracted position.



Jacks expand and automatically adjust to the terrain.



SKU# 115780



SKU# 182149



SKU# 116744



SKU# 133074



Manual Scissor Jacks

LCI manual scissor jacks have long become the industry standard.

- 24" or 30" applications
- 2.36MM steel body.
- 6000# load capacity.
- Rust inhibitive finish on all metal surfaces.
- Universal weld-on or bolt on application.
- Fits most RV applications.

[Click here to buy product online](#)
[or go to store.lci1.com](#)

PT² Next Generation Power Tongue Jack

Introducing the next generation in power tongue jacks. Here is why it's quickly becoming the standard in power tongue jacks:

- Sculpted design all but eliminates bumping and snagging while maneuvering around jack.
- Polar white exterior easily blends in with most current trends on the market today.
- No manual crank needed.
- 3500# Capacity; 18" Stroke; 30 AMP
- 4 LED lights provide the perfect lighting.

[Click here to buy product online](#)
[or go to store.lci1.com](#)

[Click to download product literature](#)



Manual Sidewind Jack

LCI also provides manual sidewind jacks at an affordable price.

- 2000# capacity.
- Powder coat finish.
- Comes with hardware mounting kit.

[Click here to buy product online](#)
[or go to store.lci1.com](#)



HYDRAULIC Landing Gear

Spend less time setting up your campsite and more time enjoying your stay! Lippert's hydraulic landing gear systems extend up to 10 times faster than traditional electric landing gear systems. Get the power of hydraulics for your coach today.

Universal Fit Electric Landing Gear

Gone are the days where there are 10-15 different landing gear applications for different coach mount styles.

LCI redesigned their universal fit landing gear to mount to any application. Systems come complete with gear box, zinc finished feet and pins. Upgrade your system with our 7000+ RPM high speed motor. This will get the job done up to 3X faster than standard landing gear motors.

Deluxe Landing Gear Pull Pin

- Makes extending/retracting landing gear legs less cumbersome.
- Quicker and easier than standard hair pins.
- Bright zinc finish.
- Easy bolt on installation.
- 3/8" diameter pin fits 7/16" hole.

[Click here to buy product online](#)
[or go to store.lci1.com](#)



SKU# 119113



Total kit shown with legs, feet, controller, brain and pump (hoses not shown)



New aluminum legs are lighter and stronger



Easy to use control pad makes setting up a breeze.



Aluminum Leveling Systems

Stronger. Lighter. Better.

Lippert Components has been manufacturing hydraulic leveling systems for years. In 2009, we overhauled the entire product to bring you something better. Here's how:

Tougher

The primary change to the standard system is the new anodized aluminum alloy jack legs. Solid aluminum rods with a Teflon impregnated hard coat finish helps the system eliminate putting which tears the seals and leads to leaks.

Our pumps have an IP rating of 66 (67 being the highest). This means the pump can be totally submerged in water and still function.

All exterior connections use Deutsch connectors ensuring a weather proof connection every time.

More Efficient

Our jacks have a patent pending retract tube extruded to the body of the cylinder eliminating the need for a lower attachment hose. All jacks come with a 9" or 12" swivel foot pad which is easily replaced if damaged.

The flow divider moves 0.8 gallons of fluid per minute with a 95% accuracy rating compared to a 39% accuracy rating of other systems.

Our pump is 40% more efficient than off the shelf pumps used by other systems.

Lighter

Because of the aluminum construction, the systems weighs 70 pounds on average.

[Click here to download product literature](#) or go to www.lci1.com



LEVEL UP

Setting up the campsite can be difficult. To eliminate unwanted rocking and swaying and to get the coach level, you may have to adjust up to 4 different manual or power jacks. Based on the terrain, you may need to position those jacks on cinder blocks to get the coach to the desired position. Enough is enough! Its time for Level Up.

The Level Up system accomplishes two tasks with flying colors:

- 1) Utilizing JT's digital wireless leveling device, the Level up system accomplishes a level coach in seconds. This eliminates a time consuming and sometimes dirty task of manually leveling your coach.
- 2) Level Up eases undo stress on the chassis, windows and sidewall when the coach's slide-outs are extended or retracted.

Already own a coach and want Level Up? No problem! Upgrade to a Level Up system no matter what any jack/leveling combination you might have! Stop wasting time setting up and get to camping!



Simply use the control pad to extend the roadside jack(s) until they touch the ground, and lower the door side jack(s) until they touch the ground. Next, level the coach from side to side, then from front to back and you're done!



Level Up OEM Kit includes two leveling cylinders with foot pads, power unit, digital leveling kit, controllers and necessary plumbing. Aftermarket kits also available to fit virtually any jack/leveling kit combination..





Double LP Kits



Tanks available in 20,30 & 40# capacities.



2-Stage LP Regulator



LP trays available in 20,30 & 40# capacity sizes..



LP Tanks and Accessories

Lippert Components supplies a full line of LP tanks, regulators and accessories. We can get you the product quickly and affordably. We have the following to offer:

LP Tanks

- 20# LP Tank, SKU# 207634
- 30# LP Tank, SKU# 207635
- 40# LP Tank, SKU# 207636

Regulator Mounting Kits

Regulator mounting kits consist of 1(EA) LP tray, 1(EA) threaded rod, 1(EA) hold down bar and 1(EA) 2-stage regulator with hoses.

- 20# Regulator Kit, SKU#211569
- 30# Regulator Kit, SKU#211048
- 40# Regulator Kit, SKU#211570

About our regulators:

LCI offers two stage regulators. This product performs the same as a single stage low pressure regulator, only it does so in two stages.

Because gas pressure is relieved in two stages, and because the second stage receives a consistent inlet pressure, our regulators do not have to work as hard. This increases overall efficiency and increases gas capacity to all appliances.

[Click here to buy product online](http://www.lci1.com)
[or go to store.lci1.com](http://www.lci1.com)



QUICKBITE

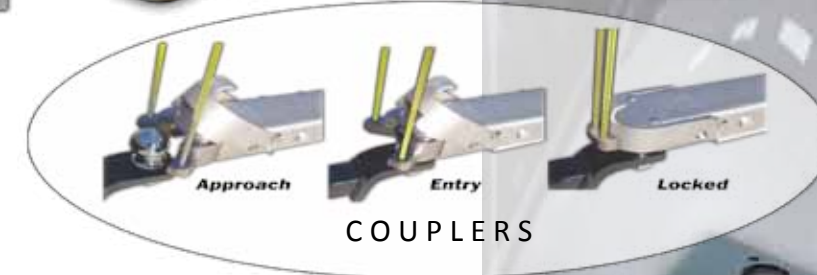

COUPLERS

For nearly 50 years, the concept of the trailer coupler has remained virtually unchanged. Quickbite™ not only revolutionized the trailer coupler, but its safety features set the benchmark for trailer towing. Why is it the best?

Safety & Security: When the ball enters the hitch, a set of inner jaws close and are immediately captured by a torsion spring loaded outer jaw making it virtually impossible for the ball escape.

Easier Entry: A 5" horizontal and increased vertical capture area lessens margin for error when backing into hitch.

Dual Rod Alignment System: Patented system provides a sighting device for the driver making coupling quicker than ever.

Optional Finishes: All Quickbite™ couplers are offered with an XT option (all 300 stainless steel working parts) or an SS option (all 300 stainless steel) ideal for salt water applications. All couplers are offered with either powder coat, zinc oxide or zinc plate finishes. [Click to buy product online](#)

Models

A-Frame Couplers

Models 7007 & 7007 XT
1-7/8" - 2" Ball; 50° A-Frame Mount;
SAE Class IV @ 10,000 LBS

Models 7700 & 7700 XT
2-5/16" Ball; 50° A-Frame Mount;
SAE rated to 15,000 LBS

Adjustable Couplers

Models 7700A & 7700A XT
2-5/16" Ball; Adjustable Mount; SAE rated to 15,000 LBS; GRD 8 bolts/nuts included

Straight Couplers

Models 7000, 7000 XT & 7000 SS
1-7/8" or 2" Ball; SAE Class IV @ 10,000 LBS;
3" channel mount (spacers available for 2.5" mount).

[Go to www.quickbitecouplers.com](http://www.quickbitecouplers.com)



A-Frame Couplers

Models 7007, 7007 XT, 7700 & 7700 XT
Ideal for travel, horse, utility and cargo trailers.



Adjustable Couplers

Models 7700A & 7700A XT
Ideal for heavy duty applications requiring adjustable mounts.



Straight Couplers

Models 7000, 7000 XT & 7000 SS
Ideal for boat trailers and harsh weather environments.



Locking Safety Pins

Models 700 (Zinc Finish) & 700 SS (Stainless Steel) replace standard safety pin.



**NO
MORE
MESS!!**

System conveniently latches to clip (included) when not in use



Sewer Management System

Make camping's most undesirable job a breeze with Lippert Component's Sewer Management System. The sewage hose is conveniently stored in our detachable swinging composite arm which eliminates unnecessary messes.

Just unclip the arm, swing the arm out to desired position, unscrew the cap, extend the hose and attach to disposal site! No one likes to do this job, but at least now it's easier and cleaner!

- No more need to store hose separately.
- Hooks and disconnects in seconds.
- Durable: Composite storage tube and steel bracketing construction.
- Weld-on or bolt-on applications.
- Easier and cleaner - get back to enjoying your vacation.

[Click here to buy this product online](#)

[...or go to store.lci1.com](#)

TOTAL CONTROL 1

IN WALL SLIDE SYSTEM

The industry leader in slide-outs is proud to introduce the Total Control 1 In-Wall Slide-Out system. This system has made vast improvements over traditional systems that have been around for years giving RV designers more options and flexibility than ever before. Made of lightweight aircraft aluminum, it reduces total system weight without sacrificing strength. All mechanics are located in the wall cavity so there are no more cables or motors to hide giving the coach an instant makeover. Consider the following advantages:

- Heavy duty aircraft aluminum construction
- Extremely light weight
- No mechanical cross shaft
- Powerful; 1,800 lbs. of extend and retract force.
- Easy to seal; Room is firmly contained inside slide wall.
- Only 4 running amps for a 1,000 lb room.
- Easy to build slide boxes - all square cuts

...and most importantly...

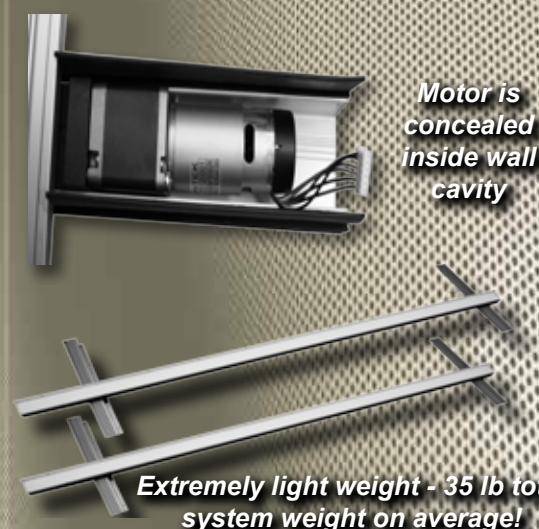
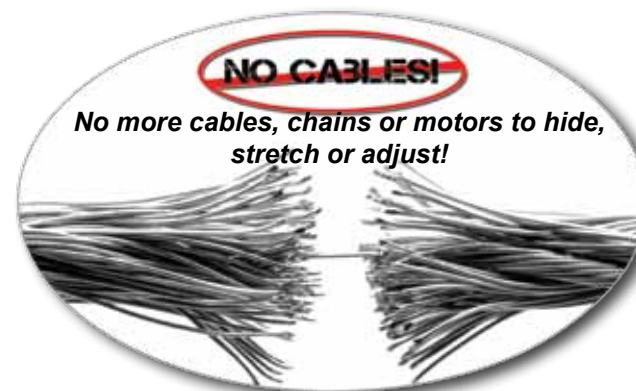

HYDRAULIC SLIDE SYSTEMS



LCI Hydraulic Slide-Outs

Why are Lippert's hydraulic slide-out systems a cut above the rest? Consider these advantages:

- Faster than electric slide-out systems - cuts down on the time it takes to set up your campsite.
- One power source vs. multiple power sources.
- Hydraulic systems can handle heavier rooms.
- One switch vs. multiple slide switches.
- Smoother room movement.
- Less wiring needed to operate all slides.
- One manual override instead of multiple in case of slide-out power issues.

Lippert's hydraulic slide-out systems are made with quality parts. Slide kits contain slide arms, hydraulic power unit, cylinders, hydraulic plumbing/fittings and strapping.

LCI has long been the leader in electric and hydraulic flush floor slide-out systems. With impeccable service, LCI will ensure that your slides work for many trips to come.



Flex Guards by LCI

Lippert Component's patented flex guard system utilizes a heavy duty flexible rail, which offers support and protection to vital slide-out plumbing, wiring and hoses under the slide room floor. The Flex Guard smoothly straightens during extension, and safely bends in an arc as it contracts. This unique design prevents sagging during slide out operation as well as the unnatural bends and stresses that can lead to breakage. These kits are an upgrade on any unit that uses a 1/4" steel rod or swing arm for the same application. Choose between single, double and triple flex guard kits. All kits come with an 8" mounting post with washer and five flex guard clips. After-market installation kits with hardware are also available.



Triple Flex Guard kit



[Click here to buy product online](#)
or go to store.lci1.com

Slide-Out Slicker



The very first thing in any RV that shows wear is the carpet on each side of a slide room. It does not matter if you own a \$20,000 or \$500,000 RV, the Lippert Component's RV Slide-Out Slicker is a must have product to PROTECT YOUR INVESTMENT!

The nearly 40" Slide-Out Slicker comes in a 2-pack and installs in seconds:

Just lift the carpet flap on slide room, lay slicker down against threshold at the end walls and retract the room!

[Click here to buy product](#)
or go to store.lci1.com





24" Single Radius Step



24" Double Radius Step



Triple Retractable Coachstep®

Manual Radius Steps

Lippert Components provides a full line of radius style steps for towable RV's. These steps extend and retract easily with only one hand. All steps have a black powder coat finish that will protect it from the elements. All steps below come with skid tape and tread measures 24" wide.

Single Radius Step

- 24"W Single Radius Step, SKU#235453

Double Radius Step

- 24"W Double Radius Step, SKU#235454

Triple Radius Steps

*All triple steps have 24" wide tread.

*Depth between steps vary by SKU.

- 24"W 7" Triple Radius Step, SKU#235455
- 24"W 9" Triple Radius Step, SKU#235456
- 24"W Widebody Triple Radius Step, SKU#235457

Quad Radius Step

- 24"W 8" Quad Radius Step, SKU#235458

[Click here to buy our steps online or go to store.lci1.com](http://store.lci1.com)

Motorized Steps

Formerly known as "Coachstep®," Lippert Components acquired this product line in the spring of 2007. These motorized steps have long since been the industry standard in electric retractable steps for motorhomes. Choose between single, double, or triple retractable step assemblies. Each assembly expands and retracts in seconds. Visit our online store by clicking the link below to see specs and dimensions.

[Click here to buy our steps online or go to store.lci1.com](http://store.lci1.com)



Quick Draw® Roll Out Storage Solutions

Quick Draw® roll out storage systems provides a quick and efficient way to store and easily access your cargo. With its patented latch and lock system, you can easily access hundreds of pounds of cargo with one hand. Make accessing your cargo a breeze today. Quick Draw® storage solutions are quality built and easy to install. Other specs include:

- Powder coat black finish protects from the elements.
- Roll out maximum options include:
 - 60% in both directions
 - 60% in one direction
- Roll out mechanism features durable steel bearing rollers.
- Patented latch and lock system makes extending tray a breeze.
- Evenly distributes up to 400 lbs.

Standard Sizes Available:

20" Wide	30" Wide	40" Wide	50" Wide
20" x 48"	30" x 48"	40" x 48"	50" x 48"
20" x 60"	30" x 60"	40" x 60"	50" x 60"
20" x 72"	30" x 72"	40" x 72"	50" x 72"
20" x 90"	30" x 90"	40" x 90"	50" x 90"

*Note that trays are not limited to these dimensions.

Quick Draw® Battery & LP Trays

Make accessing your batteries or LP tanks a breeze with our Quick Draw® sliding storage solutions. Using the Quick Draw® technology, our battery trays make accessing up to 50 lbs of batteries or two 40 lb LP tanks a breeze. The latch and lock system lets you access your batteries or LP tanks with one hand. Other options/specs include:

- Single or double battery tray options.
- Steel bearing rollers strong enough to handle up to two group 27 batteries, 50 lbs total.
- Easily supports two 40lb LP tanks.
- Powder coat black finish protects from the elements.



Quick Draw® Sliding Storage Tray



Quick Draw® Patented Latch System



Sliding LP Tray



Double Battery Tray



Bike rack in storage

Sliding Bike Rack



Folding Bike Rack



1-1/4" Receiver Bike Rack



1-1/4" Receiver Spare Tire Carrier



Spare Tire Winch with Offset Cable

Sliding/Folding Bike Rack Storage

LCI offers multiple ways to tow your bikes along for the ride. Our sliding bike racks not only conveniently store your bikes while towing, but also double as additional storage for large bulky items. How? The open construction of the LCI sliding bike rack and self storing bike post allows for storage of just about anything. Other advantages include:

- Twin dial rolling arms.
- Two position locking arms.
- 2000 lb storage capacity.
- Powder coated steel frame provides protection from the elements and worry free maintenance.
- Bike rack easily removes if needed.

Our folding bike racks come in an aluminum or black powder coat finish. Like our sliding bike racks, the bike rack arm easily detaches when not in use. When in the "up" position, the rack is held in place by two heavy duty pins. Folding bike racks are rated up to 150 lbs.

Also available are stationary 1-1/4" receiver bike racks. Latching pin included.

Spare Tire Racks/Winches

LCI also provides various styles of spare tire carriers and winches. Left is the 1-1/4 hitch receiver tire carrier that comes complete with hitch pin. Right (on next page) we offer spare tire options with our underchassis storage solutions. Winches come in several applications. Standard winch is bolt on and uses a standard crank handle to ease cable tension.

[Click here to buy products online](#)



Underchassis Storage Systems

LCI's underchassis storage systems are a great way to increase storage and ease of accessibility for your cargo. Keep maintenance supplies, tools, cords and other cargo safely and securely underneath the frame of your coach. By disengaging the spring loaded latch, the unit easily slides out for easy access to your stored cargo. An optional spare tire carrier makes this product even more useful and convenient. Anyone who has had to change a coach tire knows that easy access to the spare tire saves time and energy. To access the spare tire, simply slide the unit out, lift out the storage bin and the spare tire will slide to within reach.

- Single and double applications.
- Spare tire option available on double units.
- Spare tire option includes tire winch.
- Powdercoated side channels protect against the elements.
- Double unit includes two detachable molded storage boxes with lids.

Increase your storage capacity today with this great product.

[Click here to buy product online or go to store.lci1.com](#)



Double underchassis storage unit



Shown with spare tire option



Removable storage bin



Spare tire rack extended.





TOW N STOW™

Trailer and Storage Unit

The smart solution for towing and storage...



Light enough to be towed with a sedan.

Whether you have towing needs once a week or once a year, the Tow-N-Stow is the smart solution. Use your smaller passenger vehicle to haul anything from mulch, to building supplies, to your lawn tractor or 4-wheeler. Afterwards, convert the trailer into a lockable, watertight storage unit. Store it next to your house, inside your garage or wherever you need. Housing association won't let you keep a trailer in your driveway? No room in your garage? No problem! In storage mode the Tow-N-Stow blends nicely into most home exteriors. Interested? Read on!

- Watertight trailer w/ nearly 50 cubic ft of capacity
- Weighs 500 lbs. Tows up to 1000 lbs.
- Tow with virtually any vehicle (Class 1 hitch needed)
- Key locking doors and tailgate
- Removable tailgate allows for ramps/long loads.
- Multiple cargo tie down options
- Converts from trailer to storage unit in seconds
- Optional shelving system allows for multiple storage choices and variations
- Attractive, weatherproof, lockable & secure
- Made in the USA



No truck? No problem. You don't need a gas guzzling engine to do your hauling needs (up to 1,000 lbs). Tow-N-Stow is the smart solution.

Haul it.
Store it.
Use it year-round



www.tow-n-stow.com



At 500 pounds, Tow-N-Stow is easily transported.



Transforms from trailer to storage unit in seconds.



Stores itself and a whole lot more.



Touch Audio

TOUCH YOUR WAY
TO THE NEXT
GENERATION OF
12V MULTIMEDIA
SYSTEMS...



Designed with today's technology, the Touch Audio multimedia system offers a touch screen display with large, easy to read labels. Quality built and designed to resemble many of the leading producer's portable media systems, the Touch Audio is sure to captivate the attention of any customer. The generous offering of connection possibilities ensure the Touch Audio will overpower the competition. The Touch Audio also offers three zone entertainment. With the touch of a finger, you can move the party from the inside to the outside. The Touch Audio multimedia system is the complete package!

Specifications Include:

- AM/FM/CD/DVD
- USB Port (I-Pod/MP3 Compatible)
- SD Card Input (Memory Cards/Digital Camera)
- Audio Input/Output for external TV
- 270 Watts of Pure Power (45 per channel)
- Bass Boost
- Full Remote Control
- Zone Entertainment Selector (A-B-C)
- Alarm Clock



[Click here to download product literature](#)





FOILED AGAIN!

Loop it, lock it and leave it. ToyLok's® tamper resistant design makes it nearly impossible for scavengers to swipe your precious items. ToyLok® secures your property in just seconds, eliminating the hassle of storing everything inside the coach for safe keeping. Get to enjoying your vacation and thanks to ToyLok®, your toys will be there when you get back.

FEATURES

- Original steel model (TL1020) welds or bolts on to coach frame.
- PVC coated cable safeguards your gear from abrasion and damage.
- Internal pulley and breaking system allows you to choose your optimal length of cable.
- Built in clutch prevents cable snap back when retracting.



TL2021
New Compact
Nylon Design
Only 5.5 lbs
15 Feet of cable



TL1020
Original Industrial Strength
Steel Design
(padlock not included)
Weighs 18 lbs.
18 feet of cable



TV LIFT

Lippert Components introduces another quality product for RV's: **Power TV and Cabinet Lifts.** These space saving products are made of tough gauged steel yet are durable and lightweight. This innovative flexible mounting system accommodates a wide variety of installations.

- Save countertop space when not in use.
- Optional universal fit mounting brackets available.
- Optional remote control or manual switch applications available.
- All manual version available soon.
- Same mounting system can be applied to overhead cabinets.

Adjustable TV Mounts



LCI's adjustable TV mounts are a cost effective way to save on space and add flexibility to entertaining. Our universal mount system will fit any TV on the market. Swivels up to 180°. Adjust TV face position with additional swivel.

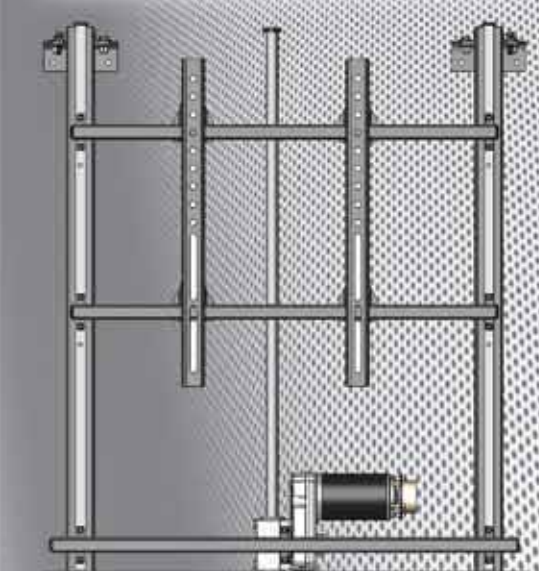

Lippert TV Lifts utilize a "power up/ power down" drive mechanism that operates smoothly without any "shake" or "shimmy."

Wireless Remote Systems

by  LIPPERT COMPONENTS, INC.



New Waterproof Remote with backlit buttons.

Press to illuminate remote. No more guessing!



Power Awnings



Power Landing Gear



Control Multiple Lighting Functions



Electric Stabilizer Jacks Systems



Control Multiple Slide-Out Systems

If everything was this easy...
Lippert Components 4-8 Function
Wireless Remote Systems

Get to camping...
In seconds!
Call your sales
rep today!



LED Style Remote



Power Cord Reel

Lippert Components is proud to introduce another great to product to the Recreational Vehicle Industry;

The Power Cord Reel

Heavy, bulk cords are extremely difficult to wind up and store, period. Our power cord reel makes this job as easy as flipping a switch. With its powder coated steel mounting plates, it self-stores by bolting on easily in most lower cargo areas. The LCI power cord reel only makes you use what you need. There is no need to drag an entire cord out of the camper to hook up. When you're done, flip the switch and hit the road! Call your sales rep today!

Folding Dinette Table

At LCI, we know that utilizing interior space is a must. This great new product is a functioning dinette table during the day. When you're ready to convert your dinette into a bed, simply turn the latch and collapse the table to use as a support for your bed. There is now no more need to take apart table legs and store them while the dinette is in bed position. Completely portable, this table can serve many functions. Take it outside for eating or recreation. With LCI's folding dinette table, things just got a little easier. Call your sales rep today!

1 1/4" Welded Hitch Receiver

Stop running into warranty issues by installing your own hitch on your camper. With LCI's new welded hitch receiver, you can now haul small items behind your coach that you would have otherwise had to leave behind. Attach anything from aftermarket bike receivers to exterior cargo carriers. CSA rated at 250 lbs, you can safely tow additional cargo with a system that was designed for your coach.



Because everything is riding on our reputation...

From humble beginnings, Lippert Components, Inc has grown from a small steel fabrication shop in rural Michigan to the leading supplier of components in the United States to the RV and Mobile Home industries. Vast product offerings, cutting edge innovation and superior customer service have gotten us to where we are today. We are dedicated to innovating and staying ahead of market sales trends in order to enhance the overall camping experience. LCI never rests until the customer is happy. For the last 50 years, Lippert Components has achieved success with its working relationships with their customers, its service and its quality...and will continue for then next 50 years and beyond.



LIPPERT COMPONENTS, INC.
LEADING SUPPLIER TO THE RECREATIONAL VEHICLE INDUSTRY

Contact Us Today

Corporate Headquarters
2703 College Ave.
Goshen, IN 46528
(P) 574-535-1125

Service and Warranty
1-866-LCI-SVC1 (1-866-524-7821)

www.lci1.com

Visit our online store at store.lci1.com

LCI is ready to serve you coast to coast. Click [here](#) to see our location map. Wherever you are, LCI is ready to serve you.

Lippert Components, Inc and its affiliates reserve the right to change designs and specifications without notice and assumes no responsibility for any error in this literature. This catalog supersedes all previous catalogs and items. Designs and trademarks are not for sale and are the sole property of Lippert Components Inc and its affiliates.

The standard by design...

2010-2011 Product Guide



HAPPIJAC

A Division of Lippert Components Inc.

For over 45 years, Happijac® has been producing the highest quality products for the RV industry. Dedicated to manufacturing the safest and highest quality products, Happijac® is the industry leader in vertical bed lifts, upgradable camper jacks, space efficient room slides, and the only camper tiedown system that efficiently controls camper movement in all directions. Since 2008, Happijac® has overseen JT's RV Accessories, maker of the Strong Arm Jack Stabilizer.

***Nothing else performs like a Happijac®,
because nothing else is made like a Happijac®.***

Visit us online at www.happijac.com

**Camper
Jack Systems**

**Direct-to-Frame Camper
Tiedown Systems**

Qwik-Load

SecureTrac
Fixed Frame Slides



HAPPIJAC
Power Bed Lift Systems



QUICK DRAW
The Toolbox That Comes to You

Camper Jack Systems

By  **HAPPIJAC**

THEY'RE SAFE, STRONG, ATTRACTIVE & EASILY UPGRADABLE



ACME Screw

Ball Screw

Happijac's Acme Screw jacks offer the industry's first redundant safety check system in an acme screw jack. By providing an additional fail-safe safety nut, Happijac's Acme Screw jack protects you and your camper against mishaps or failure. Happijac's Acme Screw jack can safely lift an astounding 1500 lbs. per jack (according to ANSI standards for dynamic (moving) loads).

Happijac's heavy-duty Quick Release Ball Screw jack utilizes over 140 chrome-moly steel ball bearings in a dual circuit configuration, providing a redundant fail-safe system that insures strength and reliability under the most demanding loads. The Happijac Quick Release Ball Screw jack can lift an incredible 1900 lbs. per jack (according to ANSI standards for dynamic (moving) loads). A precision, polished, black oxidized, alloy steel screw provides smooth, easy operation. Best of all, it's the only quick release jack that can operate with an electric option making leveling your camper quick, simple, and stress-free.

All Happijac camper jacks feature 2" square tubing which is significantly stronger than round tubes. Powder coated inner and outer tubes protect against rust. Unique concave (cupped) footpads reduce movement and provide maximum stability. Happijac camper jacks also feature the Z-bracket mounting system which is easily installed and/or retrofitted onto most campers. Best of all, **Happijac Acme (4150) and Quick Release Ball Screw (4600) jacks can easily be upgraded from manual, hand crank jacks into a remote controlled electric jack system with the purchase and simple installation of the Happijac motor drive assembly kit (600500) and wiring kit (600530).**

Since 1963, Happijac has conducted extensive research, testing, and development to produce the safest, strongest and most versatile camper jacks available today.

With Happijac's simple approach, every Happijac camper jack is upgradable from manual to electric and will fit any corner of your camper. Simply determine the load you are lifting, whether you want manual or electric operation and the number of jacks needed. It's that simple.

CAMPER JACKS

By  **HAPPIJAC**

Includes 2 jacks, mounting brackets and a standard manual crank. All Happijac camper jacks are upgradable to a remote controlled electric motor driven option in mere minutes.

Acme Screw Jack - 1 pair	4150UU.2ZS	(182468)
Quick Release Ball Screw Jack - 1 pair	4600UU.2ZS	(182481)

ELECTRIC OPTIONS

By  **HAPPIJAC**

All Happijac camper jacks can easily be upgraded from manual jacks into remote controlled electric jacks with the purchase and simple installation of the Happijac motor drive assembly kit (600500) and wiring kit (600530). Each Happijac electric motor drive assembly kit (600500) includes 4 motor drive heads, main logic board, remote controller and a coiled remote cable.

Electric Motor Drive Assembly Kit	600500	(182514)
Electric Wiring Kit	600530	(149583)

PARTS & ACCESSORIES

By  **HAPPIJAC**

Standard 4" Crank Handle	320000S	(182436)
Long 8" Crank Handle	320000L	(1824362)
6" Lift Extenders (Set of 4)	530000	(182495)
Single Acme Screw Jack ¹	4150UU.100	(182463)
Single Quick Release Ball Screw Jack ¹	4600UU.100	(182484)
Single Electric Motor Drive Head	600510	(182515)
Swing Out Extension Brackets (for dually trucks) - 1 pair	540000	(182496)
Remote Controller	600520	(183070)
Main Logic Board	600540	(183069)
Coiled Remote Cable	636320	(149557)

¹ Does not include mounting brackets or cranks.

SUGGESTED JACK PACKAGES

By  **HAPPIJAC**

Each suggested jack package consists of 4 jacks (with mounting brackets and standard cranks); for the electric option simply add a motor drive assembly kit and electric wiring kit. Refer to the guide below for the suggested package that's right for your camper.

	Basic (campers under 2,000 lbs)	Standard (campers over 2,000 lbs)	Deluxe (campers over 4,000 lbs)
Jacks	2 pair ACME Screw Jacks 2 x 4150UU.2ZS (182468)	1 pair ACME Screw Jacks 4150UU.2ZS (182468) 1 pair Quick Release Ball Screw Jacks 4600UU.2ZS (182481)	2 pair Quick Release Ball Screw Jacks 2 x 4600UU.2ZS (182487)
Electric Option	Electric Motor Drive Kit 600500 (182518) Electric Wiring Kit 600530 (149583)	Electric Motor Drive Kit 600500 (182518) Electric Wiring Kit 600530 (149583)	Electric Motor Drive Kit 600500 (182518) Electric Wiring Kit 600530 (149583)

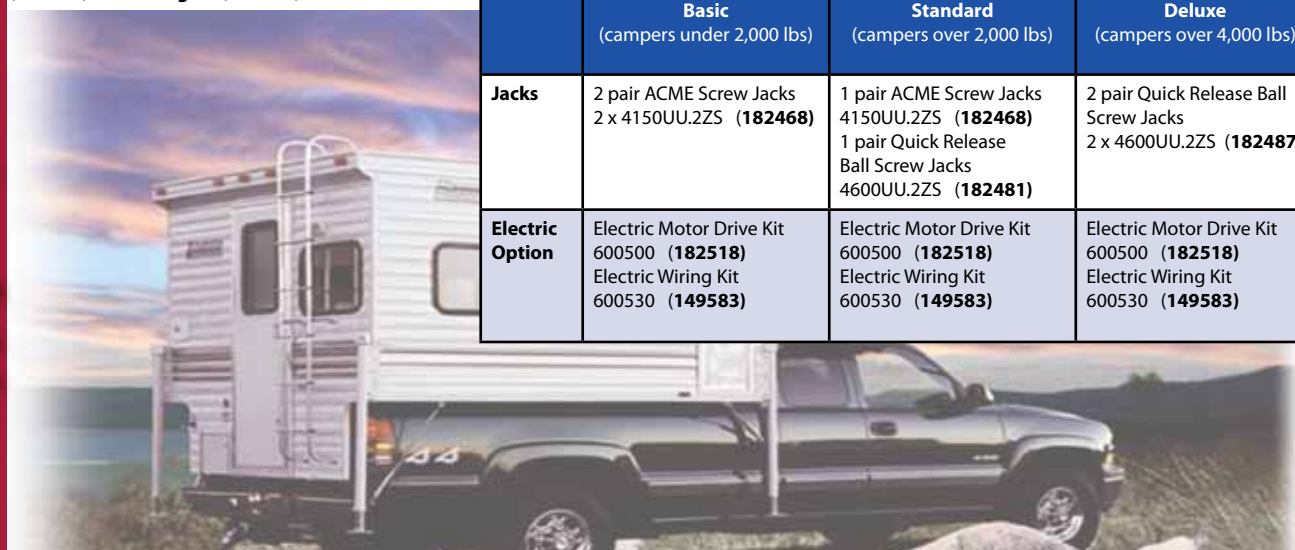

Qwik-Load™

Lever-Action Turnbuckles

- Allows for **adjustment** of turnbuckle **after installation**
- Removable handle** streamlines appearance and deters theft
- Locking pin** to ensure safe and secure performance
- Comfortable handle**

Load & Unload your camper easier than ever!

Qwik-Load Turnbuckles

Load and unload your camper easier than ever before with the Qwik-Load™ lever-action turnbuckles from Happijac®. These strong, lever-action turnbuckles provide quick installation. There is no need to remove the turnbuckle to make tension adjustments. Featuring a stainless steel barrel and a comfortable, removable handle.



Turnbuckles

The time tested, industry standard, Happijac® turnbuckles (FM-TB) are proven performers. It includes 2 ea. spring-loaded front turnbuckles and 2 ea. stress-guard rear turnbuckles with stainless steel components for superior corrosion protection.



Item	Description
182898 FM-TB	Stainless Steel Turnbuckle Set
182901 FM-TBS	Single Stainless Steel Front Turnbuckle
182900 FM-FM-TBR	Single Stainless Steel Rear Turnbuckle

Qwik-Load™ Upgrade

Upgrade your existing turnbuckles to lever-action with the FM-QL. The Qwik-Load™ upgrade (FM-QL) comes with 4 Qwik-Load adapters, 4 ea. locking pins, and 4 ea. removable handles. The Qwik-Load™ upgrade is compatible with any turnbuckles using 1/2" threaded rod.



Item	Description
182898 FM-QL	Qwik-Load Upgrade Kit

Long-Action Turnbuckles

Happijac® now offers reach below the side of the truck turnbuckles in 40" Long Action. The FM-QLLA includes 2 Qwik-Load™ lever action, spring loaded, stainless steel turnbuckles. The FM-TBLA includes 2 spring loaded, stainless steel turnbuckles.



Item	Description
191380 FM-QLLA	Qwik Load Long Action
191431 FM-TBLA	Spring Loaded Turnbuckle Set (Long Action)

Item	Description
182895 FM-QLTB	Qwik Load Stainless Steel Turnbuckle Set

Camper Jacks

Happijac®, Inc

Qwik-Load™ Lever-Action Turnbuckles

Happijac®, Inc

Direct-to-Frame Camper Tiedown Systems

CONTROLS CAMPER MOVEMENT IN ALL DIRECTIONS

By **HAPPIJAC**
A Division of Support Components

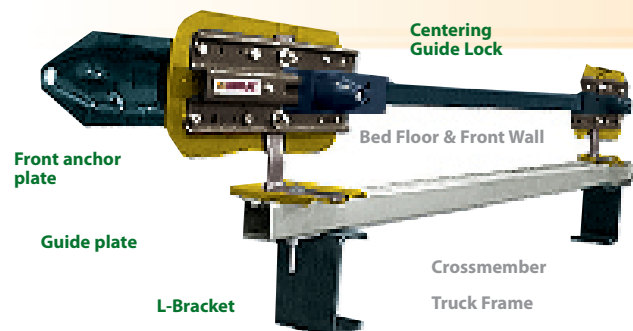

After extensive research Happijac Company has perfected an innovative Frame Mount Tiedown System that is three times stronger than other tiedowns and controls all aspects of securing a camper to a truck. While other tiedowns may "hold your camper down" only Happijac tiedowns prevent camper movement in all directions (forward-backward, up-down, left-right, yaw, pitch and roll). The Happijac Frame Mount System combines the proven design of Happijac Camper Anchor tiedowns with Happijac's patented Direct-to-Frame mount, providing the customer with unsurpassed strength, handling, and ease of use while also featuring quick and simple installation.

The complete Happijac Frame Mount Tiedown System consists of three components:

- (A) FT tiedown kit with centering guide locks (FT-UT9, FT-CG9, FT-CG07, FT-CG07S, FT-DR8 or FT-DR2).
- (B) Turnbuckles (FM-QLTB or FM-TB)
- (C) Stabilizing Bar (USB-010, SB-080 or SB-020)

DIRECT-TO-FRAME TIEDOWN COMPONENT - (A)

By **HAPPIJAC**

FT Kit (now includes centering)

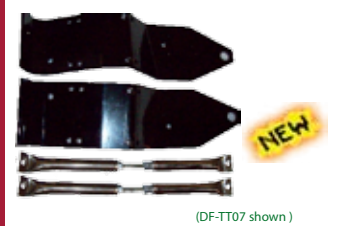
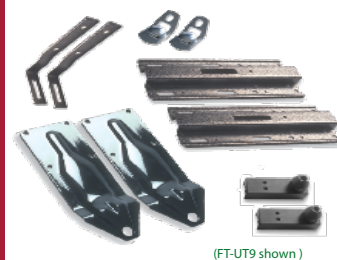

CHEV / GMC		
2007 - 2010 Chev/GMC Silverado/Sierra (new body style)	FT-CG07 ^{1,3}	(182904)
2007 - 2010 Chev/GMC Silverado/Sierra (new body style)(except extended cab)*	FT-CG07S ^{1,3}	(182905)
1999 - 2007 Chevrolet Silverado Classic	FT-CG9 ¹	(182906)
1999 - 2007 GMC Sierra Classic	FT-CG9 ¹	(182906)
1988- 2000 C/K Series (old body style)	FT-UT9 ¹	(182910)
DODGE		
2010 Ram 1500, 2500, 3500	FT-DR10 ⁵	(236326)
2008 - 2009 Ram (w/bed front panel waffle-like pattern)(except 1500)	FT-DR8 ⁵	(205220)
2003 - 2008 Ram (w/bed front panel vertical ribs only) (Including 2002 Ram 1500)	FT-DR2 ²	(182908)
1994 - 2002 Ram (except 2002 Ram 1500)	FT-UT9 ¹	(182910)
2002 Ram 1500	FT-DR2 ²	(182908)
FORD		
2008 - 2010 F450 SuperDuty	FT-UT9 ¹	(182910)
1997 - 2010 F250 SuperDuty & F350	FT-UT9 ¹	(182910)
1980 - 1996 F Series (all)	FT-UT9 ¹	(182910)
TOYOTA		
2007-2010 Tundra (except 5 1/2' Bed)	DF-TT07 ⁴	(184089)

TURNBUCKLE COMPONENT - (B)

By **HAPPIJAC**



Qwik-Load stainless steel turnbuckle set (2 FM-QLTBS & 2 FM-QLTBR)	FM-QLTB	(182895)
Stainless steel turnbuckle set (2 FM-TBS & 2 FM-TBR)	FM-TB	(182898)
Qwik-Load lever action turnbuckle upgrade	FM-QL	(182894)

STABILIZING BARS - (C)

By **HAPPIJAC**



59.25" Stabilizing bar (use with FM/FT UT9 & CG9)	USB-010	(182971)
57.375" Stabilizing bar (use with FM/FT DR2)	SB-020	(182928)
56.875" Stabilizing bar (use with FT-DR8)	SB-080	(205221)
69" Stabilizing bar (use with CA-UT8: 1980 - 98 Ford)	SB-150	(182930)
66.75" Stabilizing bar (use with CA-DRL: 1994 - 2002 Dodge Ram)	SB-200	(182931)

* If extended cab use FT-CG07. ¹ Stabilizing Bar USB-010 Required, sold separately. ² Stabilizing Bar SB-020 Required, sold separately.

³ Includes FM-CBB07. ⁴ Does not require Stabilizing Bar. ⁵ Stabilizing Bar SB-080 Required, sold separately

CAMPER ANCHOR TIEDOWNS

By **HAPPIJAC**

Happijac continues to offer their time tested Camper Anchor tiedowns. The scientific design of Happijac Camper Anchor tiedowns gives maximum strength while eliminating leverage and stress forces on the truck. A removable rear tiedown coupler rotates to direction of pull, eliminating undesirable torque. Happijac Camper Anchor tiedowns won't bend, twist or fail.

NOTE: Camper Anchor tiedowns do not mount to the frame as do the Happijac Frame Mount tiedowns. Camper Anchor tiedowns are not for use on full-size extended cab, crew cab, 4x4, diesel trucks or with campers over 2500 lbs. These applications require the Happijac Frame mount tiedowns (FT kit).



CHEV / GMC		
1973 - 1987 C/K Series	CA-CG3	(182853)
1967 - 1972 C/K Series	CA-FU	(182862)
1973 - 2010 S-10, S-15, Canyon & Colorado	CA-UR ¹	(182866)
DODGE		
1994 - 2002 Ram (except 2002 Ram 1500)	CA-DRL ⁴	
1991 - 1993 Ram	CA-FU ⁴	(182862)
1972 - 1990 Ram	CA-FU	(182862)
1997 - 2010 Dakota (except crew cab)	CA-DK9	(182856)
1987 - 1996 Dakota	CA-DRL	(182858)
FORD		
2004 - 2010 F150	CA-FD4	(182860)
2004 - F150 Heritage	CA-FD7	(182861)
1997 - 2003 F150 & F250 under 8500 gvw (except 2002)	CA-FD7	(182861)
1966 - 1979 F-Series (except 1979 F350 w/ side tire)	CA-FU	(182862)
2010 and earlier Ranger	CA-UR ¹	(182866)
TOYOTA		
1989 - 2010 Toyota (only with campers under 1500)	CA-UR ¹	(182866)
1988 and earlier Toyota	CA-MT	(182864)
ISUZU		
1989 - 2010 Isuzu	CA-UR ¹	(182866)
1988 and earlier Isuzu	CA-MT	(182864)
MAZDA		
1994 - 2010 Mazda	CA-UR ¹	(182866)
1993 - and earlier Mazda	CA-MT	(182864)
NISSAN		
1998 - 2010 Nissan	CA-UR ¹	(182866)
1997 - and earlier Nissan	CA-MT	(182864)

PARTS, FIT KITS & ACCESSORIES

By **HAPPIJAC**

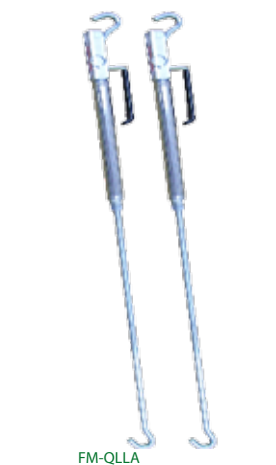

Universal Rear Anchor	CA-UR	(182866)
Chrome Anchor Bolt (Including Hardware)	CA-AB	(182852)
Chrome Coupler	CA-TC	(182865)
Front Anchor Plates (Set of 2)	FA-UT9	(182876)
Front Anchor Plates (Set of 2)	FA-CG9	(182872)
Front Anchor Plates (Set of 2)	FA-CG07	(182870)
Front Anchor Plates (Set of 2)	FA-CG07S	(182871)
Dodge Adapter Kit	FK-DAK	(182880)
Centering Guide Lock Spacer Kit for 1999+ Ford with tail	FK-GBS	(182883)
Replacement Fit Kit for FM / FT-UT9	FK-UT9	(182884)
Replacement Fit Kit for FM / FT-CG9	FK-CG9	(182878)
Front Centering Guide Locks (includes 2 rollers and 2	FM-FGL9	(182892)
Bumper Brace (1999 - 2010 F250 SuperDuty & F350)	FM-BB9	(182885)
Bumper Brace (2007 - 2010 Chev/GMC)	FM-CBB07	(182887)
Qwik-Load Front spring-loaded turnbuckle w/11" threaded hook (1 ea.)	FM-QLTBS	(182897)
Front spring-loaded turnbuckle w/11" threaded hook (1 ea.)	FM-TBS	(182901)
Qwik-Load Rear stress-guard turnbuckle w/24" threaded hook (1 ea.)	FM-QLTBR	(182896)
Rear stress-guard turnbuckle w/24" threaded hook (1 ea.)	FM-TBR	(182900)
Qwik-Load Long Action Spring Loaded w/40" reach (Set of 2)	FM-QLLA	(191380)
Long Action Spring-Loaded Turnbuckle w/40" reach (Set of 2)	FM-TBLA	(191431)
11" threaded hook (zinc plated -1 ea.)	TBH-11	(182969)
24" threaded hook (zinc plated -1 ea.)	TBH-24	(182970)

Need help? [Click this link to use our tiedown selection guide - now that's easy!](#)



Attention Fifth Wheel and Travel Trailer Owners: Stop Unwanted Chassis Movement!

With the Original, Patented JT's Strong Arm Jack Stabilizers™

JT's Strong Arm Jack Stabilizer system is a one time, permanent installation that virtually eliminates chassis movement in fifth wheels and travel trailers and eliminates the need for ineffective trips.



Stabilize All Types of Jacks

The patented universal system is designed to attach to the three main types of jacks found on RVs: Scissor, Electric and Telescoping. Each kit contains six stabilizer tubes. Four attach to the front of the coach and two on the rear. It's a bolt-on kit designed for installation by your dealer or the do-it-yourselfer.

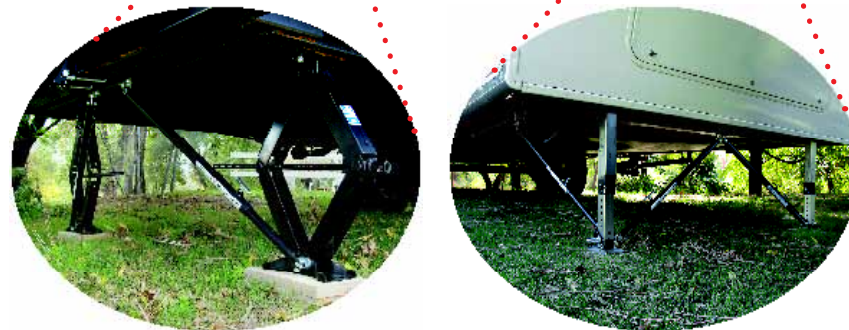

The Power of Triangulation

Using a unique system of custom designed and engineered clevises, swing-bolts and mounting hardware, one end of each stabilizer tube attaches to a leveling jack and the other end to the RV frame, forming a rigid triangle – the strongest shape in nature! There's no welding required and no need to remove and reattach during set up. It's permanent! When parked, JT's Strong Arm Jack Stabilizers telescope into place with the jack and a twist of the "T" Handles locks the system in place. It's that simple!

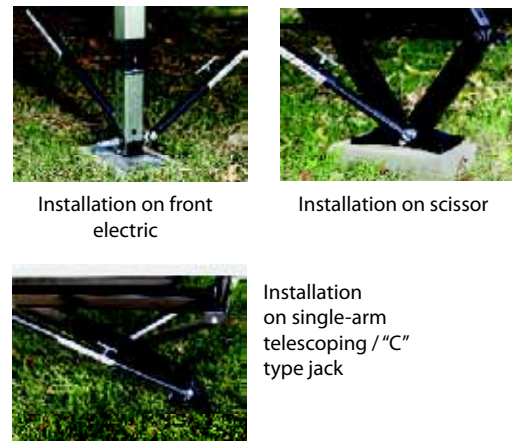

Installation on front electric

Installation on scissor

Installation on single-arm telescoping / "C" type jack

DESCRIPTION	MFG#
5th Wheel Jack Stabilizer (SJS100-S/T)	191023
5th Wheel Jack Stabilizer (SJS100-S/T/SHORT) ¹	191024
Travel Trailer Jack Stabilizer (SJS200-S/T)	191025
T-Handler (SJS5001)	191392

¹Where the distance between the front electric landing gear is less than 58 inches

Enhanced Comfort and Stability for Your RV Lifestyle

[Click here to buy JT's Products Online](#)
...or go to [store.lci1.com](#)



U.S. Patent #7,188,842



Finally, A More Stable Jack Pad

For 5th Wheels and Travel Trailers!



With JT's Elephant Foot Jack Pads™

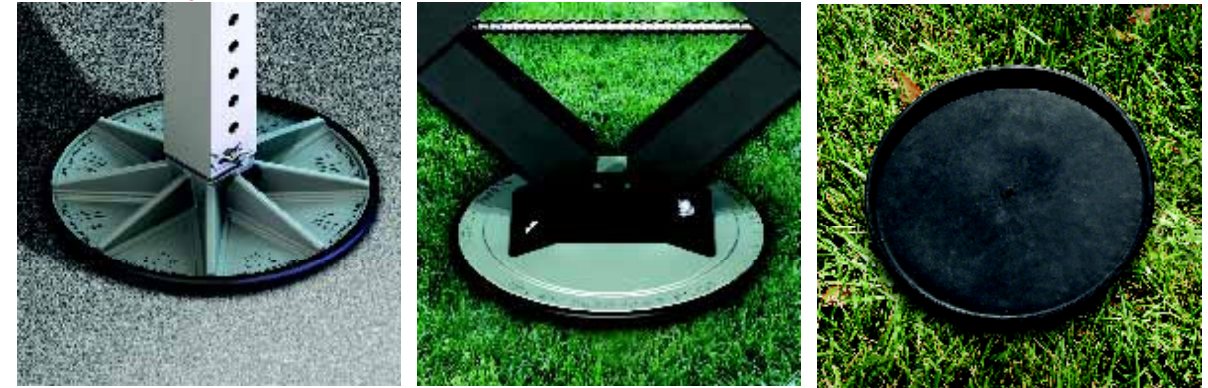

JT's Elephant Foot Jack Pads are 10 inch diameter pads of thick, sturdy composite for the toughest terrain. They replace the small, metal pads on front electric landing gear and are add-ons to scissor and single-arm telescoping or "C" type jacks. The jack pads provide 78 square inches of footprint – over twice the footing provided by standard equipment. JT's Elephant Shoes are made of durable molded rubber to fit snugly over our Elephant Foot jack pads to keep your coach from sliding on hard, smooth surfaces. **FREE** set of Elephant Shoes with purchase of any complete set of four JT's Elephant Foot Jack Pads!



DESCRIPTION	MFG#
5th Wheel Trailers - Set of 4 (includes free set of 4 Elephant Shoes) (EFJP-6100)	191386
Travel Trailers - Set of 4 (includes free set of 4 Elephant Shoes) (EFJP-6200)	191387
Electric jack pads - 1 pair (EFJP-6001E)	191388
Scissor or Telescoping jack pads w/connection hardware - 1 pair (EFJP-6012S/T)	191389
Elephant Shoes - 1 pair (EFJP-6500S)	191390

JT's RV Accessories — Manufacturer of the Original, Patented JT's Strong Arm Jack Stabilizer™ [www.happijac.com](#)

Leveling Made Easy!

With JT's LVL-1 Wireless Digital Level™

LVL-1 Wireless Digital Level eliminates guesswork and multiple trips between truck and coach during the leveling process. The "sending unit" mounts inside your coach, along the line of the axles and communicates wirelessly to the hand-held "receiver unit" which attaches to the visor of your tow vehicle. The receiver's liquid crystal display indicates how far your coach is out of level (both side-to-side and front-to-back) to 1/10th of a degree, then automatically computes location and amount of compensation required, in inches, to achieve level side-to-side. A "Mode" button enables you to switch from side-to-side to front-to-back leveling. The smartest level you'll ever use. You've tried the ones that don't work, now try the one that does! A New Standard in RV Leveling Systems

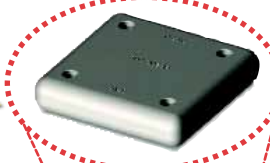

- The Smartest Level You'll Ever Use
- Takes the Guesswork Out of Leveling
- Accurate to Within a Tenth of a Degree



Sending unit mounts inside coach along line of axles; transmits wireless signal to receiver unit on visor in tow vehicle. Requires (4) AA batteries and (1) 9-volt battery (sold separately)



HAPPIJAC[®]
Power Bed Lift Systems

Happijac Keeps
Raising the ~~Bar~~
BED



Happijac Power Bed Lifts

Happijac has set the bar. For the past decade, Happijac has been the industry leader in RV interior space management. Happijac has engineered quality and secure mechanisms for room slide-outs and reliable lift mechanisms for converting cargo space into bed space and back again. It's not often when manufacturers, dealers and owners agree on something. In this case, they all come together.

Happijac Power Bed Lifts offer many quality features such as quick timing adjustment and pre-assembled base-rail units making installation a snap. A powerful, heavy duty direct drive motor and patented self-contained track make Happijac Power Bed Lifts ultra solid and stable at any height ranging from the floor to the ceiling at the simple flip of a switch.

Looking Good...and Safe Don't let its slim profile and clean appearance fool you. Underneath lies all the strength and versatility you'll ever need in an RV bed lift.

Secure at any Position Now you can securely sleep wherever you want. Simply raise or lower the bed to the desired height. That's it - the bed is ready to use. There are no pins or components to lock into place, set up or store.

Serious Motoring The difference between our bed lifts and others is like comparing a 2 cylinder engine to a V8. Our 1/4HP motor is appropriately over-engineered so you can enjoy our product for the life of your trailer.

E.Q.S. That is the acronym that Happijac Power Bed Lifts have taken on: Easy, Quiet, Smooth. Or is it Efficiency, Quality & Strength? Regardless, it means the best bed system available, period.



Unique Chain Power

- Nickel Plated
- Corrosion Resistant
- Maintenance Free



No Fault Framing

- Powder Coated
- "U" Channel Frame
- Heavy Gauge Steel
- Supports two queen beds and their occupants



Power is not an Issue

- 1/4HP Motor
- 200:1 Gear Ratio
- Under 8 AMP Draw



HAPPIJAC[®]
Secure-Trac[™]
Fixed Frame Slides



Ultra low, space saving profile. Happijac's innovative Secure-Trac[™] above floor slide-outs represent a new standard in storage space optimization. Through reduction of moving parts and drive linkage, as well as the development of a tightly integrated rail and track, these slides are virtually invisible to RV owners. With Secure-Trac[™], manufacturers are no longer bound by conventional space restraints. This simplified approach also allows RV designers

to focus more on the needs and wants of their customers rather than on hiding large and cumbersome mechanisms. With an ultra low profile, options such as a flush floor look, substantial storage space or a bed with box springs become possible without extra weight or expense. Their ultra low profile provides unprecedented living and storage space. A double ram and unique captured track design deliver smooth, stable, no play operation every time. The concise design of Secure-Trac[™] slides contributes to a lower tongue weight by eliminating heavy linkages, drive mechanisms and other compo-



Single Fixed Frame Slide



Dual Fixed Frame Slide - Stanard

Happijac Secure-Trac[™] Fixed Frame Slides come in multiple frame depths and rail lengths as well as untouched quality.

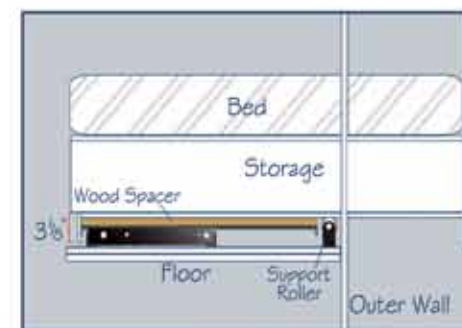

Fixed Frame - trailer application

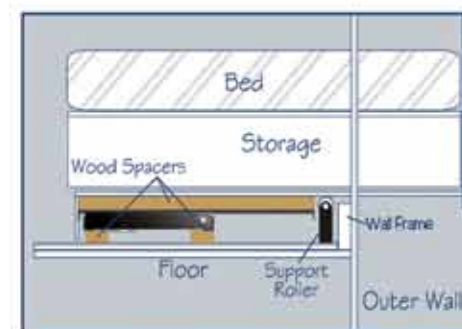

Fixed Frame - 5th wheel overhang

Quick and easy installation and alignment Happijac Secure-Trac[™] Fixed Frame Slides feature a pre-squared frame design that makes installation and alignment simple, fast and trouble free. Simply attach the motor (if using electric), align the factory assembled slide mechanism with the outer wall, bolt the frame to the floor and synchronize the drive rails using Happijac's unique timing adjustment feature. The Secure-Trac[™] unique timing adjustment feature eliminates the tedious synchronization of drive rails during installation. Simply pull back the spring loaded drive shaft to disengage it from the drive mechanism and adjust (~1/8" per tooth). This allows installers to easily match timing to the neighboring track base for a tight seal with the outer wall.

Applications Happijac Secure-Trac[™] Fixed Frame Slides are ideal for use in applications such as:

- Sofa Slides** **Bedroom Slides** **Dinette Slides**
Wardrobe Slides **Room Slides** **Entertainment Slides**



QUICK DRAW

The Toolbox That Comes to You

Proudly brought to you by



Sealed roller bearings make sliding in and out effortless.

Patented latch and lock system.

Make the job easier...

Happijac® Inc proudly brings you another quality product, the Quick-Draw Sliding Toolbox. As anyone who uses their truck as a mobile workstation will tell you, accessing your tools and cargo when you have a fully loaded bed is at times a chore in itself. Quick-Draw toolbox systems makes this task a breeze with their patented latch and lock system and sealed roller bearings. The toolbox extends out 60% in either direction, making accessing your tools and cargo simple and convenient. With an expanding line of accessories, Quick-Draw toolboxes are sure to handle any cargo need that you might have. Click the link below or go to www.happijac.com to find a Quick-Draw dealer near you!

[Quick-Draw Dealer Locator](#)



Flatbed Angled Toolbox

Toolbox trays slide out 60% in either direction. No more dead, empty space in the middle.

Pickup Toolbox; Square Style



Optional gun rack accessory

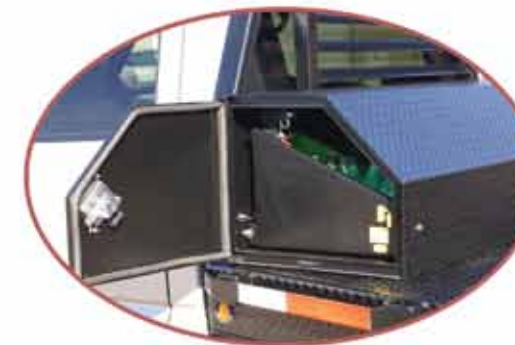

Triple lock system on each end for safety

QUICK DRAW

The Toolbox That Comes to You

Proudly brought to you by



No more crawling to get to your tools

Get to tools easily even if bed is full

Built to handle heavy loads

Tough powder coat finish

Fire extinguisher included

Rubber matt flooring

Rolls out 60% in either direction

Doors are sealed so cargo stays dry

Why work to get your tools when they can come to you?



Bolt bin accessory



Half tray accessory



Tool organizer accessory



4-pack divider accessory

Kinro

2010-2011 Product Catalog
Engineered for Quality
Designed for Reliability

Kinro offers a wide variety of quality RV windows and doors from aluminum to vinyl. Fast and efficient from coast to coast, Kinro is committed to providing the highest quality product at a competitive price.



Click on the images to jump to their pages



Kinro

America's Leading Supplier of Doors and Windows for Recreational Vehicles



HAPPIJAC®

A Division of Lippert Components Inc.

Contact Us

505 N. Kay's Dr.
Kaysville, UT 84037
(P) (801) 544-2585
(F) (801) 546-5241

Visit us on the web at
www.happijac.com

for warranty questions, dealer information or product downloads.

...or click the links below:

[Click here for dealer information](#)

[Click here for warranty](#)

[Click here for tiedown configuration](#)

Happijac® Inc reserves the right to change designs and specifications without notice and assumes no responsibility for any error in this literature. This catalog supersedes all previous catalogs and items. Designs and trademarks are not for sale and are the sole property of Happijac®.



Series 2000 SV



Series 2000 SVS



2800 Series Acrylic Window

[Click here to download Product Literature](#)

RV Radius Awning Windows

RV Radius Awning Window Features Include:

- Large mounting flange for easy installation.
- Fixed pane is drop-in glazed for easy replacement.
- All operating hardware is of zinc or steel construction.
- Sloped sill for better water drainage.
- Offset weep system reduces wind and water penetration.
- Weather exposed vinyl seals are nylon reinforced to control shrinkage.

Also Available:

- Full Egress
- Side Egress
- Egress Picture Window

Euro Style Acrylic Windows

2800 Series Euro-Style Acrylic Window Benefits Include:

- Double paned or dual glazed acrylic is lighter than traditional RV windows.
- Grey tinted acrylic offers more privacy.
- Provides energy saving thermal insulation.
- Automotive low profile design.
- Aluminum frame provides quick and secure mounting in RV wall.
- Removable latch handles.



3000 Series Bonded Window

3000 Series Bonded Window Benefits Include:

- No bulky outer frame.
- All glass flush exterior creates a clean, automotive look.
- Removable screens on all vents.
- Standard clamp ring available for various wall thicknesses.
- Single or dual glazed glass panels.

[Click here to download Product Literature](#)

Deluxe Radius Sliding Windows

8500/8600 Deluxe Radius Sliding Windows Features Include:

- Large mounting flanges for easy installation with clamp ring.
- Sloped sill/stepped sill.

Also Available:

- Full Egress
- Single Glazed (Series 8500)
- Dual Glazed (Series 8600)

Series 8700 Bus Window

8700 Series Bus Window Features Include:

- Removable screen for easy cleaning.
- Offered in both 3" radius and 4" radius sizes.
- Angled window available.
- Availability in contour.



3000 Series Bonded Window



Insulated Series 8600



Series 8700 Bus Window



Vented Exit Picture Window

VEPW Escape Windows

Vented Exit Picture Window Features Include:

- Easy screen removal.
- Easy exit escape latch.
- Positive latching hardware.
- Industry leading vented exit picture window - a sure bet!



Series 2300 Rockguard™ Window

Rockguard™ Windows

Series 2300 Rock Guard Window Features Include:

- Design reduces installation and labor costs.
- Sloped sill/stepped sill.
- Large mounting flange for easy installation.
- Fixed pane is drop-in glazed for easy replacement.

[Click here to download literature for our complete line of RV radius windows or go to \[www.kinro.com\]\(http://www.kinro.com\)](#)



Series 7500 Aluminum Rolling Glass Door

Series 7500 Aluminum Rolling Glass Door Features Include:

- Standard frame for use with wall/sliding types. Lap frame with integral sliding pocket that eliminates the need for additional sliding trim pieces.
- Available in a variety of tempered glazing options in single or insulated glass.
- 5/8" sealed insulated tempered glass with optional Low-E provides optimal thermal performance.
- Heavy duty fin seal weather strip to reduce air, water, dust and noise infiltration.
- Fully adjustable factory lubricated steel tandem rollers mounted with ball bearing ensures trouble free operation.
- Anti-rattle snugger bumper feature in lock jamb keeps the moving panel snug and tight.
- Color coordinated attractive clam type keyed lock mounted on hollow lock jamb for strength and security.
- Full length lip on lock jamb acts as lock strike, not requiring adjustments after the door is properly installed.

[Click here to download Product Literature](#)



Paned option available

Kinro

America's Leading Manufacturer of Windows and Doors for Recreational Vehicles.

Fast and Efficient Coast to Coast

Kinro can provide fast, efficient service across the continental United States. At Kinro, we understand that precise sizing and timely delivery are critical to your manufacturing operation. When you do business with Kinro, rest be assured that your order will be right and right on time. Contact us today to see how we can meet your needs.

Goshen, IN Division
1206 Eisenhower Drive South
Goshen, IN 46526
(P) 574-533-8337 (F) 574 533-6268

Pendleton, OR Division
3700 NW Westgate Dr.
Pendleton, OR 97801
(P) 541-276-4068 (F) 5541-276-4126

www.kinro.com



Kinro, Inc reserves the right to change sizes or details without notice. The customer assumes all risk for alterations made to Kinro Products.

Series 7500 Door meets or exceeds the performance requirement if AAMA 1701.2 Standard, Grade Wind Zone III, AAMA/ NWDA 101/I.S.2 Standard, Grade SGD-R15

K-6

The *Kinro* Commitment

Kinro understands its customers. Since the early 1980's, Kinro has been the leading supplier of quality windows and doors to the RV Industry. Today, Kinro is the largest supplier of RV windows in the country. With 180,000 square feet of manufacturing capacity, there is no challenge that can't be met. Kinro is dedicated to offering a quality product at a fair price.

Quality manufacturing, customer service, and warranty backed products makes Kinro the clear choice.



Click on the images to jump to their pages

2010-2011 RV Product Catalog

Continuing a Commitment to Excellence...

For over 30 years, Kinro Composites™ has been a leading supplier of quality thermoformed bath products to the manufactured housing and RV industries. No job is too big or too complex for Kinro Composites™.

Volume? No problem. Kinro Composites™ operates under 200,000 square feet of manufacturing space. They can utilize up to 9 rotary thermoformers, 2 stationary thermoformers and 5 CNC cutting machines at any given time.

Complexity/Size? Check. Kinro Composites™ is home to a 10' x 25' AVT rotary thermoformer, the largest of its kind in North America. This machine expands the limitations of what thermoforming can do for the RV industry. From front and rear caps, to sides, roofs and floors - anything is now possible.

Kinro Composites™ - Leading Today, Redefining the Limits of Tomorrow

Kinro Composites™

Strength Durability Excellence

PERMALUX PLUS™

Acrylic Alloy Polymer Finish

Permalux Plus™ is a revolutionary new process that combines the gloss and chemical resistance of thermoformed acrylic plastics with the strength of composite technology. Permalux Plus™ is a replacement for gel coat (fiberglass) that is standard for exterior finishes on most composite parts. Consider the following advantages:

- Two times the elongation of fiberglass
- Two part polyurethane backing
- High impact strength: Three times the abrasive resistance of fiberglass
- Superior finish: 10-20% higher gloss than fiberglass
- Cleaner - nearly 0% emission during manufacturing process
- Better UV resistance than fiberglass
- Lighter - lower density than fiberglass
- Chemical and stain resistant
- No chipping, peeling or "spider webs"



ABS/Acrylic RV Bath Tubs



Model 2432CD
24" x 32"

Model 436LHS
24 x 36

Model 2440RH
24" x 40"

ABS/Acrylic RV Shower Pans



Model 34NHCD9
34" x 34" Hex X 9.5"D

Model 37N
37" Angled Pan

ABS/Acrylic RV Shower Surrounds



Model PF244059
24" x 40" x 59"
Picture Frame

Model PF-37N
37" Picture Frame

Model PF244056
24" x 40" x 56"
Picture Frame

Available in white & parchment - Many more options available

Acrylic RV Kitchen/Bath/Bar Sinks

Acrylic sinks available in white, parchment & stainless steel



Model 2918
29" x 18"
Kitchen Sink



Model 3322
33" x 22"
Kitchen Sink



Model 33197
33" x 19" x 7"
Kitchen Sink



Model 23150L
23" x 15"
Offset Kitchen Sink



Model 151552
15" x 15" x 5"
Corner Bar Sink



Model 13153
13" x 15"
Lavatory Sink



Model 1720
17" x 20"
Oval Lavatory Sink



Model 1313
11.5" Round Lavatory Sink

Many more sizes available - contact your rep at sales@kinro.com

RV Sinks

Kinro Composites



Large Thermoformed RV Parts



Our 10' x 25' rotary thermoformer stretches the possibilities of large RV part manufacturing. The realism of an all plastic RV is not only obtainable, but is already being done in Australia! Large RV parts manufacturing isn't just a concept to Kinro Composites as we have successfully brought front and end RV caps to the market. Our thermoforming capabilities have also produced entire boat hulls, large advertising signs and kayaks.

This is the future! With our technology, large RV parts will be more durable and lighter than traditional fiberglass. Contact your sales rep today at sales@kinro.com.

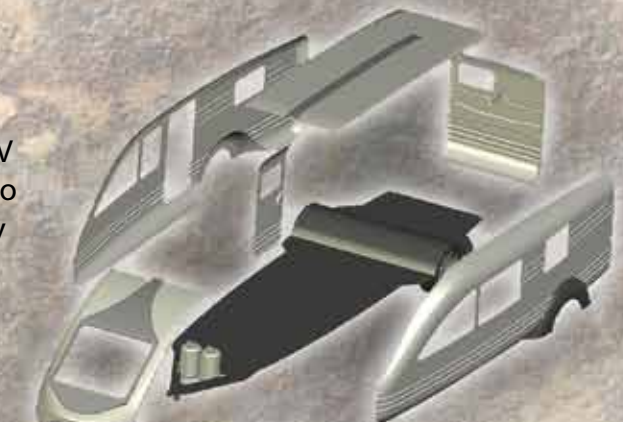

An all plastic RV concept drawn by Kinro Composites in 2005.



Custom RV front and end caps produced by Kinro Composites



Custom Thermoforming

Kinro Composites

Our Commitment to Excellence

At Kinro Composites, our goal is to continue as an industry leader of acrylic bath components to the RV and MH industries in carrying out our COMMITMENT TO EXCELLENCE.

Customers are key: Our customers are the focus of everything we do. Our work must exceed our customer's requirements.

Quality comes first: In order to satisfy our customers, the quality of our services must be our number one business priority.

People are our strength: Our future depends on every individual's contribution.

Integrity is never compromised: All actions of Kinro Composites must equal the highest ethical standards.

Innovative Excellence: All our products continue to exemplify innovation in design. We set industry standards, **not follow them!**

Contact Us Today

Kinro Composites
101 Mushroom Road
Waxahachie, Texas 75165

(P) 800-262-8827
(F) 972-937-0435

www.kinro-composites.com

Contact a sales representative today:
sales@kinro.com

Kinro Composites™ reserves the right to change designs and specifications without notice and assumes no responsibility for any error in this literature. This catalog supersedes all previous catalogs and items. Designs and trademarks are not for sale and are the sole property of Kinro Composites™.

Michiana Mattress

2010-2011 RV Product Catalog



Innerspring Mattresses	pg 2
Bunk Matts/Futons	pg 3
Heated Bunk Matts	pg 4
Evergreen Performance Core	pg 5

Since 1971, Michiana Mattress has been dedicated to constructing the highest quality sleep systems to a wide variety of industries. All mattresses are constructed in a manner that adheres to the very best commercial practices and utilize the highest quality materials. We can build to customer specification and can build custom RV, hotel, residential or medical constructions to match desired comfort ranging from extremely soft to firm. Our goal is to provide you the highest quality sleep system at the most affordable price.



Dreamscape Series

Innerspring
Mattresses

RV Innerspring Mattresses



The Sterling

- Two-Sided Smooth Top
- 312 Coil Count
- 7" Profile
- 1 Year Warranty



The Regency

- Two-Sided Quilted Top
- 312 Coil Count
- 7" Profile
- 1 Year Warranty

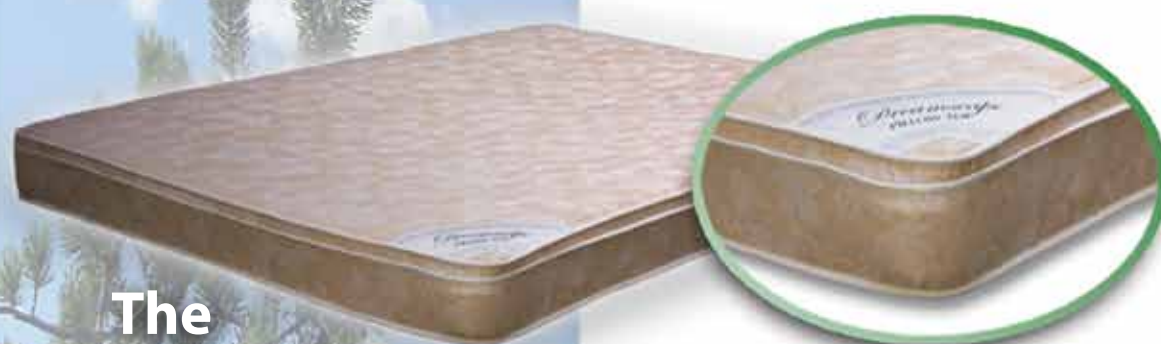

The Prestige

- One-Sided Pillow Top
- 312 Coil Count
- 8" Profile
- 1 Year Warranty

[Click here to download our full product catalog](#)



Futons & Bunk Matts

RV Bunk Matts and Futons



Bunk Matts

- Spoly & bristol beige (inset) finishes
- Foam or superloft performance core construction.
- Thickness to customer's specification
- Light weight
- Comfy Toes™ adjustable heat option



Quilted Bunk Matt

- Foam or superloft performance core construction.
- Thickness to customer's specification
- Light weight
- Superloft performance core utilizes Evergreen Performance Core technology
- Comfy Toes™ adjustable heat option



Futons

- Standard black ticking
- Flexible and lightweight.
- Pretufted
- Utilizes Evergreen Performance Core technology
- 5-7" Profile

[Click here to download our full product catalog](#)

Michiana Mattress

Michiana Mattress

Heated Bunk Matts

with Comfy Toes™

by Sunbeam



Easy to use digital controller with three heat settings



Seating Technology Inc and Michiana Mattress are proud to bring another innovative product to the RV industry - the Heated Bunk Mattress. Tent campers are gaining in popularity, and what better way to keep you warm on cool nights than a heated mattress? Utilizing Comfy Toes™ technology by Sunbeam®, our heated bunk matts are sure to keep you warm on those chilly nights. Our heated bunk matts come in any size (twin, full, queen, king) and can come in any finish (spoly, quilted, etc). Standard features of Comfy Toes™ technology include:

- 3-Heat setting controller
- 3 year limited warranty
- UL Certified

Comfy Toes™ is part of Sunbeam's® Sleep Warm, Sleep Well™ program. Rest be assured that you're sleeping on Sunbeam's® 50 years of experience, quality and performance. 25 million households can't be wrong!

Comfy Toes™ Heated Bunk Matts

Michiana Mattress

M-4



The Evergreen Performance Core



What is the Evergreen Performance Core?

Michiana Mattress [cares](#).

Though we continue to produce mattresses that incorporate traditional foams, we set out to develop an option that had some key fundamental advantages.

Introducing the *Evergreen Performance Core*. This remarkable product can be incorporated in virtually any mattress construction offered. The Evergreen Performance Core has been tested by UL and has generated superior test results compared to standard foams. The Evergreen Performance Core also meets flammability standard 16 CFR Part 1633.

The Evergreen Performance Core was produced specifically to be a cost effective option and environmentally friendly at the same time while not giving up the most important thing of all - COMFORT!

Please consider the following advantages:

- Reduces weight 30% or more.
- Water resistant.
- Hypoallergenic and anti-microbial.
- Air permeable/breathable.
- Environmentally friendly - 100% recyclable.
- Lower ILD loss than traditional foam.
- Inherently self-extinguishing.
- Not treated with harmful chemicals or fire retardants like traditional foams or cottons.
- Meets flammability standard 16 CFR Part 1633.
- Improved ergonomics improving overall health.
- Full range of sizes.
- Patented support system.
- Offered in smooth, quilted & pillow-top options.

The Evergreen Performance Core

Michiana Mattress

M-5

Michiana Mattress



Standard Coil Counts and Sizes

216 - 38" x 74" Twin
234 - 38" x 80" Twin

312 - 54" x 74" Full
338 - 54" x 80" Full

390 - 60" x 80" Queen
468 - 76" x 80" King

All mattresses and box springs are manufactured in compliance with CPSC Mattress Flammability Standard 16 CFR Part 1633. Law labels are attached and indicate legal compliance in the state that the items were produced. Due to continual research and advances, the manufacturer reserves the right to change specifications, design, price and equipment without notice and assumes no responsibility for any error in this literature.

Contact Us Today

Michiana Mattress

901 Summa Drive
Elkhart, IN 46516
(P) 574-522-5202
(F) 574-522-5181

Service & Warranty

(P) 574-312-6061
(F) 574-312-6003

Sales

sales@mcmatt.com

www.michianamattress.com



M-6



Seating Technology, Inc.

Leading Manufacturer of
Furniture to the RV Industry
2010-2011 Product Catalog

Extraordinary...
...surrounded by ordinary



For over 20 years, Seating Technology Inc and its affiliates have been providing outstanding quality service to a multitude of industries. Serving the RV, Medical, Automotive, Marine and Residential industries, Seat-Tech is dedicated to being the best; the best quality, the best service provider and the best innovator.

At Seating Technology Inc, we bring ideas to life. We have continually raised the bar on design possibilities for over 20 years. We pride ourselves on engineering the most difficult solutions and making them easy and affordable.

Your idea is our blank canvas - let us design you a solution today.

[Click the links below to jump to product pages](#)

[Traditional Sofas](#)

[Flip Sofas](#)

[Picnic Lift](#)

[Custom Interiors](#)

[Dinettes](#)

[Hide-A-Beds](#)

[Unique Furniture](#)

[Traditional Chairs](#)

[Rollover Sofas](#)

[Sit-N-Sleep](#)

[Tents & Awnings](#)

Everyday designs...



...for everyday life.



Microsuede U-Sofa with storage drawers



TRADITIONAL FURNITURE

COUCHES

Custom PV or PVC Vinyl Finishes



Traditional furniture for the RV or home.

Seating Technology Inc manufactures a full line of traditional couches from contemporary classics, to new modern styles. The sky is the limit on our design capabilities.



Two-toned rolled arm fabric



Modern/Contemporary Designs



Euro-Style Chairs and Ottomans

Seating-Tech wants you to relax - you deserve it. With our 100's of seating selections, we've been helping the auto, RV, residential and medical industries relax for years.

TRADITIONAL FURNITURE

CHAIRS

Sit down and relax...

..100 different ways!



Swivel Glide Recliners

Swivel Rockers



Theater Seating





Endless design possibilities...

Wood backed dinettes come optional with drawers

MULTIFUNCTION

DINETTES

Seat-Tech offers endless dinette possibilities. We offer wood supported dinettes (pictured above), soft backed dinettes (pictured below) and free standing tables and chairs. Configurations and options are literally endless. Dinettes are custom to any size opening.



Wood supported dinettes can be combined with our magic air and comfort air beds to maximize interior space. Soft backed dinettes can also be converted into a sleeping surface.



Interior space is always a concern when designing an RV. With our space saving flip sofas and rollover sofas, you can maximize interior storage space without sacrificing comfort. Couches by day, beds by night, these sofas are now the industry standard.



Standard Flip Sofa



56" - 76" Widths

Seat-Tech's Flip Sofas are a functional and economical way to utilize interior space. Easy to operate, this sofa attaches to the coach wall and allows additional storage underneath.

FLIP

ROLLOVER SOFAS

Conserving interior space for today's RV'er



60" - 76" Widths

The Rollover's versatile design works for even the most complex interior design. Wall mounted, its unique design allows it to be placed over wheel wells. Perfect for rear garages.



Rollover Sofa

Optional storage drawer



By day, the Magic Air Bed System is a functional, quality built sofa. At night, it easily transforms into an inflatable bed with the touch of a button! The functional design lets you get the most of your interior space. The 7" thick air mattress will no doubt add to the enjoyment of your camping experience. Relax in less than a minute all while receiving the comfort of a pillow top mattress!

MAGIC AIR BED



Includes easy to use controller

From couch, to bed in less than a minute.



Self-stores!

Attached switch lets you inflate and deflate bed in minutes.



The Comfort Hide-A-Bed's pedestal base makes it the only bed in the industry that offers a total air sleep surface. The bed inflates and deflates in three minutes by simply turning the knob at the pedestal's base. 104 baffles ensure an undisturbed night of sleep.

COMFORT

HIDE-A-BEDS

MECHANIZED

Mechanized Hide-A-Beds are our most traditional offering in the hide-a-bed line. Easy to use and affordable, these space savers have been best sellers for years and will continue to be for years to come. Custom mattress thickness available. Strong metal frame construction and a myriad of finishes make this a versatile product for any coach.





Seating Technology, Inc.



For the first time, Lippert Components and its family of companies have come together and created a truly innovative product that maximizes space, utility and outdoor enjoyment. Introducing the Picnic Lift; an answer to those who want to extend their living space into the cargo area without sacrificing outdoor enjoyment. Typically, a rear bedlift system comes with a two sided sofa that converts into a bed. If the cargo door is open and the screen is down, it is difficult, if not impossible, to face the outdoors and sit on the sofa at the same time. With this new innovative product, everyone can sit around the table and enjoy the out-

doors with no issues. Another issue with the sofa bed setup is access to the rest of the cargo area when in "sofa" mode. Climbing over the sofas becomes tedious. With the Picnic Lift system, you can simply slide on through to the cargo area without

climbing over furniture. Best of all, when it's time to turn in, the Picnic Lift turns into a bed. Simply slip on the table cover (not shown) and raise the seats to table level for a comfortable nights sleep. The table easily detaches and stores itself when not in use.

It's now easy to entertain, eat, sleep and enjoy the outdoors all with the same product. It was designed with the thoughts and needs of today's camper by Seating Technology Inc and Lippert Components. Best of all, it is built with the legendary Happijac® Vertical Bed Lift system which for years has gained industry praise for its quality and toughness.

Contact your sales rep today to find out more on this great product.

PICNIC LIFT



Seating Technology Inc and Happijac® came together to create this must have for any toy hauler incorporating their rear bedlift systems. Designed in mind for those who want to get the most out of cargo area, the Sit-And-Sleep is engineered to go from dual-sided sofa, to bed and back in seconds. Simply tug on the latch on each side and the Sit-And-Sleep smoothly ratchets from sofa to bed and back.

SIT AND SLEEP

The Sit-And-Sleep was designed tough. Powder-coated steel components easily attach to the Happijac® Vertical Bed Lift System and can easily hold up to 650 pounds. It's plush futon style seating ensures a comfortable night's rest for all.

Combine a Sit-And-Play with a futon or bunk mattress and a Happijac® double bed lift to get the most functionality out of your interior space.

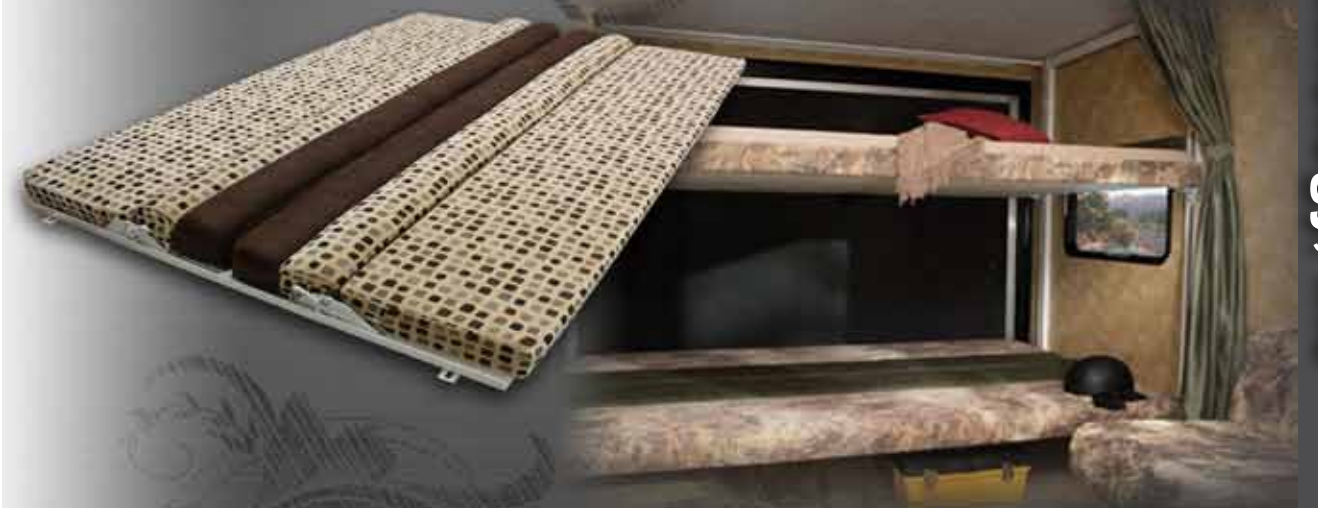



Sit-And-Play
Entertainment/Gaming Center
Doubles as Dual Sleeping System

Extraordinary...surrounded by ordinary. Seating Technology Inc takes pride in its innovative design, often making the rest of the industry play catch up. We're constantly looking for new ways to optimize interior RV space while increasing the functionality of your furniture. As the RV industry changes, so do we.

UNIQUE DESIGNS



Sleek, functional and beautiful.

For over 20 years, we have prided ourselves in engineering the most difficult furniture solutions and making them easy.

Your idea is our blank canvas. Let us help you today.



Design Time® is an
affiliate of Seating Technology Inc
and Lippert Components

CUSTOM INTERIORS

Seating Technology Inc also provides a full line of custom interiors constructed with quality and care by their affiliate, Design Time® Inc. For years, Design Time® has been servicing the RV industry with custom interiors such as valances, bedding and drapes. With their experience in the industry, Design Time® is sure to meet your interior design needs. Also servicing the automotive industry, Design Time® can take the customer's product and upholster it for them. Product offerings include but are not limited to:

- Hard Valances
- Quilting
- Bedding Sets
- Comforters
- Draperies
- Pillows/Cushions
- Shams





**Secure Lock
Tent/Door
Combo**

- Camper Tents
- Bagged Awnings
- Secure Lock Tent Doors
- Custom Silk Screening
- Exterior Entertainment Rooms

**TENTS &
AWNINGS**



National Tent and Awning is an affiliate of Seating Technology Inc and has been providing quality products to the RV industry for years. Our outstanding reputation has been built over the years by performing complete custom jobs for our customers whereas others simply can't. Our tents and awnings expand camping space without sacrificing price. Our silk screening can provide additional exterior rooms while providing protection from the elements. You're camping - you should be able to enjoy the outdoors and with our products, you can!

- Tire Covers; Standard and Decorative
- Ramp Door Patio Screen Sets
- Custom Graphics/Designs



The RV industry is changing. RV makers are constantly reengineering their products making them lighter, more spacious, and more convenient. These changes present challenges. Seat-Tech meets these challenges head on and leads the industry in new product innovation. Our unprecedented access to the entire supply chain and our synergies created by our parent company, Lippert Components, make Seat-Tech the easy choice. Contact us today - we look forward to serving you.

C O N T A C T U S

Seating Technologies, Inc
1846 Eisenhower Dr.
Goshen, IN 46526

Seating Technologies, Inc
7250 W 700 S
Topeka, IN 46571

(574) 534-8177

Design Time Inc.
921 Kersher Road
Goshen, IN 46516
(574) 533-2180

Sales: sales@seat-tech.com

Warranty: warranty@seat-tech.com

Or

1-866-524-7821

www.seatingtechnologyinc.com



Seating Technology, Inc and its affiliates reserve the right to change designs and specifications without notice and assumes no responsibility for any error in this literature. This catalog supersedes all previous catalogs and items. Designs and trademarks are not for sale and are the sole property of Seating Technology, Inc and its affiliates.



DREW

INDUSTRIES INCORPORATED

200 Mamaroneck Ave
White Plains, NY 10601

Visit us on the web at
www.drewindustries.com