

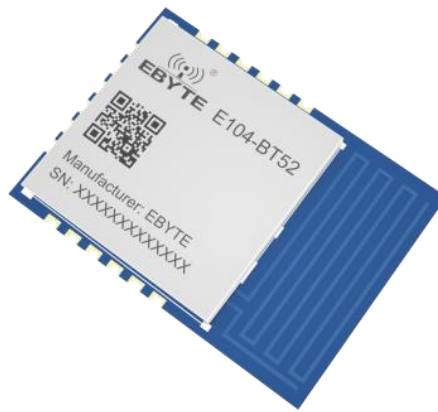

E104-BT52 User Manual

DA14531 BLE5.0 Low Power SMD BLE to Serial Module



CONTENTS

1. Overview.....	1
1.1 Introduction.....	1
1.2 Feature.....	1
1.3 Applications.....	1
2 Specification and Parameter.....	2
2.1 Limit parameter.....	2
2.2 Operating parameter.....	2
3 Size and Pin Definition.....	3
4 Basic operation.....	5
4.1 Recommended circuit diagram.....	5
5 Function Description.....	5
5.1 Role description.....	5
5.1.1 Master.....	6
5.1.2 Slave.....	6
5.1.3 Observer.....	6
5.2 Power supply mode.....	7
5.2.1 Low power consumption mode.....	7
5.2.2 Wake-up mode.....	7
5.3 Data transmission mode.....	7
5.3.1 Data transparent transmission.....	7
5.3.2 Format transmission.....	7
5.4 MAC address bonding.....	8
5.5 Advertising.....	8
5.5.1 Common advertising info.....	8
5.6 Configuration.....	8
5.7 Data indication.....	9
5.8 UUID description.....	9
5.9 Status or event printing.....	9
6 AT command.....	10
6.1 Command description.....	10
6.2 Error code.....	10
6.3 Status printing.....	10
6.4 Command sets.....	10
6.4.1 AT test command.....	10
6.4.2 +++ enter AT command mode.....	11
6.4.3 AT+EXIT exit AT command mode.....	11
6.4.4 AT+RESET reset command.....	11
6.4.5 AT+RESTORE restore to factory setting.....	11
6.4.6 AT+BAUD baud rate.....	11
6.4.7 AT+PARI uart parity bit.....	12
6.4.8 AT+DATABIT uart data bit.....	12
6.4.9 AT+ROLE bluetooth role.....	13

6.4.10	AT+DEVMANUF devise manufacturer.....	13
6.4.11	AT+ADV enable advertising.....	13
6.4.12	AT+ADV DAT advertising data.....	14
6.4.13	AT+ADVINTV advertising interval.....	14
6.4.14	AT+IBCNUUID iBeacon UUID command.....	15
6.4.15	AT+MAJOR iBeacon Major command.....	15
6.4.16	AT+MINOR iBeacon Minor command.....	15
6.4.17	AT+IPWR revise ibeacon tx power.....	16
6.4.18	AT+NAME advertising device name.....	16
6.4.19	AT+ CONINTV connection interval configuration.....	16
6.4.20	AT+DISCON disconnect command.....	17
6.4.21	AT+MAC local MAC address.....	17
6.4.22	AT+CONINFO connection device info.....	17
6.4.23	AT+BONDMAC add bond MAC address.....	18
6.4.24	AT+BONDDEL delete bond MAC address.....	18
6.4.25	AT+SCAN scan.....	18
6.4.26	AT+SCANINTV scan interval.....	19
6.4.27	AT+SCANWND scan window.....	19
6.4.28	AT+TRANMD master transmission mode.....	19
6.4.29	AT+UUIDSVR128 set service 128bit UUID.....	20
6.4.30	AT+UUIDSVR Bluetooth service UUID.....	20
6.4.31	AT+UUIDSLAVE SLAVE CHANNEL characteristic UUID.....	20
6.4.32	AT+UUIDMAST MAST CHANNEL characteristic UUID command.....	21
6.4.33	AT+AUTH Air configuration authentication password.....	21
6.4.34	AT+UPAUTH modify air configuration authentication password.....	21
6.4.35	AT+ONSLEEP sleep when power on.....	21
6.4.36	AT+SLEEP enter sleep.....	22
6.4.37	AT+LOGMSG operating status output.....	22
6.4.38	AT+PWR tx power.....	22
6.4.39	AT+MTU Set Bluetooth single packet length.....	23
6.3.40	AT+TRANMD transmission mode.....	23
7	Quick start.....	25
7.1	Configuration mode guidance.....	25
7.1.1	Serial port configuration.....	25
7.1.2	Configuration over air.....	25
7.2	Data transmission.....	27
7.2.1	Data transparent transmission.....	27
7.2.2	Format transmission.....	28
8	FAQ.....	29
8.1	Communication distance is too short.....	29
8.2	Module is easy to damage.....	29
8.3	BER(Bit Error Rate) is high.....	30
9	Welding instruction.....	30
9.1	Reflow soldering temperature.....	30

9.2 Reflow soldering curve.....	31
10 Package.....	31
11 Related Model.....	32
Revision history.....	33
About us.....	33



1. Overview

1.1 Introduction

E104-BT52 is a serial to BLE Bluetooth master-slave integrated module based on BLE 5.0. It is small in size and low in power consumption, working at 2.4GHz.

E104-BT52 is developed by Chengdu Ebyte Electronic Technology Co., Ltd. based on the dialog DA14531 chip. The module uses general AT commands to set parameters, and the operation is simple and fast. The module only supports Bluetooth master, slave and observer modes. The module functionally supports low-power advertising, data transparent transmission, and air configuration. Modules can be widely used in smart wear, home automation, home security, personal health care, smart home appliances, accessories and remote controls, automobiles, lighting, industrial Internet, smart data collection, smart control and other fields. The maximum baud rate is 460800bps for data transmission.



1.2 Feature

- BLE 5.0 protocol;
- Adjustable Bluetooth package length;
- Two working modes: configuration and transparent transmission;
- Automatic advertising and automatic connection after startup;
- IBeacon and ordinary advertising switching;
- Supports serial port wake-up;
- Good for MAC binding connection, the maximum binding number is 3 devices;
- Serial port transparent and format transmission;
- Multiple serial port modes and baud rates;
- Custom 16-bit UUID and 128-bit UUID available;
- Comes with PCB onboard antenna, no external antenna is required;
- Supports Bluetooth parameter air configuration;
- The maximum communication distance is 90m (@2.5dBm, 1Mbps);
- Ultra-low power sleep, simultaneous advertising;
- Multiple masters and multiple slaves, and the maximum connection data is 2 slaves;
- Supports transmit power modification. The maximum transmit power is 2.5dBm;
- With sniffing function;
- The maximum MTU is 247bytes;

1.3 Applications

- Wireless meter reading and wireless sensing;
- Smart home;

- Industrial remote control and telemetry;
- Intelligent buildings, intelligent buildings;
- Automatic data collection;
- Health sensor;
- Smart wearable devices;
- Intelligent robot;
- Wireless sensing;
- Electronic label;
- Intelligent control;

2 Specification and Parameter

2.1 Limit parameter

Main parameter	Performance		Remark
	Min	Max	
Power supply (V)	0	3.6	Over 3.6V damages module
Blocking power (dBm)	-	10	Chance of is slim when modules are used in short distance
Operating temperature (°C)	-40	+85	Industrial grade

2.2 Operating parameter

Main parameter	Performance			Remark	
	Min	Typ	Max		
Operating voltage (V)	2.1	3.3	3.6	$\geq 3.3V$ ensures performance	
Communication level (V)	-	3.3	-	5V will damage modules	
Operating temperature (°C)	-40	-	+85	Industrial design	
Operating frequency (MHz)	2402	-	2480	For ISM band	
Power consumption	Tx current (mA)	-	4.0	-	Default parameter
	Rx current (mA)	-	-	-	-
	Sleep current (μA)	-	9	-	Default parameter
TX power (dBm)	-19.5	0	2.5	-	
Receiving sensitivity (dBm)		-94		Air data rate 1Mbps	
Sleep advertising current(default)		9.44		Unit uA, default advertising gap 1S	
Wake-up advertising current (default)		393.15		Unit: uA, default advertising gap 1s	
Sleep without advertising current (default)		2		Unit: uA, default connection gap 500ms	

Main parameter	Description	Remark
Distance	90m	In open and clear air, weight 2.0 meter; @2.5dBm; Air data rate: 1Mbps
BLE protocol	BLE5.0	
Communication interface	UART	-
Package	SMD	-
Size	14.5*10mm	-
Antenna	PCB	50Ω

3 Size and Pin Definition

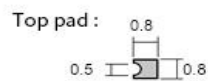
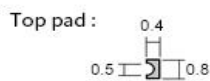
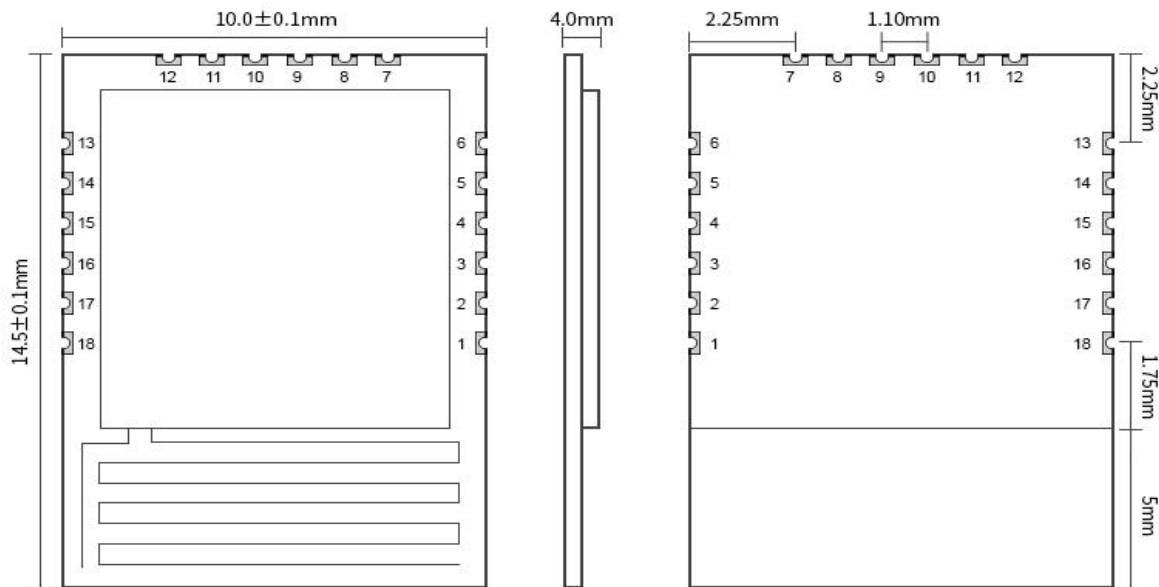

pad quantity : 18
Weight : 1.2±0.1g
Unit:mm

NO.	Item	Direction	Function	Remark
1	GND	Input	Ground	
2	VL-	--	Low voltage power supply	/
3	VCC	Input	VCC	Short-circuiting to pin 4 "VH+"
4	VH+	Input	VH+	Short-circuiting to pin 3 "VCC"
5	GND	Input	Ground	
6	GND	Input	Ground	

7	RST	Input	Reset pin	Reset in low level (take effective in 500ms)
8	DIO ¹	Input	SWDIO	SWDIO, JTAG interface
9	NC	--	NC	/
10	CLK	Input	SWCLK	SWCLK, JTAG interface
11	NC	--	NC	/
12	GND	Input	Ground	Ground
13	WKP	Input	Wake up pin	Wake up: falling edge; Sleep: rising edge
14	TXD	Output	UART	UART output
15	RXD	Input	UART	UART Input
16	LINK	Output	Link status	Linked: high level Not linked: low level
17	DATA	Output	Data	Data indication pin Note: Receive Bluetooth data: When the DATA pin has Bluetooth data in the air to send out through the TXD pin of BT52, the pin will be pulled high. After a frame of data is sent, the pin will be pulled low again. Send Bluetooth data: After the DATA pin receives the data on the RXD pin of BT52, the buffer BUFF size is 2K. As long as there is data in the BUFF that has not been sent out via Bluetooth, the DATA will be pulled high. It will be pulled low again until the data transmission in the BUFF is completed. The user can use the above description to do data framing.
18	GND	Input	Ground	Ground

4 Basic operation

4.1 Recommended circuit diagram

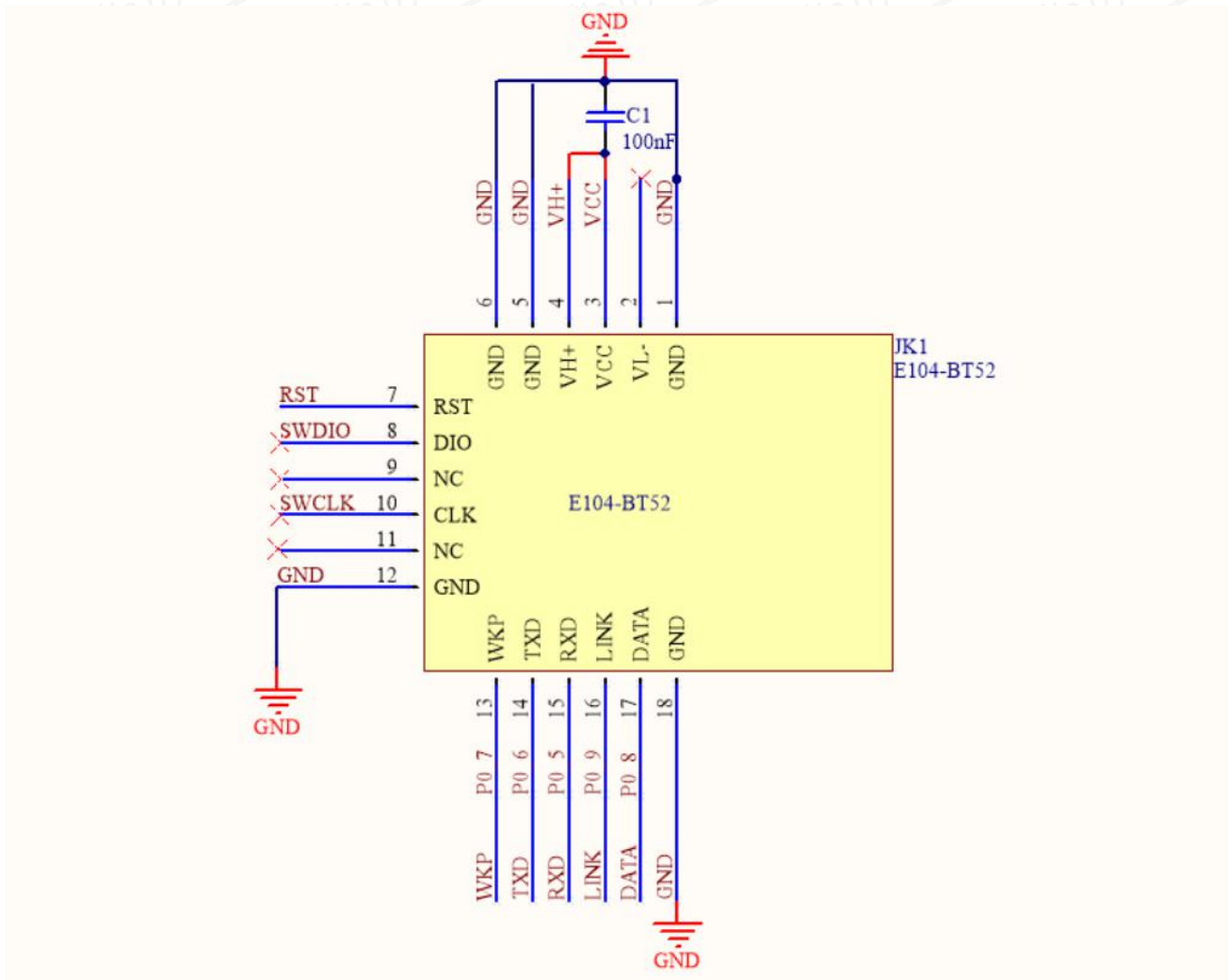

5 Function Description

5.1 Role description

The module supports three roles: master, slave, and observer.

The host supports connecting to other Bluetooth products of our company. When the module is used as a master, up to 2 slaves can be connected. Support transparent advertising and format transmission. auto connect.

The module slave can connect with other models of our company's Bluetooth products to support transparent

transmission.

The observer is only used to print the advertising information of the ble devices around the module and cannot be connected.

5.1.1 Master

1. AT+ROLE=1 select master mode
2. Command AT+SCAN=1, start master scanning function
3. Support multi-master and multi-slave connection. Up to 2 slaves can be connected.
4. Print status information when the host connection status changes. See status printing.

5.1.1.1 Master connection method

Condition filtering

The device can be configured to filter by binding MAC address and service UUID.

UUID filtering is based on the content filtering configured by AT+UUIDSVR, and the filtering conditions cannot be turned off. If MAC address filtering is not enabled, the MAC will match and the service UUID will automatically connect to the slave.

If users need MAC address filtering, add MAC addresses to the device through AT+BONDMAC. After the master scans the slave, if it is the same as the binding list MAC address and service UUID, the master automatically connects to the slave device.

Auto connection

After the conditions are met, the slave is automatically connected.

5.1.2 Slave

1. AT+ROLE=0 select slave mode
2. AT+ADV=1 to configure normal advertising mode
3. The advertising switch is configured to be on, and it will automatically enter the advertising state after power-on, otherwise the advertising device will not be found.
4. After receiving the host connection request, establish a Bluetooth connection to stop Bluetooth advertising and enter the data transmission mode.
5. For advertising data configuration, see 5.5 Advertising.

5.1.3 Observer

1. Command AT+ROLE=2 to select the observation mode (valid after restart)
2. After receiving the advertising, print out all the contents of the advertising package through the serial port.
3. The observer device cannot be connected to any device.

Check format below

LEN	MAC	RSSI	Advdata
1 byte	6 byte	1 byte	No more than 31 byte

Note: LEN is the sum of MAC, RSSI, and advertising data length.

1. The scan window and scan gap are consistent with the scan parameters.
2. The AT command is valid during the period.

5.2 Power supply mode

There are low power consumption mode and wake-up mode.

5.2.1 Low power consumption mode

The so-called low power consumption mode means that the BLE function continues to run after the module enters this mode, and peripherals other than the wake-up pin of the module are turned off. If you need lower power consumption, you can turn off advertising and scan through AT commands, disconnect all connections, and set a longer advertising gap, scan gap, and connection gap.

Enter low power consumption:

1. AT command "AT+SLEEP" immediately enters low power consumption mode;
2. AT command "AT+ONSLEEP=1" power on immediately enters low power consumption;
3. Enter low power consumption through the rising edge of pin WKP;

After the module enters the low power consumption mode, it outputs "STA: sleep" through the serial port (LOGMSG does not turn off the output).

Note: In the low-power mode, the serial port output is valid and cannot be input

5.2.2 Wake-up mode

The so-called wake-up mode means that the peripherals required by the module are in a normal working state in this mode. After the module wakes up, it outputs the status "STA: wakeup".

Wake-up method:

1. Wake up immediately through the falling edge of WKP pin;
2. The serial port RX pin wakes up. The serial port rx falling edge, and the low level remains at 50us and above, wake up immediately.

5.3 Data transmission mode

There are data transparent transmission and format transmission.

5.3.1 Data transparent transmission

The so-called data transparent transmission means that the data received by the serial port is sent to the other device through BLE without any processing, and the data received by BLE is sent through the serial port without any processing.

"AT+TRANMD" command setting.

5.3.2 Format transmission

The so-called format transmission refers to: the data sent to the module through the serial port and the data through the serial port of the module must conform to the defined format for transmission.

The serial port sends "AT+TRANMD=0" to the device to switch the device to format transmission. The data format is as

Slave No.	Valid data
1 byte	Max:243bytes
0~1	

Slave number: 0~1 is the target device number. This number comes from the "STA:connect,1<mac>" printed by the device after the successful connection between the slave and the master.

If the connection specified by the slave number does not exist, the module directly discards the packet data.

5.4 MAC address bonding

The module supports MAC address binding. If the MAC address binding function is enabled. The device only connects to devices with added MAC addresses.

5.5 Advertising

5.5.1 Common advertising info.

The advertising information includes advertising and scan response. Advertising is a broadcast report sent actively, and scan response is a broadcast report that is responded to after receiving a host scan request.

Advertising

Fixed field	Len	Manufacturing field	Manufa data
020106	N	0xFF	configurable, maximum 26 byte

For example: 020106< Len >FF< Manufa data >

Only Manufa data is configurable by users.

Scan response

Len	fixed	UUID	Len	fixed	Device name
0x03	0x03	FFF0	N	0x09	configurable, maximum 22 byte

For example : 0303FFF0<len>09< Device name >

Note: Users do not need configure it.

iBeacon info.

1. Instructions to configure UUID, Major, Minor respectively
2. Command AT+ADV=2 to configure to work in iBeacon broadcast mode and broadcast immediately
3. Bluetooth connection is not supported in iBeacon broadcast mode

Advertising

iBeacon Prefix	UUID	Major	Minor	Tx-Power
9B	16B	2B	2B	1B

For example: 0201061AFF4C000215FDAFDA50693A4E24FB1AFCFC6EB076478252775848F00

5.6 Configuration

There are two configuration methods: serial port configuration and air configuration. The two configuration methods are basically the same. Before the air configuration, the authentication password of AT+AUTH=123456 must be passed. After the authentication is passed, the module is allowed to use the air configuration. The air configuration authentication cycle is this connection, and re-authentication is required if the device is disconnected and reconnected.

The module is not connected by default in configuration mode, if the module is connected, you can enter the configuration mode by sending "+++".

5.7 Data indication

When the module outputs data through the serial port, the module sets the DATA pin to low level, indicating that data is being sent. AT command response does not change the DATA pin state.

5.8 UUID description

Service UUID	FFF0 (configurable)		
characteristic value	UUID	property	description
SLAVE CHANNEL	FFF1 (configurable)	read / notify	The slave sends the data, and the master receives the data channel.
MAST CHANNEL	FFF2 (configurable)	read / write	The master sends data and the slave receives data channels
CONFIG CHANNEL	FFF3 (not configurable)	read / write / notify	Air configuration channel

5.9 Status or event printing

Command AT+LOGMSG to enable the serial port printing function of status information. Status information includes: connected, disconnected, awake, and sleep. The format is as follows:

Status	Printing info.
Connection successfully	\r\n STA:connect\r\n
Disconnect	\r\n STA:disconnect\r\n
System wake up	\r\n STA:wakeup\r\n
Sleep mode	\r\n STA:sleep\r\n

6 AT command

Note: Before sending operation instructions, first ensure that the module is in wake-up mode, otherwise it will not be able to receive configuration instructions.

6.1 Command description

All AT commands do not need to add carriage return (\r), line feed (\n)

All AT commands are not case sensitive

The return result of AT command ends with \r\n (except for returning HEX)

Command error response format +ERR=[NUM]. (NUM is ACSII)

6.2 Error code

NUM	Description	Error reason	Solution
1	Command not exist	AT command string contains error	Check AT specified data string
2	Parameter length error	1、 AT command length sum error; 2、 Data length is beyond the correct range	Check parameter
3	Invalid parameter	1、 Parameter exceed value range	Check the parameter value according to the command

6.3 Status printing

Status	Printing info.	
Connect successfully	slave	\r\nSTA:connect,1,<MAC\r\n
	master	\r\nSTA:connect,1,<MAC\r\n
Disconnect	slave	\r\nSTA:disconnect\r\n
	master	\r\nSTA:disconnect,1\r\n
System wake up	\r\nSTA:wakeup\r\n	
Sleep mode	\r\nSTA:sleep\r\n	

6.4 Command sets

6.4.1 AT test command

Command	Response
---------	----------

AT	+OK
Note: none	

6.4.2 +++ enter AT command mode

Command	Response
+++	enter_at_mode
Notes: When disconnected, the module is in AT mode by default and there is no response when sending this command; you need to use this command to enter AT mode when module is connected.	

6.4.3 AT+EXIT exit AT command mode

Command	Response
AT+EXIT	+OK
Notes: None	

6.4.4 AT+RESET reset command

Command	Response
AT+RESET	+OK
Note: take effect immediately	

6.4.5 AT+RESTORE restore to factory setting

Command	Response
AT+RESTORE	OK
Note: 1. After resetting, it will restart automatically; 2. During the process of restoring factory settings, any form of reset is prohibited, and the power off before the operation is completed is prohibited;	

6.4.6 AT+BAUD baud rate

Command	Response
Inquiry AT+BAUD?	+OK=[para]

Set	AT+BAUD=[para]	+OK: success +ERR=[NUM]: error
Parameter	para (ASCII)	Baud rate (bps)
	0	2400
	1	4800
	2	9600
	3	14400
	4	19200
	5	38400
	6	57600
	7	115200 (default)
	8	230400
	9	460800
Note	Take effect immediately	
For example,	AT+BAUD=10. Baud rate is 115200 HEX: 41,54,2B,42,41,55,44,3D,31,30	

6.4.7 AT+PARI uart parity bit

Command		Response
Inquiry	AT+PARI?	+OK=[para]
Set	AT+PARI=[para]	+OK: success +ERR=[NUM]: error
Parameter	para(ASCII)	description
	0	None (default)
	1	Even
Note	Restart to take effect, save when power off	
For example,	AT+PARI=0	

6.4.8 AT+DATABIT uart data bit

Command		Response
Inquiry	AT+DATABIT?	+OK=[para]

Set	AT+PARI=[para]	+OK: success +ERR=[NUM]: error
Parameter	para(ASCII)	Description
	0	5 data bit
	1	6 data bit
	2	7 data bit
	3	8 data bit
Note	Restart to take effect, save when power off	
For example,	AT+PARI=0	

6.4.9 AT+ROLE bluetooth role

Command		Response
Inquiry	AT+ROLE?	+OK=[para]
Set	AT+ROLE =[para]	+OK: success +ERR=[NUM]: error
Parameter	Para(ASCII)	Description
	0	Slave (default)
	1	Master
	2	Observer
	3	Salve and master as one
Note	Restart to take effect, save when power off	

6.4.10 AT+DEVMANUF devise manufacturer

Command		Response
Inquiry	AT+DEVMANUF?	+OK=[para]
Set	AT+DEVMANUF =[para]	+OK: success +ERR=[NUM]: error
Parameter	para(string): MANUF name Default:CDEBYTE;	
Note	<ol style="list-style-type: none"> Restart to take effect, save when power off Maximum string length is 32bytes 	

6.4.11 AT+ADV enable advertising

Command	Response
----------------	-----------------

Inquiry	AT+ADV?	+OK=[para]
Set	AT+ADV=[para]	+OK: success +ERR=[NUM]: error
Parameter	para (ASCII) Description	
	0	Turn off
	1	Turn on (default)
	2	iBeacon
Note	1. Take effect immediately (if the broadcast is not turned on, or it is connected, it will take effect next time), save when power off; 2. The slave or master-slave integrated supports broadcasting.	

6.4.12 AT+ADVDAT advertising data

Command		Response
Inquiry	AT+ADVDAT?	+OK=[para]
Set	AT+ADVDAT=[para]	+OK: success +ERR=[NUM]: error
Parameter	para(HEX): 1、 For ASCII、 HEX 2、 Length is less than 26 bytes.	
Note	1. Take effect immediately (if the broadcast is not turned on, or it is connected, it will take effect next time). Save when power off; 2. The slave or master-slave integration supports broadcasting, and other roles can still be configured;	
For example,	Command: 41 54 2b 41 44 56 44 41 54 3d 31 32 33 34 35 36 37 38 39 30; Adv data: 31 32 33 34 35 36 37 38 39 30	

6.4.13 AT+ADVINTV advertising interval

Command		Response
Inquiry	AT+ADVINTV?	+OK=[para]
Set	AT+ADVINTV=[para]	+OK: success +ERR=[NUM]: error
Parameter	para(ASCII):20~10240 default: 1000 (1S)	
Note	1. Take effect immediately (if the broadcast is not turned on, or it is connected, it will take effect next time), save when power off 2. The slave or master-slave integrated supports broadcasting, other roles can still be configured;	
For example,	AT+ADVINTV=1000	

6.4.14 AT+IBCNUUID iBeacon UUID command

Command		Response
Inquiry	AT+IBCNUUID?	+OK=[para1]
Set	AT+IBCNUUID=[para]	+OK: success +ERR=[NUM]: error
Parameter	para(HEX): 16 bit UUID	
Note	1. Take effect immediately (if the broadcast is not turned on, or it is connected, it will take effect next time), save when power off 2. The slave or master-slave integrated supports broadcasting, other roles can still be configured;	
For example,	Set iBeacon UUID as "FDA50693A4E24FB1AFCFC6EB07647825" 41 54 2B 49 42 43 4E 55 55 49 44 3DFDA50693A4E24FB1AFCFC6EB07647825	

6.4.15 AT+MAJOR iBeacon Major command

Command		Response
Inquiry	AT+MAJOR?	+OK=[para]
Set	AT+MAJOR=[para]	+OK: success +ERR=[NUM]: error
Parameter	para(HEX): 0X0001-0XFFFF default:	
Note	1. Take effect immediately (if the broadcast is not turned on, or it is connected, it will take effect next time), save when power off; 2. Only the slave device supports broadcasting, other roles can still be configured;	

6.4.16 AT+MINOR iBeacon Minor command

Command		Response
Inquiry	AT+Minor?	+OK=[para]
Set	AT+Minor=[para]	+OK: success +ERR=[NUM]: error
Parameter	para(ASCII): 0X0001-0XFFFF default:	
Note	1. Take effect immediately (if the broadcast is not turned on, or it is connected, it will take effect next time), save when power off; 2. Only the slave device supports broadcasting, other roles can still be configured;	

6.4.17 AT+IPWR revise ibeacon tx_power

Command		Response
Inquiry	AT+IPWR?	+OK=[para]
Set	AT+ IPWR =[para]	+OK: success +ERR=[NUM]: error
Parameter	para(HEX): 0-0XFF default: 0	
Note	1. Take effect immediately (if the broadcast is not turned on, or it is connected, it will take effect next time), save when power off; 2. Only the slave device supports broadcasting, other roles can still be configured;	

6.4.18 AT+NAME advertising device name

Command		Response
Inquiry	AT+NAME?	+OK=[para]
Set	AT+NAME=[para]	+OK: success +ERR=[NUM]: error
Set (Do not save)	AT+NAME1=[para]	
Parameter	para(HEX): advertising device name, advertising name is not more than 22 bytes default: E104-BT52-V1.0	
Note	1. Take effect immediately, save when power off; 2. Only supported by the slave, other roles can still be configured;	

6.4.19 AT+ CONINTV connection interval configuration

Command		Response
Inquiry	AT+CONINTV?	+OK=[para]
Set	AT+CONINTV =[para]	+OK: success +ERR=[NUM]: error
Parameter	[para] (ASCII) : connection interval, value range, 10~2500; Default: 20ms	
Note	Take effect immediately, save when power off.	
Note	1. The connection timeout must be greater than the connection gap; 2. The device with incorrect parameters will not receive and save. 3. It is not recommended to modify the host connection gap.	
For example,	AT+CONINTV=20 Connection interval 20ms	

6.4.20 AT+DISCON disconnect command

Command		Response
Set (only master)	AT+DISCON=[para]	+OK: success +ERR=[NUM]: error
Disconnect all	AT+DISCON	+OK: success +ERR=[NUM]: error
Parameter	para(ASCII)	Description
	0~1	Disconnect specified connection
Note	1、Take effect immediately 2、if it is not connected, the modules will return index device no connect	

6.4.21 AT+MAC local MAC address

Command		Response
Inquiry	AT+MAC?	+OK=[para]
Parameter	para (HEX) :MAC address For example: F0E1D2C3B4A5	
Note	Take effect immediately, save when power off.	
For example,	command: AT+MAC? Return: 2B 4F 4B 3D FE 30 EE 50 35 DA Explain: local MAC address is FE 30 EE 50 35 DA	

6.4.22 AT+CONINFO connection device info.

Command		Response
Inquiry	AT+CONINFO?	+OK=[para]: success +ERR=[NUM]: error
Parameter	para (ASCII) : connected device role + connected device MAC address + handle for sending data to connected device	
Note	Effective immediately. The handle that sends data to the connected device is only valid when our device is the master.	
For example,	command: AT+CONNIFO? Return:	

6.4.23 AT+BONDMAC add bond MAC address

Command		Response
Inquiry	AT+BONDMAC?	+OK=[sum][[mac] [mac]...]
Set	AT+BONDMAC=[mac]	+OK: success +ERR=[NUM]: error
Parameter	sum(HEX): sum of current bond MAC address; mac(HEX): 6bytes mac address;	
Note	Take effect immediately, save when power off.	
For example,	Inquiry: AT+BONDMAC? Return: B 4F 4B 3D 03 CC 34 27 1A 0C D4 3D AC 82 16 0F 58 D2 D4 C3 07 0E C4	
	Set: 41 54 2B 42 4F 4E 44 4D 41 43 3D CC 34 27 1A 0C D4 Return: +OK	

6.4.24 AT+BONDDDEL delete bond MAC address

Command		Response
Set	AT+BONDDDEL=[mac]	+OK +ERR=[NUM]
Parameter	mac: 6 bytes mac address	
Note	<ol style="list-style-type: none"> 1、 Take effect immediately, save when power off 2、 Delete specific mac address 	

6.4.25 AT+SCAN scan

Command		Response						
Inquiry	AT+SCAN?	+OK=[para]						
Set	AT+SCAN=[para]	+OK: success +ERR=[NUM]: error						
Parameter	<table border="1"> <thead> <tr> <th>para (ASCII)</th> <th>Description</th> </tr> </thead> <tbody> <tr> <td>0</td> <td>Scan off</td> </tr> <tr> <td>1</td> <td>Scan on (default)</td> </tr> </tbody> </table>		para (ASCII)	Description	0	Scan off	1	Scan on (default)
	para (ASCII)	Description						
	0	Scan off						
1	Scan on (default)							
Note	<ol style="list-style-type: none"> 1、 Take effect immediately, save when power off 2. If the current number of master connections has reached the maximum, then no longer start scanning; 3. Scan enable and disable take effect in roles other than the slave. 							

6.4.26 AT+SCANINTV scan interval

Command		Response
Inquiry	AT+SCANINTV?	+OK=[para]
Set	AT+SCANINTV=[para]	+OK: success +ERR=[NUM]: error
Parameter	para(ASCII):20~6000 default: 100	
Note	1. Take effect immediately, save when power off 2. The scanning interval is not less than the scanning window 3. The slave does not support it, but it can still be set	
For example,	AT+SCANINTV=120 Scan interval: $120 * 0.625 = 75\text{ms}$	

6.4.27 AT+SCANWND scan window

Command		Response
Inquiry	AT+SCANWND?	+OK=[para]
Set	AT+SCANWND=[para]	+OK: success +ERR=[NUM]: error
Parameter	para(ASCII): 20~65535 default: 80;	
Note	1. Take effect immediately, save when power off 2. The scanning interval is not less than the scanning window 3. The slave does not support it, but it can still be set	
For example,	AT+SCANWND=20 Scan window: $20 * 0.625 = 12.5\text{ms}$	

6.4.28 AT+TRANMD master transmission mode

Command		Response
Inquiry	AT+TRANMD?	+OK=[para]
Set	AT+ TRANMD =[para]	+OK: success +ERR=[NUM]: error
Parameter	para (ASCII)	description
	0	Not transparent transmission (default)
	1	Transparent transmission
Note	1、 Take effect immediately, save when power off	

6.4.29 AT+UUIIDSVR128 set service 128bit UUID

Command		Response
Inquiry	AT+UUIIDSVR128?	+OK=[para]
Set	AT+ UUIIDSVR128=[para]	+OK: success +ERR=[NUM]: error
Parameter	para(HEX):16 bit uuid.	
Note	1、 Take effect immediately, save when power off 2、 The second and third byte are16 bit uuid, range from 1~65535; 3、 The 128 bits UUID, except for the second and third bytes, is also used for the basic UUID of the slave channel, the master channel, and the configuration channel. (For the description of uuid, refer to "BLUETOOTH SPECIFICATION Version 5.0 Vol 3, Part B 2.5.1 UUID》).	
For example,	Set 128bit UUID: "11 22 33 44 55 66 77 88 99 00 aa bb cc dd ee ff"(HEX) AT command is (HEX) : 61 74 2b 75 75 69 64 73 76 72 31 32 38 3d 11 22 33 44 55 66 77 88 99 00 aa bb cc dd ee ff	

6.4.30 AT+UUIIDSVR Bluetooth service UUID

Command		Response
Inquiry	AT+UUIIDSVR?	+OK=[para]
Set	AT+UUIIDSVR=[para]	+OK: success +ERR=[NUM]: error
Parameter	para(HEX):0-FFFF default: FFF0	
Note	1、 Take effect immediately, save when power off 2、 For the master, the service UUID is a necessary condition for connection filtering, so when setting the master service UUID, it must be consistent with the slave, otherwise the connection cannot be established.	

6.4.31 AT+UUIIDSLAVE SLAVE CHANNEL characteristic UUID

Command		Response
Inquiry	AT+DDUISLAVE?	+OK=[para]
Set	AT+UUIID CHARA1= [para]	+OK: success +ERR=[NUM]: error
Parameter	para(HEX): 0-FFFF Default: FFF1	
Note	1. Take effect immediately, save when power off 2. Slave channel. Used to send data from the slave and receive data from the master.	

6.4.32 AT+UIDMAST MAST CHANNEL characteristic UUID command

Command		Response
Inquiry	AT+UIDMAST?	+OK=[para]
Set	AT+UID CHARA2= [para]	+OK: success +ERR=[NUM]: error
Parameter	para(HEX): 0-FFFF; Default: FFF2	
Note	1、 Take effect immediately, save when power off 2、 Master channel. The master sends data and the slave receives data.	

6.4.33 AT+AUTH Air configuration authentication password

Command		Response
Set	AT+AUTH =[para]	+OK: success +ERR=[NUM]: error
Parameter	para(HEX): 6 byte password	
Note	1、 Only for air configuration authentication password 2、 Default password: 123456	
For example,	AT+AUTH=123456	

6.4.34 AT+UPAUTH modify air configuration authentication password

Command		Response
Inquiry	AT+UPAUTH?	+OK=[para]
Set	AT+UPAUTH =[para]	+OK: success +ERR=[NUM]: error
Parameter	para(HEX): 6 byte password	
Note	Take effect immediately, save when power off	

6.4.35 AT+ONSLEEP sleep when power on

Command		Response
Inquiry	AT+ONSLEEP?	+OK=[para]
Set	AT+ONSLEEP =[para]	+OK: success +ERR=[NUM]: error

Parameter	para (ASCII)	Description
	0	Off(default)
	1	On
Note	Take effect immediately, save when power off	

6.4.36 AT+SLEEP enter sleep

Command		Response
Set	AT+SLEEP	+OK
Parameter	None	
Note	Take effect immediately	

6.4.37 AT+LOGMSG operating status output

Command		Response
Inquiry	AT+LOGMSG?	+OK=[para]
Set	AT+LOGMSG =[para]	+OK: success +ERR=[NUM]: error
Parameter	para (ASCII)	Description
	0	Off(default)
	1	On
Note	Take effect immediately, save when power off	

6.4.38 AT+PWR tx power

Command		Response
Inquiry	AT+ PWR?	+OK=[para]
Set	AT+ PWR =[para]	+OK: success +ERR=[NUM]: error
Parameter	para(ASCII)	Description
	0	2.5 dBm
	1	1.5 dBm
	2	0 dBm (default)
	3	-2 dBm
	4	-5 dBm

	5	-7 dBm
	6	-13.5 dBm
	7	-19.5 dBm
Note	Take effect immediately, save when power off	

6.4.39 AT+MTU Set Bluetooth single packet length

Command		Response
Inquiry	AT+ MTU?	+OK=[para]
Set	AT+ PWR =[para]	+OK: success +ERR=[NUM], error
Parameter	Para MTU value, Min is 23, max is 247.	
Note	Take effect immediately, save when power off	

6.3.40 AT+TRANMD transmission mode

Command		Response
Inquiry	AT+TRANMD?	+OK=[para]
Set	AT+TRANMD =[para]	+OK: success +ERR=[NUM]: error
Parameter	【0】 : format transmission 【1】 : transparent transmission	
Notes	In format transmission, the hexadecimal connection handle needs to be added before the data to be transmitted, and the handle will be printed when connecting	



7 Quick start

Software for debugging and parameter setting:

- PC serial tool - AccessPort.exe;
- Phone ble debugging APP - nRF connect

7.1 Configuration mode guidance

7.1.1 Serial port configuration

- Confirm whether the module is currently in configuration mode (if not connected, the module can be configured, if it is connected, you need to send "+++)" through the serial port
- Set AccessPort. string related configuration (default configuration: 115200, 8, 1, none, no flow empty), as shown below AccessPort. parameter configuration diagram;

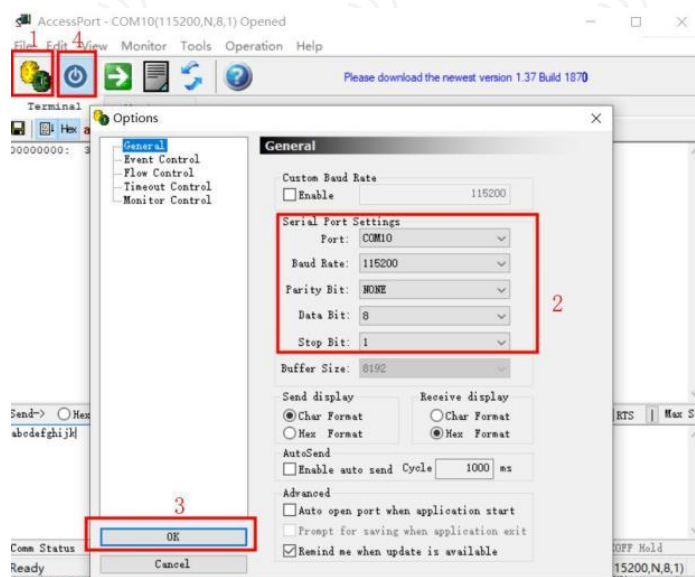

- Configure it according to AT command.

7.1.2 Configuration over air

- Only for module that works as a slave.
- Open app “nRF connect”, start scanning, find “E104-BT52” and connect to it.

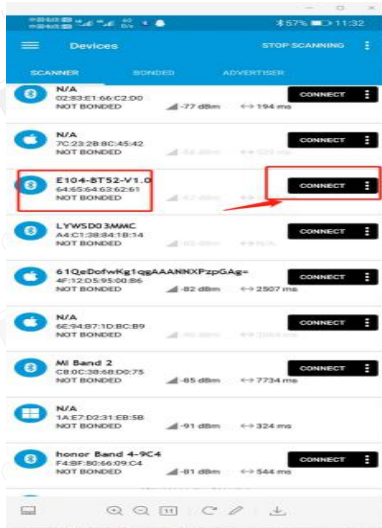

nRF connect scanning list

- Open uuid-fff0 service, Enable configuration channel: notify;

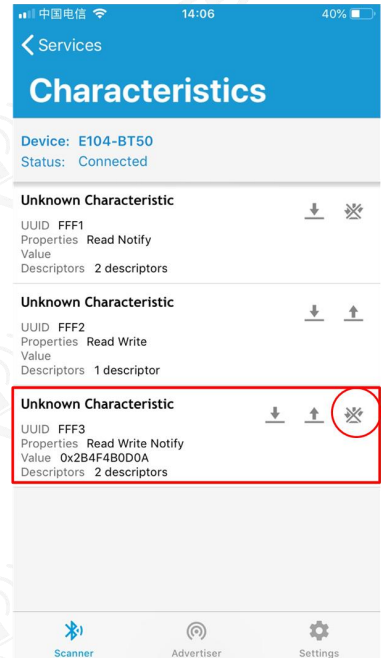
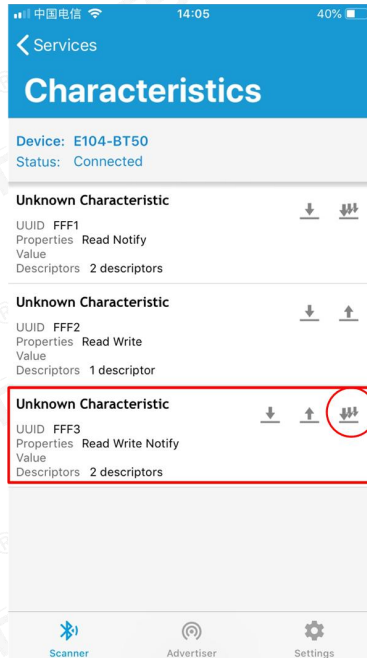
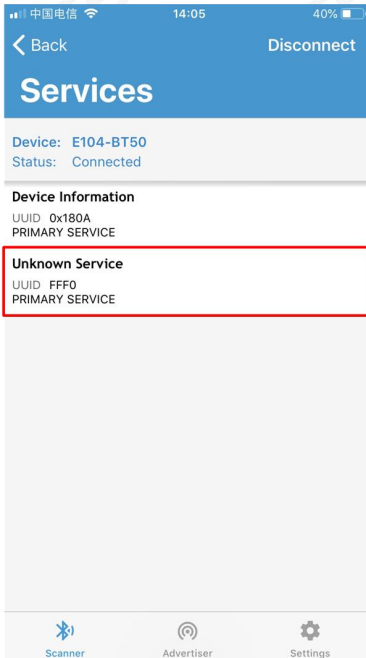

nRF connect, Enable configuration channel: notify

- Send authenticate command (`at+auth=12345`), module returns `"0x2befeb0d0a"` means success;

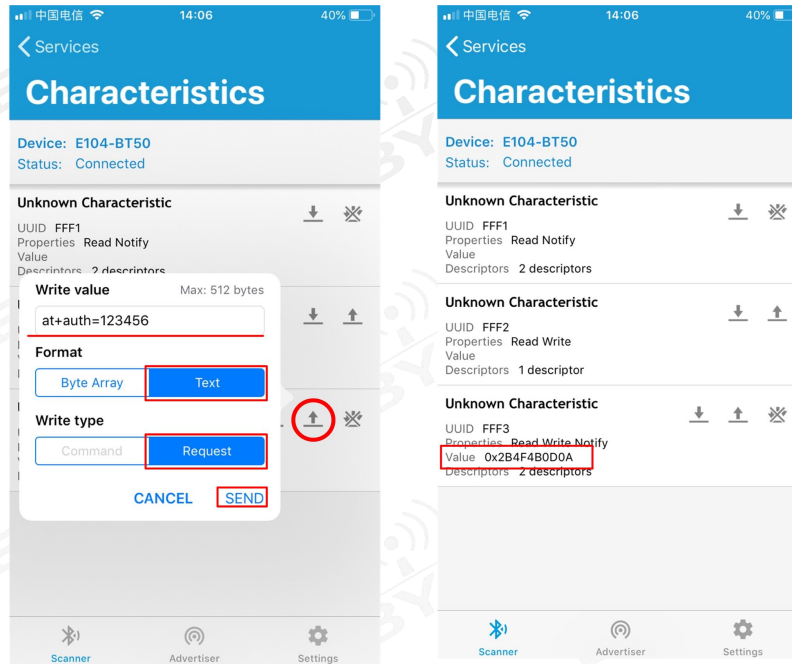

Over air configuration authentication

- Configure module according to 6.4 command table.

7.2 Data transmission

- For data transmission related instructions, see 5.3 Data Transmission Mode.
- Test Conditions:
- Configure one module as the master and one as the slave as described in the quick use guide for AT command list configuration mode;
- Software: AccessPort.
- Other parameters are the default configuration.

7.2.1 Data transparent transmission

1. Power on the module. Enable logmsg printing for master and slave (at+logmsg=1);
2. Set the module to transparent transmission mode (AT+TRANMD=1).
3. After the host is successfully connected, it will print "sta: connecte 0 616263646564"; the slave will print sta: connecte 0 616263646566". The LINK pin is high. As shown below, the host is automatically connected and printed: The slave is powered on The automatic connection printing is shown in the figure. The value before the MAC address in the host print information is the slave handle in the host, and the first byte of the format transmission comes from this.

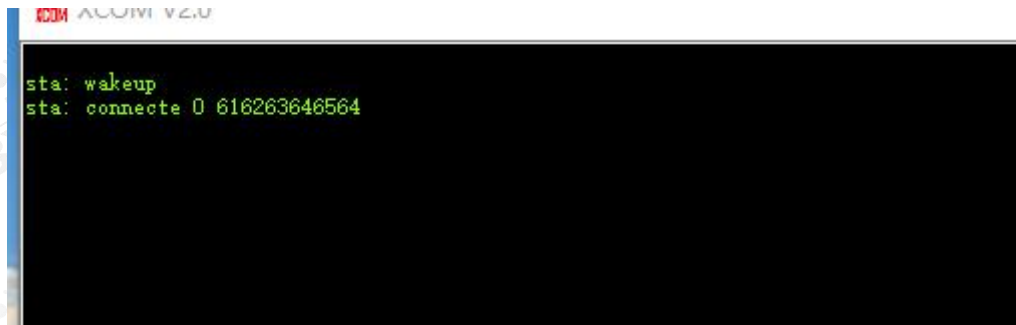

The master auto connects and prints once powered on

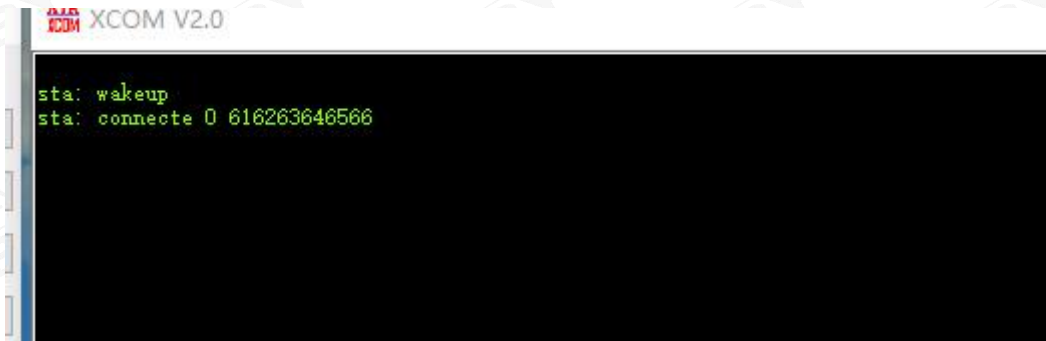

The slave auto connects and prints once powered on

1. The master sends data "0123456789" to the slave, the slave receives "0123456789", as shown below;
2. The slave sends data "abcdefghijk" to the master, the master receives "abcdefghijk", as shown below;

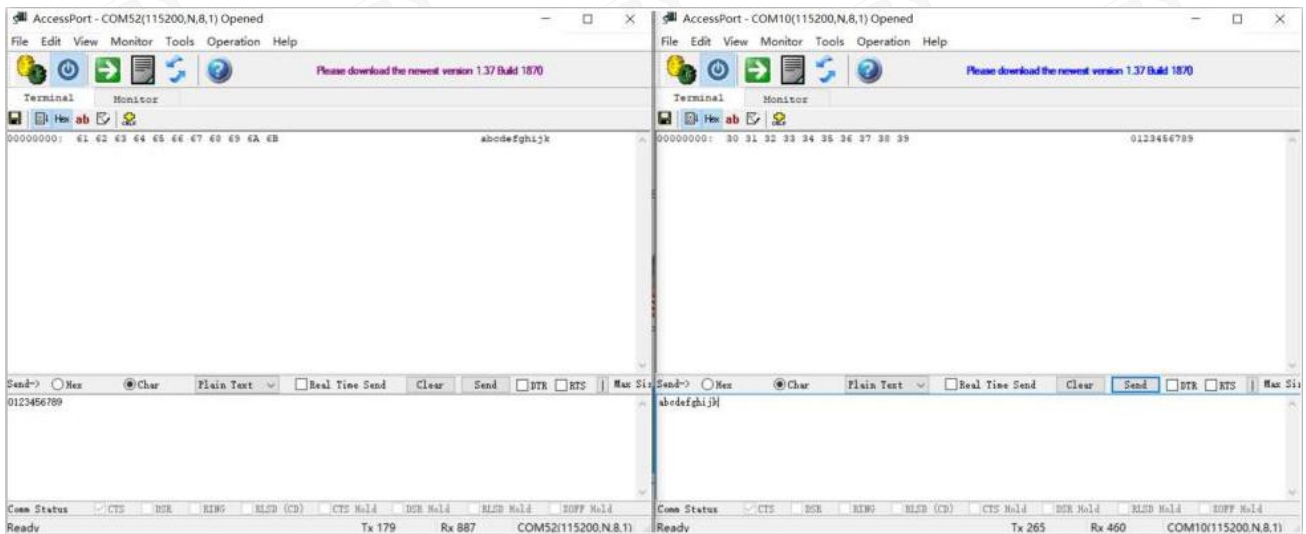

The master sends transparent data

7.2.2 Format transmission

1. Same as Step 1 of 7.2.1 Data Transparent Transmission;
2. Set to format transmission (default format transmission, set command "AT+TRANMD=0")
3. Same as Step 3 of 7.2.1 Data Transparent Transmission;
4. The effective data sent by the master to the slave is "123456789" (ASCII). The format transmission data is packed "00 30 31 32 33 34 35 36 37 38 39" (HEX). At this time, the data received by the slave is "123456789" ("30 31 32 33 34 35 36 37 38 39"). Such as

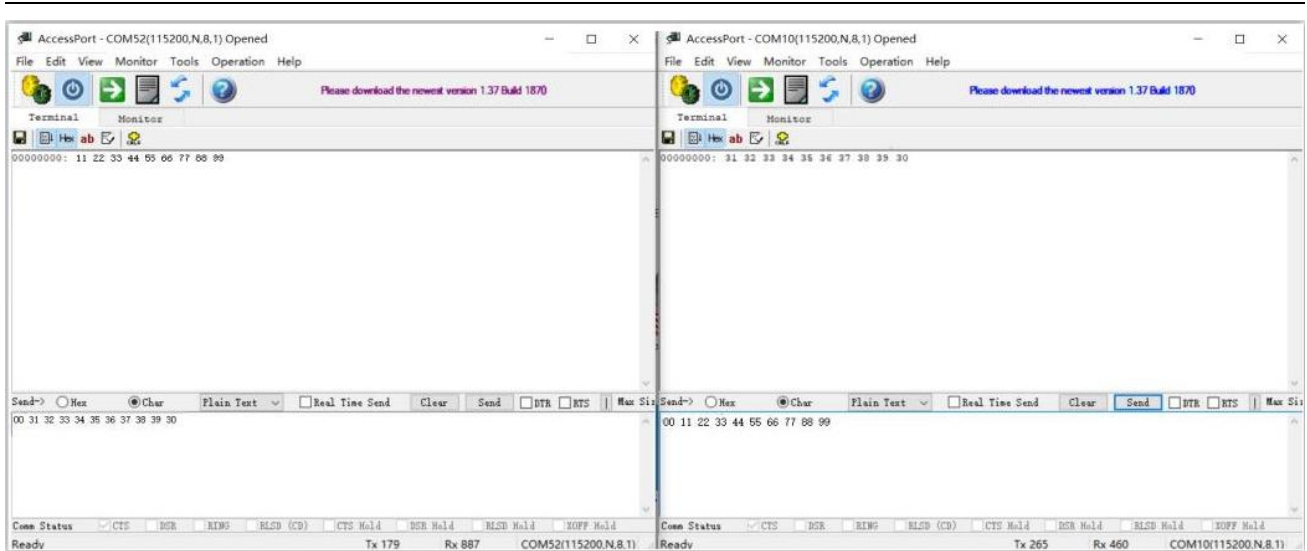

- 5 The slave sends the data “11 22 33 44 55 66 77 88 99” (hex) to the master, and the data received by the master is “11 22 33 44 55 66 77 88 99” (HEX), as long as the format transmission is turned on. The first byte is sending IDX. Both the host and the slave can use different transmission modes but the input needs to meet the transmission rules.

8 FAQ

8.1 Communication distance is too short

- The communication distance will be affected when obstacle exists;
- Data lose rate will be affected by temperature, humidity and co-channel interference;
- The ground will absorb and reflect wireless radio wave, so the performance will be poor when testing near ground;
- Sea water has great ability in absorbing wireless radio wave, so performance will be poor when testing near the sea;
- The signal will be affected when the antenna is near metal object or put in a metal case;
- Power register was set incorrectly, air data rate is set as too high (the higher the air data rate, the shorter the distance);
- The power supply low voltage under room temperature is lower than recommended value, the lower the voltage, the lower the transmitting power;
- Due to antenna quality or poor matching between antenna and module.

8.2 Module is easy to damage

- Please check the power supply source, ensure it is between the recommended supply voltage, voltage higher than the maximum will damage the module.
- Please check the stability of power source, the voltage cannot fluctuate too much;
- Please make sure antistatic measure are taken when installing and using, high frequency devices have

electrostatic susceptibility;

- Please ensure the humidity is within limited range, some parts are sensitive to humidity;
- Please avoid using modules under too high or too low temperature.

8.3 BER(Bit Error Rate) is high

- There are co-channel signal interference nearby, please be away from interference sources or modify frequency and channel to avoid interference;
- Poor power supply may cause messy code. Make sure that the power supply is reliable;
- The extension line and feeder quality are poor or too long, so the bit error rate is high.

9 Welding instruction

9.1 Reflow soldering temperature

Profile Feature	Sn-Pb Assembly	Pb-Free Assembly
Solder Paste	Sn63/Pb37	Sn96.5/Ag3/Cu0.5
Preheat Temperature min (T _{min})	100°C	150°C
Preheat temperature max (T _{max})	150°C	200°C
Preheat Time (T _{min} to T _{max})(t _s)	60-120 sec	60-120 sec
Average ramp-up rate(T _{max} to T _p)	3°C/second max	3°C/second max
Liquidous Temperature (TL)	183°C	217°C
Time (t _L) Maintained Above (TL)	60-90 sec	30-90 sec
Peak temperature (T _p)	220-235°C	230-250°C
Average ramp-down rate (T _p to T _{max})	6°C/second max	6°C/second max
Time 25°C to peak temperature	6 minutes max	8 minutes max

9.2 Reflow soldering curve

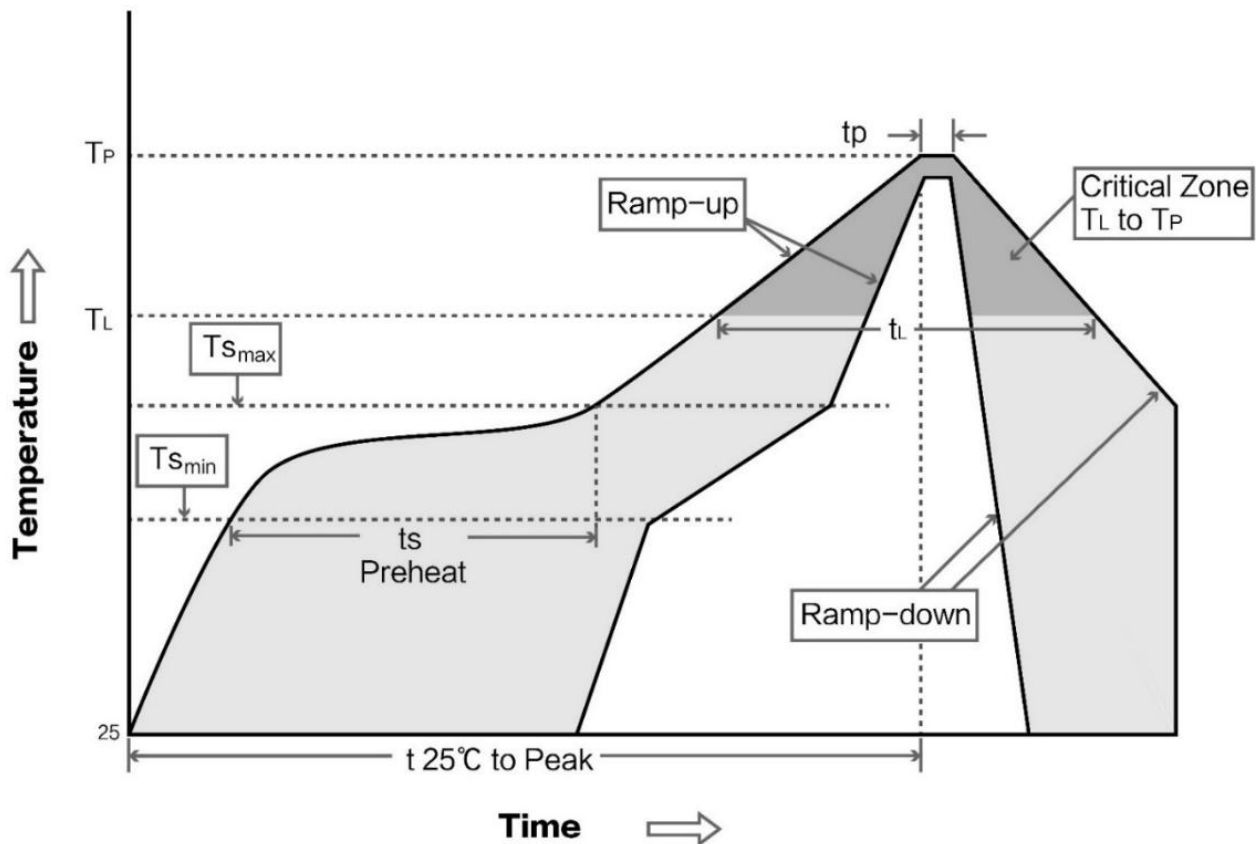

10 Package

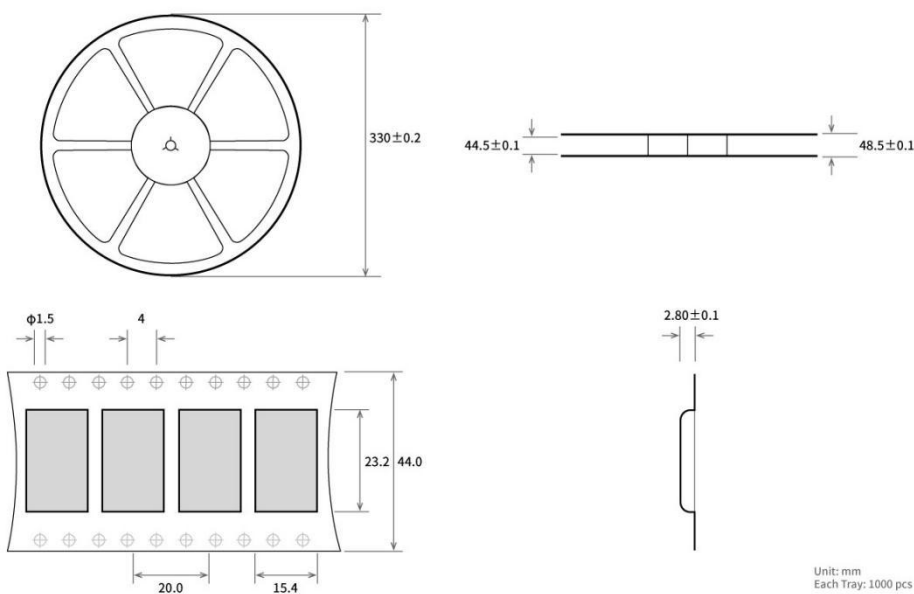

Unit: mm
Each Tray: 1000 pcs

11 Related Model

Model No.	Chip	Frequency Hz	TX power dBm	Communication interface	Protocol BLE	Size mm	Antenna	Feature
E72-2G4M05S1B	CC2640	2.4G	5	I/O	4.2	17.5*28.7	PCB/IPX	Hardware resources, requires secondary development
E73-2G4M04S1A	nRF52810	2.4G	4	I/O	4.2/5.0	17.5*28.7	PCB/IPX	Hardware resources, requires secondary development
E73-2G4M04S1B	nRF52832	2.4G	4	I/O	4.2/5.0	17.5*28.7	PCB/IPX	Hardware resources, requires secondary development
E73-2G4M08S1C	nRF52840	2.4G	8	I/O	4.2/5.0	13*18	PCB/IPX	Hardware resources, requires secondary development
E73-2G4M04S1D	nRF51822	2.4G	4	I/O	4.2	17.5*28.7	PCB/IPX	Hardware resources, requires secondary development
E104-BT01	CC2541	2.4G	0	I/O	4.0	14*22	PCB	Hardware resources, requires secondary development
E104-BT02	DA14580	2.4G	0	TTL	4.2	14*22	PCB	The lowest power, High speed continuous transmission, Sniff
E72-2G4M04S2B	CC2640	2.4G	2	TTL	4.2	14*23	PCB/IPX	Built-in ARM dual core Multiple role mode
E104-2G4U04A	CC2540	2.4G	0	USB	4.0	18*59	PCB	Dongle Protocol Analyzer
E104-BT5010A	nRF52810	2.4G	0	UART	5.0	11.5 * 16	ceramic antenna	Low power, transparent transmission

Revision history

Version	Date	Description	Issued by
1.0		Frist version	
1.1	2020-07-24	Format modification	Ren
1.2	2020-08-20	Add command	Ren
1.3	2020-09-25	Add command	Ren

About us

Technical support: support@cdebyte.com

Documents and RF Setting download link: www.ebyte.com

Thank you for using Ebyte products! Please contact us with any questions or suggestions: info@cdebyte.com

Official hotline:028-61399028

Web: www.ebyte.com

Address: B5 Mould Park, 199# Xiqu Ave, High-tech District, Sichuan, China



Chengdu Ebyte Electronic Technology Co.,Ltd.