

Description of Device Functions

CNGmass DCI

Modbus RS485

Coriolis flowmeter

For fueling with CNG (Compressed Natural Gas)

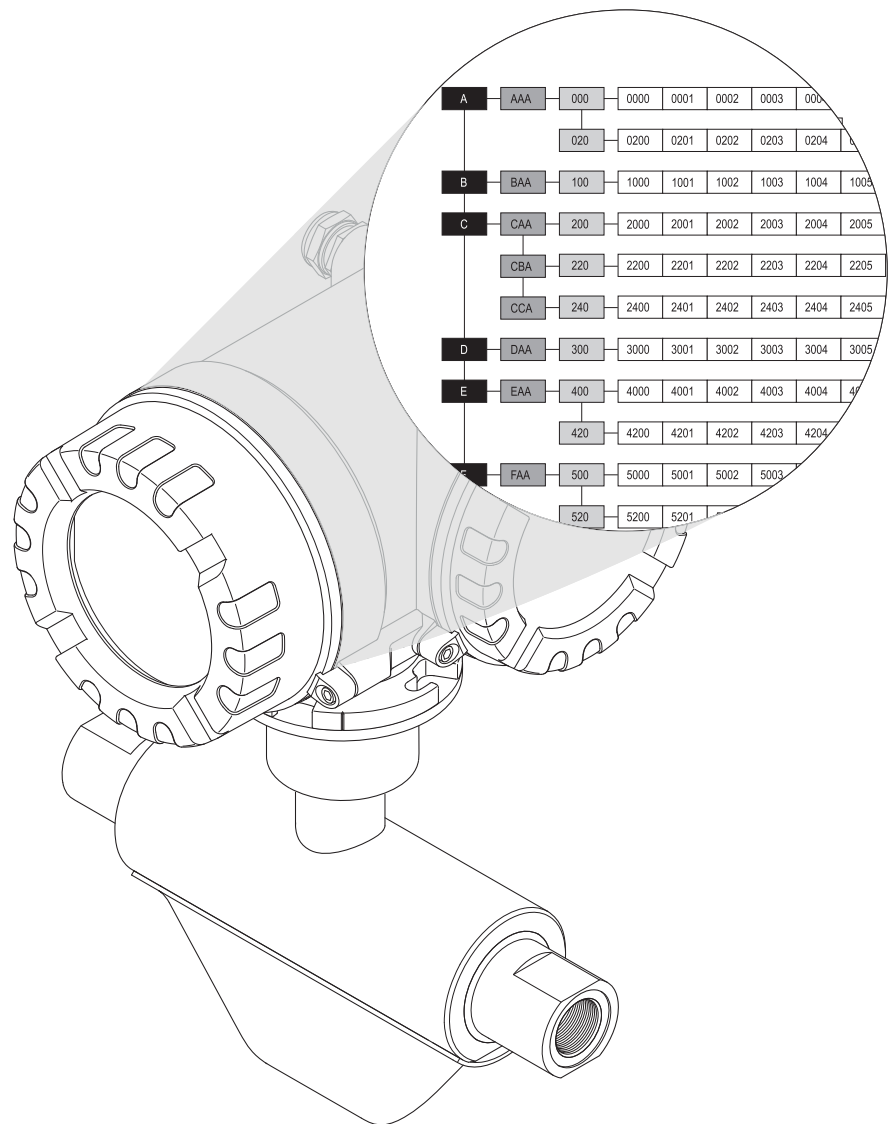



Table of contents

1	Using this manual	7
1.1	Finding a function description	7
1.1.1	Using the table of contents →  3	7
1.1.2	Using the graphic of the function matrix	7
1.1.3	Using the index of the function matrix →  135	7
2	Function matrix	8
2.1	General layout of the function matrix	8
2.1.1	Blocks (A, B, C etc.)	8
2.1.2	Groups (AAA, AEA, CAA etc.)	8
2.1.3	Function groups (000, 020, 060 etc.)	8
2.1.4	Functions (0000, 0001, 0002 etc.)	8
2.1.5	Codes identifying cells	9
2.2	Illustration of the function descriptions	10
2.3	Display lines on the local display	10
2.4	Function matrix	11
3	Block CUSTODY TRANSFER	12
4	Block MEASURED VARIABLES	14
4.1	Group MEASURING VALUES	15
4.1.1	Function group MAIN VALUES	15
4.2	Group SYSTEM UNITS	16
4.2.1	Function group CONFIGURATION	16
4.2.2	Function group ADDITIONAL CONFIGURATION	19
5	Block QUICK SETUP	21
5.1	Quick Setup	23
5.1.1	Quick Setup "Commissioning"	23
5.1.2	Quick Setup "Pulsating Flow"	25
5.1.3	Quick Setup "Gas Measurement"	27
5.1.4	Quick Setup "Communication"	28
5.2	Data back-up/transfer	29
6	Block USER INTERFACE	30
6.1	Group CONTROL	31
6.1.1	Function group BASIC CONFIGURATION	31
6.1.2	Function group UNLOCKING/LOCKING	33
6.1.3	Function group OPERATION	35
6.2	Group MAIN LINE	36
6.2.1	Function group CONFIGURATION	36
6.2.2	Function group MULTIPLEX	38
6.3	Group ADDITIONAL LINE	40
6.3.1	Function group CONFIGURATION	40
6.3.2	Function group MULTIPLEX	42
6.4	Group INFORMATION LINE	44
6.4.1	Function group CONFIGURATION	44
6.4.2	Function group MULTIPLEX	46
7	Block TOTALIZER	48
7.1	Group TOTALIZER (1 to 3)	49

7.1.1	Function group CONFIGURATION	49
7.1.2	Function group OPERATION	51
7.2	Group HANDLING TOTALIZER	52
8	Block OUTPUTS	53
8.1	Group Outputs	54
8.1.1	Function group CONFIGURATION	54
8.1.2	Function group OPERATION	63
8.1.3	Function group INFORMATION	64
8.2	Group PULSE/FREQUENCY OUTPUT	65
8.2.1	Function group CONFIGURATION	65
8.2.2	Function group OPERATION	87
8.2.3	Function group INFORMATION	92
8.3	Group RELAY OUTPUT (1 to 2)	93
8.3.1	Function group CONFIGURATION	93
8.3.2	Function group OPERATION	97
8.3.3	Function group INFORMATION	98
8.3.4	Information on the response of the relay output	99
8.3.5	Switching behavior of the relay output	100
9	Block INPUTS	102
9.1	Group STATUS INPUT	103
9.1.1	Function group CONFIGURATION	103
9.1.2	Function group OPERATION	104
9.1.3	Function group INFORMATION	105
10	Block BASIC FUNCTION	106
10.1	Group Modbus RS485	107
10.1.1	Function group CONFIGURATION	107
10.2	Group PARAMETER	110
10.2.1	Function group CONFIGURATION	110
10.2.2	Function group EPD PARAMETER	112
10.2.3	Function group REFERENCE PARAMETER	114
10.2.4	Function group ADJUSTMENT	116
10.2.5	Function group PRESSURE CORRECTION	119
10.3	Group SYSTEM PARAMETER	120
10.3.1	Function group CONFIGURATION	120
10.4	Group SENSOR DATA	121
10.4.1	Function group CONFIGURATION	121
10.4.2	Function group FLOW COEFFICIENT	122
10.4.3	Function group DENSITY COEFFICIENT	123
10.4.4	Function group ADDITIONAL COEFFICIENT	124
11	Block SUPERVISION	125
11.1	Group SYSTEM	126
11.1.1	Function group CONFIGURATION	126
11.1.2	Function group OPERATION	127
11.2	Group VERSION-INFO	129
11.2.1	Function group DEVICE	129
11.2.2	Function group SENSOR	130
11.2.3	Function group AMPLIFIER	131
11.2.4	Function group I/O MODULE	132
11.2.5	Function groups I/O SUBMODULE 2 to 4	133
12	Factory settings	134

12.1	SI units (not for USA and Canada)	134
12.1.1	Low flow cut off, full scale value, pulse value	134
12.2	US units (only for USA and Canada)	134
12.2.1	Low flow cut off, full scale value, pulse value	134
	Index of function matrix	135
	Index.....	139

1 Using this manual

This manual must be used in conjunction with the Operating Instructions of the measuring device. A description of all the functions of the measuring device is provided here.

1.1 Finding a function description

There are various ways of locating the description of a function of your choice in the manual:

1.1.1 Using the table of contents → 3

The designations of all the cells in the function matrix are listed in the table of contents. You can use these unambiguous designations (such as USER INTERFACE, INPUTS, OUTPUTS etc.) to choose whichever functions are applicable to a particular set of conditions. The page references show you exactly where to find the detailed descriptions of the functions in question.

1.1.2 Using the graphic of the function matrix

This step-by-step, top-down approach starts with the blocks, the highest level, and factory down through the matrix to the description of the function you need:

1. All blocks available, and their related groups, are illustrated on → 11. Select the block (or the group within the block) which you need for your application and use the page reference to locate the information corresponding to the next level.
2. The page in question contains a graphic showing of the block with all its subordinate groups, function groups and functions. Select the function which you need for your application and use the page reference to locate the detailed function description.

1.1.3 Using the index of the function matrix → 135

Each "cell" in the function matrix (blocks, groups, function groups, functions) has a unique identifier in the form of a code consisting of one or three letters or a three- or four-digit number. The code identifying a selected "cell" appears at the top right on the local display.

The function matrix index lists the codes for all the available "cells" in alphabetic and consecutive order, complete with the page references for the corresponding functions.

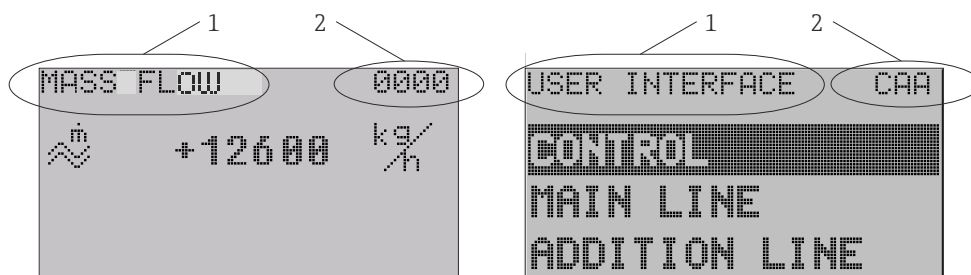

A0004821-EN

Fig. 1: Local display

- 1 Name of the function, e.g. mass flow, user interface
- 2 Function code, e.g. 0000, CAA

2 Function matrix

2.1 General layout of the function matrix

The function matrix consists of four levels:

Blocks → Groups → Function groups → Functions

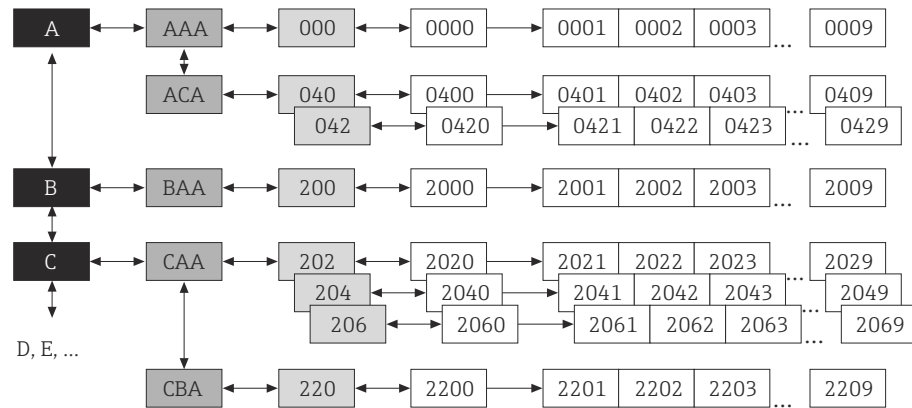

A0000961

Fig. 2: Layout of the function matrix

2.1.1 Blocks (A, B, C etc.)

The blocks are the highest-level grouping of the operation options for the device.

The blocks include, for example: MEASURED VARIABLES, QUICK SETUP, USER INTERFACE, TOTALIZER etc.

2.1.2 Groups (AAA, AEA, CAA etc.)

A block consists of one or more groups. Each group represents a more detailed selection of the operation options in the higher-order block. The groups in the "USER INTERFACE" block, for example, include: CONTROL, MAIN LINE, ADDITION LINE etc.

2.1.3 Function groups (000, 020, 060 etc.)

A group consists of one or more function groups. Each function group represents a more detailed selection of the operation options in the higher-order group. The function groups in the "CONTROL" group, for example, include: BASIC CONFIG., UNLOCKING/LOCKING, CONTROL etc.

2.1.4 Functions (0000, 0001, 0002 etc.)

Each function group consists of one or more functions. The functions are used to operate and parameterize the measuring instrument. Numerical values can be entered or parameters selected and saved.

Available functions of the function group "BASIC CONFIG." are: LANGUAGE, DISPLAY DAMPING, CONTRAST LCD etc.

The procedure for changing the language of the user interface, for example, is as follows:

1. Select the block "USER INTERFACE".
2. Select the group "CONTROL".
3. Select the function group "BASIC CONFIG.".
4. Select the function "LANGUAGE" (here you can set the language required).

2.1.5 Codes identifying cells

Each cell (block, group, function group and function) in the function matrix has an individual, unique code.

Blocks:

The code is a letter (A, B, C etc.)

Groups:

The code consists of three letters (AAA, ABA, BAA etc.).

The first letter matches the block code (i.e. each group in block A has a code starting with an A _ _; the codes of the groups in block B start with a B _ _ etc.). The other two letters are for identifying the group within the respective block.

Function groups:

The code consists of three digits (000, 001, 100 etc.).

Functions:

The code consists of four digits (0000, 0001, 0201 etc.).

The first three digits are the same as the code for the function group.

The last digit counts the functions in the function group, counting up from 0 to 9 (for example, function 0005 is the sixth function in the group 000).

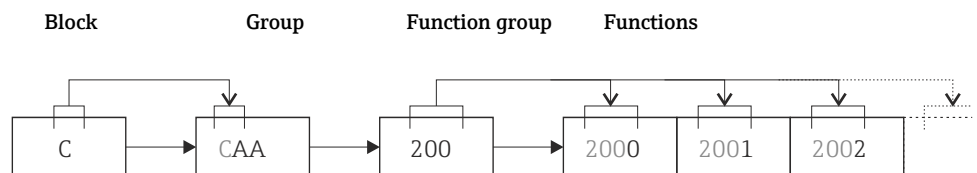

A0001251

2.2 Illustration of the function descriptions

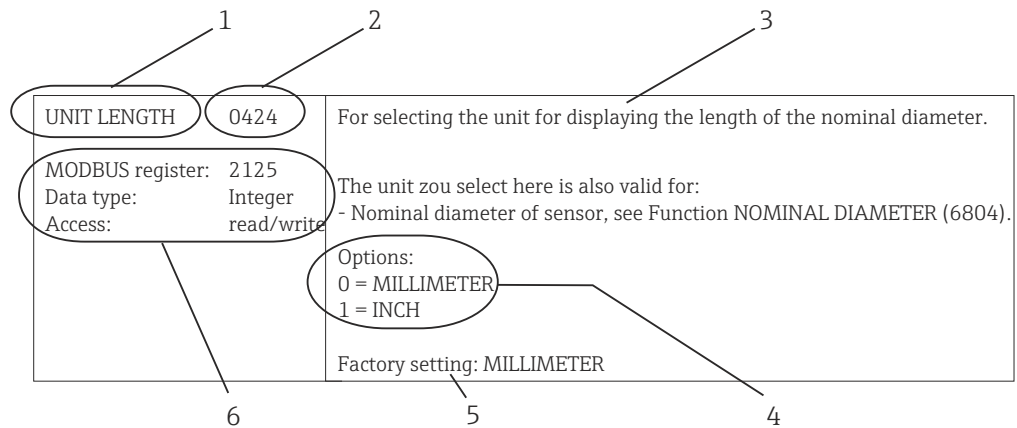

A0004827-EN

Fig. 3: Example for the description of a function

- 1 Name of the function
- 2 Number of the function (appears on the local display; is **not** identical to the Modbus RS485 register address)
- 3 Description of the function
- 4 Selection or entry options or display
- 5 Factory setting (the measuring device is delivered with this setting/selected option)
- 6 Information on communication via Modbus RS485
 - Modbus RS485 register (information in decimal numerical format)
 - Data type: float (length = 4 bytes), integer (length = 2 bytes), string (length = depends on function)
 - Possible ways of accessing the function:
 read = read access via function code 03, 04 or 23
 write = write access via function code 06, 16 or 23



Note!

If a nonvolatile device parameter is modified via the Modbus RS485 function codes 06, 16 or 23, this change is saved in the EEPROM of the measuring device. The number of writes to the EEPROM is technically restricted to a maximum of 1 million. Attention must be paid to this limit since, if exceeded, it results in data loss and measuring device failure. For this reason, avoid constantly writing nonvolatile device parameters via the Modbus RS485!

2.3 Display lines on the local display

The local display is split into various display lines.

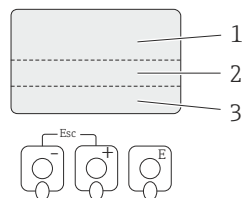

A0001253

Fig. 4: Local display

- 1 Main line
- 2 Additional line
- 3 Information line







The values are assigned to the individual lines in the block → 31.





2.4 Function matrix

Blocks		Groups		Function groups
CUSTODY TRANSFER Z (→ 12)	→		→	→ 12
↓↑				
MEASURED VARIABLES A (→ 14)	→	MEASURING VALUES AAA	→	→ 15
		SYSTEM UNITS ACA	→	→ 16
↓↑				
QUICK SETUP B (→ 21)	→	Commissioning and application setups	→	→ 21
↓↑				
USER INTERFACE C (→ 30)	→	CONTROL CAA	→	→ 31
		MAIN LINE CCA	→	→ 36
		ADDITIONAL LINE CEA	→	→ 40
		INFORMATION LINE CGA	→	→ 44
↓↑				
TOTALIZER D (→ 48)	→	TOTALIZER 1 DAA	→	→ 49
		TOTALIZER 2 DAB	→	→ 49
		TOTALIZER 3 DAC	→	→ 49
		HANDLING TOTALIZER DJA	→	→ 52
↓↑				
OUTPUTS E (→ 53)	→	CURRENT OUTPUT EAA	→	→ 54
		PULSE/FREQ. OUTPUT ECA	→	→ 65
		RELAY OUTPUT 1 EGA	→	→ 93
		RELAY OUTPUT 2 EGB	→	→ 93
↓↑				
INPUTS F (→ 102)	→	STATUS INPUT FAA	→	→ 103
↓↑				
BASIC FUNCTION G (→ 106)	→	MODBUS RS485 GDA	→	→ 107
		PROCESS PARAMETER GIA	→	→ 110
		SYSTEM PARAMETER GLA	→	→ 120
		SENSOR DATA GNA	→	→ 121
↓↑				
SUPERVISION J (→ 125)	→	SYSTEM JAA	→	→ 126
		VERSION-INFO JCA	→	→ 129

3 Block CUSTODY TRANSFER

Block	Group	Function groups	Functions			
CUSTODY TRANSFER (Z)	⇒	⇒	CUSTODY TRANSFER → 12	PULSE OUT.1 C.T. → 12	CURR. OUT. 1 C.T. → 12	TOTALIZER 1 C.T. → 13
			TOTALIZER 2 C.T. → 13	TOTALIZER 3 C.T. → 13	MODBUS CFG C.T. → 13	

Function description CUSTODY TRANSFER		
<p> Note!</p> <ul style="list-style-type: none"> ■ If the measuring device is configured in accordance with the NTEP or MC approvals, this block (CUSTODY TRANSFER) is not available. ■ If the measuring system is set to custody transfer and the hardware is sealed, then all the measuring instrument functions marked with a lock symbol  are protected against access. For additional information on this topic, refer to the Operating Instructions (BA00140D/06), Chapter 7.3.1, "Setting up custody transfer measurement". ■ These functions are not available to be used again until you disable custody transfer mode of the measuring system. For additional information on this topic, refer to the Operating Instructions (BA00140D/06), Chapter 7.3.2, "Disabling custody transfer measurement". 		
CUSTODY TRANSFER Modbus register: Data type: Access:	Z000 7550 Integer read	Use this function to check whether the measuring point is set to custody transfer. Display: 0 = C.T. NO 1 = C.T. YES Factory setting: C.T. NO
PULSE OUTPUT 1 CUSTODY TRANSFER  Modbus register: Data type: Access:	Z001 7551 Integer read/ write	<p> Note!</p> <p>This function is available only if the measuring instrument has a pulse output 1.</p> <p>Selection of the pulse output 1 for transferring the calibrated signal.</p> Options: 0 = NO 1 = YES Factory setting: NO
CURRENT OUTPUT 1 CUSTODY TRANSFER  Modbus register: Data type: Access:	Z003 7553 Integer read/ write	<p> Note!</p> <p>This function is available only if the measuring instrument has a current output 1.</p> <p>Selection of the current output 1 for transferring the calibrated signal.</p> Options: 0 = NO 1 = YES Factory setting: NO

Function description CUSTODY TRANSFER		
<p>TOTALIZER 1 CUSTODY TRANSFER</p> <p></p> <p>Modbus register: 7556 Data type: Integer Access: read/write</p>	<p>Z006</p>	<p>Selection of the totalizer 1 for transferring the calibrated signal.</p> <p>Options: 0 = NO 1 = YES</p> <p>Factory setting: NO</p>
<p>TOTALIZER 2 CUSTODY TRANSFER</p> <p></p> <p>Modbus register: 7557 Data type: Integer Access: read/write</p>	<p>Z007</p>	<p>Selection of the totalizer 2 for transferring the calibrated signal.</p> <p>Options: 0 = NO 1 = YES</p> <p>Factory setting: NO</p>
<p>TOTALIZER 3 CUSTODY TRANSFER</p> <p></p> <p>Modbus register: 7558 Data type: Integer Access: read/write</p>	<p>Z008</p>	<p>Selection of the totalizer 3 for transferring the calibrated signal.</p> <p>Options: 0 = NO 1 = YES</p> <p>Factory setting: NO</p>
<p>Modbus CONFIGURATION CUSTODY TRANSFER</p> <p></p> <p>Modbus register: Data type: 7559 Access: Integer read/write</p>	<p>Z009</p>	<p>Selection of the Modbus communication for transferring the calibrated signal.</p> <p>Options: 0 = NO 1 = YES</p> <p>Factory setting: NO</p>

4 Block MEASURED VARIABLES

Block	Groups	Function groups	Functions					
MEASURED VARIABLES (A)	MEASURING VALUES (AAA) → 15 ↓ ↑	MAIN VALUES (000) → 15 ↓ ↑	VOLUME FLOW (0001) → 15	CORRECTED VOLUME FLOW (0004) → 15	DENSITY (0005) → 15	REFERENCE DENSITY (0006) → 15	TEMPERATURE (0008) → 15	
			MASS FLOW (0000) → 15	UNIT MASS (0401) → 16	UNIT VOL. FLOW (0402) → 17	UNIT CORR. VOL. FLOW (0404) → 18	UNIT CORR. VOLUME (0405) → 18	
	SYSTEM UNITS (ACA) → 15	CONFIGURATION (040) → 16 ↓ ↑	ADDITIONAL CONFIGURATION (042) → 19	UNIT MASS FLOW (0400) → 16	UNIT TEMPERATURE (0422) → 20	UNIT LENGTH (0424) → 20	UNIT PRESSURE (0426) → 20	
				UNIT REF. DENSITY (0421) → 19				

4.1 Group MEASURING VALUES

4.1.1 Function group MAIN VALUES

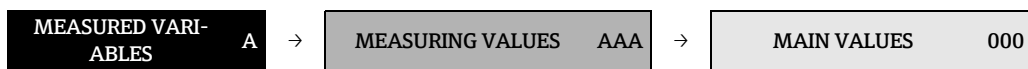





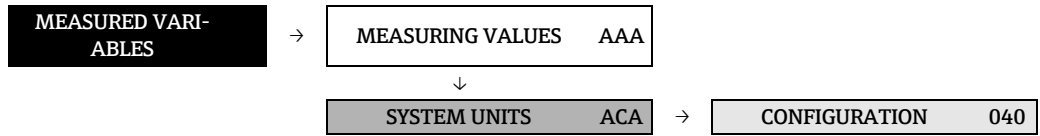

Function description MEASURED VARIABLES → MEASURING VALUES → MAIN VALUES		
<p> Note!</p> <ul style="list-style-type: none"> The units of all the measured variables shown here can be set in the SYSTEM UNITS group. If the fluid in the pipe flows backwards, a negative sign prefixes the flow reading on the display. 		
<p>MASS FLOW 0000</p> <p>Modbus register: 2007 247</p> <p>Data type: Float</p> <p>Access: read</p>		<p>The currently measured mass flow appears on the display.</p> <p>Display: 5-digit floating-point number, including unit and sign (e.g. 462.87 kg/h; -731.63 lb/min etc.)</p>
<p>VOLUME FLOW 0001</p> <p>Modbus register: 2009 253</p> <p>Data type: Float</p> <p>Access: read</p>		<p>The calculated volume flow appears on the display. The volume flow is derived from the measured mass flow and the measured density of the fluid.</p> <p>Display: 5-digit floating-point number, including unit and sign (e.g. 5.5445 dm³/min; 1.4359 m³/h; -731.63 gal/d etc.)</p>
<p>CORRECTED VOL- UME FLOW 0004</p> <p>Modbus register: 2011</p> <p>Data type: Float</p> <p>Access: read</p>		<p>The calculated corrected volume flow appears on the display. The calculated corrected volume flow is derived from the measured mass flow and the reference density of the fluid (density at reference temperature, measured or fixed entry).</p> <p>Display: 5-digit floating-point number, including unit and sign (e.g. 1.3549 Nm³/h; 7.9846 scm/day etc.)</p>
<p>DENSITY 0005</p> <p>Modbus register: 2013 249</p> <p>Data type: Float</p> <p>Access: read</p>		<p>The currently measured density or its specific gravity appears on the display.</p> <p>Display: 5-digit floating point number, incl. unit (e.g. 1.2345 kg/dm³; 993.5 kg/m³; 1.0015 SG_20 °C etc.)</p>
<p>REFERENCE DEN- SITY 0006</p> <p>Modbus register: 2015</p> <p>Data type: Float</p> <p>Access: read</p>		<p>The density of the fluid, at reference temperature, appears on the display. The reference density can be measured or also specified via the function FIXED REFERENCE DENSITY (6461) (→ 114).</p> <p>Display: 5-digit floating point number, incl. unit (e.g. 1.2345 kg/dm³; 993.5 kg/m³; 1.0015 SG_20 °C etc.)</p>
<p>TEMPERATURE 0008</p> <p>Modbus register: 2017 251</p> <p>Data type: Float</p> <p>Access: read</p>		<p>The currently measured temperature appears on the display.</p> <p>Display: Max. 4-digit fixed-point number, including unit and sign (e.g. -23.4 °C; 160.0 °F; 295.4 K etc.)</p>



4.2 Group SYSTEM UNITS

4.2.1 Function group CONFIGURATION





Function description MEASURED VARIABLES → SYSTEM UNITS → CONFIGURATION		
<p>You can select the units for measured variables in this function group.</p>		
<p>UNIT MASS FLOW 0400</p> <p></p> <p>Modbus register: 2101 Data type: Integer Access: read/ write</p>	<p>For selecting the unit for displaying the mass flow.</p> <p>The unit you select here is also valid for:</p> <ul style="list-style-type: none"> ■ Current output ■ Frequency output ■ Relay switch points (limit value for mass flow, flow direction) ■ Low flow cut off <p>Options: Metric: 0 to 3 = gram → g/s; g/min; g/h; g/day 4 to 7 = kilogram → kg/s; kg/min; kg/h; kg/day 8 to 11 = ton → t/s; t/min; t/h; t/day</p> <p>US: 12 to 15 = ounce → oz/s; oz/min; oz/h; oz/day 16 to 19 = pound → lb/s; lb/min; lb/h; lb/day 20 to 23 = ton → ton/s; ton/min; ton/h; ton/day</p> <p>Factory setting: Country-dependent (kg/h or US-lb/min)</p>	
<p>UNIT MASS 0401</p> <p></p> <p>Modbus register: 2102 Data type: Integer Access: read/ write</p>	<p>For selecting the unit for displaying the mass.</p> <p>The unit you select here is also valid for:</p> <ul style="list-style-type: none"> ■ Pulse value (e.g. kg/p) <p>Options: Metric: 0 = g 1 = kg 2 = t</p> <p>US: 3 = oz 4 = lb 5 = ton</p> <p>Factory setting: Country-dependent (kg or US-lb)</p> <p> Note! The unit for the totalizers is independent of the selection made here and is selected separately for each totalizer.</p>	



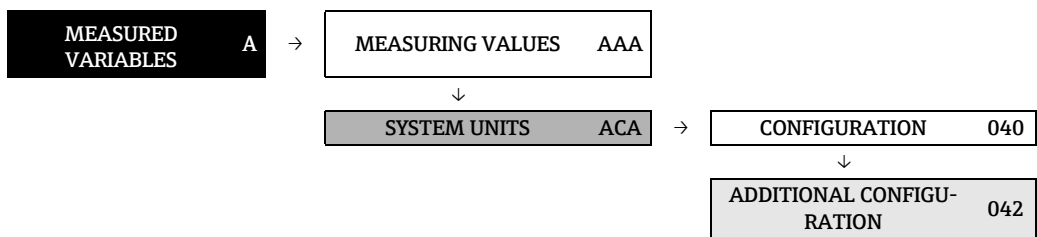

Function description		
MEASURED VARIABLES → SYSTEM UNITS → CONFIGURATION		
<p>UNIT VOLUME FLOW</p> <p></p> <p>Modbus register: 2103 Data type: Integer Access: read/write</p>	<p>0402</p>	<p>For selecting the unit for displaying the volume flow.</p> <p>The unit you select here is also valid for:</p> <ul style="list-style-type: none"> ■ Current output ■ Frequency output ■ Relay switch points (limit value for volume flow, flow direction) ■ Low flow cut off <p>Options: Metric: 0 to 3 = cubic centimeter → cm³/s; cm³/min; cm³/h; cm³/day 4 to 7 = cubic decimeter → dm³/s; dm³/min; dm³/h; dm³/day 8 to 11 = cubic meter → m³/s; m³/min; m³/h; m³/day 12 to 15 = milliliter → ml/s; ml/min; ml/h; ml/day 16 to 19 = liter → l/s; l/min; l/h; l/day 20 to 23 = hectoliter → hl/s; hl/min; hl/h; hl/day 24 to 27 = megaliter → Ml/s; Ml/min; Ml/h; Ml/day</p> <p>US: 28 to 31 = cubic centimeter → cc/s; cc/min; cc/h; cc/day 32 to 35 = acre foot → af/s; af/min; af/h; af/day 36 to 39 = cubic foot → ft³/s; ft³/min; ft³/h; ft³/day 40 to 43 = fluid ounce → oz f/s; oz f/min; oz f/h; oz f/day 44 to 47 = gallon → gal/s; gal/min; gal/h; gal/day 88 to 92 = kilo gallon → Kgal/s; Kgal/min; Kgal/h; Kgal/day 48 to 51 = million gallon → Mgal/s; Mgal/min; Mgal/h; Mgal/day 52 to 55 = barrel (normal fluids: 31.5 gal/bbl) → bbl/s; bbl/min; bbl/h; bbl/day 56 to 59 = barrel (beer: 31.0 gal/bbl) → bbl/s; bbl/min; bbl/h; bbl/day 60 to 63 = barrel (petrochemicals: 42.0 gal/bbl) → bbl/s; bbl/min; bbl/h; bbl/day 64 to 67 = barrel (filling tanks: 55.0 gal/bbl) → bbl/s; bbl/min; bbl/h; bbl/day</p> <p>Imperial: 68 to 71 = gallon → gal/s; gal/min; gal/h; gal/day 72 to 75 = mega gallon → Mgal/s; Mgal/min; Mgal/h; Mgal/day 76 to 79 = barrel (beer: 36.0 gal/bbl) → bbl/s; bbl/min; bbl/h; bbl/day 80 to 83 = barrel (petrochemicals: 34.97 gal/bbl) → bbl/s; bbl/min; bbl/h; bbl/day</p> <p>Factory setting: Country-dependent (m³/h or US-Mgal/day)</p>
<p>UNIT VOLUME</p> <p></p> <p>Modbus register: 2104 Data type: Integer Access: read/write</p>	<p>0403</p>	<p>For selecting the unit for displaying the volume.</p> <p>The unit you select here is also valid for:</p> <ul style="list-style-type: none"> ■ Pulse value (e.g. m³/p) <p>Options: 0 to 6 = metric → cm³; dm³; m³; ml; l; hl; Ml Mega 7 to 16 = US → cc; af; ft³; oz f; gal; Mgal; bbl (normal fluids); bbl (beer); bbl (petrochemicals); bbl (filling tanks) 22 = Kgal 17 to 20 = Imperial → gal; Mgal; bbl (beer); bbl (petrochemicals)</p> <p>Factory setting: m³</p> <p> Note! The unit for the totalizers is independent of the selection made here and is selected separately for each totalizer.</p>

Function description		
MEASURED VARIABLES → SYSTEM UNITS → CONFIGURATION		
<p>UNIT CORRECTED VOLUME FLOW</p> <p></p> <p>Modbus register: 2105 Data type: Integer Access: read/write</p>	<p>0404</p>	<p>For selecting the unit for displaying the corrected volume flow.</p> <p>The unit you select here is also valid for:</p> <ul style="list-style-type: none"> ■ Current output ■ Frequency output ■ Relay switch points (limit value for corrected volume flow, flow direction) ■ Low flow cut off <p>Options: Metric: 0 = Nl/s 1 = Nl/min 2 = Nl/h 3 = Nl/day 4 = Nm³/s 5 = Nm³/min 6 = Nm³/h 7 = Nm³/day</p> <p>US: 8 = Sm³/s 9 = Sm³/min 10 = Sm³/h 11 = Sm³/day 12 = Scf/s 13 = Scf/min 14 = Scf/h 15 = Scf/day</p> <p>Factory setting: Nm³/h</p>
<p>UNIT CORRECTED VOLUME</p> <p></p> <p>Modbus register: 2106 Data type: Integer Access: read/write</p>	<p>0405</p>	<p>For selecting the unit for displaying the corrected volume.</p> <p>The unit you select here is also valid for:</p> <ul style="list-style-type: none"> ■ Pulse value (e.g. Nm³/p) <p>Options: Metric: 0 = Nm³ 1 = Nl</p> <p>US: 2 = Sm³ 3 = Scf</p> <p>Factory setting: Nm³</p> <p> Note! The unit for the totalizers is independent of the selection made here and is selected separately for each totalizer.</p>

4.2.2 Function group ADDITIONAL CONFIGURATION



Function description		
MEASURED VARIABLES → SYSTEM UNITS → ADDITIONAL CONFIGURATION		
<p>UNIT DENSITY 0420</p> <p></p> <p>Modbus register: 2107 Data type: Integer Access: read/ write</p>		<p>For selecting the unit for displaying the density.</p> <p>The unit you select here is also valid for:</p> <ul style="list-style-type: none"> ■ Current output ■ Frequency output ■ Relay switch points (limit value for density) ■ Density response value for EPD ■ Density adjustment value <p>Options: 0 to 10 = metric → g/cm³; g/cc; kg/dm³; kg/l; kg/m³; SD 4 °C, SD 15 °C, SD 20 °C; SG 4 °C, SG 15 °C, SG 20 °C</p> <p>11 to 16 = US → lb/ft³; lb/gal; lb/bbl (normal fluids); lb/bbl (beer); lb/bbl (petrochemicals); lb/bbl (filling tanks)</p> <p>17 to 19 = Imperial → lb/gal; lb/bbl (beer); lb/bbl (petrochemicals)</p> <p>Factory setting: kg/l</p> <p>SD = Specific Density, SG = Specific Gravity The specific density is the ratio of fluid density to water density (at water temperature = 4, 15, 20 °C).</p>
<p>UNIT REFERENCE DENSITY 0421</p> <p></p> <p>Modbus register: 2108 Data type: Integer Access: read/ write</p>		<p>For selecting the unit for displaying the reference density.</p> <p>The unit you select here is also valid for:</p> <ul style="list-style-type: none"> ■ Current output ■ Frequency output ■ Relay switch points (limit value for density) ■ Fixed reference density (for calculation of corrected volume flow) <p>Options: Metric: 1 = kg/Nl 2 = kg/Nm³</p> <p>US: 0 = g/Sc 3 = kg/Sm³ 4 = lb/Scf</p> <p>Factory setting: kg/Nl</p>

Function description		
MEASURED VARIABLES → SYSTEM UNITS → ADDITIONAL CONFIGURATION		
<p>UNIT TEMPERATURE</p> <p></p> <p>Modbus register: 2109 Data type: Integer Access: read/write</p>	<p>0422</p>	<p>For selecting the unit for displaying the temperature.</p> <p>The unit you select here is also valid for:</p> <ul style="list-style-type: none"> ■ Current output ■ Frequency output ■ Relay switch points (limit value for temperature) ■ Reference temperature (for corrected vol. measurement with measured reference density) <p>Options: 0 = °C (Celsius) 1 = K (Kelvin) 2 = °F (Fahrenheit) 3 = °R (Rankine)</p> <p>Factory setting: °C</p>
<p>UNIT LENGTH</p> <p></p> <p>Modbus register: 2125 Data type: Integer Access: read/write</p>	<p>0424</p>	<p>For selecting the unit for displaying the length of the nominal diameter.</p> <p>The unit you select here is valid for:</p> <ul style="list-style-type: none"> ■ Nominal diameter of sensor (function NOMINAL DIAMETER (6804) on →  121) <p>Options: 0 = MILLIMETER 1 = INCH</p> <p>Factory setting: MILLIMETER</p>
<p>UNIT PRESSURE</p> <p></p> <p>Modbus register: 2130 Data type: Integer Access: read/write</p>	<p>0426</p>	<p>For selecting the unit for displaying the pressure.</p> <p>The unit you select here is valid for:</p> <ul style="list-style-type: none"> ■ Specified pressure (function PRESSURE (6501) on →  119) <p>Options: 0 = bara 1 = barg 2 = psia 3 = psig</p> <p>Factory setting: barg</p>

5 Block QUICK SETUP

Block	Group / Function groups	Functions					
QUICK SETUP (B)	⇒	QS COMMISSION (1002) → 21	⇒	QS - PULS. FLOW (1003) → 21	QS - GAS MEASUREMENT (1004) → 21	QS - COMMUNICATION(1006) →	T-DAT SAVE/LOAD(1009) → 22



Function description QUICK SETUP



Note!

- The Quick Setups are only available by means of the local display.
- The flowcharts of the various Quick Setups are provided on the pages to follow.
- For additional information on the Setups, refer to the Operating Instructions (BA00140D/06).

QUICK SETUP COMMISSIONING 	1002	For starting the Setup menu. Options NO YES Factory setting: NO
QUICK SETUP PULSATING FLOW 	1003	Note! Function only available for measuring devices with a current or frequency output. For starting the Setup menu. Options: NO YES Factory setting: NO
QUICK SETUP GAS MEASUREMENT 	1004	For starting the Setup menu. Options: NO YES Factory setting: NO
QUICK SETUP COMMUNICATION 	1006	For starting the Setup menu. Options: NO YES Factory setting: NO

Function description QUICK SETUP		
<p>T-DAT SAVE/LOAD</p> <p></p> <p>Modbus register: 2401 Data type: Integer Access: read/ write</p>	<p>1009</p>	<p>Use this function to save the parameter settings / configuration of the transmitter in a transmitter DAT (T-DAT), or to load the parameter settings from the T-DAT into the EEPROM (manual backup function).</p> <p>Application examples:</p> <ul style="list-style-type: none"> ▪ After commissioning, the current measuring point parameters can be saved to the T-DAT as a backup. ▪ If the transmitter is replaced for some reason, the data from the T-DAT can be loaded into the new transmitter (EEPROM). <p>Options: 0 = CANCEL 1 = SAVE (from EEPROM to T-DAT) 2 = LOAD (from the T-DAT into EEPROM)</p> <p>Factory setting: CANCEL</p> <p> Note!</p> <ul style="list-style-type: none"> ▪ If the target device has an older software version, the message "TRANSM. SW-DAT" is displayed during startup. Then only the SAVE function is available. ▪ LOAD This function is only possible if the target device has the same software version as, or a more recent software version than, the source device. ▪ SAVE This function is always available.

5.1 Quick Setup

In the case of measuring devices without a local display, the individual parameters and functions must be configured via the configuration program, e.g. FieldCare.

If the measuring device is equipped with a local display, all the important device parameters for standard operation can be configured quickly and easily by means of the "Commissioning" Quick Setup menu.

- Quick Setup "Commissioning", see below
- Quick Setup "Pulsating Flow" →  25
- Quick Setup "Gas Measurement" →  27
- Quick Setup "Communication" →  28

5.1.1 Quick Setup "Commissioning"



Note!

- The display returns to the function SETUP COMMISSIONING (1002) if you press the  key combination during parameter interrogation. The stored parameters remain valid.
- The "COMMISSIONING" Quick Setup must be carried out before another Quick Setup is run.

1. The "DELIVERY SETTINGS" option sets every selected unit to the factory setting. The "ACTUAL SETTING" option accepts the units you previously configured.
2. Only units not yet configured in the current Setup are offered for selection in each cycle. The unit for mass, volume and corrected volume is derived from the corresponding flow unit.
3. The "YES" option remains visible until all the units have been configured. "NO" is the only option displayed when no further units are available.
4. The prompt only appears if a current output and/or pulse/frequency output is available. Only the outputs not yet configured in the current Setup are offered for selection in each cycle.
5. The "YES" option remains visible until all the outputs have been configured. "NO" is the only option displayed when no further outputs are available.
6. The "automatic parameterization of the display" option contains the following basic settings/factory settings:

YES	Main line = mass flow Additional line = totalizer 1 Information line = operating/system condition
NO	The existing (selected) settings remain.
7. The execution of other Quick Setups are described in the following chapters.

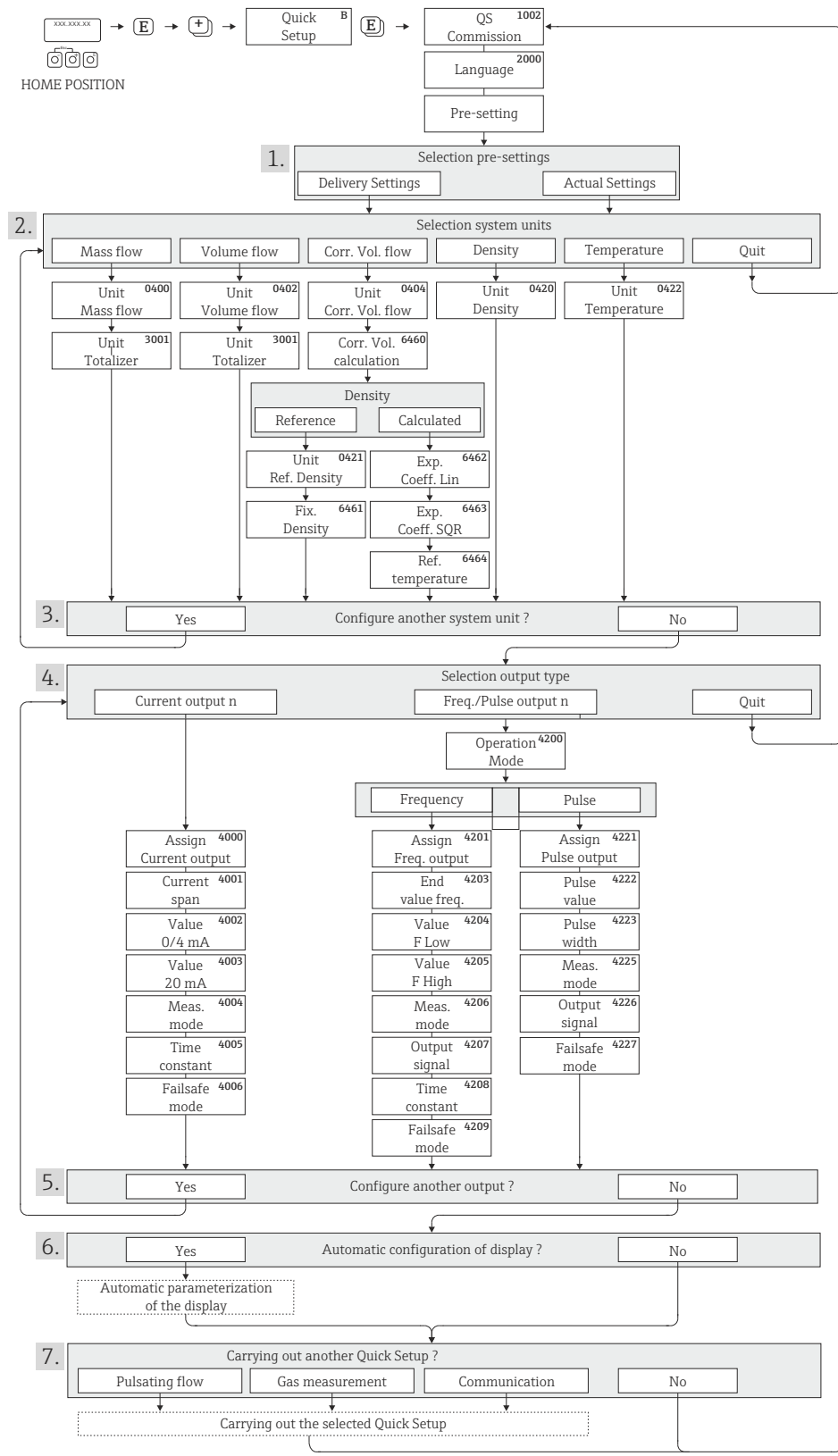

A0011952-EN

Fig. 5: "QUICK SETUP COMMISSIONING"- menu for straightforward configuration of the major device functions

5.1.2 Quick Setup "Pulsating Flow"

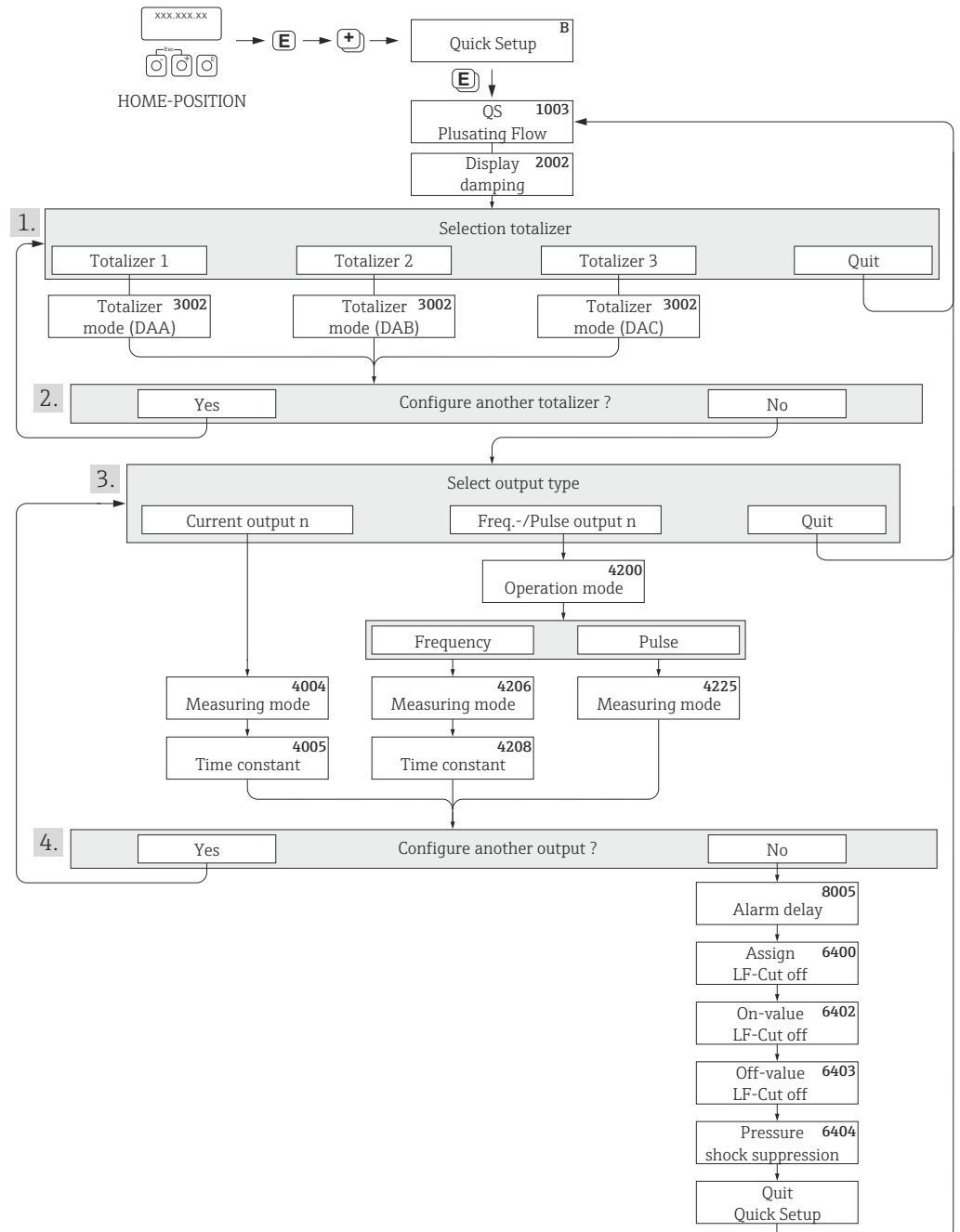

A0004431-EN

Fig. 6: "QUICK SETUP PULSATING FLOW" menu for operation with severely pulsating flow. Recommended settings are found on the following page.

1. Only totalizers not yet configured in the current Setup are offered for selection in each cycle.
2. The "YES" option remains visible until all the totalizers have been configured. "NO" is the only option displayed when no further totalizers are available.
3. Only the output not yet configured in the current Setup is offered for selection in the second cycle.
4. The "YES" option remains visible until both outputs have been parameterized. "NO" is the only option displayed when no further outputs are available.



Note!

- The display returns to the cell QUICK SETUP PULSATING FLOW (1003) if you press the key combination during parameter interrogation.
- You can call up the Setup menu either directly from the "COMMISSIONING" Quick Setup menu or manually by means of the function QUICK SETUP PULSATING FLOW (1003).

Quick Setup "Pulsating Flow"		
HOME position → → MEASURAND → → QUICK SETUP → → QS PULSATING FLOW (1003)		
Function No.	Function name	Selection with To next function with
1003	QS PULS. FLOW	YES After is pressed by way of confirmation, the Quick Setup menu calls up all the subsequent functions in succession.

Basic configuration		
2002	DISPLAY DAMPING	1 s
3002	TOTALIZER MODE (DAA)	BALANCE (Totalizer 1)
3002	TOTALIZER MODE (DAB)	BALANCE (Totalizer 2)
3002	TOTALIZER MODE (DAC)	BALANCE (Totalizer 3)
Signal type for "CURRENT OUTPUT 1"		
4004	MEASURING MODE	PULS. FLOW
4005	TIME CONSTANT	1 s
Signal type for "FREQ./PULSE OUTPUT 1" (for FREQUENCY operating mode)		
4206	MEASURING MODE	PULS. FLOW
4208	TIME CONSTANT	0 s
Signal type for "FREQ./PULSE OUTPUT 1" (for PULSE operating mode)		
4225	MEASURING MODE	PULS. FLOW
Other settings		
8005	ALARM DELAY	0 s
6400	ASSIGN LOW FLOW CUTOFF	MASS FLOW
6402	ON-VALUE LOW FLOW CUT OFF	Setting depends on diameter: DN 8 = 2,0 [kg/h] resp. [l/h] DN 15 = 6,5 [kg/h] resp. [l/h] DN 25 = 18 [kg/h] resp. [l/h]
6403	OFF-VALUE LOW FLOW CUTOFF	50%
6404	PRESSURE SHOCK SUPPRESSION	0 s

Back to the HOME position:

→ Press and hold down Esc key for longer than three seconds or

→ Repeatedly press and release Esc key → Exit the function matrix step by step

5.1.3 Quick Setup "Gas Measurement"

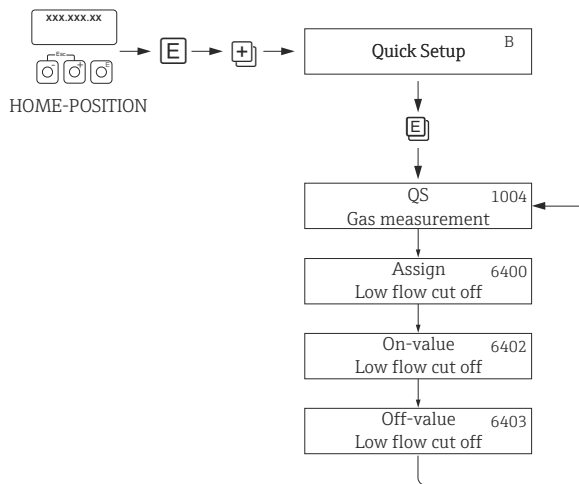

A0002502-EN

Fig. 7: QUICK SETUP GAS MEASUREMENT menu

Quick Setup "Gas measurement"		
HOME position → [E] → MEASURED VARIABLE (A) MEASURED VARIABLE → [+] → QUICK SETUP (B) QUICK SETUP → [E] → QS-GAS MEASUREMENT (1004)		
Function No.	Function name	Setting to be selected ([E]) (to next function with [E])
1004	QS GAS MEASUREMENT	YES After [E] is pressed by way of confirmation, the Quick Setup menu calls up all the subsequent functions in succession.
▼		
6400	ASSIGN LOW FLOW CUT-OFF	On account of the low mass flow involved when gas flows are measured, it is advisable not use a low flow cutoff. Setting: OFF
6402	ON-VALUE LOW FLOW CUT OFF	If the ASSIGNMENT LOW FLOW CUTOFF function was not set to "OFF", the following applies: Setting: 0.0000 [unit] User input: Flow rates for gas measurements are low, so the value for the switch-on point (= low flow cutoff) must be correspondingly low.
6403	OFF-VALUE LOW FLOW CUTOFF	If the ASSIGNMENT LOW FLOW CUTOFF function was not set to "OFF", the following applies: Setting: 50% User input: Enter the switch-off point as a positive hysteresis in %, referenced to the switch-on point.
▼		
Back to the HOME position: → Press and hold down Esc key [Esc] for longer than three seconds or → Repeatedly press and release Esc key [Esc] → Exit the function matrix step by step		

Note!

Quick Setup automatically deactivates the function EMPTY PIPE DETECTION (6420) so that the instrument can measure flow at low gas pressures.

5.1.4 Quick Setup "Communication"

To establish serial data transfer, various arrangements between the Modbus master and Modbus slave are required which have to be taken into consideration when configuring various functions.

These functions can be configured quickly and easily by means of the "Communication" Quick Setup. The following table explains the parameter configuration options in more detail.

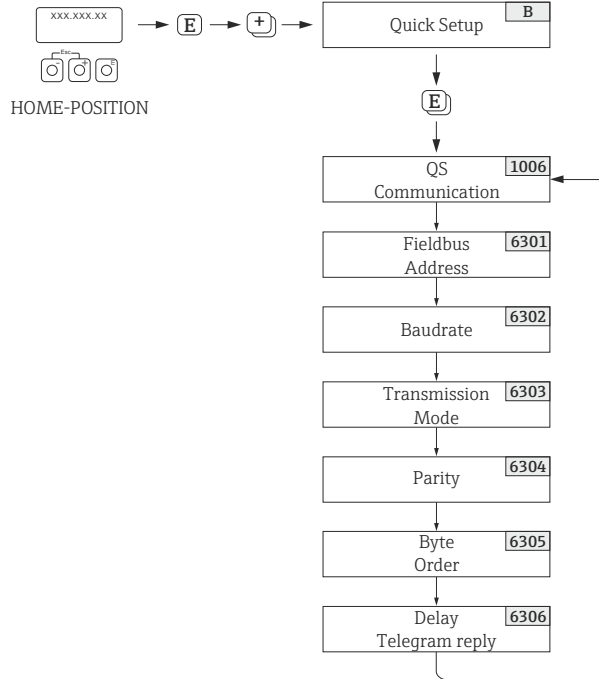

A0004430-EN

Settings for the "Communication" Setup menu:			
Fct. code	Function name	Suggested settings	Description
Call up through the function matrix:			
B	QUICK SETUP	QUICK SETUP COMMUNICATION	→ 21
1006	QUICK SETUP COMMUNICATION	YES	→ 21
Basic configuration:		Factory setting:	
6301	FIELDBUS ADDRESS	247	→ 107
6302	BAUDRATE	19200 BAUD	→ 107
6303	TRANSMISSION MODE	RTU	→ 108
6304	PARITY	EVEN	→ 108
6305	BYTE ORDER	1 - 0 - 3 - 2	→ 108
6306	DELAY TELE. REPLY	10 ms	→ 109

5.2 Data back-up/transfer

You can use the T-DAT SAVE/LOAD function to transfer data (device parameters and settings) between the T-DAT (removable memory) and the EEPROM (device memory).

This is required for the following applications:

- Creating a backup: current data are transmitted from an EEPROM to the T-DAT.
- Replacing a transmitter: current data are copied from an EEPROM to the T-DAT and then transferred to the EEPROM of the new transmitter.
- Duplicating data: current data are copied from an EEPROM to the T-DAT and then transferred to EEPROMs of identical measuring points.



Note!

Installing and removing the T-DAT → Operating Instructions (BA00140D/06)

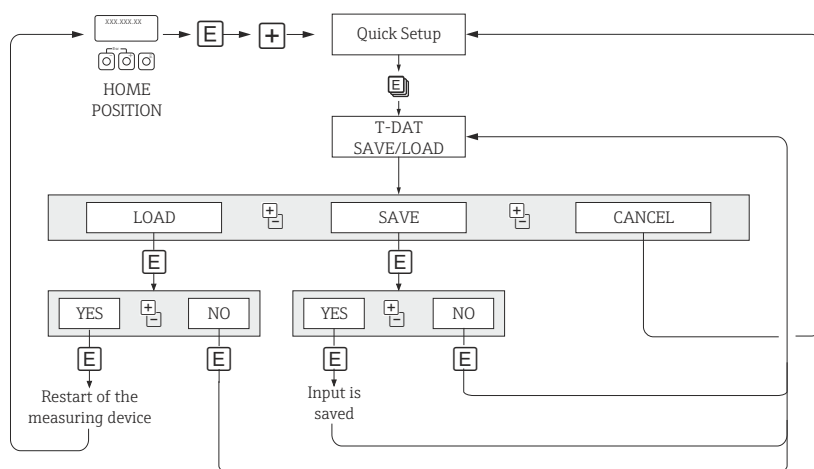

A0001221-EN

Data storage/transmission with T-DAT SAVE/LOAD

Information on the LOAD and SAVE options available:

LOAD:

Data are transferred from the T-DAT to the EEPROM.



Note!

- Any settings already saved on the EEPROM are deleted.
- This option is only available if the T-DAT contains valid data.
- This option can only be executed if the software version of the T-DAT is the same as, or more recent than, that of the EEPROM. If this is not the case, the error message "TRANSM. SW-DAT" appears after restarting and the LOAD function is then no longer available.

SAVE:

Data are transferred from the EEPROM to the T-DAT.

6 Block USER INTERFACE



Block	Groups	Function groups	Functions
USER INTERFACE (C)	CONTROL (CAA) → 31 ↓ ↑	BASIC CONFIG. (200) → 31 ↓ ↑	LANGUAGE (2000) → 31 ⇒ DISPLAY DAMPING (2002) → 31 ⇒ CONTRAST LCD (2003) → 32 ⇒ BACKLIGHT (2004) → 32
		UNLOCKING/LOCKING (202) → 33 ↓ ↑	ACCESS CODE (2020) → 33 ⇒ DEFINE PRIVATE CODE (2021) → 33 ⇒ STATUS ACCESS (2022) → 33 ⇒ ACCESS CODE COUNTER (2023) → 34
		OPERATION (204) → 35 ↓ ↑	TEST DISPLAY (2040) → 35
	MAIN LINE (CCA) → 36 ↓ ↑	CONFIGURATION (220) → 36 ↓ ↑	ASSIGN (2200) → 36 ⇒ 100% VALUE (2201) → 36 ⇒ FORMAT (2202) → 37
		MULTIPLY (222) → 38 ↓ ↑	ASSIGN (2220) → 38 ⇒ 100% VALUE (2221) → 38 ⇒ FORMAT (2222) → 39
	ADDITIONAL LINE (CEA) → 40 ↓ ↑	CONFIGURATION (240) → 40 ↓ ↑	SSIGN (2400) → 40 ⇒ 100% VALUE (2401) → 40 ⇒ FORMAT (2402) → 41 ⇒ DISPLAY MODE (2403) → 41
		MULTIPLY (242) → 42 ↓ ↑	ASSIGN (2420) → 42 ⇒ 100% VALUE (2421) → 42 ⇒ FORMAT (2422) → 43 ⇒ DISPLAY MODE (2423) → 43
	INFORMATION LINE (CGA) → 44 ↑ ↓	CONFIGURATION (260) → 44 ↓ ↑	ASSIGN (2600) → 44 ⇒ 100% VALUE (2601) → 44 ⇒ FORMAT (2602) → 45 ⇒ DISPLAY MODE (2603) → 45
		MULTIPLY (262) → 46 ↓ ↑	ASSIGN (2620) → 46 ⇒ 100% VALUE (2621) → 46 ⇒ FORMAT (2622) → 47 ⇒ DISPLAY MODE (2623) → 47

6.1 Group CONTROL

6.1.1 Function group BASIC CONFIGURATION

USER INTERFACE C → CONTROL CAA → BASIC CONFIGURATION 200

Function description		
USER INTERFACE → CONTROL → BASIC CONFIGURATION		
<p>LANGUAGE 2000</p> <p> (only for NTEP, MC)</p> <p>Modbus register: 2502 Data type: Integer Access: read/ write</p>		<p>For selecting the language for all texts, parameters and messages shown on the local display.</p> <p> Note! The displayed options depend on the language group available. The language group that is supplied with the measuring device is displayed in the LANGUAGE GROUP (8226) function (→  131).</p> <p>Options: (for language group WEST EU / USA) 0 = ENGLISH 1 = DEUTSCH 2 = FRANCAIS 3 = ESPANOL 4 = ITALIANO 5 = NEDERLANDS 12 = PORTUGUESE</p> <p>Options: (for language group EAST EU / SCAND) 0 = ENGLISH 7 = NORSK 8 = SVENSKA 9 = SUOMI 13 = POLISH 14 = RUSSIAN 15 = CZECH</p> <p>Options: (for language group ASIA) 0 = ENGLISH 10 = BAHASA INDONESIA 11 = JAPANESE (syllabary)</p> <p>Options: (for language group CHINA) 0 = ENGLISH 16 = CHINESE</p> <p>Factory setting: Depends on country →  134</p> <p> Note!</p> <ul style="list-style-type: none"> ▪ If you press the / keys simultaneously at startup, the language defaults to "ENGLISH". ▪ You can change the language group via the configuration software Field-Care. Please do not hesitate to contact your Endress+Hauser sales office if you have any questions.
<p>DISPLAY DAMPING 2002</p> <p> (only for NTEP, MC)</p> <p>Modbus register: 2503 Data type: Float Access: read/ write</p>		<p>For entering a time constant which defines how the display reacts to severely fluctuating flow variables, either very quickly (enter a low time constant) or with damping (enter a high time constant).</p> <p>Input: 0 to 100 seconds</p> <p>Factory setting: 1 s</p> <p> Note! Entering the value "0" (seconds) means that the damping is switched off.</p>

Function description		
USER INTERFACE → CONTROL → BASIC CONFIGURATION		
<p>CONTRAST LCD 2003</p> <p> (only for NTEP, MC)</p> <p>Modbus register: 2505 Data type: Float Access: read/ write</p>		<p>For adjusting the display contrast to suit local operating conditions.</p> <p>Input: 10 to 100%</p> <p>Factory setting: 50%</p>
<p>BACKLIGHT 2004</p> <p> (only for NTEP, MC)</p> <p>Modbus register: 2566 Data type: Float Access: read/ write</p>		<p>For adjusting the backlight to suit local operating conditions.</p> <p>Input: 0 to 100%</p> <p> Note! Entering the value "0" means that the backlight is "switched off". The display then no longer emits any light, i.e. the display texts can no longer be read in the dark.</p> <p>Factory setting: 50%</p>

6.1.2 Function group UNLOCKING/LOCKING

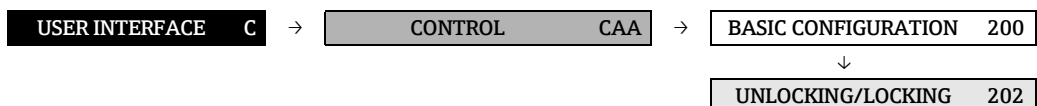

Function description	
USER INTERFACE → CONTROL → UNLOCKING/LOCKING	
<p>ACCESS CODE 2020</p> <p>Modbus register: 2508 Data type: Float Access: read/write</p>	<p> Note! This function is only relevant for local operation and has no effect on access via Modbus RS485 communication.</p> <p>All data of the measuring system are protected against inadvertent change. Programming is disabled and the settings cannot be changed until a code is entered in this function. If you press the or keys in any function, the measuring system automatically goes to this function and the prompt to enter the code appears on the display (when programming is disabled).</p> <p>You can enable programming by entering your personal code (factory setting = 84, → function DEFINE PRIVATE CODE (2021)).</p> <p>To set the measuring instrument to access-protection mode, enter the custody code 8400 here. This locks all the functions that are marked with a keyhole symbol ().</p> <p>Input: Max. 4-digit number: 0 to 9999</p> <p> Note!</p> <ul style="list-style-type: none"> ▪ Programming is disabled if you do not press a key within 60 seconds following automatic return to the HOME position. ▪ You can also disable programming in this function by entering any number (other than the defined private code). ▪ The Endress+Hauser service organization can be of assistance if you mislay your personal code.
<p>DEFINE PRIVATE CODE 2021</p> <p> (only for NTEP, MC)</p> <p>Modbus register: 2510 Data type: Float Access: read/write</p>	<p> Note! This function is only relevant for local operation and has no effect on access via Modbus RS485 communication.</p> <p>For specifying a personal code for enabling programming in the function ACCESS CODE.</p> <p>Input: 0 to 9999 (max. 4-digit number)</p> <p>Factory setting: 84</p> <p> Note!</p> <ul style="list-style-type: none"> ▪ Programming is always enabled with the code "0". ▪ Programming has to be enabled before this code can be changed. When programming is disabled this function is not available, thus preventing others from accessing your personal code.
<p>STATUS ACCESS 2022</p> <p>Modbus register: 2512 Data type: Integer Access: read</p>	<p>Indicates whether access to the function matrix is currently possible (ACCESS CUSTOMER) or whether configuration is locked (LOCKED).</p> <p>Display: 0 = LOCKED (parameterization disabled) 1 = ACCESS CUSTOMER (parameterization possible)</p>

Function description		
USER INTERFACE → CONTROL → UNLOCKING/LOCKING		
ACCESS CODE COUNTER	2023	<p>Displays how often the customer code, service code or the digit "0" (code-free) has been entered to gain access to the function matrix.</p> <p>Display: Max. 7-digit number: 0 to 9999999</p> <p>Factory setting: 0</p>
Modbus register:	2568	
Data type:	Integer	
Access:	read	

6.1.3 Function group OPERATION

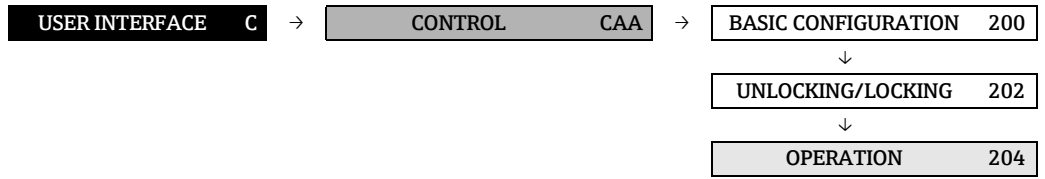





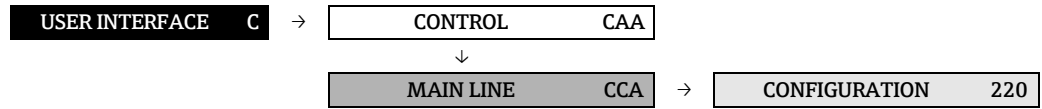

Function description USER INTERFACE → CONTROL → OPERATION		
TEST DISPLAY 2040 Modbus register: 2513 Data type: Integer Access: read/ write	For testing the operability of the local display and its pixels. Options: 0 = OFF 1 = ON Factory setting: OFF Test sequence: 1. Start the test by selecting "ON". 2. All pixels of the main line, additional line and information line are darkened for minimum 0.75 seconds. 3. Main line, additional line and information line show an "8" in each field for minimum 0.75 seconds. 4. Main line, additional line and information line show a "0" in each field for minimum 0.75 seconds. 5. Main line, additional line and information line show nothing (blank display) for minimum 0.75 second. When the test is completed, the local display returns to its initial state and the setting changes to "OFF".	

6.2 Group MAIN LINE

6.2.1 Function group CONFIGURATION







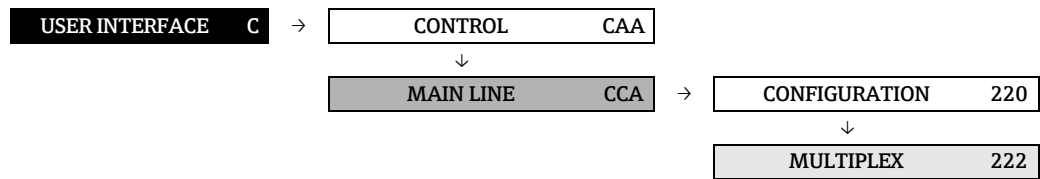

Function description		
USER INTERFACE → CONTROL → CONFIGURATION		
ASSIGN 2200  Modbus register: 2514 Data type: Integer Access: read/ write		For assigning a value to be displayed to the main line (top line in the local display). This value is displayed during normal operation. Options: (standard) 0 = OFF 1 = MASS FLOW 2 = MASS FLOW IN % 3 = VOLUME FLOW 4 = VOLUME FLOW IN % 5 = CORRECTED VOLUME FLOW 6 = CORRECTED VOLUME FLOW IN % 7 = DENSITY 8 = REFERENCE DENSITY 9 = TEMPERATURE 15 = ACTUAL CURRENT 18 = ACTUAL FREQUENCY 20 = TOTALIZER 1 21 = TOTALIZER 2 22 = TOTALIZER 3 98 = CUSTODY TRANSFER Factory setting: MASS FLOW
100% VALUE 2201  Modbus register: 2519 Data type: Float Access: read/ write		 Note! This function is not available unless one of the following was selected in the ASSIGN function (2200): <ul style="list-style-type: none"> ■ MASS FLOW IN % ■ VOLUME FLOW IN % ■ CORRECTED VOLUME FLOW IN % For specifying the flow value to be shown on the display as the 100% value. User input: 5-digit floating-point number Factory setting: depends on nominal diameter and country →  134

Function description		
USER INTERFACE → CONTROL → CONFIGURATION		
<p>FORMAT</p> <p></p> <p>Modbus register: Data type: Access:</p>	<p>2202</p> <p>2516 Integer read/ write</p>	<p>For selecting the maximum number of places after the decimal point to be displayed for the display value.</p> <p>Options: 0 = XXXXX 1 = XXXX.X 2 = XXX.XX 3 = XX.XXX 4 = X.XXXX</p> <p>Factory setting: X.XXXX</p> <p> Note!</p> <ul style="list-style-type: none"> ■ Note that this setting only affects the reading as it appears on the display, it has no influence on the accuracy of the system's calculations. ■ The places after the decimal point as computed by the measuring device cannot always be displayed, depending on this setting and the engineering unit. In such instances an arrow appears on the display between the measuring value and the engineering unit (e.g. 1.2 →kg/h), indicating that the measuring system is computing with more decimal places than can be shown on the display.

6.2.2 Function group MULTIPLEX







Function description		
USER INTERFACE → CONTROL → CONFIGURATION		
ASSIGN 2220  Modbus register: 2522 Data type: Integer Access: read/ write		For assigning a second reading to be displayed in the main line alternately (every 10 seconds) with the value defined in the ASSIGN function (2200). Options: (standard) 0 = OFF 1 = MASS FLOW 2 = MASS FLOW IN % 3 = VOLUME FLOW 4 = VOLUME FLOW IN % 5 = CORRECTED VOLUME FLOW 6 = CORRECTED VOLUME FLOW IN % 7 = DENSITY 8 = REFERENCE DENSITY 9 = TEMPERATURE 15 = ACTUAL CURRENT 18 = ACTUAL FREQUENCY 20 = TOTALIZER 1 21 = TOTALIZER 2 22 = TOTALIZER 3 98 = CUSTODY TRANSFER Factory setting: OFF
100% VALUE 2221  Modbus register: 2524 Data type: Float Access: read/ write		 Note! This function is not available unless one of the following was selected in the ASSIGN function (2200). <ul style="list-style-type: none"> ■ MASS FLOW IN % ■ VOLUME FLOW IN % ■ CORRECTED VOLUME FLOW IN % For specifying the flow value to be shown on the display as the 100% value. User input: 5-digit floating-point number Factory setting: depends on nominal diameter and country →  134



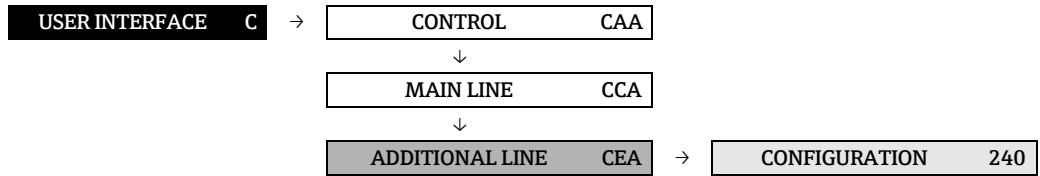



Function description		
USER INTERFACE → CONTROL → CONFIGURATION		
<p>FORMAT</p> <p></p> <p>Modbus register: Data type: Access:</p>	<p>2222</p> <p>2523 Integer read/ write</p>	<p>For selecting the maximum number of places after the decimal point to be displayed for the display value.</p> <p>Options: 0 = XXXXX 1 = XXXX.X 2 = XXX.XX 3 = XX.XXX 4 = X.XXXX</p> <p>Factory setting: X.XXXX</p> <p> Note!</p> <ul style="list-style-type: none"> ■ Note that this setting only affects the reading as it appears on the display, it has no influence on the accuracy of the system's calculations. ■ The places after the decimal point as computed by the measuring device cannot always be displayed, depending on this setting and the engineering unit. In such instances an arrow appears on the display between the measuring value and the engineering unit (e.g. 1.2 →kg/h), indicating that the measuring system is computing with more decimal places than can be shown on the display.

6.3 Group ADDITIONAL LINE

6.3.1 Function group CONFIGURATION









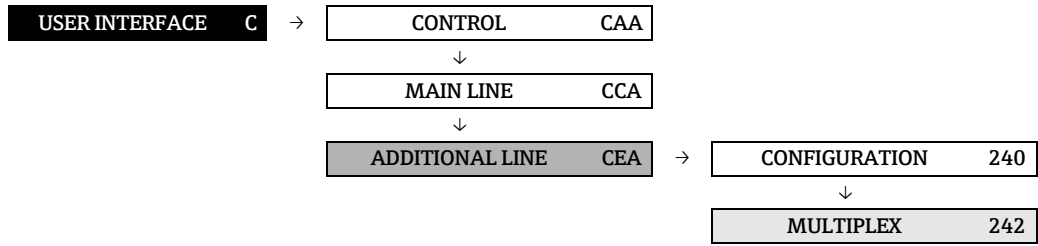



Function description		
USER INTERFACE → ADDITIONAL LINE → CONFIGURATION		
ASSIGN 2400  Modbus register: 2527 Data type: Integer Access: read/ write		For assigning a value to be displayed to the additional line (middle line in the local display). This value is displayed during normal operation. Options: 0 = OFF 1 = MASS FLOW 2 = MASS FLOW IN % 3 = VOLUME FLOW 4 = VOLUME FLOW IN % 5 = CORRECTED VOLUME FLOW 6 = CORRECTED VOLUME FLOW IN % 7 = DENSITY 8 = REFERENCE DENSITY 9 = TEMPERATURE 10 = MASS FLOW BARGRAPH IN % 11 = VOLUME FLOW BARGRAPH IN % 12 = CORRECTED VOLUME FLOW BARGRAPH IN % 15 = ACTUAL CURRENT 18 = ACTUAL FREQUENCY 20 = TOTALIZER 1 20 = TOTALIZER 2 22 = TOTALIZER 3 98 = CUSTODY TRANSFER 23 = TAG NAME Factory setting: TOTALIZER 1
100% VALUE 2401  Modbus register: 2529 Data type: Float Access: read/ write		 Note! This function is not available unless one of the following was selected in the ASSIGN function (2400): <ul style="list-style-type: none"> ■ MASS FLOW IN % ■ VOLUME FLOW IN % ■ CORRECTED VOLUME FLOW IN % ■ MASS FLOW BARGRAPH IN % ■ VOLUME FLOW BARGRAPH IN % ■ CORRECTED VOLUME FLOW BARGRAPH IN % For specifying the flow value to be shown on the display as the 100% value. User input: 5-digit floating-point number Factory setting: depends on nominal diameter and country →  134

Function description		
USER INTERFACE → ADDITIONAL LINE → CONFIGURATION		
<p>FORMAT 2402</p> <p></p> <p>Modbus register: 2528 Data type: Integer Access: read/write</p>	<p>For selecting the maximum number of places after the decimal point to be displayed for the display value.</p> <p>Options: 0 = XXXXX 1 = XXXX.X 2 = XXX.XX 3 = XX.XXX 4 = X.XXXX</p> <p>Factory setting: X.XXXX</p> <p> Note!</p> <ul style="list-style-type: none"> ▪ Note that this setting only affects the reading as it appears on the display, it has no influence on the accuracy of the system's calculations. ▪ The places after the decimal point as computed by the measuring device cannot always be displayed, depending on this setting and the engineering unit. In such instances an arrow appears on the display between the measuring value and the engineering unit (e.g. 1.2 →kg/h), indicating that the measuring system is computing with more decimal places than can be shown on the display. 	
<p>DISPLAY MODE 2403</p> <p></p> <p>Modbus register: 2531 Data type: Integer Access: read/write</p>	<p> Note!</p> <p>This function is not available unless one of the following was selected in the ASSIGN function (2400):</p> <ul style="list-style-type: none"> ▪ MASS FLOW BARGRAPH IN % ▪ VOLUME FLOW BARGRAPH IN % ▪ CORRECTED VOLUME FLOW BARGRAPH IN % <p>Use this function to define the format of the bar graph.</p> <p>Options: 0 = STANDARD 1 = SYMMETRY</p> <p>Factory setting: STANDARD</p> <p>Illustration of bar graph</p> <div style="text-align: center;">  </div> <p style="text-align: right; font-size: small;">A0001258</p> <p><i>Fig. 8: Bar graph for STANDARD option Simple bar graph with 25 / 50 / 75% gradations and integrated sign.</i></p> <div style="text-align: center;">  </div> <p style="text-align: right; font-size: small;">A0001259</p> <p><i>Fig. 9: Bar graph for SYMMETRY option Symmetrical bar graph for positive and negative directions of flow, with - 50 / 0 / +50% gradations and integrated sign.</i></p>	

6.3.2 Function group MULTIPLEX







Function description		
USER INTERFACE → ADDITIONAL LINE → MULTIPLEX		
ASSIGN 2420  Modbus register: 2532 Data type: Integer Access: read/write		For assigning a second reading to be displayed in the main line alternately (every 10 seconds) with the value defined in the ASSIGN function (2400). Options: 0 = OFF 1 = MASS FLOW 2 = MASS FLOW IN % 3 = VOLUME FLOW 4 = VOLUME FLOW IN % 5 = CORRECTED VOLUME FLOW 6 = CORRECTED VOLUME FLOW IN % 7 = DENSITY 8 = REFERENCE DENSITY 9 = TEMPERATURE 10 = MASS FLOW BARGRAPH IN % 11 = VOLUME FLOW BARGRAPH IN % 12 = CORRECTED VOLUME FLOW BARGRAPH IN % 15 = ACTUAL CURRENT 18 = ACTUAL FREQUENCY 20 = TOTALIZER 1 21 = TOTALIZER 2 22 = TOTALIZER 3 98 = CUSTODY TRANSFER 23 = TAG NAME Factory setting: OFF
100% VALUE 2421  Modbus register: 2534 Data type: Float Access: read/write		 Note! This function is not available unless one of the following was selected in the ASSIGN function (2420): <ul style="list-style-type: none"> ■ MASS FLOW IN % ■ VOLUME FLOW IN % ■ CORRECTED VOLUME FLOW IN % ■ MASS FLOW BARGRAPH IN % ■ VOLUME FLOW BARGRAPH IN % ■ CORRECTED VOLUME FLOW BARGRAPH IN % For specifying the flow value to be shown on the display as the 100% value. User input: 5-digit floating-point number Factory setting: depends on nominal diameter and country →  134



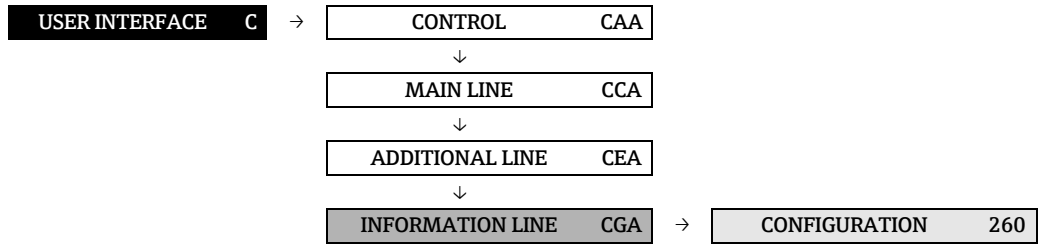



Function description		
USER INTERFACE → ADDITIONAL LINE → MULTIPLEX		
<p>FORMAT 2422</p> <p></p> <p>Modbus register: 2533 Data type: Integer Access: read/ write</p>		<p>For selecting the maximum number of places after the decimal point to be displayed for the display value.</p> <p>Options: 0 = XXXXX 1 = XXXX.X 2 = XXX.XX 3 = XX.XXX 4 = X.XXXX</p> <p>Factory setting: X.XXXX</p> <p> Note!</p> <ul style="list-style-type: none"> ■ Note that this setting only affects the reading as it appears on the display, it has no influence on the accuracy of the system's calculations. ■ The places after the decimal point as computed by the measuring device cannot always be displayed, depending on this setting and the engineering unit. In such instances an arrow appears on the display between the measuring value and the engineering unit (e.g. 1.2 →kg/h), indicating that the measuring system is computing with more decimal places than can be shown on the display.
<p>DISPLAY MODE 2423</p> <p></p> <p>Modbus register: 2536 Data type: Integer Access: read/ write</p>		<p> Note!</p> <p>This function is not available unless one of the following was selected in the ASSIGN function (2420):</p> <ul style="list-style-type: none"> ■ MASS FLOW BARGRAPH IN % ■ VOLUME FLOW BARGRAPH IN % ■ CORRECTED VOLUME FLOW BARGRAPH IN % <p>Use this function to define the format of the bar graph.</p> <p>Options: 0 = STANDARD 1 = SYMMETRY</p> <p>Factory setting: STANDARD</p> <p>Illustration of bar graph</p> <div style="text-align: center;">  </div> <p style="text-align: right; font-size: small;">A0001258</p> <p><i>Fig. 10: Bar graph for STANDARD option Simple bar graph with 25 / 50 / 75% gradations and integrated sign.</i></p> <div style="text-align: center;">  </div> <p style="text-align: right; font-size: small;">A0001259</p> <p><i>Fig. 11: Bar graph for SYMMETRY option Symmetrical bar graph for positive and negative directions of flow, with - 50 / 0 / +50% gradations and integrated sign.</i></p>

6.4 Group INFORMATION LINE

6.4.1 Function group CONFIGURATION







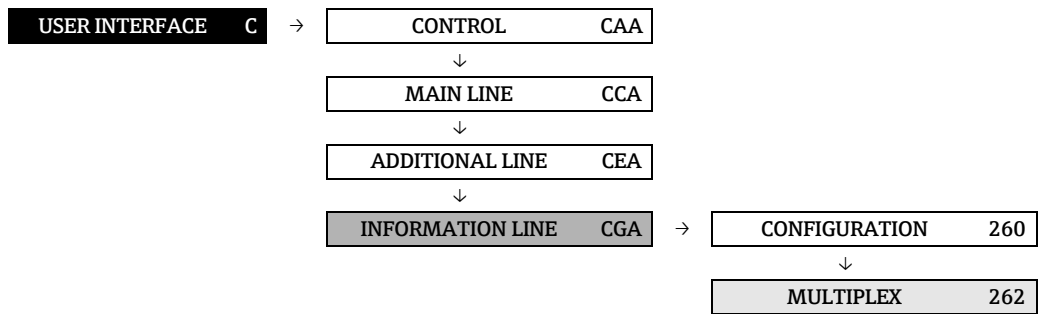

Function description		
USER INTERFACE → INFORMATION LINE → CONFIGURATION		
ASSIGN 2600  Modbus register: 2537 Data type: Integer Access: read/write		For assigning a value to be displayed to the information line (bottom line in the local display). This value is displayed during normal operation. Options: 0 = OFF 1 = MASS FLOW 2 = MASS FLOW IN % 3 = VOLUME FLOW 4 = VOLUME FLOW IN % 5 = CORRECTED VOLUME FLOW 6 = CORRECTED VOLUME FLOW IN % 7 = DENSITY 8 = REFERENCE DENSITY 9 = TEMPERATURE 10 = MASS FLOW BARGRAPH IN % 11 = VOLUME FLOW BARGRAPH IN % 12 = CORRECTED VOLUME FLOW BARGRAPH IN % 15 = ACTUAL CURRENT 18 = ACTUAL FREQUENCY 20 = TOTALIZER 1 21 = TOTALIZER 2 22 = TOTALIZER 3 98 = CUSTODY TRANSFER 23 = TAG NAME 24 = OPERATING/SYSTEM CONDITIONS 26 = DISPLAY FLOW DIRECTION Factory setting: OPERATING/SYSTEM CONDITIONS
100% VALUE 2601  Modbus register: 2539 Data type: Float Access: read/write		 Note! This function is not available unless one of the following was selected in the ASSIGN function (2600): <ul style="list-style-type: none"> ■ MASS FLOW IN % ■ VOLUME FLOW IN % ■ CORRECTED VOLUME FLOW IN % ■ MASS FLOW BARGRAPH IN % ■ VOLUME FLOW BARGRAPH IN % ■ CORRECTED VOLUME FLOW BARGRAPH IN % For specifying the flow value to be shown on the display as the 100% value. User input: 5-digit floating-point number Factory setting: depends on nominal diameter and country →  134

Function description		
USER INTERFACE → INFORMATION LINE → CONFIGURATION		
<p>FORMAT 2602</p> <p></p> <p>Modbus register: 2538 Data type: Integer Access: read/write</p>	<p>For selecting the maximum number of places after the decimal point to be displayed for the display value.</p> <p>Options: 0 = XXXXX 1 = XXXX.X 2 = XXX.XX 3 = XX.XXX 4 = X.XXXX</p> <p>Factory setting: X.XXXX</p> <p> Note!</p> <ul style="list-style-type: none"> ■ Note that this setting only affects the reading as it appears on the display, it has no influence on the accuracy of the system's calculations. ■ The places after the decimal point as computed by the measuring device cannot always be displayed, depending on this setting and the engineering unit. In such instances an arrow appears on the display between the measuring value and the engineering unit (e.g. 1.2 →kg/h), indicating that the measuring system is computing with more decimal places than can be shown on the display. 	
<p>DISPLAY MODE 2603</p> <p></p> <p>Modbus register: 2541 Data type: Integer Access: read/write</p>	<p> Note!</p> <p>This function is not available unless one of the following was selected in the ASSIGN function (2600):</p> <ul style="list-style-type: none"> ■ MASS FLOW BARGRAPH IN % ■ VOLUME FLOW BARGRAPH IN % ■ CORRECTED VOLUME FLOW BARGRAPH IN % <p>Use this function to define the format of the bar graph.</p> <p>Options: 0 = STANDARD 1 = SYMMETRY</p> <p>Factory setting: STANDARD</p> <p>Illustration of bar graph</p> <div style="text-align: center;">  </div> <p style="text-align: right; font-size: small;">A0001258</p> <p><i>Fig. 12: Bar graph for STANDARD option</i> Simple bar graph with 25 / 50 / 75% gradations and integrated sign.</p> <div style="text-align: center;">  </div> <p style="text-align: right; font-size: small;">A0001259</p> <p><i>Fig. 13: Bar graph for SYMMETRY option</i> Symmetrical bar graph for positive and negative directions of flow, with -50 / 0 / +50% gradations and integrated sign.</p>	

6.4.2 Function group MULTIPLEX



Function description		
USER INTERFACE → INFORMATION LINE → MULTIPLEX		
<p> Note! If you select the BATCHING OPERATING KEYS in the function ASSIGN (2600), the multiplex display functionality is not available in the information line.</p>		
<p>ASSIGN 2620</p> <p></p> <p>Modbus register: 2542 Data type: Integer Access: read/ write</p>	<p>For assigning a second reading to be displayed in the main line alternately (every 10 seconds) with the value defined in the ASSIGN function (2600).</p> <p>Options: 0 = OFF 1 = MASS FLOW 2 = MASS FLOW IN % 3 = VOLUME FLOW 4 = VOLUME FLOW IN % 5 = CORRECTED VOLUME FLOW 6 = CORRECTED VOLUME FLOW IN % 7 = DENSITY 8 = REFERENCE DENSITY 9 = TEMPERATURE 10 = MASS FLOW BARGRAPH IN % 11 = VOLUME FLOW BARGRAPH IN % 12 = CORRECTED VOLUME FLOW BARGRAPH IN % 15 = ACTUAL CURRENT 18 = ACTUAL FREQUENCY 20 = TOTALIZER 1 21 = TOTALIZER 2 22 = TOTALIZER 3 98 = CUSTODY TRANSFER 23 = TAG NAME 24 = OPERATING/SYSTEM CONDITIONS 26 = DISPLAY FLOW DIRECTION</p> <p>Factory setting: OFF</p>	
<p>100% VALUE 2621</p> <p></p> <p>Modbus register: 2544 Data type: Float Access: read/ write</p>	<p> Note! This function is not available unless one of the following was selected in the ASSIGN function (2620):</p> <ul style="list-style-type: none"> ■ MASS FLOW IN % ■ VOLUME FLOW IN % ■ CORRECTED VOLUME FLOW IN % ■ MASS FLOW BARGRAPH IN % ■ VOLUME FLOW BARGRAPH IN % ■ CORRECTED VOLUME FLOW BARGRAPH IN % <p>For specifying the flow value to be shown on the display as the 100% value.</p> <p>User input: 5-digit floating-point number</p> <p>Factory setting: depends on nominal diameter and country → 134</p>	

Function description		
USER INTERFACE → INFORMATION LINE → MULTIPLEX		
<p>FORMAT 2622</p> <p></p> <p>Modbus register: 2543 Data type: Integer Access: read/ write</p>		<p>For selecting the maximum number of places after the decimal point to be displayed for the display value.</p> <p>Options: 0 = XXXXX 1 = XXXX.X 2 = XXX.XX 3 = XX.XXX 4 = X.XXXX</p> <p>Factory setting: X.XXXX</p> <p> Note!</p> <ul style="list-style-type: none"> ▪ Note that this setting only affects the reading as it appears on the display, it has no influence on the accuracy of the system's calculations. ▪ The places after the decimal point as computed by the measuring device cannot always be displayed, depending on this setting and the engineering unit. In such instances an arrow appears on the display between the measuring value and the engineering unit (e.g. 1.2 →kg/h), indicating that the measuring system is computing with more decimal places than can be shown on the display.
<p>DISPLAY MODE 2623</p> <p></p> <p>Modbus register: 2546 Data type: Integer Access: read/ write</p>		<p> Note!</p> <p>This function is not available unless one of the following was selected in the ASSIGN function (2620):</p> <ul style="list-style-type: none"> ▪ MASS FLOW BARGRAPH IN % ▪ VOLUME FLOW BARGRAPH IN % ▪ CORRECTED VOLUME FLOW BARGRAPH IN % <p>Use this function to define the format of the bar graph.</p> <p>Options: 0 = STANDARD 1 = SYMMETRY</p> <p>Factory setting: STANDARD</p> <p>Illustration of bar graph</p> <div style="text-align: center;">  </div> <p style="text-align: right; font-size: small;">A0001258</p> <p><i>Fig. 14: Bar graph for STANDARD option</i> Simple bar graph with 25 / 50 / 75% gradations and integrated sign.</p> <div style="text-align: center;">  </div> <p style="text-align: right; font-size: small;">A0001259</p> <p><i>Fig. 15: Bar graph for SYMMETRY option</i> Symmetrical bar graph for positive and negative directions of flow, with -50 / 0 / +50% gradations and integrated sign.</p>

7 Block TOTALIZER





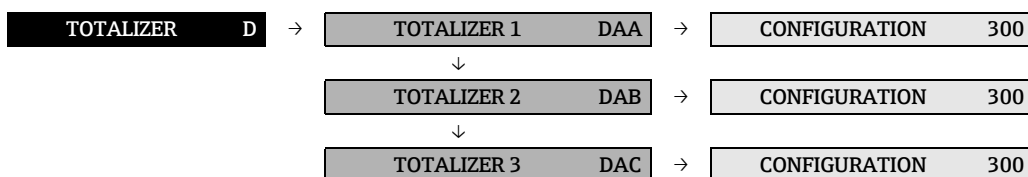

Block	Groups	Function groups	Functions	
TOTALIZER (D)	TOTALIZER 1 (DAA) → 49	CONFIGURATION (300) → 49	ASSIGN (3000) → 49	
		OPERATION (304) → 51	SUM (3040) → 51	
	TOTALIZER 2 (DAB) → 49	CONFIGURATION (300) → 49	ASSIGN (3000) → 49	TOTALIZER MODE TOTALIZER (3002) → 50
		OPERATION (304) → 51	SUM (3040) → 51	OVERFLOW (3041) → 51
	TOTALIZER 3 (DAC) → 49	CONFIGURATION (300) → 49	ASSIGN (3000) → 49	TOTALIZER MODE TOTALIZER (3002) → 50
		OPERATION (304) → 51	SUM (3040) → 51	OVERFLOW (3041) → 51
	HANDLING TOTALIZERS (DA) → 52		RESET ALL TOTALIZERS (3800) → 52	RESET TOTALIZER (3003) → 50
				FAILSAFE MODE (3801) → 52

7.1 Group TOTALIZER (1 to 3)

7.1.1 Function group CONFIGURATION



Function description TOTALIZER → TOTALIZER (1 to 3) → CONFIGURATION								
<p> Note! The function descriptions below apply to totalizers 1 to 3; the totalizers are independently configurable.</p>								
<p>ASSIGN 3000</p> <p></p> <p>Modbus register:</p> <table border="0"> <tr><td>Totalizer 1</td><td>2601</td></tr> <tr><td>Totalizer 2</td><td>2801</td></tr> <tr><td>Totalizer 3</td><td>3001</td></tr> </table> <p>Data type: Integer</p> <p>Access: read/ write</p>	Totalizer 1	2601	Totalizer 2	2801	Totalizer 3	3001	<p>For assigning a measured variable to the totalizer in question.</p> <p>Options: 0 = OFF 1 = MASS FLOW 2 = VOLUME FLOW 3 = CORRECTED VOLUME FLOW</p> <p>Factory setting: MASS FLOW</p> <p> Note!</p> <ul style="list-style-type: none"> ▪ This function cannot be changed if: <ul style="list-style-type: none"> – The measuring device has been configured in accordance with NTEP or MC approval. – The measuring device has been configured in accordance with PTB, NMi, METAS or BEV approval and YES has been selected for the available functions Z006 to Z008 in the CUSTODY TRANSFER block. ▪ The totalizer is reset to "0" as soon as the selection is changed. ▪ If you select OFF in the function group CONFIGURATION of the totalizer in question, only the ASSIGN (3000) function remains visible. 	
Totalizer 1	2601							
Totalizer 2	2801							
Totalizer 3	3001							
<p>UNIT TOTALIZER 3001</p> <p></p> <p>Modbus register:</p> <ul style="list-style-type: none"> ▪ Totalizer 1 <ul style="list-style-type: none"> – Mass flow 2602 – Volume flow 2603 – Corr. vol. flow 2604 ▪ Totalizer 2 <ul style="list-style-type: none"> – Mass flow 2802 – Volume flow 2803 – Corr. vol. flow 2804 ▪ Totalizer 3 <ul style="list-style-type: none"> – Mass flow 3002 – Volume flow 3003 – Corr. vol. flow 3004 <p>Data type: Integer</p> <p>Access: read/ write</p>	<p>For selecting the unit for the measured variable assigned in the function ASSIGN (3000).</p> <p>Options: for the MASS FLOW assignment 0 to 2 = metric → g; kg; t 3 to 4 = US → oz; lb; ton</p> <p>Factory setting:kg</p> <p>Options: for the VOLUME FLOW assignment 0 to 6 = metric → cm³; dm³; m³; ml; l; hl; Ml Mega</p> <p>7 to 16 = US → cc; af; ft³; oz f; gal; Mgal; bbl (normal fluids); bbl (beer); bbl (petrochemicals); bbl (filling tanks) 22 = Kgal</p> <p>17 to 20 = Imperial → gal; Mgal; bbl (beer); bbl (petrochemicals)</p> <p>Factory setting: m³</p> <p>(continued on next page)</p>							

Function description	
TOTALIZER → TOTALIZER (1 to 3) → CONFIGURATION	
<p>UNIT TOTALIZER 3001</p> <p>(continued)</p>	<p>Options: for the CORRECTED VOLUME FLOW assignment 0 to 1 = metric → Nm³ 2 to 3 = US → Sm³; Scf</p> <p>Factory setting: Nm³</p> <p> Note! This function cannot be changed if:</p> <ul style="list-style-type: none"> ■ The measuring device has been configured in accordance with NTEP or MC approval. ■ The measuring device has been configured in accordance with PTB, NMI, METAS or BEV approval and YES has been selected for the available functions Z006 to Z008 in the CUSTODY TRANSFER block.
<p>TOTALIZER MODE 3002</p> <p></p> <p>Modbus register:</p> <p>Totalizer 1 2605 Totalizer 2 2805 Totalizer 3 3005 Data type: Integer Access: read/ write</p>	<p>For selecting how the totalizer should operate.</p> <p>Options: 0 = BALANCE Positive and negative flow components. The positive and negative flow components are balanced. In other words, net flow in the flow direction is registered.</p> <p>1 = FORWARD Only positive flow components</p> <p>2 = REVERSE Only negative flow components</p> <p>Factory setting: Totalizer 1 = BALANCE Totalizer 2 = FORWARD Totalizer 3 = REVERSE</p> <p> Note! This function cannot be changed if:</p> <ul style="list-style-type: none"> ■ The measuring device has been configured in accordance with NTEP or MC approval. ■ The measuring device has been configured in accordance with PTB, NMI, METAS or BEV approval and YES has been selected for the available functions Z006 to Z008 in the CUSTODY TRANSFER block.
<p>RESET TOTALIZER 3003</p> <p></p> <p>Modbus register:</p> <p>Totalizer 1 2608 Totalizer 2 2808 Totalizer 3 3008 Data type: Integer Access: read/ write</p>	<p>Resets the total and the overflow of the totalizer to zero.</p> <p>Options: 0 = NO 1 = YES</p> <p>Factory setting: NO</p> <p> Note!</p> <ul style="list-style-type: none"> ■ This function cannot be changed if: <ul style="list-style-type: none"> - The measuring device has been configured in accordance with NTEP or MC approval. - The measuring device has been configured in accordance with PTB, NMI, METAS or BEV approval and YES has been selected for the available functions Z006 to Z008 in the CUSTODY TRANSFER block. ■ If the device is equipped with a status input, with the appropriate configuration a reset for each individual totalizer can also be triggered by a pulse (→ the function ASSIGN STATUS INPUT (5000) on →  103).



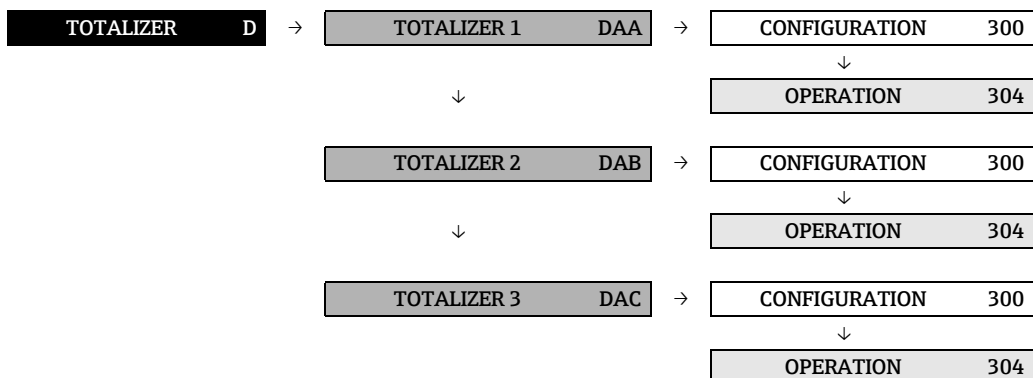

7.1.2 Function group OPERATION

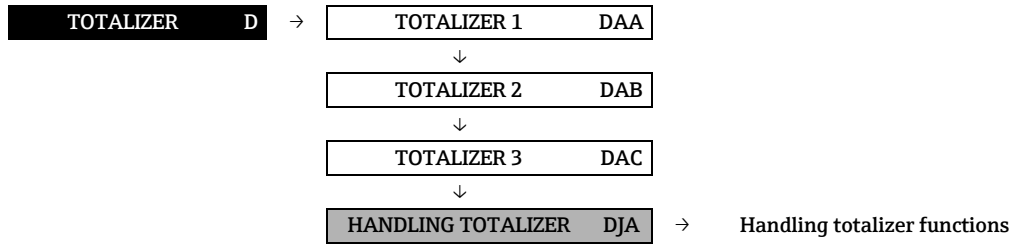

Function description		
TOTALIZER → TOTALIZER (1 to 3) → OPERATION		
<p> Note!</p> <p>The function descriptions below apply to totalizers 1 to 3; the totalizers are independently configurable.</p>		
<p>SUM 3040</p> <p>Modbus register:</p> <p>Totalizer 1 2610</p> <p>Totalizer 2 2810</p> <p>Totalizer 3 3010</p> <p>Data type: Float</p> <p>Access: read</p>	<p>Displays the total for the totalizer's measured variable aggregated since measuring began. The value can be positive or negative, depending on the setting selected in the function "TOTALIZER MODE" (3002), and the direction of flow.</p> <p>Display: max. 7-digit floating-point number, including sign and unit (e.g. 15467.04 m³; -4925.631 kg)</p> <p> Note!</p> <ul style="list-style-type: none"> ▪ The effect of the setting in the "TOTALIZER MODE" function (→ 50) is as follows: <ul style="list-style-type: none"> – If the setting is "BALANCE", the totalizer balances flow in the positive and negative directions. – If the setting is "FORWARD", the totalizer registers only flow in the positive direction. – If the setting is "REVERSE", the totalizer registers only flow in the negative direction. ▪ The totalizer's response to faults is defined in the "FAILSAFE MODE" function (3801) (→ 52). 	
<p>OVERFLOW 3041</p> <p>Modbus register:</p> <p>Totalizer 1 2612</p> <p>Totalizer 2 2812</p> <p>Totalizer 3 3012</p> <p>Data type: Float</p> <p>Access: read</p>	<p>Displays the total for the totalizer's overflow aggregated since measuring began.</p> <p>Total flow quantity is represented by a floating-point number consisting of max. 7 digits. You can use this function to view higher numerical values (>9,999,999) as overflows. The effective quantity is thus the total of plus the value returned by the function.</p> <p>Example: Reading for 2 overflows: 2 E7 kg (= 20 000 000 kg). The value displayed in the function SUM = 196 845.7 kg Effective total quantity = 20 196 845.7 kg</p> <p>Display: integer with exponent, including sign and unit, e.g. 2 E7 kg</p>	

7.2 Group HANDLING TOTALIZER



Function description		
TOTALIZER → TOTALIZER → Handling totalizer functions		
<p>RESET ALL TOTALIZERS 3800</p> <p></p> <p>Modbus register: 2609 Data type: Integer Access: read/ write</p>	<p>Resets the totals and the overflows of all totalizers to zero.</p> <p>Options: 0 = NO 1 = YES</p> <p>Factory setting: NO</p> <p> Note!</p> <ul style="list-style-type: none"> ■ This function cannot be changed if: <ul style="list-style-type: none"> - The measuring device has been configured in accordance with NTEP or MC approval. - The measuring device has been configured in accordance with PTB, NMI, METAS or BEV approval and YES has been selected for the available functions Z006 to Z008 in the CUSTODY TRANSFER block. ■ If the device has a status input and if it is appropriately configured, a reset for the totalizer (1 to 3) can also be triggered by a pulse (→ the ASSIGN STATUS INPUT function (5000) on →  103). 	
<p>FAILSAFE MODE 3801</p> <p></p> <p>Modbus register: 2607 Data type: Integer Access: read/ write</p>	<p>Use this function to define the common response of all totalizers (1 to 3) to error.</p> <p>Options: 0 = STOP The totalizers are paused until the fault is rectified.</p> <p>1 = ACTUAL VALUE The totalizer continues to count based on the current flow measuring value. The fault is ignored.</p> <p>2 = HOLD VALUE The totalizers continue to count the flow based on the last valid flow value (before the error occurred).</p> <p>Factory setting: STOP</p> <p> Note!</p> <p>This function cannot be changed if:</p> <ul style="list-style-type: none"> ■ The measuring device has been configured in accordance with NTEP or MC approval. ■ The measuring device has been configured in accordance with PTB, NMI, METAS or BEV approval and YES has been selected for the available functions Z006 to Z008 in the CUSTODY TRANSFER block. 	



8 Block OUTPUTS

Block	Groups	Function groups	Functions																							
OUTPUTS (E)	CURRENT OUTPUT (EAA) → 54	CONFIGURATION (400) → 54	CURRENT SPAN (4001) → 55	VALUE 0_4 mA (4002) → 56	VALUE 20 mA (4003) → 58	MEASURING MODE (4004) → 59	TIME CONSTANT (4005) → 62	FAILSAFE MODE (4006) → 62																		
			ASSIGN CURRENT OUTPUT (4000) → 54	SIMULATION CURRENT (4041) → 63	VALUE SIM. CURRENT (4042) → 63	END VALUE FREQUENCY (4203) → 67	START VALUE FREQUENCY (4202) → 66	ASSIGN FREQUENCY (4201) → 66	OPERATION MODE (4200) → 65	TERMINAL NUMBER (4080) → 64																
			ACTUAL CURRENT (4040) → 63	TERMINAL NUMBER (4080) → 64	OPERATION MODE (4200) → 65	FAILSAFE VALUE (4221) → 75	ASSIGN PULSE (4221) → 76	PULSE VALUE (4222) → 76	PULSE WIDTH (4223) → 77	MEASURING MODE (4225) → 78	OUTPUT SIGNAL (4207) → 72	TIME CONSTANT (4208) → 74	FAILSAFE MODE (4209) → 74													
	PULSE/FREQ. OUTPUT (ECA) → 65	OPERATION (404) → 63	OPERATION (404) → 63	ASSIGN STATUS (4241) → 82	ON-VALUE (4242) → 83	SWITCH-ON DELAY (4243) → 83	OFF-VALUE (4244) → 84	SWITCH-OFF DELAY (4245) → 84	MEASURING MODE (4206) → 70	VALUE-f HIGH (4205) → 68	VALUE-f LOW (4204) → 67	END VALUE FREQUENCY (4203) → 67	START VALUE FREQUENCY (4202) → 66	ASSIGN FREQUENCY (4201) → 66	OPERATION MODE (4200) → 65	TERMINAL NUMBER (4080) → 64										
				ACTUAL FREQUENCY (4301) → 87	SIMULATION FREQUENCY (4302) → 87	VALUE SIMUL. FREQ. (4303) → 88	ACTUAL STATUS (4341) → 91	SIMULATION SWITCH POINT (4342) → 91	VALUE SIM. SWITCH PNT. (4343) → 91	VALUE SIM. IMPULS (4323) → 90	MEASURING MODE (4225) → 78	OUTPUT SIGNAL (4226) → 79	FAILSAFE MODE (4227) → 81	ASSIGN STATUS (4241) → 82	ON-VALUE (4242) → 83	SWITCH-ON DELAY (4243) → 83	OFF-VALUE (4244) → 84	SWITCH-OFF DELAY (4245) → 84	MEASURING MODE (4206) → 70	VALUE-f HIGH (4205) → 68	VALUE-f LOW (4204) → 67	END VALUE FREQUENCY (4203) → 67	START VALUE FREQUENCY (4202) → 66	ASSIGN FREQUENCY (4201) → 66	OPERATION MODE (4200) → 65	TERMINAL NUMBER (4080) → 64
				ACTUAL PULSE (4322) → 89	VALUE SIM. IMPULS (4323) → 90	ACTUAL STATUS (4341) → 91	SIMULATION SWITCH POINT (4342) → 91	VALUE SIM. SWITCH PNT. (4343) → 91	TERMINAL NUMBER (4380) → 92	ASSIGN RELAY (4700) → 93	ACTUAL STATUS RELAY (4740) → 97	TERMINAL NUMBER (4780) → 98	OFF-VALUE (4703) → 94	SWITCH-ON DELAY (4702) → 94	ON-VALUE (4701) → 94	SWITCH-ON DELAY (4702) → 94	VALUE SIM. SWITCH PNT. (4741) → 97	TERMINAL NUMBER (4780) → 98	SWITCH-OFF DELAY (4704) → 95	MEASURING MODE (4705) → 95	TIME CONSTANT (4706) → 96					
	RELAY 1 to 2 (ECA, EGB) → 93	OPERATION (474) → 97	OPERATION (474) → 97	ACTUAL STATUS RELAY (4740) → 97	TERMINAL NUMBER (4780) → 98	SWITCH-OFF DELAY (4704) → 95	MEASURING MODE (4705) → 95	TIME CONSTANT (4706) → 96	OFF-VALUE (4703) → 94	SWITCH-ON DELAY (4702) → 94	ON-VALUE (4701) → 94	SWITCH-ON DELAY (4702) → 94	VALUE SIM. SWITCH PNT. (4741) → 97	TERMINAL NUMBER (4780) → 98	SWITCH-OFF DELAY (4704) → 95	MEASURING MODE (4705) → 95	TIME CONSTANT (4706) → 96									
				ACTUAL STATUS RELAY (4740) → 97	TERMINAL NUMBER (4780) → 98	OFF-VALUE (4703) → 94	SWITCH-ON DELAY (4702) → 94	ON-VALUE (4701) → 94	SWITCH-ON DELAY (4702) → 94	VALUE SIM. SWITCH PNT. (4741) → 97	TERMINAL NUMBER (4780) → 98	SWITCH-OFF DELAY (4704) → 95	MEASURING MODE (4705) → 95	TIME CONSTANT (4706) → 96	OFF-VALUE (4703) → 94	SWITCH-ON DELAY (4702) → 94	ON-VALUE (4701) → 94	SWITCH-ON DELAY (4702) → 94	VALUE SIM. SWITCH PNT. (4741) → 97	TERMINAL NUMBER (4780) → 98						
				ACTUAL STATUS RELAY (4740) → 97	TERMINAL NUMBER (4780) → 98	OFF-VALUE (4703) → 94	SWITCH-ON DELAY (4702) → 94	ON-VALUE (4701) → 94	SWITCH-ON DELAY (4702) → 94	VALUE SIM. SWITCH PNT. (4741) → 97	TERMINAL NUMBER (4780) → 98	SWITCH-OFF DELAY (4704) → 95	MEASURING MODE (4705) → 95	TIME CONSTANT (4706) → 96	OFF-VALUE (4703) → 94	SWITCH-ON DELAY (4702) → 94	ON-VALUE (4701) → 94	SWITCH-ON DELAY (4702) → 94	VALUE SIM. SWITCH PNT. (4741) → 97	TERMINAL NUMBER (4780) → 98						









8.1 Group Outputs

8.1.1 Function group CONFIGURATION

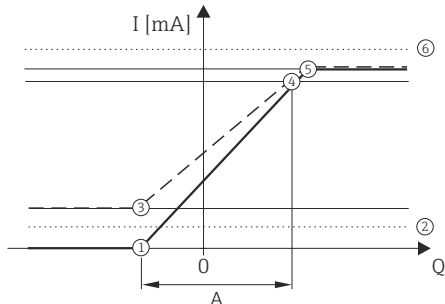
OUTPUTS	E	→	CURRENT OUTPUT	EAA	→	CONFIGURATION	400
---------	---	---	----------------	-----	---	---------------	-----

Function description	
OUTPUTS → CURRENT OUTPUT → CONFIGURATION	
<p>ASSIGN CURRENT OUTPUT 4000</p> <p></p> <p>Modbus register: 5801 Data type: Integer Access: read/ write</p>	<p>For assigning a measured variable to the current output.</p> <p>Options: 0 = OFF 2 = MASS FLOW 5 = VOLUME FLOW 6 = CORRECTED VOLUME FLOW 7 = DENSITY 8 = REFERENCE DENSITY 9 = TEMPERATURE</p> <p>Factory setting: MASS FLOW</p> <p> Note!</p> <ul style="list-style-type: none"> ■ This function cannot be changed if: <ul style="list-style-type: none"> - The measuring device has been configured in accordance with NTEP or MC approval. - The measuring device has been configured in accordance with PTB, NMI, METAS or BEV approval and YES has been selected for function Z003 in the CUSTODY TRANSFER block. ■ If you select OFF, the only function shown in the CONFIGURATION function group is this function, in other words ASSIGN CURRENT OUTPUT (4000).

Function description																														
OUTPUTS → CURRENT OUTPUT → CONFIGURATION																														
<p>CURRENT SPAN 4001</p> <p>☒</p> <p>Modbus register: 5802 Data type: Integer Access: read/ write</p>	<p>For selecting the current span. The selection specifies the operational range and the lower and upper signal on alarm.</p> <p>Options: 0 = 0–20 mA (25 mA) 1 = 4–20 mA (25 mA) 3 = 0–20 mA 4 = 4–20 mA 6 = 4–20 mA NAMUR 8 = 4–20 mA US</p> <p>Factory setting: 4–20 mA NAMUR or 4–20 mA US</p> <p>📎 Note!</p> <ul style="list-style-type: none"> ■ This function cannot be changed if: <ul style="list-style-type: none"> – The measuring device has been configured in accordance with NTEP or MC approval. – The measuring device has been configured in accordance with PTB, NMi, METAS or BEV approval and YES has been selected for function Z003 in the CUSTODY TRANSFER block. ■ When switching the hardware from an active (factory setting) to a passive output signal, select a current span of 4–20 mA → Operating Instructions (BA140D/06). 	<table border="1" style="margin: 10px auto;"> <thead> <tr> <th>a</th> <th>1</th> <th>2</th> <th>3</th> </tr> </thead> <tbody> <tr> <td>0-20 mA (25 mA)</td> <td>0 - 24 mA</td> <td>0</td> <td>25</td> </tr> <tr> <td>4-20 mA (25 mA)</td> <td>4 - 24 mA</td> <td>2</td> <td>25</td> </tr> <tr> <td>0-20 mA</td> <td>0 - 20.5 mA</td> <td>0</td> <td>22</td> </tr> <tr> <td>4-20 mA</td> <td>4 - 20.5 mA</td> <td>2</td> <td>22</td> </tr> <tr> <td>4-20 mA NAMUR</td> <td>3.8 - 20.5 mA</td> <td>3.5</td> <td>22.6</td> </tr> <tr> <td>4-20 mA US</td> <td>3.9 - 20.8 mA</td> <td>3.75</td> <td>22.6</td> </tr> </tbody> </table> <p style="text-align: right; font-size: small;">A0002959</p>	a	1	2	3	0-20 mA (25 mA)	0 - 24 mA	0	25	4-20 mA (25 mA)	4 - 24 mA	2	25	0-20 mA	0 - 20.5 mA	0	22	4-20 mA	4 - 20.5 mA	2	22	4-20 mA NAMUR	3.8 - 20.5 mA	3.5	22.6	4-20 mA US	3.9 - 20.8 mA	3.75	22.6
a	1	2	3																											
0-20 mA (25 mA)	0 - 24 mA	0	25																											
4-20 mA (25 mA)	4 - 24 mA	2	25																											
0-20 mA	0 - 20.5 mA	0	22																											
4-20 mA	4 - 20.5 mA	2	22																											
4-20 mA NAMUR	3.8 - 20.5 mA	3.5	22.6																											
4-20 mA US	3.9 - 20.8 mA	3.75	22.6																											
<p><i>Fig. 16: Overview of current span, operational range and signal on alarm level</i></p> <p>a <i>Current span</i> 1 <i>Operational range (measuring information)</i> 2 <i>Lower signal on alarm level</i> 3 <i>Upper signal on alarm level</i></p> <p>📎 Note!</p> <ul style="list-style-type: none"> ■ If the measured value exceeds the measuring range (as defined in the functions VALUE 0_4 mA (4002) and VALUE 20 mA (4003)) a notice message is generated (#351 to 354, current span). ■ In case of a fault the behavior of the current output is according to the selected option in the function FAILSAFE MODE (4006). 																														

Function description	
OUTPUTS → CURRENT OUTPUT → CONFIGURATION	
<p>VALUE 0_4 mA 4002</p> <p></p> <p>Modbus register: 5803 Data type: Float Access: read/write</p>	<p>Use this function to assign the 0/4 mA current a value. The value can be higher or lower than the value assigned to 20 (function VALUE 20 mA (4003) →  58). Positive and negative values are permissible, depending on the measured variable in question (e.g. mass flow).</p> <p>Example: 4 mA assigned value = -250 kg/h 20 mA assigned value = +750 kg/h Calculated current value = 8 mA (at zero flow)</p> <p> Note!</p> <ul style="list-style-type: none"> ■ This function cannot be changed if: <ul style="list-style-type: none"> - The measuring device has been configured in accordance with NTEP or MC approval. - The measuring device has been configured in accordance with PTB, NMI, METAS or BEV approval and YES has been selected for function Z003 in the CUSTODY TRANSFER block. ■ Note that values with different signs cannot be entered for 0/4 mA and 20 mA if SYMMETRY is the setting selected for the MEASURING MODE function (4004). In this case, the message "INPUT RANGE EXCEEDED" appears on the display. <p>Example for STANDARD measuring mode:</p> <div style="text-align: center;">  </div> <p style="text-align: right;">A0001223</p> <p>① = Lower range-value (0 to 20 mA) ② = Lower signal on alarm level: depends on the setting in the function CURRENT SPAN ③ = Lower range-value (4 to 20 mA): depends on the setting in the function CURRENT SPAN ④ = Full scale value (0/4 to 20 mA): depends on the setting in the function CURRENT SPAN ⑤ = Maximum current value: depends on the setting in the function CURRENT SPAN ⑥ = Failsafe mode (upper signal on alarm level): depends on the setting in the functions CURRENT SPAN (→  55) and FAILSAFE MODE (→  62) A = Measuring range</p> <p>User input: 5-digit floating-point number, with sign</p> <p>Factory setting: 0 [kg/h] or 0.5 [kg/l] or - 50 [°C]</p> <p> Note!</p> <ul style="list-style-type: none"> ■ The appropriate unit is taken from the following functions: <ul style="list-style-type: none"> - UNIT MASS FLOW (0400) - UNIT VOLUME FLOW (0402) - UNIT CORRECTED VOLUME FLOW (0404) - UNIT DENSITY (0420) - UNIT REFERENCE DENSITY (0421) - UNIT TEMPERATURE (0422) (→  16 to →  20). <p>(continued on next page)</p>







Function description	
OUTPUTS → CURRENT OUTPUT → CONFIGURATION	
<p>VALUE 0_4 mA 4002 (continued)</p>	<p>ⓘ Caution!</p> <p>The current output responds differently, depending on the parameters set in the various functions. Some examples of parameter settings and their effect on the current output are given in the following section.</p> <p>Parameter setting example A:</p> <ol style="list-style-type: none"> VALUE 0_4 mA (4002) = not equal to zero flow (e.g. -5 kg/h) VALUE 20 mA (4003) = not equal to zero flow (e.g. 10 kg/h) or VALUE 0_4 mA (4002) = not equal to zero flow (e.g. 100 kg/h) VALUE 20 mA (4002) = not equal to zero flow (e.g. -40 kg/h) <p>and MEASURING MODE (4004) = STANDARD</p> <p>When you enter the values for 0/4 mA and 20 mA, the working range of the measuring device is defined. If the effective flow drops below or exceeds this working range (→ Fig. ⓘ), a fault/notice message is generated (#351 to 354, current range) and the current output responds in accordance with the parameter settings in the function FAILSAFE MODE (4006).</p> <div style="display: flex; justify-content: space-around;"> <div style="text-align: center;"> <p>1)</p> </div> <div style="text-align: center;"> <p>2)</p> </div> </div> <p style="text-align: right; font-size: small;">A0001262</p> <p>Parameter setting example B:</p> <ol style="list-style-type: none"> VALUE 0_4 mA (4002) = equal to zero flow (e.g. 0 kg/h) VALUE 20 mA (4003) = not equal to zero flow (e.g. 10 kg/h) or VALUE 0_4 mA (4002) = not equal to zero flow (e.g. 100 kg/h) VALUE 20 mA (4003) = equal to zero flow (e.g. 0 kg/h) <p>and MEASURING MODE (4004) = STANDARD</p> <p>When you enter the values for 0/4 mA and 20 mA, the working range of the measuring device is defined. In doing so, one of the two values is parameterized as zero flow (e.g. 0 kg/h). If the effective flow drops below or exceeds the value parameterized as the zero flow, no fault/notice message is generated and the current output retains its value. If the effective flow drops below or exceeds the other value, a fault/notice message is generated (#351 to 354, current range) and the current output responds in accordance with the parameter settings in the function FAILSAFE MODE (4006).</p> <div style="display: flex; justify-content: space-around;"> <div style="text-align: center;"> <p>1)</p> </div> <div style="text-align: center;"> <p>2)</p> </div> </div> <p style="text-align: right; font-size: small;">A0001264</p> <p>Deliberately only one flow direction is output with this setting and flow values in the other flow direction are suppressed.</p> <p>Parameter setting example C: MEASURING MODE (4004) = SYMMETRY</p> <p>The current output signal is independent of the direction of flow (absolute amount of the measured variable). The 0_4 mA value ⓘ and the 20 mA value ⓘ must have the same sign (+ or -). The 20 mA VALUE ⓘ (e.g. back-flow) corresponds to the mirrored 20 mA VALUE ⓘ (e.g. flow).</p> <p>(continued on next page)</p>

Function description	
OUTPUTS → CURRENT OUTPUT → CONFIGURATION	
<p>VALUE 0_4 mA 4002 (continued)</p>	<div style="text-align: center;"> </div> <p style="text-align: right; font-size: small;">A0001249</p> <p>ASSIGN STATUS (4241) = FLOW DIRECTION With this setting e.g. the flow direction output via a switching contact can be made.</p> <p>Parameter setting example D: MEASURING MODE (4004) = PULSATING FLOW → 59</p>
<p>VALUE 20 mA 4003</p> <p> Modbus register: 5805 Data type: Float Access: read/write</p>	<p>Use this function to assign the 20 mA current a value. The value can be higher or lower than the value assigned to 0/4 (function VALUE 0_4 mA (4002) → 56). Positive and negative values are permissible, depending on the measured variable in question (e.g. mass flow).</p> <p>Example: 4 mA assigned value = -250 kg/h 20 mA assigned value = +750 kg/h Calculated current value = 8 mA (at zero flow)</p> <p>Note that values with different signs cannot be entered for 0/4 mA and 20 mA if SYMMETRY is the setting selected for the MEASURING MODE function (4004). In this case, the message "INPUT RANGE EXCEEDED" appears on the display.</p> <p>User input: 5-digit floating-point number, with sign</p> <p>Factory setting: Depends on nominal diameter [kg/h] or 2 [kg/l] or 200 [°C]</p> <p> Note!</p> <ul style="list-style-type: none"> ■ This function cannot be changed if: <ul style="list-style-type: none"> - The measuring device has been configured in accordance with NTEP or MC approval. - The measuring device has been configured in accordance with PTB, NMI, METAS or BEV approval and YES has been selected for function Z003 in the CUSTODY TRANSFER block. ■ The appropriate unit is taken from the following functions: <ul style="list-style-type: none"> - UNIT MASS FLOW (0400) - UNIT VOLUME FLOW (0402) - UNIT CORRECTED VOLUME FLOW (0404) - UNIT DENSITY (0420) - UNIT REFERENCE DENSITY (0421) - UNIT TEMPERATURE (0422) (→ 16 to → 20). ■ The appropriate unit is taken from the function UNIT MASS FLOW (0400) → 16. ■ An example for selecting the STANDARD option in the function MEASURING MODE (4004) can be found on → 60. <p> Caution! It is very important to read and comply with the information in the function VALUE 0_4 mA (under "Caution", examples of parameter settings) on → 56.</p>

Function description	
OUTPUTS → CURRENT OUTPUT → CONFIGURATION	
<p>MEASURING MODE 4004</p> <p>☒</p> <p>Modbus register: 5807 Data type: Integer Access: read/write</p>	<p>For selecting the measuring mode for the current output.</p> <p>Options: 0 = STANDARD 1 = SYMMETRY 2 = PULSATING FLOW</p> <p>Factory setting: STANDARD</p> <p>Note! This function cannot be changed if:</p> <ul style="list-style-type: none"> ▪ The measuring device has been configured in accordance with NTEP or MC approval. ▪ The measuring device has been configured in accordance with PTB, NMI, METAS or BEV approval and YES has been selected for function Z003 in the CUSTODY TRANSFER block. <p>Description of the individual options:</p> <p>STANDARD The current output signal is proportional to the measured variable. The flow components outside the scaled measuring range (defined by the 0_4 mA VALUE ① and the 20 mA VALUE ②) are taken into account as follows for signal output.</p> <ul style="list-style-type: none"> ▪ If one of the values is defined as equal to the zero flow (e.g. VALUE 0_4 mA = 0 m³/h), no message is given if this value is exceeded or not achieved and the current output retains its value (in example 4 mA). If the other value is exceeded or not achieved, the message "CURRENT OUTPUT AT FULL SCALE VALUE" appears and the current output responds in accordance with the parameter setting in the function FAILSAFE MODE (4006). ▪ If both values defined are not equal to the zero flow (for example VALUE 0_4 mA = -5 m³/h, VALUE 20 mA = 10m³/h), the message "CURRENT OUTPUT AT FULL SCALE VALUE" appears if the measuring range is exceeded or not achieved and the current output responds in accordance with the parameter settings in the function FAILSAFE MODE (4006).. <div style="text-align: center;"> </div> <p style="text-align: right;">A0001248</p> <p><i>Fig. 17: Example for STANDARD measuring mode</i></p> <p>SYMMETRY The current output signal is independent of the direction of flow (absolute amount of the measured variable). The 0_4 mA value ① and the 20 mA value ② must have the same sign (+ or -). The "20 mA value" ③ (e.g. back-flow) corresponds to the mirrored 20 mA value ② (e.g. flow).</p> <div style="text-align: center;"> </div> <p style="text-align: right;">A0001249</p> <p><i>Fig. 18: Example for SYMMETRY measuring mode</i></p> <p>(continued on next page)</p>





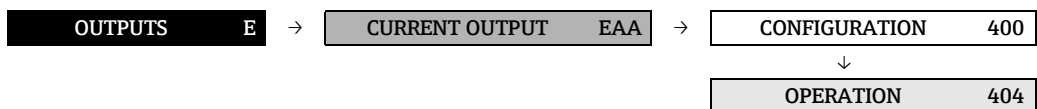

Function description OUTPUTS → CURRENT OUTPUT → CONFIGURATION	
<p>MEASURING MODE 4004 (continued)</p>	<p> Note!</p> <ul style="list-style-type: none"> The direction of flow can be output via the configurable relay or status outputs. SYMMETRY cannot be selected unless the values in the VALUE 0_4 mA (4002) and VALUE 20 mA (4003) functions have the same sign or one of the values is zero. If the values have different signs, SYMMETRY cannot be selected and an "ASSIGNMENT NOT POSSIBLE" message is displayed. <p>PULSATING FLOW If flow is characterized by severe fluctuations as is the case, for example, with reciprocating pumps, flow components outside the measuring range are buffered, balanced and output after a maximum delay of 60 seconds. If the buffered data cannot be processed within approx. 60 seconds, a fault/notice message appears. Under certain plant conditions, flow values can aggregate in the buffer, for example in the case of prolonged and unwanted fluid backflow. However, this buffer is reset in all relevant programming adjustments which affect the current output.</p>
<p>Detailed explanations and information</p>	<p>How the current output responds under the following postulated conditions:</p> <p>1. Defined measuring range (①–②): ① and ② have the same sign</p> <div style="text-align: center;"> </div> <p style="text-align: right;">A0001248</p> <p>and the following flow behavior:</p> <div style="text-align: center;"> </div> <p style="text-align: right;">A0001265</p> <ul style="list-style-type: none"> STANDARD The current output signal is proportional to the measured variable. The flow components outside the scaled measuring range are not taken into account for signal output. <div style="text-align: center;"> </div> <p style="text-align: right;">A0001267</p> <ul style="list-style-type: none"> SYMMETRY The current output signal is independent of the direction of flow. <div style="text-align: center;"> </div> <p style="text-align: right;">A0001268</p> <p>(continued on next page)</p>

Function description OUTPUTS → CURRENT OUTPUT → CONFIGURATION	
<p>Detailed explanations and information (continued)</p>	<ul style="list-style-type: none"> PULSATING FLOW Flow components outside the measuring range are buffered, balanced and output after a maximum delay of 60 seconds. <div style="text-align: center;"> </div> <p style="text-align: right;">A0001269</p> 2. Defined measuring range (①-②): ① and ② do not have the same sign. <div style="text-align: center;"> </div> <p style="text-align: right;">A0001272</p> <p>Flow a (—) outside, b (---) within the measuring range.</p> <div style="text-align: center;"> </div> <p style="text-align: right;">A0001273</p> STANDARD a (—): The flow components outside the scaled measuring range cannot be taken into account for signal output. A fault message is generated (#351 to 354, current range) and the current output responds in accordance with the parameter settings in the function FAILSAFE MODE (4006). b (---): The current output signal is proportional to the measured variable assigned. <div style="text-align: center;"> </div> <p style="text-align: right;">A0001274</p> SYMMETRY This option is not available under these circumstances because the 0_4 mA value and the 20 mA value have different signs. PULSATING FLOW Flow components outside the measuring range are buffered, balanced and output after a maximum delay of 60 seconds. <div style="text-align: center;"> </div> <p style="text-align: right;">A0001275</p>

Function description		
OUTPUTS → CURRENT OUTPUT → CONFIGURATION		
<p>TIME CONSTANT 4005</p> <p></p> <p>Modbus register: 5808 Data type: Float Access: read/ write</p>		<p>Entering a time constant defines how the current output signal reacts to severely fluctuating measured variables, either very quickly (enter a low time constant) or with damping (enter a high time constant).</p> <p>User input: fixed-point number 0.01 to 100.00 s</p> <p>Factory setting: 1.00 s</p> <p> Note! This function cannot be changed if:</p> <ul style="list-style-type: none"> ▪ The measuring device has been configured in accordance with NTEP or MC approval. ▪ The measuring device has been configured in accordance with PTB, NMI, METAS or BEV approval and YES has been selected for function Z003 in the CUSTODY TRANSFER block.
<p>FAILSAFE MODE 4006</p> <p></p> <p>Modbus register: 5810 Data type: Integer Access: read/ write</p>		<p>For safety reasons it is advisable to ensure that the current output assumes a predefined state in the event of a fault. The setting you select here affects only the current output. It has no effect on other outputs and the display (e.g. totalizers).</p> <p>Options: 0 = MIN. CURRENT The current output adopts the value of the lower signal on alarm level (as defined in the function CURRENT SPAN (4001) →  55).</p> <p>1 = MAX. CURRENT The current output adopts the value of the upper signal on alarm level (as defined in the function CURRENT SPAN (4001) →  55).</p> <p>2 = HOLD VALUE (not recommended) Measured value output is based on the last measured value saved before the error occurred.</p> <p>3 = ACTUAL VALUE Measured value output is based on the current flow measurement. The fault is ignored.</p> <p>Factory setting: MIN. CURRENT</p> <p> Note! This function cannot be changed if:</p> <ul style="list-style-type: none"> ▪ The measuring device has been configured in accordance with NTEP or MC approval. ▪ The measuring device has been configured in accordance with PTB, NMI, METAS or BEV approval and YES has been selected for function Z003 in the CUSTODY TRANSFER block.

8.1.2 Function group OPERATION



Function description	
OUTPUTS → CURRENT OUTPUT → OPERATION	
<p>ACTUAL CURRENT 4040</p> <p>Modbus register: 5811 Data type: Float Access: read</p>	<p>Use this function to view the computed actual value of the output current.</p> <p>Display: 0.00 to 25.00 mA</p>
<p>SIMULATION CURRENT 4041</p> <p></p> <p>Modbus register: 5813 Data type: Integer Access: read/write</p>	<p>Activates simulation of the current output.</p> <p>Options: 0 = OFF 1 = ON</p> <p>Factory setting: OFF</p> <p> Note!</p> <ul style="list-style-type: none"> ■ This function cannot be changed if: <ul style="list-style-type: none"> – The measuring device has been configured in accordance with NTEP or MC approval. – The measuring device has been configured in accordance with PTB, NMI, METAS or BEV approval and YES has been selected for function Z003 in the CUSTODY TRANSFER block. ■ If simulation is active, the "SIMULATION CURRENT OUTPUT" message is displayed. ■ The measuring device continues to measure while simulation is in progress, i.e. the current measured values are output correctly via the other outputs. <p> Caution! The setting is not saved in the event of a power failure.</p>
<p>VALUE SIMULATION CURRENT 4042</p> <p></p> <p>Modbus register: Data type: 5814 Access: Float read/write</p>	<p>Use this function to define a freely selectable value (e.g. 12 mA) to be output at the current output. This value is used to test downstream devices and the measuring device itself.</p> <p>User input: 0.00 to 25.00 mA</p> <p>Factory setting: 0.00 mA</p> <p> Note!</p> <ul style="list-style-type: none"> ■ This function cannot be changed if: <ul style="list-style-type: none"> – The measuring device has been configured in accordance with NTEP or MC approval. – The measuring device has been configured in accordance with PTB, NMI, METAS or BEV approval and YES has been selected for function Z003 in the CUSTODY TRANSFER block. ■ This function is displayed only if the function SIMULATION CURR. (4041) is active (= ON). <p> Caution! The setting is not saved in the event of a power failure.</p>

8.1.3 Function group INFORMATION

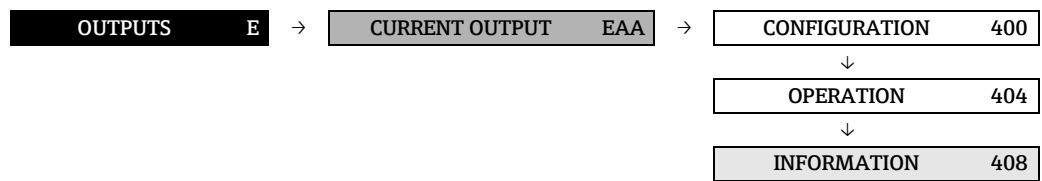





Function description		
OUTPUTS → CURRENT OUTPUT → INFORMATION		
TERMINAL NUMBER Modbus register: Data type: Access:	4080 5816 Integer read	Displays the: <ul style="list-style-type: none"> ▪ Numbers of the terminals used by the current output (in the connection compartment) ▪ Polarity Display: 3 = 20 (+) / 21 (-)

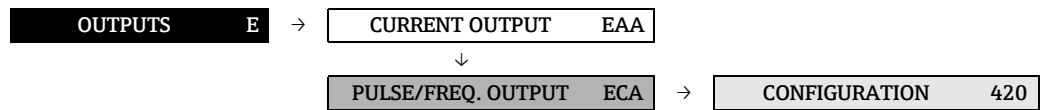





8.2 Group PULSE/FREQUENCY OUTPUT



8.2.1 Function group CONFIGURATION





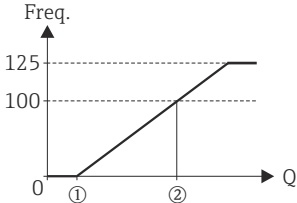
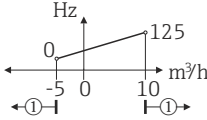
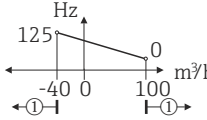

Function description	
OUTPUTS → PULSE/FREQUENCY OUTPUT → CONFIGURATION	
<p>OPERATION MODE 4200</p> <p> Modbus register: 3201 Data type: Integer Access: read/write</p>	<p>Configuration of the output as a pulse, frequency or status output.</p> <p>The functions available in this function group vary, depending on which option you select here.</p> <p>Options: 0 = PULSE 1 = FREQUENCY 2 = STATUS</p> <p>Factory setting: PULSE</p>

Function description		
OUTPUTS → PULSE/FREQUENCY OUTPUT 1 → CONFIGURATION (FREQUENCY)		
<p>ASSIGN FREQUENCY</p> <p></p> <p>Modbus register: 3202 Data type: Integer Access: read/write</p>	<p>4201</p>	<p>For assigning a measured variable to the frequency output.</p> <p>Options: 0 = OFF 2 = MASS FLOW 5 = VOLUME FLOW 6 = CORRECTED VOLUME FLOW 7 = DENSITY 8 = REFERENCE DENSITY 9 = TEMPERATURE</p> <p>Factory setting: MASS FLOW</p> <p> Note!</p> <ul style="list-style-type: none"> ■ This function cannot be changed if: <ul style="list-style-type: none"> – The measuring device has been configured in accordance with NTEP or MC approval. – The measuring device has been configured in accordance with PTB, NMI, METAS or BEV approval and YES has been selected for function Z001 in the CUSTODY TRANSFER block. ■ This function is not available unless the FREQUENCY setting was selected in the OPERATION MODE function (4200). ■ If you select OFF, the only function shown in the CONFIGURATION function group is ASSIGN FREQUENCY (4201).
<p>START VALUE FREQUENCY</p> <p></p> <p>Modbus register: 3203 Data type: Float Access: read/write</p>	<p>4202</p>	<p>For defining an initial frequency for the frequency output. You define the associated measured value of the measuring range in the function VALUE f LOW (4204).</p> <p>User input: 5-digit fixed-point number: 0 to 10000 Hz</p> <p>Factory setting: 0 Hz</p> <p>Example:</p> <ul style="list-style-type: none"> ■ VALUE f LOW = 0 kg/h, start value frequency = 0 Hz This means that at a flow rate of 0 kg/h, a frequency of 0 Hz is output. ■ VALUE f LOW = 1 kg/h, start value frequency = 10 Hz This means that at a flow rate of 1 kg/h, a frequency of 10 Hz is output. <p> Note!</p> <ul style="list-style-type: none"> ■ This function cannot be changed if: <ul style="list-style-type: none"> – The measuring device has been configured in accordance with NTEP or MC approval. – The measuring device has been configured in accordance with PTB, NMI, METAS or BEV approval and YES has been selected for function Z001 in the CUSTODY TRANSFER block. ■ This function is not available unless the FREQUENCY setting was selected in the OPERATION MODE function (4200).

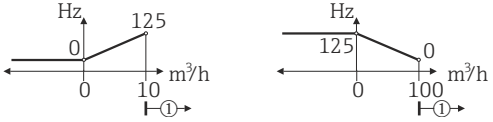
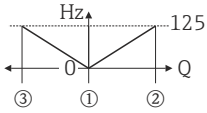
Function description	
OUTPUTS → PULSE/FREQUENCY OUTPUT 1 → CONFIGURATION (FREQUENCY)	
<p>END VALUE FREQUENCY 4203</p> <p></p> <p>Modbus register: 3205 Data type: Float Access: read/ write</p>	<p>For defining a full scale frequency for the frequency output. You define the associated measured value of the measuring range in the function VALUE-f HIGH (4205).</p> <p>User input: 5-digit fixed-point number: 2 to 10000 Hz</p> <p>Factory setting: 10000 Hz</p> <p>Example:</p> <ul style="list-style-type: none"> ■ VALUE f HIGH = 10000 kg/h, full scale value = 10000 Hz This means that at a flow rate of 10000 kg/h, a frequency of 10000 Hz is output. ■ VALUE f HIGH = 3600 kg/h, full scale value = 10000 Hz This means that at a flow rate of 3600 kg/h, a frequency of 10000 Hz is output. <p> Note!</p> <ul style="list-style-type: none"> ■ This function cannot be changed if: <ul style="list-style-type: none"> - The measuring device has been configured in accordance with NTEP or MC approval. - The measuring device has been configured in accordance with PTB, NMi, METAS or BEV approval and YES has been selected for function Z001 in the CUSTODY TRANSFER block. ■ This function is not available unless the FREQUENCY setting was selected in the OPERATION MODE function (4200). ■ In the FREQUENCY operating mode the output signal is symmetrical (on/off ratio = 1:1). At low frequencies the pulse duration is limited to a maximum of 2 seconds, i.e. the on/off ratio is no longer symmetrical.
<p>VALUE f LOW 4204</p> <p></p> <p>Modbus register: 3207 Data type: Float Access: read/ write</p>	<p>Use this function to assign a variable to the START VALUE FREQUENCY(4202). The value can be higher or lower than the value assigned to the VALUE f HIGH. Positive and negative values are permissible, depending on the measured variable in question (e.g. mass flow). You define a measuring range by defining the VALUE f LOW and VALUE f HIGH values.</p> <p>Input: 5-digit floating-point number</p> <p>Factory setting: 0 [kg/h] or 0 [kg/l] or -50 [°C]</p> <p> Note!</p> <ul style="list-style-type: none"> ■ This function cannot be changed if: <ul style="list-style-type: none"> - The measuring device has been configured in accordance with NTEP or MC approval. - The measuring device has been configured in accordance with PTB, NMi, METAS or BEV approval and YES has been selected for function Z001 in the CUSTODY TRANSFER block. ■ This function is not available unless the FREQUENCY setting was selected in the OPERATION MODE function (4200). ■ For a graphic illustration of the VALUE F LOW → the VALUE-f HIGH (4205) function. ■ Note that values with different signs cannot be entered for VALUE F LOW and VALUE F HIGH, if SYMMETRY is the setting selected for the MEASURING MODE function (4206). In this case, the message "INPUT RANGE EXCEEDED" appears on the display. ■ The appropriate unit is taken from the following functions: <ul style="list-style-type: none"> - UNIT MASS FLOW (0400) - UNIT VOLUME FLOW (0402) - UNIT CORRECTED VOLUME FLOW (0404) - UNIT DENSITY (0420) - UNIT REFERENCE DENSITY (0421) - UNIT TEMPERATURE (0422) <p>(→  16 to →  20).</p>

Function description	
OUTPUTS → PULSE/FREQUENCY OUTPUT 1 → CONFIGURATION (FREQUENCY)	
<p>VALUE-f HIGH 4205</p> <p></p> <p>Modbus register: 3209 Data type: Float Access: read/ write</p>	<p>Use this function to assign a variable to the END VALUE FREQUENCY (4203). The value can be higher or lower than the value assigned to the VALUE F LOW. Positive and negative values are permissible, depending on the measured variable in question (e.g. mass flow). You define a measuring range by defining the VALUE f LOW and VALUE f HIGH values.</p> <p>Input: 5-digit floating-point number</p> <p>Factory setting: Depends on nominal diameter [kg/h] or 2 [kg/l] or 200 [°C]</p> <p> Note!</p> <ul style="list-style-type: none"> ■ This function cannot be changed if: <ul style="list-style-type: none"> - The measuring device has been configured in accordance with NTEP or MC approval. - The measuring device has been configured in accordance with PTB, NMI, METAS or BEV approval and YES has been selected for function Z001 in the CUSTODY TRANSFER block. ■ This function is not available unless the FREQUENCY setting was selected in the OPERATION MODE function (4200). ■ Note that values with different signs cannot be entered for VALUE F LOW and VALUE F HIGH, if SYMMETRY is the setting selected for the MEASURING MODE function (4206). In this case, the message "INPUT RANGE EXCEEDED" appears on the display. <div style="text-align: center;">  </div> <p style="text-align: right;">A0001279</p> <p>① = Value f low ② = Value f high</p> <p>Parameter setting example 1:</p> <ol style="list-style-type: none"> 1. VALUE f LOW (4204) = not equal to zero flow (e.g. -5 kg/h) VALUE-f HIGH (4205) = not equal to zero flow (e.g. 10 kg/h) or 2. VALUE f LOW (4204) = not equal to zero flow (e.g. 100 kg/h) VALUE-f HIGH (4205) = not equal to zero flow (e.g. -40 kg/h) <p>and MEASURING MODE (4206) = STANDARD</p> <p>When you enter the values for VALUE f LOW and VALUE f HIGH the working range of the measuring device is defined. If the effective flow drops below or exceeds this working range (→ Fig. ①), a fault/notice message is generated (#355 to 358, frequency range) and the frequency output responds in accordance with the parameter settings in the function FAIL-SAFE MODE (4209).</p> <div style="display: flex; justify-content: space-around;"> <div style="text-align: center;">  </div> <div style="text-align: center;">  </div> </div> <p style="text-align: right;">A0001276</p> <p>(continued on next page)</p>



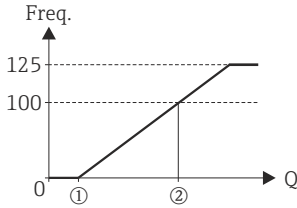

Function description	
OUTPUTS → PULSE/FREQUENCY OUTPUT 1 → CONFIGURATION (FREQUENCY)	
<p>VALUE-f HIGH 4205 (continued)</p>	<p>Parameter setting example 2:</p> <ol style="list-style-type: none"> VALUE f LOW (4204) = not equal to zero flow (e.g. 0 kg/h) VALUE-f HIGH (4205) = not equal to zero flow (e.g. 10 kg/h) or VALUE f LOW (4204) = not equal to zero flow (e.g. 100 kg/h) VALUE-f HIGH (4205) = not equal to zero flow (e.g. 0 kg/h) <p>and MEASURING MODE (4206) = STANDARD</p> <p>When you enter the values for VALUE f LOW and VALUE f HIGH the working range of the measuring device is defined. In doing so, one of the two values is parameterized as zero flow (e.g. 0 kg/h). If the effective flow drops below or exceeds the value parameterized as the zero flow, no fault/notice message is generated and the frequency output retains its value. If the effective flow drops below or exceeds the other value, a fault/notice message is generated (#355 to 358, frequency range) and the frequency output responds in accordance with the parameter settings in the function FAILSAFE MODE (4209).</p> <div style="display: flex; justify-content: space-around; align-items: center;">  </div> <p style="text-align: right; font-size: small;">A0001277</p> <p>Deliberately only one flow direction is output with this setting and flow values in the other flow direction are suppressed.</p> <p>Parameter setting example 3: MEASURING MODE (4206) = SYMMETRY</p> <p>The frequency output signal is independent of the direction of flow (absolute amount of the measured variable). The VALUE f LOW ① and VALUE f HIGH ② must have the same sign (+ or -). The VALUE f HIGH ③ (e.g. back-flow) corresponds to the mirrored VALUE f HIGH ② (e.g. flow).</p> <div style="text-align: center;">  </div> <p style="text-align: right; font-size: small;">A0001278</p> <p>ASSIGN STATUS (4241) = FLOW DIRECTION With this setting e.g. the flow direction output via a switching contact can be made.</p> <p>Parameter setting example 4: MEASURING MODE (4206) = PULSATING FLOW → 70</p>

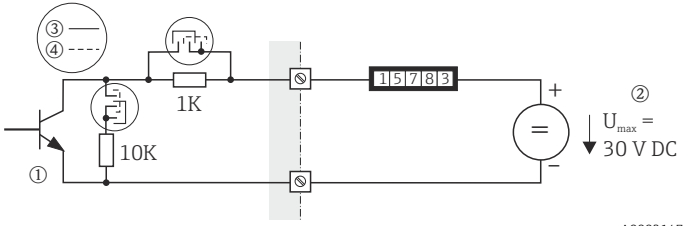
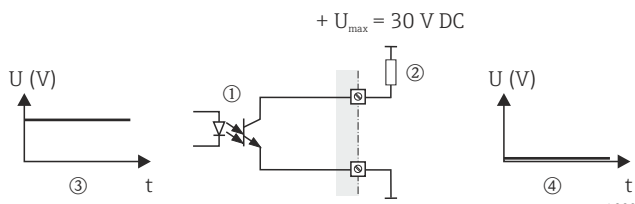
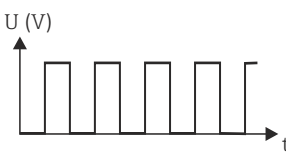

Function description	
OUTPUTS → PULSE/FREQUENCY OUTPUT 1 → CONFIGURATION (FREQUENCY)	
<p>MEASURING MODE 4206</p> <p> Note!</p> <p>Modbus register: 3211 Data type: Integer Access: read/write</p>	<p> Note!</p> <p>This function is not available unless the FREQUENCY setting was selected in the function OPERATION MODE (4200).</p> <p>Use this function to define the measuring mode for the frequency output.</p> <p>Options: 0 = STANDARD 1 = SYMMETRY 2 = PULSATING FLOW</p> <p>Factory setting: STANDARD</p> <p> Note!</p> <p>This function cannot be changed if:</p> <ul style="list-style-type: none"> ▪ The measuring device has been configured in accordance with NTEP or MC approval. ▪ The measuring device has been configured in accordance with PTB, NMI, METAS or BEV approval and YES has been selected for the available functions Z001 in the CUSTODY TRANSFER block. <p>Description of the individual options:</p> <p>STANDARD The frequency output signal is proportional to the measured variable. The flow components outside the scaled measuring range (defined by the VALUE f LOW ① and the VALUE f HIGH ②) are not taken into account for signal output.</p> <ul style="list-style-type: none"> ▪ If one of the values is defined as equal to the zero flow (e.g. VALUE f LOW = 0 m³/h), no message is given if this value is exceeded or not achieved and the frequency output retains its value (0 Hz in the example). If the other value is exceeded or not achieved, the message "FREQUENCY OUTPUT AT FULL SCALE VALUE" appears and the frequency output responds in accordance with the parameter setting in the function FAILSAFE MODE (4209). ▪ If both values defined are not equal to the zero flow (for example VALUE f LOW = -5 m³/h; VALUE F HIGH = 10m³/h), the message "FREQUENCY OUTPUT AT FULL SCALE VALUE" appears if the measuring range is exceeded or not achieved and the frequency output responds in accordance with the parameter settings in the function FAILSAFE MODE (4209).. <div style="text-align: center;">  </div> <p style="text-align: right;">A0001279</p> <p><i>Fig. 19: STANDARD measuring mode</i></p> <p>SYMMETRY The frequency output signal is independent of the direction of flow (absolute amount of the measured variable). The VALUE f LOW ① and VALUE f HIGH ② must have the same sign (+ or -). The VALUE F HIGH ③ (e.g. back-flow) corresponds to the mirrored VALUE F HIGH ② (e.g. flow).</p> <p>(continued on next page)</p>







Function description	
OUTPUTS → PULSE/FREQUENCY OUTPUT 1 → CONFIGURATION (FREQUENCY)	
<p>MEASURING MODE 4206 (continued)</p>	<div style="text-align: center;"> </div> <p style="text-align: right; font-size: small;">A0001280</p> <p><i>Fig. 20: SYMMETRY measuring mode</i></p> <p>Note!</p> <ul style="list-style-type: none"> ▪ The direction of flow can be output via the configurable relay or status outputs. ▪ SYMMETRY cannot be selected unless the values in the VALUE f LOW (4204) and VALUE-f HIGH (4205) functions have the same sign or one of the values is zero. If the values have different signs, SYMMETRY cannot be selected and an "ASSIGNMENT NOT POSSIBLE" message is displayed. <p>PULSATING FLOW</p> <ul style="list-style-type: none"> ▪ If flow is characterized by severe fluctuations as is the case, for example, with reciprocating pumps, flow components outside the measuring range are buffered, balanced and output after a maximum delay of 60 seconds. If the buffered data cannot be processed within approx. 60 seconds, a fault/notice message appears. ▪ Under certain plant conditions, flow values can aggregate in the buffer, for example in the case of prolonged and unwanted fluid backflow. However, this buffer is reset in all relevant programming adjustments which affect the frequency output.
<p>OUTPUT SIGNAL 4207</p> <p> Modbus register: 3212 Data type: Integer Access: read/write</p>	<p>For selecting the output configuration of the frequency output.</p> <p>Options: 0 = PASSIVE - POSITIVE 1 = PASSIVE - NEGATIVE 2 = ACTIVE - POSITIVE (this selection is not supported) 3 = ACTIVE - NEGATIVE (this selection is not supported)</p> <p>Factory setting: PASSIVE - POSITIVE</p> <p>Explanation PASSIVE = power is supplied to the frequency output by means of an external power supply.</p> <p>Configuring the output signal level (POSITIVE or NEGATIVE) determines the quiescent behavior (at zero flow) of the frequency output. The internal transistor is activated as follows:</p> <ul style="list-style-type: none"> ▪ If POSITIVE is selected, the internal transistor is activated with a positive signal level. ▪ If NEGATIVE is selected, the internal transistor is activated with a negative signal level (0 V). <p>(continued on next page)</p>







Function description	
OUTPUTS → PULSE/FREQUENCY OUTPUT 1 → CONFIGURATION (FREQUENCY)	
<p>OUTPUT SIGNAL 4207 (continued)</p>	<p>Note!</p> <ul style="list-style-type: none"> ■ This function cannot be changed if: <ul style="list-style-type: none"> - The measuring device has been configured in accordance with NTEP or MC approval. - The measuring device has been configured in accordance with PTB, NMi, METAS or BEV approval and YES has been selected for function Z001 in the CUSTODY TRANSFER block. ■ This function is not available unless the FREQUENCY setting was selected in the function OPERATION MODE function (4200). ■ With the passive output configuration, the output signal levels of the frequency output depend on the external circuit (→ examples). <p>Example for passive output circuit (PASSIVE) If PASSIVE is selected, the frequency output is configured as an open collector.</p>  <p style="text-align: right; font-size: small;">A0002147</p> <p>① = Open collector ② = External power supply ③ = Line monitoring off ④ = Line monitoring on (default)</p> <p>Note! For continuous currents up to 25 mA ($I_{max} = 250 \text{ mA} / 20 \text{ ms}$).</p> <p>Example for output configuration PASSIVE-POSITIVE: Output configuration with an external pull-up resistance. In the quiescent state (at zero flow), the output signal level at the terminals is 0 V.</p>  <p style="text-align: right; font-size: small;">A0004687</p> <p>① = Open collector ② = Pull-Up-Resistance ③ = Transistor activation in POSITIVE quiescent state (at zero flow) ④ = Output signal level in quiescent state (at zero flow)</p> <p>In the operating status (flow present), the output signal level changes from 0 V to a positive voltage level</p>  <p style="text-align: right; font-size: small;">A0001975</p> <p>(continued on next page)</p>

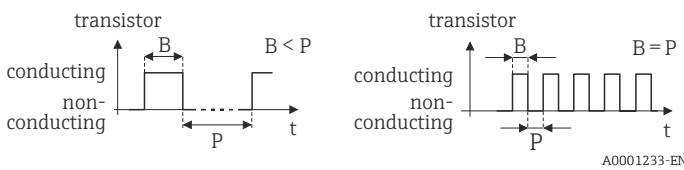

Function description	
OUTPUTS → PULSE/FREQUENCY OUTPUT 1 → CONFIGURATION (FREQUENCY)	
<p>OUTPUT SIGNAL 4207 (continued)</p>	<p>Example for output configuration PASSIVE-POSITIVE: Output configuration with an external pull-down resistance. In the quiescent state (at zero flow), a positive voltage level is measured via the pull-down resistance.</p> <p style="text-align: right;">A0004689</p> <p>① = Open collector ② = Pull-Down-Resistance ③ = Transistor activation in POSITIVE quiescent state (at zero flow) ④ = Output signal level in quiescent state (at zero flow)</p> <p>In the operating status (flow present), the output signal level changes from a positive voltage level to 0 V.</p> <p style="text-align: right;">A0001981</p> <p>Example for output configuration PASSIVE-NEGATIVE: Output configuration with an external pull-up resistance. In the quiescent state (at zero flow), the output signal level at the terminals is at a positive voltage level.</p> <p style="text-align: right;">A0004690</p> <p>① = Open collector ② = Pull-Up-Resistance ③ = Transistor activation in NEGATIVE quiescent state (at zero flow) ④ = Output signal level in quiescent state (at zero flow)</p> <p>In the operating status (flow present), the output signal level changes from a positive voltage level to 0 V.</p> <p style="text-align: right;">A0001981</p>

Function description	
OUTPUTS → PULSE/FREQUENCY OUTPUT 1 → CONFIGURATION (FREQUENCY)	
<p>TIME CONSTANT 4208</p> <p></p> <p>Modbus register: 3213 Data type: Float Access: read/ write</p>	<p>Entering a time constant defines how the frequency output signal reacts to severely fluctuating measured variables, either very quickly (enter a low time constant) or with damping (enter a high time constant).</p> <p>User input: fixed-point number 0.00 to 100.00 s</p> <p>Factory setting: 0.00 s</p> <p> Note!</p> <ul style="list-style-type: none"> ■ This function cannot be changed if: <ul style="list-style-type: none"> - The measuring device has been configured in accordance with NTEP or MC approval. - The measuring device has been configured in accordance with PTB, NMI, METAS or BEV approval and YES has been selected for function Z001 in the CUSTODY TRANSFER block. ■ This function is not available unless the FREQUENCY setting was selected in the function OPERATION MODE function (4200).
<p>FAILSAFE MODE 4209</p> <p></p> <p>Modbus register: 3215 Data type: Integer Access: read/ write</p>	<p>For safety reasons it is advisable to ensure that the frequency output assumes a predefined state in the event of a fault. The setting you select here affects only the frequency output. It has no effect on other outputs and the display (e.g. totalizers).</p> <p>Options: 0 = FALLBACK VALUE Output is 0 Hz.</p> <p>1 = FAILSAFE LEVEL Output is the frequency specified in the function FAILSAFE LEVEL (4211).</p> <p>2 = HOLD VALUE Measured value output is based on the last measured value saved before the error occurred.</p> <p>3 = ACTUAL VALUE Measured value output is based on the current flow measurement. The fault is ignored.</p> <p>Factory setting: FALLBACK VALUE</p> <p> Note!</p> <ul style="list-style-type: none"> ■ This function cannot be changed if: <ul style="list-style-type: none"> - The measuring device has been configured in accordance with NTEP or MC approval. - The measuring device has been configured in accordance with PTB, NMI, METAS or BEV approval and YES has been selected for function Z001 in the CUSTODY TRANSFER block. ■ This function is not available unless the FREQUENCY setting was selected in the function OPERATION MODE function (4200).

Function description	
OUTPUTS → PULSE/FREQUENCY OUTPUT 1 → CONFIGURATION (FREQUENCY)	
<p>FAILSAFE LEVEL 4211</p> <p> Modbus register: 3216 Data type: Float Access: read/write</p>	<p> Note! This function is not available unless FREQUENCY was selected in the OPERATION MODE function (4200) and FAILSAFE LEVEL was selected in the FAILSAFE MODE function (4209).</p> <p>For specifying the frequency that the measuring device outputs in the event of an error.</p> <p>User input: max. 5-digit number: 0 to 12500 Hz</p> <p>Factory setting: 12500 Hz</p> <p> Note!</p> <ul style="list-style-type: none"> ■ This function cannot be changed if: <ul style="list-style-type: none"> - The measuring device has been configured in accordance with NTEP or MC approval. - The measuring device has been configured in accordance with PTB, NMI, METAS or BEV approval and YES has been selected for function Z001 in the CUSTODY TRANSFER block. ■ This function is not available unless FREQUENCY was selected in the OPERATION MODE function (4200) and FAILSAFE LEVEL was selected in the FAILSAFE MODE function (4209).

Function description		
OUTPUTS → PULSE/FREQUENCY OUTPUT → CONFIGURATION (PULSE)		
<p>ASSIGN PULSE 4221</p> <p></p> <p>Modbus register: 3223 Data type: Integer Access: read/ write</p>		<p>Use this function to assign a measured variable to the pulse output.</p> <p>Options: 0 = OFF 2 = MASS FLOW 5 = VOLUME FLOW 6 = CORRECTED VOLUME FLOW</p> <p>Factory setting: MASS FLOW</p> <p> Note!</p> <ul style="list-style-type: none"> ■ This function cannot be changed if: <ul style="list-style-type: none"> - The measuring device has been configured in accordance with NTEP or MC approval. - The measuring device has been configured in accordance with PTB, NMI, METAS or BEV approval and YES has been selected for function Z001 in the CUSTODY TRANSFER block. ■ This function is not available unless the PULSE setting was selected in the OPERATION MODE function (4200). ■ If you select OFF, the only function shown in the function group is this function, in other words ASSIGN PULSE (4221).
<p>PULSE VALUE 4222</p> <p></p> <p>Modbus register: 3224 Data type: Float Access: read/ write</p>		<p>Use this function to define the flow at which a pulse is triggered. These pulses can be totaled by an external totalizer, and the total flow quantity since measuring started can be registered in this way.</p> <p>User input: 5-digit floating-point number [unit]</p> <p>Factory setting: Depends on nominal diameter</p> <p> Note!</p> <ul style="list-style-type: none"> ■ This function cannot be changed if: <ul style="list-style-type: none"> - The measuring device has been configured in accordance with NTEP or MC approval. - The measuring device has been configured in accordance with PTB, NMI, METAS or BEV approval and YES has been selected for function Z001 in the CUSTODY TRANSFER block. ■ This function is not available unless the PULSE setting was selected in the OPERATION MODE function (4200). ■ The appropriate unit is taken from the UNIT MASS FLOW (0400), UNIT VOLUME FLOW (0402) or UNIT CORRECTED VOLUME FLOW (0404) function (→  16 to →  20).



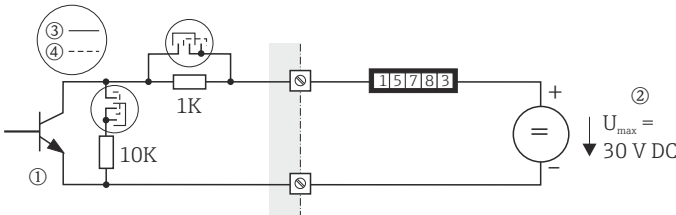

Function description	
OUTPUTS → PULSE/FREQUENCY OUTPUT → CONFIGURATION (PULSE)	
<p>PULSE WIDTH 4223</p> <p> Note!</p> <p>Modbus register: 3226</p> <p>Data type: Float</p> <p>Access: read/ write</p>	<p> Note!</p> <p>This function is not available unless the PULSE setting was selected in the OPERATION MODE function (4200).</p> <p>Use this function to enter the pulse width of the output pulse.</p> <p>User input: 0.05 to 2000 ms</p> <p>Factory setting: 100 ms</p> <p>Pulse output is always with the pulse width (B) entered in this function. The pauses (P) between the individual pulses are automatically configured. However, they must at least correspond to the pulse width (B = P).</p> <div style="text-align: center;">  </div> <p style="text-align: right; font-size: small;">A0001233-EN</p> <p><i>Fig. 21: Pulse width</i></p> <p><i>B = Pulse width entered (the illustration applies to positive pulses)</i> <i>P = Pauses between the individual pulses</i></p> <p> Note!</p> <ul style="list-style-type: none"> ■ This function cannot be changed if: <ul style="list-style-type: none"> - The measuring device has been configured in accordance with NTEP or MC approval. - The measuring device has been configured in accordance with PTB, NMi, METAS or BEV approval and YES has been selected for function Z001 in the CUSTODY TRANSFER block. ■ This function is not available unless the PULSE setting was selected in the function OPERATION MODE function (4200). ■ When entering the pulse width, select a value that can still be processed by an external totalizer (e.g. mechanical totalizer, PLC etc.). <p> Caution!</p> <p>If the pulse number or frequency resulting from the pulse value entered (→ function PULSE VALUE (4222) on →  76) and from the current flow is too large to maintain the pulse width selected (the time interval is smaller than the pulse width B entered), a system error message is generated (#359 to 362, pulse buffer) after approx. 5 seconds buffer/balance time.</p>





Function description	
OUTPUTS → PULSE/FREQUENCY OUTPUT → CONFIGURATION (PULSE)	
<p>MEASURING MODE 4225</p> <p></p> <p>Modbus register: 3228 Data type: Integer Access: read/write</p>	<p>Use this function to define the measuring mode for the pulse output.</p> <p>Options:</p> <p>0 = STANDARD Only positive flow components are totaled. Negative components are not taken into account.</p> <p>1 = SYMMETRY Positive and negative flow components are taken into account.</p> <p> Note! The direction of flow can be output via the relay output.</p> <p>2 = PULSATING FLOW If flow is characterized by severe fluctuations as is the case, for example, with reciprocating pumps, the positive and negative flow components are totaled, with the signs taken into account (e.g. -10 l and +25 l = 15 l).</p> <p>Flow components outside the maximum pulse number per second (value/width) are buffered, balanced and output after a maximum delay of 60 seconds. If the buffered data cannot be processed within approx. 60 seconds, a fault/notice message appears.</p> <p>Under certain plant conditions, flow values can aggregate in the buffer, for example in the case of prolonged and unwanted fluid backflow. However, this buffer is reset in all relevant programming adjustments which affect the pulse output.</p> <p>3 = STANDARD REVERSE Only negative flow components are totaled. Positive components are not taken into account.</p> <p>Factory setting: STANDARD</p> <p> Note!</p> <ul style="list-style-type: none"> ■ This function cannot be changed if: <ul style="list-style-type: none"> - The measuring device has been configured in accordance with NTEP or MC approval. - The measuring device has been configured in accordance with PTB, NMI, METAS or BEV approval and YES has been selected for function Z001 in the CUSTODY TRANSFER block. ■ This function is not available unless the PULSE setting was selected in the OPERATION MODE function (4200).





Function description	
OUTPUTS → PULSE/FREQUENCY OUTPUT → CONFIGURATION (PULSE)	
<p>OUTPUT SIGNAL 4226</p> <p>☒</p> <p>Modbus register: 3229 Data type: Integer Access: read/ write</p>	<p>For selecting the output configuration of the pulse output.</p> <p>Options: 0 = PASSIVE - POSITIVE 1 = PASSIVE - NEGATIVE 2 = ACTIVE - POSITIVE (this selection is not supported) 3 = ACTIVE - NEGATIVE (this selection is not supported)</p> <p>Factory setting: PASSIVE - POSITIVE</p> <p>Explanation PASSIVE = power is supplied to the pulse output by means of an external power supply.</p> <p>Configuring the output signal level (POSITIVE or NEGATIVE) determines the quiescent behavior (at zero flow) of the pulse output. The internal transistor is activated as follows:</p> <ul style="list-style-type: none"> ▪ If POSITIVE is selected, the internal transistor is activated with a positive signal level. ▪ If NEGATIVE is selected, the internal transistor is activated with a negative signal level (0 V). <p>Note!</p> <ul style="list-style-type: none"> ▪ This function cannot be changed if: <ul style="list-style-type: none"> – The measuring device has been configured in accordance with NTEP or MC approval. – The measuring device has been configured in accordance with PTB, NMi, METAS or BEV approval and YES has been selected for function Z001 in the CUSTODY TRANSFER block. ▪ This function is not available unless the PULSE setting was selected in the OPERATION MODE function (4200). ▪ With the passive output configuration, the output signal levels of the pulse output depend on the external circuit (→ examples). <p>Example for passive output circuit (PASSIVE) If PASSIVE is selected, the pulse output is configured as an open collector.</p>  <p style="text-align: right; font-size: small;">A0002147</p> <p>① = Open collector ② = External power supply ③ = Line monitoring off ④ = Line monitoring on (default)</p> <p>Note! For continuous currents up to 25 mA ($I_{max} = 250 \text{ mA} / 20 \text{ ms}$).</p> <p>(continued on next page)</p>

Function description	
OUTPUTS → PULSE/FREQUENCY OUTPUT → CONFIGURATION (PULSE)	
<p>OUTPUT SIGNAL 4226 (continued)</p>	<p>Example for output configuration PASSIVE-POSITIVE: Output configuration with an external pull-up resistance. In the quiescent state (at zero flow), the output signal level at the terminals is 0 V.</p> <p style="text-align: right;">A0004687</p> <p>① = Open collector ② = Pull-Up-Resistance ③ = Transistor activation in POSITIVE quiescent state (at zero flow) ④ = Output signal level in quiescent state (at zero flow)</p> <p>In the operating status (flow present), the output signal level changes from 0 V to a positive voltage level.</p> <p style="text-align: right;">A0001975</p> <p>Example for output configuration PASSIVE-POSITIVE: Output configuration with an external pull-down resistance. In the quiescent state (at zero flow), a positive voltage level is measured via the pull-down resistance.</p> <p style="text-align: right;">A0004689</p> <p>① = Open collector ② = Pull-Down-Resistance ③ = Transistor activation in POSITIVE quiescent state (at zero flow) ④ = Output signal level in quiescent state (at zero flow)</p> <p>In the operating status (flow present), the output signal level changes from a positive voltage level to 0 V.</p> <p style="text-align: right;">A0001981</p> <p>(continued on next page)</p>



Function description	
OUTPUTS → PULSE/FREQUENCY OUTPUT → CONFIGURATION (PULSE)	
<p>OUTPUT SIGNAL 4226 (continued)</p>	<p>Example for output configuration PASSIVE-NEGATIVE: Output configuration with an external pull-up resistance. In the quiescent state (at zero flow), the output signal level at the terminals is at a positive voltage level.</p> <div style="text-align: center;"> </div> <p>① = Open collector ② = Pull-Up-Resistance ③ = Transistor activation in <i>NEGATIVE</i> quiescent state (at zero flow) ④ = Output signal level in quiescent state (at zero flow)</p> <p>In the operating status (flow present), the output signal level changes from a positive voltage level to 0 V.</p> <div style="text-align: center;"> </div>
<p>FAILSAFE MODE 4227 </p> <p>Modbus register: 3230 Data type: Integer Access: read/ write</p>	<p>For safety reasons it is advisable to ensure that the pulse output assumes a predefined state in the event of a fault. The setting you select here affects only the pulse output. It has no effect on other outputs and the display (e.g. totalizers).</p> <p>Options: 0 = FALLBACK VALUE Output is 0 pulse.</p> <p>3 = ACTUAL VALUE Measured value output is based on the current flow measurement. The fault is ignored.</p> <p>4 = MAX. PULSE RATE Outputs the maximum pulse rate $f = 1/(2 \times T)$</p> <p>Factory setting: FALLBACK VALUE</p> <p> Note!</p> <ul style="list-style-type: none"> ■ This function cannot be changed if: <ul style="list-style-type: none"> – The measuring device has been configured in accordance with NTEP or MC approval. – The measuring device has been configured in accordance with PTB, NMi, METAS or BEV approval and YES has been selected for function Z001 in the CUSTODY TRANSFER block. ■ This function is not available unless the PULSE setting was selected in the OPERATION MODE function (4200).

Function description		
OUTPUTS → PULSE/FREQUENCY OUTPUT → CONFIGURATION (STATUS)		
ASSIGN STATUS	4241	<p>Use this function to assign a switching function to the status output.</p> <p> Options: 0 = OFF 1 = ON (operation) 2 = FAULT MESSAGE 3 = NOTICE MESSAGE 4 = FAULT MESSAGE or NOTICE MESSAGE 5 = EMPTY PIPE DETECTION (only with active function) 6 = FLOW DIRECTION 7 = MASS FLOW LIMIT VALUE 8 = VOLUME FLOW LIMIT VALUE 14 = CORRECTED VOLUME FLOW LIMIT VALUE 15 = DENSITY LIMIT VALUE 16 = REFERENCE DENSITY LIMIT VALUE 17 = TEMPERATURE LIMIT VALUE 19 = TOTALIZER 1 LIMIT VALUE 20 = TOTALIZER 2 LIMIT VALUE 21 = TOTALIZER 3 LIMIT VALUE</p> <p>Factory setting: FAULT MESSAGE</p> <p> Note!</p> <ul style="list-style-type: none"> ■ This function cannot be changed if: <ul style="list-style-type: none"> - The measuring device has been configured in accordance with NTEP or MC approval. - The measuring device has been configured in accordance with PTB, NMI, METAS or BEV approval and YES has been selected for function Z001 in the CUSTODY TRANSFER block. ■ This function is available only if the STATUS setting was selected in the OPERATION MODE (4200) function. ■ The behavior of the status output is a normally closed behavior, in other words the output is closed (transistor conductive) when normal, error-free measuring is in progress. <ul style="list-style-type: none"> - "Normal, error-free" operation: Flow direction = forwards; limit values = not exceeded; no fault or notice message present. - Switching response like relay output, →  100 ■ If you select OFF, the only function shown in the CONFIGURATION function group is this function, in other words ASSIGN STATUS (4241). ■ Switching response like relay output →  100.
Modbus register:	3236	
Data type:	Integer	
Access:	read/ write	

Function description		
OUTPUTS → PULSE/FREQUENCY OUTPUT → CONFIGURATION (STATUS)		
<p>ON-VALUE 4242</p> <p></p> <p>Modbus register: 3237 Data type: Float Access: read/ write</p>		<p>Use this function to assign a value to the switch-on point (activation of the status output). The value can be higher or lower than the switch-off point. Positive or negative values are permissible, depending on the measured variable in question (e.g. mass flow, totalizer reading).</p> <p>User input: 5-digit floating-point number [unit]</p> <p>Factory setting: 0 [kg/h] or 2 [kg/l] or 200 [°C]</p> <p> Note!</p> <ul style="list-style-type: none"> ■ This function cannot be changed if: <ul style="list-style-type: none"> – The measuring device has been configured in accordance with NTEP or MC approval. – The measuring device has been configured in accordance with PTB, NMI, METAS or BEV approval and YES has been selected for function Z001 in the CUSTODY TRANSFER block. ■ This function is not available unless STATUS was selected in the OPERATION MODE function (4200) and LIMIT VALUE or FLOW DIRECTION was selected in the ASSIGN STATUS function (4241). ■ If SYMMETRY is selected in the function MEASURING MODE (4246) and values with different signs are entered for the switch-on and switch-off points, the notice message "INPUT RANGE EXCEEDED" appears. ■ Only the switch-on point is available for flow direction output (no switch-off point). If you enter a value not equal to the zero flow (e.g. 5), the difference between the zero flow and the value entered corresponds to half the switchover hysteresis.
<p>SWITCH-ON DELAY 4243</p> <p></p> <p>Modbus register: 3239 Data type: Float Access: read/ write</p>		<p>Use this function to define a delay (0 to 100 seconds) for the switch-on (i.e. signal changes from "not conductive" to "conductive") of the status output. The delay starts when the limit value is reached. The status output does switch when the delay has timed out and the switch on condition has been valid over the delay time.</p> <p>User input: fixed-point number: 0.0 to 100.0 s</p> <p>Factory setting: 0.0 s</p> <p> Note!</p> <ul style="list-style-type: none"> ■ This function cannot be changed if: <ul style="list-style-type: none"> – The measuring device has been configured in accordance with NTEP or MC approval. – The measuring device has been configured in accordance with PTB, NMI, METAS or BEV approval and YES has been selected for function Z001 in the CUSTODY TRANSFER block. ■ This function is not available unless STATUS was selected in the OPERATION MODE function (4200) and LIMIT VALUE or FLOW DIRECTION was selected in the ASSIGN STATUS function (4241).





Function description		
OUTPUTS → PULSE/FREQUENCY OUTPUT → CONFIGURATION (STATUS)		
<p>OFF-VALUE 4244</p> <p></p> <p>Modbus register: 3241 Data type: Float Access: read/ write</p>		<p>Use this function to assign a value to the switch-off point (deactivation of the status output). The value can be higher or lower than the switch-on point. Positive and negative values are permissible, depending on the measured variable in question (e.g. mass flow, totalizer reading).</p> <p>User input: 5-digit floating-point number [unit]</p> <p>Factory setting: 0 [kg/h] or 2 [kg/l] or 200 [°C]</p> <p> Note!</p> <ul style="list-style-type: none"> ■ This function cannot be changed if: <ul style="list-style-type: none"> - The measuring device has been configured in accordance with NTEP or MC approval. - The measuring device has been configured in accordance with PTB, NMI, METAS or BEV approval and YES has been selected for function Z001 in the CUSTODY TRANSFER block. ■ This function is not available unless STATUS was selected in the OPERATION MODE function (4200) and LIMIT VALUE was selected in the ASSIGN STATUS function (4241). ■ The appropriate unit is taken from the function UNIT VOLUME FLOW (0402) or UNIT MASS FLOW (0400). ■ If SYMMETRY is selected in the function MEASURING MODE (4246) and values with different signs are entered for the switch-on and switch-off points, the notice message "INPUT RANGE EXCEEDED" appears.
<p>SWITCH-OFF DELAY 4245</p> <p></p> <p>Modbus register: 3243 Data type: Float Access: read/ write</p>		<p>Use this function to define a delay (0 to 100 seconds) for the switch-off (i.e. signal changes from "conductive" to "not conductive") of the status output. The delay starts when the limit value is reached. The status output does switch when the delay has timed out and the switch off condition has been valid over the delay time.</p> <p>User input: fixed-point number: 0.0 to 100.0 s</p> <p>Factory setting: 0.0 s</p> <p> Note!</p> <ul style="list-style-type: none"> ■ This function cannot be changed if: <ul style="list-style-type: none"> - The measuring device has been configured in accordance with NTEP or MC approval. - The measuring device has been configured in accordance with PTB, NMI, METAS or BEV approval and YES has been selected for function Z001 in the CUSTODY TRANSFER block. ■ This function is not available unless the STATUS setting was selected in the OPERATION MODE function (4200).

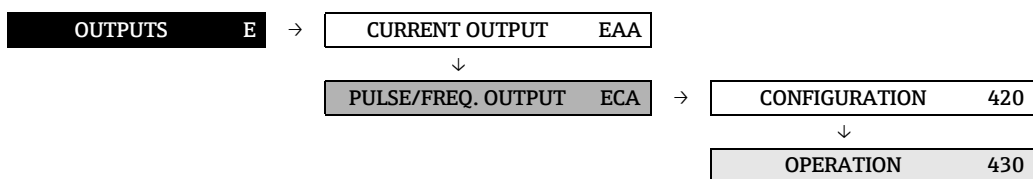

Function description	
OUTPUTS → PULSE/FREQUENCY OUTPUT → CONFIGURATION (STATUS)	
<p>MEASURING MODE 4246</p> <p>☒</p> <p>Modbus register: 3245 Data type: Integer Access: read/write</p>	<p>Use this function to define the measuring mode for the status output.</p> <p>Options: 0 = STANDARD The status output signal switches at the defined switch points.</p> <p>1 = SYMMETRY The status output signal switches at the defined switch points, irrespective of the sign. If you define a switch point with a positive sign, the status output signal switches as soon as the value is reached in the negative direction (negative sign), (→ illustration).</p> <p>Factory setting: STANDARD</p> <div style="text-align: center;"> </div> <p style="text-align: right; font-size: small;">A0001247</p> <p><i>Fig. 22: Example for the SYMMETRY measuring mode</i></p> <p>Switch-on point $Q = 4$ Switch-off point $Q = 10$ ① = Status output switched on (conductive) ② = Status output switched off (nonconductive)</p> <p>Note!</p> <ul style="list-style-type: none"> ■ This function cannot be changed if: <ul style="list-style-type: none"> - The measuring device has been configured in accordance with NTEP or MC approval. - The measuring device has been configured in accordance with PTB, NMI, METAS or BEV approval and YES has been selected for function Z001 in the CUSTODY TRANSFER block. ■ This function is not available unless STATUS was selected in the OPERATION MODE function (4200) and the status output was assigned a limit value. ■ SYMMETRY cannot be selected unless the values in the ON-VALUE (4242) and OFF-VALUE (4244) functions have the same sign or one of the values is zero. ■ If the values have different signs, SYMMETRY cannot be selected and an "ASSIGNMENT NOT POSSIBLE" message is displayed.





Function description	
OUTPUTS → PULSE/FREQUENCY OUTPUT → CONFIGURATION (STATUS)	
<p>TIME CONSTANT 4247</p> <p></p> <p>Modbus register: 3246 Data type: Float Access: read/ write</p>	<p>Entering a time constant defines how the measuring signal reacts to severely fluctuating measured variables, either very quickly (enter a low time constant) or with damping (enter a high time constant). Damping acts on the measuring signal before the switch status changes, and consequently before switch-on or switch-off delay is activated. The purpose of damping, therefore, is to prevent the status output changing state continuously in response to fluctuations in flow.</p> <p>User input: fixed-point number 0.00 to 100.00 s</p> <p>Factory setting: 0.00 s</p> <p> Note!</p> <ul style="list-style-type: none"> ■ This function cannot be changed if: <ul style="list-style-type: none"> – The measuring device has been configured in accordance with NTEP or MC approval. – The measuring device has been configured in accordance with PTB, NMI, METAS or BEV approval and YES has been selected for function Z001 in the CUSTODY TRANSFER block. ■ This function is not available unless the STATUS setting was selected in the OPERATION MODE function (4200).





8.2.2 Function group OPERATION









Function description		
OUTPUTS → PULSE/FREQUENCY OUTPUT → OPERATION (FREQUENCY)		
ACTUAL FREQUENCY Modbus register: 3218 Data type: Float Access: read	4301	Use this function to view the computed actual value of the output frequency. Display: 0 to 12500 Hz  Note! This function is not available unless the FREQUENCY setting was selected in the OPERATION MODE function (4200).
SIMULATION FREQUENCY  Modbus register: 3220 Data type: Integer Access: read/write	4302	Activates simulation of the frequency output. Options: 0 = OFF 1 = ON Factory setting: OFF  Note! <ul style="list-style-type: none"> ▪ This function cannot be changed if: <ul style="list-style-type: none"> – The measuring device has been configured in accordance with NTEP or MC approval. – The measuring device has been configured in accordance with PTB, NMi, METAS or BEV approval and YES has been selected for function Z001 in the CUSTODY TRANSFER block. ▪ This function is not available unless the FREQUENCY setting was selected in the OPERATION MODE function (4200). ▪ The "SIMULATION FREQUENCY OUTPUT" message indicates that simulation is active. ▪ The measuring device continues to measure while simulation is in progress, i.e. the current measured values are output correctly via the other outputs.  Caution! The setting is not saved in the event of a power failure.

Function description		
OUTPUTS → PULSE/FREQUENCY OUTPUT → OPERATION (FREQUENCY)		
VALUE SIMULATION FREQUENCY  Modbus register: Data type: 3221 Access: Float read/write	4303	<p>Define a selectable frequency value (e.g. 500 Hz) which should be output at the frequency output (with maximum pulse frequency or shortened minimum pulse width). This value is used to test downstream devices and the measuring device itself.</p> <p>User input: 0 to 12500 Hz</p> <p>Factory setting: 0 Hz</p> <p> Note!</p> <ul style="list-style-type: none"> ■ This function cannot be changed if: <ul style="list-style-type: none"> - The measuring device has been configured in accordance with NTEP or MC approval. - The measuring device has been configured in accordance with PTB, NMI, METAS or BEV approval and YES has been selected for function Z001 in the CUSTODY TRANSFER block. ■ This function is not available unless FREQUENCY was selected in the OPERATION MODE function (4200) and the SIMULATION FREQUENCY function (4302) is active (= ON). <p> Caution! The setting is not saved in the event of a power failure.</p>

Function description		
OUTPUTS → PULSE/FREQUENCY OUTPUT → OPERATION (PULSE)		
<p>SIMULATION PULSE</p> <p> <input type="checkbox"/></p> <p>Modbus register: 4322 Data type: Integer Access: read/write</p>	<p>4322</p>	<p>Activates simulation of the pulse output.</p> <p>Options: 0 = OFF 1 = COUNTDOWN 2 = CONTINUOUSLY</p> <p>The pulses specified in the VALUE SIMULATION PULSE function are output. Pulses are continuously output with the pulse width specified in the PULSE WIDTH function. Simulation is started once the CONTINUOUSLY option is confirmed with the <input type="checkbox"/> key.</p> <p> Note! Simulation is started by confirming the CONTINUOUSLY option with the <input type="checkbox"/> key. The simulation can be switched off again via the SIMULATION PULSE function.</p> <p>Factory setting: OFF</p> <p> Note!</p> <ul style="list-style-type: none"> ■ This function cannot be changed if: <ul style="list-style-type: none"> – The measuring device has been configured in accordance with NTEP or MC approval. – The measuring device has been configured in accordance with PTB, NMI, METAS or BEV approval and YES has been selected for function Z001 in the CUSTODY TRANSFER block. ■ This function is available only if the PULSE setting was selected in the OPERATION MODE (4200) function. ■ The notice message #631 "SIM. PULSE" indicates that simulation is active. ■ The on/off ratio is 1:1 for both types of simulation. ■ The measuring device continues to measure while simulation is in progress, i.e. the current measured values are output correctly via the other outputs. <p> Caution! The setting is not saved in the event of a power failure.</p>

Function description	
OUTPUTS → PULSE/FREQUENCY OUTPUT → OPERATION (PULSE)	
<p>VALUE SIMULATION PULSE </p> <p>Modbus register: 4323</p> <p>Data type: 3234</p> <p>Access: Float read/write</p>	<p>Specify the number of pulses (e.g. 50) to be output during the simulation. This value is used to test downstream devices and the measuring device itself. The pulses are output with the pulse width specified in the PULSE WIDTH function. The on/off ratio is 1:1.</p> <p>Simulation is started once the specified value is confirmed with the  key. The display remains at 0 if the specified pulses have been output.</p> <p>User input: 0 to 10 000</p> <p>Factory setting: 0</p> <p> Note!</p> <ul style="list-style-type: none"> ■ This function cannot be changed if: <ul style="list-style-type: none"> – The measuring device has been configured in accordance with NTEP or MC approval. – The measuring device has been configured in accordance with PTB, NMI, METAS or BEV approval and YES has been selected for function Z001 in the CUSTODY TRANSFER block. ■ This function is not available unless the COUNTDOWN setting was selected in the function SIMULATION PULSE. ■ Simulation is started by confirming the simulation value with the  key. The simulation can be switched off again via the SIMULATION PULSE function. <p> Caution! The setting is not saved in the event of a power failure.</p>

Function description		
OUTPUTS → PULSE/FREQUENCY OUTPUT → OPERATION (STATUS)		
<p>ACTUAL STATUS 4341</p> <p>Modbus register: 3248 Data type: Integer Access: read</p>		<p>Use this function to check the current status of the status output.</p> <p>Display: 0 = NOT CONDUCTIVE 1 = CONDUCTIVE</p> <p> Note! This function is not available unless the STATUS setting was selected in the OPERATION MODE function (4200).</p>
<p>SIMULATION SWITCH POINT</p> <p></p> <p>Modbus register: 3249 Data type: Integer Access: read/ write</p>		<p>Use this function to activate simulation of the status output.</p> <p>Options: 0 = OFF 1 = ON</p> <p>Factory setting: OFF</p> <p> Note!</p> <ul style="list-style-type: none"> ■ This function cannot be changed if: <ul style="list-style-type: none"> – The measuring device has been configured in accordance with NTEP or MC approval. – The measuring device has been configured in accordance with PTB, NMi, METAS or BEV approval and YES has been selected for function Z001 in the CUSTODY TRANSFER block. ■ This function is available only if the STATUS setting was selected in the OPERATION MODE (4200) function. ■ The "SIMULATION STATUS OUTPUT" message indicates that simulation is active. ■ The measuring device continues to measure while simulation is in progress, i.e. the current measured values are output correctly via the other outputs. <p> Caution! The setting is not saved in the event of a power failure.</p>
<p>VALUE SIMULATION SWITCH POINT</p> <p></p> <p>Modbus register: 3250 Data type: Integer Access: read/ write</p>		<p>Use this function to define the switching response of the status output during the simulation. This value is used to test downstream devices and the measuring device itself.</p> <p>Options: 0 = NOT CONDUCTIVE 1 = CONDUCTIVE</p> <p>Factory setting: NOT CONDUCTIVE</p> <p> Note!</p> <ul style="list-style-type: none"> ■ This function cannot be changed if: <ul style="list-style-type: none"> – The measuring device has been configured in accordance with NTEP or MC approval. – The measuring device has been configured in accordance with PTB, NMi, METAS or BEV approval and YES has been selected for function Z001 in the CUSTODY TRANSFER block. ■ This function is not available unless STATUS was selected in the OPERATION MODE function (4200) and the SIMULATION SWITCH POINT function (4342) is active (= ON). <p> Caution! The setting is not saved in the event of a power failure.</p>

8.2.3 Function group INFORMATION

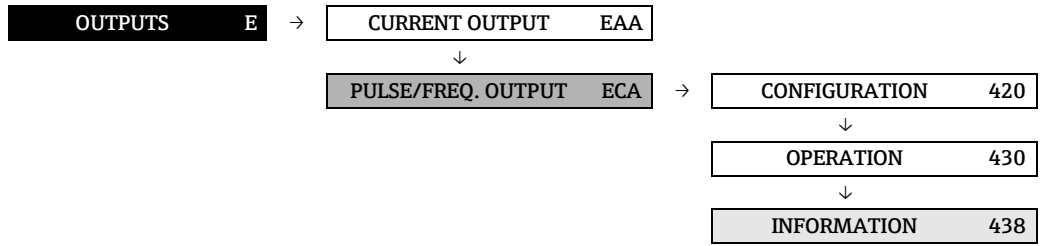







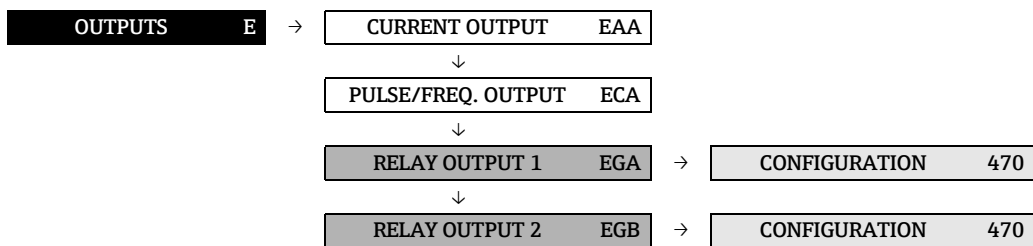



Function description		
OUTPUTS → PULSE/FREQUENCY OUTPUT → INFORMATION		
TERMINAL NUMBER	4380	Use this function to view the numbers of the terminals (in the connection compartment) and the polarity used by the pulse/frequency output. Display: 2 = 22 (+) / 23 (-)
Modbus register:	3251	
Data type:	Integer	
Access:	read	







8.3 Group RELAY OUTPUT (1 to 2)

8.3.1 Function group CONFIGURATION



Function description		
OUTPUTS → RELAY OUTPUT (1 to 2) → CONFIGURATION		
ASSIGN RELAY	4700	Use this function to assign a switching function to the relay output.
		Options: (standard) 0 = OFF 1 = ON (operation) 2 = FAULT MESSAGE 3 = NOTICE MESSAGE 4 = FAULT MESSAGE or NOTICE MESSAGE 5 = EPD (empty pipe detection, only if active) 6 = FLOW DIRECTION 7 = MASS FLOW LIMIT VALUE 8 = VOLUME FLOW LIMIT VALUE 14 = CORRECTED VOLUME FLOW LIMIT VALUE 15 = DENSITY LIMIT VALUE 16 = REFERENCE DENSITY LIMIT VALUE 17 = TEMPERATURE LIMIT VALUE 19 = TOTALIZER 1 LIMIT VALUE 20 = TOTALIZER 2 LIMIT VALUE 21 = TOTALIZER 3 LIMIT VALUE
Modbus register:	3801	
Relay output 1	4001	
Relay output 2	Integer	
Data type:	read/ write	
Access:		
		Factory setting: FAULT MESSAGE
		 Note!
		<ul style="list-style-type: none"> It is very important to read and comply with the information on the switching characteristics of the relay output (→  100). It is advisable to configure at least one relay output as a fault output and define the outputs' failsafe mode. The relay output is configured as a normally open (NO or make) contact by default. It can be reconfigured as a normally closed (NC or break) contact by means of a jumper on the relay module → Operating Instructions BA.140D/06. If you select OFF or ON, the only function shown in the function group is the function ASSIGN RELAY (4700).

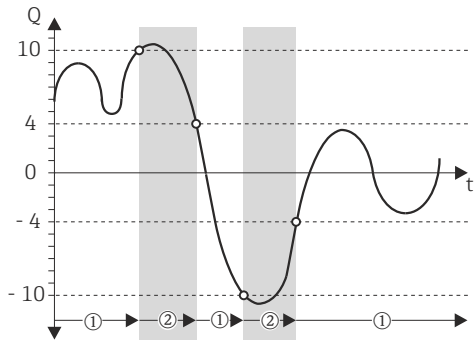



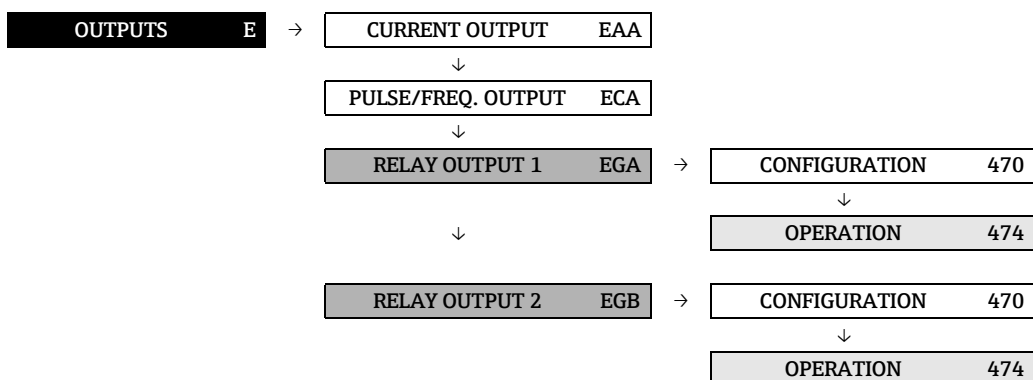

Function description	
OUTPUTS → RELAY OUTPUT (1 to 2) → CONFIGURATION	
<p>ON-VALUE 4701</p> <p></p> <p>Modbus register: 3802 Relay output 1 4002 Relay output 2 Float Data type: read/ Access: write</p>	<p> Note! This function is not available unless LIMIT VALUE or FLOW DIRECTION was selected in the ASSIGN RELAY function (4700).</p> <p>Use this function to assign a value to the switch-on point (relay output pulls up). The value can be higher or lower than the switch-off point. Positive or negative values are permissible, depending on the measured variable in question (e.g. mass flow, totalizer reading).</p> <p>User input: 5-digit floating-point number [unit]</p> <p>Factory setting: 0 [kg/h] or 2 [kg/l] or 200 [°C]</p> <p> Note!</p> <ul style="list-style-type: none"> ▪ The appropriate unit is taken from the function UNIT VOLUME FLOW (0402) or UNIT MASS FLOW (0400). ▪ Only the switch-on point is available for flow direction output (no switch-off point). If you enter a value not equal to the zero flow (e.g. 5), the difference between the zero flow and the value entered corresponds to half the switchover hysteresis.
<p>SWITCH-ON DELAY 4702</p> <p></p> <p>Modbus register: 3804 Relay output 1 4004 Relay output 2 Float Data type: read/ Access: write</p>	<p> Note! This function is not available unless LIMIT VALUE or FLOW DIRECTION was selected in the ASSIGN RELAY function (4700).</p> <p>Use this function to define a delay (0 to 100 seconds) for pull-up (i.e. signal changes from 0 to 1) of the relay output. The delay starts when the limit value is reached. The relay output does switch when the delay has timed out and the switch on condition has been valid over the delay time.</p> <p>User input: fixed-point number 0.0 to 100.0 s</p> <p>Factory setting: 0.0 s</p>
<p>OFF-VALUE 4703</p> <p></p> <p>Modbus register: 3806 Relay output 1 4006 Relay output 2 Float Data type: read/ Access: write</p>	<p> Note! This function is not available unless LIMIT VALUE was selected in the ASSIGN RELAY function (4700).</p> <p>Use this function to assign a value to the switch-off point (relay drops out). The value can be higher or lower than the switch-on point. Positive or negative values are permissible, depending on the measured variable in question (e.g. mass flow, totalizer reading).</p> <p>User input: 5-digit floating-point number [unit]</p> <p>Factory setting: 0 [kg/h] or 2 [kg/l] or 200 [°C]</p> <p> Note!</p> <ul style="list-style-type: none"> ▪ The appropriate unit is taken from the function UNIT VOLUME FLOW (0402) or UNIT MASS FLOW (0400). ▪ If SYMMETRY is selected in the function MEASURING MODE (4705) and values with different signs are entered for the switch-on and switch-off points, the notice message "INPUT RANGE EXCEEDED" appears.

Function description		
OUTPUTS → RELAY OUTPUT (1 to 2) → CONFIGURATION		
<p>SWITCH-OFF DELAY 4704</p> <p></p> <p>Modbus register: Relay output 1 3808 Relay output 2 4008 Data type: Float Access: read/ write</p>		<p> Note! This function is not available unless LIMIT VALUE was selected in the ASSIGN RELAY function (4700).</p> <p>Use this function to define a delay (0 to 100 seconds) for dropout (i.e. signal changes from 1 to 0) of the relay output. The delay starts when the limit value is reached. The relay output does switch when the delay has timed out and the switch off condition has been valid over the delay time.</p> <p>User input: fixed-point number 0.0 to 100.0 s</p> <p>Factory setting: 0.0 s</p>
<p>MEASURING MODE 4705</p> <p></p> <p>Modbus register: Relay output 1 3810 Relay output 2 4010 Data type: Integer Access: read/ write</p>		<p> Note! This function is not available unless LIMIT VALUE was selected in the ASSIGN RELAY function (4700).</p> <p>Use this function to define the measuring mode for the relay output.</p> <p>Options: 0 = STANDARD The relay output signal switches at the defined switch points.</p> <p>1 = SYMMETRY The relay output signal switches at the defined switch points, irrespective of the sign. If you define a switch point with a positive sign, the relay output switches as soon as the value is reached in the negative direction (negative sign), (→ illustration).</p> <p>Factory setting: STANDARD</p> <div style="text-align: center;">  </div> <p style="text-align: right; font-size: small;">A0001247</p> <p><i>Fig. 23: Example for the SYMMETRY measuring mode</i></p> <p>Switch-on point $Q = 4$ Switch-off point $Q = 10$ ① = Relay energized ② = Relay de-energized</p> <p> Note!</p> <ul style="list-style-type: none"> ■ SYMMETRY cannot be selected unless the values in the ON-VALUE (4701) and OFF-VALUE (4703) functions have the same sign or one of the values is zero. ■ If the values have different signs, SYMMETRY cannot be selected and an "ASSIGNMENT NOT POSSIBLE" message is displayed.

Function description	
OUTPUTS → RELAY OUTPUT (1 to 2) → CONFIGURATION	
<p>TIME CONSTANT 4706</p> <p></p> <p>Modbus register: Relay output 1 3811 Relay output 2 4011 Data type: Float Access: read/ write</p>	<p>Entering a time constant defines how the measuring signal reacts to severely fluctuating measured variables, either very quickly (enter a low time constant) or with damping (enter a high time constant). Damping acts on the measuring signal before the switch status changes, and consequently before switch-on or switch-off delay is activated. The purpose of damping, therefore, is to prevent the relay output changing state continuously in response to fluctuations in flow.</p> <p>User input: fixed-point number: 0.00 to 100.00 s</p> <p>Factory setting: 0.00 s</p>

8.3.2 Function group OPERATION



Function description		
OUTPUTS → RELAY OUTPUT (1 to 2) → OPERATION		
ACTUAL STATUS RELAY 4740 Modbus register: Relay output 1 3813 Relay output 2 4013 Data type: Integer Access: read		Use this function to check the current status of the relay output. A jumper on the contact side defines the relay output as a normally open (NO or maker) or normally closed (NC or breaker) contact → Operating Instructions (BA00140D/06). Display: 0 = BREAK CONTACT OPEN 1 = BREAK CONTACT CLOSED 2 = MAKE CONTACT OPEN 3 = MAKE CONTACT CLOSED
SIMULATION SWITCH POINT 4741  Modbus register: Relay output 1 3814 Relay output 2 4014 Data type: Integer Access: read/write		Use this function to activate simulation of the relay output. Options: 0 = OFF 1 = ON Factory setting: OFF  Note! <ul style="list-style-type: none"> The "SIMULATION RELAY" message indicates that simulation is active. The measuring device continues to measure while simulation is in progress, i.e. the current measured values are output correctly via the other outputs.  Caution! The setting is not saved in the event of a power failure.
VALUE SIMULATION SWITCH POINT 4742  Modbus register: Relay output 1 3815 Relay output 2 4015 Data type: Integer Access: read/write		 Note! The function is not visible unless the function SIMULATION SWITCH POINT (4741) is active. Use this function to define the status of the relay output during the simulation. This value is used to test downstream devices and the measuring device itself. Depending on the relay configuration (as make or break contact) the following selections are available. Options: Relay output configured as NC (breaker) contact 0 = BREAK CONTACT OPEN 1 = BREAK CONTACT CLOSED Options: Relay output configured as NO (maker) contact 2 = MAKE CONTACT OPEN 3 = MAKE CONTACT CLOSED  Caution! The setting is not saved in the event of a power failure.

8.3.3 Function group INFORMATION

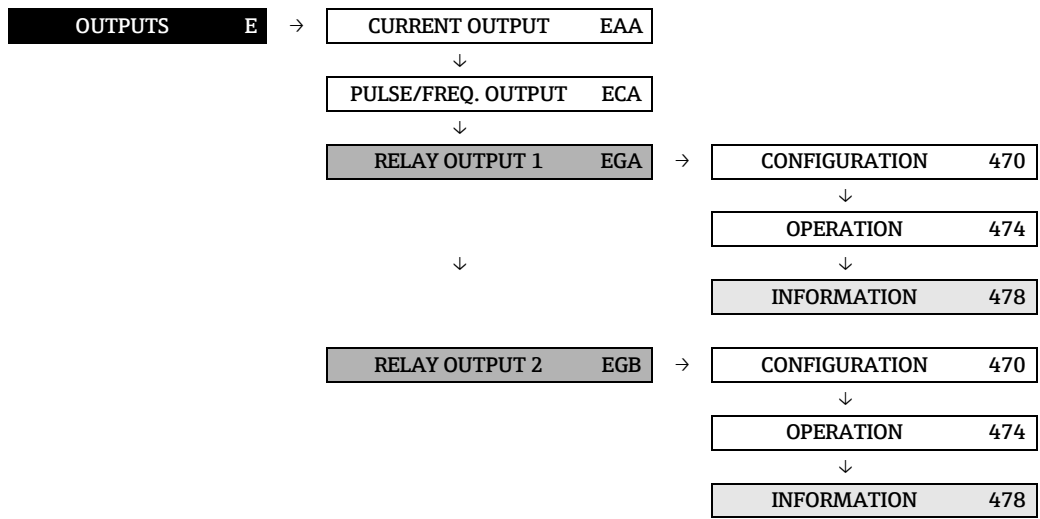

Function description													
OUTPUTS → RELAY OUTPUT (1 to 2) → INFORMATION													
<table border="0"> <tr> <td>TERMINAL NUMBER</td> <td>4780</td> </tr> <tr> <td>Modbus register:</td> <td></td> </tr> <tr> <td>Relay output 1</td> <td>3816</td> </tr> <tr> <td>Relay output 2</td> <td>4016</td> </tr> <tr> <td>Data type:</td> <td>Integer</td> </tr> <tr> <td>Access:</td> <td>read</td> </tr> </table>	TERMINAL NUMBER	4780	Modbus register:		Relay output 1	3816	Relay output 2	4016	Data type:	Integer	Access:	read	<p>Use this function to view the numbers of the terminals (in the connection compartment) and the polarity used by the relay output.</p> <p>Display: 2 = 22 (+) / 23 (-) →RELAY OUTPUT 1 3 = 20 (+) / 21 (-) →RELAY OUTPUT 2</p>
TERMINAL NUMBER	4780												
Modbus register:													
Relay output 1	3816												
Relay output 2	4016												
Data type:	Integer												
Access:	read												

8.3.4 Information on the response of the relay output

General

If you have configured the relay output for "LIMIT VALUE" or "FLOW DIRECTION", you can define the requisite switch points in the ON-VALUE and OFF-VALUE functions. When the measured variable in question reaches one of these predefined values, the relay output switches as shown in the illustrations below.

Relay output configured for "flow direction"

The value you entered in the function ON-VALUE defines the switch point for the positive and negative directions of flow.

If, for example, the switch point you define is $= 1 \text{ m}^3/\text{h}$, the relay drops out at $-1 \text{ m}^3/\text{h}$ and pulls up at $+1 \text{ m}^3/\text{h}$. Set the switch point to 0 if your process calls for direct switchover (no switching hysteresis). If low flow cut off is used, it is advisable to set hysteresis to a value higher than or equal to the low flow cut off rate.

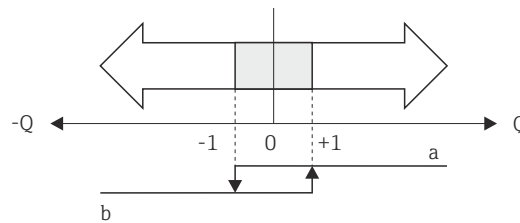

A0001236

Fig. 24: Relay output configured for "flow direction"

- a Relay energized
- b Relay de-energized

Relay output configured for "limit value"

The relay output signal switches as soon as the measured variable undershoots or overshoots a defined switch point.

Application: Monitoring flow or process-related boundary conditions.

Measured variable

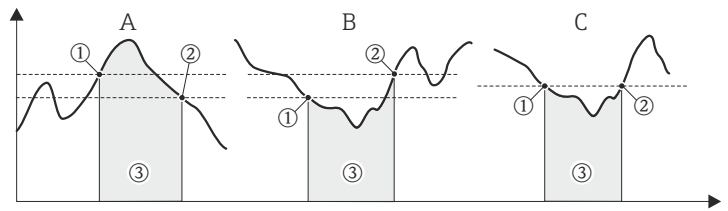











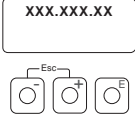

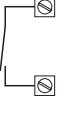
A0001235

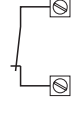

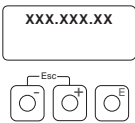
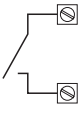

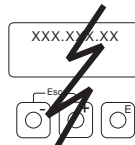
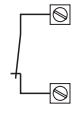
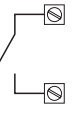
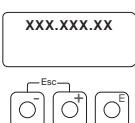
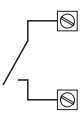
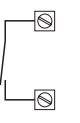

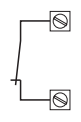
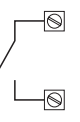
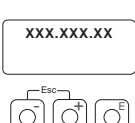
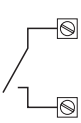
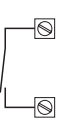

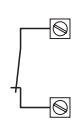
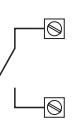



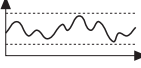

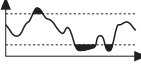



Fig. 25: Relay output configured for "limit value"

- ① = Switch-off point, ② = Switch-on point, ③ = Relay de-energized

- A = Maximum safety (SWITCH-OFF POINT > SWITCH-ON POINT)
- B = Minimum safety (SWITCH-OFF POINT < SWITCH-ON POINT)
- C = Minimum safety (SWITCH-OFF POINT = SWITCH-ON POINT, this configuration is to be avoided)

8.3.5 Switching behavior of the relay output

Function	State	Relay coil	Contact*	
			NC	NO
ON (operation)	System in measuring mode 	energized		
	System not in measuring mode (power supply failed) 	de-energized		
Fault message	System OK 	energized		
	(System or process error) Fault → Failsafe mode, out-puts/inputs and totalizers 	de-energized		
Notice message	System OK 	energized		
	(System or process error) Fault → Continuation of mea-suring 	de-energized		
Fault message or Notice message	System OK 	energized		
	(System or process error) Fault → Response to error or Note → Continuation of mea-suring 	de-energized		

Function	State	Relay coil	Contact*	
			NC	NO
Empty pipe detection (EPD)	Measuring tube full 	energized	 A0001239	 A0001237
	Measuring tube partially filled /empty measuring tube 	de-energized	 A0001240	 A0001238
Flow direction	Forward  A0001241	energized	 A0001239	 A0001237
	Reverse  A0001242	de-energized	 A0001240	 A0001238
Limit value - Mass flow - Volume flow - Corrected volume flow - Density - Reference density - Temperature - Totalizer	Limit value not overshoot or undershot  A0001243	energized	 A0001239	 A0001237
	Limit value overshoot or undershot  A0001244	de-energized	 A0001240	 A0001238
<p>* Terminal numbers in accordance with the TERMINAL NUMBER function (4780) → 98.</p> <p> Note! If the measuring device has two relays, the factory setting is:</p> <ul style="list-style-type: none"> ■ Relay 1 → normally open contact (NO) ■ Relay 2 → normally closed contact (NC) 				





9 Block INPUTS

Block	Groups	Function groups	Functions
<p>INPUTS (F)</p>	<p>STATUS INPUT (FAA) → 103</p>	<p>CONFIGURATION (500) → 103</p> <p>⇕</p> <p>OPERATION (504) → 104</p> <p>⇕</p> <p>INFORMATION (508) → 105</p>	<p>ASSIGN STATUS INPUT (5000) → 103</p> <p>ACTIVE LEVEL (5001) → 103</p> <p>MIN. PULSE WIDTH (5002) → 103</p> <p>ACTUAL STATUS INPUT (5040) → 104</p> <p>SIMULATION STATUS INPUT (5041) → 104</p> <p>VALUE SIM. STATUS IN (5042) → 104</p> <p>TERMINAL NUMBER (5080) → 105</p>

9.1 Group STATUS INPUT







9.1.1 Function group CONFIGURATION

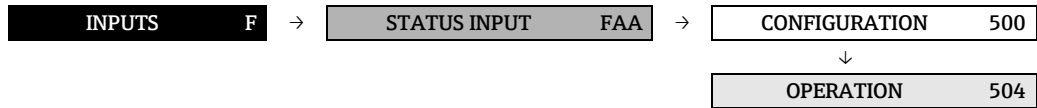

Function description INPUTS → STATUS INPUT → CONFIGURATION		
<p>ASSIGN STATUS INPUT 5000</p> <p></p> <p>Modbus register: 4301 Data type: Integer Access: read/ write</p>	<p>Use this function to assign a switching function to the status input.</p> <p>Options: 0 = OFF 1 = RESET TOTALIZER 1 2 = RESET TOTALIZER 2 3 = RESET TOTALIZER 3 4 = RESET ALL TOTALIZERS 5 = POSITIVE ZERO RETURN 8 = ZEROPOINT ADJUST</p> <p>Factory setting: OFF</p> <p> Caution! POSITIVE ZERO RETURN is active as long as the level is available at the status input (continuous signal). All other assignments react to a change in level (pulse) at the status input.</p>	
<p>ACTIVE LEVEL 5001</p> <p></p> <p>Modbus register: 4302 Data type: Integer Access: read/ write</p>	<p>Use this function to define whether the assigned function (→ function ASSIGN STATUS INPUT (5000)) is released when the signal level is present (HIGH) or not present (LOW).</p> <p>Options: 1 = HIGH 0 = LOW</p> <p>Factory setting: HIGH</p>	
<p>MINIMUM PULSE WIDTH 5002</p> <p></p> <p>Modbus register: 4303 Data type: Float Access: read/ write</p>	<p>Use this function to define a minimum pulse width which the input pulse must achieve in order to trigger the selected switching function, (→ function ASSIGN STATUS INPUT (5000)).</p> <p>User input: 20 to 100 ms</p> <p>Factory setting: 50 ms</p>	

9.1.2 Function group OPERATION



Function description		
INPUTS → STATUS INPUT → OPERATION		
ACTUAL STATUS INPUT 5040 Modbus register: 4305 Data type: Integer Access: read		Use this function to view the current level of the status input. Display: 0 = LOW 1 = HIGH
SIMULATION STATUS INPUT 5041  Modbus register: 4306 Data type: Integer Access: read/write		Use this function to simulate the status input, in other words to trigger the function assigned to the status input (→ function ASSIGN STATUS INPUT (5000) on →  103). Display: 0 = OFF 1 = ON Factory setting: OFF  Note! <ul style="list-style-type: none"> ▪ The "SIMULATION STATUS INPUT" notice message indicates that simulation is active. ▪ The measuring device continues to measure while simulation is in progress, i.e. the current measured values are output correctly via the other outputs.  Caution! The setting is not saved in the event of a power failure.
VALUE SIMULATION STATUS INPUT 5042  Modbus register: 4307 Data type: Integer Access: read/write		 Note! The function is not visible unless the function SIMULATION STATUS INPUT (5041) is active. Use this function to define the level to be assumed at the status output during the simulation. This value is used to test downstream devices and the measuring device itself. Options: 0 = LOW 1 = HIGH Factory setting: LOW  Caution! The setting is not saved in the event of a power failure.

9.1.3 Function group INFORMATION

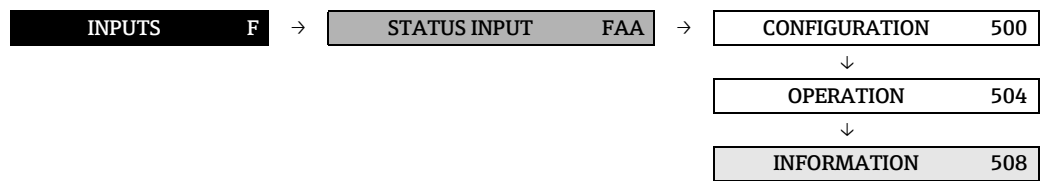

Function description		
INPUTS → STATUS INPUT → INFORMATION		
TERMINAL NUMBER Modbus register: Data type: Access	5080 4308 Integer read	Use this function to view the numbers of the terminals (in the connection compartment) and the polarity used by the status input. Display: 1 = 24 (+) / 25 (-)







10 Block BASIC FUNCTION







Block	Functions										
	Groups	Function groups	TAG NAME	FIELD BUS ADDRESS	BAUDRATE	TRANSMISSION MODE	PARITY	BYTE ORDER	DELAY TELE. REPLY	WRITE PROTECTION	SCAN LIST REGISTER 1 to 16
BASIC FUNCTION (G)	MODBUS RS485 (GDA) → 107	CONFIGURATION (630) → 107	⇒	65011 → 107	6302 → 107	6303 → 108	6304 → 108	6305 → 108	6306 → 109	6307 → 109	16 → 109
		PROCESS PARAMETER (G/A) → 110	⇒	6402 → 110	6402 → 110	6404 → 111					
	EPD PARAMETER (642) → 112	CONFIGURATION (640) → 110	⇒	6402 → 110	6402 → 110	6404 → 111					
		EPD (6420) → 112	⇒	6423 → 112	6424 → 112	6425 → 112	6426 → 113				
	REFERENCE PARAMETER (646) → 114	CONFIGURATION (640) → 110	⇒	6402 → 110	6402 → 110	6404 → 111					
		COR. VOL. CALC. (6460) → 114	⇒	6462 → 114	6462 → 114	6463 → 114	6464 → 115				
	ADJUSTMENT (648) → 116	CONFIGURATION (640) → 110	⇒	6402 → 110	6402 → 110	6404 → 111					
		ZERO POINT ADJUSTMENT (6480) → 116	⇒	6482 → 116	6483 → 116	6484 → 117	6485 → 117	6486 → 117	6487 → 117	6488 → 118	
	PRESSURE CORRECTION (650) → 119	CONFIGURATION (640) → 110	⇒	6402 → 110	6402 → 110	6404 → 111					
		PRESSURE MODE (6500) → 119	⇒	6501 → 119							
	SYSTEM PARAMETER (G/A) → 120	CONFIGURATION (660) → 120	⇒	6602 → 120	6603 → 120	6605 → 120					
		INST. DIR. SENSOR (6600) → 120	⇒	6602 → 120	6603 → 120	6605 → 120					
	SENSOR DATA (G/A) → 121	CONFIGURATION (680) → 121	⇒	6803 → 121	6804 → 121						
		FLOW COEFF. (684) → 122	⇒	6841 → 122	6842 → 122	6843 → 122	6844 → 122				
DENSITY COEFFICIENT (685) → 123		⇒	6851 → 123	6852 → 123	6853 → 123	6854 → 123	6855 → 123				
ADDITIONAL COEFFICIENT (686) → 124		⇒	6861 → 124	6862 → 124	6863 → 124	6864 → 124	6865 → 124	6866 → 124			





10.1 Group Modbus RS485

10.1.1 Function group CONFIGURATION

BASIC FUNCTION	G	→	MODBUS RS485	GDA	→	CONFIGURATION	630
----------------	---	---	--------------	-----	---	---------------	-----

Function description		
BASIC FUNCTION → MODBUS RS485 → CONFIGURATION		
<p>TAG NAME 6300</p> <p></p> <p>Modbus register: 4901 Data type: String Access: (16) read/ write</p>		<p>For entering a tag name for the measuring device. You can edit and read this tag name via the local display or the Modbus RS485 protocol.</p> <p>User input: max. 16-character text, permissible: A-Z, 0-9, +, -, punctuation marks</p> <p>Factory setting: " _ _ _ _ _ _ _ _ _ _ " (No text)</p> <p> Note! This function cannot be changed if:</p> <ul style="list-style-type: none"> ■ The measuring device has been configured in accordance with NTEP or MC approval. ■ The measuring device has been configured in accordance with PTB, NMI, METAS or BEV approval and YES has been selected for function Z009 in the CUSTODY TRANSFER block.
<p>FIELD BUS ADDRESS 6301</p> <p></p> <p>Modbus register: 4910 Data type: Integer Access: read/ write</p>		<p>For entering the device address.</p> <p>User input: 1 to 247</p> <p>Factory setting: 247</p> <p> Note! This function cannot be changed if:</p> <ul style="list-style-type: none"> ■ The measuring device has been configured in accordance with NTEP or MC approval. ■ The measuring device has been configured in accordance with PTB, NMI, METAS or BEV approval and YES has been selected for function Z009 in the CUSTODY TRANSFER block.
<p>BAUDRATE 6302</p> <p></p> <p>Modbus register: 4912 Data type: Integer Access: read/ write</p>		<p>For selecting the baudrate.</p> <p>Options: 0 = 1200 BAUD 1 = 2400 BAUD 2 = 4800 BAUD 3 = 9600 BAUD 4 = 19200 BAUD 5 = 38400 BAUD 6 = 57600 BAUD 7 = 115200 BAUD</p> <p>Factory setting: 19200 BAUD</p> <p> Note! This function cannot be changed if:</p> <ul style="list-style-type: none"> ■ The measuring device has been configured in accordance with NTEP or MC approval. ■ The measuring device has been configured in accordance with PTB, NMI, METAS or BEV approval and YES has been selected for function Z009 in the CUSTODY TRANSFER block.





Function description		
BASIC FUNCTION → MODBUS RS485 → CONFIGURATION		
<p>TRANSMISSION MODE</p> <p></p> <p>Modbus register: 4913 Data type: Integer Access: read/write</p>	<p>6303</p>	<p>For selecting the data transfer mode.</p> <p>Options: 0 = RTU 1 = ASCII</p> <p>Factory setting: RTU</p> <p> Note!</p> <ul style="list-style-type: none"> ■ RTU = transmission of data in binary form. Error protection via CRC16. ■ RTU = transmission of data in the form of readable ASCII characters. Error protection via LRC. ■ This function cannot be changed if: <ul style="list-style-type: none"> - The measuring device has been configured in accordance with NTEP or MC approval. - The measuring device has been configured in accordance with PTB, NMI, METAS or BEV approval and YES has been selected for function Z009 in the CUSTODY TRANSFER block.
<p>PARITY</p> <p></p> <p>Modbus register: 4914 Data type: Integer Access: read/write</p>	<p>6304</p>	<p>For selecting whether no parity bit or an even or uneven parity bit should be transmitted. The options available depend on the TRANSMISSION MODE function:</p> <p>Options: (for TRANSMISSION MODE = RTU) 0 = EVEN 1 = UNEVEN 2 = NONE</p> <p>Options: (for TRANSMISSION MODE = ASCII) 0 = EVEN 1 = UNEVEN</p> <p>Factory setting: EVEN</p> <p> Note!</p> <p>This function cannot be changed if:</p> <ul style="list-style-type: none"> ■ The measuring device has been configured in accordance with NTEP or MC approval. ■ The measuring device has been configured in accordance with PTB, NMI, METAS or BEV approval and YES has been selected for function Z009 in the CUSTODY TRANSFER block.
<p>BYTE ORDER</p> <p></p> <p>Modbus register: 4915 Data type: Integer Access: read/write</p>	<p>6305</p>	<p>For selecting the byte transmission sequence for the Integer, Float and String data types.</p> <p>Options: 0 = 0-1-2-3 1 = 3-2-1-0 2 = 2-3-0-1 3 = 1-0-3-2</p> <p>Factory setting: 1-0-3-2</p> <p> Note!</p> <ul style="list-style-type: none"> ■ The transmission sequence must suit the Modbus master. ■ For additional information, refer to the "Byte transmission order" section in the Operating Instructions (BA00140D/06). ■ This function cannot be changed if: <ul style="list-style-type: none"> - The measuring device has been configured in accordance with NTEP or MC approval. - The measuring device has been configured in accordance with PTB, NMI, METAS or BEV approval and YES has been selected for function Z009 in the CUSTODY TRANSFER block.



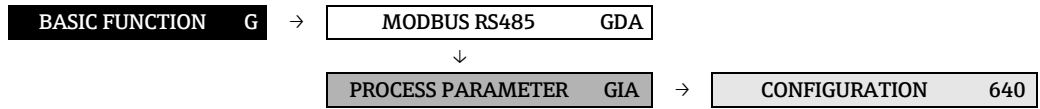

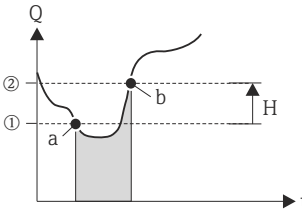

Function description	
BASIC FUNCTION → MODBUS RS485 → CONFIGURATION	
<p>DELAY TELE. REPLY 6306</p> <p></p> <p>Modbus register: 4916 Data type: Float Access: read/ write</p>	<p>For entering a delay time after which the measuring device replies to the request telegram of the Modbus master. This allows communication to be adapted to slow Modbus RS485 masters.</p> <p>User input: 0 to 100 ms</p> <p>Factory setting: 10 ms</p> <p> Note! This function cannot be changed if:</p> <ul style="list-style-type: none"> ■ The measuring device has been configured in accordance with NTEP or MC approval. ■ The measuring device has been configured in accordance with PTB, NMI, METAS or BEV approval and YES has been selected for function Z009 in the CUSTODY TRANSFER block.
<p>WRITE PROTECTION 6307</p> <p>Modbus register: 4918 Data type: Integer Access: read</p>	<p>Indicates whether write access to the measuring device is possible via local operation or Modbus RS485.</p> <p>Display: 0 = OFF (write access via Modbus possible) 1 = ON (write access via Modbus blocked)</p> <p>Factory setting: OFF</p> <p> Note! Hardware write protection is activated and deactivated by means of a jumper on the I/O board → Operating Instructions (BA00140D/06).</p>
<p>SCAN LIST REGISTER 1 to 16 6308</p> <p></p> <p>Modbus register: SCAN LIST REG. 1 5001 SCAN LIST REG. 2 5002 SCAN LIST REG. 3 5003 SCAN LIST REG. 4 5004 SCAN LIST REG. 5 5005 SCAN LIST REG. 6 5006 SCAN LIST REG. 7 5007 SCAN LIST REG. 8 5008 SCAN LIST REG. 9 5009 SCAN LIST REG. 10 5010 SCAN LIST REG. 11 5011 SCAN LIST REG. 12 5012 SCAN LIST REG. 13 5013 SCAN LIST REG. 14 5014 SCAN LIST REG. 15 5015 SCAN LIST REG. 16 5016 Data type: Integer Access: read/ write</p>	<p>By entering the register address, up to 16 device parameters can be grouped in the auto-scan buffer where they are assigned to the scan list registers 1 to 16. The data of the device parameters assigned here are read out via the register addresses 5051 to 5081.</p> <p>User input: 0 to 9999</p> <p>Factory setting: 0</p> <p> Note!</p> <ul style="list-style-type: none"> ■ For additional information and examples of using the auto-scan buffer, refer to the Operating Instructions (BA00140D/06). ■ This function cannot be changed if: <ul style="list-style-type: none"> – The measuring device has been configured in accordance with NTEP or MC approval. – The measuring device has been configured in accordance with PTB, NMI, METAS or BEV approval and YES has been selected for function Z009 in the CUSTODY TRANSFER block.

10.2 Group PARAMETER

10.2.1 Function group CONFIGURATION



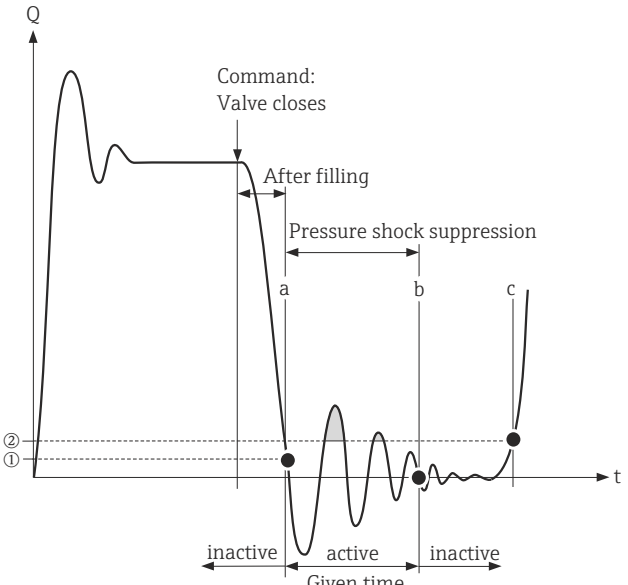





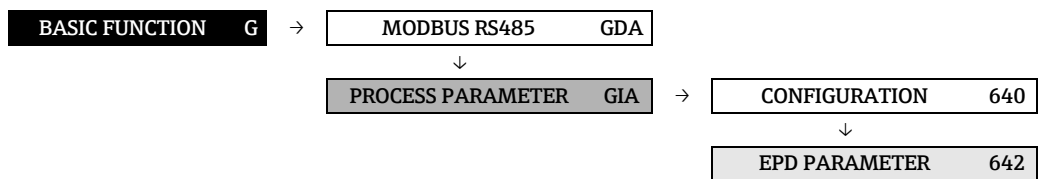

Function description	
BASIC FUNCTION → PROCESS PARAMETER → CONFIGURATION	
<p>ASSIGN LOW FLOW CUTOFF 6400</p> <p></p> <p>Modbus register: 5101 Data type: Integer Access: read/ write</p>	<p>Use this function to assign the switch point for low flow cut off rate suppression.</p> <p>Options: 0 = OFF 1 = MASS FLOW 2 = VOLUME FLOW 3 = CORRECTED VOLUME FLOW</p> <p>Factory setting: MASS FLOW</p>
<p>ON-VALUE LOW FLOW CUT OFF 6402</p> <p></p> <p>Modbus register: 5138 Data type: Float Access: read/ write</p>	<p>Use this function to assign a value to the switch-on point for low flow cut off.</p> <p>Low flow cut off is active if the value entered is not equal to 0. The sign of the flow value is highlighted on the display to indicate that low flow cut off is active.</p> <p>User input: 5-digit floating-point number, [unit]</p> <p>Factory setting: Depends on nominal diameter</p> <p> Note! The appropriate unit is taken from the function group (→  16).</p>
<p>OFF-VALUE LOW FLOW CUTOFF 6403</p> <p></p> <p>Modbus register: 5104 Data type: Float Access: read/ write</p>	<p>Enter the off-value (b) of the low flow cut off. Enter the switch-off point as a positive hysteresis (H) from the switch-on point (a).</p> <p>User input: Integer 0 to 100%</p> <p>Factory setting: 50%</p> <div style="text-align: center;">  </div> <p style="text-align: right;">A0003882</p> <p>① = on-value ② = off-value a Low flow cut off is switched on b Low flow cut off is switched off (a + a · H) H Hysteresis: 0 to 100% ■ Low flow cut off active Q Flow</p>

Function description	
BASIC FUNCTION → PROCESS PARAMETER → CONFIGURATION	
<p>PRESSURE SHOCK SUPPRESSION 6404</p> <p></p> <p>Modbus register: 5140 Data type: Float Access: read/write</p>	<p>The closure of a valve can cause brief but severe movements of the fluid in the piping system, movements which the measuring system registers. The pulses totaled in this way result in a totalizer reading error, particularly in the case of batching processes. For this reason, the measuring device is equipped with pressure shock suppression (= short-term signal suppression) which can eliminate system-related "disruptions".</p> <p> Note! Note that pressure shock suppression cannot be used unless the low flow cut off is active, (→ function ON-VALUE LOW FLOW CUT OFF on →  110). Use this function to define the time span for active pressure shock suppression.</p> <p>Activation of the pressure shock suppression Pressure shock suppression is activated after the flow falls below the switch-on point of the low flow cut off (→ point a in graphic). While pressure shock suppression is active, the following conditions apply:</p> <ul style="list-style-type: none"> ■ Flow reading on display → 0 ■ Totalizer reading → the totalizers are pegged at the last correct value. <p>Deactivation of the pressure shock suppression The pressure shock suppression is deactivated after the time interval, set in this function, has passed (→ point b in graphic).</p> <p> Note! The actual flow value is displayed and output, when the time interval for the pressure shock suppression has passed and the flow exceeds the switch-off point of the low flow cut off (→ point c in graphic).</p> <div style="text-align: center;">  </div> <p style="text-align: right; font-size: small;">A0001285-EN</p> <p>① = Off-value (low flow cut off), ② = On-value (low flow cut off) a Active when value falls below the on-value of the low flow cut off b Deactivated after specified time expires c Flow values are again used to calculate the pulses  Suppressed values Q Flow</p> <p>User input: max. 4-digit number, incl. unit: 0.00 to 100.0 s</p> <p>Factory setting: 0.00 s</p>

10.2.2 Function group EPD PARAMETER









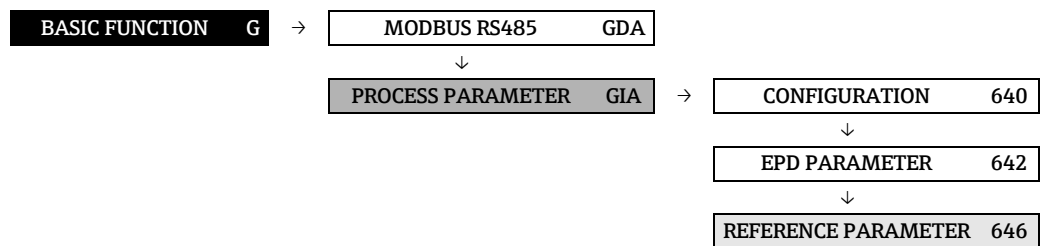



Function description		
BASIC FUNCTION → PROCESS PARAMETER → EPD PARAMETER		
EMPTY PIPE DETECTION  Modbus register: 5106 Data type: Integer Access: read/write	6420	Use this function to activate the empty pipe detection (EPD). With empty measuring tubes the density of the fluid falls below the value specified in the function EPD VALUE LOW. Options: 0 = OFF 1 = ON Factory setting: Liquid: ON Gas: OFF  Caution! <ul style="list-style-type: none"> Select a correspondingly low EPD response value in the function EPD VALUE LOW, so that the difference to the effective density of the fluid is sufficiently large enough. This ensures that totally empty measuring tubes and not partially filled ones are detected. For gas measurement we strongly recommend to switch off empty pipe detection.
EPD VALUE LOW  Modbus register: 5110 Data type: Float Access: read/write	6423	 Note! This function is not available unless the ON selection was selected in the EMPTY PIPE DETECTION function. Use this function to set a lower threshold for the measured density value, in order to detect possible problems in the process indicated by too low density. User input: 5-digit floating-point number Factory setting: 0.2000 g/cc
EPD VALUE HIGH  Modbus register: 5112 Data type: Float Access: read/write	6424	 Note! This function is not available unless the ON selection was selected in the EMPTY PIPE DETECTION function. Use this function to set an upper threshold for the measured density value. User input: 5-digit floating-point number Factory setting: 6.0000 g/cc
EPD RESPONSE TIME  Modbus register: 5108 Data type: Float Access: read/write	6425	Use this function to enter the time span for which the criteria for an empty pipe have to be satisfied without interruption before a notice message or fault message is generated. User input: fixed-point number: 1.0 to 60 s Factory setting: 1.0 s

Function description		
BASIC FUNCTION → PROCESS PARAMETER → EPD PARAMETER		
<p>EPD EXC.CURR. 6426</p> <p> Modbus register: 5233 Data type: Float Access: read/write</p>		<p>Empty pipe detection (EPD) can be switched on in this function.</p> <p>In the event of inhomogeneous fluids or air bubbles, the exciting current of the measuring pipes increases. If the exciting current specified in this function is overshoot, error message #700 "EPD ACTIVE" is output similar to the EPD VALUE LOW (6423) function.</p> <p>User input: 5-digit floating-point number</p> <p>Factory setting: 100 mA (deactivated)</p> <p> Note! The function is not activated until a value under 100 mA is input. Entering the value 100 mA deactivates the function.</p>

10.2.3 Function group REFERENCE PARAMETER









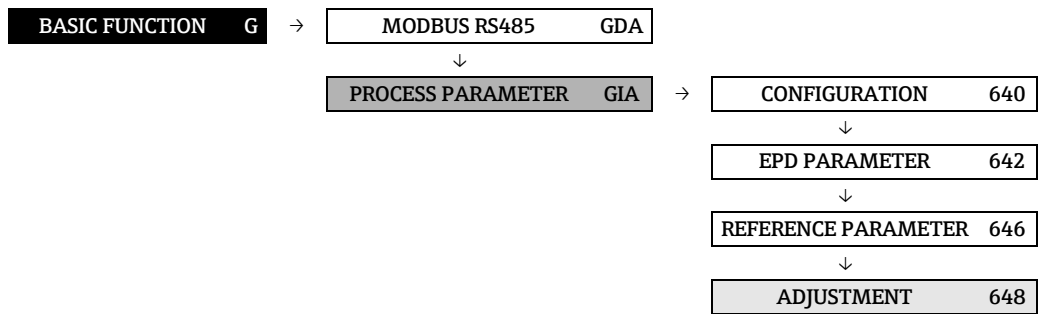







Function description		
BASIC FUNCTION → PROCESS PARAMETER → REFERENCE PARAMETER		
CORRECTED VOLUME CALCULATION  Modbus register: 5129 Data type: Integer Access: read/write	6460	This function is used to set the reference density for calculating the corrected volume flow. Options: 0 = CALCULATED REFERENCE DENSITY 1 = FIXED REFERENCE DENSITY Factory setting: CALCULATED REFERENCE DENSITY
FIXED REFERENCE DENSITY  Modbus register: 5130 Data type: Float Access: read/write	6461	 Note! This function is not available unless the FIXED REFERENCE DENSITY setting was selected in the CORRECTED VOLUME CALCULATION function (6460). In this function, a fixed value for the reference density can be entered, with which the corrected volume flow or corrected volume is calculated. User input: 5-digit floating-point number Factory setting: 1 kg/Nl
EXPANSION COEFFICIENT  Modbus register: 5132 Data type: Float Access: read/write	6462	 Note! This function is not available unless the CALCULATED REFERENCE DENSITY setting was selected in the CORRECTED VOLUME CALCULATION function (6460). For temperature-compensated calculations of the reference density an expansion coefficient specific to the fluid is required and can be entered in this function (→ REFERENCE TEMPERATURE (6464) function on →  115). User input: 5-digit floating-point number Factory setting: 0.5000 e-3 [1/K]
EXPANSION COEFFICIENT SQUARE  Modbus register: 5134 Data type: Float Access: read/write	6463	Use this function to enter a square expansion coefficient, if the temperature compensation follows a nonlinear behavior (→ REFERENCE TEMPERATURE (6464) function on →  115). User input: 5-digit floating-point number Factory setting: 0 e-6 [1/K ²]

Function description	
BASIC FUNCTION → PROCESS PARAMETER → REFERENCE PARAMETER	
<p>REFERENCE TEMPERATURE 6464</p> <p></p> <p>Modbus register: 5136 Data type: Float Access: read/write</p>	<p> Note! This function is not available unless the CALCULATED REFERENCE DENSITY setting was selected in the CORRECTED VOLUME CALCULATION function (6460).</p> <p>For entering the reference temperature for calculating the corrected volume flow, the corrected volume and the reference density.</p> <p>User input: 5-digit floating-point number</p> <p>Factory setting: 20.000 °C</p> <p>The reference density is calculated as follows: $\rho_N = \rho \cdot (1 + \alpha \Delta t + \beta \Delta t^2)$; Δ where $t = t - t_N$</p> <p>ρ_N = Reference density ρ = currently measured fluid density (measuring value) t = Actual measured temperature of fluid (measuring value) t_N = Reference temperature for calculating the reference density (e.g. 20 °C) α = Vol. expansion coefficient of the fluid, unit [1/K] (K = Kelvin) β = Square volumetric expansion coefficient of the fluid, unit [1/K²]</p>

10.2.4 Function group ADJUSTMENT







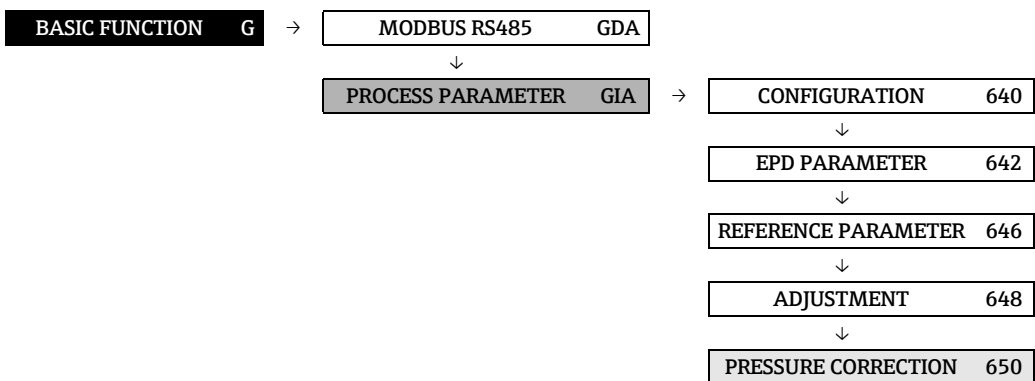

Function description		
BASIC FUNCTION → PROCESS PARAMETER → ADJUSTMENT		
ZERO POINT ADJUSTMENT  Modbus register: 5121 Data type: Integer Access: read/write	6480	This function enables a zero point adjustment to be automatically carried out. The new zero point determined by the measuring system is adopted by the function ZERO POINT. Options: 0 = CANCEL 1 = START Factory setting: CANCEL  Caution! Before carrying this out, please refer to the Operating Instructions (BA00140D/06) for a detailed description of the procedure for zero point adjustment.  Note! <ul style="list-style-type: none"> ▪ Programming is locked during zero point adjustment. The message "ZERO ADJUST RUNNING" appears on the display. ▪ If the zero point adjustment is not possible (e.g. if $v > 0.1$ m/s) or has been canceled, the alarm message "ZERO ADJUST NOT POSSIBLE" appears on the display. ▪ If the CNGmass DCI measuring electronics are fitted with a status input, then the zero point adjustment can also be activated by using this input.
DENSITY ADJUST MODE  Modbus register: 5180 Data type: Integer Access: read/write	6482	Use this function to select whether a 1-point or a 2-point density adjustment should be carried out. Options: 0 = CANCEL 1 = 1-POINT 2 = 2-POINT
DENSITY SET VALUE 1  Modbus register: 5124 Data type: Float Access: read/write	6483	Use this function to enter the density setpoint value for the first fluid for which you want to carry out field density adjustment. User input: 5-digit floating-point number, incl. unit  Note! <ul style="list-style-type: none"> ▪ The preset density entered here should not vary from the actual fluid density by a more than $\pm 10\%$. ▪ The appropriate unit is taken from the function group SYSTEM UNITS (→  16).

Function description BASIC FUNCTION → PROCESS PARAMETER → ADJUSTMENT		
MEASURE FLUID 1 6484  Modbus register: 5126 Data type: Integer Access: read/write	In this function the actual density of the first fluid is measured for density adjustment. Options: 0 = CANCEL 1 = START	
DENSITY SET VALUE 2 6485  Modbus register: 5181 Data type: Float Access: read/write	Use this function to enter the density setpoint value for the second fluid for which you want to carry out field density adjustment. User input: 5-digit floating-point number, incl. unit  Note! <ul style="list-style-type: none"> ■ The preset density entered here should not vary from the actual fluid density by a more than ±10%. ■ The difference between the density setpoint values must be at least 0.2 kg/l. ■ The appropriate unit is taken from the function group SYSTEM UNITS (→  16). 	
MEASURE FLUID 2 6486  Modbus register: 5183 Data type: Integer Access: read/write	In this function the current density of the second fluid is measured for density adjustment. Options: 0 = CANCEL 1 = START	
DENSITY ADJUSTMENT 6487  Modbus register: 5127 Data type: Integer Access: read/write	With this function a density adjustment can be carried out on site. The density adjustment values will thus be recalculated and stored. This ensures that the values dependent on density calculations (e.g. volume flow) are as accurate as possible.  Note! Before carrying this out, please refer to the Operating Instructions (BA00140D/06) for a detailed description of the procedure for density adjustment. Two types of adjustment are possible: 1-point density adjustment (with one fluid) This type of density adjustment is necessary under the following conditions: <ul style="list-style-type: none"> ■ The sensor does not measure exactly the density value that the user expects on the basis of laboratory analyses. ■ The fluid properties are outside the measuring points set at the factory, or the reference operating conditions used to calibrate the measuring device. ■ The plant is used solely for measuring a fluid whose density is to be determined very accurately under constant conditions. 2-point density adjustment (with two fluids) This type of adjustment must always be carried out when the measuring tubes are changed mechanically, e.g. due to deposits, abrasion or corrosion: In such instances, the measuring tube resonance frequency is influenced in such a way that it is no longer compatible with the calibration data determined at the factory. The 2-point density adjustment takes these mechanically-based changes into account and calculates new, adjusted calibration data. Options: 0 = CANCEL 1 = MEASURE FLUID 1 2 = MEASURE FLUID 2 3 = DENSITY ADJUST Factory setting: CANCEL	

Function description		
BASIC FUNCTION → PROCESS PARAMETER → ADJUSTMENT		
RESTORE ORIGINAL  Modbus register: Data type: Access:	6488 5128 Integer read/write	With this function the original density coefficient determined at the factory are restored. Options: 0 = NO 1 = YES Factory setting: NO

10.2.5 Function group PRESSURE CORRECTION





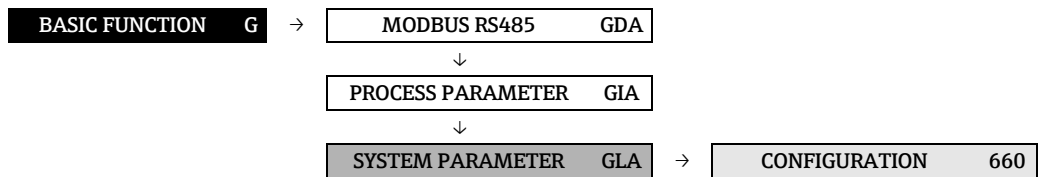

Function description		
BASIC FUNCTION → PROCESS PARAMETER → PRESSURE CORRECTION		
<p>PRESSURE MODE 6500</p> <p></p> <p>Modbus register: 5184 Data type: Integer Access: read/ write</p>		<p>Use this function to configure an automatic pressure correction. In this way, the effect of a pressure deviation between the calibration and process pressures on the measured error for mass flow can be compensated → also Operating Instructions (BA00140D/06), section "Performance characteristics".</p> <p>Options: 0 = OFF 1 = FIX (a fixed process pressure for pressure correction is specified).</p> <p>Factory setting: OFF</p>
<p>PRESSURE 6501</p> <p></p> <p>Modbus register: 5185 Data type: Float Access: read/ write</p>		<p> Note! This function is not available unless the FIXED setting was selected in the PRESSURE MODE function (6500).</p> <p>Use this function to enter the value for the process pressure which should be used during pressure correction.</p> <p>User input: 7-digit floating-point number</p> <p>Factory setting: 0 bar g</p> <p> Note! The appropriate unit is taken from the function group SYSTEM UNITS (→  16).</p>

10.3 Group SYSTEM PARAMETER

10.3.1 Function group CONFIGURATION



Function description	
BASIC FUNCTION → SYSTEM PARAMETER → CONFIGURATION	
INSTALLATION DIRECTION SENSOR 6600  Modbus register: 5501 Data type: Integer Access: read/write	Use this function to reverse the sign of the flow direction, if necessary.  Note! Ascertain the actual direction of fluid flow with reference to the direction indicated by the arrow on the sensor (nameplate). Options: 0 = NORMAL (flow as indicated by the arrow) 1 = INVERSE (flow opposite to direction indicated by the arrow) Factory setting: NORMAL
DENSITY DAMPING 6602  Modbus register: 5508 Data type: Float Access: read/write	The density filter allows the sensitivity of the density measuring signal to be lowered with respect to variations in the density of the fluid, e.g. with inhomogeneous liquids. The damping acts on all functions and outputs of the measuring device. User input: max. 5-digit number, including unit: 0.00 to 100.00 s Factory setting: 0.00 s
FLOW DAMPING 6603  Modbus register: 5510 Data type: Float Access: read/write	Setting the filter depth of the digital filter. The sensitivity of the flow measurement signal can be reduced with respect to interference peaks (e.g. in the event of a high solid content, gas bubbles in the fluid etc.). The reaction time of the measuring device increases with every increase in the filter setting. The damping acts on all functions and outputs of the measuring device. User input: 0 to 100 s Factory setting: 0 s
POSITIVE ZERO RETURN 6605  Modbus register: 5503 Data type: Integer Access: read/write	Use this function to interrupt evaluation of measured variables. This is necessary when a piping system is being cleaned, for example. This setting acts on all function and outputs of the measuring device. Options: 0 = OFF 1 = ON (signal output is set to the "ZERO FLOW" value, temperature and density are still output) Factory setting: OFF

10.4 Group SENSOR DATA

10.4.1 Function group CONFIGURATION

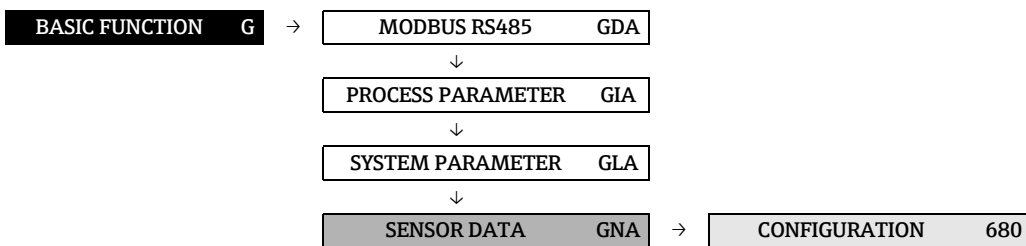

Function description		
BASIC FUNCTION → SENSOR DATA → CONFIGURATION		
<p>All sensor data (calibration factor, zero point and nominal diameter) are set at the factory and saved on the S-DAT sensor memory chip.</p> <p> Caution! Under normal circumstances you should not change the following parameter settings, because changes affect numerous functions of the entire measuring facility in general and the accuracy of the measuring system in particular. For this reason, the functions described below cannot be changed even when you enter your personal code. Contact the Endress+Hauser service organization if you have any questions about these functions.</p> <p> Note! The individual values of the functions are also provided on the sensor nameplate.</p>		
<p>K-FACTOR 6800</p> <p></p> <p>Modbus register: 7513 Data type: Float Access: read</p>	<p>This function shows the current calibration factor for the sensor.</p> <p>Factory setting: Depends on nominal diameter and calibration</p>	
<p>ZERO POINT 6803</p> <p></p> <p>Modbus register: 7527 Data type: Float Access: read/ write</p>	<p>This function shows the current zero point correction value for the sensor.</p> <p>Display: max. 5-digit number: -99999 to +99999</p> <p>Factory setting: Depends on calibration</p>	
<p>NOMINAL DIAMETER 6804</p> <p></p> <p>Modbus register: mm 7525 inch 7526 Data type: Integer Access: read</p>	<p>Display: Nominal diameter of the sensor 6 = DN 8 or 3/8" 8 = DN 15 or 1/2" 11 = DN 25 or 1"</p>	



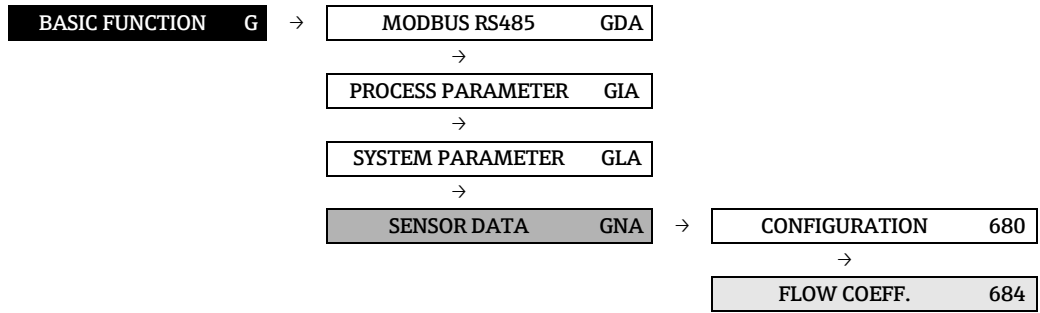





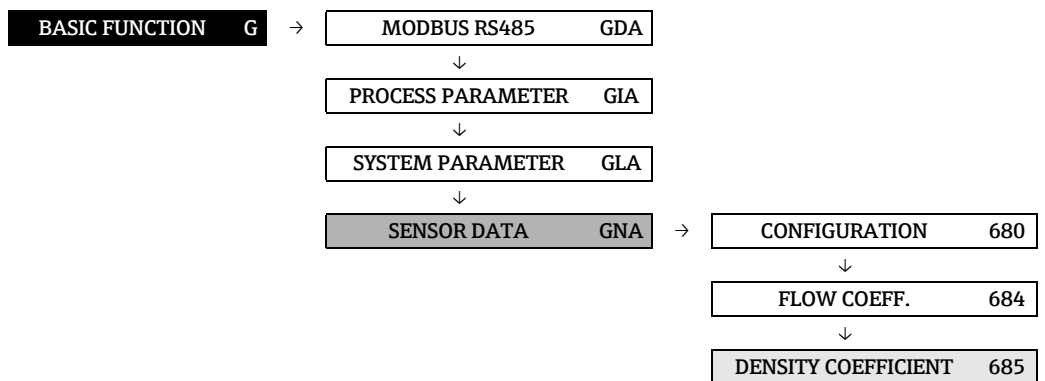



10.4.2 Function group FLOW COEFFICIENT



Function description		
BASIC FUNCTION → SENSOR DATA → FLOW COEFFICIENT		
<p>All flow coefficients are set at the factory. All the sensor's parameter settings are saved on the S-DAT memory chip.</p> <p>Contact the Endress+Hauser service organization if you have any questions about these functions.</p>		
<p>TEMPERATURE COEFFICIENT KM 6840</p> <p>Modbus register: 7519 Data type: Float Access: read</p>	<p>This function shows the temperature coefficient KM.</p>	
<p>TEMPERATURE COEFFICIENT KM2 6841</p> <p>Modbus register: 7521 Data type: Float Access: read</p>	<p>This function shows the temperature coefficient KM2.</p>	
<p>TEMPERATURE COEFFICIENT KT 6842</p> <p>Modbus register: 7523 Data type: Float Access: read</p>	<p>This function shows the temperature coefficient KT.</p>	
<p>CALIBRATION COEFFICIENT KD 1 6843</p> <p>Modbus register: 7515 Data type: Float Access: read</p>	<p>This function shows the calibration coefficient KD 1.</p>	
<p>CALIBRATION COEFFICIENT KD 2 6844</p> <p>Modbus register: 7517 Data type: Float Access: read</p>	<p>This function shows the calibration coefficient KD 2.</p>	

10.4.3 Function group DENSITY COEFFICIENT



Function description		
BASIC FUNCTION → SENSOR DATA → DENSITY COEFFICIENT		
<p>All density coefficients are set at the factory. All the sensor's parameter settings are saved on the S-DAT memory chip. Contact the Endress+Hauser service organization if you have any questions about these functions.</p>		
<p>DENSITY COEFF. 6850 C0</p> <p></p> <p>Modbus register: 7501 Data type: Float Access: read</p>	<p>This function shows the actual density coefficient C0.</p> <p> Caution! A density adjustment can alter the calibration value of this coefficient.</p>	
<p>DENSITY COEFF. 6851 C1</p> <p></p> <p>Modbus register: 7503 Data type: Float Access: read</p>	<p>This function shows the actual density coefficient C1.</p> <p> Caution! A density adjustment can alter the calibration value of this coefficient.</p>	
<p>DENSITY COEFF. 6852 C2</p> <p></p> <p>Modbus register: 7505 Data type: Float read Access:</p>	<p>This function shows the actual density coefficient C2.</p> <p> Caution! A density adjustment can alter the calibration value of this coefficient.</p>	
<p>DENSITY COEFF. 6853 C3</p> <p></p> <p>Modbus register: 7507 Data type: Float Access: read</p>	<p>This function shows the actual density coefficient C3.</p> <p> Caution! A density adjustment can alter the calibration value of this coefficient.</p>	
<p>DENSITY COEFF. 6854 C4</p> <p></p> <p>Modbus register: 7509 Data type: Float Access: read</p>	<p>This function shows the actual density coefficient C4.</p> <p> Caution! A density adjustment can alter the calibration value of this coefficient.</p>	
<p>DENSITY COEFF. 6855 C5</p> <p></p> <p>Modbus register: 7511 Data type: Float Access: read</p>	<p>This function shows the actual density coefficient C5.</p> <p> Caution! A density adjustment can alter the calibration value of this coefficient.</p>	

10.4.4 Function group ADDITIONAL COEFFICIENT

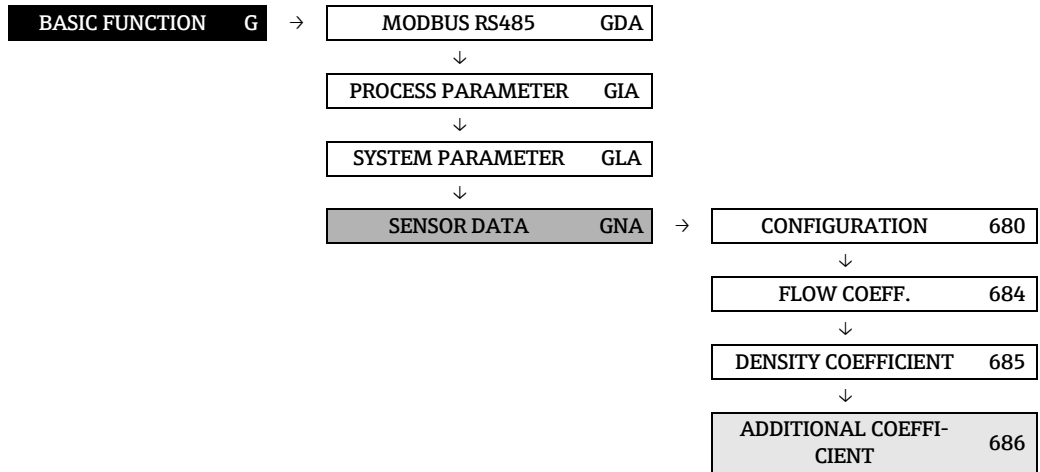

Function description	
BASIC FUNCTION → SENSOR DATA → ADDITIONAL COEFFICIENT	
<p>All sensor data are set at the factory. All the sensor's parameter settings are saved on the S-DAT memory chip.</p> <p> Caution! These functions are used for displaying device parameters only and consequently cannot be accessed.</p> <p>Contact the Endress+Hauser service organization if you have any questions about these functions.</p>	
<p>MINIMAL TEMPERATURE MEASURED 6860</p> <p>Modbus register: Data type: 7529 Access: Float read</p>	<p>The lowest fluid temperature measured appears on the display.</p>
<p>MAXIMAL TEMPERATURE MEASURED 6861</p> <p>Modbus register: 7531 Data type: Float Access: read</p>	<p>The highest fluid temperature measured appears on the display.</p>
<p>MINIMAL TEMPERATURE CARRIER TUBE 6862</p> <p>Modbus register: 7533 Data type: Float Access: read</p>	<p>The lowest carrier tube temperature measured appears on the display.</p>
<p>MAXIMUM TEMPERATURE CARRIER TUBE 6863</p> <p>Modbus register: 7535 Data type: Float Access: read</p>	<p>The highest carrier tube temperature measured appears on the display.</p>





11 Block SUPERVISION

Block	Groups	Function groups	Functions	
SUPERVISION (U)	SYSTEM (AAA) → 126	CONFIGURATION (800) → 126	STORAGE (8007) → 126	
		OPERATION (804) → 127	ALARM DELAY (8005) → 126	
	VERSION-INFO (UCA) → 129	DEVICE (810) → 129	ACT. SYST. CON- DITION (8040) → 127	PREV. SYST. CON- DITION (8041) → 127
		SENSOR (820) → 130	DEVICE SOFTWARE (8100) → 129	SIM. FAILSAFE MODE (8042) → 127
	AMPLIFIER (822) → 131	AMPLIFIER (822) → 131	SERIAL NUMBER (8200) → 130	SIM. MEASURAND (8043) → 128
		I/O MODULE (830) → 132	SW REV. NO. AMPLIFIER (8222) → 131	VAL. SIM. MEASURAND (8044) → 128
	I/O SUBMODULE 2 (834) → 133	I/O MODULE (830) → 132	SW REV. NO. T-DAT (8255) → 131	SYSTEM RESET (8046) → 128
		I/O SUBMODULE 3 (836) → 133	I/O MODULE TYPE (8300) → 132	OPERATION HOURS (8048) → 128
	I/O SUBMODULE 4 (838) → 133	I/O SUBMODULE 3 (836) → 133	SUB IN- /OUTPUT TYPE 2 (8340) → 133	
		I/O SUBMODULE 4 (838) → 133	SUB IN- /OUTPUT TYPE 3 (8360) → 133	
			SUB IN- /OUTPUT TYPE 4 (8380) → 133	
			SW REV. SUB I/O (8343) → 133	
			SW REV. SUB I/O (8363) → 133	
			SW REV. SUB I/O (8383) → 133	
			SW REV. NO. I/O-MODULE (8303) → 132	
			SW REV. NO. S-DAT (8205) → 130	
			LANGUAGE GROUP (8226) → 131	

11.1 Group SYSTEM

11.1.1 Function group CONFIGURATION





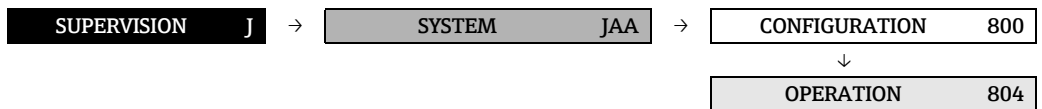

SUPERVISION	J	→	SYSTEM	JAA	→	CONFIGURATION	800
-------------	---	---	--------	-----	---	---------------	-----

Function description		SUPERVISION → SYSTEM → CONFIGURATION
<p>ALARM DELAY 8005</p> <p></p> <p>Modbus register: 6808 Data type: Float Access: read/ write</p>	<p>Enter the time span for which the criteria for an error have to be satisfied without interruption before a fault or notice message is generated. This suppression acts on:</p> <ul style="list-style-type: none"> ▪ Display ▪ Current output ▪ Frequency output ▪ Relay output ▪ Modbus RS485 <p>Input: 0 to 100 s (in steps of one second)</p> <p>Factory setting: 0 s</p> <p> Caution! If this function is activated, fault and notice messages are delayed by the time corresponding to the setting before being transmitted to the higher-order controller (process controller etc.). It is therefore imperative to check in advance in order to make sure whether a delay of this nature could affect the safety requirements of the process. If fault and notice messages may not be suppressed, a value of 0 seconds must be entered here.</p>	
<p>STORAGE 8007</p> <p></p> <p>Modbus register: 6907 Data type: Integer Access: read</p>	<p>Displays whether the automatic, permanent storage of parameter changes in the EEPROM is switched on or off.</p> <p>Display: 0 = OFF 1 = ON</p> <p>Factory setting: ON</p> <p> Caution!</p> <ul style="list-style-type: none"> ▪ The selection in the function can be changed by the Endress+Hauser service organization. ▪ If you select OFF, all parameter changes are not stored permanently in the EEPROM. This means that these parameter changes are no longer available after a power failure. In this case, the measuring instrument starts up with the last parameter configurations saved in the EEPROM. 	

11.1.2 Function group OPERATION



Function description SUPERVISION → SYSTEM → OPERATION		
<p>ACTUAL SYSTEM CONDITION 8040</p> <p>Modbus register: 6859 Data type: Integer Access: read</p> <p>Modbus register: 6821 Data type: String Access: (18) read</p>		<p>Displays the present system condition.</p> <p>Display: 1 = "SYSTEM OK" or The fault / notice message with the highest priority.</p> <p> Note! For additional information, refer to the "System or process error messages" section in the Operating Instructions (BA00140D/06).</p>
<p>PREVIOUS SYSTEM CONDITIONS 8041</p> <p>Modbus register: See Note Data type: Integer Access: read</p>		<p>Use this function to view the sixteen most recent fault and notice messages since measuring last started.</p> <p>Display: The 16 most recent fault or notice messages.</p> <p> Note to MODBUS! The various previous system conditions are available via the following MODBUS registers (data Modbus register Integer/String):</p> <ul style="list-style-type: none"> ■ Fault/notice message 1 = Modbus register 6860 ■ Fault/notice message 2 = Modbus register 6861 ■ Fault/notice message 3 = Modbus register 6862 ■ Fault/notice message 4 = Modbus register 6863 ■ Fault/notice message 5 = Modbus register 6864 ■ Fault/notice message 6 = Modbus register 6865 ■ Fault/notice message 7 = Modbus register 6866 ■ Fault/notice message 8 = Modbus register 6867 ■ Fault/notice message 9 = Modbus register 6868 ■ Fault/notice message 10 = Modbus register 6869 ■ Fault/notice message 11 = Modbus register 6870 ■ Fault/notice message 12 = Modbus register 6871 ■ Fault/notice message 13 = Modbus register 6872 ■ Fault/notice message 14 = Modbus register 6873 ■ Fault/notice message 15 = Modbus register 6874 ■ Fault/notice message 16 = Modbus register 6875 <p> Note! For additional information, refer to the "System or process error messages" section in the Operating Instructions (BA00140D/06).</p>
<p>SIMULATION FAIL-SAFE MODE 8042</p> <p></p> <p>Modbus register: 6812 Data type: Integer Access: read/ write</p>		<p>Use this function to set all inputs, outputs and totalizers to their defined failsafe modes, in order to check whether they respond correctly. During this time, the message "SIMULATION FAILSAFE MODE" appears on the display.</p> <p>Options: 0 = OFF 1 = ON</p> <p>Factory setting: OFF</p>

		Function description
		SUPERVISION → SYSTEM → OPERATION
<p>SIMULATION MEASURAND 8043</p> <p></p> <p>Modbus register: 6813 Data type: Integer Access: read/write</p>		<p>Use this function to set all inputs, outputs and totalizers to their defined flow-response modes, in order to check whether they respond correctly. During this time, the message "SIMULATION MEASURAND" appears on the display.</p> <p>Options: 0 = OFF 1 = MASS FLOW 2 = VOLUME FLOW 3 = CORRECTED VOLUME FLOW 4 = DENSITY 5 = REFERENCE DENSITY 6 = TEMPERATURE</p> <p>Factory setting: OFF</p> <p> Caution!</p> <ul style="list-style-type: none"> ▪ The measuring device cannot be used for measuring while this simulation is in progress. ▪ The setting is not saved in the event of a power failure.
<p>VALUE SIMULATION MEASURAND 8044</p> <p></p> <p>Modbus register: 6814 Data type: Float Access: read/write</p>		<p> Note!</p> <p>The function is not visible unless the function SIMULATION MEASURAND (8043) is active.</p> <p>For entering a freely selectable value (e.g. 12 m³/s) to check the associated functions in the device itself and downstream signal loops.</p> <p>User input: 5-digit floating-point number [unit]</p> <p>Factory setting: 0 [unit]</p> <p> Caution!</p> <ul style="list-style-type: none"> ▪ The setting is not saved in the event of a power failure. ▪ The appropriate unit is taken from the function group SYSTEM UNITS (ACA) (→  16).
<p>SYSTEM RESET 8046</p> <p></p> <p>Modbus register: 6817 Data type: Integer Access: read/write</p>		<p>Use this function to perform a reset of the measuring system.</p> <p>Options: 0 = NO 1 = RESTART SYSTEM (restart without interrupting power supply)</p> <p>Factory setting: NO</p>
<p>OPERATION HOURS 8048</p> <p>Modbus register: 6810 Data type: Float Access: read</p>		<p>The hours of operation of the device appear on the display.</p> <p>Display: Depends on the number of hours of operation elapsed</p> <ul style="list-style-type: none"> ▪ Hours of operation < 10 hours → display format = 0:00:00 (hr:min:sec) ▪ Hours of operation 10 to 10000 hours → display format = 0000:00 (hr:min) ▪ Hours of operation > 10000 hours → display format = 000000 (hr)

11.2 Group VERSION-INFO

11.2.1 Function group DEVICE

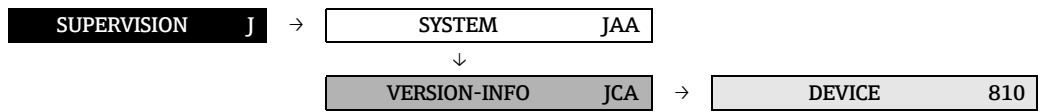

Function description	
SUPERVISION → VERSION-INFO → DEVICE	
DEVICE SOFTWARE 8100 Modbus register: 7277 Data type: String Access: (16) read	Displays the current device software version.

11.2.2 Function group SENSOR

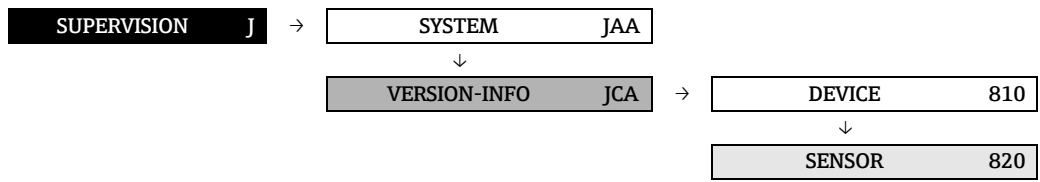

Function description		
SUPERVISION → VERSION-INFO → SENSOR		
SERIAL NUMBER	8200	Use this function to view the serial number of the sensor.
Modbus register:	7003	
Data type:	String	
Access:	(16) read	
SENSOR TYPE	8201	Use this function to view the sensor type.
Modbus register:	7012	
Data type:	String	
Access:	(16) read	
SW REV. NO. S-DAT	8205	Use this function to view the software revision number of the software used to create the content of the S-DAT.
Modbus register:	7021	
Data type:	String	
Access:	(16) read	

11.2.3 Function group AMPLIFIER

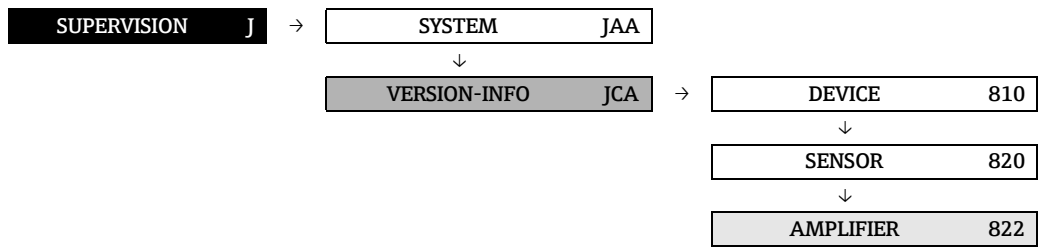

Function description		
SUPERVISION → VERSION-INFO → AMPLIFIER		
SW REV. NO. AMPLIFIER Modbus register: 7039 Data type: String Access: (16) read	8222	Use this function to view the software revision number of the amplifier.
SW REV. NO. T-DAT Modbus register: 7048 Data type: String Access: (16) read	8225	Use this function to view the software revision number of the software used to create the content of the T-DAT.
LANGUAGE GROUP Modbus register: 7262 Data type: Integer Access: read	8226	Displays the installed language group. Display: 0 = TYPE UNKNOWN 1 = WEST EU / USA 2 = EAST EU / SCAND 3 = ASIA. 4 = CHINA  Note! <ul style="list-style-type: none"> ■ The language options of the available language group are displayed in the LANGUAGE (2000) function. ■ You can change the language group via the configuration software Field-Care. Please do not hesitate to contact your Endress+Hauser sales office if you have any questions.

11.2.4 Function group I/O MODULE

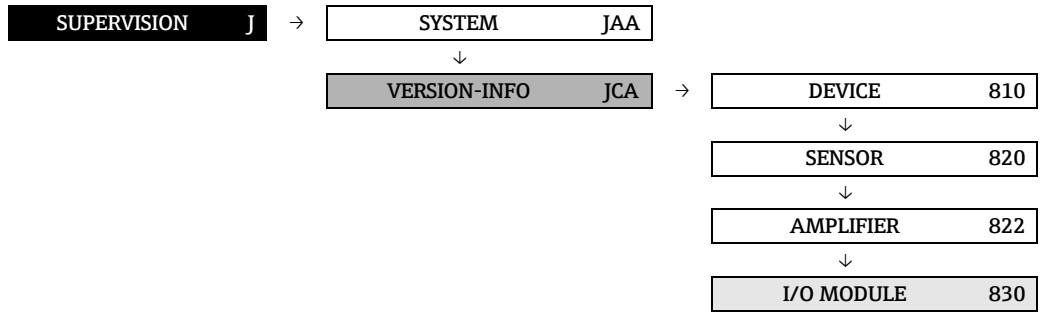

Function description		
SUPERVISION → VERSION-INFO → I/O MODULE		
I/O MODULE TYPE 8300 Modbus register: 7086 Data type: Integer Access: read	Display: 12 = Modbus RS485	Displays the configuration of the I/O module.
SW REV. NO. 8303 I/O MODULE Modbus register: 7078 Data type: String Access: (18) read		Use this function to view the software revision number of the I/O module.

11.2.5 Function groups I/O SUBMODULE 2 to 4

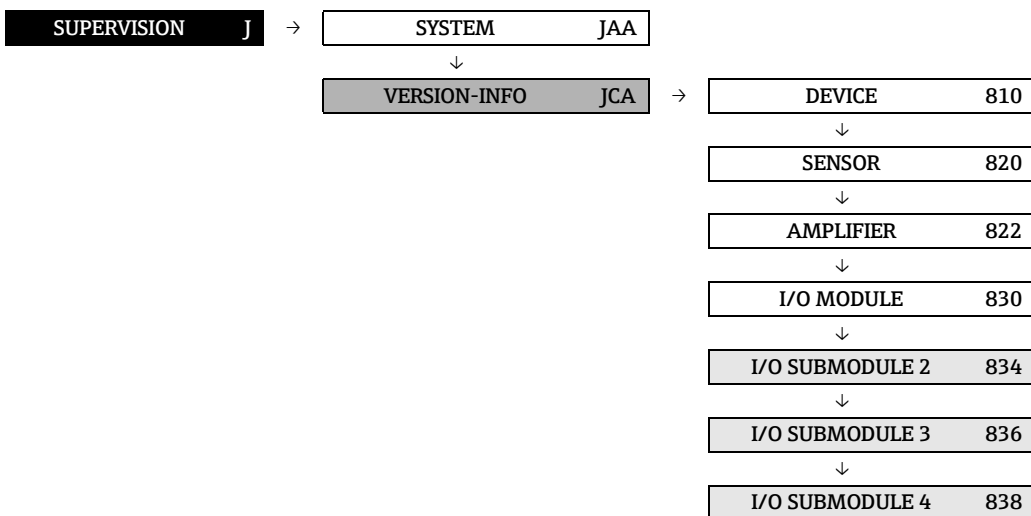

Function description		
SUPERVISION → VERSION-INFO → I/O SUBMODULE 2 to 4		
SUB I/O TYPE 8340 Modbus register: 7106 Data type: Integer Access: read		Displays the configuration of the I/O submodule 2. Display: 7 = STATUS INPUT
SW REV. SUB I/O TYPE 8343 Modbus register: 7190 Data type: String Access: (18) read		Use this function to view the software revision number of the submodule 2.
SUB I/O TYP 8360 Modbus register: 7107 Data type: Integer Access: read		Displays the configuration of the I/O submodule 3. Display: 0 = TYPE UNKNOWN 5 = PULS/FREQ. OUT. 6 = STATUS/REL. OUT
SW REV. SUB I/O TYPE 8363 Modbus register: 7199 Data type: String Access: (18) read		Use this function to view the software revision number of the submodule 3.
SUB I/O TYPE 8380 Modbus register: 7108 Data type: Integer Access: read		Displays the configuration of the I/O submodule 4. Display: 0 = TYPE UNKNOWN 4 = CURRENT OUTPUT 6 = STATUS/REL. OUT
SW REV. SUB I/O TYPE 8383 Modbus register: 7199 Data type: String Access: (18) read		Use this function to view the software revision number of the submodule 4.

12 Factory settings

12.1 SI units (not for USA and Canada)

12.1.1 Low flow cut off, full scale value, pulse value

Nominal diameter [mm]	Low flow cut off [kg/min]	Full scale value Current output [kg/min]	Pulse value [kg/p]
8	0.13	25	0.0005
15	0.45	100	0.0020
25	1.20	250	0.0050

12.2 US units (only for USA and Canada)

12.2.1 Low flow cut off, full scale value, pulse value

Nominal diameter [inch]	Low flow cut off [lb/min]	Full scale value Current output [lb/min]	Pulse value [kg/p]
$\frac{3}{8}$ "	0.300	50	0.001
$\frac{1}{2}$ "	1.000	200	0.004
1"	2.600	500	0.010

Index of function matrix

Blocks

A = MEASURED VARIABLES	14
B = QUICK SETUP	21
C = USER INTERFACE	30
D = TOTALIZER	48
E = OUTPUT	53
F = INPUT	102
G = BASIC FUNCTION	106
J = SUPERVISION	125
Z = CUSTODY TRANSFER	12

Groups

AAA = MEASURING VALUES	15
ACA = SYSTEM UNITS	16
CAA = CONTROL	31
CCA = MAIN LINE	36
CEA = ADDITIONAL LINE	40
CGA = INFORMATION LINE	44
DAA = TOTALIZER 1	49
DAB = TOTALIZER 2	49
DAC = TOTALIZER 3	49
DJA = HANDLING TOTALIZER	52
EAA = OUTPUTS	54
ECA = PULSE/FREQUENCY OUTPUT	65
EGA = RELAY OUTPUT 1	93
EGB = RELAY OUTPUT 2	93
FAA = STATUS INPUT	103
GDA = MODBUS RS485	107
GIA = PROCESS PARAMETER	110
GLA = SYSTEM PARAMETER	120
GNA = SENSOR DATA	121
JAA = SYSTEM	126
JCA = VERSION INFO	129

Function groups

000 = MAIN VALUES	15
040 = CONFIGURATION	16
042 = ADDITIONAL CONFIGURATION	19
200 = BASIC CONFIGURATION	31
202 = UNLOCKING/LOCKING	33
204 = OPERATION	35
220 = CONFIGURATION	36
222 = MULTIPLEX	38
240 = CONFIGURATION	40
242 = MULTIPLEX	42
260 = CONFIGURATION	44
262 = MULTIPLEX	46
300 = CONFIGURATION	49
304 = OPERATION	51
400 = CONFIGURATION	54
404 = OPERATION	63
408 = INFORMATION	64
420 = CONFIGURATION	65
430 = OPERATION	87
438 = INFORMATION	92
470 = CONFIGURATION	93

474 = OPERATION	97
478 = INFORMATION	98
500 = CONFIGURATION	103
504 = OPERATION	104
508 = INFORMATION	105
630 = CONFIGURATION	107
640 = CONFIGURATION	110
642 = EPD PARAMETER	112
646 = REFERENCE PARAMETER	114
648 = ADJUSTMENT	116
650 = PRESSURE CORRECTION	119
660 = CONFIGURATION	120
680 = CONFIGURATION	121
684 = FLOW COEFFICIENT	122
685 = DENSITY COEFFICIENT	123
686 = ADDITIONAL COEFFICIENT	124
800 = CONFIGURATION	126
804 = OPERATION	127
810 = DEVICE	129
820 = SENSOR	130
822 = AMPLIFIER	131
830 = I/O MODULE	132
832 = INPUT/OUTPUT 1	133
834 = I/O SUBMODULE 2	133
836 = I/O SUBMODULE 3	133
838 = I/O SUBMODULE 4	133
Z000 = CUSTODY TRANSFER	12
Z001 = PULS. OUT. 1 C.T.	12
Z003 = CURR. OUT. 1 C.T.	12
Z006 = TOTALIZER 1 C.T.	13
Z007 = TOTALIZER 2 C.T.	13
Z008 = TOTALIZER 3 C.T.	13
Z009 = MODBUS CONFIGURATION CUSTODY TRANSFER	13

Functions 0...

0000 = MASS FLOW	15
0000 = TEMPERATURE	15
0001 = VOLUME FLOW	15
0004 = CORRECTED VOLUME FLOW	15
0005 = DENSITY	15
0006 = REFERENCE DENSITY	15
0400 = UNIT MASS FLOW	16
0401 = UNIT MASS	16
0402 = UNIT VOLUME FLOW	17
0403 = UNIT VOLUME	17
0404 = UNIT CORRECTED VOLUME FLOW	18
0405 = UNIT CORRECTED VOLUME	18
0420 = UNIT DENSITY	19
0421 = UNIT REFERENCE DENSITY	19
0422 = UNIT TEMPERATURE	20
0424 = UNIT LENGTH	20
0426 = UNIT PRESSURE	20

1...

1002 = QS COMMISSION	21
----------------------	----

1003 = QS PULSATING FLOW	21
1009 = QS COMMUNICATION	21
1009 = T DAT SAVE/LOAD	22

2...

2000 = LANGUAGE	31
2002 = DISPLAY DAMPING	31
2003 = CONTRAST LCD	32
2004 = BACKLIGHT	32
2020 = ACCESS CODE	33
2021 = DEFINE PRIVATE CODE	33
2022 = STATUS ACCESS	33
2023 = ACCESS CODE	34
2040 = TEST DISPLAY	35
2200 = ASSIGN	36
2201 = 100% VALUE	36
2202 = FORMAT	37
2220 = ASSIGN	38
2221 = 100% VALUE	38
2222 = FORMAT	39
2400 = ASSIGN	40
2401 = 100% VALUE	40
2402 = FORMAT	41
2403 = DISPLAY MODE	41
2420 = ASSIGN	42
2421 = 100% VALUE	42
2422 = FORMAT	43
2423 = DISPLAY MODE	43
2600 = ASSIGN	44
2601 = 100% VALUE	44
2602 = FORMAT	45
2603 = DISPLAY MODE	45
2620 = ASSIGN	46
2621 = 100% VALUE	46
2622 = FORMAT	47
2623 = DISPLAY MODE	47

3...

3000 = ASSIGN	49
3001 = UNIT TOTALIZER	49
3002 = TOTALIZER MODE	50
3003 = RESET TOTALIZER	50
3040 = SUM	51
3041 = OVERFLOW	51
3800 = RESET ALL TOTALIZERS	52
3801 = FAILSAFE MODE	52

4...

4000 = ASSIGN CURRENT OUTPUT	54
4001 = CURRENT SPAN	55
4002 = VALUE 0_4 mA	56
4003 = VALUE 20 mA	58
4004 = MEASURING MODE	59
4005 = TIME CONSTANT	62
4006 = FAILSAFE MODE	62
4040 = ACTUAL CURRENT	63
4041 = SIMULATION CURRENT	63
4042 = VALUE SIMULATION CURRENT	63
4080 = TERMINAL NUMBER	64

4200 = OPERATION MODE	65
4201 = ASSIGN FREQUENCY	66
4202 = START VALUE FREQUENCY	66
4203 = END VALUE FREQUENCY	67
4204 = VALUE f LOW	67
4205 = VALUE f HIGH	68
4206 = MEASURING MODE	70
4207 = OUTPUT SIGNAL	71,72
4208 = TIME CONSTANT	74
4209 = FAILSAFE MODE	74
4301 = ACTUAL FREQUENCY	87
4302 = SIMULATION FREQUENCY	87
4303 = VALUE SIMULATION FREQUENCY	88
4322 = SIMULATION PULSE	89
4323 = VALUE SIMULATION PULSE	90
4341 = ACTUAL STATUS	91
4342 = SIMULATION SWITCH POINT	91
4343 = VALUE SIMULATION SWITCH POINT	91
4380 = TERMINAL NUMBER	92
4700 = ASSIGN RELAY	93
4701 = ON-VALUE	94
4702 = SWITCH-ON DELAY	94
4703 = OFF-VALUE	94
4704 = SWITCH-OFF DELAY	95
4705 = MEASURING MODE	95
4706 = TIME CONSTANT	96
4740 = ACTUAL STATUS RELAY	97
4741 = SIMULATION SWITCH POINT	97
4742 = VALUE SIMULATION SWITCH POINT	97
4780 = TERMINAL NUMBER	98

5...

5000 = ASSIGN STATUS INPUT	103
5001 = ACTIVE LEVEL	103
5002 = MINIMUM PULSE WIDTH	103
5040 = ACTUAL STATUS INPUT	104
5041 = SIMULATION STATUS INPUT	104
5042 = VALUE SIMULATION STATUS INPUT	104
5080 = TERMINAL NUMBER	105

6...

6300 = TAG NAME	107
6301 = FIELDBUS ADDRESS	107
6302 = BAUDRATE	107
6303 = TRANSMISSION MODE	108
6304 = PARITY	108
6305 = BYTE ORDER	108
6306 = DELAY TELEGRAM REPLY	109
6307 = WRITE PROTECTION	109
6308 = SCAN LIST REGISTER 1 to 16	109
6400 = ASSIGN LOW FLOW CUT OFF	110
6402 = ON-VALUE LOW FLOW CUT OFF	110
6403 = OFF-VALUE LOW FLOW CUT OFF	110
6404 = PRESSURE SHOCK SUPPRESSION	111
6420 = EMPTY PIPE DETECTION	112
6423 = EPD VALUE LOW	112
6424 = EPD VALUE HIGH	112
6425 = EPD RESPONSE TIME	112
6426 = EPD EXC.CURR.	113

6460 = CORRECTED VOLUME CALCULATION.....	114
6461 = FIXED REFERENCE DENSITY.....	114
6462 = EXPANSION COEFFICIENT.....	114
6463 = EXPANSION COEFFICIENT SQUARE.....	114
6464 = REFERENCE TEMPERATURE.....	115
6480 = ZEROPOINT ADJUST.....	116
6482 = DENSITY ADJUST MODE.....	116
6483 = DENSITY SETPOINT 1.....	116
6484 = MEASURE FLUID 1.....	117
6485 = DENSITY SETPOINT 2.....	117
6486 = MEASURE FLUID 2.....	117
6487 = DENSITY ADJUST.....	117
6488 = RESTORE ORIGINAL.....	118
6500 = PRESSURE MODE.....	119
6501 = PRESSURE.....	119
6600 = INSTALLATION DIRECTION SENSOR.....	120
6602 = DENSITY DAMPING.....	120
6603 = FLOW DAMPING.....	120
6605 = POSITIVE ZERO RETURN.....	120
6800 = K-FACTOR.....	121
6803 = ZERO POINT.....	121
6804 = NOMINAL DIAMETER.....	121
6840 = TEMPERATURE COEFFICIENT KM.....	122
6841 = TEMPERATURE COEFFICIENT KM2.....	122
6842 = TEMPERATURE COEFFICIENT KT.....	122
6843 = CALIBRATION COEFFICIENT KD 1.....	122
6844 = CALIBRATION COEFFICIENT KD 2.....	122
6850 = DENSITY COEFFICIENT C0.....	123
6851 = DENSITY COEFFICIENT C1.....	123
6852 = DENSITY COEFFICIENT C2.....	123
6853 = DENSITY COEFFICIENT C3.....	123
6854 = DENSITY COEFFICIENT C4.....	123
6855 = DENSITY COEFFICIENT C5.....	123
6860 = MIN. TEMPERATURE MEASURED.....	124
6861 = MAX. TEMPERATURE MEASURED.....	124
6862 = MIN. TEMPERATURE CARRIER TUBE.....	124
6863 = MAX. TEMPERATURE CARRIER TUBE.....	124
8...	
8005 = ALARM DELAY.....	126
8007 = STORAGE.....	126
8040 = ACTUAL SYSTEM CONDITION.....	127
8041 = PREVIOUS SYSTEM CONDITION.....	127
8042 = SIMULATION FAILSAFE MODE.....	127
8043 = SIMULATION MEASURAND.....	128
8044 = VALUE SIMULATION MEASURAND.....	128
8046 = SYSTEM RESET.....	128
8048 = OPERATION HOURS.....	128
8100 = DEVICE SOFTWARE.....	129
8200 = SERIAL NUMBER.....	130
8201 = SENSOR TYPE.....	130
8205 = SW-REV. NUMBER S-DAT.....	130
8222 = SW-REV. NUMBER AMPLIFIER.....	131
8225 = SW-REV. NUMBER T-DAT.....	131
8226 = LANGUAGE GROUP.....	131
8300 = I/O MODULE TYPE.....	132
8303 = SW-REV. NO. I/O MODULE.....	132
8340 = SUB I/O MODULE TYPE 2.....	133
8343 = SW-REV NO. SUB I/O MODULE TYPE 2.....	133
8360 = SUB I/O MODULE TYPE 3.....	133
8363 = SW-REV NO. SUB I/O MODULE TYPE 3.....	133
8380 = SUB I/O MODULE TYPE 4.....	133
8383 = SW-REV NO. SUB I/O MODULE TYPE 4.....	133

Index

A

Access type	10
Active level	103
Actual	
Current	63
Frequency	87
Actual status	
Relay output	97
Status	91
Status input	104
Actual system condition	127
Additional coefficient	124
Additional configuration	19
Additional line	
Assign	40
Configuration	40
Display mode	41
Format	41
Multiplex	42
Assign	42
Display mode	43
Format	43
100% Value	42
100% Value	40
Alarm delay	126
Amplifier (version info)	131
Assign	
Additional line	40
Additional line (Multiplex)	42
Frequency (pulse/freq. output)	66
Information line	44
Information line (Multiplex)	46
Low flow cut off	110
Main line	36
Main line (Multiplex)	38
Pulse (pulse/freq. output)	76
Relay output	93
Status input	103
Status (pulse/freq. output)	82
Totalizer	49
Assign current output	54

B

Backlight	32
Basic configuration (user interface)	31
Basic functions	106
Baudrate	107
Block	
Basic functions	106
Custody transfer	12
Inputs	102
Measured variables	14
Outputs	53
Quick Setup	21
Supervision	125
Totalizer	48

User interface	30
Byte order	108

C

Calibration coefficient	
KD1	122
KD2	122
Code	
Access	33
Access counter	34
Configuration	
Additional line	40
Current output	54
Information line	44
Main line	36
MODBUS	
RS485	107
Process parameter	110
Pulse/frequency output	65
Relay output	93
Sensor data	121
Status input	103
System	126
System parameter	120
System units	16
Totalizer	49
Contrast LCD	32
Control	
Basic configuration	31
Operation	35
Unlocking/locking	33
Corrected Volume calculation	114
Corrected volume flow	15
Current output	
Actual current	63
Assign	54
Configuration	54
Current span	55
Failsafe mode	62
Information	64
Measuring mode	59
Operation	63
Simulation current	63
Terminal number	64
Time constant	62
Value simulation current	63
Value 0 to 4 mA	56
Value 20 mA	58
Current span	55
Curr. out. 1 C.T.	12

D

Damping	
Density	120
Display	31
Data type	10

Define private code	33	Amplifier	131
Delay resp. tele.	109	Basic configuration (user interface)	31
Density	15	Configuration	
Density adjustment	117	Additional line	40
Density coefficient		Current output	54
C0	123	Information line	44
C1	123	Main line	36
C2	123	MODBUS	
C3	123	RS485	107
C4	123	Process parameter	110
C5	123	Pulse/freq. output	65
Device software	129	Relay output	93
Display lines of local operation	10	Sensor data	121
Display mode		Status input	103
Additional line	41	System	126
Additional line (Multiplex)	43	System parameter	120
Information line	45	System units	16
Information line (Multiplex)	47	Totalizer	49
E		Density coefficient	123
EEPROM	10	Device	129
Empty pipe detection (EPD)	112	EPD parameter	112
End value frequency	67	Flow coefficient	122
EPD		Information	
Empty pipe detection	112	Current output	64
Exciting current	113	Pulse/Frequency output	92
Parameter	112	Relay output	98
Response time	112	Status input	105
Value high	112	Input/Output	133
Value low	112	I/O Module	132
Expansion coefficient	114	Main values	15
Square (reference parameter)	114	Multiplex	
F		Additional line	42
Factory settings		Information line	46
Full scale value	134	Main line	38
Low flow cut off	134	Operation	
Pulse value	134	Current output	63
Failsafe mode		Pulse/frequency output	87
Current span	62	Relay output	97
Frequency (pulse/freq. output)	74	Status input	104
Pulse (pulse/freq. output)	81	System	127
Totalizer	52	Totalizer	51
Fieldbus address	107	Operation (user interface)	35
Fixed		Pressure correction	119
Reference density	114	Reference parameter	114
Float	10	Sensor	129, 130
Flow damping	120	Unlocking/locking (display)	33
Format		Function matrix	
Additional line	41	Codes identifying	9
Additional line (Multiplex)	43	General layout	8
Information line	45	Overview	11
Information line (Multiplex)	47	G	
Main line	37	Group	
Main line (Multiplex)	39	Additional line	40
Function group		Control (user interface)	31
Additional coefficient	124	Current output	54
Additional configuration	19	Handling Totalizer	52
Adjustment	116	Information line	44
		Main line	36

Measuring values	15	Configuration	36
MODBUS		Format	37
RS485	107	Multiplex	38
Process parameter	110	Assign	38
Pulse/frequency output	65	Format	39
Relay output	93	100% Value	38
Sensor data	121	100% Value	36
Status input	103	Main values	15
System	126	Mapping reg. 1 to 16	109
System parameter	120	Mass flow	15
System units	16	Maximum	
Version Info	129	Medium temperature	124
H		Temperature carrier tube	124
Handling Totalizer	52	Max. writes	10
I		Measure	
Illustration of function description	10	Fluid 1	117
Information		Fluid 2	117
Current output	64	Measure fluid 1	117
Pulse/frequency output	92	Measure fluid 2	117
Relay output	98	Measured variables	14
Status input	105	Measuring mode	
Information line		Current span	59
Assign	44	Frequency (pulse/freq. output)	70
Configuration	44	Pulse (pulse/freq. output)	78
Display mode	45	Relay output	95
Format	45	Status (pulse/freq. output)	85
Multiplex	46	Measuring values	15
Assign	46	Main values	15
Display mode	47	Minimal	
Format	47	Temperature carrier tube	124
100% Value	46	Minimum	
100% Value	44	Medium temperature	124
Inputs	102	Minimum pulse width (status input)	103
Input/output 2 to 4	133	MODBUS configuration custody transfer	13
Installation direction sensor	120	MODBUS register	10
Integer	10	MODBUS	
I/O Module	132	RS485	107
I/O module type	132	Mode	
I/O submodule		Data transfer	108
Type 2	133	Density adjustment	116
Type 3	133	Multiplex	
Type 4	133	Additional line	42
K		Information line	46
K-Factor	121	Main line	38
L		N	
Language	31	Nominal diameter	121
Language group	131	O	
Local operation (display lines)	10	Off value	
Low flow cut off		Low flow cut off	110
Assign	110	Pulse/freq. output	84
Off value	110	Relay output	94
On value	110	On value	
M		Low flow cut off	110
Main line		Pulse/freq. output	83
Assign	36	Relay output	94
		Operation	
		Current output	63

Pulse/frequency output	87	Value simulation	90
Relay output	97	Status	
Status input	104	Actual	91
System	127	Assign status	82
Totalizer	51	Measuring mode	85
User interface	35	Off value	84
Operation hours	128	On value	83
Output signal		Simulation	91
Frequency (pulse/freq. output)	71, 72	Switch-off delay	84
Pulse (pulse/freq. output)	79	Switch-on delay	83
Outputs	53	Time constant	86
Overflow	51	Value simulation	91
P		Terminal number	92
Parity	108	Q	
Positive zero return	120	Quick Setup	21
Pressure	119	Commissioning	21
Correction	119	Communication	21
Mode	119	Gas measurement	21
Pressure shock suppression	111	Pulsating flow	21
Previous system condition	127	R	
Process parameter		Read	10
Adjustment	116	Reference density	15
Configuration	110	Fixed	114
EPD parameter	112	Reference Temperature	115
Pressure correction	119	Relay output	
Reference parameter	114	Actual status	97
Pulse		Assign	93
Value	76	Configuration	93
Width	77	Flow direction	99
Pulse out. 1 C.T.	12, 13	General	99
Pulse/frequency output		Information	98
Configuration	65	Limit value	99
Information	92	Measuring mode	95
Operation	87	Off value	94
Pulse/freq. output		On value	94
Frequency		Operation	97
Actual	87	Simulation switch point	97
Assign frequency	66	Switching behavior	100
End value frequency	67	Switch-off delay	95
Failsafe level	75	Switch-on delay	94
Failsafe mode	74	Terminal number	98
Measuring mode	70	Time constant	96
Output signal	71, 72	Value simulation switch point	97
Simulation	87	Reset	
Start value frequency	66	All totalizers	52
Time constant	74	System	128
Value F Low	67	Totalizer	50
Value simulation	88	Restore original	118
Value-f high	68	S	
Operation mode	65	Sensor data	
Pulse		Additional coefficient	124
Assign pulse	76	Configuration	121
Failsafe mode	81	Density coefficient	123
Measuring mode	78	Flow coefficient	122
Output signal	79	Sensor type	130
Pulse value	76	Sensor (Version info)	129
Pulse Width	77	Serial number	130
Simulation	89		

Setpoint		T-DAT Save/Load	22
Density 1	116	Temperature	15
Density 2	117	Temperature coefficient	
Simulation		KM	122
Current	63	KM2	122
Failsafe mode	127	KT	122
Frequency	87	Terminal number	
Measured variable	128	Current output	64
Pulse	89	Pulse/freq. output	92
Relay output	97	Relay output	98
Status input	104	Status input	105
Switch point	91	Test display	35
Start value frequency	66	Time constant	
Status access	33	Current span	62
Status input		Frequency (pulse/freq. output)	74
Active level	103	Relay output	96
Actual status	104	Status (pulse/freq. output)	86
Assign	103	Totalizer	48
Configuration	103	Assign	49
Information	105	Configuration	49
Minimum pulse width	103	Failsafe mode	52
Operation	104	Operation	51
Simulation	104	Overflow	51
Terminal number	105	Reset all totalizers	52
Value simulation	104	Reset totalizer	50
Storage	126	Sum	51
String	10	Totalizer Mode	50
Sum	51	Unit	49
Supervision	125	Totalizer Mode	50
SW revision number		Totalizers 1 to 3, custody transfer measurement	13
Amplifier	131		
I/O Module	132	U	
I/O submodule		Unit	
Type 2	133	Corrected volume	18
Type 3	133	Corrected volume flow	18
Type 4	133	Density	19
S-DAT	130	Length	20
T-DAT	131	Mass	16
Switching behavior of the relay output	100	Mass flow	16
Switch-off delay		Reference density	19
Pulse/freq. output	84	Temperature	20
Relay output	95	Totalizer	49
Switch-on delay		Volume	17
Pulse/freq. output	83	Volume flow	17
Relay output	94	Unlocking/locking (display)	33
System		User interface	30
Configuration	126	V	
Operation	127	Value	
System condition		EPD value high	112
Actual	127	EPD value low	112
Previous	127	F low	67
System parameter	120	Failsafe level	75
System reset	128	Simulation current	63
System units		Simulation frequency	88
Additional configuration	19	Simulation measurand	128
Configuration	16	Simulation Pulse	90
T		Simulation relay output	97
Tag Name	107	Simulation status input	104

Simulation switch point	91
0 to 4 mA	56
20 mA	58
Value F high	68
Version Info	
Amplifier	131
Input/output 1 to 4	133
I/O Module	132
Sensor	129
Volume flow	15
W	
Write	10
Write protection	109

Writes (max.)	10
---------------------	----

Z

Zero point	121
Zero point adjustment	116

Numbers

100% Value	
Additional line	40
Additional line (Multiplex)	42
Information line	44
Information line (Multiplex)	46
Main line	36
Main line (Multiplex)	38

www.addresses.endress.com
