



Security solutions
over plastic optical fiber

End user prices list 2020.1

Κεντρικό: ΠΛΑΣΤΗΡΑ 257 & ΑΙΟΛΟΥ 36, ΑΓ.ΑΝΑΡΓΥΡΟΙ
ΑΘΗΝΑ, ΤΗΛ.ΚΕΝΤΡΟ: 2102620250, FAX: 2102623805

Υποκατάστημα: ΣΜΥΡΝΗΣ 31, Ν.ΦΙΛΑΔΕΛΦΕΙΑ
ΑΘΗΝΑ, ΤΗΛ.2102525534, FAX:2102584495

www.tridimas.gr info@tridimas.gr

PROTECTION OF FLEXIBLE AND CHAIN-LINK FENCES

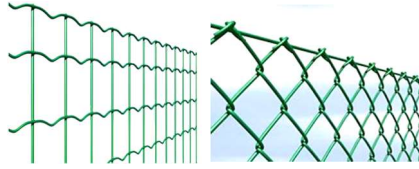

VIDEO:

<https://vimeo.com/183302281>



| Item | Description | Price |
|--------------|---|-------------|
| FKIT125M002K | Kit FENCE 125 – 2P (2 passages of fiber) Anti-climb over system for 125m of chain-link fence <i>Kit includes:</i> 1 LiteFENCE analyser, 250m LiteWIRE simplex anti-UV cable, 200 cable ties, 1 coupler, 25 tensioning bolts, 10 FSMA connectors, sand paper. | € 1,720.00 |
| FKIT250M002K | Kit FENCE 250 – 2P (2 passages of fiber) Anti-climb over system for 250m of chain-link fence <i>Kit includes:</i> 2 LiteFENCE analysers, 500m LiteWIRE simplex anti-UV cable, 300 cable ties, 1 coupler, 50 tensioning bolts, 10 FSMA connectors, sand paper. | € 3,328.00 |
| FKIT500M002K | Kit FENCE 500 (2 passages of fiber) Anti-climb over system for 500m of chain-link fence <i>Kit includes:</i> 4 LiteFENCE analysers, 1,000m LiteWIRE simplex anti-UV cable, 500 cable ties, 2 couplers, 100 tension bolts, 20 FSMA connectors, sand paper. | € 6,458.00 |
| FKIT1KMM002K | Kit FENCE 1000 – 2P (2 passages of fiber) Anti-climb over system for 1000m of chain-link fence <i>Kit includes:</i> 8 LiteFENCE analysers, 2,000m LiteWIRE simplex anti-UV cable, 1,000 cable ties, 4 couplers, 200 tension bolts, 30 FSMA connectors, sand paper. | € 12,540.00 |

EXAMPLES :

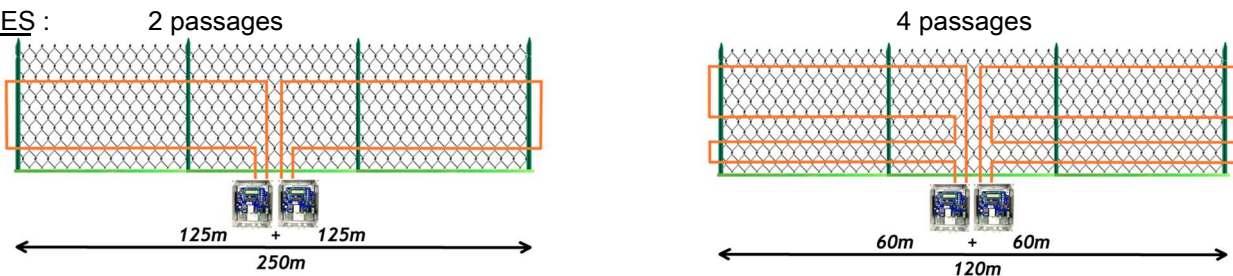

| Item | Description | Price |
|--------------|--|-------------|
| FKIT125M002K | Kit FENCE 80 – 3P (3 passages of fiber) Anti-climb over system for 80m of chain-link fence <i>Kit includes:</i> 1 LiteFENCE analyser, 250m LiteWIRE simplex anti-UV cable, 200 cable ties, 1 coupler, 25 tension bolts, 10 FSMA connectors, sand paper. | € 1,720.00 |
| FKIT250M002K | Kit FENCE 160 – 3P (3 passages of fiber) Anti-climb over system for 160m of chain-link fence <i>Kit includes:</i> 2 LiteFENCE analysers, 500m LiteWIRE simplex anti-UV cable, 300 cable ties, 1 coupler, 50 tensioning bolts, 10 FSMA connectors, sand paper. | € 3,328.00 |
| FKIT500M002K | Kit FENCE 320 – 3P (3 passages of fiber) Anti-climb over system for 320m of chain-link fence <i>Kit includes:</i> 4 LiteFENCE, 1,000m LiteWIRE simplex anti-UV cable, 500 cable ties, 2 couplers, 100 tensioning bolts, 20 FSMA connectors, sand paper | € 6,458.00 |
| FKIT1KMM002K | Kit FENCE 640 – 3P (3 passages of fiber) Anti-climb over system for 640m of chain-link fence <i>Kit includes:</i> 8 LiteFENCE, 2,000m LiteWIRE simplex anti-UV cable, 1,000 cable ties, 4 couplers, 200 tensioning bolts, 30 FSMA connectors, sand paper. | € 12,540.00 |

 In case you protect the fence with 3 passages of fiber, add one LiteFENCE TX (cod. LFEN300F011T) as a signal transmitter when the perimeter is linear or not closed.

EXAMPLE: 3 passages

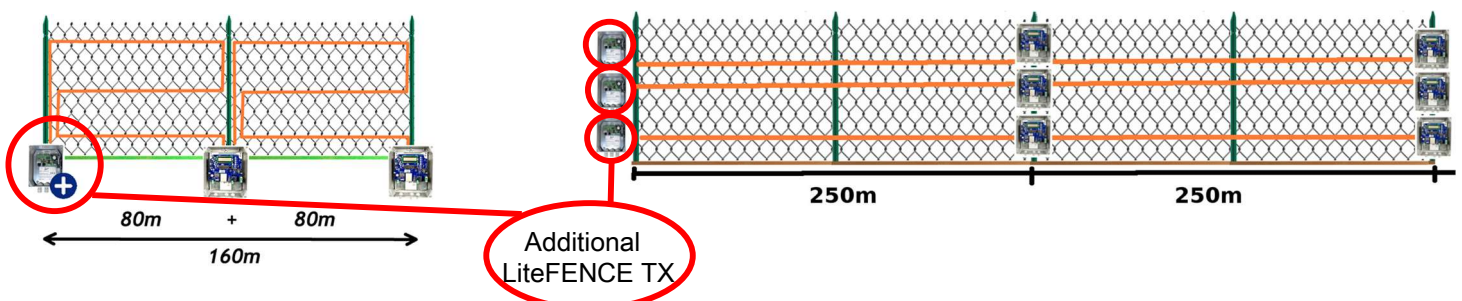

PROTECTION OF FENCES WITH BARBED WIRE



VIDEO

<https://vimeo.com/183292826>



| Item | Description | Price |
|--------------|--|------------|
| FKIT125M002B | Kit FENCE 125 BW Anti-climb over system on barbed wire for 125m of fence, 2 passages of fiber <u>Kit includes:</u> 1 LiteFENCE analyser, 250m LiteWIRE simplex anti-UV cable, 300 cable ties, 1 coupler, 25 tension bolts, 120 clips, 10 FSMA connectors sand paper. > Brackets are optional, not included | € 2,100.00 |
| FKIT250M002B | Kit FENCE 250 BW Anti-climb over system on barbed wire for 250m of fence, 2 passages of fiber <u>Kit includes:</u> 2 LiteFENCE analysers, 500m LiteWIRE simplex anti-UV cable, 800 cable ties, 1 coupler, 50 tension bolts, 250 clips, 10 FSMA connectors sand paper. > Brackets are optional, not included | € 4,090.00 |
| FKIT500M002B | Kit FENCE 500 BW Anti-climb over system on barbed wire for 500m of fence, 2 passages of fiber <u>Kit includes:</u> 4 LiteFENCE analysers, 1,000m LiteWIRE simplex anti-UV cable, 1,500 cable ties, 2 Couplers, 100 tension bolts, 500 clips, 20 FSMA connectors sand paper > Brackets are optional, not included | € 7.936.00 |

ESEMPIO: 2 passages of fiber on overhand brackets. L-shaped brackets can also be used.

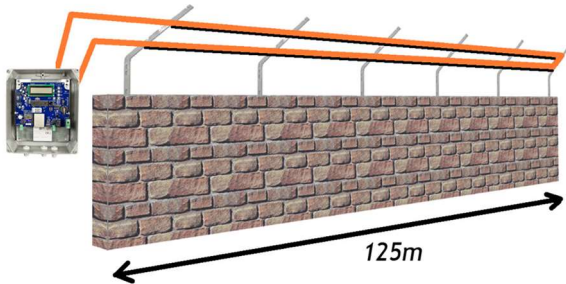

Overhang bracket



L-shaped bracket

PROTECTION OF FENCES WITH METAL ROPE



| Item | Description | Price |
|--------------|---|------------|
| FKIT080M002F | Kit FENCE 80 FM Anti-climb over system on metal rope for 80m of fence 2 passages of fiber <u>Kit includes:</u> 1 LiteFENCE analyser, 200m LiteWIRE simplex anti-UV cable, 300 cable ties, 1 coupler, 40 tension bolts, 80 clips, 10 FSMA connectors, sand paper. > Brackets are optional, not included | € 2,086.00 |
| FKIT160M002F | Kit FENCE 160 FM Anti-climb over system on metal rope for 160m of fence with 2 passages of fiber <u>Kit includes:</u> 2 LiteFENCE analysers, 2x200m LiteWIRE simplex anti-UV cable, 600 cable ties, 1 coupler, 80 tension bolts, 160 clips, 10 FSMA connectors, sand paper. > Brackets are optional, not included | € 4,012.00 |

EXAMPLE: 2 passages of fiber and L-shaped brackets. Overhang brackets can also be used

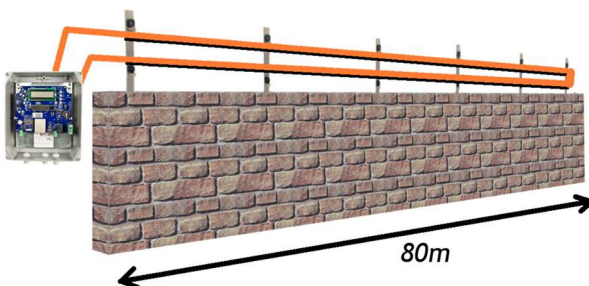

L-shaped bracket



Overhang bracket

PROTECTION OF TEMPORARY FENCES

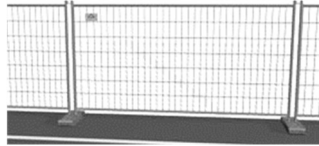

VIDEO:



<https://vimeo.com/206553892>

| Item | Description | Price |
|--------------|---|------------|
| FKIT050M001T | Kit FENCE MOBILE 50 Anti-climb over/anti-lift system for 50m of temporary fence <u>Kit includes:</u> 1 LiteFENCE, 30 fast bolts for armoured cable, 50m LiteWIRE Simplex armoured cable (already terminated with FSMA connectors), 1 coupler, 100 cable ties. | € 2,186.00 |
| FKIT100M001T | Kit FENCE MOBILE 100 Anti-climb over/anti-lift system for 100m of temporary fence <u>Kit includes:</u> 1 LiteFENCE, 60 fast bolts for armoured cable, 2x50m LiteWIRE Simplex armoured cable (already terminated with FSMA connectors), 1 coupler, 200 cable ties | € 3,307.00 |

EXAMPLE: closed perimeter

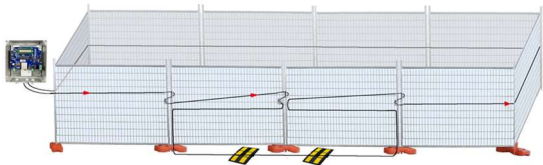

EXAMPLE: open perimeter



Add 1 LiteFENCE TX (item no. LFEN300F011T) as a signal transmitter if the perimeter is linear or not closed.

PROTECTION OF GRATINGS AND RIGID FENCES

VIDEO:



<https://vimeo.com/183304721>

- minimum height: 145cm

| Item | Description | Price |
|--------------|---|------------|
| FKIT100M0SVL | Kit FENCE SV Lite 100 Anti-climb over system for rigid electro-welded fences (height > 145cm) This kit protects up to 100mt fence <u>Kit includes:</u> 1 LiteFENCE Lite, 3 SV Lite pre-cabled (20m+20m) sensors, 2 couplers, 100 cable ties, 10 FSMA connectors, sand paper. Mounting brackets for the sensors are included. | € 1,372.00 |



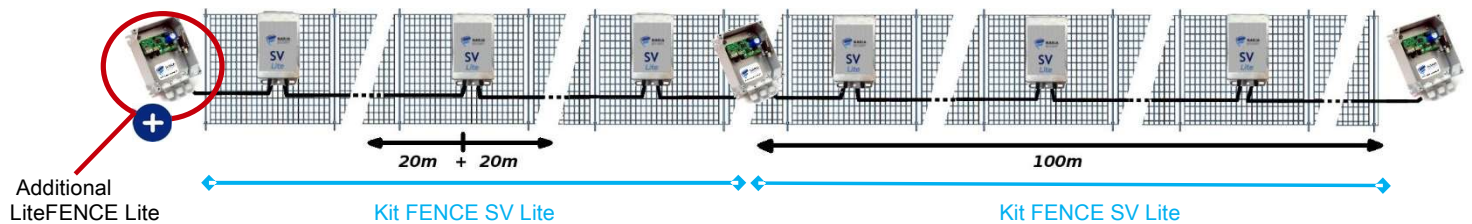

In case the perimeter is not a closed loop, add 1 LiteFENCE Lite analyser (item no. LFEN300F011L) as an initial signal transmitter:

EXAMPLE: around 200m fence



- minimum height: 110cm

| Item | Description | Price |
|--------------|--|------------|
| FKIT060M00SV | <p>Kit FENCE SV 100 Anti-climb over system for rigid electro-welded fences (height > 110cm) This kit protects up to 100mt fence Kit includes: 1 LiteFENCE analyser, 3 SV Lite pre-cabled (20m+20m) sensors, 2 couplers, 100 cable ties, 10 FSMA connectors, sand paper. Mounting brackets for the sensors are included.</p>  | € 2,094.00 |

 In case the perimeter is not a closed loop, add 1 LiteFENCE TX (item no. LFEN300F011T) as an initial signal transmitter:

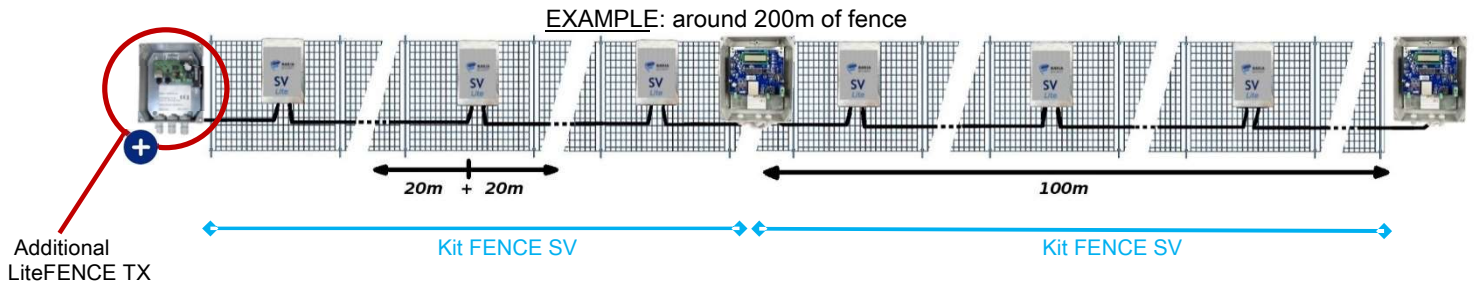

THEFT DETECTION FOR COPPER WIRES

- in underground ducts

VIDEO:  <https://vimeo.com/183304977>

| Item | Description | Price |
|--------------|---|------------|
| CKIT250L002C | <p>Kit COPPER 250 DUCTS Theft detector for 250m of cable in underground ducts and for 10manhole lids Kit includes: 1 LiteCOPPER TX transmitter, 1 LiteCOPPER analyser, 10 fast bolts for armoured cable to be attached to manhole lids, 250m LiteWIRE Simplex cable with double armouring, 100 Cable ties, 10 FSMA connectors, sand paper.</p> | € 2,647.00 |
| CKIT500L003C | <p>Kit COPPER 500 DUCTS Theft detector for 500m of cable in underground ducts and for 20 manhole lids Kit includes: 1 LiteCOPPER TX transmitter, 2 LiteCOPPER analysers, 20 fast bolts for armoured cable to be attached to manhole lids, 500m LiteWIRE Simplex cable with double armouring, 300 Cable ties, 10 FSMA connectors, sand paper.</p> | € 4,727.00 |
| CKIT1000L05C | <p>Kit COPPER CORRUGATI 1000 Theft detector for 1000m of cable in underground ducts and for 40 manhole lids Kit includes: 1 LiteCOPPER TX transmitter, 4 LiteCOPPER analysers, 40 fast bolts for armoured cable to be attached to manhole lids, 1000 LiteWIRE Simplex cable with double armouring, 500 cable ties, 20 FSMA connectors, sand paper.</p> | € 8,280.00 |

ESEMPIO: Theft detection of copper cable laid in underground ducts, and opening detection of manhole lids.



- in cable trays

| Item | Description | Prezzo |
|--------------|--|------------|
| CKIT250L002P | <p>Kit COPPER 250 CABLE TRAY Theft detector for 250m of cable in cable tray Kit includes: 1 LiteCOPPER TX transmitter, 1 LiteCOPPER analyser, 500m LiteWIRE Simplex, 25 fast bolts to be attached to the lids of cable tray, 100 cable ties, 10 FSMA connectors, sand paper.</p> | € 1,912.00 |
| CKIT500L003P | <p>Kit COPPER 500 CABLE TRAY Theft detector for 250m of cable in cable tray Kit includes: 1 LiteCOPPER TX transmitter, 2 LiteCOPPER analysers, 500m LiteWIRE Simplex, 50 fast bolts to be attached to the lids of cable tray, 300 cable ties, 10 FSMA connectors, sand paper.</p> | € 3,083.00 |

ESEMPIO: Theft detection of copper cable laid in cable trays, and opening detection of the lids.

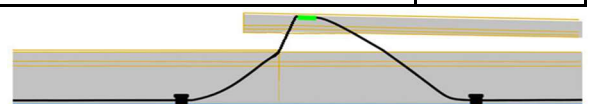

ANTI-THEFT SYSTEM FOR PHOTOVOLTAIC PANELS



VIDEO:

<https://vimeo.com/261131412>

| Item | Description | Price |
|---------------|---|------------|
| SKIT200M50KW | Kit SUN 50kW* Anti-theft system for 200 solar panels (ground mounted) <u>Kit includes:</u> 250m LiteWIRE Anti-UV Simplex cable, 1 LiteSUN analyser, 200 drilled bolts, 10 FSMA connectors, sand paper. | € 985.00 |
| SKIT200P50KWC | Kit SUN Plus 50kW (with glue) Anti-theft system for 200 solar panels (ground mounted) (fiber cut + bend detection) <u>Kit includes:</u> 250m LiteWIRE Anti-UV simplex cable, 1 LiteSUN Plus analyser, 2 drums of glue, 400 omega clips, 10 FSMA connectors, sand paper. > Every plant where glue is used must have at least one "LiteSUN Plus analyser with built-in Power Meter" | € 1,305.00 |
| SKIT200P50KW | Kit SUN Plus 50kW * (with fast bolts) Anti-theft system for 200 solar panels (ground mounted) (fiber cut + bend detection) <u>Kit includes:</u> 250m LiteWIRE Anti-UV simplex cable, 1 LiteSUN Plus analyser, 200 fast bolts, 10 FSMA connectors, sand paper. | € 1,769.00 |

ANTI-THEFT SYSTEM FOR PHOTOVOLTAIC PANELS for small dimension plants

Analysing boards with plug in connectors
No termination kit required!



- only cut of LiteWIRE cable is detected

| Item | Description | Price |
|--------------|---|----------|
| FILO025C001S | Kit SUN 3Kw* Anti-theft system for 15 solar panels mounted on rooftop <u>Kit includes:</u> 25m Anti-UV simplex cable, 1 analyser (only fiber cut sensitive, plug-in connectors), 1 indoor power supply, 15 pins for rooftop installations, 1 cutter. | € 298.00 |
| FILO050C001S | Kit SUN 6kW* Anti-theft system for 30 solar panels mounted on rooftop <u>Kit includes:</u> 50m Anti-UV simplex cable, 1 analyser (only fiber cut sensitive, plug-in connectors), 1 indoor power supply, 30 pins for rooftop installations, 1 cutter. | € 353.00 |
| FILO100C001S | Kit SUN 10kW* Anti-theft system for 60 solar panels mounted on rooftop <u>Kit includes:</u> 100m Anti-UV simplex cable, 1 analyser (only fiber cut sensitive, plug-in connectors), 1 indoor power supply, 60 pins for rooftop installations, 1 cutter. | € 483.00 |

- both bend and cut of LiteWIRE cable are detected

| Item | Description | Price |
|--------------|--|----------|
| FILO025C001P | Kit SUN Plus 3Kw* Anti-theft system for 15 solar panels mounted on ground <u>Kit includes:</u> 25m Anti-UV simplex cable, 1 analyser (both bend and cut sensitive, plug-in connectors), 1 indoor power supply, 15 fast bolts, 1 cutter. | € 654.00 |
| FILO050C001P | Kit SUN Plus 6Kw* Anti-theft system for 30 solar panels mounted on ground <u>Kit includes:</u> 50m Anti-UV simplex cable, 1 analyser (both bend and cut sensitive, plug-in connectors), 1 indoor power supply, 30 fast bolts, 1 cutter. | € 721.00 |
| FILO100C001P | Kit SUN Plus 10kW* Anti-theft system for 60 solar panels mounted on ground <u>Kit includes:</u> 100m Anti-UV simplex cable, 1 analyser (both bend and cut sensitive, plug-in connectors), 1 indoor power supply, 60 fast bolts, 1 cutter. | € 865.00 |

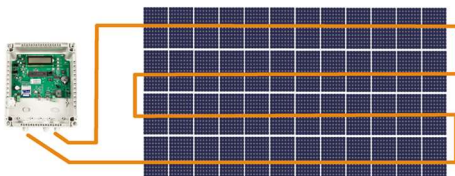

* Approximate dimensions, calculated considering a 250W panel of 1x1.6m laid as shown in the pictures. If the installation is different, the quantity of bolts/pins/fiber could be different to protect all the. We recommend getting in touch with us.

THEFT DETECTOR FOR EQUIPMENT ON FARMS AND JOB SITES

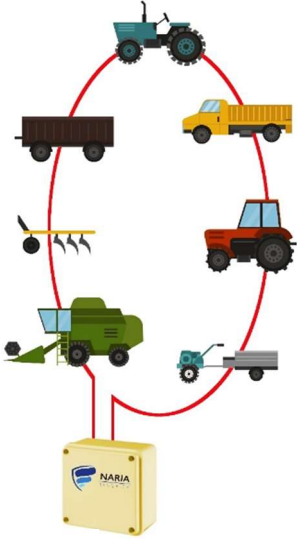



VIDEO:



<https://vimeo.com/205865129>

| Item | Description | Price |
|--------------|--|------------|
| AMINI210011S | Theft detector for equipment - MINI - LiteFARM Mini, analysing board only sensitive to cut of fiber LiteWIRE - 2x10mt alarmed patch - 1 coupler | € 432.00 |
| APLUS210011S | Theft detector for equipment - PLUS - LiteFARM Plus, analysing board sensitive both to bend and cut of fiber LiteWIRE - 2x10mt alarmed patch - 1 coupler | € 1,054.00 |

The composition of a kit can be easily customised, choosing the type of analysing board, the number and length of alarmed patch, adding an outdoor casing and/or GSM dialler.

| Item | Description | Price |
|--------------|--|------------------|
| LCUT300S011A |  LiteFARM Mini Analysing board only sensitive to the cut of plastic fiber LiteWIRE, IP55 casing | € 261.00 |
| LFAR300P011S |  LiteFARM Plus Analysing board sensitive both to cut and bend of fiber LiteWIRE, I IP55 casing. | € 943.00 |
| | Outdoor transportable box – Customized product - 230V power inlet - 3 open collector outputs (low battery, overload, network) Batteries not included: for 3 days, one battery (12V 48Ah) is recommended SIZE:45cm x 22cm x h.52cm | Price on request |
| | GSM Mini alarm panel – Product available on request - can be programmed/managed via SMS (functions and I/O) - Buzzer when switching on/off the alarm - contact ID transmission - Message for no power/low battery - Anti-jammer and life-test functions - SMS and/or vocal messages to up to 8 telephone numbers - Memory of 16.000 events | Price on request |
| SMAA001M022M |  Coupler to connect patches to each other. | € 19.80 |
| PATC000N005A | 5m alarmed patch of armoured LiteWIRE cable, pre-terminated with reinforced FSMA connectors (max. 9 x 5mt patches for every analyser). | € 75.00 |
| PATC000N010A | 10m alarmed patch of armoured LiteWIRE cable, pre-terminated with reinforced FSMA connectors (max. 7 x 10mt patches for every analyser). | € 96.00 |
| PATC000N015A | 15m alarmed patch of armoured LiteWIRE cable, pre-terminated with reinforced FSMA connectors (max. 6 x 15mt patches for every analyser). | € 124.00 |
| PATC000N020A | 20m alarmed patch of armoured LiteWIRE cable, pre-terminated with reinforced FSMA connectors (max. 5 x 20mt patches for every analyser). | € 149.00 |
| PATC000N050A | 50m alarmed patch of armoured LiteWIRE cable, pre-terminated with reinforced FSMA connectors (max. 2 x 50mt patches for every analyser). | € 291.00 |

ANALYSERS

| Item no | Description | | Price |
|--------------|---|---|------------|
| LFEN300F011S |  | <p>LiteFENCE Analyser for anti-climb fence protection It detects the variations in power of the luminous signal, i.e. <u>cut and bend</u> of the plastic fiber. It manages up to 300m of plastic fiber LiteWIRE⁽¹⁾. Optical power meter is in-built. Alarm output: normally closed relay both optical and electrical.</p> | € 1,061.00 |
| LFEN300F011L |  | <p>LiteFENCE Lite Analyser for anti-climb fence protection Use only with SV Lite sensors. It manages up to 3 SV Lite sensors. Alarm output: normally closed relay.</p> | € 477.00 |
| LFEN300F011T |  | <p>LiteFENCE TX Transmitter; to be used in combination with LiteFENCE as a receiver (e.g. in case of 3 passages of fiber on flexible fences in open perimeters). It manages up to 300m of plastic fiber LiteWIRE⁽¹⁾.</p> | € 472.00 |
| LCOP300C011S |  | <p>LiteCOPPER Analyser for the protection of copper cables and manhole lids It detects the variations in power of the luminous signal, i.e. <u>cut and bend</u> of the plastic fiber. It manages up to 300m of plastic fiber LiteWIRE⁽¹⁾. Optical power meter is in-built. Alarm output: normally closed relay.</p> | € 1,160.00 |
| LFEN300F011T |  | <p>LiteCOPPER TX Transmitter; to be used in combination with LiteCOPPER as a receiver</p> | € 472.00 |
| LCUT300S011S |  | <p>LiteSUN Analyser (<u>cut sensitive only</u>) for the protection of solar panels This transceiver detects the <u>cut</u> of the plastic fiber. It can be used as a transmitter, as a receiver or as an amplifier, in combination with other LiteSUN analysers. It manages up to 300m of plastic fiber LiteWIRE⁽¹⁾. Alarm output: normally closed relay.</p> | € 215.00 |
| LSUN300P011S |  | <p>LiteSUN Plus Analyser for the protection of solar panels It detects the variations in power of the luminous signal, i.e. <u>cut and bend</u> of the plastic fiber. It manages up to 300m of plastic fiber LiteWIRE⁽¹⁾. Alarm output: normally closed relay.</p> | € 897.00 |
| LSUN300PM11S |  | <p>LiteSUN Plus with built-in Power Meter In addition, it has a built-in optical power meter to measure the optical power of the signal.</p> | € 975.00 |
| LSUN300P011A |  | <p>LiteSUN Plus AMPLI Amplifier for LiteSUN Plus It amplifies the signal received from a LiteSUN Plus analyser. It manages up to 300m of plastic fiber LiteWIRE⁽¹⁾.</p> | € 564.00 |









⁽¹⁾ These equivalent distances can be reached considering a correct installation of the fiber and WITHOUT AFFIXING ELEMENTS. In addition, passages on edges, misplaced or over-tightened cable ties and mechanical stresses on the fiber can increase the attenuation of the optical signal, reducing, even considerably, the maximum operating range, even preventing the system from working correctly.

SIGNAL CONVERTERS

NORMALLY CLOSED SIGNAL (N.C.)

| Item | Description | Price |
|--------------|---|----------|
| LCUT300NC11S | RX per NC Receiver for normally closed contact. To be used in combination with LiteFENCE/LiteCOPPER. It manages up to 300mt of plastic fiber LiteWIRE ⁽¹⁾ . | € 215.00 |
| LBAS300N001C | TX-RX per NC Transceiver for normally closed contact. It manages up to 300mt of plastic fiber LiteWIRE ⁽¹⁾ . For LiteSUN Plus only: the transmitter is mounted on the LiteSUN Plus board; the receiver is a separate device. Transmitter already built in LiteFENCE and LiteCOPPER. | € 293.00 |





VIDEO ANALOGICO

| Item | Description | Price |
|--------------|---|----------|
| VIDEOHD002S |  HD VIDEO SYSTEM 200 Transmitter + Receiver for CCTV AHD and Full HD signal, manual gain adjustment. It also supports PAL/NTSC It manages up to 200mt of plastic fiber LiteWIRE ⁽¹⁾  PLUG-IN CONNECTORS (no termination kit required) | € 306.00 |
| VIDA300C150S |  VIDA300 S Transmitter + Receiver. Converts for analogue PAL/NTSC signal, automatic gain adjustment, max. 300mt ⁽¹⁾ | € 327.00 |
| VIDA300R151R |  VIDA300 AMPLI Signal (PAL/NTSC) amplifier with automatic gain adjustment (max. 30dB) ⁽¹⁾ | € 254,00 |
| VIDEOHD002T |  VIDEO Transmitter Transmitter for all VIDA receivers (PAL/NTSC, AHD and Full HD signals)  PLUG-IN CONNECTORS | € 91.00 |
| VIDEOHD002R |  VIDEO HD 200 Receiver AHD and Full HD receiver (it also supports PAL/NTSC), manual gain adjustment. (max. 200mt) ⁽¹⁾  PLUG-IN CONNECTORS | € 225.00 |
| VIDA300S002R |  VIDA300 Receiver Receiver for PAL/NTSC signal, with automatic gain adjustment, max.300mt ⁽¹⁾ . | € 232.00 |

RS485

| Item | Description | Price |
|--------------|---|----------|
| SER4300C000B |  RS485 BIDI Transmitter + Receiver for bi-directional signals, max. 300mt ⁽¹⁾ . It is used with LiteWIRE Duplex cable for bi-directionality | € 327.00 |

ETHERNET

| Item | Description | Price |
|--------------|--|----------|
| VDIP101S002P |  VIDA IP MC Ethernet converter, 100Mbit up to 100m ⁽¹⁾ :1 optical port + 1 RJ45 port. | € 344.00 |
| VDIP202S004P |  VIDA IP SW Ethernet switch, 100Mbit up to 100m ⁽¹⁾ : 2 optical ports + 2 RJ45 ports. | € 704.00 |
| VDIP202S004S |  VIDA IP SW + SFP As above + 1Gbit SFP Uplink to create mixed connections plastic fiber/glass fiber | € 842.00 |
| VIDEOIP2025 |  VIDA IP SW 200 New Ethernet switch (2x optical ports + 2x RJ45 ports) Ethernet 100Mbit up to 200m ⁽¹⁾ | € 704.00 |

⁽¹⁾ These equivalent distances can be reached considering a correct installation of the fiber and WITHOUT AFFIXING ELEMENTS. In addition, b passages on edges, misplaced or over-tightened cable ties and mechanical stresses on the fiber can increase the attenuation of the optical signal reducing, even considerably, the maximum operating range, even preventing the system from working correctly.

LITEWIRE – PLASTIC OPTICAL FIBER CABLE

| Item | Description | Price |
|--------------|--|------------|
| LEA1100B022M | LiteWIRE Simplex Anti-UV – cable per meter | € 2.07/mt |
| LPL1025P022M | LiteWIRE Simplex Anti-UV - 250m | € 446.00 |
| LPL1050P022M | LiteWIRE Simplex Anti-UV - 500m | € 836.00 |
| LPL1100P022M | LiteWIRE Simplex Anti-UV - 1000m | € 1,643.00 |

Suitable for outdoor use: jacket with specific anti-UV filters, according to regulations UL1581 section 1200, UL 2556, ISO 4892-2, EN50289-4-17 and ASTM D 2565EN5).
LSZH (Low Smoke Zero Halogen)

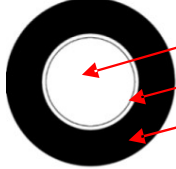
- A) Core: PoliMetilMetAcrylate (PMMA) 980um
- B) Cladding: 20um fluorinated polymer
- C) Jacket: M1 quality, self-lubricating low friction high density polyethylene (HDPE with anti-UV additives).

| | | |
|--------------|---|------------|
| TOL2025V044P | LiteWIRE Duplex Anti-UV - cable per meter | €3.10/mt |
| TOL2025V044P | LiteWIRE Duplex Anti-UV - 250m | € 677.00 |
| TOL2050V044P | LiteWIRE Duplex Anti-UV - 500m | € 1,305.00 |
| TOL2100V044P | LiteWIRE Duplex Anti-UV - 1000m | € 2,593.00 |

Suitable for outdoor use: jacket with specific anti-UV filters, according to regulations UL1581 section 1200, UL 2556, ISO 4892-2, EN50289-4-17 and ASTM D 2565EN5).
LSZH (Low Smoke Zero Halogen)



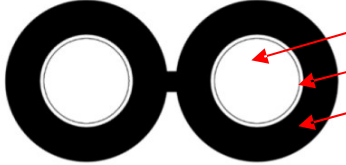



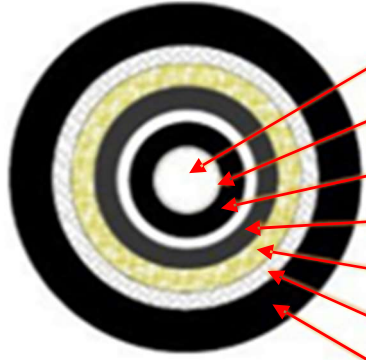









- A) Core: PoliMetilMetAcrylate (PMMA) 980um
- B) Cladding: 20um fluorinated polymer
- C) M1 quality, self-lubricating low friction high density polyethylene (HDPE with anti-UV additives).





| | | |
|--------------|--|------------|
| KEY1100B050E | LiteWIRE Simplex anti-rodent, double armouring – cable per meter. (in multiples of 50m) | € 4.90/m |
| KEY0250B050E | LiteWIRE Simplex anti-rodent, double armouring - 250m | € 1,139.00 |
| KEY0500B050E | LiteWIRE Simplex anti-rodent, double armouring - 500m | € 2,162.00 |

- A) Core: PoliMetilMetAcrylate (PMMA)
- B) Cladding: fluorinated polymer
- C) Fiber jacket: PE-HD, M1 quality
- D) Primary armouring: steel reinforced spiral
- E) Tensile elements: aramid yarns – Kevlar
- F) Secondary armouring: Steel mesh
- G) Outer jacket: PE

ACCESSORIES

| Item | Description | Price |
|---------------|--|-----------------------------|
| BULF0D210110 |  Tensioning bolt for attaching the fiber to the posts of flexible fences/barbed wire (1 bolt every 10m of fiber) and of metal rope (1 every 4m of fiber) | € 9.83 |
| CLIP001S000P |  Mounting clip for bracket (10pcs/pack) To keep barbed wire/metal rope + plastic fiber attached on every bracket. 1 clip for every passage on bracket (1 bracket every 2m) | € 29.80 |
| VBRS025S000L |  SV Lite sensor For gratings with height ≥ 145 cm: used with LiteFENCE Lite analyser (max.3 sensors for every LiteFENCE Lite) OR for gratings and rigid fences with height ≥ 145 cm used with LiteFENCE analyser (max.3 sensors for every analyser) Every sensor is pre-cabled with 2x20m patches of fiber. > Mounting brackets are included. | € 413.00 |
| GOLF580G060Z |  Fast bolt for armoured cable To be attached to the lid of the manhole or to a temporary fence | € 32.60 |
| BULS020M006 |  Fast bolt To be attached to the cover of cable trays (combined with LiteCOPPER analyser) or to the frame of solar panels (combined with LiteSUN Plus) VIDEO: https://vimeo.com/188273923  | € 2.26 |
| 3MSCOTCH160M |  Structural adhesive tape 16m; used only with LiteSUN PLUS, for solar panels on rooftop, where the rear of the panels is hardly accessible. | € 222.00 |
| COLL100P400G |  Glue For outdoor, UV resistant. One drum is enough for affixing the fiber to around 100 photovoltaic panels. To be used only with LiteSUN Plus | Price depending on quantity |
| CLOM100P200P |  Omega Clip For affixing the fiber to the panels using the slots on the frame. One pack is enough for 100 panels (2 clips every panel). To be used only with glue COLL100P400G and LiteSUN Plus. 1 pack= 200pcs | Price depending on quantity |
| BULS010M006I |  Drilled bolt (M6x6) For ground installations. Composed of one drilled bolt (head 15mm) and a 15x35mm nut, to be installed in PV panels mounting holes | € 2.03 |
| BULS010M012T |  Drilled pin Only for rooftop installations where the mounting holes on the frame are not accessible | € 1.22 |
| |  Overhang bracket/L shaped bracket – Customised product For barbed wire/metal rope, drilled for clips and tensioning bolts. They are manufactured on request and specifically for 2,3 or 4 passages of fiber, according to the customer's needs. One bracket every 2m. | Price on request |
| iPOLF100A000W |  Sand paper 5um | € 6.38 |
| PUCK001M022M |  Polishing disc for FSMA metal connectors | € 51.45 |
| SMAA001M022M |  Coupler To be used with 2 FSMA connectors, it increases attenuation by 2dB. | € 19.80 |
| SMAC001M022M |  FSMA connector Metal connector with protective rubber boot, 10pcs per pack. | € 60.00 |

| Item | Description | Price |
|--------------|---|------------|
| SMAK001M022M | <p>LiteWIRE termination and reparation kit</p>  <p>Tool-case containing: cutter, crimping tool, automatic cable stripper, 20 FSMA connectors, 2 couplers for reparations, polishing disc for FSMA, 5um sand paper.</p> <p>VIDEO: https://vimeo.com/188277133</p>  | € 400.00 |
| KITD001A001N | <p>"Naria Security" demo and assistance toolkit</p>  <p>This tool-case contains:</p> <ul style="list-style-type: none"> - Tool-case containing: cutter, crimping tool, automatic cable stripper, 20 FSMA connectors, 2 couplers for reparations, polishing disc for FSMA, 5um sand paper. - LiteFENCE on a panel - battery powered - patch-cord in plastic fiber with transparent jacket, to see the light signal passing through the fiber and understand how the analyser works - patch cord with black jacket (anti-UV) - samples of fixing bolts: tensioning bolt, drilled bolt, fast bolt, fast bolt for anti-rodent cable, easy bolt, clip <p>VIDEO: https://vimeo.com/286515820</p>  | € 1,498.00 |

*Οι τιμές είναι λιανικής και δεν περιλαμβάνουν ΦΠΑ

*Retail prices without VAT

