

EPSON

Robot Controller RC620 Option

Fieldbus I/O

Rev.8

EM15XC3082F

Robot Controller RC620 Option Fieldbus I/O Rev.8

Robot Controller RC620 Option

Fieldbus I/O

Rev.8

Copyright © 2009-2015 SEIKO EPSON CORPORATION. All rights reserved.

FOREWORD

This manual contains important information necessary to use the robot controller option Fieldbus I/O properly and safely. This manual is intended for personnel who perform any operations using the pendant, such as teaching robot points.

Please thoroughly read this manual and other related manuals before and while using the equipment.

WARRANTY

The robot and its optional parts are shipped to our customers only after being subjected to the strictest quality controls, tests, and inspections to certify its compliance with our high performance standards.

Product malfunctions resulting from normal handling or operation will be repaired free of charge during the normal warranty period. (Please ask your supplier for warranty period information.)

However, customers will be charged for repairs in the following cases (even if they occur during the warranty period):

1. Damage or malfunction caused by improper use which is not described in the manual, or careless use.
2. Malfunctions caused by customers' unauthorized disassembly.
3. Damage due to improper adjustments or unauthorized repair attempts.
4. Damage caused by natural disasters such as earthquake, flood, etc.

Warnings, Cautions, Usage:

1. If the robot or associated equipment is used outside of the usage conditions and product specifications described in the manuals, this warranty is void.
2. If you do not follow the WARNINGS and CAUTIONS in this manual, we cannot be responsible for any malfunction or accident, even if the result is injury or death.
3. We cannot foresee all possible dangers and consequences. Therefore, this manual cannot warn the user of all possible hazards.

TRADEMARKS

Microsoft, Windows, and Windows logo are either registered trademarks or trademarks of Microsoft Corporation in the United States and/or other countries. Other brand and product names are trademarks or registered trademarks of the respective holders.

TRADEMARK NOTATION IN THIS MANUAL

Microsoft® Windows® XP Operating system

Microsoft® Windows® Vista Operating system

Microsoft® Windows® 7 Operating system

Throughout this manual, Windows XP, Windows Vista, and Windows 7 refer to above respective operating systems. In some cases, Windows refers generically to Windows XP, Windows Vista, and Windows 7.

NOTICE

No part of this manual may be copied or reproduced without authorization.

The contents of this manual are subject to change without notice.

Please notify us if you should find any errors in this manual or if you have any comments regarding its contents.

INQUIRIES

Contact the following service center for robot repairs, inspections or adjustments.
If service center information is not indicated below, please contact the supplier for your region.

Please prepare the following items before you contact us.

- Your controller model and its serial number
- Your manipulator model and its serial number
- Software and its version in your robot system
- A description of the problem

SERVICE CENTER

MANUFACTURER

Seiko Epson Corporation

Toyoshina Plant

Robotics Solutions Operations Division

6925 Toyoshina Tazawa,

Azumino-shi, Nagano, 399-8285

Japan

TEL : +81-(0)263-72-1530

FAX : +81-(0)263-72-1495

SUPPLIERS

North & South America **Epson America, Inc.**
Factory Automation/Robotics
18300 Central Avenue
Carson, CA 90746
USA
TEL : +1-562-290-5900
FAX : +1-562-290-5999
E-MAIL : info@robots.epson.com

Europe **Epson Deutschland GmbH**
Factory Automation Division
Otto-Hahn-Str.4
D-40670 Meerbusch
Germany
TEL : +49-(0)-2159-538-1391
FAX : +49-(0)-2159-538-3170
E-MAIL : robot.infos@epson.de

China	<p>Epson (China) Co., Ltd. Factory Automation Division 7F, Jinbao Building No. 89, Jinbao Street, Dongcheng District, Beijing, China, 100005 TEL : +86-(0)-10-8522-1199 FAX : +86-(0)-10-8522-1120</p>
Taiwan	<p>Epson Taiwan Technology & Trading Ltd. Factory Automation Division 14F, No.7, Song Ren Road, Taipei 110, Taiwan, ROC TEL : +886-(0)-2-8786-6688 FAX : +886-(0)-2-8786-6677</p>
Korea	<p>Epson Korea Co., Ltd. Marketing Team (Robot Business) 27F DaeSung D-Polis A, 606 Seobusaet-gil, Geumcheon-gu, Seoul, 153-803 Korea TEL : +82-(0)-2-3420-6692 FAX : +82-(0)-2-558-4271</p>
Southeast Asia	<p>Epson Singapore Pte. Ltd. Factory Automation System 1 HarbourFront Place, #03-02, HarbourFront Tower One, Singapore 098633 TEL : +65-(0)-6586-5696 FAX : +65-(0)-6271-3182</p>
India	<p>Epson India Pvt. Ltd. Sales & Marketing (Factory Automation) 12th Floor, The Millenia, Tower A, No. 1, Murphy Road, Ulsoor, Bangalore, India 560008 TEL : +91-80-3051-5000 FAX : +91-80-3051-5005</p>
Japan	<p>Epson Sales Japan Corporation Factory Automation Systems Department Nishi-Shinjuku Mitsui Bldg.6-24-1 Nishishinjuku, Shinjuku-ku, Tokyo 160-8324 Japan TEL : +81-(0)3-5321-4161</p>

Before Reading This Manual

This section describes what you should know before reading this manual.

Safety Precautions



Installation and transportation of robots and robotic equipment shall be performed by qualified personnel and should conform to all national and local codes.

Please carefully read this manual and other related manuals before installing the robot system or before connecting cables.

Keep this manual handy for easy access at all times. Please read the Safety chapter in User's Guide to understand safety requirements before installing the robot system.

Conventions

Important safety considerations are indicated throughout the manual by the following symbols. Be sure to read the descriptions shown with each symbol.

 WARNING	This symbol indicates that a danger of possible serious injury or death exists if the associated instructions are not followed properly.
 WARNING	This symbol indicates that a danger of possible harm to people caused by electric shock exists if the associated instructions are not followed properly.
 CAUTION	This symbol indicates that a danger of possible harm to people or physical damage to equipment and facilities exists if the associated instructions are not followed properly.

Security support for the network connection

The network connecting function (Ethernet) on our products assumes the use in the local network such as the factory LAN network. Do not connect to the external network such as the Internet.

In addition, please take security measure such as the antivirus software to block the virus from the network connection.

Security support for the USB memory

Make sure that the USB memory is not infected with virus when connecting to the Controller.

1. Introduction	1
1.1 Overview of Fieldbus I/O.....	1
1.2 DeviceNet	2
1.2.1 Overview of DeviceNet.....	2
1.2.2 Features of DeviceNet	2
1.2.3 General Specifications	4
1.3 PROFIBUS DP	5
1.3.1 Overview of PROFIBUS DP	5
1.3.2 Features of PROFIBUS DP.....	5
1.3.3 General Specifications	6
1.4 EtherNet/IP	7
1.4.1 Overview of EtherNet/IP.....	7
1.4.2 Features of EtherNet/IP	7
1.4.3 General Specifications	8
1.5 CC-Link.....	9
1.5.1 Overview of CC-Link	9
1.5.2 Features of CC-Link	9
1.5.3 General Specifications	10
1.6 PROFINET.....	11
1.6.1 Overview of PROFINET	11
1.6.2 Features of PROFINET	11
1.6.3 PROFINET Communication	12
2. Installation.....	13
2.1 DeviceNet	13
2.1.1 How to Setup a DeviceNet Network	13
2.1.2 DeviceNet Network Construction	14
2.1.3 DeviceNet Master Board Installation	20
2.1.4 DeviceNet Slave Board Installation	39
2.2 PROFIBUS DP	46
2.2.1 How to Setup a PROFIBUS DP Network	46
2.2.2 PROFIBUS DP Network Construction	46
2.2.3 PROFIBUS-DP Master Board Installation	51
2.2.4 PROFIBUS-DP Slave Board Installation	78
2.3 EtherNet/IP	85
2.3.1 How to Setup a EtherNet/IP Network	85
2.3.2 EtherNet/IP Network Construction	85
2.3.3 EtherNet/IP Master Board Installation	86
2.3.4 EtherNet/IP Slave Board Installation	107
2.4 CC-Link	113
2.4.1 CC-Link Slave Board Installation	113

2.5 PROFINET	124
2.5.1 PROFINET Slave Board Installation	124
3. Operation.....	130
3.1 SPEL+ Fieldbus I/O Commands.....	130
3.2 Outputs Off by Emergency Stop and Reset Instruction	130
3.3 Using FbusIO_SendMsg	131
3.4 Explicit Message Connection (for DeviceNet, EtherNet/IP) ..	132
3.5 Remote Control Input and Output Setting.....	133
4. Troubleshooting	140
4.1 DeviceNet.....	140
Exclusion	140
Tools.....	140
4.1.1 Examining a Problem.....	140
4.1.2 Problems and Countermeasures	142
4.1.3 Procedures for Examining Possible Causes	160
4.2 PROFIBUS DP Troubleshooting.....	173
Exclusion	173
Tools.....	173
4.2.1 Examining a Problem.....	173
4.2.2 Problems and Countermeasures	175
4.2.3 Procedures for Examining Possible Causes	190
4.3 EtherNet/IP Troubleshooting	200
Exclusion	200
4.3.1 Examining a Problem.....	200
4.3.2 Problems and Countermeasures	202
4.3.3 Tests and diagnostics	202
5. Maintenance Parts List	209

1. Introduction

1.1 Overview of Fieldbus I/O

The Fieldbus I/O option is an integrated I/O system that supports the following Fieldbuses:

- DeviceNet
- PROFIBUS DP
- EtherNet/IP
- CC-Link
- PROFINET

Fieldbus is a standard of signal communications between field devices operating in a factory (sensor, actuator, robot controller, etc.) and controller (PLC or robot controller) using serial communications. Compared to signal communications using analog signals, Fieldbus has the following features:

Access to signals from multiple devices and multiple data from each device using one cable.

Precise signal transmission since there is no need for A/D conversion and D/A conversion.

Less wiring costs, including signal relay board costs and installation area due to several dozen (or a hundred) devices connected on one Fieldbus.

More flexible modification and expansion of a system because multiple devices are simply added to one Fieldbus without additional wiring.

Slave devices can transmit self-diagnostics information.

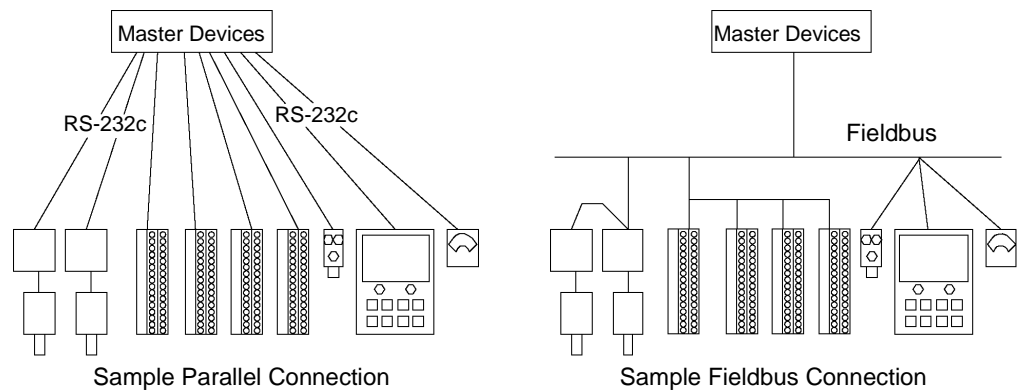

The Fieldbus master function can be added to the RC620 robot controller by installing the Fieldbus master board. Each type of Fieldbus supports the following boards.

- DeviceNet master board
- PROFIBUS-DP master board
- EtherNet/IP master board

You can install one Fieldbus master board per controller. To use the Fieldbus master I/O, the Fieldbus master option of the EPSON RC+ software options key must be enabled.

You can also add the Fieldbus slave function by installing the Fieldbus slave board. Each type of Fieldbus supports the following boards.

DeviceNet slave board

PROFIBUS-DP slave board

EtherNet/IP slave board

CC-Link slave board

PROFINET slave board

You can install one Fieldbus slave board per controller.

One Fieldbus master board and one Fieldbus slave board can be used together regardless of Fieldbus types.

1.2 DeviceNet

1.2.1 Overview of DeviceNet

DeviceNet is a fieldbus network that provides easy interconnection between control devices (PLC, PC, sensor, actuator, etc.).

DeviceNet was developed by Allen-Bradley as an open communication standard to connect various field devices (sensor, actuator, robot controller, etc.). Because of the open communication standard, DeviceNet users can easily construct a multi-vendor system with various devices developed around the world.

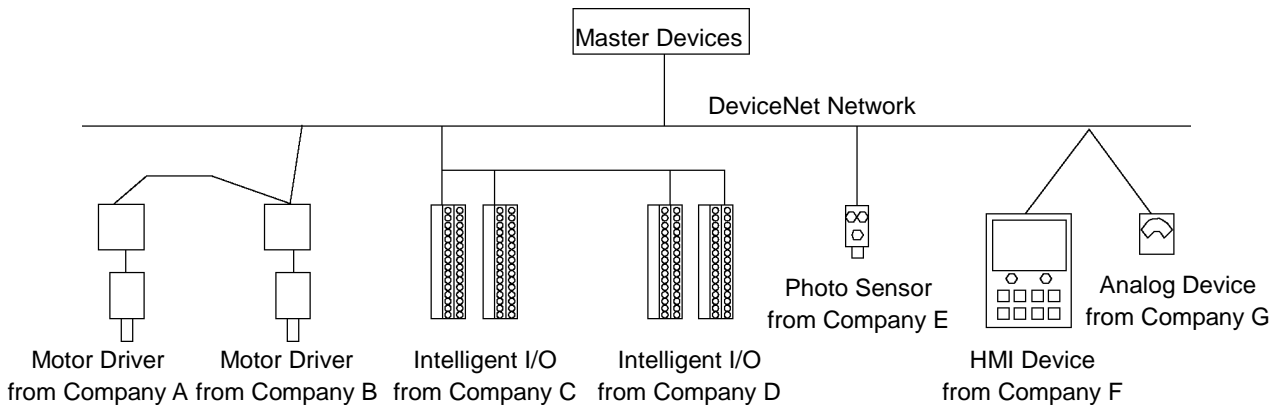

1.2.2 Features of DeviceNet

Reduced Wiring

Compared with parallel wiring, DeviceNet employs a dedicated 5-wire cable (signal wires and power wires) which substantially reduces the number of necessary wires, wiring time and cost.

Detachable communication connectors provide you with simple wiring between nodes and easy network separation or reconstruction.

Specified environment-resistance cables allow you to construct an environment-resistant system at low cost.

Open Standard (Multi-vendor)

Due to an open communication standard, various devices from many manufacturers are available. Standardized communication connectors provide you with easy network reconstruction.

Maintenance spare parts stored on site (factory, etc.) can be reduced because different manufacturers' devices can be used in case of a breakdown. Similar products are available around the world due to a global standard DeviceNet.

Numbers of Inputs/Outputs

Using a Fieldbus master board, you can control 1,024 inputs (128 bytes) and 1,024 outputs (128 bytes).

Also, using a Fieldbus slave board, you can exchange 256 inputs (32 bytes) and 256 outputs (32 bytes) with a master.

Communication Types

There are two types of messaging connections: I/O messaging connection and Explicit messaging connection. I/O messaging connection includes the following 4 methods explained below:

- Polling** : First, a master device sends output data to a slave device and then the slave device responds. Data is normally exchanged in every communication cycle. The communication frequency can be changed by setting. This connection type is the most often used.
- Strobe** : First, a master device requests slave devices to send data with multicast messages, and then, each slave device responds individually. Data from many sensors on the system can be effectively gathered. When the master does not receive responses from all requested slave devices, a timeout error occurs.
- Change Of State**: A device sends data whenever it changes. Signals for device diagnosis are sent regularly in the background. This connection type is useful for remedying DeviceNet communication traffic.
- Cyclic** : A slave device transfers data regularly according to its internal timer. This connection type is typically used for communicating with a temperature controller. The data transfer frequency is defined by master configuration.



For Change of State and Cyclic, the ACK which verifies communication completion can be disabled by setting. However, never disable the ACK since communication errors cannot be detected.

1.2.3 General Specifications

DeviceNet Communication Specifications

Item	Specification			
Supported Connection	- I/O messaging connection (Polling, Strove, Cyclic, Change of State) - Explicit messaging connection All connections are conformed to DeviceNet communication protocol.			
Baud Rates	125 kbps, 250 kbps, 500 kbps			
Transfer Distance	Baud Rates	Max. Network Length	Drop Length	Total Drop Line Length
	0 kbps	10 m	6m or under	39 m or under
	250 kbps	250 m *	6 m or under	78 m or under
	125 kbps	500 m *	6 m or under	156 m or under
Maximum Nodes	64 (including master unit)			
Data Length / Frame	8 byte (data can be divided and transferred.)			
Bus Access	CSMA/NBA			
Error Detection	CRC error / Duplicate node address check			
Cable	5-wire cable dedicated to DeviceNet (2 wires for signal, 2 wires for power supply, 1 shield wire)			
Communications Power Supply Voltage	24 V DC (supplied from a connector)			

* When thin cable is used for trunk line, the maximum network length is 100 m.

1.3 PROFIBUS DP

1.3.1 Overview of PROFIBUS DP

PROFIBUS DP is a fieldbus network that provides easy interconnection between control devices (PLC, PC, sensor, actuator, etc.).

PROFIBUS DP was co-developed by Siemens, Bosch, and ABB as an open communication standard to connect various field devices (sensor, actuator, robot controller, etc.). Because of the open communication standard, PROFIBUS DP can easily construct multi-vendor system with various devices developed around the world.

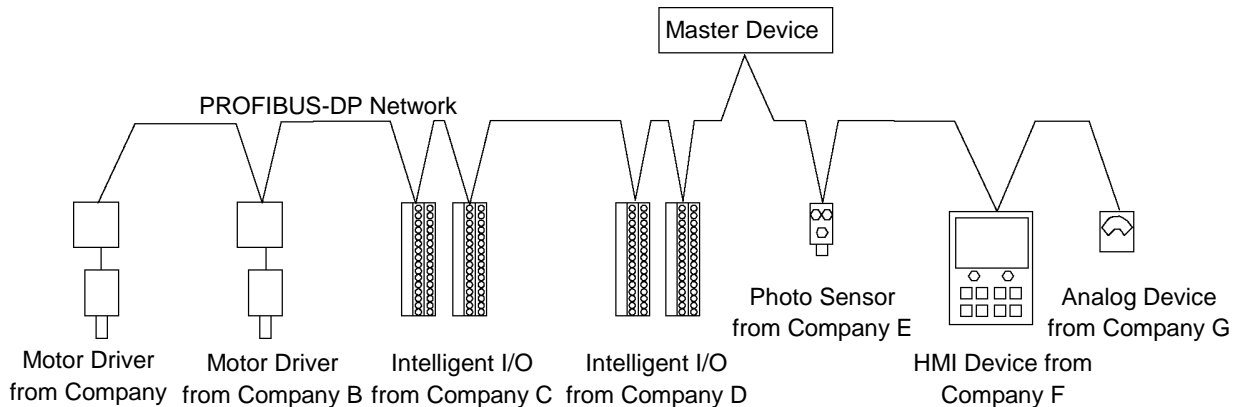

1.3.2 Features of PROFIBUS DP

Reduced Wiring

Compared with a parallel wiring, PROFIBUS DP employing dedicated 2-wire cable substantially reduces the number of necessary wires, wiring time and cost.

Detachable communication connector provides you a simple wiring between devices (stations) and an easy network separation or reconstruction.

Fast Communication

PROFIBUS DP communication speed can be set up to 12Mbps. This is faster than DeviceNet, another communication standard supported by the fieldbus I/O.

Open Standard (Multi-vendor)

Due to an open communication standard, various devices from many manufacturers are available. Standardized communication connectors allow you to reconstruct your network easily.

Maintenance parts stored on site (factory, etc.) can be reduced because different manufacturers' devices can be used in case of a breakdown. Similar products are available around the world due to a global standard PROFIBUS DP.

Numbers of Inputs/Outputs

Using a Fieldbus master board, you can control 1,024 inputs (128 bytes) and 1,024 outputs (128 bytes).

Also, using a Fieldbus slave board, you can exchange 256 inputs (32 bytes) and 256 outputs (32 bytes) with a master.

1.3.3 General Specifications

PROFIBUS DP Communication Specifications

Item	Specification	
Communication Method	Hybrid (token passing procedure and master-slave communication)	
Baud Rates	9.6 kbps, 19.2 kbps, 93.75 kbps, 187.5 kbps, 500 kbps, 1500 kbps, 3 Mbps, 6 Mbps, and 12 Mbps.	
Transfer Distance	Baud Rates	Cable Length
	12 Mbps	100 m
	6 Mbps	100 m
	3 Mbps	100 m
	1500 kbps	200 m
	500 kbps	400 m
	187.5 kbps	1000 m
	93.75 kbps	1200 m
	19.2 kbps	1200 m
9.6 kbps	1200 m	
Maximum Stations	126 (including master unit and repeater)	
Data Length / Frame	244 bytes	
Cable	2-wire cable dedicated to PROFIBUS (2 wires for signal)	

1.4 EtherNet/IP

1.4.1 Overview of EtherNet/IP

EtherNet/IP is a fieldbus network that provides easy interconnection between control devices (PLC, PC, sensor, actuator, etc.).

EtherNet/IP was developed by Allen-Bradley as an open communication standard to connect various field devices (sensor, actuator, robot controller, etc.). Because of the open communication standard, EtherNet/IP users can easily construct a multi-vendor system with various devices developed around the world.

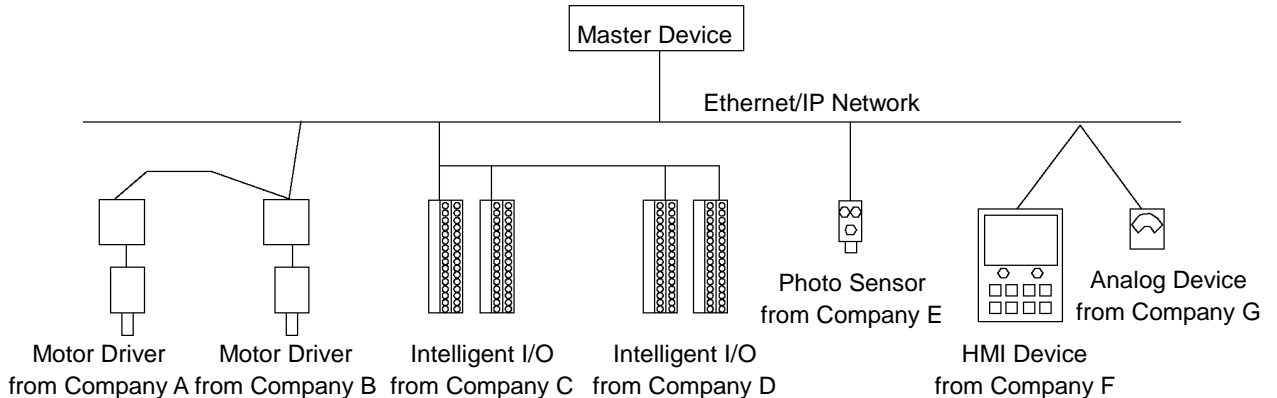

1.4.2 Features of EtherNet/IP

Reduced Wiring

Compared with parallel wiring, EtherNet/IP employs a standard Ethernet cable which substantially reduces the number of necessary wires, wiring time and cost.

Detachable communication connectors provide you with simple wiring between nodes and easy network separation or reconstruction.

Specified environment-resistance cables allow you to construct an environment-resistant system at low cost.

NOTE



You can use the general Ethernet hub or Ethernet switch for EtherNet/IP.

However, be sure to use a product complying with the industrial standards or a noise-resistant Ethernet cable (STP cable). If you use an office use product or UTP cable, it may causes communication errors and may not offer the proper performance.

Open Standard (Multi-vendor)

Due to an open communication standard, various devices from many manufacturers are available. Standardized communication connectors provide you with easy network construction.

Maintenance spare parts stored on site (factory, etc.) can be reduced because different manufacturers' devices can be used in case of a breakdown. Similar products are available around the world due to a global standard EtherNet/IP.

Numbers of Inputs/Outputs

Using a Fieldbus master board, you can control 1,024 inputs (128 bytes) and 1,024 outputs (128 bytes).

Also, using a Fieldbus slave board, you can exchange 256 inputs (32 bytes) and 256 outputs (32 bytes) with a master.

Connection Types

There are two types of messaging connections: I/O messaging connection and Explicit messaging connection. I/O messaging connection includes the following 2 methods explained below:

Change Of State: A device sends data whenever it changes. Signals for device diagnosis are sent regularly in the background. This connection type is useful for remedying EtherNet/IP communication traffic.

Cyclic : A slave device transfers data regularly according to its internal timer. This connection type is typically used for communicating with a temperature controller. The data transfer frequency is defined by master configuration.



For Change of State and Cyclic, the ACK which verifies communication completion can be disabled by setting. However, never disable the ACK since communication errors cannot be detected.

1.4.3 General Specifications

EtherNet/IP Communication Specifications

Item	Specification
Supported Connection	- I/O messaging connection (Cyclic, Change of State) - Explicit messaging connection All connections are conformed to EtherNet/IP communication protocol.
Baud Rates	100 Mbps, 10 Mbps
Maximum Nodes	128 (including master unit)
Data Length / Frame	244 bytes
Access Control Type	CSMA/CD
Cable	Universal Ethernet cable

1.5 CC-Link

1.5.1 Overview of CC-Link

CC-Link is a Fieldbus network that provides easy interconnection between control devices (PLC, PC, sensor, actuator, etc.).

CC-Link was developed as an open communication standard to connect various field devices (sensor, actuator, robot controller, etc.). Because of the open communication standard, CC-Link can easily construct multi-vendor system with various devices developed around the world.

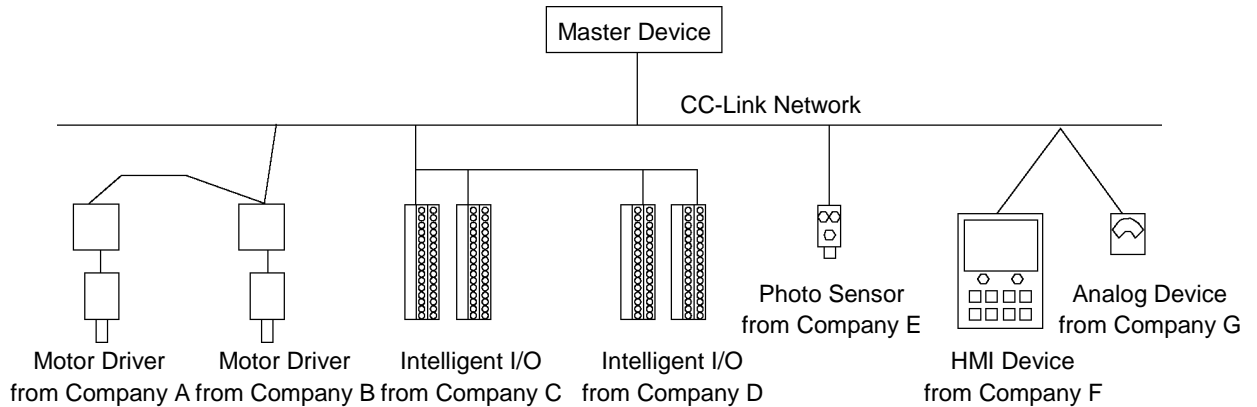

1.5.2 Features of CC-Link

Reduced Wiring

Compared with a parallel wiring, CC-Link employs triplex shielded twisted pair cable which substantially reduces the number of necessary wires, wiring time and cost.

Detachable communication connector provides you a simple wiring between devices (nodes) and an easy network separation or reconstruction.

Fast Communication

From 156k bps to 10M bps is available. The speed of 10M bps is the fastest field network next to PROFIBUS-DP.

Transmission Control

The communication network includes master stations and slave stations. Normally, PLC becomes a master station. Up to 64 slave stations can be connected to a master station. The slave station includes remote device stations (handling the bit data and word data), remote I/O stations (handling the bit data), and others. The master station stores the information such as the type and address of slave stations in the network and controls the whole network.

Open Standard (Multi-vendor)

Due to an open communication standard, various devices from many manufactures are available. Standardized communication connectors allow you to reconstruct your network easily.

Maintenance parts stored on site (such as factory) can be reduced because different manufacturers' devices can be used in case of a breakdown. Similar products are available around the world due to a global standard PROFIBUS DP.

1.5.3 General Specifications

CC-Link Specifications (Ver.1.10)

Item	Specification
Baud Rates (bps)	156 k, 625 k, 2.5 M, 5 M, 10 M (bps)
Connection Method	Broadcast polling
Synchronization Method	Frame synchronization
Encoding Method	NRZI
Transmission Channel Type	Bus (EIA RS485 compliant)
Transmission Format	HDLC compliant
Maximum Number of Devices	64 units
Slave Station Number	1 to 64
Connection Cable	CC-Link Ver1.10 cable (3 core twist cable with a shield)

1.6 PROFINET

1.6.1 Overview of PROFINET

PROFINET is a fieldbus network that uses industrial Ethernet.

PROFINET was developed as an open communication standard to connect various field devices (sensor, actuator, robot controller, etc.). Because of the open communication standard, PROFIBUS DP can easily construct multi-vendor system with various devices developed around the world.

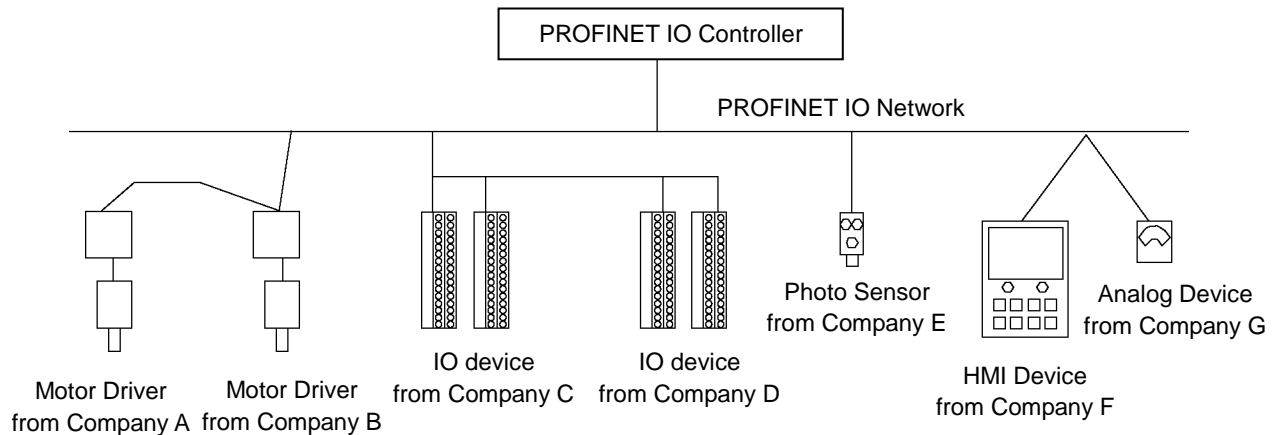

1.6.2 Features of PROFINET

Everything on one cable

With its integrated, Ethernet-based communication, PROFINET satisfies a wide range of requirements, from extremely fast I/O data transmission to parameter monitoring and configurations of equipment.

Flexible network topology

PROFINET is 100% Ethernet compatible according to IEEE standards and adapts to the environment of existing plant due to its flexible line, ring, and star structures.

Standardization

PROFINET is defined by international standards “IEC 61158” and “IEC 61784”.

Concept of PROFINET has been developed based on standard Ethernet of IEEE802 through a joint effort with its users. Functionality has been added to cover the area that standard Ethernet cannot satisfy.

1.6.3 PROFINET Communication

PROFINET is designed to support all applications in a plant versatily with one bus.

Therefore, PROFINET has three different performance levels as described below.

For RC620 option fieldbus I/O, “2: RT (Real-time)” communication is supported.

1: NRT (Non Real-time)

This communication is based on TCP/IP.

This is used for applications where real-time communication is not required, such as inter-unit communication and parameter communication.

2: RT (Real-time)

By adding a software protocol to the standard Ethernet hardware, this method actualizes real-time communication with approximately 10 ms intervals.

In particular, by defining a priority in VLAN tag (IEEE803.1Q) in Ethernet frame, RT frame is processed with a higher priority to non-real-time data (NRT, TCP/IP, etc.)

RT can offer almost the same performance as the existing fieldbus.

3: IRT (Isochronous Real-time)

Isochronous real-time communication (IRT) guarantees that communication is surely executed within an arbitral communication time (Deterministic) at a higher level than Real-time communication (RT).

This enables a clock rate of < 1 ms and a jitter precision of < 1 μ s.

IRT is used for applications where a strict real-time performance is required, such as motion control. As a communication hardware, switch-function-embedded special ASIC is used. This method guarantees the real-time performance by dividing the communication band on Ethernet.

2. Installation

This chapter describes procedures for installing the network.

DeviceNet
PROFIBUS DP
EtherNet/IP
CC-Link
PROFINET

Refer to the sections according to the type of network you are installing.

2.1 DeviceNet

2.1.1 How to Setup a DeviceNet Network

The following is a basic procedure for setting up a DeviceNet network:

1. Choose node layout and pathway on your network.
For details, refer to the following section 2.1.2 DeviceNet Network Construction.
2. Choose power supply method for communication.
For details, refer to the following section 2.1.2 DeviceNet Network Construction.
3. Choose baud rate.
Choose the baud rate based on the network length. Select the fastest baud allowed for the length. Increasing network load due to slow baud rate may cause trouble including communication failure.
4. Lay cables.
For details, refer to the following section 2.1.2 DeviceNet Network Construction.
5. Configure the nodes.
For details, refer to respective manuals of your desired nodes.
6. Turn ON the communications power supply and nodes.
Turn ON the communications power supply. After that (or simultaneously), turn ON the nodes to supply power. When the power to the nodes is supplied earlier than the power to the communication power supply, communication with the nodes may fail.
7. Install the DeviceNet board in your controller.
When installing the DeviceNet master board, refer to the section *2.1.3 DeviceNet Master Board Installation* later in this chapter.
When installing the DeviceNet slave board, refer to the section *2.1.4 DeviceNet Slave Board Installation* later in this chapter.
8. Operate the DeviceNet network.

2.1.2 DeviceNet Network Construction

Network Configuration

DeviceNet network is configured as shown in the following figure.

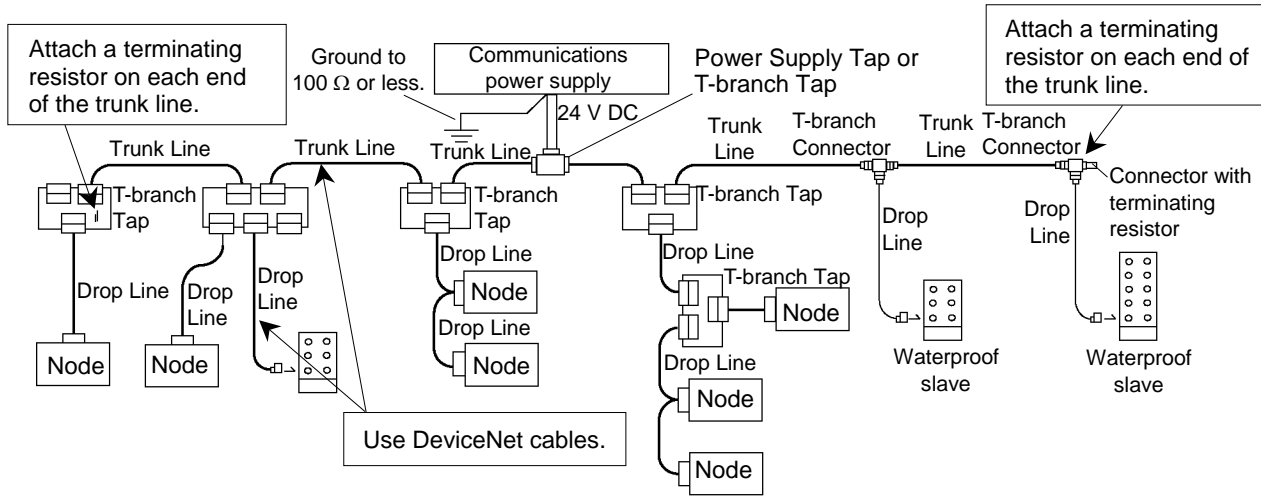

Node

There are two types of nodes: master and slave. The master controls a network and gathers data from its slaves. The slaves, including external I/O and other devices, output data in response to the master's output order and informs the master of its input status.

You can install masters anywhere in the network. You can connect up to 64 nodes (including the server) in the network.

Trunk Line and Drop Line

Trunk line is a backbone cable of DeviceNet network with terminating resistors on the both ends.

Drop line is a branch of the trunk line.

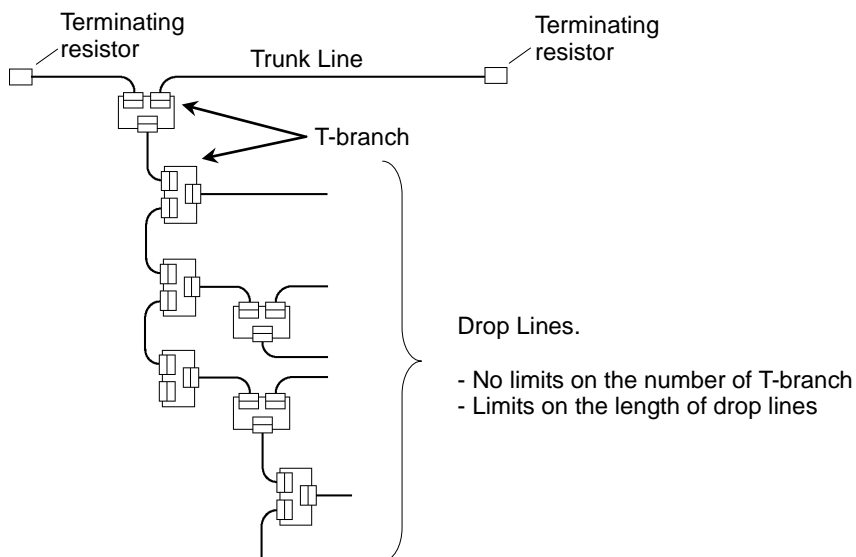

For DeviceNet, 5-wire cables are used for trunk lines and drop lines. Commercially available DeviceNet cables can be used. There are two types of DeviceNet cables: Thick cable and Thin cable. Environment-resistant cable and flexible cable are available. For details of cables, see ODVA's Web site (<http://www.odva.org/>).

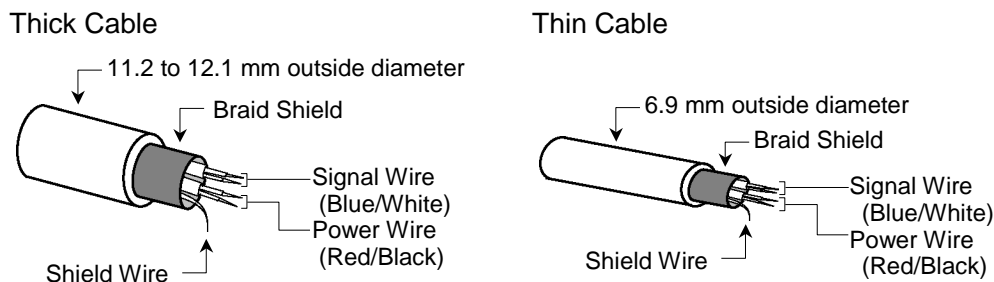

Communications Cable Signal

Wire Type	Color	Details of Signal		Wire Identity
Signal wire	Blue	Signal	Low	CAN L
	White	Signal	High	CAN H
Power wire	Red	Communications Power	Positive	V+
	Black	Communications Power	Negative	V-
Shield wire	-	Shield		S

Terminating Resistor

To reduce reflections of communication signal, terminating resistors should be attached on both ends of the trunk line. For DeviceNet, nodes have no terminating resistor on the ends. Attach 121 Ω +/-1%, 1/4W terminating resistors between the signal wires (CAN-H and CAN-L) of the trunk line cable. Some commercially available T-branch taps and connectors can accept terminating resistors. Molded terminating resistors with connectors are also available to attach to environment-resistant T-branch taps and connectors.

Node Connection

Nodes can be connected to a DeviceNet network by the following topologies: tree, multi-drop, T-branch, daisy chain. For tree topology, there is no limitation of daisy chain layer but drop line length is limited. For details of drop line length, refer to the following section *Drop Line Length*.

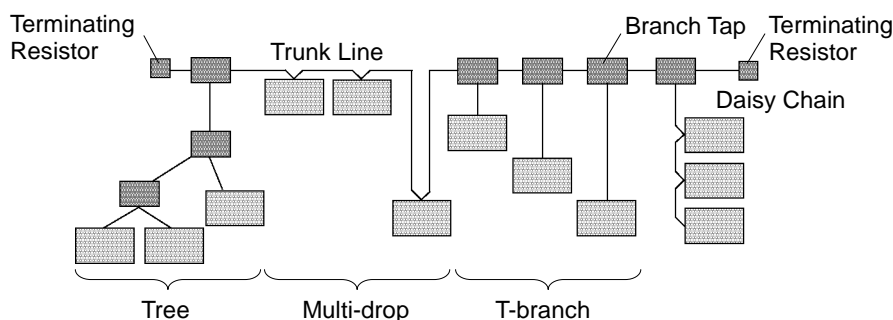

Communications Power Supply

DeviceNet supplies 24V DC communications power to each node via 5-wire cables. You can install the communications power supply at any location in the DeviceNet network. Although the power can be shared to the node internal circuit power supply and I/O power supply, it is recommended to use a dedicated communications power supply.

Shield Ground of Signal Wire

Ground the DeviceNet network at one point with 100 Ω or less. As a noise countermeasure, you can leave the network ungrounded. For details, refer to 4. *Trouble shooting*.

Maximum Network Length (Maximum Trunk Length)

The maximum network length is the longest distance either between terminating resistors or between the two most distant nodes on the network.

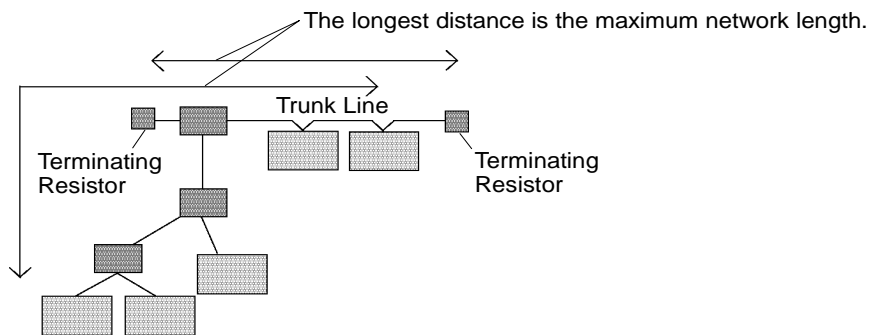

The maximum network length is determined by the type of cable and the baud rate.

Baud Rate	Maximum Network Length	
	Thick Cable	Thin Cable
500 kbps	100 m	100 m
250 kbps	250 m	100 m
125 kbps	500 m	100 m

Both Thick Cable and Thin Cable can be combined and used for trunk lines. In this case, the maximum network length is calculated using the following formulas.

Baud Rate	Maximum Network Length
500 kbps	Thick Cable Length + Thin Cable Length ≤ 100m
250 kbps	Thick Cable Length + 2.5 × Thin Cable Length ≤ 250m
125 kbps	Thick Cable Length + 5.0 × Thin Cable Length ≤ 500m

Drop Line Length

Drop line length is the distance from a branch on the trunk line to the end of that branch.

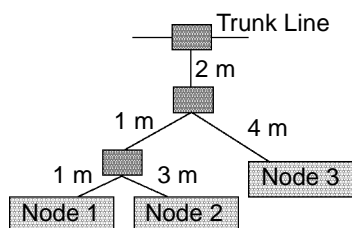

In the figure above, each drop line length is as follows:

Drop Line to Node 1: 4 m

Drop Line to Node 2: 6 m

Drop Line to Node 3: 6 m

One drop line length should be 6m or less.

Total Drop Line Length

Total drop line length is the total distance of all drop lines in one network.

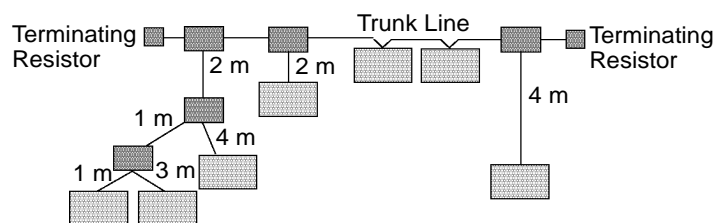

In the figure above, the total drop line length is 17 m.

The maximum total drop line length is restricted by baud rate as shown in the table below.

The cable thickness is not related to the restriction.

Baud Rate	Max. Total Drop Line Length
500 kbps	39 m
250 kbps	78 m
125 kbps	156 m

Cable Current Capacity

Current-carrying capacity of the DeviceNet network cable is restricted as below:

	Trunk Line		Drop Line (Unit: A)
	Thick Cable	Thin Cable	
Current Capacity	8A	3A	$4.57 / \text{Drop Line Length (m)} \leq 3A$

Following figures illustrate examples of power supply configuration.

When an external power supply is installed in the network as shown in the figure below, the current capacity is 11A and it exceeds the permissible current of the cable.

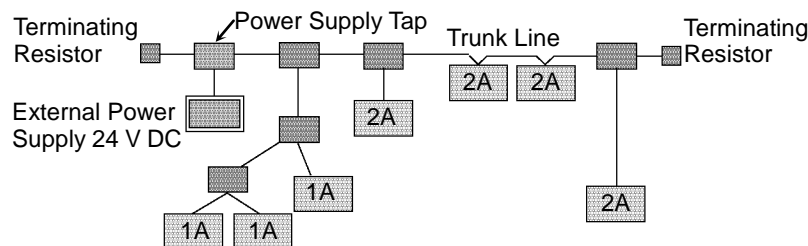

2. Installation

If the location of the external power supply is changed as shown in the figure below, the power supply can be used because the current capacity on the left side of the power supply tap is 5 A and 6 A on the right side.

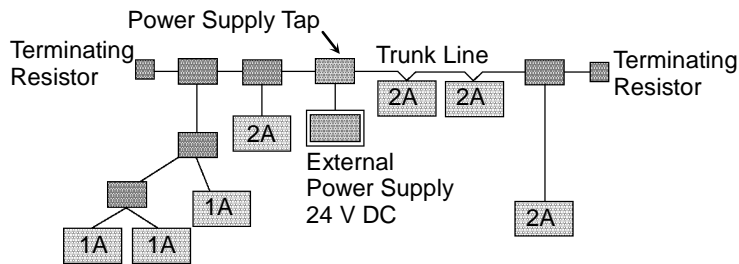

If the current capacity consumed in the network exceeds the restriction of cable current capacity, it is possible to install more than one power supply in the network. If you attempt to install two or more power supplies, take necessary measures (pulling out a fuse on the power supply tap, etc.) to avoid conflicts between power outputs from multiple power supplies.

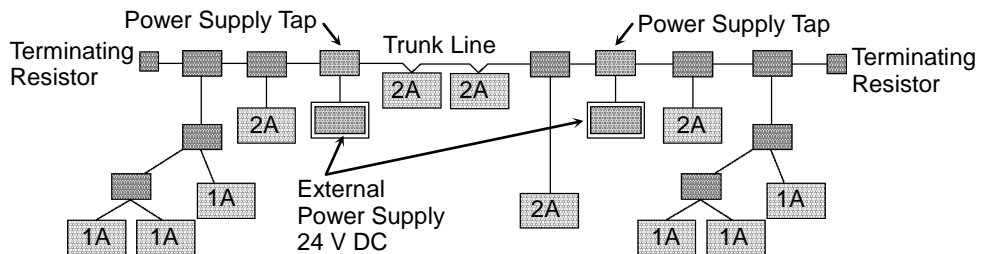

Following figure illustrates a sample wiring. An OMRON power supply tap is used in the example.

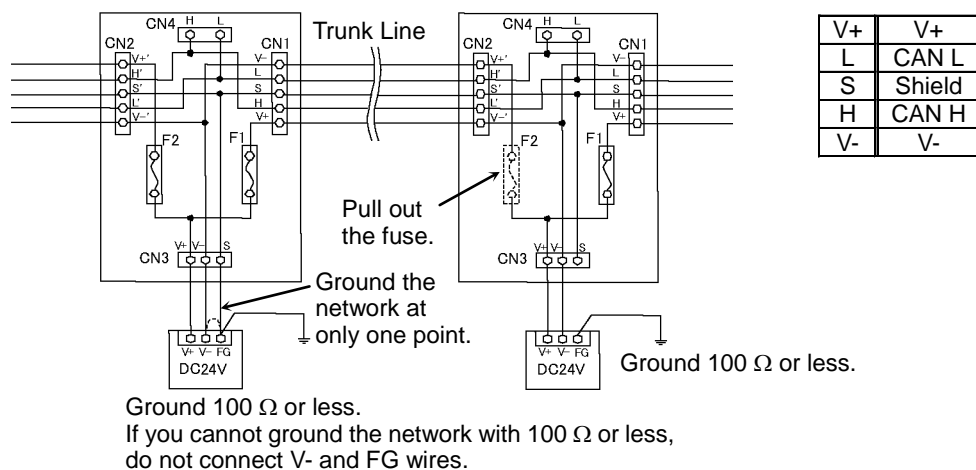

CAUTION

- Carefully connect the wires. Incorrect wiring may cause node malfunction and severe damage to the entire DeviceNet network.

Modification and Installation of Communication Cables

Follow the steps described below to modify communication cables and connect them to connectors.



- Be careful not to injure your hands or fingers on any sharp blades or tools used to modify the cable.

Use appropriate blades and/or tools to modify the cable. Using inappropriate blades and/or tools may result in bodily injury and/or equipment damage.

1. Strip approx. 30 mm of the cable covering with extra care so that you do not scratch on the braided shield underneath. Do not strip the cable covering more than necessary. Excess stripping may cause short-circuit and/or make the cable more sensitive to noise.

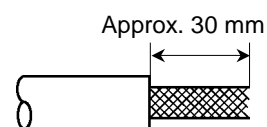

2. Carefully expand the meshes of the braided shield. Under the braided shield, there is one exposed bare twisted shield wire other than the signal wires and power wires that are wrapped with aluminum tape. The shield wire is slightly harder than the mesh.

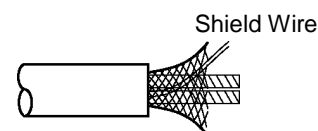

3. Cut off the expanded braided shield and remove the aluminum tape around the signal wires and power wires. Then, strip the insulation from the signal wires and power wires for a length sufficient to connect them to crimp terminals.

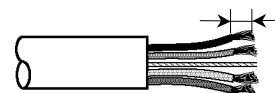

Peel the coverings in enough length to connect the wires to crimping terminals.

4. Set the crimping terminal on the stripped part of the wire and crimp it with a crimp tool. The following crimping terminals are recommended products.

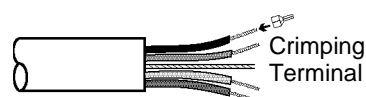

NICHIFU TC series

Model Number	Specifications	Special Tool
TMEV TC-0.5	For Thin Cable	MH-32
TMEV TC-2-11	For Thick Cable (power wire)	
TMEV TC-1.25-11	For Thick Cable (signal wire)	

Phoenix Contact AI series

Model Number	Specifications	Special Tool
AI 0.5-8WH	For Thin Cable (power wire)	CRIMPFOX UD6
AI 0.25-8YE	For Thin Cable (signal wire)	
AI 2.5-8BU	For Thick Cable (signal wire)	
AI 1-8RD	For Thick Cable (signal wire)	

5. Wrap or cover the cable with vinyl tape or heat-shrink tubing.

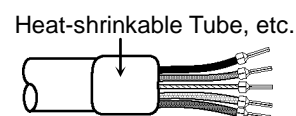

Loosen the screws securing the cables on the connector. If the screws are not loosened, the wires go into different openings on the rear of connector instead of the correct openings and the wires cannot be secured.

6. Ensure the correct connector orientation and insert the signal wires and shield wire to their respective holes on the connector.

As shown in the figure, insert the wires (black, blue, shield, white, and red) into the holes in the order named.

The following table shows the specified colors of the cables.

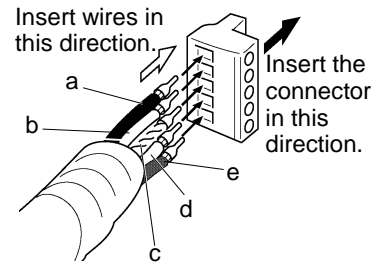

	Color	Details of Signal	Wire Identity
a	Black	Communications Power Supply (negative)	V-
b	Blue	Signal (Low)	CAN L
c	-	Shield	S
d	White	Signal (High)	CAN H
e	Red	Communications Power Supply (positive)	V+

7. Tighten each screw securing the wires on the connector.

Tighten the screw securing the wire at a correct tightening torque (0.25 to 0.3 N·m). To prevent thick cable from coming out due to cable tension, install the thick cable with enough length to allow for stretch.

Use a small flat blade screwdriver that has the correct width and thickness. If you use a typical screwdriver whose point is narrow, you cannot deeply insert it into the hole on the connector. Specific screwdrivers for DeviceNet connector screw are:

- OMRON : XW4Z-00C
- Phoenix Contac : SZF-1 0.6×3.5

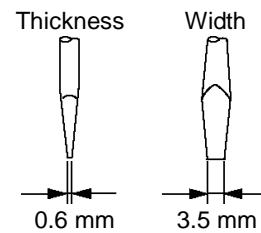

2.1.3 DeviceNet Master Board Installation

Board Appearance

Part names and functions of the DeviceNet master board are shown in the following figure. For details of the status display LEDs (Module/NetWork LED and IO LED), refer to 4. *Troubleshooting* in this manual.

PCI-DVNIO

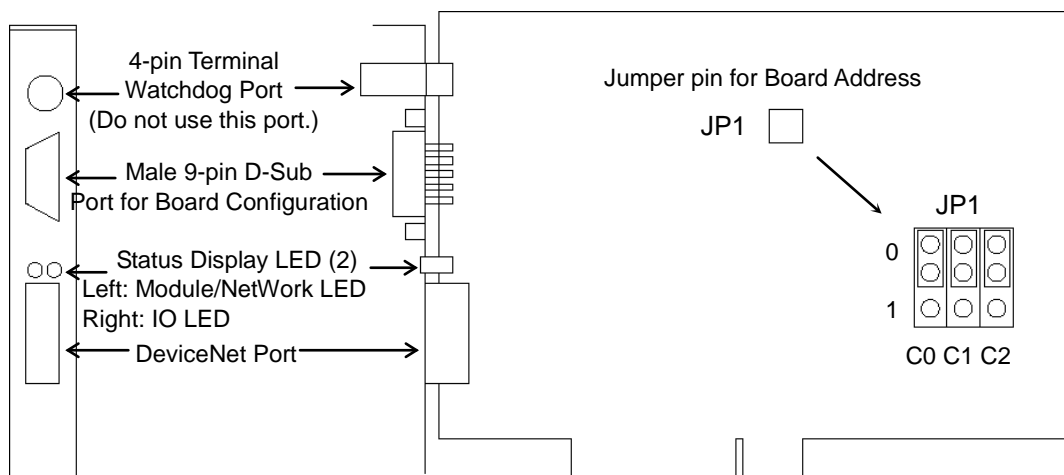

Specifications	
Item	Specification
Name	DeviceNet master board
Part Number	applicom PCI-DVNIO
Modes	Master
Baud rates	125, 250, 500 kbps
Interface	1 DeviceNet port
Supported Devices	Group 2 Only Server and U.C.M.M. capable
Maximum Nodes	63
Connection Types	Strobe, Polling, Cyclic and Change of State
Explicit Messaging Connection	Yes
EDS Support	Yes
Max. Input Data Size	1024 bits (128 bytes)
Max. Output Data Size	1024 bits (128 bytes)
Automatic Detection	Yes. Devices can be detected automatically.

Modes

DeviceNet master board has the master mode and slave mode as motion modes. However, do not select the slave mode.

Master mode

The master device gathers and controls all nodes on one network.

DeviceNet master can control up to 64 nodes (max. 128 bytes) in one network.

PLC is typically configured as a master and controls all nodes in factory automation system, but EPSON RC+ is also capable of being a master.

DeviceNet network configuration is specified by configuration management software. This is normally provided by a master device manufacturer. The configuration management software determines parameters for each slave device via an Electronic Data Sheet (EDS).

Available connection types are Polling, Strobe, Cyclic, Change Of State, and Explicit messaging.

Available baud rates are 125 kbps, 250 kbps, and 500 kbps.

For the setting instruction, refer to *Master Mode* later in this chapter.

Software Installation

Before installing DeviceNet master boards in your controller, you must install the applicomIO console application and drivers according to the type of board you are using.

1. Start the controller.
2. Run the file from the install folder in the controller to start the installation.
C:\Install\FieldBus\Install\applicomIO\Disk1\Setup.EXE
3. The dialog shown below appears. Select the desired language for the installer.

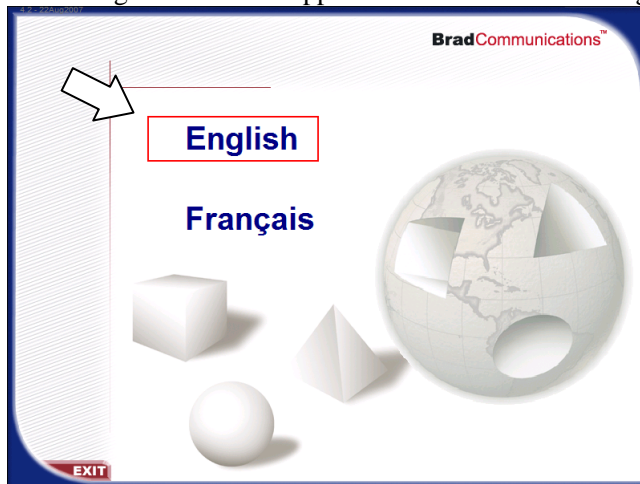

4. The [Summary] dialog box appears. Select "Products Installation".

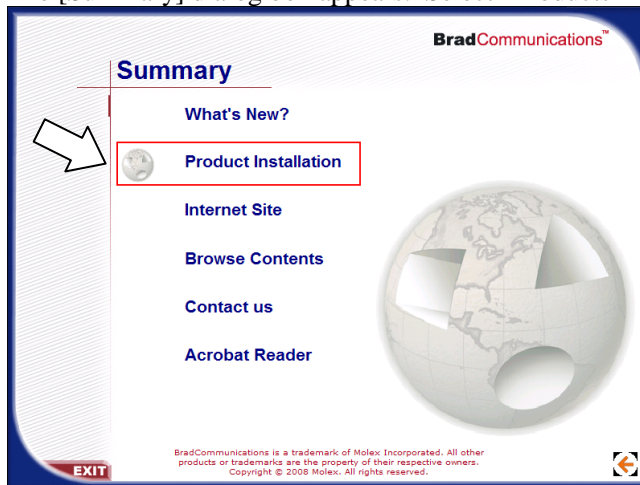

5. The [applicomIO] dialog box appears. Select "Installation".



6. The [Installation] dialog box appears. Select “applicomIO”.

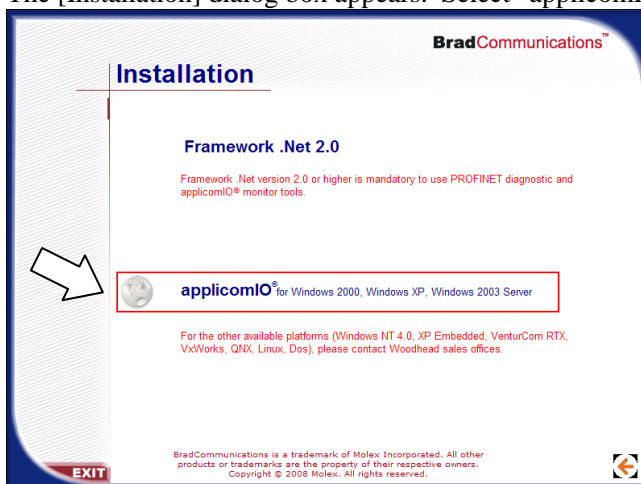

7. The applicomIO console application installer starts, and the [Welcom to applicomIO 2.4 Setup] dialog box appears.

Click <Next>.

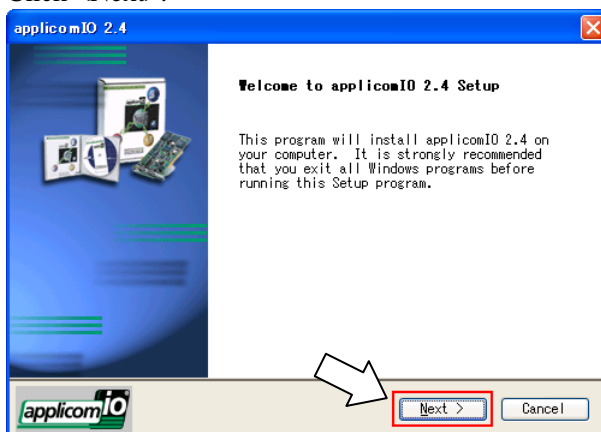

8. The [License Agreement] dialog box appears. Read the software license agreement and click <Yes>.

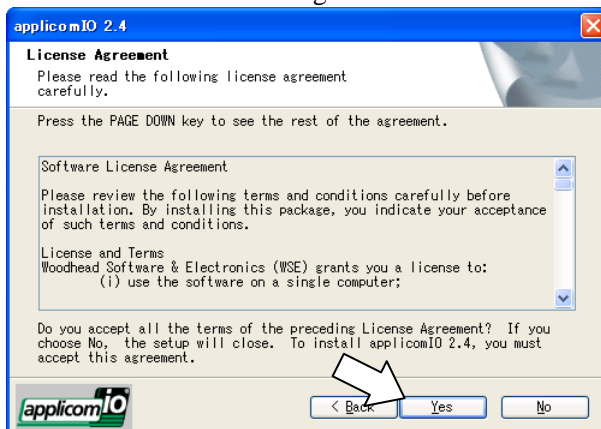

9. The [User Information] dialog box appears. Now register the user information. Type in the user name (Name:) and company name (Company:).

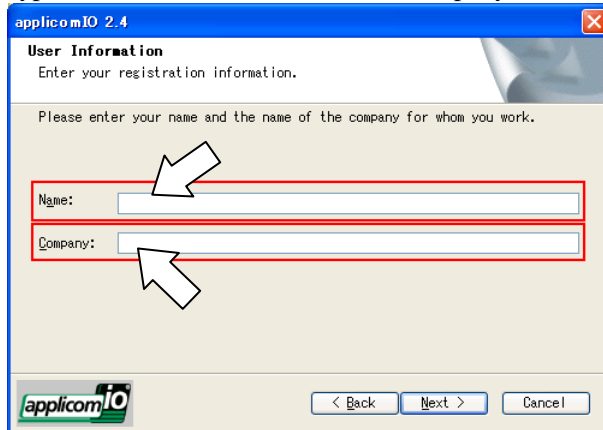

10. The [Choose Destination Location] dialog box appears. Specify the installation folder for the applicomIO console application. The default specifies here:

C:\Program Files\Woodhead\Direct-Link\applicomIO\2.4

If you agree to the default installation folder, click <Next>.

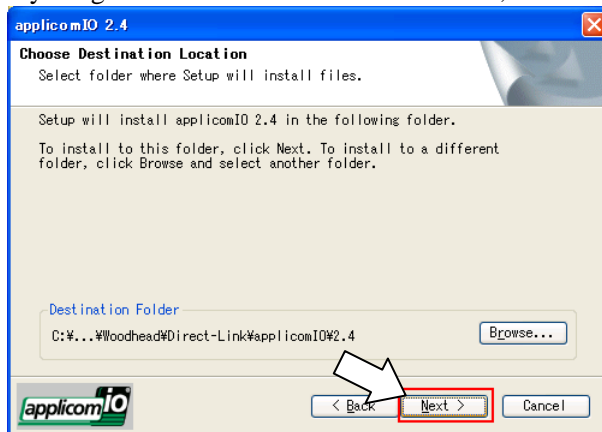

11. The [Select Components] dialog box appears. Install the default components. Click <Next>.

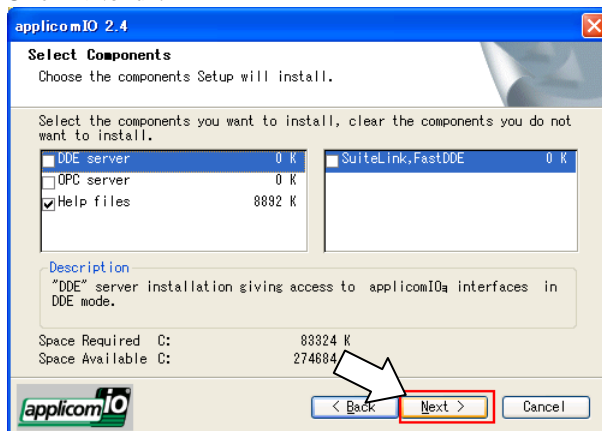

12. The [Select protocols] dialog box appears. Select the protocol.
Check the [DeviceNet] checkbox.

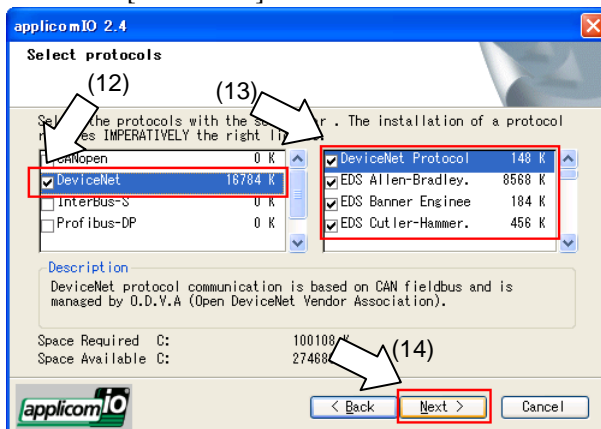

13. Check the device data file you want to install (EDS for DeviceNet).
14. Click <Next>.
15. The [Select options] dialog box appears. Click <Next>.

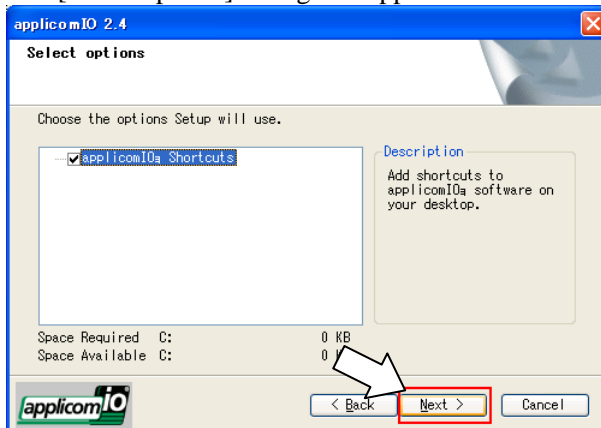

16. The [Start Copying files] dialog box appears. Click <Next>.

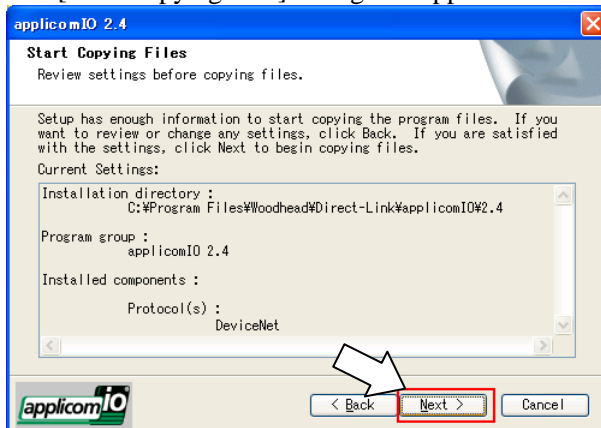

17. The [Setup Status] dialog box appears. Installation of applicomIO console application starts.

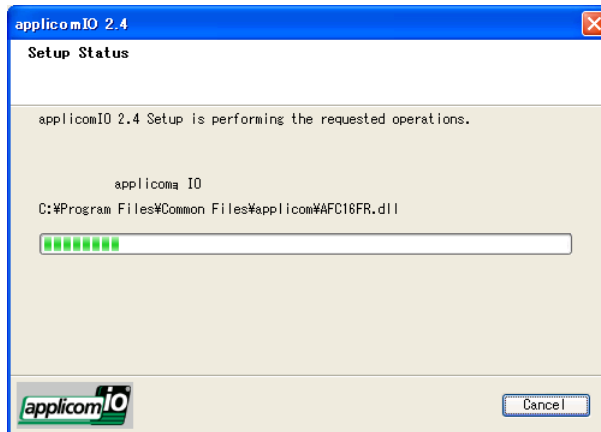

18. When the installation is completed, the [Setup Complete] dialog box appears. The message prompting you to reboot your controller appears. Select “Yes, I want to restart my computer now.”

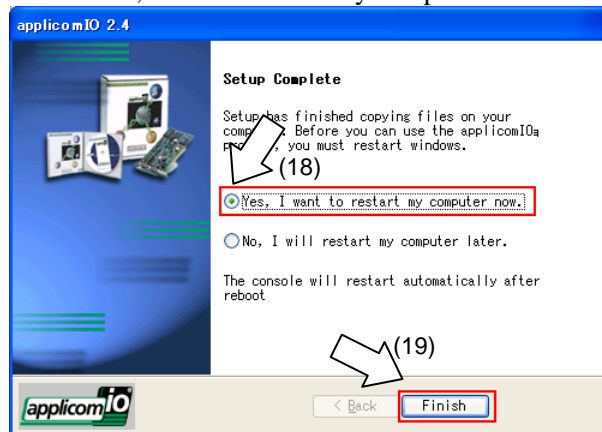

19. Click <Finish> and reboot the controller.

20. Start the C:\Install\FieldBus\Install\SP\Setup.exe, and install the service pack.

No installation is necessary when a service pack is not attached to controller.

21. After completing the installation of the service pack, shutdown the computer.

22 Refer to the next section *Board Installation* to install the DeviceNet master board.

Board Installation



- Make sure that the power is turned OFF before installing/removing any boards or connecting/disconnecting any cables. Working with the power ON is extremely hazardous and may result in electrical shock and/or malfunction of equipment.

- Configure the board address jumper (JP1) on DeviceNet master board.
You can install one Fieldbus master board in the RC620 robot controller.
The board number should be "1".

Refer to the following table for JP1 configuration.

Board No. \ Short Socket	C0	C1	C2
1	0: Short	0: Short	0: Short

- Follow the instruction below and insert the board to the general purpose slot.
 - Remove ten screws (+) on the top face of RC620 controller.
Remove the top plate.

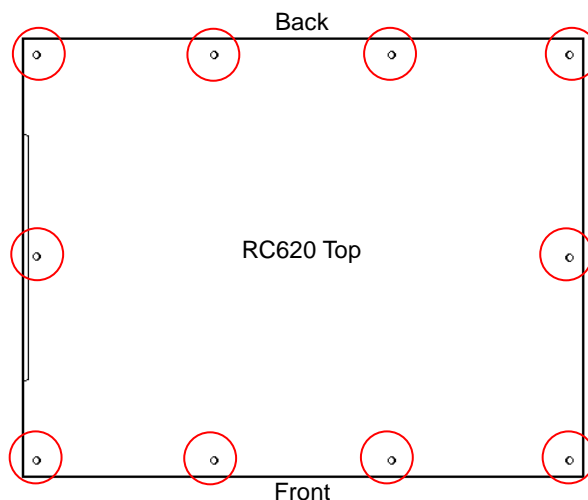

- Remove two screws (+) inside the RC620 controller.

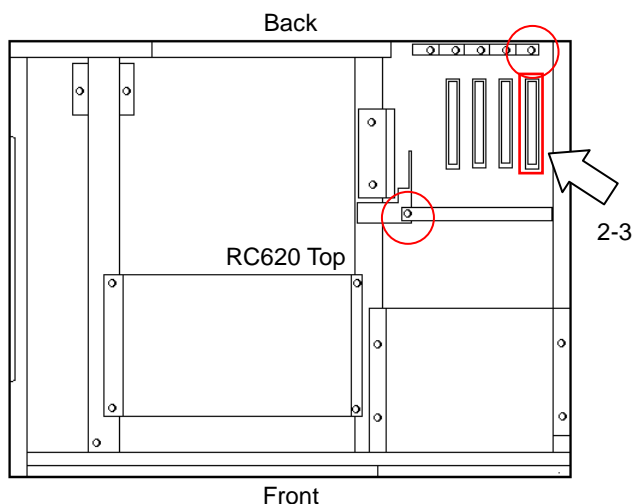

- Insert the Fieldbus master board into the general purpose slot on the far right (recommended).
- Put two screws removed in the step 2-2 back and secure them.
- Put the top plate back and secure it with ten screws.

3. Connect the board with the Fieldbus.
4. Start up the controller.
5. The DeviceNet master board is detected and the [Found New Hardware Wizard] dialog box appears.

Select <No, not this time> and click <Next>.

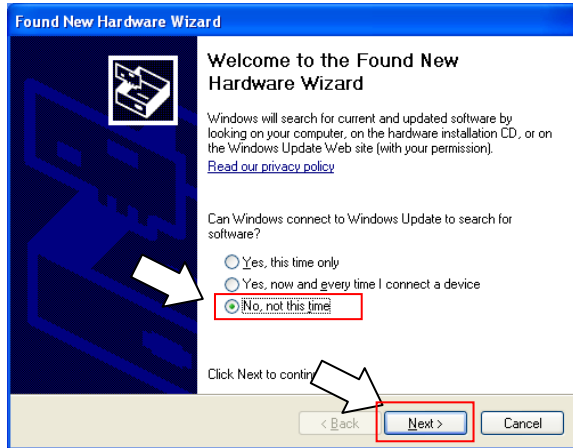

6. The next dialog appears.
Confirm that the detected hardware is “applicomIO PCI Boad 32K”.

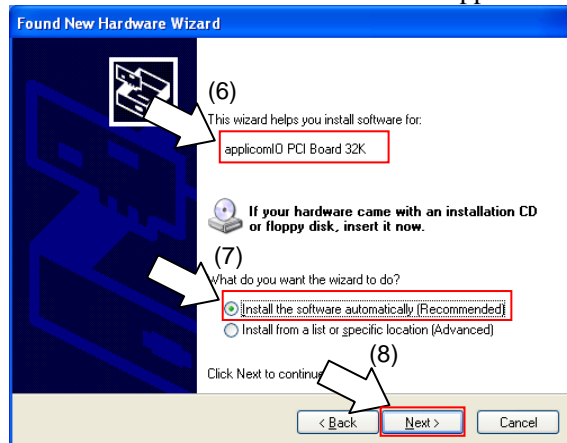

7. Select<Install the software automatically (Recommended)>.
8. Click <Next>.
9. The following dialog box appears.

Necessary software is automatically installed.

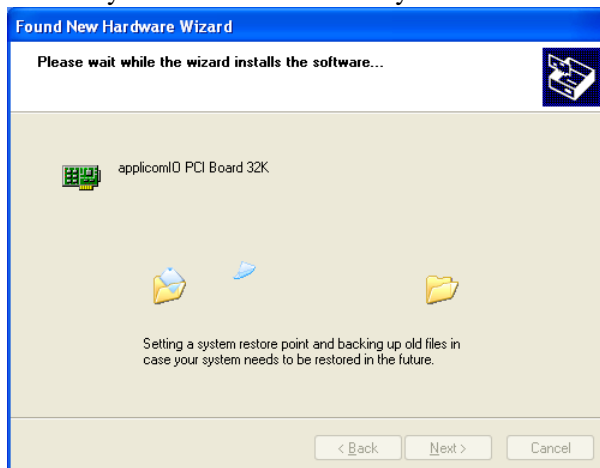

10. When the installation is completed, the [Completing the Found New Hardware Wizard] dialog box appears.

Click <Finish>.

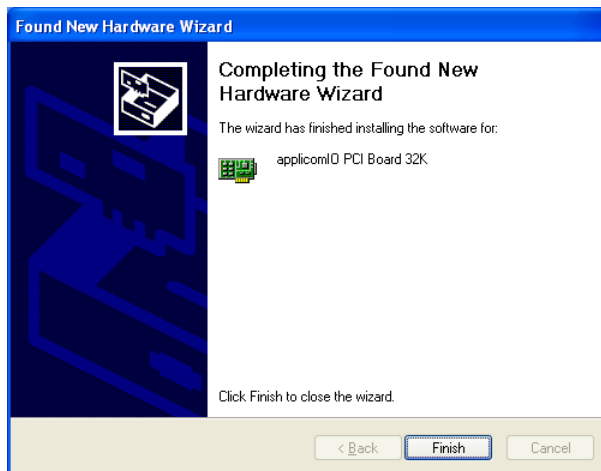

11. Start the <applicomIO Console> application.

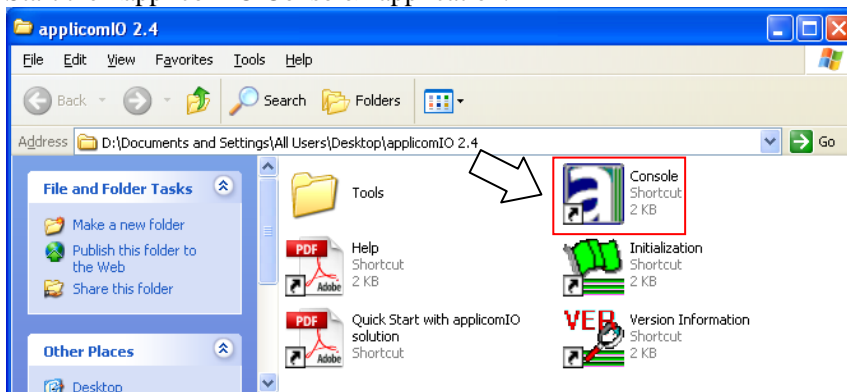

12. The [applicomIOR console] dialog box appears. Add the DeviceNet master board.

Click the <Add Board> icon.

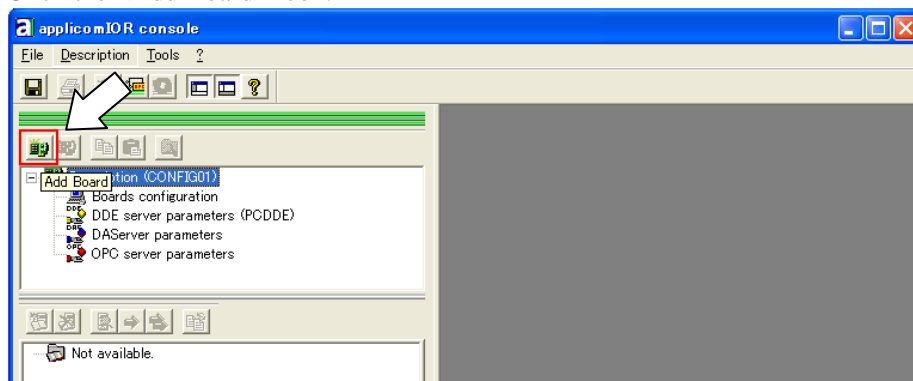

13. The [Add New Board] dialog box appears. Confirm that “PCI-DVNIO” is displayed in [Board to Add]-[Board Type] and click <OK>.

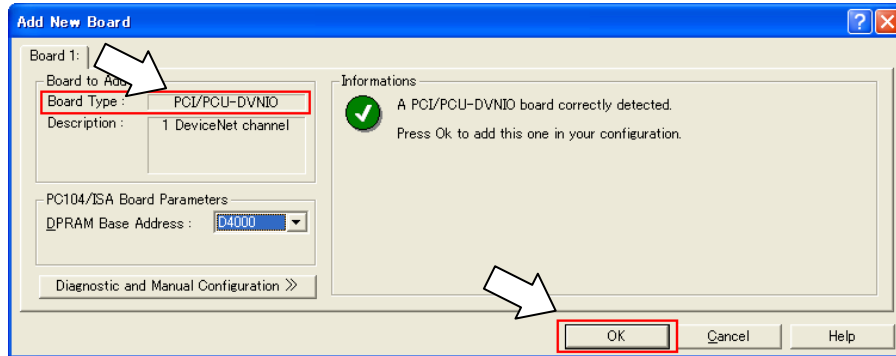

If the board cannot be detected, the following dialog appears. Make sure that the board is correctly inserted.

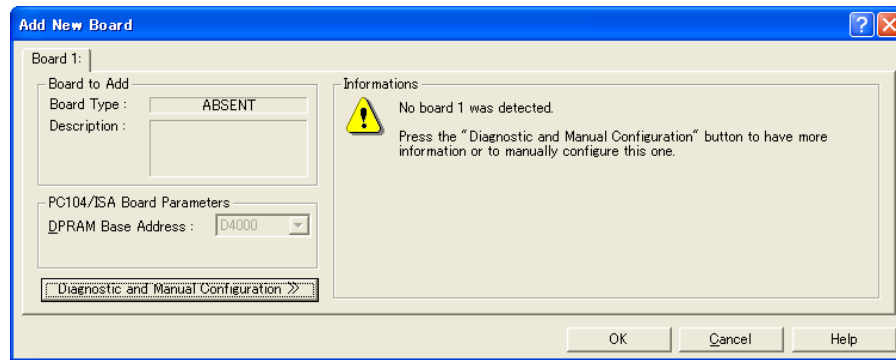

14. When you finish adding the DeviceNet master board to the applicomIO Console application, reboot the controller.

- 14-1 Shutdown the applicomIO Console application. When the applicomIO Console application shuts down, the message below appears. Click <Yes>.

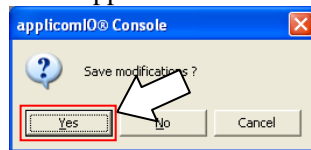

- 14-2 The next message dialog follows. Click <OK>.



- 14-3 Reboot the Windows.

15. After the controller is rebooted, refer to the next section *Master Mode* and continue the step.

Master Mode

1. Ensure that the board is connected to the Fieldbus.
2. Start the <applicomIO Console> application.

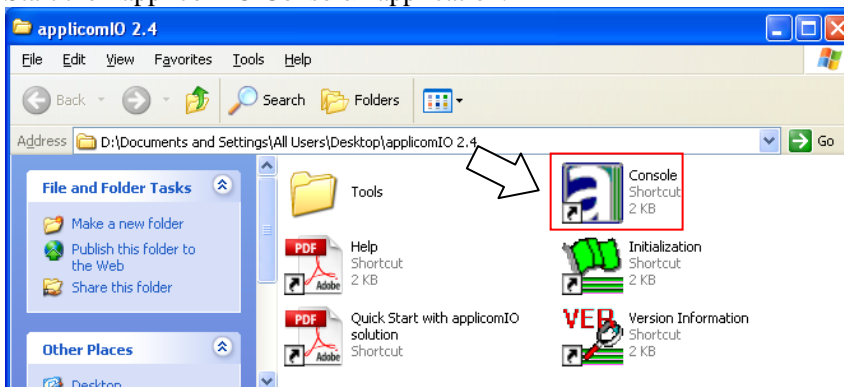

3. The [applicomIOR console] dialog box appears. Register the device information (EDS file) that is necessary for the network setup.

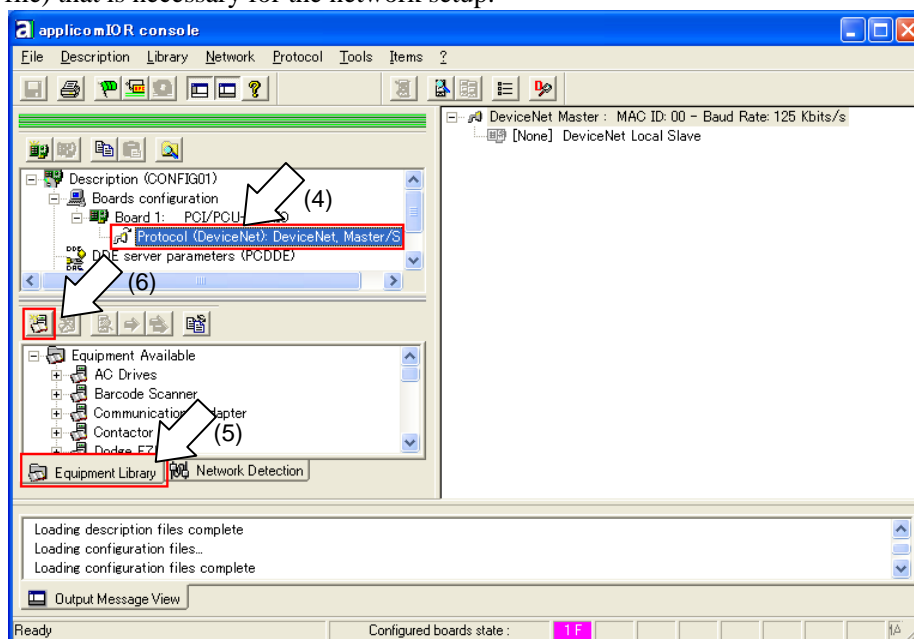

4. Select [Protocol].
5. Select the [Equipment Library] tab.
6. Click the <Add> icon.
7. The [Select configuration files] dialog box appears. Specify the EDS file that is supplied by the device manufacturer. Click <Open>.

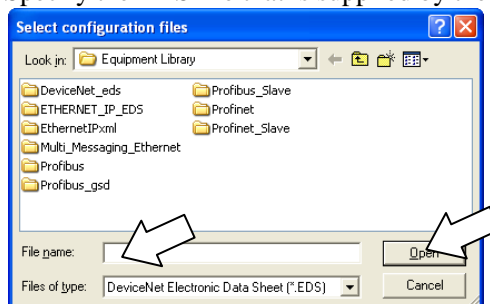

8. Select [Protocol]-[Properties] from the applicomIOR console menu.

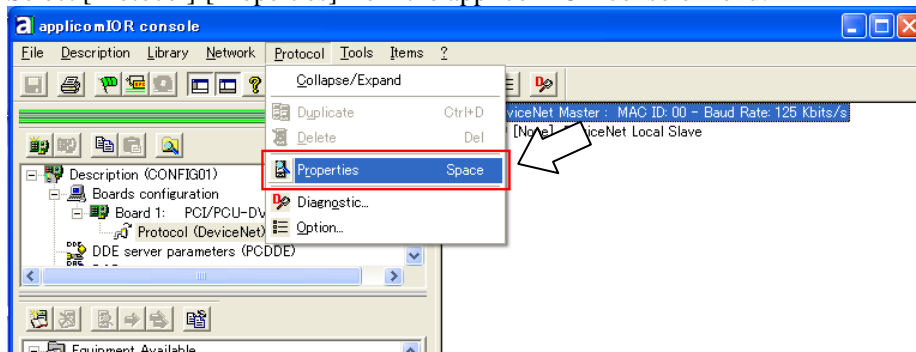

9. The [Device Net Master] dialog box appears. Configure the Baud Rate, MAC ID (master address), and so on for the DeviceNet network. When the master setting is completed, click <OK>.

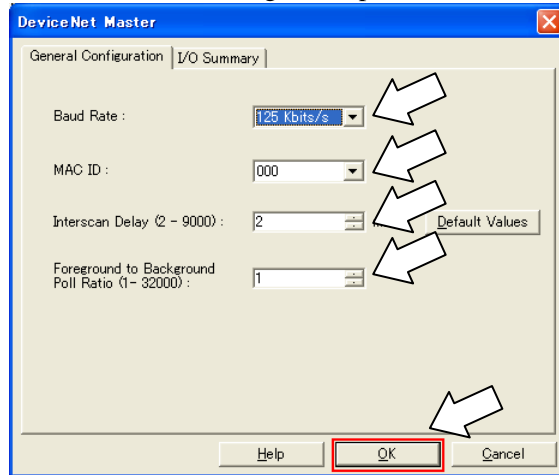

Load on a bus can be controlled by the Baud Rate and Interscan Delay settings. When the load exceeds 60%, the DeviceNet network communication will be unstable, for example, more communication errors. Set the configuration to minimize the load. For verification of the load on the bus using the applicomIO Console application, refer to *4. Troubleshooting* in this manual.

10. Select [Network Detection].

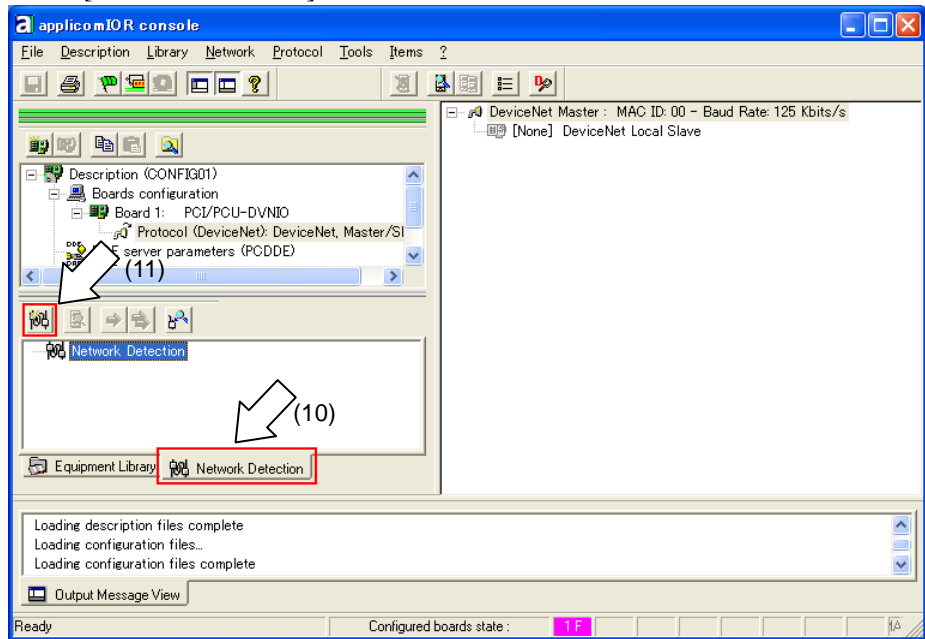

11. Click the <Read Network Configuration> icon.
12. The following message appears. Click <Yes>.

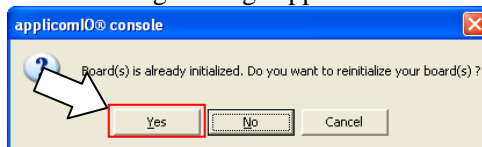

13. The [Network Detection] dialog box appears and the devices on the Fieldbus will be read in.



14. The list of detected devices is displayed in [Network detection] panel.

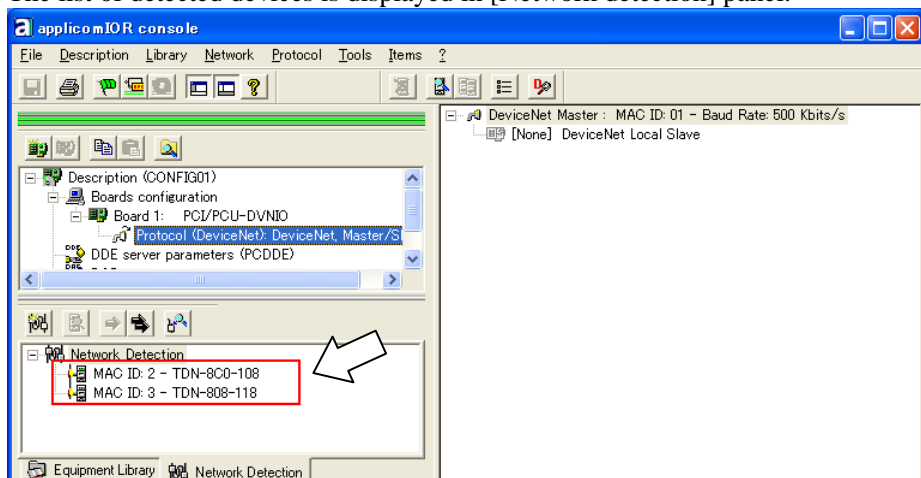

15. Select a device you want to scan.

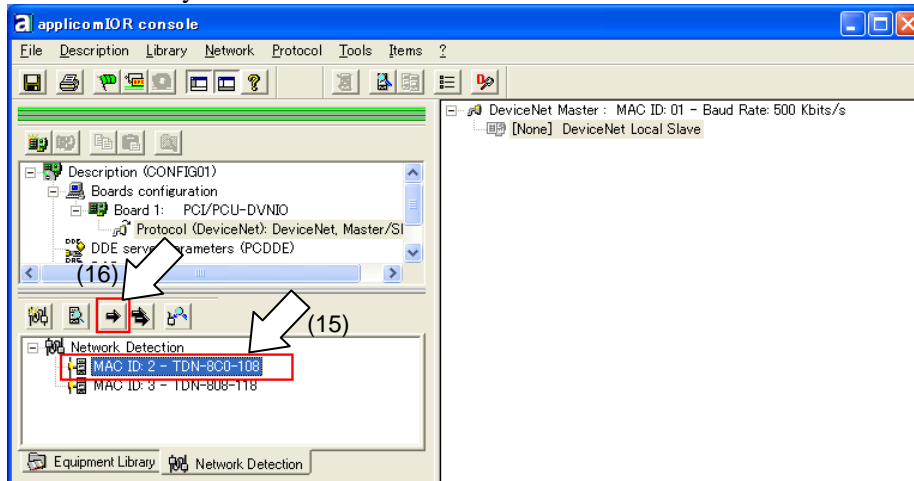

16. Click the <Insert in Configuration> icon.

17. The following dialog box appears.

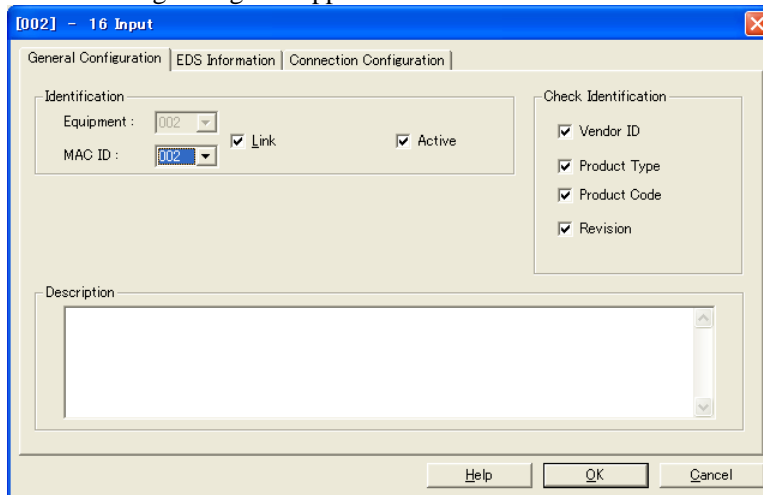

17-a Select [Connection Configuration] tab and the following panel appears.

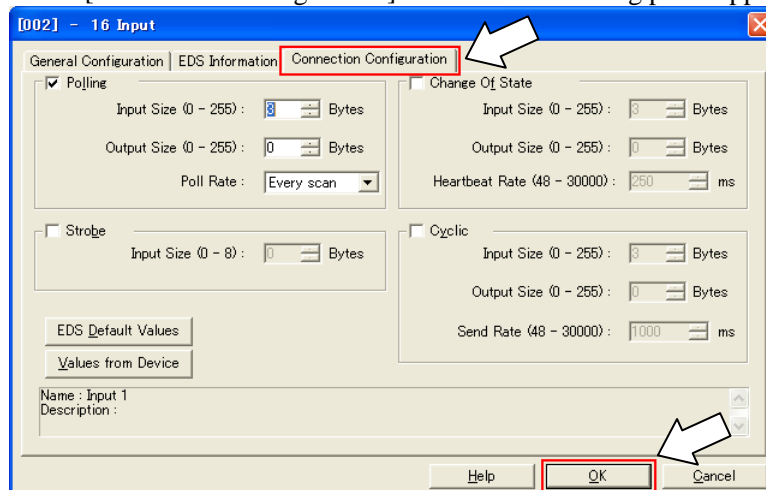

You can verify the connection configuration. Change the configuration if necessary. When the device setting is completed, click <OK>.



NOTE
Not every slave device supports all connection types. Understand the specifications of the slave device you want to use and configure the connection correctly.

17-b <Expert Mode> will appear when the applicomIO Console application is used in the “Expert Mode”.

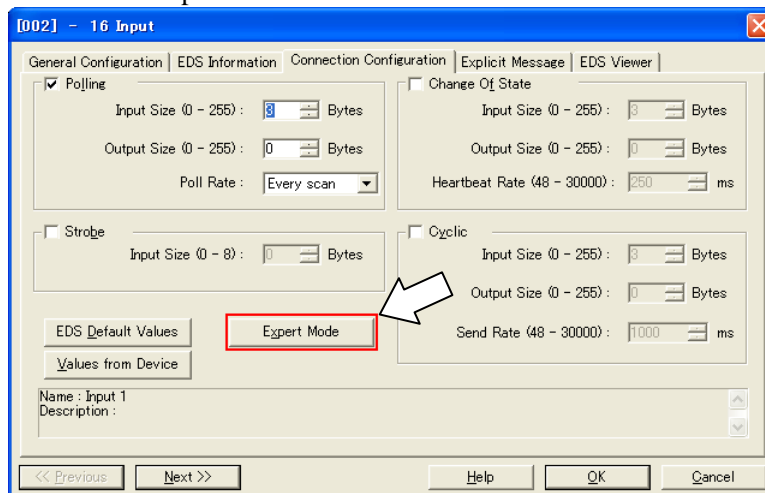

To configure details of “Change Of State” and “Cyclic”, click <Expert Mode> and display the [Expert Mode] dialog box.

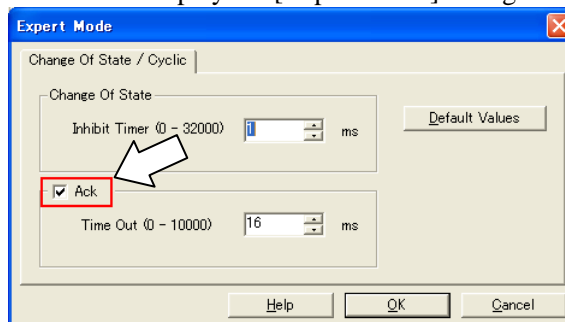

Never disable [Ack]. When the [Ack] checkbox is unchecked, a failed connection is not regarded as an error.

17-c When the system cannot identify the device you want to use (its EDS file is not registered), the following dialog box will appear.

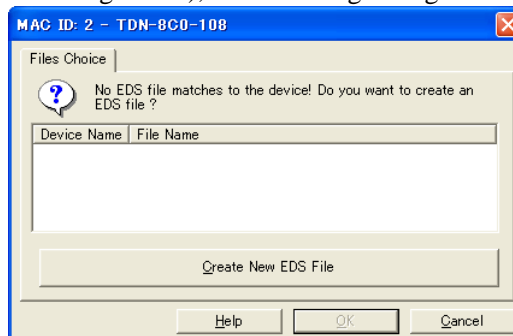

In this case, obtain the EDS file from the device manufacturer and register it by following the step 7. After that, follow the step 10.

18. Select [File]-[Download in Flash] from the applicomIOR console menu. Register the configuration to the Fieldbus master board.

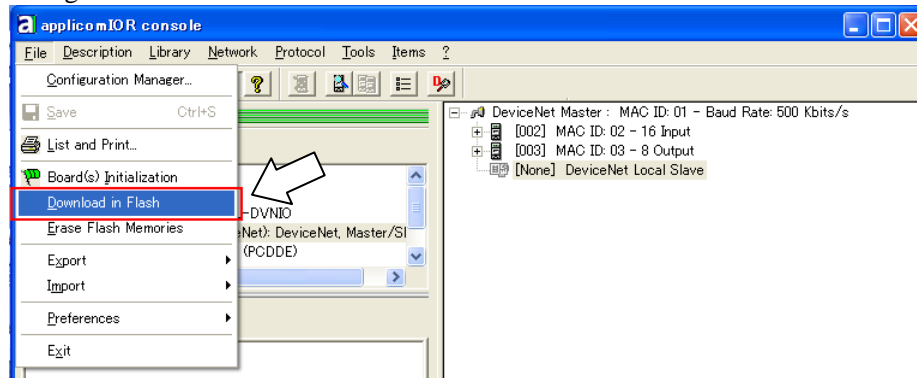

Make sure that the flash memory of Fieldbus master board stores the configuration; otherwise the Fieldbus master board cannot correctly function. Also, you cannot control it from EPSON RC+6.0.

If you changed the configuration, select [File]-[Download in Flash] from the applicomIOR console menu and register the configuration to the Fieldbus master board.

19. After few seconds, the display of “Configured boards state” on the status bar turns to green.

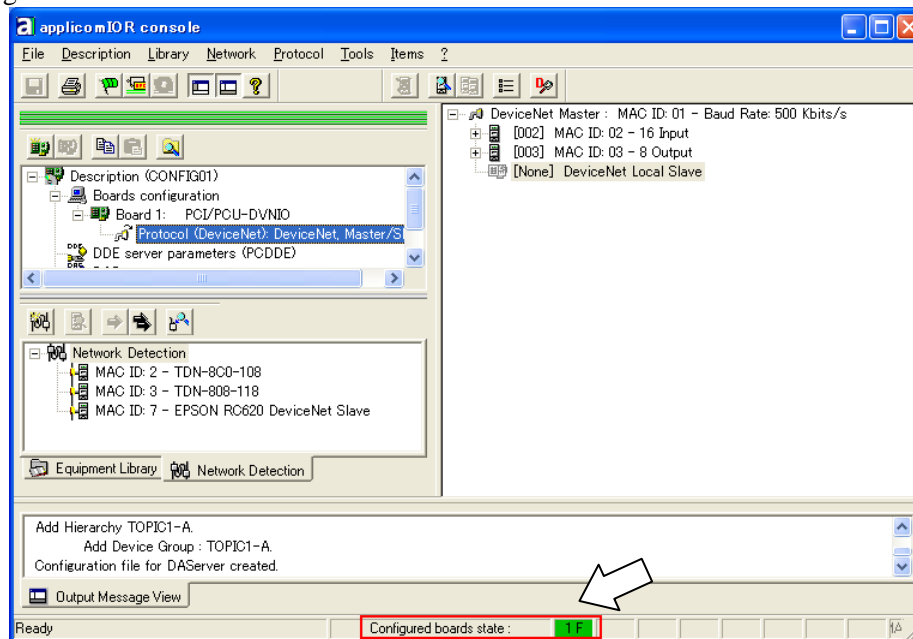

Now, the Fieldbus master board is ready to operate in the master mode.

20. Close the applicomIO Console application.
21. Refer to the section *EPSON RC+6.0 configuration* and continue the step.

EPSON RC+6.0 configuration

To use the Fieldbus master board, the RC620 option setting and Fieldbus master setting should be enabled.

1. Select [Setup]-[Option Setting] and display the [Option] dialog box.
2. See the *EPSON RC+ Users Guide: 18. Installing Controller Options* and enable the Fieldbus Master option.
3. The following message dialog appears.

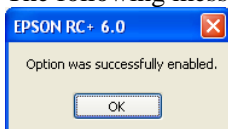

Click <OK> and reboot the EPSON RC+6.0.

After the EPSON RC+6.0 is started, the option setting is enabled.

4. Select [Setup]-[System Configuration] and display the [System Configuration] dialog box.

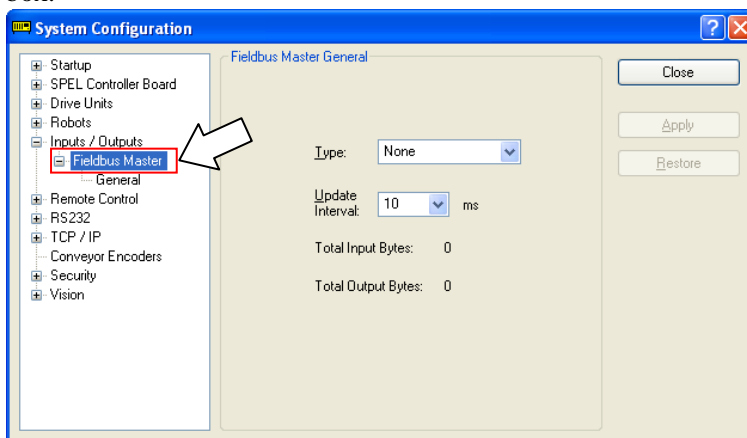

5. Select [Inputs/Outputs]-[Fieldbus Master]-[General].
6. Set the following items:
 [Type:] DeviceNet
 [Update Interval:] Update cycle for the DeviceNet master I/O

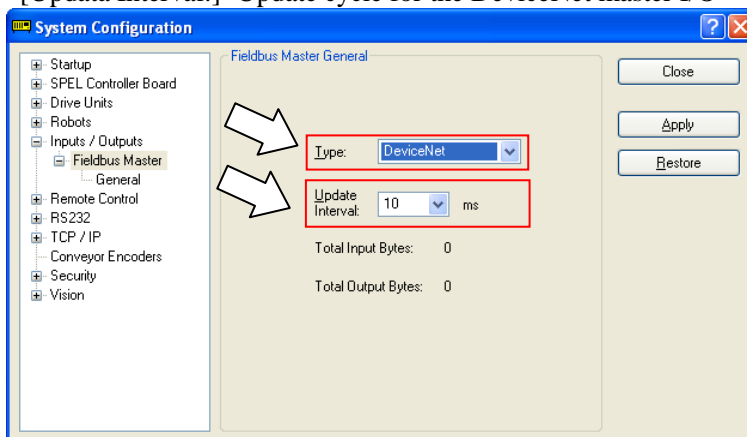

7. Click <Apply>.

Confirm that the following is displayed.

Total Input Bytes : Number of inputs the master controls (Bytes)

Total Output Bytes : Number of outputs the master controls (Bytes)

8. Click <Close>. The following dialog box appears.
 SPEL⁺ control part of the RC620 robot controller automatically starts rebooting.

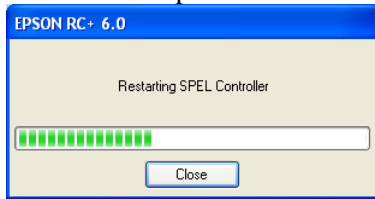

9. Select [Setup]-[System Configuration] and display the [System Configuration] dialog box.

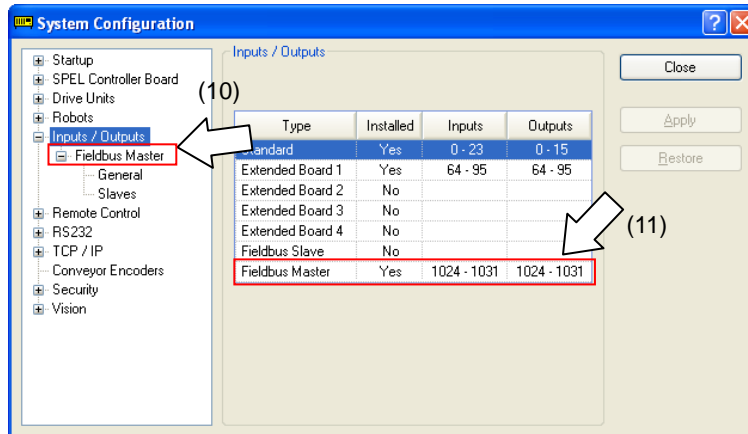

10. Select [Inputs / Outputs].
11. Confirm that “Fieldbus master” displays the following:

Installed : Yes

Inputs : 1024 – (1024 + Number of inputs the master controls (Bits))

Outputs : 1024 – (1024 + Number of outputs the master controls (Bits))

12. Select [Fieldbus Master]-[General].

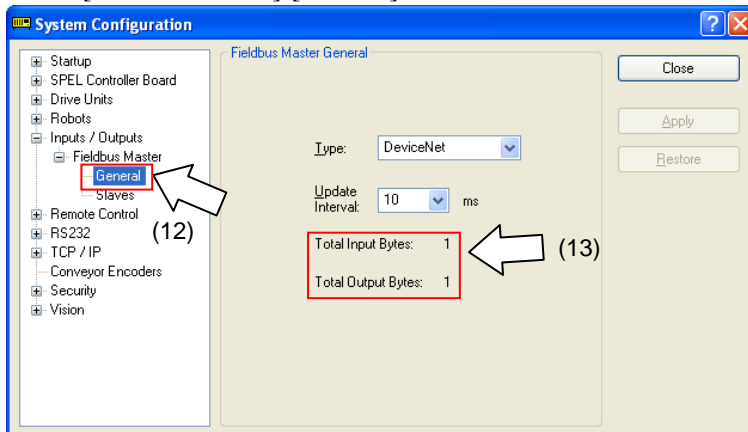

13. Confirm that the following is displayed.

Total Input Bytes : Number of inputs the master controls (Bytes)

Total Output Bytes : Number of outputs the master controls (Bytes)

14. Select [Fieldbus Master]-[Slaves].

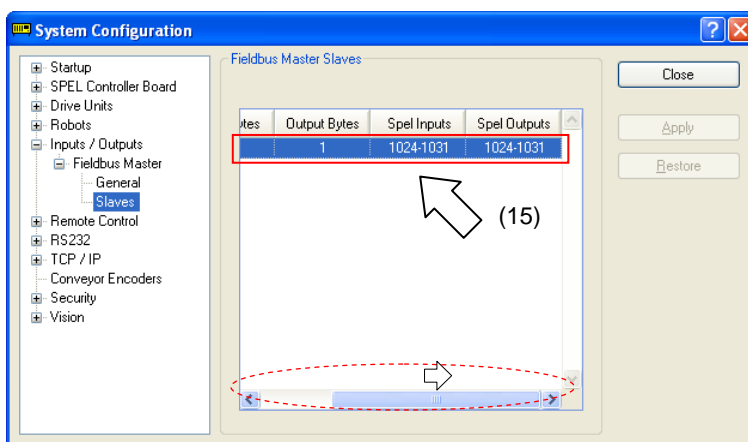
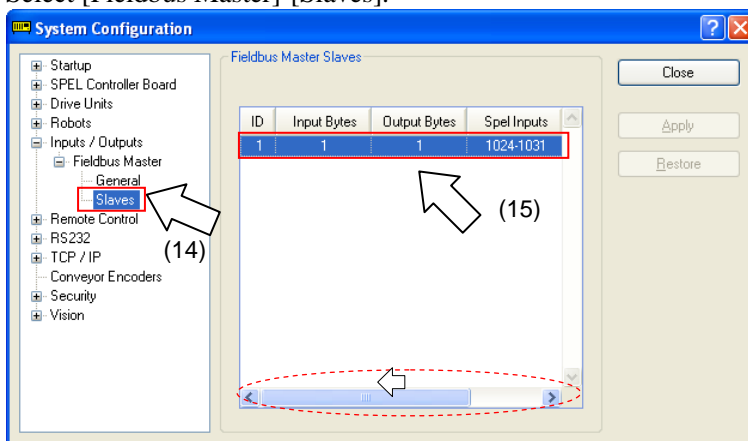

15. Confirm that the following information the master controls is displayed.

- ID : Fieldbus station ID of slave
- Input Bytes : Number of inputs per slave (Bytes)
- Output Bytes : Number of outputs per slave (Bytes)
- Spel Inputes : Number of inputs per slave (Bits)
- Spel Outputs : Number of outputs per slave (Bits)

2.1.4 DeviceNet Slave Board Installation

Appearance

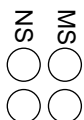

NS MS

 NS LED : Network status display
 MS LED : Module status display

The LED shows the board status.
 For details, refer to the section *LED Description of DeviceNet*.

2. Installation

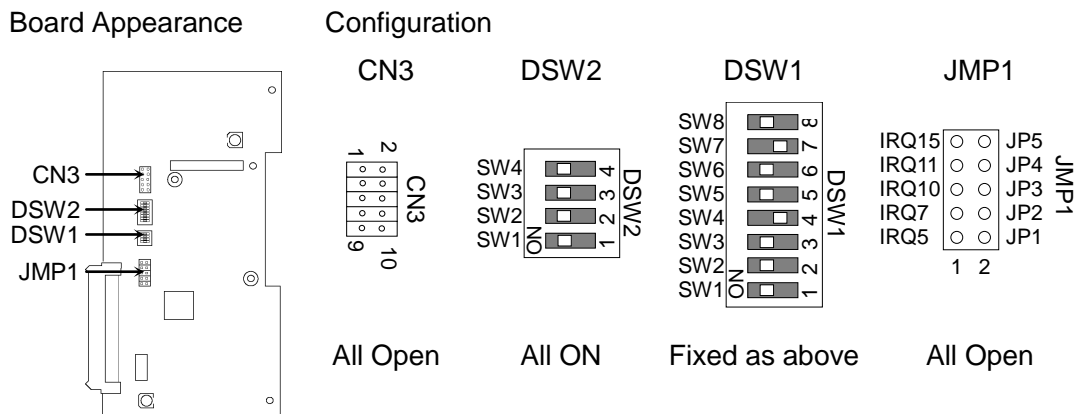
The Fieldbus slave board is configured as follows at shipment.



DeviceNet Communication Specifications

Item	Specification			
Name	DeviceNet slave board			
Code	R12B040706			
Supported Connection	I/O messaging connection (Polling), Explicit message connection DeviceNet communication protocol			
Baud Rates	125 k / 250 k / 500 k (bps)			
Transfer Distance	Baud Rates	Max. Network Length	Drop Length	Total Drop Line Length
	500 k (bps)	100 m	6 m or under	39 m or under
	250 k (bps)	250 m *	6 m or under	78 m or under
	125 k (bps)	500 m *	6 m or under	156 m or under
Cable	5-wire cable dedicated to DeviceNet (2 wires for signal, 2 wires for power supply, 1 shield wire)			
Communications Power Supply Voltage	24 VDC (supplied from a connector)			
Communication Power Supply Current Consumption	Maximum 30 mA			
Mode	Slave			
Interface	1 DeviceNet port			
Max. Input data size	256 bits (32 bytes)			
Max. Output data size	256 bits (32 bytes)			

* When Thin cable is used for trunk line, the maximum network length is 100 m.

LED Description of DeviceNet

LED status represents the status of the fieldbus board.

LED status		NS	MS
OFF		Communications power supply OFF Disconnected	Device power supply OFF
GRN	ON	Link OK Online connected	Device operating
	Blinking	Online disconnected	Data size error
RED	ON	Link error	Critical error
	Blinking	Communication time out	Error

Configure switch configuration



- Make sure that the power is turned OFF before installing/removing any boards or connecting/disconnecting any cables. Working with the power ON is extremely hazardous and may result in electrical shock and/or malfunction of equipment.

Set the baud rates between the MAC address of the device and the master by setting the DeviceNet slave board configure switch.

- Set the MAC address for DeviceNet slave board by setting the configure switch. Make sure that the MAC address is different from the other devices in the network. Refer to the following table for the configuration.

MAC address	Switch					
	sw3 (MSB)	sw4	sw5	sw6	sw7	sw8 (LSB)
0	OFF	OFF	OFF	OFF	OFF	OFF
1	OFF	OFF	OFF	OFF	OFF	ON
2	OFF	OFF	OFF	OFF	ON	OFF
3	OFF	OFF	OFF	OFF	ON	ON
⋮	OFF	OFF	OFF	OFF	OFF	OFF
62	ON	ON	ON	ON	ON	OFF
63 (at shipment)	ON	ON	ON	ON	ON	ON

- Set the DeviceNet slave baud rate. Check the master configuration and set the same baud rate. Refer to the following table for configuration settings.

Baud Rate	Switch	
	sw1	sw2
125 k	OFF	OFF
250 k	OFF	ON
500 k	ON	OFF
Configuration prohibited	ON	ON

Wiring

DeviceNet connector is a 5-pin open connector. Use the connector attached to the board for wiring.

Terminal name for each pin

Terminal Number	Terminal Name
1	V-
2	CAN_L
3	SHELD
4	CAN_H
5	V+



Prepare the cable for DeviceNet sold in the market as a communication cable. Install terminating resistors at both ends of the network.

Board Installation



- Make sure that the power is turned OFF before installing/removing any boards or connecting/disconnecting any cables. Working with the power ON is extremely hazardous and may result in electrical shock and/or malfunction of equipment.

Follow the instruction below and insert the board into the dedicated slot of the controller.

1. Remove two screws (+) on the back side of the RC620 robot controller.

RC620 Back

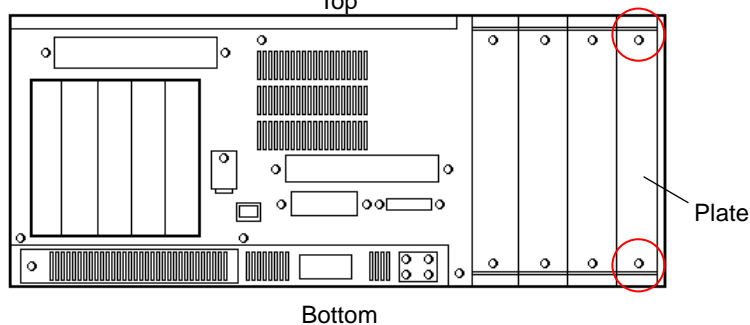

2. Remove the plate.
3. Insert the board into the slot along the guide.
4. Put the plate removed in the step 2 back and secure it with two screws.

Confirmation with EPSON RC+ 6.0

When the DeviceNet slave board is installed to the controller, it is recognized automatically. Confirm whether EPSON RC+ 6.0 has recognized the DeviceNet slave board using the following procedure.

1. Select [Setup]-[System Configuration] and display the [System Configuration] dialog box.

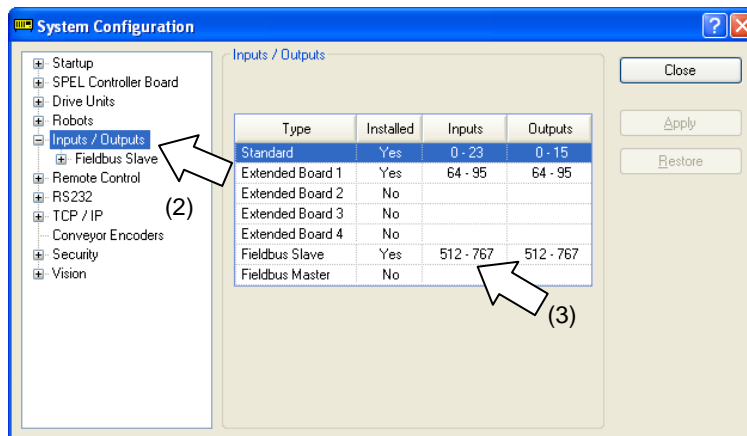

2. Select [Inputs / Outputs].
3. Make sure that the following are displayed in the Fieldbus slave.

Installed : Yes
 Inputs : 512-767 (default setting)
 Outputs : 512-767 (default setting)

4. Select [Fieldbus Slave]-[General].

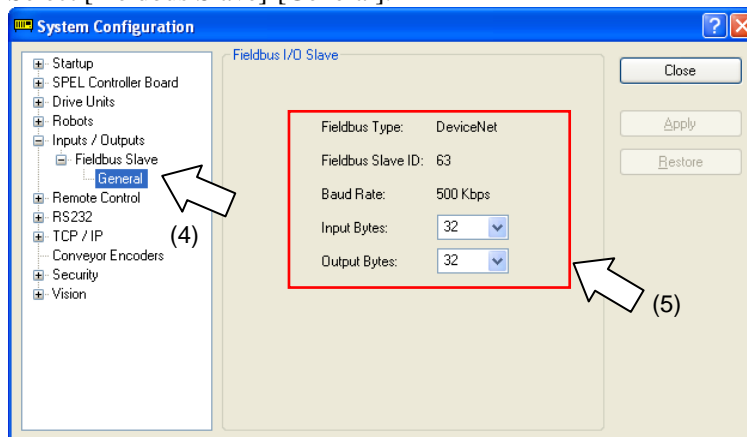

5. Make sure that the following is displayed.

Fieldbus Type : DeviceNet
 Fieldbus Slave ID : (Displays the configure switch MAC address)
 Baud Rate : (Displays the configure switch baud rate)
 Input Bytes : 32 (default setting)
 Output Bytes : 32 (default setting)

6. Click <Close>.

Editing of input / output size

You can change the input/output size of DeviceNet slave board if necessary.

1. Select [Setup]-[System Configuration] and display the [System Configuration] dialog box.
2. Select [Inputs / Outputs]-[Fieldbus Slave]-[General].

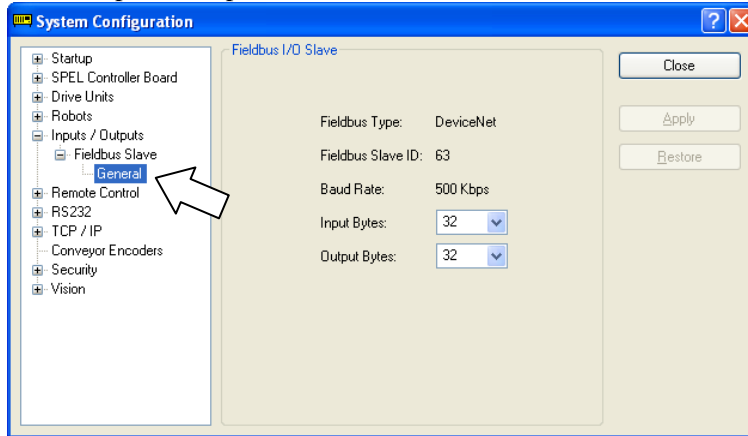

3. Change the settings of [Input Bytes] and [Output Bytes].
In this example, both of them are changed to 20 Bytes.

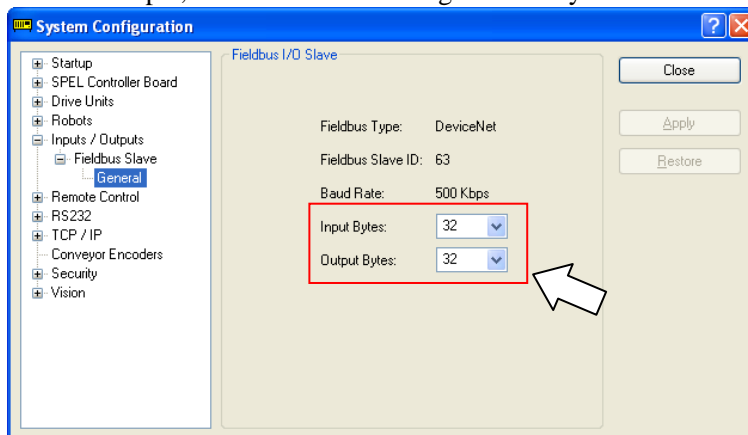

4. Click <Apply>.
5. Click <Close> and the following message dialog appears.
SPEL⁺ control part of RC620 robot controller automatically starts rebooting.

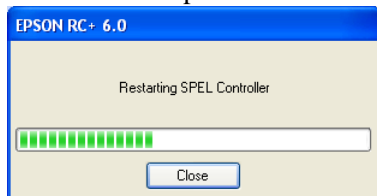

6. Select [Setup]-[System Configuration] and display the [System Configuration] dialog box.

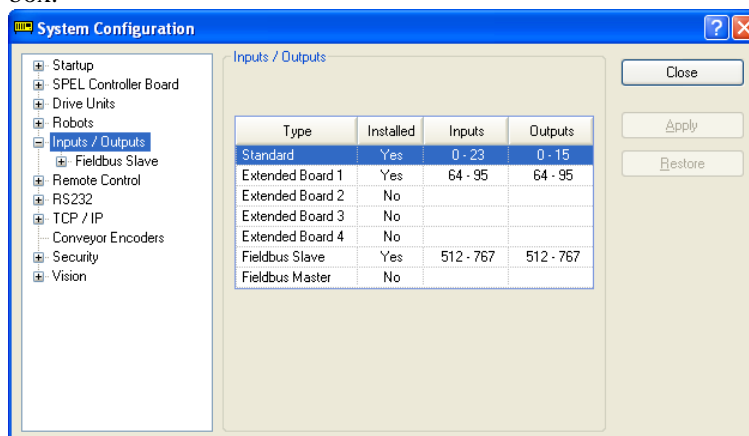

7. Select [Inputs / Outputs].
8. Make sure that the following is displayed in “Fieldbus Slave”.

Inputs :512 - (512 + Changed number of input (Bits))

Outputs :512 - (512 + Changed number of output (Bits))

In this example, Input byte is 20 bytes (160 bits) and 512-671 is displayed in Inputs.

Also, Output byte is 20 bytes (160 bits) and 512-671 is displayed in Outputs.

9. Click <Close>.



When you change the input/output size of DeviceNet slave board, you need to change the input/output size of the slave information registered in the Fieldbus master device.

Use the window below to change the input/output size of the slave information registered in the Fieldbus master device by the applicomIO console application.

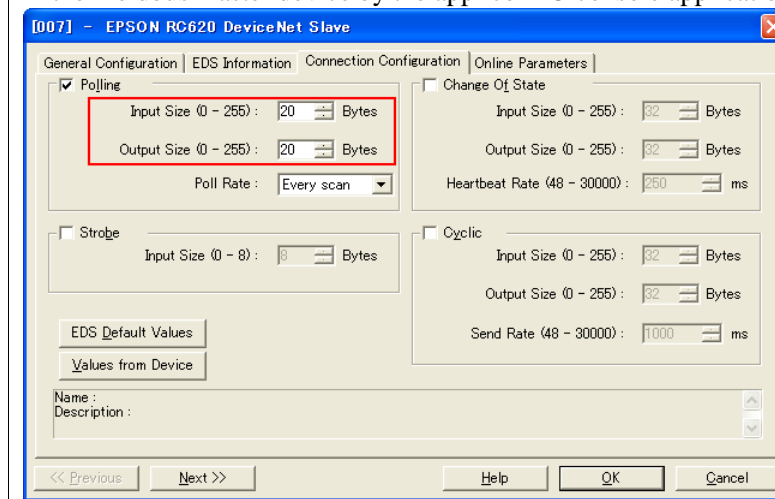

Electronic Information File (EDS file)

An EDS file is supplied for DeviceNet slave board network configuration. The file is located in the following folder in the Installer DVD that is attached to the Robot Controller.

\EpsonRC60\Fieldbus\DeviceNet

2.2 PROFIBUS-DP

2.2.1 How to Setup a PROFIBUS DP Network

The following is a basic procedure for setting up a PROFIBUS DP network:

1. Choose station layout and pathway in your network.
For details, refer to the following section 2.2.2 *PROFIBUS DP Network Construction*.
2. Choose the baud rate.
Choose the baud rate based on the network length. Select the fastest baud rate allowed for the length. Increasing network load due to slow baud rate may cause trouble including communication failure.
3. Lay cables.
For details, refer to the following section 2.2.2 *PROFIBUS DP Network Construction*.
4. Configure stations.
For details, refer to respective manuals of your desired stations.
5. Turn ON the stations.
6. Install the PROFIBUS-DP board into the controller.
When installing the PROFIBUS-DP master board (Code: R12B040702), refer to the section 2.2.3 *PROFIBUS-DP Master Board Installation*.

When installing the PROFIBUS-DP slave board (Code: R12B040707), refer to the section 2.2.4 *PROFIBUS-DP Slave Board Installation*.

7. Operate the PROFIBUS DP network.

2.2.2 PROFIBUS DP Network Construction

Network Configuration

PROFIBUS DP network is configured as shown in the following figure.

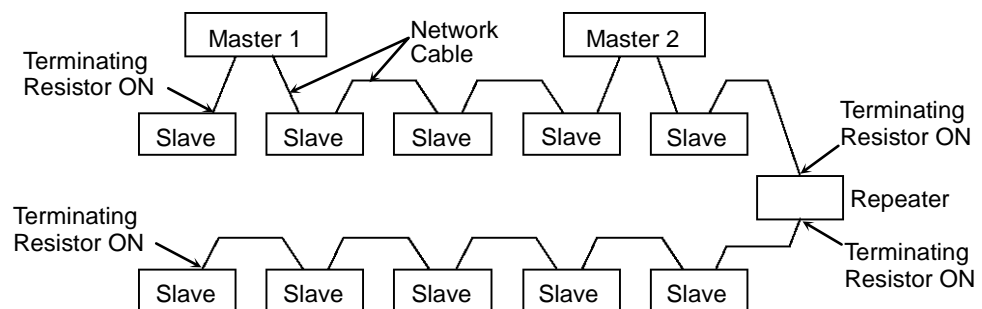

Station

There are four types of stations (devices):

- Master : Controls a network and gathers its slaves.
- Slave : External I/O and other devices/
Slave outputs data as a response to a master's output order and informs the master of its input status.
- Repeater : Repeater is necessary for a network with more than 32 slaves to separate network segments.
- Configurator : Used only for network installation. It configures a scan list of the slaves on the master device.

You can install masters anywhere in the network. You can connect up to 126 stations including server and repeater in the network. However, it is recommended to keep one device for the engineering device.

Network Cable

The PROFIBUS cable can be used as a network cable. There are four types (A, B, C, and D) of PROFIBUS cables. Normally, cable type A is used for PROFIBUS DP network. The cable type A specifications are shown in the table below.

Item	Specification
Impedance	135 to 165 Ω
Capacity	< 30 pf/m
Loop resistance	110 Ω /km
Wire diameter	0.64 mm
Core cross-section	> 0.34 mm ²

It is recommended to use a 9-pin D-Sub connector for protecting rating IP 20. For IP 65/67, M12 connector (IEC 947-5-2 compliant), Han-Bird connector (DESINA compliant), and Siemens hybrid connector are available.

Pin assignment (9-pin D-Sub)

Pin No.	Signal	Assignment
1	Shield	Shield / Protective ground
2	M24	Ground of output voltage (24 V)
3	RxD/TxD-P	Data line B
4	CNTR-P	Repeater control signal (directional control)
5	DGND	Communications power supply (5 V)
6	VP	Supply voltage to terminating resistor (P5V)
7	P24	Output voltage (24 V)
8	RxD/TxD-N	Data line A
9	CNTR-N	Repeater control signal (directional control)

Use pins 2 and 7 for connecting a maintenance device without any power supply.

The following figure illustrates wiring sample.

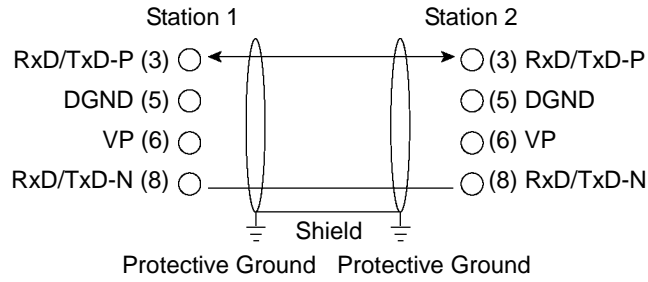

PROFIBUS cables are produced by a variety of manufacturers. For details of the PROFIBUS cables, see PROFIBUS International's website (<http://www.profibus.com/>).

Terminating Resistor

To reduce reflections of communication signal, terminating resistors should be attached on both ends of each segment. Attach the terminating resistor as shown below.

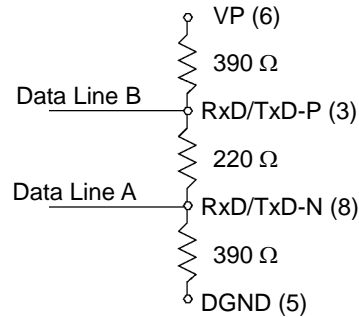

Some commercially available PROFIBUS 9-pin D-Sub connectors have functions of terminating resistor and they can enable/disable the terminating resistors. (Example: Woodhead MA9D00-32)

Molded terminating resistors with connector that can be attached to environment-resistant M12 connector are also available.

Baud Rate and Maximum Cable Length

Available baud rates are 9.6 kbps, 19.2 kbps, 93.75 kbps, 187.5 kbps, 500 kbps, 1500 kbps, 3 Mbps, 6 Mbps, and 12 Mbps.

PROFIBUS DP requires approximately 1ms at 12 Mbps for transmission of 512 bits input data and 512 bits output data distributed over 32 stations. The following figure shows typical PROFIBUS DP transmission times depending on the number of stations and baud rate.

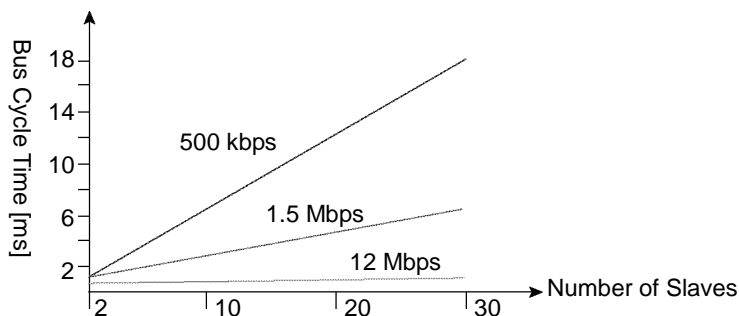

The maximum cable length is restricted by the baud rate.

Baud Rate	Maximum Cable Length
12 Mbps	100 m
6 Mbps	100 m
3 Mbps	100 m
1500 kbps	200 m
500 kbps	400 m
187.5 kbps	1000 m
93.75 kbps	1200 m
19.2 kbps	1200 m
9.6 kbps	1200 m

Multi-Master Configuration

PROFIBUS DP allows you to install multiple masters in a single physical network.

All slave devices in the network can be accessed by different masters. Only one master on the network can be used for device configuration.

The following figure illustrates the communication procedure for a multi-master configuration.

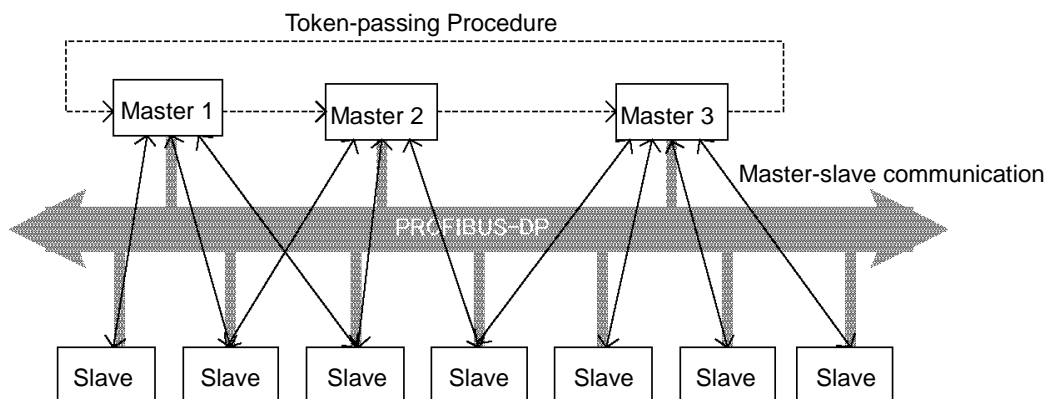

When the master receives the logic token, it inquires data from its slaves. After all communications are completed, the master passes the token to another master. In this way, the master can only communicate with its slaves while it is holding the token. The slaves respond to only the inquiry from the master. No slave can output any messages.

Modification and Installation of Communication Cables

The following procedure explains how to modify and install a Woodhead 9-pin D-Sub connector (MA9D00-32).

Follow the steps described below to modify communication cables and connect them to the connector.

 CAUTION	<p>■ Be careful not to injure your hands or fingers on any sharp blades or tools used to modify the cable. Use appropriate blades and/or other tools to modify the cable. Using inappropriate blades and/or other tools may result in bodily injury and/or equipment damage.</p>
---	--

1. Strip approx. 47.5 mm of the cable covering with extra care so that you do not scratch on braided shield underneath. Do not strip the cable covering more than necessary. Excess stripping may cause short-circuit and/or make the cable more sensitive to noise.
2. Carefully expand meshes of the braided shield and fold back the shield over the cable covering. Cut off the shield at approx. 10 mm from the stripped side of the cable covering.
3. Strip the covering of the signal wire as shown in the figure.

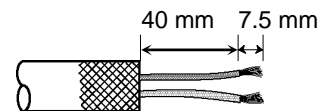
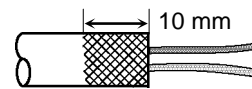
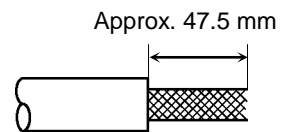

4. Insert the signal wires into the terminal block on the connector and secure the signal wires. Carefully connect the same signal wire to the same terminal on both ends. To prevent faulty wiring, make a rule of connection. For instance, connect the green signal wire to the A1/A2 terminal and the red signal wire to the B1/B2 terminal.

2.2.3 PROFIBUS-DP Master Board Installation

Appearance

Part names and functions of the PROFIBUS-DP master board are shown in the following figure. For details of the status display LEDs, refer to 4. *Trouble shooting* in this manual.

PCI-DPIO

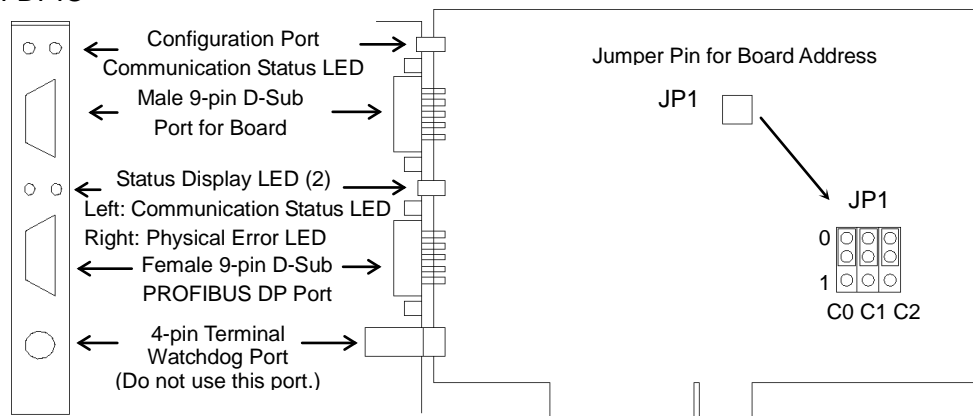

PCU-D2PIO

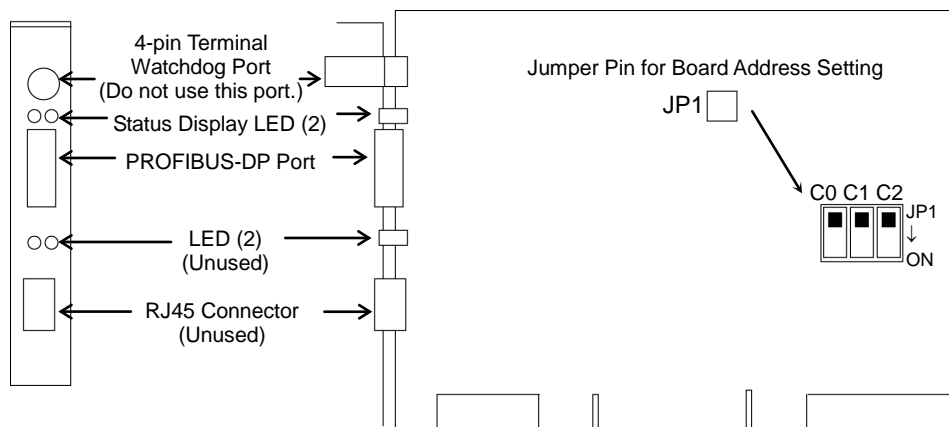

Specifications

Item	Specification
Part Number	PROFIBUS-DP master board
Models	applicom PCI-DPIO
Modes	Master
Baud Rates	9.6, 19.2, 93.75, 187.5, 500, 1500, 3000, 6000, 12000 kbps
Interface	1 PROFIBUS port (EN 50 170)
Output Current Capacity	Maximum 150mA
Supported Devices	All DP Devices
Maximum Stations	126 (32 per segment)
GDS Support	Yes
PROFIBUS DP Class 1	Yes
PROFIBUS DP Class 2	Yes
Max. Input Data Size	1024 bits (128 bytes)
Max. Output Data Size	1024 bits (128 bytes)
Automatic Detection	Yes. Devices can be detected automatically.

Moiton Mode

PROFIBUS-DP master board has two motion modes; Master mode and Slave mode. However, do not select the Slave mode.

Master Mode

There are two types of PROFIBUS DP master: DPM1 and DPM2. DPM1 (DP Master Class 1) gathers and controls all stations in one PROFIBUS DP network. DPM2 (DP master Class 2) operates network configurations, network maintenance, and diagnosis.

PROFIBUS DP master can control up to 126 stations (max. 128 bytes) in one network.

PLC is typically configured as a master and controls all devices in factory automation system, but EPSON RC+ is also capable of being a master.

PROFIBUS DP network configuration is specified by the configuration management software. This software is normally provided by a master device manufacturer. The configuration management software determines parameters for each slave device via an Electronic Data Sheet (GSD).

The connection type is token passing procedure and master-slave communication. The token passing procedure is applied to the PROFIBUS DP network with more than two master devices to transfer network control between masters. The master-slave communication is applied to the communication between the master device with network control and its slave devices.

Available baud rates are 9.6 kbps, 19.2 kbps, 93.75 kbps, 187.5 kbps, 500 kbps, 1500 kbps, 3 Mbps, 6 Mbps, and 12 Mbps.

For the instruction of configuration, refer to the section *Master Mode*.

Software Installation (PCI-DPIO)

Before installing the PROFIBUS-DP master board in your controller, you must install the applicomIO Console application and drivers according to the type of board you are using.

For PCU-D2PIO, refer to *Software Installation (PCU-D2PIO)*.

1. Start the controller.
2. Execute the following file in the install folder of the controller and start the installation.
C:\Install\FieldBus\Install\applicomIO\Disk1\Setup.EXE
3. The following dialog box appears. Select the desired language for the installer.

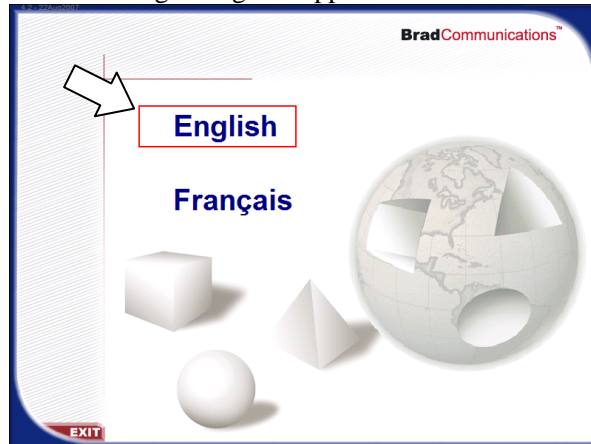

4. The [Summary] dialog box appears. Select “Products Installation”.

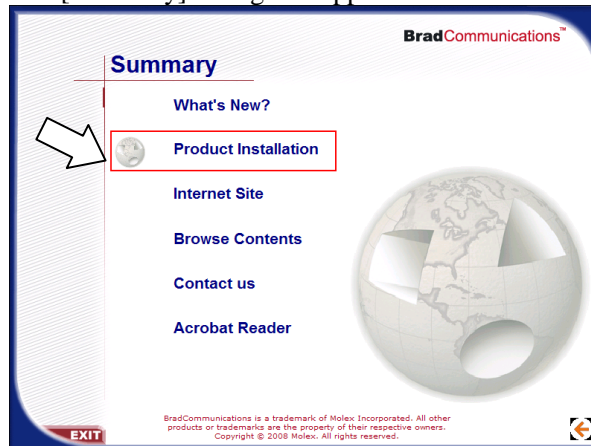

5. The [applicomIO] dialog box appears. Select “Installation”.



6. The [Installation] dialog box appears. Select “applicomIO”.

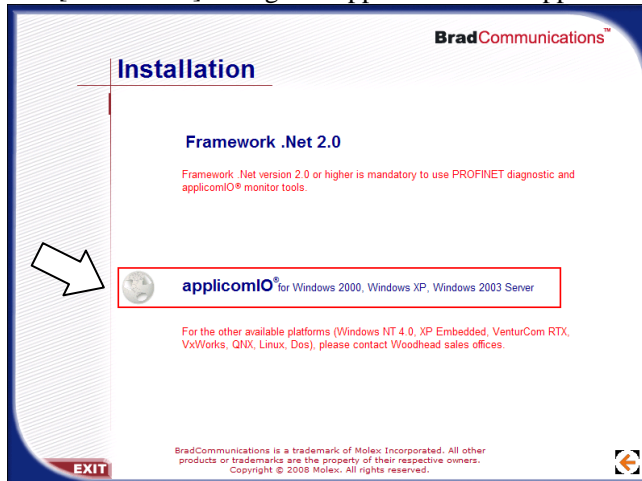

7. The applicomIO Console application installer starts up and the [Welcome to applicomIO 2.4 Setup] dialog box appears. Click <Next>.



8. The [License Agreement] dialog box appears. Read the software license agreement and click <Yes>.

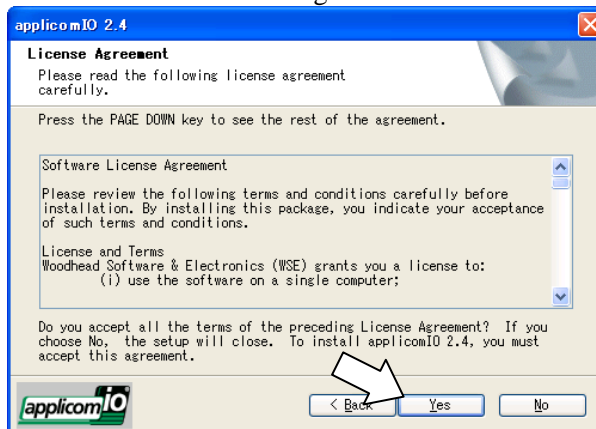

9. The [User Information] dialog box appears. Register the user information. Type in the user name (Name:) and company name (Company:).

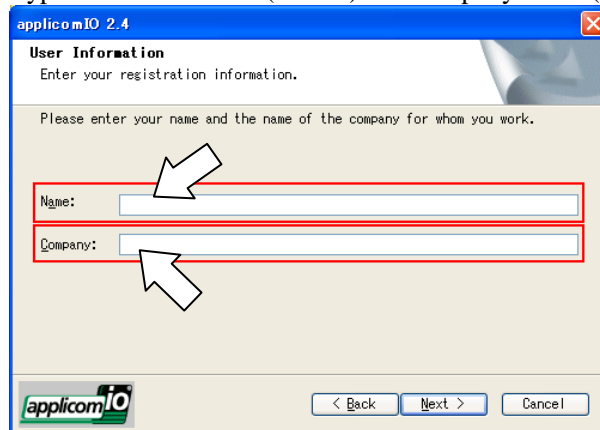

10. The [Choose Destination Location] dialog box appears. Specify the installation folder for the applicomIO console application. The default specifies here:

C:\Program Files\Woodhead\Direct-Link\applicomIO\2.4

If you agree to the default installation folder, click <Next>.

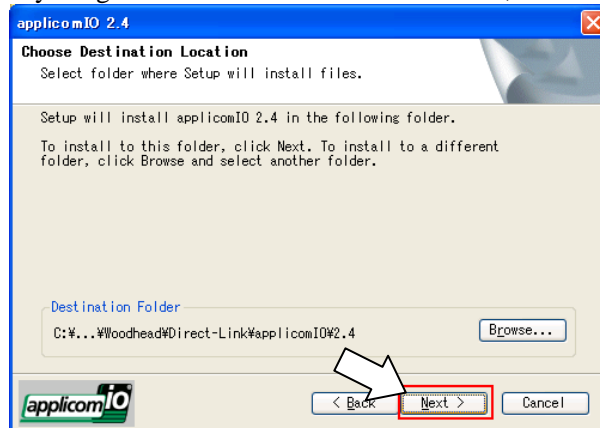

11. The [Select Components] dialog box appears. Install the default components. Click <Next>.

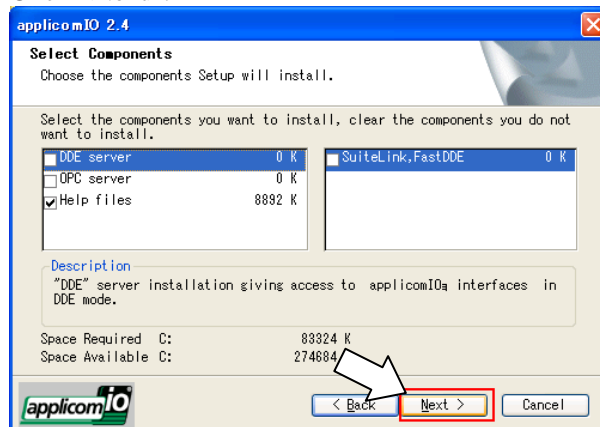

12. The [Select protocols] dialog box appears. Check the [Profibus-DP] checkbox.

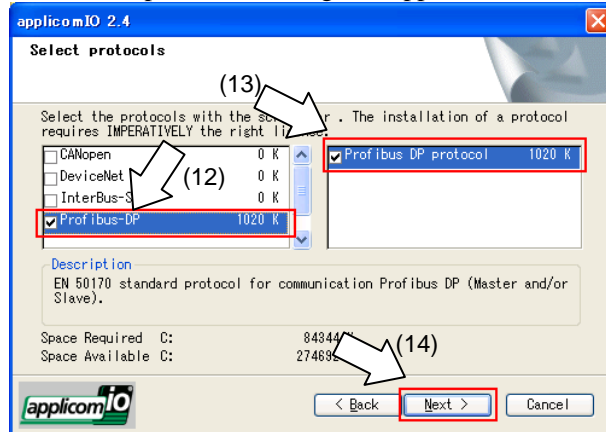

13. Check the device data file you want to install (GSD for PROFIBUS-DP).

14. Click <Next>.

15. The [Select options] dialog box appears. Click <Next>.

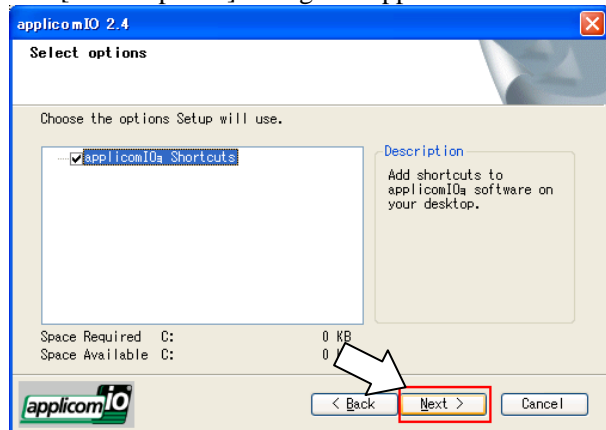

16. The [Start Copying files] dialog box appears. Click <Next>.

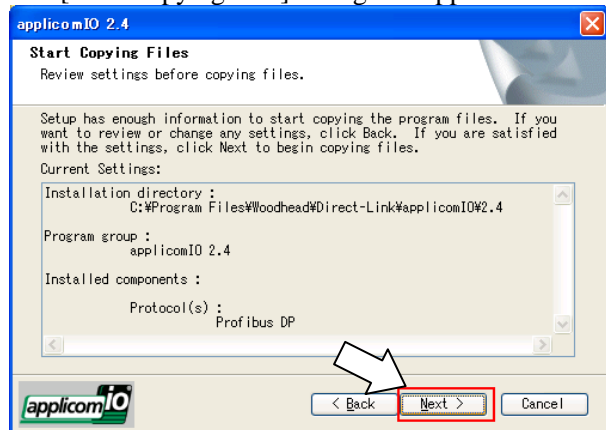

17. The [Start Copying Files] dialog box appears. Click <Next>.

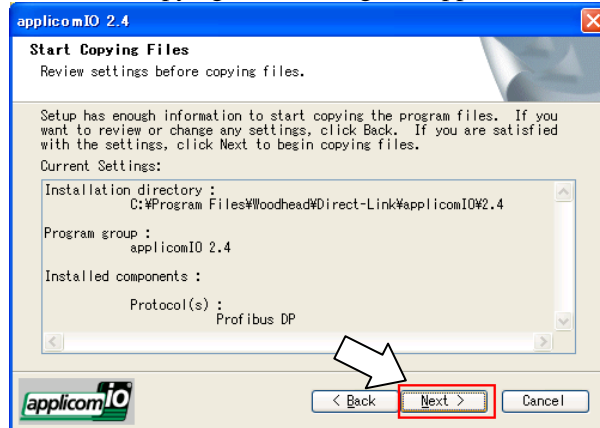

18. The [Setup Status] dialog box appears and the installation of applicomIO Console application starts.

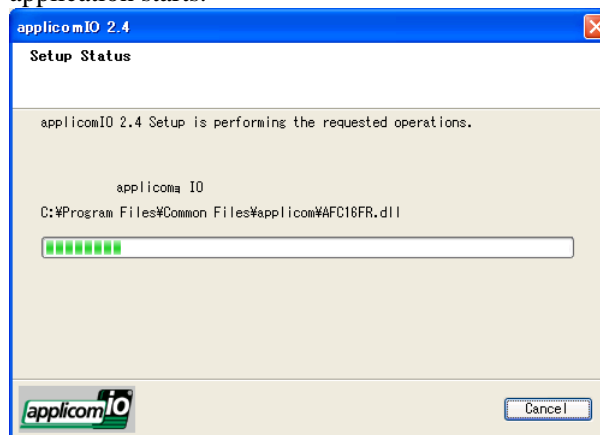

19. When the installation is completed, the [Setup Complete] dialog box appears. The message prompts you to reboot your controller. Select "Yes".

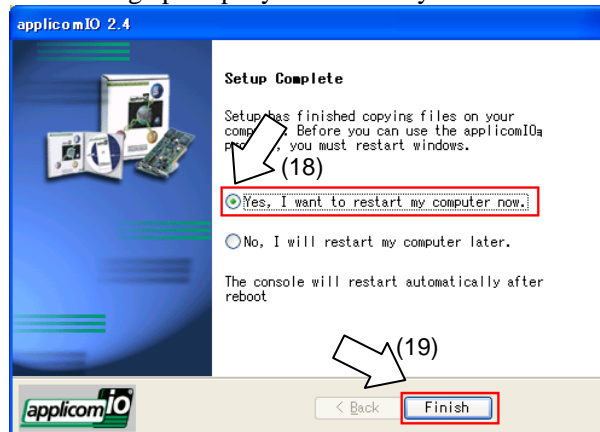

20. Click <Finish> and reboot the controller.

21. Start the following file and install the service pack.

C:\Install\FieldBus\Install\Sp\Setup.EXE

No installation is necessary when a service pack is not attached to the controller.

22. After completing the installation of the service pack, shutdown the computer.

23. Refer to the next section *Board Installation* and install the PROFIBUS-DP master board.

Software Installation (PCU-D2PIO)

Before installing the PROFIBUS-DP master board in your controller, you must install the applicomIO Console application and drivers according to the type of board you are using.

1. Start the controller.
2. Execute the following file in the install folder of the controller and start the installation.
C:\Install\FieldBus\Install\applicomIO\Disk1\Setup.EXE
3. The following dialog box appears. Select <Run setup.exe>.

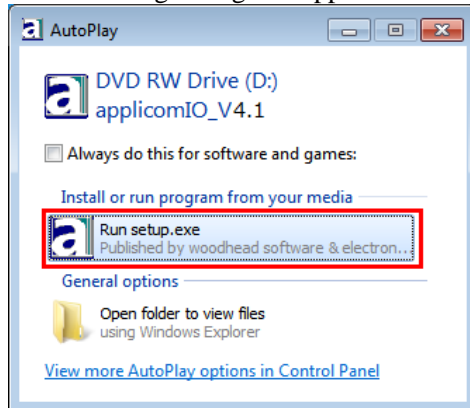

4. The [Summary] dialog box appears. Select “Products Installation”.

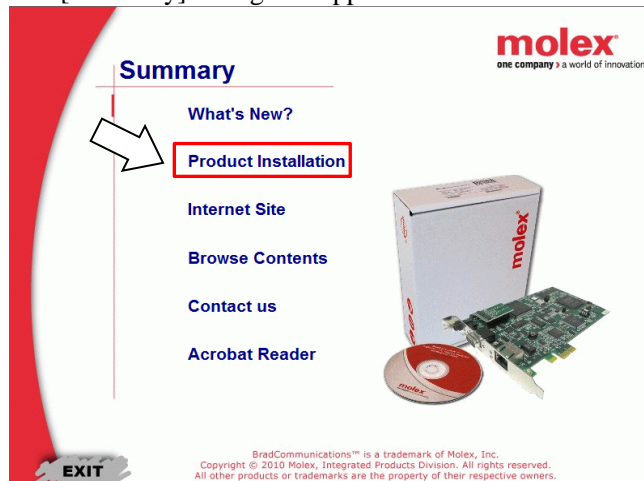

5. The [Installation] dialog box appears. Select “applicomIO”.

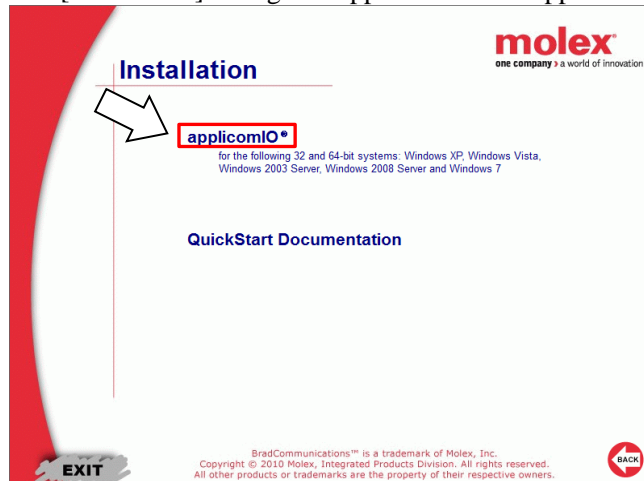

6. If the Microsoft.NET Framework 4.0 is not installed, following dialog window appears.

Click <Install>.

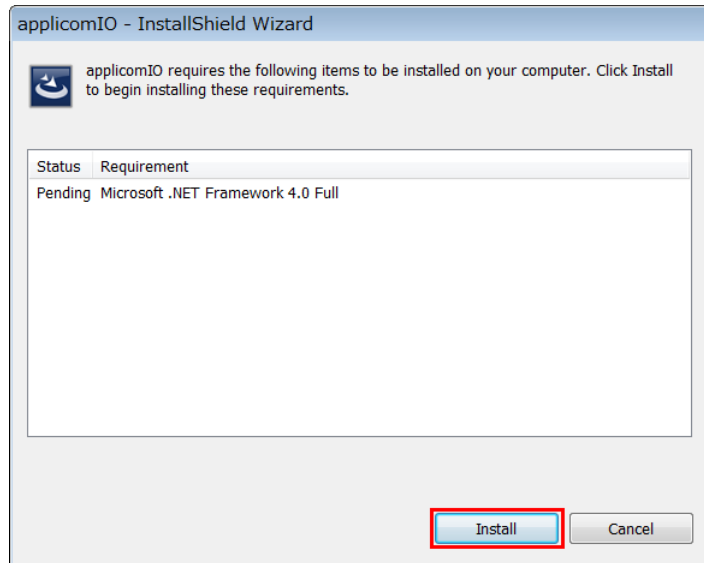

7. The applicomIO Console application installer starts up and the [Welcome to the InstallShield Wizard for applicomIO] dialog box appears. Click <Next>.

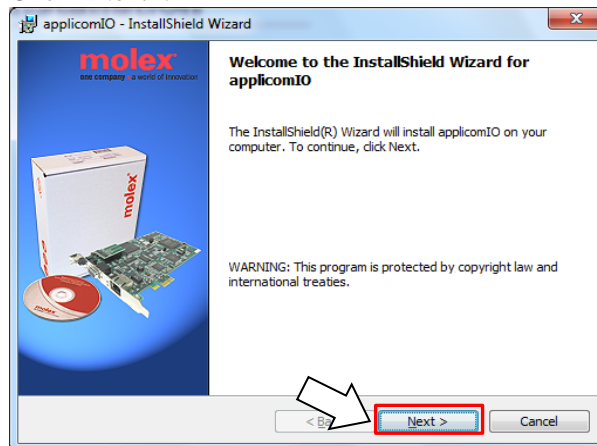

8. The [License Agreement] dialog box appears. Read the software license agreement and click <Next>.

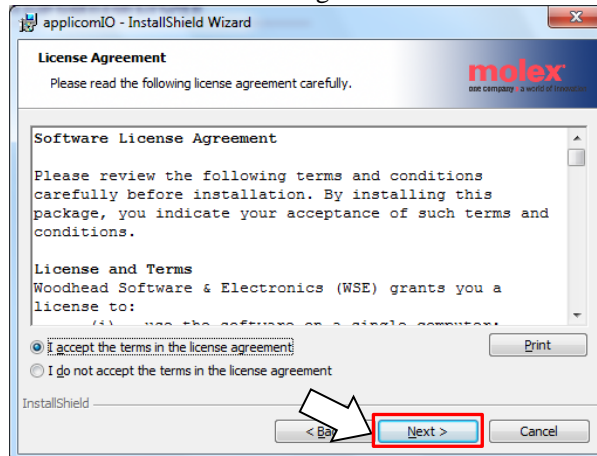

9. The [Customer Information] dialog box appears. Register the user information. Type in the user name (Name:) and company name (Company:).

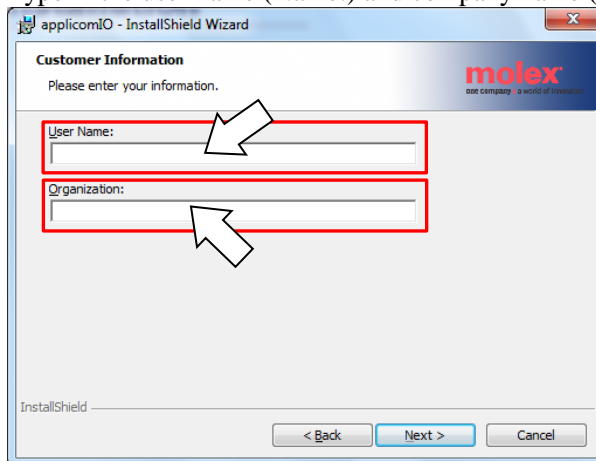

10. The [Destination Folder] dialog box appears. Specify the installation folder for the applicomIO console application. The default specifies here:
C:\Program Files(x86)\BoadCommunications\applicomIO\4.1
If you agree to the default installation folder, click <Next>.

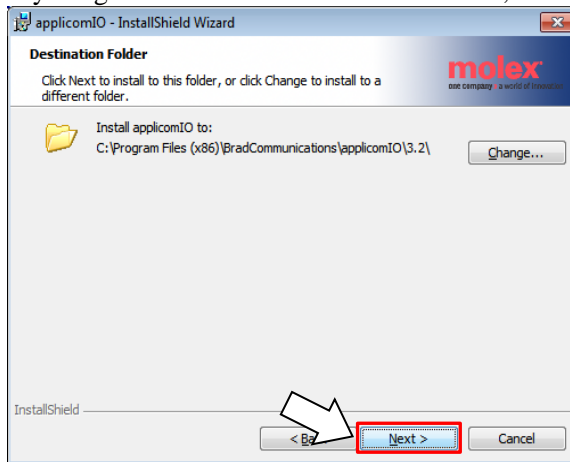

11. The [Ready to Install the Program] dialog box appears. Click <Install>.

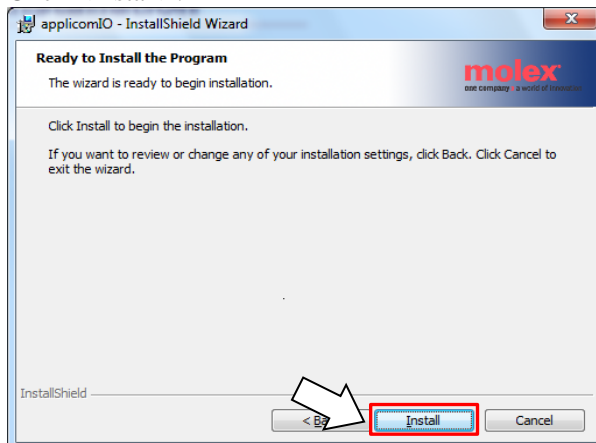

12. Installation of applicomIO Console application starts.
After the installation completes, the [InstallShield Wizard Completed] dialog box appears.
Click <Finish>.

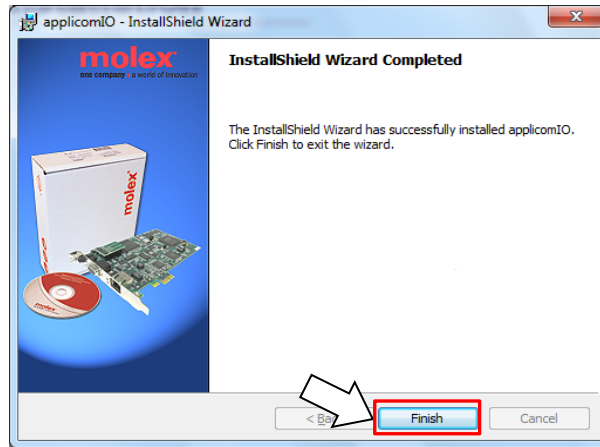

13. The message prompting you to reboot your PC appears.
Select "Yes" and reboot the PC.

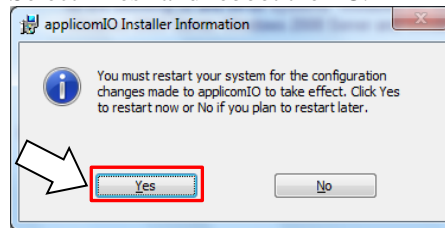

14. Refer to the next section *Board Installation* and install the PROFIBUS-DP master board.

Board Installation



■ Make sure that the power is turned OFF before installing/removing any boards or connecting/disconnecting any cables. Working with the power ON is extremely hazardous and may result in electrical shock and/or malfunction of equipment.

1. Configure the board address jumper (JP1) on PROFIBUS-DP master board.
 You can install one Fieldbus master board in the RC620 robot controller.
 The board number should be “1”.
 Refer to the following table for JP1 configuration.

PCI-DPIO

Short Socket Board No.	C0	C1	C2
1	0: Short	0: Short	0: Short

PCU-D2PIO

Switch Board No.	C0	C1	C2
1	OFF	OFF	OFF

2. Follow the instruction below and insert the board to the general purpose slot.
 - 2-1 Remove ten screws (+) on the top face of RC620 controller.
 Remove the top plate.

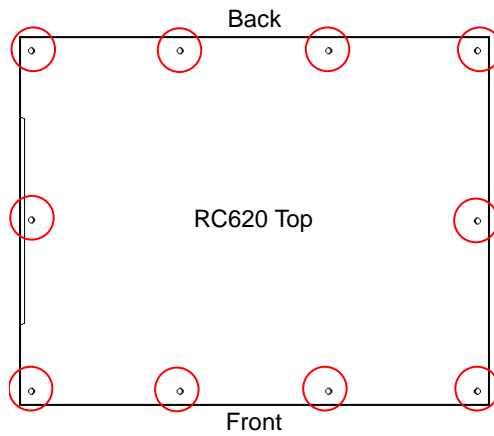

- 2-2 Remove two screws (+) inside of the RC620 controller.

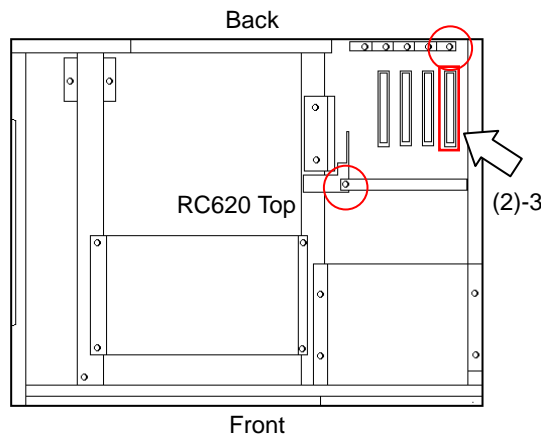

- 2-3 Insert the Fieldbus master board into the general purpose slot on the far right (recommended).

- 2-4 Put two screws removed in the step 2-2 back and secure them.
- 2-5 Put the top plate back and secure it with ten screws.
3. Connect the board with the Fieldbus.
4. Start up the controller.
5. The PROFIBUS-DP master board is detected and the [Found New hardware Wizard] dialog box appears.
Select <No, not this time> and click <Next>.

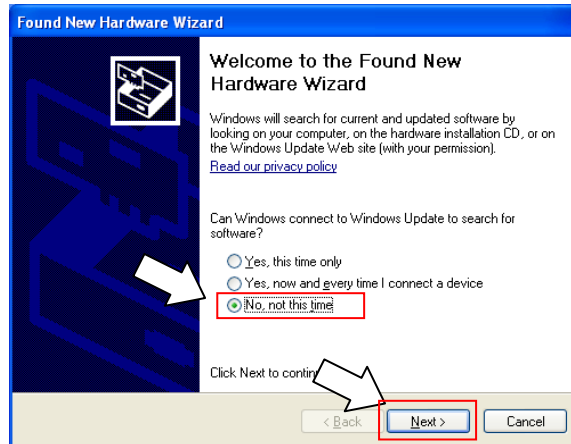

6. The following dialog box appears.
Confirm that the detected hardware is "applicomIO PCI Board 32K".

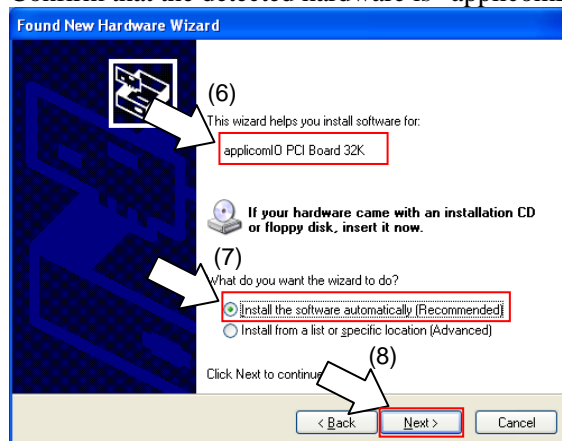

7. Select <Install the software automatically (Recommended)>.
8. Click <Next>.

9. The following dialog box appears.
Necessary software is automatically installed.

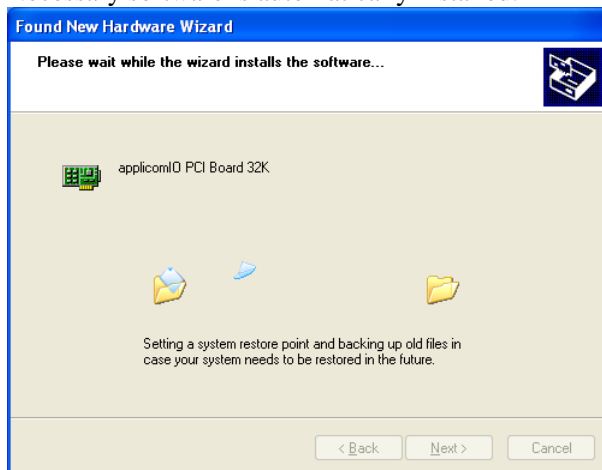

10. When the installation is completed, the [Completing the Found New Hardware Wizard] dialog box appears.
Click <Finish>.

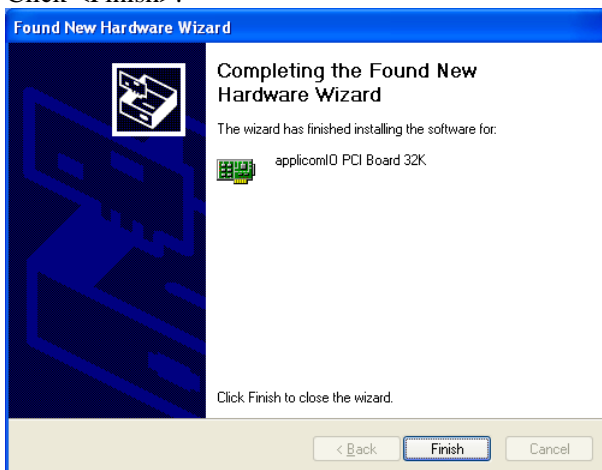

11. Start the <applicomIO Console> application.

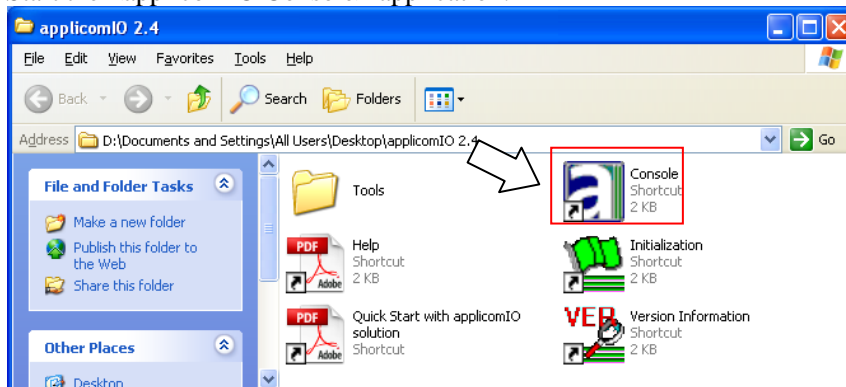

12. The [Add New Board] dialog box appears. Add the PROFIBUS-DP master board. Click <Add Board>.

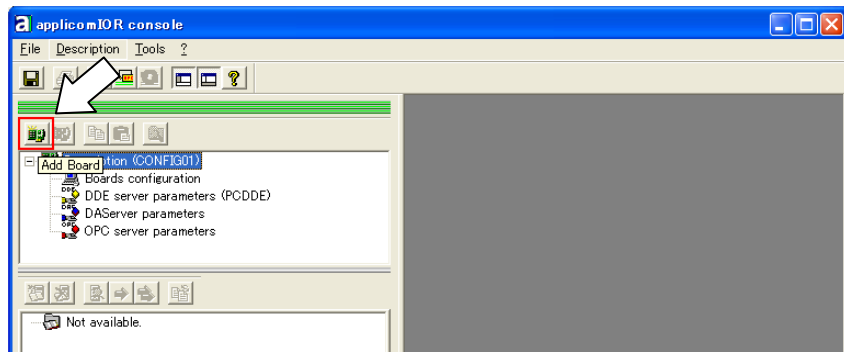

13. The [Add New Board] dialog box appears. Confirm that “PCI-DPIO” is displayed in [Board to Add]-[Board Type] and click <OK>.

PCI-DPIO

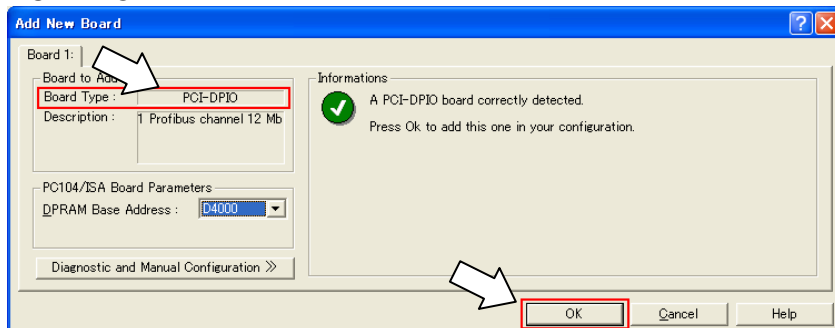

PCU-D2PIO

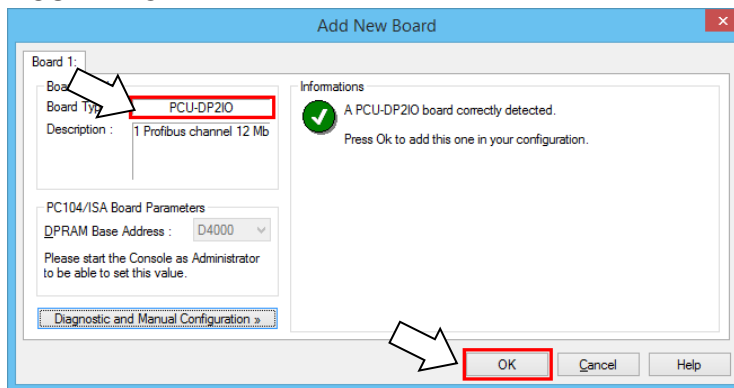

If the board cannot be detected, the following dialog appears. Make sure that the board is correctly inserted.

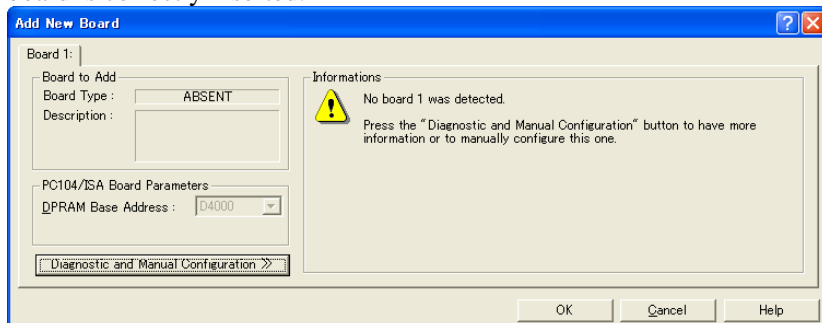

14. When you finish adding the PROFIBUS-DP master board to the applicomIO Console application, reboot the controller.

14-1 Close the applicomIO Console application.

When closing the applicomIO Console application, the following message box appears. Click <Yes>.

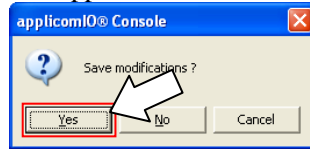

14-2 The following dialog appears. Click <OK>.

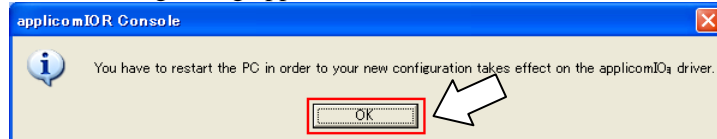

14-3 Reboot the Windows.

15. After the controller is rebooted, refer to the next section *Master Mode* and continue the step.

Master Mode

1. Ensure that the board is connected to the fieldbus.
2. Start the applicomIO Console application.

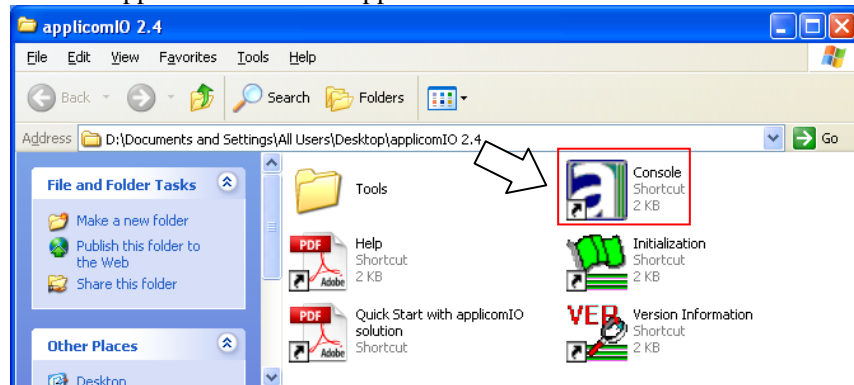

3. The [applicomIOR console] dialog box appears. Register the device information (GSD file) that is necessary for the network setup.

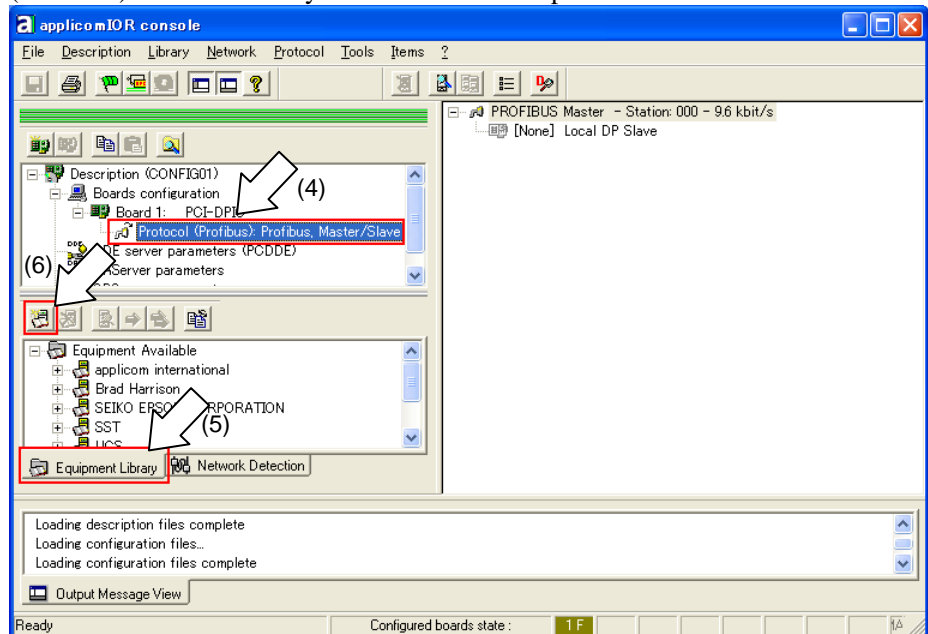

4. Select "Protocol".
5. Select the [Equipment Library] tab.
6. Click the <Add> icon.
7. The [Select configuration files] dialog box appears. Specify the GSD file that is supplied from the device manufacturer. Click <Open>.

PCI-DPIO

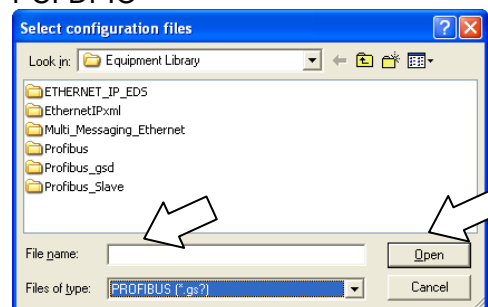

PCU-D2PIO

7-(1) The [GSD Management] dialog box appears. Register the GSD file that is supplied from the device manufacturer in the controller. Click <Next>.



7-(2) Following dialog box appears. Specify the folder in which the GSD file is stored.

Select <Add all the GSD from the Directory>.

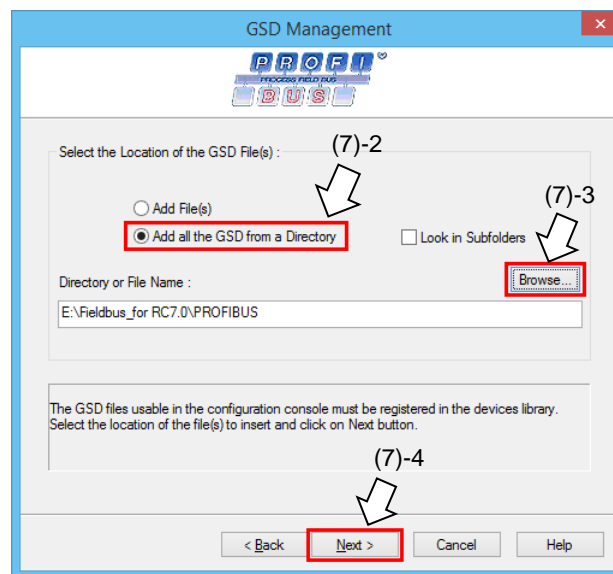

7-(3) Click <Browse>.

7-(4) Click <Next>.

7-(5) The following dialog box appears. Confirm the retrieved device information.

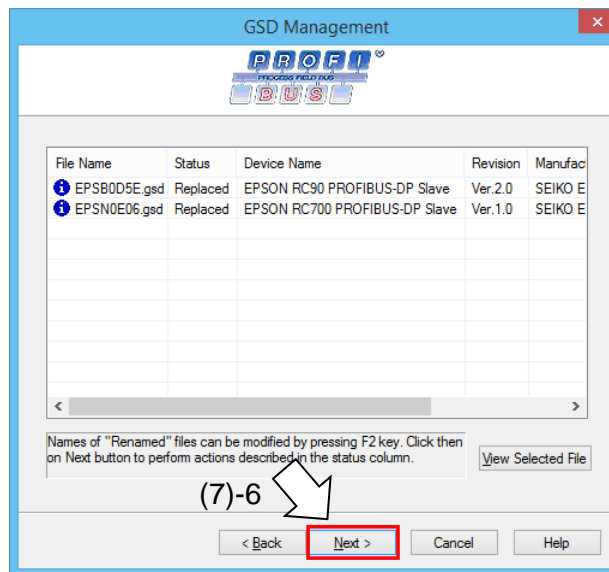

7-(6) Click <Next>.

7-(7) The following dialog box appears. Click <Finish> to complete the GSD file registration.



- Configure the PROFIBUS-DP master.
Select [Description]-[Properties] from the applicomIOR console menu.

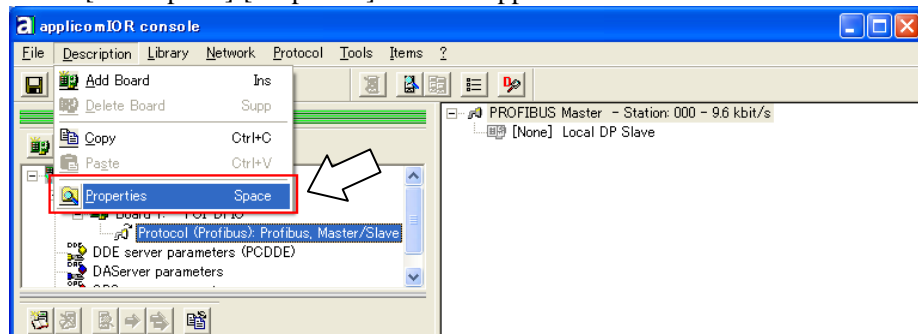

- The [Channel Properties] dialog box appears.
Select "Profibus, Master/Slave" and click <OK>.

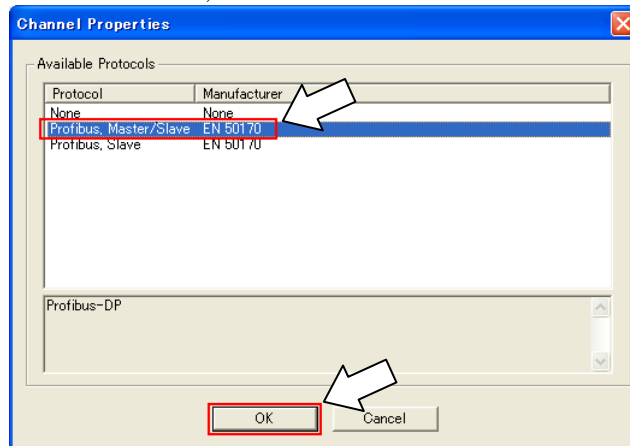

- Select [Protocol]-[Properties] from the applicomIOR console menu.

PCI-DPIO

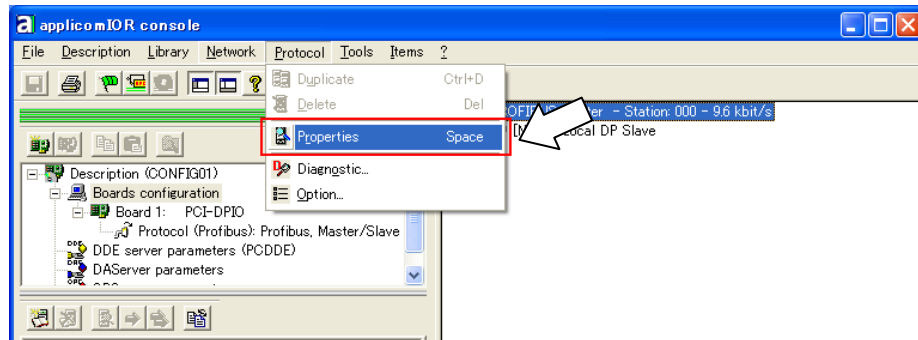

PCU-D2PIO

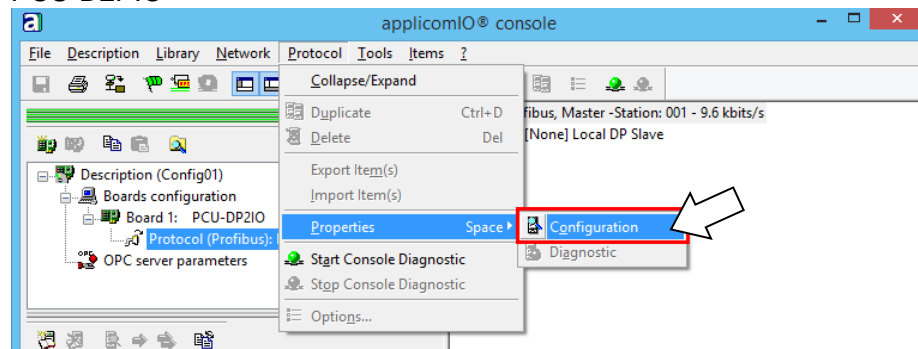

- The [Profibus Master] dialog box appears.
Set Baud Rate for the PROFIBUS-DP network, the master address (Master Profibus Address), and Number of Repeaters in the network.

PCI-DPIO

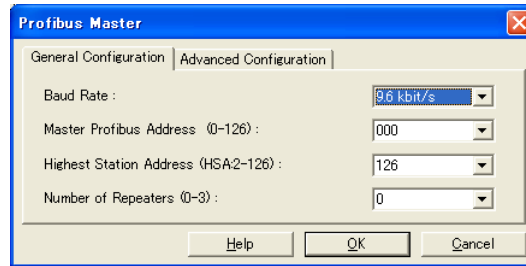

PCU-D2PIO

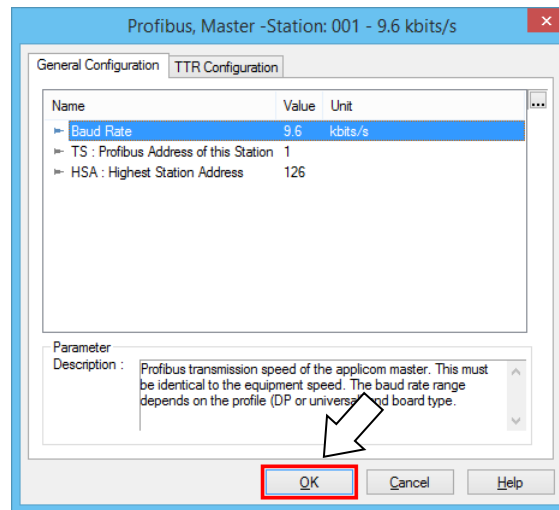

When the master setting is completed, click <OK>.

- Select the [Network Detection] tab.

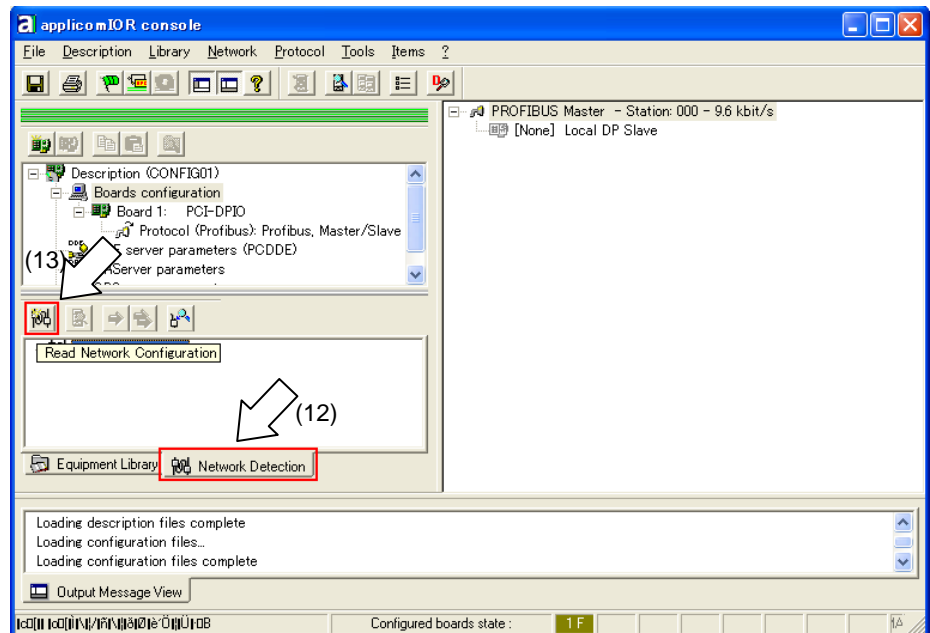

- Click the <Read Network Configuration> icon.

14. The following message box appears. Click <Yes>.

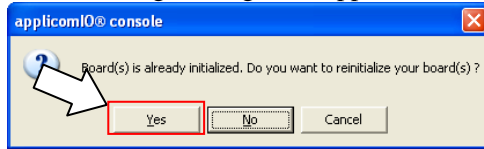

15. The [Network Detection] dialog box appears and starts loading the device information on the Fieldbus.



16. The list of detected devices is displayed in the [Network Detection] panel.

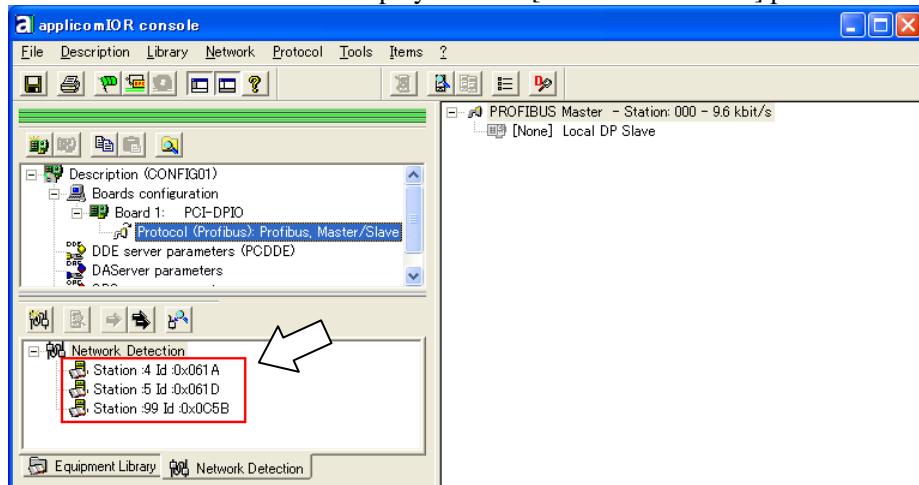

17. Select a device you want to scan.

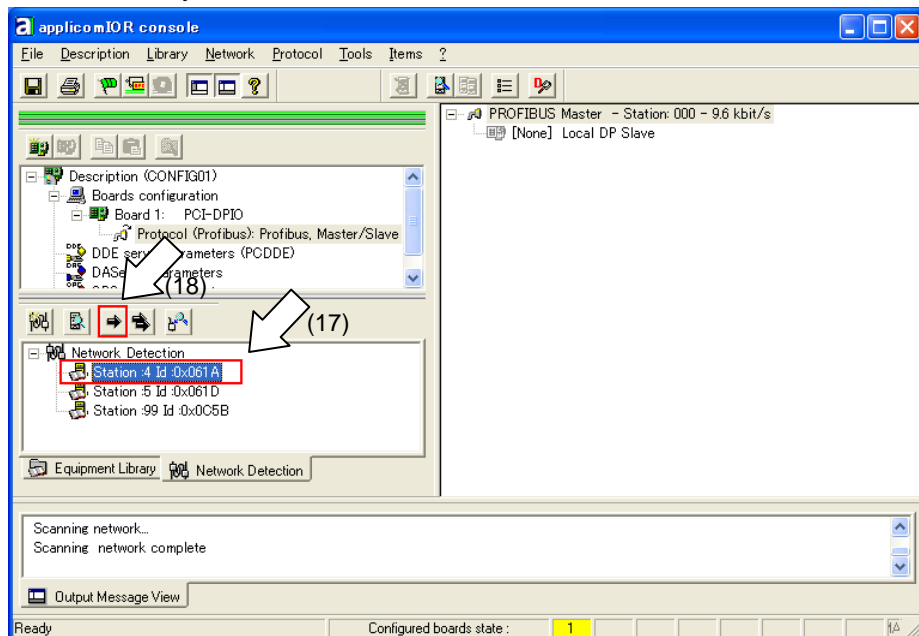

18. Click the <Insert in Configuration> icon.

19. The following dialog box appears. The dialog displays the device name. Click <OK>.

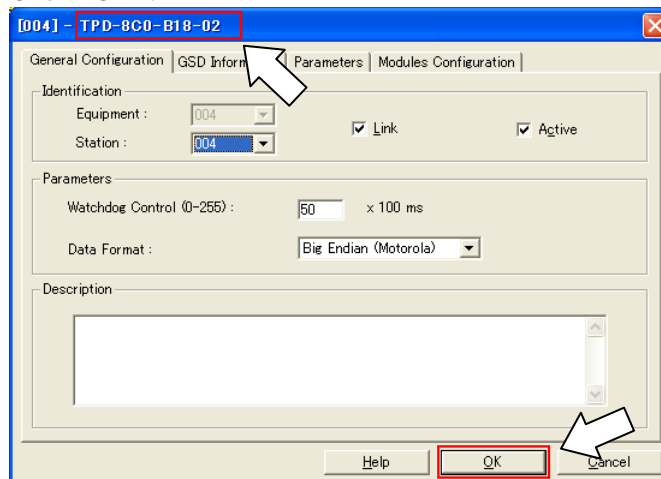

When the system cannot identify the device you want to use (its GSD file is not registered), the following dialog box will appear.

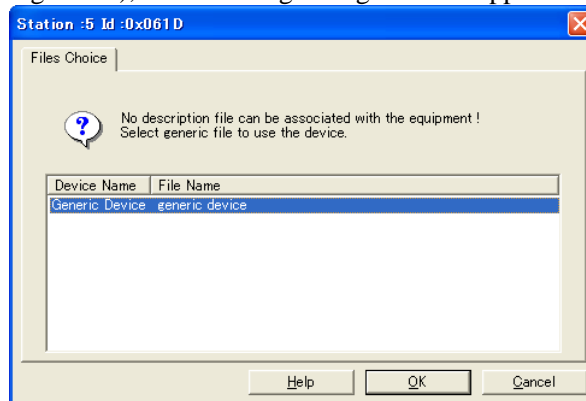

In this case, get the EDS file from the device manufacturers and register it by following the step 3 through 6. After that, follow the steps 12 and 13.

20. Select [File]-[Download in Flash] from the applicomIOR console menu. Register the configuration to the Fieldbus master board.

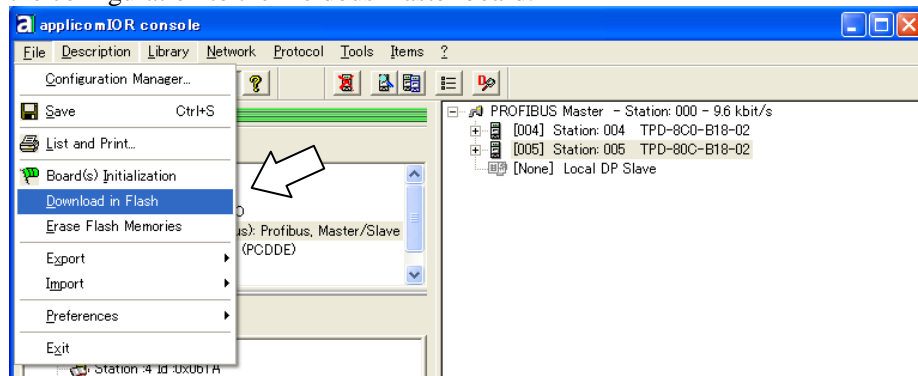

NOTE

Make sure that the flash memory of the Fieldbus master board stores the configuration; otherwise, the Fieldbus master board cannot correctly function. Also, you cannot control it from EPSON RC+6.0.

If you changed the configuration, select [File]-[Download in Flash] from the applicomIOR console menu and register the configuration to the Fieldbus master board.

21. After a few seconds, the display of “Configured boards state” on the status bar turns to green.

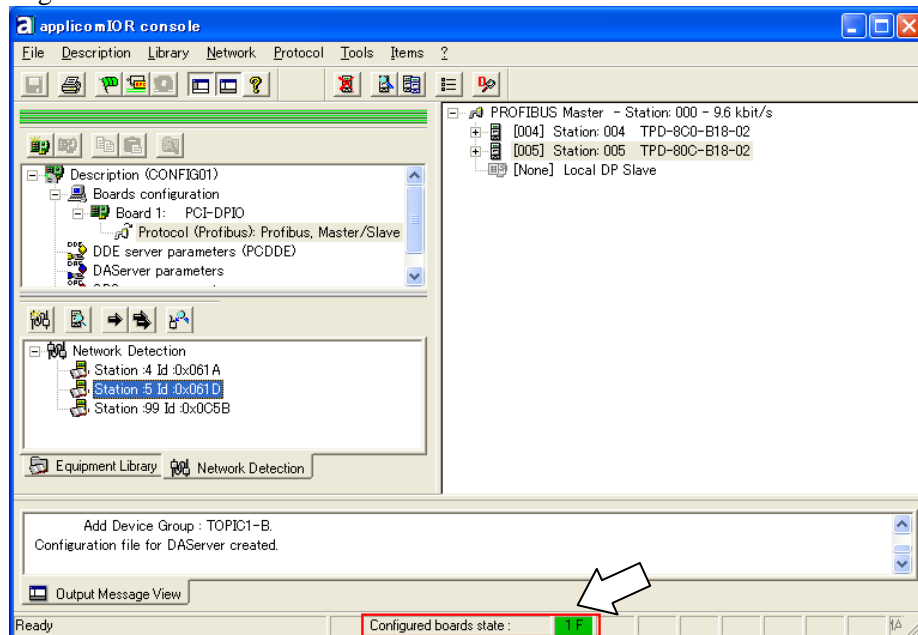

Now, the Fieldbus master board is ready to operate in the master mode.

22. Close the applicomIO console application.
23. Refer to the section *EPSON RC+6.0 configuration* and continue the step.

EPSON RC+6.0 configuration

To use the Fieldbus master board, the RC620 option setting and Fieldbus master setting should be enabled.

1. Select [Setup]-[Option Setting] and display the [Option] dialog box.
2. Refer to the EPSON RC+ Users Guide: *18. Installing Controller Options* and enable the Fieldbus Master option.
3. The following message dialog appears.

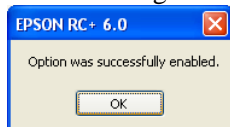

Click <OK> and reboot the EPSON RC+6.0.

After the EPSON RC+6.0 is started, the option setting is enabled.

4. Select [Setup]-[System Configuration] and display the [System Configuration] dialog box.

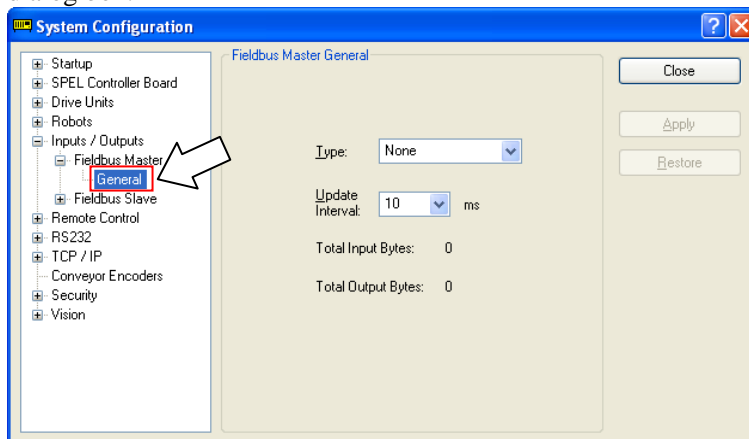

5. Select [Inputs/Outputs]-[Fieldbus Master]-[General].

6. Set the following items:

[Type:] PROFIBUS-DP

[Update Interval:] Update cycle for the PROFIBUS-DP master I/O

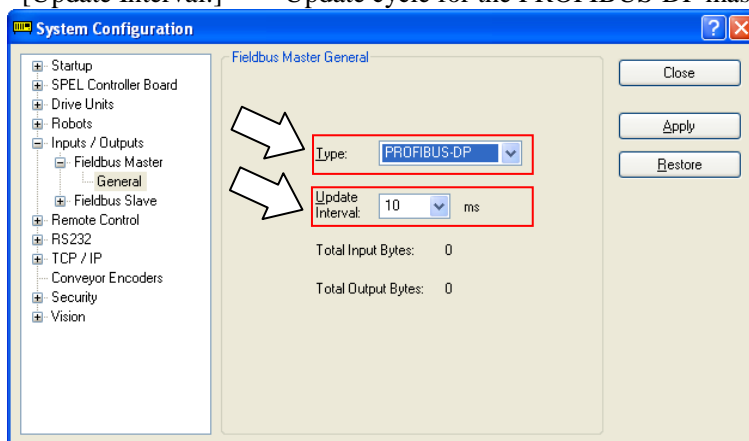

7. Click <Apply>.

Confirm that the following is displayed.

Total Input Bytes : Number of inputs the master controls (Bytes)

Total Output Bytes : Number of outputs the master controls (Bytes)

8. Click <Close>. The following dialog box appears.
SPEL⁺ control part of the RC620 robot controller automatically starts rebooting.

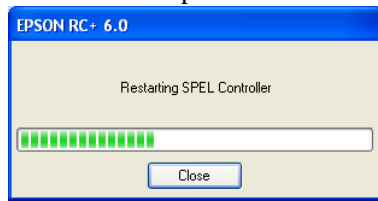

9. Select [Setup]-[System Configuration] and display the [System Configuration] dialog box.

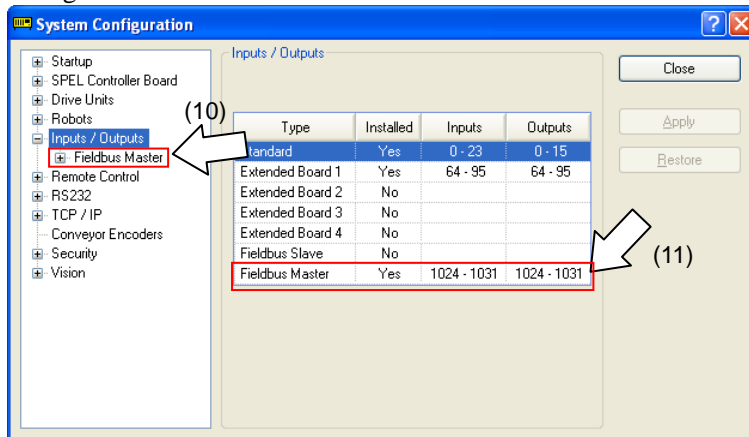

10. Select [Inputs / Outputs].
11. Confirm that the following are displayed in “Fieldbus Master”.
 - Installed : Yes
 - Inputs : 1024 – (1024 + Number of inputs the master controls (Bits))
 - Outputs : 1024 – (1024 + Number of outputs the master controls (Bits))
12. Select [Fieldbus Master]-[General].

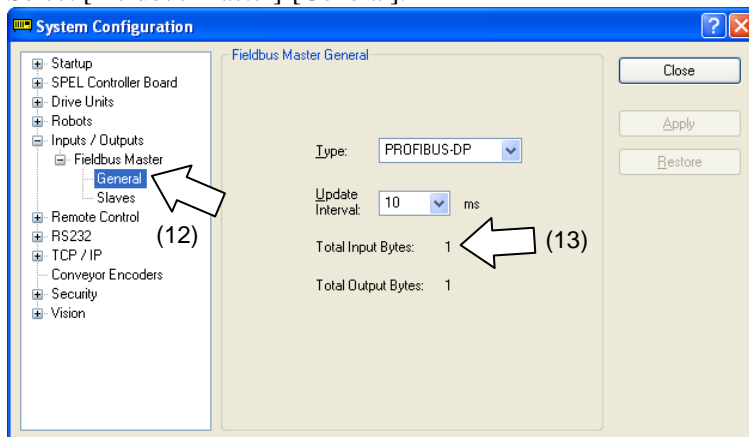

13. Confirm that the following are displayed.
 - Total Input Bytes : Number of inputs the master controls (Bytes)
 - Total Output Bytes : Number of outputs the master controls (Bytes)

14. Select [Fieldbus Master]-[Slave].

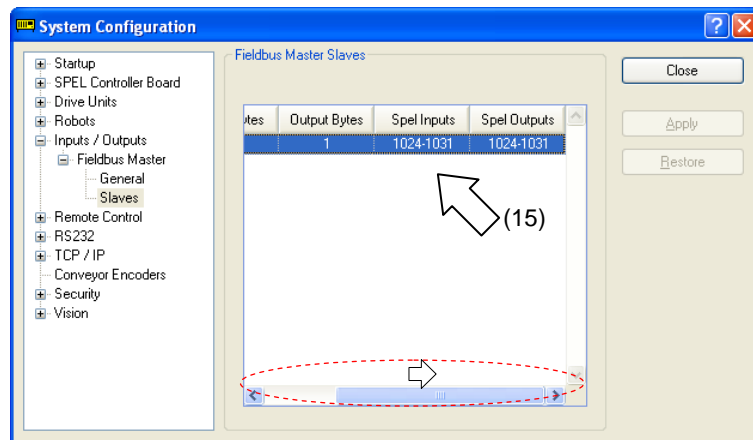
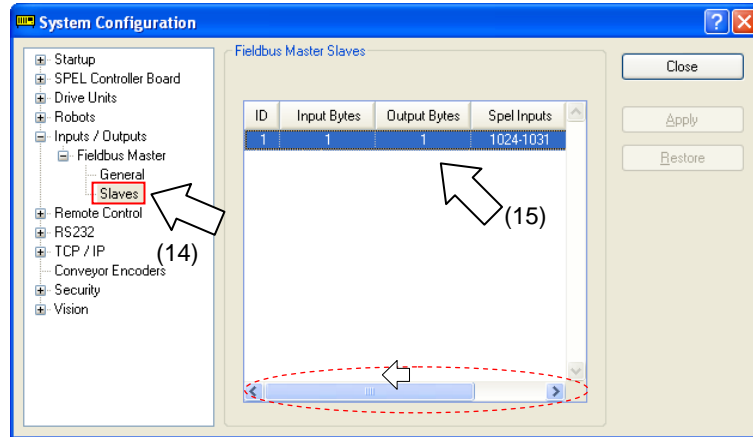

15. Confirm that the following information the master controls is displayed.

- ID : Fieldbus station ID of slave
- Input Bytes : Number of inputs per slave (Bytes)
- Output Bytes : Number of outputs per slave (Bytes)
- Spel Inputs : Number of inputs per slave (Bits)
- Spel Outputs : Number of outputs per slave (Bits)

2.2.4 PROFIBUS-DP Slave Board Installation

Appearance

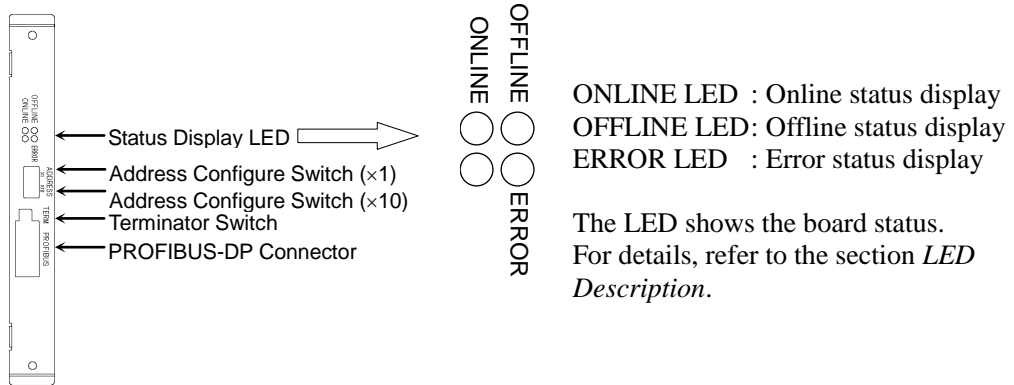

The Fieldbus slave board is configured as follows at shipment.

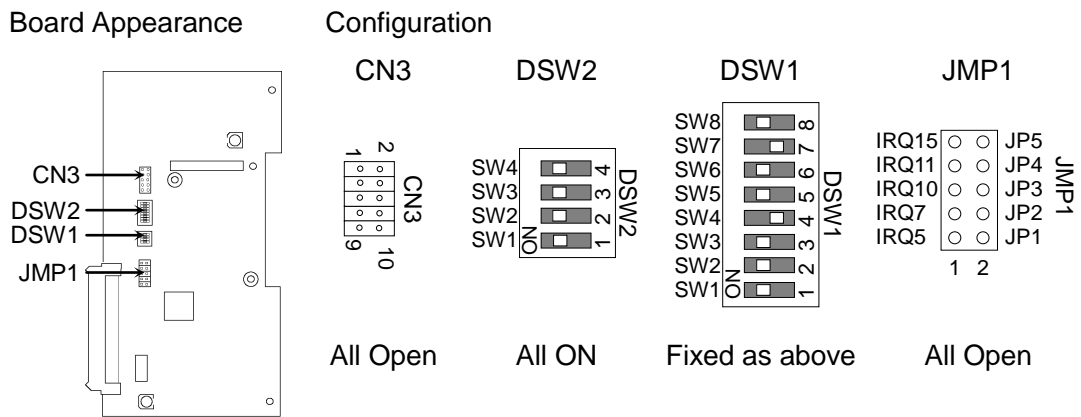

Specifications		
Item	Specification	
Name	PROFIBUS-DP slave board	
Code	R12B040707	
Connection Method	Hybrid (token passing procedure and master-slave communication)	
Baud Rates (bps)	9.6 k, 19.2 k, 45.45 k, 93.75 k, 187.5 k, 500 k, 1.5 M, 3 M, 6 M, 12 M (bps)	
Transfer Distance	Baud Rates	Cable Length
	12 M (bps)	100 m
	6 M (bps)	100 m
	3 M (bps)	100 m
	1.5 M (bps)	200 m
	500 k (bps)	400 m
	187.5 k (bps)	1000 m
	93.75 k (bps)	1200 m
	45.45 k (bps)	1200 m
19.2 k (bps)	1200 m	
9.6 k (bps)	1200 m	
Maximum Stations	126 (including master unit and repeater)	
Data Length / Frame	244 bytes	
Cable	2-wire cable dedicated to PROFIBUS (2 wires for signal)	
Modes	Slave	
Interface	1 PROFIBUS-DP port (EN 50170)	
Output Current Capacity	Maximum 150 mA	
Max. Input Data Size	256 bits (32 bytes)	
Max. Output Data Size	256 bits (32 bytes)	

LED Description

LED status represents the status of the fieldbus board.

LED status	ONLINE GRN	OFFLINE RED	ERROR RED
OFF	Offline	Online	Normal operation
ON	Online Data exchangeable	Offline Data unexchangeable	–
1 Hz blinking	–	–	Initialization error (Mismatch with network configuration)
2 Hz blinking	–	–	Initialization error (Mismatch with user parameter)
4 Hz blinking	–	–	Initialization error (Module initialization error)

Configure switch configuration



WARNING

- Make sure that the power is turned OFF before installing/removing any boards or connecting/disconnecting any cables. Working with the power ON is extremely hazardous and may result in electrical shock and/or malfunction of equipment.

Set the node address of the device using the address configuration switch of the PROFIBUS-DP slave board. Set network termination ON or OFF with the terminator switch.

1. Set the node address of the PROFIBUS-DP slave board using the address configuration switch. Make sure that the node address is different from the other devices in the network. Switch on the “×10” side is for tenths digit address configuration. Switch on the “×1” side is for units digit address configuration.



NOTE Generally, a node address from 0 to 125 is available for the PROFIBUS-DP device. However, this Controller supports node addresses from 0 to 99.

Generally, node addresses are recommended to be configured as shown in the table.

Node address	Device Name
0	Service unit such as PG/PC
1	Operation panel such as HMI
2	Master station
3-99 (-125)	DP slave station

2. Turn the network termination ON or OFF using the terminator switch.

Wiring

PROFIBUS-DP connector is standard 9-pins D-sub connector.

Terminal name for each pin

Terminal No	Terminal Name
Case	Shield
1	NC
2	NC
3	B line
4	RTS
5	GND BUS
6	+5V BUS
7	NC
8	A line
9	NC



NOTE Prepare the cable for PROFIBUS-DP sold in the market as a communication cable.

Install terminating resistors at both ends of the network.

A terminating resistor is installed in the PROFIBUS-DP slave board. Turn the terminating resistor ON or OFF using the terminator switch on the front panel.

Board Installation



WARNING

- Make sure that the power is turned OFF before installing/removing any boards or connecting/disconnecting any cables. Working with the power ON is extremely hazardous and may result in electrical shock and/or malfunction of equipment.

Follow the instruction below and insert the board into the dedicated slot of the controller.

- Remove two screws (+) on the back side of the RC620 robot controller.

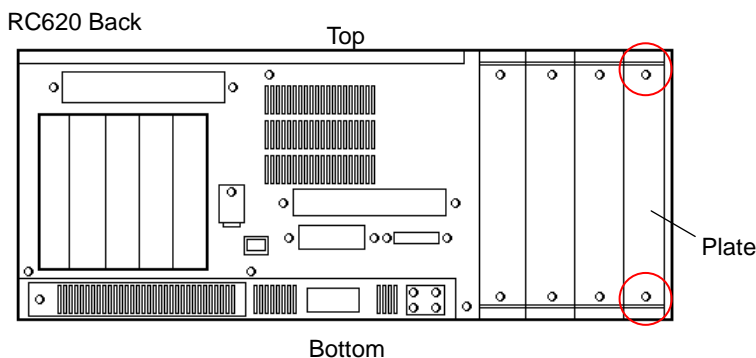

- Remove the plate.
- Insert the board into the slot along the guide.
- Put the plate removed in the step 2 back and secure it with two screws.

Confirmation with EPSON RC+ 6.0

When a PROFIBUS-DP slave board is installed to the controller, it is recognized automatically. Confirm whether EPSON RC+ 6.0 has recognized the PROFIBUS-DP board using the following procedure.

- Select [Setup]-[System Configuration] and display the [System Configuration] dialog box.

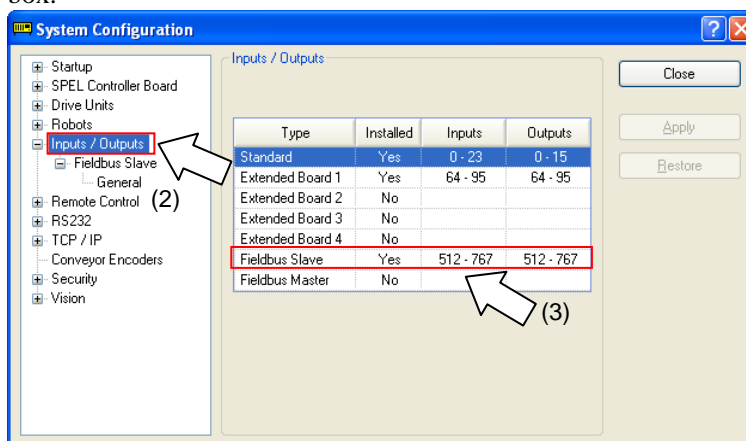

- Select [Inputs / Outputs].
- Make sure that the following are displayed in “Fieldbus Slave”.

Installed : Yes
 Inputs : 512-767 (default setting)
 Outputs : 512-767 (default setting)

4. Select [Fieldbus Slave]-[General].

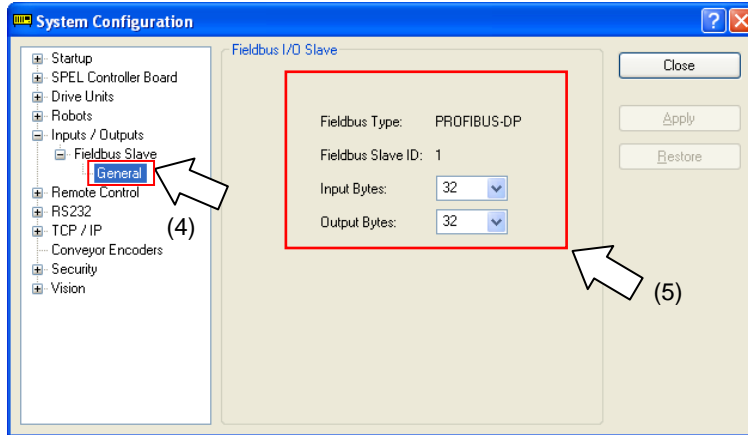

5. Make sure that the following are displayed.

Fieldbus Type : PROFIBUS-DP
Fieldbus Slave ID : (Displays the configure switch node address)
Input Bytes : 32 (default setting)
Output Bytes : 32 (default setting)

6. Click <Close>.

Editing of input / output size

You can change the input/output size of PROFIBUS-DP slave board if necessary.

1. Select [Setup]-[System Configuration] and display the [System Configuration] dialog box.
2. Select [Inputs / Outputs]-[Fieldbus Slave]-[General].

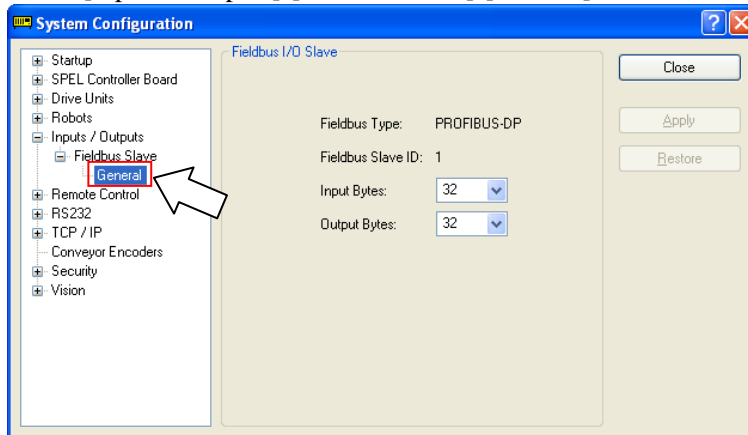

3. Change the settings of [Input Bytes] and [Output Bytes].
In this example, both of them are changed to 20 Bytes.

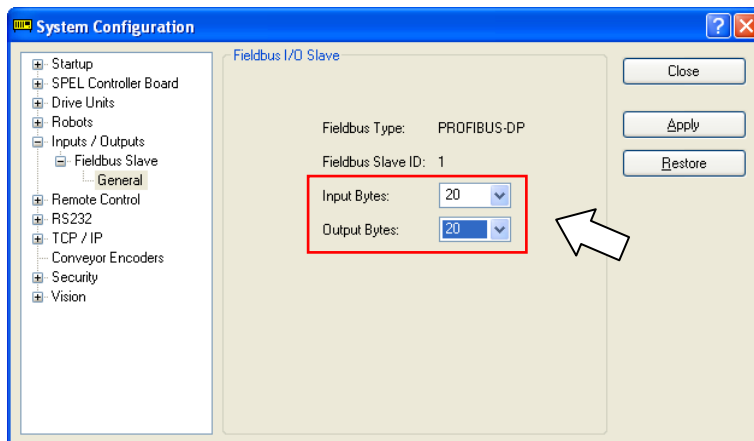

4. Click <Apply>.
5. Click <Close> and the following dialog box appears.
SPEL⁺ control part of RC620 robot controller automatically starts rebooting.

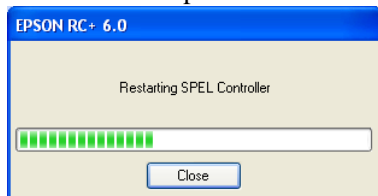

6. Select [Setup]-[System Configuration] and display the [System Configuration] dialog box.

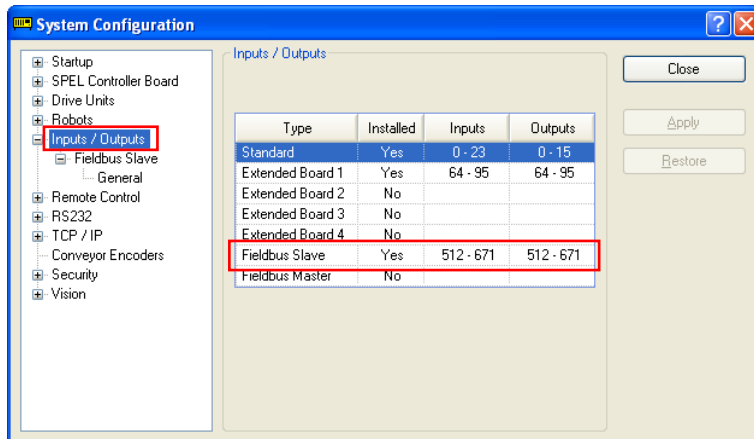

7. Select [Inputs / Outputs].
8. Make sure that the following are displayed in “Fieldbus Slave”.

Inputs : 512 – (512 + Changed number of input (Bits))
 Outputs : 512 – (512 + Changed number of output (Bits))

In this example, Input byte is 20 bytes (160 bits) and 512-671 is displayed in Inputs.
 Also, Output byte is 20 bytes (160 bits) and 512-671 is displayed in Outputs.

2. Installation

NOTE



When you change the input/output size of PROFIBUS-DP slave board, you need to change the input/output size of the slave information registered in the Fieldbus master device.

Use the window below to change the input/output size of the slave information registered in the Fieldbus master device by the aplicomIO console application.

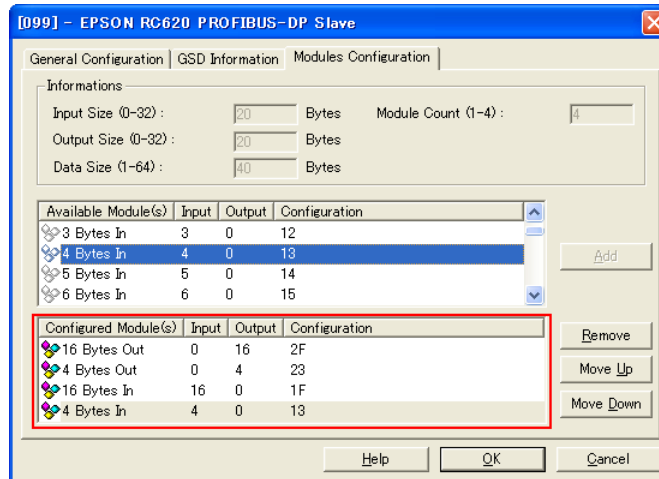

16 Byte Out	}	Output : 20 Byte
4 Byte Out		
16 Byte In	}	Input : 20 Byte
4 Byte In		

Electronic Information File (GSD file)

A GSD file is supplied for PROFIBUS-DP slave board network configuration. The file is located in the following folder in the Installer DVD that is attached to the Robot Controller.

\\EpsonRC60\Fieldbus\Profibus

2.3 EtherNet/IP

2.3.1 How to Setup a EtherNet/IP Network

The following is a basic procedure for setting up an EtherNet/IP network:

1. Choose node layout and pathway in your network.
For details, refer to the following section *2.3.2 EtherNet/IP Network Construction*.
2. Lay cables.
For details, refer to the following section *2.3.2 EtherNet/IP Network Construction*.
3. Configure nodes.
For details, refer to respective manuals of your desired nodes.
4. Turn ON the nodes.
5. Install the EtherNet/IP board in the controller.
When installing the EtherNet/IP master board (Code: R12B040720), refer to *2.3.3 EtherNet/IP Master Board Installation*.

When installing the EtherNet/IP slave board (Code: R12B040719), refer to *2.3.4 EtherNet/IP Slave Board Installation*.
6. Operate the EtherNet/IP network.

2.3.2 EtherNet/IP Network Construction

Network Configuration

EtherNet/IP network is configured as shown in the following figure.

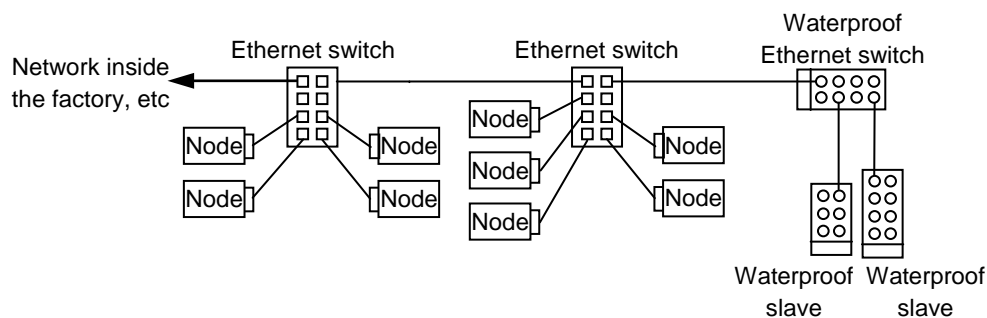

Node

There are two types of node: master and slave. The master controls a network and gathers data from its slaves. The slaves, including external I/O and other devices, output data in response to the master's output order and informs the master of its input status.

You can install the master anywhere in the network. One master node can control up to 127 nodes.

Universal Ethernet cable is used for EtherNet/IP. Use a proper cable such as environmental resistance and refraction resistance that fulfills the environment.

For details, see the website of ODVA. (<http://www.odva.org/>)

Wiring

Wirings should be conformed to EtherNet/IP connection protocol.

NOTE



You can use the general Ethernet hub or Ethernet switch for the EtherNet/IP. However, be sure to use a product complying with the industrial standards or noise resistant Ethernet cable (STP cable). If you use an office use product or UTP cable, it may causes communication errors and may not offer the proper performance.

2.3.3 EtherNet/IP Master Board Installation

Appearance

Part names and functions of the EtherNet/IP Master Board is shown in the following figure. For details of the status display LEDs, refer to 4. *Troubleshooting* in this manual.

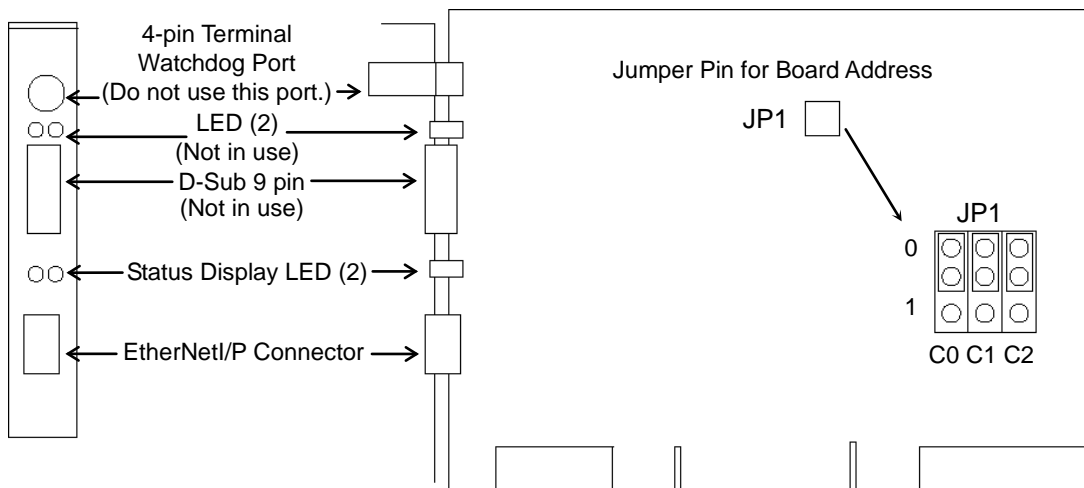
PCU-ETHIO



Specifications

Item	Specification
Part Number	EtherNet/IPMaster Board
Mode	applicom PCU-ETHIO-EI
Baud Rates	Master
Interface	10, 100 Mbps
Maximum Node	EtherNet/IP 1 port
Connection Type	127
Explicit message connection	Cyclic, Change of State
EDS support	Yes
Part Number	Yes
Max. Input Data Size	1024 bit (128 bytes)
Max. Output Data Size	1024 bit (128 bytes)
Automatic Detection	Yes. Devices can be detected automatically.

Modes

EtherNet/IP master board has the Master mode and Slave mode as the motion mode. However, do not select the Slave mode.

Master mode

The Master device gathers and controls all nodes in one network.

EtherNet/IP master can control up to 127 nodes (max. 128 bytes) on one network.

PLC is typically configured as a master and controls all nodes in factory automation system, but EPSON RC+ is also capable of being a master.

EtherNet/IP network configuration is specified by configuration management software. This software is normally provided by a master device manufacturer. The configuration management software determines parameters for each slave device via an Electronic Data Sheet (EDS).

Available connection types are Cyclic, Change Of State, and Explicit messaging.

Available baud rates are 100 Mbps and 10 Mbps. (auto-detect)

For the instruction of configuration, refer to the section *Master Mode* in this chapter.

Software Installation

Before installing EtherNet/IP master board in your controller, you must install the applicomIO Console application and drivers according to the type of board you are using.

1. Start the controller.
2. Run the following file from the install folder in the controller to start the installation.
C:\Install\FieldBus\Install\applicomIO\Disk1\Setup.EXE
3. The following dialog box appears. Select the desired language for the installer.

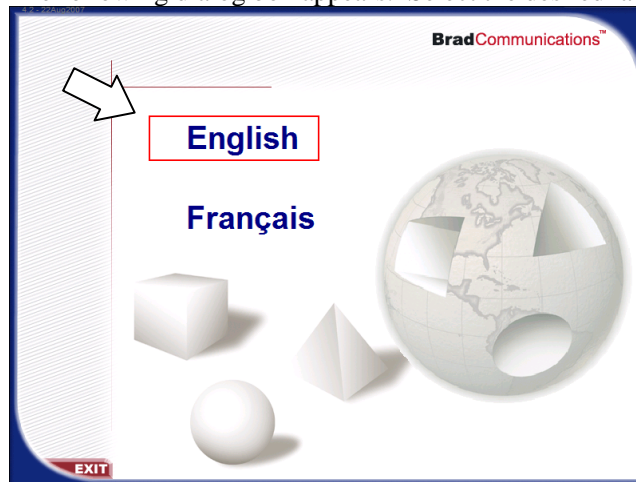

4. The [Summary] dialog box appears. Select “Products Installation”.



5. The [applicomIO] dialog box appears. Select “Installation”.



6. The [Installation] dialog box appears. Select “applicomIO”.

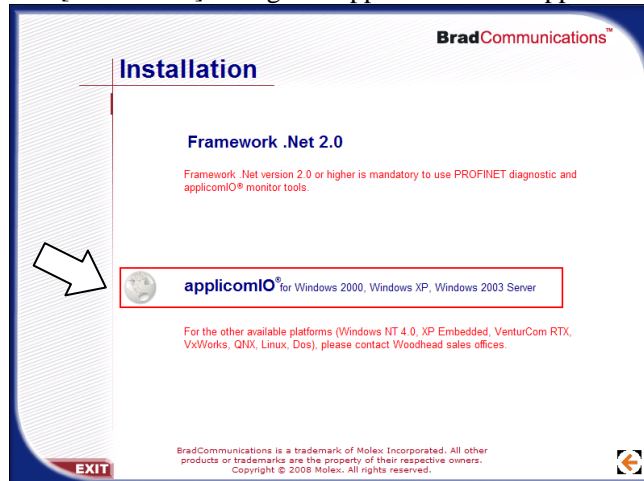

7. The applicomIO console application starts and the [Welcome to applicomIO 2.4 Setup] dialog box appears. Click <Next>.



8. The [License Agreement] dialog box appears. Read the software license agreement and click <Yes>.

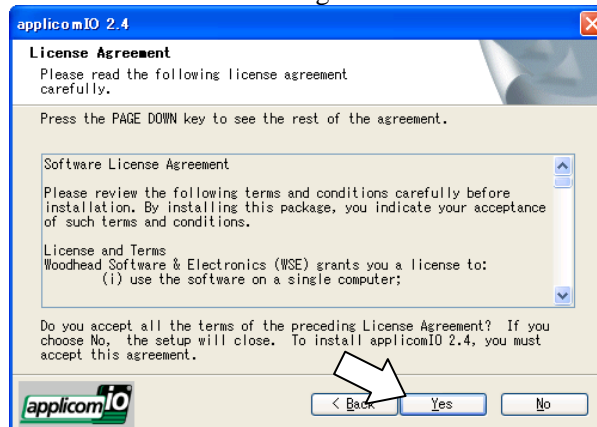

2. Installation

9. The [User Information] dialog box appears. Now register the user information. Type in the user name (Name:) and company name (Company:).

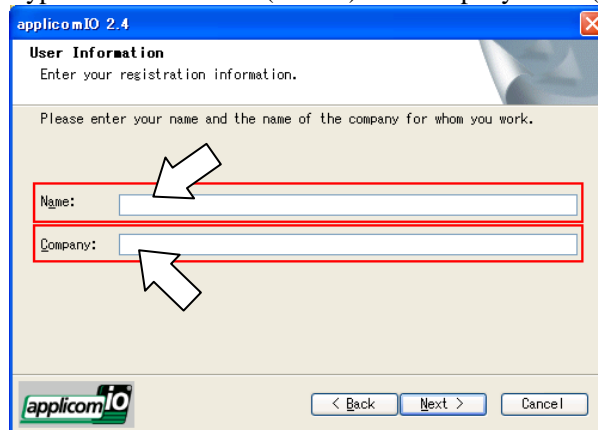

10. The [Choose Destination Location] dialog box appears. Specify the installation folder for the applicomIO Console application. The default specifies here:

C:\Program Files\Woodhead\Direct-Link\applicomIO\2.4

If you agree to the default installation folder, click <Next>.

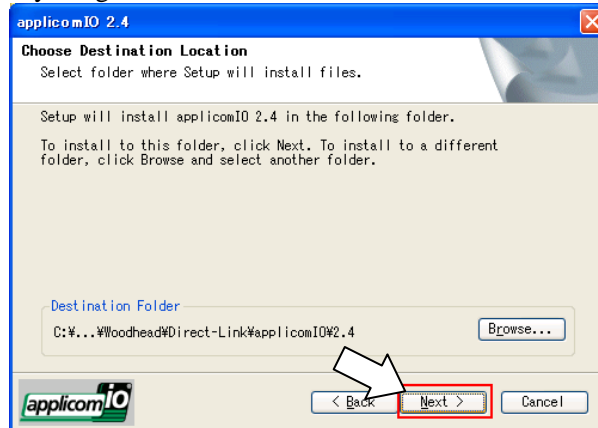

11. The [Select Components] dialog box appears. Install the default components. Click <Next>.

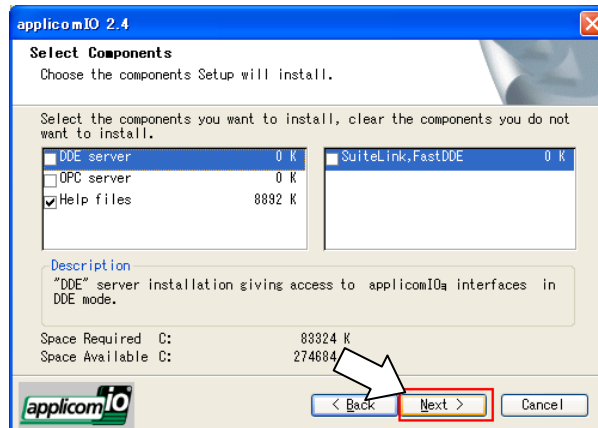

12. The [Select protocols] dialog box appears. Check the [EtherNet/IP] checkbox.

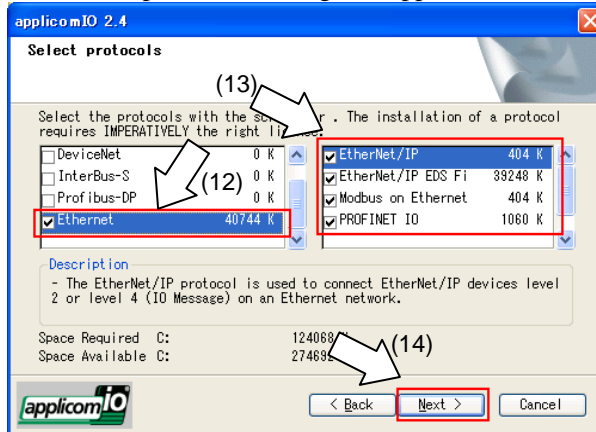

13. Check the device data file you want to install (EDS for EtherNet/IP).

14. Click <Next>.

15. The [Select options] dialog box appears. Click <Next>.

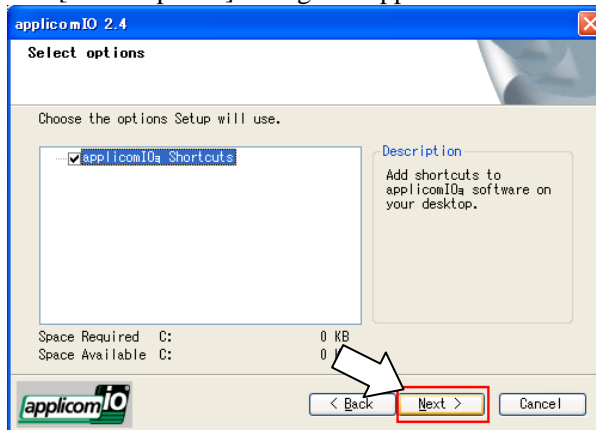

16. The [Start Copying files] dialog box appears. Click <Next>.

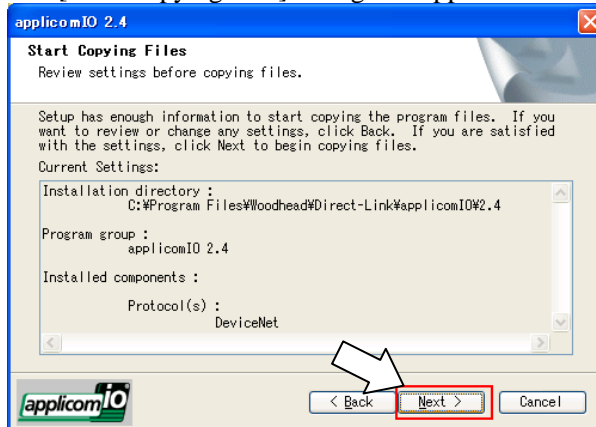

17. The [Setup Status] dialog box appears and the installation of applicomIO Console application starts.

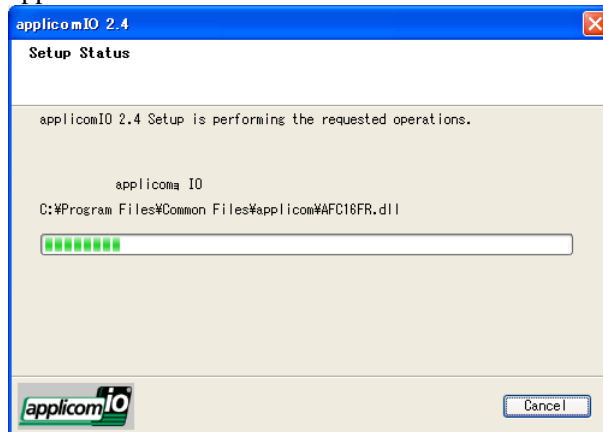

18. When the installation is completed, the [Setup Complete] dialog box appears. The message prompts you to reboot your controller. Select “Yes, I want to restart my computer now”.

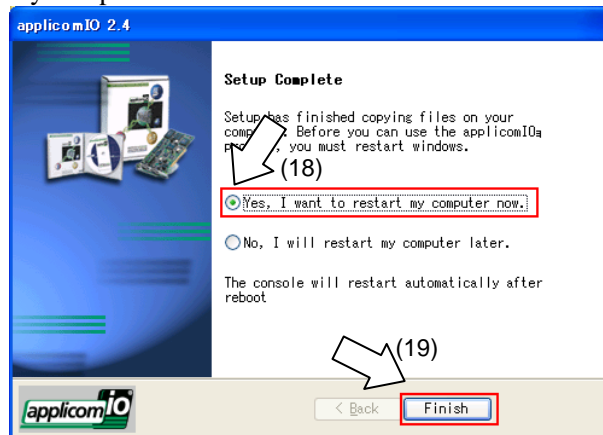

19. Click <Finish> and reboot the controller.
20. Start the following file and install the service pack.
C:\Install\FieldBus\Install\Sp\Setup.EXE
No installation is necessary when a service pack is not attached to the controller.
21. After completing the installation of the service pack, shutdown the computer.
22. Refer to the next section *Board Installation* to install the EtherNet/IP master board.

Board Installation



- Make sure that the power is turned OFF before installing/removing any boards or connecting/disconnecting any cables. Working with the power ON is extremely hazardous and may result in electric shock and/or malfunction of equipment.

- Configure the board address jumper (JP1) on EtherNet/IP master board.
You can install one Fieldbus master board in the RC620 robot controller.
The board number should be "1".

Refer to the following table for JP1 configuration.

Short Socket	C0	C1	C2
Board No.			
1	0: Short	0: Short	0: Short

- Follow the instruction below and insert the board to the general purpose slot.

- Remove ten screws (+) on the top face of RC620 controller.
Remove the top plate.

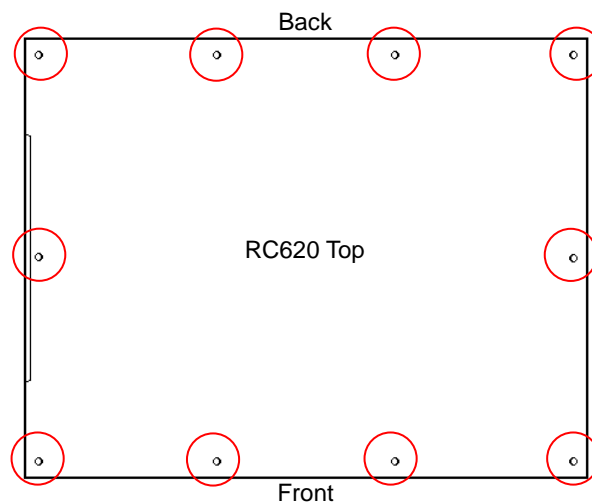

- Remove two screws (+) inside of the RC620 controller.

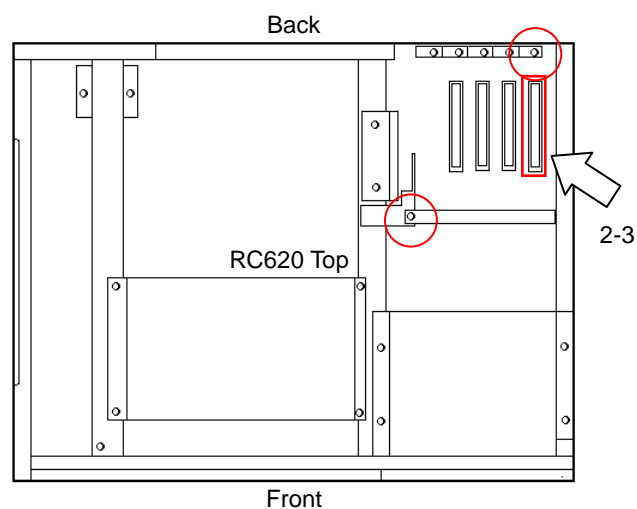

- Insert the fieldbus master board into the general purpose slot on the far right (recommended).
- Put two screws removed in the step 2-2 back and secure them.
- Put the top plate back and secure it with ten screws.

3. Connect the board with the Fieldbus.
4. Start up the controller.
5. The EtherNet/IP master board is detected and the [Found New Hardware Wizard] dialog box appears.
Select <No, not this time> and click <Next>.

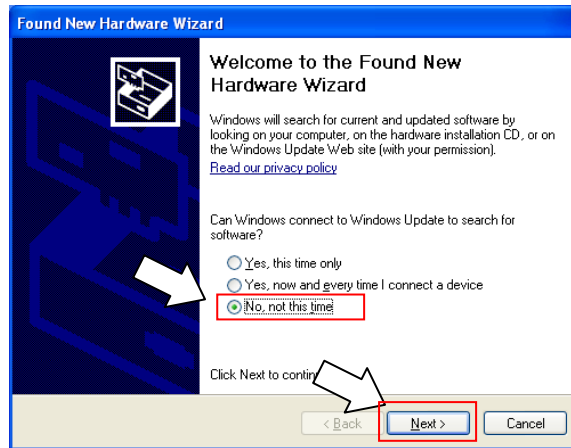

6. The following dialog box appears.
Confirm that the detected hardware is “applicomIO PCI Board 32K”.

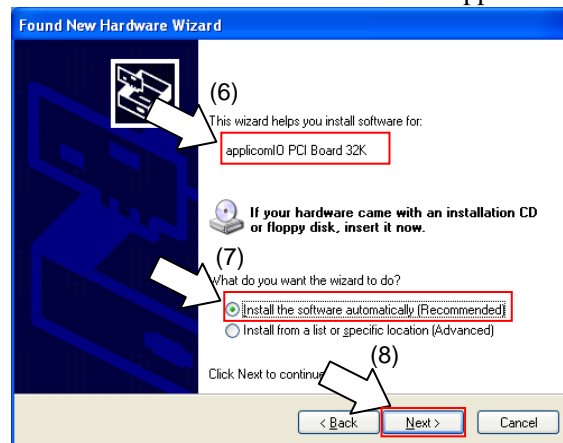

7. Select <Install the software automatically (Recommended)>.
8. Click <Next>.
9. The following dialog box appears.
Necessary software is automatically installed.

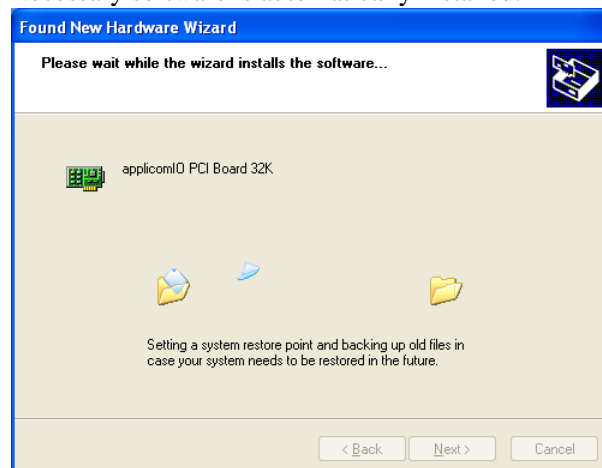

10. When the installation is completed, the [Completing the Found New Hardware Wizard] dialog box appears.
Click <Finish>.

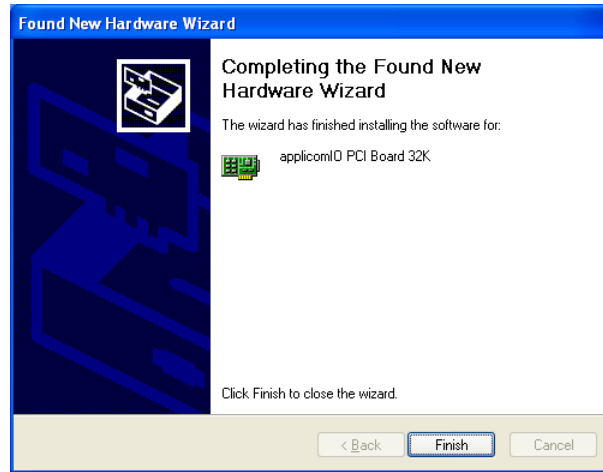

11. Start <applicomIO Console> application.

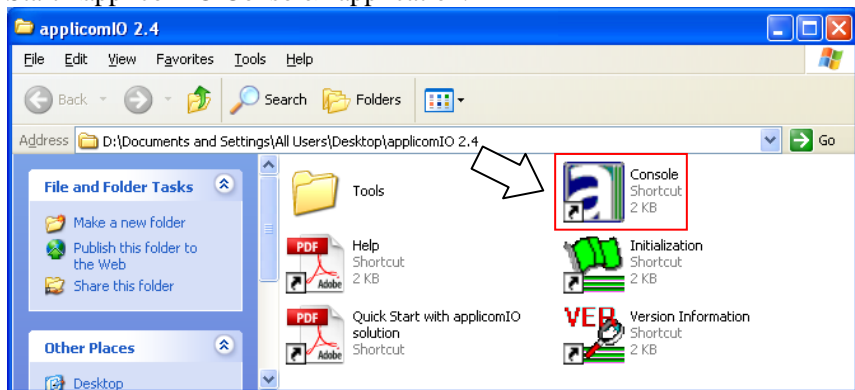

12. The [applicomIOR console] dialog box appears. Add the EtherNet/IP master board.
Click <Add Board>.

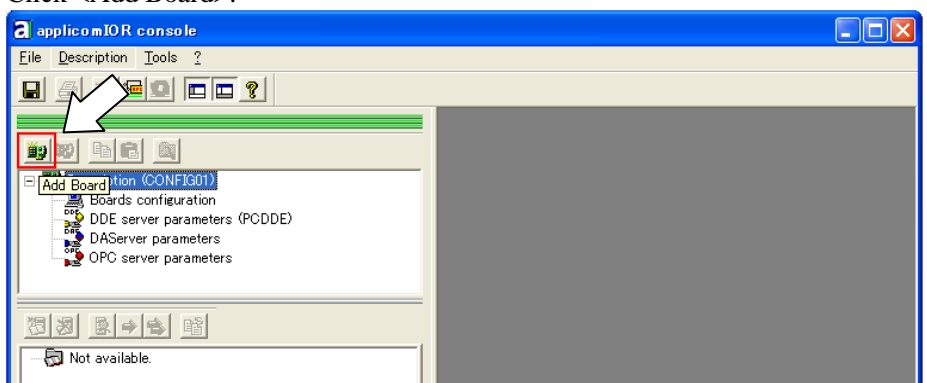

13. The [Add New Board] dialog box appears.

Confirm that “PCI/PCU-ETHIO” is displayed in [Board to Add]-[Board Type] and click <OK>.

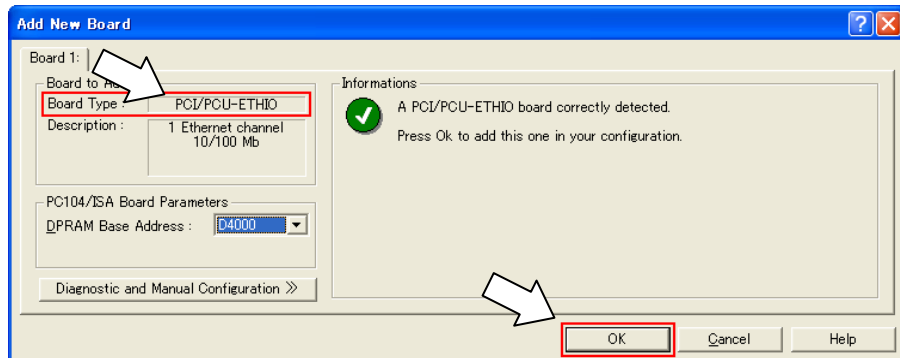

If the board cannot be detected, the following dialog box appears. Make sure that the board is correctly inserted.

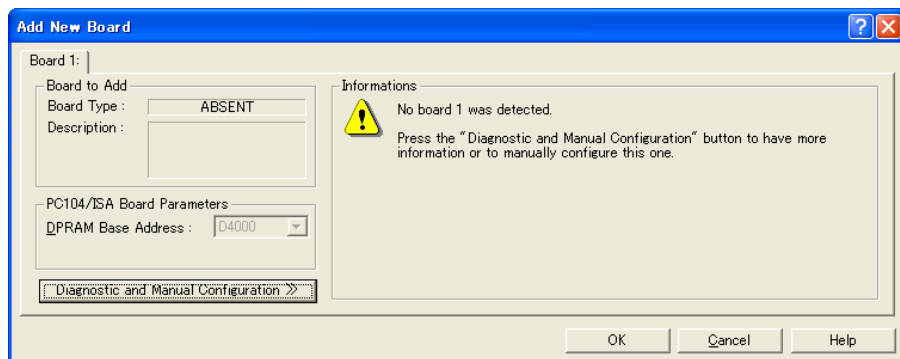

14. The [Channel Properties] dialog box appears.

Select [Protocol]-[EtherNet/IP] and click <OK>.

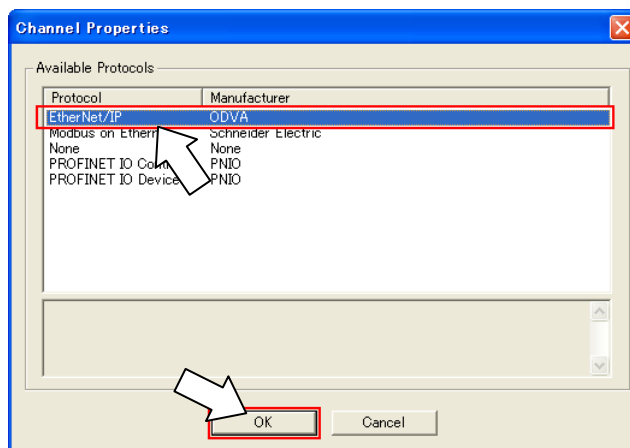

15. The following dialog box appears. Set the IP address for the EtherNet/IP master board.

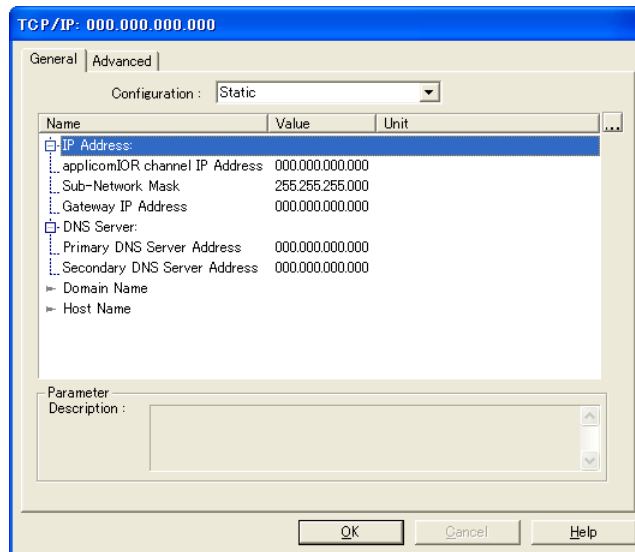

Select the IP address from [Configuration]. There are following three types (Do not select “Flash Memory”)

“Static (assign as fixed IP address)”

“DHCP (obtain from the DHCP server)”

“BOOTP (obtain from the BOOTP server)”

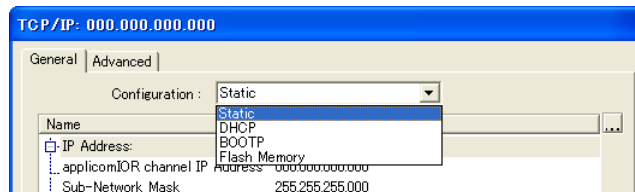

If you select “Static (Fixed IP address)”, enter the values in each item.

16. When you complete adding the DeviceNet master board to the applicomIO Console application, reboot the controller.

16-1 Close the applicomIO Console application.

When closing the applicomIO Console application, the following message appears. Click <Yes>.

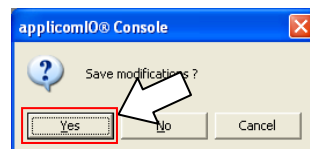

16-2 The following message appears. Click <OK>.

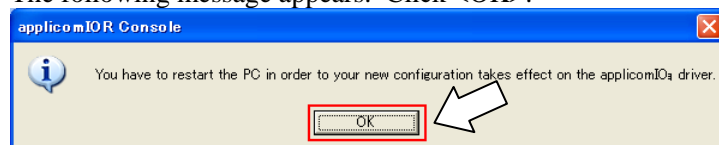

16-3 Reboot the Windows.

17. After the controller is rebooted, refer to the next section *Master Mode* and continue the step.

Master Mode

1. Ensure that the board is connected to the fieldbus.
2. Start <applicomIO Console> application.

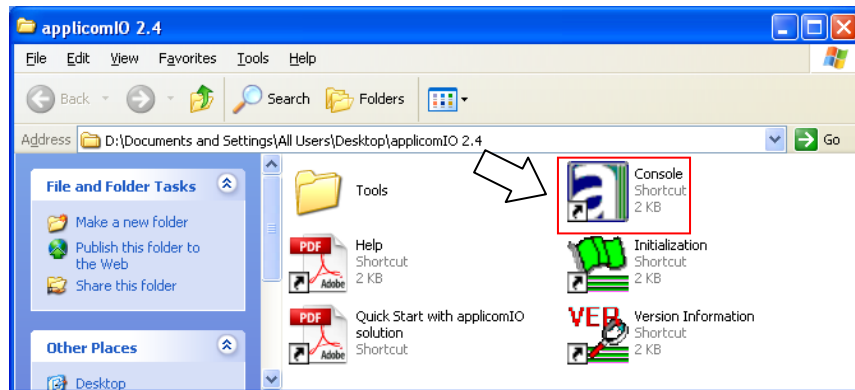

3. The [applicomIOR console] dialog box appears. Register the device information (EDS file) that is necessary for the network setup.

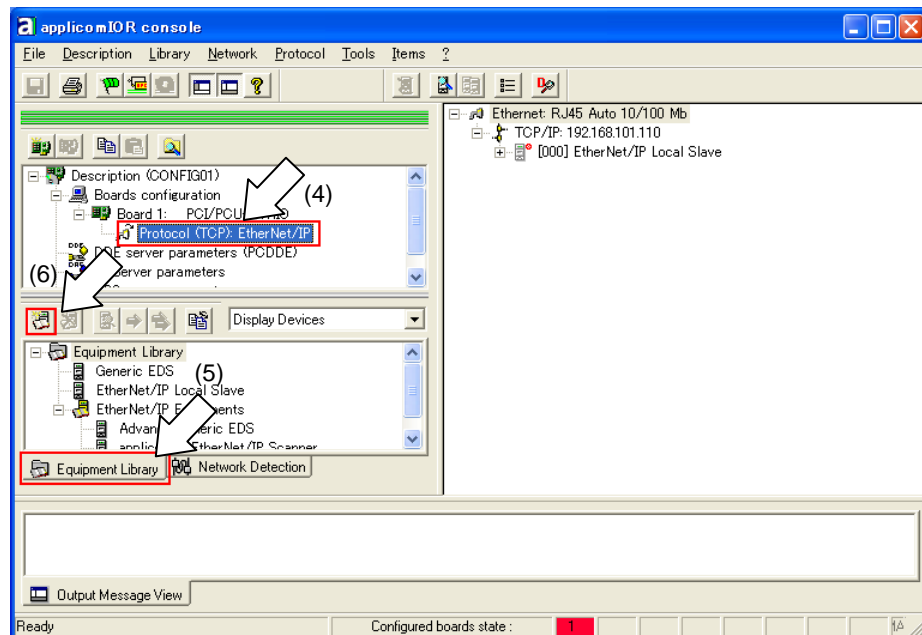

4. Select "Protocol".
5. Select the [Equipment Library] tab.
6. Click the <Add> icon.

7. The [EDS Management] dialog box appears. Register the EDS file that is supplied from the device manufacturer in the controller. Click <Next>.

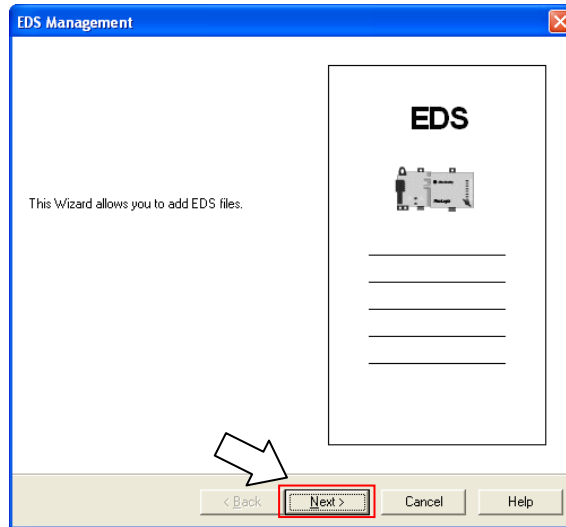

8. The following dialog box appears. Specify the folder in which the EDS file is stored.
Select <Add all the EDS from the Directory>.

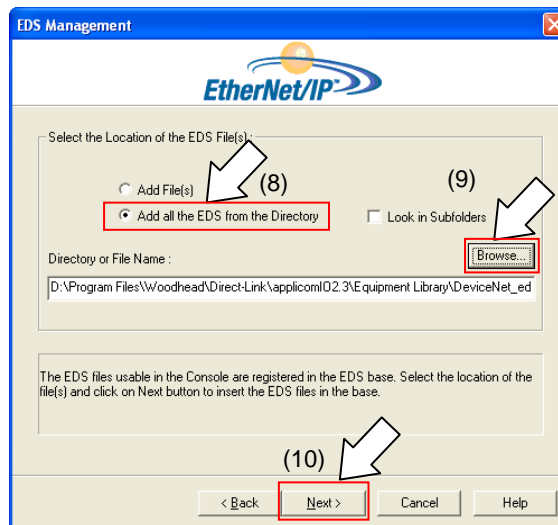

9. Click <Browse>.
10. Click <Next>.

11. The following dialog box appears. Confirm the retrieved device information.

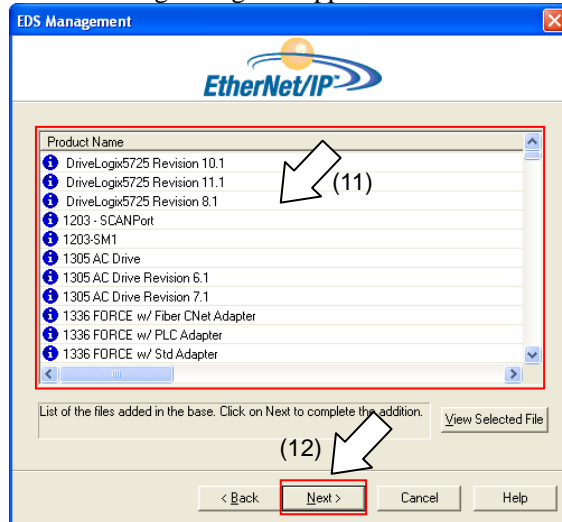

12. Click <Next>.

13. The following dialog box appears. Click <Finish> to complete the EDS file registration.

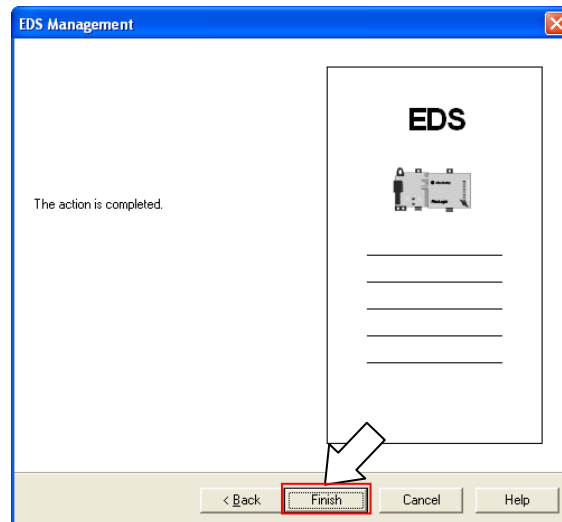

14. Select the [Network Detection] tab.

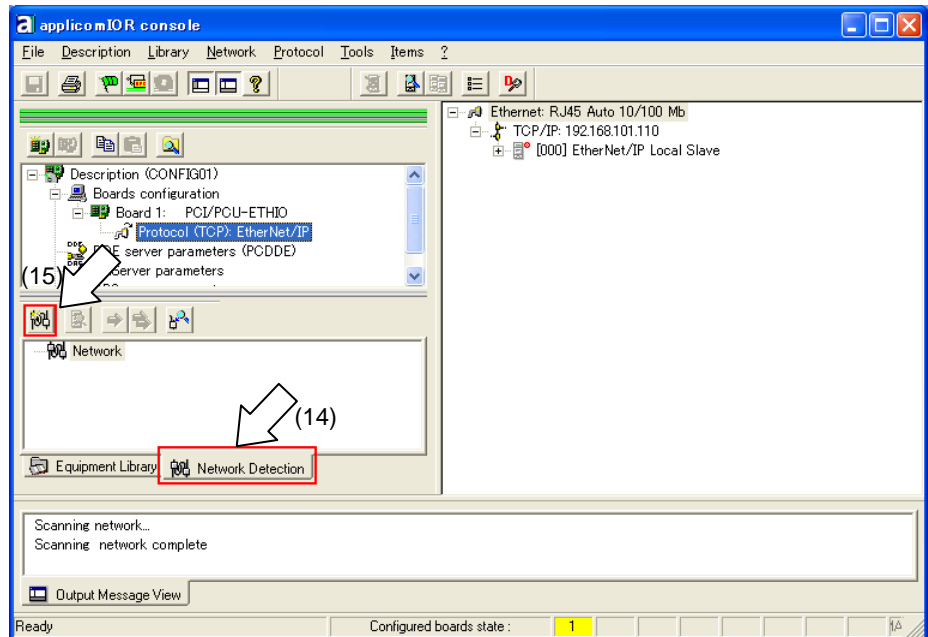

15. Click the <Read Network Configuration> icon.

16. The following message appears. Click <Yes>.

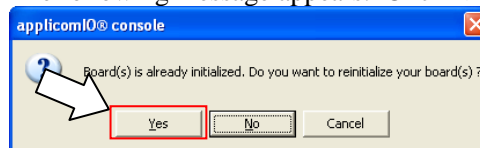

17. Specify the range of detection. If you do not change the range, click <OK>.

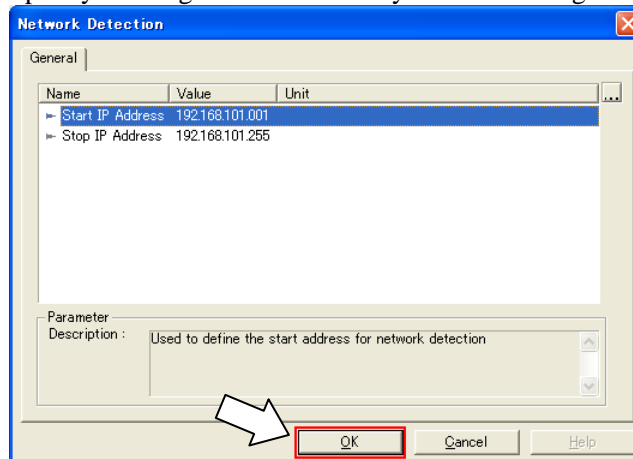

18. The following dialog box appears and read in the devices on the Fieldbus.

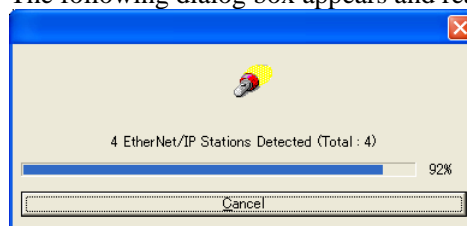

19. The list of detected devices is displayed in the [Network detection] panel.

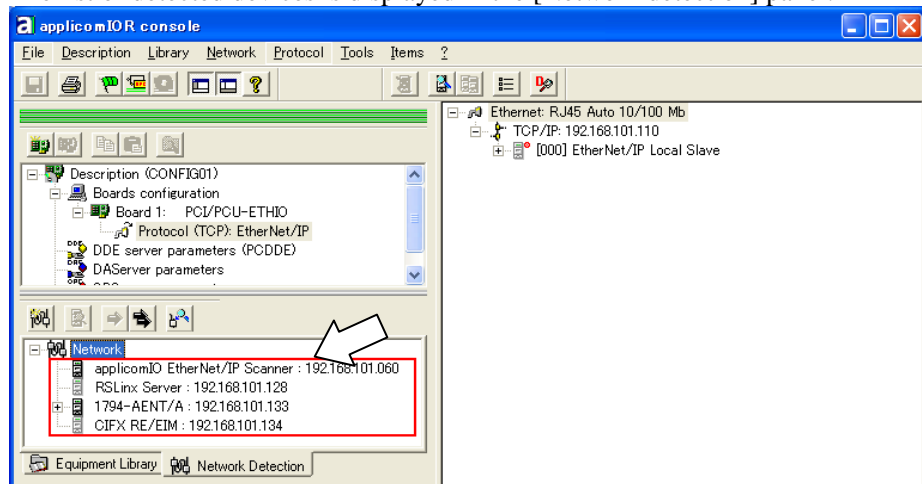

20. Select a device you want to scan.

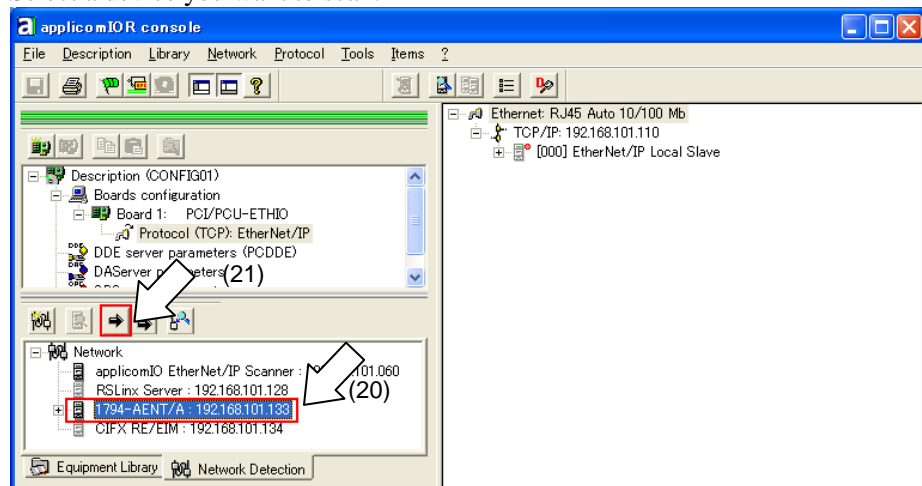

21. Click the <Insert in Configuration> icon.

22. The following dialog box appears. Clear the [Link Parameters] checkbox.

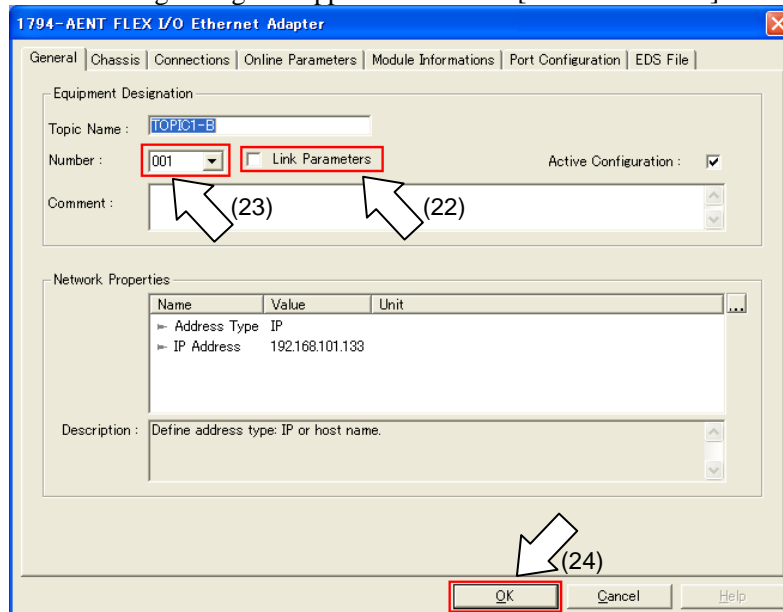

23. Assign the values from 1 to 127 in [Number:;].

This number is “Device ID” and required to create a SPEL⁺ program.

24. Click <OK> and complete the registration.
25. Select [File]-[Download in Flash] from the applicomIOR console menu. Register the configuration to the Fieldbus master board.

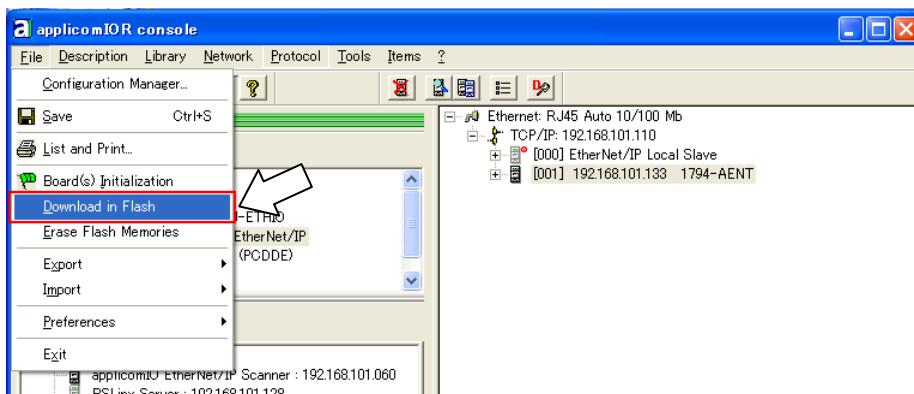

NOTE

Make sure that the flash memory of Fieldbus master board stores the configuration; otherwise, the Fieldbus master board cannot function correctly. Also, you cannot control it from EPSON RC+6.0.

If you changed the configuration, select [File]-[Download in Flash] from the applicomIOR console menu and register the configuration to the Fieldbus master board.

26. After a few seconds, the display of “Configured boards state” on the status bar turns to green.

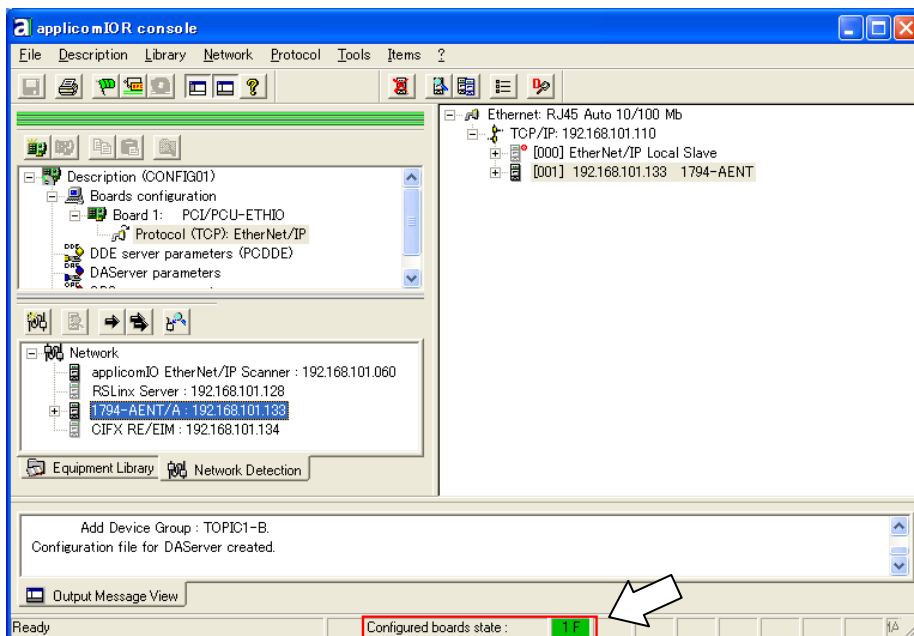

Now, the Fieldbus master board is ready to operate in the master mode.

27. Close the applicomIO console application.
28. Refer to the section *EPSON RC+6.0 configuration* and continue the step.

EPSON RC+6.0 configuration

To use the Fieldbus master board, the RC620 option setting and Fieldbus master setting should be enabled.

1. Select [Setup]-[Option Setting] and display the [Option] dialog box.
2. See *EPSON RC+ User's Guide: 17. Installing Controller Options* and enable the Fieldbus Master option.
3. The following dialog box appears.

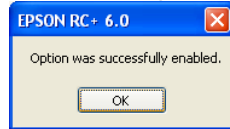

Click <OK> and reboot EPSON RC+6.0.

After EPSON RC+6.0 is started, the option setting is enabled.

4. Select [Setup]-[System Configuration] and display the [System Configuration] dialog box.

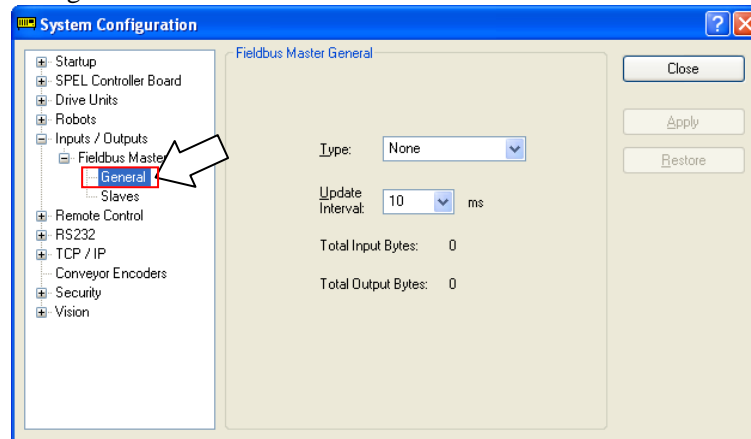

5. Select [Inputs/Outputs]-[Fieldbus Master]-[General].

6. Set the following items:

[Type:] EtherNet/IP

[Update Interval:] Update cycle for the EtherNet/IP master I/O

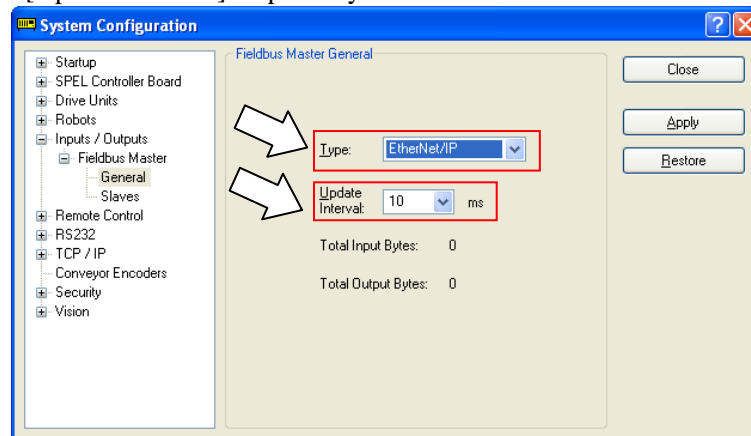

7. Click <Apply>.

Confirm that the following are displayed.

Total Input Bytes : Number of inputs the master controls (Bytes)

Total Output Bytes : Number of outputs the master controls (Bytes)

- Click <Close>. The following dialog box appears.
SPEL⁺ control part of the RC620 robot controller automatically starts rebooting.

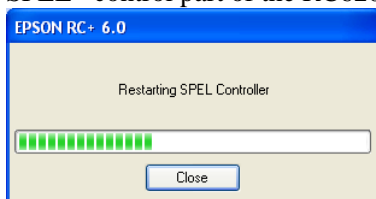

- Select [Setup]-[System Configuration] and display the [System Configuration] dialog box.

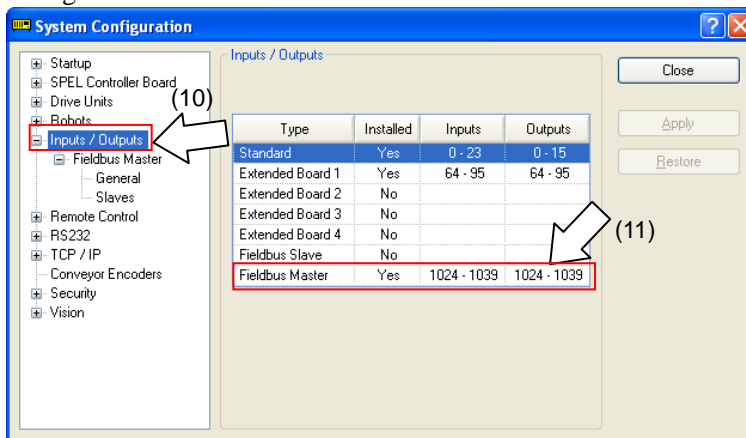

- Select [Inputs / Outputs].
- Confirm that the following are displayed in “Fieldbus Master”.
 Installed : Yes
 Inputs : 1024 – (1024 + Number of inputs the master controls (Bits))
 Outputs : 1024 – (1024 + Number of outputs the master controls (Bits))
- Select [Fieldbus Master]-[General].

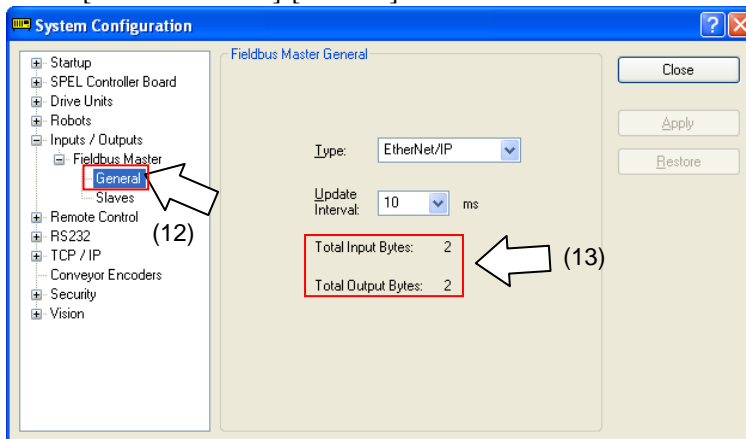

- Confirm that the following are displayed.
 Total Input Bytes : Number of inputs the master controls (Bytes)
 Total Output Bytes : Number of outputs the master controls (Bytes)

14. Select [Fieldbus Master]-[Slave].

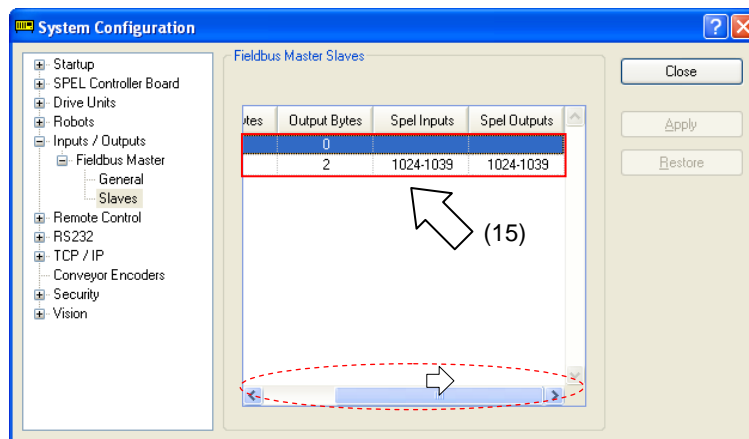
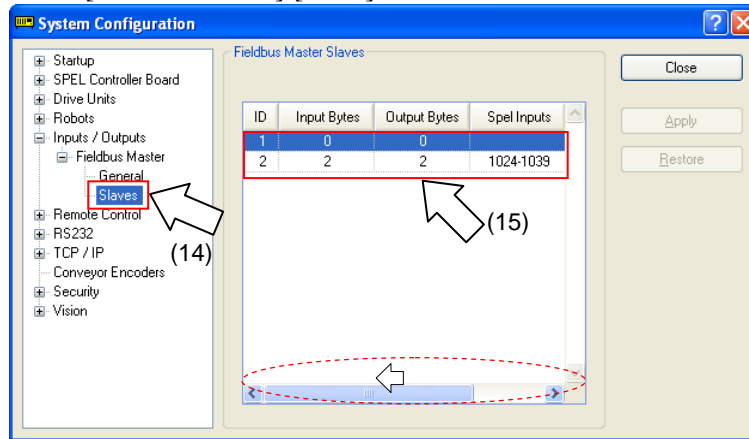

15. Confirm that the following information the master controls are displayed.

- ID : Fieldbus station ID of slave
- Input Bytes : Number of inputs per slave (Bytes)
- Output Bytes : Number of outputs per slave (Bytes)
- Spel Inputs : Number of inputs per slave (Bits)
- Spel Outputs : Number of outputs per slave (Bits)

2.3.4 EtherNet/IP Slave Board Installation

Appearance

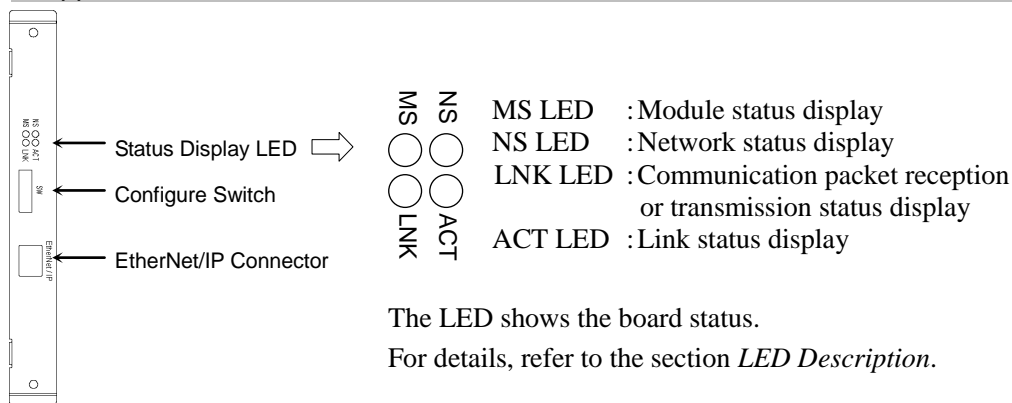

The Fieldbus slave board is configured as follows at shipment.

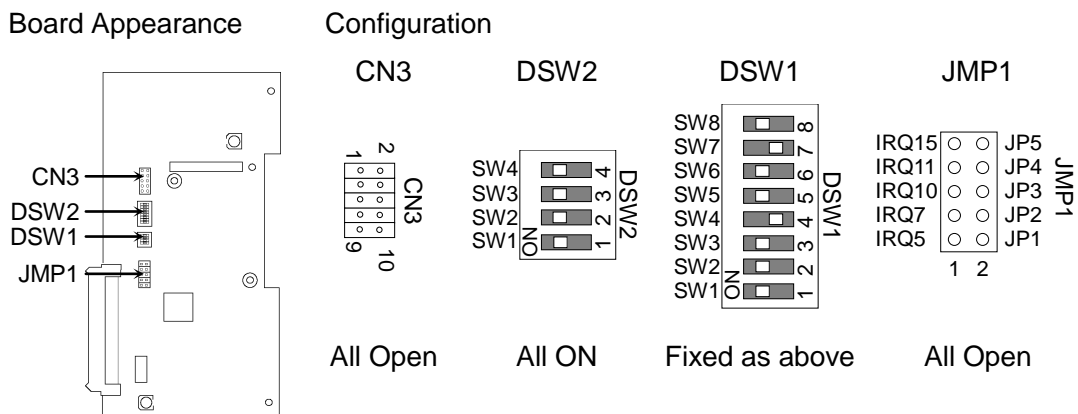

Specifications	
Item	Specification
Name	EtherNet/IP slave board
Code	R12B040719
Supported Connection	I/O messaging connection (Cyclic), Explicit messaging connection EtherNet/IP communication protocol
Baud Rates	10 M, 100 M (bps)
Transfer Distance	Standard Ethernet protocol
Cable	Standard Ethernet protocol
Mode	Slave
Interface	1 EtherNet/IP port
Max. Input data size	256 bits (32 bytes)
Max. Output data size	256 bits (32 bytes)

LED Description

LED status		MS	NS
OFF		Power supply OFF	Power supply OFF or IP address not configured
GRN	ON	Master connected (executing)	Online operating
	Blinking	Master connected (idling)	Waiting master connection
RED	ON	Non-recoverable error	Wrong IP address (duplication)
	Blinking	Recoverable error	Connection time out
GRN/RED alternate		Self-diagnosing	Self-diagnosing

LED status		LNK	ACT
OFF		No link	No communication packet reception or transmission
ON		Linking	Communication packet reception or transmission

Configure switch configuration

 WARNING	<p>■ Make sure that the power is turned OFF before installing/removing any boards or connecting/disconnecting any cables. Working with the power ON is extremely hazardous and may result in electrical shock and/or malfunction of equipment.</p>
--	--

Set all EtherNet/IP board configure switches OFF. Otherwise, the initialization error occurs.

All the EtherNet/IP communication configurations are set by the development software (EPSON RC+ 6.0).

Wiring

Use a standard Ethernet connector for wiring to the board.

 CAUTION	<p>■ You can use the general Ethernet hub or Ethernet switch for the EtherNet/IP. However, be sure to use a product complying with the industrial standards or noise resistant Ethernet cable (STP cable). If you use an office use product or UTP cable, it may cause communication errors and may not offer the proper performance.</p>
---	---

Board Installation



- Make sure that the power is turned OFF before installing/removing any boards or connecting/disconnecting any cables. Working with the power ON is extremely hazardous and may result in electric shock and/or malfunction of equipment.

Follow the instruction below and insert the board into the dedicated slot of the controller.

1. Remove two screws (+) on the back side of the RC620 robot controller.

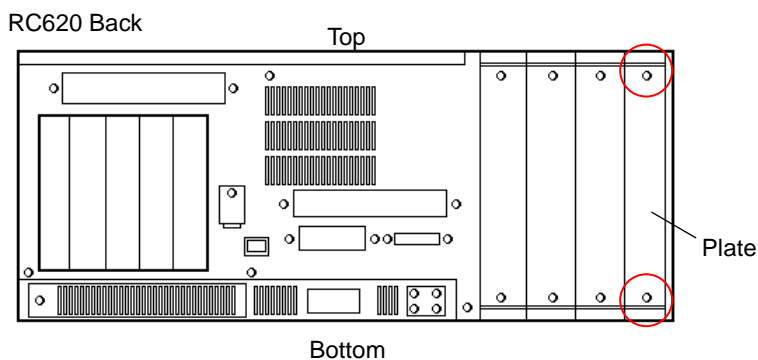

2. Remove the plate.
3. Insert the board into the slot along the guide.
4. Put the plate removed in the step 2 back and secure it with two screws.

Confirmation and configuration of EPSON RC+ 6.0

When the EtherNet/IP slave board is installed to the controller, it is recognized automatically. Confirm whether EPSON RC+ 6.0 has recognized the EtherNet/IP slave board using the following procedure.

1. Select [Setup]-[System Configuration] and display the [System Configuration] dialog box.

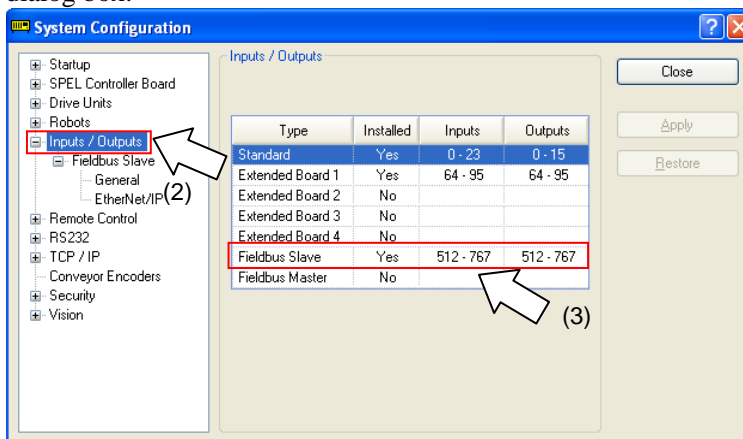

2. Select [Inputs / Outputs].
3. Make sure that the following are displayed in “Fieldbus Slave”.
 - Installed : Yes
 - Inputs : 512-767 (default setting)
 - Outputs : 512-767 (default setting)

4. Select [Fieldbus Slave]-[General].

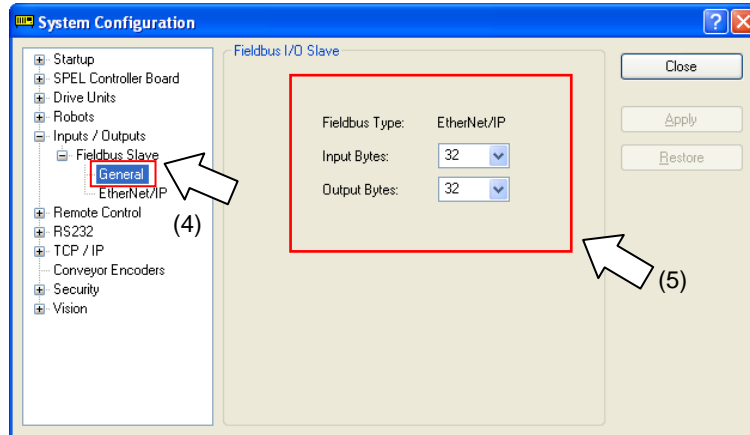

5. Make sure that the following are displayed.

Fieldbus Type : EtherNet/IP
 Input Bytes : 32 (default setting)
 Output Bytes : 32 (default setting)

6. Click <Close>.

7. Select [Fieldbus Slave]-[EtherNet/IP].

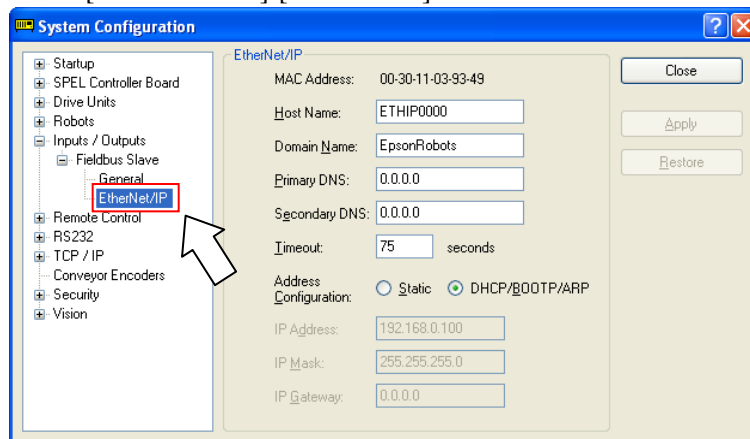

8. Set each item to the specific value to connect the Ethernet network.

For information about the setting values, contact your network administrator.
 Address Configuration is set to “DHCP/BOOTP/ARP” at shipment.

9. When the configuration is completed, click <Apply> to apply the setting.

10. Click <Close>.



When Address Configuration is set to “DHCP/BOOTP/ARP”, the controller waits for DHCP/BOOTP/ARP sever response for 30 seconds at controller startup. When DHCP/BOOTP/ARP does not respond within the time, the Controller stops the request to the DHCP/BOOTP/ARP server and waits ARP.

Editing of input / output size

You can change the input/output size of the EtherNet/IP slave board if necessary.

1. Select [Setup]-[System Configuration] and display the [System Configuration] dialog box.
2. Select [Inputs / Outputs]-[Fieldbus Slave]-[General].

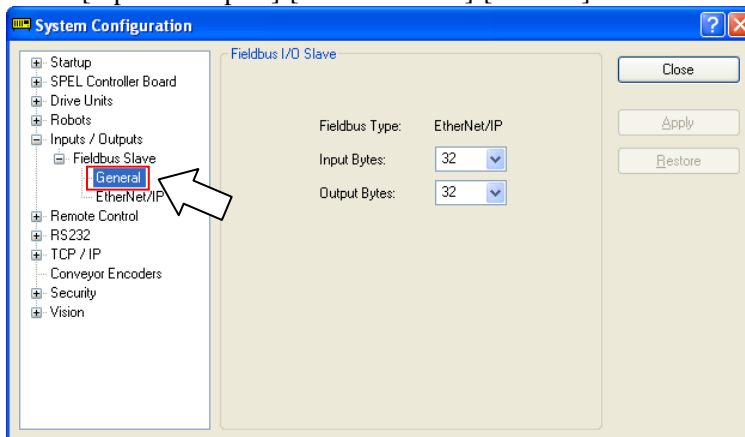

3. Change the settings of [Input Bytes] and [Output Bytes].
In this example, both of them are changed to 20 Bytes.

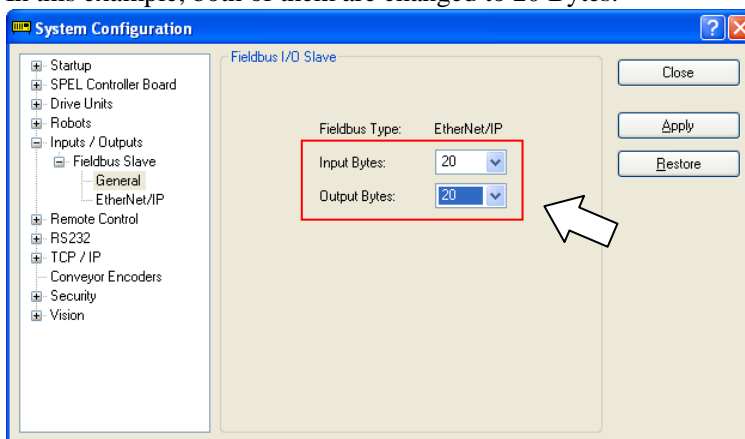

4. Click <Apply>.
5. Click <Close> and the following dialog box appears.
SPEL⁺ control part of the RC620 robot controller automatically starts rebooting.

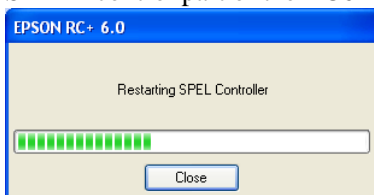

6. Select [Setup]-[System Configuration] and display the [System Configuration] dialog box.

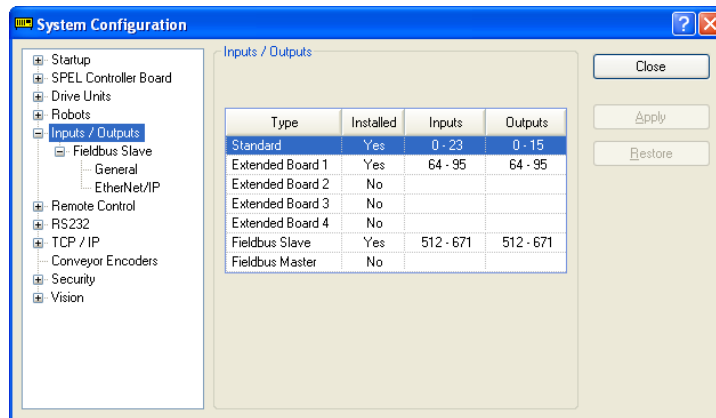

7. Select [Inputs / Outputs].
8. Make sure that the following are displayed in “Fieldbus slave”.
 Inputs : 512 – (512 + Changed number of input (Bits))
 Outputs : 512 – (512 + Changed number of output (Bits))

In this example, Input byte is 20 bytes (160 bits) and 512-671 is displayed in Inputs.

Also, Output byte is 20 bytes (160 bits) and 512-671 is displayed in Outputs.

9. Click <Close>.

NOTE



When you change the input/output size of EtherNet/IP slave board, you need to change the input/output size of the slave information registered in the Fieldbus master device.

Use the window below to change the input/output size of the slave information registered in the Fieldbus master device by the aplicomIO Console application.

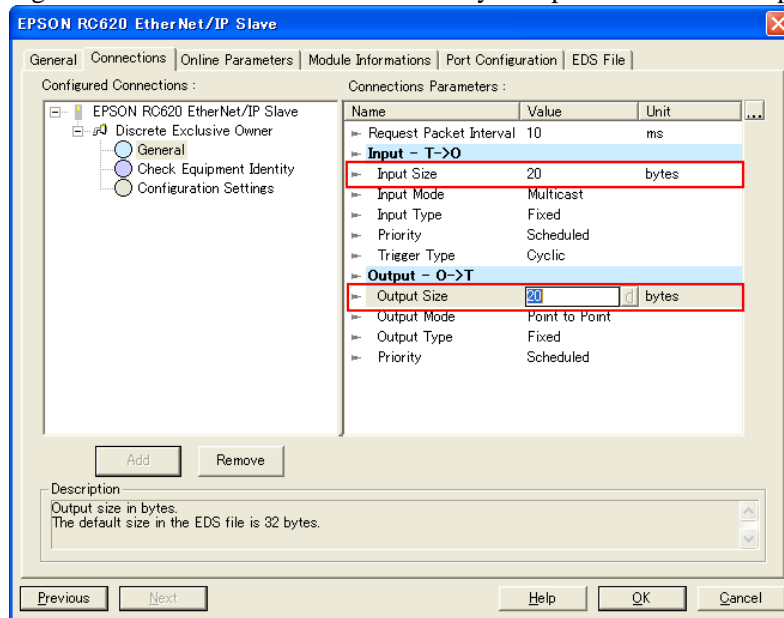

Electronic Information File (EDS file)

An EDS file is supplied for EtherNet/IP slave Board network configuration. The file is located in the following folder in the Installer DVD that is attached to the Robot Controller.

\\EpsonRC60\Fieldbus\EtherNet/IP

2.4 CC-Link

2.4.1 CC-Link Slave Board Installation

Appearance

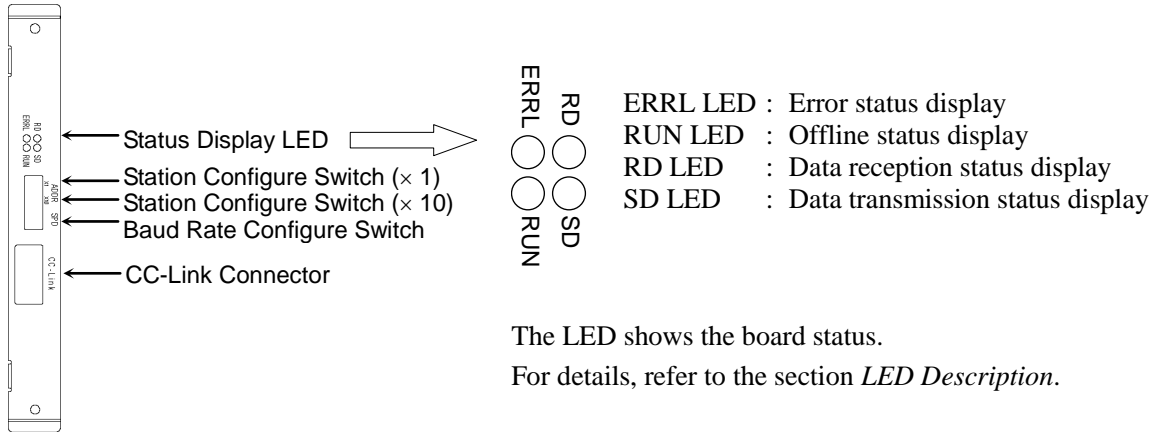

The Fieldbus slave board is configured as follows at shipment.

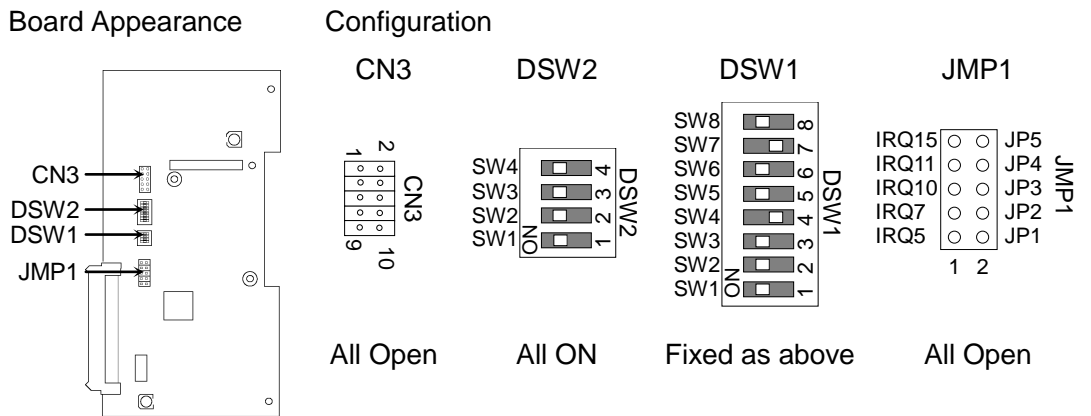

Specifications		
Item	Specification	
Name	CC-Link Slave Board	
Code	R12B040708	
Connection Method	Broadcast polling	
Baud Rates (bps)	156 k, 625 k, 2.5 M, 5 M, 10 M (bps)	
Transfer Distance	Baud Rates	Cable Length
	10 M (bps)	100 m
	5 M (bps)	160 m
	2.5 M (bps)	400 m
	625 k (bps)	900 m
156 k (bps)	1200 m	
Maximum Device Number	64 units	
Cable	Dedicated cable supporting CC-Link Ver.1.10	
Mode	Slave	
Interface	1 CC-Link V1 port	
Occupied Stations	1 to 3 station(s) (Remote device station)	
Master Station's Handshake		
Max. Input Data Size	256 bits (32 bytes)	
Max. Output Data Size	256 bits (32 bytes)	

LED Description

LED status represents the status of the fieldbus I/O board.

LED status	ERRL RED	RUN GRN	RD GRN	SD GRN
OFF	Normal operation Device power supply OFF	Offline Device power supply OFF	No data reception Device power supply OFF	No data transmission Device power supply OFF
ON	CRC error: station Address error Baud rate configuration error	Normal operation	Data reception	Data transmission
Blinking	—	—	—	—

Configure switch configuration

 WARNING	<p>■ Make sure that the power is turned OFF before installing/removing any boards or connecting/disconnecting any cables. Working with the power ON is extremely hazardous and may result in electrical shock and/or malfunction of equipment.</p>
---	--

Configuration of the device station is available with the station configure switch on the CC-Link slave board.

Baud rate configuration is available with baud rate configure switch on the CC-Link board.

- Set the station of the CC-Link slave board with the station configuration switch.
Make sure that the station does not duplicate with the other devices inside the network at configuration.
Switches on the ×10 side are for tenths digit address value configuration. Switches on the ×1 side are for units digit address value configuration. Stations from 1 to 62 are available.

2. Set the CC-Link baud rate. Check the master configuration and set the same baud rate. Refer to the following table for configuration.

Baud Rate	Switch
156 k	0
625 k	1
2.5 M	2
5 M	3
10 M	4
Configuration prohibited	5-9

Wiring

The CC-Link connector is a 5-pin open connector. Use the connector attached to the board for wiring.

Terminal name for each pin

Terminal No	Terminal Name
1	DA
2	DB
3	DG
4	SLD
5	FG

Connect the CC-Link master module and the CC-Link slave board as follows.

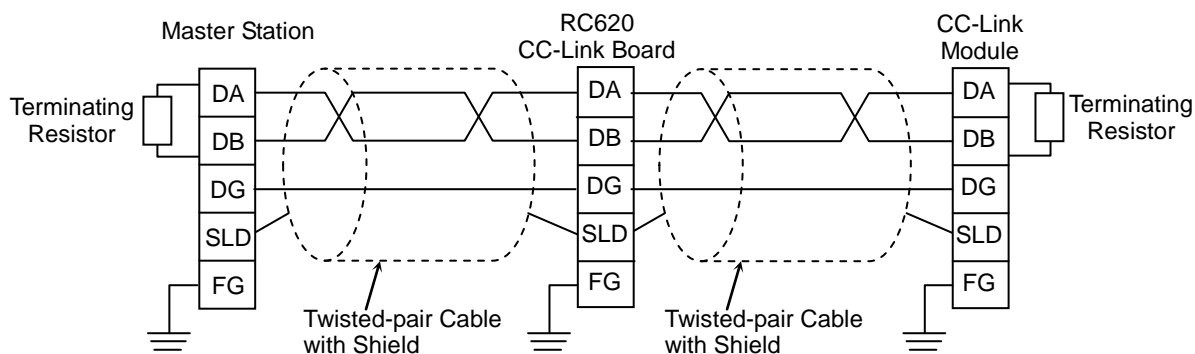

- NOTE
- Prepare the cable for CC-Link Ver.1.10 sold in the market as a communication cable.
 - Install terminating resistors at both ends of the network.
 - Use the terminating resistors attached to the CC-Link master station.

Make sure to disconnect the connectors only after turning OFF the power supply of the specific station.

Connect the shield wire for CC-Link to the "SLD" of each unit and ground the both ends via "FG".

Board Installation



■ Make sure that the power is turned OFF before installing/removing any boards or connecting/disconnecting any cables. Working with the power ON is extremely hazardous and may result in electrical shock and/or malfunction of equipment.

Follow the instruction below and insert the board into the dedicated slot of the controller.

1. Remove two screws (+) on the back side of the RC620 robot controller.

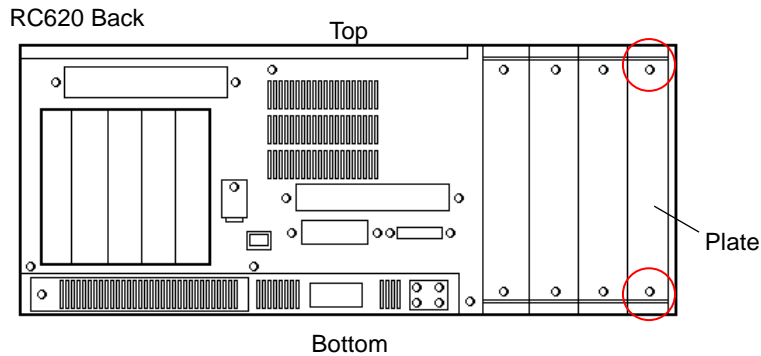

2. Remove the plate.
3. Insert the board into the slot along the guide.
4. Put the plate removed in the step 2 back and secure it with two screws.

Confirmation of EPSON RC+ 6.0

When the CC-Link slave board is installed to the controller, it is recognized automatically. Confirm whether EPSON RC+ 6.0 has recognized the CC-Link board using the following procedure.

1. Select [Setup]-[System Configuration] and display the [System Configuration] dialog box.

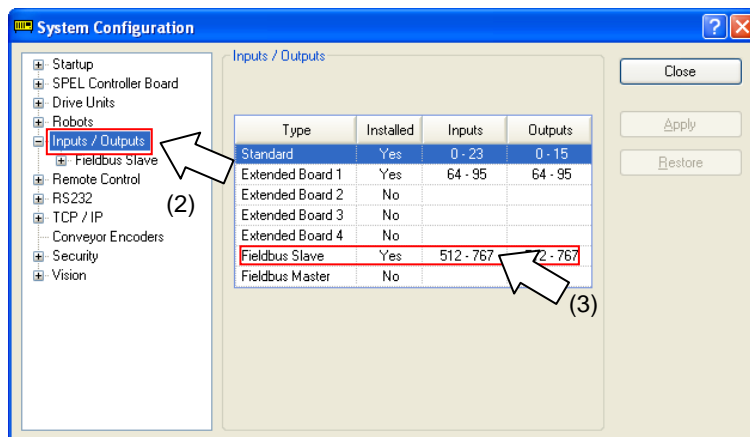

2. Select [Inputs / Outputs].
3. Make sure that the following are displayed in “Fieldbus slave”.

Installed : Yes
 Inputs : 512-767 (default setting)
 Outputs : 512-767 (default setting)

4. Select [Fieldbus Slave]-[General].

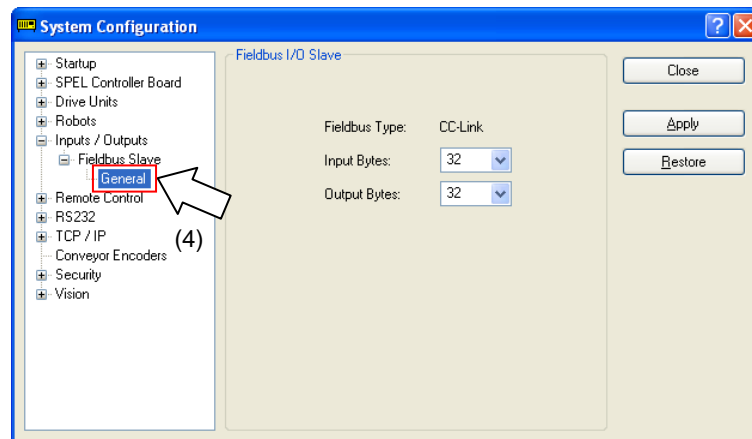

5. Make sure that the following are displayed.

Fieldbus Type : CC-Link
 Input Bytes : 32 (default setting)
 Output Bytes : 32 (default setting)

6. Click <Close>.

Editing of input / output size

You can change the input/output size of the CC-Link slave board if necessary.

1. Select [Setup]-[System Configuration] and display the [System Configuration] dialog box.
2. Select [Inputs / Outputs]-[Fieldbus Slave]-[General].

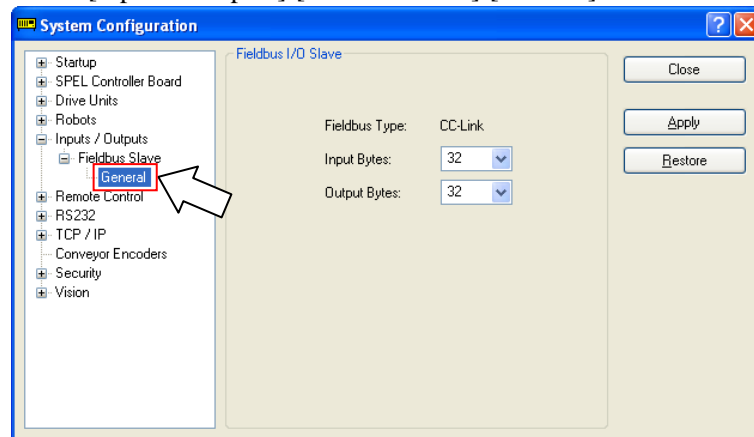

- Change the settings of [Input Byte] and [Output Byte].
In this example, both of them are changed to 20 Bytes.

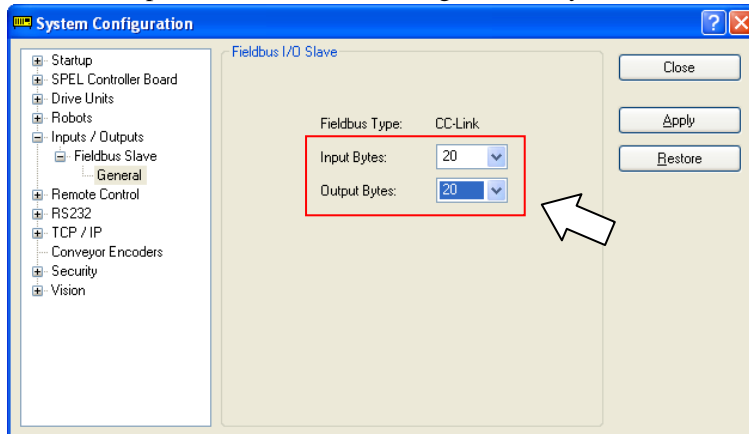

- Click <Apply>.
- Click <Close> and the following dialog box appears.
SPEL⁺ control part of the RC620 robot controller automatically starts rebooting.

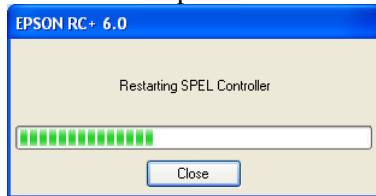

- Select [Setup]-[System Configuration] and display the [System Configuration] dialog box.

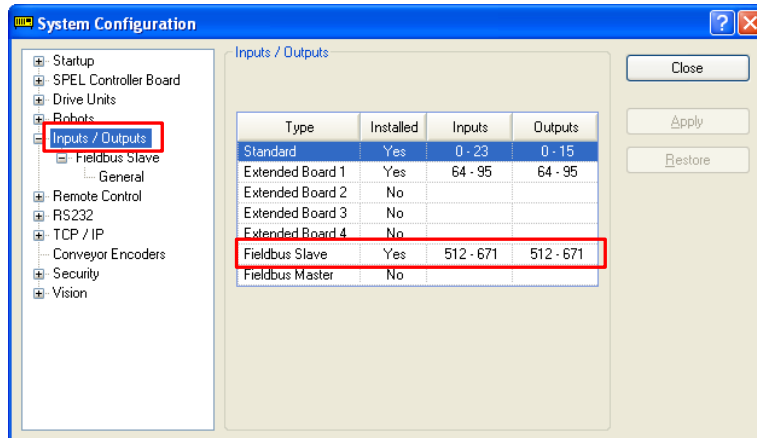

- Select [Inputs / Outputs].
- Make sure that the following are displayed in “Fieldbus slave”.

Inputs : 512 - (512 + Changed number of input (Bits))
 Outputs : 512 - (512 + Changed number of output (Bits))

In this example, Input byte is 20 bytes (160 bits) and 512-671 is displayed in Inputs.
 Also, Output byte is 20 bytes (160 bits) and 512-671 is displayed in Outputs.

- Click <Close>.

Operation

When the CC-Link is installed, some operation differs from the other Fieldbus I/O options. This section describes about these differences.

Remote Input

Remote input (RX) and remote output (RY) indicates ON/OFF information. Remote data is bit data and the FROM/TO command is executed per 16 bits (1 word).

“n” in the following tables is address configured as a master station with the station configure. This is calculated by the following expression.

$$n = (\text{Station} - 1) \times 2$$

Result of the calculation is in decimal number. Substitute the result to “n” after converting to hexadecimal number.

(Example)

When CC-Link board station is 1

Remote Input RXn0 to RX(n+5)F → RX00 to RX5F

Remote Output RYn0 to RY(n+5)F → RY00 to RY5F

When CC-Link board station is 4

Remote Input RXn0 to RX(n+5)F → RX60 to RXAF

Remote Output RYn0 to RY(n+5)F → RY60 to RYAF

Remote Input List (3 stations occupied, Default configuration *1)

Signal direction: Remote device station (CC-Link board) → Master station (PLC)

Bits indicated as “NA” are left for user. Use these free for SPEL+ program.

Address	Signal Name		Controller Bit No
RXn0	Ready	*1	512
RXn1	Running	*1	513
RXn2	Paused	*1	514
RXn3	Error	*1	515
RXn4	EStopOn	*1	516
RXn5	SafeguardOn	*1	517
RXn6	SError	*1	518
RXn7	Warning	*1	519
RXn8	MotorsOn	*1	520
RXn9	AtHome	*1	521
RXnA	CurrProg1	*1	522
RXnB	CurrProg2	*1	523
RXnC	CurrProg4	*1	524
RXnD	AutoMode	*1	525
RXnE	TeachMode	*1	526
RXnF	ErrorCode1	*1	527
RX(n+1)0	ErrorCode2	*1	528
RX(n+1)1	ErrorCode4	*1	529

Address	Signal Name		Controller Bit No
RX(n+1)2	ErrorCode8	*1	530
RX(n+1)3	ErrorCode16	*1	531
RX(n+1)4	ErrorCode32	*1	532
RX(n+1)5	ErrorCode64	*1	533
RX(n+1)6	ErrorCode128	*1	534
RX(n+1)7	ErrorCode256	*1	535
RX(n+1)8	ErrorCode512	*1	536
RX(n+1)9	ErrorCode1024	*1	537
RX(n+1)A	ErrorCode2048	*1	538
RX(n+1)B	ErrorCode4096	*1	539
RX(n+1)C	ErrorCode8192	*1	540
RX(n+1)D	CmdRunning	*1	541
RX(n+1)E	CmdError	*1	542
RX(n+1)F	NA		543
RX(n+2)0	NA		544
:	:		
RX(n+4)F	NA		591
RX(n+5)0	NA		592
RX(n+5)1	NA		593
RX(n+5)2	NA		594
RX(n+5)3	NA		595
RX(n+5)4	NA		596
RX(n+5)5	NA		597
RX(n+5)6	NA		598
RX(n+5)7	NA		599
RX(n+5)8	NA		600
RX(n+5)9	NA		601
RX(n+5)A	NA		602
RX(n+5)B	NA		603
RX(n+5)C	NA		604
RX(n+5)D	NA		605
RX(n+5)E	NA		606
RX(n+5)F	NA		607

*1: Remote control input and output are not allocated to fieldbus slave I/O by default.

To allot remote control inputs and outputs to fieldbus slave I/O, refer to *3.5 Remote Control Input and Output setting* later in this manual.

Remote Output List (3 stations occupied, Default configuration *1)

Signal direction: Master station (PLC) → Remote device station (CC-Link board)

Bits indicated as “NA” are left for user. Use these free for SPEL+ program.

Address	Signal Name		Controller Bit No
RYn0	Start	*1	512
RYn1	SelProg1	*1	513
RYn2	SelProg2	*1	514
RYn3	SelProg4	*1	515
RYn4	Stop	*1	516
RYn5	Pause	*1	517
RYn6	Continue	*1	518
RYn7	Continue	*1	519
RYn8	SetMotorsOn	*1	520
RYn9	SetMotorsOff	*1	521
RYnA	Home	*1	522
RYnB	Shutdown	*1	523
RYnC	NA		524
RYnD	NA		525
RYnE	NA		526
RYnF	NA		527
RY(n+1)0	NA		528
:	:		
RY(n+4)F	NA		591
RY(n+5)0	NA		592
RY(n+5)1	NA		593
RY(n+5)2	NA		594
RY(n+5)3	NA		595
RY(n+5)4	NA		596
RY(n+5)5	NA		597
RY(n+5)6	NA		598
RY(n+5)7	NA		599
RY(n+5)8	NA		600
RY(n+5)9	NA		601
RY(n+5)A	NA		602
RY(n+5)B	NA		603
RY(n+5)C	NA		604
RY(n+5)D	NA		605
RY(n+5)E	NA		606
RY(n+5)F	NA		607

*1: Remote control inputs and outputs are not allocated to fieldbus slave I/O by default.

To allot remote control inputs and outputs to fieldbus slave I/O, refer to 3.5 *Remote Control Input and Output setting* later in this manual.

Remote Register

Remote register (RW_r, RW_w) is numeric value

“m” indicated in the following tables are master station address configured with station configure. This is calculated by the following expression.

$$m = (\text{Station} - 1) \times 4$$

Result of the calculation is in decimal number. Substitute the result to “m” after converting to hexadecimal number.

(Example)

When the CC-Link board is 1

Remote Register RW_m to RW_m+B → RW_r0 to RW_rB

Remote Register RW_wm to RW_wm+B → RW_w0 to RW_wB

When the CC-Link board is 4

Remote Register RW_m to RW_m+B → RW_rC to RW_r17

Remote Register RW_wm to RW_wm+B → RW_wC to RW_w17

Remote Register List (3 stations occupied, Default configuration *1)

Signal direction: Remote device station (CC-Link board) → Master station (PLC)

Bits indicated as “NA” are left for user. Use these free for SPEL+ program.

Address	Signal Name	Controller Word No	Controller Bit No
RW _m	NA	38	608 to 623
:	:		
RW _m +9	NA	47	752 to 767
RW _m +A	System reserved	-	-
RW _m +B	System reserved	-	-

Signal direction: Master station (PLC) → Remote device station (CC-Link board)

Bits indicated as “NA” are left for user. Use these free for SPEL+ program.

Address	Signal Name	Controller Word No	Controller Bit No
RW _w m	NA	38	608 to 623
:	:		
RW _w m+9	NA	47	752 to 767
RW _w m+A	System reserved	-	-
RW _w m+B	System reserved	-	-

The number of stations, remote I/O range, and remoteregister range depend on the input / output size.

Input / Output Size (x)	Occupied Stations	Remote I/O (Bytes)	Remote Register (Bytes)
0 < x = < 4	1	S	0
4 < x = < 12		4	x - 4
12 < x = < 24	2	8	x - 8
24 < x = < 32	3	12	x - 12

The number of occupied stations is the ones on the CC-Link network. Set this number to the master station.

Remote I/O is the information of ON/OFF.

Remote I/O data is in bit data and the FROM/TO command are executed in units of 16 bits.

Remote register is in numeric data.

Electronic Information File

A CSP file is supplied for the CC-Link slave board network configuration. The file is located in the following folder in the Installer DVD that is attached to the robot controller.

\EpsonRC60\Fieldbus\CCLink

According to the input/output size, the CSP file you use differs.

See the table below and select the CSP file.

Input / Output Size (x)	Occupied stations	Electronic file name
$0 < x \leq 12$	1	EPSN0200_1.csp
$12 < x \leq 24$	2	EPSN0200_2.csp
$24 < x \leq 32$	3	EPSN0200_3.csp

2.5 PROFINET

2.5.1 PROFINET Slave Board Installation

Appearance

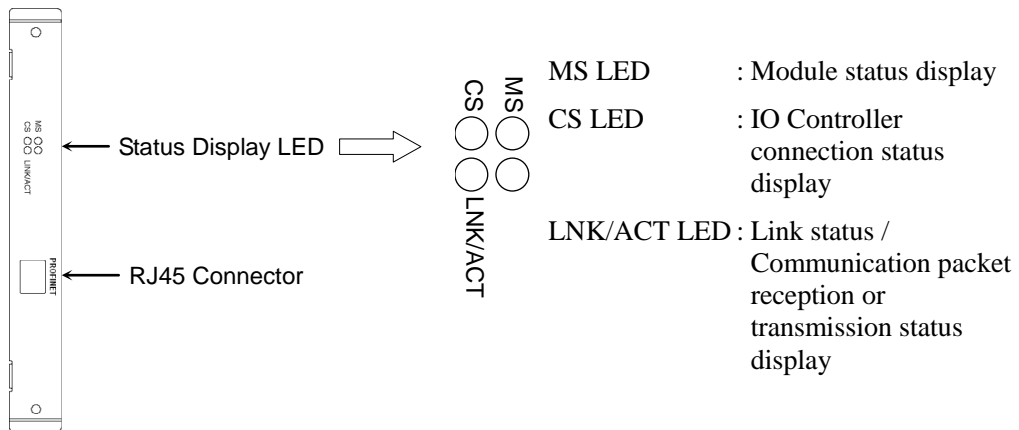

The LED shows the board status.

For details, refer to the section LED Description.

The Fieldbus slave board is configured as follows at shipment.

Board Appearance

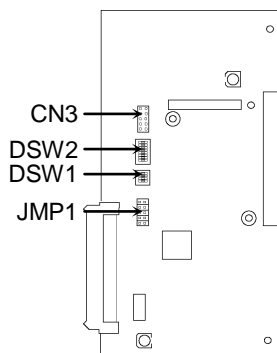

Configuration

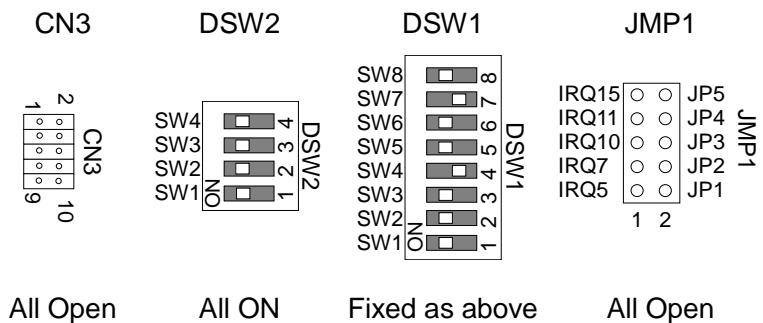

Specifications

Item	Specification
Name	PROFINET board
Code	R12B040707
Connection Method	RT (Real-Time)
Protocol	PROFINET IO
Device type	IO device
Baud Rates (bps)	100 M bps, full duplex
Maximum segment length	100 m
Cable	RJ45 with connector 100BASE-TX (Cat5)
Cycle time	2 msec
Interface	RJ45 port × 1
Input Data Size	256 bits (32 bytes)
Output Data Size	256 bits (32 bytes)

LED Description

LED status represents the status of the fieldbus board.

LED status		MS	CS	LNK/ACT
OFF		Power OFF or Device is being initialized	Offline	No link or Power OFF
GRN	ON	Normal operation	Offline IO controller is in RUN	Linking
	Blinking	-	-	Receiving/transmitting communication packet
	Blinking once	Evaluating	Offline / IO controller is in STOP	-
RED	Blinking	Blinking once	-	-
		Blinking 3 times	No station name has been set or No IP address has been set	-
		Blinking 4 times	Internal error	-

Configure switch configuration

 WARNING	<ul style="list-style-type: none"> Make sure that the power is turned OFF before installing/removing any boards or connecting/disconnecting any cables. Working with the power ON is extremely hazardous and may result in electric shock and/or malfunction of equipment.
---	---

The PROFINET board requires no configurations.

All the PROFINET communication configurations are set by the development software (EPSON RC+ 6.0).

Wiring

PROFINET connector is RJ45 connector. Use 100BASE-TX (STP type) cable.

 CAUTION	<ul style="list-style-type: none"> Be sure to use cables and connectors complying with the industrial standards or noise resistant Ethernet cable (STP cable). If you use an office use product or UTP cable, it may cause communication errors and may not offer the proper performance.
---	--

Board Installation



- Make sure that the power is turned OFF before installing/removing any boards or connecting/disconnecting any cables. Working with the power ON is extremely hazardous and may result in electrical shock and/or malfunction of equipment.

Follow the instruction below and insert the board into the dedicated slot of the controller.

- Remove two screws (+) on the back side of the RC620 robot controller.

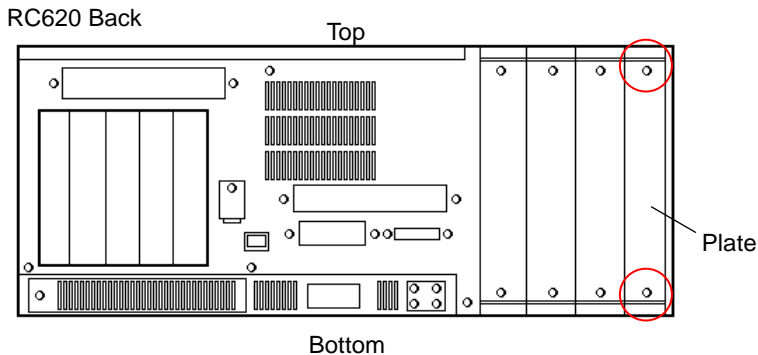

- Remove the plate.
- Insert the board into the slot along the guide.
- Put the plate removed in the step 2 back and secure it with two screws.

Confirmation with EPSON RC+ 6.0

When PROFINET slave board is installed in the controller, it is recognized automatically. Confirm that EPSON RC+ 6.0 has recognized the board in the following procedure.

- Select [Setup]-[System Configuration] and display the [System Configuration] dialog box.

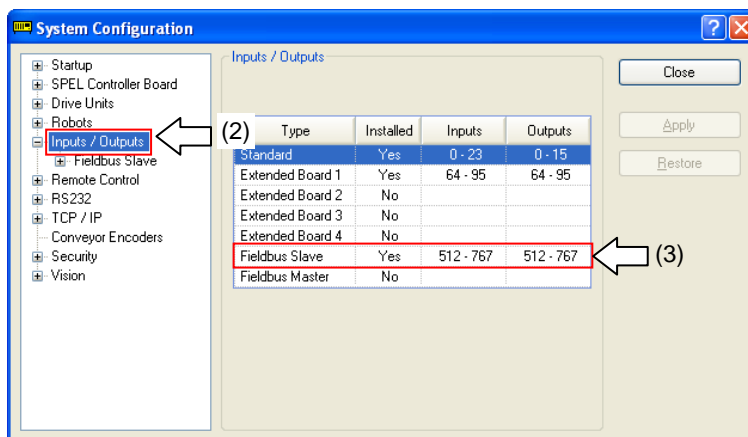

- Select [Inputs / Outputs].
- Make sure that following are displayed in “Fieldbus”.
 - Installed : Yes
 - Inputs : 512-767 (default setting)
 - Outputs : 512-767 (default setting)

- Click [Fieldbus Slave]-[General].

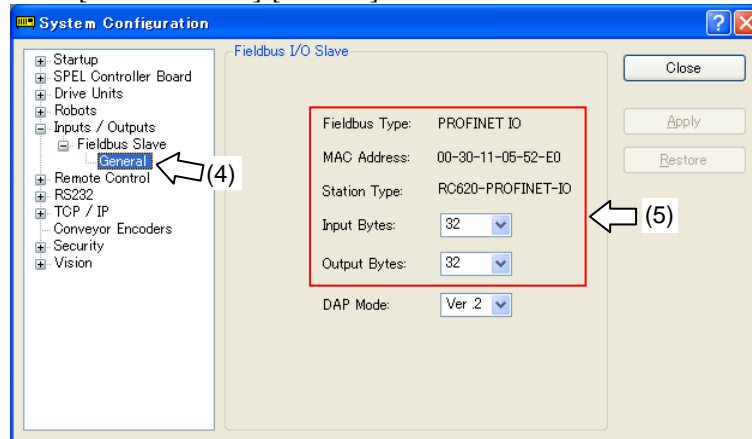

- Make sure that following are displayed.
 Fieldbus Type : PROFINET IO
 Input Byte : 32 (default setting)
 Output Byte : 32 (default setting)
- Click <Close>.

Editing of input / output size and DAP mode

You can change the input/output size of the PROFINET slave board if necessary.

- Select [Setup]-[System Configuration] and display the [System Configuration] dialog box.
- Select [Inputs / Outputs]-[Fieldbus Slave]-[General].

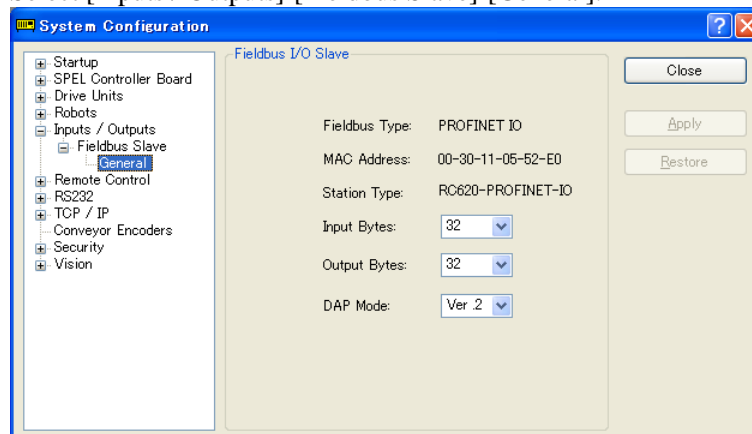

3. Change the settings of [Input Byte] and [Output Byte].
In this example, both of them are changed to 20 Bytes.

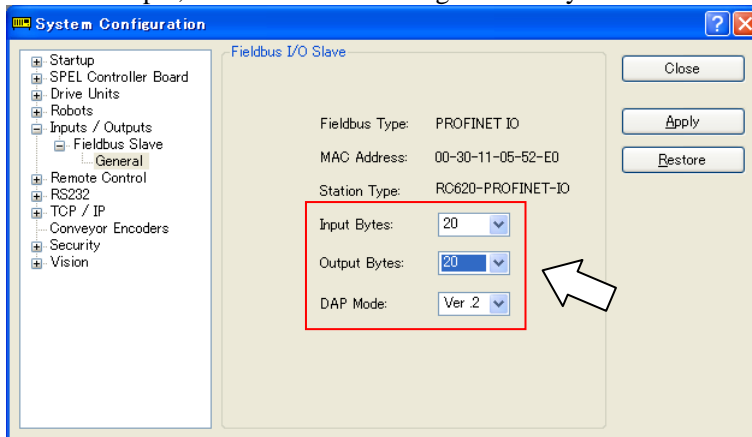

4. Change the setting of [DAP mode] if necessary.
5. Set [DAP mode] according to the PROFINET IO controller that you want to use.
Usually, select DAP Ver.2. DAP Ver.1 is available for the obsolete PROFINET IO controller.



The PROFINET option does not have the alert function that is an optional function in DAP Ver.2.

6. Click <Apply>.
7. Click <Close> and the following dialog box appears.
SPEL⁺ control part of the RC620 robot controller automatically starts rebooting.



8. Select [Setup]-[System Configuration] and display the [System Configuration] dialog box.

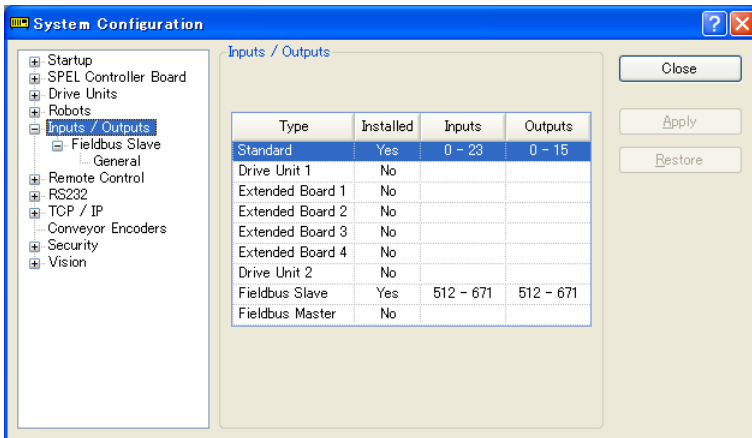

9. Select [Inputs / Outputs].

10. Make sure that the following are displayed in “Fieldbus slave”.

Inputs : 512 – (512 + Changed number of input (Bits))

Outputs : 512 – (512 + Changed number of output (Bits))

In this example, Input byte is 20 bytes (160 bits) and 512-671 is displayed in Inputs.

Also, Output byte is 20 bytes (160 bits) and 512-671 is displayed in Outputs.

11. Click <Close>.



NOTE

When setting this option to the PROFINET IO controller (Master), configure as below. The RC620 controller includes eight pseudo I/O slots. In these slots, add 1 to 8 bytes input modules, output modules.

Make sure to add the output modules first, and then, add the input modules.

<Example> Input: 21 bytes / Output: 10 bytes (set in the RC+ window)

Slot 1 : 8 bytes output module

Slot 2 : 8 bytes output module

Slot 3 : 5 bytes output module

(Set 21 bytes in total for the Output.)

Slot 4 : 8 bytes input module

Slot 5 : 2 bytes input module

(Set 10 bytes in total for the Input.)

Electronic Information File (GSDML file)

A GSDML file is provided for the PROFINET slave board network configuration. The file is located in the following folder in the Installer DVD that is attached to the robot controller.

\EpsonRC60\Fieldbus\PROFINET

3. Operation

This chapter describes how to use the Fieldbus I/O option after installing it.

3.1 SPEL⁺ Fieldbus I/O Commands

Here are the main commands for Fieldbus I/O. Input/output command and function for fieldbus I/O are same as these for the normal I/O. For details, refer to the *Online Help* or *SPEL⁺ Language Reference manual*.

FbusIO_GetBusStatus	Returns the status of the specified fieldbus.
FbusIO_GetDeviceStatus	Returns the status of the specified fieldbus device.
FbusIO_SendMsg	Sends an explicit message to a device and returns the reply.
In	Returns the status of an 8-bit input port.
InW	Returns the status of a 16-bit input port.
IONumber	Returns the I/O port number of the specified Fieldbus I/O label.
Off	Turns an output off.
On	Turns an output on.
Out	Simultaneously sets eight output bits.
OutW	Simultaneously sets 16 output bits.
Sw	Returns the status of one input bit.

NOTE



Response times for Fieldbus I/O varies and depends on several factors, including baud rate, scan rate, number of tasks, communication error, etc. EPSON RC+ does not guarantee the real-time response for the fieldbus I/O and message inputs. When the fastest and most consistent response times are required, please use EPSON Standard digital I/O, which incorporates interrupt driven inputs and outputs.

3.2 Outputs Off by Emergency Stop and Reset Instruction

You can configure the system so that all outputs including the fieldbus outputs will be turned off when the emergency stop occurs and when a Reset instruction is executed. For details of the configuration, refer to the chapter *SPEL⁺ Options* in the EPSON RC+ User's Guide.

NOTE



A command that was issued just before an emergency stop can be executed after the emergency stop condition is cleared. If the outputs from the fieldbus involve risk, the “Outputs off during Emergency Stop” option should be enabled to remove all power to output devices when an emergency stop occurs.

3.3 Using FbusIO_SendMsg

To use FbusIO_SendMsg, install the Fieldbus master board.

FbusIO_SendMsg is used to send an explicit message to a device and return a reply. This command operates according to the protocol.

The syntax is as follows:

```
FbusIO_SendMsg bus, device, msgParam, sendBytes(), recvBytes()
```

Description of parameter

There are two arrays passed to the parameter. The sendData array contains the data that is sent to the device in bytes. This array must be dimensioned to the correct number of bytes to send. If there are no bytes to send, you must use "0" for the parameter. The recvData array returns the response in bytes. This array is automatically re-dimensioned to the number of bytes received.

For DeviceNet, you need to initialize the sendData array with the command, class, instance, and attribute, as shown in the example below. Consult the documentation that came with the device for the values that can be used. The msgParam parameter value is always "0" for DeviceNet messages.

Here is an example for DeviceNet and EtherNet/IP:

The following example acquires the information of a device MacID = 1.

```
' Send explicit message to the device
Byte sendData(5)
Byte recvData(10)
Integer i
sendData(0) = 14 ' Command (GetAttributeSingle)
sendData(1) = 1  ' Class
sendData(3) = 1  ' Instance
sendData(5) = 7  ' Attribute
FbusIO_SendMsg 16, 1, 0, sendData(), recvData()
For i = 0 To UBound(recvData)
    Print recvData(i)
Next i
```

For PROFIBUS DP, you need to specify the service number in the msgParam parameter. Consult the documentation that came with the device for the services that are supported. Some services require "0" send bytes. In this case, use "0" for the sendBytes parameter.

Here is an example for PROFIBUS DP:

```
' Send message to Profibus device
Byte recvData(10)
Integer i
' Service 56 - read all inputs
' sendBytes = 0
FbusIO_SendMsg 1, 1, 56, 0, recvData()
For i = 0 To UBound(recvData)
    Print recvData(i)
Next i
```

3.4 Explicit Message Connection (for DeviceNet, EtherNet/IP)

Issuing an Explicit message from the DeviceNet/EtherNet/IP master unit to the RC620 controller acquires and configures the DeviceNet and EtherNet/IP I/O area.

Supported function and Class ID configurations are as follows:

When using Assembly Object Class (Class ID = 4)

Function	Class ID	Instance	Service Code
Input acquisition	4 (04h)	100 (64h)	14 (0Eh)
Output configuration	4 (04h)	150 (96h)	16 (10h)
Output acquisition	4 (04h)	150 (96h)	14 (0Eh)

When using I/O Data Mapping Object Class (Class ID = 160, 161)

Function	Class ID	Instance	Service Code
Input acquisition	160 (A0h)	01 (01h)	14 (0Eh)
Output configuration	161 (A1h)	01 (01h)	16 (10h)
Output acquisition	161 (A1h)	01 (01h)	14 (0Eh)

Command response

It can acquire up to 32 bytes* input/output data.

* It depends on the input/output size setting.

3.5 Remote Control Input and Output Setting

Remote control inputs and outputs are not allocated to fieldbus I/O by default.

To allot remote control inputs and outputs to fieldbus I/O, follow the steps below.

- (1) Select EPSON RC+6.0 menu-[Setup]-[System Configuration] and display the [System Configuration] dialog box. Select-[Controller]-[Remote Control]-[Inputs] or [Outputs].

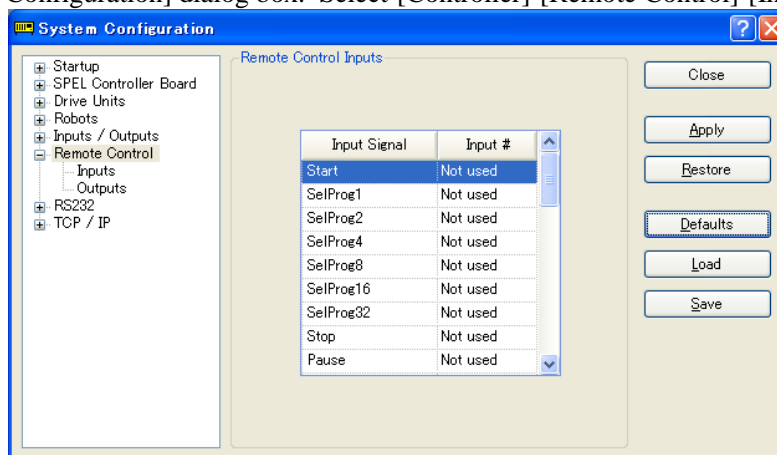

- (2) Click <Defaults> to display the [Default Remote Type] dialog box.

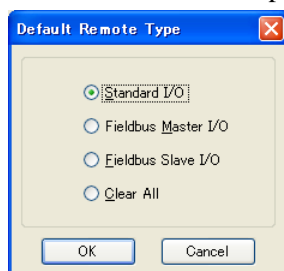

- (3) Select [Fieldbus Master I/O] or [Fieldbus Slave I/O] and click <OK>.
- (4) Fieldbus I/O will be allotted default remote control input and output setting. Select bit numbers by clicking the input or output numbers corresponding to the signals to be used for remote control.
- (5) Click <Apply> to save the settings. Then, click <Close>.

To enable the remote control, refer to *EPSON RC+ 6.0 User's Guide 11. Remote Control*.

Default Remote Control Input Setting for Fieldbus Master I/O

Default remote control input settings for fieldbus master I/O are as follows:

Input Signal	Controller Input Bit No
Start	1024
SelProg1	1025
SelProg2	1026
SelProg4	1027
SelProg8	Not used
SelProg16	Not used
SelProg32	Not used
Stop	1028
Pause	1029
Continue	1030
Reset	1031
Shutdown	1035
SelRobot1	Not used
SelRobot2	Not used
SelRobot4	Not used
SelRobot8	Not used
SelRobot16	Not used
SetMotorsOn	1032
SetMotorsOff	1033
SetPowerHigh	Not used
SetPowerLow	Not used
ForcePowerLow	Not used
Home	1034
MCal	Not used
Recover	Not used

Default Remote Control Output Setting for Fieldbus Master I/O

Default remote control output settings for fieldbus master I/O are as follows:

Output Signal	Controller Output Bit No
Ready	1024
Running	1025
Paused	1026
Error	1027
EStopOn	1028
SafeguardOn	1029
SError	1030
Warning	1031
MotorsOn	1032
AtHome	1033
PowerHigh	Not used
MCalReqd	Not used
RecoverReqd	Not used
RecoverInCycle	Not used
WaitingRC	Not used
CmdRunning	1053
CmdError	1054
CurrProg1	1034
CurrProg2	1035
CurrProg4	1036
CurrProg8	Not used
CurrProg16	Not used
CurrProg32	Not used
AutoMode	1037
TeachMode	1038
EnableOn	Not used
ErrorCode1	1039
ErrorCode2	1040
ErrorCode4	1041
ErrorCode8	1042
ErrorCode16	1043
ErrorCode32	1044
ErrorCode64	1045
ErrorCode128	1046
ErrorCode256	1047
ErrorCode512	1048
ErrorCode1024	1049
ErrorCode2048	1050
ErrorCode4096	1051
ErrorCode8192	1052
InsideBox1	Not used
InsideBox2	Not used
InsideBox3	Not used

Output Signal	Controller Output Bit No
InsideBox4	Not used
InsideBox5	Not used
InsideBox6	Not used
InsideBox7	Not used
InsideBox8	Not used
InsideBox9	Not used
InsideBox10	Not used
InsideBox11	Not used
InsideBox12	Not used
InsideBox13	Not used
InsideBox14	Not used
InsideBox15	Not used
InsidePlane1	Not used
InsidePlane2	Not used
InsidePlane3	Not used
InsidePlane4	Not used
InsidePlane5	Not used
InsidePlane6	Not used
InsidePlane7	Not used
InsidePlane8	Not used
InsidePlane9	Not used
InsidePlane10	Not used
InsidePlane11	Not used
InsidePlane12	Not used
InsidePlane13	Not used
InsidePlane14	Not used
InsidePlane15	Not used

Default Remote Control Input Setting for Fieldbus Slave I/O

Default remote control input settings for fieldbus slave I/O are as follows:

Input Signal	Controller Input Bit No
Start	512
SelProg1	513
SelProg2	514
SelProg4	515
SelProg8	Not used
SelProg16	Not used
SelProg32	Not used
Stop	516
Pause	517
Continue	518
Reset	519
Shutdown	523
SelRobot1	Not used
SelRobot2	Not used
SelRobot4	Not used
SelRobot8	Not used
SelRobot16	Not used
SetMotorsOn	520
SetMotorsOff	521
SetPowerHigh	Not used
SetPowerLow	Not used
ForcePowerLow	Not used
Home	522
MCal	Not used
Recover	Not used

Default Remote Control Output Setting for Fieldbus Slave I/O

Default remote control output settings for fieldbus slave I/O are as follows:

Output Signal	Controller Output Bit No
Ready	512
Running	513
Pauseed	514
Error	515
EStopOn	516
SafeguardOn	517
SError	518
Warning	519
MotorsOn	520
AtHome	521
PowerHigh	Not used
MCalReqd	Not used
RecoverReqd	Not used
RecoverInCycle	Not used
WaitingRC	Not used
CmdRunning	541
CmdError	542
CurrProg1	522
CurrProg2	523
CurrProg4	524
CurrProg8	Not used
CurrProg16	Not used
CurrProg32	Not used
AutoMode	525
TeachMode	526
EnableOn	Not used
ErrorCode1	527
ErrorCode2	528
ErrorCode4	529
ErrorCode8	530
ErrorCode16	531
ErrorCode32	532
ErrorCode64	533
ErrorCode128	534
ErrorCode256	535
ErrorCode512	536
ErrorCode1024	537
ErrorCode2048	538
ErrorCode4096	539
ErrorCode8192	540
InsideBox1	Not used
InsideBox2	Not used
InsideBox3	Not used

Output Signal	Controller Output Bit No
InsideBox4	Not used
InsideBox5	Not used
InsideBox6	Not used
InsideBox7	Not used
InsideBox8	Not used
InsideBox9	Not used
InsideBox10	Not used
InsideBox11	Not used
InsideBox12	Not used
InsideBox13	Not used
InsideBox14	Not used
InsideBox15	Not used
InsidePlane1	Not used
InsidePlane2	Not used
InsidePlane3	Not used
InsidePlane4	Not used
InsidePlane5	Not used
InsidePlane6	Not used
InsidePlane7	Not used
InsidePlane8	Not used
InsidePlane9	Not used
InsidePlane10	Not used
InsidePlane11	Not used
InsidePlane12	Not used
InsidePlane13	Not used
InsidePlane14	Not used
InsidePlane15	Not used

4. Troubleshooting

4.1 DeviceNet

Exclusion

Every system has its special environment, conditions, specifications, and usages. This guide is provided as a general reference for troubleshooting a DeviceNet network. Every effort has been made to ensure the information is accurate. However, we do not guarantee the complete accuracy of the information and thus we decline any liability for damages or costs incurred by the use of this troubleshooting.

Before examining a problem on the network, please ensure that your established DeviceNet system satisfies network specifications. (Refer to this troubleshooting and the section 2.2 *DeviceNet Network Construction*.)

Tools

Prepare the following tools for troubleshooting.

- Philips screwdriver
- Flat-blade screwdriver
- Tester



Using the Woodhead NetMeter (DeviceNet diagnostic tool) is a simple way to learn physical status of the DeviceNet network. For details of NetMeter, see Woodhead's Web site (<http://www.mysst.com/diagnostics/NetMeter.asp>).

4.1.1 Examining a Problem

4.1.1.1 Scanner Board Diagnostic LEDs

The DeviceNet board used with EPSON RC+ has two status display LEDs. The layout of the LEDs is shown in the following figure.

PCI-DVNIO

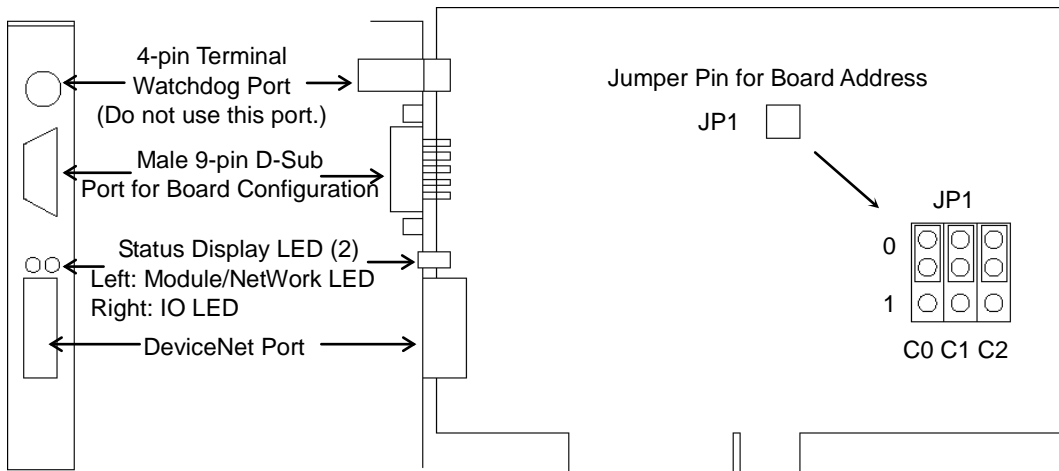

The Module/NetWork LED is on the left side and the IO LED is on the right side seen from the rear panel. These LED names are used in applicomIO Console application and

this manual. Only in this troubleshooting section, general names of the status display of the DeviceNet device are used.

The Module/NetWork LED is referred to as the Network Status (NS) in this section.

The IO LED is referred to as the Module Status LED (MS) in this section.

4.1.1.2 Check Network Status

(1) Master Status: MS/NS LEDs

LED	Color		Light Condition		
MS (Module Status)	<input type="checkbox"/> Green	<input type="checkbox"/> Red	<input type="checkbox"/> ON	<input type="checkbox"/> Blinking	<input type="checkbox"/> OFF
NS (Network Status)	<input type="checkbox"/> Green	<input type="checkbox"/> Red	<input type="checkbox"/> ON	<input type="checkbox"/> Blinking	<input type="checkbox"/> OFF

(2) Node Number of Absent Slaves

Absent slaves are disconnected from or not added to the network.

1. See the status flag regarding to the removal and addition if the master has status information.
2. See the MS/NE LEDs of all slaves if the master has no status information.

(3) Absent Slave Status: MS/NS LEDs

LED	Color		Light Condition		
MS (Module Status)	<input type="checkbox"/> Green	<input type="checkbox"/> Red	<input type="checkbox"/> ON	<input type="checkbox"/> Blinking	<input type="checkbox"/> OFF
NS (Network Status)	<input type="checkbox"/> Green	<input type="checkbox"/> Red	<input type="checkbox"/> ON	<input type="checkbox"/> Blinking	<input type="checkbox"/> OFF

(4) Physical Node Location of Absent Slave

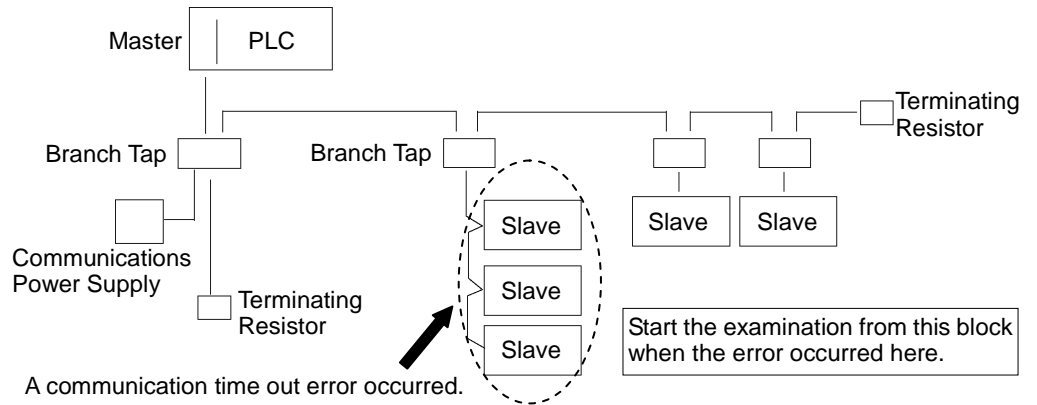

(5) Error Occurrence Condition

- Immediate occurrence (high reproducibility)
- Rare occurrence (low reproducibility)

4.1.2 Problems and Countermeasures

Master Unit LED		Error	Description [Reference]
MS	NS		
Green Light ON	Green Light ON	Normal communication	- Normal condition
Green Light ON	Green Light Blinking	During connection establishment	- Processing connection establishment (The NS LED will be ON in green in a few seconds.) - Master function in stop state (When communication does not start, master analysis with NetMeter is required.)
Green Light ON	Red Light Blinking	Communication error	[Refer to the section 4.1.2.1 Master: Communication Error.] - Slave disconnected from the network (Remote I/O communication error) - Slave not added to the network (Scan list collation error) - Communications power supply OFF (Error detection after the communication establishment)
Green Light ON	Red Light ON	Busoff detection Duplicate MAC ID	[Refer to the section 4.1.2.2 Master: Busoff Detection.] - Busoff detection: Communication stopped due to critical error. - Duplicate MAC ID: The MAC ID configuration was duplicated. (This error occurs only during unit start-up)
Green Light ON	Light OFF	Unestablished communication	[Refer to the section 4.1.2.3 Master: Unestablished Communication.] - No slave (Error detection before communication establishment) - Communications power supply OFF (Error detection before the communication establishment) - Duplicate MAC ID: The MAC ID configuration was duplicated.
Red Light Blinking	No Matter	Configuration error	- Master unit configuration error Refer to the respective device manuals. When EPSON RC+ was configured as a master: [Refer to the section 4.1.2.4 Master: Configuration Error.] - Slave disconnected from the network (Remote I/O communication error) - Slave not added to the network (Scan list collation error) - Duplicate MAC ID: The MAC ID configuration was duplicated.
Red Light ON	No Matter	Module error	- Broken master unit → Unit Replacement
Light OFF	Green Light Blinking	Absent slave	[Refer to the section 4.1.2.5 Absent Slave.] - No slave (Error detection before communication establishment) - Communications power supply OFF
Light OFF	Light OFF	Uninitialized network Absent slave	[Refer to the section 4.1.2.6 Uninitialized Network.] - Master unit start-up error - No slave (Error detection before communication establishment) - Communications power supply OFF

◆ Process Flowchart

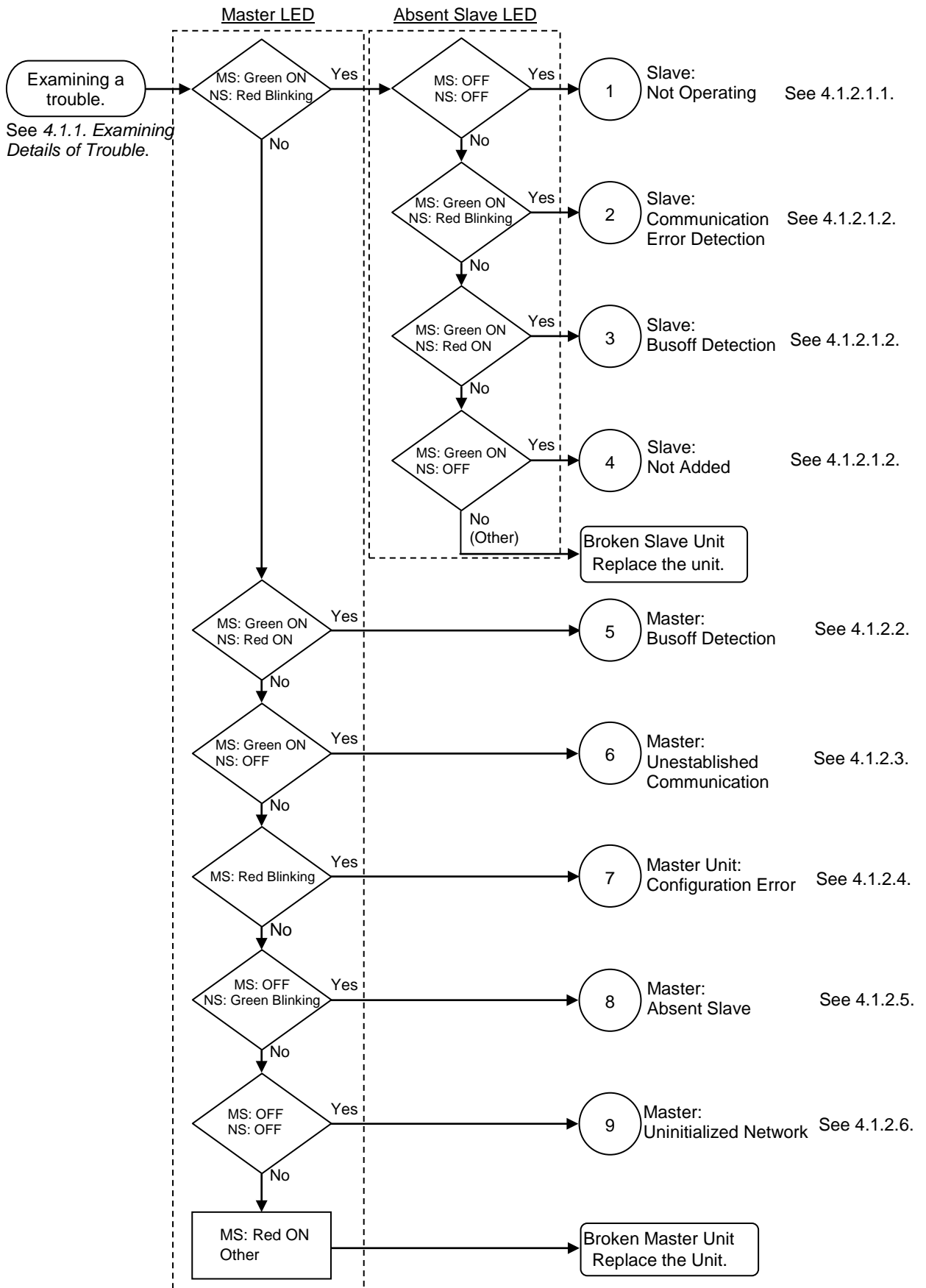

4.1.2.1 Master: Communication Error

Master Unit LED		Error	Description
MS	NS		
Green Light ON	Red Light Blinking	Communication error	- Slave disconnected from the network (Remote I/O communication error) - Slave not added to the network (Scan list collation error) - Communications power supply OFF (Error detection after the communication establishment)

Slave: Not Operating

	MS	NS
Master LED Condition	Green Light ON	Red Light Blinking
Absent Slave LED Condition	Light OFF	Light OFF

◆ Process Flowchart

Check

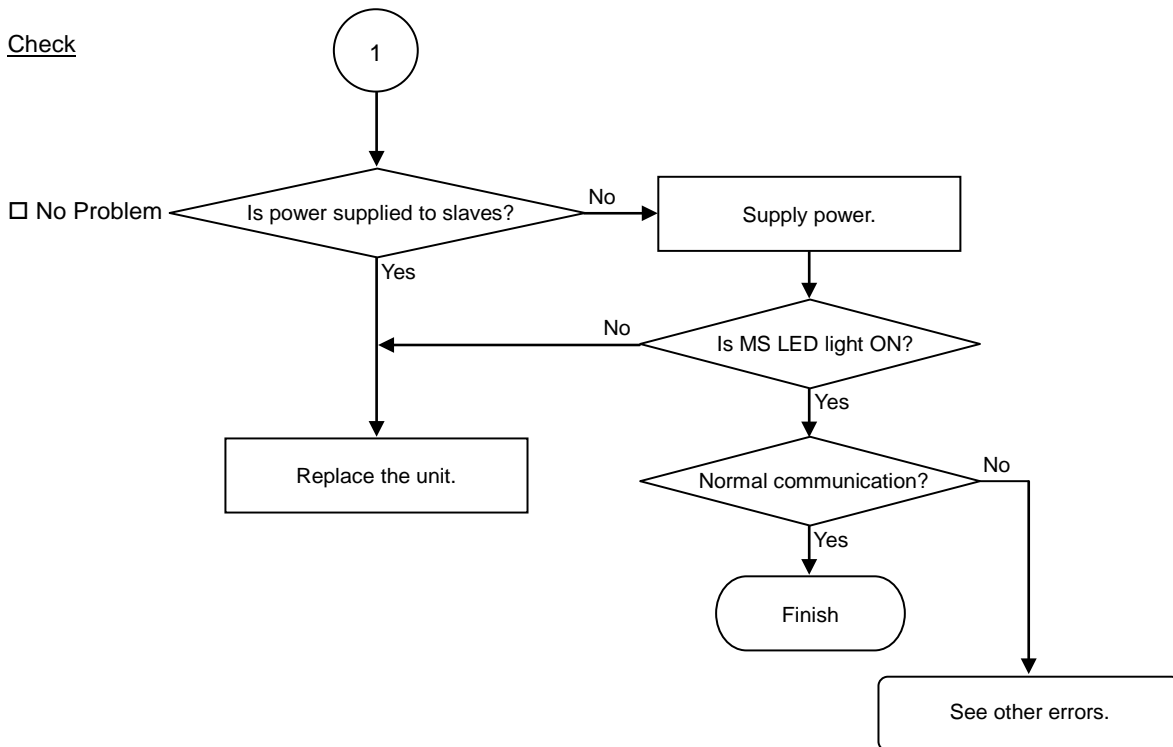

◆ Causes of Error

Possible Cause	Examination Method	Countermeasure
○ Slave power OFF	Measure the power voltage of the slaves. (It should be within the range of sufficient voltage for the slave operation.) NOTE: For slaves operating with communications power supply, measure voltage at the DeviceNet connector.	Supply power to the slave.
○ Broken unit	Slave unit replacement	Replace the broken slave unit with a new one.

Slave: Communication Error Detection / Busoff Detection / Not-added

	MS	NS
Master LED Condition	Green Light ON	Red Light Blinking
(1) Absent Slave LED Condition (Communication error detection)	Green Light ON	Red Light Blinking
(2) Absent Slave LED Condition (Busoff detection)	Green Light ON	Red Light ON
(3) Absent Slave LED Condition (Slave not added to the network)	Green Light ON	Light OFF

4. Troubleshooting (DeviceNet)

◆ Process Flowchart

Check

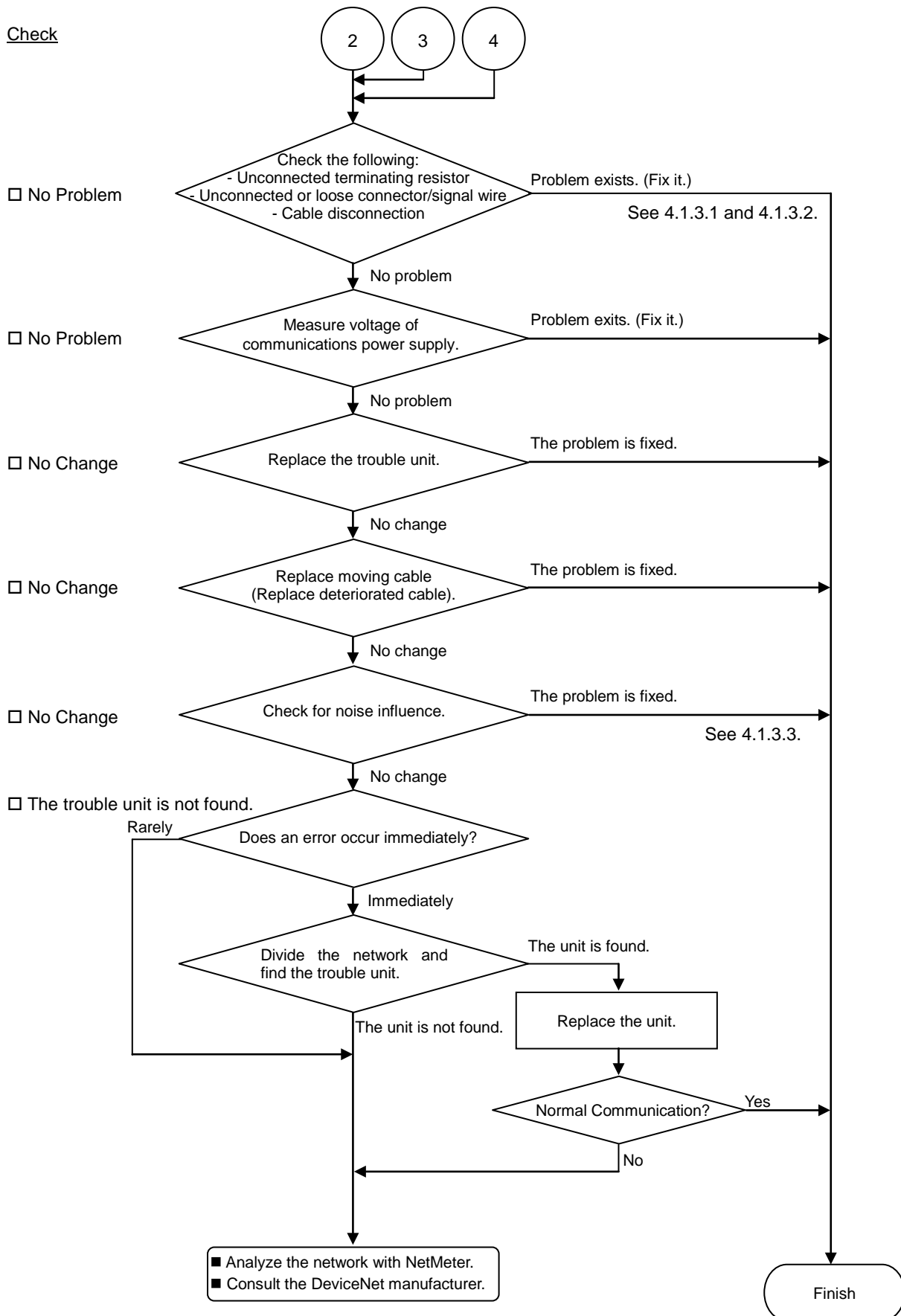

◆ Causes of Error		
Possible Cause	Examination Method	Countermeasure
<ul style="list-style-type: none"> ○ Disconnected terminating resistors ○ Cable disconnection ○ Disconnected connector ○ Disconnected signal wire 	<p>(1) Check that terminating resistors are connected to both ends of the network.</p> <p>(2) Measure resistance between signal wires with communications power supply OFF. → Normal: 50 to 70 Ω</p> <ul style="list-style-type: none"> ● Measuring point: Connection of the trouble unit ● For details, refer to the section <i>4.1.3.1 Connection Problem</i>. 	<p>Fix the problem.</p> <p>How to find the trouble point: Remove the terminating resistor on one end of the network. The trouble point is where resistance changes from 120 Ω.</p>
<ul style="list-style-type: none"> ○ Loose connector ○ Loose signal wire 	<p>Check for the connection of connectors and signal wires. → The connectors and signal wires should be firmly connected.</p> <ul style="list-style-type: none"> ● Checkpoint: all nodes and all branch taps ● For details, refer to the section <i>4.1.3.2 Loose Connector and Signal Wire</i>. 	<p>Connect the connectors and signal wires again.</p>
<ul style="list-style-type: none"> ○ Voltage drop of communications power supply 	<p>Measure voltage of communications power supply at the unit with a trouble. → Normal: 11V or more between V+ and V-</p> <ul style="list-style-type: none"> ● If the voltage is 11 to 14 V, the unit is a possible cause. Fix the problem on the unit. 	<p>Check the voltage of the power supply. Calculate the current capacity of the cable and add more communications power supplies.</p>
<ul style="list-style-type: none"> ○ Noise (external cause) 	<p>Check the noise intrusion via the following paths (1) to (3).</p> <p>(1) Noise via DRAIN (FG) (2) Induced noise via communication cable (3) Communications power supply</p> <p>→ For details, refer to the section <i>4.1.3.3 Noise Intrusion</i>.</p>	<p>Take countermeasures against noise.</p>
<ul style="list-style-type: none"> ○ Broken unit 	<p>Replace the broken unit with a new one. → Verify whether the problem is fixed.</p>	<p>Replace the unit with a new one.</p>
<ul style="list-style-type: none"> ● No cause is identified. 	<p>Identify the trouble point by dividing the network. → For details, refer to the section <i>4.1.3.4 Broken Unit Examination</i>.</p>	

4.1.2.2 Master: Busoff Detection

Master Unit LED		Error	Description
MS	NS		
Green Light ON	Red Light ON	Busoff detection	Communication stopped due to critical error.
		Duplicate MAC ID	The MAC ID configuration was duplicated. (This error occurs only during unit start-up)

◆ Process Flowchart

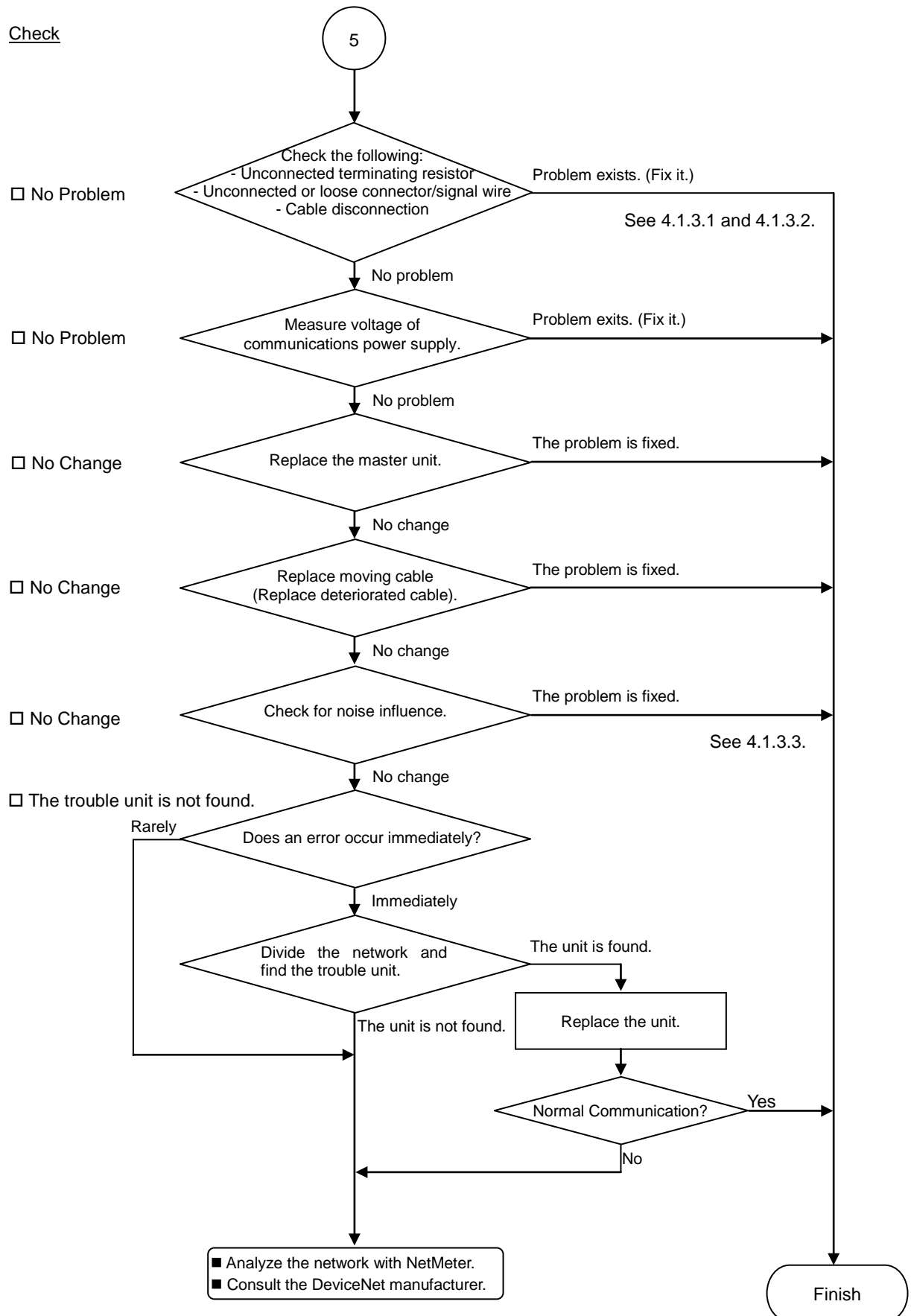

◆ Causes of Error		
Possible Cause	Examination Method	Countermeasure
<ul style="list-style-type: none"> ○ Disconnected terminating resistors ○ Cable disconnection ○ Disconnected connector ○ Disconnected signal wire 	<p>(1) Check that terminating resistors are connected to both ends of the network.</p> <p>(2) Measure resistance between signal wires with communications power supply OFF.</p> <p>→ Normal: 50 to 70 Ω</p> <ul style="list-style-type: none"> ● Measuring point: Connection of the problem unit ● For details, refer to the section <i>4.1.3.1 Connection Problem.</i> 	<p>Fix the problem.</p> <p>How to find the trouble point: Remove the terminating resistor on one end of the network. The trouble point is where resistance changes from 120 Ω.</p>
<ul style="list-style-type: none"> ○ Loose connector ○ Loose signal wire 	<p>Check for the connection of connectors and signal wires.</p> <p>→ The connectors and signal wires should be firmly connected.</p> <ul style="list-style-type: none"> ● Checkpoint: all nodes and all branch taps ● For details, refer to the section <i>4.1.3.2 Loose Connector and Signal Wire.</i> 	<p>Connect the connectors and signal wires again.</p>
<ul style="list-style-type: none"> ○ Voltage drop of communications power supply 	<p>Measure voltage of communications power supply at the trouble unit.</p> <p>→ Normal: 11V or more between V+ and V-</p> <ul style="list-style-type: none"> ● If the voltage is 11 to 14 V, the unit is a possible cause. Fix the problem on the unit. 	<p>Check the voltage of the power supply. Calculate the current capacity of the cable and add more communications power supplies.</p>
<ul style="list-style-type: none"> ○ Noise (external cause) 	<p>Check the noise intrusion via the following paths (1) to (3).</p> <p>(1) Noise via DRAIN (FG)</p> <p>(2) Induced noise via communication cable</p> <p>(3) Communications power supply</p> <p>→ For details, refer to the section <i>4.1.3.3 Noise Intrusion.</i></p>	<p>Take countermeasures against noise.</p>
<ul style="list-style-type: none"> ○ Broken unit 	<p>Replace the broken unit with a new one.</p> <p>→ Verify whether the problem is fixed.</p>	<p>Replace the unit with a new one.</p>
<ul style="list-style-type: none"> ● No cause is identified. 	<p>Identify the trouble point by dividing the network.</p> <p>→ For details, refer to the section <i>4.1.3.4 Broken Unit Examination.</i></p>	

4.1.2.3 Master: Unestablished Communication

Master Unit LED		Error	Description
MS	NS		
Green Light ON	Light OFF	Master Unestablished communication	Communications power supply OFF No slave

◆ Process Flowchart

Check

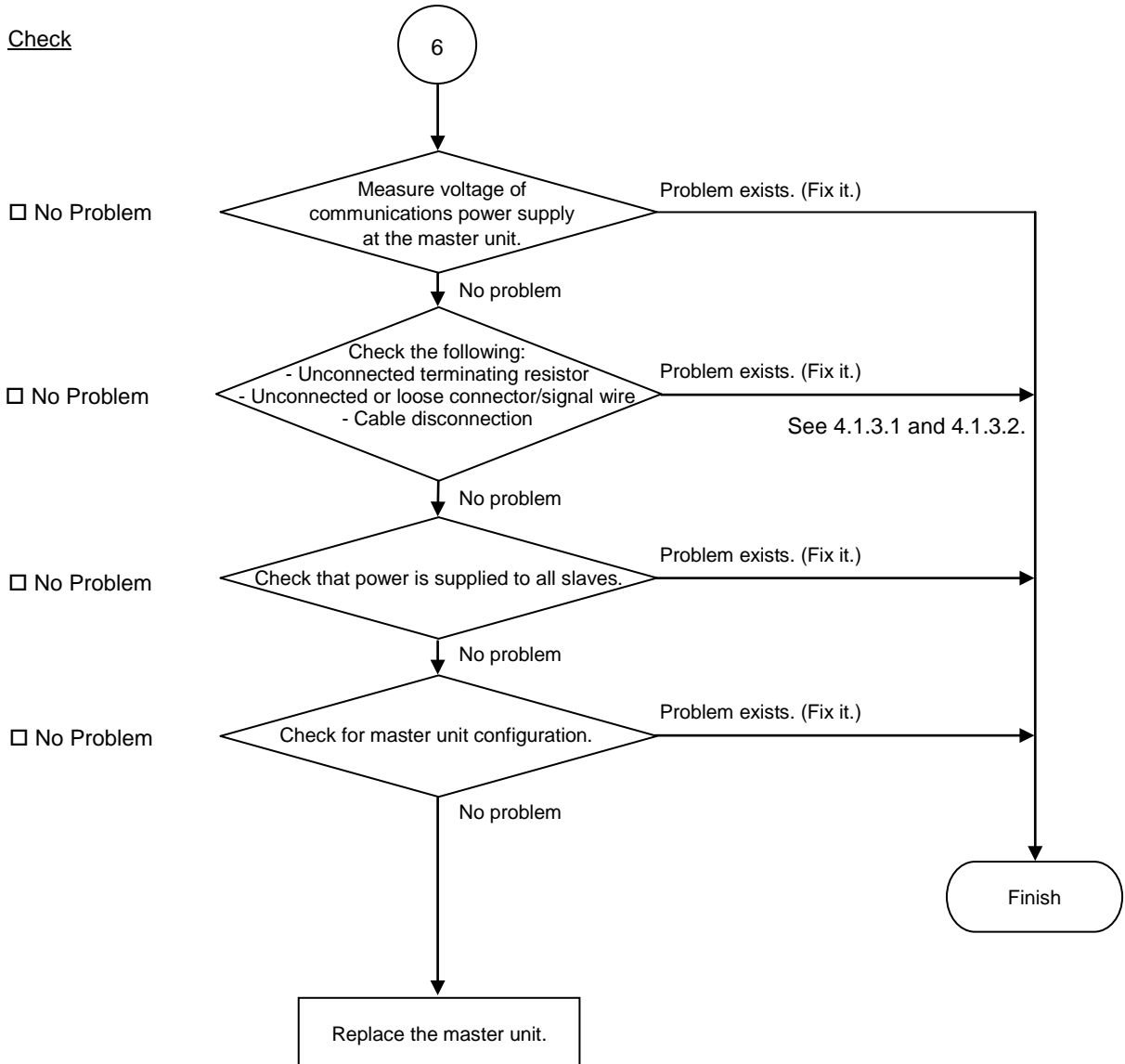

◆ Causes of Error

Possible Cause	Examination Method	Countermeasure
○ Voltage drop of communications power supply	Measure voltage of communications power supply at the master unit. → Normal: 11V or more between V+ and V- ● If the voltage is 11 to 14 V, the master unit is a possible cause. Fix the problem on it.	Check voltage of the power supply.
○ Disconnected terminating resistors ○ Cable disconnection ○ Disconnected connector ○ Disconnected signal wire	(1) Check that terminating resistors are connected to both ends of the network. (2) Measure resistance between signal wires with communications power supply OFF. → Normal: 50 to 70Ω ● Measuring point: Connection of the master ● For details, refer to the section <i>4.1.3.1 Connection Problem</i> .	Fix the problem. How to find the trouble point: Remove the terminating resistor on one end of the network. The trouble point is where resistance changes from 120 Ω.
○ Loose connector ○ Loose signal wire	Check for the connection of connectors and signal wires. → The connectors and signal wires should be firmly connected. ● Checkpoint: Between the master and its slaves ● For details, refer to the section <i>4.1.3.2 Loose Connector and Signal Wire</i> .	Connect the connectors and signal wires again.
○ All slaves power OFF	Measure the power voltage of the slaves. (It should be within the range of sufficient voltage for slave operation.)	Supply power to the slaves.
○ Master unit configuration	(1) Start applicomIO Console application and check that the configuration has no difference with the network condition. (2) Check that the configuration data were written in flash. ● For details, refer to the section <i>4.1.3.6 EPSON RC+ Master Configuration</i> .	Change the configuration.

4.1.2.4 Master: Configuration Error

Master Unit LED		Error	Description
MS	NS		
Red Light Blinking	No Matter	Configuration error Slave error detection	- Slave disconnected from the network (Remote I/O communication error) - Slave not added to the network (Scan list collation error) - Duplicate MAC ID: The MAC ID configuration was duplicated.

4. Troubleshooting (DeviceNet)

◆ Process Flowchart

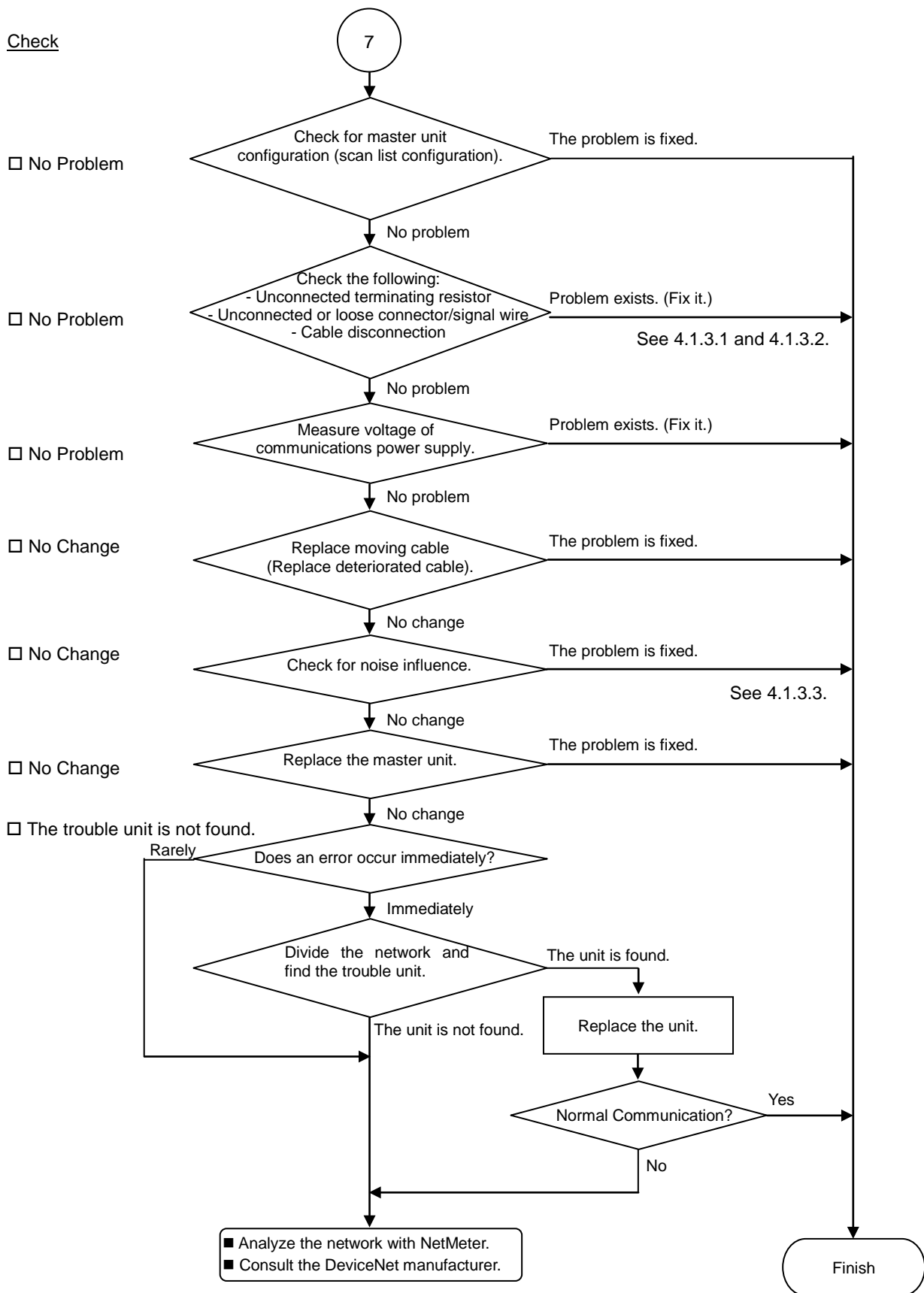

◆ Causes of Error

Possible Cause	Examination Method	Countermeasure
○ Master unit configuration	<p>(1) Start applicomIO Console application and check that the configuration has no difference with the network condition.</p> <p>(2) Check that the configuration data were written in flash.</p> <p>(3) Check that the network load is within allowable range.</p> <p>● For details, refer to the section <i>4.1.3.6 EPSON RC+ Master Configuration</i>.</p>	Change the configuration.
○ Disconnected terminating resistors ○ Cable disconnection ○ Disconnected connector ○ Disconnected signal wire	<p>(1) Check that terminating resistors are connected to both ends of the network.</p> <p>(2) Measure resistance between signal wires with communications power supply OFF. → Normal: 50 to 70Ω</p> <p>● Measuring point: Connection of the trouble unit</p> <p>● For details, refer to the section <i>4.1.3.1 Connection Problem</i>.</p>	<p>Fix the problem.</p> <p>How to find the trouble point: Remove the terminating resistor on one end of the network. The trouble point is where resistance changes from 120 Ω.</p>
○ Loose connector ○ Loose signal wire	<p>Check for the connection of connectors and signal wires. → The connectors and signal wires should be firmly connected.</p> <p>● Checkpoint: all nodes and all branch taps</p> <p>● For details, refer to the section <i>4.1.3.2 Loose Connector and Signal Wire</i>.</p>	Connect the connectors and signal wires again.
○ Voltage drop of communications power supply	<p>Measure voltage of communications power supply at the unit with a trouble. → Normal: 11V or more between V+ and V-</p> <p>● If the voltage is 11 to 14 V, the unit is a possible cause. Fix the problem on the unit.</p>	<p>Check the voltage of the power supply.</p> <p>Calculate the current capacity of the cable and add more communications power supplies.</p>
○ Noise (external cause)	<p>Check the noise intrusion via the following paths (1) to (3).</p> <p>(1) Noise via DRAIN (FG)</p> <p>(2) Induced noise via communication cable</p> <p>(3) Communications power supply → For details, refer to the section <i>4.1.3.3 Noise Intrusion</i>.</p>	Take countermeasures against noise.
○ Broken unit	<p>Replace the broken unit with a new one. → Verify whether the problem is fixed.</p>	Replace the unit with a new one.
● No cause is identified.	<p>Identify the trouble point by dividing the network. → For details, refer to the section <i>4.1.3.4 Broken Unit Examination</i>.</p>	

4.1.2.5 Absent Slave

Master Unit LED		Error	Description
MS	NS		
Light OFF	Green Light Blinking	Absent slave	- No slave (Error detection before communication establishment) - Communications power supply OFF

◆ Process Flowchart

Check

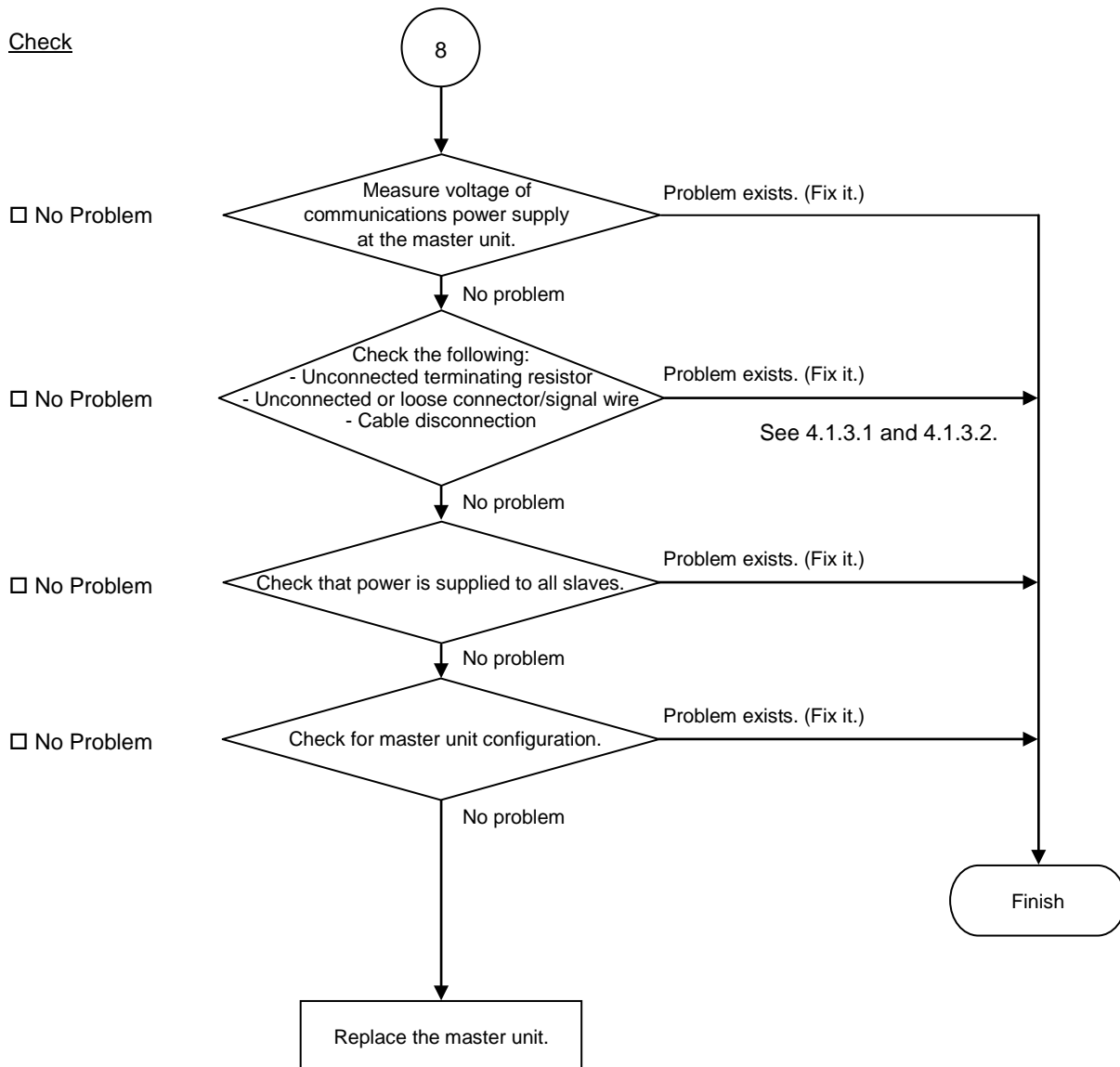

◆ Causes of Error

Possible Cause	Examination Method	Countermeasure
○ Voltage drop of communications power supply	Measure voltage of communications power supply at the master unit. → Normal: 11V or more between V+ and V- ● If the voltage is 11 to 14 V, the unit is a possible cause. Fix the problem on the unit.	Check voltage of the power supply.
○ Disconnected terminating resistors ○ Cable disconnection ○ Disconnected connector ○ Disconnected signal wire	(1) Check that terminating resistors are connected to both ends of the network. (2) Measure resistance between signal wires with communications power supply OFF. → Normal: 50 to 70 Ω ● Measuring point: Connection of the master ● For details, refer to the section <i>4.1.3.1 Connection Problem</i> .	Fix the problem. How to find the trouble point: Remove the terminating resistor on one end of the network. The trouble point is where resistance changes from 120 Ω.
○ Loose connector ○ Loose signal wire	Check for the connection of connectors and signal wires. → The connectors and signal wires should be firmly connected. ● Checkpoint: Between the master and its slaves ● For details, refer to the section <i>4.1.3.2 Loose Connector and Signal Wire</i> .	Connect the connectors and signal wires again.
○ All slaves power OFF	Measure the power voltage of the slaves. (It should be within the range of sufficient voltage for the slave operation.)	Supply power to the slaves.
○ Master unit configuration	(1) Start applicomIO Console application and check that the configuration has no difference with the network condition. (2) Check that the configuration data were written in flash. ● For details, refer to the section <i>4.1.3.6 EPSON RC+ Master Configuration</i> .	Change the configuration.

4.1.2.6 Uninitialized Network

Master Unit LED		Error	Description
MS	NS		
Light OFF	Light OFF	Uninitialized network Absent slave	- Master unit start-up error - No slave (Error detection before communication establishment) - Communications power supply OFF

◆ Process Flowchart

Check

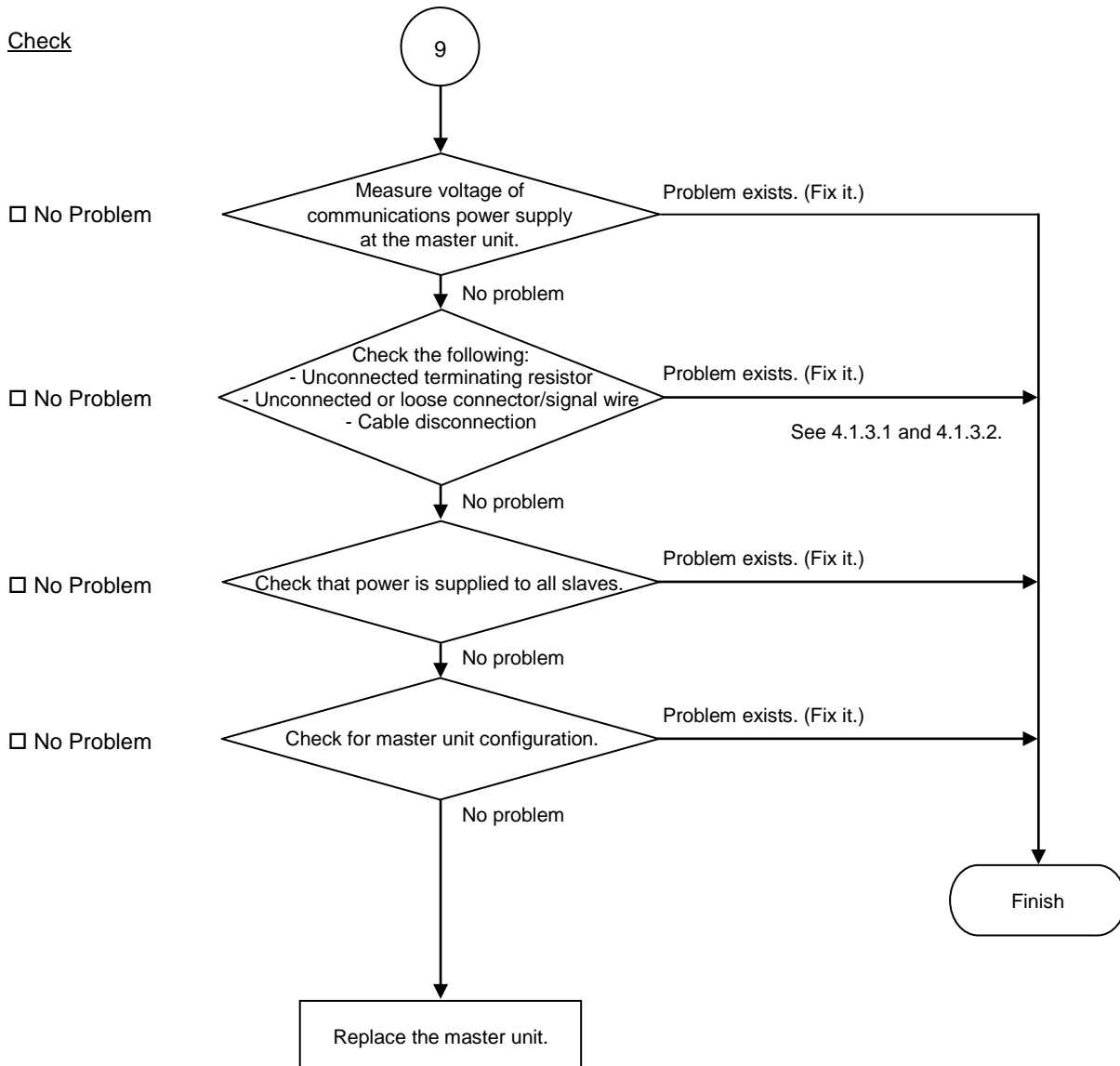

◆ Causes of Error		
Possible Cause	Examination Method	Countermeasure
○ Voltage drop of communications power supply	Measure voltage of communications power supply at the master unit. → Normal: 11V or more between V+ and V- ● If the voltage is 11 to 14 V, the master unit is a possible cause. Fix the problem on it.	Check voltage of the power supply.
○ Disconnected terminating resistors ○ Cable disconnection ○ Disconnected connector ○ Disconnected signal wire	(1) Check that terminating resistors are connected to both ends of the network. (2) Measure resistance between signal wires with communications power supply OFF. → Normal: 50 to 70 Ω ● Measuring point: Connection of the master ● For details, refer to the section <i>4.1.3.1 Connection Problem</i> .	Fix the problem. How to find the trouble point: Remove the terminating resistor on one end of the network. The trouble point is where resistance changes from 120 Ω.
○ Loose connector ○ Loose signal wire	Check for the connection of connectors and signal wires. → The connectors and signal wires should be firmly connected. ● Checkpoint: Between the master and its slaves ● For details, refer to the section <i>4.1.3.2 Loose Connector and Signal Wire</i> .	Connect the connectors and signal wires again.
○ All slaves power OFF	Measure the power voltage of the slaves. (It should be within the range of sufficient voltage for slave operation.)	Supply power to the slaves.
○ Master unit configuration	(1) Start applicomIO Console application and check that the configuration has no difference with the network condition. (2) Check that the configuration data were written in flash. ● For details, refer to the section <i>4.1.3.6 EPSON RC+ Master Configuration</i> .	Change the configuration.

4.1.3 Procedures for Examining Possible Causes

4.1.3.1 Connection Problem (Disconnected Terminating Resistors, Cable Disconnection, Disconnected Connector, and Disconnected Signal Wire)

- (1) Ensure that two terminating resistors are connected to both ends of the network.
- (2) Turn OFF the communications power supply.
- (3) Measure resistance between CAN_H and CAN_L wires of the absent slave using the tester.

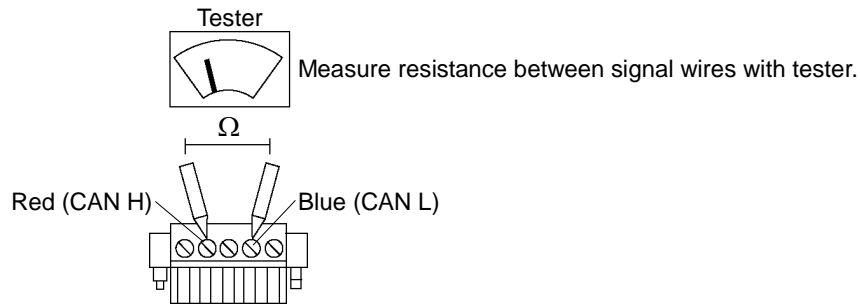

Resistance	Determination
0 Ω	Short circuit
Under 50 Ω	Three or more terminating resistors on one network
50 to 70 Ω	Normal
70 to 120 Ω	Error (cable disconnection or disconnected signal wire on the trunk line)
Over 120 Ω	Error (cable disconnection or disconnected signal wire on drop line or trunk line → Both CAN_H and CAN_L)

- (4) How to find the trouble point:
 - Remove the terminating resistor on one end of the network.
(The resistance at the point where the terminating resistor is connected is 120 Ω .)
 - Measure resistance at branch taps of all units.
 - The trouble point is where resistance changes from 120 Ω .
 - After finding the trouble point, verify the connector and cable conditions.

◆ Process Flowchart

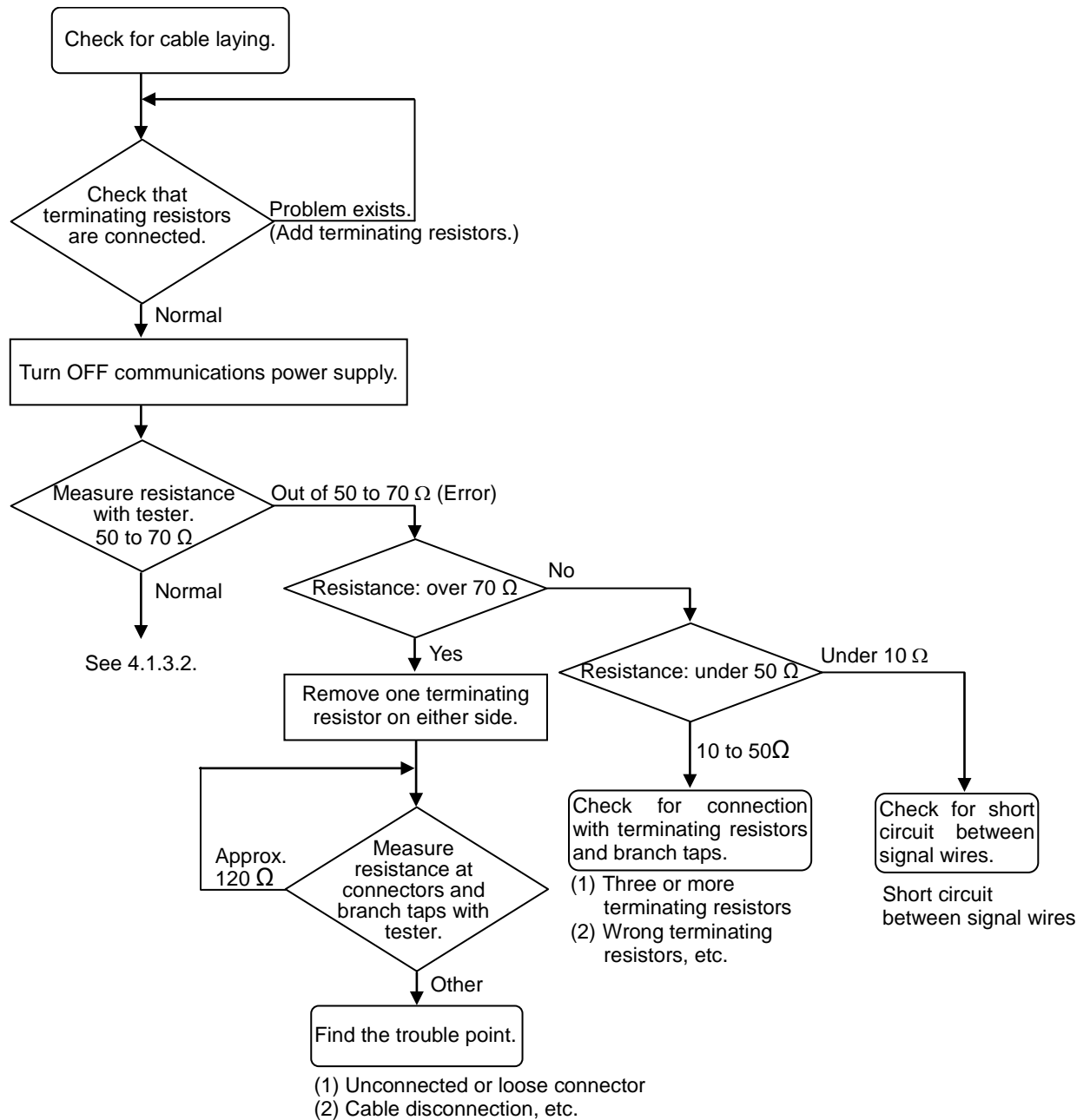

4.1.3.2 Loose Connector and Signal Wire

Check for the connections of the following parts on the connector and cable.

(1) Crimping Terminal

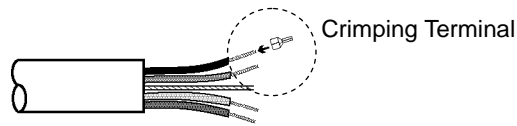

(2) Connection of the connector and the signal wire

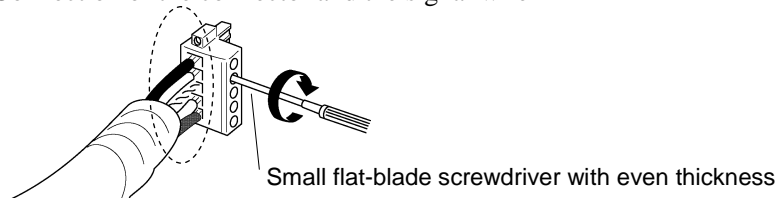

(3) Connection of the connector and the unit (T-branch tap)

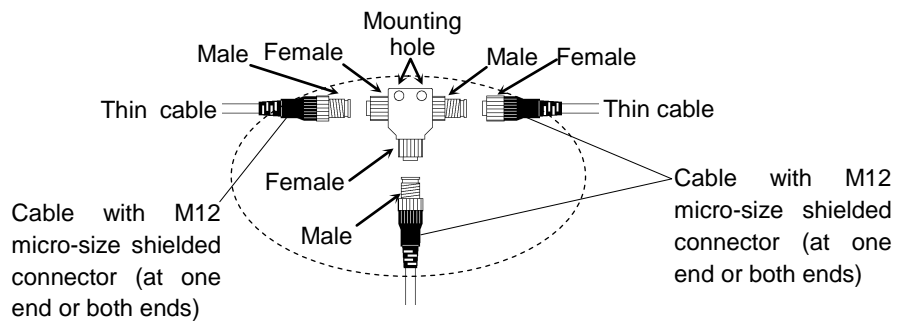
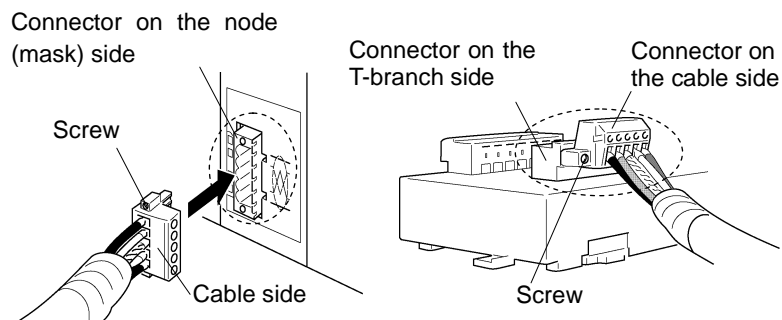

4.1.3.3 Noise Intrusion

Verify how an error occurrence condition changes while taking the following countermeasures.

◆ Ground of FG (DRAIN) wire

Normal Grounding: Ground the DeviceNet network at only one point.

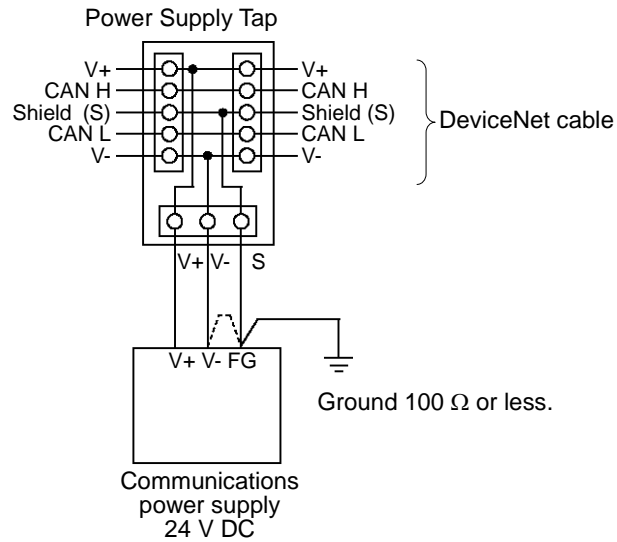

Countermeasure 1: Disconnect the wire between V- and FG.

Disconnect the wire between V- and FG when you cannot ground the FG wire.

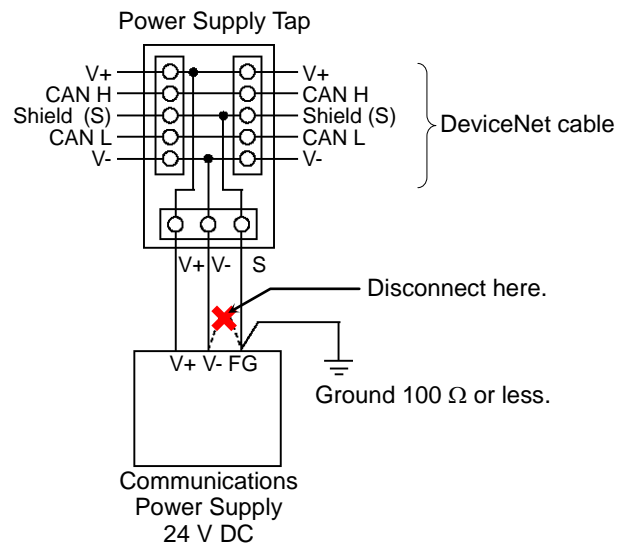

Countermeasure 2: Disconnect the shield wire to isolate it from the ground.

When noise intrudes the ground line due to a noise source such as an inverter installed near the communications power supply, disconnect the shield wire of the communication cable and isolate it from the ground to restrain noise intrusion.

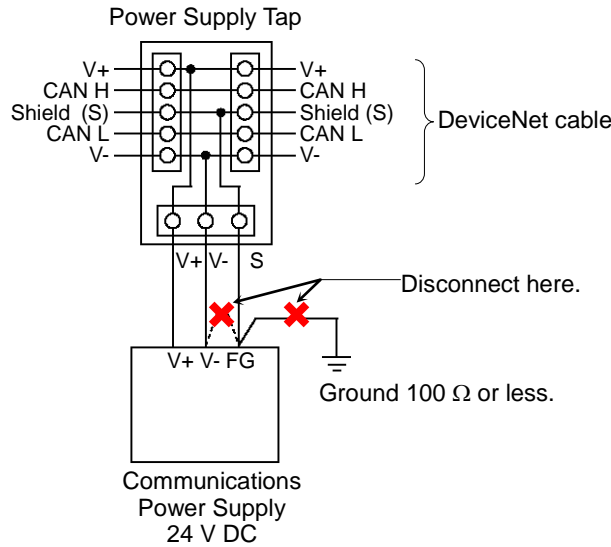

◆ Induced noise via communication cable

Separate the DeviceNet signal wire from the other wires (especially power wires).

* Separate the signal wire from the power wires 300 mm or more.

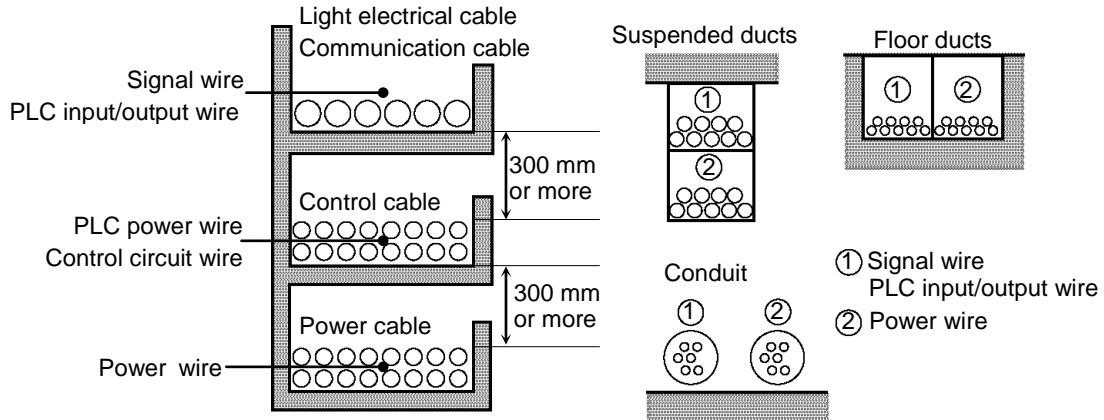

During site inspection, bypass the wire that is possibly affected by induced noise with other cables and then lay the cables. Establish the communication under no induced noise condition and verify whether an error occurs.

◆ Communications Power Supply

When sharing the communications power supply with I/O devices, provide power sources separately.

Separating power source prevents noise caused by I/O device operations from affecting communication.

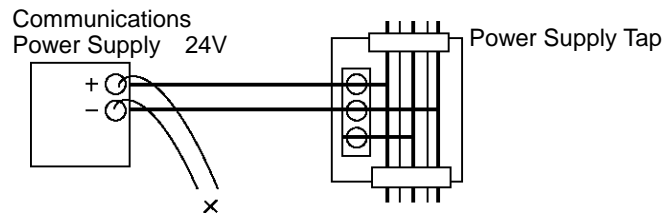

Disconnect I/O devices from the communications power supply.

4.1.3.4 Broken Unit Examination (Dividing Network Examination)

When you cannot quickly find the trouble point due to a broken unit, connection failure including loose connector, or cable partial disconnection, divide the network to find the trouble point. Verify how error occurrence conditions change while taking the following countermeasures.

How to Examine

Divide the network to find which node is the cause of the problem.

Verify that a master can establish communications with the slaves even though one slave is separated from the network.

After finding the problem node, check the cables connected to it and replace the unit.

How to Divide

To divide the network, follow either procedure described below depending on the cable layout.

(1) Separating each block from the network

Divide the network by block and check each block.

1. Ensure that the master has no problem by connecting it to its slaves one by one.
(MS/NS: green light ON)
2. Divide the network in the middle of it and check for the communication condition.
(MS/NS: green light ON)
Normal: The trouble point is on the other half of the network.
Error: The trouble point is on the current half of the network.
(Continue dividing the network further to distinguish error part from normal part.)
3. Check for communication on the block to specify the trouble point.

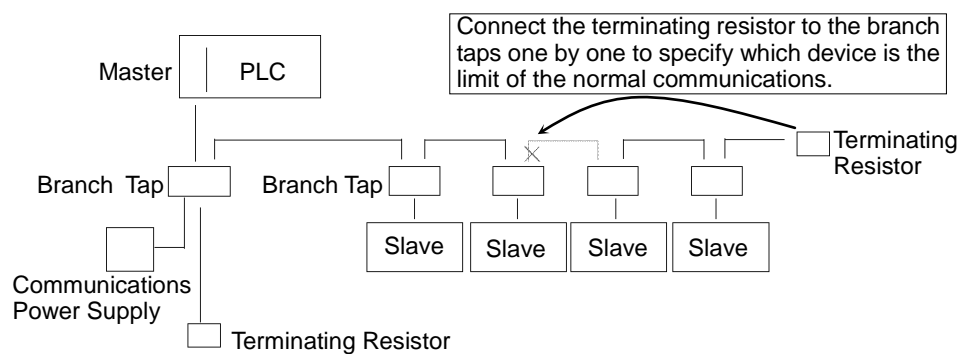

- (2) Separate each slave from the network
 Check for each slave. The trouble point is where error condition changes into normal condition.

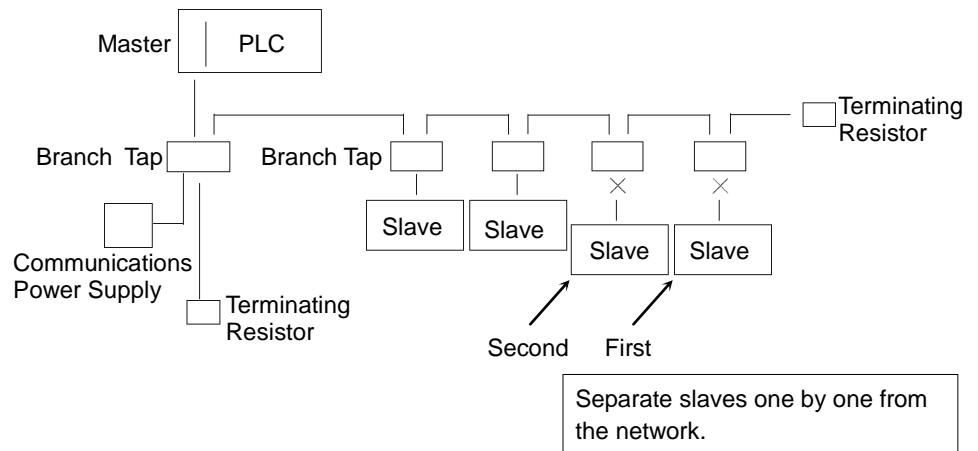

4.1.3.5 Network Configuration and Specifications

- (1) Maximum Network Length and Drop Line Length
 Check that the cables used on the network meet the following specifications.

Type	Baud Rate	Max. Network Length	Drop Line Length	Total Drop Line Length
Thick Cable	500 kbps	100 m	6 m	39 m
	250 kbps	250 m		78 m
	125 kbps	500 m		156 m
Thin Cable	500 kbps	100 m		39 m
	250 kbps	100 m		78 m
	125 kbps	100 m		156 m

- (2) Terminating Resistor
 Ensure that two terminating resistors are connected to both ends of the network (trunk line). The terminating resistor should be 121 Ω 1/4 W.
- (3) Cable and Branch Tap
 The cables and branch taps should meet the DeviceNet specifications.
- (4) Communications Power Supply
 The communications power supply should be dedicated to DeviceNet.
 Do not share the communications power supply with I/O devices. *
 * Noise due to load on/off may affect DeviceNet communications via the communications power supply.
 (The noise causes remote I/O communication error, Busoff detection, and broken unit.)

4.1.3.6 EPSON RC+ Master Configuration

For details of EPSON RC+ master configuration, refer to the section 2.5 *DeviceNet Board Installation*.

The following section describes the procedure for verifying the scanner board condition with applicomIO Console application.

Verifying applicomIO Console application condition

The status bar at the bottom of the window shows the applicomIO Console application status. The status bar varies as shown below:

Character : The address number of the scanner board is indicated with characters. When the character “F” appears, the flash memory on the board initialized the scanner board.

Background color : The background color indicates the scanner board status. For details, refer to the table below.

Background	Character	Status
Gray	Black	Access to scanner board was failed. After that, the status bar will not be renewed automatically. To renew the status bar, right-click the status bar and select Refresh .
Magenta	Black	The scanner board was initialized with an earlier version applicomIO Console application. It is recommended that the scanner board be written into the flash memory (reinitializing the scanner board) again with the current version applicomIO Console application.
Red	Black	The scanner board was not initialized. Initialize the scanner board to use it.
Yellow	Black	The scanner board was partially initialized. This status happens only during network detection and on-line actions.
Dark green	White	Although the scanner board was initialized, it is different than the currently opened configuration. (Different version, etc.) It is recommended that the scanner board be written into the flash memory (reinitializing the scanner board) again with the current version applicomIO Console application. This status happens only during network detection, on-line actions, and diagnostic.
Green	Black	The scanner board was initialized properly and it is no different with the currently opened configuration. This status happens only during network detection, on-line actions, and diagnostics.

Verifying the DeviceNet network condition

The applicomIO Console application has a network diagnostic function (Diagnostic). The procedure for using the Diagnostic is described below.

- (1) Open the Diagnostic window, click the magnifying glass icon, and select the “Channel” on the device tree in the left side of the window.

The window changes as shown below.

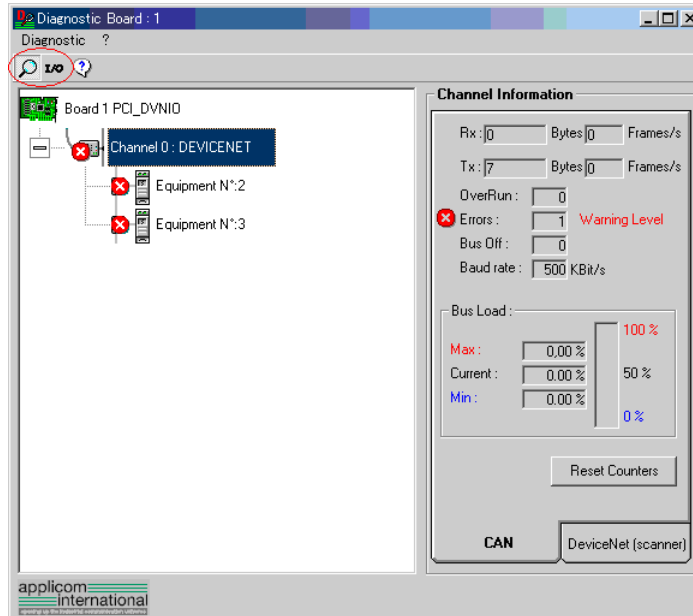

The **CAN** and **DeviceNet (scanner)** tabs appear on the data display in the right side of the window.

The CAN controller status of the scanner board is displayed on the **CAN** tab.

Rx : Number of receive data bytes and flames

Tx : Number of send data bytes and flames

OverRun : Number of communication overrun errors detected by CAN controller

Errors : Number of communication errors detected by CAN controller

Bus Off : Number of Busoff detections

Baud Rate : Baud rate

Bus Load : Load on the bus (maximum, minimum, current)

NOTE



Use DeviceNet so that the load on a bus is under 60% of the maximum load. When the load exceeds 60%, the DeviceNet network communication will be unstable. (For example, more communication errors)

For the procedure for master configuration, refer to respective master device manuals. For EPSON RC+ master configuration, refer to the section 2.5.5 *Master Mode*.

(2) Select the [DeviceNet (Scanner)] tab. The window changes as shown below.

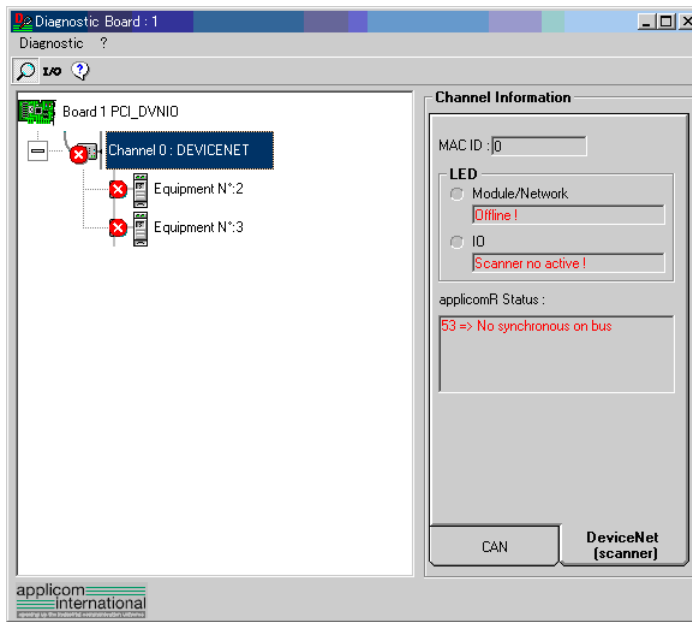

- MAC ID : MAC ID specified for the scanner board
- Module/NetWork LED : Network Status (NS) LED status
- IO LED : Module Status (MS) LED status
- applicomR Status : Scanner board status

The scanner board status is shown in the “Code No. => Comment” form. The table below shows the code numbers.

Status Code		Descriptions
General	Protocol	
0		No fault detected. The function was performed correctly.
	4	Inaccessible data. Additional information: The remote device is in error. Check its status.
32		The parameters passed to the functions are not correct (eg: Number of requested variables too large)
	33	Response time-out error. Additional information: The device does not respond. Check the device status and the wiring. The DeviceNet master has no device to be scanned in the configuration.
	34	Physical defect on the line. Additional information: No +24V power supply was detected. The CAN component of the applicomIO® interface is "Bus Off". Check the network wiring and Baud Rate.
36		Device not configured. Define the device configuration with the applicomIO® Console and re-initiate the initialization of the applicomIO® product by running the PcInitIO

Status Code		Descriptions
General	Protocol	
45		Non-resident dialogue software. Additional information: Initialize the applicomIO® interface before use by running the PcInitIO
47		Targeted applicomIO® card invalid or incorrectly initialized by the function IO_Init
	53	Synchronization problem on the line. Additional information: The DeviceNet master is “off line” (power supply not detected or the CAN component of the applicomIO® is “Bus Off”) Check the network wiring and Baud Rate.
	55	Response time-out exceeded. Additional information: The device accepted the connection but did not respond the request. Check the device status.
	65	Connection denied. Additional information: Connection to the DeviceNet master is in progress or refused by the device.
	70	Connection finished. Additional information: Duplication of MAC ID detected on the DeviceNet network. Modify the MAC ID of the DeviceNet master.
	79	Profile incompatible. Additional information: The device does not match the configuration. Check the device identity and the connection sizes.
63		Indicates that a communication error has been encountered on serial Port.
66		Not enough applicomIO® interface memory.
93		Driver cannot be accessed.
99		Indicates that applicomIO® solution is already running.
255		Indicates that the local input buffer was not updated beforehand by the function IO_RefreshInput.

- (3) When you click <I/O> icon on the upper left of the window, the window changes as shown below.

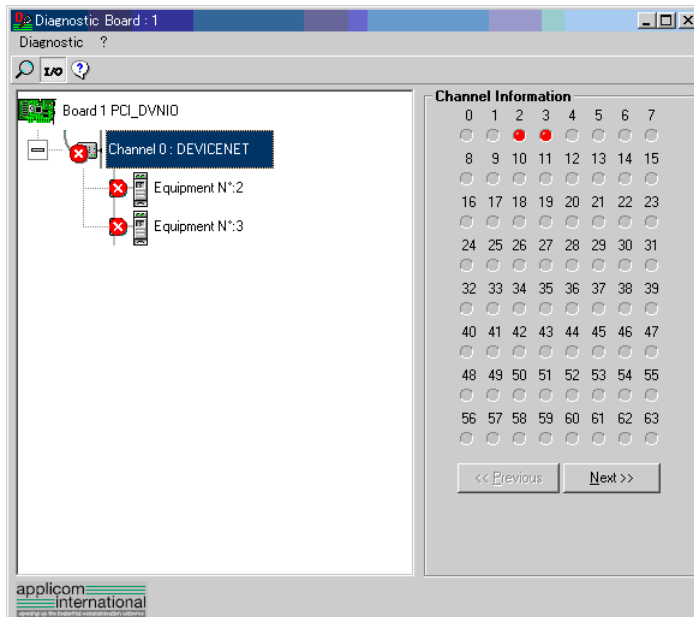

Each slave device status is shown in the right side of the window.

A green circle indicates that the communication of the corresponding device is normal, and a red circle indicates that there is a communication error.

A grey circle indicates that the corresponding device does not exist.

- (4) When you select “Equipment” on the device tree in the left side of the window, the window changes as shown below.

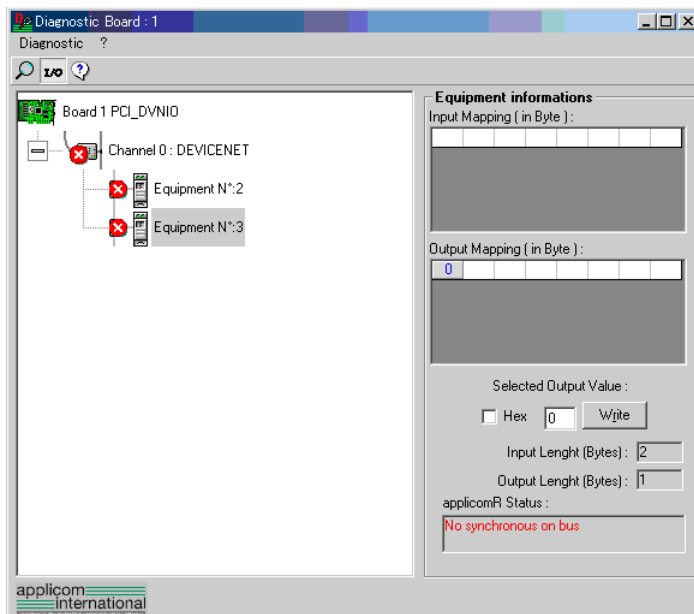

The input and output statuses of the selected device are shown in the right side of the window.

If you want to change output data, click the byte number you want to change in [Output Mapping]. Then, enter a value in [Selected Output Value:]-[Write] and click the <Write> button.

4.2 PROFIBUS DP Troubleshooting

Exclusion

Every system has its special environment, conditions, specifications, and usages. This guide is provided as a general reference for troubleshooting a PROFIBUS DP network. Every effort has been made to ensure the information is accurate. However, we do not guarantee the complete accuracy of the information and thus we decline any liability for damages or costs incurred by the use of this troubleshooting.

Before examining a problem on the network, please ensure that your established PROFIBUS DP system satisfies network specifications. (Refer to this troubleshooting and the section 2.4 PROFIBUS DP Network Construction.)

Tools

Prepare the following tools for troubleshooting.

- Philips screwdriver
- Flat-blade screwdriver
- Tester

4.2.1 Examining a Problem

4.2.1.1 Scanner Board Diagnostic LEDs

The PROFIBUS DP board used with EPSON RC+ has two status display LEDs. The layout of the LEDs is shown in the following figure.

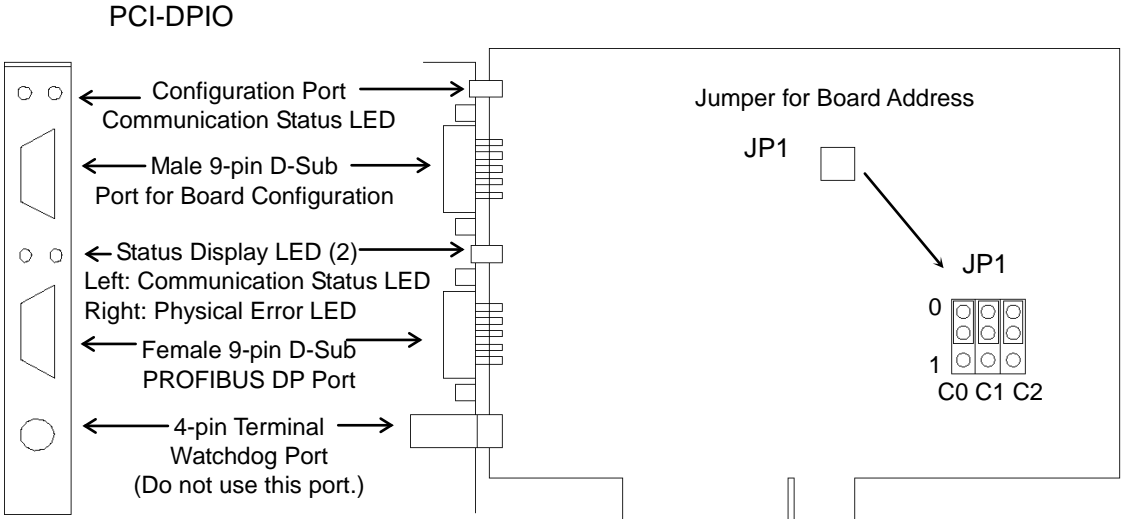

The Communication Status LED is on the left and the Physical Error LED is on the right seen from the rear panel.

The Communication Status LED is referred to as the ST LED (ST) in this section.

The Physical Error LED is referred to as the BF LED (BF) in this section.

4.2.1.2 Check Network Status

As a first step, check the current condition of the network. There are different specifications of status display LED on a device in the PROFIBUS DP standard. This section explains how to check the network status assuming that EPSON RC+ is configured as a master or slave.

(1) Master Status: BF/ST LEDs

LED	Color		Light Condition		
BF (Physical error)	<input type="checkbox"/> Green	<input type="checkbox"/> Red	<input type="checkbox"/> ON	<input type="checkbox"/> Blinking	<input type="checkbox"/> OFF
ST (Communication Status)	<input type="checkbox"/> Green	<input type="checkbox"/> Red	<input type="checkbox"/> ON	<input type="checkbox"/> Blinking	<input type="checkbox"/> OFF

(2) Station Number of Absent Slaves

Absent slaves are disconnected from or not added to the network.

1. See the status flag regarding to the removal and addition if the master has status information.
2. See the BF/ST LEDs of all slaves if the master has no status information.

(3) Absent Slave Status: BF/ST LEDs

LED	Color		Light Condition		
BF (Physical error)	<input type="checkbox"/> Green	<input type="checkbox"/> Red	<input type="checkbox"/> ON	<input type="checkbox"/> Blinking	<input type="checkbox"/> OFF
ST (Communication Status)	<input type="checkbox"/> Green	<input type="checkbox"/> Red	<input type="checkbox"/> ON	<input type="checkbox"/> Blinking	<input type="checkbox"/> OFF

(4) Physical Node Location of Absent Slave

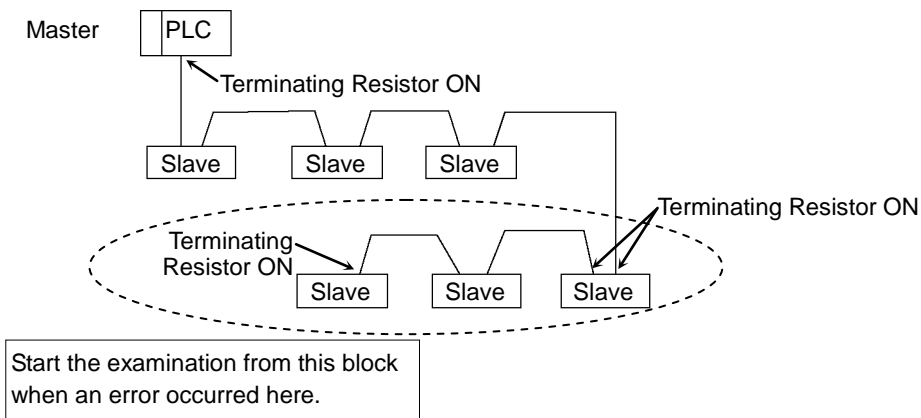

(5) Error Occurrence Condition

- Immediate occurrence (high reproducibility)
- Rare occurrence (low reproducibility)

4.2.2 Problems and Countermeasures

Master Unit LED		Error	Description [Reference]
BF	ST		
Light OFF	Green Light Blinking	Normal communication	- Normal condition
Light OFF	Green Light ON	Ready for communication	- Normal condition
Light OFF	Red Light Blinking	Communication error	[Refer to the section 4.2.2.1 <i>Master Communication Error.</i>] - Slave disconnected from the network (Remote I/O communication error) - Slave not added to the network (Scan list collation error) - Nonstandard wiring - No or too many terminating resistors - Noise intrusion
Light OFF	Red Light ON	Data link layer error	[Refer to the section 4.2.2.2 <i>Master: Data Link Layer Error.</i>] - Nonstandard wiring - Noise intrusion
Light OFF	Light OFF	Uninitialized network	[Refer to the section 4.2.2.3 <i>Master: Uninitialized Network.</i>] - Master unit power error - Master unit configuration error
Red Light ON	No Matter	Physical error	[Refer to the section 4.2.2.4 <i>Master: Configuration Error.</i>] - Nonstandard wiring - Signal wire connection failure - Signal wire short circuit

◆ Process Flowchart

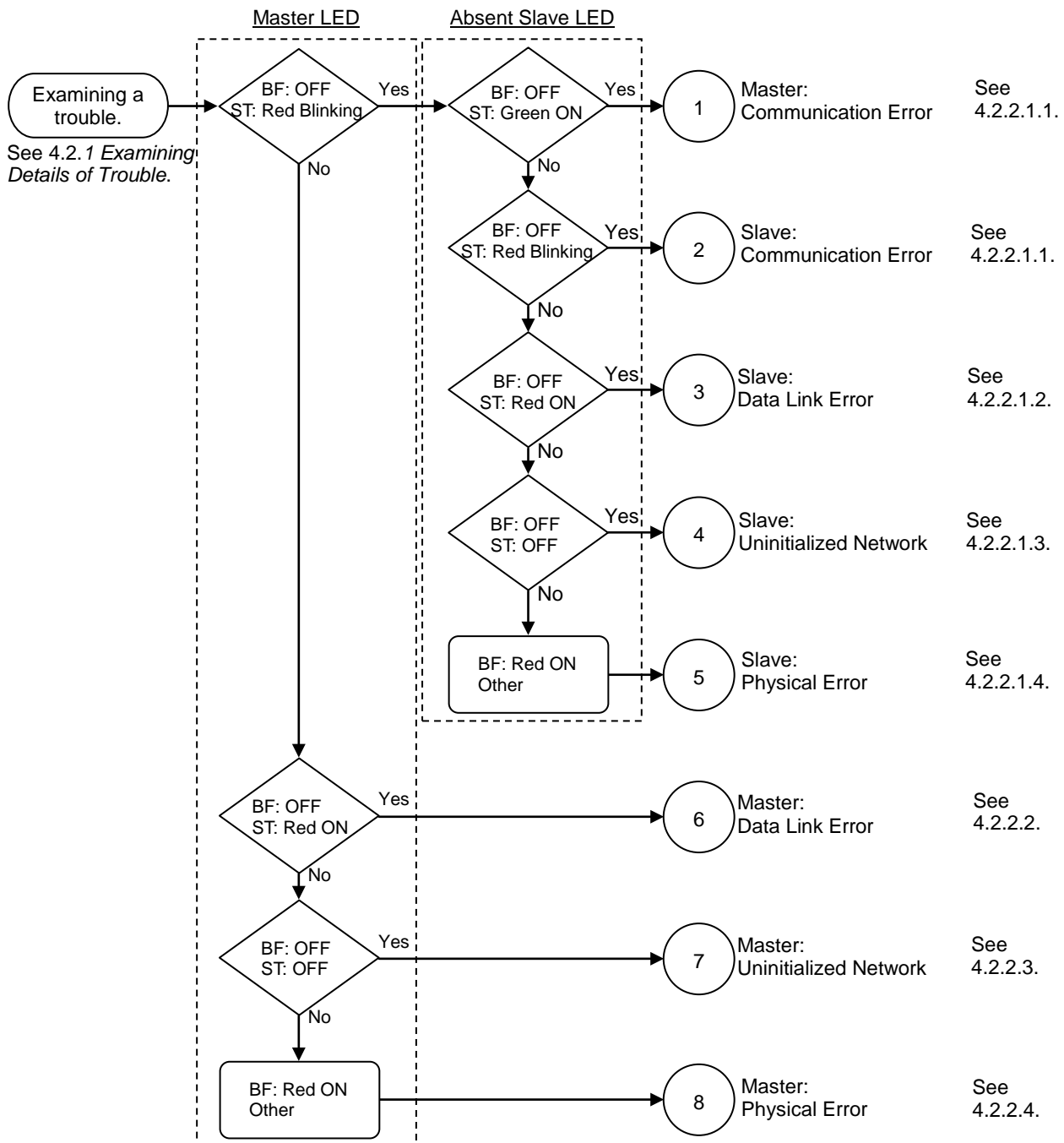

4.2.2.1 Master: Communication Error

Master Unit LED		Error	Description
BF	ST		
Light OFF	Red Light Blinking	Communication error	<ul style="list-style-type: none"> - Slave disconnected from the network (Remote I/O communication error) - Slave not added to the network (Scan list collation error) - Nonstandard wiring - No or too many terminating resistors - Noise intrusion

Master/Slave: Communication Error

	BF	ST
Master LED Condition	Light OFF	Red Light Blinking
Absent Slave LED Condition (Communication error)	Light OFF	Green Light Blinking
	Light OFF	Red Light Blinking

4. Troubleshooting (PROFIBUS DP)

◆ Process Flowchart

Check

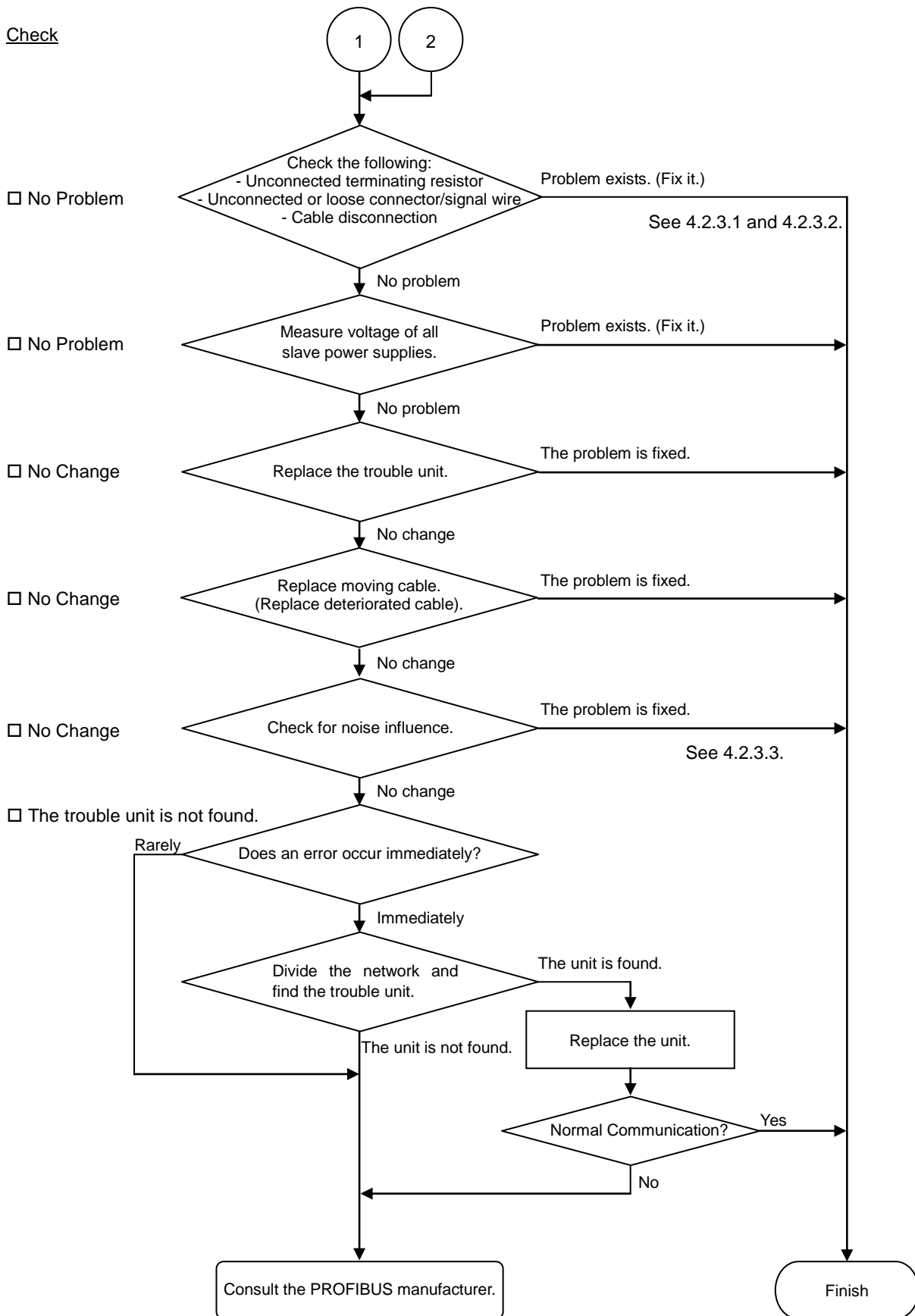

◆ Causes of Error		
Possible Cause	Examination Method	Countermeasure
<ul style="list-style-type: none"> ○ Disconnected terminating resistors ○ Cable disconnection ○ Disconnected connector ○ Disconnected signal wire 	<p>(1) Check that terminating resistors are connected to both ends of the network.</p> <p>(2) Measure resistance between signal wires with device power supply OFF.</p> <p>→ Normal: 100 to 120 Ω</p> <ul style="list-style-type: none"> ● Measuring point: Connection of the trouble unit ● For details, refer to the section <i>4.2.3.1 Connection Problem.</i> 	<p>Fix the problem.</p> <p>How to find the trouble point: Remove the terminating resistor on one end of the network. The trouble point is where resistance changes from 220 Ω.</p>
<ul style="list-style-type: none"> ○ Loose connector ○ Loose signal wire 	<p>Check for the connection of connectors and signal wires.</p> <p>→ The connectors and signal wires should be firmly connected.</p> <ul style="list-style-type: none"> ● Checkpoint: all stations and all branch taps ● For details, refer to the section <i>4.2.3.2 Loose Connector and Signal Wire.</i> 	<p>Connect the connectors and signal wires again.</p>
<ul style="list-style-type: none"> ○ Electrical surges of device power supply 	<p>Measure voltage of the device power supply at the trouble unit.</p> <p>→ It should be within the range of sufficient voltage for device operation.</p>	<p>Check voltage of the device power supply.</p>
<ul style="list-style-type: none"> ○ Noise (external cause) 	<p>Check the noise intrusion via the following paths (1) to (3).</p> <p>(1) Noise via shield</p> <p>(2) Induced noise via communication cable</p> <p>(3) Device power supply</p> <p>→ For details, refer to the section <i>4.2.3.3 Noise Intrusion.</i></p>	<p>Take countermeasures against noise.</p>
<ul style="list-style-type: none"> ○ Broken unit 	<p>Replace the trouble unit with a new one.</p> <p>→ Verify whether the problem is fixed.</p>	<p>Replace the unit with a new one.</p>
<ul style="list-style-type: none"> ● No cause is identified. 	<p>Identify the trouble point by dividing the network.</p> <p>→ For details, refer to the section <i>4.2.3.4 Broken Unit Examination.</i></p>	

4. Troubleshooting (PROFIBUS DP)

Slave: Data Link Error

	MS	NS
Master LED Condition	Light OFF	Red Light Blinking
Absent Slave LED Condition (Data link error)	Light OFF	Red Light ON

◆ Process Flowchart

Check

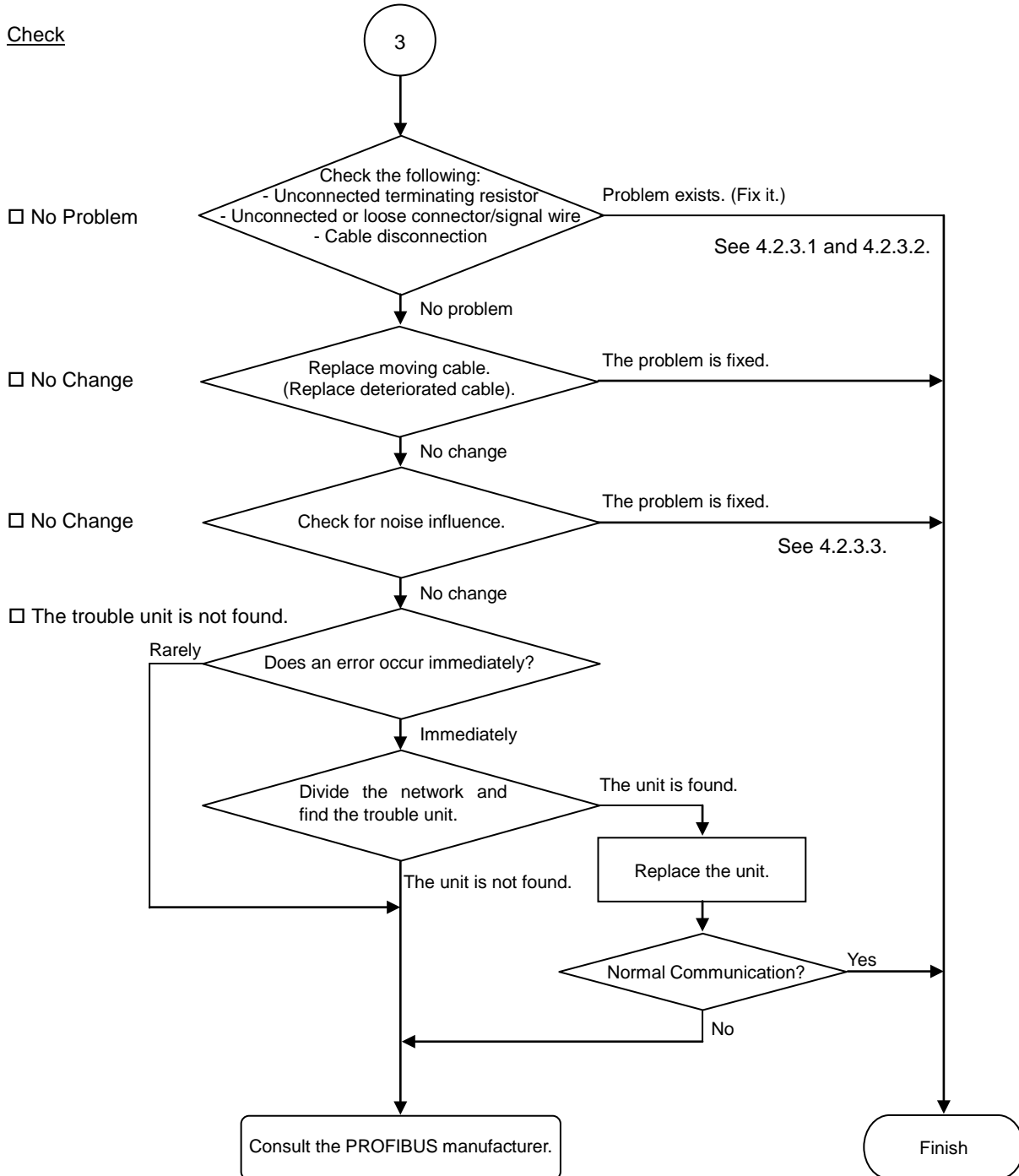

◆ Causes of Error		
Possible Cause	Examination Method	Countermeasure
<ul style="list-style-type: none"> ○ Disconnected terminating resistors ○ Cable disconnection ○ Disconnected connector ○ Disconnected signal wire 	<p>(1) Check that terminating resistors are connected to both ends of the network.</p> <p>(2) Measure resistance between signal wires with device power supply OFF.</p> <p>→ Normal: 100 to 120 Ω</p> <ul style="list-style-type: none"> ● Measuring point: Connection of the trouble unit ● For details, refer to the section <i>4.2.3.1 Connection Problem.</i> 	<p>Fix the problem.</p> <p>How to find the trouble point: Remove the terminating resistor on one end of the network. The trouble point is where resistance changes from 220 Ω.</p>
<ul style="list-style-type: none"> ○ Loose connector ○ Loose signal wire 	<p>Check for the connection of connectors and signal wires.</p> <p>→ The connectors and signal wires should be firmly connected.</p> <ul style="list-style-type: none"> ● Checkpoint: all stations and all branch taps ● For details, refer to the section <i>4.2.3.2 Loose Connector and Signal Wire.</i> 	<p>Connect the connectors and signal wires again.</p>
<ul style="list-style-type: none"> ○ Noise (external cause) 	<p>Check the noise intrusion via the following paths (1) to (3).</p> <p>(1) Noise via shield</p> <p>(2) Induced noise via communication cable</p> <p>(3) Device power supply</p> <p>→ For details, refer to the section <i>4.2.3.3 Noise Intrusion.</i></p>	<p>Take countermeasures against noise.</p>
<ul style="list-style-type: none"> ○ Broken unit 	<p>Replace the trouble unit with a new one.</p> <p>→ Verify whether the problem is fixed.</p>	<p>Replace the unit with a new one.</p>
<ul style="list-style-type: none"> ● No cause is identified. 	<p>Identify the trouble point by dividing the network.</p> <p>→ For details, refer to the section <i>4.2.3.4 Broken Unit Examination.</i></p>	

4. Troubleshooting (PROFIBUS DP)

Slave: Uninitialized Network

	BF	ST
Master LED Condition	Light OFF	Red Light Blinking
Absent Slave LED Condition (Uninitialized Network)	Light OFF	Light OFF

◆ Process Flowchart

Check

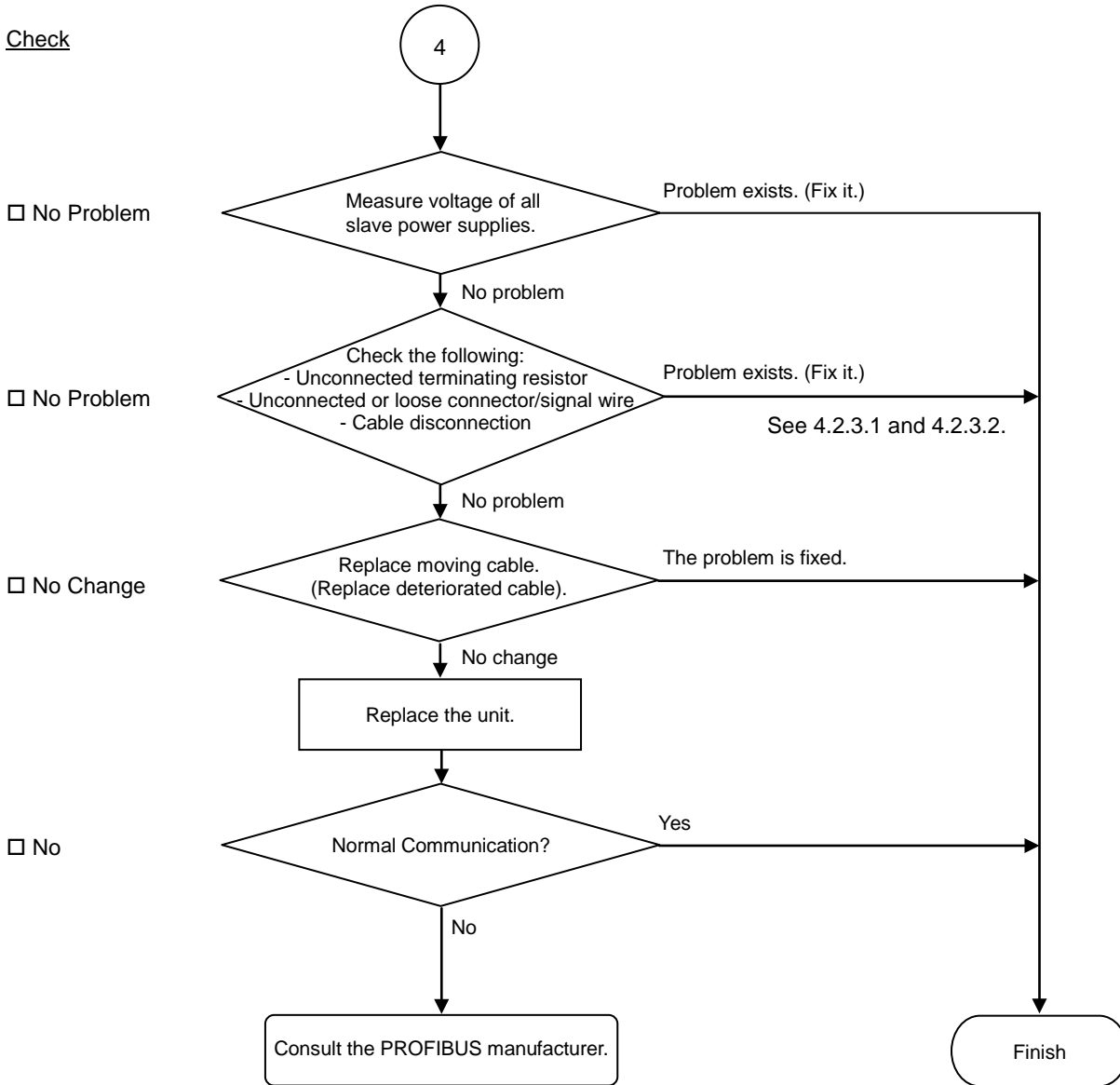

◆ Causes of Error

Possible Cause	Examination Method	Countermeasure
○ Electrical surges of device power supply	Measure voltage of the device power supply at the trouble unit. → It should be within the range of sufficient voltage for device operation.	Check voltage of the device power supply.
○ Disconnected terminating resistors ○ Cable disconnection ○ Disconnected connector ○ Disconnected signal wire	(1) Check that terminating resistors are connected to both ends of the network. (2) Measure resistance between signal wires with device power supply OFF. → Normal: 100 to 120 Ω ● Measuring point: Connection of the trouble unit ● For details, refer to the section <i>4.2.3.1 Connection Problem</i> .	Fix the problem. How to find the trouble point: Remove the terminating resistor on one end of the network. The trouble point is where resistance changes from 220 Ω.
○ Loose connector ○ Loose signal wire	Check for the connection of connectors and signal wires. → The connectors and signal wires should be firmly connected. ● Checkpoint: all stations and all branch taps ● For details, refer to the section <i>4.2.3.2 Loose Connector and Signal Wire</i> .	Connect the connectors and signal wires again.
○ Broken unit	Replace the trouble unit with a new one. → Verify whether the problem is fixed.	Replace the unit with a new one.

4. Troubleshooting (PROFIBUS DP)

Physical Error

	BF	ST
Master LED Condition	Light OFF	Red Light Blinking
Absent Slave LED Condition (Physical error)	Red Light ON	No Matter

◆ Process Flowchart

Check

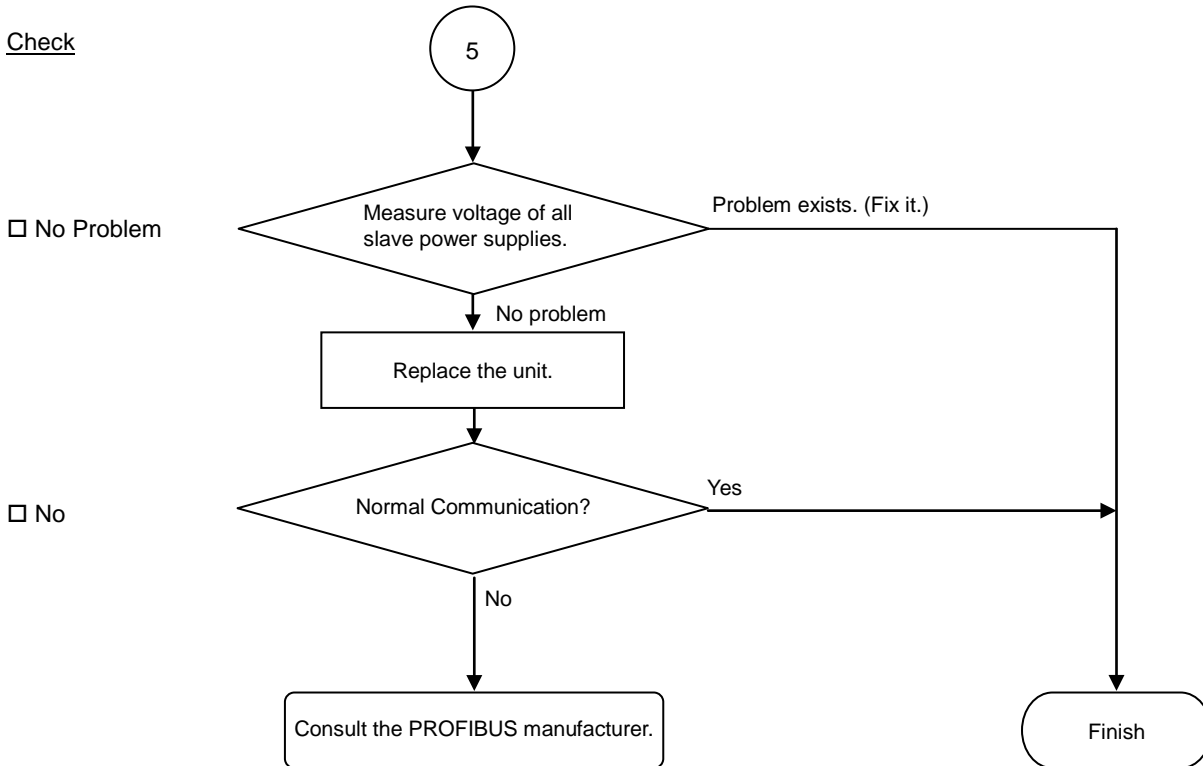

◆ Causes of Error

Possible Cause	Examination Method	Countermeasure
○ Electrical surges of device power supply	Measure voltage of the device power supply at the trouble unit. →It should be within the range of sufficient voltage for device operation.	Check voltage of the device power supply.
○ Broken unit	Replace the trouble unit with a new one. →Verify whether the problem is fixed.	Replace the unit with a new one.

4.2.2.2 Master: Data Link Layer Error

Master Unit LED		Error	Description
BF	ST		
Light OFF	Red Light ON	Data link layer error	- Nonstandard wiring - Noise intrusion

◆ Process Flowchart

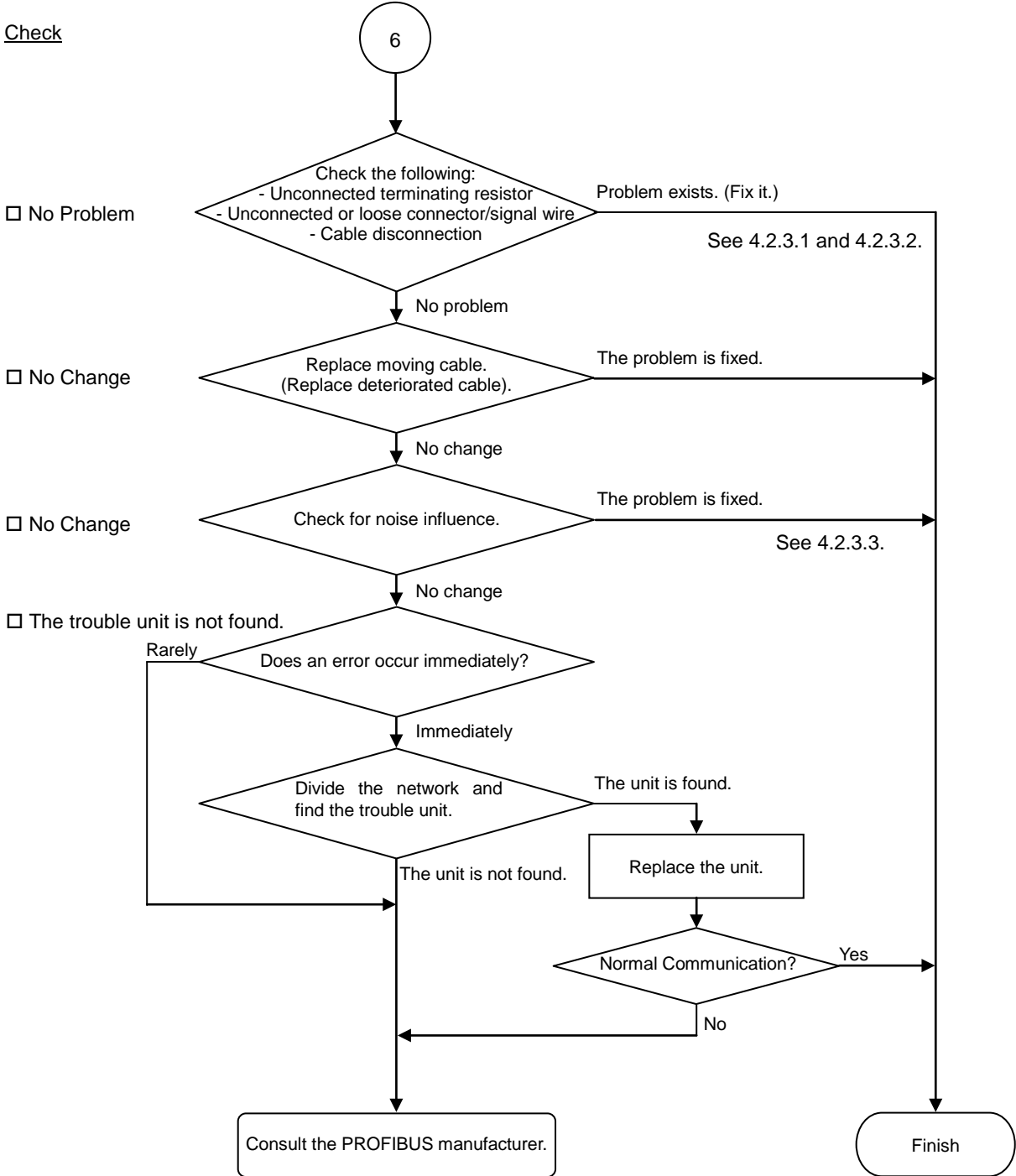

◆ Causes of Error

Possible Cause	Examination Method	Countermeasure
<ul style="list-style-type: none"> ○ Disconnected terminating resistors ○ Cable disconnection ○ Disconnected connector ○ Disconnected signal wire 	<p>(1) Check that terminating resistors are connected to both ends of the network.</p> <p>(2) Measure resistance between signal wires with device power supply OFF.</p> <p>→ Normal: 100 to 120 Ω</p> <ul style="list-style-type: none"> ● Measuring point: Connection of the trouble unit ● For details, refer to the section <i>4.2.3.1 Connection Problem.</i> 	<p>Fix the problem.</p> <p>How to find the trouble point: Remove the terminating resistor on one end of the network. The trouble point is where resistance changes from 220 Ω.</p>
<ul style="list-style-type: none"> ○ Loose connector ○ Loose signal wire 	<p>Check for the connection of connectors and signal wires.</p> <p>→The connectors and signal wires should be firmly connected.</p> <ul style="list-style-type: none"> ● Checkpoint: all stations and all branch taps ● For details, refer to the section <i>4.2.3.2 Loose Connector and Signal Wire.</i> 	<p>Connect the connectors and signal wires again.</p>
<ul style="list-style-type: none"> ○ Noise (external cause) 	<p>Check the noise intrusion via the following paths (1) to (3).</p> <p>(1) Noise via shield</p> <p>(2) Induced noise via communication cable</p> <p>(3) Device power supply</p> <p>→For details, refer to the section <i>4.2.3.3 Noise Intrusion.</i></p>	<p>Take countermeasures against noise.</p>
<ul style="list-style-type: none"> ○ Broken unit 	<p>Replace the trouble unit with a new one.</p> <p>→Verify whether the problem is fixed.</p>	<p>Replace the unit with a new one.</p>
<ul style="list-style-type: none"> ● No cause is identified. 	<p>Identify the trouble point by dividing the network.</p> <p>→For details, refer to the section <i>4.2.3.4 Broken Unit Examination.</i></p>	

4.2.2.3 Master: Uninitialized Network

Master Unit LED		Error	Description
BF	ST		
Light OFF	Light OFF	Uninitialized network	- Master unit power error - Master unit configuration error

◆ Process Flowchart

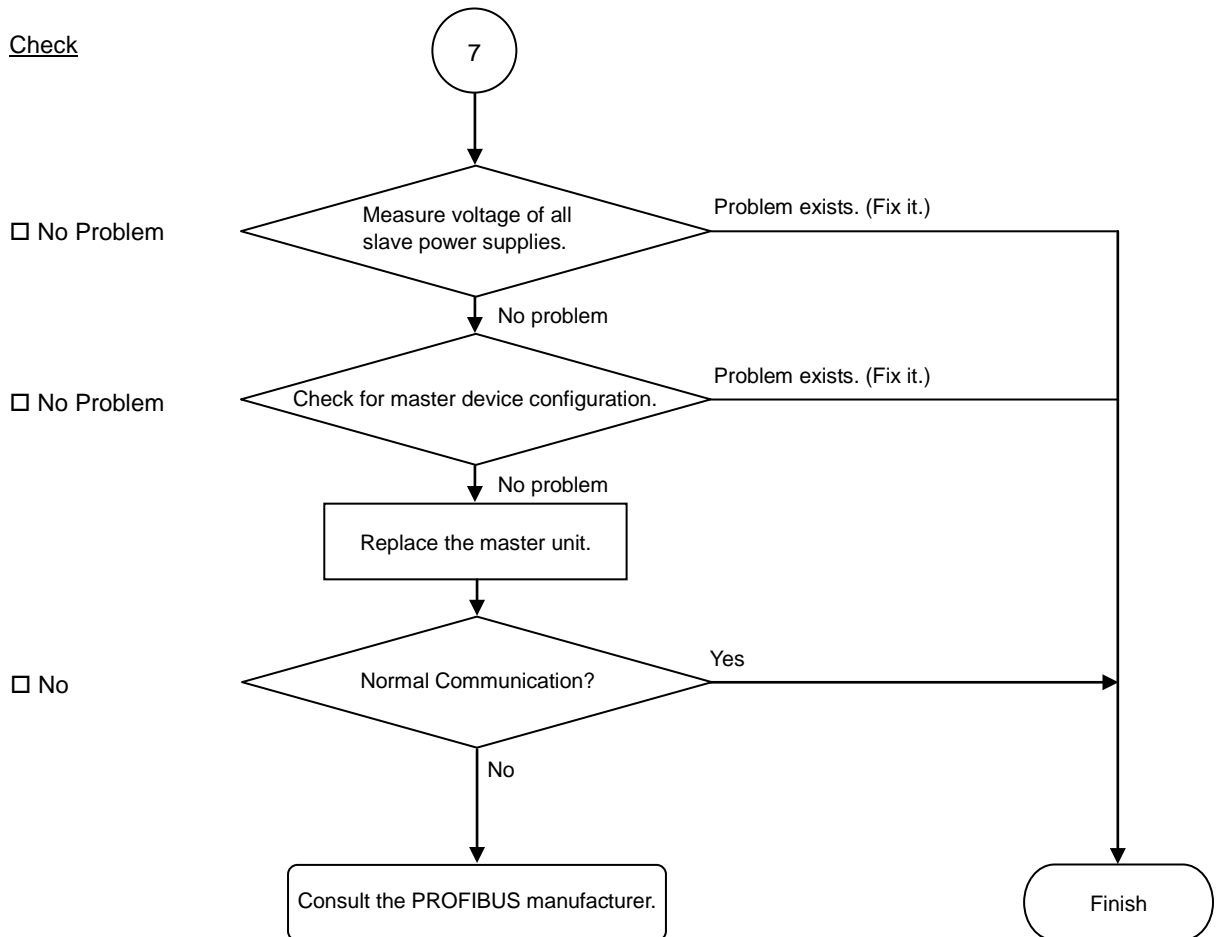

◆ Causes of Error

Possible Cause	Examination Method	Countermeasure
○ Electrical surges of master device power supply	Measure voltage of the device power supply at the master unit. →It should be within the range of sufficient voltage for device operation.	Check voltage of the device power supply.
○ Master device configuration error	Check that the master device was configured properly. →After changing the configuration, verify whether the problem is fixed.	Check the master unit configuration.
○ Broken master unit	Replace the broken master unit with a new one. →Verify whether the problem is fixed.	Replace the master unit with a new one.

4.2.2.4 Master: Configuration Error

Master Unit LED		Error	Description
BF	ST		
Red Light ON	No Matter	Physical error	- Nonstandard wiring - Signal wire connection failure - Signal wire short circuit

◆ Process Flowchart

Check

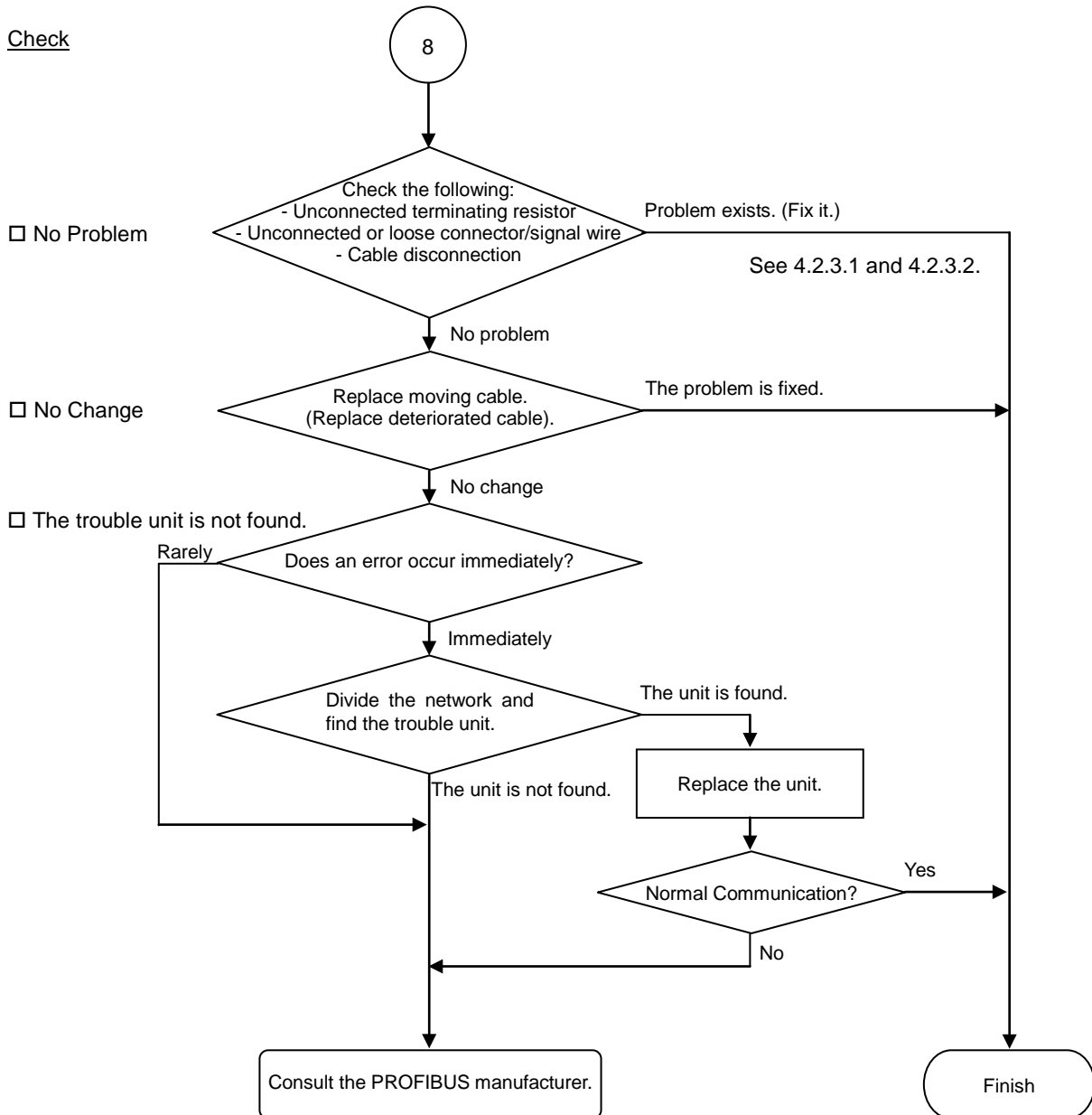

◆ Causes of Error

Possible Cause	Examination Method	Countermeasure
<ul style="list-style-type: none"> ○ Disconnected terminating resistors ○ Cable disconnection ○ Disconnected connector ○ Disconnected signal wire 	<p>(1) Check that terminating resistors are connected to both ends of the network.</p> <p>(2) Measure resistance between signal wires with device power supply OFF.</p> <p>→ Normal: 100 to 120 Ω</p> <ul style="list-style-type: none"> ● Measuring point: Connection of the trouble unit ● For details, refer to the section <i>4.2.3.1 Connection Problem.</i> 	<p>Fix the problem.</p> <p>How to find the trouble point: Remove the terminating resistor on one end of the network. The trouble point is where resistance changes from 220 Ω.</p>
<ul style="list-style-type: none"> ○ Loose connector ○ Loose signal wire 	<p>Check for the connection of connectors and signal wires.</p> <p>→The connectors and signal wires should be firmly connected.</p> <ul style="list-style-type: none"> ● Checkpoint: all stations and all branch taps ● For details, refer to the section <i>4.2.3.2 Loose Connector and Signal Wire.</i> 	<p>Connect the connectors and signal wires again.</p>
<ul style="list-style-type: none"> ○ Broken unit 	<p>Replace the trouble unit with a new one.</p> <p>→Verify whether the problem is fixed.</p>	<p>Replace the unit with a new one.</p>
<ul style="list-style-type: none"> ● No cause is identified. 	<p>Identify the trouble point by dividing the network.</p> <p>→ For details, refer to the section <i>4.2.3.4 Broken Unit Examination.</i></p>	

4.2.3 Procedures for Examining Possible Causes

4.2.3.1 Connection Problem (Disconnected Terminating Resistors, Cable Disconnection, Disconnected Connector, and Disconnected Signal Wire)

- (1) Ensure that two terminating resistors are connected to both ends of the network.
- (2) Turn OFF all device power supplies.
- (3) Measure resistance between A1 and B1 wires of the absent slave using the tester.

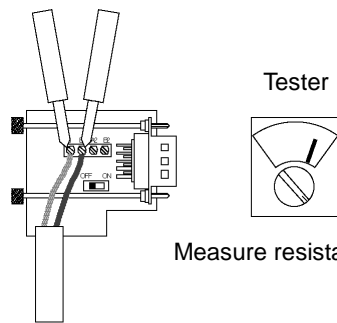

Measure resistance between signal wires with tester.

Resistance	Determination
0 Ω	Short circuit
Under 100 Ω	Three or more terminating resistors on one network
100 to 120 Ω	Normal
Over 120 Ω	Error (cable disconnection, disconnected signal wire, one or zero terminating resistor)

- (4) How to find the trouble point:
 - Remove the terminating resistor on one end of the network.
(The resistance at the point where the terminating resistor is connected is 220 Ω.)
 - Measure resistance at branch taps of all units.
 - The trouble point is where resistance changes from 220 Ω.
 - After finding the trouble point, verify the connector and cable conditions.

◆ Process Flowchart

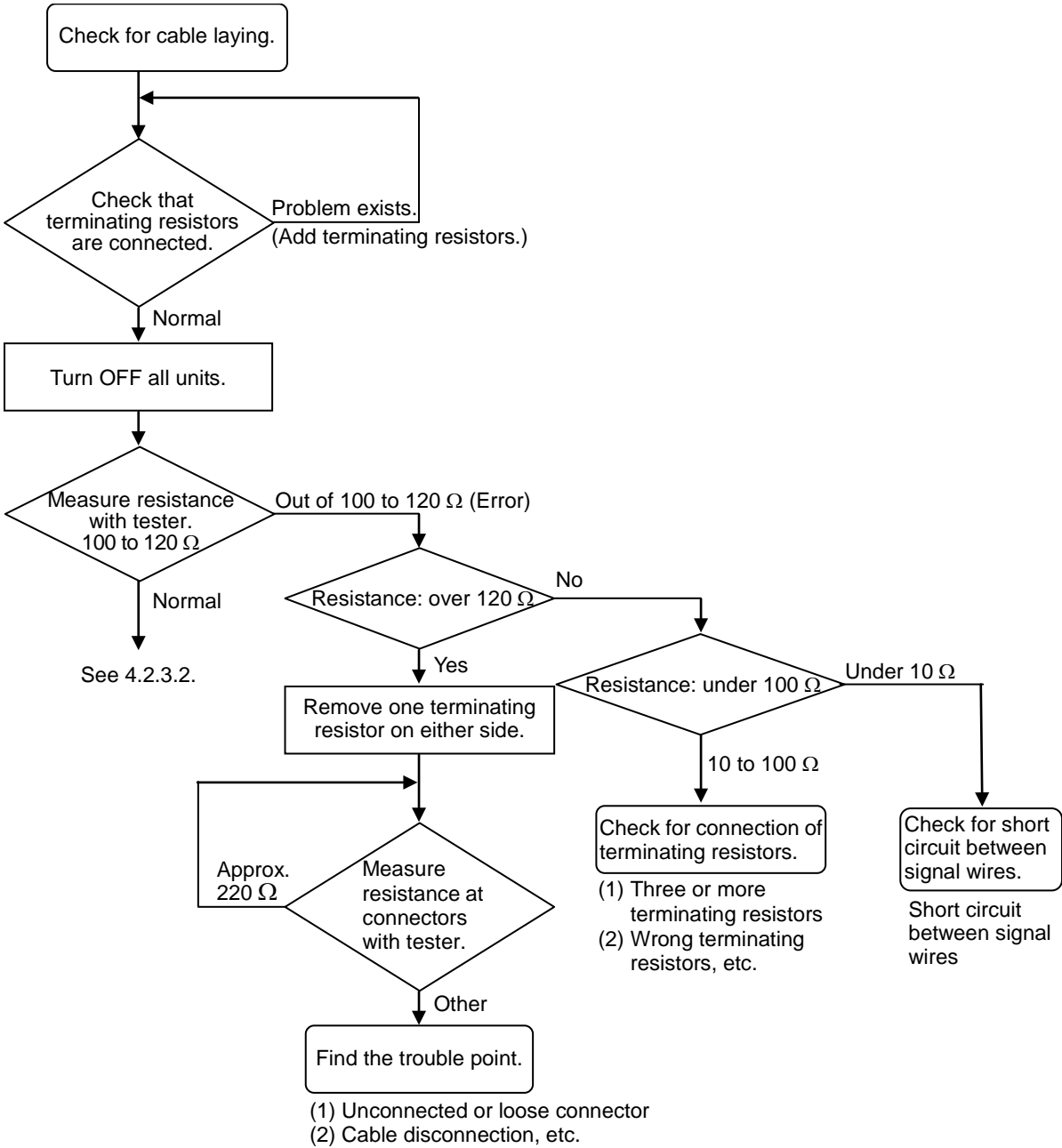

4.2.3.2 Loose Connector and Signal Wire

Check for the connections of the following parts on the connector and cable.

- (1) Connection of connector and signal wire

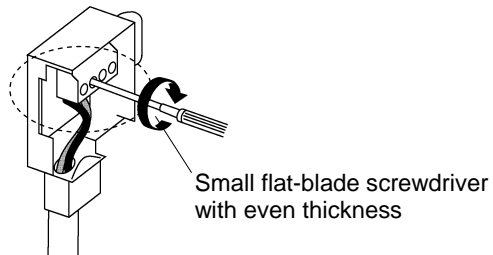

- (2) Connection of connector and unit

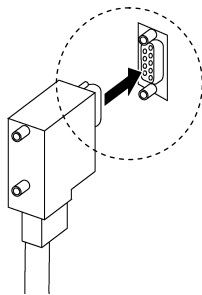

4.2.3.3 Noise Intrusion

Verify how error occurrence condition changes while taking the following countermeasures.

◆ Ground of FG wire

Normal Grounding: Peel the cable covering and ground the FG wire.

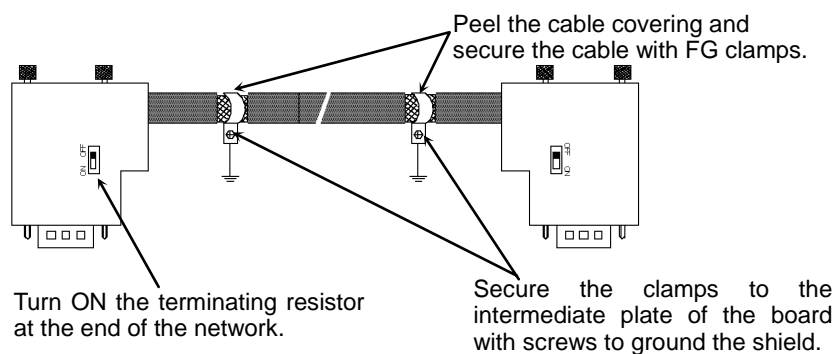

Countermeasure 1: Improve FG.

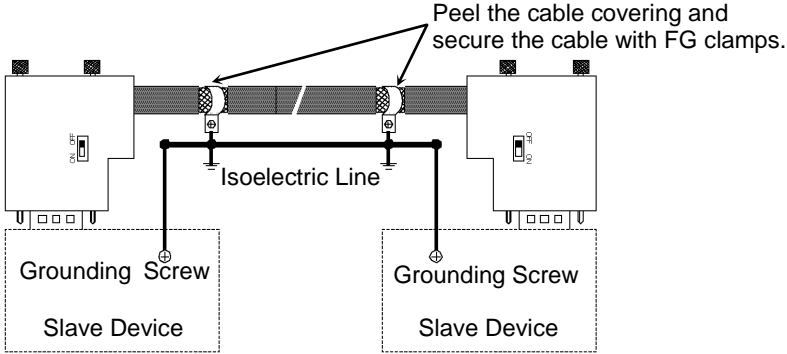

Countermeasure 2: Disconnect the FG wire to isolate it from the ground.

When noise intrudes the ground line due to a noise source such as an inverter installed near the grounding point, disconnect the shield wire of the signal cable and isolate it from the ground to restrain noise intrusion.

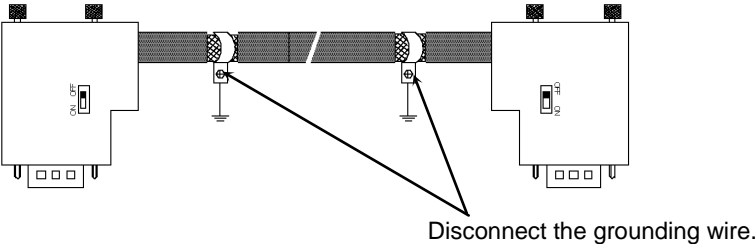

◆ Induced noise via communication cable

Separate the PROFIBUS DP signal wire from the other wires (especially power wires).

* Separate the signal wire from the power wires 300 mm or more.

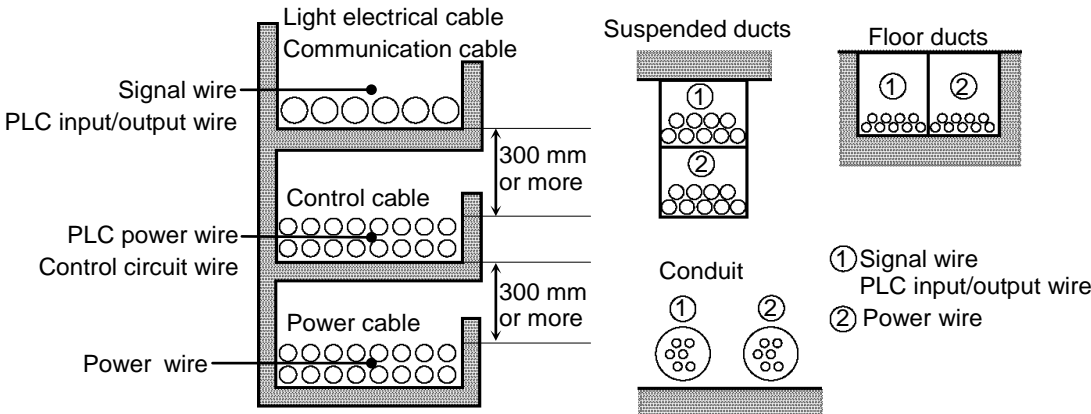

During site inspection, bypass the wire that is possibly affected by induced noise with other cables and then lay the cables. Establish the communication under no induced noise condition and verify whether an error occurs.

4.2.3.4 Broken Unit Examination (Dividing Network Examination)

When you cannot quickly find the trouble point due to broken unit, connection failure including loose connector, or cable partial disconnection, divide the network to find the trouble point. Verify how error occurrence conditions change while taking the following countermeasures.

How to Examine

Divide the network to find which station is a cause of a trouble.

Verify that a master can establish communications with the slaves even though one slave is separated from the network.

After finding the trouble station, check the cables connected to it and replace the unit.

How to Divide

Divide the network by block and check each block.

1. Ensure that the master has no problem by connecting it to its slaves one by one.
(BF/ST: light OFF/green light ON or blinking)
2. Divide the network in the middle of it and check for the communication condition.
(BF/ST: light OFF/green light ON or blinking)
Normal: The trouble point is on the other half of the network.
Error: The trouble point is on the current half of the network.
(Continue dividing the half of the network further to distinguish error part from normal part.)
3. Check for communication on the block to specify the trouble point.

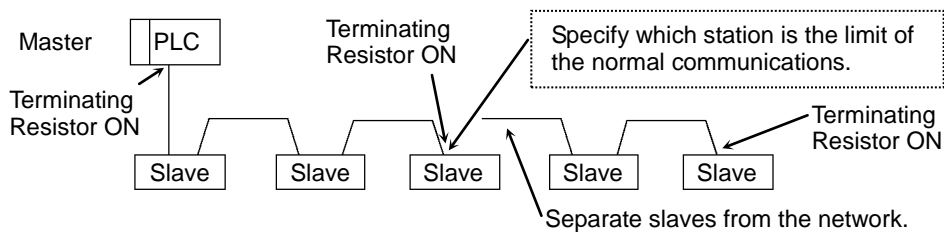

4.2.3.5 Network Configuration and Specifications

(1) Maximum Cable Length

Check that the cables used on the network meet the following specifications.

Baud Rates	Max. Cable Length
12 Mbps	100 m
6 Mbps	100 m
3 Mbps	100 m
1500 kbps	200 m
500 kbps	400 m
187.5 kbps	1000 m
93.75 kbps	1200 m
19.2 kbps	1200 m
9.6 kbps	1200 m

(2) Terminating Resistor

Ensure that two terminating resistors are connected to both ends of the network. The terminating resistor should be connected as shown below.

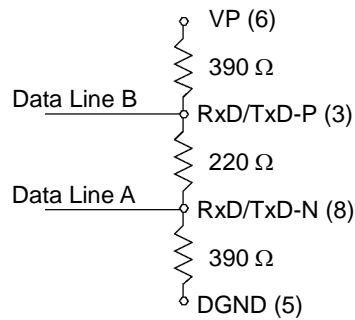

(3) Cable

The cables should meet the PROFIBUS specifications.

Item	Property
Impedance	135 to 165 Ω
Capacity	< 30 pf/m
Loop resistance	110 Ω/km
Wire diameter	0.64 mm
Core cross-section	> 0.34mm ²

4.2.3.6 EPSON RC+ Master Configuration

For details of EPSON RC+ master configuration, refer to the section 2.6 *PROFIBUS DP Board Installation*.

The following section describes the procedure for verifying the scanner board condition with the applicomIO Console application.

Verifying applicomIO Console application condition

The status bar at the bottom of the window shows the applicomIO Console application status. The status bar varies as shown below:

Character : The address number of the scanner board is indicated with characters. When the character “F” appears, the flash memory on the board initialized the scanner board.

Background color : The background color indicates the scanner board status. For details, refer to the table below.

Background	Character	Status
Gray	Black	Access to scanner board was failed. After that, the status bar will not be renewed automatically. To renew the status bar, right-click the status bar and select [Refresh].
Magenta	Black	The scanner board was initialized with the earlier version applicomIO Console application. It is recommended that the scanner board be written into the flash memory (reinitializing the scanner board) again with the current version applicomIO Console application.
Red	Black	The scanner board was not initialized. Initialize the scanner board to use it.
Yellow	Black	The scanner board was partially initialized. This status happens only during network detection and on-line actions.
Deep green	White	Although the scanner board was initialized, it is different with the currently opened configuration. (Different version, etc.) It is recommended that the scanner board be written into the flash memory (reinitializing the scanner board) again with the current version applicomIO Console application. This status happens only during network detection, on-line actions, and diagnostic.
Green	Black	The scanner board was initialized properly and it is no different with the currently opened configuration. This status happens only during network detection, on-line actions, and diagnostic.

Verifying the PROFIBUS DP network condition

The applicomIO Console application has the following functions:

Network Monitor function : Monitoring error condition detected on the network

Diagnostic function : Network diagnosis

- (1) Select the [Network Detection] tab in the left center of the applicomIO Console application.

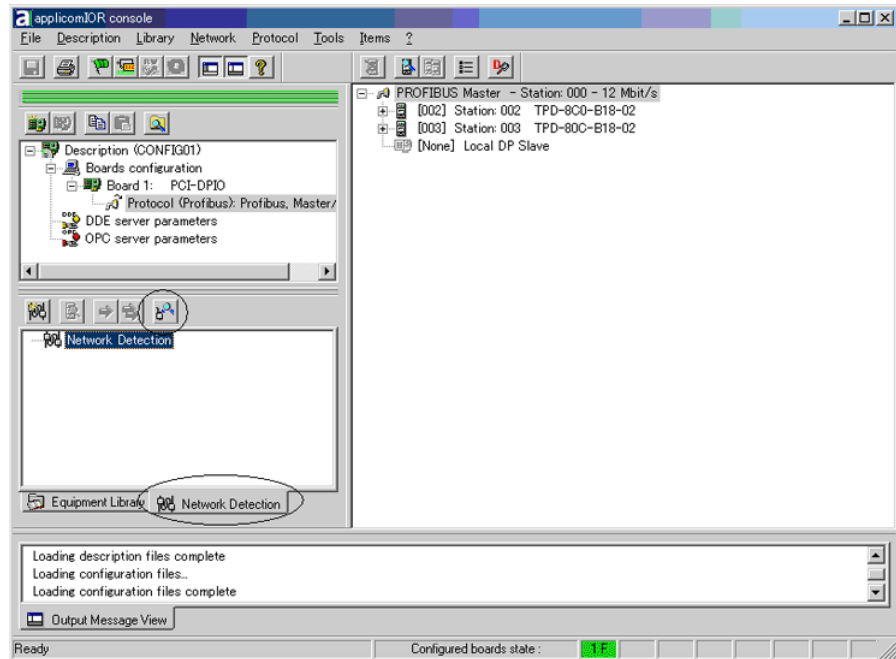

- (2) Click the <Online Action> icon. The [Network Monitor] dialog box appears.

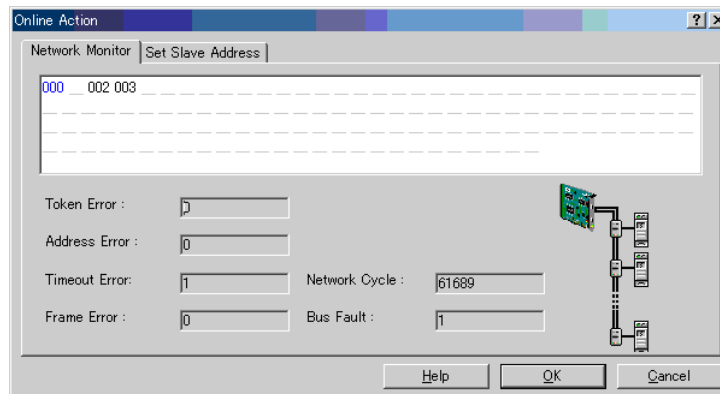

You can check the conditions of the following errors on this dialog.

Token Error	Address Error	Timeout Error
Frame Error	Network Cycle	Bus Fault

When an error occurs on the network, it is added to the corresponding error counter.

4. Troubleshooting (PROFIBUS DP)

- (3) Select [Protocol]-[Diagnostic] from the applicomIO Console application menu. Click the magnifying glass icon on the [Diagnostic] dialog box. Then, select the slave you want from the device tree in the left side of the window. The window changes as shown below.

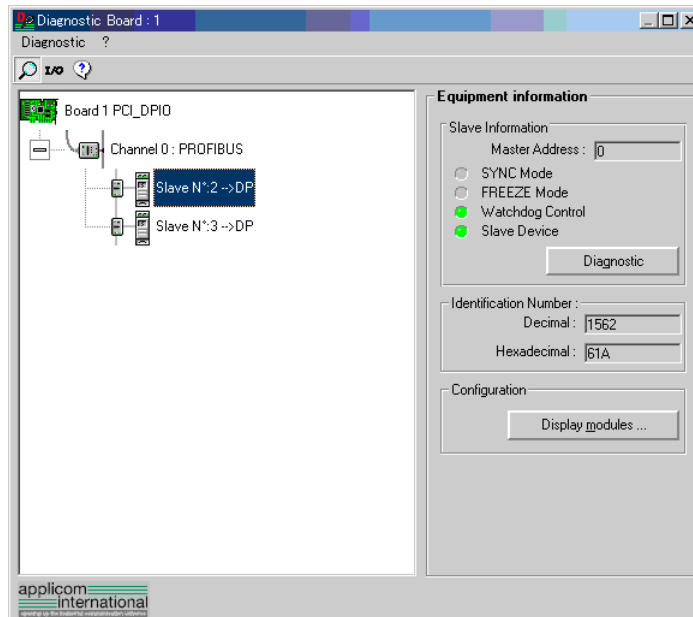

To check the device condition in detail, click <Diagnostic> in [Equipment information] in the right side of the window. If an error occurs, the information is displayed in red.

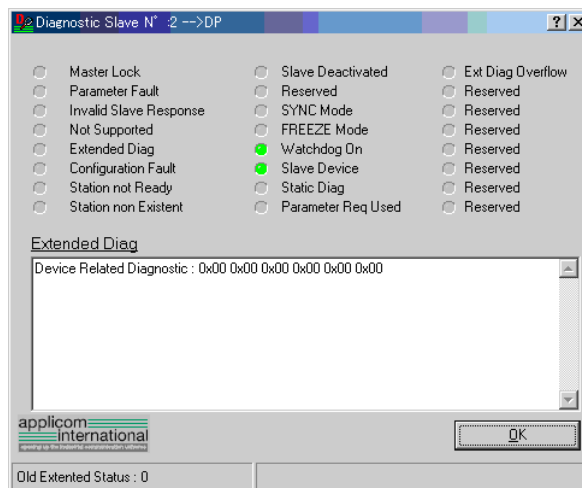

- (4) When you click the <I/O> icon, the window changes as shown below.

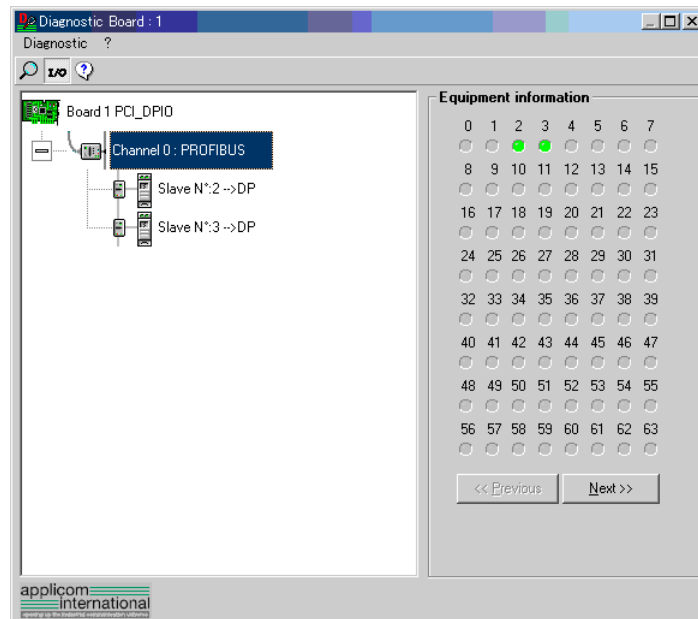

The status of each slave device is shown in the right side of the window.

A green circle indicates that the communication of the corresponding device is normal, and a red circle indicates that there is a communication error.

A gray circle indicates that the corresponding device does not exist.

- (5) When you select the slave from the device tree in the left side of the window, the window changes as shown below.

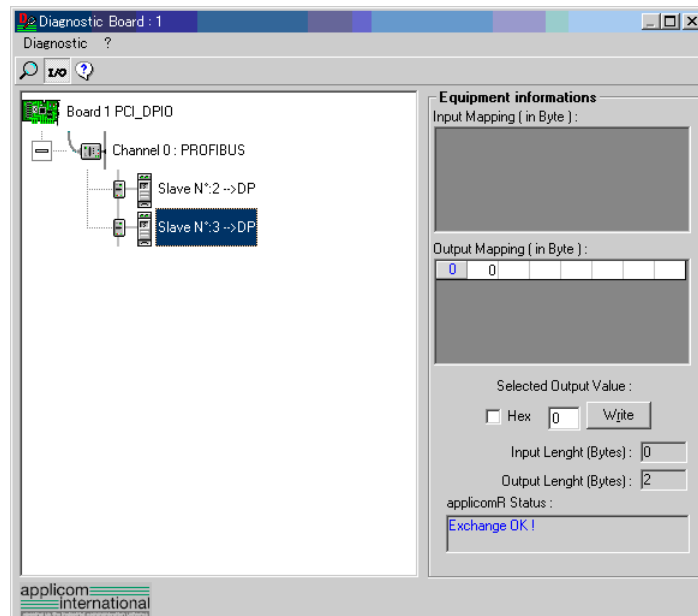

The input and output statuses of the selected device are shown in the right side of the window.

If you want to change output data, click the bite number you want to change in [Output Mapping]. Then, enter a value in [Write] in the “Selected Output Value” and click <Write>.

4.3 EtherNet/IP Troubleshooting

Exclusion

Every system has its special environment, conditions, specifications, and usages. This guide is provided as a general reference for troubleshooting a EtherNet/IP network. Every effort has been made to ensure the information is accurate. However, we do not guarantee the complete accuracy of the information and thus we decline any liability for damages or costs incurred by the use of this troubleshooting.

Before examining a problem on the network, please ensure that your established DeviceNet system satisfies network specifications. (Refer to this troubleshooting and the section 2.6 *EtherNet/IP Network Construction.*)

4.3.1 Examining a Problem

4.3.1.1 Scanner Board Diagnostic LEDs

The EtherNet/IP board used with EPSON RC+ has two status display LEDs. The layout of the LEDs is shown in the following figure.

PCU-ETHIO

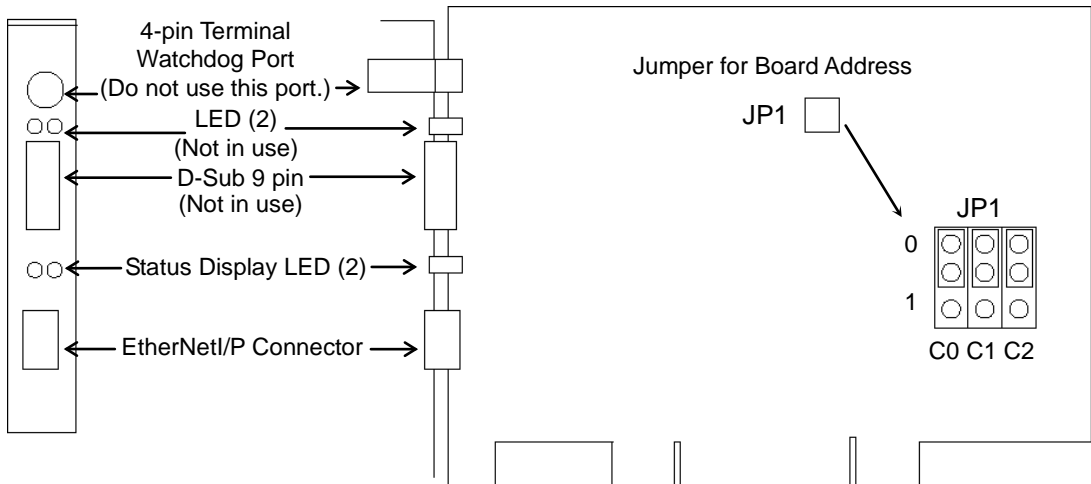

The Module/NetWork LED is on the left and the IO LED is on the right seen from the rear panel. These LED names are used in applicomIO Console application and this manual. Only in this troubleshooting section, general names of the status display of the DeviceNet device are used instead.

The Network Status LED is referred to as the NS LED (NS) in this section.

The Module Status LED is referred to as the MS LED (MS) in this section.

4.3.1.2 Check Network Status

(1) Master Status: MS/NS LEDs

LED	Color		Light Condition		
MS (Module Status)	<input type="checkbox"/> Green	<input type="checkbox"/> Red	<input type="checkbox"/> ON	<input type="checkbox"/> Blinking	<input type="checkbox"/> OFF
NS (Network Status)	<input type="checkbox"/> Green	<input type="checkbox"/> Red	<input type="checkbox"/> ON	<input type="checkbox"/> Blinking	<input type="checkbox"/> OFF

(2) Node Number of Absent Slaves

Absent slaves are disconnected from or not added to the network.

1. See the status flag regarding to the removal and addition if the master has status information.
2. See the MS/NE LEDs of all slaves if the master has no status information.

(3) Absent Slave Status: MS/NS LEDs

LED	Color		Light Condition		
MS (Module Status)	<input type="checkbox"/> Green	<input type="checkbox"/> Red	<input type="checkbox"/> ON	<input type="checkbox"/> Blinking	<input type="checkbox"/> OFF
NS (Network Status)	<input type="checkbox"/> Green	<input type="checkbox"/> Red	<input type="checkbox"/> ON	<input type="checkbox"/> Blinking	<input type="checkbox"/> OFF

(4) Physical Node Location of Absent Slave

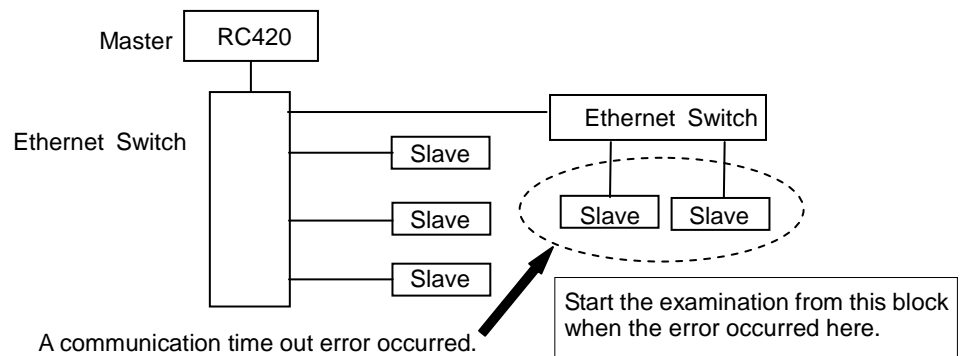

(5) Error Occurrence Condition

- Immediate occurrence (high reproducibility)
- Rare occurrence (low reproducibility)

4.3.2 Problems and Countermeasures

Master Unit LED		Error	Description [Reference]
MS	NS		
Green Light ON	Green Light ON	Normal communication	- Normal condition
Green Light ON	Green Light Blinking	During connection establishment	- Processing connection establishment (The NS LED will be ON in green in a few seconds.) - Master function in stop state (Communication does not start.)
Green Light ON	Red Light Blinking	Communication timeout	- Network channel error
Green Light ON	Light OFF	IP address not defined	- The IP address is not defined
Red Light Blinking	No Matter	Critical error	[Refer to the section 4.3.3 Tests and diagnostics.] - Unrecoverable critical error
Red Light ON	No Matter	Module error	[Refer to the section 4.3.3 Tests and diagnostics.] - Recoverable error occurred
Light OFF	Light OFF	Not initialized status	[Refer to the section 2.3.3 EtherNet/IP Master Board Installation - Master Mode.] - The communication board is not initialized Check the configuration

4.3.3 Tests and diagnostics

4.3.3.1 The diagnostic tool

After configuring the EtherNet/IP master, adding and configuring the devices of your network and downloading your configuration in the board, the statuses of all devices can be tested with the diagnostic tool.

Start this tool by selecting the menu command “**Protocol/Diagnostic...**” or selecting the  icon.

See also: To display the help, select [Start]-[Program]-[Direct-Link]-[applicomIO 2.3]-[Help].

Ethernet/IP channel on Ethernet diagnostics

The EtherNet/IP on Ethernet channel diagnostic information can be displayed by selecting the MULTI-MSG ETH channel.

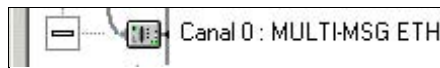

All devices in the configuration are visualized by a LED corresponding to the applicomIO device number.

The LED may be red or green depending on the device error status.

1. Diagnostic of the TCP/IP layer

This dialog box displays the status of the TCP/IP layer.

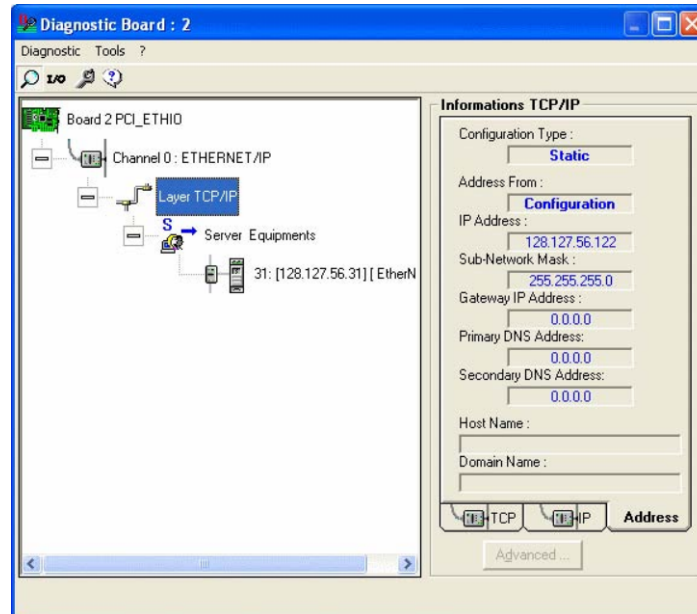

Configuration Type	Mode type selected in the configuration: DHCP, BOOTP, Static
Address From	How the IP address has been obtained: from the server, flash memory or factory address.
IP address	IP address of the applicomIO master on this channel.
Sub-Network Mask	Sub-network address of the applicomIO master on this channel.
Gateway IP Address	Address of the gateway configured on the applicomIO master on this channel.
Primary DNS Address	IP Address of the primary DNS server.
Secondary DNS Address	IP address of the secondary DNS server.
Host Name	Host name of the applicomIO master on this channel.
Domain Name	Domain name of the applicomIO master on this channel.

TCP tab

Passive connections :	0
Active connections :	1
Current connections :	1
Bytes received :	674
Bytes transmitted :	1034
Time-out retransmitted :	0

TCP IP Address

Passive connections
Active connections
Current connections
Bytes received
Bytes transmitted
Retries on time-out

Number of passive connections.
Number of active connections.
Number of current connections.
Number of bytes received.
Number of bytes transmitted.
Number of retries on reception of a time-out.

IP tab

Packets received :	13080
Packets transmitted :	13124
Errors :	0

TCP IP Address

Packets received
Packets transmitted
Errors

Number of packets received.
Number of packets transmitted.
Number of IP errors.

2. Diagnostic of server devices

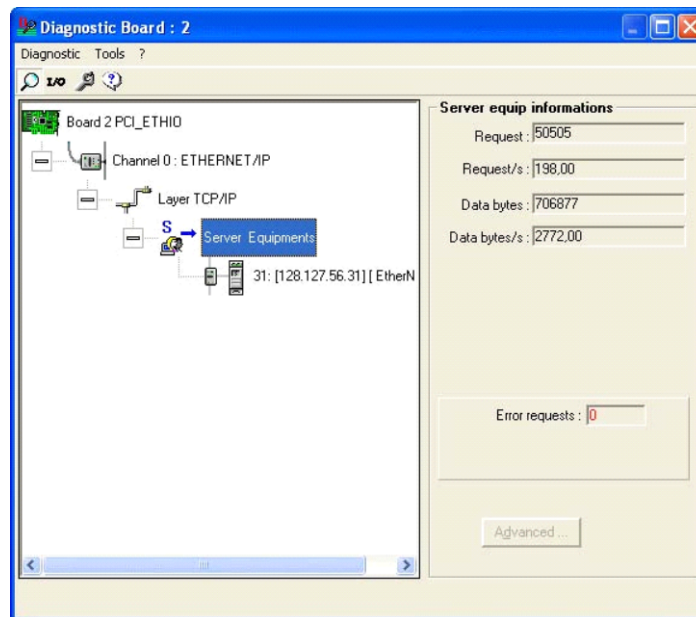

Requests	Number of requests.
Requests / s	Number of requests per second.
Useful bytes	Number of useful data bytes.
Useful bytes / s	Number of useful data bytes per second.
Requests in error	Number of requests in error.

3. Overall device diagnostics

View the diagnostic information on a device in the configuration by selecting the node which corresponds to the device.

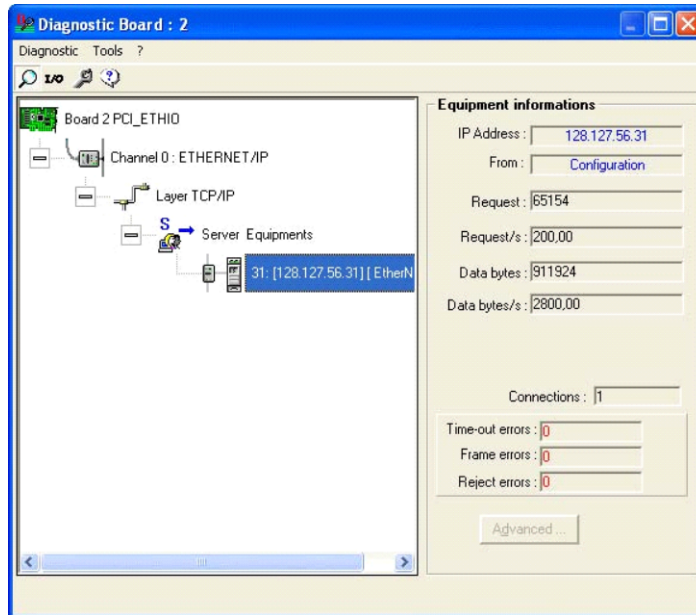

IP Address	IP address of the device.
From	How the IP address of the device was obtained: from the configuration from the DNS server (IP address of the device has been resolved)
Requests	Number of requests.
Requests / s	Number of requests per second.
Useful bytes	Number of useful data bytes.
Useful bytes / s	Number of useful data bytes per second.
Connections	Number of connections created for this device.
Time-out errors	Number of time-outs received for this device.
Frame errors	Number of frame errors for this device.
Refusal errors	Number of errors excluding time-out and frame errors.

TCP/IP tool

By clicking in the  icon and selecting [TCP/IP layer], the [services] window displays the following options.

DNS

ICMP (ping)

See also: To display the help, select [Start]-[Program]-[Direct-Link]-[applicomIO 2.3]-[Help].

1. Resolution of IP address or name

DNS functionality can be enabled by selecting the applicomIO menu-[Protocol/Diagnostic...]-the [DNS] tab.

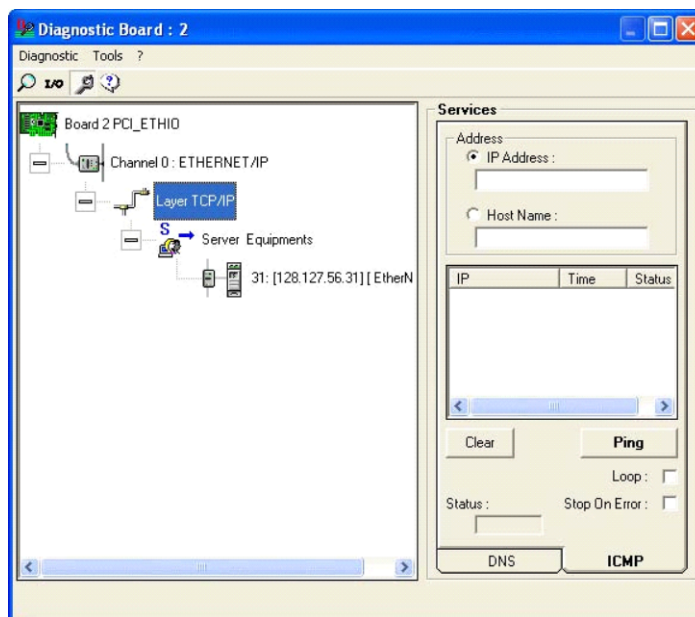

(1) Selects the type of resolution to be carried out.

IP Address : the host name is obtained from the IP address.

Host Name : the IP address is obtained from the host name.

(2) Carries out a resolution.

(3) Status: Status of resolution carried out

0 : No error

33 : Response time-out exceeded

132 : Negative reply from DNS server (SERVER FAILURE, etc.)

2. Ping

ICMP ECHO “PING” functionality can be enabled by selecting the applicomIO menu-[Protocol/Diagnostic···]-the [ICMP] tab.

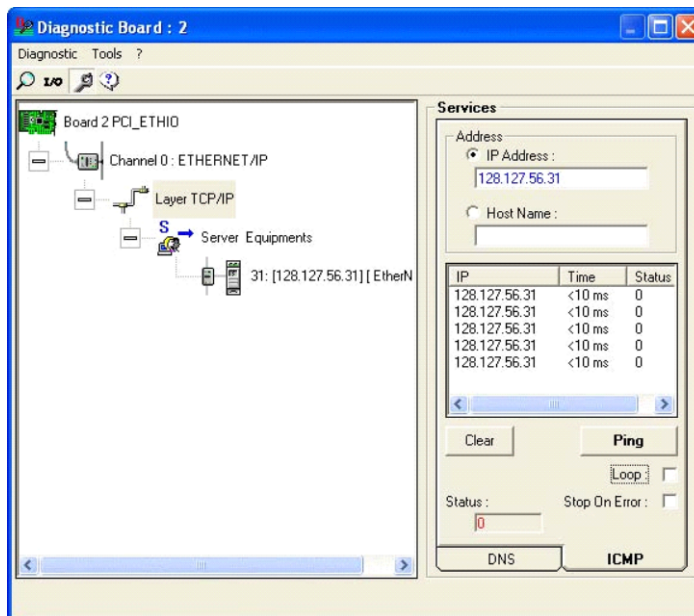

(1) Entry field for the IP address or name of the remote station.

(2) Field showing result obtained:

Status 0 : The station is present and has responded
(the response time is given in the Time column)

Status 33 : The station is not present

(3) Command field:

Clear : Clears the list of results

Ping : Sends a PING command

Loop : Executes PING command in a loop

Stop on Error : If Loop has been selected, stops if an error has occurred

Status : Status of the PING request

0 :OK

33 : TIME-OUT

132: Resolution error

5. Maintenance Parts List

Slave

Part Name	Code
DeviceNet board	R12B040706
PROFIBUS-DP board	R12B040707
CC-Link board	R12B040708
EtherNet/IP board	R12B040719
PROFINET board	R12B040728

Master

Part Name	Code	
DeviceNet board	R12B040701	
PROFIBUS-DP board	PCI-DPIO	R12B040702
	PCU-D2PIO	R12N747191
EtherNet/IP board	R12B040720	

