



# Air Conditioner Product Manual Vertical Wall-Mount Air Conditioners with Gas Heat & Front Control Box Panel

## Installation & Operation Manual

9-10 EER Vertical Wall-Mount  
Air Conditioners w/Gas Heat

### **MODELS:**

AVGA 24-30-36-42-48-60



### IMPORTANT

This manual may include information for options and features which may not be included on the unit being installed. Refer to the unit data label or Model Identification to determine which features and options this unit is equipped with.

**INSTALLER:** Affix the instructions on the inside of the building adjacent to the thermostat.  
**END USER:** Retain this manual for future reference.

*Manufactured By:*

### **A Division of the AIRXCEL® Commercial Group**

P.O. Box 400 • Cordele, Georgia 31010 • 156 Seedling Drive • Cordele, Georgia 31015  
(229) 273-3636 • Fax (229) 273-5154

E-mail: [marvairsales@airxcel.com](mailto:marvairsales@airxcel.com) • Internet: [www.Marvair.com](http://www.Marvair.com)

The most current version of this manual can be found at [www.Marvair.com](http://www.Marvair.com).

## How To Use This Manual

This manual is intended to be a guide to Marvair GPac family of vertical air conditioners. It contains installation, troubleshooting, maintenance, warranty, and application information. The information contained in this manual is to be used by the installer as a guide only. This manual does not supersede or circumvent any applicable national or local codes.

If you are installing the GPac unit, first read Chapter 1 and scan the entire manual before beginning the installation as described in Chapter 2. Chapter 1 contains general, descriptive information and provides an overview which can speed up the installation process and simplify troubleshooting.

If a malfunction occurs, follow this troubleshooting sequence:

1. Make sure you understand how the GPac unit works (Chapters 1 & 3).
2. Identify and correct installation errors (Chapter 2).
3. Refer to the troubleshooting information in Chapter 4.

If you are still unable to correct the problem, contact the Factory at 1-800-841-7854 for additional assistance.

**Please read the following “Important Safety Precautions” before beginning any work.**

## Important Safety Precautions

1. USE CARE when LIFTING or TRANSPORTING equipment.
2. TRANSPORT the UNIT UPRIGHT. Laying it down on its side may cause oil to leave the compressor and breakage or damage to other components.
3. TURN ELECTRICAL POWER OFF AT THE breaker or fuse box BEFORE installing or working on the equipment. LINE VOLTAGES ARE HAZARDOUS or LETHAL.
4. OBSERVE and COMPLY with ALL applicable PLUMBING, ELECTRICAL, and BUILDING CODES and ordinances.
5. SERVICE may be performed ONLY by QUALIFIED and EXPERIENCED PERSONS.
  - \* Wear safety goggles when servicing the refrigeration circuit
  - \* Beware of hot surfaces on refrigerant circuit components
  - \* Beware of sharp edges on sheet metal components
  - \* Use care when recovering or adding refrigerant
6. Use COMMON SENSE - BE SAFETY-CONSCIOUS

This is the safety alert symbol . When you see this symbol on the GPac unit and in the instruction manuals be alert to the potential for personal injury. Understand the signal word DANGER, WARNING, CAUTION and IMPORTANT. These words are used to identify levels of the seriousness of the hazard.



Failure to comply will result in death or severe personal injury and/or property damage.



Failure to comply could result in death or severe personal injury and/or property damage.



Failure to comply could result in minor personal injury and/or property damage.



Used to point out helpful suggestions that will result in improved installation, reliability or operation.

SPECIFICATIONS SUBJECT TO CHANGE WITHOUT NOTICE.

© 03/2019 Airxcel Commercial Group



## WARNING - SAFETY REQUIREMENTS

- If the information in these instructions are not followed exactly, a fire, carbon monoxide poisoning or explosion may result causing property damage, personal injury or loss of life.
- Read all instructions carefully prior to beginning the installation. Do not begin installation if you do not understand any of the instructions.
- Improper installation, adjustment, alteration, service or maintenance can cause property damage, personal injury or loss of life.
- Installation and service must be performed by a qualified installer, service agency or the gas supplier in accordance with these instructions and in compliance with all codes and requirements of authorities having jurisdiction.
- Follow all safety codes.



## AVERTISSEMENT - EXIGENCES POUR LA SÉCURITÉ

- Si les informations contenues dans ces instructions ne sont pas suivies exactement, il peut en résulter un empoisonnement au monoxyde de carbone ou une explosion, causant dommages, blessure ou mort.
- Lisez soigneusement toutes les instructions avant de commencer l'installation. Ne la commencez pas si vous n'avez pas assimilé toutes ces instructions.
- Une mauvaise exécution d'installation, réglage, altération, intervention ou entretien peut causer dégâts matériels et dommages corporels ou même mort.
- Installation et interventions doivent être effectuées par un installateur ou une agence de dépannage qualifiés, ou par le fournisseur de gaz en conformité avec toutes les normes et exigences des autorités ayant juridiction en la matière.
- Respectez toutes les normes de sécurité.

## Table of Contents

### Chapter 1 - Description & Specifications

1.1	General Description .....	5
1.2	Model Identification & Serial Number Date Code .....	5
1.3	Cooling Mode .....	6
1.4	Sequence of Operation - Heating Mode .....	6
1.5	Controls - Standard PC Board.....	7
1.6	Ventilation Options .....	9
1.7	Economizer Operation – Cooling Cycle (Marvair® GPac unit with Economizer only) .....	9

### Chapter 2 – Safe Installation Requirements

2.1	Safety Rules .....	11
-----	--------------------	----

### Chapter 3 – Installation

3.1	Location and Clearances .....	13
3.2	Installation Requirements .....	14
3.3	Dimensional Data .....	16
3.4	Equipment Inspection .....	18
3.5	Clearances .....	18
3.6	Installation Materials .....	19
3.7	Porting and Duct Work .....	20
3.8	General Information .....	20
3.9	Wall Openings .....	20
3.10	Minimum Airflow Requirements .....	20
3.11	Ducting .....	21
3.12	Hanging the AVG Unit on the Wall .....	21
3.13	Gas Supply and Piping .....	22
3.14	Gas Supply Requirements .....	22
3.15	Gas Piping Requirements .....	23
3.16	Electrical Connections .....	25
3.17	Venting of the Furnace .....	29
3.18	Installation of the Vent Hood. ....	29

### Chapter 4 – Checks and Adjustments

4.1	Gas Supply Pressure .....	30
4.2	Manifold Gas Pressure Adjustment .....	30
4.3	Natural Gas Input Rating Check .....	32

4.4	Orifice Sizing .....	32
4.5	LP Gas Conversion .....	33
4.6	High Altitude Installations .....	35
4.7	Changing Orifices .....	36
4.8	Main Burner Flame Check .....	37
4.9	Temperature Rise Range .....	37

## Chapter 5 – Start-up

5.1	Cooling Cycle .....	38
5.2	Heating Cycle .....	38
5.3	Start-Up Checklist.....	40

## Chapter 6 – Maintenance

6.1	Maintenance – Burner and Vent Outlet. ....	41
6.2	Air Filter .....	41
6.3	Indoor Coil .....	41
6.4	Outdoor Coil .....	41
6.5	Cabinet .....	41
6.6	Drains .....	42
6.7	Lubrication .....	42
6.8	Burner Flame .....	42
6.9	Burner .....	43
6.10	Combustion Air Inlet and Outlet .....	43
6.11	Venting of the Furnace .....	43
6.12	Clearances .....	44

## Chapter 7 – Parts List.....

## Chapter 8 – Warranty Policy

8.1	Airxcel Commercial Group Limited Product Warranty.....	47
-----	--	----

## Illustrations

Figure 1.	Electronic Control Board .....	8
Figure 2a.	AVG Models 24/30/36 Dimensional Data .....	16
Figure 2b.	AVG Models 42/48/60 Dimensional Data .....	17
Figure 3.	Mounting the Unit on a Wall.....	21
Figure 4a.	Typical Electrical Schematic - AVG without Economizer.....	27
Figure 4b.	Typical Electrical Schematic - AVG with Economizer.....	28
Figure 5.	Vent Hood Installation .....	29
Figure 6.	Gas Valve Manifold Pressure Tap.....	31
Figure 7.	Gas Valve Protective Cover .....	31
Figure 8.	Gas Valve Manifold Pressure Tap.....	34
Figure 9.	Gas Valve Protective Cover .....	35
Figure 10.	Burner Flame .....	37
Figure 11.	Gas Control Valve Switch.....	38
Figure 12.	Burner Flame .....	42

## Tables

Table 1.	Minimum Clearances from Unprotected Combustible Material and For Service.....	14
Table 2.	Electrical Rating Designations.....	15
Table 3.	Minimum Clearances from Unprotected Combustible Material and For Service.....	18
Table 4.	Gas Pressures .....	22
Table 5.	Natural Gas Input Rating .....	32
Table 6.	Altitude/Orifice Sizing.....	32
Table 7.	Altitude/Orifice Sizing.....	36
Table 8.	Temperature Rise Range.....	37

# 1. Description and Specifications

## 1.1 General Description

The Marvair® GPac line of air conditioners with gas heat are high efficiency vertical wall mounted units that provide cooling and economical gas heating. In addition, various ventilation packages are factory installed for a variety of applications. Nominal cooling capacities are 24,000 BTUH, 30,000 BTUH, 36,000 BTUH, 42,000 BTUH, 48,000 BTUH and 60,000 BTUH with EER's of 8.6. Models AVG24, 30 & 36 are factory set up for natural gas with nominal heating capacities of 45,000 BTUH, 67,5000 BTUH and 90,000 BTUH. Models AVG42, 48 & 60 are factory set up for natural gas with nominal heating capacities are 75,000 BTUH, 100,000 BTUH and 125,000 BTUH. The units are easily field convertible to propane.

GPac air conditioners with gas heat are designed for easy installation. All units have built-in side mounting flanges and are shipped with a bottom support bracket. All units are factory wired and charged. Service ports have been provided for field service, if required. All internal wiring is complete.

**A wide selection of fresh air ventilation packages, all factory installed and tested to insure optimum performance, are available to meet various installation requirements. For school classrooms, models are available to comply with the ASHRAE 62-1999 standard, "Ventilation for Acceptable Indoor Air". The exclusive GreenWheel® energy recovery unit (ERV), provides fresh air while removing both sensible and latent heat form the incoming air stream.**

All GPac air conditioners with gas heat furnaces are tested in accordance with UL standard 1995 and listed by ETL. Performance and Efficiency Ratings are in accordance with the Air Conditioning and Refrigeration Institute (ARI) standard 390.

## 1.2 Model Identification & Serial Number Date Code

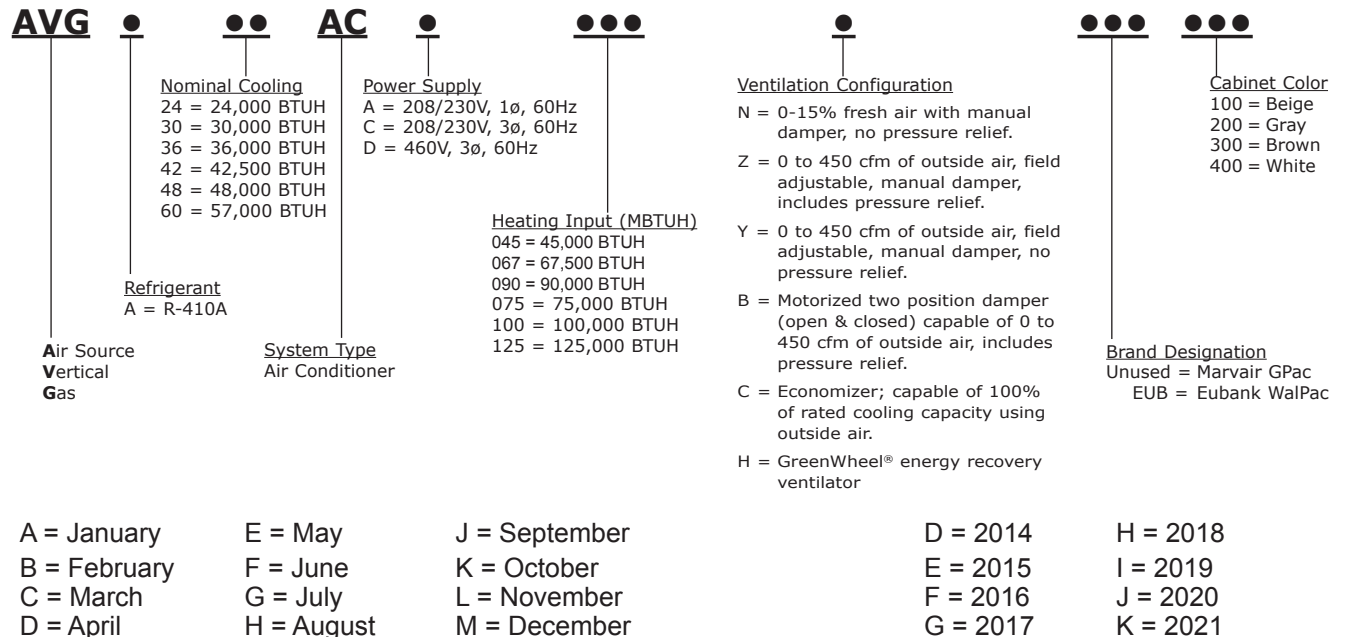

### 1.3 Cooling Mode

GPac air conditioners with gas heat use R410A refrigerant in a conventional vapor-compression refrigeration cycle to transfer heat from air in an enclosed space to the outside. A double blower assembly blows indoor air across the evaporator. Cold liquid refrigerant passing through the evaporator is boiled into gas by heat removed from the air. The warmed refrigerant gas enters the compressor where its temperature and pressure are increased. The hot refrigerant gas condenses to liquid as heat is transferred to outdoor air drawn across the condenser by the condenser fan. Liquid refrigerant is metered into the evaporator through capillary tubes to repeat the cycle.

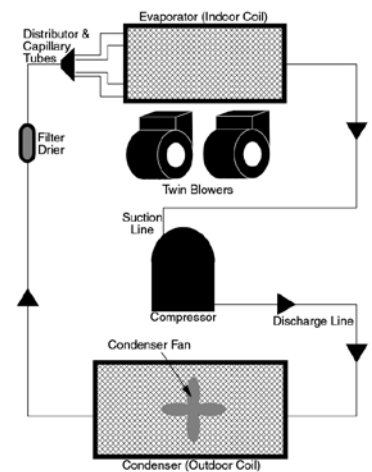

### 1.4 Sequence of Operation - Heating Mode

1. On a call for heat, two stage thermostat contact(s) close, providing 24 VAC to “4” terminal on the ignition control.
2. Draft inducer is energized at high speed (B-W leads) at line voltage.
3. Air Pressure Switch (APS) closes, initiating 30 second prepurge.
4. At end of 30 second prepurge period, Spark & Gas Valve are energized for up to 5 second ignition trial. Gas valve will open in either low or high fire position, depending upon the heat requirements and contact closure in the thermostat.
5. Burners ignite and carryover.
6. Flame is detected by flame sensor and control operates in steady state heating position.
7. The two stage thermostat powers the low fire contact continuously on a call for heat and will close the high fire contact if necessary to meet heat requirements. Unit continues in operation in either low or high fire until the thermostat set point is reached.
8. Low fire contact in thermostat opens, interrupting power to “4” terminal on control and closing the gas valve.
9. The Draft inducer continues to run for a 60 second post purge period.
10. The control system is capable of three retrials if the above sequence is interrupted at any point.

*If the above sequence does not occur then:*

11. If ignition is not achieved within 5 seconds, the gas valve is shut off, the inducer keeps running for an inter-purge period of 60 seconds and additional trials follow the specified sequence. If all 3 trials for ignition have occurred without proper ignition and flame detection, the control is locked out.
12. Control may be brought out of lock out by a. turning the thermostat to OFF for a minimum of 5 seconds and then ON, or b. turning the disconnect to OFF for a minimum of 5 seconds and then ON. Control will automatically also attempt another ignition sequence one hour after a lockout occurrence.
13. If flame is lost once it has been established, the control will shut off the gas supply within .8 seconds and enter the inter-purge period. Control will initiate up to 3 additional trials per normal sequence of operation. (To restart, refer to item 12).
14. If flame sensor indicates presence of a flame during the purge period when no flame is present, the inducer will remain energized, but the gas valve will not be energized until the cause of the false flame is removed.

15. If the air pressure switch (APS) is closed when the inducer is energized or does not close after the inducer is energized, the control will wait one minute for the air switch to open or close and then lock out. (To restart, refer to item 12).
16. If the control detects power to the gas valve when the it should be off or no power when it should be on, the control will go into lockout with all outputs off. (To restart, refer to item 12).

The AVG gas heat and air conditioner has a LED indicator that shows operating status and simplifies service by flashing fault codes.

<b>On-Steady</b>	<b>Control Operation Normal</b>
<b>1 Flash</b>	Open Air pressure switch, limit switch or flame rollout switch
<b>2 Flashes</b>	Pressure switch stuck closed
<b>3 Flashes</b>	Ignition/flame sensor failure
<b>4 Flashes</b>	Repeated flame loss
<b>5 Flashes</b>	Internal control fault
<b>6 Flashes</b>	Repeated pressure switch losses

**LED Flash Code Key**

## **1.5 Controls - Standard PC Board**

### **Normal**

24 VAC power must be continuously applied to “R” and “C”. Upon a call for cooling “Y” and with the high pressure switch (HPS) closed, the compressor will be energized. (Note: See the delay on make feature.) The compressor will remain energized during the 3 minute timed low pressure by-pass cycle. If the low pressure switch (LPS) is open after the 3 minute by-pass cycle, the compressor will de-energize.

### **Lock-out**

If either of the fault conditions (LPS or HPS) occurs twice, the control board will enter into and indicate the lockout mode. In the lockout mode, the compressor is turned off. If there is a call for indoor air flow “G”, the blower remains energized, the alarm output is energized and the status led will blink to indicate which fault has occurred. When the lockout condition is cleared, the unit will reset if the demand for the thermostat is removed or when the power is reset. With the control board, the user can now have either normally closed or normally open contacts by moving a wire on the control board. GPac air conditioners with gas heat are factory wired to be normally open.

### **Delay on Break**

If the compressor is de-energized due to a loss of a cooling “Y” call or the first fault, the unit re-start will be delayed 3 minutes from the time the contactor is de-energized. (Note: There is no delay on break if the lockout condition is reset.)

### **Delay on Make**

On initial power up only, the unit will wait 0.03 to 10 minutes from the cooling “Y” call before allowing the contactor to energize. The delay can be adjusted by the DOM wheel on the board. Factory recommended wait is 3 minutes.

### **Low Pressure By-Pass Time**

When starting, the low pressure switch (LPS) fault condition will be by-passed for 3 minutes before the contactor is de-energized.

## **Post Purge**

Upon a call for indoor airflow “G” the blower will energize immediately. When in the cooling mode, the blower will remain energized for 10 to 90 seconds (adjustable) after the compressor has been de-energized. The time period can be changed by fan purge wheel on the board. Factory setting is 90 seconds.

## **LED Indicator Lights**

COLOR	TYPE	STATUS	DESCRIPTION
Green	Power	Constant On	24 VAC power has been applied
		Constant On	Normal operation
		1 Blink	High pressure switch has opened twice
Red	Status	2 Blinks	Low pressure switch has opened twice

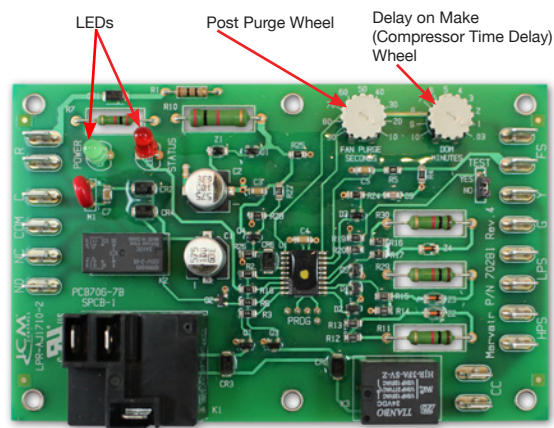

**Figure 1. Electronic Control Board**

## **Low Ambient Control**

The low ambient control permits cooling when outdoor ambient temperatures are low. The control uses a reverse-acting high pressure switch to cycle the condenser fan motor according to liquid refrigerant pressure conditions. Switch closure and fan operation occurs when the pressure reaches 250 PSIG. The switch opens again when the refrigerant pressure falls to 190 PSIG. Therefore, the outdoor fan always starts after the compressor, and it will cycle frequently during normal operation at low outdoor conditions.

## **High Pressure Switch**

The high pressure switch is mounted on the compressor discharge line. It is electrically connected to a lockout relay which shuts down the system if the refrigerant pressure rises to 400 PSIG (AVP60 setting is 450 PSIG). This protects the unit if airflow through the condenser is blocked or if the outdoor fan motor fails.

Although the contacts of the high pressure switch close when the refrigerant pressure falls to approximately 300 PSIG, the system must be manually reset once the lockout relay is activated. A manual reset is necessary to prevent harmful short-cycling. To reset switch, turn primary power off, then back on or turn thermostat system switch off, then back on.

## **Low Pressure Switch**

The low pressure switch is mounted on the compressor suction line. It is designed to open if the refrigerant pressure drops to 35 PSIG; it resets when the pressure rises to 60 PSIG. The switch protects the unit if airflow through the indoor blower is impeded, if the blower motor fails, or if there is a loss of refrigerant.



## 1.6 Ventilation Options

- Manual damper capable of up to 15% of rated airflow of outside air; field adjustable, no pressure relief. (Standard - Ventilation Configuration N)
- Manual damper capable of 0 to 450 cfm (maximum of 40% of rated airflow) of outside air; field adjustable, no pressure relief. (Optional - Ventilation Configuration Y)
- Manual damper capable of 0 to 450 cfm (maximum of 40% of rated airflow) of outside air; field adjustable, includes pressure relief. (Optional - Ventilation Configuration Z)
- Motorized, two position damper (open and closed) capable of 0 to 450 cfm (maximum of 40% of rated airflow) of outside air; includes pressure relief. A 24-volt actuated motor controls the damper from an external input such as: a time clock, CO2 sensor, energy management system or manual switch. (Optional - Ventilation Configuration B)
- GreenWheel® Operation (Ventilation Option "H")

The GreenWheel® is a total energy (both sensible and latent) wheel that reduces both construction and operating cost while ventilating the classroom to ASHRAE 62-1999 requirements. The use of the GreenWheel ERV reduces the energy load of the outside air. Exhausting stale, inside air keeps indoor pollutants and harmful gases to a minimum. The GreenWheel ERV has been tested and certified according to ARI Standard 1060.

### How It Works

During the summer, cool dry air from the classroom is exhausted through the GreenWheel® ERV to the outside. As the air passes through the rotating wheel, the desiccant becomes cooler and drier. Simultaneously, hot humid air is being pulled across the rotating wheel. The cool, dry desiccant absorbs moisture and heat from the incoming air. The cooler, drier air is mixed with the return air from the classroom and distributed throughout the room.

In the winter, warm moist air is exhausted through the GreenWheel® ERV to the outside. As the air passes through the rotating wheel, the desiccant becomes warmer and absorbs moisture. Simultaneously, cold dry air is being pulled across the rotating wheel. The cold, dry air absorbs heat and moisture from the desiccant. The warmed air is mixed with the return air from the classroom and distributed throughout the room.

### Quality Components

The GreenWheel® module consists of a desiccant wheel, two blowers and the drive motor and belt. The two blowers simultaneously pull fresh air from outside and exhaust air from the classroom through the rotating wheel. The air streams are separated by an insulated partition so that the incoming fresh air is not mixed with the exhaust air. Two variable speed blowers ensure that up to 450 CFM of outside air can be brought into the room and the indoor air is properly exhausted. Variable speed blowers permit that the desired quantity of outside air is delivered into the room. Optional independent exhaust air blower control allows positive pressurization of the classroom, i.e., more outside air can be introduced through the GreenWheel ERV than is exhausted.

## 1.7 Economizer Operation – Cooling Cycle *(Marvair GPac unit with Economizer only)*

The economizer is a regulated damper system with controls. The damper regulates the circulation of outside air into the enclosure (when the outdoor air conditions are suitable) to reduce the need for mechanical cooling, save energy, and extend compressor life.

Depending upon the options selected, the damper responds to either enthalpy or dry bulb temperature of the outdoor air. On a call for cooling from a space thermostat, it operates as follows:

When the enthalpy of the outdoor air is below the set point, the outdoor air damper is proportioned open (and return air damper is proportioned closed) to maintain between 50°F and 56°F at the mixed/discharge air sensor.

When the enthalpy of the outdoor air is above the set point, the outdoor air damper closes to its minimum position. A call for cooling from the space thermostat brings on mechanical cooling.

An optional built-in adjustable minimum position potentiometer, p/n 70012, controls the amount of outdoor air admitted to meet minimum ventilation requirements.

## 2. Safe Installation Requirements

### WARNING - SAFETY REQUIREMENTS

**Improper adjustment, alteration, service, maintenance or installation could cause serious injury, death and/or property damage.**

**Installation or repairs made by unqualified persons could result in hazards to you and others. Installation MUST conform with local codes or, in the absence of local codes, with codes of all governmental authorities have jurisdiction.**

**The information contained in this manual is intended for use by a qualified service agency that is experienced in such work, is familiar with all precautions and safety procedures required in such work, and is equipped with the proper tools and test instruments.**

### AVERTISSEMENT DANGER D'INCENDIE, EXPLOSION OU ASPHYXIE

**Une mauvaise exécution d'installation, réglage, altération, intervention ou entretien peut causer dégâts matériels et dommages corporels ou même mort.**

**Une installation ou des réparations faites par des personnes non qualifiées peuvent entraîner des dangers pour vous et les autres. L'installation DOIT être faite en conformité avec les normes locales, ou en leur absence avec les normes des autorités nationales ayant juridiction en la matière.**

**Les informations contenues dans ce manuel sont prévues pour être utilisées par une agence de dépannage qualifiée, ayant de l'expérience dans ce type de travaux, familière avec les précautions et procédures de sécurité que cela implique, et équipée des outils et instruments de test adéquats.**

### WARNING - CARBON-MONOXIDE POISONING HAZARD

**Failure to follow instructions could result in severe personal injury or death due to carbon-monoxide poisoning, if combustion products infiltrate into the building.**

**Check that all openings in the outside wall around the vent (and air intake) pipe(s) are sealed to prevent infiltration of combustion products into the building.**

**Check that furnace vent (and air intake) terminal(s) are not obstructed in any way during all seasons.**

### AVERTISSEMENT - RISQUE D'INTOXICATION AU MONOXYDE DE CARBONE

**Si ces directives ne sont pas suivies, cela peut entraîner des blessures graves ou une intoxication au monoxyde de carbone pouvant causer la mort, si des produits de combustion s'infiltrent dans le bâtiment.**

**Vérifier que toutes les ouvertures pratiquées dans le mur extérieur autour du ou des tuyaux d'évent (at de la prise d'air) sont scellées de manière à empêcher l'infiltration de produits de combustion dans le bâtiment.**

**Veiller à ce que la ou les sorties de l'évent de l'appareil de chauffage (et la prise d'air) ne soient, en aucune façon, obstruées, quelle que soit la saison.**

**NOTE:** This furnace is design-certified by the CSA International (formerly AGA and CGA) for installation in the United States and Canada. Refer to the appropriate codes, along with this manual, for proper installation.

- Use only the Type of gas approved for this furnace (see Rating Plate on unit). Overfiring will result in failure of heat exchanger and cause dangerous operation. (Furnaces can be converted to LP gas with approved kit.)
- Install this furnace only in a location and position as specified in the Installation Requirements section of these instructions.
- Provide adequate combustion and ventilation air to the furnace as specified in Venting the Furnace section of these instructions. Vent this furnace only as specified in Venting the Furnace.
- The AVG air conditioner with gas heat is only to be installed on the exterior of a building.
- Never test for gas leaks with an open flame. Use a commercially available soap solution made specifically for the detection of leaks to check all connections, as specified in Gas Supply and Piping, Final Check check of these instructions.
- Always install furnace to operate within the furnace's intended temperature rise range with a duct system which has an external static pressure within the allowable range, as specified in Porting and Ductwork section of these instructions and on the data plate.
- Supply ducts and the return air shall be handled by a duct(s) sealed to the furnace casing as specified in Porting and Ductwork.
- Seal around supply and return air ducts.
- Install correct filter type and size.

## 2.1 Safety Rules

Your unit is built to provide many years of safe and dependable service providing it is properly installed and maintained. However, abuse and/or improper use can shorten the life of the unit and create hazards for you, the owner.

- A. The U.S. Consumer Product Safety Commission encourages installation of carbon monoxide alarms. There can be various sources of carbon monoxide in a building or dwelling. The sources could be gas-fired clothes dryers, gas cooking stoves, water heaters, furnaces, gas-fired fireplaces, wood fireplaces, and several other items.

Carbon monoxide can cause serious bodily injury and/or death. Carbon monoxide or “CO” is a colorless and odorless gas produced when fuel is not burned completely or when the flame does not receive sufficient oxygen.

Therefore, to help alert people of potentially dangerous carbon monoxide levels, you should have a commercially available carbon monoxide alarm that is listed by a nationally recognized testing agency in accordance with Underwriters Laboratories, Inc. Standard for Single and Multiple Station Carbon Monoxide Alarms, ANSI/UL 2034 or the CSA 6.19-01 Residential Carbon Alarming Devices installed and maintained in the building or dwelling concurrently with the gas-fired furnace installation (see Note below). The alarm should be installed as recommended by the alarm manufacturer’s installation instructions.

- B. There can be numerous sources of fire or smoke in a building or dwelling. Fire or smoke can cause serious bodily injury, death and/or property damage. Therefore, in order to alert people of potentially dangerous fire or smoke, you should have fire extinguisher and smoke alarms listed by Underwriters Laboratories installed and maintained in the building or dwelling (see note below).

***NOTE:*** Airxcel Commercial Group does not test any alarms and makes no representations regarding any brand or type of alarms.

C. To ensure safe and efficient operation of your unit, you should do the following:

1. **Thoroughly read this manual and labels on the unit.** This will help you understand how your unit operates and the hazards involved with gas and electricity.
2. **Do not use this unit if any part has been under water.** Immediately call a quality service agency to inspect the unit and to replace any part of the control system and any gas control which has been under water.
3. **Never obstruct the vent grilles, or any ducts that provide air to the unit.** Air must be provided for proper combustion and ventilation of flue gases.

 **WARNING**  
**FROZEN AND BURST WATER PIPE HAZARD**

**Failure to protect against the risk of freezing could result in property damage and/or personal injury.**

**Do not leave the structure unattended for long periods during freezing weather without turning off water supply and draining water pipes or otherwise protecting against the risk of frozen pipes and resultant damage.**

 **AVERTISSEMENT**  
**DANGER DE GEL ET D'ÉCLATEMENT DES CONDUITES D'EAU**

**Le manque de protection contre le risque de gel peut entraîner des dégâts matériels et/ou des blessures corporelles.**

**Ne laissez pas la structure sans surveillance durant de longues périodes à la saison où il peut geler sans avoir auparavant coupé toutes les alimentations en eau et vidangé les conduites d'eau, ou bien protégez les conduites contre le gel et les dommages qui peuvent en résulter..**

Your furnace is designed solely to provide a safe and comfortable living environment. The furnace is NOT designed to ensure that water pipes will not freeze. It is equipped with several safety devices that are designed to turn the furnace off and prevent it from restarting in the event of various potentially unsafe conditions.

If your furnace remains off for an extended time, the pipes in the structure could freeze and burst, resulting in serious water damage.

If the structure will be unattended during cold weather, you should take these precautions:

1. Turn off the water supply to the structure and drain the water lines if possible and add an antifreeze for potable water to drain traps and toilet tanks. Open faucets in appropriate areas. OR
2. Have someone check the structure frequently during cold weather to make sure it is warm enough to prevent pipes from freezing. Instruct them on a service agency to call to provide service if required.
3. Install a reliable remote sensing device that will notify somebody of freezing conditions within the structure.

D. Important Safety Precautions

 **WARNING**

**TURN ELECTRICAL POWER OFF AT THE breaker or fuse box BEFORE installing or working on the equipment. LINE VOLTAGES ARE HAZARDOUS or LETHAL.**

 **AVERTISSEMENT**

**COUPEZ L'ALIMENTATION ÉLECTRIQUE, au niveau du disjoncteur ou du fusible en amont, AVANT l'installation de cet équipement ou une intervention dessus. LES TENSIONS D'ALIMENTATION SECTEUR SONT DANGEREUSES OU MORTELLES.**

1. USE CARE when LIFTING or TRANSPORTING equipment.
2. TRANSPORT the UNIT UPRIGHT. Laying it down on its side may cause oil to leave the compressor or other problems, resulting in DAMAGE upon START-UP.
3. OBSERVE and COMPLY with ALL applicable PLUMBING, ELECTRICAL, and BUILDING CODES & ordinances.
4. SERVICE may be performed ONLY by QUALIFIED and EXPERIENCED PERSONS.
  - Wear safety goggles when servicing the refrigeration circuit
  - Beware of hot surfaces on refrigerant circuit components.
  - Beware of sharp edges on sheet metal components
  - Use care when reclaiming or adding refrigerant.
5. Use COMMON SENSE - BE SAFETY CONSCIOUS.

## 3. Installation

 **WARNING**

**CARBON MONOXIDE POISONING HAZARD**

Failure to properly vent this furnace or other appliances could result in death, personal injury and/or property damage.

If this furnace is replacing a previously common-vented furnace, it may be necessary to resize the existing vent system to prevent oversizing problems for the other remaining appliance(s). See *Venting the Furnace* section of this instruction.

 **AVERTISSEMENT**

**DANGER D'EMPOISONNEMENT AU MONOXYDE DE CARBONE**

Un défaut de ventilation pour cette chaudière ou d'autres appareils peut causer la mort, des dommages corporels et/ou des dégâts matériels.

Si cette chaudière remplace une chaudière précédente à ventilation partagée, il pourra être nécessaire de redimensionner le système de ventilation existant pour éviter des problèmes de surdimensionnement au niveau du ou des autres appareils. Reportez-vous à la section *Ventilation de la chaudière* dans ce manuel d'instructions.

### 3.1 Location and Clearances

Choose the location or evaluate the existing location based upon the minimum clearance and furnace dimensions.

MODEL	Min. Clearance From the Front	Min. Clearance Around Both Sides	Min. Clearance Above the Unit	Min. Clearance Below the Unit	Min. Clearance Around the Flue Vent or Pipe
AVG24/30/36	36"	19"	2"	0"	18"
AVG42/48/60	36"	19"	2"	0"	18"

**Table 1. Minimum Clearances from Unprotected Combustible Material and For Service**

 **WARNING**  
**CARBON MONOXIDE POISONING HAZARD**

Failure to follow safety warnings could result in serious injury, death, or property damage.

Do NOT operate furnace in a corrosive atmosphere containing chlorine, fluorine or any other damaging chemicals which could harm the furnace and vent system, and permit spillage of combustion products into an occupied space.

Refer to *Venting the Furnace* section, contaminated combustion air for combustion air evaluation and remedy.

 **AVERTISSEMENT**  
**DANGER D'EMPOISONNEMENT AU MONOXYDE DE CARBONE**

La non-observation des AVERTISSEMENTS de sécurité peut causer des blessures graves ou mortelles ou des dégâts matériels.

NE faites PAS fonctionner la chaudière dans une atmosphère corrosive contenant chlore, fluor ou tout produit chimique détériorant qui pourrait attaquer la chaudière et le système de ventilation, et permettre le déversement de produits de combustion dans un lieu habité.

Reportez-vous à la section *Ventilation de la chaudière, air de combustion contaminé, pour une évaluation de l'air de combustion et les remèdes s'il y a lieu.*

### 3.2 Installation Requirements

1. Install furnace level.
2. Install the vent pipes as short as practical. (See *Venting the Furnace* section).
3. Maintain clearance for fire safety and servicing. See Table 1 for minimum clearances.
4. Furnace must be located or physically protected from possible damage by a vehicle.
5. When the unit is installed on a new building, make sure that:
  - a. The air temperature rise is within the rated rise range on the furnace rating plate, and the firing rate has been set to the rating plate value.
  - b. The filters used to clean the circulating air during the construction process must be either changed or thoroughly cleaned prior to occupancy.
  - c. The furnace, ductwork and filters are cleaned as necessary to remove drywall duct and construction debris from all HVAC system components after construction is completed.
  - d. Verify proper furnace operating conditions including ignition, gas input rate, and venting according to these installation instructions.
6. The AVG wall mounted air conditioner with gas heat furnace is designed to be installed on the EXTERIOR wall of a building. Do NOT install this unit in an interior space.
7. The AVG unit is not certified or suitable for use in drying or process applications. Use in such

applications voids any warranty and Airxcel Commercial Group disclaims any responsibility for the duct furnace and/or application.

8. The AVG unit is not designed for use in hazardous atmospheres containing flammable vapors or combustible dust, in atmospheres containing chlorinated or halogenated hydrocarbons, or in applications with airborne substances containing silicone.
9. The presence of chlorine vapors in the combustion air supply to gas fired heaters presents a substantial corrosion hazard.
10. The use and storage of gasoline or other flammable vapors and liquids in the vicinity of the AVG unit is hazardous.
11. Install the unit so that the least amount of noise will be transmitted to the living spaces.
12. Condensate is produced during the cooling cycle. This condensate must be disposed of to a suitable location.
13. In the cooling mode, condenser air is drawn in through the sides of the unit and discharged through the coil in the front of the unit. Both the intake and exhaust air must not be impeded or restricted by shrubbery or any other obstructions.
14. The power supply must have the appropriate voltage, phase and ampacity for the model selected. Refer to the data plate on the unit for ampacity requirements. Voltage must be maintained above minimum levels and below maximum levels shown below.

<b>Electrical Rating Designations*</b>	<b>A</b>	<b>C</b>	<b>D</b>
<b>Nominal Voltage</b>	208/230	208/230	460
<b>Phase</b>	1	3	3
<b>Minimum Voltage</b>	197	197	414
<b>Maximum Voltage</b>	253	253	506

\*Letters refer to model number code designations. Refer to Model Identification on page 5.

**Table 2. Electrical Rating Designations**

15. The AVG air conditioner with gas heat may be used for heating and cooling in buildings under construction provided that ALL installation procedures described in this manual are followed including, but not limited to:
  - a. The unit must be properly vented,
  - b. The unit must be controlled by a thermostat,
  - c. The return air duct must be sealed to the unit,
  - d. The air filters must be in place,
  - e. The input rate and the temperature rise must be within the range shown on the data plate on the unit,
  - f. The unit must be installed on the exterior of the building for providing outdoor air for combustion, and
  - g. Return air temperature between 55°F (13°C) and 80°F (27°C)

Upon the completion of the construction process, the unit, duct work and components must be cleaned and the proper operation of the furnace verified including ignition, input rate, temperature rise and venting as described in this manual.

### 3.3 Dimensional Data

MODEL	A	B	C	D	E	F	G	H	I	J	K	L	M	N	O	P	Q	R	S	T	U
AVG24/30/36	41-1/2	25-5/16	76-1/2	10	18-1/4	14	35-1/8	28	3-3/8	38-7/8	36-7/8	1-1/8	43	28	26	2	76-1/4	2	52-3/4	2-9/16	62 3/8

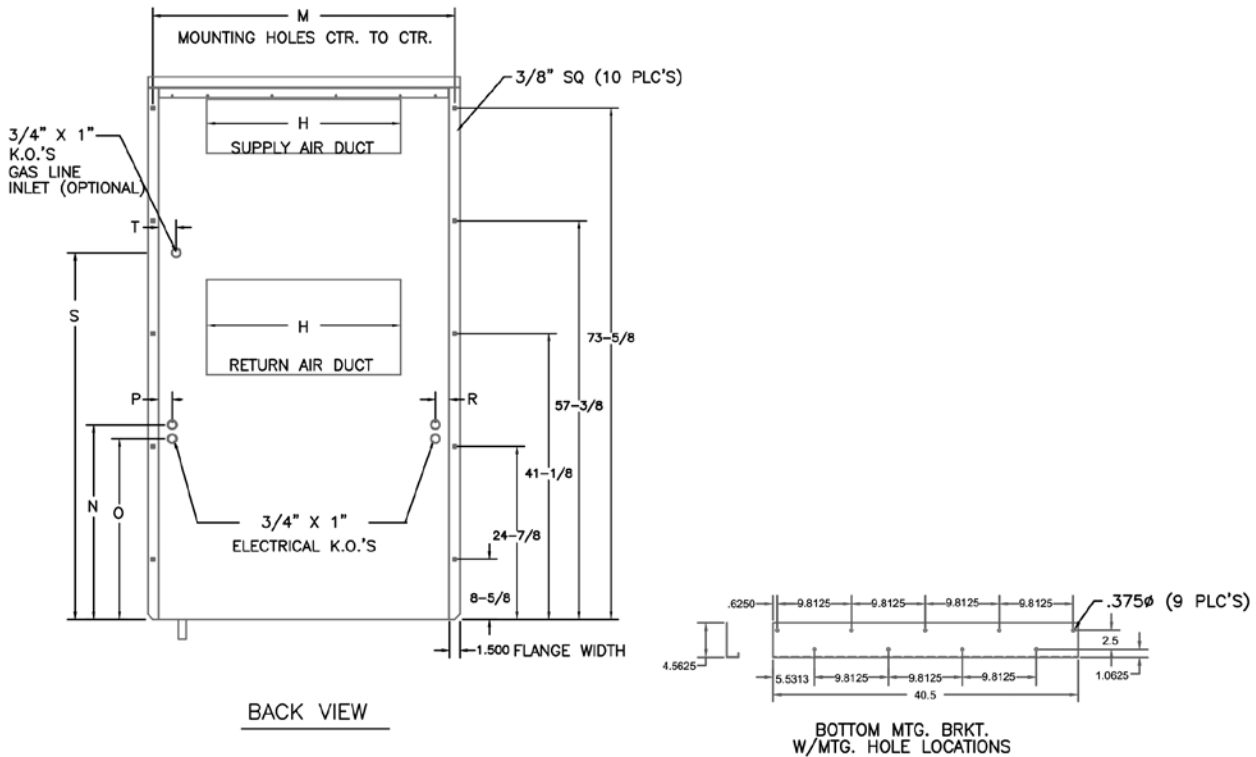
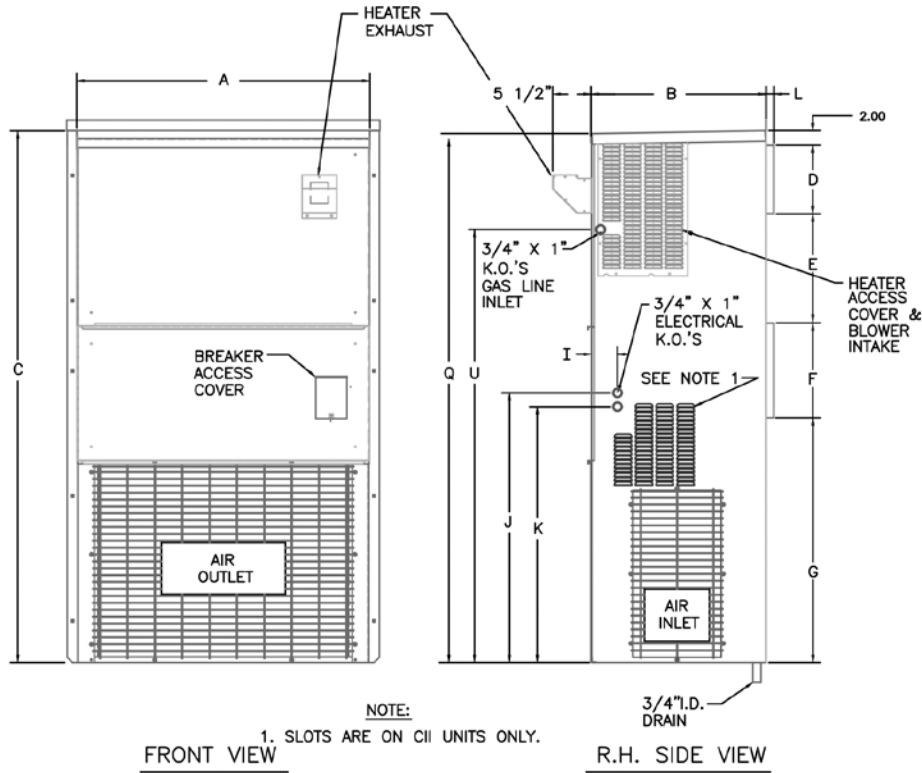

**Figure 2a. AVG Models 24/30/36 Dimensional Data**



MODEL	A	B	C	D	E	F	G	H	I	J	K	L	M	N	O	P	Q	R	S	T	U
42/48/60	42-1/8	29-3/8	84-1/2	10	30	16	26-1/2	30	1-5/16	36-15/16	34-15/16	1-1/8	43-1/2	32-3/8	30-3/8	1.250	83.30	1.725	60-11/16	2-9/16	69 3/4

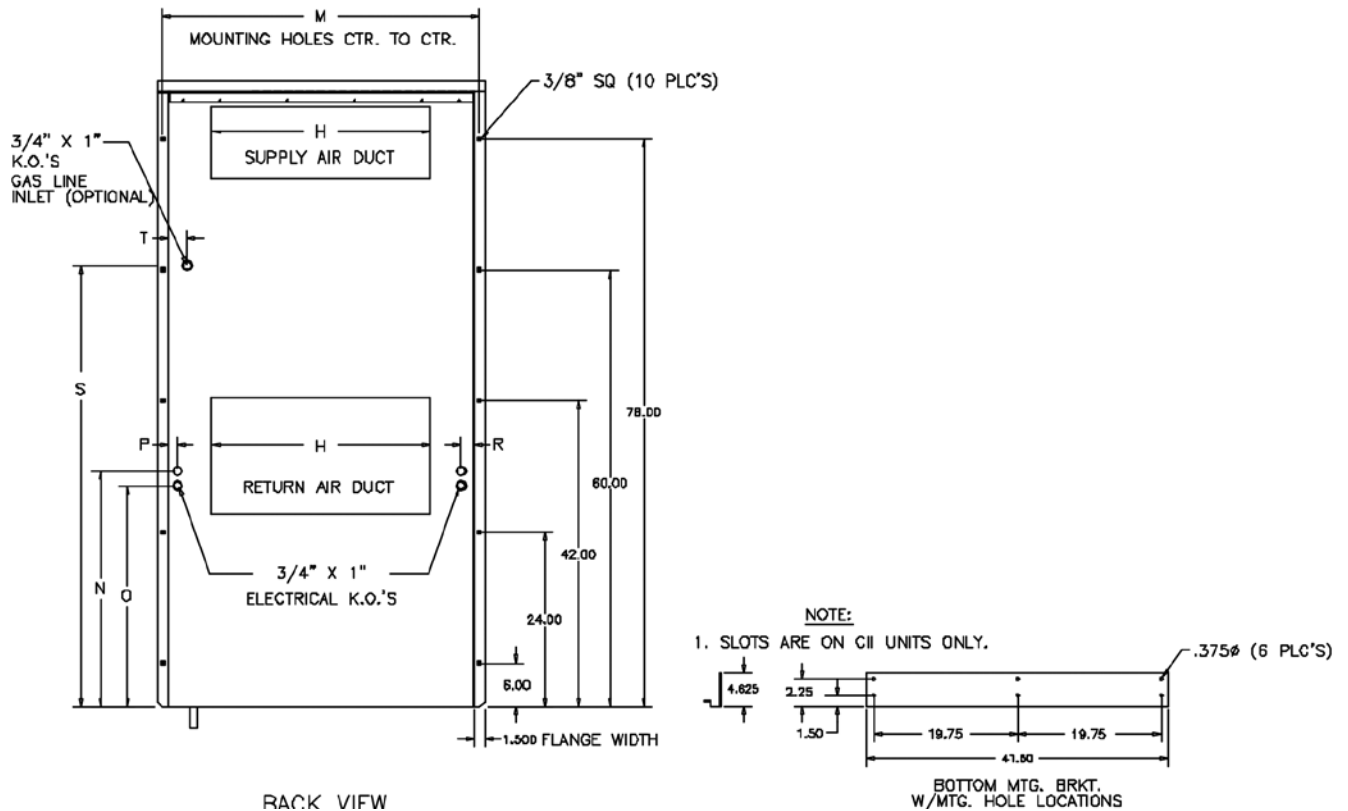
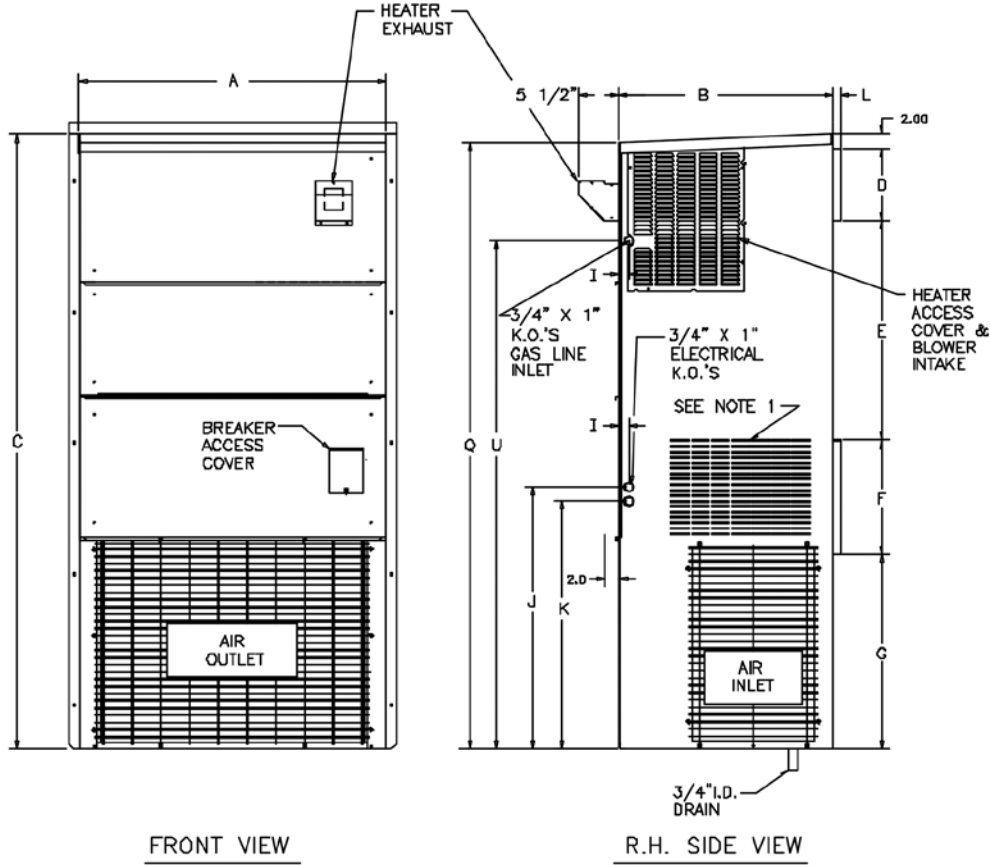

**Figure 2b. AVG Models 42/48/60 Dimensional Data**

### 3.4 Equipment Inspection

#### Concealed Damage

Inspect all cartons and packages upon receipt for damage in transit. Remove cartons and check for concealed damage. Important: Keep the unit upright at all times. Remove access panels and examine component parts. (Note: The top (optional) and bottom brackets are stored in the condenser air compartment. Remove them before replacing the side screen). Inspect refrigerant circuit for fractures or breaks. The presence of refrigerant oil usually indicates a rupture. If damage is apparent, immediately file a claim with the freight carrier.

Units that have been turned on their sides or tops may have concealed damage to compressor motor mounts, to the oil system or to other components. If the unit is not upright, immediately file a claim for concealed damages and follow these steps:

1. Set unit upright and allow to stand for 24 hours with primary power turned on.
2. Attempt to start the compressor after 24 hours.
3. If the compressor will not start, makes excessive noise, or will not operate, return the unit to the freight carrier.

#### General

1. Inspect unit for completeness. Check for missing parts (e.g. hardware). Refer to the installation kit information in section 5.6, Installation Kits.
2. Remove access panels and check for loose wires. Tighten screw connections.
3. Complete and mail the warranty registration card.

### 3.5 Clearances

The sides and front of the unit must be kept free of any obstructions or anything that impedes or restricts the movement of intake or exhaust air. Follow local codes.

 **WARNING**  
**CARBON MONOXIDE, FIRE OR EXPLOSION HAZARD**

**Failure to have the minimum clearances could result in severe personal injury or death.**

 **AVERTISSEMENT**  
**DANGER DE MONOXYDE DE CARBONE, D'INCENDIE OU D'EXPLOSION**

**Ne pas respecter les écartements minimum peut entraîner des blessures graves voire mortelles.**

MODEL	Min. Clearance From the Front	Min. Clearance Around Both Sides	Min. Clearance Above the Unit	Min. Clearance Below the Unit	Min. Clearance Around the Flue Vent or Pipe
<b>AVG24/30/36</b>	36"	19"	2"	0"	18"
<b>AVG42/48/60</b>	36"	19"	2"	0"	18"

**Table 3. Minimum Clearances from Unprotected Combustible Material and For Service**

After the unit has been installed, make sure that the unit is level.

### 3.6 Installation Materials

#### Installation Kits

GPac air conditioners with gas heat have built-in mounting flanges that function as side brackets. All models require and are shipped with a bottom mounting bracket. There is also an air intake hood packed inside each unit and a vent hood.

#### Standard Kit Components

1. One 12 Ga. “L”-shaped bottom bracket

The package may include other factory-supplied items ( optional ) listed below and on the following page:

#### Part # Description

##### ***Thermostats***

- |       |  |
|-------|--|
| 50121 | Digital thermostat. 1 stage heat, 1 stage cool. Non-programmable. Fan switch: Auto & On. Manual changeover system switch: Cool-Off-Heat. Low temperature protection. °F or °C.   |
| 50123 | Digital thermostat. 1 stageheat, 1 stagecool. 7 dayprogrammable. Fanswitch:Auto& On.Auto-change over. Keypad lockout. Non-volatile program memory. Title 24 compliant - no batteries needed.   |
| 50124 | Digital thermostat. 1 stage heat, 1 stage cool. 7 day programmable. Fan switch: Auto & On. Manual changeover system switch. LCD display. Title 24 compliant - no batteriesneeded.  |
| 50100 | Seven day programming. Two occupied and two unoccupied periods per day. Individual heat and cool setpoints. Manual or automatic changeover. System switch: Off, Cool, Heat, Emergency Heat. Fan Switch: Auto & On. Keypad lockout available. Ventilation terminals. No batteries required. Display indicates when Auxiliary Heat or Emergency Heat are activated. Requires a 50101 sub-base if used on a heat pump or a 50109 if used on an air conditioner. |
| 70076 | Internal Thermostat - Factory Installed 1 Stage Heat, 1 Stage Cool withAuto Changeover, Eliminates need for External Wall Mount T’Stat and Sub-Base.   |
| 50092 | Thermostat Guard. For use with the 50107, 50122, 50121, 50123 and 50124.   |

##### ***Supply Grilles***

- |       |   |
|-------|---|
| 80675 | 28 x 8” Adjustable, Aluminum, Double Deflection Supply Grille for AVG 24-30-36  |
| 80676 | 30 x 10” Adjustable, Aluminum, Double Deflection Supply Grille for AVG 42-48-60 |

##### ***Return Grilles***

- |       |  |
|-------|--|
| 80678 | 28 x 14” Aluminum Return Grille for AVG 24-30-36 |
| 80679 | 30 x 16” Aluminum Return Grille for AVG 42-48-60 |

#### Additional Items Needed:

Additional hardware and miscellaneous supplies (not furnished) are needed for installation. For example, the list below contains approximate quantities of items typically needed for mounting a unit on a wood frame wall structure with standard full length mounting bracket or flanges. Concrete or fiberglass structures have different requirements.

- (10) **3/8” mounting bolts** or lag screws for side brackets and anchors, if required for side brackets.
- (20) **3/8” washers**
- (10) **3/8” hex nuts**
- (6) **3/8” x 2-1/2” lag screws** for bottom bracket
- **Silicone Sealer** to seal around cracks and openings
- **7-conductor low voltage multi-colored wire cable** (i.e. thermostat wire)
- Appropriate electrical supplies such as conduit, electrical boxes, fittings, wire connectors, etc.
- **High voltage wire**, sized to handle the MCA (minimum circuit ampacity) listed on the dataplate.
- **Over-Current Protection Device** sized in accordance with the MFS (maximum fuse size) listed on the unit data plate.

Duct materials usually are also needed in addition to the mounting hardware. To save time, design the duct work before mounting the unit.

### 3.7 Porting and Duct Work

 <b>WARNING</b> <b>FIRE AND CARBON MONOXIDE POISONING HAZARD</b>
<p>Failure to properly install the duct work could result in death, bodily injury and/or property damage. In each installation, the duct system must be properly engineered and installed to insure sufficient air flow to prevent overheating. All units must have at least one inch clearance on all four sides of the supply outlet duct flange on the unit. The minimum one inch clearance must extend on all sides of the supply duct for the first three feet from the unit.</p>

 <b>AVERTISSEMENT</b> <b>DANGER D'INCENDIE ET D'EMPOISONNEMENT AU MONOXYDE DE CARBONE</b>
<p>Une installation incorrecte de la tuyauterie peut entraîner mort, blessure corporelle et/ou dégâts matériels. Sur chaque installation le système de conduites doit être bien calculé et installé, afin d'assurer un flux d'air suffisant évitant la surchauffe. Toutes les unités doivent avoir au moins 2,5 cm de dégagement sur les quatre côtés de la bride de sortie de conduite d'amenée sur l'unité. Ce minimum de 2,5 cm doit s'étendre de tous les côtés de la conduite d'arrivée sur ses premiers 90 cm en partant de l'unité.</p>

### 3.8 General Information

**NOTE:** The following instructions are for general guidance only. Due to the wide variety of installation possibilities, specific instructions will not be given. When in doubt, follow standard and accepted installation practices, or contact Airxcel Commercial Group for additional assistance.

### 3.9 Wall Openings

Measure the dimensions of the supply and return openings on the unit.

Cut the supply opening in the exterior wall for the supply and return. **IMPORTANT: All units must have at least one inch clearance on all four sides of the supply outlet duct flange on the unit. The one inch clearance must extend on all sides of the supply duct for the first three feet from the unit.** The duct must be constructed of galvanized steel with a minimum thickness of .019”.

### 3.10 Minimum Airflow Requirements

The duct system must be engineered to assure sufficient air flow through the AVG air conditioner with gas heat, even under adverse conditions such as dirty filters, etc. Proper engineering will insure longevity and maximum performance from the AVG unit.

### 3.11 Ducting

Extensions should be cut flush with the inside wall for applications without duct work.

Applications using duct work should be designed and installed in accordance with *all* applicable safety codes and standards. Airxcel Commercial Group strongly recommends referring to the current edition of the National Fire Protection Association Standards 90A and 90B *before* designing and installing ductwork. The ductsystem must be engineered to insure sufficient air flow through the unit to prevent over-heating. This includes proper supply duct sizing, sufficient quantity of supply registers, adequate return and filter area. Ductwork must be of correct material and must be properly insulated. Ductwork must be constructed of galvanized steel with a minimum thickness of

.019". Ductwork must be firmly attached, secured and sealed to prevent air leakage. Do not use duct liner on inside of supply duct within four feet of the unit.

Galvanized metal duct extensions should be used to simplify connections to duct work and grilles. Use fabric boots to prevent the transmission of vibration through the duct system. The fabric must be U.L. rated (UL-181) to a minimum of 197°F.

**Note:** Follow local codes and standards when designing duct runs to deliver the required airflow. Minimize noise and excessive pressure drops caused by duct aspect ratio changes, bends, dampers and outlet grilles in duct runs.

### 3.12 Hanging the AVG Unit on the Wall

1. Remove and discard the 4 x 4 shipping boards attached to the base of the unit.
2. The AVG models have built-in mounting flanges. See Figure 2.
3. Refer to Figure 2. Attach the bottom support bracket to the wall using appropriate 3/8" diameter hardware.

For example, on wooden structures, use 3/8 x 2-1/2 inch all-thread lag screws. The screws must penetrate the center of the wall stud. Drill a pilot hole in the stud to prevent it from splitting.

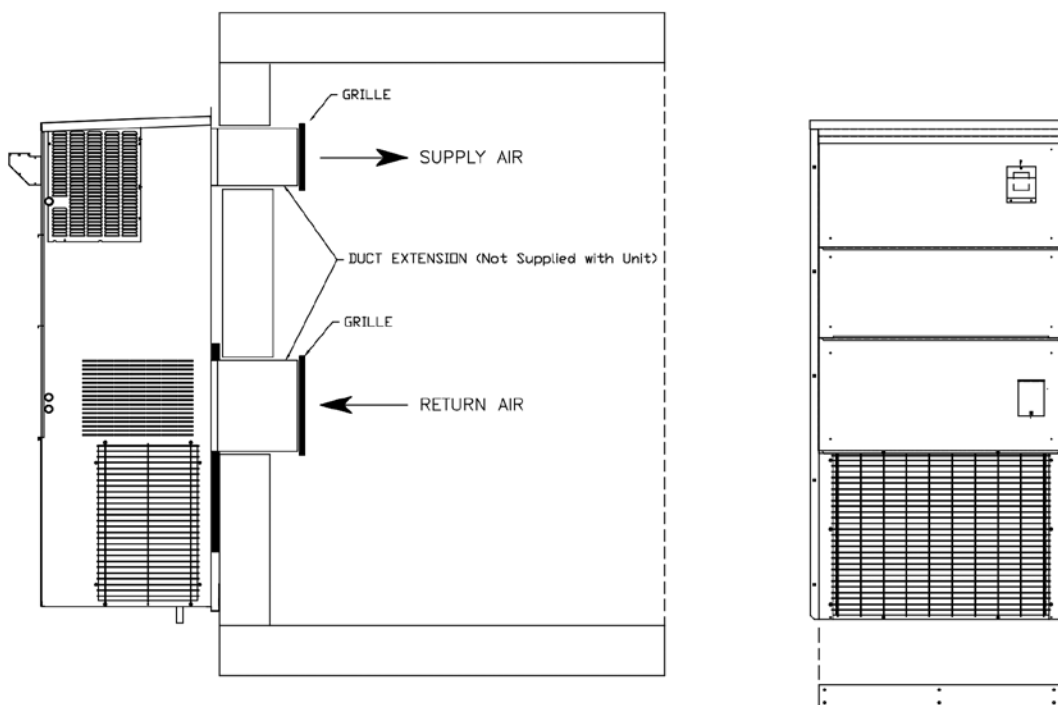

**Figure 3. Mounting Unit on a Wall**

4. For wiring into the back of unit, locate the lower of the two knock-outs on the wall side of the unit. Drill a one inch hole in the building wall to match this opening. Allow sufficient clearance to run 3/4" conduit through the hole and to the unit.
5. Apply a bead of silicone sealer on the wall side of the mounting brackets. Circle the mounting holes with the silicone bead.
6. Using an appropriate and safe lifting device, set the unit on the bottom support bracket mounted on the wall. You must stabilize the unit on the bracket with the lifting device or by some other means - the bracket alone is not sufficient.
7. Make sure that the duct flanges are properly aligned with the wall opening. Adjust as necessary.
8. Note the holes in each side bracket. Using the holes for guides, drill holes through the wall with a 3/8 inch drill bit. Insert the 3/8" bolts or lag screws through the brackets. Tighten the bolts to secure the unit.
9. Apply a bead of silicone where the top flange and side brackets contact to the structure wall.
10. Fasten the top flange to the wall using #10 x 1/2 inch sheet metal screws.
11. On the inside of the structure, wall sleeves must be installed in the supply and return air openings. The sleeves should be trimmed to fit flush with the inside wall.
12. Check the fit of each sleeve to its mating flange for possible air leaks. Apply silicone sealer to close any gaps. Install the air return and supply grilles.

### 3.13 Gas Supply and Piping

 <b>WARNING</b> <b>CARBON MONOXIDE, FIRE AND EXPLOSION HAZARD</b>
<p><b>Failure to follow safety warnings exactly could result in serious injury, death and/or property damage.</b></p> <p><b>Models designated for Natural Gas are to be used with Natural Gas ONLY, unless properly converted to use with LP gas.</b></p>

 <b>AVERTISSEMENT</b> <b>DANGER DE MONOXYDE DE CARBONE, D'INCENDIE OU D'EXPLOSION</b>
<p><b>Ne pas respecter exactement les AVERTISSEMENTS de sécurité peut causer des dommages corporels graves ou mortels et/ou des dégâts matériels.</b></p> <p><b>Les modèles conçus pour du gaz naturel ne doivent fonctionner qu'avec ce gaz UNIQUEMENT, sauf s'ils ont été convertis dans les règles pour utiliser du gaz propane (LP).</b></p>

### 3.14 Gas Supply Requirements

- Use only the type of gas approved for this furnace. See rating plate for approved gas type.
- Gas input must not exceed the rated input shown on the rating plate. Overfiring will result in failure of heat exchanger and cause dangerous operation.
- Do not allow minimum supply pressure to vary downward. Doing so will decrease input to furnace. Refer to Table 4 for gas supply pressure. Refer to Section 6.2 Gas Manifold Pressure Adjustments.

Gas Type	Supply Pressure		
	Recommended	Max.	Min.
<b>Natural</b>	7"	14"	4.5"
<b>Propane</b>	11"	14"	11"

**Table 4. Gas Pressures**

### 3.15 Gas Piping Requirements

**NOTE:** The gas supply line must be installed by a qualified service technician in accordance with all building codes.

**NOTE:** In the state of Massachusetts.

- a. Gas supply connections **MUST** be performed by a licensed plumber or gas fitter.
  - b. When flexible connectors are used, the maximum length shall not exceed 36" (915 mm).
  - c. When lever handle type manual equipment shutoff valves are used, they shall be T-handle valves.
1. Install gas piping in accordance with local codes, or in the absence of local codes, the applicable national codes.
  2. It is recommended that a manual equipment shutoff valve be installed in the gas supply line outside the furnace. Locate valve as close to the furnace as possible where it is readily accessible.

 **WARNING**  
**FIRE HAZARD**

**Failure to follow safety warnings exactly could result in serious injury, death and/or property damage.**

**Use wrench to hold furnace gas control valve when turning elbows and gas line to prevent damage to the gas control valve and furnace.**

 **AVERTISSEMENT**  
**DANGER D'INCENDIE**

**Ne pas respecter exactement les AVERTISSEMENTS de sécurité peut causer des dommages corporels graves ou mortels et/ou des dégâts matériels.**

**Utilisez une clé pour maintenir la vanne de contrôle de gaz de la chaudière quand vous tournez coudes ou conduite de gaz, afin d'éviter d'endommager la vanne et la chaudière.**

3. Use black iron or steel pipe and fittings or other pipe approved by local code.
4. Use pipe thread compound which is resistant to natural and LP gases.
5. Use ground joint unions and install a drip leg no less than 3" long to trap dirt and moisture before it can enter gas control valve inside furnace.
6. Provide a 1/8" NPT plugged tapping for test gauge connection immediately up stream of gas supply connection to furnace.
7. Use two pipe wrenches when making connections to prevent furnace gas control valve from turning.

**NOTE:** If local codes allow the use of a flexible gas appliance connector, always use a new listed connector. Do not use a connector which has previously serviced another gas appliance.

8. Flexible corrugated metal gas connector may **NOT** be used inside the furnace or be secured or supported by the furnace or ductwork.
9. Properly size gas pipe to handle combined appliance load or run gas pipe directly from gas meter or LP gas regulator.
10. Install correct pipe size for run length and furnace rating.
11. Measure pipe length from gas meter or LP second stage regulator to determine gas pipe size.

 **WARNING**  
**FIRE OR EXPLOSION HAZARD**

Failure to properly install metal gas connector could result in death, bodily injury and/or property damage.  
A flexible corrugated metal gas connector must be properly installed, shall not extend through the side of the furnace, and shall not be used inside the furnace.  
Black iron pipe shall be installed at the furnace gas control valve and extend a minimum of 2" outside furnace.

 **AVERTISSEMENT**  
**DANGER D'INCENDIE OU D'EXPLOSION**

Ne pas installer correctement le connecteur métallique du gaz peut causer des dommages corporels graves ou mortels et/ou des dégâts matériels.  
Un connecteur métallique de gaz flexible ondulé doit être correctement installé, ne doit pas dépasser du côté de la chaudière, et ne doit pas être utilisé à l'intérieur de la chaudière.  
Un tuyau en fer noir doit être installé sur la vanne de contrôle du gaz de chaudière et dépasser d'au moins 5 cm hors de la chaudière.

**Additional LP Piping Requirements**

- Have a licensed LP gas dealer make all connections at storage tank and check all connections from tank to furnace.
- If copper tubing is used, it MUST comply with limitation set in local codes, or in the absence of local codes, the gas codes of the country having jurisdiction.
- Two-stage regulation of LP gas is recommended.

 **WARNING**  
**FIRE OR EXPLOSION HAZARD**

A natural gas or LP gas leak ignited by an open flame or spark could result in death, personal injury and/or property damage.  
Natural gas is lighter than air and will rise. Liquidified petroleum (LP) gas is heavier than air and will settle and remain in low areas and open depressions.  
Thoroughly ventilate area and dissipate gas. DO NOT use a match or open flame to test for leaks, or attempt to start up furnace before thoroughly ventilating area. Use a commercially available soap solution made specifically for the detection of leaks to check all connections. A fire or explosion may result causing property damage or loss of life.

 **AVERTISSEMENT**  
**DANGER D'INCENDIE OU D'EXPLOSION**

Une fuite de gaz naturel ou propane allumée par une flamme nue ou une étincelle peut causer des dommages corporels graves ou mortels et/ou des dégâts matériels.  
Le gaz naturel est plus léger que l'air et va monter. Le gaz propane (pétrole liquéfié) est plus lourd que l'air et va descendre et s'accumuler dans les zones basses et les dépressions ouvertes.  
Ventilez complètement la zone. N'utilisez PAS d'allumette ou de flamme nue pour chercher des fuites, et n'essayez pas de démarrer la chaudière avant d'avoir bien ventilé la zone.  
Utilisez une solution savonneuse disponible dans le commerce faites spécialement pour vérifier l'absence de fuite à tous les raccordements. Une fuite peut causer incendie ou explosion, avec dégâts matériels et blessures mortelles.



### Final Check of Gas Piping

- Test all pipes for leaks.
- If orifices were changed, make sure they are checked for leaks.
- During pressure testing of gas supply piping system:
  - a. If test pressure does not exceed 1/2” psi, isolate the furnace from the gas supply piping system by closing the equipment shutoff valve.
  - b. If test pressure exceed 1/2” psi, the furnace and its manual equipment shutoff valve must be disconnected from the gas supply piping system.
- To check for leaks apply soap suds or a liquid detergent to each joint. Bubbles forming indicate a leak.
- Do not use an open flame to test for gas leaks. Fire or explosion could occur.
- Correct even the smallest leak at once.

### 3.16 Electrical Connections

 **WARNING**  
**ELECTRICAL SHOCK HAZARD**

**Failure to follow safety warnings exactly could result in serious injury, death, and/or property damage.**

**Turn off electrical power at fuse box or service panel BEFORE making any electrical connections and ensure a proper ground connection is made before connecting line voltage.**

 **AVERTISSEMENT**  
**DANGER D'ÉLECTROCUTION**

**Ne pas respecter exactement les AVERTISSEMENTS de sécurité peut causer des dommages corporels graves ou mortels et/ou des dégâts matériels.**

**Coupez l'alimentation électrique en amont au boîtier de fusibles ou au panneau de distribution secteur AVANT d'effectuer des raccordements électriques, et assurez-vous qu'une bonne liaison de terre est réalisée avant de brancher la tension d'alimentation secteur.**

The AVG air conditioner with gas furnace MUST be wired and grounded in accordance with electrical codes, or in the absence of local codes, with the current editions of the National Electrical Code (NEC), ANSI/NRPA 70-2002 in the US. In Canada, follow the Canadian Electrical Code (CEC), C22.1 CSA.

GPac air conditioner may incorporate an internal crankcase heater for compressor protection. **The crankcase heater must be energized for at least 24 hours prior to starting the compressor.**

### High Voltage Wiring

The power supply should have the proper voltage, phase, and ampacity for the selected model.

1. Refer to electrical data stamped on the unit rating plate for field wiring requirements. The electrical data lists heater sizes, fuse sizes, and wire sizes for all models. Also shown are the number for field power circuits required for the various modes with the electric heaters.

Each unit is marked with a “Minimum Circuit Ampacity”. This means that the field wiring used must be sized to carry that amount of current. Use “Copper Conductions Only”. Refer to the National Electrical Code for complete current carrying capacity data on the various insulation grades of wiring materials.

**Note:** Power supply service must be within allowable range (+10% - 5%) of rated voltage stamped on the unit rating plate. To operate nominal 230/208V unit at 208V, change the transformer line tap from 240V to 208V following the instruction on wiring label in unit.

2. Connect the wires to the input side of the internal breaker (L1 & L2 for single-phase units; L1, L2, & L3 for three phase models).

 **CAUTION**

**This system contains components that require phasing for correct rotation. Failure to observe rotation and correct on start-up will cause damage not covered by the warranty.**

 **ATTENTION**

**Ce système contient des composants qui nécessitent un phasage pour une rotation correcte. Il faut observer le sens de rotation et le corriger tout de suite s'il y a lieu au démarrage, sous peine de dommages qui ne seraient pas couverts par la garantie.**

Scroll compressors, like several other types of compressors, will only compress in one rotational direction. The direction of rotation is not an issue with single-phase compressors since they will always start and run in the proper direction. However, three phase compressors will rotate in either direction depending upon phasing of power. Since there is a 50-50 chance of connecting power in such a way as to cause rotation in the reverse direction, it is imperative to confirm that the compressor is rotating in the proper direction at the initial field start-up of the system. Verification of proper rotation is made by observing

that the suction pressure drops and the discharge pressure rises when the compressor is energized. An alternate method of verification for self contained system with small critical refrigerant charges, where the installation of gauges may be objectionable, can be made by monitoring the temperature of the refrigerant lines at the compressor. The temperature should rise on the discharge line while the suction line temperature decreases. Reverse rotation also results in a substantially reduced current draw when compared to tabulated values.

There is no negative impact on durability caused by operating three phase compressors in the reversed direction for a short duration of time, usually defined as less than one hour. However, after several minutes of operation the compressor's internal protector will trip. The compressor will then cycle on the protector until the phasing is corrected. Reverse operation for longer than one hour may have a negative impact on the bearings.

3. Install the ground wire on the ground lug.

### **Low Voltage Wiring**

1. Pull the low voltage wiring from the air conditioner to the thermostat / sub-base assembly.
2. Mount the sub-base on a level plane. Connect the thermostat wire to the unit terminal board and the thermostat.
3. If applicable, attach the thermostat assembly to the sub-base. Check the stage two heat anticipator setting. For units with electric heat and thermostats with an adjustable heat anticipator, energize the electric heat and measure the current on the lead attached to the W2 terminal. Adjust/set the heat anticipator per the instructions provided with the thermostat.

Terminals 8 & 10 on the Marvair® GPac with economizer can be connected to a normally closed smoke alarm or fire stat to cause equipment shutdown when the circuit is opened. (Remove factory jumper).

**THE INTERNAL TRANSFORMER IS NOT DESIGNED TO POWER OTHER EXTERNAL DEVICES.**

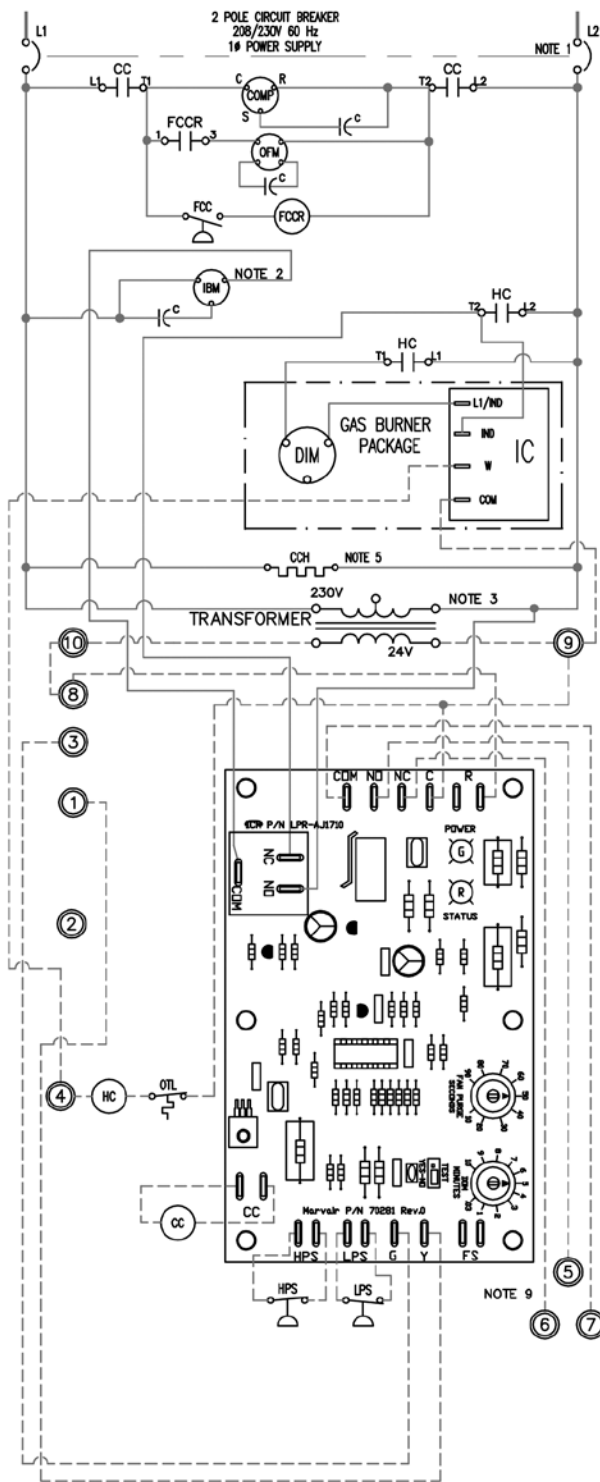

**ELECTRICAL LEGEND:**

C	CAPACITOR	LPS	LOW PRESSURE SWITCH
CC	COMPRESSOR CONTACTOR	OFM	OUTDOOR FAN MOTOR
CCH	CRANKCASE HEATER	OTL	ONE TIME LIMIT
COMP	COMPRESSOR	PCB	PRINTED CIRCUIT BOARD
DIM	DRAFT INDUCER MOTOR	XFMR	TRANSFORMER
DL	DUAL LIMIT		
EH	ELECTRIC STRIP HEAT		
FCC	FAN CYCLE CONTROL		
FCCR	FAN CYCLE CONTROL RELAY		
HPS	HIGH PRESSURE SWITCH		
HC	HEAT CONTRACTOR		
IBM	INDOOR BLOWER MOTOR		
IC	IGNITION CONTROL		

**VOLTAGE LEGEND**

—————	LINE VOLTAGE FACTORY
—————	LINE VOLTAGE FIELD
-----	LOW VOLTAGE FACTORY
-----	LOW VOLTAGE FIELD
-----	ALT. VOLTAGE (FIELD SPEC.)

**COLOR CODE**

BK	BLACK	O	ORANGE
BL	BLUE	R	RED
BR	BROWN	Y	YELLOW
G	GREEN	WHT	WHITE
GY	GRAY		
BK/RED	BLACK WITH RED STRIPE		

**GENERAL NOTES:**

1. 208/230 VOLT 60 Hz 1φ POWER SUPPLY. SEE DATA PLATE FOR AMPACITY & FUSE SIZE. OPTIONAL CKT BKR SHOWN.
2. SPEED TAP - SEE MOTOR NAMEPLATE FOR WIRE COLOR.
3. TRANSFORMER IS FACTORY WIRED FOR 230 VOLT OPERATION. FOR LOWER VOLTAGES, INTERCHANGE ORANGE AND RED LEADS. INSULATE UNUSED LEADS.
4. ALTERNATE DEVICE IS NOT ADJUSTABLE AND HAS ORANGE LEADS.
5. CRANKCASE HEATER MAY NOT BE REQUIRED ON ALL COMPRESSORS.
6. PTCR IS NOT REQUIRED ON ALL COMPRESSORS.
7. COMPRESSOR TIME DELAY AND FAN PURGE DELAY ARE LOCATED ON THE PCB (PRINTED CIRCUIT BOARD) AND ARE ADJUSTABLE.
8. THE (STATUS LED) WILL BLINK ONE TIME AFTER THE HPS (HIGH PRESSURE SWITCH) HAS OPENED TWICE AND THE UNIT WILL LOCKOUT.  
THE (STATUS LED) WILL BLINK TWICE AFTER THE LPS (LOW PRESSURE SWITCH) HAS OPENED TWICE AND THE UNIT WILL LOCKOUT.
9. THE LOCKOUT CIRCUIT CONTACTS ARE N.O. BETWEEN TERMINALS 5 AND 7 OF THE LOW VOLTAGE TERMINAL BOARD AND N.C. BETWEEN TERMINALS 7 AND 6 OF THE LOW VOLTAGE TERMINAL BOARD.

**Figure 4a. Typical Electrical Schematic - AVG without Economizer**

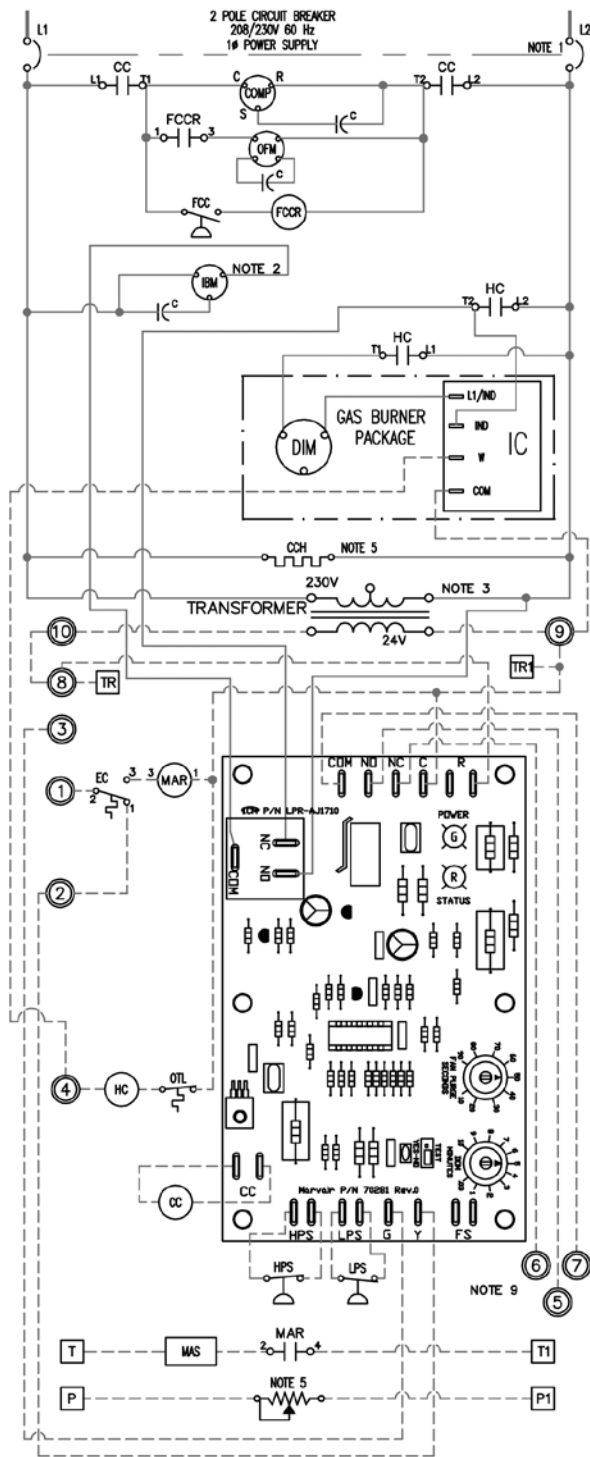

**ELECTRICAL LEGEND:**

C	CAPACITOR	IC	IGNITION CONTROL
CC	COMPRESSOR CONTACTOR	LPS	LOW PRESSURE SWITCH
CCH	CRANKCASE HEATER	MAR	MIXED AIR RELAY
COMP	COMPRESSOR	MAS	MIXED AIR SENSOR
DIM	DRAFT INDUCER MOTOR	OFM	OUTDOOR FAN MOTOR
DL	DUAL LIMIT	OTL	ONE TIME LIMIT
EC	ENTHALPY CONTROLLER	PCB	PRINTED CIRCUIT BOARD
EH	ELECTRIC STRIP HEAT	XFMR	TRANSFORMER
EP-A	ECON. PACKAGE ACTUATOR		
FCC	FAN CYCLE CONTROL		
FCCR	FAN CYCLE CONTROL RELAY		
HPS	HIGH PRESSURE SWITCH		
HC	HEAT CONTRACTOR		
IBM	INDOOR BLOWER MOTOR		

**VOLTAGE LEGEND**

—————	LINE VOLTAGE	FACTORY
—————	LINE VOLTAGE	FIELD
-----	LOW VOLTAGE	FACTORY
-----	LOW VOLTAGE	FIELD
- - - - -	ALT. VOLTAGE	(FIELD SPEC.)

**COLOR CODE**

BK	BLACK	O	ORANGE
BL	BLUE	R	RED
BR	BROWN	Y	YELLOW
G	GREEN	WHT	WHITE
GY	GRAY		
BK/RED	BLACK WITH RED STRIPE		

**GENERAL NOTES:**

- 208/230 VOLT 60 Hz 1φ POWER SUPPLY. SEE DATA PLATE FOR AMPACITY & FUSE SIZE. OPTIONAL CKT BKR SHOWN.
- SPEED TAP - SEE MOTOR NAMEPLATE FOR WIRE COLOR.
- TRANSFORMER IS FACTORY WIRED FOR 230 VOLT OPERATION. FOR LOWER VOLTAGES, INTERCHANGE ORANGE AND RED LEADS. INSULATE UNUSED LEADS.
- ALTERNATE DEVICE IS NOT ADJUSTABLE AND HAS ORANGE LEADS.
- CRANKCASE HEATER MAY NOT BE REQUIRED ON ALL COMPRESSORS.
- OPTIONAL FIELD INSTALLED 270 OHM MINIMUM POSITION POTENTIOMETER.
- COMPRESSOR TIME DELAY AND FAN PURGE DELAY ARE LOCATED ON THE PCB (PRINTED CIRCUIT BOARD) AND ARE ADJUSTABLE.
- THE (STATUS LED) WILL BLINK ONE TIME AFTER THE HPS (HIGH PRESSURE SWITCH) HAS OPENED TWICE AND THE UNIT WILL LOCKOUT.  
THE (STATUS LED) WILL BLINK TWICE AFTER THE LPS (LOW PRESSURE SWITCH) HAS OPENED TWICE AND THE UNIT WILL LOCKOUT.
- THE LOCKOUT CIRCUIT CONTACTS ARE N.O. BETWEEN TERMINALS 5 AND 7 OF THE LOW VOLTAGE TERMINAL BOARD AND N.C. BETWEEN TERMINALS 7 AND 6 OF THE LOW VOLTAGE TERMINAL BOARD.

**Figure 4b. Typical Electrical Schematic - AVG with Economizer**

### 3.17 Venting of the Furnace

The AVG wall mounted air conditioner with gas heat furnace is a Category I furnace, i.e., a central furnace which operates with a non-positive vent static pressure and with a flue loss not less than 17%. The furnace is fan assisted, i.e., an appliance equipped with an integral means to either draw or force products of combustion through the combustion changer and/or the heat exchanger. The installation of the furnace vent must be in accordance with the National Fuel Gas Code (NFGC), ANSI Z223.1-2000/NFPA 54-2002, and /or Section 7 and Appendix C of the CSAB149.1-00, National Standard of Canada, Natural Gas & Propane Installation Code; the local building codes; furnace and vent manufacturer's instructions. The AVG air conditioner with gas heat shall not be connected to a chimney flue serving a separate appliance designed to burn solid fuel. Do not connect any other vents or flues from any other appliances to the flue of the AVG unit. Multistory venting is prohibited. Single wall metal vents shall not be used. Vents must be installed vertically. Use only the vent supplied with the AVG unit. Vent connectors shall not be connected into any portion of mechanical draft systems operating under positive pressure.

#### WARNING

#### **CARBON MONOXIDE POISONING, FIRE, AND EXPLOSION HAZARD**

**Failure to properly vent this furnace could result in death, personal injury and/or property damage. Read and follow all the instructions in this section.**

#### AVERTISSEMENT

#### **DANGER DE MONOXYDE DE CARBONE, D'INCENDIE OU D'EXPLOSION**

**Une mauvaise ventilation de cette chaudière peut entraîner blessures graves ou mortelles et/ou dégâts matériels. Lisez et respectez toutes les instructions dans cette section.**

### 3.18 Installation of the Vent Hood.

1. The vent hood assembly is shipped inside the compressor/lower compartment. Remove the side screen to access the vent hood assembly.
2. Attach the vent hood for the AVG wall mounted air conditioner with gas heat furnace as shown below. Maintain 18" clearance between the vent hood and any thing that would restrict or impede air flow from the hood.



VENT HOOD OPENING



INSERT TAB IN THE HOOD INTO THE SLOT IN THE UNIT



SECURE HOOD TO UNIT WITH TWO SCREWS



COMPLETED INSTALLATION

**Figure 5. Vent Hood Installation**

3. The intake of the combustion air is thru louvers located on the side of the AVG wall mounted air conditioner with gas heat furnace. Maintain 19” clearance between the louvers and anything that would restrict or impede air flow into the louvers.

## 4. Checks and Adjustments

The unit must be operating in the heating mode while doing the following check and adjustments. Refer to the Start up instructions for starting the unit.

### WARNING

**ELECTRICAL SHOCK, FIRE, EXPLOSION OR  
CARBON MONOXIDE POISONING HAZARD**

Failure to follow safety warnings exactly could result in serious injury, death and/or property damage.

If any sparks, odors or unusual noises occur, **IMMEDIATELY** shut OFF gas and power to the AVG unit. Check for wiring errors, gas leaks or obstructions to the blower.

### AVERTISSEMENT

**DANGER D'ÉLECTROCUTION, INCENDIE, EXPLOSION  
OU EMPOISONNEMENT AU MONOXYDE DE CARBONE**

Ne pas respecter exactement les AVERTISSEMENTS de sécurité peut causer des dommages corporels graves ou mortels et/ou des dégâts matériels.

En cas de constatation d'étincelles, odeurs ou bruits anormaux, **COUPEZ IMMÉDIATEMENT** le gaz et l'alimentation secteur de l'unité AVG. Vérifiez s'il y a des erreurs de câblage, des fuites de gaz ou des obstructions au soufflage.

### 4.1 Gas Supply Pressure

Gas supply pressure should be within the minimum and maximum values listed on the data plate on the AVG air conditioner with gas heat furnace. Pressures are typically set by the gas supplier.

### 4.2 Manifold Gas Pressure Adjustment

### WARNING

**FIRE, EXPLOSION OR CARBON MONOXIDE POISONING HAZARD**

Failure to turn the gas OFF at the shut off valve before connecting manometer could result in death and/or personal injury.

Turn the gas valve to OFF before connecting the manometer.

### AVERTISSEMENT

**DANGER D'INCENDIE, EXPLOSION  
OU EMPOISONNEMENT AU MONOXYDE DE CARBONE**

Ne pas couper l'arrivée de gaz au robinet de coupure avant de brancher le manomètre peut causer des blessures graves ou mortelles.

Fermez le robinet de gaz (position OFF) avant de brancher le manomètre.

1. With gas valve OFF, connect the manometer to manifold pressure tap on outlet (1/8” NPT) of the gas control valve. Use a manometer with a 0” to 12” water column range.

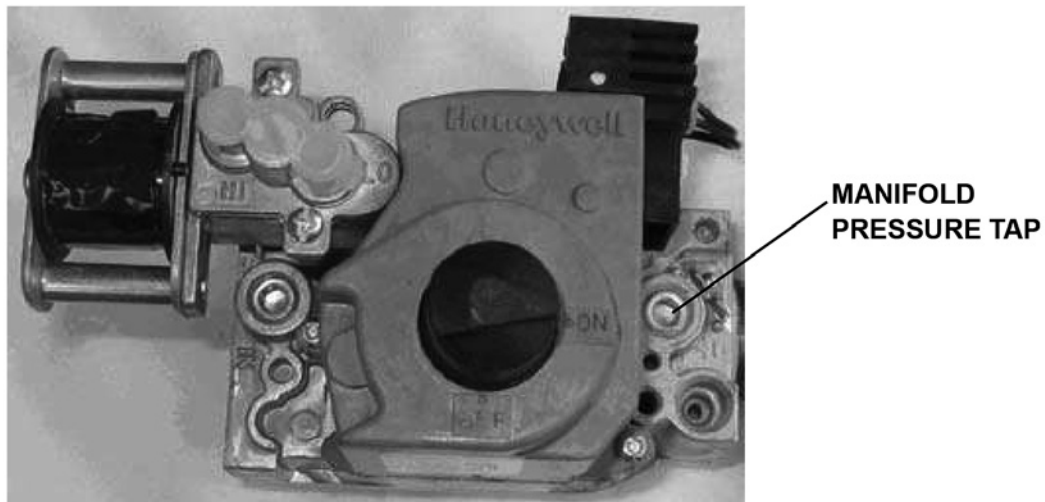

**Figure 6. Gas Valve Manifold Pressure Tap**

2. Turn gas ON. Operate furnace by using a jumper wire on the “10” and “4” thermostat connections on the low voltage board. The board is located in the electrical compartment in the AVG unit.
3. Regulator pressure may be adjusted by removing the plastic cap on top of gas valve, as shown below. Turn the “HI” adjustment screw counterclockwise to decrease the manifold pressure and clockwise to increase the manifold pressure. Set the manifold pressure to 3.5” w.c. for Natural Gas and 10.0” w.c. for LP gas. Only adjust the setting marked “HI”. A 3/32” Allen Key is required for adjustment.

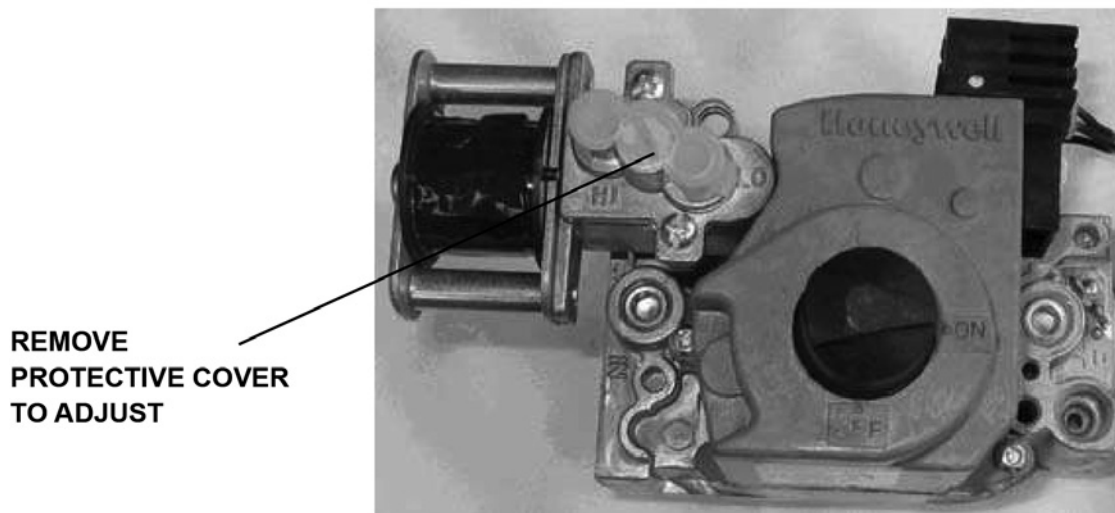

**Figure 7. Gas Valve Protective Cover**

4. When the manifold pressure is properly set, replace the adjustment screw cover on the gas control valve.
5. Remove manometer and replace the 1/8” NPT tapping.

**⚠ WARNING  
FIRE, EXPLOSION HAZARD**

**Failure to replace the 1/8” NPT tapping will result in accumulation of gas and an explosion.**

**⚠ AVERTISSEMENT  
DANGER D’INCENDIE OU EXPLOSION**

**Ne pas remplacer le taraudage 1/8” NPT peut entraîner une accumulation de gaz suivie d’une explosion.**

6. Remove jumper wire.
7. Check for gas leaks at the plug and repair as required.

### 4.3 Natural Gas Input Rating Check

The gas meter can be used to measure the input to the furnace.

Check with the gas supplier for the actual BTU content of the gas.

1. Turn off the gas supply to any other appliance, other than the AVG unit, and start the furnace. Use jumper wire “10” to “4” as described in 2 above.
2. With a watch or stop watch, time how many seconds it takes the smallest dial on the gas meter to make one complete revolution. Note: if the meter has 2 cubic foot dials, divide seconds by two. See example below. The example is based upon a natural gas BTU content of 1,000 BTU’s per cubic foot.

Natural Gas BTU Content	No. of Seconds per Hour	Time per Cubic Foot in Seconds	BTU per Hour
1,000	3,600	50	72,000
(1,000 x 3,600) /48 = 72,000 BTUH			

**Table 5. Natural Gas Input Rating**

3. Remove jumper wire from “10” to “4”.
4. Relight any appliances turned off in step one and that all are operating properly.

### 4.4 Orifice Sizing

Ensure that the furnace has the correct main burner orifices for the altitude of the site. Refer to the following table for the correct orifice for both natural and propane gas.

HMG 22,500 BTUH/Burner (Used with AVG24- AVG 36 Heat Exchangers)					HMG 25,000 BTUH/Burner (Used with AVG42- AVG 60 Heat Exchangers)				
Altitude	Orifice- Natural		Orifice- Propane		Altitude	Orifice- Natural		Orifice- Propane	
	Drill Size	Dia.	Drill Size	Dia.		Drill Size	Dia.	Drill Size	Dia.
0-1999 ft	#43	0.089	#54	0.055	0-1999 ft	2.30	0.0906	1.5	0.0591
2000-2999 ft	2.2	0.0866	1.35	0.531	2000-2999 ft	#43	0.0890	#54	0.0550
3000-3999 ft	2.15	0.0846	#55	0.052	3000-3999 ft	2.20	0.0866	1.35	0.0531
4000-4999 ft	2.1	0.0827	1.3	0.0511	4000-4999 ft	2.15	0.0846	#55	0.0520
5000-5999 ft	#45	0.082	1.25	0.0492	5000-5999 ft	2.10	0.0827	1.30	0.0511
6000-6999 ft	2.05	0.087	1.2	0.0472	6000-6999 ft	#45	0.0820	1.25	0.0492

Burner Input	Number of Orifices	Burner Input	Number of Orifices
40,500	2	81,000	4
45,000	2	90,000	4
60,750	3	100,000	4
67,500	3	112,500	5
75,000	3	125,000	5

Orifice Size (mm)	Orifice Diameter	Orifice Size (mm)	Orifice Diameter
2.10	0.0826	2.45	0.0964
2.15	0.0846	2.50	0.0984
2.20	0.0866	2.60	0.1024
2.25	0.0885	2.70	0.1063
2.30	0.0905	2.75	0.1082
2.35	0.0925	2.80	0.1102
2.40	0.0945	2.90	0.1142

**Table 6. Altitude/Orifice Sizing**



## 4.5 LP Gas Conversion

The following instructions are for the field conversion of an AVG gas heat with air conditioning from using Natural Gas to LP (propane) gas. This kit includes parts required to convert a burner assembly beginning with model number HMG075-125 only. Refer to the name plate attached to the right side of the burner assembly to verify the first three letters of the Model number. These instructions are specific to this burner assembly only.

The kit contains the following items required to make the conversion:

Item	Qty.	Description
1	1	Gas valve regulator conversion kit – Honeywell P/N 396021
2	5	Gas orifices – Drill size 1.5mm for propane gas
3	1	Label to attach to the manifold indicating that the unit has been converted to use LP Gas.

### WARNING

#### FIRE, CARBON MONOXIDE OR EXPLOSION HAZARD

**Failure to properly install the LP gas conversion kit could result in death, serious injury or property damage.**

**The AVG unit is shipped from the factory for operation on natural gas. When used on LP gas, the gas orifice spud and the gas valve spring must be replaced and the gas valve regulator must be adjusted. This conversion kit shall be installed by a qualified service agency in accordance with the manufacturer's instructions and all applicable codes and requirements of the authority having jurisdiction. If the information in these instructions is not followed exactly, a fire, explosion or production of carbon monoxide may result causing property damage, personal injury or loss of life. The qualified service agency performing this work assumes the responsibility for the proper conversion of the appliance with this kit.**

### AVERTISSEMENT

#### DANGER D'INCENDIE, MONOXYDE DE CARBONE OU EXPLOSION

**Ne pas installer correctement le kit de conversion au gaz propane (LP) peut entraîner des blessures graves ou mortelles ou des dégâts matériels.**

**L'unité AVG est livrée de l'usine pour fonctionner au gaz naturel. Quand elle est utilisée avec du gaz propane, il faut remplacer tête d'injecteur et ressort de vanne, et le réglage du régulateur de vanne de gaz doit être modifié. Ce kit de conversion ne doit être installé que par une agence de dépannage qualifiée en suivant les instructions du**

**constructeur et toutes les normes et exigences applicables édictées par les autorités ayant juridiction dans ce domaine. Si les informations contenues dans ces instructions ne sont pas suivies exactement, il peut en résulter un empoisonnement au monoxyde de carbone ou une explosion, causant dommages, blessure ou mort. C'est l'agence de dépannage qualifiée qui effectue le travail qui assume la responsabilité de la conversion correcte de l'appareil avec ce kit.**

### LP Gas Conversion Installation Procedures

1. First, shut off all gas supply to the unit using the manual shut off valve. The gas must be shut off BEFORE disconnecting the electrical power or proceeding with any other step in the LP gas conversion.
2. Disconnect or shut off all electrical power to the AVG unit and then turn the thermostat to the OFF position.
3. Disconnect wire to the gas valve. If wire colors are not evident or do not match the wiring diagram, label each wire.

4. Loosen the gas pipe union and remove the gas supply pipe from the gas valve.
5. Remove the screws holding the manifold pipe assembly to the burner assembly.
6. Remove manifold.
7. Loosen and remove the Natural Gas Orifices and remove from the manifold.
8. Install LP gas orifices provided with the kit.
9. Open the Gas Valve Regulator conversion kit and follow the instructions provided for conversion of the gas valve regulator. Be sure to apply the label indicating that the valve has been converted from Natural Gas to LP gas.
10. Secure the manifold burner assembly to the burner assembly with the four screws. Be sure the orifices are aligned with the opening on each burner.
11. Reconnect the gas supply pipe, using pipe joint compound resistant to LP gas on the pipe threads, to the gas valve. Tighten the union fitting.
12. Reconnect wires to the gas valve following the wiring diagram provided on the AVG unit.
13. Turn on the gas supply at the manual shut off valve.
14. Carefully leak check union fitting and connection at gas valve using soap suds or a liquid detergent to each joint. Bubbles indicate a leak. Correct even the smallest leak immediately. Do NOT use a flame to check for leaks.
15. Turn Gas Valve to OFF.
16. With gas valve OFF, connect the manometer to manifold pressure tap on outlet (1/8" NPT) of the gas control valve. Use a manometer with a 0" to 12" water column range.

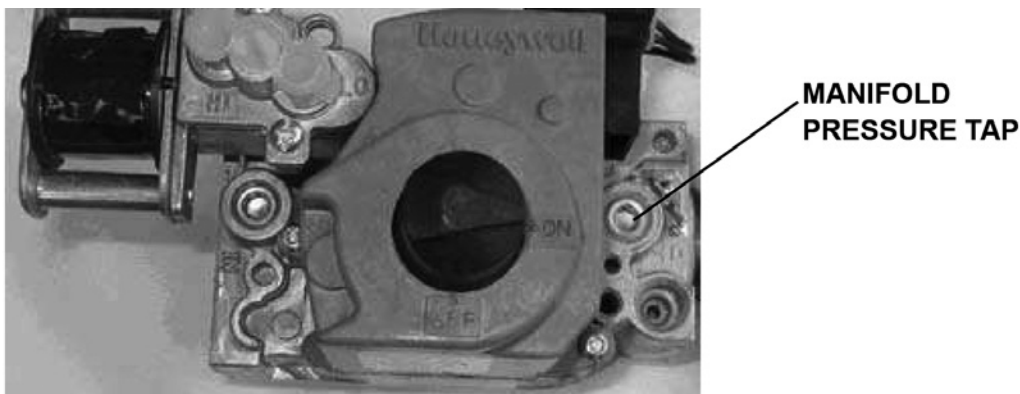

**Figure 8. Gas Valve Manifold Pressure Tap**

17. Turn gas ON. Operate furnace by using a jumper wire on the "10" and "4" thermostat connections on the low voltage board. The board is located in the electrical compartment in the AVG unit.
18. Regulator pressure may be adjusted by removing the plastic cap on top of gas valve, as shown below. Turn the "HI" adjustment screw counterclockwise to decrease the manifold pressure and clockwise to increase the manifold pressure. Set the manifold pressure to 10.0" w.c. for LP gas. Only adjust the setting marked "HI". A 3/32" Allen Key is required for adjustment.
19. When the manifold pressure is properly set, replace the adjustment screw cover on the gas control valve.
20. Remove manometer and replace the 1/8" NPT tapping.

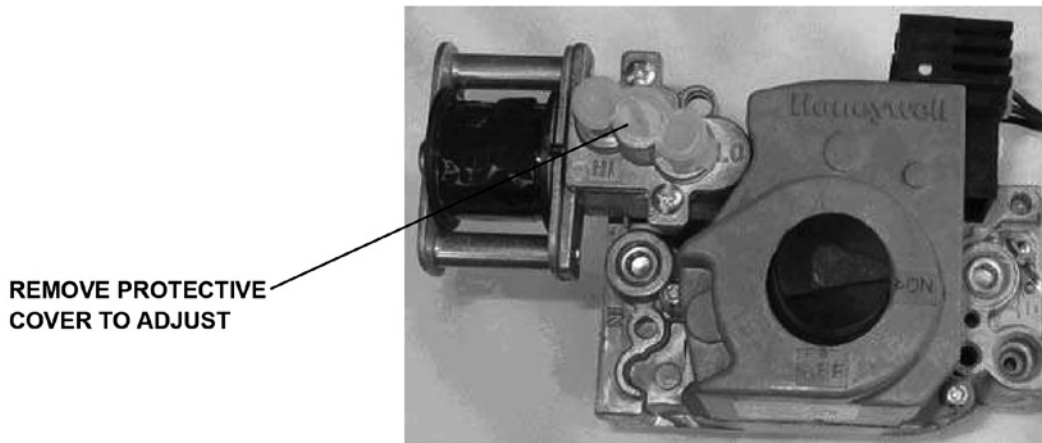

Figure 9. Gas Valve Protective Dust Cover

**⚠ WARNING  
FIRE, EXPLOSION HAZARD**

**Failure to replace the 1/8" NPT tapping will result in accumulation of gas and an explosion.**

**⚠ AVERTISSEMENT  
DANGER D'INCENDIE OU EXPLOSION**

**Ne pas remplacer le taraudage 1/8" NPT peut entraîner une accumulation de gaz suivie d'une explosion.**

21. Remove jumper wire.
22. Check for gas leaks at the plug and repair as required.

#### 4.6 High Altitude Installations

**⚠ WARNING  
FIRE, EXPLOSION, CARBON MONOXIDE POISONING HAZARD**

**Failure to follow these instructions exactly could result in death, personal injury and/or property damage.  
This high altitude conversion must be done by a qualified service agency in accordance with the following instructions or in the absence of local codes, the applicable national code.**

**⚠ AVERTISSEMENT  
DANGER D'INCENDIE, EXPLOSION OU MONOXYDE DE CARBONE**

**Ne pas respecter exactement des instructions peut causer des dommages corporels graves ou mortels et/ou des dégâts matériels.  
Cette conversion pour altitude importante doit être réalisée par une agence de dépannage qualifiée en suivant les instructions qui suivent et les normes locales, ou les normes nationales en leur absence.**

All AVG units are shipped from the factory for operation at sea level up to 2,000 feet (610 m). For installations from 2,000 (610 m) to 7,000 feet (2,134 m), see the following chart for proper sizing of the orifice.

When the AVG air conditioner with gas heat is installed above 7,000 ft. (2,134 m), please contact Airxcel Commercial Group.

HMG 22,500 BTUH/Burner (Used with AVG24- AVG 36 Heat Exchangers)					HMG 25,000 BTUH/Burner (Used with AVG42- AVG 60 Heat Exchangers)				
Altitude	Orifice- Natural		Orifice- Propane		Altitude	Orifice- Natural		Orifice- Propane	
	Drill Size	Dia.	Drill Size	Dia.		Drill Size	Dia.	Drill Size	Dia.
0-1999 ft	#43	0.089	#54	0.055	0-1999 ft	2.30	0.0906	1.5	0.0591
2000-2999 ft	2.2	0.0866	1.35	0.531	2000-2999 ft	#43	0.0890	#54	0.0550
3000-3999 ft	2.15	0.0846	#55	0.052	3000-3999 ft	2.20	0.0866	1.35	0.0531
4000-4999 ft	2.1	0.0827	1.3	0.0511	4000-4999 ft	2.15	0.0846	#55	0.0520
5000-5999 ft	#45	0.082	1.25	0.0492	5000-5999 ft	2.10	0.0827	1.30	0.0511
6000-6999 ft	2.05	0.087	1.2	0.0472	6000-6999 ft	#45	0.0820	1.25	0.0492

Burner Input	Number of Orifices	Burner Input	Number of Orifices
40,500	2	81,000	4
45,000	2	90,000	4
60,750	3	100,000	4
67,500	3	112,500	5
75,000	3	125,000	5

Orifice Size (mm)	Orifice Diameter	Orifice Size (mm)	Orifice Diameter
2.10	0.0826	2.45	0.0964
2.15	0.0846	2.50	0.0984
2.20	0.0866	2.60	0.1024
2.25	0.0885	2.70	0.1063
2.30	0.0905	2.75	0.1082
2.35	0.0925	2.80	0.1102
2.40	0.0945	2.90	0.1142

**Table 7. Altitude/Orifice Sizing**

**NOTE:** Data for LP gas is based upon a 0.60 specific gravity. For fuels with different specific gravity, consult the National Fuel Gas Code ANSI Z223.1/NFPA 54-2002 or the National Standard of Canada, Natural & Propane Gas Installation Code CSA B149.1-00.

### **High Altitude Air Pressure Switch**

The factory installed pressure switch is factory set for installations from sea level up to 6,000 ft (1,829 m). Consult the factory for installations above 6,000 ft.

## **4.7 Changing Orifices**

1. Turn OFF gas at the shut off valve.
2. Turn off all power to the AVG unit at the fuse box or service panel.
3. Remove the burner compartment door, exposing the burner.
4. Disconnect the gas line from gas valve so that manifold can be removed.
5. Disconnect wiring at the gas valve. Be sure to note or mark the location of all electrical connections.
6. Remove the 4 screws holding the manifold and gas valve to the manifold supports. Keep screws.
7. Carefully remove the manifold assembly.
8. Remove the orifices from the manifold and replace them with the proper sized orifices.
9. Tighten orifices so that they are seated and gas tight.
10. Reassemble all parts in the reverse order as removed. Be sure to engage the main burner orifices in the proper openings in the burners.

11. After reassembly, turn on the gas and check for leaks using a soapy solution. Correct all leaks immediately.
12. Turn power back on to the AVG unit.
13. Turn gas ON at the shut off valve.

#### 4.8 Main Burner Flame Check

Allow the furnace to run for at least 10 minutes. Then inspect the main burner flame.

Look at the flames on the burners. They should be predominately blue in color and robust in appearance. The flame should be in the middle of the heat exchanger tubes. Check to see that all the burners are lit and that the flame does not impinge on the sides of the heat exchanger. Observe the flame. There should be little or no change to the shape or size of the flame. Changes in the shape and size of the flame may indicate a leak in the heat exchanger. See Figure 10.

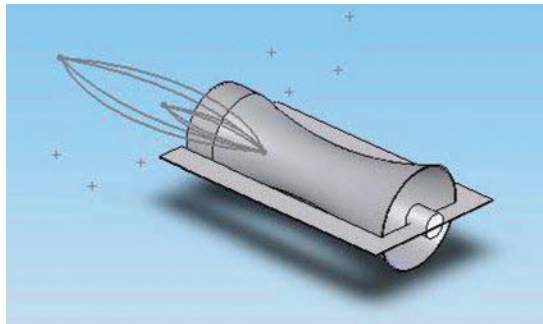

**Figure 10. Burner Flame**

Distorted flame or yellow tips of the natural gas flame or long yellow tips on LP gas flames may be caused by one or more of the following:

1. Lint or dirt inside the burner or burner ports,
2. Lint or dirt at the air inlet between the burner and the manifold pipe, or
3. An obstruction over the burner plate.

If any of these are visible, turn the unit off and use a vacuum or a soft brush to clean the affected areas.

#### 4.9 Temperature Rise Range

When the AVG unit is in the heating mode, the inlet air and outlet air temperatures should be measured to ensure that the temperature rise (the difference between the outlet air temperature and the inlet air temperature) is within an acceptable range as shown below. The temperatures must be measured at the discharge of the supply and the intake of the return air with no more than a .35 IWG static pressure.

Heating Input (Btu/Hr)	Temperature Rise at 0.35" H2O External Static Pressure (°F)					
	Gas/Electric Model Number					
	AVG24	AVG30	AVG36	AVG42	AVG48	AVG60
45,000	25 to 55	25 to 55	25 to 55			
67,500	40 to 70	40 to 70	40 to 70			
90,000	50 to 80	50 to 80	50 to 80			
75,000				25 to 55	25 to 55	25 to 55
100,000				40 to 70	40 to 70	40 to 70
125,000				50 to 80	50 to 80	50 to 80

**Table 8. Temperature Rise Range**

# 5. Start-up

Before lighting the unit, smell around the unit for gas. Be sure to smell next to the floor because LP gas is heavier than air and will settle on the floor.

The gas valve on your unit is equipped with an ON/OFF knob. Use only your hand to turn the knob. Never use tools. If the knob will not push in or turn by hand, do not try to repair it. Call a qualified service technician. Force or attempted repair may result in a fire or explosion.

The AVG air conditioner with gas heat is equipped with an automatic spark ignition system. There is no pilot. In case of a safety shutdown on units with electronic temperature control, shut main disconnect OFF and then back ON to reset ignition control. On units with an electro-mechanical thermostat, move the thermostat switch to OFF and return the thermostat switch to HEAT. On initial start-up of the unit in the heating mode, a burn-off of excess paint and oils remaining from the manufacturing process may cause some smoking and smell for 5-10 minutes.

## 5.1 Cooling Cycle

1. Set the fan switch to "Auto" and the system switch to "Off".
2. Move the cooling temperature on the wall thermostat to a point higher than the room temperature. Move the heating temperature to a temperature that is lower than the room temperature.
3. Set the thermostats system switch to "Cool" or "Auto" position. Nothing should operate at this time.
4. Set the time delay in the control box to three minutes. Note that time delay is an option on some AVG units and may not be on your air conditioner.
5. Remove the cover plate from the thermostat. Slowly lower the thermostat cooling temperature. Once the indoor fan turns on, allow approximately three minutes for the compressor and outdoor fan to start.

For units equipped with the low ambient control, note that the outdoor fan may not come on immediately, because it is cycled by refrigerant pressures. Some units have a time delay module which prevents the compressor from restarting immediately after interruption of power. See Cooling Mode section of the Installation Instructions for details on the operation of the low ambient control and the time delay.

## 5.2 Heating Cycle

1. Turn off electrical power to the unit.
2. Set thermostat to its lowest setting.
3. Remove heat section access panel.
4. Turn knob on the gas control valve to ON. Do not force. Never light the burner with a match or torch.

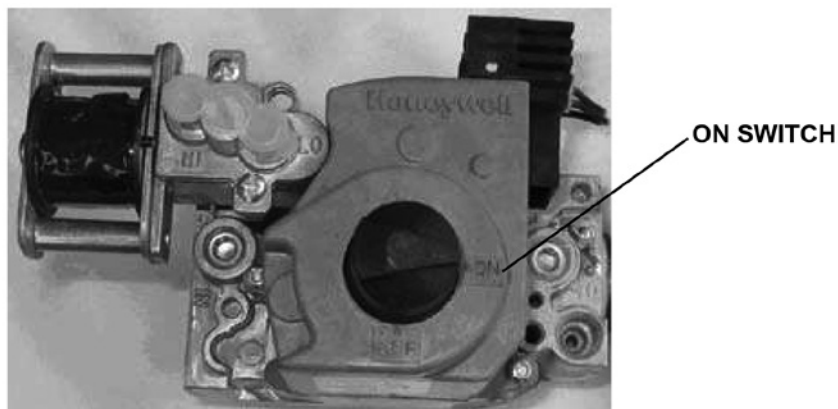

Figure 11. Gas Control Valve On Switch

5. Replace heat section access panel.
6. Turn on electrical power to the unit.
7. Set room thermostat to desired temperature.
8. On a call for heating, the air switch closes, initiating a 30 second pre-purge.
9. At end of pre-purge period, the Spark and Gas valve is energized for up to a 5 second ignition trial. Gas valve will open.
10. Burners ignite and carryover.
11. Flame is detected by the flame sensor and control operates in a steady state condition.
12. Unit continues to heat until the room temperature set point is met.

If ignition is not achieved within 5 seconds, the gas valve is shut off, the inducer keeps running for an interpurge period of 60 seconds and additional ignition trials follow the specified sequence. If after three trials for ignition have occurred without proper ignition and flame detection, the control is locked out.

Control may be brought out of lockout by cycling the thermostat or turning the main power off for at least 5 seconds. Control will also attempt another ignition sequence after a one hour after a lock out occurrence.

13. If flame is lost once it has been established, the control will shut off the gas supply within 0.8 seconds and enter the interpurge period. Control will initiate up to 3 additional trials per normal operation sequence.
14. If flame sensor indicates presence of flame during purge period, when no flame should be present, the inducer will remain energized but the gas valve will not be energized until the cause of the “false flame” is removed.
15. If the air pressure switch is closed when the inducer is energized or does not close after the inducer is energized, the control will wait one minute for the air switch to open or close and then lock out.
16. If the control detects power to the gas valve when it should be off, or if no power when it should be on, the control will go into lock out with all outputs off.

<b>LED Flash Code</b>	
<b>On- Steady</b>	<b>Control operation normal</b>
<b>1 Flash</b>	<b>Open pressure switch, limit switch or flame rollout switch</b>
<b>2 Flashes</b>	<b>Pressure switch stuck closed</b>
<b>3 Flashes</b>	<b>Ignition/flame sensor failure</b>
<b>4 flashes</b>	<b>Repeated flame losses</b>
<b>5 flashes</b>	<b>Internal control fault</b>
<b>6 flashes</b>	<b>Repeated pressure switch losses</b>

### 5.3 Start-Up Checklist

Dealer Name: \_\_\_\_\_

Address: \_\_\_\_\_

City/State/Zip: \_\_\_\_\_

Phone: \_\_\_\_\_

Owners Name: \_\_\_\_\_

Address: \_\_\_\_\_

City/State/Zip: \_\_\_\_\_

Model Number: **AVG** \_\_\_\_\_

Serial Number: \_\_\_\_\_

Type of Gas: Natural  LP

Blower Motor HP: \_\_\_\_\_

Supply Voltages: \_\_\_\_\_

Limit Opens at: \_\_\_\_\_°F or \_\_\_\_\_°C

Limit Closes at: \_\_\_\_\_°F or \_\_\_\_\_°C

Temperature of Supply Air: \_\_\_\_\_°F or \_\_\_\_\_°C

Temperature of Return Air: \_\_\_\_\_°F or \_\_\_\_\_°C

Rise (Supply Temp. – Return Temp.): \_\_\_\_\_°F or \_\_\_\_\_°C

Filter Type and Size: \_\_\_\_\_

Fan "Time ON" Setting: \_\_\_\_\_

Fan "Time OFF" Setting: \_\_\_\_\_

Dealer Comments: \_\_\_\_\_  
 \_\_\_\_\_  
 \_\_\_\_\_  
 \_\_\_\_\_  
 \_\_\_\_\_  
 \_\_\_\_\_  
 \_\_\_\_\_  
 \_\_\_\_\_  
 \_\_\_\_\_  
 \_\_\_\_\_

Business Card Here

Manual Gas Shut-Off Upstream of Furnace/Drip-Leg?

YES  NO

Drip-Leg Upstream of Gas Valve? YES  NO

Blower Speed Check? YES  NO

All Electrical Connections Tight? YES  NO

Gas Valve OK? YES  NO

Measured Line Pressure When Firing Unit: \_\_\_\_\_

Gas Input Rating Check: \_\_\_\_\_  
 (See *Checks and Adjustments* section)

Measured Manifold Pressure: \_\_\_\_\_

Thermostat OK? YES  NO

Sub-Base Level? YES  NO

Anticipator Set? YES  NO  Set At? \_\_\_\_\_

Breaker On? YES  NO

Date of Installation: \_\_\_\_\_

Date of Start-up: \_\_\_\_\_



# 6. Maintenance

 **WARNING**  
**ELECTRICAL SHOCK, FIRE OR EXPLOSION HAZARD**

Failure to follow safety warnings exactly could result in dangerous operation, serious injury, death or property damage.

Improper servicing could result in dangerous operation, serious injury, death or property damage.

- Before servicing, disconnect all electrical power to the AVG unit.
- When servicing controls, label all wires prior to disconnecting. Reconnect all wires correctly.
- Verify proper operation after servicing.

 **AVERTISSEMENT**  
**DANGER D'ÉLECTROCUTION, DANGER D'INCENDIE OU D'EXPLOSION**

Ne pas suivre les AVERTISSEMENTS de sécurité à la lettre peut entraîner un fonctionnement dangereux, des blessures graves ou mortelles ou des dégâts matériels.

Une intervention inappropriée peut entraîner un fonctionnement dangereux, des blessures graves ou mortelles ou des dégâts matériels.

- Avant d'intervenir, débranchez toute alimentation électrique vers l'unité AVG.
- Quand vous intervenez sur des commandes, étiquetez les fils avant de les débrancher, afin de les rebrancher tous correctement.
- Vérifiez le bon fonctionnement après une intervention.

## 6.1 Maintenance – Burner and Vent Outlet.

Airxcel Commercial Group strongly recommends that the unit be serviced a minimum of twice a year – once prior to the heating season and once prior to the cooling season. At this time the filters, evaporator coil, condenser coil, the cabinet, and condensate drains, the burner flame, the burner and the combustion air inlet and outlet should be serviced and inspected as described below. Also at this time, the unit should be operated in the cooling and heating cycles as described in Chapter 2, Start-Up. In addition to this seasonal check-out, the unit should be maintained as follows:

## 6.2 Air Filter

Replace the air filter whenever it is visibly dirty. Note: Filters must be U.L.C approved or equivalent for use in Canada.

## 6.3 Indoor Coil

If the coil becomes clogged or dirty, it may be cleaned by careful vacuuming or with a commercial evaporator cleaning spray. DO NOT use a solvent containing bleach, acetone, or flammable substances. Turn power OFF before cleaning. Be careful not to wet any of the electrical components. Be sure the unit has dried before restarting.

## 6.4 Outdoor Coil

Periodically inspect the outdoor coil and the cabinet air reliefs for dirt or obstructions. Remove foreign objects such as leaves, paper, etc.

If the coil is dirty, it may be washed off with a commercial solvent intended for this purpose. TURN OFF POWER BEFORE CLEANING! Be sure that all electrical components are thoroughly dry before restoring power.

## 6.5 Cabinet

The cabinet may be cleaned with a sponge and warm, soapy water or a mild detergent. Do not use bleach, abrasive chemicals or harmful solvents.

 **WARNING**  
**CARBON MONOXIDE POISONING**

A crack or hole in the heat exchanger could result in carbon monoxide gas which can cause death or serious injury. Carbon monoxide is colorless and odorless. Signs that there is a hole or crack in the heat exchanger include:

- Headaches, Nausea or Dizziness.
- Excessive humidity or heavily frosted windows or a clammy feeling in the structure.

 **AVERTISSEMENT**  
**EMPOISONNEMENT AU MONOXYDE DE CARBONE**

Une fissure ou un trou dans l'échangeur thermique peut laisser échapper du gaz avec monoxyde de carbone qui peut causer des troubles sévères ou mortels. Le monoxyde de carbone est sans couleur et sans odeur. Les signes pouvant indiquer un problème d'étanchéité sur l'échangeur thermique sont :

1. Maux de tête, nausées ou vertiges.
2. Humidité excessive ou fenêtres très givrées, ou viscosité sur la structure.

## 6.6 Drains

Regularly check the primary and secondary condensate drains. The secondary drain has a stand pipe. An obstruction will force water to dump into the middle of the unit and drain out the sides of the air conditioner, causing discoloration of the side panels. If discoloration is noted, service the drains.

If a commercial drain solvent is used, flush out the drain pan and system with plenty of fresh water to prevent corrosion.

## 6.7 Lubrication

Oiling of the condenser fan motor or the evaporator blower motor is not recommended.

## 6.8 Burner Flame

**Inspect the burner flame periodically during the heating season to ensure proper burner operation.**

Light the burners and allow the unit to operate for a few minutes to establish normal burning conditions. Look at the flames on the burners. They should be predominately blue in color and robust in appearance. The flame should be in the middle of the heat exchanger tubes. Check to see that all the burners are lit and that the flame does not impinge on the sides of the heat exchanger. Observe the flame. There should be little or no change to in the shape or size of the flame. Changes in the shape and size of the flame may indicate a leak in the heat exchanger. See Figure 3.

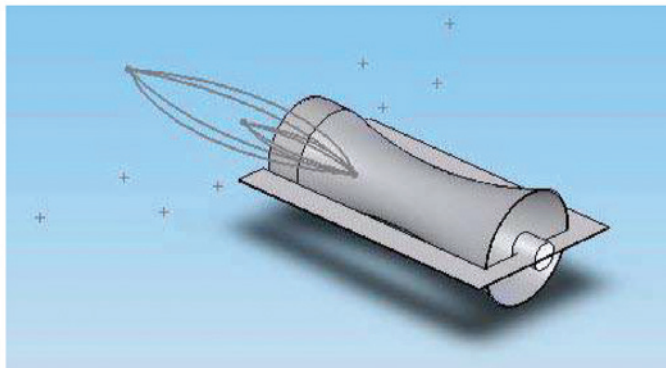

**Figure 12. Burner Flame**

Distorted flame or yellow tips of the natural gas flame or long yellow tips on LP gas flames may be caused by one or more of the following:

1. Lint or dirt inside the burner or burner ports,
2. Lint or dirt at the air inlet between the burner and the manifold pipe, or any obstruction over the burner plate.

If any of these are visible, turn the unit off and use a vacuum or a soft brush to clean the affected areas.

## 6.9 Burner

Inspect the burners at least once a year, prior to each heating season, for rust, water damage or dust accumulation. The burner should be replaced if rust or water damage is present. Dust should be removed if present.

## 6.10 Combustion Air Inlet and Outlet

Visually inspect both the combustion air inlet and gas outlet at least once a year, prior to the heating season, to make sure that there is no build up of soot, debris or dirt. If required, clean to maintain adequate air flow.

### ***Service reminder!***

Always call a qualified service technician if the unit is not working properly. Before calling, check the following to be sure service is required:

1. Be sure the electrical disconnect is ON.
2. Check room thermostat for proper setting.
3. Replace any blown fuses or reset circuit breakers.
4. Gas valve must be ON.
5. Air filters should not be plugged, limiting air flow.
6. Make sure all service panels are in place.

## 6.11 Venting of the Furnace

The AVG wall mounted air conditioner with gas heat furnace is a Category I furnace, i.e., a central furnace which operates with a non-positive vent static pressure and with a flue loss not less than 17%. The furnace is fan assisted. The installation of the furnace vent must be in accordance with the National Fuel Gas Code (NFGC), ANSI Z223.1-2000/NFPA 54-2002, and /or Section 7 and Appendix C of the CSA B149.1-00, National Standard of Canada, Natural Gas & Propane Installation Code; the local building codes; furnace and vent manufacturer's instructions.

### **WARNING**

#### **CARBON MONOXIDE POISONING, FIRE, AND EXPLOSION HAZARD**

**Failure to properly vent this furnace could result in death, personal injury and/or property damage. Read and follow all the instructions in this section.**

### **AVERTISSEMENT**

#### **DANGER D'EMPOISONNEMENT AU MONOXYDE DE CARBONE, D'INCENDIE OU D'EXPLOSION**

**Une mauvaise ventilation de cette chaudière peut entraîner blessures graves ou mortelles et/ou dégâts matériels. Lisez et respectez toutes les instructions dans cette section.**

## **6.12 Clearances**

Maintain 18” clearance between the vent hood and anything that would restrict or impede air flow from the hood. The intake of the combustion air is thru louvers located on the side of the AVG wall mounted air conditioner with gas heat furnace. Maintain 19” clearance between the louvers and anything that would restrict or impede air flow into the louvers.

# 7. Parts List

MAJOR PURCHASED PARTS		AVG42AC	AVG48AC	AVG60AC
Compressor, Scroll	ACA	10052	10202	10096
	ACC	10093	10203	10097
	ACD	10094	10204	10098
Capacitor, Scroll Compressor		50322	50294	50315 (2)
		55 / 370	60 / 440	40 / 370
Refrigerant R22 (Oz)	60 Hz	100	110	107
Sound Blanket, Compressor		20017	20038	20038
Crankcase Heater, Compressor		n/a	70044	70044
Evaporator Coil		60340	60340	60061
		3CZ1404D-	3CZ1404D-	3CY1404D-
		18 x 36	18 x 36	18 x 36
Indoor Cap Tube - Cooling		n/a	80660	n/a
		n/a	.070 x 70 (4)	n/a
Strainer (.378/.382 by Four .127/.131)		n/a	80042	n/a
Strainer (.378/.382 by Three .114/.118)		n/a	n/a	n/a
Strainer (.378/.382 by Two .127/.131)		n/a	n/a	n/a
Cap Tube / Strainer Assembly (Alternate)		n/a	20297	n/a
Distributor - Indoor		20116	n/a	20033 (9)
Orifice - Cooling		20093 (.072)	n/a	20078 (.088)
		60350	60345	60345
Condenser Coil		3CZ1402D-	3CY1303D-	3CY1303D-
		28 x36	28 x 36	28 x 36
Filter Drier		70370	70370	70389
Indoor Motor (HP/RPM)		40099	40099	40046
		1/2 1075	1/2 1075	3/4 1120
Capacitor, Indoor		50360	50360	50360
Blower, L.H.		30090	30090	30090
Blower, R.H.		30092	30092	30092
Blower Wheel / Housing		10-8 DD	10-8 DD	10-8 DD
		40098	40098	40098
Outdoor Motor (HP/RPM)		1/3 825	1/3 825	1/3 825
		40098	40098	40098
Capacitor, Outdoor		50240	50240	50240
Fan Blade (Clockwise Rotation)		30135	30135	30135
		T2404-20	T2404-20	T2404-20
High Pressure Control (400 Open, 300 Close)		70080	70080	70080
Low Pressure Control (35 Open, 60 Close)		70050	70050	70050
Filter (2" Thick)		81257 (2)	81257 (2)	81257 (2)
		18 x 24	18 x 24	18 x 24
Motor, Economizer (EPA)		40101	40101	40101
Enthalpy Control, H205A (EC)		70230	70230	70230
Mixed Air Relay (MAR)		50164	50164	50164
Mixed Air Sensor (MAS)		70229	70229	70229
GreenWheel Blower, Flanged, 400 CFM		50780	50780	50780
Energy Recovery Wheel		01226	01226	01226
Motor, GreenWheel Drive		40007	40007	40007
Fan Speed Controller (230 Volt)		70049	70049	70049
Belting, 3/16" Round Urethane		P/80390	P/80390	P/80390
Contactora, Compressor, 30 Amp	ACA	50020	n/a	n/a
Contactora, Compressor, 40 Amp	ACA	n/a	50030	50030
Contactora, Compressor, 30 Amp	ACC/ACD	50040	50040	50040

MAJOR PURCHASED PARTS		AVG42AC	AVG48AC	AVG60AC
Circuit Breaker, 2 Pole, 60 Amp	ACA	70178	70178	70178
Circuit Breaker, 3 Pole, 60 Amp	ACC	70183	70183	70183
Circuit Breaker, 3 Pole, 40 Amp	ACD	70299	70299	70299
Fan Blower Control (BTR)		50419	50419	50419
Lockout Relay (LOR)		50214	50214	50214
Clip for Low Vibration		01257	01257	01257
Relay, Outdoor Fan Motor (OFR)		50205	50205	50205
Relay, B Damper		50420	50420	50420
Low Voltage Transformer (50 VA)		50199	50199	50199
Transformer (460 to 230 Volts)		50147	50147	50147
		1.5 KVA	1.5 KVA	1.5 KVA
Transformer (460 to 230 Volts), GreenWheel		P/50007	P/50007	P/50007
		2.0 KVA	2.0 KVA	2.0 KVA
Duct Furnace Heat Module: 45,000 Btu/Hr		n/a	n/a	n/a
Duct Furnace Heat Module: 67,500 Btu/Hr		n/a	n/a	n/a
Duct Furnace Heat Module: 90,000 Btu/Hr		n/a	n/a	n/a
Duct Furnace Heat Module: 75,000 Btu/Hr			50413	
Duct Furnace Heat Module: 100,000 Btu/Hr			50414	
Duct Furnace Heat Module: 125,000 Btu/Hr			50415	
Direct Spark Ignition Control, 24 VAC, 250 ma		50418		
Gas Valve, 2 Stage (3.5/1.2" WC High/Low)		20354		
Induced Draft Blower (230 v)		n/a	n/a	n/a
Induced Draft Blower (460 v)		n/a	n/a	n/a
Induced Draft Blower, 3000 RPM, 0.9 A, 230 v		30064		
Induced Draft Blower (460 v)				
Pressure Switch, Low (0.36" WC PR)		70377		
Pressure Switch, High (1.1" WC PF)		70373		
Flame Rollout Switch, L270				
Spark Igniter				
Flame Sensor				
In-Shot Burner (2.5 x 4.5)				
Limit Control, High (45,000 Btu/Hr)		n/a	n/a	n/a
Limit Control, High (67,500 Btu/Hr)		n/a	n/a	n/a
Limit Control, High (90,000 Btu/Hr)		n/a	n/a	n/a
Limit Control, High (75,000 Btu/Hr)		70372		
Limit Control, High (100,000 Btu/Hr)		70372		
Limit Control, High (125,000 Btu/Hr)		70372		
Limit Switch, High (45,000 Btu/Hr)		n/a	n/a	n/a
Limit Switch, High (67,500 Btu/Hr)		n/a	n/a	n/a
Limit Switch, High (90,000 Btu/Hr)		n/a	n/a	n/a
Limit Switch, High (75,000 Btu/Hr)				
Limit Switch, High (100,000 Btu/Hr)				
Limit Switch, High (125,000 Btu/Hr)				
Suppression Ignition Cable				
Nox Screen				
Gas Orifice, Natural Gas (Standard)		n/a	n/a	n/a
Gas Orifice, Propane (Standard)		n/a	n/a	n/a
Gas Orifice, Natural Gas (2.30 mm Standard)			20355	
Gas Orifice, Propane (1.50 mm Standard)			20356	
Relay, Heat/Blower, 460 Volt Only		50190	50190	50190
Relay, Condenser Fan, 460 Volt Only		50190	50190	50190

# 8. Warranty

## 8.1 Airxcel Commercial Group Limited Product Warranty

Airxcel Commercial Group (ACG) warrants its products to be free from defects in materials and workmanship under normal use to the original purchaser when installed within the contiguous United States, the District of Columbia, and Canada for the period of time in the table below. If any part of your ACG product fails within 15 months from the date of the original shipment from ACG, or within twelve months from the date of original start-up but not to exceed 18 months from date of original shipment from ACG, whichever comes first, ACG will furnish without charge, EXW Cordele, Georgia, the required replacement part. The owner must provide proof of the date of the original start-up. The contractor's invoice, the certificate of occupancy, or similar documents are examples of acceptable proof of the date of the original start-up.

Marvair, ICE, Eubank	Suburban Applied Products
90 Days* w/Flat Rate Labor <i>(See Marvair, ICE, Eubank Flat Rate Labor Guidelines)</i>	1 Year Parts/Labor – w/Flat Rate Labor <i>(See Suburban AP Flat Rate Labor Guidelines)</i>
1 Year Parts	5 Years Heat Exchanger
5 Years Compressor	5 Years Compressor

\*If any part of your ACG unit fails within 90 days of the commencement of the warranty, ACG will furnish without charge, EX Works, Cordele, Georgia, the required replacement part and pay for the labor to replace the part in accordance with the ACG Flat Rate Labor Guidelines.

The following optional warranties are available from Airxcel Commercial Group:

Bronze	Silver	Gold	Diamond
Any Special Warranty Written for a Job	1 Year Parts/Labor	2 Years Parts/Labor	5 Years Parts/Labor

The responsibility of the equipment owner includes:

1. To operate the equipment in accordance with the manufacturer's instructions.
2. To provide easy accessibility for servicing.
3. To check and reset any circuit breaker(s) and/or disconnect(s) prior to calling for service.
4. To keep the unit clean and free of dirt and containment and replace filters as required.
5. To keep the outdoor coil clean and free of leaves, paper, or other debris.
6. To pay the charges incurred when any of the above have not been done.
7. To pay for repair or replacement of any material or part other than those within the ACG unit or controller.

ACG will not be responsible for labor, transportation costs, delays or failures to complete repairs caused by events beyond our control. This warranty does not cover:

1. Any transportation, related service labor, diagnosis calls, filter, driers, refrigerant, or any other material charges.
2. Damages caused by shipping, accident, abuse, negligence, misuse, fire, flood, or Acts of God.
3. Damages caused by operating or staging the unit in a corrosive environment
4. Damages caused by improper application of the product.
5. Damages caused by failing to perform proper routine maintenance.
6. Expenses incurred for erecting, disconnecting or dismantling the product or installing the replacement part(s).
7. Products not installed or operated according to the included instructions, local codes, and good trade practices.
8. Products moved from the original installation site.
9. Products lost or stolen
10. Consequential damages or incidental expenses including losses to persons, property or business.
11. Modifications to original unit after it leaves the factory, such as breaking the any part of the sealed systems unless authorized in advance in writing by ACG.

When service is required, it must be performed during normal working hours (8:00 AM - 5:00 PM) Monday - Friday and must be performed by ACG personnel or a designated Service Representative. ACG will pay for non-priority shipping costs of the compressor during the first twelve months of the warranty period. After the first twelve months of the warranty period, all costs of shipment and risk of loss during the shipment of the compressor shall be the responsibility of the owner.

The owner of the product may ship the allegedly defective or malfunctioning product or part to ACG, at such owner's expense, and ACG will diagnose the defect and, if the defect is covered under this warranty, ACG will honor its warranty and furnish the required replacement part. All costs for shipment and risk of loss during shipment of the product to ACG and back to the owner shall be the responsibility and liability of the owner. Upon written request by an owner, ACG may arrange for remote diagnosis of the allegedly defective or malfunctioning product or part but all costs for transportation, lodging and related expenses with regard to such diagnostic services shall be the responsibility and liability of the owner.

An owner requesting performance under this Warranty shall provide reasonable access to the allegedly defective or malfunctioning product or part to ACG and its authorized agents and employees.

**THIS WARRANTY CONSTITUTES THE EXCLUSIVE REMEDY OF ANY PURCHASER OF AN AIRXCEL COMMERCIAL GROUP HEAT PUMP OR AIR CONDITIONER AND IS IN LIEU OF ALL OTHER WARRANTIES, EXPRESSED OR IMPLIED, INCLUDING, WITHOUT LIMITATION, ANY IMPLIED WARRANTY OF MERCHANTABILITY OR FITNESS FOR USE, TO THE FULLEST EXTENT PERMITTED BY LAW. IN NO EVENT SHALL ANY IMPLIED WARRANTY OF MERCHANTABILITY OR FITNESS FOR USE EXCEED THE TERMS OF THE APPLICABLE WARRANTY STATED ABOVE AND AIRXCEL COMMERCIAL GROUP SHALL HAVE NO OTHER OBLIGATION OR LIABILITY. IN NO EVENT SHALL MARVAIR BE LIABLE FOR INCIDENTAL OR CONSEQUENTIAL DAMAGES OR MONETARY DAMAGES.**

THIS WARRANTY GIVES YOU SPECIFIC LEGAL RIGHTS, AND YOU MAY ALSO HAVE OTHER RIGHTS WHICH VARY FROM STATE-TO-STATE. Some states do not allow limitations or exclusions, so the above limitations and exclusions may not apply to you.