



U
N
I
V
E
R
S
I
T
Y

2013

Security & Communication Solutions

MADE IN
U.S.A.



ADA Compliant Emergency Phones
See page 4



Compact Handsfree Entry Phones
See page 42

Inside: 8 New Products
that can solve your communications and security problems!

Access Control.....36-43	Enhanced Weather Protection9	Paging Products16-21
ADA Emergency Phones.....4-8	Enclosures14, 33	Self Amplified Paging17
Alarm Dialers.....13	Hot Line Products.....10-12	Service Observers29
Apartment Entry.....37-40	Gadgets15	Video (CCTV) Products.....35
Door/Gate Entry.....36-43	Long Loop Adapters31	Wireless Clocks21

Prices are suggested trade net: Verify pricing with your distributor.
Manufactured in the USA • American Product Support



SEC-5-B 2612

Quick Index - Alphabetical by Model Number. Document On Demand (DOD) number, Description and Catalog Page Number

Model	Description	DOD #	Catalog Page	Model	Description	DOD #	Catalog Page	Model	Description	DOD #	Catalog Page
25AE, 30AE	Paging Horn Paging Spkr	498	19	HID-2	Weigand Keypad	199	38	PI-1A	Telecom Paging Interface	491	18
35AE	Paging Spkr w/Vol Cont	498	19	K-600F	Night Bell Over Paging	476	18	PJ-14	2 Line Privacy Device	560	23
ACA-1A	Auto Attendant	005	27	K-1200	Apt. Entry Phone System	182	37	PROX Series	Prox Card Reader		38
AES-2000S/F	Apt Entry Sys. w/Display	202	39	K-1205	Video Entry Phone System	183	35, 37	PS-1A, PS-2, PS-3	Replacement Pwr Supplies	510	31
AES-2005S/F	Apt. Entry Sys. w/Camera	204	35, 39	K-1500-6A	Space Saving Panel Phone	352	11	PS-48-RGA	Talk Batt/Ringing Supply	515	31
NEW AR-1	Automated Receptionist	105	27	K-1500-7	Panel Phone, Stainless	352	11	PTR-1	Prof Telecom Record Adpt.	438	29
NEW BLK-4	Blue Strobe Light Kit	654	28	K-1500-E	Handset Elevator Phone	220	14	Q170600	Electronic Ringer	834	10
C-200	E Series Controller	169	41	K-1500-EHFA	Handsfree Elevator Phone	220	14	RAD-1A	Remote Access Paging/Audio	410	22
C-250	E Series Controller	172	41	K-1500P-D	No Dial Desk Phone	355	11	RAD-AMP	Amp. Remote Access Device	415	22
C-1000B	W Series Controller	168	36	K-1500P-W	No Dial Wall Phone	355	11	RC-2A	Remote DTMF Controller	160	40
C-2000B	E Series Controller	156	41	K-1600-EHFA	ADA Elevator Phone	215	5	RC-3	Remote DTMF Controller	165	40
C-3000	No CO Line Apt Entry Sys	162	40	K-1700-3 Series	Keypad Entry Phone	157	37	RC-4	Network Relay Controller	580	39
C-4000	4 Door Prox Card System	164	40	K-1705-3 Series	Keypad Video Phone	159	35, 37	RG-4	1 Line Ring Shaper/Booster	416	30
CL Series	Wireless Clocks/Accessories	466	21	K-1900-3	1 Door Apt. Entry Controller	312	37	RG-10A	Ring Booster	420	31
CPC-1	CPC Disconnect 1 Line	442	31	K-1900-4	Pulse Auto Dialer	315	12	RG-204	4 Line Ring Shaper/Booster	417	30
CPC-4	CPC Disconnect 4 Line	444	31	K-1900-5	Touch Tone Auto Dialer	317	12	RG-212	12 Line Ring Shaper/Booster	419	30
CTG-1	Clock Tones Over Paging	460	20	K-1900-6	Hot Line Network Board	360	11	RG-224	24 Line Ring Shaper/Booster	418	30
CTG-2	Clock Tone/Message Page	463	21	K-1900-7	Hot Line Panel Phone	364	11	SA-Series	Self-Amplified Paging	520	17
Directories	For Apt. Entry Systems	158	37	K-1900-8	Hot Line Phone w/Keypad	362	11	SC-911	Strobe Controller	236	28
DLE-200B	Telephone Line Simulator	605	32	K-1900-9	100 Number Speed Dialer	321	12	NEW SL-2, SL-2-EWP	Blue Strobe Light	242	28
DLE-300	Telephone Line Simulator	607	32	K-1900-30	Smart Touch Tone Dialer	300	12	SLP-1	Single Line Paging	478	16
DNA-510	Mass Notification Paging	492	20	K-1900D-2	Hot Line Dialer Phone	360	10	SLP-4	Paging and Door Chime	479	20
DVA-1003B	(3)1 Minute Digital Announcer	125	26	K-1900W-2	Hot Line Dialer Phone	360	10	SO-24A	Silently Monitor Phone Lines	690	29
DVA-2WA	7 Min MOH Digital Announcer	110	26	K-202-DVA	2 Input Voice Alarm Dialer	305	13	SO-24 AK	Digital Phone Kit for SO-24A	819	29
DVA-3003	(3)4 Minute Digital Announcer	127	26	K-2000-DVA	8 Input Voice Alarm Dialer	303	13	SQRG-12	TMS6X/12A Ring Generator	060	27
DVA-500A	1 Min Digital Announcer	115	26	K-6000-DVA	Voice Message Delivery Sys.	307	13	SR-1	Single Line Loud Ringer	477	19
DVA-LPA	Line Powered Announcer	128	26	NEW LC-6	6 Phone Line Concentrator	245	8	SRC-1	Secure Relay Controller	176	40
DVA-TNT	Time & Temp Announcer	129	26	LDB-1	Loop Detector Board	406	15	SV-5W	Speaker Volume Control	488	19
E-10A, E-20B	Door Entry Phones	210	14, 42	LDB-2	Ring and Loop Detector	408	15	TBB-1B	Talk Battery Booster	632	31
E-30	Entry Phone w/Dialer	212	7	LDB-3	Ring and/or Loop Detector	409	15	TDR-1	Time Delay Relay	421	15
E-30-PT	Entry Phone, Push To Talk	214	7	LLA-1	1 Line Long Loop Extender	615	31	TG-1, TG-2	Telephone Line Privacy	560	23
E-35	Video Entry Phone	178	7, 35	LLA-4	4 Line Long Loop Extender	620	31	TMS-2	2 Line Call Sequencer	062	27
E-40 Series	Single Gang Entry Phone	187	42	LM-1A	Message Waiting Lamp	662	28	TMS-6X	6 Line Call Sequencer	065	27
E-50 Series	Single Gang Video Phone	191	35, 42	LM-24D, LM-24S	Line Status Monitor	670	28	TMS-12A	12 Line Call Sequencer	070	27
E-60 Series	Double Gang Entry Phone	206	43	NEW LPL-1	Line Powered Light	640	28	TMS-RDMA	Status Display for Sequencer	075	27
E-65 Series	Double Gang Video Phone	203	43	LPR-1	Line Powered Ringer	550	15	TR-1	Toll Restrictor	705	22
E-70 Series	2 Gang Card Reader Phone	207	43	LS-4x4 Series	Line Scanner/Sharing	270	23	VCAM-1	Replacement Video Camera	190	35
E-75 Series	Video Card Reader Phone	208	43	LS-911	Line Sharing Device	238	8	VCAM-1IR	Replacement IR Video Cam.	190	35
1600A Series	ADA Emergency Phones	215	4-7	LSD-2	Line Seizure Device	262	8	VCAM-2 Series	Single Gang Video Camera	190	35
E-1600A-BLT-EWP	Blue Light Tower Phone	217	5	LSR-1	Line Seizure Relay	230	8	VE-3X5	Surface	424	33
E-1600A-BLT2EWP	2 Button Tower Phone	217	5	NEW LV-1K	Line Verification Panel	246	8	VE-5X5/PNL/SS	Mounting	424	33
E-1600A-TP-EWP	ADA Replacement	218	6	M2W	Telephone Speaker Amp.	480	18	VE-5X10/PNL/SS	Boxes and	424	33
E-1600A-TP2-EWP	Emergency Phones	218	6	NEW MSB-30	Voice Comm for IP Camera	213	39	VE-6X7/PNL/SS	Panels	424	33
ERAM-60	Memory Expansion	813	26	MTG-10	Multi Tone Generator	482	15	VE-9x12 Series	Outdoor	413	14
ERAM-4M	Memory Expansion	854	39	NS-1	Night Switch	540	18	VE-9x20 Series	Enclosures	413	14
ES-1	Wiegand Controller	193	38	PA-2A	Paging/Ringing 2 watt Amp.	485	16	VE-GNP Series	Gooseneck Pedestals	424	33
ES-3	Door Control for AES-2000	195	38	NEW PA-15	Paging/Ringing 15 watt Amp.	486	16	VE-LIGHT	Lighting Kit	428	33
EV-1	Outbound Announcer	135	26	PA-30	Paging/Ringing 30 watt Amp.	489	16	VR-1B	Telephone Status Indicator	697	28
FAQJ-1000	Fax/Auto Routing Switch	261	23	PAN-1	Panasonic Doorphone Adapt.	145	15	W-1000	Door Box w/Ring Voltage	170	36
FBI-1A	Anti-Feedback Paging	465	18	PB-1	Panic Button Kit	233	4	W-2000A	Door Box w/Ring Voltage	170	36
GLS-12	Ground to Loop Start Conv.	570	30	PB-100	Programmer for AES-2000	232	25	W-3000	Door Box w/Ring Voltage	180	36
FXI-1	IP Paging Interface	494	18	PC-7	Phone line Privacy Cord	560	23	W-3005	Video Doorbox w/Ring Volt	181	36
HF-3W	Handsfree Talkback Paging	470	18	PF-6A	Power Fail Phone Line Bypass	680	30	ZPI-4	Zone Paging Controller	499	19

Compatible IP Gateway Equipment - Page 34 •  Indicates products available with enhanced weather protection (Page 9) DOD# 859



How to Contact Us:

Information: (715) 386-8861
 Online: www.VikingElectronics.com
 Email: Help@VikingElectronics.com

FREE Product Support is available to Professional Installers who have purchased a **VIKING** product through an authorized Distributor.
 Call: 715-386-8666
 Monday thru Friday
 8 am to 5 pm Central Time
 Product Support E-mail
ProductSupport@VikingElectronics.com

Fax Number: (715) 386-4344

All Viking products are available nationwide through distributors listed on the back cover.

MSRP

To determine the **Manufacturers Suggested Retail Price** multiply the trade net price x 2.

One Year Warranty

All **VIKING**® products are warranted to be free from defects in workmanship and material for a period of one year from the date of purchase. For complete information request **DOD# 101**.

Compatible IP Gateway Equipment - Page 34

Blue Clues - For a definition of a term in blue see Telecom Glossary pages 24 & 25.

Index of Applications... **DOD# 800**

Improved features in purple print.

FREE American Product Support

When you call **VIKING** for product support, you'll be talking to a professional located right here in our Hudson, WI plant, not half way around the world. American product support, located right here in America. What a concept!



Visit our comprehensive website

- Download product catalogs
- Rapid click-throughs
- Up-to-date information at your fingertips
- Online Product Training Center
- Download Application and Technical Documents on every product!

Product info online at VikingElectronics.com

NEW: "Document On Demand" Search

Viking wants to make it easy for you to get the product information you need, so we've added a new search to our website called "Document On Demand" (DOD). All Viking catalogs and literature have **DOD #**'s. Enter the **DOD #** on our homepage for a direct link to product cut sheets.

Look for **DOD** numbers throughout this catalog!



Need a product that's not in this catalog? Call or E-mail us!



ASK VIKING FIRST!
(715) 386-8861
 If we don't make what you need we'll refer you to someone who does.

ADA Compliant Emergency Phones

- Complies with ASME A17.1 Elevator Code
- Phone Numbers and I.D. Announcement Stored in Non-Volatile Memory
- Battery Back-Up Not Required
- Analog PABX, CO Line or FXS Port powered - 2 Wire Installation
- Automatically Dials 4 Additional 1 - 20 Digit Numbers on Busy or No Answer
- Compatible With Central Station Monitoring
- Temperature range (-15 to 130)

ADA Compliant with Braille Label and "Call Connected" LED



Viking Electronic's 1600A Series Emergency Phones are designed to provide quick and reliable access to emergency personnel via two-way, handsfree voice communication over the public switched telephone network. The 1600A Series have braille labels and meet ADA* requirements for elevator telephones. Compatible with analog PABX, CO line or FXS port and ringdown circuits.

The 1600A Series can be programmed on site or remotely from a Touch Tone phone. All parameters, phone numbers, location numbers, and voice announcement are stored in non-volatile E² memory. Batteries are not required for memory retention.

When the "Push for Help" button is pressed, the 1600A Series phone goes off-hook, and the built-in Touch Tone or pulse dialer calls the pre-programmed 1 to 20 digit number. The "Call Connected" LED flashes during dialing. In the event that the line is busy or there is no answer, the unit can automatically dial up to 4 more numbers. 1600A phones light the "Call Connected" LED and send a field-programmed 1 to 20 digit Touch Tone number or 16 second voice announcement indicating the location of the emergency phone.

Silent Panic Button Kit for E-1600A Series

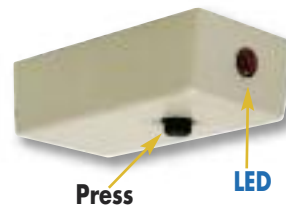

Model	DOD #
PB-1	233

Applications include:

- Court Rooms
- Convenience Stores
- Gas Stations • Motels
- All Night Restaurants

Can be mounted under desk, counter, etc. and connected to a Viking E-1600A. When the button is pressed, the E-1600A calls up to five numbers and gives a pre-recorded message. The E-1600A speaker is disabled but the called party hears what is happening. The LED indicates activation.

Handsfree Emergency Phones - Models E-1600-45A, E-1600A, E-1600-60A, and E-1600-65A

ADA Compliant with Braille Label and "Call Connected" LED

- Material: .062" (16 gauge) steel, powder painted
- Mounting: Surface mount to walls, posts, single gang boxes or recess mount in elevator phone boxes
- Two-wire installation - analog PABX, CO line or FXS port powered
- Dimensions: 5.25" x 4.0" x 2.0"

When installing E Series emergency phones outdoors, always use the EWP version - See page 9



Model	DOD #
E-1600A	215
E-1600-45A	215
E-1600-60A	215
E-1600-65A	215

42" Tower Phone with LED Strobe and Steady-on Beacon

ADA Compliant with Braille Label, "Call Connected" LED and High Intensity Flashing LED Strobe with Steady-on-Beacon

General Emergency Phone Features and Operation: (refer to **1600A series** on page 4)

- New high intensity, long life **LED** technology
- 4 programmable flash patterns
- 6 programmable brightness settings
- Max Strobe Power Run on **CAT-5** using 3 pair = 325 ft.
- Mounting: Surface mount to rigid wall or post
- Connections: Color-coded wires with gel-filled butt connectors
- Material: Enclosure - .125 aluminum, 76.2mm x 152.4mm (3" x 6") tube, powder painted high- visible yellow, Phone - .074 (14 gauge) stainless steel with stainless steel button, Strobe - Vandal resistant polycarbonate plastic
- **Enhanced Weather Protection (EWP)** standard
- **Power supply included**
- Two-button version available with "Info" and "Help" buttons
- Dimensions: 42" x 6" x 4.5"

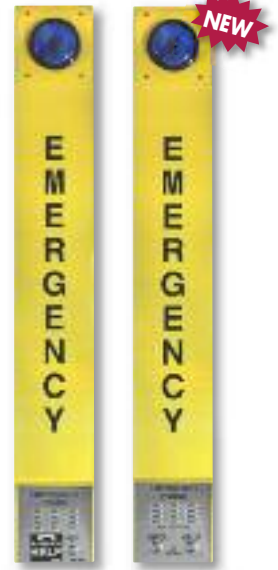

Model	Description	DOD #
E-1600A-BLT-EWP	42" Yellow Tower Phone	217
E-1600A-BLT2EWP	Two Button 42" Yellow Tower Phone	217

Vandal Resistant Handsfree Emergency Phone

ADA Compliant with Braille Label and "Call Connected" LED

General Emergency Phone Features and Operation: (refer to **1600A series** on page 4)

- Material: .074" (14 gauge) brushed 316 marine grade stainless steel
- Mounting: Surface mount to walls, posts, single gang boxes or recess mount in elevator phone boxes
- Two-wire installation - analog **PABX, CO** line or **FXS** port powered
- Dimensions: 7.22" x 5.86" x 1.55"

⚠ When installing E Series emergency phones outdoors, always use the EWP version - See page 9

Model	Description	DOD #
E-1600-03B	Stainless Steel Emergency Phone	215



Vandal Resistant Handsfree Emergency Phone

ADA Compliant with Braille Label and "Call Connected" LED

General Emergency Phone Features and Operation: (refer to **1600A series** on page 4)

- Material: .125" (11 gauge) brushed 316 marine grade stainless steel
- Two-wire installation - analog **PABX, CO** line or **FXS** port powered
- Dimensions: 13.0" x 10.5" x 2"
- Mounting: Flush mount in elevator cabs, ATMs, stairwells, hallways, etc.

⚠ When installing E Series emergency phones outdoors, always use the EWP version - See page 9

Model	Description	DOD #
E-1600-02A	Stainless Steel Emergency Phone	215



Handsfree Emergency Phone for Elevator Phone Box

ADA Compliant with Braille Label and "Call Connected" LED

General Emergency Phone Features and Operation: (refer to **1600A series** on page 4)

- Material: 0.062" (16 gauge) red powder painted steel
- Two-wire installation - analog **PABX, CO** line or **FXS** port powered
- Dimensions: 9.875" x 6.86" x 2.1"
- Mounting: Recess mounting in standard elevator phone box (10" x 7" x 3")

Model	Description	DOD #
K -1600-EHFA	Handsfree Elevator Phone	215



Specialty Emergency Phones

Two Button 5" x 5" ADA Stainless Steel Emergency Phones

Emergency Phone Features and Operation: (See page 4)

- Material: 14 gauge brushed marine grade 316 stainless steel
- Mounting: Flush mount with included plastic rough-in, surface mount with optional **VE-5x5** enclosure (Page 33)
- Two wire installation – analog **PABX, CO** line or **FXS** port powered
- Dimensions: 5.0" x 5.0" x 2.25"
- **Two button version dials up to 3 additional numbers for general info or directions**

⚠ When installing E Series emergency phones outdoors, always use the EWP version – See page 9

Model	Description	DOD #
E-1600-20A	Two Button Emergency Phone	215



Replacement Phone for Talk-A-Phone Applications

ADA Compliant with Braille label, "Call Connected" LED

Emergency Phone Features and Operations: (See page 4)

- Direct replacement for the Talk-A-Phone ETP-400(V) panel phone, Code Blue towers require redrilling and tapping
- Material: 11 gauge brushed marine grade 316 stainless steel
- Mounting: Flush mount to Talk-A-Phone ETP towers, wall mounts, boxes and Pedestals
- Analog **PABX, CO** line or **FXS** port powered emergency phone (**LDB-3** requires power) and **Enhanced Weather Protection (EWP)** standard
- Dimensions: 9.5" x 11.75" x 2.0"
- Two button version dials up to 3 additional numbers for general info or directions

Model	Description	DOD #
E-1600A-TP-EWP	Talk-A-Phone Replacement	218
E-1600A-TP2-EWP	Two Button Replacement	218



Universal Emergency Phone Kit

ADA Compliant, Ideal for Custom Elevator Panels

General Emergency Phone Features and Operation: (See page 4)

- Material: 0.062" (16 gauge) zinc plated steel
- Analog **PABX, CO** line or **FXS** port powered
- Dimensions: 5.0" x 5.0" x 2.25"
- Mounting: Install behind elevator panels for installations requiring a custom panel

Model	Description	DOD #
E-1600-55A	Panel kit	215

⚠ When installing E Series door entry or emergency phones outdoors, always use the EWP version – See page 9



Non-Chassis Emergency Phones

ADA Compliant, Comes with Braille Label and LED

General Emergency Phone Features and Operation: (See page 4)

- **E-1600A** parts kit without a chassis
- Model **E-1600-52A** has 2 push buttons, one "Info" and one "Help"
- Ideal for applications that don't require traditional housing
- **Kit includes: printed circuit board, speaker, microphone, switch(s), RJ-11 jack and cable harness assembly**
- Analog **PABX, CO** line or **FXS** port powered
- Connections: 2-position terminal block or gel-filled butt connectors

⚠ When installing E Series door entry or emergency phones outdoors, always use the EWP version – See page 9

Model	Description	DOD #
E-1600-50A	Non-Chassis Emergency Phone	215
E-1600-52A	Non-Chassis Two-Button Phone	215



E-1600-50A-EWP version shown



Viking Emergency Poolside Phones Can Help Save Lives!



E-1600-30A
Marine Grade 316
Stainless Steel ADA
Compliant phone
 (see page 4)



For other
Emergency Phones
 see pages 4-8

State by State
Regulations
DOD # 870

Pool Phone Laws

The map shows the states in red that are required by code to have pool emergency phones. If your state is not shown in red, it does not mean you are exempt. Please check your local codes for guidance.



E-1600-30A-EWP
 shown in optional
 surface mount box.
 (Page 33)

⚠ When installing E Series
emergency phones outdoors,
always use the EWP version
- See page 9

Model	Description	DOD #
E-1600-30A	ADA Compliant Emergency Phone	215

Handsfree Speaker Phone with Dialer

- Analog **PABX**, **CO** line or **FXS** port powered entry or emergency phone
- **Marine Grade 316 stainless steel faceplate with metal call button**

When the call button is pressed, the **E-30** automatically dials a pre-programmed 1-20 digit number. The phone will dial up to 4 additional numbers if a busy signal or no-answer is detected. The phone numbers are programmed from any touch tone phone and stored in non-volatile memory. The **E-30** can be set to auto-answer and disconnects on silence, busy, dial tone, **CPC** or time out. The unit is designed for non-**ADA** emergency, door and gate entry applications. Temperature range is -15° F to 130° F. Size is 5" x 5" x 2.25".

⚠ When installing E Series door entry or emergency phones outdoors, always use the EWP version - See page 9



Model E-30
 shown in optional
VE-5x5 surface mount box
 (Page 33)

Model	Description	DOD #
E-30	Emergency Handsfree Phone	212



Model E-30-PT
 shown in optional
VE-5x5 surface mount box
 (Page 33)

"Push to Talk" Speaker Phone

The **E-30-PT** has the same audio, temperature and dialer specifications as the **E-30** (above). The unit is designed to be used in place of the **E-10A**, **E-20B** or **E-30** handsfree phones in noisy applications. In applications where the background noise can be louder than the person calling, a handset type phone is recommended. Marine grade 316 stainless steel panel.

Video Speaker Phone with Dialer

The **E-35** has the same audio, temperature and dialer specifications as the **E-30** (above). The **E-35** also includes a high resolution color CCTV camera - refer to page 35 for camera specifications. The camera operates up to 150 feet on **CAT-5E** cable. Marine grade 316 stainless steel panel.
Power supply included.



Model E-35
 shown in optional
VE-5x5 surface mount box
 (Page 33)

Model	Description	DOD #
E-30-PT	Push to Talk Entry Phone	214
E-35	Video Entry Phone with Dialer	178

⚠ When installing E Series door entry or emergency phones outdoors, always use the EWP version - See page 9

Concentrate 6 Emergency Phones

- Meets the new ASME A17.1 Requirements
- Communicate with local and/or remote authorized personnel



The **LC-6** eliminates the monthly charges for a dedicated line to each elevator. Up to six emergency phones can communicate with authorized personnel on 3 other phones within a building, or add a telephone line to allow communication outside the

building. A call initiated by an emergency phone can dial internally, externally, or both. Any other phones that are activated will be conferenced into the conversation, thus filling ASME A17.1 requirements. Fire officials can call each cab, place an "all call" to all cabs, or break into in-progress "911" calls.

Per ASME A17.1 requirements, the **LC-6** can verify the operability of the telephone line on a daily basis and with the optional Viking model **LV-1K** line verification alarm panel, can display an "Elevator Communications Failure".

Power supply included. Purchase 550 VA battery backup separately.

Model	DOD #
LC-6	245

Line Verification Panel with Key Switch

- Meets the new ASME A17.1 Requirements
- Immediate Alarm on loss of line
- Compatible with all Analog Elevator Phones



Use with any existing single line **Viking E-1600A** series emergency phone to provide an audible and visual indication that the telephone line is not functional. Easily mounts in a standard double gang electrical box. With the **LV-1K** installed, the **E-1600A** series phone will check the telephone line on a daily basis. In accordance to ASME A17.1, the **LV-1K** is labeled "ELEVATOR COMMUNICATION FAILURE" in 1/4" high letters, and will sound an audible signal every 30 seconds and flash a red light when a telephone line fault is detected. Authorized personnel can silence the audible signal with the included key switch. The **LED** light will remain flashing until the fault is corrected. Use in conjunction with the Viking model **LC-6** to show line verification for up to six **E-1600A** series emergency phones.

Model	DOD #
LV-1K	246

A Smart Line Sharing Device with Inbound Switching Capability

- Routes both incoming and outgoing calls
- Allows an Emergency device to share a phone line with other devices (fax machines, phones, modems)
- Gives priority to the Emergency devices
- Incoming calls routed to one of two ports by Caller ID, **Distinctive Ring** or Call Back
- Status **LED** displays mode of operation
- Can store up to 12 Caller ID numbers



- Provides a busy signal to the phone port when an Emergency device is in use

Power supply included.

Model	DOD #
LSD-2	262

Your Emergency Device can Share a Line with Your Phone System

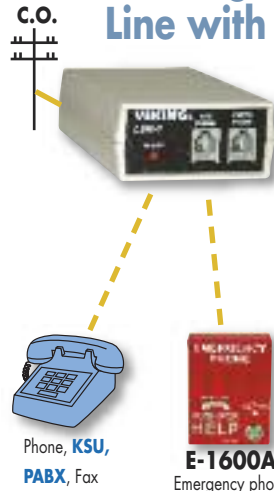

Share Lines – Save Hundreds of Dollars Per Year

Viking's Emergency Line Seizure Relay allows the Elevator/Emergency phone or alarm dialer to share an existing **C.O.** line. When the emergency phone or alarm dialer initiates a call, the line is taken away from its normal use and receives new dial tone for the emergency call. Any call in process is disconnected. The **LSR-1** always connects to emergency device during power failure.

Power supply included.

Model	DOD #
LSR-1	230

Analog Line Sharing For IP PBX's, VoIP Phone Systems

The **LS-911** offers a cost-effective, reliable method of handling 911 emergency calls for IP PBX's and networked phone systems. Connected to an **FXO** port, it lets you enjoy the advantages of conventional analog 911 service, including traceability and 911 callback, without having to dedicate an analog line exclusively for this purpose.

911 calls routed to the **LS-911** receive priority, taking the analog line from the fax, card reader etc. if it is in use. A special recall feature maintains the availability of the line in the event the emergency call is disconnected, so 911 personnel can call back to reestablish the connection. **Power supply included.**



Model	DOD #
LS-911	238

EWP Products Last Longer and Save Money!

Outdoor environments cause ordinary circuit boards to fail early. But Viking's **Enhanced Weather Protection (EWP)** products are weather-sealed with a thick protective coating that keeps the elements out. **EWP** is so effective that our early production models are still out in the field, working as well as the day they were installed - without a single service call. That was over 9 years ago! So, if you want to save money on your outdoor installations, invest a bit more upfront in **EWP**. Just order Viking products with an **EWP** suffix. Then install it and forget it.



EWP board working under water

Features

- **PCB** completely sealed in an injection molded thermoplastic potting compound
- Sealed **LED**, push button switch and microphone connections
- Internally sealed push button switches, trim pots and dip switches
- Mylar speaker with foam gasket
- Closed cell foam gasketing to prevent water penetration
- Weatherproof connectors filled with anti-corrosive gel
- **EWP** products are designed to meet an Ingress Protection rating of IP66.



Tough and durable thermoplastic potting

Does my installation require Enhanced Weather Protection?

If you answer "yes" to one or more of the following statements, we recommend a Viking Emergency or Entry phone with **EWP (Enhanced Weather Protection)**.

1. The product is located outside where it is exposed to precipitation or condensation.
2. The product is mounted near an indoor swimming pool or spa.
3. The products wire runs use conduit which could funnel warm inside air to the product mounted outside, causing condensation on the circuit board.
4. The product is mounted in a location with a known corrosive atmosphere.
5. The product is mounted in a parking garage with vehicle exhaust.
6. The temperature of the product can get below the dew point.



E-1600-30A-EWP
page 7



K-1200-EWP
Shown in optional **VE-5x10-SS** surface mount box **page 37**



E-1600A-EWP
page 4



K-1700-3-EWP
Shown in optional **VE-6x7** surface mount box **page 37**

Model	Description	DOD #	Page
BLK-3-EWP	Blue Strobe Light Kit	653	28
BLK-4-EWP	Blue Strobe Light Kit	654	28
E-1600-02A-EWP	Stainless Steel Emergency Phone	215	5
E-1600A-EWP	Red Emergency Phone	215	4
E-1600-20A-EWP	Two-Button Emergency Phone	215	6
E-1600-45A-EWP	Yellow Emergency Phone	215	4
E-1600-03B-EWP	Stainless Steel Emergency Phone	215	5
E-1600-30A-EWP	Stainless Steel Emergency Phone	215	7
E-1600-50A-EWP	No-Chassis Emergency Phone	215	6
E-1600-52A-EWP	No-Chassis Emergency Phone	215	6
E-1600-55A-EWP	Custom Emergency Phone Kit	215	6
E-1600-60A-EWP	Blue Emergency Phone	215	4
E-1600-65A-EWP	Blue Emergency Phone	215	4
E-1600A-BLT-EWP	Strobe Light Tower Phone	217	5
E-1600A-BLT2EWP	Two Button Tower Phone	217	5
E-1600A-TP-EWP	Talk-A-Phone Replacement	218	6
E-1600A-TP2-EWP	Talk-A-Phone Replacement	218	6
E-10A-EWP	Speaker Phone	210	14/42
E-20B-EWP	Speaker Phone	210	14/42
E-30-EWP	Speaker Phone	212	7
E-30-PT-EWP	Speaker Phone	214	7
E-35-EWP	Video Speaker Phone	178	7/35
E-40-SS-EWP	Single Gang Entry Phone	187	42
E-40-BN/WH/PB/BK-EWP	Compact Entry Phone	187	42
E-50-SS-EWP	Compact Video Entry Phone	191	35/42
E-50-BN/WH/PB/BK-EWP	Compact Video Entry Phone	191	35/42
E-60-SS-EWP	Double Gang Entry Phone	206	43
E-60-BN/WH/PB/BK-EWP	Double Gang Entry Phone	206	43
E-65-SS-EWP	Double Gang Video Entry Phone	203	43
E-65-BN/WH/PB/BK-EWP	Double Gang Video Entry Phone	203	43
E-70-SS-EWP	Entry Phone with Prox Card Reader	207	43
E-70-BN/WH/PB/BK-EWP	Entry Phone with Prox Card Reader	207	43
E-75-SS-EWP	Video Phone with Prox Card Reader	208	43
E-75-BN/WH/PB/BK-EWP	Video Phone with Prox Card Reader	208	43
HID-2	Wiegand Keypad	199	38
K-1200-EWP	12 Button Entry Phone	182	37
K-1205-EWP	12 Button Video Entry Phone	183	35/37
K-1700-3-EWP	Keypad Door Phone	157	37
K-1700-3-BN-EWP	Bronze Keypad Door Phone	157	37
K-1705-3-EWP	Video Keypad Door Phone	159	35/37
K-1705-3-BN-EWP	Bronze Video Keypad Door Phone	159	35/37
K-1900-7-EWP	Stainless Steel Panel Phone	364	11
K-1900-8-EWP	Panel Phone with Keypad	362	11
PROX-1	Proximity Card Reader	221	38
PROX-2	Proximity Card Reader/Keypad	219	38
PROX-3-MK-GNP	Mounting Kit for VE-GNP Pedestals	229	38
PROX-3-MK-VEGNP	Mounting Kit for VE-GNP Pedestals	229	38
SL-2-EWP	LED Strobe/Beacon	242	28
VCAM-1	Compact Color Video Camera Kit	190	35
VCAM-11R	Video Camera Kit IR Compatible	190	35
VCAM-2-SS	Video Camera Mounts in Single Gang Box	190	35
VCAM-2-BN	Video Camera Mounts in Single Gang Box	190	35
W-1000-EWP	Doorbox	170	36
W-2000A-EWP	Doorbox	170	36
W-3000-EWP	Doorbox	180	36
W-3005-EWP	Video Doorbox	181	35/36

Hot Line , Courtesy and Special Color Phones

Hot-Line Single Number Dialer Phones

- **Auto Dialing Emergency/Courtesy Phones**
- **Dials a Pre-Programmed Number Whenever the Handset is Lifted**
- 1-32 digit programmable speed dial number
- Telephone line powered and touch tone programmable
- Hearing aid compatible amplified handsets with rotary handset volume control
- Touch tone and 10/20 pps pulse dialing
- Non-volatile memory (no batteries required)
- Restricts fraudulent calls from hand held dialers
- Available in red or ash color
- Operates on a **C.O.** line or analog **PABX/KSU** extensions

Applications: Courtesy and Emergency Phones Cash Machines
 Customer Service Taxi Service
 Airline/Hotel/Rental Car Reservations Security
 Help Lines
 POS Displays



K-1900W-2

K-1900D -2

Replace leased ringdown circuits using standard loop start **C.O. lines**. The Hot-Line phone automatically dials the programmed number whenever the handset is picked up. Four-second pauses can be programmed for use on **Centrex** or behind **PABX**.

Free Programming (100 Unit Minimum)

Viking will pre-program hot line phones or dialers with any number up to 32 digits or pauses, at no charge (minimum quantity 100). To take advantage of this free service, contact us at 715-386-8861. The following models are covered by this program:

- | | |
|----------------------|------------------------|
| K-1900-5 | K-1900W-2 (Red) |
| K-1900W-2 ASH | K-1900D-2 (Red) |
| K-1900D-2 ASH | K-1900-7 |

Model	Description	DOD #
K-1900D-2	Red Hot-Line Desk Phone	360
K-1900W-2	Red Hot-Line Wall Phone	360
K-1900D-2 ASH	Ash Hot-Line Desk Phone	360
K-1900W-2 ASH	Ash Hot-Line Wall Phone	360

Need Hot-Line Phones with Special Colors?

You can add an electronic ringer to the **K-1900W-2** or **K-1900D-2**. Order **Viking Model Q170600 Ringer... DOD# 834**

ANY Pantone color available!

MINIMUM QUANTITY NOW REDUCED TO ONLY 144 UNITS!

CALL SALES AT (715) 386-8861 FOR DETAILS.



Vandal Resistant Hot-Line Panel Phone

- Touch tone or pulse auto-dialing (up to 32 digits) programmable speed dial number
- Vandal resistant 0.105" thick 316 marine grade stainless panel, armored cable and metal cradle
- Temperature Range (-30° to 140°F)
- Armored cable: STD-36"; **EWP-54"**

- Hearing aid compatible amplified handset with sealed push button volume control
- Optional surface mount box available, model VE-5x10 (see page 33)
- Dimensions: 5"W x 10"H x 4"D

 **When installing K-Series phones outdoors, always use the EWP version - See page 9**



Model	Description	DOD #
K-1900-7	Hot-Line Panel Phone	364

Vandal Resistant Hot-Line Panel Phone with Built-In Keypad

- Auto-dials (up to 32 digits) programmable speed dial number
- Touch tone or pulse dialing with a programmable pre-dial pause
- Sealed metal touch tone keypad
- Multi-number dialer mode adds 5 speed dial numbers
- Temperature Range (-30° to 140°F)

- Vandal resistant 0.105" thick 316 marine grade stainless steel panel, armored cable and metal cradle
- Armored cable: STD-36"; **EWP-54"**
- Hearing aid compatible amplified handset with sealed push button volume control
- Optional **VE-5x10** (page 33) surface mount box available
- Dimensions: 5"W x 10"H x 4"D

 **When installing K-Series phones outdoors, always use the EWP version - See page 9**



Model	Description	DOD #
K-1900-8	Hot-Line Panel Phone with Keypad	362

Vandal Resistant Stainless Steel Manual Panel Phones

- **K-1500-6A**: 0.075" thick stainless steel panel
- **K-1500-7**: 0.105" thick 316 marine grade stainless steel panel
- Armored cable and heavy-duty hookswitch
- Compatible with Viking ringdown circuits
- Mounts on a standard double-gang electrical box
- 316 Marine Grade Stainless Steel Panel
- Optional **VE-5x10** (page 33) surface mount box available for model **K-1500-7**

Model	DOD #
K-1500-6A	352
K-1500-7	352



Network Insert Dialer

This electronic network, used in Viking's Hot-Line Phones, can be used to convert any standard phone into a single number hot-line phone.



Model	DOD #
K-1900-6	360



K-1500P-W

K-1500P-D

Manual (No Dial) Phones with Ringers

Ringdown, Courtesy or Emergency Phone Applications

These manual phones are compatible with ringdown circuits such as model **DLE-200B** (page 32), dialers such as Viking's **K-1900-5** and **K-1900-30** (page 12) as well as an analog **PABX, CO line** or **FXS** port configured as a ringdown circuit.

Model	Description	DOD #
K-1500P-W	Red Manual Wall Phone	355
K-1500P-D	Red Manual Desk Phone	355
K-1500P-W-ASH	Ash Manual Wall Phone	355
K-1500P-D-ASH	Ash Manual Desk Phone	355

Touch Tone and Pulse Hot-Line Dialers

- Applications:** • Help Lines • POS Displays • Information Kiosks
• Hotel/Car Reservations • Courtesy Phones • Money Transfer
• **Non-Volatile Memory**
• **No Batteries to Replace**
• **Convert any Phone to a Hot-Line Dialer**

These analog **PABX, CO** line or **FXS** port powered dialers automatically dial the programmed number each time the connected phone goes off-hook. They can help eliminate mileage charges on leased lines, toll fraud on courtesy or emergency phones and hand-held dialers. They are compatible with analog **PABX, CO** line or **FXS** port and will not dial on incoming calls. **Program from any Touch Tone phone.**

Model **K-1900-4** provides 10 or 20 pps **pulse** dialing and with external switches, can dial up to 31 different 1 to 16 digit phone numbers. "Pulse only" phone lines usually cost less per month and cannot be hacked by hand-held dialers. **K-1900-4** can store 4-second pauses.

Model **K-1900-5** provides **1 to 32 digit Touch Tone** dialing and 1 and 4 second pauses as needed to use behind a **PABX, access a pager from an alarm contact**, etc. The **K-1900-5** blocks hand-held dialers and "hook-switch" or pulse dialing. The dialer can provide fast (50 mS) or normal (120 mS) on/off Touch Tones.



K-1900-4



K-1900-5

Model	Description	DOD #
K-1900-4	Pulse Dialer	315
K-1900-5	Touch Tone Dialer	317

- The **K-1900-5** can be activated by a momentary contact closure see **DOD# 818**.
- Program a Multitude of Dialers or Hot Line Phones see **DOD# 901**.



Model	DOD #
K-1900-9	321

100 Number Speed Dialer

- **Non-volatile memory**
- **Use on analog PABX, CO line or FXS port**
- **Use with any touch tone phone**

When used as a multi-number dialer the **K-1900-9** will allow the user to enter a 1 or 2 digit code that will speed dial a pre-programmed number. When the dialer calls the number, the user can be blocked from entering additional touch-tones. Alternatively, the **K-1900-9** can be programmed to allow touch-tones for use with interactive voice response systems.

The **K-1900-9** can also be programmed as a single number hotline. Because the dialer is A.C. powered, it can be used on low current phone lines.

The **K-1900-9** has a programmable call timer and can be programmed on-site or from a remote location using a touch-tone phone. **Power supply included.**

Smart Touch Tone Dialer with Redialing

The **K-1900-30** is an automatic dialer that dials a 1-20 digit phone number, and can be programmed to call up to 4 additional phone numbers if the line is busy, or is not answered. The **K-1900-30** can be used to add the smart dialing features of a Viking Model **E-30** to other non-dialing **E-Series** or **K-Series** phones, or any analog phone.

The **K-1900-30** connects to an analog **PABX, CO** line or **FXS** port. Programming can be done locally, or remotely by calling the unit. **Power supply included.**

Model	DOD #
K-1900-30	300



Automated Voice Message Delivery System

Model K-6000-DVA can automatically notify up to **1000** people of an event cancellation, school, church or business closing or delayed opening *with one call*. You can also **record and forward** a caller's message to a group of phone numbers.

Six Contacts

The **K-6000-DVA** is designed to connect to a standard analog **PABX, CO** line or **FXS** port. To activate the unit, an authorized administrator calls the **K-6000-DVA**, dials a 6 digit password, selects a pre-recorded message or records a live message up to 1 minute, then activates the unit via a touch tone command to automatically call all the phone numbers in a pre-programmed group. Up to 6 groups of phone numbers can be preprogrammed into the unit. On site each group can be initiated by a contact closure.

Alternatively the unit can be activated on site by 1 of 6 contacts.

Power supply, USB Adapter and Application CD ROM included.



Model K-6000-DVA

Model	DOD #
K-6000-DVA	307

User friendly
PC programmable



RS-232 to USB
Adapter Included.



For faster calling
multiple units and
phone lines can be used
to form a "phone tree."

Eight-Input Alarm Dialer with Digital Announcer

- "Store Caster" mode available
- **Non-Volatile memory (no batteries required)**
- **Eight normally open or closed contact inputs**

The **K-2000-DVA** is a programmable, eight input, multi-number auto dialer and digital announcer, designed for emergency and non-emergency message notification. It can store up to eight 32-digit numbers per input, for a total of up to 64 different numbers. The unit is capable of local or remote recording of up to eight different messages (one message per input), with a total recording time of eight minutes. In the "Store Caster" mode, eight different messages ("customer assistance needed in hardware please" etc.) can be provided.

Eight Contacts

Power supply included.



Model K-2000-DVA

Model	DOD #
K-2000-DVA	303

User friendly
PC programmable



RS-232 to USB
Adapter available.



Two-Input Alarm Dialer with Digital Announcer

- **Non-Volatile memory (no batteries required)**
- **Two normally open or closed contact inputs**

The **K-202-DVA** Voice Alarm Dialer is a smaller version of the popular **K-2000-DVA** above.

The **K-202-DVA** is a fully programmable two input, multi-number auto dialer and digital announcer, designed for emergency and non-emergency message notification. **Power supply included.**

- 2 messages (1 minute record time per input)
- Stores up to seven 32-digit phone numbers per input
- In the event that the dialer receives a busy or no answer it will automatically dial up to six more numbers until it gets through
- Local or remote programming and recording

Two Contacts



Model K-202-DVA

Model	DOD #
K-202-DVA	305

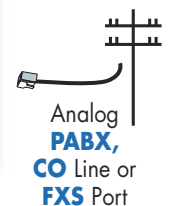

Enclosures for Installing Viking Products Outdoors

VE-9x12 and VE-9x20 provide weather protection for Viking products!

- Parking Lots
- Playgrounds
- College Campuses
- Maintenance Areas
- Swimming Pools
- Roadside Help Areas
- Hospitals
- Building Exteriors

These enclosures are constructed of cast aluminum. They are made for years of outdoor service. The heavy-duty aluminum doors are labeled 'Telephone' and have a gasket seal. The **VE-9x12 -1** and **-2** allow you to choose between two panels that permit mounting many different Viking products. The **VE-9x20** provides mounting for panel phones with handsets.



Model	DOD #
VE-9x12-0	413
VE-9x12-1,2	413
VE-9x20-0	413
VE-9x20	413
VE-PBL	413
VE-SPG	413

VE-PBL – Push Button Lock for **VE-9x12** and **VE-9x20**

VE-SPG – hinge door return spring for **VE-9x12**. (Not assembled)

VE-9x12 (R, Y or B)-0	VE-9x12 (R, Y or B)-1	VE-9x12 (R, Y or B)-2	VE-9x20 (R, Y or B)-0	VE-9x20 (R, Y or B)
Basic Enclosure - No internal mounting panel	E-1600A/E-1600-45A E-1600-03B, E-1600-60A K-1900W-2/K-1500P-W W-2000A/E-20B	E-10A, E-1600-30A E-30/E-35/E-1600-20A W-1000 W-3000/W-3005	Basic Enclosure - No internal mounting panel	K-1500-7 K-1900-7 K-1900-8



For more enclosures see page 33



Model K-1500-E

Fits standard 10" x 7" x 3" elevator phone box



Model K-1500-EHFA



Model E-10A

5" x 5" flush mount



Model E-20B

4" x 5.25" surface mount

Also see New Models **E-40, E-50, E-60, E-65, E-70 and E-75** (Page 42, 43)

Standard Elevator/Emergency Phones

Applications: Elevator, Parking Ramp, Campus, Door Entry (For ADA compliant elevator phones see page 4)

- Intelligent auto disconnect on **CPC**, busy, dial tone, silence.
- **E-10A, E-20B, K-1500-EHFA** now detects ringing as low as 30V AC

These vandal-resistant analog **PABX, CO** line or **FXS** port powered Emergency Phones have no dial pads to help eliminate long distance fraud or abuse. There are 3 ways of using the unit: (1) Use on analog **PABX, CO** line or **FXS** port with **Viking's K-1900-4, or K-1900-5** Single Number Dialers (Page 12); (2) Use on analog **PABX, CO** line or **FXS** port programmed to automatically ring to security; (3) Use with **Viking's DLE-200B Ringdown Circuit**. (Page 32).

Handsfree models **E-10A, E-20B** and **K-1500-EHFA** go off hook on the phone line when the button is pressed then auto disconnects on **CPC**, busy, dial tone or silence. The **E-10A, E-20B**, and **K-1500-EHFA** will auto answer on an incoming call. The **K-1500-E** will not answer.

- **K-1500-E** now with amplified handset per FCC regulations

When installing E Series door entry phones outdoors, always use the EWP version – See page 9

Model	Description	DOD #
E-10A	Standard	210
E-20B	Emergency	210
K-1500-EHFA	Phones	220
K-1500-E		220





Panasonic Doorphone Station Adapter

The **PAN-1** allows a Viking "E" series speaker phone (**E-10A, E-20B, E-30, E-35, E-40, E-50, E-60, E-65, E-70, E-75**, etc.) to be connected in place of a Panasonic KX-T30865 or KX-T7775.

Power supply included.

Model	DOD #
PAN-1	145



Time Delay Relay

The **TDR-1** can be programmed to produce one of 8 closure times from .5 to 20 seconds. Can also be set up as a delay on operate relay. Accepts positive or negative-going logic level voltage or a contact closure. **Power supply included.**

Model	DOD #
TDR-1	421



Line Powered Loud Ringer

This auxiliary electronic ringer operates on any analog line that provides a minimum of 40 volts 20-30 Hz AC ring voltage. Nominal 3 KHz warble provides up to 92 dB SPL @ 1 meter. The **LPR-1** can be connected via screw terminals or modular **RJ-11** jack. A volume control and a 6 foot modular cord are provided. **No power supply is required.**

Model	DOD #
LPR-1	550



Loop Detector Board

The **LDB-1** provides a contact closure when used in series with telecom devices on analog phone lines. Analog **PABX, CO** line or **FXS** port powered.

Model	DOD #
LDB-1	406

Talk Battery Booster

Model **TBB-1B** (see page 31)

Generate a CPC Disconnect

Model **CPC-1** (see page 31)



Loop and/or Ring Detector

Operate strobe lights, security cameras, etc. The **LDB-2** Ring/Loop Detect monitors an analog phone line for ringing and/or in use condition. 2 sets of relay contacts are activated when these conditions are detected. When monitoring for ring, the relay can be adjusted to stay on steady or follow a ring cadence. A 12 volt output is provided. **Power supply included.**

Model	DOD #
LDB-2	408



Multi-Tone Generator

Provides 10 different siren, warble, and chime tones.

The **MTG-10** can be connected to a paging source, phone system's paging port or background music. When a contact closure is provided to one of the inputs, the paging or background music is faded out and the appropriate tone is generated over the paging system. The siren and the evacuation whoop have priority and override any other tone.

The **MTG-10** can also be configured to provide a tone every 15 seconds to notify callers that their call is being recorded.

Power supply included.

Model	DOD #
MTG-10	482



Advanced Loop and/or Ring Detector

Ideal for use with two-button emergency phones!

The **LDB-3** monitors an analog phoneline, **PABX** or **FXS** line and provides a **normally open** or **normally closed** contact during ringing, off hook or both. The unit can also provide a 12V DC 350 mA output for strobes. The **LDB-3** can follow the ring cadence or stay on steady during ring. It can be set up not to activate from "Info" on two-button phones.

Power supply included.

Model	DOD #
LDB-3	409



Model	DOD #
PA-2A	485

Multi-Line Loud Ringer/2 Watt Paging Amplifier

- For **PABX** and electronic key system applications
- Drives up to 3 eight Ohm paging horns/speakers

The **PA-2A** monitors up to 6 analog lines for ringing or can be activated by a phone system contact closure. A loud electronic warble (110 db @ 1 meter), a chime, a gong or a door chime can be selected to announce incoming calls. To page, connect to a paging port or unused **trunk** input or **FXO** port on a phone system. The unit provides 2 watts of power - enough to drive 3 eight ohm speakers. The **PA-2A** has an input for a loud ringing on/off switch, an output for controlling a 12 volt relay and a 600 ohm output for sourcing high powered paging amplifiers. The **PA-2A** includes one paging horn and **power supply**.

For additional ceiling speakers and paging horns use models **25AE**, **30AE** and **35AE** (see page 19 for specifications).



Model	DOD #
PA-15	486

General Purpose 15 Watt Telecom Paging Amplifier

- Supports background music and loud ringing
- For **Centrex**, **PABX**, **IP**, and key system applications
- Drives up to 15 eight Ohm paging horns/speakers

The **PA-15** allows paging from a **Key**, **PABX** or **Centrex** paging port, or connect to an unused **trunk** input or **FXO** port (36 volts of talk battery). The **PA-15** can also answer a ringing analog **PABX station**, **Centrex**, **C.O. line** or **FXS**, to allow paging, then disconnect on **CPC**, busy, silence or 16 to 72 sec (on/off) default timer. The **PA-15** provides an alert tone (on/off) prior to paging. Background music (muted during page) can be added from an external source. 4 electronic tones are available for loud ringing. **Power supply included**.

For ceiling speakers and paging horns use models **25AE**, **30AE** and **35AE** (see page 19 for specifications).



Model	DOD #
PA-30	489

30 Watt Professional Telecom Paging Amplifier

- For **PABX** and electronic key system applications
- Drives up to 30 eight Ohm paging horns/speakers or 50 70V or 25V speakers

The **PA-30** provides paging from the phone system paging port or connect to an unused **trunk** input or **FXO** port (provides 40 volts of talk battery). The **PA-30** has separate inputs and volume controls for paging, auxiliary source, loud ringing and background music. A contact closure or ringing line can activate loud ringing. A warble, double gong, quadruple chime or door chime sound can be selected. The **PA-30** also has inputs for a night transfer (loud ringing) on/off switch. The **PA-30** has a 600 ohm output to drive additional amplifiers. Electronic switching eliminates pops and clicks. **Power supply included**.

For ceiling speakers and paging horns use models **25AE**, **30AE** and **35AE** (see page 19 for specifications).



Model	DOD #
SLP-1	478

Single Line Paging Controller/2 Watt Amplifier

- Add paging, phone-to-phone intercom and door chimes to your whole house audio system.

The **SLP-1** allows the user to page family members or coworkers from any phone in your home or small business. Pages are heard over the same speakers installed for multi-zone music distribution. Music is muted during the page and optionally during phone calls. If the user is on an in- or out-bound call, the caller can be placed on hold with music during the page. The **SLP-1** can provide ringing and door chime over the system. An input for a lighted doorbell switch and an output for 12 volt trigger or relay contact is provided. The unit controls both mono and stereo sound systems. An auxiliary 2 watt mono amplifier can power 3 paging horns or speakers. Analog **PABX**, **CO** line or **FXS** port. **Power supply included**. (Also see **SLP-4** on page 20)

Self-Amplified Paging System

NEW



Viking's SA-Series Self-Amplified Paging System eliminates a ladder climb every time users want to change any speaker's volume or features, and there is no need to manage background music zones. Just point the remote at the individual speaker and adjust the volume, mute background music but still receive pages, or mute both background music and paging.

Up to (25) SA-1S Self Amplified Speakers

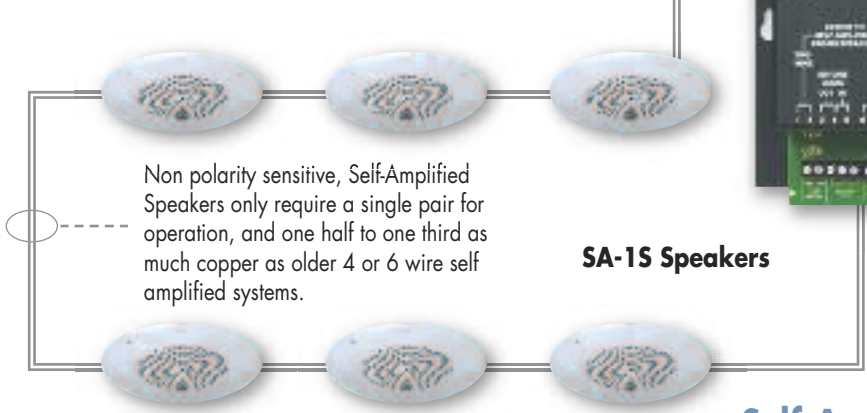

Includes one SA-IR remote

Self-Amplified Paging Control Unit

The SA-25 Self-Amplified Paging control unit interfaces with virtually any telecom or IP phone system with a paging port, a ringing analog FXS or an FXO port. The system can provide background music from an external source and generate loud or night ringing from a ringing analog station or phone system contact closure. The SA-25 control unit is backwards compatible with the older Legacy Valcom and Bogen 4-wire self-amplified speakers.

The SA-25 can directly drive a combination of up to 25 self amplified Viking 2-wire and/or older Legacy 4-wire self-amplified speakers. **Power supply included.**

SA-25 Brochure DOD #902

Model	DOD #
SA-25	520

Infrared Remote

Model SA-IR is a three button infrared remote control for use with Model SA-1S self amplified paging speakers. Aim the infrared transmitter at the speaker. The up/down buttons allow users to set the appropriate volume level for each room, while the mute button eliminates just background music or all sounds.



Model	DOD #
SA-IR	527

Remote Controlled Self-Amplified Speaker



Model SA-1S is an 8 inch paging speaker that has built in 1.5 watt power amplifier, an infrared remote control detector, and an integrated digital volume control, all built into an attractive off-white grill for flush mounting in office ceilings. The SA-1S self-amplified paging speaker uses a proprietary two wire protocol in which both 40 volts DC power and audio are combined on the same pair of wires. Connect only to Viking Model SA-25 controller or use the SA-X12 expander to connect to any paging system.

Model	DOD #
SA-1S	525

Infrared Remote Controllable Paging Horn



The Viking model SA-1H is a 5 inch paging horn that includes a 1.5 watt power amplifier, an infrared remote control detector, and an integrated digital volume control. The SA-1H self amplified paging horn uses a proprietary two wire protocol in which both 40 volts DC power and audio are combined on the same pair of wires. It is designed for direct connection to the Viking model SA-25 Controller or SA-X12 Expander.

Model	DOD #
SA-1H	526

Expander/Adapter



Model SA-X12 is a cost effective way to expand an existing paging system while adding remote control. Connect the SA-X12 to any existing paging audio (600 ohms, 25V, 70V, 4, 8, or 16 ohms or an SA-25 controller) and add up to (12) SA-1S speakers. **Power supply included.**

Model	DOD #
SA-X12	529

Eliminate The Feedback "Squeal" When Paging

- **Contact or VOX (adjustable sensitivity) activates Paging Amp**
- **Improved Fidelity (80K) • Output: 2V RMS into 600 Ohms**

Now your paging amplifier can be turned up to any level and your phones can be located anywhere – even directly under a high-power paging horn. The unit maximizes efficiency by adjusting to the actual page length (up to 32 seconds). A **contact** is provided to activate the amplifier, if needed.

Power supply included.

HOW IT WORKS: The "live" input from the paging port is digitally recorded. When complete, the paging amplifier is activated and the page is replayed once or twice.



Model	DOD #
FBI-1A	465

Two-Way, Handsfree Talkback Amplifier

- **Unused Trunk Input or FXO Port**

Provides handsfree talkback paging for use in city desks, shipping, warehouses, service departments or any application where quick answers are needed. Connects to an unused **trunk** input or **FXO** port. Weatherproof bi-directional **paging horn (25AE) and power supply included.** One additional **25AE** paging horn can be used.



Model	DOD #
HF-3W	470

Page Port, Trunk Input, FXO Paging Interface

- **Night Bell • Mutes Music • 600 ohm output • VOX switching**
- **Provides Talk Battery for connection to an unused trunk input or FXO port.**

Provides paging using phones (instead of a microphone) over a PA audio system. **VOX** contact closure mutes background music for phone systems with out a paging contact (Panasonic, S.W. Bell, Intertel, etc.). If a Paging Port is not available, use an unused **trunk** input or **FXO** port. **Power supply included.**



Model	DOD #
PI-1A	491

Loud Call Announce/Ringing Amplifier For electronic key telephones in noisy areas

The **M2W** will amplify call announce messages and ringing tones when connected to the speaker leads of an electronic or digital telephone. It cannot be connected to a 2500 set. Use model **PA-2A**. The **M2W** is also useful for expanding the number of speakers connected to a **Viking PA-2A** or **PA-15**. (Page 16) Each **M2W** can provide 2 watts of paging power to drive three paging speakers.

25AE paging horn and power supply included.

Model	DOD #
M2W	480



Maximum distance from **M2W** to paging horn is 250 feet.

Night Bell Over Existing Paging System

Applications: Offices, Warehouses, Clinics – Anywhere people may be working after the receptionist goes home.

Connect to the night service line to provide electronic warble tone over an existing paging system whenever ring voltage is detected. The **K-600F** has both tone and level adjust and provides a relay **contact** for muting music or operation of external signalling devices, 120V bells, strobe lights, chimes, etc. The **K-600F** operates from 60V ringing.

For generating audible tones from a **contact closure** use model **PA-2A** (Page 16) or **PI-1A**. **No power supply required.**



Model	DOD #
K-600F	476

Universal Telecom/IP Paging Interface

- **Select: FXO (loop start), FXS (ring trip) or paging port (VOX relay) interface mode**
- **30 V Talk Battery for use with an FXO port or unused trunk input.**
- **600 ohm volume controlled floating output - Mutes Music during page**

In all modes the **FXI-1** provides normally open or normally closed relay contacts to activate the central paging amplifier equipment or connect to an external background music source. After paging, the **FXI-1** auto disconnects on **CPC**, busy signal, silence or default disconnect timer. An electronic night bell over paging feature can be activated from a momentary phone system contact closure. **Power supply included.**



Model	DOD #
FXI-1	494

Night Switch for Viking Products

The **NS-1** is an on/off toggle switch mounted in a convenient plastic case. The **NS-1** can be used with any product that requires an external switch closure. The compact design and foam mounting tape make it easy to install the **NS-1** almost anywhere. The **NS-1** has 24" wires and comes with two quick connectors.



Model	DOD #
NS-1	540



4 Zone Paging Controller

- Expand up to 8 zones using 2 units
- Switch up to 200 Watts to 8 ohm speakers

Applications

- Multiple zone paging for **Centrex** systems
- Multiple zone paging for phone systems with paging ports, unused analog station/**FXS** ports or unused **trunk/FXO** ports
- Multilevel warehouse
- Multiple department manufacturing business
- Multi building office complex
- **Power supply included**

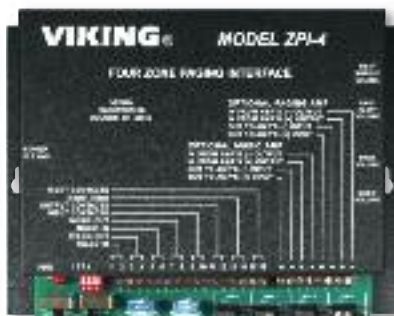

Compatible with these Viking Products

- PA-2A
 - PA-15
 - PA-30
- } Page 16
- Any paging Amp up to 200 Watts

Model	Description	DOD #
ZPI-4	4 Zone Paging Controller	499

The **ZPI-4** is a four-zone Touch Tone controlled paging system capable of switching a line level (600 ohms) signal to amplifiers or an amplified signal (up to 200 watts to 70V or 8 ohm speakers).

The **ZPI-4** features balanced audio circuitry throughout for low noise and compatibility with balanced or unbalanced paging system inputs and outputs. There are separate level controls for paging and background music. Background music can be disabled on a per-zone basis. Also provided, is a night bell with adjustable volume, activated by a dry contact closure or a ringing **C.O./**analog **PABX/KSU/FXS** station. The **ZPI-4** is compatible with ringing **C.O.** lines, **Centrex** lines and analog **PABX/KSU/FXS** station ports (Disconnects on silence, **CPC** or time out) as well as unused trunk inputs, and will interface directly with standard paging ports.

Single Line Smart Loud Ringer

- Operates from a ringing analog line or a contact closure
- 4 different tones available, Warble, Double Gong, Quadruple chime, Electronic Bell
- Provides a door chime tone for either a doorbell, door open or "Push for Assistance" sensor
- 90 db @ 1 meter, 105 db with external **25AE** paging horn



• **Power supply included.**

Line powered loud ringer (see page 15)

Model	DOD #
SR-1	477

8-ohm Ceiling Speaker Assembly

Includes white grill, mounting hardware and 8" wide range speaker. For **1-** and **2-way** applications with **DVA-2WA, HF-3W, M2W, PA-2A, PA-15,** and **PA-30.**



Model	DOD #
30AE	498

Paging Speakers: How many? Where should I place them? What model? Request **DOD# 877**



NEW

Tile Bridge

Use when mounting Viking Models **SA-15, 30AE** or **35AE** Ceiling speakers on 2' x 2' or 2' x 4' ceiling tiles

Model	DOD #
SA-TB	532

Outdoor/indoor 12-Watt 8-ohm Paging Horn

Use for any directional outdoor, factory paging application. Compatible with Viking Models: **DVA-2WA, HF-3W, M2W, PA-2A, PA-15** and **PA-30.**



Model	DOD #
25AE	498

Ceiling Speaker with Volume Control

Includes 8" wide range 8 ohm speaker, white grill, **built-in volume control** and mounting/installation hardware. Use for any office or commercial ceiling application. Compatible with all Viking 1-way paging amps: **DVA-2WA, M2W, PA-2A, PA-15,** and **PA-30,** or any 8 or 16 ohm paging system. Not recommended for 2-way (talkback) paging applications (instead use **Model 30AE.**)

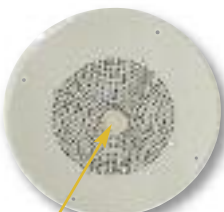

Volume Control

Model	Description	DOD #
35AE	Ceiling Speaker with Volume Control	498

Speaker Volume Control

Adjust the volume of individual paging horns, ceiling or wall speakers. Compatible with Viking 1-way paging amps. or any 8 or 16 ohm or 25 volt paging system. Mounts in standard single gang electrical box. Not recommended for 2-way (talkback) applications.



Model	Description	DOD #
SV-5W	Speaker Volume Control	488

Add Paging & CD Quality Door Chimes to Your Whole House Audio System

- Select from 8 preloaded **CD quality** files or download your own custom **WAV files** via your **USB port**.
- Page from multiple lines by connecting multiple units

The **SLP-4** Single Line Paging controller will allow you to page family members or co-workers from any phone in your home or small business office. The pages can be heard over the same speakers that are installed for multi-zone music distribution.

The **SLP-4** provides inputs for 4 lighted doorbell switches. The inputs select 4 different **CD quality** sounds from a library of eight pre-recordings including Westminster 4 bell chimes, wind chime notes, barking dog, etc. Alternatively, users may record their own **CD quality** sounds into the **SLP-4** from their **PC's USB** port. When the doorbell switch is pressed, or the user pages, the music is muted while the appropriate sound or page is heard over the system speakers.

The **SLP-4** connects in series with a single existing phone line. The unit has a built-in 2 watt amplifier, stereo pre-amp output, music on hold input, intercom features, and selectable loud ringing.

Power supply included.



Compatible with the C-200, C-250, C-1000B, C-2000B

Model	Description	DOD #
SLP-4	Single Line Paging Adapter with 4 Chimes	479

NEW Online: A library of over 80 different downloadable sounds on the Viking website to customize your **SLP-4**. Go to www.vikingelectronics.com and click on "Library of Sounds" under Quick Links. Select model **SLP-4** to preview and download sounds directly to your computer - easily upload to the **SLP-4** via **USB**.

Digital Mass Emergency Notification/ Evacuation Announcer

- 5 Different Recorded Mass Notification/Evacuation Messages Over Your Existing Paging System
- Securely Activate, Reset or Live Page from a Remote Phone
- Select from 10 Different Alert Tones

Model **DNA-510** is a cost effective digital mass notification/ emergency announcer designed to work with a building or campus's existing paging system.

Model **DNA-510** can provide up to 10 different alert tones and up to 5 different digitally pre-recorded voice evacuation or lockdown instructions with a total record time of 2 minutes. Tones and messages can be repeated 1-99 times. The **DNA-510** connects to a phone line, **FXS** or **FXO** port, **PABX** station, or line input of a phone system and can be securely activated or reset from a remote location using a touch tone security code. A live page can also be broadcast.

When activated, the **DNA-510** will interrupt any current paging or background music and inject alert tones and emergency instructions over your paging system.

Power supply included.

Compatible with the **PA-2A, PA-15, PA-30** or any paging system.



Alert Tone Applications:

- Evacuation
- Terrorist Alert
- Flash Flood
- Lockdown
- Fire
- All Clear
- Severe Weather
- Tornado

Model	Description	DOD #
DNA-510	Mass Notification Announcer	492

Clock Controlled Tone Generator Over Paging

- Timed single, double or triple chime, or buzzer tones
- Easy to program, easy to change
- Alarm and standard NFPA/ANSI evacuation tones
- Programmable day of week on/off feature

Provides your paging systems with up to 128 timed alert tones per 24 hour period. Different alert tones may be used to indicate start or end of shift, break, lunch, etc. Dry **contact closures** can activate alarm, fire, evacuation etc., sounds over paging. A door chime is also available for night ring or doorbell. These sounds can be activated remotely via a telephone using **Viking RC-3** (Page 40). Use with the **DVA-2WA** (Page 26) for timed announcements.

All programmed tone events are stored in **non-volatile memory**. A 9-volt NiMH rechargeable battery (factory installed) maintains clock time for over 8 hours during a power failure. In the event of battery failure, only the time needs to be re-entered. **Power supply included.**



Model	DOD #
CTG-1	460



NEW Master Clock/Clock Controlled Tone Generator Over Existing Paging System

- **Accurate time base synchronizes periodically with the atomic clock via Internal modem**
- **Can also be used as a Master Clock to synchronize Viking CL series clocks**
- **Automatic daylight savings time and leap year correction**

Viking's model **CTG-2** is an advanced clock controlled tone/message generator designed to provide accurately timed tones and/or messages over your existing paging system. This provides a cost effective way of signaling school period changes, factory shifts, breaks, lunch periods or provide messages at specific times for store sales, promotions, closing times, airport loading zones, etc. The **CTG-2** can also be used as a master clock to automatically synchronize **Viking CL Series** clocks.

- Up to 14 schedules, and up to 1000 events
 - Pre-loaded with common school, business and factory alert tones or download with your own messages/tones via the **USB** port
 - Total of 6 minutes of **CD** quality WAV file record time
 - 4 inputs for triggering emergency fire evacuation, severe weather, lock down and all clear alert tones or messages
 - RS-485 output for communicating time sync data when used with **Viking CL Series** wireless analog and digital clocks (see below)
- The **CTG-2** comes with programming software and a **USB** port to allow PC programming of timed events, schedules, Atomic clock synchronization, wave file download, message volume, day light savings time, leap year, auxiliary relay control, etc.



Once programmed you can change the **CTG-2's** schedules or turn the unit on or off remotely from any touch tone phone. **Power Supply Included.**

Model	DOD #
CTG-2	463

NEW Wireless Synchronized Clocks, RF Transmitters and Accessories

- **All clocks have built in 1/4 watt repeaters capable of retransmitting the clock sync signal up to 500 ft in open space.**

Viking's Wireless Clock System provides reliable, accurately synchronized clocks for your entire facility. Eliminating dedicated clock wiring can save you thousands of dollars on installation and also allows for easy retrofitting. The system is comprised of a **CTG-2** master clock, a **CL-RFT** clock RF transmitter and Analog or Digital wireless slave clocks. The clocks will always display the correct time via Atomic clock updates from the **CTG-2**.



CL-D2 & CL-D4

2.5" and 4" Digital Clocks (shown with optional double mount bracket **CL-DMD2** or **CL-DMD4**)

Wireless bright digital clocks require 120 volt VAC outlet (24V Power supply included). The clocks are updated every minute from the **CTG-2**.



CL-A16

16" Analog Clocks

(shown with optional double mount bracket **CL-DMA16**)

Wireless Analog clocks are battery operated and require no wiring. Battery life using (2) D size Duracell Procell batteries is more than 5 years. The clocks are updated every 4 hours from the **CTG-2**. Clocks can be located up to 6,500 ft. from the **CL-RFT** transmitter/repeater or up to 500 ft. from another synchronized clock.

CAUTION: CL series clocks cannot be used as stand alone clocks. They must be used in conjunction with a **CTG-2** master clock and one or more **CL-RFT** transmitters.

12" Analog Clock



CL-A12

RF Transmitter/Repeater

The **CL-RFT** transmitter receives time sync data from the **CTG-2** and transmits to the clocks via 915 to 928 MHZ frequency hopping technology. Powerful 1 watt (30dBm) output communicates up to 6,500 ft. in open space. Can also be configured as a repeater for larger spaces. Dimensions 11"H x 8" W x 1.7" D. No FCC license required.



CL-RFT

CL-WGA12 & 16
12" and 16" Analog
Clock Wire Guard

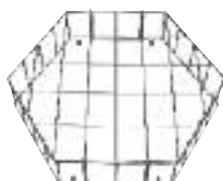

Model	Description	DOD #
CTG-2	Master Clock	463
CL-A12	12" Analog Clock	466
CL-A16	16" Analog Clock	466
CL-D2	2.5" Digital Clock	466
CL-D4	4" Digital Clock	466
CL-RFT	RF Transmitter/Repeater	466
CL-DMA12	12" Double Mount (Analog)	466
CL-DMA16	16" Double Mount (Analog)	466
CL-DMD2	2.5" Double Mount (Digital)	466
CL-DMD4	4" Double Mount (Digital)	466
CL-SMD2	2.5" Surface Mount (Digital)	466
CL-SMD4	4" Surface Mount (Digital)	466
CL-WGA12	12" Wire Guard (Analog)	466
CL-WGA16	16" Wire Guard (Analog)	466
CL-WGD4	4" Wire Guard (Digital)	466

Amplified Remote Access Device

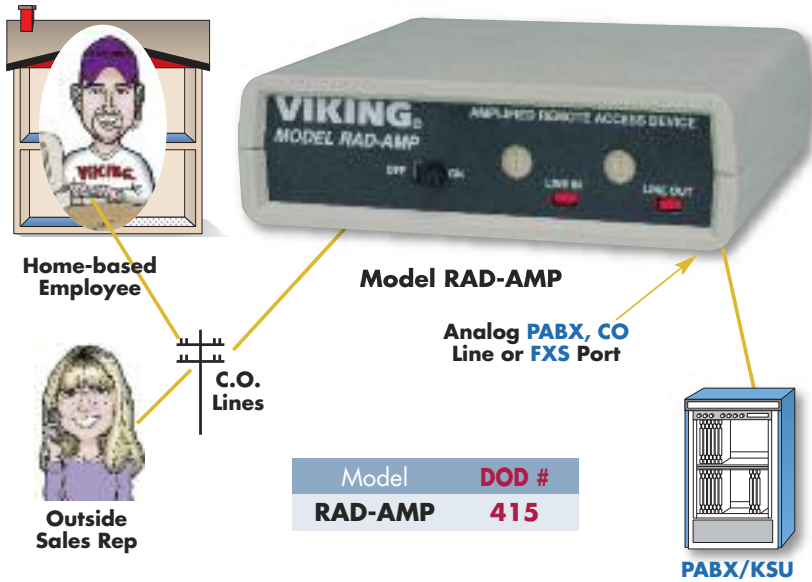

Telecommuting Features

- Works with cell and standard phones
- Supports **PABX** call transfer, voice mail, call conferencing and paging
- Log in, Log out capability
- Callers don't realize they've been transferred

Features

- Call Diverter, Line Extender • DISA
- Remote **SO-24A** Service Observation (Page 29)

The **RAD-AMP** is amplified for **DISA**, line extender, call diverter and remote access to **Viking's SO-24A Service Observer** (Page 29). The **RAD-AMP** disconnects on **CPC**, return dial tone, silence, busy signal or call timer.

It can provide two levels of security before allowing access to DISA or line extender applications. In line extender applications, the user does not have to hang up and redial the **RAD-AMP** to make another call. Simply dial "#2" to get a new dial tone. Dialing a "#1" provides a hook flash on the "Line Out" port to access **PABX/Centrex** features. **Power supply included.**

Phone Line Powered Remote Access Device

- Remote Access to 1 way Paging Amplifiers • Advertisements • Radio or Church Programs

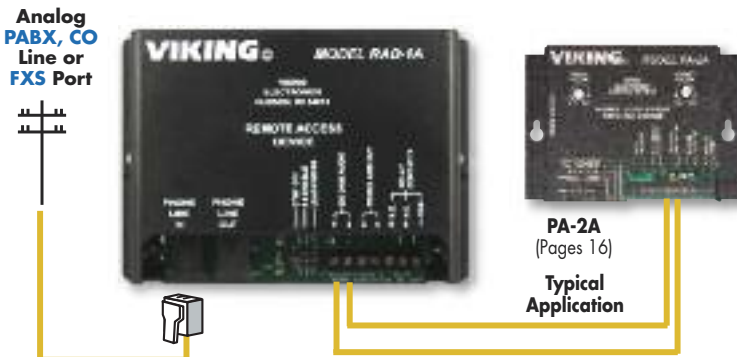

The **RAD-1A** is designed to allow you to call from any Touch Tone phone and then remotely access paging systems, digital recorders, etc. The unit connects to any **loop** or **ground start C.O., Centrex, PABX** line or **FXS** Port.

The **RAD-1A** answers on the first ring and disconnects on **CPC**, call time out, silence time out, or by dialing "#7". The **RAD-1A** provides a floating 600 ohm output and also an auxiliary relay **contact**.

The **RAD-1A's** call timer can be set to limit access time from 3 seconds to 2 hours.

For other applications; see **DOD# 874**

Eliminate Long Distance Toll Abuse • Field Programmable **Non-Volatile** Toll Restrictors

- Applications: Courtesy Phones • Bars and Restaurants • Construction Site Phones • Employee Lunch Rooms • Time Share Condos
- Roommates • Prevents 976 & 900 Abuse • Hotel/Motel • Inbound Only Phones (with override) • Calling Card Only
- Emergency Phones

Programmable Touch Tone and Rotary Toll Restrictor with Override Bypass Code

- **Non-Volatile Memory** - No batteries required
- **1 to 50 Minute Call Timer**
- Analog **PABX, CO** Line or **FXS** Port Powered
- **Centrex** and **PABX** Compatible

Program up to 40 prefixes, area codes or phone numbers to be blocked or allowed. The **TR-1** can block all Operator assisted calls, Directory Assistance, 976 and 900 calls, and "1+" long distance, while "1-800", "911", and other user selected calls are allowed.

The **TR-1** features can be programmed on site or remotely using a Touch Tone phone. The programmer must know the unit's security code to change the programming. The 6 digit override bypass code allows parents or supervisors to make calls normally blocked by the **TR-1**.



Model **TR-1** (shown open) are concealed in a standard **RJ-11** Jack.

Model	DOD #
TR-1	705

Fax machines, modems and credit card readers save time and improve communications. **Viking's Line Sharing** devices can save you the monthly \$20 to \$60 cost of installing additional phone lines. Now you can enjoy all the benefits of a modem or fax without the additional telephone line charges. **Viking's Fax Switches** pay for themselves in just a few short months.

Line Scanner for Modem Pooling

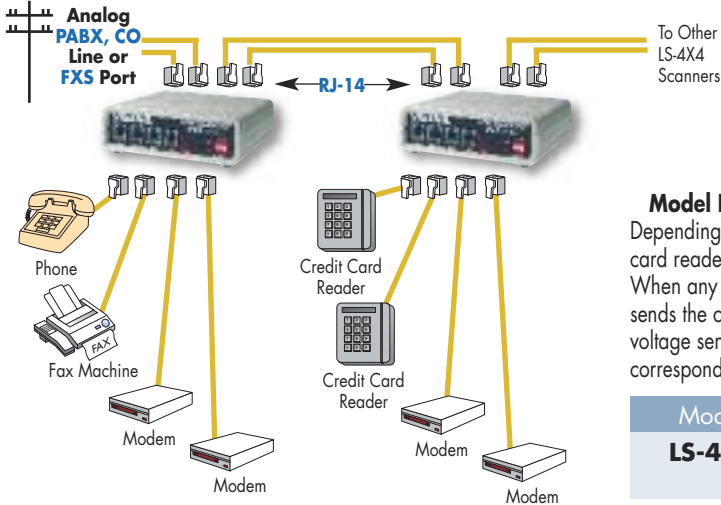

Model LS-4x4 is a 4 device by 4 line unit which can be modularly expanded. Depending on the number of 4x4 scanners used, 4, 8, 12, 16, 20 or more modems, credit card readers, faxes, phones, etc., can share 1 to 4 analog **PABX, CO** lines or **FXS** ports. When any connected telecom device goes off hook, the **LS-4x4** scans for an open line and sends the call out. If no lines are available, the user receives a busy signal - compatible with voltage sensitive credit card readers. Incoming calls on each line can be routed to their corresponding device port. **Power supply included.**

Model	Description	DOD #
LS-4x4	Line Scanner for Modem Pooling	270

Single Line Privacy Devices

For punch down or terminal block installation in series with Tip or Ring.

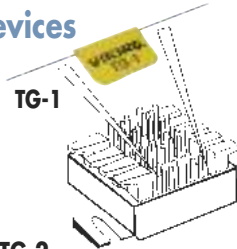

For modular applications. One **TG-2** will protect two devices.

The 7 foot **Automatic Privacy Cord** replaces the standard modular line cord connecting your telephone, fax machine or modem to any type of telephone line.



Prevent Interruptions In Voice, Fax or Data

Viking's Teleguard Automatic Privacy Devices prevent your phone calls or fax/modem transmissions from being interrupted if someone accidentally picks up another extension. Teleguard also protects against eavesdroppers.

With **Viking's Teleguard**, whichever device accesses the analog **PABX, CO** line or **FXS** port first denies any other teleguard-equipped device access to the line until the call in progress is terminated. Incoming calls will ring into all devices simultaneously. The device that answers first denies any other teleguard-equipped device access.

Any telecom device not equipped with **Teleguard** can always break into a phone call or transmission.

Two Line Privacy Device



The **PJ-14** provides one or two lines of Teleguard protection built into a wall mountable **RJ-14** jack.

Model	Description	DOD #
TG-1	Single Line Privacy Device	560
TG-2	Two Device Modular Device	560
PC-7	Automatic Privacy Cord	560
PJ-14	Two Line Privacy Device	560

Four Port Enhanced Auto Routing Switch

- Allows any four analog devices to share a single line
- **Ports are balanced to prevent noise on long runs**
- **Caller ID information is stored and retransmitted during transfer**
- **Provides realistic ring-back tones while re-ringing selected device**
- Routes calls via **CNG** tone, **distinctive ringing**, touch tones sent by calling device or manually
- Compatible with high speed modems
- Automatic "privacy" eliminates interruptions on both in and outbound calls
- Monitors for calling party control (**CPC**)
- **Power supply included.**



Model	Description	DOD #
FAXJ-1000	Four Port Enhanced Auto Routing Switch	261

Glossary of Telecom Terms

26 Bit Wiegand Format - The industry standard data output of access control card readers.

ACD - Automatic Call Distributor - A device for distributing many calls uniformly among a group of agents or operators. The ACD pays attention to real time traffic load and other factors like which agent has been the busiest or idle the longest, to evenly distribute call traffic to the agents (also see **UCD**).

ADA - Americans with Disabilities Act - Legislation passed in 1992 to assure equal building access for the disabled, which also included equal access to emergency assistance in the event of an elevator emergency.

AGC - Automatic Gain Control - Electronic circuit which automatically increases the volume when someone is speaking quietly and drops the volume when someone is speaking loudly, to keep the transmitted signal constant.

A-Lead - Control leads that come from 1A2 key telephone to operate features like flashing of lights to indicate a busy, holding or ringing line.

Analog Single Line Station - An extension port on a **PABX/KSU** that will allow a standard household type phone to interface with the system. (**POTS**)

ATA - Analog Telephone Adapter - Analog Telephone Adapter, allows user to connect analog telecom devices to their **LAN, WAN** or internet (See **FXO, FXS**).

AWG - American Wire Gauge - The higher the **AWG** number the thinner the wire.

BOM - Beginning of Message - A short electrical pulse provided by a digital announcer when used in certain 4 wire **E & M** modes. The pulse alerts the **PABX** that the Beginning of a Message is coming.

Butt Set: a sophisticated, one piece, telephone used by technicians to diagnose telephone lines or equipment.

Call Progress Detection (Analysis) - A feature of some terminal devices that allows the **Terminal Device** to detect when a call has been answered, so the device can play a recorded announcement to the person that answered.

Carbon Transmitter (Handset) - The microphone of a telephone handset which uses carbon granules and a diaphragm. The diaphragm responds to voice and varies the pressure on the granules and hence, their resistance.

Cat 5E - This is a performance category for 8 conductor twisted pair wire. It defines the maximum data rate that a cable can handle.

CD Quality - Digital audio utilizing 16 bits of resolution at a sampling rate of 44.1k, which is the same as audio CD's. Better sounding than other compressed formats such as MP3.

C.O./CO - Central Office - A main telephone office where switching equipment is housed and customer lines originate. Also contains **Trunk** line connections to other Central Offices. A **C.O.** line is a phone line coming from the Central Office and terminating at the user's premise.

Central Station Monitoring - Service provided to monitor security systems and emergency phones 24 hours a day. Often uses a high speed **DTMF** communication format to automatically identify where the call is coming from.

Centrex - A name for an umbrella service offering of the local telephone company. Customers lease a portion of the Central Office switch to create a centralized point of control and routing. In concept, Centrex is providing similar features to a **PABX**. In some areas, also known as Centron, Cenpac, or **Plexar**.

CMOS - "Complimentary, Metal Oxide Semiconductor" - When used for the image sensor in video cameras it allows a wide operating temperature range with high reliability.

CNG - Calling - 1100 Hz .5 second tone generated every 3.5 seconds by fax machines.

Contact Closure - Contacts that when "closed" connect a pair of wires together and disconnects the wires when "open". A doorbell button is a simple example of a momentary contact closure.

CPC - Calling Party Control (Disconnect Supervision) - A short break in the line current in the called party's phone line when the calling party hangs up. Not available on most **PABX**'s.

Demarcation Point (box) - Typically the point at which the phone line enters the building. The telephone company is responsible for all wiring up to this point.

DHCP - Dynamic Host Configuration Protocol

DISA - Direct Inward System Access

DID - Direct Inward Dialing is a feature allowing callers to directly reach a **PABX** extension without an operator's assistance.

Distinctive Ringing (also known as ringmate, custom ring, identifying ring master) - Different patterns of ringing that allow a user to identify the source of the call, outside, or inside (intercom) or who the call is for. Usually two burst or three burst with different durations.

DSL - Digital Subscriber Line - High Speed digital data on standard two conductor voice grade telephone wiring. Allows high speed Internet access and telephone calls to take place simultaneously.

DSL Filter - Filter designed for **DSL** lines that prevents the normal telephones from hearing the high speed digital data and interfering with the data.

DTMF - Dual Tone Multi-Frequency (Touch Tone) - Audible tones which conform to North American Telephone Standards. These are generated by push-button telephones to dial telephone numbers, as well as to provide control or data input to voice processing systems. Especially significant in the operation of Viking automated attendants and fax/data line sharing devices.

E² Memory (See **Non-Volatile E² Memory**)

E & M Control /4 Wire E & M - An equipment signaling system usually used in **PABX** applications with a digital announcer. This interface control scheme is standard equipment on most Viking announcers.

Earth Ground - A wire conductor that terminates in the earth for electrical purposes.

FCC - Federal Communications Commission

Facility Code - A 3 digit number that each **Proxy Card** contains in order to provide greater security. Usually the cards used at a given building all have the same facility code.

Fiber Optic Modems - Devices to extend a telephone link on fiber optic cable.

FXO - An analog input **RJ-11** port just like a **POTS** trunk input on a **PABX** or key system. An FXO port receives talk battery and ring voltage.

FXS - An analog output **RJ-11** just like a station port on a phone system or **PABX** extension. It provides **Talk Battery**, dial tone, and **Ring Voltage**.

Ground Start Line - A type of call signaling. In this scheme, when a call is routed to a subscriber, the phone company will apply a ground signal on the TIP side of the line even before a **Ring Signal** is sent. By detecting this signal, phone systems can immediately determine that the line is about to be in use, and avoid call crashing.

Hook Switch Flash or Switch Hook Flash - A signal originated by momentarily depressing the switch hook on a single line phone. Typically used for accessing **C.O.** or **PABX** features.

Hz - Hertz - Indicates the frequency (number of cycles per second) of alternating current such as **Ringing Voltage** or Touch Tone signals.

Intercept - To stop a telephone call directed to an improper telephone number, and redirect that call to an operator or recording.

Industry Canada - Is the equivalent of U.S. **FCC**.

ISDN - Integrated Services Digital Network - An emerging international standard that defines interfaces for simultaneous voice and data transmission through a single channel over the public network.

ISDN Terminal Adapter - An interface between an **ISDN** line and a computer. Often these provide 1 or 2 analog **POTS** output ports.

KSU - Key Service Unit - A central control cabinet serving many multi-button key telephones. Contains equipment which enables the user to pick up and hold **PABX** or Central Office lines and provide flashing line, steady, busy, and wink hold signals. Dial intercom service is also an option.

LED - Light Emitting Diode.

Loop Current - (typically 20 to 50 mA) Current that flows from the **C.O.** when a telecom device goes off hook.

Loop Start Line - A type of calling signal that relies on a telecom device to allow DC current to flow when it goes into an off hook condition. The **C.O.** or **PABX** senses this current and intercepts it as a request for service. Also known as "**POTS**".

Loud Ringing - A tone sent over a paging system that is typically triggered by **Ring Voltage** or a dry **Contact Closure**.

MOH - Music On Hold

Night Ringing - The same as **Loud Ringing**, but usually disabled during the day or "normal business" hours.

N.O./N.C. - Normally Open/Normally Closed Contact.

"No KSU" - A phone containing all control functions normally associated with a **KSU**, thus not requiring a **KSU**.

Non-Volatile E² Memory - Memory that will not be lost from a power failure: Does not need battery backup.

OPX - Off Premise eXtension - A telephone line from the phone system terminated in a different building than the phone system.

PABX - Private Automatic Branch eXchange - Phone system used to switch telephones between extensions and to outside lines. For incoming and outgoing (dial 9) calls.

Page Code - An access code of a **PABX** that allows users to access the paging equipment to voice page.

Page Port - A 600 ohm audio output of a **PABX** intended to connect to an external paging amplifier.

Page Trigger - A signal provided to an amplifier to automatically switch the amplifiers input or mute background music during a page. Typically a "dry" **Contact Closure**, but in some cases can be a 5 volt DC or 12 volt DC trigger voltage.

PBX (See **PABX**).

PCB - Printed Circuit Board.

POTS - Plain Old Telephone Service (See **C.O., Analog Single Line Station, Loop Start Line**).

Continued on next page



Phono (RCA) Plugs - Shielded cable and connector arrangement that is primarily used for low level audio or video connections.

Plexar - (See **Centrex**)

Proxy Card - A credit card sized card that identifies itself when within close proximity of a reader. Card "swiping" is not necessary. The card contains a 3 digit **Facility Code**, a 5 digit Internal card number and a 5 digit External Printed number, that may or may not match the Internal number.

Proxy Card Reader - A device used to read the data from a **Proxy Card**. The **Proxy Card** can be read when held within a few inches of the reader.

Rack Mount - Equipment which is designed to mount in a standard steel framework consisting of parallel pairs of steel channel verticals spaced 19" and drilled for mounting screws.

RAD/RAN Device - Record/Announce - a device such as a Digital Announcer.

RAN Trunk/RAN Circuit - Record/Announce Trunk or Circuit - Connects the telephone system to a record/announce device.

REN - Ringer Equivalency Number - 1 REN = The energy to ring 1 Plain Old Telephone. The REN number can be found on the **FCC** label on the device. The total ringer load on a line is equal to the sum of all the REN numbers of all the telephone devices connected to the line.

RF - Radio Frequency - Electromagnetic waves operating between 10 KHz and 3 MHz propagated without guide (wire or cable) in free space.

RF Choke - A device intended to prevent **RF** waves from entering a wire or cable.

Ring Back Tone - The sound you hear when the phone you call is ringing.

Ringdown Circuit - A circuit connecting 2 devices so that when one device goes off hook it automatically rings the other device.

Ring Generator - (See **Ring Voltage**) - A circuit producing AC voltage that is higher than 50 Volts and has a frequency of 20 Hz.

Ring Signal - (See **Ring Voltage**).

Ring Trip - The process of stopping the AC **Ring Signal** and connecting the voice path at the **C.O.** when the ringing telephone is answered.

Ring Voltage - A 20 Hz AC voltage higher than 50 Volts **RMS** superimposed on the phone line to ring bells, activate ring detectors in phone systems, faxes, modems, etc.

RJ-11, RJ-14, RJ-21X, RJ-25 - Request DOD# 839

RMS - Root Mean Square - This is simply a fancy way of describing the average voltage level of an audio signal or **Ring Voltage**.

RS232 - An Electronic Industry Association (EIA) standard that defines a computer interface for connecting serial communication devices such as printers and modems.

RS-485 - is a standard defining the electrical characteristics of drivers and receivers for use in balanced digital multipoint systems.

66 Block - A terminal block where up to 4 sets of up to 25 pairs of wire can be interconnected. The installer uses a special "punch down" tool to connect the wires.

SLT - Single Line Telephone.

SOHO - Small Office/Home Office - An acronym for a new class of employment where the employee may be performing part or all of their work at home in a small office set up.

Subscriber Line - The telephone line connecting the local **Telco** Central Office to the customer's telephone instrument or telephone system.

T1 - 24 channel high speed digital line.

Talk Battery - DC voltage supplied by the **C.O.** to the subscriber's loop to operate the telephone equipment.

Telco - Local Telephone Company

Terminal Device - Telephone, phone system, fax, modem, etc. capable of terminating an analog phone line.

Trunk - A telephone communication path or channel between two points, one usually being a Central Office.

Trunk Port - An input on a **PABX** or **KSU** that is used to interface the system with **C.O.** lines.

UCD - Uniform Call Distribution - A device for distributing many calls uniformly among a group of agents or operators, following simple logic like "top down" or "round robin". It will not pay attention to real time traffic load or any other factors like which agent has been the busiest or idle the longest (see **ACD**).

UPS - Uninterruptible Power Supply - Provides power to your phone equipment, computers, etc., in the event of a commercial power failure.

USB - Universal Serial Bus - A serial bus standard to interface devices to a host computer.

VoIP Gateway - A digital-to-analog converter. Some multi-function gateway units combine several functions in one device, such as a built-in cable/**DSL** modem, Ethernet ports and router capabilities, and **FXS** ports. A single function gateway, also known as an analog telephone Adapter (**ATA**), contains an **RJ-45** port to connect to the internet, and an **RJ-11** port to connect to analog devices.

VoIP - Voice over Internet Protocol - The technology used to send voice over a data network using internet protocol. There are many potential benefits to this new technology; less cost (no local/long distance charges), voice and data handled by the same network, and many new integrated services become available.

VOX - Voice Operated eXchange - The feature of some Terminal devices that provides automatic switching or activation when sound or voice energy is detected. Sometimes used to eliminate the need for push-to-talk operation.

WAV File (or WAVE File) - is short for Waveform audio format, and is a Microsoft and IBM file format standard for storing an audio bitstream on PCs.

When you buy a Viking Product everything you need to install it is included in the box!

Viking provides all the following items if required...power supply, paging horn, T-adaptor, allen wrench, screws, audio and remote cables, double backed tape, rubber feet, a technical practice and warranty information.



Gabriel and Grace Trapani
Babies priceless, not included.

P.C. to Phone Line Interface/Controller

- Windows 98, NT 4.0, 2000, XP and 7 compatible software
- Emergency Phone Polling (Page 4-7)
- Remote Programming of AES-2000 Entry System (Page 39)



(PC not included)

The **PB-100** connects to a serial or **USB** port on your P.C. and also to an analog phone line. The **PB-100** accepts ASCII commands to seize the phone line, watch for busy, and to send and receive Touch Tones or data. If the P.C. is equipped with a sound card, the audio input and output can be coupled to the phone line. **CD ROM** is included with programs to do emergency phone polling, **AES-2000** (Page 39) programming, hotel/motel wake up dialer or design your own voice announcer, message center, etc.

Power Supply Included.

Model	DOD #
PB-100	232

Digital Voice Announcer with 7.5 Minutes of Record Time

**Applications: Promotion-On-Hold, Airports,
Message Repeater, Museum/Information Displays,
Moving Sidewalks**

- 2 watt amplifier for use with paging speakers and horns
- **AGC** for recording from handset, tape, CD, PC soundcard, etc.
- 4 professional on-hold messages included
- Recording can be on-site or in a professional studio
- **Power supply included**



Brahms Lullaby Announcer
see **DOD# 865**

Model	Description	DOD #
DVA-2WA	Digital Announcer with 2 Watt Amplifier	110

Time and Temperature Announcer

**Applications: Stand Alone Time and Temperature, Banks,
Hotel/Motel Wake Up, Remote Temperature Monitor**

- Select Celsius or Fahrenheit
- **Ring trip** operation
- Local or remote recording
- Record up to 30 seconds of customized messages before or after the time and temperature announcement
- Can provide night message
- **Power supply included**



To listen to the **DVA-TNT**, call 715-386-8861 and request ext. 255

Model	Description	DOD #
DVA-TNT	Time and Temperature Digital Announcer	129

Professional Digital Voice Announcer /Recorders

**Applications: ACD, UCD, Intercept, Hotel/Motel Wake Up, Night Answer, Ski Resorts,
Movie Theaters, Work Schedules, School Closings, Out of Service, Etc.**



Model DVA-500A

- Single, up to 1 minute channel
- **Ring trip** or **4 wire E&M**
- Local or remote recording
- **Power supply included**



Model DVA-1003B

- 3 independent 1 minute channels
- **Ring trip** or **4 wire E&M**
- Local or remote recording
- Announcer cycles automatically, adjusts to message length
- **Power supply included**



Model DVA-3003

- 3 independent 1-4 minute channels or a single 12-minute channel
- **Ring trip** or **4 wire E&M**
- Local or remote recording
- **Power supply included**



Standard Carbon Handset for voice recording. Use with: **DVA-2WA, DVA-500A, DVA-1003B, DVA-3003, TMS-6X, TMS-12A**

Model
Q171030

**Hotel/Motel Wake Up
Application - See PB-100 (Page 25).**

Expand each channel to 2, 3 or 4 minutes with **ERAM-60** 1 minute kit
DOD# 813

Model	Description	DOD#
DVA-500A	Digital Announcer (1 minute)	115
DVA-1003B	3-Channel Digital Announcer (1 minute/channel)	125
DVA-3003	3-Channel Digital Announcer (1-4* minutes/channel)	127

*requires ERAM-60 expansion chips.

Phone Line Powered Inbound Announcer

- **Ring trip** answer
- Single 16 second channel
- Remote record
- Plays 1-99 times (programmable)
- Also disconnects on **CPC**

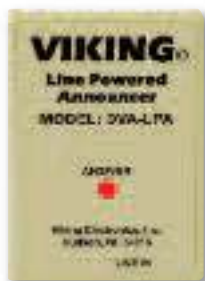

Model	Description	DOD #
DVA-LPA	Phone Line Powered Digital Announcer	128

Phone Line Powered Outbound Announcer

- Installs in series with outbound phone-gives announcement when answered
- Single 10 second channel
- Elevator ID/location identifier
- Record on-site



Model	Description	DOD #
EV-1	Phone Line Powered Digital Announcer	135



Automated Receptionist - Digital Call Screening and Messaging System

- Cost effective - Quick and easy programming via your phone
- 12 minutes of flash memory

The **AR-1** Automated Receptionist answers calls with an informative greeting then, let callers ring through to talk to someone live, select from other prerecorded messages or hang up. Programming functions and message recording are accessed locally or remotely, using a standard Touch Tone phone, or record from tape, CD, PC, etc. Up to 8 different messages can be recorded. They consist of a Day greeting, a Night greeting, a transfer message, four Menu messages, and a Goodbye message. The **AR-1** can allow callers with the correct code to bypass the greeting and ring through. The unit can allow callers to enter 0, 7, 8, or 9 to ring the phone port in 4 different distinctive ring patterns. **AR-1** can allow calls to ring through after the caller has listened to the entire greeting message. The **AR-1** passes caller ID to the phones or phone system. **Power supply included.**

Model	DOD #
AR-1	105



User-Friendly Auto Attendant... For Centrex, PABX, and Many Key Systems

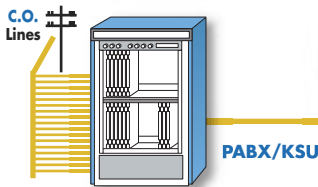

- Non-Volatile Memory-No Batteries
- 60 Seconds Record Time

Model	DOD #
ACA-1A	005



Each auto attendant answers 1 analog station line. Program 6 or more **C.O.** lines to ring at that station. Stack as many **ACA-1A's** as your **C.O.** lines require. Ring delay is programmable.

Viking's Automated Attendants answer calls with a high-quality digital voice announcement, then allow callers to use their Touch Tone phone to route themselves to departments or specific extensions. Callers can get to the right person faster without interrupting office personnel.

Announcement for "Greeting menu" (with up to 10 departments), "transfer", and "Busy extension" can be recorded on site, remotely from a Touch Tone phone or downloaded from tape. Callers may interrupt the announcement at any time by dialing an extension or live operator. Callers reaching a busy extension will be advised and allowed to choose again. As soon as a call is transferred, **Viking's Auto Attendants** are free to process new calls. The unit disconnects on **CPC**. **Power supply included.**

Call Sequencers Answer Calls Promptly and Professionally Eliminate "ring, no answer" during busy periods without hiring additional staff.

Viking's call sequencers answer incoming calls promptly when your staff is busy using your receptionist's own voice. The calls are held in the **TMS-6X** or **TMS-12A** until a staff member is available. While holding, the caller can listen to music or promotion from an external source. Callers calling in after business hours are given info on office hours then disconnected. Announcements are digitally stored

and can be recorded remotely from a touch tone phone or on site using a standard **carbon handset** or tape player. **Viking's** call sequencers are compatible with loop start lines ahead of the electronic or 1A2 key, and **ground start lines** ahead of Mitel and some Siemens **PABX's**. Other **PABX's** using **loop** or **ground start lines** require the **SQRG-12**.



12-Line Call Sequencer

• Link (2) **TMS-12A's** for 24 line service
The **TMS-12A** answers calls after 1, 2, 3 or 5 rings and displays the oldest call. The **TMS-RDMA**, **SQRG-12** and **LM-24D** provide added features. Can provide "A-Lead" control for 1A2 key systems. Changes to a day or night answer mode via remote contact timer or switch. **Power supply included.**

Model	DOD #
TMS-12A	070

Remote Status Displays

Easily seen (up to 50'), displays the next line (1-24) to answer. The **TMS-RDMA** has a volume-adjustable audible ring. The **LM-24D** (Page 28) indicates the line to answer next and also displays all lines held in queue on the **TMS-12A**.

Model	DOD #
TMS-RDMA	075



Eliminate Confusion on Which Line to Answer

Only the oldest call is displayed on the ringing line on all phones. Compatible with **loop** and **ground start lines**. **Power supply included.**

Model	DOD #
SQRG-12	060



6-Line Call Sequencer

The **TMS-6X** answers calls after 3 or 5 rings and displays the oldest call. The **SQRG-12** and **TMS-RDMA** provide added features. **Power supply included.**

Model	DOD #
TMS-6X	065



Call Sequencer for 2-line Phones Includes Music on Hold Input

The **TMS-2** answers the calls you can't because you are on the other line, plays a message in your voice, then provides music or promotion on hold until you can answer. **Power supply included.**

Model	DOD #
TMS-2	062



See if Lines are in Use or Ringing

- Viking's **24 Line Status Monitor** is compatible with analog **PABX** Station, **FXS** ports or **Centrex Loop** and **Ground Start Lines**
- **In-use lines show a steady LED, ringing lines flash**
- Volume adjustable common audible tone
- Ringing can be delayed up to 7 rings on a per line basis
- **Non-volatile memory**
- Desk or wall mounting display requires only 1 cable pair - Up to 3 displays can be connected to the scanner.
- **Power supply included**



Model	Description	DOD #
LM-24S	Display and Scanner	670
LM-24D	Additional Display	670

Blue Strobe with Steady-On-Beacon Kit

- **High intensity long life LED** technology
- **4 programmable flash patterns**
- **6 programmable brightness settings**



Model **BLK-4-EWP** monitors analog lines for ringing and/or off hook or use a switch contact. Program the strobe to flash steady or follow ring cadence.

It will not flash on incoming call (selectable) or "info" calls (**E-1600-20A** page 6). The kit includes 4" diameter LED strobe, hardware, control module and **12V power supply**. For use with **Viking** emergency phone or any analog phone. **Enhanced Weather Protection (EWP) available.**

Red, Amber and Clear lens sold separately (go to vikingelectronics.com and click spare parts)

Model	DOD #
BLK-4	654
BLK-4-EWP	654

911 Strobe Controller

Nursing Homes, Office Buildings, Strobes for Rural Houses - When you need to know where a 911 call originated.

- Activates on 911, 9-911, and 8-911 calls and 555 (test) or "custom number"
- Bright flashing $\frac{3}{4}$ " **LED** visible over 100ft
- Resets by Contact Closure or Touch Tones
- Can provide 12VDC or relay contact to operate an external strobe or visual indicator



Also activates on user programmable number

- **Power supply included**

Model	DOD #
SC-911	236

LED Strobe Light

- **High intensity long life LED** technology
- **4 programmable flash patterns**
- **6 programmable brightness settings**
- Requires 12VDC Power



Red, Amber and Clear lens sold separately (go to vikingelectronics.com and click spare parts)

Model	DOD #
SL-2	242
SL-2-EWP	242

Visual Telephone Status Indicator

- **Bright $\frac{3}{4}$ " LED** visible over 100 feet

APPLICATIONS:

- **Telemarketing**
- **Office cubicles**
- **Tech Support**
- **Customer Service**
- **Message Waiting**
- **Sales offices**



HEADSETS: Flashing **LED** ends interruptions by indicating that you are "On the Phone". (Special T adapter provided.)

ELECTRONIC PHONES: Flashing **LED** eliminates guessing whose phone is ringing. Connect to electronic phone's speaker.

ANALOG PHONES: Flashing **LED** indicates "Ringing", steady **LED** indicates "On the Phone" and "stutter" flash indicates message waiting stutter dial tone is detected. Will also follow the cadence of 90 to 125v message waiting voltage.

Power supply included.

Model	DOD #
VR-1B	697

Visual "Ring", "Off-Hook" and "Message Waiting" Indication

The **Viking Model LPL-1** connects to any standard analog phone line to provide visual flashing "Ring", steady "On the Phone" or fast flash "Message Waiting*" indication. The large flashing **LED** can be seen up to 100 feet away. When used with a headset on an analog phone, you can end interruptions when associates don't realize you are on the phone.

Phoneline powered.

Model	DOD #
LPL-1	640

*When installed on phone systems with standard 90VDC message waiting voltage.



LM-1A Message Waiting Light Retrofit Kit

- Operates on standard 70-180V DC message waiting voltage
- Fully modular for quick plug-in installation
- Blinks on message waiting or ringing
- 100% solid state for highest reliability
- **LED** visible for 50 feet
- **Replaces LM-1 and LM-11V**
- Not designed to detect stutter dial tone (use model **VR-1B** above.)



Model	DOD #
LM-1A	662



Add Silent Service Observation to Any Phone System



- Allows supervisors to silently monitor their employee's phones
- New station wiring not required for analog key or single line phones
- Higher volume levels (adjustable)
- 24 station capacity can be expanded to 240 stations. Each SO-24A added, provides an additional 24 stations.
- Dial up code can be programmed to match the phone system's station or extension numbers.
- Call progress tones for observing supervisor



Cord set for digital phone systems

Model	DOD #
SO-24 AK	819

Important Features

- Connect one to ten SO-24As to an unused phone system line input or to a dedicated single line phone
- Built-in "Talk Assist" feature
- Cables provided for external cassette recorder
- Can be configured for digital phones with SO-24 AK
- Automatic gain control equalizes in and outbound conversation levels
- Additional supervisors each require a parallel system

For remote access use
Viking Model RAD-AMP (Page 22)

Now you can monitor, train, motivate, even assist your personnel or customer service staff without disrupting the activity at their work station.

Each SO-24A Service Observation Unit lets you access 24 stations (up to 240 with 10 units) or phone lines by dialing a two to four - digit code from any supervisory phone. Install additional SO-24A's for larger installations.

Station being monitored hears nothing; however, a supervisor can quickly enter the conversation by dialing a "*". A cassette recorder output permits selective recording by simply dialing a "9". Alternatively, all monitored conversations may be recorded.

The SO-24A is a valuable management tool for training new staff and improving performance of current employees. **Power supply included**

Model	DOD #
SO-24A	690

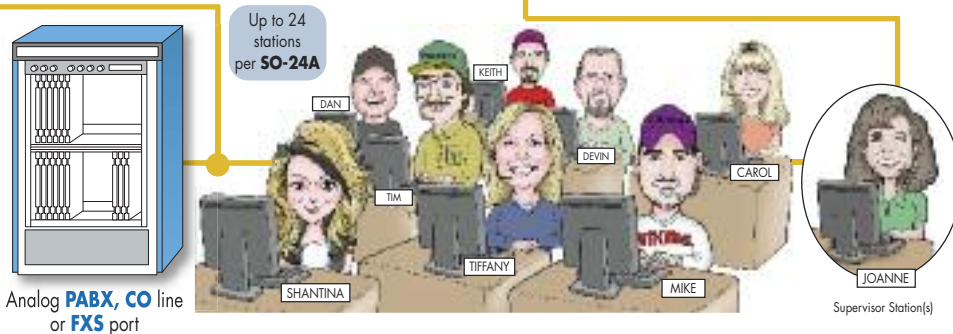

Professional Telecom Recording Kit



- The PTR-1 allows you to record:
- 1) All conversations on a particular phone line.
 - 2) Only conversations on your analog or digital telephone set.
 - 3) Only selected conversations (using the recorder controls).

The PTR-1 is designed to work with standard digital or tape recorders with built-in VOX and ACG circuits.

Model	DOD #
PTR-1	438

What is a beta site?

A beta site is where a customer allows our products to be tested in the field prior to being released for production. VIKING makes a practice of using beta sites to seek input on improvements in operations, installation or other design parameters. They are useful in ensuring that the product is of the best quality before full production. It allows the customer to be the first to try a new design or concept without waiting the usual pre-production lead-time of eight to twelve weeks. For more information regarding beta sites call the beta site coordinator at 715-386-8861.

Q. How do I qualify to participate as a beta site?

A. Qualifications include being willing to evaluate the product for at least thirty days and communicate with a VIKING technician regarding the application and performance of the unit. You must also be willing to accept that VIKING may need to make changes in hardware or software.

Q. When would VIKING not use a beta site?

A. Occasionally, on custom designs or software, or if the customer time frame is too short to permit a normal beta test. In that case the customer must take financial responsibility for problems or changes.

Q. Can I order beta units directly from VIKING?

A. Like all VIKING products, beta units must be ordered through our distributors.

Q. What if I decide to keep the product?

A. You are under no obligation to keep the product, but if you decide to do so, your distributor will bill you directly.

Does Your New IP Phone System Need More Power for Ringing Legacy Equipment?

Ring Shape Conditioner / Power Booster

- For applications behind IP and digital phone systems

Often IP phone systems, when used with Legacy phones, loud bells, strobes, etc. do not ring the older equipment loud enough or in some cases, operate them at all.

Designed for applications requiring higher ring voltage, higher ring power (up to 4 REN per line) or a sine wave (vs. square) ring signal. **Need to ring more phones?** The **RG-10A** (page 31) rings 12 or more phones per line.

Viking's 1-24 line ring shaper/boosters put the ring power back into your installation.



Any Viking Ring Booster



1-Line Wall Mounted Ring Shaper/Booster

- Power supply included

Model	DOD #
RG-4	416



4-Line Wall Mounted Ring Shaper/Booster

- Power supply included

Model	DOD #
RG-204	417

12 and 24-Line Ring Shape Conditioner / Power Booster



RG-212 and RG-224 Rear View

- RJ-21X "plug and play" install for CISCO VG224
- 19 inch rack mount
- Power supply(s) included

Model	No. Lines	DOD #
RG-212	12	419
RG-224	24	418

Convert Loop Start Equipment to Operate on Ground Start CO Lines

- 12 Circuit Converter
- No Power Supply required

Model **GLS-12** is designed to allow up to 12 standard telephone sets, multi-line key systems and other loop start equipment to be connected to 2 wire ground start **CO** trunk lines. The **GLS-12** provides the **CO** with the signaling required to draw dial tone when the loop start equipment goes off hook. Incoming calls ring directly to the loop start devices.



Model	DOD #
GLS-12	570

Receive Incoming Calls During Power or System Failure

- Operates on 24 to 48 Volt systems
- Improved automatic ground start converter for outbound calls.
- Loop or ground start

Continue to receive your calls, even if the phone system is down. **Viking's** bypass unit connects 6 standard single line station phones directly to the **CO** lines.

When the system is restored, calls in process will not be interrupted. **Viking's** bypass unit will reconnect the phones to their station circuit only after they become idle. **Power supply included.**

Model **PF-6A** operates when power is lost or on an alarm **contact closure.**

Model	DOD #
PF-6A	680

Ring Booster Rings Twelve Additional Analog Phones

- Compatible with Caller ID
- Provides 90V AC Nominal

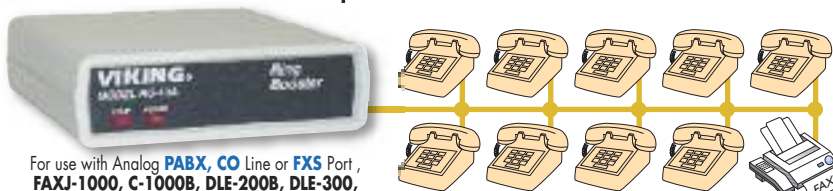

For use with Analog **PABX, CO** Line or **FXS** Port, **FAXJ-1000, C-1000B, DLE-200B, DLE-300, W-1000, W-2000A, W-3000** etc.

Up to twelve standard **1 REN** phones

Viking's Ring Booster increases ringing power to 12 **REN**. The **RG-10A** permits installation of up to 12 additional ringing phones or telecom devices on any analog **PABX, CO** line or **FXS** port, **FAX-JACK** type line sharing device, **W-1000/2000A/3000** doorboxes, or **DLE-200B** or **DLE-300** (Page 32) **ringdown circuits**.

The Ring Booster duplicates the incoming ring frequency and cadence. Compatible with **distinctive ringing**.

Power supply included.

Model	DOD #
RG-10A	420

Talk Battery Booster



Boost Talk Battery and Loop Current to Line Powered Devices

- Screw terminal connections for easy installation
- Boost talk battery to 48V
- Boost loop current to 26mA.
- Alarm panel compatible.



TBB-1B

Improved Technology!

The **TBB-1B** will boost talk battery and loop current on single analog **PABX, CO** line or **VoIP ATA FXS** port. This is helpful for powering line powered devices, such as dialers and emergency phones on low voltage and/or loop current extensions and **X-10** wireless phone jacks. **Power supply included.**

Model	DOD #
TBB-1B	632

Long Loop Adapter - Extend PABX Station to 30,000 feet!

- Designed to Ring AVAYA IP Office Trunk Input



- Provides additional lightning and surge protection
- Provides 48VDC talk battery
- Provides 20Hz, 10 **REN** sine wave ringing
- DTMF and pulse dialing compatible
- Detects AC and DC ring signals
- Passes Caller ID
- Passes hook flash and **CPC**
- Electronically isolates **PABX** from extended loop
- **Replacement for Proctor 46222**

Model	DOD #
LLA-1	615

Talk Battery and Ringing Power Supply

Provide 48V @ 150mA DC **Talk Battery** and 90V 20Hz ringing. 10 **REN**. 120V 60Hz input. Typical applications include **KSUs** that require an external ring generator.



Power supply included.

Model	DOD #
PS-48-RGA	515

Four Channel Long Loop Adapter

- 4 Line Version
Direct replacement for Proctor model 46224



Model	DOD #
LLA-4	620

Replacement Power Supplies

Model	DOD #
PS-1A (13.8V AC)	510
PS-2 (12V DC)	510
PS-3 (15V AC)	510

Generate a CPC Disconnect

Applications:

- Voice mail or call sequencers behind **PABX**
- **ISDN, VoIP, T-1** channel bank lines
- **C.O.** lines that don't provide **CPC**
- **VoIP FXS** ports

CPC-1, CPC-4 provides a momentary (1 sec) break in the line current to signal telephone equipment the calling party has hung up. The **CPC-1, CPC-4** generates the disconnect signal after detecting busy, fast busy, return to dial tone (programmable) and silence (programmable). The status **LED** indicates call progress. The **CPC-1** and **CPC-4** are caller ID compatible. **Phone line powered.**



CPC-1 (1 Line Version)



CPC-4 (4 Line Version)

Model	DOD #
CPC-1	442
CPC-4	444

Two-Way Ringdown Circuit

Features

- 0.15 or 2 sec **CPC**
- Precise dial tone
- Standard or **distinctive ringing**
- 20 **Hz/2 REN** ring output
- Prison phone mode
- 4.75" x 2.75" x 1.38
- 32V **talk battery**

Applications

- Demonstrate telecom gear
- Prison Phones
- Program alarm panels
- Test and repair
- Inter system communication
- Dialogic or rhetorex cards interface
- Golf course phones

The **DLE-200B** Line Simulator produces two-way communication between standard telecom products such as key systems, **PABXs**, fax machines, modems, dialogic cards and standard single line phones without the requirement for phone lines.

Model	DOD #
DLE-200B	605



Power supply included.

Using Voice Mail, Dialogic Cards, or Dictaphone Equipment on Electronic Key Systems



Many electronic key systems will not support this equipment because proprietary key phones do not send **DTMF** on station-to-station calls.

Prison Phone Application



K-1500-6A

K-1500-6A

Ringdown Applications between Phone or Phone Systems. Elevator or Emergency Phones (a UPS is recommended)



E-1600A

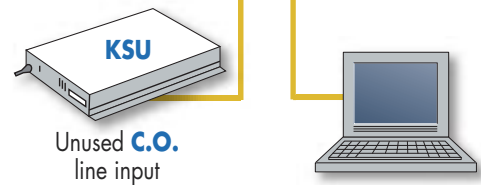

Unused **C.O.** line input

Viking's E-1600A
Series and Models
E-10A, E-20B, E-30, E-40, E-50, E-60, E-70, E-75, K-1200, K-1500-EHFA, K-1500-6A, K-1500-7, K-1500-E or standard phone

Max. loop length per port: 7,000 feet using 24 ga. twisted pair

Advanced Two Way Ringdown Circuit Supports High Speed Data



Power supply included.

Max. loop length per port: 7,000 feet using 24 ga. twisted pair

Model	DOD #
DLE-300	607

- 911 mode for classroom training
- Produces precise dial tone, ringback, busy, reorder, and S.I.T. tones
- Touch tone detection or standard **Ringdown**
- Provides name and number caller ID
- Audio input/output jack for amplified speaker or loading voice mail systems.

The **DLE-300** simulates **loop start** phone lines and allows two-way communication between telecom devices or systems. It provides standard or **distinctive ringing** (6 **REN**) and 40 volts **talk battery**.

The **DLE-300** eliminates leasing phone lines for diagnostics testing or demonstrations. A **CPC** break is provided after hang up.



Vandal Resistant Surface Mount Boxes

The VE-Series surface mount boxes are black powder painted or stainless steel. They are designed to surface mount to a single gang electrical box, a gooseneck pedestal or directly to a wall.

Compatible with these Viking products:

VE-3x5:	VE-5x5:	VE-6x7:	VE-5x10:
<ul style="list-style-type: none"> • E-40 • E-50 	<ul style="list-style-type: none"> • E-10A • E-30/E-35 • E-30-PT • E-60, 65, 70, 75 • E-1600-20A • E-1600-30A • W-1000 • W-3000 	<ul style="list-style-type: none"> • K-1700-3 • K-1705-3 	<ul style="list-style-type: none"> • K-1200 • K-1205 • K-1500-7 • K-1900-7 • K-1900-8



• SS Models built with 316 Marine Grade Stainless Steel

Model	Description	DOD #
VE-3x5	Black Surface Mount Box	424
VE-5x5	Black Surface Mount Box	424
VE-6x7	Black Surface Mount Box	424
VE-5x10	Black Surface Mount Box	424

Model	Description	DOD #
VE-5x5-SS	Stainless Steel Surface Mount Box	424
VE-6x7-SS	Stainless Steel Surface Mount Box	424
VE-5x10-SS	Stainless Steel Surface Mount Box	424

Surface Mount Boxes with Panels

Viking's **VE-PNL**'s are the perfect solution to the problem of mounting a switch, keypad or card reader to the outside of a building. Built from black powder painted steel or stainless steel, the back box provides a durable enclosure suitable for most outdoor applications. The blank front panel is made from aluminum, making it easy to drill, cut or form for the required mounting arrangement. The panel is straight lined and coated with a tough clear powder coating to resist corrosion. Four screws and a gasket are included to make installation a snap.

• SS Models built with 316 Marine Grade Stainless Steel



Model	Description	DOD #
VE-5x5-PNL	Black Box with Panel	424
VE-6x7-PNL	Black Box with Panel	424
VE-5x10-PNL	Black Box with Panel	424

Model	Description	DOD #
VE-5x5-PNL-SS	Stainless Steel Box with Panel	424
VE-6x7-PNL-SS	Stainless Steel Box with Panel	424
VE-5x10-PNL-SS	Stainless Steel Box with Panel	424

Illuminate Your Door or Emergency Phone

The **VE-Light kit** adds bright **LED** illumination to any doorbox or entry phone that is housed in a **Viking VE-5x5**, **VE-6x7** or **E-1600A-BLT-EWP** surface mount box. The stainless steel bracket is easily mounted using existing holes and hardware.

VE-LIGHT shown alone below and in conjunction with the E-30 and VE-5x5 right



Model	DOD #
VE-LIGHT	428

Gooseneck Pedestals

The gooseneck pedestals are designed to be used with select Viking VE-Series surface mount boxes or **VE-PNL** surface mount panels. Ideal for drive up communications, the gooseneck pedestals are constructed of heavy duty black powder painted steel or stainless steel. Pad mount to a floor or concrete with 4 available bolt holes or use the **VE-GNP-IG** to mount in ground or wet cement.

Compatible with the following Viking products:

- VE-5x5
- VE-5x5-SS
- VE-5x5-PNL
- VE-5x5-PNL-SS
- VE-6x7
- VE-6x7-SS
- VE-6x7-PNL
- VE-6x7-PNL-SS
- VE-5x10
- VE-5x10-SS
- VE-5x10-PNL
- VE-5x10-PNL-SS

Model	Description	DOD #
VE-GNP	42" Pad Mount Pedestal	424
VE-GNP-SS	42" Stainless Steel Pedestal	424
VE-GNP-IG	64" In-Ground Pedestal	424
VE-GNP-2	72" Double Pedestal	424

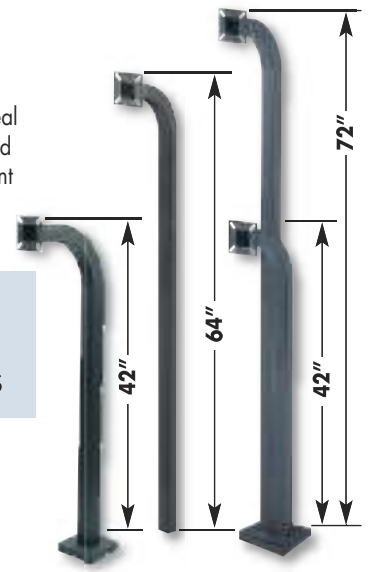

Examples and Definitions

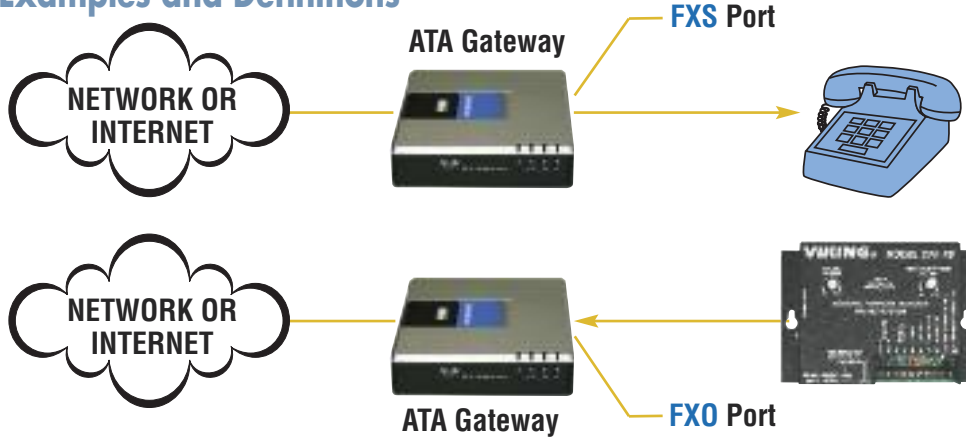

Definitions:

FXS Port: Provides talk battery, dial tone and ring voltage for an analog telecom device, such as a telephone or fax machine.

FXO Port: Receives talk battery, dial tone and ring voltage from an analog telephone line, **PABX** station or **FXS** port.

Compatible Gateway Equipment

LinkSys: FXS/FXO Audio Only

LinkSys manufactures audio ATA equipment that operates with analog telephones, fax, voicemail, entry phones and many paging amplifiers. Model **SPA3102** is shown. The unit encodes the audio for transmission across an IP network or the internet where it can be accessed from any location on the network.



SPA3102

For more information, go to www.voipdw.com, www.ipphone-warehouse.com, www.amazon.com, www.officedepot.com

Axis: Video Only

Axis manufactures video servers that encode analog video signal for transmission across an IP network or the internet. The single-channel model **M7001** is shown. Supplied software allows you to access Axis units connected to the network (auto-discovery) and program them via a web page interface. The video can then be monitored from any location on the network.



M7001

For more information, go to www.axis.com

How to Connect a Viking Door/Gate Entry System to Existing Phones/Phone System

When line sharing is not required (if connected directly to an **FXS**, Key or **PABX Analog Station** or **Trunk**) us **SRC-1** (page 40) for door strike or gate control.

Analog PABX, CO Line or FXS Port

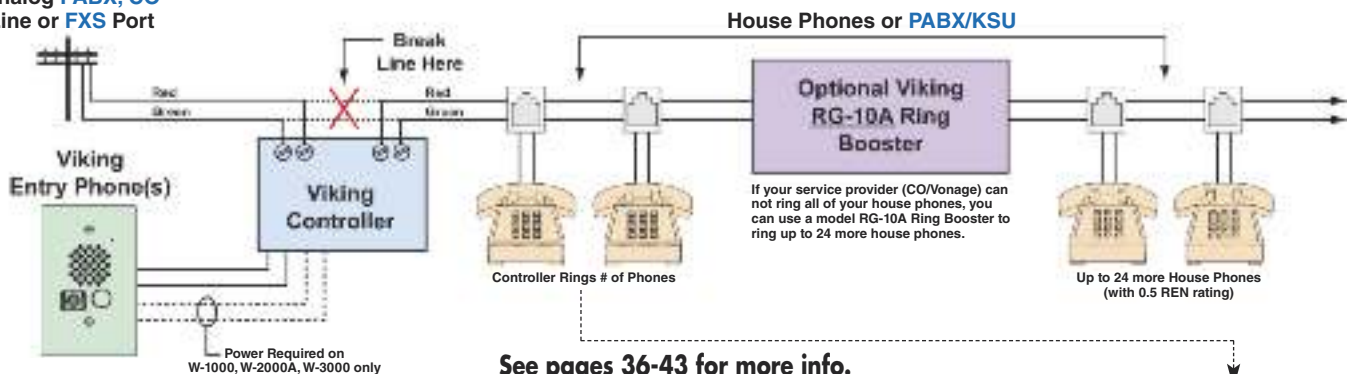

See pages 36-43 for more info.

Entry Phones / Doorboxes	Use Controller	Maximum # Door Phones	Maximum # Doorstrikes	Entry Phone Caller ID	Keyless Entry	Postal Lock Input	Controller Rings # of 0.5 REN House Phones
E-10A, E-20B, E-30, E-35*, E-40, E-50*, E-60, E-65*, E-70, E-75* (Page 42, 43)	C-200 (Page 41)	1	0	No	No	No	7
E-10A, E-20B, E-30, E-35*, E-40, E-50*, E-60, E-65*, E-70, E-75* (Page 42, 43)	C-250 (Page 41)	1	1	No	No	Yes	10
E-10A, E-20B, E-30, E-35*, E-40, E-50*, E-60, E-65*, E-70, E-75* (Page 42, 43)	C-2000B (Page 41)	4	4	Yes	No	Yes	16
K-1700-3, K-1705* K-1900-8 (Pages 11, 37)	C-2000B (Page 41)	4	4	Yes	Yes	Yes	16
W-1000, W-2000A, W-3000, W-3005* (Page 36)	C-1000B (Page 36)	2**	2**	No	No	Yes	6

* Includes a built-in CCTV color camera, which requires additional wiring.

Up to (4) entry phones and (4) door strikes can be accommodated by using (2) C-1000B controllers. For more info: **DOD# 881.



Handsfree Video Speaker Phone - Model E-35



- See **E-30** for complete specifications on page 7
- Shown in optional **VE-5x5** surface mount box (Page 33)

! When installing E Series door entry phones outdoors, always use the EWP version - See page 9

Model	Description	DOD #
E-35	Video Speaker Phone	178
E-35-EWP	EWP Version	178

Video Entry Phones - Model E-50



- See **E-40** for complete specifications on page 42

! When installing E Series door entry phones outdoors, always use the EWP version - See page 9

Model	Description	DOD #
E-50-SS	Video Speaker Phone	191
E-50-BN, PB, BK, WH	Video Speaker Phone	191
E-50-SS-EWP	EWP Version	191
E-50-BN, PB, BK, WH-EWP	EWP Version	191

Accessible Video Entry System - Model AES-2005



- See **AES-2000** for complete specifications on page 39
- Available in flush or surface mount styles

Model	Description	DOD #
AES-2005F	Flush mount AES-2005	204
AES-2005S	Surface mount AES-2005	204

12-Button Video Entry Phone - Model K-1205



- See **K-1200** for complete specifications on page 37
- Shown in optional **VE-5x10-SS** surface mount box (Page 33)

! When installing K Series phones outdoors, always use the EWP version - See page 9

Model	Description	DOD #
K-1205	Multi-Button Entry Phone	183
K-1205-EWP	EWP Version	183

Video Entry Phone with Keypad - Model K-1705-3



- See **K-1700-3** for complete specifications on page 37
- Shown in optional **VE-6x7** surface mount box (page 33)

! When installing K Series phones outdoors, always use the EWP version - See page 9

Model	Description	DOD #
K-1705-3	Video Entry Phone	159
K-1705-3-EWP	EWP Version	159
K-1705-3-BN	Bronze Video Entry Phone	159
K-1705-3-BN-EWP	Bronze EWP Version	159

Handsfree Video Doorbox - Model W-3005



- See **W-3000** for complete specifications on page 36
- Shown in optional **VE-5x5** surface mount box (page 33)

! When installing W Series doorboxes outdoors, always use the EWP version - See page 9

Model	Description	DOD #
W-3005	Video Doorbox	181
W-3005-EWP	EWP Version	181

Double Gang Handsfree Video Entry Phones
Model E-65 series (see page 43)

Double Gang Video Entry Phones with
Proximity Card Reader
Model E-75 series (see page 43)

Compact Color Video Camera Kit



- Stainless steel mounting hardware
- Potted circuit board
- 5V DC adapter/wire connections
- Tilt and swivel adjustment

IR illuminator compatible when using model **VCAM-11R**.

Model	DOD #
VCAM-1	190
VCAM-11R	190

- Color composite video output for versatility: 1V p-p composite, NTSC, 75 ohms
- Extreme temperature rating: -40° to 185°F
- Wide 70° viewing angle
- Tilt/Swivel adjustment: vertical +/- 20°, horizontal +/- 30°
- Resolution: 420 lines (640 x 480 / 307,200 pixels)
- Sensitivity: 0.26 LUX (20 IRE) F2.0
- Lens: 3.4mm, pinhole 70° FOV
- Maximum wire run length: 150 ft on **CAT5E** for video and power, 1000 ft with RG59/RG6 for video and **CAT5** for power (doubled pairs).

To integrate your video entry phones with your home TV sets!

Check out DOD# 886

High Resolution Color Video Camera Mounts in a Single Gang Box

NEW

The compact, high resolution, color composite video output provides versatility and a wide 70° viewing angle. The tilt and swivel adjustment permits optimum alignment. The -40° to 185° F temperature rating and **Enhanced Weather Protection** allow exposed outdoor installation. **Power supply included.**



Model	Description	DOD#
VCAM-2-SS	Brushed Stainless Steel	190
VCAM-2-BN	Oil Rubbed Bronze	190

Handsfree Doorboxes

⚠ When installing W Series doorboxes outdoors, always use the EWP version - See page 9

- Provides 24 volt talk battery and 20 Hz ring generator for phone system unused Trunk input or FXO port applications.

Provide your business or residential customers with the security and convenience of conversing with visitors from their own phone prior to allowing entry. Ideal for night doors, shipping/receiving departments, warehouses, residential applications or any security-sensitive entry. Designed to install on an unused Trunk input or FXO port. When the "Call" button is pressed, the unit rings the phones up to 30 times (adjustable) or until answered. Microphone volume adjustment is also provided.

Permits loop lengths of up to 6300 ft., using 24 AWG twisted pair. The **power supply included** can be mounted up to 150 ft. from the unit using 24 AWG twisted pair. The units provide 3 REN output (enough to ring six .5 REN phones). To ring additional phones use model RG-10A Ring Booster. (Page 31)

Model	DOD #
W-1000	170
W-2000A	170
W-3000	180
W-3005	181
VE-5x5	424

These units are compatible with C-1000B (below) and SRC-1 (Page 40) controllers.

- These units are now designed to ring AVAYA IP Office, NEC 2000 and Electra Pro 2, INTERTEL 5000, and VODAVI DHS.

W-3000 is a vandal resistant 5" x 5" brushed 14 Ga. marine grade 316 stainless steel flush mount unit. **LED** indicates switch location and call progress. Can generate **distinctive ringing**. An electrical mounting box is supplied. Can provide a push to talk option for noisy locations.

Illuminate your **W-1000/W-3000** mounted in a **VE-5x5 - Model VE-LIGHT** (Page 33) **W-3005 Video Doorbox** Now available - see page 35 for camera specifications.



W-3000
W-3000 shown in optional VE-5x5 surface mount box. (Page 33)

W-2000A is a surface mount unit in a durable plastic case. The 4.5" x 5.5" x 1.5" unit can mount on a single gang electrical box. Provides distinctive ringing. **Improved sound quality.**



W-2000A

W-1000 is a 5" x 5" vandal-resistant black powder painted aluminum flush mount unit. Provides distinctive ringing. An electrical mounting box is supplied. **Improved sound quality.**



W-1000



VE-5x5 Surface mount box for W-1000, W-3000 (Page 33)

Universal Door Entry System for Key, PABX, or Single Line Phones

Now Controls Two CCTV Cameras

- Share an existing phone line with two Viking doorboxes
- Operates 2 door strikes or gate openers • Monitor doors from your phone.

Now you can add Viking doorboxes to any system, even Centrex or those with just single line phones! The **C-1000B** shares an existing phone line with 2 door speaker units, but does not interfere with normal phone operation. In-process calls can be placed on hold while using the door speakers. The **C-1000B** has 5 amp contacts for operating 2 door strikes or gate openers from a Touch Tone or rotary phone. Tones confirm relay action. **Power supply included.**

- Auxiliary relay provides maintained or programmable .5 to 10 second relay contacts for activating a doorbell, light, etc.
- Provides power output for up to 2 doorboxes (only one power supply needed per system)
- Provides unique front and back chimes plus whole house paging when used with **SLP-1** (Page 16), **SLP-4** (Page 20)
- Add proximity card or keyless entry with Viking Model **ES-1** and **PROX-1** or **PROX-2** (Page 38)
- Built-in **Talk Battery** for "no C.O. line" applications
- Programmable (.5 to 10 sec) momentary or continuous relay contacts for controlling door strikes or gate openers
- Can provide custom ring from door box
- Postal lock input for activating door strike 1

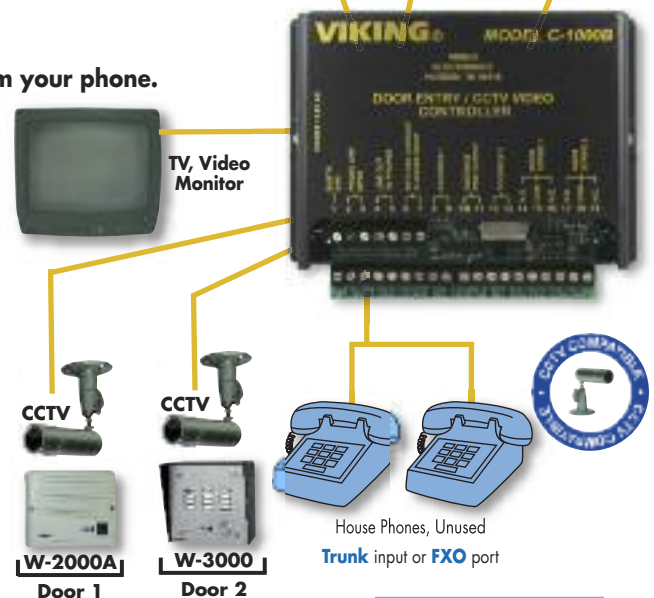

Expand your existing **C-1000B Door Entry System** to 3 or 4 Doorboxes Application **DOD# 881**

Model	DOD #
C-1000B	168



Directories for Apartment Entry Systems



Viking's vandal-resistant directories are an easily installed, high-quality 18 gauge brushed stainless steel display. Designed specifically to complement newly installed or existing

secure building entry systems. All models feature both weather and vandal resistant construction. The visitor looks up the apartment's one to three digit code then dials it on the Touch Tone phone. Name card not included.

Model	DOD #
D6	158
D10	158
D22	158
D32	158
D44	158
D56	158

Apartment/Office Door Entry 250 Number Dialer

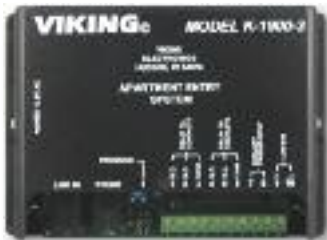

- Now provides a different keyless entry code for each apartment or office.
- "Buzz" the visitors in from your phone
- Non-volatile E² memory (no batteries required)

- Output for external data logging.
- Compatible with Viking's vandal-resistant K-1700-3, K-1900-8 or any Touch Tone phone.
- Also provides 5 additional keyless entry codes for management, maintenance, etc.

Model K-1900-3 allows the visitor to enter 1 to 3 digits on a Touch Tone phone located in the entry way. The K-1900-3 then dials the associated apartment. After conversing with the visitor, the tenant can "Buzz" them in by dialing a 1 or 2 digit code on their Touch Tone phone. An adjustable timed relay closure is provided for gate openers or door strikes. DPDT 5 amp contact closures are provided.

The K-1900-3 can be programmed remotely or locally using a Touch Tone phone. Each position stores up to 16 digits, except position "000 and 001", which can hold up to 32 digits and pauses for applications such as calling the facility manager's pager. A keyless entry feature using a 4 to 6 digit code can be used. Inputs for a postal lock are provided. The K-1900-3 will allow 911 and 311 emergency calls. **Power supply included.**

Model	Description	DOD #
K-1900-3	Apartment/Office Door Entry	312

12 Button Apartment Entry Phone with Built in Door Strike Relay



K-1205 shown in optional VE-5x10-SS surface mount box (page 33)

- Calling a tenant is as easy as pressing a single button
- 50 Keyless Entry Codes

The K-1200 Entry Phone is a two way, hands free telephone with 12 buttons for calling individual residences in an apartment building.

The rugged marine grade 316 stainless steel faceplate has a printed directory housed in a water proof plastic lens. Each button is beside the tenant's name in the directory, so there are no confusing codes to deal with. The K-1200 has a built in speed dialer that can handle up to 12 primary phone numbers, each with 22 digits. If there is no answer at the first number, a second number

such as a tenant's cell phone, can be called automatically. Once the tenant answers their phone, a single touch tone command can activate the built in door strike relay. **Power supply included.** • K-1205 Video Entry Phone - see page 35 for camera specifications.

! When installing K Series phones outdoors, always use the EWP version - See page 9

Model	Description	DOD #
K-1200	Apartment Entry	182
K-1205	Video Entry Phone	183

Vandal Resistant Handsfree Speaker Phone with Keypad

! When installing K Series phones outdoors, always use the EWP version - See page 9



K-1700-3-BN shown in oil rubbed bronze finish

- 14 Gauge Marine Grade 316 Stainless Steel or Oil Rubbed Bronze (BN) Faceplate
- Metal Call Button and Keypad
- Analog PABX, CO Line or FXS Port Powered
- Use with C-2000B for Keyless Door Entry (Page 41)

The K-1700-3 is an attractive, handsfree telephone designed especially for apartment and door entry applications.

When the "Call" button is pressed, the K-1700-3 returns dial tone. The keypad can then be used to call any number. The unit disconnects on busy, return to dial tone, CPC, silence or call timer. Volume adjustments are provided for microphone and speaker. Yellow LED indicates an "off hook" condition.

Illuminate your entry phone - Model VE-LIGHT (Page 33)

Handsfree Video Speaker Phone with Keypad

For Camera specifications see page 35. **Power supply included.**



K-1705-3 shown in optional VE-6x7 Surface Mount Box (Page 33)

Model	Description	DOD #
K-1700-3	S.S. Entry Phone	157
K-1705-3	S.S. Video Entry Phone	159
K-1700-3-BN	Oil Rubbed Bronze Entry Phone	157
K-1705-3-BN	Oil Rubbed Bronze Video Entry Phone	159

Wiegand Keypad

Slender aluminum housing for mullion mounting. Pigtail leads. Beeper and **LEDs** show status. **26 bit Wiegand** interface. Potted **pcb**.



Model	DOD #
HID-2	199

Compact 16" Range Proximity Card Reader NEW



Model **PROX-3** permits reading standard Proximity cards up to 16 inches from the reader. It is ideal for parking control, gate access, turnstiles, or any application requiring a longer read range. The **PROX-3** provides data in the standard **26-bit Wiegand** format.

The unit is equipped with **Enhanced Weather Protection (EWP)** for outdoor installations. Install alone or with Viking Door Entry phones on **VE-GNP** pedestals.

Model	DOD #
PROX-3	228

Proximity Key Fob NEW

- Attach to a key chain or neckband
- Compact size 1.5 x 1.2 x 0.15 inches
- Durable - it can withstand the washing machine
- Read up to 2" with **PROX-1** or 8" with **PROX-3**
- **No minimum quantities**



Model	DOD #
PROXFOB	198

Mounting Kits for VE-GNP Pedestals

PROX-3-MK-GNP for mounting **PROX-3** Alone

PROX-3-MK-VEGNP for Mounting **PROX-3** Plus a **VE-5x5**, **VE-6x7**, or **VE-5x10**

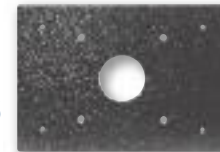

PROX-3-MK-GNP



PROX-3-MK-VEGNP

Model	DOD #
PROX-3-MK-GNP	229
PROX-3-MK-VEGNP	229

PROX-3 shown with **VE-GNP** pedestal, **PROX-3-MK-VEGNP** mounting kit and **K-1700-3** with **VE-6x7**



Proximity Card

- No magnetic strip to wear out - no batteries
- Credit card size, neckband slot on **PROXCARD**
- New thinner, more flexible **PROXCARD-ISO**
- Also see **C-4000** (Page 40)
- **No minimum quantities**

Model	DOD #
PROXCARD	198
PROXCARD-ISO	198



Proximity Card Reader

- Standard **26 bit Wiegand** interface
- Potted **pcb** enclosure with pigtail connection for indoor and outdoor applications. Black & white covers provided.

Model	DOD #
PROX-1	221

Keypad with Prox Card Reader

Model **PROX-2** is fully potted, has blue back lighting and mounts directly to a standard single gang box. The card reader and keypad transmits **26-bit Wiegand** format. Black and off-white covers provided.

Model	DOD #
PROX-2	219

Wiegand Card Reader/Keypad Entry System for 1 Door - 250 Users

Stand-alone keyless entry system can be programmed with a touch-tone phone. An output for data logging is provided. **Power supply included.**



Model	DOD #
ES-1	193

Add Up To 32 Access Entry Points To Viking's Accessible Entry System

Up to 32 additional points of entry may be added to Viking's model **AES-2000** Accessible Entry System. One **ES-3**, one Wiegand device and a door strike or magnetic lock of your choice is required for each additional entry point.



Model	DOD #
ES-3	195



Accessible Entry System

Usable by people with sensory and physical impairments

The **VIKING** Accessible Entry System is a Hands-Free phone with a built in auto-dialer, which will allow access to apartment/office buildings by using existing public telephone lines. In order to assist people of varying abilities, the "directory" is displayed on a **LCD** as well as an audible announcement.

Features:

- Digital announcer set from factory for 75 names. Additional names may be added by using **ERAM-4M** expansion kits. (75 names per kit for up to 525 names).
- Non-Volatile memory
- Door strike contacts
- Postal lock input
- Remote recording and programming
- Designed to help meet **ADA** requirements

Applications:

- Apartment/Office Buildings
- Assisted Living Residences
- Nursing Homes
- Hospitals
- Public Housing
- Available with video. (See page 35 for camera specifications)

Model	Description	DOD #
AES-2000S	Surface Mount	202
AES-2000F	Flush Mount	202
AES-2005S	Video Phone	204
AES-2005F	Video Phone	204
ERAM-4M	Expansion Memory	854

Panel size: Brushed 12 Gauge Stainless 12 in. x 9.5 In.

Back-Lit LCD Alpha Numeric Display

Optional Braille Label
 EZ™ Help Audio/Visual Operating Instructions

Panel Lock

Black surface mount box included with AES-2000S

Call/Hang-up Button

Metal Keypad

TTY Jack

Directory Buttons (4)

Digital Announcer/ Speaker Phone

Speaker Volume Control

EZ Help/Access is a trademark of the Wisconsin Alumni Research Foundation. For more information click on www.trace.wisc.edu

AES-2000F Flush Mount
 (Mounting bezel and back box included)

***PB-100 required for programming.** (Page 25)

The system is housed behind a marine grade 316 stainless steel panel with a keypad and control buttons. An analog telephone line and low voltage wiring must be available for operation. **Data logging via the PB-100** (Page 25). **Power supply included.**

Network Enabled Relay Controller

- Control (4) 5A@30VDC/250VAC relays across a network
- Monitor the status of 4 sensors at the remote location
- Now with Email notification capability

Relays can be toggled on or off, or user-programmed timed closures of 1 to 99 seconds.

The ready-to-use webpage control interface features password protection with two levels of security. Administrative users have full programming rights, while guests are limited to basic functional control.

Installation is simple on any **DHCP**-capable network, with a free down-loadable discovery tool for network setup. The **RC-4** can also be assigned a static IP address if you prefer. Network and functional parameters are fully programmable on separate programming pages.



Remote control of

- Secure building entry/Gates
- Heating/cooling equipment
- Pumps, fans and lighting
- Security system/Emergency tones

Remote sensing of

- Temperature/Door entry/Light
- Alarm contact closure
- Sound level threshold

Model	DOD #
RC-4	580

Add Two-Way Voice Communication to Your Existing IP Network Camera

If your IP Network Camera has line level audio connections, add the **MSB-30** to allow both audio and video to stream over the internet. Even if your camera already has a tiny speaker and mic, the **MSB-30** can be added to provide better and louder sounding audio.

The **MSB-30** has a microphone, a speaker, controls for speaker volume and microphone sensitivity, and a momentary push button housed in a stainless steel flush mount panel. An optional Viking Model **VE-5x5** can be used to surface mount it to a wall or pedestal. A 2 watt amplifier powers the internal speaker and can be used to power external speaker/paging horns.

The **MSB-30** "CALL" switch can provide a momentary contact to trigger the IP network camera, or ring a door bell. The blue LED shows the unit is powered, helps identify the "CALL" button at night, and can wink off when the button is pressed. Marine grade 316 stainless steel panel.

⚠ When installing the MSB-30 outdoors, always use the EWP version - see page 9.



MSB-30

Model	DOD #
MSB-30	213

Secure Remote DTMF Controller



- Secure Control of Building Entry Systems
- Provides 32 Keyless Entry Codes

The **SRC-1** enables a standard touch tone phone to securely operate a set of timed 5 amp relay contacts to control a door strike or gate controller from a remote location. The **SRC-1** is fully user programmable and uses non-volatile memory. The **SRC-1** eliminates the possibility of dialing the activation code through the entry phone using a hand held touch tone dialer.

The **SRC-1** features switchable 32 volt **talk battery** to allow use with any of Viking's **E Series**, **W Series** or **K Series** entry phones. A postal lock input is provided. **Power supply included.**

Model	Description	DOD #
SRC-1	Secure Remote Control	176

No C.O. Line Entry System for 12 Apartments/Offices



- Functions with or without tenant C.O. lines
- Expands to 96 apartments by adding more C-3000's (each C-3000 adds 12 additional apartments)

Eliminates the monthly expense of an entry phone line and **CO** "call waiting" feature on tenants lines. Connect a front and rear touch tone entry phone. The **C-3000** rings the tenant's phone or provides call waiting tones. The tenant can "Buzz" the visitor in from their touch tone phone via the front and rear door strike contacts. **Power supply included.**

- Compatible with:
- K-1700-3
 - AES-2000
 - AES-2005
 - K-1200
 - K-1205
 - K-1705-3
 - K-1900-8
 - Any Touch Tone Phone

Model	Description	DOD #
C-3000	No C.O. Line Entry System	162

4 Door Keyless or Prox Card Entry System - For Up To 250 Tenants

- Requires an analog **PABX, CO** line or **FXS** port to call tenants
- Supports 4 Wiegand keypad or card readers
- **RS-232** port for programming
- Output for external logging
- "Buzz" visitors in from tenants phone - **N.O.** & **N.C.** contacts
- Program dialer locally or remotely
- Provides toll restriction - allows 911 and 311 calls
- **Power Supply Included.**

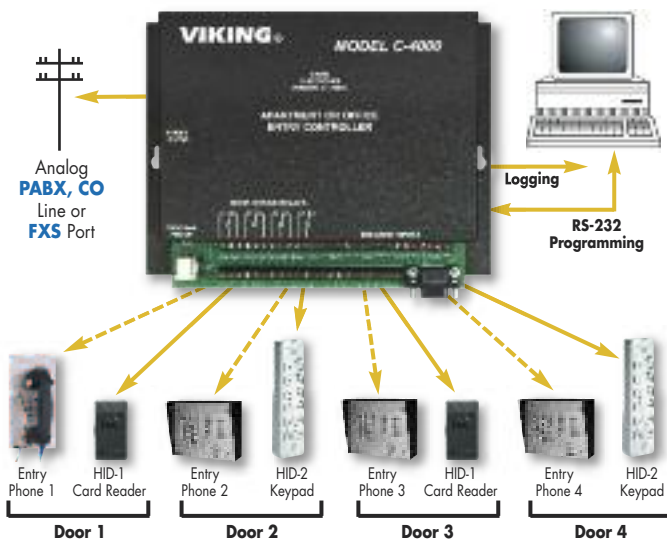

Model	Description	DOD #
C-4000	4 Door Keyless or Prox Card Entry System	164

Remote DTMF Controllers - Controls Door Strikes and Gate Openers From a Touch Tone Phone



Model RC-2A - single output



Model RC-3 - three outputs

Designed for use with **E, K** or **W Series** Emergency phones or as a stand-alone "Dial-up" remote Touch Tone controller. These units can operate door strikes, gate openers, or control equipment at a remote location. The **RC-2A** and **RC-3** can answer a ringing line. Three **RC-3**'s can be connected to the same line for 9 outputs. Tones confirm relay action. Either unit can be set up to operate with or without security codes. **Power supply included.**

Model	Description	DOD #
RC-2A	1 Output Unit	160
RC-3	3 Output Unit	165

Add a Viking Entry Phone to Existing Phones or Phone System

- **Allows Your House Phones or Phone System to Share a Phone Line with one Viking Entry Phone**

The **Model C-200** allows a single line telephone or a telephone system to share a phone line with a single **Viking** Entry phone. When a visitor presses the call button on the entry phone, the resident's phone rings. The resident can now answer and converse with the visitor prior to manually allowing entry. If you are on a call, the **C-200** provides a "Call Waiting" tone. The resident can "hook flash" which puts the call on hold while he converses with the visitor.

Residents may call out to the entry phone for monitoring purposes. Auxiliary contacts are provided to operate a doorbell, or activate a camera, lights, etc.

If additional features (such as door strike, multiple entry phones with caller ID, and keyless entry) are needed, use the **Viking C-2000B** below.

Power supply included.

Compatible with Viking:

- E Series Entry Phones
- K Series Entry Phones
- Any analog Phone



Model	Description	DOD #
C-200	Entry Phone Interface	169

Single Entry Phone Controller With Call Forwarding and Door Strike Control

- **In the event you're not home it will call your cell phone plus 4 other numbers**
- **5 amp door strike or gate opener contact**
- **Built in 5 number 1- 20 digit dialer**
- **Immediate call forward to your cell phone mode**
- **No CO mode**

The **C-250** allows single line phones or a phone system to share a phone line with a **Viking E or K Series** entry phone. When the entry phone initiates a call, the **C-250** provides a double ring. If you are on a call the controller provides call waiting tones. You can place the existing call on hold, talk to the visitor, then return to the original caller. Buzz the visitor in with a 1 or 2 digit touch tone command.

The **C-250** allows tenants to monitor the entry phone and has a postal lock input.

Power supply included.

Compatible with Viking:

- E Series Entry Phones
- K Series Entry Phones
- Touch Tone Phones



Model	Description	DOD #
C-250	Entry Controller	172

Advanced Door/Gate and Entry Phone Controller for up to 4 Entrance Locations

- **Now with Analog Station Dial-Thru Mode for Apartment/Office Entry Applications**
- **Provides 6 different keyless entry codes per door and 6 master codes (use at any door). Codes can be set up as permanent or "1 time" use.**
- **Provides 4 unique CD quality door chimes plus whole house paging when used with the SLP-4 (page 20)**

Answer and open up to 4 doors or gates from your nearest phone. The **C-2000B** can provide a double ring and/or caller ID to indicate which entry phone is calling. If you are on a call the controller provides call waiting tones and caller ID. You can place the existing call on hold, talk to the visitor, then return to the original caller.

A lighted Doorbell switch can be located near entry phone #1 to also initiate an entry phone call. The **C-2000B** requires a pair of wires (up to 5000 feet) for voice communications. A second pair of wires is needed to operate the door strike or gate opener. The unit can ring up to 10 existing phones. Programmable "Privacy Number", eliminates prank calls.

The **C-2000B** allows the user to monitor any entry phone with auto answer capability.

Add proximity card entry with Viking Model **ES-1** and **PROX-1** (Page 38).

Power supply included.

Compatible with Viking:

- E Series Entry Phones
- K Series Entry Phones
- Touch Tone Phones



Model	Description	DOD #
C-2000B	Advanced Entry Controller	156

Compact Handsfree Entry Phones Mount in Single Gang Box



⚠ When installing E Series door entry phones outdoors, always use the EWP version - See page 9

Model	Description	DOD #
E-40-SS	Stainless Steel Entry Phone	187
E-40-BN	Oil Rubbed Bronze Entry Phone	187
E-40-PB	Polished Brass Entry Phone	187
E-40-WH	Satin White Entry Phone	187
E-40-BK	Satin Black Entry Phone	187

- Analog **PABX, CO** Line or **FXS** Port Powered Door Entry Phones with Consumer Styling - Commercial Quality

2 wire installation – Analog **PABX, CO** or **FXS** powered. Blue **LED** continually provides light for locating the push button in dark locations.

Extended temperature range (-30°F to 150°F) - vandal resistant.

Compact size for flush mounting in a single gang box (with minimum inside dimensions of: 2"W x 2.84"H x 2.25"D)

Dimensions: 3.12"W x 4.87"H x 1.7"D

Auto answer feature for monitoring

Auto disconnect on **CPC**, busy, dial tone, or silence

VE-3x5 surface mount box available (Page 33)

E Series Compatible with these Controllers

- C-200 (Page 41)
- C-2000B (Page 41)
- C-250 (Page 41)
- SRC-1 (Page 40)

Single Gang Handsfree Video Entry Phones

- Built in color composite video camera with 420 lines of resolution wide 70° viewing angle.
- Audio and video transmission on one **CAT5E** cable (150 ft. max video)
- Extended temperature (-30°F to 150°F)
- Same entry phone operating specifications as E-40 (above)
- Surface mount box available for E-50, model **VE-3x5** (see page 33)

⚠ When installing E Series door entry phones outdoors, always use the EWP version - See page 9

Model	Description	DOD #
E-50-SS	Stainless Steel Video Phone	191
E-50-BN	Oil Rubbed Bronze Video Phone	191
E-50-PB	Polished Brass Video Phone	191
E-50-WH	Satin White Video Phone	191
E-50-BK	Satin Black Video Phone	191

E-50 Series available in the same attractive finishes as **E-40** (above).

Tilt and swivel adjustments to achieve the perfect camera angle. **Refer to page 35 for camera specifications.**



E-50-PB

Camera power supply included

E Series Compatible with these Controllers

- C-200 (Page 41)
- C-2000B (Page 41)
- C-250 (Page 41)
- SRC-1 (Page 40)



E-10A
5"x5" flush mount



E-20B
4"x5.25" surface mount

Hands Free Door Entry Phone

- Intelligent auto disconnect on **CPC**, busy, dial tone, silence.
- **VE-5x5** surface mount box available for the **E-10** (see page 33)

See page 14 for complete specifications

Handsfree models **E-10A** and **E-20B** go off hook on the phone line when the button is pressed, the units auto disconnect on **CPC**, busy, dial tone or silence. The **E-10A** and **E-20B** will auto answer on an incoming call.

⚠ When installing E Series door entry phones outdoors, always use the EWP version - See page 9

Model	Description	DOD #
E-10A	Flush Mount Entry Phone	210
E-20B	Surface Mount Entry Phone	210

Handsfree Entry Phones Mount in Double Gang Box

- 2 wire installation – Analog **PABX, CO** Line or **FXS** Port Powered
- E-60's blue **LED** continually provides light for locating the push button in dark locations
- Same operating specifications as **E-40** (see page 42)
- Surface mount box available for **E-60**, model **VE-5x5** (see page 33)
- Dimensions: 4.99"W x 4.87"H x 1.7"D

Model	Description	DOD #
E-60-SS	Stainless Steel Entry Phone	206
E-60-BN	Oil Rubbed Bronze Entry Phone	206
E-60-PB	Polished Brass Entry Phone	206
E-60-WH	Satin White Entry Phone	206
E-60-BK	Satin Black Entry Phone	206



E-60-BN

E-60, 65, 70, 75
Series available in the same attractive finishes as **E-40** (page 42).

! When installing E Series door entry phones outdoors, always use the EWP version – See page 9

Double Gang Handsfree Video Entry Phone

- Built in color composite video camera with 420 lines of resolution wide 70° viewing angle.
- Audio and video transmission on one **CAT5E** cable (150 ft. max video)
- Same entry phone operating specifications as **E-40** (see page 42)
- Surface mount box available for **E-65**, model **VE-5x5** (see page 33)

Model	Description	DOD #
E-65-SS	Stainless Steel Video Phone	203
E-65-BN	Oil Rubbed Bronze Video Phone	203
E-65-PB	Polished Brass Video Phone	203
E-65-WH	Satin White Video Phone	203
E-65-BK	Satin Black Video Phone	203



E-65-WH

! When installing E Series door entry phones outdoors, always use the EWP version – See page 9

Double Gang Entry Phones with Proximity Card Reader

- Built in 125KHz compatible 26-bit Wiegand proximity card reader (see page 38 for other HID compatible products)
- Same entry phone operating specifications as **E-40** (see page 42)
- Surface mount box available for **E-70**, model **VE-5x5** (see page 33)

Model	Description	DOD #
E-70-SS	Stainless Steel Prox Reader Phone	207
E-70-BN	Oil Rubbed Bronze Prox Reader Phone	207
E-70-PB	Polished Brass Prox Reader Phone	207
E-70-WH	Satin White Prox Reader Phone	207
E-70-BK	Satin Black Prox Reader Phone	207



E-70-SS

! When installing E Series door entry phones outdoors, always use the EWP version – See page 9

Double Gang Video Entry Phones with Proximity Card Reader

- Built in 125KHz compatible 26-bit Wiegand proximity card reader (see page 38 for other HID compatible products)
- Built in color composite video camera with 420 lines of resolution wide 70° viewing angle.
- Surface mount box available for **E-75**, model **VE-5x5** (see page 33)

Model	Description	DOD #
E-75-SS	Stainless Steel Video/Reader Phone	208
E-75-BN	Oil Rubbed Bronze Video/Reader Phone	208
E-75-PB	Polished Brass Video/Reader Phone	208
E-75-WH	Satin White Video/Reader Phone	208
E-75-BK	Satin Black Video/Reader Phone	208



E-75-PB

! When installing E Series door entry phones outdoors, always use the EWP version – See page 9

VIKING Electronics, Inc.

1531 Industrial Street
Hudson, Wisconsin 54016

Printed in the USA

Address Service Requested

Network Enabled Relay Controller



Olivia Hanson



Shea Hewitt



Nolan Hewitt



See page 39

Model **DOD #**
RC-4 580



Cecilia Hanson



Thomas Hanson

What's new in 2013

Digital Call Screening and Messaging System



- Answers calls with informative message and lets caller ring thru or hang up.
- Quick and easy programming via your phone
- 8 messages - 12 min of flash memory

Model **DOD #**
AR-1 105

See page 27

Add 2-Way Audio to Your IP Network Camera



- Separate speaker and mic volume controls
- 2 Watt amp can power external paging horns
- Momentary "call" switch to trigger camera, etc.
- Marine grade 316 stainless steel

Model **DOD #**
MSB-30 213

See page 39

General Purpose 15 Watt Telecom Paging Amplifier



- With background music and loud ringing
- For Centrex, PABX, IP, and key system applications
- Drives up to 15 eight Ohm paging horns/ speakers

Model **DOD #**
PA-15 486

See page 16

VIKING Products are in stock in the US and CANADA at the distributors below.

ADI
800-233-6261 • www.adilink.com

Graybar
800-825-5517 • www.graybar.com

Jenne Inc.
800-422-6191 • www.jenne.com

Anixter
800-323-8167 • www.anixter.com

TeleDynamics
800-847-5629 • www.teledynamics.com

Communications Supply
800-786-9584 • www.gocsc.com

Target Distributing
800-873-5528 • www.targetdist.com

Capitol Sales
800-467-8255 • www.capitolsales.com

Goldcom, Inc.
800-788-8848 • www.Gold-com.com

Hall Telecommunications
519-822-5420 • www.halltel.com
800-265-2667 (CANADA)

KPG Logistics
800-755-1950 • www.kpglogistics.com

Rexel
800-637-3972
www.rexelusa.com

High Tech Communication
800-256-3010
www.high-techcomm.com

HB Distributors
800-266-3478
www.HBdistributors.com

Customers outside of the USA and Canada, please contact:
+1-715-386-3794

vikinginternational@vikingelectronics.com
www.vikingelectronics.com

For more information contact us at:
715-386-8861
www.vikingelectronics.com

Designed, Manufactured and Supported in the USA