



Intelligent Ballast Controls

Application Guide



The Ultimate in Flexibility

The digital revolution sweeping the lighting controls industry has created a generation of electronic ballasts offering the ultimate in performance, flexibility, energy savings and cost-effectiveness.

Each ballast contains embedded intelligence and connects to other ballasts and control devices using soft configuration schemes, enabling zoning and rezoning using programming, not wiring, with zones as small as a single ballast.

The ballasts are networked via a low-voltage bus, creating opportunities to cost-effectively combine multiple control strategies such as automatic shut-off, daylight harvesting, personal dimming control and demand response. Two-way communication may be possible depending on the ballast, providing status information that can be used for energy analysis and maintenance.

Digital ballasted control systems are typically designed based on the Digital Addressable Lighting Interface (DALI) or a proprietary protocol, presenting integration challenges.

Synergy Lighting Controls has solved these challenges with a new Intelligent Ballast Control (IBC) module for its lighting control system.

Controlling SIMPLY5™, DALI-based or Lutron® Eco-System® ballasts, the IBC module allows digital ballasted control systems to easily and seamlessly integrate with other lighting control systems and, because Synergy is a native BACnet® solution, building automation systems as well.

With Synergy's IBC module, lighting control system integration is a snap.

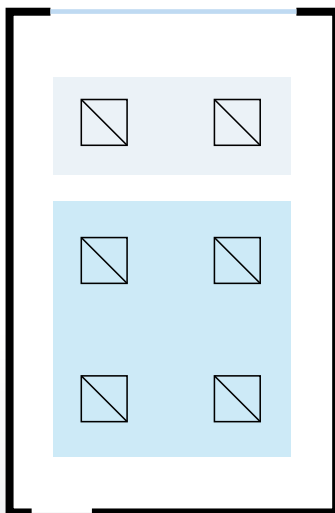

DAYLIGHT HARVESTING

Digital ballast control is ideally suited for daylight harvesting by enabling luminaires to respond individually to variable daylight conditions.

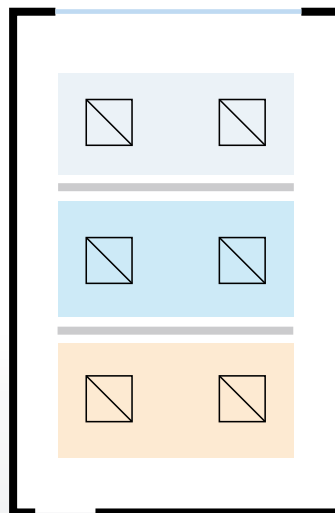

PARTITIONS



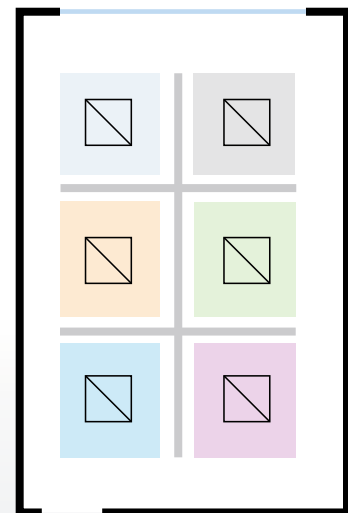

Digital control gives lighting systems the ability to adapt fluidly to different uses.



PERSONAL DIMMING

Digital ballast control combined with dedicated workstation luminaires in offices empowers occupants to select light levels based on need or preference.

Why Specify Intelligent Lighting?

1	<p>FLEXIBLE Lighting systems are able to adapt to changing space needs such as office buildings welcoming new tenants, classrooms switching from lecture to a multimedia presentation, and any other multipurpose space.</p>	
2	<p>INTUITIVE Digital ballast control systems are simple to install and reconfigure.</p>	
3	<p>AFFORDABLE Lighting solutions based on digital ballasts can be highly cost-effective, particularly when implementing multiple control strategies via a single wiring bus.</p>	
4	<p>ENERGY SAVING Ideal for projects requiring energy code compliance or LEED energy points, digital ballast control systems maximize energy savings by allowing multiple control strategies to be combined economically in a system that enables layers of control zones as small as individual luminaires.</p>	
5	<p>COMMUNICATIVE With two-way communication, building operators can collect information from the ballast such as power and lamp and ballast status, which can be used for energy analysis and maintenance.</p>	

Synergy Advantages

INTEGRATED LIGHTING CONTROL
Digital ballast control systems offer highly configurable capabilities and are therefore ideally matched to applications requiring a high degree of flexibility and energy savings.

Synergy enables specifiers to tie conventional panel-based automatic shutoff and architectural dimming control with digital ballast control in a seamlessly integrated lighting control system.

INTEGRATED BUILDING CONTROL
Digital ballast control systems are designed based on DALI or proprietary protocols. Integration with building automation systems may use a building control protocol such as BACnet.

Synergy control systems are native BACnet, eliminating the need for a gateway and enabling seamless control between DALI/proprietary lighting controls, non-digital control systems and building automation—with a comprehensive suite of software tools that connect room occupants to the building system in ways never before possible.

COMPLETE SOLUTION
Synergy offers a family of lighting control devices to complete any lighting control solution, including wall station controls, photosensors, switches, remotes and occupancy sensors. Whatever the control need, Synergy has an optimized solution.



INTELLIGENT
BALLAST



OCCUPANT
SENSOR



SYNERGY
REMOTE
STATION



INDOOR
PHOTOSENSOR



Intelligent Ballast Controller

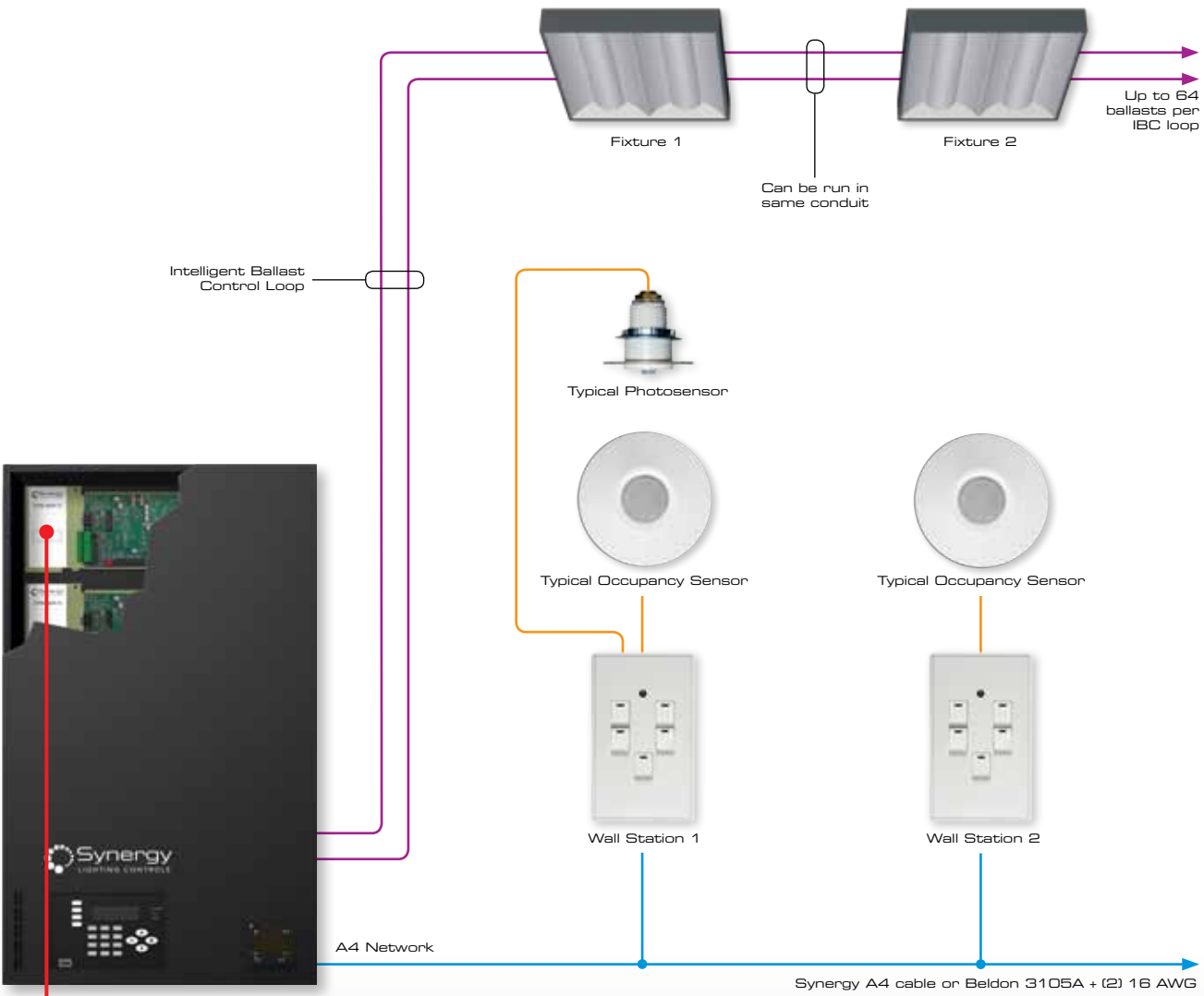



IBC POWER MODULE

Three individually controllable intelligent ballast control loops; 64 ballasts each. Compatible with SIMPLY5, DALI and Lutron ECO System ballasts.

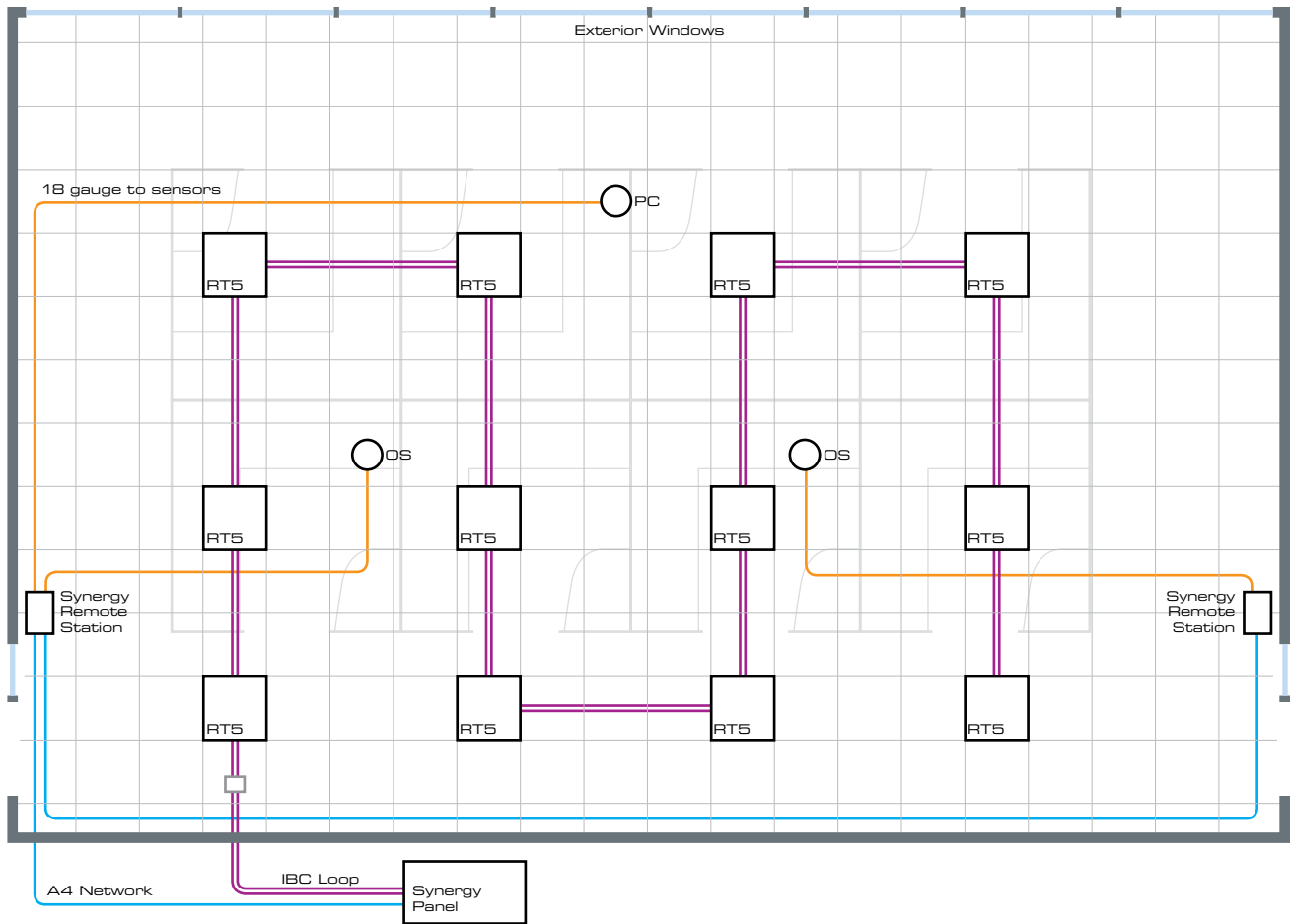

Power Module Options

Power modules may be combined within the same enclosure to meet job site requirements.



RELAY POWER MODULE

Eight single-pole relays with zero-cross switching, plus eight switch and two analog input terminals.



DIMMER POWER MODULE

Six universal load digital dimmers suitable for 120V or 277V incandescent, fluorescent, low-voltage, neon, cold cathode and non-dim loads.



CONTACTOR MODULES

Contains up to (4) two-, three- or four-pole lighting contactors to provide integral control of multi-phase lighting loads.



TAP FEED LUG OPTION

This option allows several Synergy enclosures to share a single main feed up to 400A, three phase.

Beyond Intelligent Ballasts

Synergy's plug-and-play modules allow easy customization to create an ideal lighting control solution for any combination of load types, including digital control as well as 0-10V DC dimming, phase-control dimming and switching.

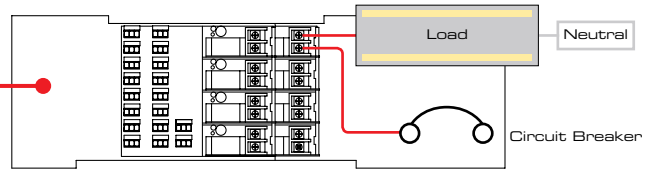

RELAY POWER MODULE

- Available with and without branch breakers
- Individually replaceable relays (30A, 120/277V) with 18,000A short circuit current rating (SCCR)
- Versatile in application; supports switching and 0-10V dimming

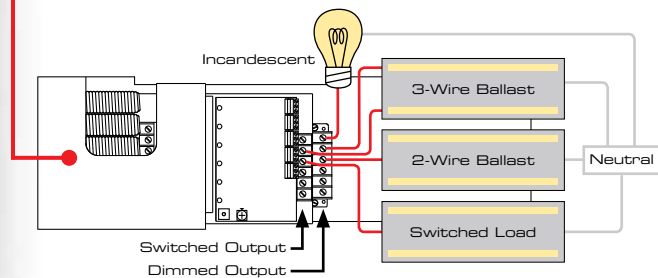

DIMMER POWER MODULE

- Six universal dimmers per module: incandescent, magnetic low-voltage, electronic low-voltage, Advanced Mark10[®] fluorescent, Lutron Hi-Lume[®] and ECO10[®] fluorescent, neon, cold cathode
- Square-law dimming curve, heavy-duty toroidal chokes, thermal magnetic circuit breakers
- Dual voltage (120V or 277V), air-gap relays, over-temperature cut-out, selectable soft-start for all loads

Enclosures

SYEL

Large enclosure; 20" w x 48" h, up to six modules.

SYEM

Medium enclosure; 20" w x 34.5" h, up to four modules.

SYES

Small enclosure; 20" w x 21" h, up to two modules.



Synergy Applications

Synergy's intelligent ballast control solutions are ideally suited for a broad range of commercial building applications—any application seeking to maximize flexibility and energy savings—from convention centers and manufacturing plants to schools and offices.



CONVENTION CENTERS

Partition large meeting spaces in any configuration you choose. Rezone the lighting as needed and assign these zones to control devices for local control.



MANUFACTURING

Adapt light levels to different space uses while minimizing energy consumption with automatic shutoff and daylight harvesting capabilities.



SCHOOLS

Integrating high-efficiency lighting and digital controls will reduce electric lighting consumption by 85% and, when combined with proper daylighting, can increase student performance over 20%.



OFFICES

Gain flexibility in meeting rooms, facilitate lighting maintenance and energy monitoring, and promote occupant job and environmental satisfaction by providing the ability to select light levels in their personal workspace.

Synergy Products

Synergy offers best-in-class control of intelligent ballast controls and ease-of-use for room occupants. Completely programmable out of the box to satisfy client needs, with no design limits.

- Flexible Control Choices
- Customized Functionality
- Maximum Expandability
- Maximum Energy Savings
- Energy Code Compliant
- Architectural Dimming
- Distributed Control
- Low-Voltage Switching
- Controllable Circuit Breakers
- Daylighting Controls

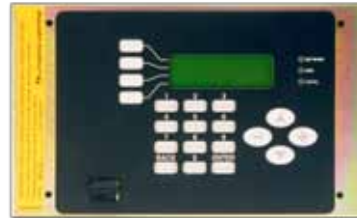

SYSC: SYSTEM CONTROLLER

The System Controller provides user interface, display, time clock and logic circuits for Synergy lighting control system enclosures, and a means to set up lighting control functions such as manual switching, manual and preset dimming, scheduling, astronomical time control and daylight harvesting.



SQCS: PRESET CONTROL STATION

The preset control station provides manual dimming and preset lighting control for architectural dimming applications such as presentation and multimedia rooms, providing up to 16 scenes, control of multiple loads, and a variety of styles and architectural finishes suitable for virtually any application.



Accessories

From switches to dimmers to handheld remotes, Synergy's accessories provide extended capabilities such as manual override and preset control.



SYRSP

Provides a convenient means to add push-button controls for on/off, preset, raise/lower, partition control or other user interface to a Synergy lighting control system. Standard infrared receiver for use with the SYWR wireless remote transmitters.



SYRSP EXT

Ideal for applications which require manual and automatic control of fluorescent or HID lighting equipped with compatible 4-wire (0-10V) electronic dimming ballasts. Provides local on/off, manual dimming, auto-daylight harvesting dimming and stand-alone/networked operation.



LVPS

Provides durable and attractive solution to override lights controlled by Synergy lighting controls systems. This decorator-style switch uses standard decorator wallplates for single or multi-gang applications. A pilot light is provided for both switches so it can be used as a single switch for on or off.



LVKS

The LVKS provides a reliable, durable and secure means to override lighting. Switches are supplied with pigtail connectors for low-voltage wire connections. Switches are to be used with Synergy or SwitchPak™ lighting control panels.



SSPL

Provides individual local line-voltage override control of lighting in time-based control schemes. Can be used manually to turn lighting on and off in the normal manner. Resets itself automatically to the off position in response to a programmed power interruption signal provided by the lighting control panel.



LVDS

The LVDS momentary switch provides a durable low-voltage switch solution with a standard strap-mount form factor and designer styling. DSA wallplates are offered in a variety of sizes and finishes.



SYWR

Used for wireless remote control of lighting functions in a Synergy system. Operates with a standard IR receiver on the SYRSP digital remote wallstation. The 17-button, hand-held programmer version is useful for preset dimming control.



DEQ LC

Integrates a localized zone of fluorescent lighting equipped with compatible 4-wire electronic dimming ballasts into a Synergy system. Provides on/off, dimming and automated daylight dimming control for a single lighting zone.

Synergy CONFIG Software

CONFIGURATION SOFTWARE
Synergy Config is a PC-based Windows™ application used to configure and program all system parameters and schedules. It offers both local and remote access for system programming.

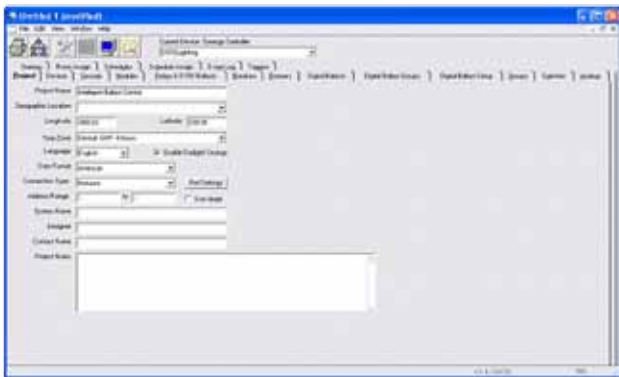

The software utilizes a familiar Windows graphical user interface to provide easy access to all system data through a simple tab-based navigation.

Access privileges for different software features can be set up for multiple users through the use of administrator-defined login IDs and passwords.

The online mode allows real-time monitoring and override of input and load status as well as diagnostic functions.

Personal dimming controls available to customize user experience. Provides the ability to control the lights for an individual workspace from a desktop PC. Screens are customizable for individual level control or facility level control. When used with Synergy configuration software the system allows simple re-configuration of the space.

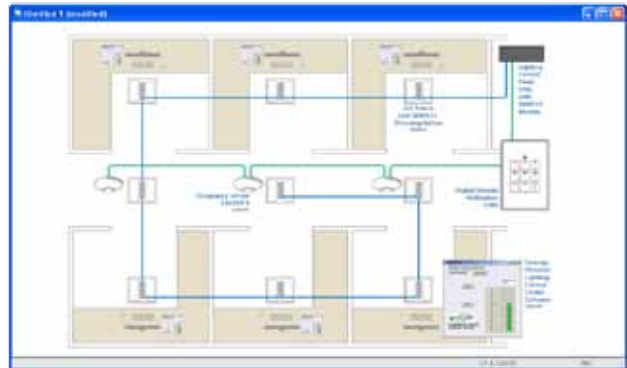

Customized graphics and personal dimming controls for individual level or facility level control.

BACnet[®]
International



Native BACnet

Integrates with BACnet compatible building automation and control systems.



WWW



Sensor Options

Sensor Switch passive infrared and passive dual-technology wall, ceiling and corridor/aisle occupancy sensors save energy as well as ensure energy code compliance in virtually any commercial building environment that is intermittently occupied throughout the day.



WIDE VIEW

Wide View sensors unobtrusively mount in a corner near the ceiling, detecting small motions up to 40 ft away and large motions up to 70 ft away. The unique tilting feature allows this sensor to be mounted anywhere from 8 to 10 ft with excellent long-range coverage.



HALLWAY

For control of corridor lighting, the Hallway Series sensor is the best solution. Typically mounted at either end of a long corridor, these sensors detect occupants entering the hallway up to 130 ft away. Detection at these distances is for entrances at right angles to the beam pattern. Hallway sensors may also be used with other low voltage sensors to adequately view a space.



AISLEWAY

Bi-Directional High Bay Aisleway sensors detect motion extending 70 to 110 ft when mounted at heights of 30 to 45 ft. The sensor's view pattern covers the area lit by three typically spaced lighting fixtures and is ideal for warehouse applications.



CEILING-MOUNT 360°

Ceiling-Mount 360° sensors are perhaps the most versatile of all sensors. Ideal for numerous applications these sensors are available in either standard range (for small motion detection) and extended range (for large/walking motion). Mounted at 9 ft, these sensors view up to 28 ft in all directions.



END-OF-AISLE VIEW

End-of-Aisle sensors view up to 110 linear ft of aisleway space when mounted between 30 to 45 ft. These sensors are perfect for detecting occupants walking or riding in forklift trucks and typically are used to control an entire aisle of lighting together.

RELOC® Wiring Solutions

LAYERED VALUE: INCREASED RETURN

Our intelligent ballast controls, lighting and modular wiring products are engineered to work together. Leverage their unified strengths to increase your client's return on investment.

RELOC INTELLIGENT BALLAST WIRING SYSTEM

RELOC is a plug-in wiring system consisting of connectors and cables that replace traditional wiring methods such as pipe and wire and MC Cable.

Invest in the RELOC modular wiring system and reduce installation costs by an average of 35%. How? RELOC eliminates up to 75% of on-site labor.

After initial construction, RELOC continues to save your client money during remodels and retrofits.



TRADITIONAL WIRING SYSTEMS

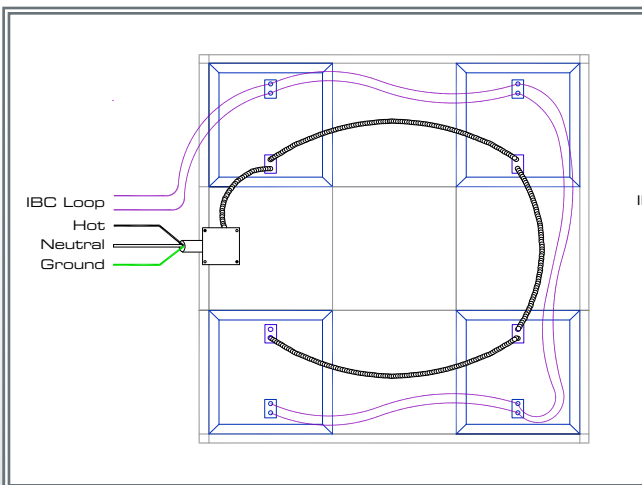

RELOC WIRING SYSTEM

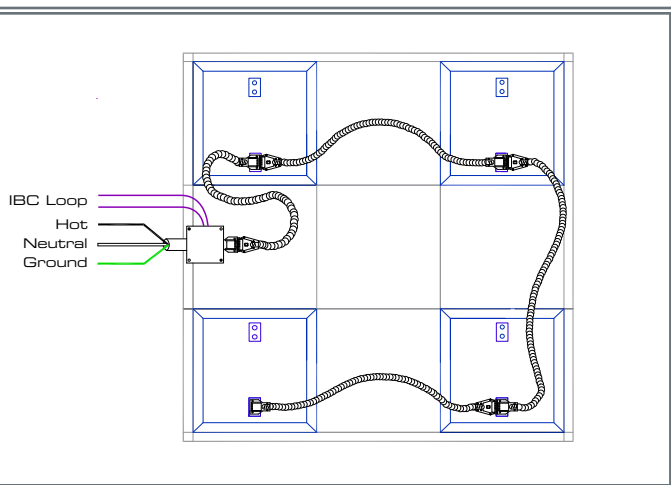

Acuity Brands® Lighting

RT5 VOLUMETRIC RECESSED LIGHTING

Looking for something better than the harsh overhead light and confining cave effect of parabolics? Choose the new standard in fluorescent lighting—RT5 Volumetric Recessed Lighting from Lithonia® Lighting.

Unlike parabolics, RT5 is designed to deliver the right amount of soft, comfortable light throughout a room, truly enhancing the work environment. Which makes this new fixture an ideal solution for offices, schools, hospitals, retail and other workspaces.

For additional information about RT5 fixtures, visit www.lithonia.com/rt5

ES8 HIGH PERFORMANCE T8 LIGHTING

ES8 lighting represents a breakthrough in fluorescent systems, fusing high-performance T8 technology with an extremely efficient and comfortable distribution of light.

Unlike common parabolic fixtures employing three standard-life, standard-output T8 lamps, ES8 systems use just two long-life, high-efficiency, superior color-rendering lamps.

For additional information about relighting, visit www.lithonia.com/relight





ACUITY BRANDS

Acuity Brands is a North American market leader and one of the world's leading providers of luminaires, lighting control systems and related products and services with FY2010 net sales of over \$1.6 billion. Headquartered in Atlanta, the company employs approximately 6,000 associates and has operations throughout North America, Europe and Asia.

