



KTC 3 KTC 4

Contemporary entrance applications – dormakaba high-capacity revolving doors

Wherever central entrances of buildings have to handle heavy traffic volumes, where ease of use is paramount and where architecturally refined façades require an equally attractive complement, the dormakaba high-capacity range of revolving doors provides the perfect application.

Superb user convenience

KTC revolving doors are characterised by their especially generous diameters – ranging from 3,600 to 6,200 mm. The automatic program modes can be selected in accordance with different usage requirements. This ensures optimum ease of use with access effectively aligned also to the requirements of the disabled. Even the high traffic volumes that can occur in peak periods are handled by these doors without difficulty. In addition, the pivot-mounted wings will fold out in any position to provide a clear escape route.

Optimum cost efficiency

KTC revolving doors protect the building interior reliably against draft, noise and dirt. The overall concept and the sophisticated detail applications of the KTC program range contribute to the optimization of the building energy balance. Modern safety and security aspects have been taken fully into account. Various night shields are also available as an option.

Flexible applications with respect to design

The design versatility and variability of the KTC range provides for enormous architectural scope. Matched materials and surface finishes enable the door to be harmonised with virtually any façade concept. The center part of the door is also available with an optional showcase for individual decoration purposes. Hereby the entrance area can already be used to draw your customers attention to an attractive presentation display.



Benefits – point by point

For the installer

- Comprehensive range that also includes applications suitable for sophisticated and prestigious entrances
- Trouble-free installation and commissioning
- Guaranteed advanced technology conforming to all relevant national and international standards

For the architect/specifier

- The sheer range of KTC system components ensures a high degree of design flexibility
- Hassle-free adaptability to individual requirements
- Visually, technically and economically convincing application

For the user

- Exceptional convenience
- Outstanding safety features
- Tailored integrated application of industrial engineering precision and assured manufacturing quality
- Optimisation of building energy balance and workplace environment

Data and features

	KTC 3	KTC 4
Internal diameter (D)	3600, 4200, 4800, 5400, 6000	3600, 4200, 4800, 5400, 6200
External diameter (B1, B2), Clear passage width (LW), Clear escape route width	(see page 6)	(see page 7)
Clear passage height (LH) *	2200 - 2500 mm (up to Ø 4800 mm) 2200 mm (from Ø 5400 mm)	
Canopy height *	420 - 700	
Total height (H) *	Clear passage height + canopy height	
Drum walls glazed	●	
Suitable for application in emergency exits and escape routes	○	
Floor ring	○	
Floor mat	○	
LED downlights	○ (6 pcs.)	○ (8 pcs.)
Additional LED Downlight	○	
Preparation for rainproof roof	○	
Type approval according to DIN 18650 and EN 16005 (certified)	○	

● standard ○ option All dimensions in mm * other sizes on request

1) The theoretical capacity value indicates how many people can pass through the revolving door in one (→) direction per hour, assuming that the traffic flow is uniform and the internal segments are fully occupied.

2) The practical capacity values indicate how many people can actually pass through the revolving door in one (→) and in both (↔) directions.

3) The maximum capacity value indicates how many people can pass through the revolving door in one direction (→) per minute when there is a constant stream of traffic, for example in the morning and evening.



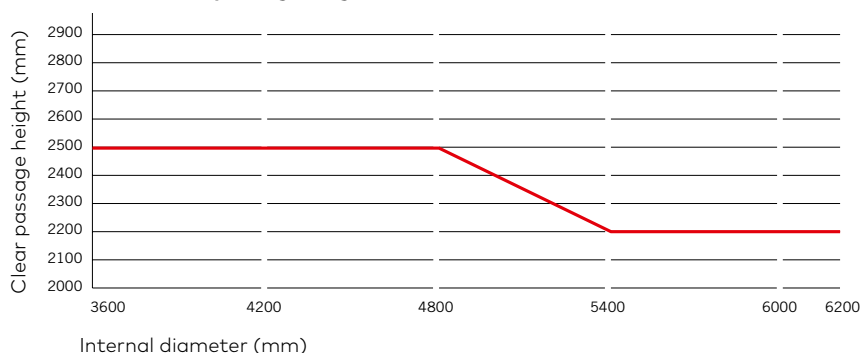

Traffic capacities

Internal diameter (D) in mm	Theoretical capacity ¹⁾ Persons/hour →	Practical capacity ²⁾ Persons/hour		Maximum capacity ²⁾ Persons/min. ↔
		→	↔	
KTC 3				
3600	2916	972	1944	48
4200	3312	1104	2208	55
4800	4320	1440	2880	72
5400	4536	1512	3024	75
6000	5184	1728	3456	86
KTC 4				
3600	2592	864	1728	43
4200	3312	1104	2208	55
4800	3840	1280	2560	64
5400	4320	1440	2880	72
6200	5208	1736	3472	86

Maximum clear passage height for KTC 3/KTC 4

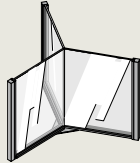
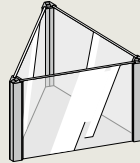
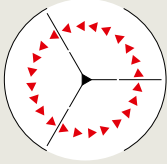
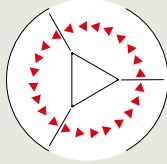
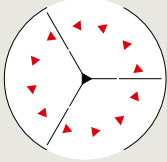
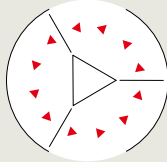
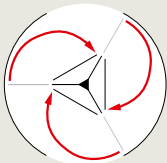
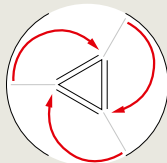
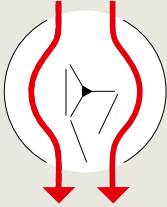
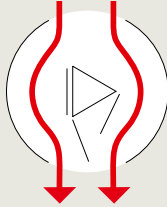
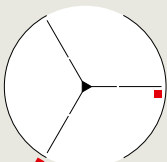
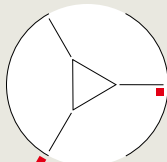
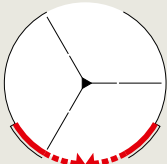

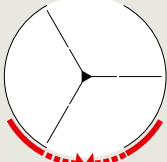
Versions, configurations

Versions	KTC 3/0 without showcase	KTC 3/2 with showcase
Central part		
Automatic I: The door starts and stops automatically II: The door rotates continuously at low speed, which is increased as soon as a user approaches the door		
Speed limiter, decreases the speed to approx. 2 rpm (see page 11), for example for senior citizens and the disabled		
Configurations		
Summer configuration, Also ideal for the passage of bulky items or luggage, and for consignment deliveries		
Emergency escape configuration		
Options		
Manually or electrically lockable wings		
Night shield, internal		
Night shield, external		

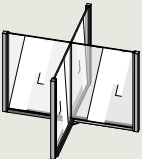
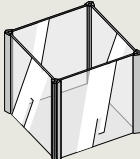
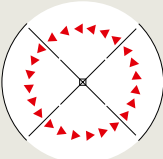
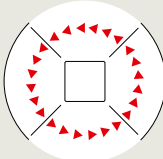
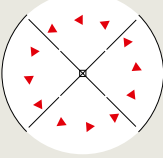
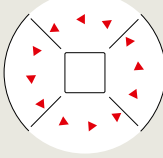
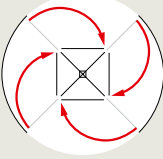
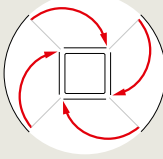
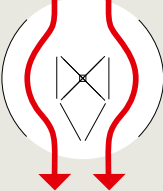
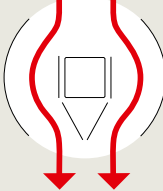
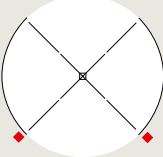
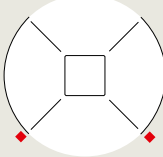
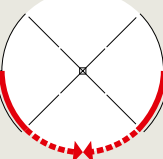
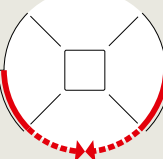
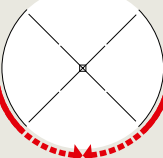
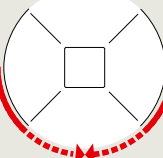
Versions	KTC 4/0 without showcase	KTC 4/2 with showcase
Central part		
Automatic I: The door starts and stops automatically II: The door rotates continuously at low speed, which is increased as soon as a user approaches the door		
Speed limiter, decreases the speed to approx. 2 rpm (see page 11), for example for senior citizens and the disabled		
Configurations		
Summer configuration, Also ideal for the passage of bulky items or luggage, and for consignment deliveries		
Emergency escape configuration		
Options		
Manually or electrically lockable wings		
Night shield, internal		
Night shield, external		

KTC 3 – Three-wing design

KTC 3 revolving doors are available in 5 standard sizes. The 3-wing revolving doors are available in different versions. The pivot-mounted wings are equipped with horsehair brushes in order to ensure the reliable exclusion of draft air in the entrance area.

Turnstile versions

- Without showcase
- With showcase

Drum wall versions

- Without night shield
- With manually operated internal or external night shield

Dimensions

Internal diameter (D)	3600	4200	4800	5400	6000
External diameter (B1)	3692	4292	4892	5492	6092
External diameter (B2)	3834	4434	5034	5634	6234
Clear passage width (LW)	1645	1945	2245	2524	2845
Escape route width	986	1186	1386	1586	1786
Clear passage height (LH)	up to 2500*			up to 2200*	
Total height (H)	up to 3200*			up to 2900*	
Canopy height (SH)					
Standard	420 to 700*				
Preparation for rainproof roof	480 to 700				
Overhead warm-air curtain	700				

All dimensions in mm * Other heights on request

Plan view

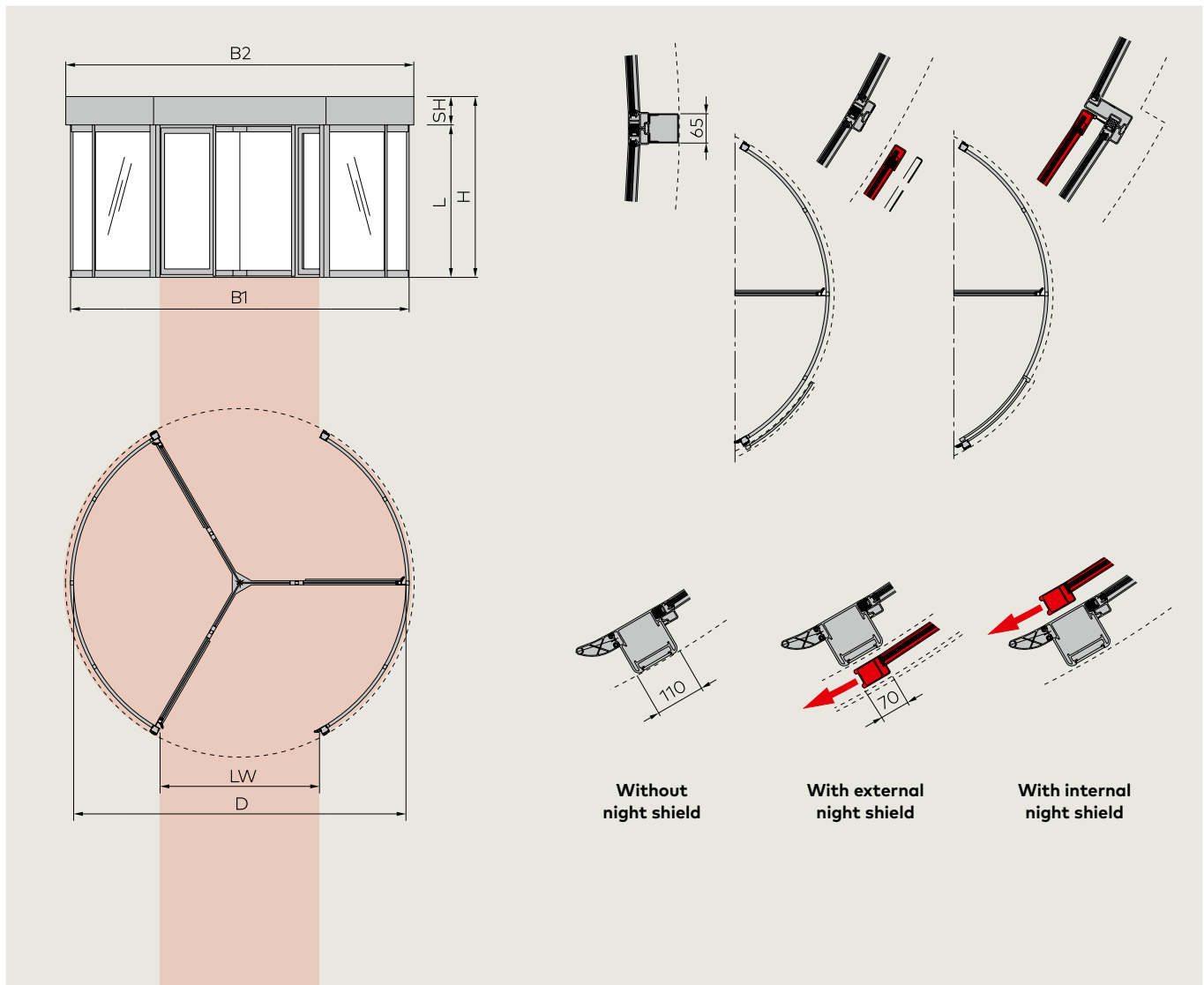

KTC 4 – Four-wing design

KTC 4 revolving doors are available in 5 standard sizes. The 4-wing revolving doors are available in different versions. The pivot-mounted wings are equipped with horsehair brushes in order to ensure the reliable exclusion of draft air in the entrance area.

Turnstile versions

- Without showcase
- With showcase

Drum wall versions

- Without night shield
- With manually operated internal or external night shield

Dimensions

Internal diameter (D)	3600	4200	4800	5400	6200
External diameter (B1)	3692	4292	4892	5492	6292
External diameter (B2)	3834	4434	5034	5634	6434
Clear passage width (LW)	2466	2891	3315	3740	4305
Escape route width	896	1066	1236	1406	1633
Clear passage height (LH)	up to 2500*			up to 2200*	
Total height (H)	up to 3200*			up to 2900*	
Canopy height (SH)					
Standard	420 to 700*				
Preparation for rainproof roof	480 to 700				
Overhead warm-air curtain	700				

All dimensions in mm * Other heights on request

Plan view

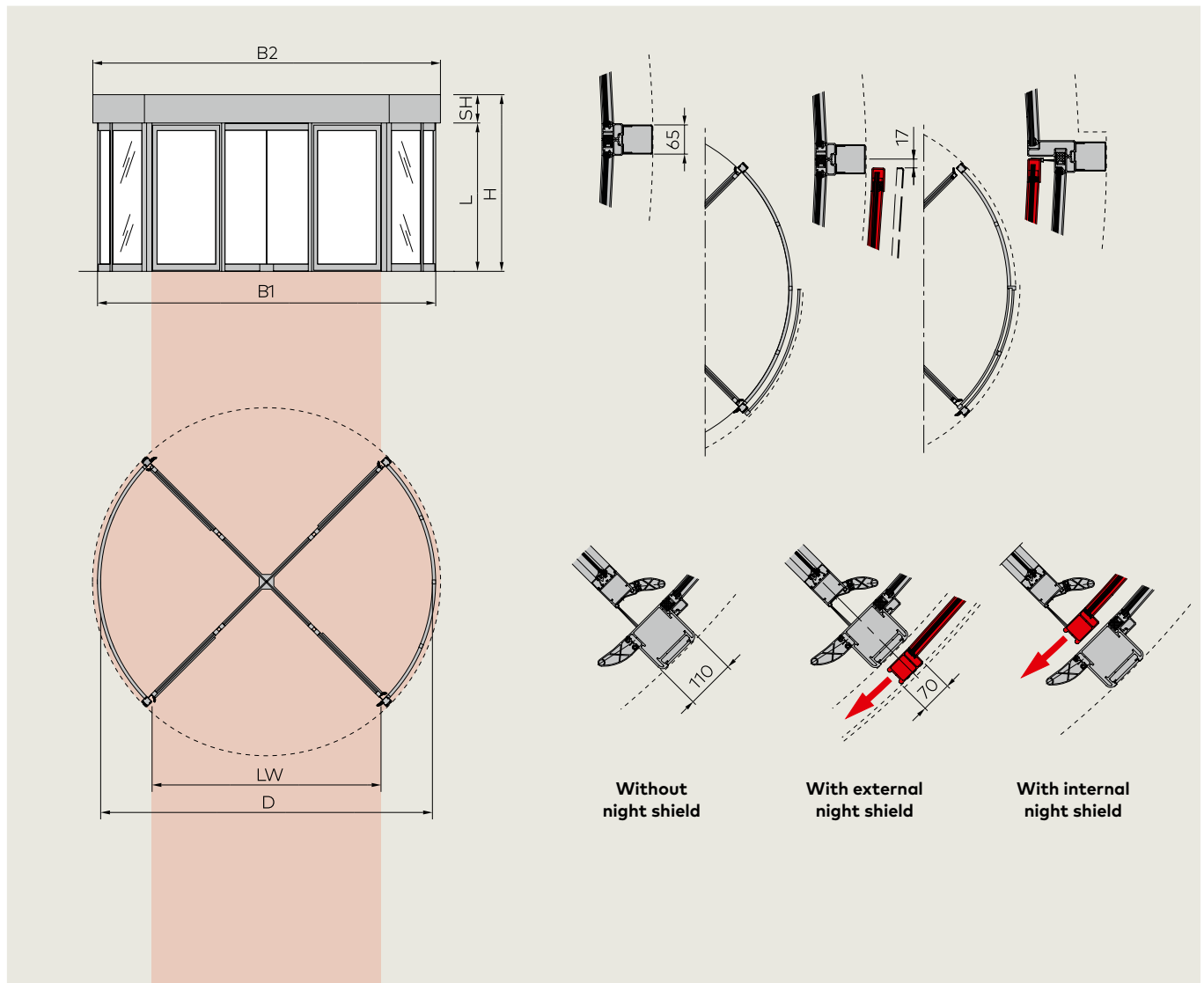

Vertical sections

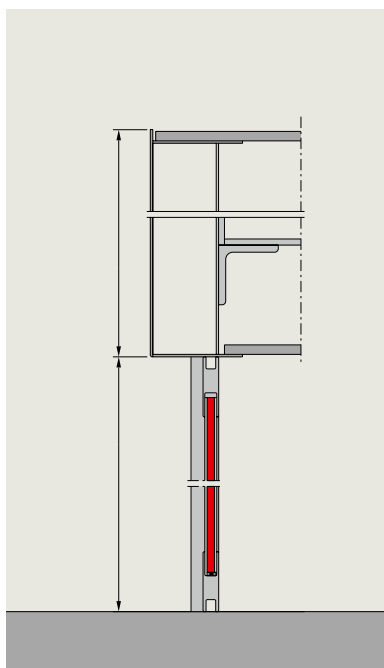
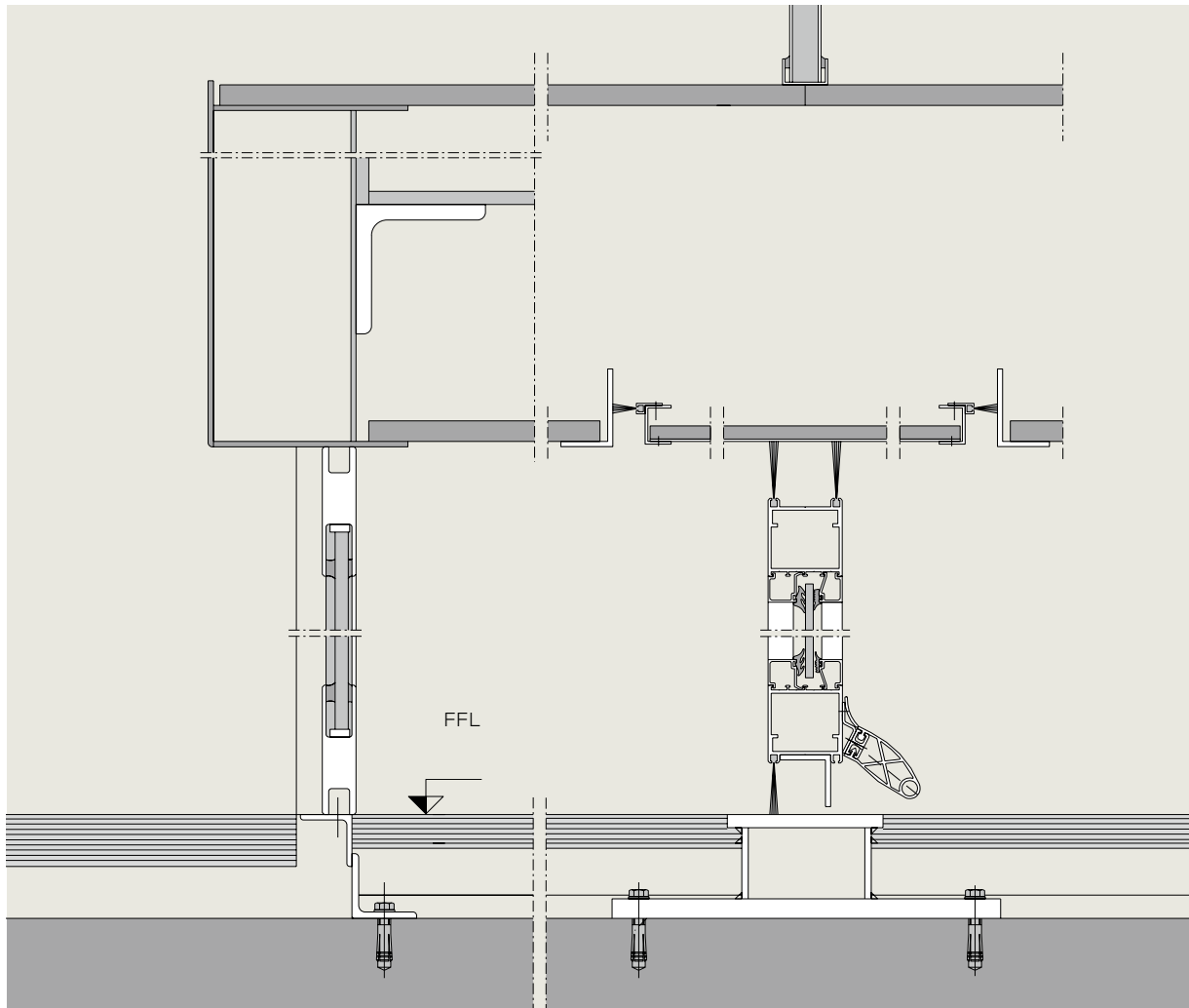

**Drum wall
with glazing**

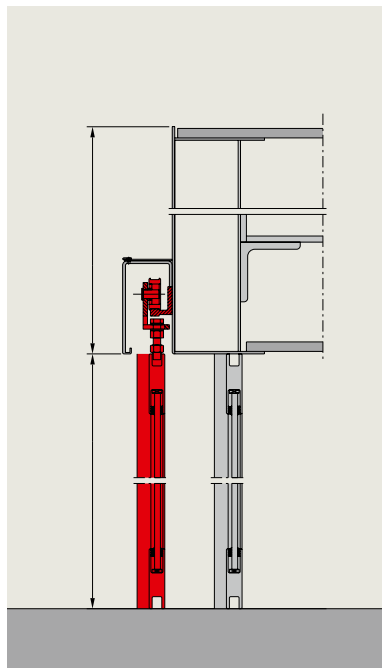

**Additional manual night shield,
external**

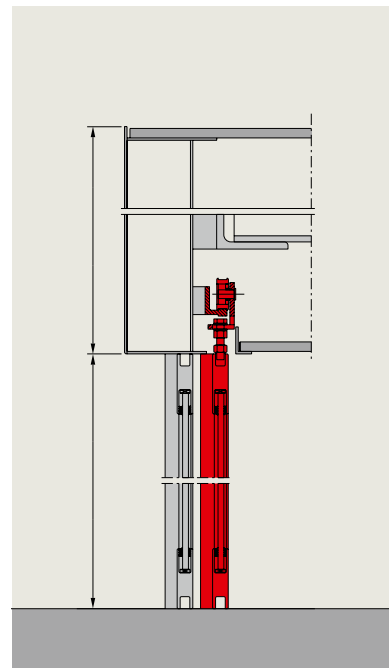

**Additional manual night shield,
internal**

Floor ring

Dimensions

Installation size, diameter	3600	4200	4800	5400	(6000 ¹⁾)	(6200 ²⁾)
Untreated floor to FFL (A)	70 – 250					
Nominal radius (R)	1800	2100	2400	2700	3000	3100
Floor mat (C)	bis 30					
All dimensions in mm ¹⁾ KTC 3 only ²⁾ KTC 4 only						

KTC 3

KTC 4

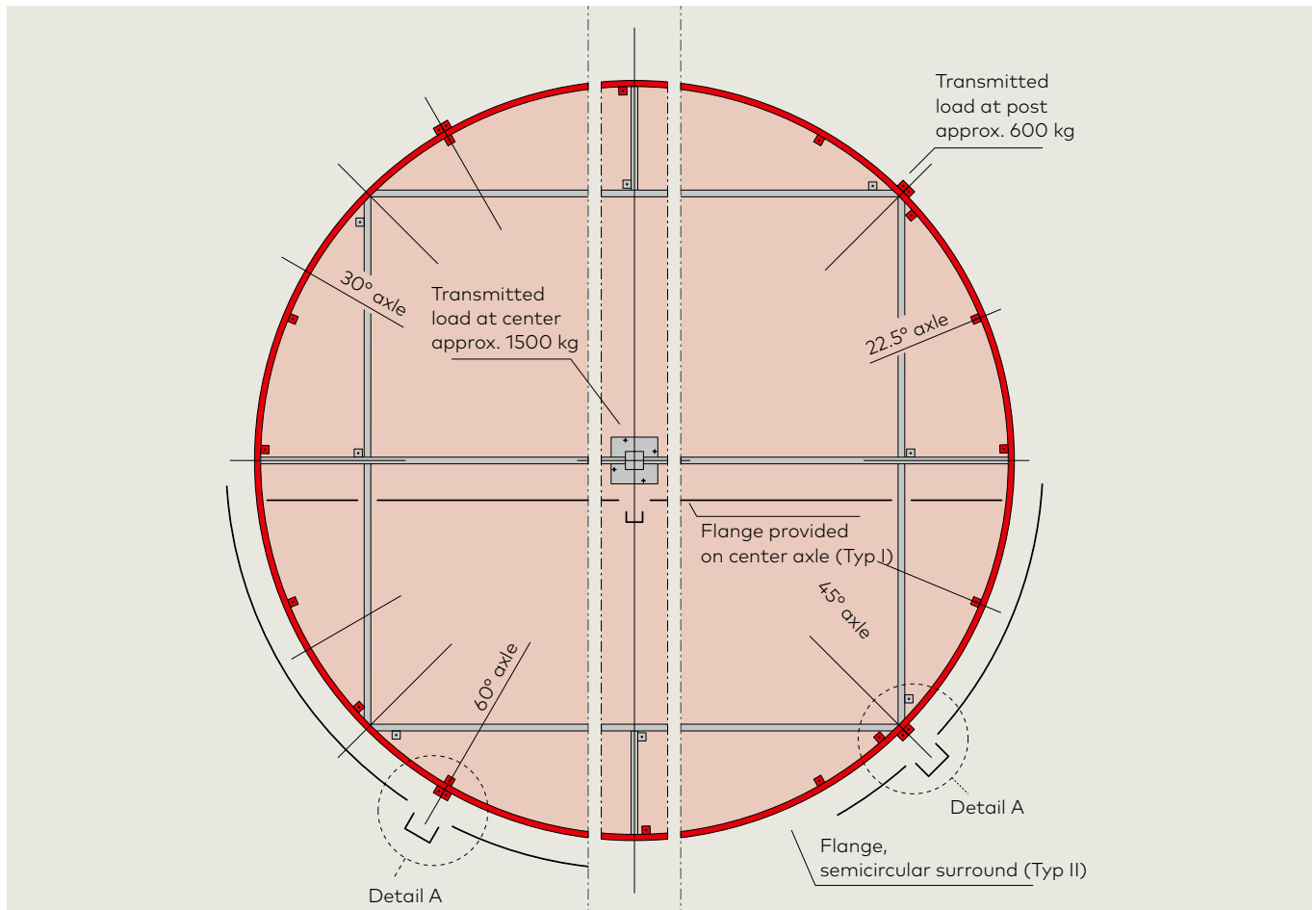

Detail A

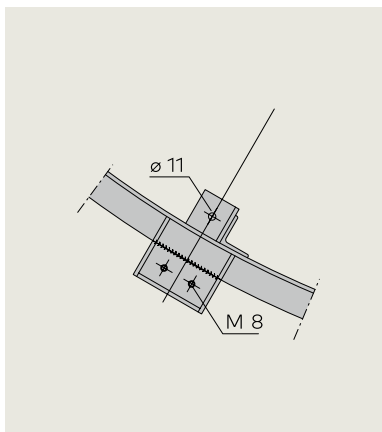

Cross section

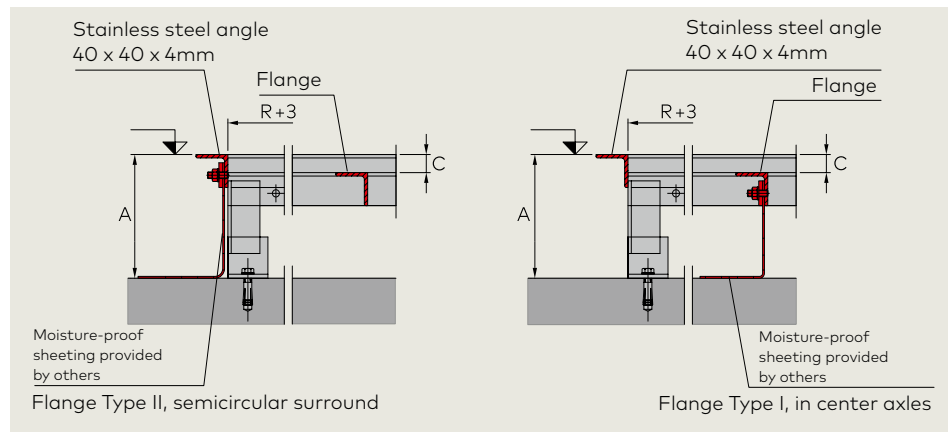

Safety equipment

KTC 3/KTC 4 revolving doors offer a comprehensive range of safety equipment to ensure optimum protection of people and objects.

The main closing edges are each equipped with two infrared safety sensors and a safety contact strip. As a wing arrives at a point 500 mm from the upright post at the end of the drum wall, the infrared safety sensors and the contact strips on the post are activated. The outer edges and the bottom edges of the wings are likewise protected by safety contact strips. In addition, the wings fold on contact. As an optional extra, sensors can be provided on the top wing profile to protect the space in front of the wing.

Automatic programs

Two different Automatic functions can be selected.

- **Automatic I:** The door is in starting position and activated as soon as a user approaches. Following an adjustable time, it stops again at its starting position.
- **Automatic II:** The door rotates continuously at approx. 1 rpm. As a user enters the detection range, the speed is increased to approx. 3 rpm. Following an adjustable period of time, the speed of the door is reduced again.

Speed limiter

The speed limiter is activated by means of a special pushbutton to reduce the speed of the door during passage to approx. 2 rpm.

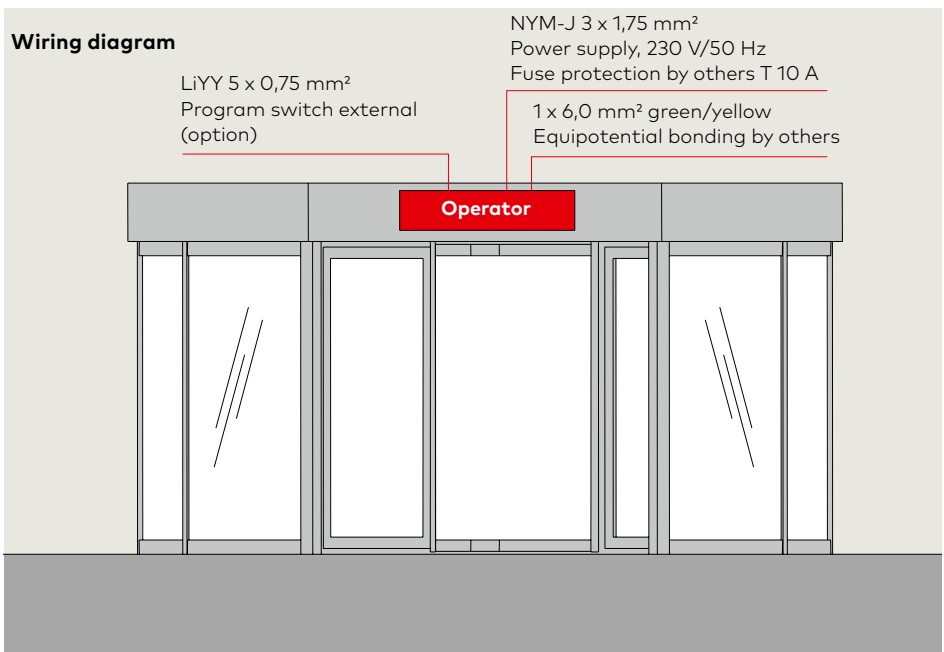

Components	Function
1 Canopy safety sensor	Slow cycle/stop
2 Safety bumper (leading mullion)	Stop
3 Active safety bumper (wing, bottom)	Stop
4 Active safety bumper (wing, side)	Stop
5.1 Emergency stop button (leading mullion, inside)	Stop
5.2 Emergency stop button (leading mullion, outside)	Stop
6 Safety switch (collapsible wing)	Stop
7 Light barrier (wing, bottom)	Stop
8.1 Top sensor (collapsible wing, top)	Slow cycle/stop
8.2 Top sensor (rigid wing, top)	Slow cycle/stop
9* Disabled access pushbutton (leading mullion)	Slow cycle

* Not standardly prescribed, however recommended as a safety aspect.

Please note

The safety equipment has to be selected according to the prevailing national requirements.

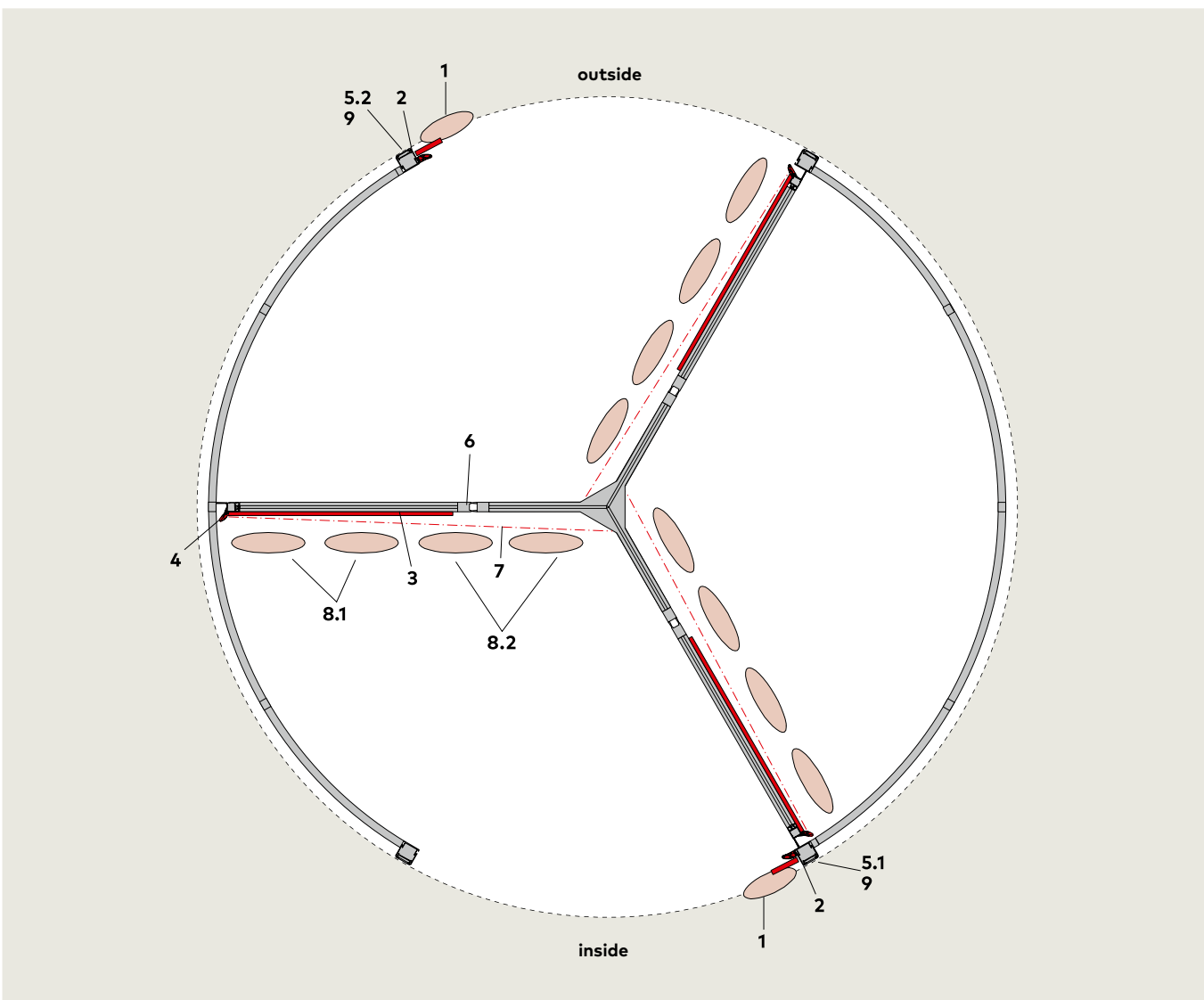
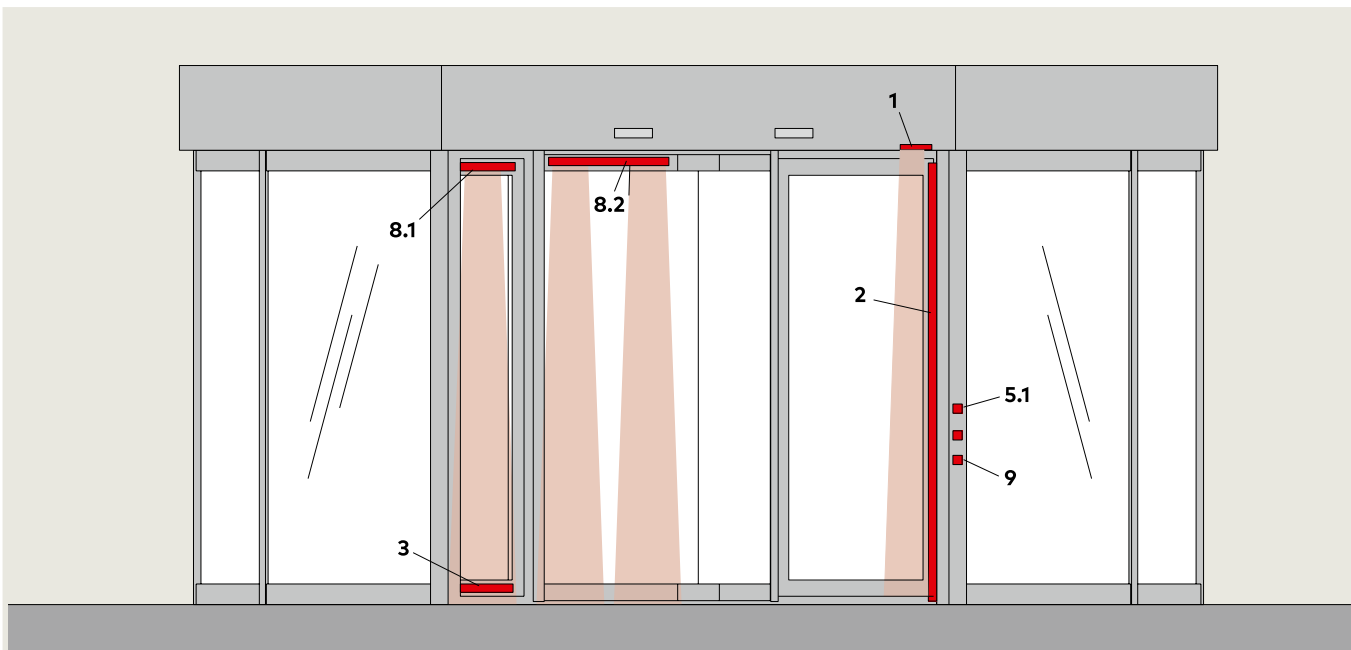



www.dormakaba.com

dormakaba Deutschland
GmbH
DORMA Platz 1
58256 Ennepetal
Germany

T: +49 2333 793-0
F: +49 2333 793-4950

WN 051761 51532, 11/17, KTC 3/KTC 4, GB,
Subject to change without notice.