

SPORTAGE

Features & Functions Guide



Delivery First
The priority that delivers more

GETTING TO KNOW YOUR **SPORTAGE**

Congratulations on Your New Kia Purchase!

Your new Kia vehicle has been designed, engineered and manufactured to provide you with years of comfortable and dependable driving. Kia is committed to quality, innovation, safety and — above all — your satisfaction.

Using This Guide

The information contained in this guide is a brief overview that will help you become familiar with the operation and features of your new Kia vehicle. The flipbook format facilitates information access, while the detailed illustrations help to ensure the instructions are easy to follow.

This **Features & Functions Guide**, and the specific operational and safety information it provides, is not a substitute for your Owner's Manual. In the interest of your safety and that of your family, and to help you avoid risks that may result in death or serious injury, Kia reminds you to carefully read your Owner's Manual in order to fully familiarize yourself with the important information it contains.

While Kia endeavors to ensure that the information contained in this guide is accurate at the time of printing, Kia may change vehicle specifications without notice in advance or after the fact, and assumes no liability in connection with such changes.

www.kia.com

Consumer - Roadside Assistance
1-800-333-4KIA (4542)

See Back Pages for Vehicle Maintenance Schedule

Always check the Owner's Manual for complete operating information and safety warnings.

ESSENTIAL FEATURES

Air Conditioning / Climate Control	25
Audio System — Standard Audio System*	20
Audio System: UVO eServices / Android Auto™/ Apple CarPlay® Setup*	22
Audio System — UVO eServices	22
Audio System — UVO eServices Premium Navigation*	23
Aux/USB/iPod® Port, Power Outlets & USB Charger	24
Bluetooth® Wireless Technology	18
Cruise Control	17
Digital Clock	24
ECO Mode (Active ECO)	08
Front Seat Headrest Adjustment	33
Passenger Airbag Off Indicator	42
Reclining/Folding Rear Seats	33
Tire Pressure Monitoring System (TPMS)	05
Windshield/Rear Wipers & Washers	16

Driving while distracted can result in a loss of vehicle control that may lead to an accident, severe personal injury and death. The driver's primary responsibility is in the safe and legal operation of a vehicle, and use of any handheld devices, other equipment or vehicle systems which take the driver's eyes, attention and focus away from the safe operation of a vehicle or that are not permissible by law should never be used during operation of the vehicle.



VIDEOS & QR CODES	02
-----------------------------	----

INSTRUMENT CLUSTER

Instrument Cluster Overview	03
Indicators & Warning Lights	04
Fuel Economy	05
Tire Pressure Monitoring System (TPMS)	05
LCD Instrument Cluster Modes	06
Trip Modes / Trip Computer	06
Instant Fuel Consumption Mode*	06
User Settings Mode	07
Service Mode	07
Drive Mode Integrated Control System	08
ECO Mode (Active ECO)	08

DRIVER'S PANEL

Blind-Spot Collision Warning (BSW)*	09
Instrument Cluster Control	10
Electronic Stability Control (ESC)	10
Lane Departure Warning (LDW)*	10
Hill-Start Assist Control (HAC)	11
Power Liftgate Release Button*	11
Forward Collision-Avoidance Assist (FCA) / Forward Collision Warning (FCW)*	11
Power Windows, Window Lock & Central Door Lock	12
Automatic Door Lock/Unlock	12
Power-Folding Outside Mirrors*	12
Heated Outside Mirrors*	12
Engine Start/Stop Button*	13

STEERING WHEEL CONTROLS

Headlights & High Beams	14
Turn Signals & Fog Lights*	15
Daytime Running Lights (DRL)*	15
Windshield Wipers & Washers	16
Rear Wiper & Washer	16
Tilt/Telescoping Steering Wheel	16
Audio Controls	17
Cruise Control	17
Bluetooth® Wireless Technology	18

AUDIO SYSTEMS

Standard Audio System*	20
UVO eServices / Android Auto™/ Apple CarPlay® Setup*	21
UVO eServices*	22
UVO eServices with Premium Navigation*	23

LEGAL DISCLAIMERS (See Back Inside Cover Page)

CENTER PANEL

Digital Clock	24
Aux/USB/iPod® Port, Power Outlets & USB Charger*	24
Automatic Climate Control*	25
Manual Climate Control*	26
Automatic Gear Shift / Sportmatic® Shifting	27
Paddle Shifters*	27
Electronic Parking Brake (EPB)*	28
Auto Hold*	28
Downhill Brake Control	29
AWD (All-Wheel Drive) Lock*	29
Heated Steering Wheel*	29
Parking Distance Warning-Forward* and Reverse	30
Seat Warmers / Ventilated Seats*	31

SEATING

Power Adjustable Driver's Seat*	32
6-Way Manual Adjustable Driver's Seat*	32
Reclining/Folding Rear Seats	33
Front Seat Headrest Adjustment	33
Unfastening Center Seat Belt	33

OTHER KEY FEATURES

Smart Key*	34
Remote Keyless Entry (Folding Key)*	35
Double-Turn Lock/Unlock All	35
Fuel Filler Lid Release	35
Fuel Cap / Malfunction Indicator	35
HomeLink® with Auto-Dimming Rearview Mirror*	36
Map/Room Lamps	37
Panoramic Sunroof Operation w/Power Sunshade	37
Power Liftgate*	38
Smart Power Liftgate*	39
Liftgate Release Button	39
Rear-Camera Display	40
Child-Protector Rear Door Lock	40
Sunvisor	40
Hood Release Lever and Latch	41
Tire Mobility Kit*	41

SAFETY FEATURES

Seat Belts	42
Seat Belt Retractor Locks	42
Occupant Detection System (ODS) / Passenger Airbag Off Indicator	42

TURBO MAINTENANCE CHART 44

NON-TURBO MAINTENANCE CHART Back Cover

Kia provides a number of video resources at your disposal to assist you with becoming familiar with the features and functions found in your Kia vehicle. You can access these resources by snapping the QR Codes with your smartphone/tablet (mobile devices) or by visiting the following website: www.youtube.com/KiaFeatureVideos. Continue reading for a more in-depth look at QR Codes and for instructions on how to use them.

What are QR Codes?

A QR Code is a square, 2-dimensional barcode that can be read by mobile devices loaded with an appropriate barcode or QR Code Reader App. The app reads the barcode image and then launches/uploads the specific information the code contains, such as URLs, text, photos, videos and so much more.

How to use QR Codes

If you have a mobile device with a QR Code Reader App, you can snap the code with your phone and you'll be provided a video with additional information pertaining to the topic. For example, in the Fuel Cap section, if you would like additional information, just snap the code with your mobile device to view the selected Kia Features & Functions Video.

How to snap a QR Code

1. With your mobile device, download a QR Code Reader App. With many devices, you can do this through an app store or marketplace
2. Open the QR Code Reader App on your mobile device
3. The app will utilize your device's camera. Center the code in the camera viewing area:
 - With some apps, as soon as the app recognizes the code, it will launch the corresponding video
 - With other apps, you will have to snap or take a picture of the code. The app will then launch the corresponding video
 - For operation specifics, refer to the instructions that come with the QR Code Reader App

QR CODE

One-Click Fuel Cap Video

To view a video on your mobile device, snap this QR Code or visit the listed website.



www.youtube.com/KiaFeatureVideos

REMINDER: When accessing videos on your mobile device, standard cellular data rates may apply.

QUICK TIPS

1. If you're having trouble scanning codes, check the following:
 - The code should be centered and focused in your mobile device's camera screen
 - Consider moving your device closer to or farther away from the code
 - The code should be well lit, without significant shadow
 - Avoid scanning from a significant angle
 - Confirm that the device's app supports 2D QR Code scanning
 - Try another QR Code Reader App; not all apps are created equal
2. After scanning, if a "connecting" message appears and then nothing happens or there's a "connection error" message, this typically indicates that your device is having trouble connecting to the Internet
3. When accessing videos on your mobile device, standard cellular data rates will apply

Instrument Cluster Overview

- A** Tachometer
- B** Turn Signal Indicators
- C** Speedometer
- D** Engine Temperature Gauge
- E** Indicator & Warning Lights
- F** Gear Shift Position Indicator
- G** Odometer
- H** Trip Modes / Trip Computer*
- I** Fuel Gauge

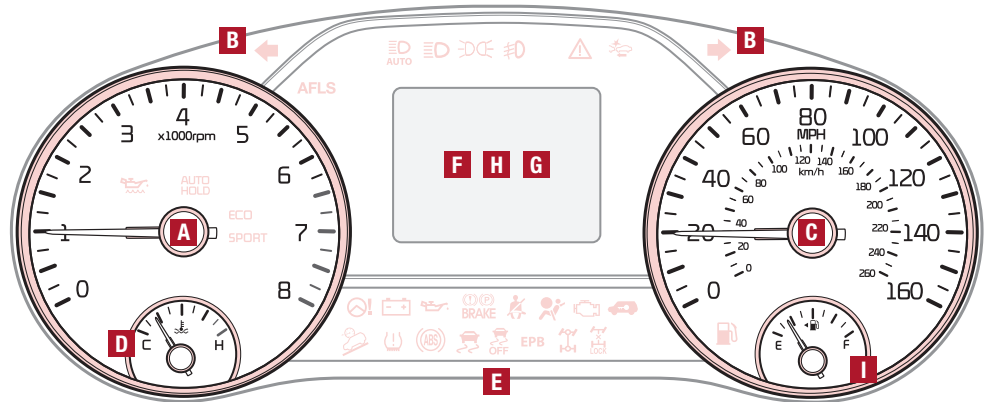

(Type A Cluster)

This illustration is for demonstration purposes only. Some indicators and warning lights may not appear in illustration. On the vehicle, they may appear in the LCD.

Your vehicle's instrument cluster & indicator light locations may differ from those in the illustrations.

For more information on the instrument cluster and the function of all indicator and warning lights, please refer to the Owner's Manual.

Indicators & Warning Lights

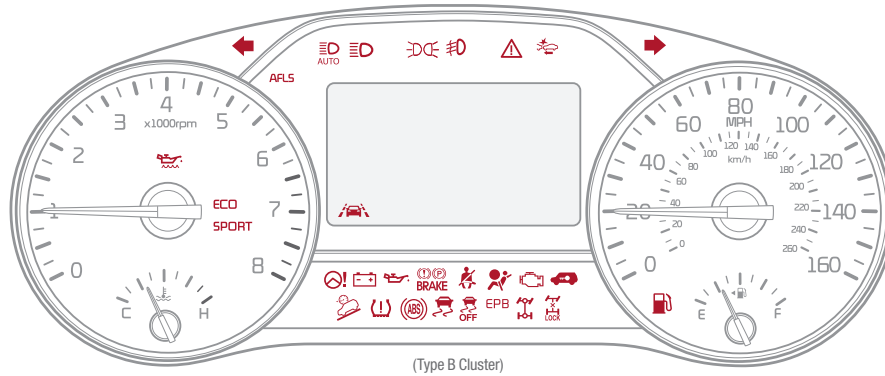

This illustration is for demonstration purposes only. Some indicators and warning lights may not appear in illustration. On the vehicle, they may appear in the LCD.

Your vehicle's instrument cluster & indicator light locations may differ from those in the illustrations.

For more information on the instrument cluster and the function of all indicator and warning lights, please refer to the Owner's Manual.

- | | | | | | |
|--|--|--|--|--|--|
| | Turn Signal Indicator Lights | | Forward Collision-Avoidance Assist (FCA) | | Parking Brake & Brake Fluid Warning Light |
| | Low Engine Oil Level Warning Light | | Lane Departure Warning (LDW) Indicator Light* | | Low Tire Pressure Light / Tire Pressure Monitoring System (TPMS) Malfunction Indicator |
| | Active ECO ON/OFF Indicator | | Electric Power Steering (EPS) Warning Indicator | | Anti-lock Braking System (ABS) Warning Light |
| | Sport Mode Indicator Light | | Charging System Warning Light | | Electronic Stability Control (ESC) Indicator Light |
| | Adaptive Front Lighting System (AFLS) Warning Light* | | Engine Oil Pressure Warning Light | | Electronic Stability Control (ESC) OFF Indicator Light |
| | High Beam Assist Indicator Light* | | Parking Brake & Brake Fluid Warning Light | | All Wheel Drive (AWD) System Warning Light |
| | High Beam Indicator Light | | Seat Belt Warning Light | | AWD LOCK Indicator Light* |
| | Light ON Indicator Light | | Airbag Warning Light | | Low Fuel Level Warning Light |
| | Front Fog Light Indicator | | Malfunction Indicator Light | | Auto Hold Indicator Light* |
| | Master Warning Light* | | Cruise Indicator Light* | | Icy Road Warning Indicator Light* |
| | Electric Parking Brake (EPB) Warning Light* | | Electronic Brakeforce Distribution (EBD) System Warning Light (Two separate indicators on Instrument Cluster lit at same time) | | Immobilizer Indicator Light |
| | Cruise Control SET Indicator* | | | | |

Tire Pressure Monitoring System (TPMS)^{†24}

 The TPMS indicator  functions as both Low Tire Pressure Light and TPMS Malfunction Indicator.

The indicator  will illuminate if one or more tires is significantly underinflated, the vehicle has a spare tire installed without TPMS or the outside temperature becomes significantly lower.

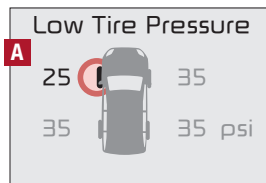

Inflate tire(s) to specifications using an accurate digital tire pressure gauge to turn off Low Tire Pressure Indicator . See front driver's door jamb for PSI specification. The Low Tire Pressure Position Indicator **A** is displayed on the LCD screen in the Instrument Cluster when the tire(s) are underinflated.

When there is a problem with the TPMS, the TPMS Malfunction Indicator  will blink for approximately one minute and then illuminate. See dealer for service.

Fuel Economy

There are several factors that contribute to your vehicle's fuel economy, including maintenance of your vehicle, driving style, environmental conditions, vehicle weight and vehicle aerodynamics. Below are tips on how to help improve fuel economy:

- Keep your vehicle in good condition with regular maintenance
- Don't let the engine idle longer than necessary
- Drive at a moderate speed, accelerating smoothly and at a moderate rate
- Keep tires inflated to the recommended pressure
- Travel lightly, without carrying unnecessary weight in your vehicles
- Avoid placing large or heavy items on roof racks
- Avoid hilly, winding or poorly maintained roads

REMINDER: Driving range varies depending on a vehicle's fuel tank size, (e.g., 12-gal. vs. 24-gal). Even though the two vehicles MPG may be the same, the vehicle with the larger tank will have the greater range.

For more information on Fuel Economy, you can snap the QR Code above to view a video or refer to the Owner's Manual.

QUICK TIPS

- Even with TPMS, tire pressure should be checked manually at least once a month. Only adjust tire pressure on "cold tires"
- For proper maintenance and optimal fuel economy, maintain recommended tire inflation pressures and stay within the load limits and weight distribution recommended for your vehicle
- In winter or cold weather, the TPMS light may illuminate if the tire pressure was adjusted to the recommended tire inflation pressure during warm weather

REMINDERS:

- Check the recommended tire pressure label located on the left side of driver's door jam, visible when the door is opened.
- Consult your dealer for service if Low Tire Pressure Light remains illuminated after inflating your tire(s).
- Personal electronic devices (such as laptops, wireless chargers, remote start systems, etc.) which has electronic noise may interfere with TPMS system, which may cause the Malfunction Warning Indicator (Check Engine Light) to illuminate.

QR CODES

To view these videos on your mobile device, snap these QR codes or visit the listed website.

Refer to page 2 for more information.

Tire Pressure Monitoring System Video



www.youtube.com/KiaFeatureVideos

Fuel Economy Video



www.youtube.com/KiaFeatureVideos

LCD Instrument Cluster Modes

Press the Mode button **A** to cycle through different LCD Instrument Cluster Modes:



Trip Computer Mode: Displays driving information for tripmeter, fuel economy, etc.



Turn-by-Turn Mode*: Displays the state of the navigation system



Lane Departure Warning (LDW)*†: Displays the state of the LDW system



A/V Mode: Displays the state of the A/V System



Service Modes / Master Warning: Informs on upcoming service intervals and warning messages related to TPMS[†], BCW[†] and others



User Settings Mode: Change the settings of the doors, lamps and other features

Instant Fuel Consumption Mode*

Press the Mode button **A** and cycle to the Fuel Economy screen in the Trip Computer to display Instant Fuel Consumption, which calculates fuel consumption during the past few seconds.

1. Keep your vehicle in good condition with regular maintenance
2. Travel lightly, without carrying unnecessary weight in your vehicles
3. Don't let the engine idle longer than necessary

Trip Modes / Trip Computer

The Trip Computer is a driver information system that displays information related to driving. It appears on the display when the ignition switch or the Engine Start/Stop button* is in the ON position.

To cycle through the different LCD Instrument Cluster modes, press the Mode button **A**.

When in Trip Computer mode , press the Move button **B** to cycle through the screens. When displaying TRIP A or TRIP B screens, press and hold the Set/Reset (OK) button **C** to reset the Tripmeter to zero.

REMINDERS:

- Appearance of Tripmeter display may differ, as equipped
- All stored driving information (except Odometer and Range) is reset if the battery is disconnected

Your vehicle's steering wheel buttons may differ from those in the illustrations.

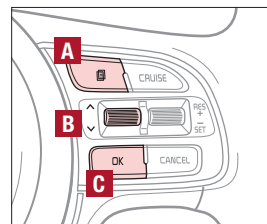

(Type A; Controls located on Steering Wheel)

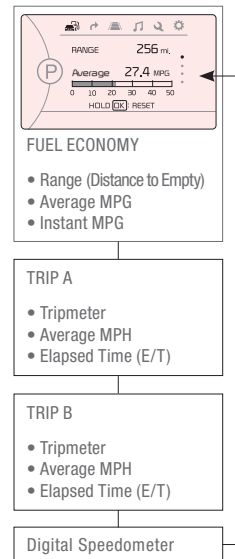

(Type B cluster)

REMINDERS:

- Instant Fuel Consumption Mode is not to be used in calculation or as a reference for AVERAGE fuel economy
- If the vehicle speed exceeds 1 MPH (1.6 km/h) after being refueled with more than 1.6 gallons (6 liters), the average fuel economy will be cleared to zero (---)

User Settings Mode

To enter the User Settings mode in the LCD Instrument Cluster Modes, press the Mode button **A** when the vehicle is at a standstill and with the Engine Start/Stop button in the ON position and select User Settings  by pressing the Move button **B** up/down.

You can navigate the selections on the display by pressing the Move button **B**. Select the item by pressing the SET/RESET (OK) button **C**.

User Settings Modes:

Driving Assist*

- Rear Cross-Traffic Collision Warning
- Forward Collision-Avoidance Assist (FCA)*
- Forward Collision Warning (FCW)*

Door/Liftgate

- Automatic Lock
- Automatic Unlock
- Two Press Unlock*
- Power Liftgate*
- Smart Liftgate*

Lights

- One-Touch Turn Signal
- Head Lamp Delay
- Welcome Light*

Sound

- Parking Distance Warning-Forward* and Reverse Volume*
- Blind-Spot Collision Warning Sound*
- Welcome Sound*

Service Interval

- ON/OFF
- Set mileage/months

Convenience

- Steering Position
- Wiper/Light Display*

Other Features

- Fuel Economy Auto Reset
- Fuel Economy Unit
- Temperature Unit
- Tire Pressure Unit*

Service Mode

To enter Service Mode, press the Mode button **A** and cycle to Service Mode . Then press the OK button **C** to enter. System will display tire pressure status, number of miles remaining until next service is due, as well as the type of service due.

When service is required, the following will be displayed:
Service Required.

To reset the Service Mode system, press and hold the OK button **C** for more than 1 second.

To turn **Service In** OFF, go to User Settings.

Service Interval Setting

To set the service interval in User Settings mode:

- Press the Mode button **A** to cycle to User Settings
- If Service Interval is OFF, press the OK button **C** to turn ON
- Use the Move switch **B** to select/change the interval setting
- Press the OK button **C** to select the interval

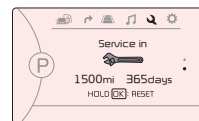
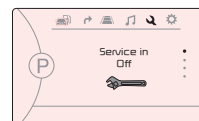

(Images are for illustration purposes only and may vary)

QR CODES

To view these videos on your mobile device, snap these QR codes or visit the listed website.

Refer to page 2 for more information.

LCD Display Video



www.youtube.com/KiaFeatureVideos

LCD Display: Maintenance Video



www.youtube.com/KiaFeatureVideos

Drive Mode Integrated Control System

The Drive Mode may be selected based on the driver's preferences and road conditions.

To cycle through the different Drive Modes **A**, press the DRIVE MODE button **B**. The instrument cluster will display SPORT or ECO when selected. When in NORMAL mode, it will not display in the instrument cluster.

REMINDERS:

- The system is turned ON and in NORMAL mode when ignition is in the ON position
- When ECO mode is selected, the indicator will display and system remains on, even when ignition is cycled. Otherwise the system will default to NORMAL.
- Steering effort may be slightly increased in Sport mode
- When ECO mode is selected, the following may occur to improve fuel economy:
 - Acceleration may be slightly reduced even when the accelerator is fully depressed
 - Air conditioner performance may be limited
 - Shift pattern of the automatic transmission may change
 - Engine noise may increase
 - System's power will be limited when driving uphill
- When SPORT mode is selected, fuel economy may decrease

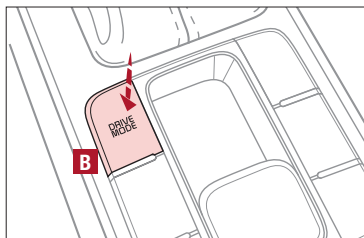
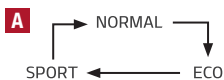

(Type A shown. Located below gear shift)

ECO Mode (Active ECO)

Active ECO is designed to help improve fuel economy by controlling several vehicle components. When activated, it optimizes drivetrain operations such as engine power and transmission to help improve fuel economy.

To turn ON, press the DRIVE MODE button **B** and scroll through options until in the ECO mode. The green ECO indicator light **C** in the instrument cluster will illuminate, indicating that Active ECO is operating. Active ECO will remain on even when the ignition is cycled.

To turn Active ECO OFF, press the DRIVE MODE button **B** again and change to another mode.

REMINDER: When the Engine Start/Stop button is turned off, the system will default to NORMAL mode and each mode will need to be selected again when the vehicle restarts.



(Located in instrument cluster)

QUICK TIPS

To help improve your fuel economy:

- Drive at a moderate speed, accelerating smoothly and at a moderate rate
- Keep tires inflated to the recommended pressure
- Be sure the wheels are properly aligned

QR CODE

Drive Mode Integrated Control Video

To view a video on your mobile device, snap this QR Code or visit the listed website.

Refer to page 2 for more information.



www.youtube.com/KiaFeatureVideos

For more information on the Active ECO indicator, refer to your Owner's Manual or contact your local dealership.

Blind-Spot Collision Warning (BSW)^{†5}

The BSW system uses radar sensors to help alert the driver before changing lanes. The light on the BSW button **A** will illuminate when turned ON. The outside rearview mirror warning lights will also illuminate for 3 seconds.

The system will become active when the vehicle is traveling more than 20 mph and will alert the driver if another vehicle is detected by the radar sensor.

Blind-Spot Collision Warning* / Lane Change Assist (LCA)*

1st-stage alert: When another vehicle is detected within the BSW System boundary **B**, or when a vehicle detected with the LCA boundary, a yellow indicator will illuminate on the outside rearview mirrors.

2nd-stage alert: When 1st-stage alert is on and the driver activates a turn signal, a flashing yellow indicator will illuminate on the outside rearview mirrors and the system will sound an alert.

Rear Cross-Traffic Collision Warning (RCCW)*

If the RCCW system sensors detect approaching vehicles from the left or right side **C**, the system will sound an audible alert, the warning indicators on the outside rearview mirror will illuminate and a message will appear on the LCD screen. RCCW is designed to operate under these following conditions:

- When the gear shift is in Reverse
- When the vehicle moves in reverse from a parked position
- When the vehicle is moving less than 6 mph

REMINDERS:

- When the BSW is ON and the vehicle power is cycled to OFF then ON again, the BSW system returns to ON
- The RCCW feature can be turned OFF/ON in User Settings from the LCD Instrument Cluster modes
- When vehicle power is cycled, the RCCW will remain in the previous state

For more information on the BSW / RCCW, refer to your Owner's Manual.

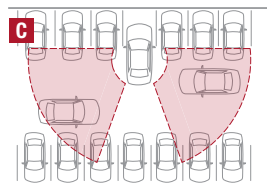
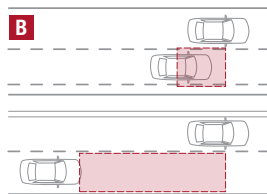
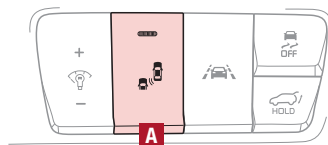

QR CODE

Blind-Spot Collision Warning w/ RCCW Video

To view a video on your mobile device, snap this QR Code or visit the listed website.

Refer to page 2 for more information.



www.youtube.com/KiaFeatureVideos

Instrument Cluster Control

With parking lights/headlights ON, toggle switch **A** up (+) or down (-) to adjust the brightness of the instrument panel illumination.

REMINDER: The Instrument Cluster Control does not adjust brightness on the audio/navigation system* screens; see the display settings in the Setup menu to adjust the brightness on the screen.

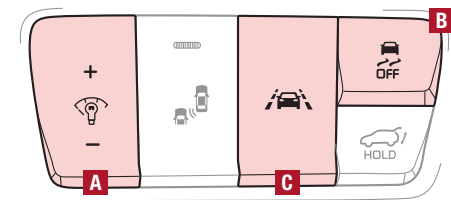

(Buttons located on left of Steering Wheel)

Electronic Stability Control (ESC)^{†6}

The ESC system is designed to help stabilize the vehicle during cornering maneuvers. It is a good idea to keep the ESC turned ON for daily driving whenever possible.

Press ESC button **B** to turn ESC OFF/ON.

REMINDEES:

- ESC is turned ON by default at vehicle start-up. When ignition is cycled, ESC will turn ON again
- The ESC Indicator Light in the instrument cluster will illuminate whenever the ESC is in operation

For more information on Electronic Stability Control (ESC) and its specific features and operations, please refer to your Owner's Manual.

Lane Departure Warning (LDW)^{*+5}

With the Engine Start/Stop button in the ON position, press the LDW button **C** to turn system ON. The instrument cluster indicator  will illuminate white. It will remain white when vehicle is traveling less than 40 mph and the system does not detect the lane markers. When system detects the lane markers, the LDW icon will illuminate green.

If the LDW detects that you are moving outside of your lane, the system may issue a warning on the LCD screen and an alert may sound, under these conditions:

- The vehicle exceeds approximately 40 mph
- The LDW system recognizes the lane the vehicle is traveling in and the vehicle is not between the lane markers

If the LDW button is ON and ignition is cycled, the system will turn ON again. If the LDW button is OFF, the system remains OFF.

REMINDER: LDW will not issue a warning if the turn signal or hazard lights are activated.

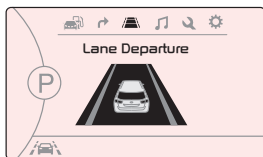

When the LDW sensor does not detect the the indicator will not illuminate

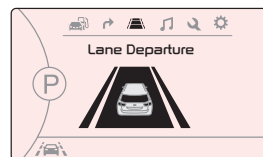

When the LDW sensor detects the lane traveling in, both indicators are illuminated

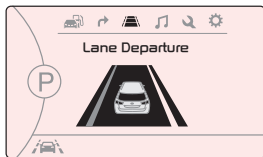

When the LDW sensor detects the vehicle moving outside of the lane the vehicle's traveling in, a yellow indicator will illuminate either on the left or right lane (shown in both images above)

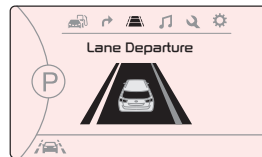

The Lane Departure Warning (LDW) is not a substitute for safe and proper driving. Always drive safely and use caution. LDW may not always alert the driver if the vehicle is driven outside of its lane.

QR CODE

Lane Departure Warning Video

To view a video on your mobile device, snap this QR Code or visit the listed website.

Refer to page 2 for more information.



www.youtube.com/KiaFeatureVideos

Hill-Start Assist Control (HAC)^{†6}

HAC helps prevent the vehicle from rolling backward when accelerating from a stop while on a steep incline.

The HAC automatically activates whether the ESC is OFF or ON but does NOT activate when the ESC has malfunctioned.

REMINDER: The HAC does not operate when the gear shift is in the P (Park) or the N (Neutral) position.

QUICK TIPS

- When HAC is active (e.g., during initial acceleration from a stop on an incline), you may notice that the brakes will momentarily remain engaged after you depress the accelerator – this is normal operation.
- HAC provides a 2-second delay before the vehicle may start rolling backward

Power Liftgate Release Button*

Press the **A** button for approximately one second to open the liftgate.

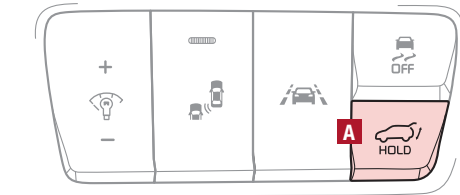

(Buttons located on left of Steering Wheel)

Forward Collision-Avoidance Assist (FCA)^{*†5} / Forward Collision Warning (FCW)^{*†5}

The FCA is designed to alert the driver if it detects the vehicle approaching another vehicle in front that is slowing down, braking or stopped. A warning message will appear on the LCD screen and a chime will sound. The FCA/FCW will become active when the vehicle is traveling more than 5 mph.

Select alert settings (Early, Normal, Late) in the User Settings in the instrument cluster LCD display. To turn the FCW/FCA off, go to User Settings in the LCD Instrument Cluster modes.



REMINDEES:

- The FCW/FCA will be activated by default when vehicle power is cycled on, even when previous setting is off
- The FCW will not operate when the vehicle is traveling more than approximately 50 mph
- If the FCA is operating and the ESC (Electronic Stability Control) is turned off, the FCA system is automatically turned off.
- When FCA system is off, the FCA warning indicator is on in the Instrument Cluster.

The Forward Collision-Avoidance Assist (FCA) / Forward Collision Warning (FCW)* are not substitutes for safe and proper driving.*

Always drive safely and use caution. FCA may not always alert the driver when the vehicle is approaching another vehicle.

QR CODE

Forward Collision-Avoidance Assist Video

To view a video on your mobile device, snap this QR Code or visit the listed website.

Refer to page 2 for more information.



www.youtube.com/KiaFeatureVideos

Power Windows, Window Lock & Central Door Lock

A Pull/Press to operate Driver's Window Auto Up/Down*

QUICK TIP

Press button again to stop Auto Up/Down function

B Press to Lock/Unlock All Doors (also unlocks Fuel Door)

C Press to disable Rear Passenger Windows

REMINDER: When pressed **C**, the rear passengers cannot operate the window controls.

Button configuration may vary depending on vehicle model.

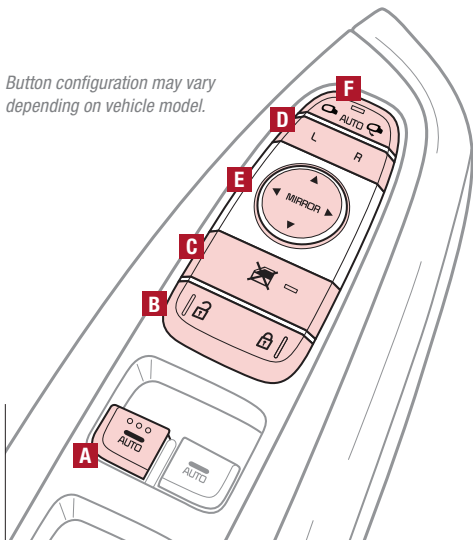

Automatic Door Lock/Unlock

Auto Door Lock/Unlock will engage when the gear shift is moved in to or out of the P (Park) position. Refer to the User Settings in the LCD Instrument Cluster modes on how to turn Auto Door Lock/Unlock ON/OFF.

Power Folding Outside Mirrors*

D Press the L or R buttons to select the mirror to adjust

E Press button arrows left/right or up/down to adjust mirror position

F Toggle button left/right to unfold/fold the outside rearview mirrors

Toggle button to center to automatically fold/unfold mirrors when:

- Smart Key* lock/unlock buttons are pressed
- Outside door handle button is pressed
- Driver approaches the vehicle with the Smart Key*

REMINDERS:

- When mirror button **F** is in the center, press the Lock button on the Smart Key to automatically fold the mirrors
- To lock position of mirrors, toggle switch to the neutral (center) position

Heated Outside Mirrors*

Use mirrors heaters to defrost / defog mirrors. Mirror heaters are activated when Rear Defroster is turned on.

Engine Start/Stop Button*†7

To start the engine:

1. Depress the brake pedal
2. Press the Engine Start/Stop button while in P (Park) or N (Neutral)

To turn the engine OFF, press the Engine Start/Stop button.

To use the Engine Start/Stop button, you must have the Smart Key fob on your person or inside the vehicle.

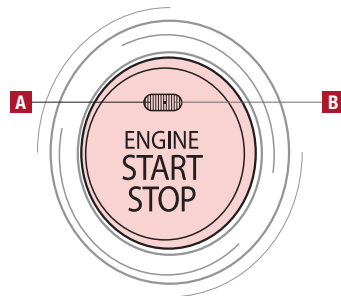

QUICK TIPS

To use electrical accessories:

ACC position

- When in the OFF position and without depressing the brake pedal, press the Engine Start/Stop button once (amber light **A**)

On position

- When already in the ACC position (amber light **A**) and without depressing the brake pedal, press the Engine Start/Stop button again (red light **B**)
- When in the OFF position and without depressing the brake pedal, press the Engine Start/Stop button twice (amber illuminated **B**)

Keeping the vehicle in ACC or the ON position for extended periods of time without turning engine on may discharge the vehicle's battery

REMINDERS:

- In an emergency situation while the vehicle is in motion, you are able to turn the engine off and to the ACC position by pressing the Engine Start/Stop button for more than 2 seconds or 3 times successively within 3 seconds
- If Smart Key fob battery is dead, with the lock button facing the Engine Start/Stop button, hold the fob up against the Engine Start/Stop button and press

QR CODES

To view these videos on your mobile device, snap these QR codes or visit the listed website.

Refer to page 2 for more information.

Engine Start/Stop Button and Smart Key Video



Key Fob Video



www.youtube.com/KiaFeatureVideos

Headlights & High Beams

To operate:

- Rotate lever to change the Headlight function
- Push lever to turn High Beams ON
- Pull lever to flash Headlights / High Beams

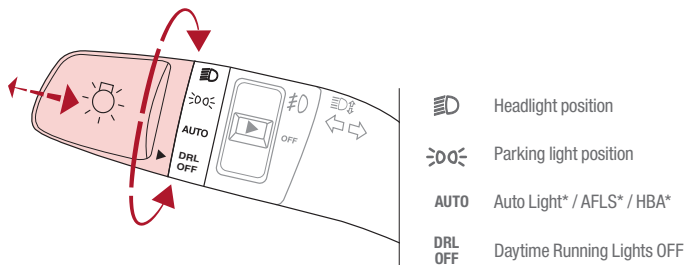

AUTO Light* — When the light switch is in the AUTO Light position, the tail lights and headlights will turn ON/OFF automatically, depending on the amount of light outside the vehicle.

Low Beam Assist (LBA) (Dynamic Bending Light)*

The LBA is designed to help improve visibility during nighttime driving by aiming the low beam headlights in the direction the vehicle is moving. LBA controls the aiming direction based on steering angle and speed.

When the light switch is in the AUTO Light position, the LBA will activate.

REMANDER: When the LBA indicator illuminates on the instrument cluster, the LBA is not working properly. See an authorized Kia dealer for service.

High Beam Assist (HBA)*

High Beam Assist automatically adjusts the headlight range by switching between high and low beams based on light detected from other vehicles and road conditions.

To enable HBA, toggle the light switch to the AUTO Light position and turn on the high beams by pushing the lever away from you. The High Beam Assist indicator  will illuminate.

REMANDERS:

- HBA will operate when vehicle speed exceeds 25 mph
- If the lever is pushed away from you while HBA is operational, HBA will turn off and the high beams will be on continuously. If the lever is pulled toward you while HBA is operational, HBA will turn off
- If the light switch is switched to the headlight position, HBA will turn off and the low beams will be on continuously
- When the LBA indicator illuminates on the instrument cluster, the LBA is not working properly. See an authorized Kia dealer for service.

QR CODE

Low Beam Assist Video

To view a video on your mobile device, snap this QR Code or visit the listed website.

Refer to page 2 for more information.



www.youtube.com/KiaFeatureVideos

Turn Signals & Fog Lights*

To operate:

- Turn Signals - Move lever Up/Down for Right/Left Turn Signal
- Fog Lights - Press switch **A** up/down to turn Fog Lights ON/OFF

REMINDER: Headlights must be ON for fog light operation.

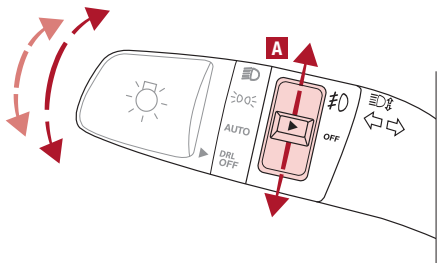

One-Touch Lane Change Signal is activated by moving the Turn Signal Lever up/down slightly for less than 1 second and then releasing. The lane change signal will blink 3 times.

To change how many times (3/5/7) the Lane Change Signal blinks, go to User Settings Mode in the LCD Instrument Cluster modes.

For more information on the User Settings Mode, please refer to your Owner's Manual.

Daytime Running Lights (DRL)*

DRL may help others to see the front of your vehicle during the day. The lights will be on automatically when the ignition or Engine Start/Stop button is ON and the headlight switch is in the AUTO position, unless one of the following occurs:

- Headlights are on
- Parking brake is applied
- Fog lights are on
- Engine is turned off
- Switch is in the OFF position

REMINDER: DRL only operates during the daytime.

QR CODE

Sportage Daytime Running Lights Video

To view a video on your mobile device, snap this QR Code or visit the listed website.

Refer to page 2 for more information.



www.youtube.com/KiaFeatureVideos

Windshield Wipers & Washers

Front Wiper & Washer

To operate front wipers and washers:

- Move lever Up/Down to change Wiper modes
- Press INT switch **A** up/down to adjust Intermittent Wipe Speed
- Pull lever to spray and wipe

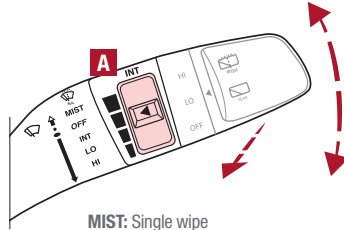

MIST: Single wipe
OFF: Wiper off
INT: Intermittent Wipe
LO: Slow wipe
HI: Fast wipe

QUICK TIPS

- Moving switch **A** up increases intermittent wipe frequency and wipe speed. Moving switch **A** down decreases frequency of wipes
- Set the wiper to OFF position when the wiper is not in use

Rear Wiper & Washer*

To operate rear wipers and washers:

- Rotate Rear Wiper switch to change Wiper modes
- Push lever to spray and wipe

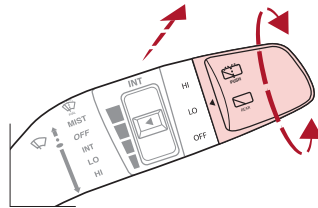

HI: Fast wipe
LO: Slow wipe
OFF: Wiper off

QUICK TIP

LO and HI sets wiper speed. No intermittent wipe function is available on rear wipers.

Tilt/Telescoping Steering Wheel†23

To adjust the Steering Wheel, press the lock-release lever **B** down and adjust to the desired angle **C** and then the distance **D**.

When finished, pull the lock-release lever **B** up to lock Steering Wheel in place.

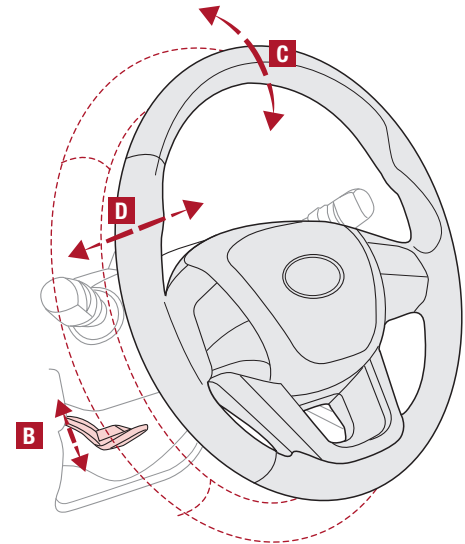

QUICK TIP

It may be helpful to pull/push bottom of Steering Wheel towards/away from you to adjust desired distance prior to adjusting the angle.

Audio Controls†21

Cruise Control†21

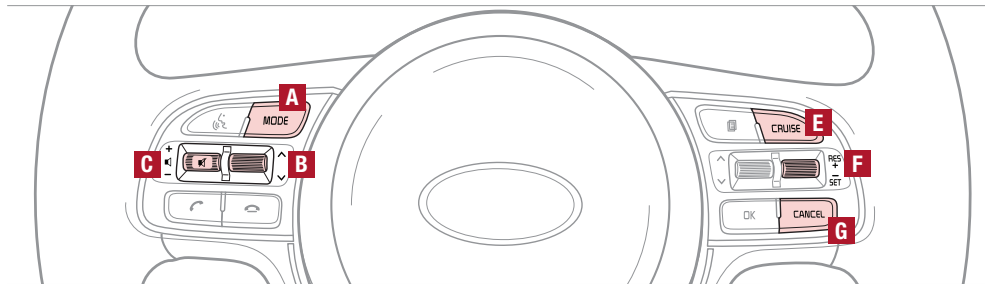

A Audio MODE button: Press to cycle through FM/AM/SiriusXM®/Media modes

B Seek/Preset button

Radio Mode (FM/AM/SiriusXM®): Press to advance through Preset Stations. Press and hold to Auto Seek
Media Modes: Press to move Track Forward/Back. Press & hold to Fast Forward/Rewind

C Volume button: Press up/down to raise/lower volume
Mute button: Press to mute all audio

QUICK TIP

Pressing the Audio Mode button for more than 1 second will turn Audio Mode ON/OFF.

Your vehicle's steering wheel buttons may differ from those in the illustrations. For further audio system operations, refer to pages 20-23. See your Owner's Manual for more details.

Driving while distracted is dangerous and should be avoided. Drivers should remain attentive to driving and always exercise caution when using the steering-wheel-mounted controls while driving.

E CRUISE Control button: Press to turn the Cruise Control ON/OFF

F Resume Cruising Speed button: Press up to resume or increase cruising speed

Set Cruising Speed button: Press down to set or decrease Cruising Speed

G Cruise Control CANCEL button: To cancel Cruise Control, do one of the following:

- Press the brake pedal
- Press the CANCEL button

QUICK TIPS

- Cruise Control is designed to function above approximately 25 mph
- The Cruise Control system will not activate until the brake pedal has been depressed at least once after ignition ON or engine starting

Bluetooth® Wireless Technology†4,20

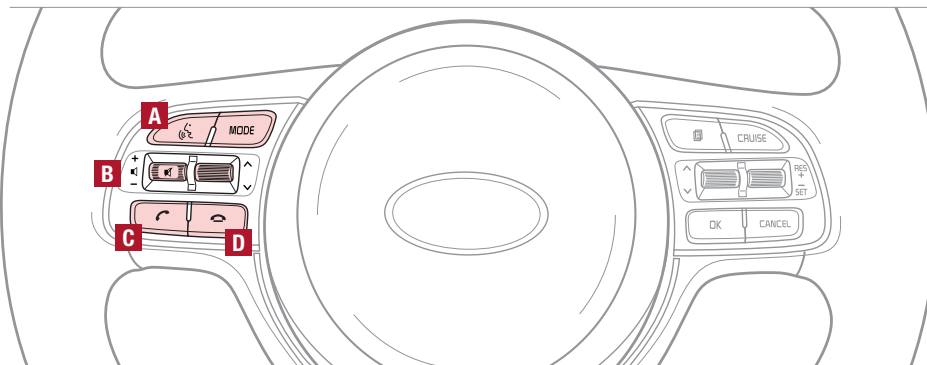

- A Talk button:** Press to activate voice recognition / bring up available commands for current mode / place calls.
- B Volume button:** Press up/down to raise/lower speaker volume
- Mute button:** Press to mute the microphone during a call
- C Call button:** Press the button to display the Dial Number screen. Press again to display the most recently made call number. Press a third time to initiate making the call to the number displayed
- D End Call button:** Press to end or cancel a call

QUICK TIPS

- When using the voice command feature, wait for the system BEEP before speaking the command
- Phone book transfer upload time varies by phone model and with number of phone book entries
- Because of differences in phone quality, service providers and **Bluetooth®** Wireless Technology chip programming, functionality may differ from one phone to another

For Bluetooth® Wireless Technology FAQs, go to www.kia.com, or call Consumer Information for Bluetooth® Technology at (800) 333-4KIA.

Refer to your Owner's Manual for more specific Bluetooth® Wireless Technology phone pairing and operation instructions.

Your vehicle's steering wheel buttons may differ from those in the illustrations. See your Owner's Manual for more details.

Driving while distracted is dangerous and should be avoided. Drivers should remain attentive to driving and always exercise caution when using the steering-wheel-mounted controls while driving.

Bluetooth® Wireless Technology†4,20

Pairing a Phone

For instructions on how to pair a phone, refer to the audio system's user's guide or your vehicle's Quick Start Guide.

QUICK TIP

During the pairing process, be sure to accept the connection requests on the phone for phone book download and to allow acceptance of all future **Bluetooth®** connection requests.

How to Place a Call

When using the voice command feature, wait for the system BEEP before speaking the command.

There are two options for placing a call using the Steering Wheel controls:

- Option 1: Press the Receive/Place Call button **C** (system displays the call history with the most recent calls)
- Option 2: Press the Talk button **A** (system will BEEP to indicate it is ready for call placement). Then say the command "Call {name}" or "Dial {number}"

Voice Recognition and Phone Contact Tips

To help optimize the **Bluetooth®** Wireless Technology Voice Recognition system, below are some tips and reminders. Improve the performance by making a few simple changes to your phone contacts:

- Use full names (first and last names) vs. short or single-syllable names ("John Smith" vs. "Dad," "Smith Residence" vs. "Home")
- Avoid using special characters, emoji's or hyphenated names (@, &, #, /, -, *, +, etc.)
- Avoid using acronyms ("In Case of Emergency" vs. "ICE") or words with all capital letters
- Spell words completely, no abbreviations ("Doctor Smith" vs. "Dr. Smith")

The system may have difficulty understanding some accents or uncommon names. Below are other tips to optimize using the voice recognition.

QUICK TIPS

- When placing a call, speak in a natural, moderate tone, with clear pronunciation. The system may have trouble recognizing commands if you speak too soft or too loud
- Always wait for the beep before speaking any commands
- Close windows and sunroof and turn off A/C. Open windows, sunroof, weather (wind/rain), or an A/C fan operating at higher speeds can interfere with Voice Recognition
- Press the talk button and say "Help" to get a list of available commands

QR CODE

Voice Recognition Tips Video

To view a video on your mobile device, snap this QR Code or visit the listed website.

Refer to page 2 for more information.



www.youtube.com/KiaFeatureVideos

Standard Audio System*

FM/AM/SiriusXM®/Media (CD, MP3, USB, iPod, Aux, My Music, *Bluetooth*® Audio)*

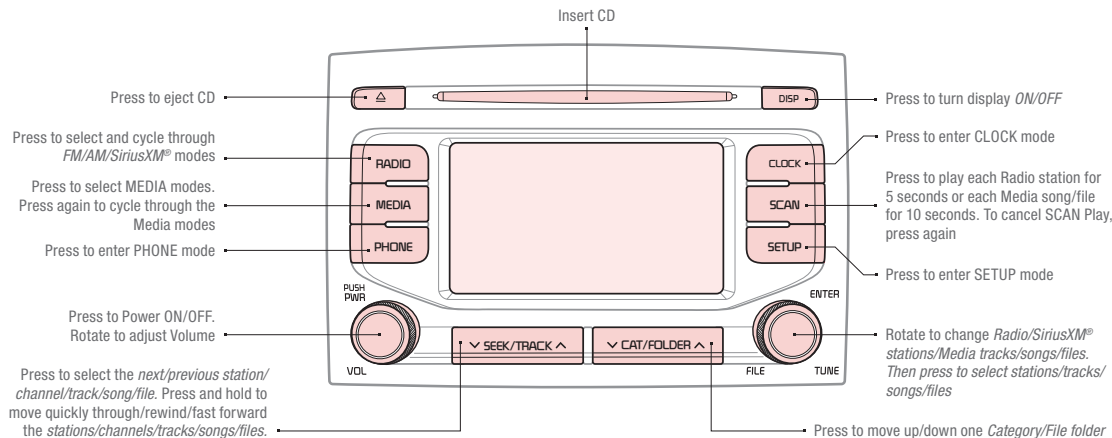

Audio System Setup Options

Press the SETUP key, then using the touchscreen, press the menu item to enter (Display, Sound, Clock/Calendar, Phone, System). Adjust the available settings for each equipped audio system setup option by pressing the onscreen buttons/arrows. Audio system setup options may include the following:

- **Display settings** - Adjusting the Brightness, Mode Popup, Media Display
- **Sound settings** - Sound Settings (fader, balance, bass, middle, treble), Speed Dependent Volume Control, Voice Recognition Volume, Touchscreen Beep
- **Clock/Calendar settings** - Clock Settings, Calendar Settings, Time Format, Clock Display
- **Phone settings** - Pair Phone, Paired Phone List, Contacts Download, Outgoing Volume, Bluetooth® System Off
- **System settings** - Memory Information, Prompt Feedback, Language

QR CODE

Standard Audio System Video

To view a video on your mobile device, snap this QR Code or visit the listed website.

Refer to page 2 for more information.



www.youtube.com/KiaFeatureVideos

To adjust the Sound settings (bass, middle, treble, fader, balance) – When in the SETUP menu, select Sound and then Sound Setting. Adjust the settings by pressing the onscreen arrows and then Return  to exit.

Your vehicle's audio system may differ from that in the illustration. See your Owner's Manual for more details.

REMINDER: To help minimize driver distraction, some audio system functionalities have been modified while the vehicle is in Drive, Reverse or moved out of Park.

UVO eServices^{†1} / Android Auto^{™†3} / Apple CarPlay^{®*†1}

UVO eServices Registration/Activation – To use UVO eServices:

1. Using a compatible smartphone to access your App Store, download the Kia UVO app.
2. In your smartphone's settings, *ensure that Location Services are enabled.*
3. Using the Kia UVO app, register for a new MyUVO.com account
4. Follow the In Car Setup Instructions on the Kia UVO app to complete the UVO eServices Activation

Android Auto^{™*}

Setting up Android Auto[™]:

1. From an Android Auto[™] compatible device, download the Android Auto[™] app from the Google Play[™] Store.
2. Open the Android Auto[™] app and proceed with the on-screen instructions to complete setup on the mobile device.

How to start Android Auto[™]:

1. Press the SETUP key on your audio system's control panel.
2. Press the Phone Projection or Connectivity button , select Android Auto[™] then select ENABLE ANDROID AUTO. Accept all terms, conditions and requests on the head unit and phone in order to use Android Auto[™].
3. Connect the Android[™] device with the vehicle's USB port using the manufacturer's cable provided with your phone.
4. From the vehicle's home screen, select the Android Auto[™] button, where you'll see all the Android Auto[™] supported apps.

Apple CarPlay^{®*}

Setting up and starting Apple CarPlay[®]:

1. On the head unit, press the SETUP key.
2. Press the Phone Projection or Connectivity button , select Apple CarPlay[®] then select ENABLE APPLE CARPLAY. [Accept all terms, conditions and requests on the head unit and phone in order to use Apple CarPlay[®]]
3. Connect the Apple CarPlay[®] compatible iPhone with the vehicle's USB port using the manufacturer's cable provided with your iPhone
4. From the vehicle's home screen, select the Apple CarPlay[®] button, where you'll see all the Apple CarPlay[®] supported apps

REMINDERS:

- Android Auto compatibility requirements: Micro-USB cable that came with your phone, OS Android[™] 5.0 or higher, compatible Android smartphone and data and wireless plan for applicable feature(s).
- Apple CarPlay compatibility requirements: Apple Lightning cable, latest iOS software, iPhone 5 or later and data and wireless plan for applicable feature(s)
- It is recommended to always update your phone to the latest operating system release

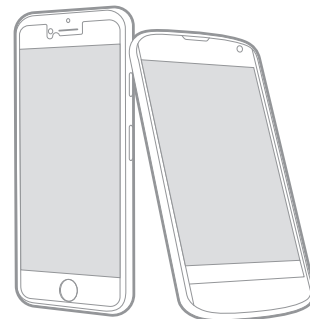

For further UVO operations, refer to the Car Multimedia System User's Manual. For other audio system information, refer to pages 20-23.

UVO eServices*†1,2,5

FM/AM/SiriusXM®/Media (USB, iPod®, My Music, Aux, Bluetooth® Audio)

Press briefly to do the following:

- FM/AM mode: Play the previous/next frequency.
- SiriusXM™ mode: Change the channel.
- MEDIA mode: Change the track, file or title (except for AUX).

Press and hold to do the following (over 0.8 seconds):

- FM/AM mode: Move quickly through all of the frequencies. When released, the system seeks the next available frequency.
- MEDIA mode: Rewinds or fast forwards the track or file (except for AUX and Bluetooth® Audio).

Press to display PHONE mode

Press to select MEDIA mode

Press to select FM/AM/SiriusXM® mode

Press knob to turn Power On/Off. Rotate knob to adjust Volume up/down

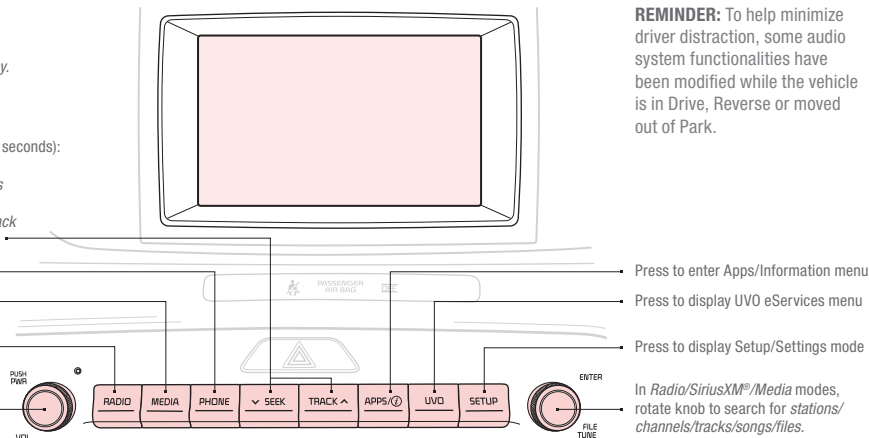

REMINDER: To help minimize driver distraction, some audio system functionalities have been modified while the vehicle is in Drive, Reverse or moved out of Park.

Press to enter Apps/Information menu

Press to display UVO eServices menu

Press to display Setup/Settings mode

In Radio/SiriusXM®/Media modes, rotate knob to search for stations/channels/tracks/songs/files.

Sound settings: To adjust the UVO eServices System sound settings:

1. Press the SETUP key on the audio control unit or the on-screen SETUP button in ALL MENUS
2. Select the on-screen SOUND button, or SOUND SETTINGS
3. Select the menu item (Position, Tone, Priority Advanced, Default, Beep)
4. Use the on-screen buttons to adjust settings
5. Press the return button to save settings

Radio Presets: You can listen to FM, AM and SiriusXM radio and save frequently used stations.

How to Save a Preset: Press and hold the desired slot. This saves the current station in the selected slot

SiriusXM Smart Favorites: For the first ten favorite SiriusXM channels, you may play live or repeat from the beginning of a song or a program segment. In Radio mode, choose SiriusXM, then select any of the first six favorites. During song or program play, tap the Skip Backward icon to start from the beginning of the song or program. Tap the Play Live icon to return to the live broadcast.

QR CODE

UVO eServices Video

To view a video on your mobile device, snap this QR Code or visit the listed website.

Refer to page 2 for more information.



www.youtube.com/KiaFeatureVideos

QUICK TIPS

- When using the voice command feature, wait for the system BEEP before speaking the command
- Navigation may be available when connected to Android™ Auto or Apple CarPlay® supported smartphones
- At any time, you can interrupt the Voice Command Feedback by pressing the TALK button on the Steering Wheel
- Prolonged use of the audio system in ACC mode may drain the vehicle's battery
- A warning screen may appear periodically to remind users that the audio system should be operated when the engine is running to prevent battery discharge

Your vehicle's audio system may differ from that in the illustration. For further audio system operations, refer to pages 20-23. For more information, refer to the Car Multimedia System User's Manual.

UVO eServices^{†1,25} with Premium Navigation^{*†12}

FM/AM/SiriusXM[®]/Media (USB, iPod[®], Aux, Bluetooth[®] Audio)

Press briefly to do the following:

- FM/AM mode: Play the previous/next frequency.
- SiriusXM[™] mode: Change the channel.
- MEDIA mode: Change the track, file or title (except for AUX).

Press and hold to do the following (over 0.8 seconds):

- FM/AM mode: Move quickly through all of the frequencies. When released, the system seeks the next available frequency.
- MEDIA mode: Rewinds or fast forwards the track or file (except for AUX and Bluetooth[®] Audio).

Press to go to Custom (Set) Menu

Press to select MEDIA modes

Press to select FM/AM/SiriusXM[®] modes

Press to Power ON/OFF. Rotate to adjust Volume

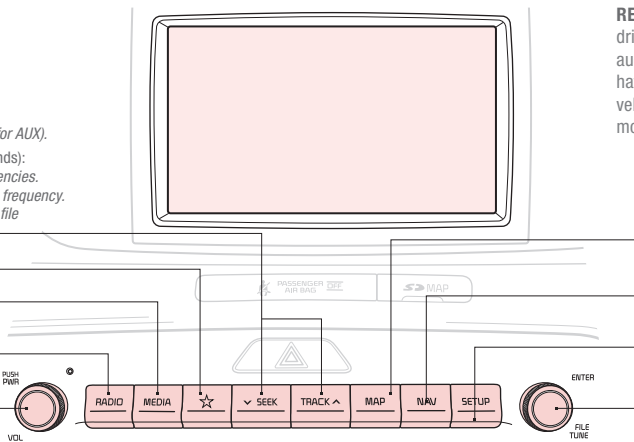

REMINDER: To help minimize driver distraction, some audio system functionalities have been modified while the vehicle is in Drive, Reverse or moved out of Park.

Press to display the MAP screen for the current position mode

Press to select navigation mode

Press to display Setup/Settings mode

In Radio/SiriusXM[®]/Media modes, rotate knob to search for stations/channels/tracks/songs/files. Press the knob to receive the selected channel/track/song/file

To adjust the sound settings (Position, Volume Tone, Priority, Navigation Volume, Advanced, Default, Beep) from any audio mode:

1. Press the SETUP key on the audio control unit or the on-screen SETUP button in ALL MENUS
2. Select the on-screen SOUND button, or SOUND SETTINGS. Select the menu item to change settings
3. Use the on-screen buttons to adjust settings. Press the Return button to save settings

Radio Presets: You can listen to FM, AM and SiriusXM radio and save frequently used stations.

How to Save a Preset: Press and hold the desired slot. This saves the current station in the selected slot

SiriusXM Smart Favorites: For the first ten favorite SiriusXM channels, you may play live or repeat from the beginning of a song or a program segment. In Radio mode, choose SiriusXM, then select any of the first six favorites. During song or program play, tap the Skip Backward icon to start from the beginning of the song or program. Tap the Play Live icon to return to the live broadcast.

Custom button ☆ – A programmable button to provide quick access to one of several available system features. To Program the Custom button:

1. Press the SETUP button, then press the Custom button ☆
2. Select one of the available features you would like the Custom button to open

ALWAYS CHECK THE OWNER'S MANUAL FOR COMPLETE OPERATING INFORMATION AND SAFETY WARNINGS

QR CODE

UVO eServices with Premium Navigation Video

To view a video on your mobile device, snap this QR Code or visit the listed website.

Refer to page 2 for more information.



www.youtube.com/KiaFeatureVideos

QUICK TIPS

- When using the voice command feature, wait for the system BEEP before speaking the command
- Prolonged use of the audio system in ACC mode may drain the vehicle's battery.
- A warning screen may appear periodically to remind users that the navigation system should be operated when the engine is running to prevent battery discharge
- At any time, you can interrupt the Voice Command Feedback by pressing the TALK button on the steering wheel

Your vehicle's audio system may differ from that in the illustration. For further audio system operations, refer to pages 20-22. For more information refer to the Car Multimedia System User's Manual.

Digital Clock

Press SETUP button on audio system, then follow on-screen instructions to change clock settings.

QUICK TIP

- Press the RETURN button on the navigation screen* to ensure changes are saved.
- When needed, Daylight Savings must be enabled in the Clock Settings screen
- To access manual date and time setting, turn GPS time OFF in the Clock Settings (UVO eServices with Premium Navigation*)

Aux/USB/iPod® Port, Power Outlets & USB Charger*

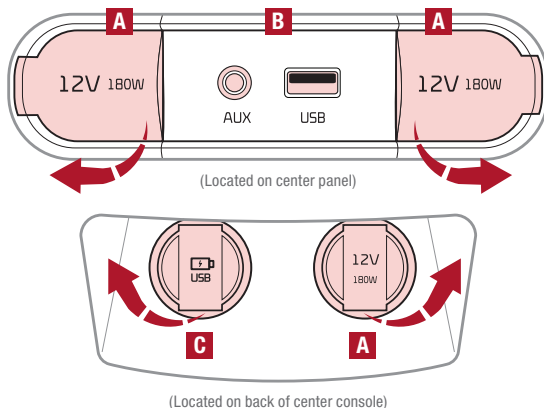

Power Outlets **A:** Use the power outlets for mobile phones and other devices designed to operate on a 12V (180W max) power outlet.

Aux/USB/iPod® Port **B:** Use the Aux port to connect audio devices and the USB port to connect USB audio devices, smartphones and iPod® devices.

USB Charger* **C:** Devices can be recharged using a USB cable. The Engine Start/Stop button needs to be in the ACC/ON/START position to operate the USB Charger.

QUICK TIP

The power outlets are inactive when ignition is in the OFF position.

REMINDERS:

- Using the power outlets, USB/Aux ports for prolonged periods of time with the Engine Start/Stop button in the ACC position (Engine OFF) could cause the battery to discharge.
- Use manufacturer cables only that came with your device. Third party cables may cause damage to device

For more information on the Aux/USB/iPod® Ports and Power Outlets, refer to the Owner's Manual.

Automatic Climate Control*

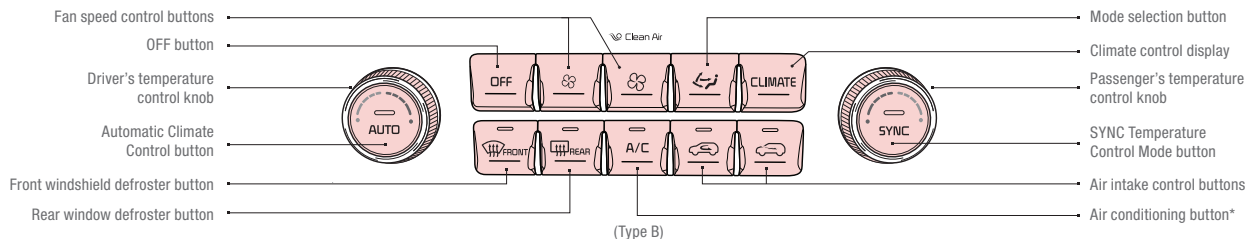

Climate Control Auto Function

1. Press **AUTO** to select Full Auto Operation - The Auto setting automatically controls the airflow modes, fan speeds, air intake and air conditioning according to the temperature setting selected
2. Set desired **Temperature**
3. Press **SYNC** to select Sync Temperature Control Operation

Defrost Outside Windshield:

1. Set **Fan Speed** to the highest position
2. Set **Temperature** to **Hot**
3. Press the **Front Defrost** button

Defog Inside Windshield:

1. Set **Fan Speed** to desired position
2. Set desired **Temperature**
3. Press the **Front Defrost** button

QUICK TIPS

- Defrost mode activates A/C and opens Fresh Air vent to help dehumidify the air and improve Defroster performance
- During Auto Operation, the A/C indicator will NOT illuminate. The fan speed, air intake, air flow and air conditioning may automatically be engaged at any time to reach desired temperature and reduce humidity
- Keep inside glass as clean as possible to reduce window fogging

Air Flow Modes

To select Air Flow Modes, press the mode selection button to cycle to the desired mode:



REMINDERS:

- When in AUTO mode, Air Flow mode and Fan Speed do not display on the Climate Control Display
- Warm air may flow in through vents if Recirculated Air button is not pressed ON (LED lit)
- Pressing any button during AUTO operation will deactivate the AUTO function and switch to manual mode, except for Temperature Control or SYNC Temperature Control

Your Automatic Climate Control system may differ from those in the illustrations. See your Owner's Manual for more details.

Manual Climate Control*

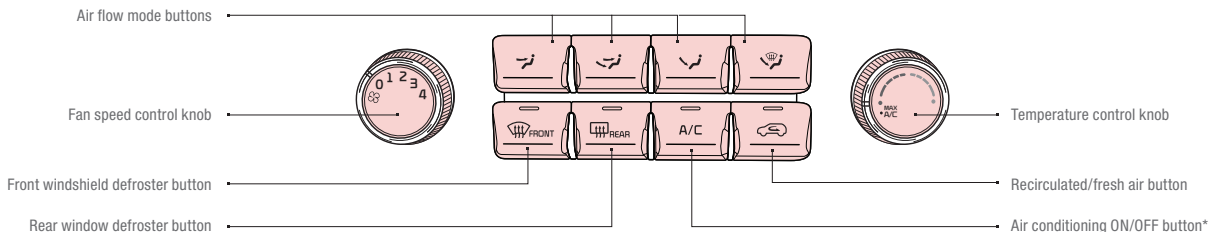

Defrost Outside Windshield:

1. Set **Fan Speed** to the highest position
2. Set **Temperature** to **Hot**
3. Press the **Front Defrost** button 

Defog Inside Windshield:

1. Set **Fan Speed** to desired position
2. Set **Temperature** to desired position
3. Press the **Front Defrost** button 

Air Flow Modes

To select Air Flow modes, press the Mode selection buttons:

-  Face-Level
-  Bi-Level
-  Floor-Level
-  Floor/Defrost-Level

QUICK TIPS

- Defrost  mode activates A/C and opens Fresh Air vent to help dehumidify the air and improve Defroster performance
- MAX A/C mode automatically engages Recirculated Air
- Keep inside glass as clean as possible to reduce window fogging

REMINDER: Warm air may flow in through vents if Recirculated Air button is not pressed ON (LED lit)

Your Manual Climate Control system may differ from those in the illustrations. See your Owner's Manual for more details.

Automatic Gear Shift with Sportmatic® Shifting^{†19}

- P:** Park [+]: Manual Mode Upshift
- R:** Reverse [-]: Manual Mode Downshift
- N:** Neutral
- D:** Drive

Manual Mode:

To enter Manual mode, move shift lever from D to left gate **A**

To shift while in Manual mode, move shift lever up [+] to upshift or down [-] to downshift **A**

QUICK TIPS

- Press brake pedal and depress release button to move gear shift from N to P, N to R or from P to any gear
- Manual mode downshifts are made automatically when the vehicle slows down. When the vehicle stops, 1st gear is automatically selected

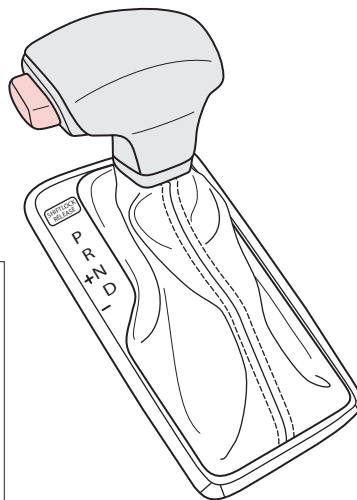
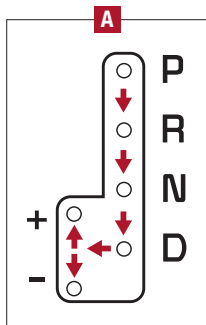

QR CODE

Sportmatic® Shifting Video

To view a video on your mobile device, snap this QR Code or visit the listed website.

Refer to page 2 for more information.



www.youtube.com/KiaFeatureVideos

Paddle Shifters*

Paddle Shifters are operable when the shift lever is moved into the left gate of the D position (Manual mode).

Paddle Shifting: Pull the [+] or [-] paddle shifter once to shift up or down one gear.

REMINDERS:

- The paddle shifters can be operated when the vehicle speed is more than 6 mph
- When in Manual mode, pulling the left and right paddle shifters at the same time will NOT shift gears

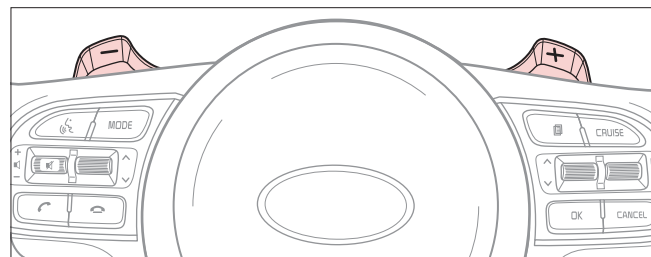

Electronic Parking Brake (EPB)*

The Electronic Parking Brake (EPB) system utilizes an electric motor to engage the parking brake.

Applying the Parking Brake

Depress the brake pedal and pull up the EPB switch **A**. Ensure that the indicator light is illuminated on the instrument cluster.

If parked on a steep incline/decline, pull up the EPB switch for more than 3 seconds for a firmer EPB application.

Releasing the Parking Brake

The EPB will automatically release when the shifter is placed in Reverse or Drive.

To release EPB manually, depress the brake pedal, then press the EPB switch **A**, with the ignition switch in the ON position. Ensure that the indicator light is OFF.

QUICK TIPS

- When leaving your keys with parking lot attendants or valet, make sure to inform them how to operate the EPB
- If parked on a steep incline, pull up the EPB switch for more than 3 seconds for a firmer EPB application
- Pull up and hold EPB switch a second time to increase brake pressure if parked on a decline or incline

REMINDERS:

- EPB will not release unless the hood, liftgate and all doors are closed and seat belts are fastened
- As a bulb check, the EPB malfunction indicator will illuminate for approximately 3 seconds when the ignition switch is turned ON
- If the warning light does not illuminate temporarily, or continues to remain lit, take your vehicle to an authorized Kia dealer and have the system checked
- The EPB should not be operated while the vehicle is moving
- A click or electric brake motor sound may be heard while operating or releasing the EPB, but these conditions are normal and indicate that the EPB is functioning properly

Auto Hold*

Auto Hold temporarily maintains the vehicle at a standstill even though the brake pedal is not depressed after the driver brings the vehicle to a complete stop by depressing the brake pedal. Auto Hold can be turned On/Off using the AUTO HOLD button **B** on the center panel below gear shift. Before Auto Hold will operate, the driver's door, engine hood and liftgate must be closed, and the driver's seat belt must be fastened.

The AUTO HOLD indicator on the Instrument Cluster has four states:

White: Standby - With vehicle at a standstill, and AUTO HOLD button **B** is pressed ON, the indicator will illuminate white. While driving the vehicle (vehicle is not at a standstill), the Auto Hold indicator will remain white.

Green: Engaged - When coming to a complete stop by depressing the brake pedal, the Auto Hold indicator changes from white to green.

Off (not illuminated) - The indicator will turn Off when the AUTO HOLD button **B** is manually pressed Off or when the EPB is manually turned On.

Yellow: Malfunction - When the indicator is illuminated yellow, there may be a system malfunction. Take your vehicle to a local Kia dealer.

Refer to page 4 for location of Instrument Cluster indicators.

QR CODE

Electric Parking Brake Video

To view a video on your mobile device, snap this QR Code or visit the listed website.

Refer to page 2 for more information.



www.youtube.com/KiaFeatureVideos

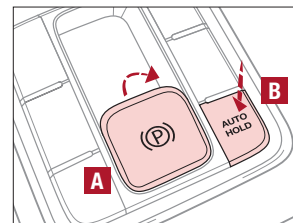

(Type B shown. Located below gear shift)

Downhill Brake Control (DBC)^{†6}

DBC helps drivers maneuver down steep hills by automatically braking for them, allowing drivers to concentrate on steering.

Press button **A** to turn DBC ON/OFF.

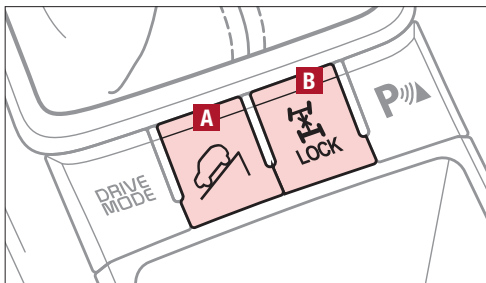

(Type A shown. Located below gear shift)

QUICK TIPS

- When on, the DBC will turn OFF when button is pressed again or vehicle speed is over 38 mph
- If the red indicator illuminates, the DBC system may have malfunctioned. Take your vehicle to an authorized Kia dealer and have the system checked

REMINDER: The DBC defaults to OFF when ignition is cycled.

AWD (All-Wheel Drive) Lock*

When you select AWD Lock mode by pressing the AWD LOCK button **B**, the AWD LOCK mode increases the drive power when driving on wet pavement, snow-covered roads and/or off-road.

- This mode is used for climbing or descending sharp grades, off-road driving, driving on sandy and muddy roads, etc., to maximize traction
- This mode automatically begins to deactivate at speeds above 19 mph and is shifted to AWD AUTO mode at speeds above 25 mph. If the vehicle decelerates to speeds below approximately 25 mph, however, the transfer mode is shifted into AWD LOCK mode again

When the AWD LOCK mode is deactivated, a shock may be felt as the drive power is delivered entirely to the front wheels. This shock is not a mechanical failure.

Heated Steering Wheel*

While the Engine Start/Stop button is in the ON position, press the Heated Steering Wheel button A to turn the steering wheel heater ON/OFF. The steering wheel heater will turn off automatically in 30 minutes, or when button **C** is pressed again to deactivate.

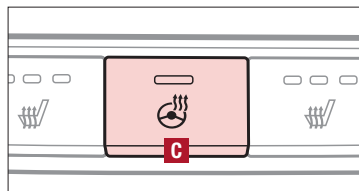

(Located on center panel)

QUICK TIPS

- If the ignition is turned OFF then ON again within 30 minutes of the steering wheel heater being turned ON, the system will remain in the ON position
- System does NOT turn off when the ignition is cycled. To turn the system off, press the Heated Steering Wheel button **C**

Parking Distance Warning-Forward and Reverse*†5

The Parking Distance Warning-Forward and Reverse is not a safety device. The Parking Distance Warning-Forward and Reverse is a supplemental system that assists the driver by chiming if any object is detected within the sensing area to the front, rear and side of the vehicle when moving forward or backing up.

The system is activated when the ignition is ON and the vehicle is in R (Reverse). To deactivate the system, press the Parking Distance Warning-Forward and Reverse button **A** (LED illuminated).

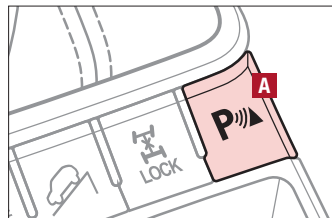
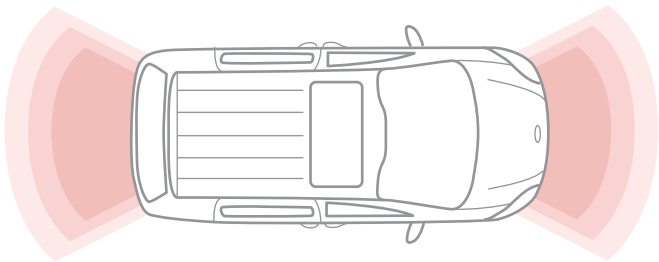

(Type A shown. Located below gear shift)

REMINDERS:

- If the vehicle is moving at speeds over 3 mph, the system may not activate correctly
- When more than two objects are sensed at the same time, the closest one will be recognized first

The Parking Distance Warning-Forward and Reverse is not a substitute for proper and safe backing-up procedures. Always drive safely and use caution when backing up. The Parking Distance Warning-Forward and Reverse may not detect every object in front of or behind the vehicle.

Seat Warmers / Ventilated Seats*†18

A Seat Warmers:

- Press button once for high setting (3 LEDs lit)
- Press button twice for medium setting (2 LEDs lit)
- Press a third time for low setting (1 LED lit) and again to turn OFF

B Ventilated Seats:

- Press button once for high setting (3 LEDs lit)
- Press button twice for medium setting (2 LEDs lit)
- Press a third time for low setting (1 LED lit) and again to turn OFF

QUICK TIPS

- System is OFF by default. To turn system ON, press the seat warmer switch
- With the seat warmer switch in the ON position, the heating system in the seat turns off or on automatically depending on the seat temperature

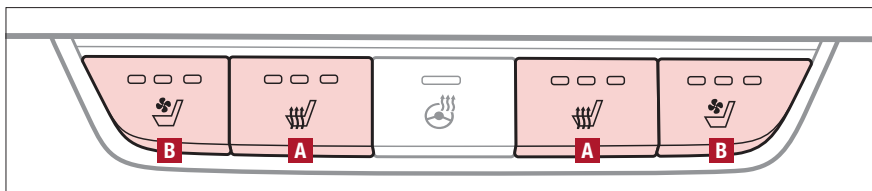

(Buttons located on center panel)

QR CODE

Heated and Ventilated Seats Video

To view a video on your mobile device, snap this QR Code or visit the listed website.

Refer to page 2 for more information.



www.youtube.com/KiaFeatureVideos

Power Adjustable Driver's Seat*

Move/Press controls to adjust Seat forward/backward, Seat Cushion height, Seatback recline or Lumbar forward/backward.

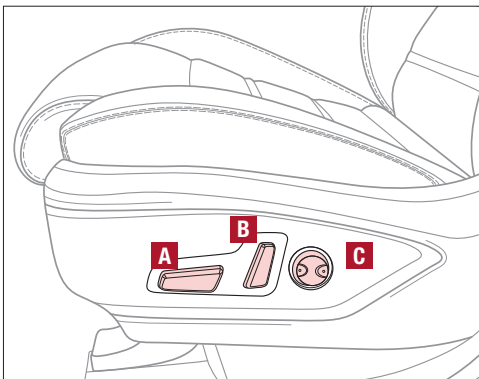
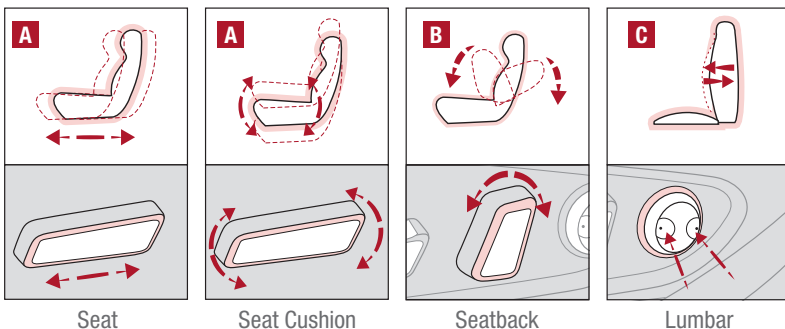

For more information on Power Adjustable Driver's Seat operation, refer to the Owner's Manual.

6-Way Manual Adjustable Driver's Seat*

Pull lever **D** to slide seat forward/backward.

Pull/press lever **E** to adjust seat height.

Pull lever **F** to adjust seatback recline.

Press **G** to adjust lumbar support

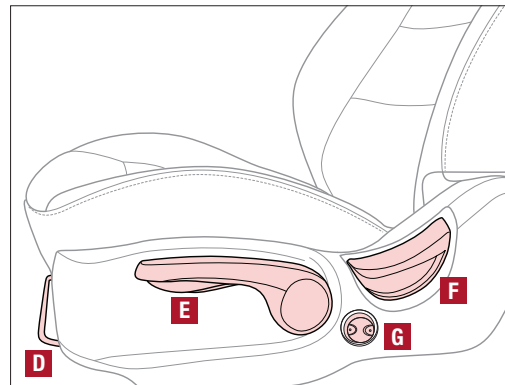

QUICK TIPS

When adjusting seat forward or backward, ensure seat clicks or locks into place before driving vehicle.

For more information on 6-Way Manual Adjustable Driver's Seat operation, refer to the Owner's Manual.

Reclining/Folding Rear Seats

(Seat type with lever in front)

To recline the Rear Seatback:

1. Pull lever **A** up to unlock seat
2. Holding the lever **A** up, adjust Seatback to desired position **B**
3. Release the lever **A** and ensure the Seatback is locked in place

To fold the Rear Seatback:

1. Pull lever **A** up to unlock seat
2. Fold Seatback flat

QUICK TIP

When adjusting seat forward or backwards, ensure seat clicks or locks into place before driving the vehicle.

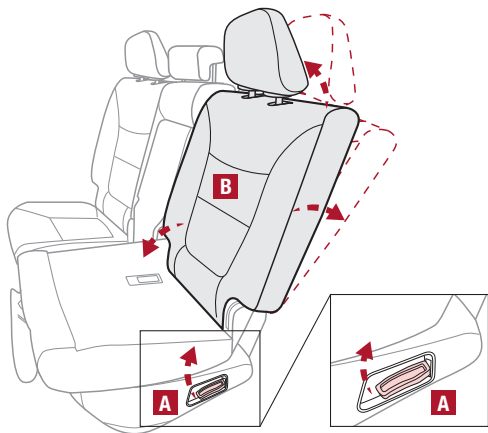

REMINDER: The lever must return to its original position for the Seatback to lock.

Front Seat Headrest Adjustment

To raise headrest —

Pull headrest up to the desired position.

To lower headrest —

Press lock **C**, then press the headrest down.

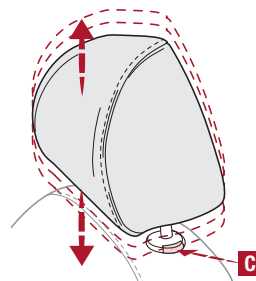

QUICK TIP

For easy adjustments, hold a headrest post with one hand while using the other hand to pull the headrest from underneath.

REMINDER: The headrest only moves up and down as described above. It does not adjust forward or backward.

Unfastening Center Seat Belt

1. If Seat Belt is buckled, press the release button on the buckle.
2. To retract the center seatbelt webbing **D** in 2nd and/or 3rd rows, use the lap belt tongue plate **E** to push the “release button” in the small slot on the center belt buckle **F**.

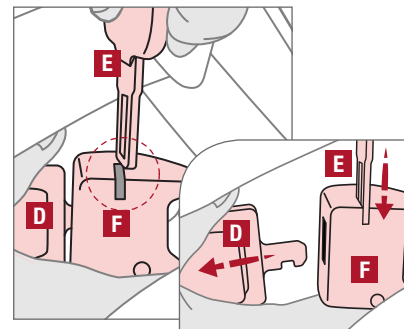

QR CODE

Second and Third Row Center Seatbelt Video

To view a video on your mobile device, snap this QR Code or visit the listed website.

Refer to page 2 for more information.



www.youtube.com/KiaFeatureVideos

Smart Key*†7

- A** Press to lock All Doors
- B** Press to unlock Driver's Door. Press twice in 4 seconds to unlock All Doors and Liftgate
- C Manual Liftgate*:** Press and hold for more than 1 second to unlock Liftgate. Then lift by the handle to manually open Liftgate.
 - REMINDERS:**
 - The Liftgate does not automatically open when the **C** button is pressed.
 - The Liftgate unlocks when the Smart Key fob is within close proximity of the vehicle
 - Power Liftgate*:** Press and hold for Power Liftgate to open automatically. Press again at any time to stop. Press and hold again to automatically close.
- D** Press and hold for more than a half-second for Panic Alarm. To turn off Alarm, press any button
- E** Press to release Mechanical Key (Button on reverse side of fob)

Remote button configuration may vary depending on vehicle options. For more information on the Mechanical Key, please refer to your Owner's Manual.

Driver's Door Lock/Unlock button **F**:

- Press button once to unlock Driver's Door
- Press again within 4 seconds to unlock All Doors
- Press again to lock All Doors

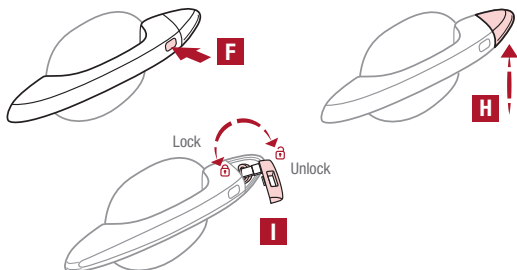

Mechanical Key **G**:

1. Pull out door handle
2. Remove door handle keyhole cover with Mechanical Key by pressing up into slot as shown **H**
3. Insert Mechanical Key **I** and turn right to Unlock Driver's Door. Turn twice within 4 seconds to Unlock all doors
4. Insert Mechanical Key and turn left to Lock Driver's Door
5. Return keyhole cover to its original position

Use to lock glove box and to turn Child-Protector Rear Door Lock.

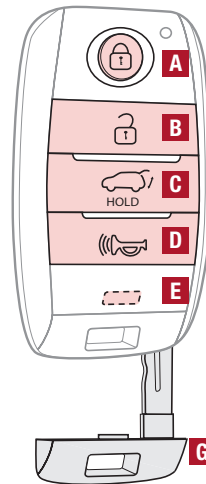

QR CODE

Engine Start/Stop Button & Smart Key Video

To view a video on your mobile device, snap this QR Code or visit the listed website.

Refer to page 2 for more information.



www.youtube.com/KiaFeatureVideos

QUICK TIPS

- If the Smart Key battery is weak or not working properly, hold the Smart Key fob up to the Engine Start/Stop button (Lock button side closest) and press to start engine
- The Smart Key's signal can be blocked by the normal operation of a cell or smartphone. To help prevent this, store each device separately.
- When reinserting the mechanical key into the fob, make sure it is pushed all the way in until there is a click sound

Remote Keyless Entry (Folding Key)*

- A** Press the release button to unfold the key
- B** Press to lock all doors
- C** Press to unlock driver's door. Press twice in 4 seconds to unlock all doors and liftgate
- D** **Manual Liftgate***: Press and hold for more than 1 second to unlock Liftgate. Then lift by the handle to manually open Liftgate.
- Power Liftgate***: Press and hold for Power Liftgate to open automatically. Press again at any time to stop. Press and hold again to automatically close.
- E** Press and hold more than 1 second for Panic Alarm. To turn OFF Alarm, press any button

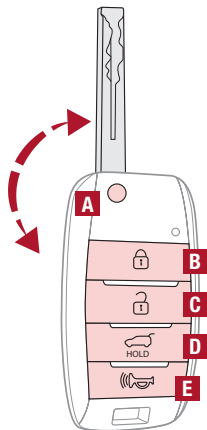

REMINDERS:

- Remote button configuration may vary depending on vehicle options
- The Liftgate unlocks when the Smart Key fob is within close proximity of the liftgate

Double-Turn Lock/Unlock All

- Turn clockwise once to unlock driver's door
- Turn clockwise again within 4 seconds to unlock all doors
- Turn counterclockwise once to lock all doors

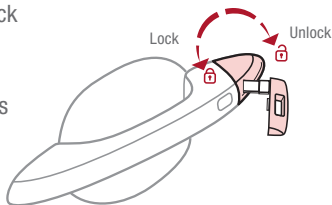

Fuel Filler Lid Release

To open the Fuel Filler lid:

1. Press the right edge of the Fuel Filler lid **F**
 2. Pull the Fuel Filler lid out to fully open **G**
- To open the Fuel Cap, turn it counterclockwise **H**

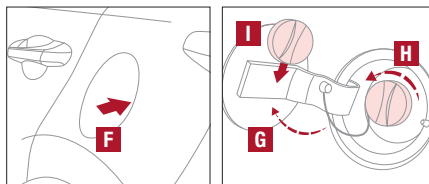

QUICK TIP

Place the Fuel Cap on the inside of the Fuel Filler Lid when fueling **I**

REMINDER:

The fuel filler lid lock will unlock/open only when driver's side door is unlocked.

Fuel Cap / Malfunction Indicator (Check Engine Light)

Tighten for **ONE CLICK** to prevent Malfunction Indicator  from illuminating.

REMINERS:

- To open the fuel door, press the right edge of the fuel door.
- It is normal operation when tightening to hear one click and then when Fuel Cap is released, it clicks back.

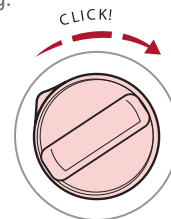

QR CODES

To view videos on your mobile device, snap these QR Codes or visit the listed website.

Refer to page 2 for more information.

Kia Key Fob Video



One-Click Fuel Cap Video



www.youtube.com/KiaFeatureVideos

HomeLink® with Auto-Dimming Rearview Mirror*†10

- A** HomeLink® button
- B** HomeLink® button
- C** Indicator light
- D** HomeLink® button
- E** Glare detection sensor
- F** Automatic dimming ON
- G** Automatic dimming OFF

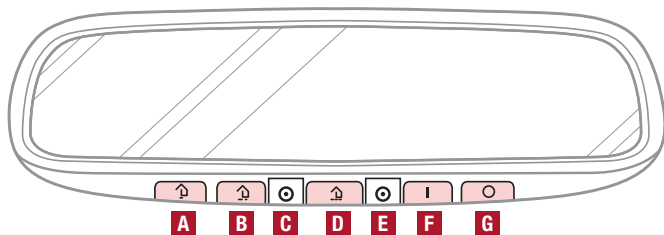

The Auto-Dimming Rearview Mirror* is designed to reduce glare from a vehicle's headlights located in the rear and also connect up to three electronic transmitters into one location.

- To turn automatic dimming ON, press **I** button **F**
- To turn automatic dimming OFF, press **O** button **G**

REMINDER: Mirror indicator light **C** will illuminate when automatic dimming is ON.

If your garage door opener was manufactured in 2011 or later, and you're unable to program your vehicle's HomeLink® system, you may need to purchase a HomeLink Repeater Kit. For more information, go to www.HomeLink.com or call (800) 355-3515.

HomeLink® Setup - How to Sync Transmitter

If programming for the first time, begin with Step 1 (repeating this step will delete all information).

To program non-rolling and rolling code garage door openers and other devices:

1. Press and hold the left **A** and center **D** buttons simultaneously until the indicator light **C** begins to flash (to reprogram buttons, skip this step)
2. Press and hold the desired button **A**, **B** or **D** and hold the button on the transmitter while it is approximately 1 to 3 inches away from the mirror. The HomeLink® Indicator light **C** will flash rapidly once the frequency signal has been successfully programmed

To finish programming rolling code garage door openers, complete these steps:

3. Locate the "learn" or "smart" button on the garage door's motor head unit. Press and release the button and complete Step 4 within 30 seconds.
4. Firmly press and release the programmed HomeLink® button up to three times.

QUICK TIP

- You can reprogram a single HomeLink® button by repeating Step 2
- Erasing programmed buttons will delete all trained transmitters

Operating HomeLink®:

Press one of the programmed HomeLink® buttons.

Erasing programmed buttons:

Press and hold the left **A** and center **D** buttons simultaneously for approximately 20 seconds, and then release both buttons within 30 seconds.

QR CODE

HomeLink Setup Video

To view a video on your mobile device, snap this QR Code or visit the listed website.

Refer to page 2 for more information.



www.youtube.com/KiaFeatureVideos

Map/Room Lamps

Automatic turn off function*

The interior lights automatically turn off approximately 30 seconds after the ignition or Engine Start/Stop button* is OFF.

Map Lamp/Room Lamp Operation

Push the lens **A** to turn the map lamp ON/OFF. This light produces a spot beam for convenient use as a map lamp or as a personal lamp for the driver or the front passenger.

Front/Rear Room Lamps Button  – Press button **B**, to turn the front and rear room lamps on and off.

Door Mode Button – Press button  **C**, to enable or disable Door Mode. In Door Mode, the map and room lamps turn on when any door is opened. When all doors are locked or the ignition is on, the map and room lamp will turn off immediately.

Rear Room Lamps – Press the button **D** to turn the rear passenger lamp ON/OFF.

QUICK TIP

- When doors are unlocked by the Smart Key, the lamp turns ON for approximately 30 seconds
- If your vehicle is equipped with the theft alarm system, the interior lights automatically turn off approximately 3 seconds after the system is in armed stage
- Using interior lights for an extended period of time may cause battery discharge

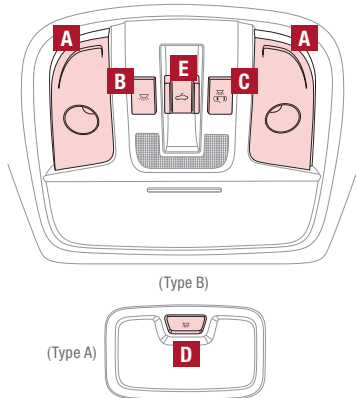

Panoramic Sunroof Operation w/Power Sunshade*

The sunroof operation is controlled through a multi-directional switch/lever. The ignition or Engine Start/Stop button* needs to be in the ON position to operate the sunroof.

To slide the sunshade and sunroof:

- Auto Open: Slide the lever **E** backward to the farthest position and release
- Auto Close (sunroof only): Slide the lever **E** forward to the farthest position and release

To slide the sunshade only:

- Open: Slide the lever **E** partially backward to the first detent position and release
- Auto Close: Slide the lever **E** partially forward to the first detent position and release

To slide the sunroof (with sunshade open):

- Open: Slide the lever **E** backward to the first detent position and release
- Close: Slide the lever **E** forward to the first detent position and release to close sunroof glass only. Slide the lever backward to the farthest position and release to close sunroof glass and sunshade

To tilt the sunroof:

- Raise: Push lever **E** upward.
- Lower: Push lever **E** upward again or slide the lever forward to the first detent position and release

REMINDERS:

- Sunshade needs to remain OPEN while sunroof is open and vehicle is moving
- Sunshade cannot slide when it is in the tilt position or tilt while in an open or slide position

QR CODE

Sunroof Operation Video

To view a video on your mobile device, snap this QR Code or visit the listed website.

Refer to page 2 for more information.



www.youtube.com/KiaFeatureVideos

QUICK TIP

To stop the sunroof/sunshade at any position, push or pull the sunroof control lever in any direction.

Power Liftgate*†14

Opening from Inside the Vehicle:

Press and hold the Power Liftgate Open/Close button **A** to automatically open/close the Liftgate.

Smart Key:

To open the Power Liftgate, press and hold the Liftgate button **B** (next page) until the Liftgate begins opening. Press again to close.

REMINDER: Pulling the Rear Hatch upward by the handle or pressing the button a second time will interrupt the automatic opening of the Power Liftgate.

Opening from Outside the Vehicle:

To open Power Liftgate automatically, press the Rear Hatch Release button **C** on exterior of the Liftgate.

Automatically close by pressing the Power Liftgate Close button **D**.

Power Liftgate Opening Height Adjustment

Adjust the liftgate height opening to suit user's preference. The height setting of a fully opened liftgate can be adjusted by the following steps:

1. Position the liftgate manually to the preferred height
2. Press Power Liftgate Close button **D** more than 3 seconds
3. A system beep will sound twice indicating the height setting has been saved

The liftgate will then open to the set height. To change setting again, repeat steps 1-3.

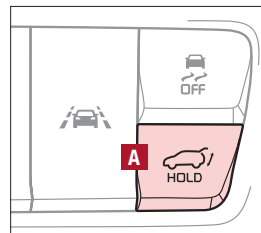

(Buttons located on Driver's Panel)

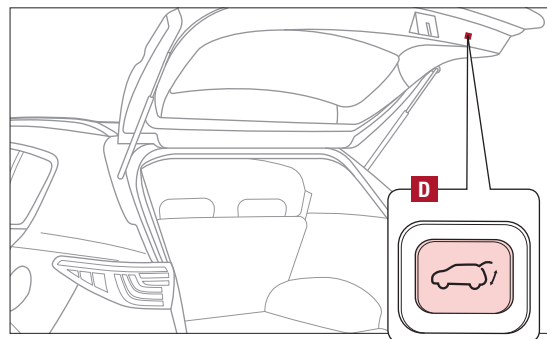
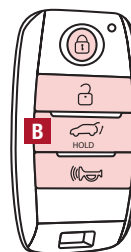

(Located on Liftgate inside lip near latch)

QR CODE

Power Liftgate Opening Height Adjustment Video

To view a video on your mobile device, snap this QR Code or visit the listed website.

Refer to page 2 for more information.



www.youtube.com/KiaFeatureVideos

Smart Power Liftgate^{*†14}

When the Smart Key fob is on your person and you are near the back of the vehicle, within close proximity, the hazard lights will blink and a chime will sound for about 3 seconds as an alert that the Smart Power Liftgate is about to open. Then the alert system will blink and chime two additional times before opening the Smart Power Liftgate.

The Smart Power Liftgate feature is off by default. To enable the Smart Power Liftgate, go to User Settings in the LCD Instrument Cluster modes.

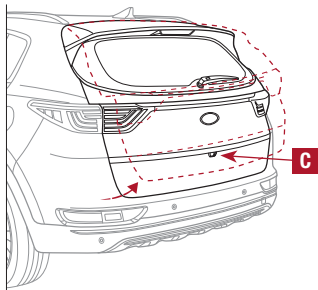

QUICK TIPS

- During the Smart Power Liftgate alert, the Smart Power Liftgate can be deactivated with the Smart Key by pressing any button on the key fob.
- The open height can be adjusted. For information on how to set open height, see your owner's manual

REMINDERS:

- All doors are closed and locked after about 15 seconds
- The Smart Power Liftgate feature will not operate when:
 - The doors are recently closed and locked, and the Smart Key is still detected after 15 seconds near the vehicle or within 60 inches of the door handles
 - A door is not locked or closed
 - The Smart Key is in the vehicle
- Press any button on the Smart Key fob during the Detect and Alert stage to deactivate the Smart Power Liftgate function.

Liftgate Release Button (for manual liftgate)

Located underneath the rear liftgate hatch. With liftgate unlocked, press the Liftgate Release Button **A** and pull the liftgate up by the handle to open.

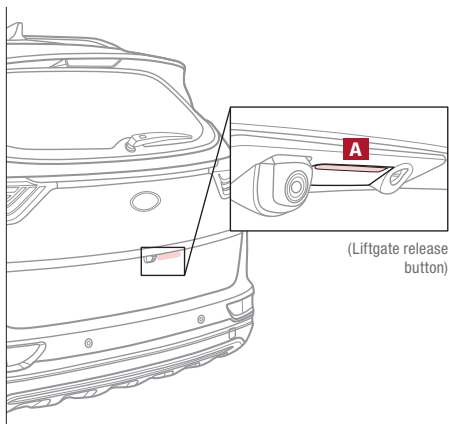

QUICK TIPS

- The liftgate must be unlocked before it can be opened by the Liftgate Release Button
- The liftgate unlocks automatically, and can then be opened, when the Smart Key fob^{*} is within close proximity to the vehicle

QR CODE

Smart Power Liftgate Video

To view a video on your mobile device, snap this QR Code or visit the listed website.

Refer to page 2 for more information.



www.youtube.com/KiaFeatureVideos

Rear-Camera Display†5

The Rear-Camera Display system is not a safety device. It is a supplemental system that displays the view behind the vehicle through the audio control unit screens while the vehicle is in Reverse.

The Rear-Camera Display activates when the:

1. Engine Start/Stop* button is in the ON (Red light) or RUN (not illuminated) position.
2. Gear Shift Lever is in the R (Reverse) position

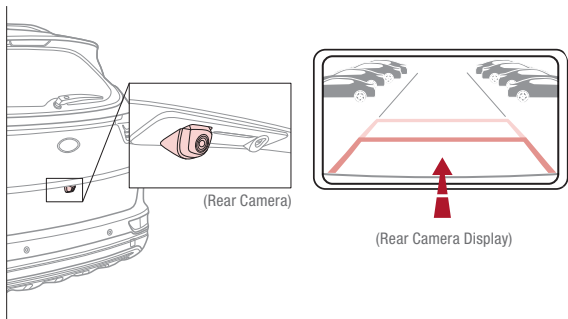

REMINDERS:

- The Rear-Camera Display is ON by default when ignition is cycled
- The screen image above is for illustration purposes only. The actual image or graphics may differ in your vehicle

The Rear-Camera Display is not a substitute for proper and safe backing-up procedures. Always drive safely and use caution when backing up. The Rear-Camera Display may not detect every object behind the vehicle.

Child-Protector Rear Door Lock

Located on the rear edge of the rear passenger doors. Insert the ignition key into the hole and turn the key to the LOCK position to disable the inner door handles from opening the rear doors.

REMINDER: Child-Protector Rear Door Lock is located on rear passenger's door jamb.

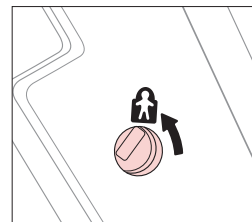

(Located on rear edge of rear passenger doors)

Sunvisor†22

Use the sunvisor to shield direct light through the front or side windows. Slide the Sunvisor out and adjust as needed.

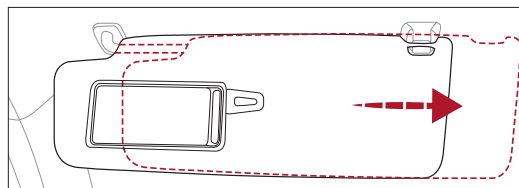

REMINDERS:

- Sunvisor may not shield all direct light
- The sunvisor may impair visibility if not adjusted properly
- Do not operate the vehicle if the sunvisor is impairing your visibility
- Be aware of seating position when adjusting or swinging sunvisor around to or from the front or side windows

Hood Release Lever and Latch

Opening the Hood:

1. Pull the Hood Release Lever **A** to unlatch the Hood
2. In the front of the vehicle, lift the Hood slightly, push the secondary Latch **B** to the left inside of the Hood's center and lift the Hood

Closing the Hood:

Lower the Hood by pressing the front center of the Hood. Then, press down to securely lock in place.

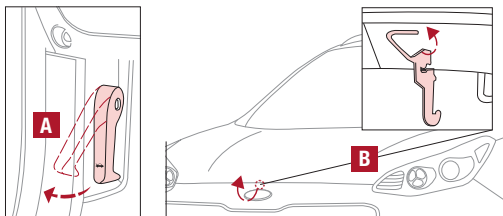

REMINDERS:

- While lowering and closing, keep hands away from under the Hood
- Open the Hood only after turning the engine off, on a flat surface, with the gear shift in P (Park) position and setting the parking brake.

Tire Mobility Kit*

The Tire Mobility Kit may temporarily seal certain types of tire damage.

For operational information, please refer to the Owner's Manual.

C Sealant Bottle

D Compressor

REMINDERS:

- The Tire Mobility Kit requires the use of the 12V/15A/180W Power Outlet, which is located on the right side of the outlet/ aux port area
- After tire is properly sealed, drive cautiously at a maximum speed of 50 mph for no longer than a maximum distance of 120 miles

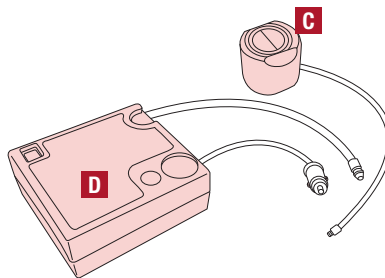

QR CODE

Tire Mobility Kit Video

To view a video on your mobile device, snap this QR Code or visit the listed website.

Refer to page 2 for more information.



www.youtube.com/KiaFeatureVideos

QUICK TIPS

- The Tire Mobility Kit is a temporary fix and is to be used for one tire only; the tire should be inspected as soon as possible
- The kit should only be used for sealing/inflating passenger car tires; do not use for inflating any other type of tires
- Some damaged tires cannot be sealed completely; do not use the kit if it appears a tire is damaged beyond repair

Seat Belts^{†2}

To properly fasten your seat belts:

1. Insert the belt tongue plate **A** into the buckle **B** until it clicks
2. Position the lap portion of the belt across your lap as LOW ON THE HIPS as possible **C**. Adjust the belt to a SNUG FIT by pulling up on the shoulder portion **D**.

REMINDER: For maximum protection, always wear your seat belt.

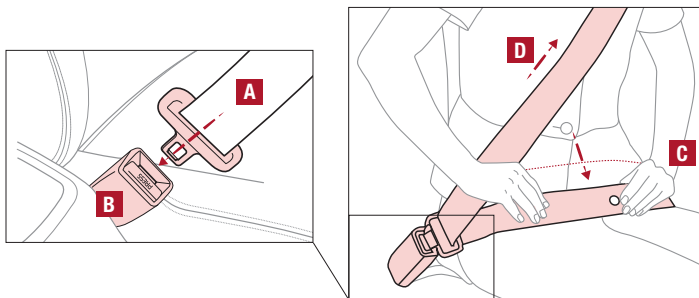

QUICK TIP

The Seat Belt warning chime operates for driver's seat only.

Seat Belt Retractor Locks

Retractor locks allow lap/shoulder seat belts to remain unlocked during normal vehicle operation for freedom of movement and increased comfort.

During a STRONG STOP, SUDDEN TURN OR CERTAIN COLLISIONS, seat belt retractors will automatically lock the belts to reduce the risk of injury.

Occupant Detection System (ODS)^{†13} / Passenger Airbag Off Indicator^{†2}

ODS detects the presence of the front passenger and adjusts or turns off airbag deployment accordingly.

Depending on the situation and type of accident, the system may:

- Deploy airbag (Adult)
- Not deploy the airbag (Unoccupied)

If the system determines that the airbag should not be deployed, the "PASSENGER AIRBAG OFF" indicator will illuminate.

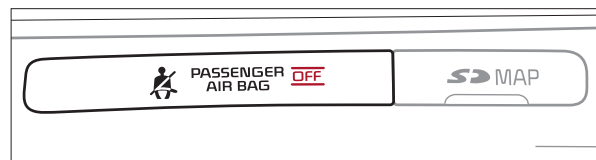

(Type B)

REMINDER: For more information about the seat belts and airbags in the vehicle, please refer to the Owner's Manual.

(up to 60,000 miles)^A

For Non-Turbo maintenance, see back cover

MAINTENANCE INTERVALS (MILES)

MAINTENANCE ITEMS - TURBO	6,000	12,000	18,000	24,000	30,000	36,000	42,000	48,000	54,000	60,000
Add fuel additive ^C	P	P	P	P	P	P	P	P	P	P
Rotate tires	P	P	P	P	P	P	P	P	P	P
Engine Oil & Filter	R	R	R	R	R	R	R	R	R	R
Climate control air filter	R	R	R	R	R	R	R	R	R	R
Battery condition	I	I	I	I	I	I	I	I	I	I
Brake lines, hoses and connections	I	I	I	I	I	I	I	I	I	I
Disc brakes and pads	I	I	I	I	I	I	I	I	I	I
Vacuum hose	I	I	I	I	I	I	I	I	I	I
Steering gear rack, linkage & boots	I	I	I	I	I	I	I	I	I	I
Drive shafts and boots	I	I	I	I	I	I	I	I	I	I
Suspension mounting joints	I	I	I	I	I	I	I	I	I	I
Air conditioner compressor/refrigerant	I	I	I	I	I	I	I	I	I	I
Propeller shaft	I	I	I	I	I	I	I	I	I	I
Exhaust system	I	I	I	I	I	I	I	I	I	I
Intercooler, in/out hose, air intake hose	I	I	I	I	I	I	I	I	I	I
Air cleaner filter		I		R		I		R		I
Brake fluid		I		I		I		I		I
Fuel tank air filter ^{+D}		I		I		I		I		I
Parking brake		I		I		I		I		I
Vapor hose, fuel filler cap and fuel tank		I		I		I		I		I
Cooling System				I		I		I		I
Fuel lines, hoses and connections				I				I		
Transfer case oil (AWD)				I				I		
Differential Oil, rear (without LSD)						I				
Differential Oil, rear (with LSD)						R				
Differential Oil, front (AWD) ^E						I				
Spark Plugs							R			
Valve clearance ^F										I
Drive belts (First 60,000 miles, then every 15,000 miles) ^G										I

QUICK TIP Check your Maintenance Schedule or schedule an appointment with a dealer using your UVO eServices account by logging into your UVO eServices App or your account on MyUVO.com (Vehicles equipped with UVO eServices only – See page 21 for setup information)

- ‡ If equipped.
- A. See the Owner's Manual for complete maintenance schedule. These are approximate estimated intervals. Refer to vehicle mileage for maintenance item schedule.
- B. And, if necessary, adjust, correct, clean or replace.
- C. If TOP TIER detergent gasoline is not available, one bottle of additive is recommended. Additives are available from your authorized Kia dealer along with information on how to use them. Do not mix other additives.
- D. Fuel filter & fuel tank air filter are considered to be maintenance free but periodic

inspection is recommended for this maintenance schedule depends on fuel quality. If there are some important safety matters like fuel flow restriction, surging, loss of power, hard starting problem etc., replace the fuel filter immediately regardless of maintenance schedule and consult an authorized Kia dealer for details.

E. Front/rear differential oil should be changed anytime they have been submerged in water.

F. Inspect for excessive tappet noise and/or engine vibration and adjust if necessary.

G. The drive belt should be replaced when cracks occur or tension is reduced excessively.

See your Owner's Manual for more details and complete maintenance information, including severe maintenance schedule. Warranty may be voided if maintenance schedule is not followed.

LEGAL DISCLAIMERS

Driving while distracted is dangerous and should be avoided. Drivers should remain attentive to driving and always exercise caution when using the steering-wheel-mounted controls while driving.

Driving while distracted can result in a loss of vehicle control that may lead to an accident, severe personal injury and death. The driver's primary responsibility is in the safe and legal operation of a vehicle, and use of any handheld devices, other equipment or vehicle systems which take the driver's eyes, attention and focus away from the safe operation of a vehicle or that are not permissible by law should never be used during operation of the vehicle.

Safety Features: No system, no matter how advanced, can compensate for all driver error and/or driving conditions. Always drive responsibly.

1. Purchase/lease of certain new Kia vehicles may include a complimentary UVO eServices subscription (length of subscription varies by vehicle model and year) starting from new vehicle retail sale/lease date as recorded by the dealer. After your complimentary UVO eServices subscription expires, your access to UVO eServices will immediately terminate. Use of UVO eServices is subject to agreement to the UVO Privacy Policy available at <https://www.myuvo.com/legal/privacy-policy.shtml> and Terms of Service (available at <https://www.myuvo.com/legal/terms-of-service.shtml>). UVO eServices transferrable to subsequent owner during the original UVO eServices service term. Only use UVO eServices when safe to do so. UVO eServices App is available from the App Store® or Google Play™ Store. Kia Motors America, Inc. reserves the right to change or discontinue UVO eServices at any time without prior notification or incurring any future obligation. Message and data rates may apply. Cellular and GPS coverage is required to use most features. UVO eServices features may vary by model, model year, and trim level. Features and specifications are subject to change. For more on details and limitations, visit <https://www.myuvo.com/> or your authorized Kia dealer. Google and logos are trademarks of Google, Inc. App Store is a service mark of Apple, Inc.
2. **Airbags:** For maximum protection, always wear your seat belt.
3. **Android Auto:** Android Auto is a trademark of Google, Inc.. Android™ is a registered trademark of Google, Inc. Distracted driving can result in a loss of vehicle control. Never use a handheld device or vehicle system that takes your focus away from safe vehicle operation. Navigation is for information purposes only, and Kia does not make any warranties about the accuracy of the information.
4. **Bluetooth® Wireless Technology:** A compatible Bluetooth® wireless technology-enabled cell phone is required to use Bluetooth® wireless technology. The Bluetooth® word mark and logos are registered trademarks owned by Bluetooth SIG, Inc. and any use of such marks by Kia is under license. Other trademarks and trade names are those of their respective owners. A Bluetooth® enabled cell phone is required to use Bluetooth® wireless technology.
5. **Driver Assist Features – Parking Distance Warning-Forward/Reverse, Blind-Spot Collision Warning with Lane Change Assist, Rear Cross-Traffic Collision Warning, Lane Departure Warning, Rear Camera Display, Forward Collision-Avoidance Assist / Forward Collision Warning:** These features are not substitutes for safe driving, and may not detect all objects surrounding vehicle. Always drive safely and use caution.
6. **Electronic Stability Control (ESC)/Traction Control System (TCS)/Hill-start Assist Control (HAC), Downhill Brake Control (DBC):** No system, no matter how advanced, can compensate for all driver error and/or driving conditions. Always drive responsibly.
7. **Engine Start/Stop Button with Smart Key:** Always come to a complete stop before turning the engine on or off. However, if you have an emergency while the vehicle is in motion and must turn the engine off, you can turn the engine off to the ACC position by pressing the Start/Stop button for more than 3 seconds or 3 times in succession. If the vehicle is still moving, you can restart the engine by pressing the Start/Stop button with the shift lever in Neutral (N). With the engine off, power assist for steering and braking will be disabled, and the vehicle will be more difficult to control.
8. **Front Seat Headrest Adjustment:** Never attempt to adjust headrests when vehicle is in motion.
9. **Google Play™ Store** is a trademark of Google, Inc. ©2018 Google Inc. All rights reserved. Google and the Google Logo are registered trademarks of Google Inc.
10. **HomeLink®:** HomeLink® is a registered trademark of Gentex Corporation.
11. **iPhone®/iPod®, Apple CarPlay™:** Apple CarPlay, iPhone, iPod are registered trademarks of Apple Inc. Distracted driving can result in a loss of vehicle control. Never use a handheld device or vehicle system that takes your focus away from safe vehicle operation.
12. **Navigation:** Distracted driving can result in a loss of vehicle control. When operating a vehicle, never use a handheld device or vehicle system that takes your focus away from safe vehicle operation. Navigation is for information purposes only, and Kia does not make any warranties about the accuracy of the information.
13. **Occupant Detection System (ODS):** Kia vehicles use a number of different ODS types that vary by model. Children age 12 and under should always be seated in the REAR seats.
14. **Power Liftgate/Smart Power Liftgate:** Driving with the trunk open may be unlawful and can draw dangerous exhaust fumes into your vehicle; if you choose to do so, keep air vents and all windows open for proper ventilation.
15. **Roadside Assist:** 24-hour Enhanced Roadside Assistance is a service plan provided by Kia Motors America, Inc. Certain limitations apply. Coverage details are available in the Kia Warranty and Consumer Information Manual. For access to Enhanced Roadside Assistance, a connected mobile phone via Bluetooth® within the cellular service coverage area is required.
16. **Seat adjustments:** Reclining the passenger seats can reduce the effectiveness of the safety restraint system and may lead to additional injury in an accident.
17. **Seat Belts / Airbags:** For maximum protection, always wear your seatbelt.
18. **Seat warmers:** Use extreme caution when using the seat warmers to avoid burns. Refer to the Owner's Manual for more information.
19. **SiriusXM®:** SiriusXM Satellite Radio, SiriusXM Traffic and SiriusXM Travel Link each require a subscription sold separately, or as a package, by SiriusXM Radio Inc. **If you decide to continue your service at the end of your trial subscription, the plan you choose will automatically renew and bill at then-current rates until you call 1-866-635-2349 to cancel. See SiriusXM Customer Agreement for complete terms at www.siriusxm.com.** Other fees and taxes will apply. All fees and programming are subject to change. Not all vehicles or devices are capable of receiving all services offered by SiriusXM. Data displays and individual product availability vary by vehicle hardware. Current information and features may not be available in all locations, or on all receivers. Weather Forecast, Current Conditions may not be available in all locations. Images above are for representative purposes only and are not real products. For actual features and images of real products, consult the vehicle manufacturer. SiriusXM is not responsible for any errors or inaccuracies in the data services or their use in the vehicle. Travel Link Stocks displays current price and daily delta of around 7,000 actively reported securities traded on the NYSE®, NASDAQ® and AMEX®. The service is delayed approximately 20 minutes. SiriusXM satellite service is available only to those at least 18 years of age in the 48 contiguous USA, DC, and Puerto Rico (with coverage limitations). SiriusXM Internet Radio service is available throughout our satellite service area and in AK and HI. © 2018 SiriusXM Radio Inc. Sirius, XM and all related marks and logos are trademarks of SiriusXM Radio Inc.
20. **Sportmatic®** is a registered trademark of Kia Motors America.
21. **Steering Wheel Controls:** Driving while distracted is dangerous and should be avoided. Remain attentive to driving and be cautious when using steering-wheel-mounted controls while driving.
22. **Sunvisors:** Sunvisor may not shield all direct light. Do not operate the vehicle if Sunvisor is impairing your visibility.
23. **Tilt/Telescoping Steering Wheel:** Never attempt to adjust steering wheel position when vehicle is in motion.
24. **Tire Pressure Monitoring System (TPMS):** Even with Tire Pressure Monitoring System, check tire pressure on regular basis.
25. **Vehicle Diagnostics:** Vehicle Diagnostics checks powertrain, chassis and air bag systems, and is not a substitute for maintenance. See UVO eServices Maintenance Feature or Owner's Manual for maintenance schedule.



KEY FEATURE WALKTHROUGH

Demonstrate the following with the customer

- Standard Audio System* – page 20
For more information, refer to the Owner’s Manual.

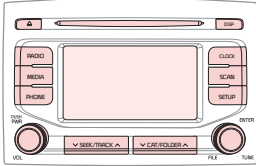

- UVO eServices / Android Auto™ / Apple CarPlay® Setup* – page 21

For further UVO eServices operations, refer to the Car Multimedia System User’s Manual. For other audio system information, refer to pages 20-23.

- UVO eServices* – page 22
For more information, refer to the Car Multimedia System User’s Manual.

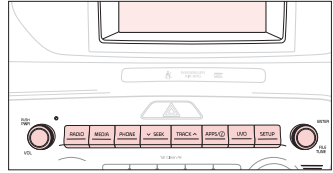

- UVO eServices with Premium Navigation* – page 23
For more information, refer to the Car Multimedia System User’s Manual.

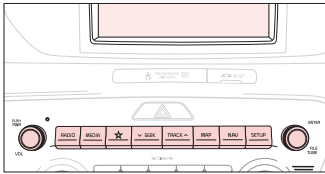

- Cruise Control – page 17
Demonstrate operation

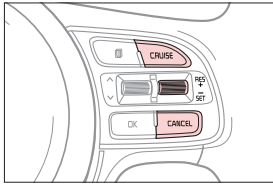

- Bluetooth® Wireless Technology – pages 18-19
Demonstrate operation

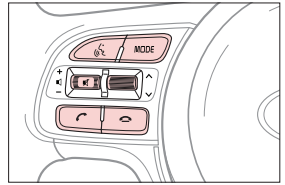

- ECO Mode (Active ECO) – page 8
- Parking Distance Warning-Forward* and Reverse* – page 30
- Digital Clock – page 24
- Engine Start/Stop Button* – page 13
- HomeLink® with Auto-Dimming Rearview Mirror* – page 36
- Panoramic Sunroof Operation* – page 37
- Passenger Airbag Off Indicator – page 42
- Rear-Camera Display – page 40

- Reclining/Folding Rear Seats – page 33
- Seat Warmers / Ventilated Seats* – page 31
- Smart Key* – page 34
- Sunvisor – page 40
- Tire Pressure Monitoring System (TPMS) – page 5
- Aux/USB/iPod® Port, Power Outlets & USB Charger – page 24

DURING DELIVERY

*if equipped

- Explain first service process and schedule first service appointment
- Tour Parts & Service departments, introduce staff & explain value of Kia Parts and Service
- Review recommended maintenance schedule and maintenance requirements to validate warranty
- Review business hours & Customer 360° Care
- Review the Kia 10-year/100,000-mile warranty program
- Ensure 100% satisfaction with sales and delivery process and no problems with the vehicle
- Confirm time and best contact number for initial dealer follow-up

Sales Consultant: _____ Date: _____

Sales Manager: _____ Date: _____

Customer: _____ Date: _____



SPORTAGE CUSTOMER DELIVERY CHECKLIST

Owner's Name: _____ VIN: _____ Mileage: _____

Dealership Name: _____ Sales Consultant: _____ Date: _____

BEFORE DELIVERY

- Test and confirm "Good Battery" using the Kia GR8-1299 battery tester and affix Results Label
- Verify all tire pressures are to spec (see driver's door label) LF_____ LR_____ RF_____ RR_____
- Verify proper operation of Remote Keyless Entry and Smart Key lock/unlock
- Ensure floor mats are snapped into place (if applicable)
- Verify vehicle is clean (interior and exterior), in good condition and free of chips and scratches
- Ensure all key documents are in the vehicle (Owner's Manual, Warranty and Consumer Information booklet, Tire Warranty booklet and Features & Functions Guide and any Audio System User's Manual)

KEY FEATURE WALKTHROUGH

- Air Conditioning / Climate Control – pages 25-26
Demonstrate Air Flow modes, Defogging and Defrosting Windshield

Automatic*

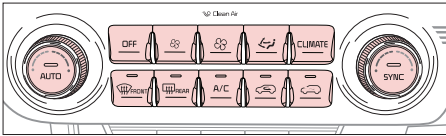

Manual*

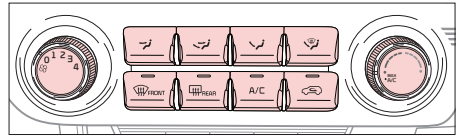

- Windshield Wipers & Washers – page 16

To operate:

- Move lever Up/Down to change Wiper modes
- Rotate INT switch to adjust Intermittent Wipe Speed
- Pull lever to spray and wipe

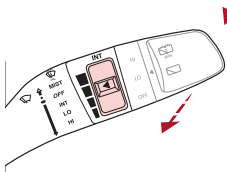

- MIST: Single wipe
- OFF: Wiper off
- INT: Intermittent wipe
- LO: Slow wipe
- HI: Fast wipe

- Rear Wiper & Washer – page 16

To operate:

- Rotate Rear Wiper switch to change Wiper modes
- Push lever to spray and wipe

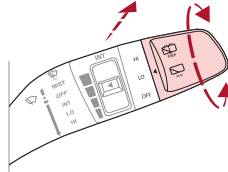

- ON: Normal wipe
- INT: Intermittent wipe*
- OFF: Wiper off



SPORTAGE NORMAL MAINTENANCE SCHEDULE NON-TURBO

P=Perform • R=Replace • I=Inspect^B

(up to 60,000 miles)^A

For Turbo maintenance, see page 44

MAINTENANCE ITEMS	MAINTENANCE INTERVALS (MILES)								
	7,500	15,000	22,500	30,000	37,500	45,000	52,500	60,000	
Add fuel additive ^C	P	P	P	P	P	P	P	P	
Rotate tires	P	P	P	P	P	P	P	P	
Engine Oil & Filter	R	R	R	R	R	R	R	R	
Climate control air filter	R	R	R	R	R	R	R	R	
Battery condition	I	I	I	I	I	I	I	I	
Brake lines, hoses and connections	I	I	I	I	I	I	I	I	
Brake discs and pads	I	I	I	I	I	I	I	I	
Vacuum hose	I	I	I	I	I	I	I	I	
Steering gear rack, linkage & boots	I	I	I	I	I	I	I	I	
Drive shafts and boots	I	I	I	I	I	I	I	I	
Suspension ball joints	I	I	I	I	I	I	I	I	
Air conditioner compressor/refrigerant	I	I	I	I	I	I	I	I	
Propeller shaft (AWD)	I	I	I	I	I	I	I	I	
Exhaust system	I	I	I	I	I	I	I	I	
Air cleaner filter	I	I	I	R	I	I	I	R	
Brake fluid		I		I		I		I	
Fuel tank air filter ^{†‡}		I		I		I		I	
Parking brake		I		I		I		I	
Vapor hose and fuel filler cap		I		I		I		I	
Cooling System				I		I		I	
Fuel lines, fuel hoses and connections				I				I	
Transfer case oil (AWD) [‡]				I				I	
Rear Axle Oil (AWD) [‡]				I				I	
Valve clearance ^F								I	
Drive belts (First 60,000 miles, then every 12,000 miles) ^G								I	

QUICK TIP Check your Maintenance Schedule or schedule an appointment with a dealer using your UVO eServices account by logging into your UVO eServices App or your account on MyUVO.com (Vehicles equipped with UVO eServices only – See page 21 for setup information)

- ‡ If equipped
- A. See the Owner's Manual for complete maintenance schedule. These are approximate estimated intervals. Refer to vehicle mileage for maintenance item schedule. For Turbo Maintenance intervals, see page 44.
- B. And, if necessary, adjust, correct, clean or replace
- C. If TOP TIER detergent gasoline is not available, one bottle of additive is recommended. Additives are available from your authorized Kia dealer along with information on how to use them. Do not mix other additives

D. Fuel filter & fuel tank air filter are considered to be maintenance free but periodic inspection is recommended for this maintenance schedule depends on fuel quality. If there are some important safety matters like fuel flow restriction, surging, loss of power, hard starting problem etc., replace the fuel filter immediately regardless of maintenance schedule and consult an authorized Kia dealer for details

E. Front/rear differential oil should be changed anytime they have been submerged in water

F. Inspect for excessive tappet noise and/or engine vibration and adjust if necessary

G. The drive belt should be replaced when cracks occur or tension is reduced excessively

See your Owner's Manual for more details and complete maintenance information, including severe maintenance schedule. Warranty may be voided if maintenance schedule is not followed.

© 2018 Kia Motors America, Inc. All rights reserved.
Consumer - Roadside Assistance^{†††}: 1-800-333-4KIA (4542)

Part Number: UL-190-PS-004

†LEGAL DISCLAIMERS ON BACK INSIDE COVER