

**VS1 AND THE VOICE SYNTHESIZER EDITOR
INSTRUCTION MANUAL**

4/12/94

COPYRIGHT (c) 1994 CAMPBELL SCIENTIFIC, INC.

WARRANTY AND ASSISTANCE

The **VS1 AND THE VOICE SYNTHESIZER EDITOR** is warranted by CAMPBELL SCIENTIFIC, INC. to be free from defects in materials and workmanship under normal use and service for twelve (12) months from date of shipment unless specified otherwise. Batteries have no warranty. CAMPBELL SCIENTIFIC, INC.'s obligation under this warranty is limited to repairing or replacing (at CAMPBELL SCIENTIFIC, INC.'s option) defective products. The customer shall assume all costs of removing, reinstalling, and shipping defective products to CAMPBELL SCIENTIFIC, INC. CAMPBELL SCIENTIFIC, INC. will return such products by surface carrier prepaid. This warranty shall not apply to any CAMPBELL SCIENTIFIC, INC. products which have been subjected to modification, misuse, neglect, accidents of nature, or shipping damage. This warranty is in lieu of all other warranties, expressed or implied, including warranties of merchantability or fitness for a particular purpose. CAMPBELL SCIENTIFIC, INC. is not liable for special, indirect, incidental, or consequential damages.

Products may not be returned without prior authorization. To obtain a Returned Materials Authorization (RMA), contact CAMPBELL SCIENTIFIC, INC., phone (435) 753-2342. After an applications engineer determines the nature of the problem, an RMA number will be issued. Please write this number clearly on the outside of the shipping container. CAMPBELL SCIENTIFIC's shipping address is:

CAMPBELL SCIENTIFIC, INC.

RMA# _____
815 West 1800 North
Logan, Utah 84321-1784

CAMPBELL SCIENTIFIC, INC. does not accept collect calls.

Non-warranty products returned for repair should be accompanied by a purchase order to cover the repair.



CAMPBELL SCIENTIFIC, INC.

815 W. 1800 N.
Logan, UT 84321-1784
USA
Phone (435) 753-2342
FAX (435) 750-9540
www.campbellsci.com

Campbell Scientific Canada Corp.
11564 -149th Street
Edmonton, Alberta T5M 1W7
CANADA
Phone (403) 454-2505
FAX (403) 454-2655

Campbell Scientific Ltd.
Campbell Park
80 Hathern Road
Shepshed, Leics. LE12 9RP
ENGLAND
Phone (44)-50960-1141
FAX (44)-50960-1091

VS1 AND THE VOICE SYNTHESIZER EDITOR

1. INTRODUCTION TO VS1 AND VS1 VOICE SYNTHESIZER EDITOR

- Bell 212A and CCITT V.22 Compatible
- Full Duplex at 300/1200 Baud
- Hayes "AT" Command Set
- RJ11C Modular Telephone Jack
- Tone Dialing
- Direct connection to and powered by a CSI CR10 datalogger.
- Signal level connects/disconnects 5 VDC external power minimizing current drain.

The VS1 Voice Synthesizer is a 300/1200 baud modem voice synthesizer, that uses the Hayes "AT" command set.

The CR10 that will be communicating with the VS1 will require a special UVEPROM in order for the system to operate.

The VS1 can be operated as a remote site modem connected to a CR10 datalogger and used to transmit, by voice, real-time data stored in the datalogger to the end user. A touch-tone phone must be used to access the voice synthesis functions. The VS1 will not work with the older pulse-style phones. A Hayes or Hayes-compatible modem must be at the computer site to use the VS1 as a standard modem.

The voice synthesizer is powered and enabled by the battery powered datalogger. When the voice synthesizer is disabled, it will draw less than 50µA from the datalogger 5VDC output.

The VS1 Voice Synthesizer Editor is used to adapt user-created *.DLD files to work with the datalogger and the voice synthesis functions in the VS1.

The VS1 can also be used as an originate modem at the datalogger site. This allows the user to program the datalogger to call specific phone numbers when certain preprogrammed conditions are met. For more information, refer to Section 8.4 in this manual and to the CR10 Operator's Manual regarding Instruction 97.

2. SPECIFICATIONS

2.1. VS1 VOICE SYNTHESIZER

Current Drain:

ON HOOK(Quiescent state)-approx. 50µA.

OFF HOOK(Voice transmitting)-approx. 110 mA.

OFF HOOK(Data transmitting)-approx. 75 mA.

Voltage Supply Requirements:

A single 5 VDC-regulated supply. This supply is from the CR10.

Operational Temperature Range:

-25°C to +50°C

Humidity:

If the VS1 Voice Synthesizer is installed in a remote site that is exposed to the elements, we recommend using a NEMA Class 4 enclosure with a desiccant pack to control humidity. Comparable enclosures are the CSI model number ENC 12/14 with desiccant pack part number 4905.

Installation in a building at standard room temperature and humidity should not present a problem.

Size:

5.15" X 1.675" X 3.615"

13.08 cm X 4.25 cm X 9.18 cm

Weight:

12.2 oz.

0.346 Kg.

Additional Specifications:

Equipment complies with FCC Rules Part 68.

Equipment complies with requirements in Part 15 of FCC Rules for Class A computing devices.

FCC Registration No. - B9QUSA-75378-MM-T

Ringer Equivalence No. (REN) - 0.6B

Canadian Load No. 5

Required Connector - USOC RJ11C

Screw terminals for - GND, RING, and TIP.

VS1 AND VOICE SYNTHESIZER EDITOR

2.2. VS1 VOICE SYNTHESIZER EDITOR SOFTWARE

The VS1 requires an IBM or IBM-compatible computer with at least 256K of available RAM memory, along with DOS 2.1 or greater. It requires an 80-column by 25-line monitor. This monitor can be Monochrome, Text, CGA, EGA, VGA, etc.

The VS1 Voice Synthesizer Editor can be run from the floppy drive, but it is recommended to install the software package on a hard drive. See Section 4 in this manual for hard drive installation instructions.

3. HARDWARE INSTALLATION

3.1. INTERNAL JUMPER SETTINGS

The VS1 Voice Synthesizer has five user-changeable jumpers. Table 3-1 lists jumper settings and their meaning along with factory settings. See Figure 3-1 for jumper locations.

3.2. UVEPROM INSTALLATION IN THE CR10

Your CR10 will require a special UVEPROM in order to work properly with the VS1. If the VS1 UVEPROM was not installed at the factory, refer to the CR10 Operator's Manual, Appendix G or to Appendix A in this manual for installation instructions.

3.3. SITE INSTALLATION

Your VS1 is designed to be used on standard device telephone lines. The VS1 connects to the telephone line by means of a USOC RJ11C jack (standard modular telephone jack).

Connection to telephone company-provided COIN service (Central Office ImplemeNted systems) is prohibited. Connection to party line service is subject to state tariffs.

TABLE 3-1. VS1 Internal Jumper Settings

<u>JUMPER</u>	<u>PINS</u>	<u>MEANING</u>	<u>FACTORY SETTING</u>
1. D8	1 TO 2	RESULT CODES ENABLED	JUMPER IN PLACE
2. D8	3 TO 4	AUTO-ANSWER DISABLED	JUMPER NOT IN PLACE
3. D8	5 TO 6	ENABLE CCITT V.22	JUMPER NOT IN PLACE
4. C8	1 TO 2	ENABLE VOICE SYNTHESIZER	JUMPER IN PLACE
5. J4	1 TO 2	ENABLES MODEM ENABLE	JUMPER NOT IN PLACE
JUMPER 1:	Result codes are sent to your terminal screen.		
JUMPER 2:	Auto answer is disabled by putting the jumper in place. This option is used only when the modem is not to answer a call.		
	For example: The VS1 is connected to a phone line which is to be used for both voice and modem communication. In this situation it its best to have the datalogger call the computer.		
JUMPER 3:	Selects Bell 212A (U.S. and Canada) or CCITT V.22 (Foreign). This does not mean that the VS1 is tested and approved for all foreign countries.		
JUMPER 4:	Selects the option to hear voice synthesis communication over the lines. Jumper 5 needs to be OFF for voice synthesis to occur.		
JUMPER 5:	This option is to be used when talking with dataloggers other than the CR10 or when talking via modem only. Jumper 4 needs to be OFF when this jumper is in place.		

If the unit is mounted where there is a standard modular phone plug available then connect the phone cable provided with the VS1 from the modular wall plug to the VS1, as shown in Figure 3-2.

Connect the 14 AWG grounding wire (provided with the VS1) to the grounding terminal (GND)

on the VS1. Connect the other end to the CR10 ground (G) on the wiring panel. If the enclosure has a grounded bus bar, then connect the ground wire to the bus bar instead of the datalogger ground. The datalogger ground should be tied to earth ground. See Section 14.7 in the CR10 Operator's Manual.

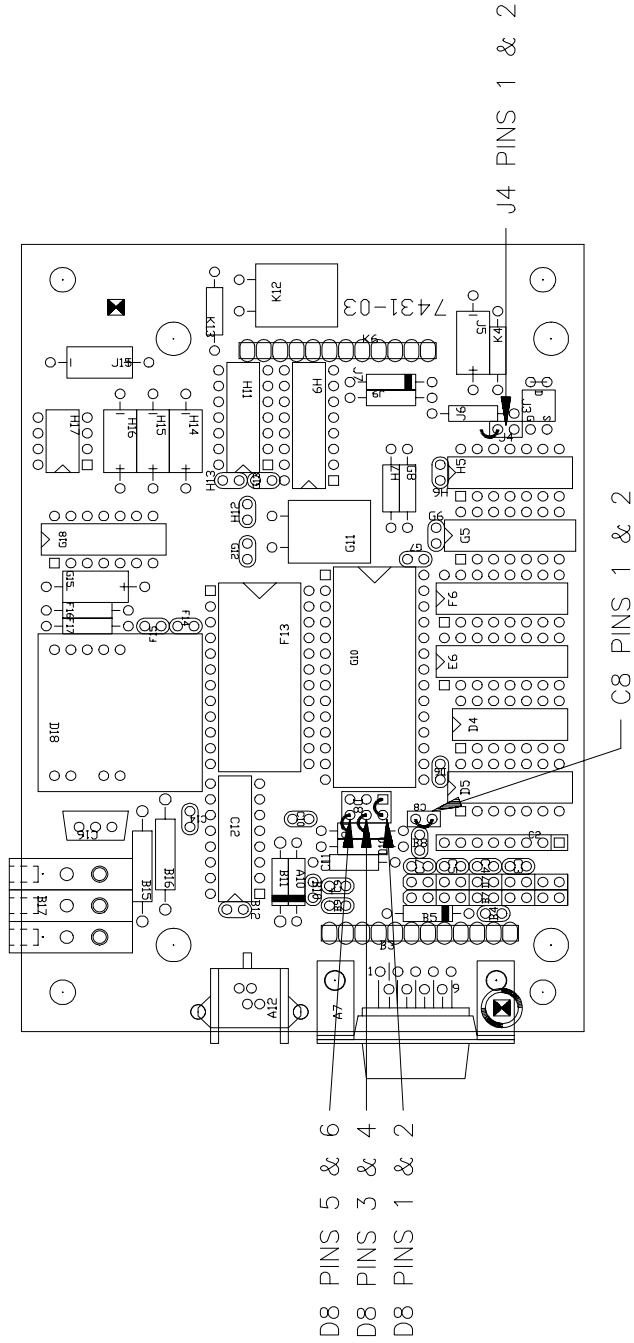

FIGURE 3-1. VS1 Jumper Locations

VS1 AND VOICE SYNTHESIZER EDITOR

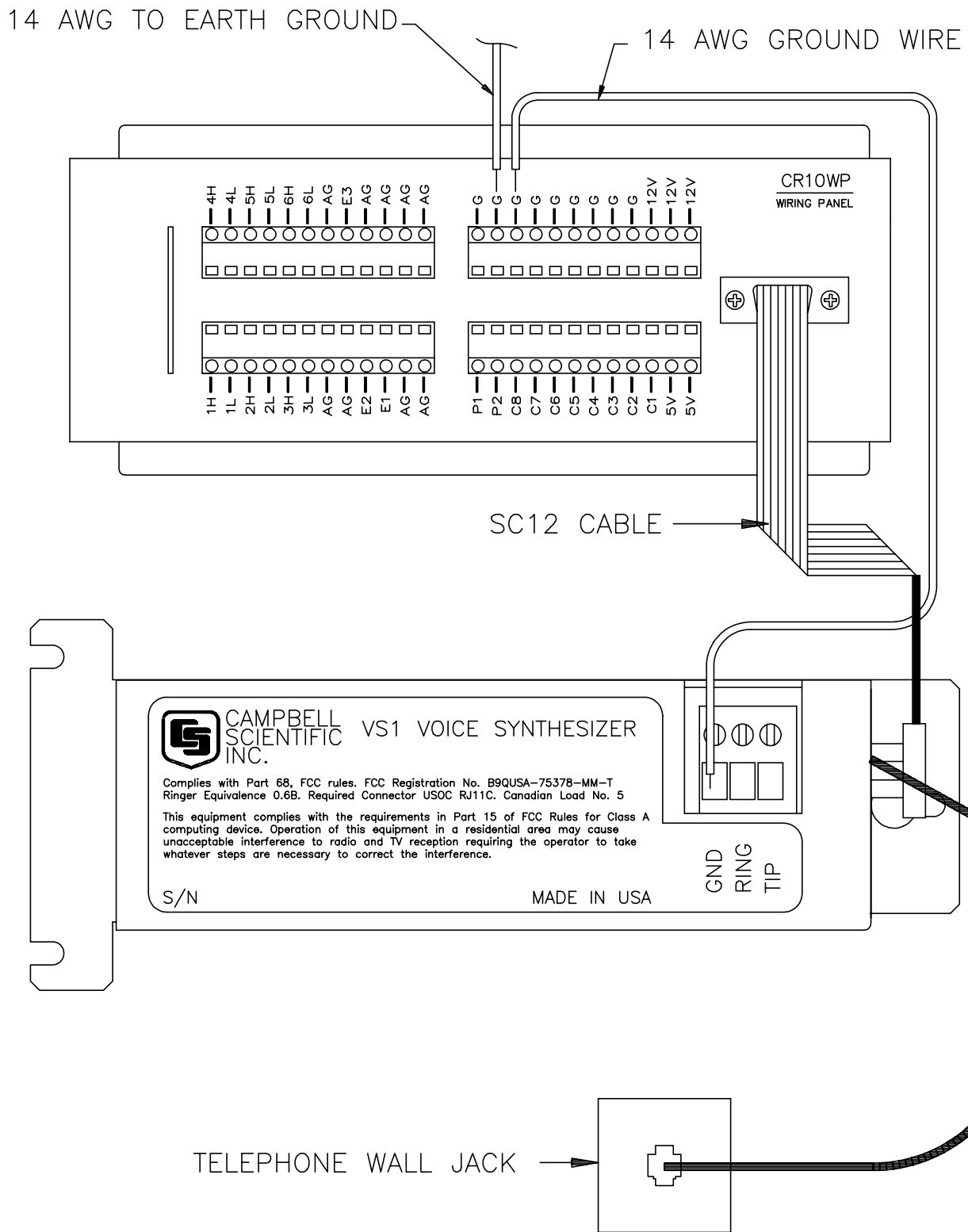

FIGURE 3-2. Standard Telephone Jack Connection

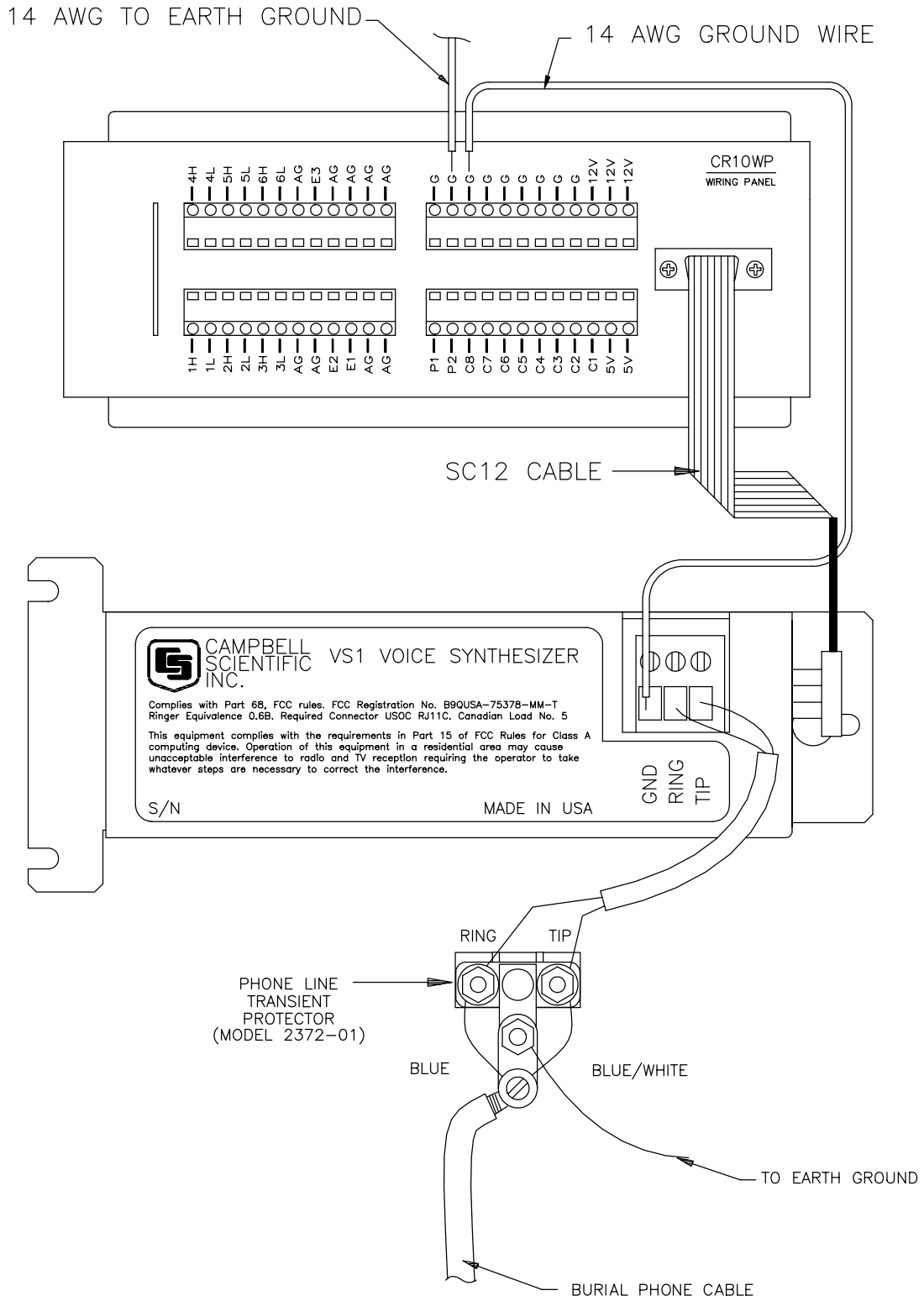

FIGURE 3-3. Remote Site Connection

VS1 AND VOICE SYNTHESIZER EDITOR

Remote datalogger installations require a telephone transient surge protector (P/N 6362 for enclosure mount. P/N 2372-01 for direct replacement) unless the telephone company confirms a surge protector has already been installed at the remote site. See Figure 3.3.

If a burial phone line and a telephone transient surge protector are used, attach the wires to the VS1 as shown in Figure 3-3.

NOTE: It is important that the datalogger and VS1 are well grounded to an earth ground to ensure proper operation.

Connect the VS1 to the CR10 via the SC12 Cable. Neither the CR10 or the VS1 use RS232 Serial I/O type pin outs or protocols to communicate. If you would like more information on what each pin does on the CR10 please refer to the CR10 Operator's Manual, Section 6 on 9 PIN SERIAL INPUT/OUTPUT or to Appendix B in this manual.

If any of your telephone equipment is not operating properly, you should remove it immediately from your telephone line, as it may cause harm to the telephone network. If the telephone company notes a problem, they may temporarily discontinue service. When practical, they will notify you in advance of this disconnection. If advance notice is not feasible, you will be notified as soon as possible. When you are notified, you will be given the opportunity to correct the problem and informed of your right to file a complaint with the FCC.

For assistance in installation or for repair, call or write to:

Campbell Scientific, Inc.
815 West 1800 North
Logan, UT 84321-1784
(801) 753-2342.

To comply with FCC Rules and Regulations, all repairs on the VS1 will be performed by Campbell Scientific, Inc. or an authorized agent of Campbell Scientific, Inc.

In order to provide you with the best service, it may be necessary for the telephone company to make occasional changes in their equipment, operations, or procedures. If these changes might affect your service or the operation of your equipment, the telephone company will

give you notice in writing to allow you to make any changes necessary to maintain uninterrupted service.

If you have any questions about your telephone line, such as how many pieces of equipment you can connect to it, the telephone company will provide this information upon request.

In certain circumstances, it may be necessary for the telephone company to request information from you concerning the equipment which you have connected to your telephone line. In this instance, provide the FCC registration number and the Ringer Equivalence Number (REN) of the equipment which is connected to your line; both of these items are listed on the equipment label and Section 2.1 of this manual. The sum of all of the RENs on your telephone lines should be less than five in order to assure proper service from the telephone company. In some cases, a sum of five may not be usable on a given line.

For theory of operation on the modem part of the VS1 and an "AT" command summary please refer to Appendix E.

4. SOFTWARE INSTALLATION

The VS1 Voice Synthesizer Editor can be run directly off the floppy disk you received with the VS1. We recommend copying the disk to your hard drive. It is always a good idea to make a back up copy of your original disks and then archive the originals. The disk is not copy protected.

Follow normal DOS COPY command procedures to load the VS1 Voice Synthesizer Editor onto your hard drive. The files necessary to run the editor are: VS1.EXE and VOICE.TXT. If there is room on the hard drive, load the example file called EXMPL1.DLD. This file will be used later.

5. USING THE VS1 FOR MODEM COMMUNICATIONS

In order to download files to your datalogger via modem you will need to modify the phone number in GRAPHTERM or TERM. Insert three commas and "**9" at the end of the phone number for your datalogger.

For example, if the number of your datalogger is "555-4321" you would need to make the following additions: "555-4321,,,*9".

The commas add delays so the VS1 has time to recognize the "*9". The "*9" disables the voice synthesizer and sets the VS1 to operate as a standard 1200 baud modem. By inserting extra commas into the phone number string, you can usually correct communication problems with the VS1. This is particularly true if the call is long distance.

6. DOWNLOADING AND COMMUNICATING WITH THE VS1

Let's take a brief tour through the VS1. The VS1 Voice Synthesizer will allow you to monitor preconfigured input locations in the datalogger as well as check or manipulate flags and ports.

For this example you will need to have the datalogger attached to the VS1 and all phone lines connected.

Using GRAPHTERM or TERM, download EXMPL1.DLD to the datalogger. Make sure the datalogger is connected to the VS1. Quit GRAPHTERM or TERM after downloading EXMPL1.DLD.

NOTE: The datalogger does not need to be connected to the VS1 to download a program to it. You can download your program via an SC32A interface, or a storage module, to the datalogger and then connect it up with the VS1.

6.1. INPUT LOCATIONS

Using a standard touch-tone phone, call up the datalogger. After connecting you should hear:

Campbell Scientific datalogger program.
Datalogger internal temperature is (some value) degrees Fahrenheit.
Press "1" for input locations.
Press "2" for ports.
Press "3" for flags.
Press "pound" to hear menu again.
Press "star" to disconnect.

The first two lines of the spoken message are called the "Initial Message". This message is created by the user using the VS1 Voice Synthesizer Editor. Pressing the "#" symbol on

the telephone keypad will cause the VS1 to repeat what is listed above. Pressing the "*" symbol will cause the VS1 to say "goodbye" and disconnect the phone.

For right now let's only look at the input locations. Press "1" on your touch-tone phone. You should hear:

You have selected to monitor input locations.
Press the pound key following your selections.
Press "1" for datalogger internal temperature.
Press "2" for datalogger battery voltage.
Press "pound" to hear menu again.
Press "star" for previous menu.

Press "1" followed by "#" on your touch-tone phone. You should hear:

Campbell Scientific datalogger program.
Datalogger internal temperature is (some value) degrees Fahrenheit.
Press "pound" to hear menu again.
Press "star" for previous menu.

Press "2" followed by "#" on your touch-tone phone. You should hear:

Datalogger battery voltage is (some value) volts.
Press "pound" to hear menu again.
Press "star" for previous menu.

Let's back completely out of the VS1 and disconnect the phone. Press "*" followed by another "*" on your touch-tone phone. You should hear the VS1 say "goodbye" and then disconnect the phone.

Pressing the "#" key by itself will cause the VS1 to repeat the menu of the input locations and the main menu. The "#" key will not cause the menu to be repeated in the flag or port menus. Pressing the "*" key will always back you up to the previous menu, unless you are in the main menu. There, the "*" will cause the VS1 to disconnect the phone.

You do not have to wait for the voice to finish speaking before pressing keys. If you know the input location you want to hear just press the correct sequence of keys without waiting for the voice to finish speaking.

For example, to hear the datalogger battery voltage without waiting for the voice to finish the initial message, call up the VS1 and press the following sequence of keys after the line has connected: "1", "2", "#". You should hear:

VS1 AND VOICE SYNTHESIZER EDITOR

Datalogger battery voltage is (some value) volts.
Press "pound" to hear menu again.
Press "star" for previous menu.

If you don't wish to hear the rest of the message after hearing what the datalogger voltage level is press "*", "*". You should hear the VS1 say "goodbye" and disconnect the phone. The first "*" exits you out of the input locations menu to the main menu. The second "*" causes the VS1 to disconnect the phone.

6.2. FLAGS AND PORTS

Monitoring and changing the status of flags and ports is almost identical. For this exercise, let's work only with the flags.

Call up the VS1 using your phone and at the main menu press "3" on the phone keypad to get to the flag menu. You should hear:

You have selected the flag menu.
Press "1" through "8" to monitor status of flag.
Press "star" for previous menu.

Let's look at flag #2. Press "2" on the phone keypad. You should hear:

Flag two is low.
To toggle flag press "pound", "pound."
Press "star" to return to previous menu.
Press "1" through "8" to monitor flag status.

Let's toggle flag #2. Press "#", "#". You should hear:

Flag two is high.
To toggle flag press "pound", "pound."
Press "star" to return to previous menu.
Press "1" through "8" to monitor flag status."

Before disconnecting let's return flag #2 to its original condition. Press "#", "#". You should hear:

Flag two is low.
To toggle flag press "pound", "pound."
Press "star" to return to previous menu.
Press "1" through "8" to monitor flag status.

This is exactly what we had before. Press "*", "*" to disconnect.

You can skip listening to the VS1 and go directly to the port or flag menu if you know what flag or port you wish to monitor or toggle. You can go through the identical steps above with the ports menu.

WARNING: There is an inherent hazard to being able to toggle ports and flags over the phone. Anybody who has the phone number to the datalogger can call up and toggle ports and flags. You might be using the flags to control sections of your program in the datalogger, or you might be using the ports to control external circuitry. The VS1 has the capability of using a security code to lock out callers from everything but the initial message information. See Section 8.1 in this manual on generating and using the security code.

7. USING THE VS1 VOICE SYNTHESIZER EDITOR

7.1. GETTING STARTED

EDLOG is used to create the initial *.DLD files and the VS1 Voice Synthesizer Editor has to modify those files to work with the VS1. From now on, let's refer to the VS1 Voice Synthesizer Editor simply as the Editor.

Make sure EXMPL1.DLD is in the same directory as the VS1.EXE file. It doesn't have to be in the same directory, but it will make using the Editor easier.

The Editor can be used with a mouse or with a keyboard. Only the left mouse button is used in VS1. Both mouse and keyboard use will be explained. If you have a keyboard and a mouse you can use either mouse or keyboard, or use combinations of both.

Instructions for mouse use will be preceded with the symbol:



Instructions for keyboard use will be preceded with the symbol:



The instructions for both the mouse and the keyboard will be separated from the text by rules.

 The following convention will be used concerning keyboard keys. Special use keys will be surrounded by <>. For example, when you are requested to press the "Enter" key it will look like this: press <Enter>. Combinations of keys, such as pressing the "Alt" key simultaneously with the "F3" key will look like this: press <Alt> <F3>.

Enter the Editor by typing "VS1" <Enter>. You should see a screen similar to Figure 7-1. Let's describe each of the main menu options. Through practice you should get a thorough understanding of each option. VS1 will always come up with the FILE main menu option highlighted unless a particular file is specified at the time VS1 is booted up. There are several ways to move from option to option.

 Put the mouse cursor anywhere on the main menu option you want and click the left mouse button to select.

 For keyboard use do the following:

- Use the right or left arrow keys to highlight a different main menu option.
- Press and hold <Alt> followed by the first letter of the main menu option. Release both keys together.

Let's describe each individual main menu option and suboption starting with the FILE main menu option. Use the keyboard or the mouse to highlight FILE.

7.2. THE FILE MAIN MENU OPTION

Don't select any of the suboptions at this time. The various suboptions and a brief description under the FILE option are as follows:

NEW FILE - opens a user selected *.DLD file to be edited.

SAVE - saves the present *.DLD file that has been loaded into VS1 for editing.

SAVE AS - allows you to save the present file being edited under a different file name.

ABOUT - gives a brief description of the VS1 Editor and its version number.

EXIT - leaves the VS1 editing environment and returns you to the DOS prompt. VS1 will warn you if you try to exit without saving a file previously selected for editing.

You can also exit VS1 from the main menu by pressing <Esc>.

 If you have a mouse, place the mouse cursor on the suboption you want and click the left mouse button to select.

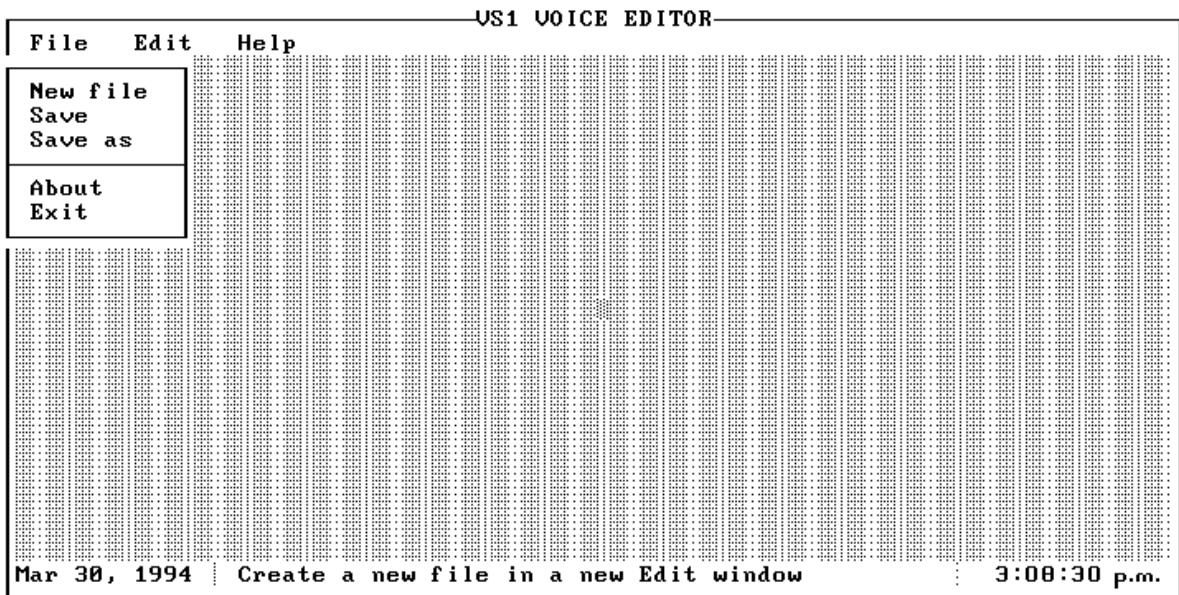

FIGURE 7-1. VS1 Text Editor Initial Window



From the keyboard you can select a suboption by:

- Pressing the key on the keyboard that matches the highlighted key on each suboption. For example, to get the SAVE suboption you would press <S> on the keyboard.
- Using the up or down arrow keys to highlight different suboptions, then press <Enter>.

Let's go through and explain each of the main options and suboptions first. Highlight the EDIT option.

7.3. THE EDIT MAIN MENU OPTION

Moving through and selecting the various suboptions while in the EDIT main menu option is the same as described in the FILE option. If you try to select any of these options without opening a new file you will get an INFORMATION error message. These functions only work when there is a *.DLD file loaded in the editor. Let's go through and explain each of the suboptions.

EDIT LINE - edits the highlighted line in the editor.

DELETE LINE F3 - deletes the highlighted line in the editor. You can also delete a highlighted line by pressing <F3>.

INSERT LINE F4 - inserts a line in the highlighted location. You can also insert a line by pressing <F4>. If you try to insert a line at a location that already contains text the new line will be inserted above the old. See Section 7.5 for more information.

STRING MENU - creates a security code to lock callers out from changing flags or ports. Allows the user to change the VS1 default words used to describe the input location menu string, port menu string, and flag menu string. See Section 8 in this manual for more details.

INITATE CALL - associates particular flag settings in the CR10 with phone numbers to call in an initiate call situation. This command is used in conjunction with Instruction 97 used with the CR10. See Section 8.4 in this manual for more details.

Again, don't select any of the suboptions. Now highlight the HELP main menu option.

7.4. THE HELP MAIN MENU OPTION

Notice there is only one suboption. Go ahead and select it by using the mouse or a keyboard. A help window will appear in the middle of your computer screen. Help windows can be called up from anywhere in the Editor.



To erase the window using a mouse, put the mouse cursor on the OK box or on the small solid square in the upper left corner of the help window and click the left mouse button. This will put you back to the FILE main menu option.



To erase the window press <Enter>, <O>, or <Esc>.

7.5. EDITING EXAMPLE USING EXMPL1.DLD

Let's go through and analyze EXMPL1.DLD and see how the initial messages were created. We will also do some modifications.

Enter the Editor and get into the FILE main menu option. Select NEW FILE. The CHOOSE A FILE window should appear in the center of your screen.

Notice the cursor is in the NAME: area. The cursor is presently in the INSERT mode. You can identify this by a large blinking cursor. Press <Ins> and notice the cursor changes to a line in size. The cursor is now in TYPEOVER mode. Press <Ins> again to get the cursor back in INSERT mode. The cursor is set to come up in INSERT mode wherever you are allowed to type in text.

Only files that end with .DLD can be edited by the Editor. You can select files for editing a number of different ways.



If you have a mouse, you can select a file in the following ways:

- If you need to change directories put the mouse cursor either on DIRECTORIES or somewhere in the directories area and click the left button. DIRECTORIES should be highlighted. Put the mouse cursor on the correct directory and click the left mouse button to highlight it.

To select the directory, quickly double click the left mouse button while the mouse cursor is on the highlighted

directory or put the mouse cursor on OK and click the left mouse button.

If the number of directories to choose from exceeds 11, you will see a vertical bar appear on the right side of the DIRECTORIES: area. You can move through the directories several ways. To move quickly through the directory selection put the mouse cursor somewhere on the vertical bar and click the left mouse button. You will soon learn where you need to click on the bar to move quickly through the directories.

To move slowly through the directories, put the mouse cursor on the up or down arrow located on the vertical bar. Click and release the left mouse button to move slowly through the listing or click and hold the left mouse button to scroll faster. Release the left mouse button to stop scrolling. Use the same methods described above to select the directory you want.

Notice the moving rectangle in the vertical bar as you scroll through the directories. This rectangle indicates your place in the directory listing.

- Select a file by putting the mouse cursor either on FILES: or somewhere in the files area and then clicking the left mouse button. Selecting a file is done the same way you select directory, except that as soon as you select a file you will enter the editing environment and exit the CHOOSE A FILE window.



From the keyboard you can do the following:

1. While in the NAME: area type in the name of the file you wish to edit and press <Enter>. If the file is in a different drive and/or directory then type in the path and then the name of the file. You must include the .DLD extension on the file name. The cursor can be moved around in the NAME: area using the right or left arrow keys.

2. Use the <Tab> key to highlight DIRECTORIES: If the *.DLD file is in a different drive or directory. Use the up or down arrow key to highlight the drive and/or directory. To scroll quickly through the selections press and hold the arrow key. To stop scrolling release the arrow key. Once the correct drive and/or directory is highlighted press <Enter> to select the drive and/or directory or <Tab> over and highlight the OK and press <Enter>.
3. After you are in the correct drive and/or directory, use the <Tab> key or <Shft> <Tab> to highlight the FILES: section. Use the up or down arrow keys to move through the files and highlight the file you wish to edit. You can scroll with the <PgUp> and <PgDn> keys.

At the bottom of the CHOOSE A FILE window you will see the present directory, file name presently highlighted, and file creation date information. Press <Enter> to select the file for editing, or use <Tab> to highlight OK and press <Enter>.

Only 11 files or drive/directories will show in the FILES: or DIRECTORIES area at any given time. If you would like to move through the files or directories faster, use <PgUp> and <PgDn>.



If you need help while in the CHOOSE A FILE window, place the mouse cursor on HELP and click the left mouse button. To exit the HELP window, either place the cursor on OK or on the solid square in the upper left hand corner of the HELP window and click the left mouse button.



For keyboards, either <Tab> over to HELP and press <Enter>, or press <Alt> and <H> simultaneously and release. To exit the HELP window, press <Enter>, <Esc>, or <O>.

The CANCEL option in the CHOOSE A FILE window will cause the window to close with no choices being made. If there are no files loaded into the Editor you will get an INFORMATION warning asking you if you want to quit or continue. Selecting QUIT will exit you out of the Editor and back into DOS. Selecting CONTINUE will take you back to the CHOOSE A FILE window.

VS1 AND VOICE SYNTHESIZER EDITOR



To select CANCEL using a mouse, place the mouse cursor on CANCEL and click the left mouse button. Placing the mouse cursor on the solid square in the upper left hand corner of the CHOOSE A FILE window and then clicking the left mouse button has the same effect as the CANCEL option.



You can select CANCEL from the keyboard by using <Tab> or <Shift> <Tab> to highlight CANCEL and then press <Enter>. Pressing <Esc> has the same effect as the CANCEL option.

Select EXMPL1.DLD from the FILES: area. The CHOOSE A FILE window will close and you will see a new window with the name of the directory and file at the top of the window (See Figure7-2). Inside the window you should see two lines of text.

When you called the datalogger earlier, it went through a message concerning the internal temperature of the datalogger as soon as the receiver was picked up. This message is called an INITIAL MESSAGE.

Notice the first line in EXMPL1.DLD is highlighted and has an "I" on the far left side. This indicates this line is an initial message and will be spoken whenever someone calls the datalogger. You can have as many initial messages as you like but the VS1 will only speak them in the order they are entered in the Editor. This order is from top to bottom as you see them in the Editor.

In the column to the right of the "I" you should see the name of the input memory location used in EXMPL1.DLD. Each input location line is associated with a specific input memory location in the datalogger.

```
VS1 VOICE EDITOR
File Edit Help
C:\EXMPL1.DLD
>I Input Location LOG TEMPF: CAMPBELL SCIENTIFIC DATALOGGER PROGRAM PAUSE(5
Input Location BAT VOLT : " DATALOGGER BATTERY VOLTAGE " IS $1 VOLTS.
Mar 30, 1994 | 3:40:00
```

FIGURE 7-2 Edit Screen for EXMPL1.DLD



To select a line to edit, place the mouse cursor on the line you wish to edit. Click the left mouse button once to highlight the line to select it, then quickly double click the mouse button while the mouse cursor is still on the highlighted line.

If the line of text you want is out of the present window, place the mouse cursor on the window frame on the bottom or on the right hand side and click the left mouse button. The highlighted area should jump to another line of text.

To scroll through the lines of text, place the mouse cursor on either the arrows on the bottom frame, or the arrows on the right frame of the editing window. Then click and hold the left mouse button. Release it to stop scrolling. By clicking the arrow icons you can single step through text lines.



To select a line to edit using the keyboard use the up or down arrow keys to highlight different lines. To scroll quickly through the selections press and hold the up or down arrow key. To stop scrolling release the key. If the text line you are looking for is out of the present window use <PgUp> and <PgDn> to move through the text entries faster and then use the arrow keys to get to the exact line you want. After you have highlighted the line you wish to edit, press <Enter> to select it.

Notice the highlight bar can be moved past text and into blank areas. Also notice on the bottom and on the right-hand side of the editing window the frame has a different texture than on the top or the left hand side. On both frames there is a small rectangle with a solid circular dot in the middle of the rectangle. As you move the highlight bar down through the text area the rectangle on the bottom will move from left to right and the rectangle on the right hand side will move from top to bottom. These rectangles identify approximately where you are in the text area and are used with the mouse to move through the text area.



With the top line of EXMPL1.DLD highlighted, place the mouse cursor on the top line and click the left mouse button once to highlight it and then quickly double click the mouse button again to select it for editing.



Use the arrow keys to move around in the editing window to highlight the line to be edited. Highlight the top line and press <Enter> from the keyboard to select the line for editing.

An editing window will appear in the middle of the computer screen. From this window you can do all the creation and editing of your messages.



To use a mouse place the mouse cursor on the option you want and click the left mouse button once.



Use the <Tab> key from the keyboard to move through the various fields and <Enter> to select an option.

Notice the "Initial Message" box has an "X" checked in it. This particular input location has been flagged to be heard in the initial message. Clicking on the box with the mouse or pressing the space bar will cause this box to be checked or unchecked.

Next to the "Initial Message" area is "Decimal Places: 4". The VS1 will speak from 0-5 digits past the decimal. Sometimes you don't need all the decimals spoken. "Decimal Places" is user settable from zero to five digits spoken past the decimal. The default is five.

Click on "Decimal Places" with the mouse or <Tab> over to "Decimal Places" with a keyboard to activate it. Type in <2>.



To exit this field with a mouse, click on another field or click on OK.

VS1 AND VOICE SYNTHESIZER EDITOR



To exit using a keyboard, press <Tab> to move to another field.

Use a mouse or the <Tab> key to highlight the input location line. You will see a flashing cursor at the beginning of the input location line.

To move through the line, use the right or left arrow keys to move letter by letter. To move quickly through the line, use the <Home> and <End> keys. If the line is very long and takes up more than one full window of characters, the <End> key will not move the cursor to the end of the sentence. Pressing <End> and then the left arrow key will take the cursor to the end of the line.

As you scroll through the line of text you will see "DATALOGGER INTERNAL TEMPERATURE" in double quotes and a "\$" sign followed by a number. The words in double quotes is the input location name and the number following the "\$" sign is an input memory location in the datalogger. The input location name is associated with the memory location by the VS1. Every line must contain one input location name associated with one memory location.

The VS1 will give a verbal list of input locations and their names when a user calls the datalogger and requests to monitor input locations. Users only have access to input locations that are associated with an input location name.

The VS1 has a limited vocabulary of 199 words. A list of these words can be found in Appendix C. To enter words into the input location line you can either type them in directly using all capital letters and the word list, or use the option called "List" which allows you to copy and paste words into the input location line.

Let's modify the existing list of input locations and add an additional line. Place the cursor on the first letter in the word "FAHRENHEIT".



If you are using a mouse, place the mouse cursor on the "List" option and click the left mouse button once.



For a keyboard, press <F2> to set up the editor to import words. <F2> puts the editor in the copy and paste mode for the word list. You can't transfer in a word from the word list via keyboard any other way.

The WORD LIST window will appear in the center of your screen. To select a word to copy and paste, you must first highlight it. The highlight area can be moved around the same as was done earlier to select a directory and file. Both mouse and keyboard control is the same except the right and left arrows can be used as well as the up and down arrow keys. Highlight the word "CELSIUS" and double click the left mouse button if using a mouse or press <Enter> from the keyboard.

Notice the cursor has moved to the front of the line. The cursor will automatically go to the front of the input location line whenever you leave or return to it. Go to the end of the line. Notice "CELSIUS" has been inserted where the cursor was when you moved to the word list.

Delete the word "FAHRENHEIT" using the <Delete> key. Make sure the line terminates with a period. Move the cursor to "\$" and delete everything up to the letter "D" in the word "DEGREES". Leave the cursor on the "D" in the word "DEGREES".



To insert the memory location number using a mouse, click on the LABELS option.





To use a keyboard, press <F7> to get into the LABELS option. The <F7> key puts the Editor in copy and paste mode for labels. The same restrictions apply to using <F7> as to what was explained for <F2> above.

The DATALOGGER LABELS window will appear in the middle of your screen. This window contains all the input memory locations and their labels from the EXMPL1.DLD program. Select LOG TEMPC from the list in the same way you selected words from the word list. Once you are back into the input location line, move the cursor to where you inserted the new memory location. You will only see the input memory location number.

Use the mouse or the <Tab> key to get to the OK option. Double click the mouse or press <Enter> to save your changes.

Notice the input memory location at the front of the input location line has changed from LOG TEMPF to LOG TEMPC.

 If you don't wish to save your changes, put the mouse cursor on the solid square in the upper left-hand corner and click the left mouse button.

 Using the keyboard, press <Esc> or <F10>.

Up to this point, we have altered the initial message to give us the internal temperature of the datalogger in degrees Celsius. Next, let's get the datalogger to tell us it's internal temperature in degrees Fahrenheit.

Move the highlight area in the Editor to the second line. Get into the EDIT main option by either placing the mouse cursor on EDIT and clicking the left mouse button once or pressing <Alt> <E> from the keyboard.

Most of the editing functions can be accessed through function keys directly from the Editor or by getting into the main edit menu in this manner. Press <I> to insert a line. The next window will ask you what kind of line you wish to edit. Select INPUT LOCATION.

Highlight the input location window. Using LIST and LABEL options, type in the following line:

```
"DATALOGGER INTERNAL TEMPERATURE
IN DEGREES FAHRENHEIT" IS $3.
```

After every word you import into your line press <End> to get to the end of the line and import the next word. The line must be terminated with a period. After the line is completed, use OK to save the line you created.

Notice the line is inserted ahead of the BAT VOLT line. If you wanted to insert the line after BAT VOLT you would have moved the highlighted area past the BAT VOLT line and then selected the INSERT option.

Let's run the changes. Use the mouse or press <Alt> <F> to get into the file main menu options and select <S>ave to save your changes. Exit

out of the Editor and download the file to your datalogger.

Call the datalogger and notice the extra input location and the changes you made to the file. Let's take those changes out. Type:

```
vs1 exmpl1
```

at the cursor and press <Enter>. The Editor will automatically call up your file and put you in the editing mode. This is a handy shortcut if you already know the name of the file you wish to edit.

Move the highlighted area down to the second line and press <F3>. The <F3> key is the function key command to delete a line. You could have also deleted the line by getting into the EDIT main menu option and pressing <D>. The second line has been removed.

CAUTION: When you delete anything using the Editor it is gone. Be careful when you use DELETE.

Let's leave the rest of the file as it is and save these changes.

Download the file to the datalogger and afterwards call it up to hear the changes. We have gone through all the techniques necessary to call up and listen to input locations.

7.6 USING THE "SAVE AS" SUBOPTION

On occasion you might wish to add some changes to an existing *.DLD file that you have created to work with VS1, but save it under a different file name, and/or path. This can be done with the SAVE AS suboption.

Here is an example on how to use this option: Make sure EXMPL1.DLD is presently loaded in the Editor. Select the SAVE AS suboption from the FILE main menu option. A window will appear in the middle of your screen showing the existing file and it's path in the computer drive directory.

Move the cursor over to EXMPL1.DLD and delete EXMPL1. Insert the name TEST. You should see the path followed by TEST.DLD. To save the changes either tab over to OK or click the mouse on OK. If you check into your directory you will notice two new files: TEST.DLD and TEST.VS1.

VS1 AND VOICE SYNTHESIZER EDITOR

7.7 QUICK SAVE

The Editor appends special characters to the end of the *.DLD file after it has been modified and saved. These characters are vital for the VS1 to operate. These special characters are lost if you change a modified *.DLD file using EDLOG and then save it.

If you decide to change some of the datalogger instructions in a previously modified *.DLD file, using EDLOG, but don't want to change any input memory locations, there is a simple way to modify it to work with the VS1. At the DOS prompt, type the following:

```
vs1 [path][filename] /s <Enter>
```

The path is required if the *.DLD file is not in the same directory as VS1.EXE. It isn't required to put the .DLD extension at the end of your filename. You should see the Editor briefly appear on your screen. It will modify the file, then save it.

8. ADDITIONAL FEATURES

8.1 SETTING THE SECURITY CODE

A four digit security code can be used with the VS1 to prevent users from setting or resetting flags or ports. To implement this into your program do the following:

1. Load your program into the Editor.
2. Select the EDIT main menu option and the STRING MENU suboption.
3. A window will appear in the center of your screen with the SECURITY CODE: field highlighted. Enter a four digit number into this field.
4. To save your security code either <Tab> to OK and press <Enter>, or if you have a mouse, click on the OK.

If you do forget this number you can reenter the Editor and go back into your file to see what security number you originally created.

When the VS1 is called up by telephone it will eventually ask you to enter the security code followed by the pound button on the telephone. Enter your specific security code followed by the pound button. For example, if my security code was "1234" I would enter "1234#" from my touch-tone phone. After entering your security

code you will be able to change flag and port settings from your touch-tone phone.

The security code used with the VS1 is not the same security code you can use with the datalogger. See the CR10 OPERATOR'S MANUAL for more information.

Exit the VS1 as normal.

NOTE: Remember to write this number down. The datalogger WILL NOT let you alter any of the ports or flags if you do not enter this number.

8.2 RENAMING MENU STRINGS FOR INPUT LOCATION, PORTS, AND FLAGS

The Editor will allow you to rename the input location, port, and flag strings. These strings are what you hear when you call the datalogger.

The STRING MENU suboption in the EDIT main menu option is used to rename these strings. You must use words that are presently in the vocabulary list. In order to change an input string:

1. Enter your program into the Editor.
2. Select the EDIT main menu option. Select the STRING MENU suboption.
3. Use the <Tab> key or your mouse to highlight the string field you wish to change.
4. Delete the present string setting using the key.
5. Either type in a word from the word list or import a word using the same method to create input message strings.
6. Save your changes from the keyboard by using <Tab> to highlight OK and press <Enter>. If you have a mouse put the mouse cursor on OK and click the left mouse button.

8.3 USING THE VS1 TO HEAR OUTPUT LOCATION DATA

Output data is normally stored in the datalogger's ring memory. This prevents VS1 from getting access to the data stored there. In order to hear the present output data it needs to be diverted to an input location and then use this input location with the VS1.

Use Instruction 80 to divert output location data to an input location. See the CR10 Operator's Manual for information on Instruction 80. The following is an example of a *.DLD file using Instruction 80.

```
*****
*
THE NEXT SECTION DIVERTS 60 MINUTE
MAXIMUM DATA GOING INTO THE OUTPUT
SECTION TO THE INPUT DATA SECTION.
*****
*
02: P 11      Temp 107 Probe
    01: 1      Rep
    02: 1      IN Chan
    03: 1      Excite all reps w/EXchan 1
    04: 4      Loc [:AIR TEMPC]
    05: 1      Mult
    06: 0.0000 Offset
.
.
.
.
.
32: P 92      If time is
    01: 0000   minutes into a
    02: 60     minute interval
    03: 10     Set high Flag 0 (output)

33: P80      Set Active Storage Area
01: 3        Input Storage Area
02: 5        Array ID or location

34: P73      Maximize
01: 1        Rep
02: 11       Value with Hr-Min-Sec
03: 4        Loc AIR TEMPC
```

Every sixty minutes the maximum air temperature information will be diverted to input location #5. No output data will be sent to the datalogger ring memory.

Instruction 80 needs to follow the instruction setting Flag 0 and preceding the output instruction. Keep in mind that all output processing instructions following Instruction 80 will be diverted to an input memory location until another Instruction 80 is used to reroute data. It is best to use Instruction 80 at the end of your program to make sure you divert only what you want.

8.4 USING THE VS1 TO INITIATE CALLS

The VS1 can be used to initiate calls to specific phone numbers in voice or modem mode when preset datalogger conditions are met. The original *.DLD file created using EDLOG will require specific instructions as well as using the Editor to modify the EDLOG created *.DLD file to initiate calls.

8.4.1 INITIATE VOICE CALLS

To initiate voice calls you will need to include Instruction 97 in your *.DLD file. This instruction uses a modem option code that may or may not be on the prompt sheet or in the CR10 Operator's Manual that came with your datalogger. The rest of the information concerning Instruction 97 in the manual is correct.

Modem option code 31 is used with Instruction 97 to initiate voice calls.

NOTE: Do not follow Instruction 97 with Instruction 63. It is not needed to initiate voice calls.

If EDLOG is being used to create the program it will highlight modem option code 31 as an error. Press <Enter> and it will eventually take it. In order for Instruction 97 to initiate you will need to decide on the condition to reset your flag and which flags to set. See the CR10 Operator's Manual for more information.

To initiate voice calls in your *.dld program use the Editor to do the following:

1. Load your *.DLD file into the Editor after it has been created in EDLOG.
2. Once in the Editor, highlight the line that will initiate the call and pull it up for editing.
3. Highlight the "Initiate Call Flag [1..8]" field and enter the number of the flag you are using in your *.DLD program to initiate the call. The "Initiate Call Flag [1..8]" field will only appear if the correct Instruction 97 is in the *.DLD file being edited.
4. Save your changes.
5. Either press <F6> or call up the "Initiate call" suboption from the EDIT main menu option. You should see a window appear in the middle of your screen showing all the user flags available for the CR10 and an area to put in a phone number.

VS1 AND VOICE SYNTHESIZER EDITOR



If you have a mouse use the mouse cursor to check the box in front of the correct flag.



For keyboards use the <Tab> to go to the appropriate box in front of the flag and press the space bar to check the box.

6. Enter the phone number the VS1 is to call in the PHONE NUMBER: field. Do not use parenthesis around the phone numbers. The numbers can be all grouped together or separated with a hyphen (-).
7. Move the cursor to the OK field to save your changes and exit.

Below is an example of a .DLD file that has incorporated Instruction 97 to initiate a voice call.

```
*      1Table 1 Programs
01:   60Sec. Execution Interval

      01: P10Battery Voltage
      01: 1Loc [:BAT VOLT ]

02:   P86Do
      01: 12Set high Flag 2

03:   P91If Flag/Port
      01: 21Do if flag 1 is low
      02: 30Then Do

04:   P89If X<=>F
      01: 1X Loc BAT VOLT
      02: 4   <
      03: 10.5F
      04: 22Set low Flag 2

05:   P95End

06:   P97Initiate Telecomm
      01: 31Modem/Baud Option
      02: 2Disabled when User Flag 2 is high
      03: 40Seconds Call Time Limit
      04: 30Seconds Before Fast Retry
      05: 3Fast Retries
      06: 0000Minutes Before Slow Retry
      07: 3Failures Loc [:ERRORS ]
      08: 100Datalogger ID

07:   P      End Table 1
```

If the battery voltage should fall below 10.5 VDC the datalogger will initiate voice call. Notice how the flags are used to control Instruction 97.

Flag 1 is used by the user to disable the callback routine. If the datalogger detects an alarm condition it will attempt to call the phone number everytime the alarm condition is met. When the VS1 initiates a voice call it does not allow the user to listen to any of the initial messages or get at any of the flag or port locations. The voice call delivers the the initial message line that has been flagged. To disable the alarm condition the user would need to call the datalogger back and set flag 1 high. After the alarm condition is past, or corrected, flag 1 would need to be set back to low.

8.4.2 INITIATE MODEM CALLS

The Editor is not used to modify the *.DLD file to initiate modem calls. To implement modem calls in a *.DLD file you will need to use Instruction 97 followed by Instruction 63. Instruction 97 will require a special modem option code.

The instruction to initiate modem calls is Instruction 97 with modem option code 41.

If EDLOG is being used to create the program it will highlight modem option code 41 as an error. Press <Enter> and it will eventually take it. In order for Instruction 97 to initiate you will need to decide on the condition to reset your flag and which flags to set. See the CR10 Operator's Manual for more information.

Follow Instruction 97 with Instruction 63 to include the phone number the datalogger is to call.

An example of a .DLD file that has incorporated Instruction 97 and 63 to initiate a modem call follows.

```
*      1Table 1 Programs
01:   60Sec. Execution Interval

01:   P11Temp 107 Probe
      01: 1Rep
      02: 1IN Chan
      03: 1Excite all reps w/EXchan 1
      04: 4Loc [:AIR TMP C]
      05: 1Mult
      06: 0Offset
```

```

02: P86Do
   01: 11Set high Flag 1

03: P91If Flag/Port
   01: 22Do if flag 2 is low
   02: 30Then Do

04: P89If X<=>F
   01: 4X Loc AIR TMP C
   02: 3 >=
   03: 40 F
   04: 21Set low Flag 1

   05: P95End

06: P97Initiate Telecomm
   01: 41Modem/Baud Option
   02: 1Disabled when User Flag 1 is high
   03: 40Seconds Call Time Limit
   04: 0Seconds Before Fast Retry
   05: 00Fast Retries
   06: 0000Minutes Before Slow Retry
   07: 3Failures Loc [:ERRORS ]
   08: 123Datalogger ID

07: P63Extended Parameters
   01: 5 5
   02: 5 5
   03: 5 5
   04: 4 4
   05: 3 3
   06: 2 2
   07: 1 1
   08: 13
    
```

Flags 1 and 2 are used the same way as in the example for 8.4.1 except their roles are reversed.

This program will initiate a modem call if the air temperature should exceed 40°C. See your PC208 manual for instructions on setting up your PC to receive modem calls.

8.4.3 MIXING MODEM AND VOICE CALLS

You can intermix voice and modem calls in the same program. Make sure you are not using the same flag for a voice and a modem call. Set up the different types of calls as shown in the previous two sections.

8.5 READING VS1 INFORMATION FROM A *.DLD FILE

After an editing process is completed the information for the VS1 is added to the end of

the *.DLD file. This information can be checked to make sure it is accurate.

A copy of the VS1 information added to the end of EXMPL1.DLD follows. The numbers between the "smiley faces" and the "&" symbols are the numbers associated with the words used from the word list. The "smiley face" is equivalent to control code A (^A). Turn to Appendix C to see the word list used with the VS1.

The first line is the wording used for input locations. The second line is the wording used for port. The third line is the wording used for flag. The lines following are used for initial message descriptions. Each initial message will terminate with a period.

Line four starts with "\4". The number following the slash indicates the number of digits following the decimal point that the VS1 will speak.

The numbers inside of quotation marks is the wording for the input location.

The number(s) following the "\$" symbol are the input memory location numbers used in the datalogger.

```

;|#"©56&©57&"#
#"©53&"#
#"©52&"#
>\4©88&©89&©109&©74&©71&©71&©71&"
©109&©135&©86&"©85&$3©87&©122&.\
\4"©109&©98&©191&"©85&$1©192&.\
|
♣♣
    
```

If the datalogger has been programmed to initiate voice calls you will see the phone number associated with the call command at the very end of the listing. The flag number used to initiate the call and the phone number will be between "at" symbols (@).

VS1 AND VOICE SYNTHESIZER EDITOR

This example initiates a voice call:

```
;|#Ⓜ56&Ⓜ57&"#  
#"Ⓜ53&"#  
#"Ⓜ52&"#  
><2\4"Ⓜ98&Ⓜ191&"Ⓜ85&$1Ⓜ192&.\  
@2555-1234@  
|  
♣♣
```

Notice line four starts out as "2\4". The "2" in front of the "4" indicates the flag number that is used to initiate a voice call. The "2" appears again in front of the phone number.

This last example uses the security code "1234" to allow access. Notice the characters following the "?" at the beginning of the character stream. The security code will always be the very first thing in the imbedded character portion of the *.DLD file.

```
;|?1234#"Ⓜ56&Ⓜ57&"#  
#"Ⓜ53&"#  
#"Ⓜ52&"#  
>\4Ⓜ88&Ⓜ89&Ⓜ109&Ⓜ74&Ⓜ71&Ⓜ71&Ⓜ71&"  
Ⓜ109&Ⓜ135&Ⓜ86&"Ⓜ85&$3Ⓜ122&.\  
\4"Ⓜ109&Ⓜ98&Ⓜ191&"Ⓜ85&$1Ⓜ192&.\  
|  
♣♣
```

APPENDIX A. CHANGING RAM OR PROM CHIPS IN THE CR10

The CR10 has two sockets for Random Access Memory (RAM) and one socket for Programmable Read Only Memory (PROM). The standard CR10 has 64K of RAM, (a 32K RAM chip in each socket). Earlier CR10s had 16K of RAM (an 8K RAM chip in each socket).

A.1 DISASSEMBLING THE CR10

The sockets provided for RAM and PROM are located on the CR10 CPU circuit card inside the CR10 can. To expose the RAM and PROM sockets, remove the two Phillips head screws from the end opposite the connectors. Remove the end cap. The ends of two circuit cards and the RF shield will be visible (see Figure A-1). Now lay the CR10 on a flat surface, (i.e., a table), and push on the RF shield with your thumbs while grasping the can with your hands. Remove the circuit cards from the can. Orient the cards with the connector on the left and with the card that matches Figure A-2 up. The Central Processing Unit (CPU) is found at location H-9 and the three slots for RAM and PROM will be directly beneath it.

A.2 INSTALLING NEW RAM CHIPS IN CR10S WITH 16K RAM

The two 8K RAM chips are found at locations C-11 and C-14. With a small flat screw driver gently pry out the two 8K RAM chips at these locations and replace them with the 32K RAM chips provided in the memory upgrade. The new chips should be installed so the notched end is towards the nearest card edge. Before pushing the chips into the socket make certain that all the pins are correctly seated. After installing the 32K chips check for pins that may be bent or not firmly seated in the socket. If you notice a bent pin, remove the chip, carefully straighten it and repeat the installation procedure.

A.2.1 CHANGING JUMPERS

There are six jumpers used to configure hardware for different RAM sizes. Figure A-2 shows the jumper settings for different memory configurations. A pin or small screw driver tip will work best for pulling these jumpers and relocating them as shown in Figure A-2.

A.2.2 RAM TEST

Attach the CR10KD Keyboard/Display and apply power to the CR10. After the CR10 executes the RAM/PROM self test, the number 96 should be displayed in the window. The number is the sum of Kbytes in RAM (64) plus the number of Kbytes in ROM (32).

A.3 INSTALLING NEW PROM

The PROM chip is found at location C8 on the CR10 CPU board, (see Figure A-2). With a small flat screw driver, gently pry out the PROM chip and replace it with the new one. The new chip should be installed so that the notched end is towards the nearest card edge. Before pushing the chip into the socket make certain that all the pins are seating correctly. After installing the chip check for pins that may be bent or not making contact. If you notice a bent pin, remove the chip, carefully straighten it and repeat the installation procedure.

To make certain that the new chip is installed correctly enter the CR10 *B mode, (Section 1.6 in the CR10 Operator's Manual), and advance to the second window. This window displays the PROM signature. The five digit number in the window should match the PROM signature given with the new PROM documentation. If the numbers are different disassemble the CR10 and look for pins that are bent or not firmly seated.

APPENDIX A. CHANGING RAMOR PROM CHIPS IN THE CR10

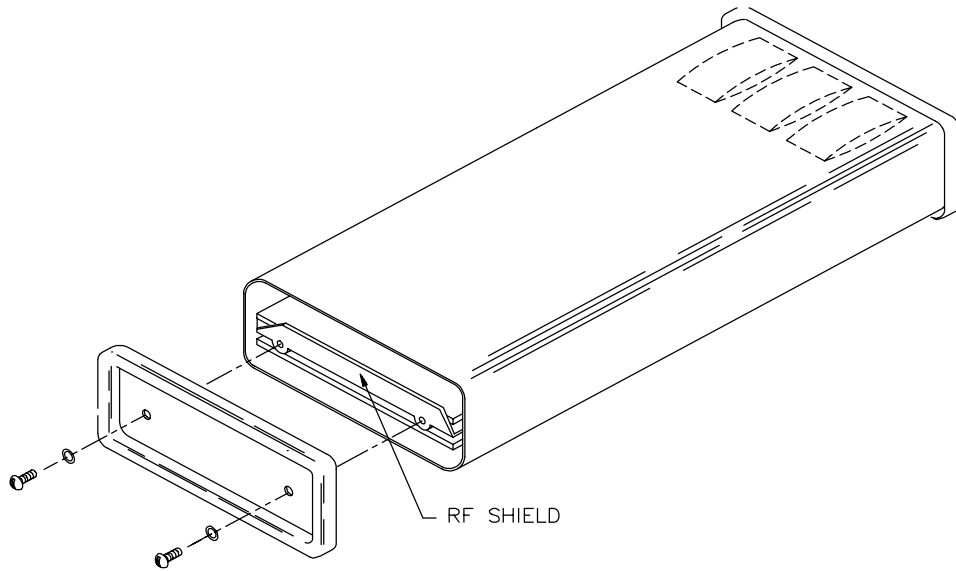

FIGURE A-1. Disassembling CR10

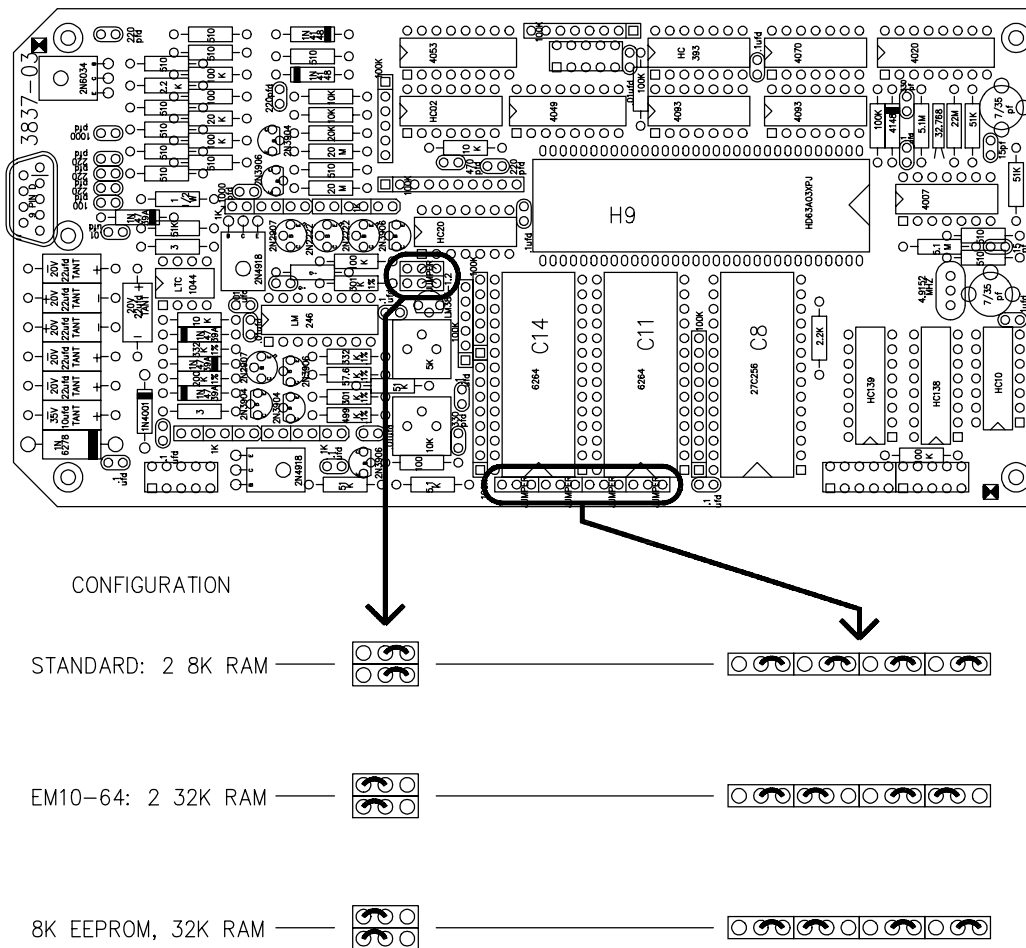

FIGURE A-2. Jumper Settings for Different RAM Configurations

APPENDIX B. 9 PIN SERIAL INPUT/OUTPUT

B.1 PIN DESCRIPTION

All external communication peripherals connect to the CR10 through the 9-pin subminiature D-type socket connector located

on the front of the Wiring Panel (Figure B-1). Table B-1 shows the I/O pin configuration, and gives a brief description of the function of each pin.

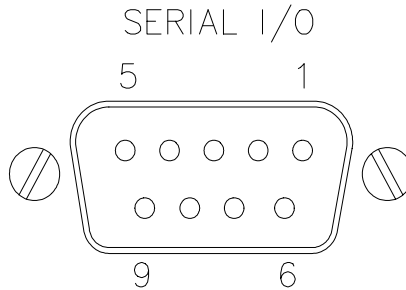

FIGURE B-1. 9 Pin Connector

TABLE B-1. Pin Description

ABR = Abbreviation for the function name.
 PIN = Pin number.
 O = Signal Out of the CR10 to a peripheral.
 I = Signal Into the CR10 from a peripheral.

<u>PIN</u>	<u>ABR</u>	<u>I/O</u>	<u>Description</u>	<u>PIN</u>	<u>ABR</u>	<u>I/O</u>	<u>Description</u>
1	5V	O	5V: Sources 5V DC, used to power peripherals.	6	SDE	O	Synchronous Device Enable: Used to address Synchronous Devices (SDs), and can be used as an enable line for printers.
2	SG		Signal Ground: Provides a power return for pin 1 (5V), and is used as a reference for voltage levels.	7	CLK/HS	I/O	Clock/Handshake: Used with the SDE and TXD lines to address and transfer data to SDs. When not used as a clock, pin 7 can be used as a handshake line (during printer output, high enables, low disables).
3	RING	I	Ring: Raised by a peripheral to put the CR10 in the telecommunications mode.	8	TE	O	Tape Enable: Powers the cassette recorder during tape transfer.
4	RXD	I	Receive Data: Serial data transmitted by a peripheral are received on pin 4.	9	TXD	O	Transmit Data: Serial data are transmitted from the CR10 to peripherals on pin 9; logic low marking (0V) logic high spacing (5V) standard
5	ME	O	Modem Enable: Raised when the CR10 determines that a modem raised the ring line.				asynchronous ASCII, 8 data bits, no parity, 1 start bit, 1 stop bit, 300, 1200, 9600, 76,800 baud (user selectable).

APPENDIX C - VS1 WORD LIST

STANDARD VS1 WORD LIST IN NUMERICAL ORDER

0. ZERO	26. EIGHTY	52. FLAGS
1. ONE	27. NINETY	53. PORTS
2. TWO	28. HUNDRED	54. THRU
3. THREE	29. THOUSAND	55. PORT
4. FOUR	30. MILLION	56. INPUT
5. FIVE	31. PRESS	57. LOCATIONS
6. SIX	32. POUND	58. FLAG
7. SEVEN	33. DEW	59. AND
8. EIGHT	34. HEAR	60. OF
9. NINE	35. MENU	61. SECURITY
10. TEN	36. AGAIN	62. CODE
11. ELEVEN	37. STAR	63. YOUR
12. TWELVE	38. DISCONNECT	64. POINT
13. THIRTEEN	39. YOU	65. PLEASE
14. FOURTEEN	40. THE	66. BY
15. FIFTEEN	41. HAVE	67. MINUS
16. SIXTEEN	42. SELECTED	68. ENTER
17. SEVENTEEN	43. MONITOR	69. SELECTION
18. EIGHTEEN	44. KEY	70. GOODBYE
19. NINETEEN	45. FOLLOWING	71. PAUSE(50MS)
20. TWENTY	46. RETURN	72. MESSAGE
21. THIRTY	47. PREVIOUS	73. CALLBACK
22. FORTY	48. STATUS	74. PROGRAM
23. FIFTY	49. HIGH	75. SIGNATURE
24. SIXTY	50. LOW	76. EPROM
25. SEVENTY	51. TOGGLE	77. KILOBYTES

APPENDIX C. VS1 WORD LIST

78. MEMORY	106. CURRENT	134. INCHES
79. NUMBER	107. DAM	135. INTERNAL
80. E08'S	108. DATA	136. KILO
81. TABLE	109. DATALOGGER	137. LAST
82. OVERRUNS	110. DAY	138. LEVEL
83. VERSION	111. DEPTH	139. LITER
84. REVISION	112. DEVIATION	140. RESET
85. IS	113. DIRECTION	141. MAXIMUM
86. TEMPERATURE	114. D-O	142. MERCURY
87. DEGREES	115. DOWN	143. METER
88. CAMPBELL	116. DRAW	144. METERS
89. SCIENTIFIC	117. EQUAL	145. MICRO
90. ACRE	118. ET	146. MILES
91. AIR	119. EVENT	147. MILLI
92. ALARM	120. EXTERNAL	148. MINIMUM
93. ARE	121. EXCEEDS	149. MINUTE
94. AT	122. FAHRENHEIT	150. MOISTURE
95. AVERAGE	123. FALL	151. MONTH
96. BAROMETRIC	124. FEET	152. MULTIPLIER
97. BARS	125. FLOW	153. NEW
98. BATTERY	126. FROM	154. N-T-U
99. CALIBRATE	127. GALLONS	155. OFF
100. CELSIUS	128. GRAM	156. OFFSET
101. CENTI	129. HELLO	157. ON
102. CHILL	130. SET	158. OPEN
103. CLOSED	131. HOUR	159. OVERFLOW
104. CONDUCTIVITY	132. HUMIDITY	160. PARTS
105. CUBIC	133. IN	161. PER

APPENDIX C. VS1 WORD LIST

- | | | |
|--------------------|---------------|----------------|
| 162. PERCENT | 175. SECOND | 188. TIME |
| 163. P-H | 176. SECONDS | 189. TURBIDITY |
| 164. PRECIPITATION | 177. SIEMENS | 190. VELOCITY |
| 165. PRESSURE | 178. SITE | 191. VOLTAGE |
| 166. PROGRESS | 179. SNOW | 192. VOLTS |
| 167. P-S-I | 180. SOIL | 193. WARNING |
| 168. RADIATION | 181. SOLAR | 194. WATER |
| 169. RAIN | 182. SPEED | 195. WATTS |
| 170. RATE | 183. SQUARED | 196. WEATHER |
| 171. REFERENCE | 184. STAGE | 197. WELL |
| 172. RELATIVE | 185. STANDARD | 198. WIND |
| 173. R-P-M | 186. STATION | |
| 174. SAMPLE | 187. STORM | |

STANDARD VS1 WORD LIST IN ALPHABETICAL ORDER

- | | | |
|----------------|-------------------|-----------------|
| 90. ACRE | 73. CALLBACK | 109. DATALOGGER |
| 36. AGAIN | 88. CAMPBELL | 110. DAY |
| 91. AIR | 100. CELSIUS | 87. DEGREES |
| 92. ALARM | 101. CENTI | 111. DEPTH |
| 59. AND | 102. CHILL | 112. DEVIATION |
| 93. ARE | 103. CLOSED | 33. DEW |
| 94. AT | 62. CODE | 113. DIRECTION |
| 95. AVERAGE | 104. CONDUCTIVITY | 38. DISCONNECT |
| 96. BAROMETRIC | 105. CUBIC | 115. DOWN |
| 97. BARS | 106. CURRENT | 116. DRAW |
| 98. BATTERY | 114. D-O | 80. E08'S |
| 66. BY | 107. DAM | 8. EIGHT |
| 99. CALIBRATE | 108. DATA | 18. EIGHTEEN |

APPENDIX C. VS1 WORD LIST

26. EIGHTY	129. HELLO	30. MILLION
11. ELEVEN	49. HIGH	148. MINIMUM
68. ENTER	131. HOUR	67. MINUS
76. EPROM	132. HUMIDITY	149. MINUTE
117. EQUAL	28. HUNDRED	150. MOISTURE
118. ET	133. IN	43. MONITOR
119. EVENT	134. INCHES	151. MONTH
121. EXCEEDS	56. INPUT	152. MULTIPLIER
120. EXTERNAL	135. INTERNAL	154. N-T-U
122. FAHRENHEIT	85. IS	153. NEW
123. FALL	44. KEY	9. NINE
124. FEET	136. KILO	19. NINETEEN
15. FIFTEEN	77. KILOBYTES	27. NINETY
23. FIFTY	137. LAST	79. NUMBER
5. FIVE	138. LEVEL	60. OF
58. FLAG	139. LITER	155. OFF
52. FLAGS	57. LOCATIONS	156. OFFSET
125. FLOW	50. LOW	157. ON
45. FOLLOWING	141. MAXIMUM	1. ONE
22. FORTY	78. MEMORY	158. OPEN
4. FOUR	35. MENU	159. OVERFLOW
14. FOURTEEN	142. MERCURY	82. OVERRUNS
126. FROM	72. MESSAGE	163. P-H
127. GALLONS	143. METER	167. P-S-I
70. GOODBYE	144. METERS	160. PARTS
128. GRAM	145. MICRO	71. PAUSE(50MS)
41. HAVE	146. MILES	161. PER
34. HEAR	147. MILLI	162. PERCENT

APPENDIX C. VS1 WORD LIST

- | | | |
|--------------------|-----------------|----------------|
| 65. PLEASE | 7. SEVEN | 54. THRU |
| 64. POINT | 17. SEVENTEEN | 188. TIME |
| 55. PORT | 25. SEVENTY | 51. TOGGLE |
| 53. PORTS | 177. SIEMENS | 189. TURBIDITY |
| 32. POUND | 75. SIGNATURE | 12. TWELVE |
| 164. PRECIPITATION | 178. SITE | 20. TWENTY |
| 31. PRESS | 6. SIX | 2. TWO |
| 165. PRESSURE | 16. SIXTEEN | 190. VELOCITY |
| 47. PREVIOUS | 24. SIXTY | 83. VERSION |
| 74. PROGRAM | 179. SNOW | 191. VOLTAGE |
| 166. PROGRESS | 180. SOIL | 192. VOLTS |
| 173. R-P-M | 181. SOLAR | 193. WARNING |
| 168. RADIATION | 182. SPEED | 194. WATER |
| 169. RAIN | 183. SQUARED | 195. WATTS |
| 170. RATE | 184. STAGE | 196. WEATHER |
| 171. REFERENCE | 185. STANDARD | 197. WELL |
| 172. RELATIVE | 37. STAR | 198. WIND |
| 140. RESET | 186. STATION | 39. YOU |
| 46. RETURN | 48. STATUS | 63. YOUR |
| 84. REVISION | 187. STORM | 0. ZERO |
| 174. SAMPLE | 81. TABLE | |
| 89. SCIENTIFIC | 86. TEMPERATURE | |
| 175. SECOND | 10. TEN | |
| 176. SECONDS | 40. THE | |
| 61. SECURITY | 13. THIRTEEN | |
| 42. SELECTED | 21. THIRTY | |
| 69. SELECTION | 29. THOUSAND | |
| 130. SET | 3. THREE | |

APPENDIX D. EXMPL1.DLD PROGRAM

```
};CR10  
;EXMPL1.DLD  
;$  
;;BAT VOLT :LOG TEMPC:LOG TEMPF  
;$
```

```
MODE 1  
SCAN RATE 1
```

```
1:P10  
1:1
```

```
2:P17  
1:2
```

```
3:P37  
1:2  
2:1.8  
3:3
```

```
4:P34  
1:3  
2:32  
3:3
```

```
MODE 2  
SCAN RATE 0.0000
```

```
MODE 3
```

```
MODE 10  
1:28  
2:64  
3:0.0000
```

```
MODE 12
```

```
1:0  
2:0
```

```
3:0000
```

```
;|#"Ⓢ56&Ⓢ57&"#
```

```
#"Ⓢ53&"#
```

```
#"Ⓢ52&"#
```

```
>4Ⓢ88&Ⓢ89&Ⓢ109&Ⓢ74&Ⓢ71&Ⓢ71&Ⓢ71&"Ⓢ109&Ⓢ135&Ⓢ86&"Ⓢ85&$3Ⓢ87&Ⓢ122&.\
```

```
\4"Ⓢ109&Ⓢ98&Ⓢ191&"Ⓢ85&$1Ⓢ192&.\
```

```
|
```

```
♣♣
```

APPENDIX E. THEORY OF OPERATION

The VS1 Voice Synthesizer is used to transmit data over bandwidth-limited channels such as telephone lines by modulating audio tones, using Frequency Shift Keying (FSK) at 300 baud, or Phase Shift Keying (PSK) at 1200 baud.

The telephone company gives a 40 to 150 VRMS, 20 Hz signal on the phone lines to signify a ring, which is typically on for 2 seconds and off for 4 seconds. The ring detection circuitry is continuously powered but draws less than 2 μ A. The ring signal is passed on to the datalogger through an opto-coupler. The datalogger responds by raising the Modem Enable line which enables the 5VDC power to the modem. The modem then answers and remains off-hook until it loses the carrier or the datalogger lowers the Modem Enable line. The datalogger lowers the Modem Enable line by remote command or after 40 seconds in the absence of a command. When the Modem Enable line goes low, the 5 VDC power is removed from the modem circuitry, dropping power to the off-hook relay and thus placing the phone line on-hook.

To reject noise common to both phone lines and to satisfy registration requirements, the modem circuitry is electrically isolated from the phone lines by using an opto-isolator and coupling transformer.

This manual does not attempt to be a primer on the "AT" command set. The commands are therefore only summarized below. For most applications, the modem commands are issued automatically by the PC208 software. The commands apply only when the modem is used as an originate modem, which is not the primary use of this modem. Except as noted, all commands begin with "AT" and end with carriage return. As an example, the command ATDT5551212 followed by carriage return will tone dial the number that follows the ATDT, then go on-line and wait up to 30 seconds for the remote modem carrier. If the carrier is detected, the result code 1 will be returned, otherwise the result code 3 will be returned, and the modem will return to the command mode.

COMMANDS:

AT	Prefix to all commands (except /A)
A/	Repeat last command (not followed by carriage return)
D	Dial
P	Pulse
T	Tone
0..9	Telephone number digits
W	Wait for another dial tone
;	Return to command state after dialing
,	Pause
Z	Reset to default settings
A	Answer without ring
H	Hang up
O	Go to on-line state

COMMANDS TO CHANGE DEFAULT MODES:

R	Call an originate modem
B	CCITT mode
B1	BELL 212A mode
C	Carrier off
C1	Carrier on
E	Commands not echoed
E1	Commands echoed
F	Half duplex
F1	Full duplex
Q	Return result codes
Q1	Disable result codes
Sr?	What is the value in register r
Sr=n	Set register r to value n
V	Digit result codes
V1	Word result codes

RESULT CODES:

0	OK
1	Connect
2	Ring
3	No Carrier
4	Error

REGISTERS:

S0	Rings before auto-answer (0..255)
S6	Wait for dial tone (2..255 seconds)
S7	Wait for remote carrier (1..255 seconds)
S8	Comma pause time (0..255 seconds)
S10	Delay time between loss of carrier and hang up (1..255 in 10th of seconds)

APPENDIX F. FCC WARNING TO USERS OF CLASS A COMPUTING DEVICES

WARNING: This equipment generates, uses, and can radiate radio frequency energy, and if not installed and used in accordance with the instruction manual, may cause interference to radio communications. It has been tested and found to comply with the limits for a Class A computing device pursuant to Subpart J of Part 15 of FCC Rules, which are designed to provide reasonable protection against such interference when operated in a COMMERCIAL ENVIRONMENT. Operation of this equipment in a residential area may cause interference to radio and television reception. The operator must take whatever measures are necessary to correct the interference.

APPENDIX G. HELP, INFORMATION, AND ERROR MESSAGES

HELP MESSAGES

HELP 0001:

A *.DLD file has not been opened at this time. Please open a file using the NEW FILE command in the FILE menu.

HELP 0002:

This screen is a listing of all the strings for input locations, ports, and flags, that are in the *.DLD file.

If the voice strings have not been created this screen will be blank. Some keys have special uses in this screen. They are as follows:

Enter: Invokes the editing window for the line highlighted.

F1: Invokes Help screens.

F3: Deletes the highlighted line.

F4: Inserts a line before the highlighted line.

F5: Enlarges the editing screen to full size.

F6: Invokes the Initiate Call Flag window. The user can then specify the flag and telephone number for call.

NOTE: Initiate Call will only work if Instruction 97 is used in the *.DLD file. The screen will refresh itself and update any changes made to the strings.

HELP 0003:

Enter in the number to specify the 'labell'.

HELP 0004:

Enter in the string to specify the set state of the 'labell'. If the 'labell' is set, this string will be spoken. The format of the string will be required to end in a period. No input location will be allowed in the string.

HELP 0005:

Enter in the string to specify the reset state of the 'labell'. If the 'labell' is reset this string will be spoken. The format of the string will be required to end in a period. No input location will be allowed in the string.

HELP 0006:

The initial message will be spoken when the user calls the VS1. To include this message in the initial messages, press the space bar. An X in the box signifies that this string will be spoken as an initial message.

HELP 0007:

Enter in the flag number or numbers of flags to initiate call. Initiate Call occurs when the flag specified in Instruction 97 is toggled. This string will be included in the Initiate Call message delivered to the user.

HELP 0008:

Enter in the input location string to specify the string to be spoken. The string must be entered in the following format: The string must have a key word or phrase (for example: "temp") and an input memory location \$n, where n is an input memory location from the CR10.

Example: THE "TEMPERATURE" IS \$3 DEGREES CELSIUS.

In the example, "TEMPERATURE" is the key word and \$3 is the input memory location.

HELP 0009:

The help button invokes HELP screens for each of the fields in the window.

HELP 0010:

The VS1 has a pre-determined list of valid words that can be used to create the voice strings. To invoke this list press <F2>, or click on the "List" bar with the mouse. The user can insert a word at the cursor position from the word list window by using a mouse or <TAB> to

APPENDIX G. HELP, INFORMATION AND ERROR MESSAGES

highlight a word then entering the word into the voice string by double clicking the mouse or by pressing <Enter>.

HELP 0011:

Press the space bar to tag (X) the flag used in Instruction 97 in the *.DLD file. If the flag is tagged, then the phone number will be dialed when the associated flag is reset.

HELP 0012:

Enter in the phone number to be called.

HELP 0013:

Enter in the security code to lock out everything but the initial messages to the user. Default is no security code.

HELP 0014:

Enter in the string to specify the input location name for the user to access information to input locations of the datalogger. Default is "INPUT LOCATIONS".

HELP 0015:

Enter in the string to specify the port name for the user to access information to ports on the datalogger. Default is "PORTS".

HELP 0016:

Enter in the string to specify the flag name for the user to access information to ports on the datalogger. Default is "FLAGS".

HELP 0017:

The help button invokes HELP screens for each of the fields in the window.

HELP 0018:

The VS1 has a pre-determined list of valid words that can be used to create the voice strings. To invoke this list, press <F2>, or click on the LIST bar with the mouse. The user can insert a word at the cursor position from the word list window by using a mouse or <TAB> to highlight a word then entering the word into the voice string by double clicking the mouse or by pressing <Enter>.

HELP 0019:

Enter a filename (or file mask) in the Name box, or <TAB> to the file list and select a file from the list by pressing <Enter> or double clicking the left button on the mouse.

To change directories, <TAB> to the Directories list and select one.

HELP 0020:

Enter in the new name you want to save the file under, include the path and the extension.

HELP 0021:

The VS1 has the capability to limit the number of digits spoken to the user. By placing 0, 1, 2, 3, 4, or 5 in this field, the corresponding input location will be limited. By default, 5 decimal places will be spoken.

INFORMATION MESSAGES

INFORMATION 0001:

A *.DLD file has not been opened at this time. Please open a file using the NEW FILE command in the FILE menu.

INFORMATION 0002:

Would you like to quit or continue?

INFORMATION 0003:

'name' has been modified. Save?

INFORMATION 0004:

Is this string for 'inp', 'prt' or 'flg'?

ERROR MESSAGES

ERROR 0001:

Please use a *.DLD file.

ERROR 0002:

'name' input file not found

ERROR 0003:

voice.txt input file not found.

APPENDIX G. HELP, INFORMATION AND ERROR MESSAGES

This file contains the word list and must be located in the path. The program will now exit.

ERROR 0004:

There must only be one input location per line. Please re-enter the input string.

Example: THE "TEMPERATURE" IS \$4.

ERROR 0005:

'no_word' are not in the word list. Please check the word list for valid words.

ERROR 0006:

'no_word' is not in the word list. Please check the word list for valid words.

ERROR 0007:

Please specify the 'labell' number.

ERROR 0008:

Please end the Set string with a period.

ERROR 0009:

Please end the Reset string with a period.

ERROR 0010:

Enter in the input location string to specify the string to be spoken. The string must be entered in the following format: The string must have a key word or phrase (for example "temp") and an input memory location \$n, where n is an input location from the CR10.

Example: THE "TEMPERATURE" IS \$3 DEGREES CELSIUS.

In the example, "TEMPERATURE" is the key word and \$3 is the input memory location.

ERROR 0011:

A voice file (.vs1) does not exist for file 'name'

Would you like to create a voice file with the file 'name' ?

ERROR 0012:

Initiate Call is not set by Instruction 97 in the *.DLD file.

ERROR 0013:

File 'name' already exists. Overwrite?

ERROR 0014:

Extension longer than three characters.

ERROR 0015:

Illegal drive specifier.

ERROR 0016:

Illegal characters in path.

ERROR 0017:

Invalid path.

ERROR 0018:

No file specified.

ERROR 0019:

Illegal characters in name.

ERROR 0020:

Name longer than eight characters.

NOTE: Words that are inside ' ' are code variables.

Example: 'labell', labell specifies either a PORT or a FLAG.