

# BYTE

AUGUST 1988

A MCGRAW-HILL PUBLICATION

## REVIEWS

- Apple A/UX
- PC Input Devices
- Three 20-MHz 80386s
- VersaCAD for the Mac



PRODUCT FOCUS  
Script-Driven Communications

**The First of  
the 25-MHz  
Machines:**  
Computing moves up  
another notch

**IN DEPTH**  
**The C Language**  
with Kernighan and Ritchie,  
Stroustrup, and others

**PLUS**  
Borland, Lotus, Norton on OS/2  
Four New Columns  
Short Takes:  
Dell System 220  
T-DebugPLUS  
Grammatik III  
Paradox OS/2



Netpro 386/25



Compaq Deskpro 386/25



Intel SYP302



Everex Step 386/25



\$3.50 U.S.A./\$4.50 IN CANADA  
0360-5280

BORLAND PRESENTS

# THE ADVENTURES OF TURBOMAN

**"Fastest and most approachable  
implementation of that language"**

—Darryl Rubin, *AI Expert*, on *Turbo Prolog*

**"Most powerful  
version of Basic ever"**

—Ethan Winer, *PC Magazine*, on *Turbo Basic*

**And able to leap  
onto "new ground in the  
price/performance arena"**

—John H. Mayer, *Computer Design*,  
on *Turbo C*

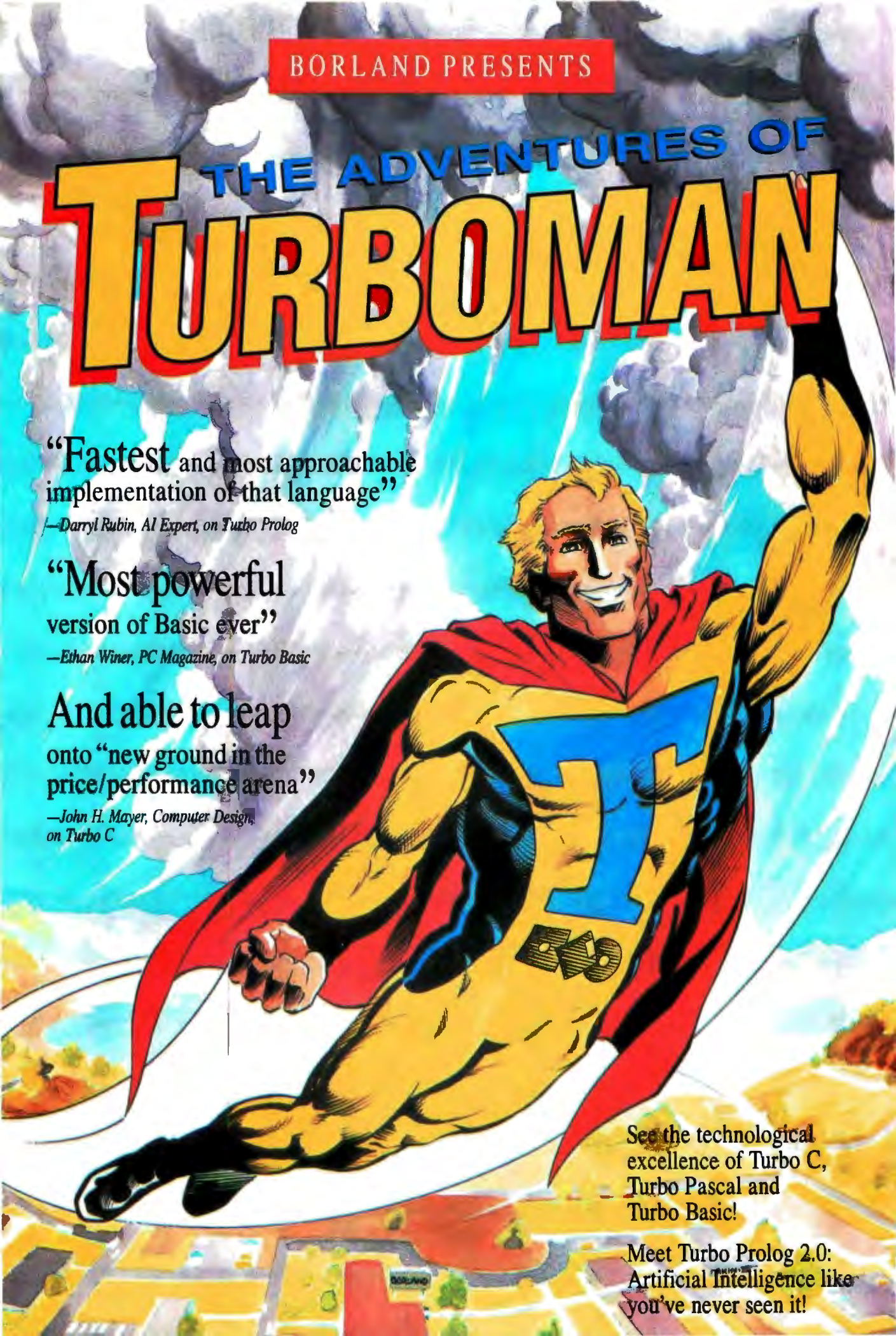

See the technological  
excellence of Turbo C,  
Turbo Pascal and  
Turbo Basic!

Meet Turbo Prolog 2.0:  
Artificial Intelligence like  
you've never seen it!

# The Critics Agree: Borland's



“Turbo C ... will stun you with in-RAM compilations that operate at warp speed.”

—Richard Hale Shaw, *PC Magazine*



Turbo C's® sleek compiler is so fast and powerful, we used it to write our equation solver, Eureka.™ Even better, all that muscle is wrapped in a smooth,

integrated environment with everything you need to make writing, editing and compiling your programs a snap:

- Compiles 10,000 lines per minute\*
- Online, context-sensitive help
- ANSI compatible
- Six memory models—tiny to huge
- 450 library functions
- Utilities: Librarian, Make, GREP
- Source code for MicroCalc spreadsheet
- Command-line version of the compiler
- Inline assembly that lets you mix C and assembler

- Professional-quality graphics library supporting VGA, CGA, EGA, Hercules, and IBM 8514
- Interfaces with Turbo Pascal 4.0 and Turbo Prolog

**Just \$99.95**

“A lightning fast, fully featured C compiler suitable for almost everything ... Borland's Turbo C compiler is flexible, fast and friendly.

—Peter Feldman, *PC Week* ”

## Heap Sort

	Turbo C 1.5	Microsoft C 5.0
Compile time	4.7 sec.	16.3 sec.
Compile & link time	7.4 sec.	19.5 sec.
Execute time	10.5 sec.	15.5 sec.
Object code size	1119	1313
Execution size	6392	7891

Sort benchmark run on an 8 MHz IBM AT using Turbo C version 1.5 and the Turbo Linker version 1.1; Microsoft C version 5.0 and the MS overlay Linker version 3.61.

“Turbo Pascal 4.0 flies 4.0 is ballistic!” —Tom Swan,



Almost from its introduction, Turbo Pascal® has been the world-wide Pascal standard. It's fast. It's flexible. It's affordable. And it

gives you full control.

Compile more than 27,000 lines of code per minute\*. And work in a complete, integrated programming environment with pull-down menus and a full-featured editor.

You don't have to swap code in and out to beat the 64K barrier; it's designed for large programs. Break your code into convenient modules and work with them swiftly and separately. If there's an error in one, you can see it and fix it.

System Requirements For the IBM PS/2™ and the IBM® family of personal computers and all 100% compatibles. PC-DOS (MS-DOS) 2.0 or later. 384K RAM.

† Customer satisfaction is our main concern: If within 60 days of purchase this product does not perform in accordance with our claims, call our customer service department, and we will arrange a refund.

System Requirements For the IBM PS/2™ and the IBM® family of personal computers and all 100% compatibles. PC-DOS (MS-DOS) 2.0 or later. 384K RAM.

All Borland products are trademarks or registered trademarks of Borland International, Inc. Other brand and product names are trademarks of their respective holders. Copyright © 1988 Borland International, Inc. BI 1230A

# Turbo Languages are Super!

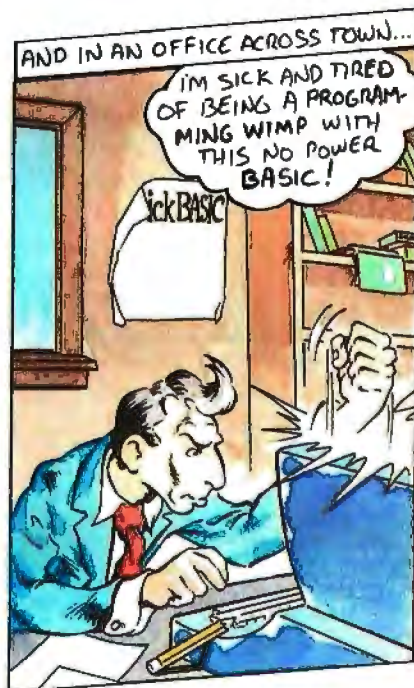

like a rocket ...

1987 Programmer's Journal

Powerful features include:

- Producing EXE files
- Separate compilation
- Built-in project management
- Graph unit including support for IBM CGA, EGA, VGA, and 3270, Hercules and ATT 6300
- Online, context-sensitive help

\*Run on an 8 MHz IBM PC AT.

Add expertise:

## The Turbo Pascal Toolboxes

Start with Turbo Pascal Tutor for just \$69.95 and add the others as your interests and expertise grow:

- Database Toolbox
- Editor Toolbox
- Graphix Toolbox
- Numerical Methods Toolbox
- GameWorks

Toolboxes require Turbo Pascal 4.0

**Just \$99.95 each**

“Each new Turbo Pascal 4.0 Toolbox is a virtual treasure of programming methods and tips.

—Giovanni Perrone, *PC Week*”

Circle 26 on Reader Service Card  
(DEALERS: 27)

“Turbo Basic compiles faster than anything I have seen.” —Ethan Winer, *PC Magazine*



Turbo Basic® is the lightning-fast Basic compiler with a total development environment that puts you in full control. Even novices can

write professional programs with Turbo Basic's full-screen windowed editor, pull-down menus, and trace debugging system. You also get a long list of innovative Borland features like binary disk files, true recursion, and increased compilation control. Plus the ability to create programs as large as your system's memory can hold—not just a cramped 64K.

The choice is basic: Turbo Basic!

**Just \$99.95!**

“Turbo Basic, simply put, is an incredibly good product ... Not only is this the most advanced BASIC ever, but Borland has lived up to its Turbo tradition.

—William Zachmann, *Computerworld*”

Add another Basic advantage:  
**The Turbo Basic Toolboxes**

- The Database Toolbox
- The Editor Toolbox

Toolboxes require Turbo Basic 1.1

**Just \$99.95 each.**

System Requirements For the IBM PS/2™ and the IBM® family of personal computers and all 100% compatibles. PC-DOS (MS-DOS) 2.0 or later. 384K RAM. 640K to compile toolboxes.

## Compare the BASIC differences

	<b>Turbo Basic 1.1</b>	QuickBASIC 4.0 Compiler	QuickBASIC 4.0 Interpreter
Compile & Link to stand-alone EXE	3 sec.	7 sec.	—
Size of .EXE	28387	25980	—
Execution time w/80287	0.16 sec.	16.5 sec.	21.5 sec.
Execution time w/o 80287	0.16 sec.	286.3 sec.	292.3 sec.

The Elkins Optimization Benchmark program from March 1988 issue of Computer Language was used. The Program was run on an IBM PS/2 Model 60 with 80287. The benchmark tests compiler's ability to optimize loop-invariant code, unused code, expression and conditional evaluation.

TURBOMAN VISITS SILICON MOTORS, SILICON CITY'S LARGEST MANUFACTURING PLANT...

HELP US TURBOMAN! WE'RE TRYING TO DESIGN A MAPPING SYSTEM INTO OUR NEW CARS, AND WE'RE STUCK!

A PERFECT JOB FOR NEW TURBO PROLOG 2.0 - ITS ARTIFICIAL INTELLIGENCE WILL DO ALL THE HARD WORK FOR YOU!



# Turbo Prolog 2.0: Powerful Artificial Intelligence for your real-world applications!



New Turbo Prolog® 2.0 lets you harness powerful AI techniques. And you don't have to be an expert programmer or artificial intelligence genius!

You get an all-new Prolog compiler that's been optimized to produce smaller and more efficient programs than ever before. An improved full-screen, completely customizable editor with easy pull-down menus. All-new documentation, including a tutorial rich with examples and instructions to take you all the way from basic programming to advanced techniques. Even online help!

System Requirements For the IBM PS/2™ and the IBM® family of personal computers and all 100% compatibles. PC-DOS (MS-DOS) 2.0 or later. 384K RAM.

- More new features!**
- An external database system for developing large databases. Supports B+ trees and EMS
  - Source code for a fully-featured Prolog interpreter written entirely in Turbo Prolog. Plus step-by-step instructions to adapt it or include it as is in your own applications!
  - Support for the Borland Graphics Interface, the same professional-quality graphics in Turbo Pascal, Turbo C, and Quattro
  - Improved windowing
  - Powerful exception handling and error trapping features
  - Full compatibility with Turbo C so the two languages can call each other freely
  - Supports multiple internal databases
  - High-resolution video support

**Just \$149.95!**

60-Day Money-back Guarantee †

For the dealer nearest you  
Call (800) 543-7543

Turbo Prolog Toolbox is 6 toolboxes in one!

More than 80 tools and 8,000 lines of source code help you build your own Turbo Prolog applications. Includes toolboxes for menus, screen and report layouts, business graphics, communications, file-transfer capabilities, parser generators, and more!

Toolbox requires Turbo Prolog 2.0

**Just \$99.95**

“ If I had to pick one single recommendation for people who want to try to keep up with the computer revolution, I'd say, 'Get and learn Turbo Prolog.'

—Jerry Pournelle, *Byte* 1/88

An affordable, fast, and easy-to-use language.

—Darryl Rubin, *AI Expert* 99



# BYTE

AUGUST 1988 VOLUME 13 NUMBER 8

## PRODUCTS IN PERSPECTIVE

- 67 What's New**
- 89 Short Takes**  
Dell System 220, a small but powerful desktop system  
T-DebugPLUS 4.0, symbolic debugging for Turbo Pascal 4.0  
Cambridge Computer Z88, small is beautiful  
Grammatik III, comprehensive grammar checking  
Watcom C 6.0, a class act  
Paradox OS/2, a solid entrée into OS/2 applications

## EXPERT ADVICE

- 101 Computing at Chaos Manor: A Fond Farewell**  
by Jerry Pournelle  
Is Jerry's old friend Zeke II retiring to greener pastures?
- 115 Applications Plus: New Directions**  
by Ezra Shapiro  
The column's horizons are expanded, and GrandView defines a new class of software.
- 121 Down to Business: Staking Out the Territory**  
by Wayne Rash Jr.  
What trends are most important to business users? This new column starts with some thoughts on networking and database servers.
- 125 Macinations: What's Up with Apple?**  
by Don Crabb  
New columnist Don Crabb discusses Macintosh products and issues.
- 131 OS/2 and You: Why OS/2?**  
by Mark Minasi  
The debut of this column covers some of OS/2's attractive features.



Cover Story:  
25-MHz 80386 Machines/140

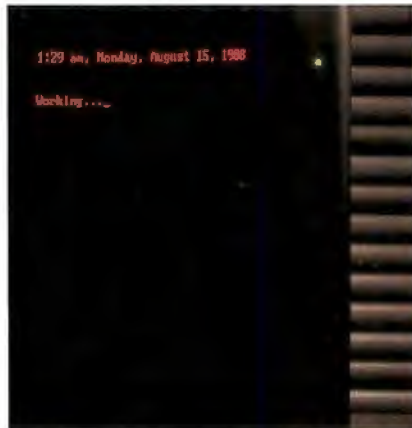

Communications Packages/148

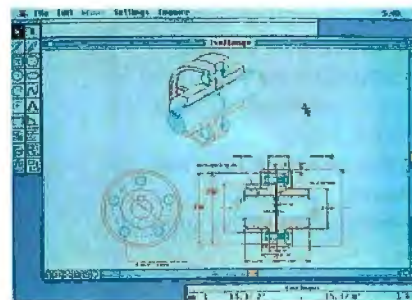

VersaCAD/195

- 135 COM1: The Wired Society**  
by Brock N. Meeks  
Noted telecommunicator Brock N. Meeks surveys the communications landscape.

## FIRST IMPRESSIONS

- 140 25-MHz Computing Buzzsaws**  
by Rick Grehan  
From Compaq, Everex, Intel, and SimpleNet, here they come: the first of the 25-MHz 80386-based AT clones.

## REVIEWS

- 148 Product Focus: Communications According to Script**  
by Steve Apiki and Stan Diehl  
Stand-alone communications packages that can handle a communications session unattended.
- 162 Variations on the 20-MHz Theme**  
by Ed McNierney  
The Tatung TCS-8000, Proteus 386A, and Everex Step 386/20 offer a range of performance and capabilities.
- 173 Four Surrogate Mice**  
by Jeff Holtzman  
PC-Trac, FastTRAP, Trackball Plus, and Felix offer the functionality of a mouse without the hassle.
- 185 Unix for the Mac II**  
by David Betz and Eva M. White  
Transform the Mac II into a Unix workstation with A/UX.
- 195 VersaCAD on a Mac**  
by Paul Tuten  
The MS-DOS-based drafting tool is now available in a Macintosh edition.
- 200 Review Update**

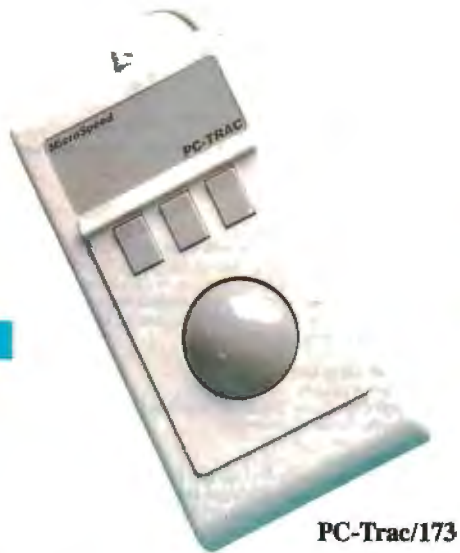

PC-Trac/173

**202 Introduction: The C Language**

**205 The State of C**

*by Brian W. Kernighan  
and Dennis M. Ritchie*

Originally designed for systems programming, C has become one of the most widely used languages in the world.

**215 A Better C?**

*by Bjarne Stroustrup*

The C++ language is a superset of C that supports data abstraction and object-oriented programming.

**219 It's an Attitude**

*by Jonathan S. Linowes*

A mechanism for doing object-oriented programming in conventional C.

**226 Resource Guide**

## FEATURES

**229 Making the Move to OS/2**

*by Robert E. Shostak, John Socha, Linda Dudinyak,  
and David P. Reed*

Top programmers from Borland, Norton, and Lotus talk about what it took to port their programs to OS/2.

## HANDS ON

**239 Ciarcia's Circuit Cellar: Why Microcontrollers?, Part 1**

*by Steve Ciarcia*

A tutorial perspective of the Intel 8031/8051 microcontroller family.

**249 Some Assembly Required: The Pitfalls of Porting, Part 2**

*by Rick Grehan*

Porting an MS-DOS application to the Mac is discussed.



The C Language/202



Circuit Cellar/239

## DEPARTMENTS

- 6 Editorial: Touching All the Bases
- 11 Microbytes
- 22 Letters
- 33 Chaos Manor Mail
- 38 Ask BYTE
- 51 Book Reviews
- 291 Coming Up in BYTE

## READER SERVICE

- 290 Editorial Index by Company
  - 292 Alphabetical Index to Advertisers
  - 294 Index to Advertisers by Product Category
- Inquiry Reply Cards: after 296

## PROGRAM LISTINGS

From BIX: see 182

From BYTEnet:  
call (617) 861-9764

On disk or in print:  
see card after 248

BYTE (ISSN 0360-5280) is published monthly with an additional issue in October by McGraw-Hill Inc. Founder: James H. McGraw (1860-1948). Executive, editorial, circulation, and advertising offices: One Phoenix Mill Lane, Peterborough, NH 03458, phone (603) 924-9281. Office hours: Monday through Thursday 8:30 AM-4:30 PM, Friday 8:30 AM-1:00 PM, Eastern Time. Address subscriptions to BYTE Subscriptions, P.O. Box 7643, Teaneck, NJ 07666-9866. Postmaster: Send address changes, USPS Form 3579, undeliverable copies, and fulfillment questions to BYTE Subscriptions, P.O. Box 7643, Teaneck, NJ 07666-9866. Second-class postage paid at Peterborough, NH 03458 and additional mailing offices. Postage paid at Winnipeg, Manitoba. Registration number 9321. Subscriptions are \$22.95 for one year, \$39.95 for two years, and \$55.95 for three years in the U.S. and its possessions. In Canada and Mexico, \$25.95 for one year, \$45.95 for two years, \$64.95 for three years. \$75 for one-year air delivery to Europe. \$28,800 for one-year air delivery to Japan, \$14,400 for one-year surface delivery to Japan, \$40 surface delivery elsewhere. Air delivery to selected areas at additional rates upon request. Single copy price is \$3.50 in the U.S. and its possessions, \$3.95 in Canada, \$4.50 in Europe, and \$5 elsewhere. Foreign subscriptions and sales should be remitted in U.S. funds drawn on a U.S. bank. Please allow six to eight weeks for delivery of first issue. Printed in the United States of America.

Address editorial correspondence to: Editor, BYTE, One Phoenix Mill Lane, Peterborough, NH 03458. Unacceptable manuscripts will be returned if accompanied by sufficient postage. Not responsible for lost manuscripts or photos. Opinions expressed by the authors are not necessarily those of BYTE.

Copyright © 1988 by McGraw-Hill Inc. All rights reserved. Trademark registered in the United States Patent and Trademark Office. Where necessary, permission is granted by the copyright owner for libraries and others registered with the Copyright Clearance Center (CCC) to photocopy any article herein for the flat fee of \$1.50 per copy of the article or any part thereof. Correspondence and payment should be sent directly to the CCC, 29 Congress St., Salem, MA 01970. Specify ISSN 0360-5280/83, \$1.50. Copying done for other than personal or internal reference use without the permission of McGraw-Hill Inc. is prohibited. Requests for special permission or bulk orders should be addressed to the publisher. BYTE is available in microform from University Microfilms International, 300 North Zeeb Rd., Dept. FR, Ann Arbor, MI 48106 or 18 Bedford Row, Dept. FR, London WC1R4EJ, England.



Subscription questions or problems should be addressed to: BYTE Subscriber Service, P.O. Box 7643, Teaneck, NJ 07666-9866.

# BYTE

**EDITOR IN CHIEF**  
Frederic S. Langa

**PUBLISHER/GROUP VICE PRESIDENT**  
J. Burt Totaro

## OPERATIONS

Glenn Hartwig *Associate Managing Editor*

## REVIEWS (Hardware, Software, Product Focus)

Cathryn Baskin *Associate Managing Editor*, Dennis Allen *Senior Technical Editor, Software*, Curtis Franklin Jr. *Senior Testing Editor, BYTE Lab*, Stephen Apiki *Testing Editor, BYTE Lab*, Stanford Diehl *Testing Editor, BYTE Lab*

## NEWS AND TECHNOLOGY (Microbytes, What's New, Short Takes)

Rich Malloy *Associate Managing Editor*, D. Barker *Senior Editor, News and Technology*, Anne Fischer *Leit Senior Editor, New Products*

Peterborough: Roger Adams *Associate News Editor*, David Andrews *Associate News Editor*, Martha Hicks *Associate News Editor*

West Coast: Gene Smarte *Bureau Chief*, Costa Mesa, Nicholas Baran *Technical Editor*, San Francisco, Frank Hayes, *Associate News Editor*, Jeffrey Bertolucci *Editorial Assistant*, San Francisco

## SENIOR TECHNICAL EDITORS

Ken Sheldon *Features*, Jane Morrill *Tazelaar In Depth*, Richard Grehan *At Large*, Tom Thompson *At Large*

## TECHNICAL EDITORS

Janet J. Barron, Janet Fiderio, Jon Udell, Eva M. White, Stanley Wszola

## ASSOCIATE TECHNICAL EDITOR

Robert Mitchell

## CONSULTING EDITORS

Steve Ciarcia, Jerry Pournelle, Ezra Shapiro, Don Crabb, Brock Meeks, Mark Minasi, Wayne Rash Jr.

## CONTRIBUTING EDITORS

Jonathan Amsterdam *Programming Projects*, Mark Dahmke *Video, Operating Systems*, Mark Haas *At Large*, Rik Jadrnicek *CAD, Graphics, Spreadsheets*, Robert T. Kurosaka *Mathematical Recreations*, Alastair J. W. Mayer *Software*, Stan Miastkowski *New Technology*, Alan R. Miller *Languages and Engineering*, Dick Pountain *Algorithms, Roger Powell Computers and Music*, Phillip Robinson *Semiconductors*, Jon Shiell *High-Performance Systems*, Ernest Tello *Artificial Intelligence*

## COPY EDITORS

Lauren Stickler *Chief*, Susan Colwell, Judy Connors-Tenney, Jeff Edmonds, Nancy Hayes, Cathy Kingery, Margaret A. Richard, Warren Williamson

## EDITORIAL ASSISTANTS

Peggy Dunham *Office Manager*, Linda C. Ryan, June N. Sheldon, Lynn Susan Valley

## ART

Nancy Rice *Director*, Joseph A. Gallagher *Assistant Director*, Jan Muller *Assistant*, Alan Easton *Technical Artist*

## PRODUCTION

David R. Anderson *Director*, Virginia Reardon *Senior Editorial Production Coordinator*, Denise Chartrand *Editorial Production Coordinator*, Michael J. Lonsky *Editorial Production Coordinator*

## TYPOGRAPHY

Sherry Fiske *Systems Manager*, Donna Sweeney *Applications Manager*, Selinda Chiquoine, Christa Patterson

## ADVERTISING/PRODUCTION (603) 924-8448

Lisa Wozmak *Director*, Lyda Clark *Senior Account Coordinator*, Karen Cillley, Linda Fluhr, Jeanne Gatcombe, Brian Higgins, Rod Holden, Wai Chiu Li *Quality Control Manager*, Julie Murphree *Advertising/Production Coordinator*

## MARKETING COMMUNICATIONS

Horace T. Howland *Director*, Pamela Petrakos-Wilson *Promotion Manager*, Wilbur S. Watson *Marketing Services Manager*, Dawn Matthews *Marketing Events Coordinator*, Lisa Jo Steiner *Marketing Assistant*, Stephanie Warnesky *Marketing Art Director*, Sharon Price *Associate Art Director*, Julie Perron *Market Research Analyst*

## PLANNING AND RESEARCH

Michele Perron *Director*, Faith Kluntz *Copyrights Coordinator*, Cynthia Damato *Sands Reader Service Coordinator*

## FINANCIAL SERVICES

Philip L. Penny *Director of Finance and Services*, Kenneth A. King *Business Manager*, Christine Monkton *Assistant*, Marilyn Haigh, Diane Henry, JoAnn Walter, Jaime Huber

## CIRCULATION

Dan McLaughlin *Director*, James Bingham *Newsstand Sales Manager*, Vicki Weston *Assistant Manager*, Karen Desroches *Distribution Coordinator*, Donna Healy *Direct Accounts Coordinator*, Louise Menegus *Back Issues*

## PERSONNEL

Patricia Burke *Personnel Coordinator*, Beverly Goss *Receptionist*

## BUILDING SERVICES

Tony Bennett *Manager*, Cliff Monkton, Mark Monkton, Agnes Perry

## BIX

BYTE INFORMATION EXCHANGE

## ACTING DIRECTOR

Edward A. Reno Jr.

## EXECUTIVE EDITOR

George Bond

## ASSOCIATE EDITORS

Tony Lockwood, Donna Osgood *San Francisco*

## MICROBYTES DAILY

D. Barker *Coordinator*, Peterborough, Rich Malloy *New York*, Gene Smarte *Costa Mesa*, Nicholas Baran *San Francisco*, Rick Cook *Phoenix*, Frank Hayes *San Francisco*, Jason Levitt *Austin, TX*, Larry Loeb *Wallingford, CT*, Brock N. Meeks *La Mesa, CA*, Stan Miastkowski *Peterborough*, Wayne Rash Jr., Sue Rosenberg *Washington, DC*, David Reed *Lexington, KY*

## GROUP MODERATORS

David Allen *Applications*, Frank Boosman *Artificial Intelligence*, Leroy Casterline *Other*, Marc Greenfield *Programming Languages*, Jim Howard *Graphics*, Gary Kendall *Operating Systems*, Steve Krenek *Computers*, Brock N. Meeks *Telecommunications*, Barry Nance *New Technology*, Donald Osgood *Computers*, Sue Rosenberg *Other*, Jon Swanson *Chips*

## BUSINESS AND MARKETING

Doug Webster *Director (603) 924-9027*, Patricia Bausum *Secretary*, Denise A. Greene *Customer Service*, Brian Warnock *Customer Service*, Tammy Burgess *Customer Credit and Billing*

## TECHNOLOGY

Clayton Lisle *Director, Business Systems Technology*, MHS, Bill Garrison *Senior Business Systems Analyst*, Jack Reilly *Senior Business Systems Analyst*, Bob Dorobis *Business Systems Analyst*, Fred Strauss *Senior Business Systems Analyst*

## ADVERTISING SALES

Dennis J. Riley *Director*, (603) 924-9281  
Sandra Foster *Administrative Assistant*

## NEW ENGLAND

ME, NH, VT, MA, RI, ONTARIO, CANADA & EASTERN CANADA  
John C. Moon (617) 282-1160

## ATLANTIC

NY, NYC, CT, NJ (NORTH)  
Leah G. Rabinowitz (212) 512-2098  
(203) 866-7111

## EAST

PA, KY, NJ (SOUTH), MD, VA, W. VA, DE, DC  
(215) 496-3833

## SOUTHEAST

NC, SC, GA, FL, AL, TN  
Carolyn F. Lovett (404) 252-0628

## MIDWEST

IL, MO, KS, IA, ND, SD, MN, WI, NE, IN, MI, MS, OH  
Bob Denmead (312) 751-3740

## SOUTHWEST, ROCKY MOUNTAIN

CO, WY, OK, TX, AR, LA  
Karl Heinrich (713) 482-0757

## SOUTH PACIFIC

SOUTHERN CA, AZ, NM, LAS VEGAS  
Jack Anderson (714) 557-6292  
Tom Harvey (213) 480-5243

## NORTH PACIFIC

HI, WA, OR, ID, MT, NORTHERN CA, NV (except LAS VEGAS), UT, WESTERN CANADA  
Mike Kisseberth (415) 362-4800  
Bill McAfee (415) 348-4100

## TELEMARKETING

L. Bradley Browne *Director*  
Susan Boyd *Administrative Assistant*

## BYTE BITS (2x3)

Dan Harper (603) 924-8830

## THE BUYER'S MART (1x2)

Mark Stone (603) 924-3754

## REGIONAL ADVERTISING SECTIONS

MID-ATLANTIC, METRO NY & NEW ENGLAND, SOUTHERN CALIFORNIA  
Elisa Lister (603) 924-8830

## MIDWEST, PACIFIC NORTHWEST,

METRO NY & NEW ENGLAND  
Scott Gagnon (603) 924-8830

## SOUTHEAST, SOUTHWEST

Denise Vernier (603) 924-9281

## BYTE DECK MAILINGS

National  
Ed Ware (603) 924-8166

## A/E/C COMPUTING DECK

COMPUTING FOR ENGINEERS DECK  
Mary Ann Goulding (603) 924-9281

## INTERNATIONAL ADVERTISING SALES STAFF

See listing on page 293.

## EDITORIAL AND BUSINESS OFFICE:

One Phoenix Mill Lane, Peterborough, NH 03458, (603) 924-9281.

West Coast Branch Offices: 425 Battery St., San Francisco, CA 94111, (415) 954-9718; 3001 Red Hill Ave., Building #1, Suite 222, Costa Mesa, CA 92626, (714) 557-6292.

New York Branch Editorial Office: 1221 Avenue of the Americas, New York, NY 10020, (212) 512-3175.

BYTEnet: (617) 861-9764 (set modem at 8-1-N or 7-1-E; 300 or 1200 baud). Fax: (603) 924-7507. Telex: (603) 924-7861.

SUBSCRIPTION CUSTOMER SERVICE: Non-U.S. (201) 837-1315; inside U.S. (outside NJ) 1-800-423-8272; (inside NJ) 1-800-367-0218.

Officers of McGraw-Hill Information Systems Company: President: Richard B. Miller, Executive Vice Presidents: Frederick P. Jennott, Construction Information Group; Russell C. White, Computers and Communications Information Group; J. Thomas Ryan, Marketing and International. Senior Vice Presidents-Publishers: Laurence Altman, Data Communications; David J. McGrath, Engineering News-Record. Group Vice Presidents: J. Burt Totaro, BYTE; Frank A. Shinal, Dodge; Vice Presidents: Robert D. Daleo, Controller; Fred O. Jensen, Planning and Development; Michael J. Koeller, Human Resources; Julia Lonard, Systems Planning and Technology.

Officers of McGraw-Hill Inc.: Joseph L. Dionne, Chairman and Chief Executive Officer; Robert N. Landes, Executive Vice President, General Counsel, and Secretary; Walter D. Serwetka, Executive Vice President and Chief Financial Officer; Shel F. Asen, Senior Vice President, Manufacturing; Robert J. Bahash, Senior Vice President, Finance and Manufacturing; Frank D. Penglass, Senior Vice President, Treasury Operations; Ralph R. Schulz, Senior Vice President, Editorial.

BYTE and BITE are registered trademarks of McGraw-Hill Inc.



# Integrated Software for Schematics & PCB Artwork



## Introducing HiWIRE® Plus

Wintek's smARTWORK® pioneered low-cost printed-circuit-board CAD. Then HiWIRE set the standard for productivity and ease-of-use in schematic capture. Now Wintek introduces HiWIRE-Plus, integrating HiWIRE's schematic features with a powerful printed-circuit-design facility.

## Creating Schematics

With HiWIRE-Plus, simply connect library symbols with wires and buses. Creating and changing symbols is fast and painless. Produce your drawing using a dot-matrix printer, laser printer, or pen plotter.

## Circuit-Board Design

HiWIRE-Plus gives you all the design freedom you want: you choose the grid size, trace widths, and pad shapes. The board size and number of layers are virtually unlimited. HiWIRE-Plus is perfect for surface-mount, micro-strip, and ECL applications.

## HiWIRE-Plus Advantages

- One tool for schematics and printed-circuit artwork
- Easy-to-learn menu-driven operation; complete documentation and tutorial
- Schematic libraries with TTL, CMOS, ECL, ladder, micro-processor, and discrete components
- Netlist and bill-of-materials utilities included
- Circuit boards up to 60x60 inches and 256 layers
- Variable grid size, trace width, and pad size (.001" resolution)
- PCB library with DIPs, SIPs, SMDs, PGAs, TOs, and edge and D connectors
- Schematic-to-layout cross-checking
- Design-rule checker
- 800 number for free support



"HiWIRE", "smARTWORK", "Wintek", and the Wintek logo are registered trademarks of Wintek Corporation.

## System Requirements

- IBM PC, XT, AT, or PS/2 with 512K RAM, printer port, color monitor, and CGA, EGA, or VGA graphics card
- Microsoft Mouse
- IBM ProPrinter or Epson dot-matrix printer, and/or
- Houston Instrument or Hewlett-Packard pen plotter

## Higher Performance Better Value

Still only \$895, HiWIRE-Plus delivers quality schematics and PCB artwork. You don't need to guess if HiWIRE-Plus is right for you—we *guarantee it!* Try it for 30 days at absolutely no risk. Call toll free today and put HiWIRE-Plus to work for you.

## Wintek Corporation

1801 South Street  
Lafayette, Indiana 47904-2993  
(800) 742-6809 or  
(317) 742-8428  
FAX: (317) 448-4823  
Telex: 70-9079

Europe: RIVA Ltd., England,  
Phone: 0420 22666, FAX: 0420 23700  
Australia: Entertainment Audio Pty, Ltd.,  
Phone: (08) 363-0454

CURRENT VERSIONS  
HiWIRE, V1.1r4; smARTWORK, V1.4r1

# TOUCHING ALL THE BASES

Hybrid speed demons, a new 80386 chip, four new monthly columns, and an In Depth section on the C language

**J**ust 90 days ago, a handful of relatively new 20-MHz 80386-based machines sat comfortably at the top of the heap: the fastest desktop computers. Today, they have been relegated to second-tier status by a veritable explosion of 25-MHz computers.

Their reign, in turn, also may be brief: We know of at least one manufacturer who is preparing 30-MHz motherboards using "goosed" 25-MHz chips. (If it turns into a working product, you'll read about it in a future BYTE.)

But, at least for now, 25 MHz is as fast as it gets for real, desktop machines using more-or-less conventional architectures. The enhancements usually include fast RAM accessed by a proprietary 32-bit-wide memory bus and built-in disk caching. The rest of such a machine tends to be built from stock IBM PC AT-class parts. Our cover story gives you an early look at preproduction models of four examples of this new wave of hybrid speed demons.

Speaking of hybrids, the cover story also discusses the Compaq 386S, a very-small-footprint machine that uses a new kind of 16-MHz 80386 chip: It's 32 bits wide internally, but it communicates with the outside world through an IBM PC AT-style 16-bit bus. (No, at this time, you can't use the chip as a plug-and-play replacement for an 80286. To date, the only such replacement we know of is the Cheetah Adapter/386, which we covered in April 1987.)

This new chip, which is called the 80386SX, may produce a whole new

kind of IBM PC AT-class machine based on the 80386. (The 80286 could be pushed downward into entry-level machines.) In theory, this would simplify things, because everyone above the entry level could standardize on 80386-specific software and thus circumvent some of the current hoop jumping required to cope with the limitations of the 80286. (An entry-level user isn't likely to bump up against the 80286's shortcomings.) It's a development that bears close watching.

While enhancements abound on the IBM PC side, the machines based on the 68000 family haven't exactly been dead in the water, either—witness the steady stream of new products for the Macintosh.

In fact, there's so much interesting Macintosh material, that we've placed a special Macintosh supplement between this month's Products in Perspective and In Depth sections. Be sure to take a look.

With all this activity, it's getting more difficult to stay abreast of all the important developments in microcomputing—harder to touch all the bases. That's why we've added four new monthly columns starting with this issue. They'll help ensure that you get the information you need—when you need it—in these critical areas:

**OS/2:** You've read about the theory, you've seen some sample code, and you may have seen an actual OS/2 application in action. But chances are, you don't own a copy of OS/2 yet. Noted OS/2 consultant Mark Minasi's "OS/2 and You" column offers some welcome perspective on making the move to OS/2 by combining technical insights, practical tips, and plain old common sense.

**Communications:** Brock Meeks, an award-winning author, writes about his passion: telecommunications. Each month, Brock's "COM1:" column will offer a mix of "hard" and "soft" telecommunications topics, examining the

technology and issues relating to point-to-point and area computer communications.

**Business:** Wayne Rash's name is familiar to longtime BYTE readers: He's a regular and popular contributor. When he isn't writing for BYTE, Wayne makes his living as a computer consultant to government and business. His specialty is solving the distinctive problems encountered by those who deal with large installations of microcomputers—networking, security, operational issues... the list of possible bottlenecks is almost infinite. Proven solutions to those myriad problems are the focus of his "Down to Business" column.

**Macintosh:** Don Crabb is another familiar name. Don has been a regular reviewer of Mac products for us. He's a participant in Apple's educational consortium and a frequent beta tester of new Mac products. The "Macinations" column is Don's forum to share his experiences with us.

This month's In Depth section also deserves special attention: It focuses on the top language for serious software development today. Virtually every major software package available today was coded in C: The C language is quite literally the foundation of today's software industry.

For our In Depth, we went to the folks who literally wrote the book: We have excellent articles by Kernighan and Ritchie, Bjarne Stroustrup, and others. (Dennis Ritchie is the designer of the C language; he and Brian Kernighan are the authors of the standard "K&R" reference on C. Bjarne Stroustrup is the creator of the general-purpose, object-oriented superset of C called C++.) This In Depth also features an unusually rich two-page Resource Guide. It's definitely a keeper.

—Fred Langa  
Editor in Chief  
(BIX name "flanga")

And then...  
Maxell created  
the RD Series.

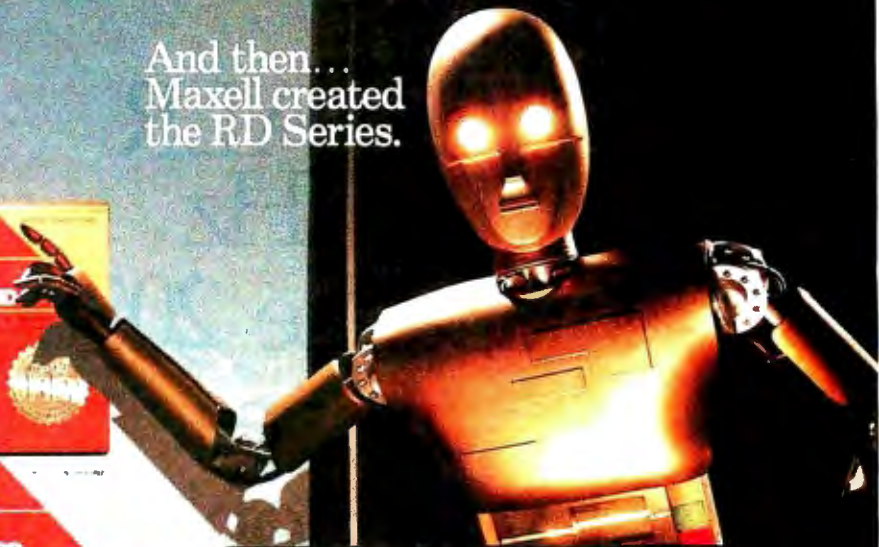

The  
Evolution  
of the  
Floppy Disk

Maxell Corporation of America, 22-08 Route 208, Fair Lawn, NJ 07410

Never before has this level of Reliability and Durability been available in floppy disks. Introducing the new RD Series from Maxell. Twice the durability of the disks you're now using. Twice the resistance to dust and dirt. And the RD Series is ten times more reliable than conventional floppy disks. The Gold Standard has always meant maximum safety for your data. Now it means even more.



**maxell**  
THE GOLD STANDARD

“The ALR  
20MHz  
FlexCache 20386  
proves  
that you don't have  
to be based in  
Texas to build the  
world's fastest  
PCs.”

**PCWEEK**

March 29,  
1988



Welcome to  
California, the  
zero wait  
state.

In July of '86 Advanced Logic Research was the world's first manufacturer to release an 80386 based PC, adding to a long list of California firsts. Today at ALR, we manufacture the world's fastest PCs. Industry peers have recognized the FlexCache 386 series as the ultimate tool for the most demanding business applications in network, multi-user and CAD/CAM environments.

**NOVELL**

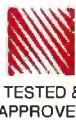

*"The ALR FlexCache 20386 will make a name for itself as a heavy-duty file server. ...the FlexCache is destined for success."*



excerpts from  
Editors Choice  
June 28, 1988

The ALR FlexCache 20386 Model 150 achieved a rating of 19.7 in Byte Lab. *"Tops in price and performance"*



Byte June, 1988

*"The performance they achieve sets a new standard for PCs."*

**PCResource** June, 1988

400% annual growth since 1984

**PC MAGAZINE**

*"ALR has come out of nowhere over the last two years to earn a spot in the sun among important PC-compatible makers."*  
- Jim Seymour January 12, 1988

*"Well, for once the answer isn't to run right out and get your hands on a Compaq Deskpro 386/20." Rather, it's to get your hands on an ALR FlexCache 20386."*

First Looks  
March 15, 1988



*"... the FlexCache 20386 yields the highest number of MIPS (million instructions per second) per dollar."*

**TECH** JOURNAL June, 1988



FlexCache  
386

## Redefining PC Speed

Although we can't go any further west, ALR is claiming new frontiers in PC performance and processing speeds. Now, fast is even faster. The ALR FlexCache 25386 breaks every current speed record. Our proprietary 64Kbyte *Extended Emulation* 82385™ is the key to 25386 Cache speed.

25 Mhz

PC performance is redefined.

	ALR FlexCache	ALR FlexCache	IBM PS/2 70 386	ALR FlexCache	IBM PS/2 70 386
Models	Desktop 20386DT-R66	20386-150	8570-121	25386-150	8570-A21
Microprocessor	80386 20MHz 32KB, 82385 Memory Cache (35ns)	80386 20MHz 32KB, 82385 Memory Cache (35ns)	80386 20MHz 0-2 wait-	80386 25MHz 64KB Extended Emulation 82385 Memory Cache (25ns)	80386 25MHz 64KB Memory Cache (30ns)
Bench Mark Data Base Power Meter Ver. 1.2	<b>4.71 Mips</b>	<b>4.71 Mips</b>	<b>3.53 Mips</b>	<b>6.09 Mips</b>	<b>5.74 Mips</b>
Optional Math CoProcessor	80387 20MHz	80387 20MHz	80387 20MHz	80387 25MHz	80387 25MHz
Memory (RAM)	1MB (80ns)	2MB (80ns)	2MB (85ns)	2MB (60ns)	2MB (80ns)
Storage 1.2MB, 5 1/4" FD 1.44MB, 3 1/2" FD	1 Optional (\$225.00)	1 Optional (\$225.00)	Not Available 1	1 Optional (\$225.00)	Not Available 1
Fixed Disk std. Opt. Internal Full Height Fixed Di	66MB (28ms) 66MB or 100MB	150MB (18ms) 150MB or 300MB	120MB (23ms) No Support	150MB (18ms) 150MB or 300MB	120MB (23ms) No Support
Video	Optional 16 bit VGA (\$339.00)	Optional 16 bit VGA (\$339.00)	VGA	16 bit VGA	VGA
Price	\$4590.00*	\$7490.00*	\$7995.00*	\$9499.00*	\$11,295.00*

\* Prices and configurations as of June 1988 and subject to change.

Now that things are get'n kind'a slow in Texas...

...go West young man.

Call ALR for the world's fastest PCs, under the California Sun.

**1-800-444-4ALR**



**Advanced Logic Research, Inc.**

9401 Jeronimo, Irvine, CA 92718  
Phone: 714-581-6770 FAX: 714-581-9240  
Telex: 510-601-4525  
Answer back Advanced Logic

Circle 6 on Reader Service Card  
(DEALERS: 7)



# QNX OPERATING SYSTEM

## REAL TIME

### Speed without compromise.

**QNX®DELIVERS** QNX delivers the speed of a dedicated real-time executive as well as multi-tasking, integrated networking and a multi-user development environment as rich and powerful as UNIX.

**SPEED** The tightly coded QNX kernel performs 3200 task switches/second on an AT, with full pre-emptive prioritized scheduling.

**TASK COMMUNICATION** QNX is based on a message-passing architecture, radically more innovative than PC-DOS, UNIX, or OS/2. User tasks and system tasks use the same messaging interface. This results in a single unified environment.

**INTEGRATED NETWORKING** On the QNX network, any task can send messages to any other task anywhere on the network. This direct communication is not available on other networks. The resultant "feel" of the QNX network is that of a homogeneous, tightly connected array of computers, rather than a collection of computing islands strung together on a network with comparatively limited functionality.

**DEVELOPMENT ENVIRONMENT** QNX comes with a rich set of utilities including a powerful full-screen editor, C compiler, symbolic debugger and multiple full-screen windows.

**RUNTIME ENVIRONMENT** QNX architecture is modular not monolithic. The

system consists of a set of tasks that provide services. Software developers can easily write tasks that add services to suit their specific application needs. It is straightforward to write tasks that interface to hardware through interrupts, I/O ports, DMA and dual-ported memory.

**TECHNICAL SUPPORT** Technical support is provided free of charge, and updates can be downloaded 24 hours/day from our online BBS.

QNX is now installed at over 60,000 sites in North America and Europe for manufacturing, process control, process monitoring, point-of-sale and many other applications.

Eliminate compromises in your real-time applications. Call for details today.

**THE ONLY MULTI-USER, MULTI-TASKING, NETWORKING, REAL-TIME OPERATING SYSTEM FOR THE IBM PC, AT, PS/2, THE HP VECTRA, AND COMPATIBLES.**

<b>Multi-User</b>	10 (32) serial terminals per PC (AT).	<b>C Compiler</b>	Standard Kernighan and Ritchie.
<b>Multi-Tasking</b>	64 (150) tasks per PC (AT).	<b>Flexibility</b>	Single PC, networked PC's, single PC with terminals, networked PC's with terminals. No central servers. Full sharing of disks, devices and CPU's.
<b>Networking</b>	2.5 Megabit token passing. 255 PC's and/or AT's per network. 10,000 tasks per network. Thousands of users per network.	<b>PC-DOS</b>	PC-DOS runs as a QNX task.
<b>Real Time</b>	3,200 task switches/sec (AT).	<b>Cost</b>	From US \$450. Runtime pricing available.
<b>Message Passing</b>	Fast intertask communication between tasks on any machine.		

**For further information or a free demonstration diskette, please telephone (613) 591-0931.**

Quantum Software Systems Ltd. • Kanata South Business Park • 175 Terrence Matthews Crescent • Kanata, Ontario, Canada • K2M 1W8

Circle 196 on Reader Service Card

QNX is a registered trademark of Quantum Software Systems Ltd.

UNIX is a registered trademark of AT & T Bell Labs. IBM, PC, AT, XT and PS/2, PC-DOS and OS/2 are trademarks of International Business Machines. HP and Vectra are registered trademarks of Hewlett-Packard Company.

# MICROBYTES

*Staff-written highlights of developments  
in technology and the microcomputer industry*

## Experimental Adder Circuit Could Speed Up Clock Cycles

**P**robably the most fundamental operation in computing is the use of logic gates to add two register values. The speed of register-to-register addition plays a large role in determining a computer's clock cycle speed. A typical 16-MHz machine would have an add time of 62 nanoseconds (this figure does not include register-to-register times, which would increase the number somewhat); high-

performance machines like the VAX typically have an add time of 45 ns.

Researchers at Stanford University have developed a new adder circuit that they hope will speed up addition times to about 1 ns for full 32-bit addition. The "subnanosecond arithmetic project," directed by professor Michael Flynn, is sponsored by the Center for Integrated Systems, a very large scale integration (VLSI)

research center funded by several major electronics companies.

The adder circuit is based on a new addition algorithm that combines the best features of three commonly used addition algorithms: Ling's algorithm, the carry look-ahead algorithm, and the conditional sum algorithm. The adder circuit requires only three gate delays (the time span between the input and the output of the final sum), while current adder circuits generally require about eight gate delays.

"Ultimately," Flynn said, "we're trying to create a technology to achieve 1-ns cycle times." He sees the adder circuit as the first step in that direction. However, the speed of the new circuit won't have much impact until other major processing bottlenecks, such as memory and cache access speeds, are also accelerated. The entire design of microprocessors will have to change in order to realize 1-ns processing speeds, Flynn said.

The first prototype is currently being fabricated using emitter coupled logic (ECL) gates. Flynn said he hopes the first chip will yield an addition speed of about 1.5 ns. The research group is also working on a CMOS version. The next phase of the project will include the development of a bipolar ECL floating-point multiplier circuit.

The "subnanosecond" project is futuristic, but Flynn sees more immediate potential for application of the adder and multiplier circuits in floating-point coprocessors.

## ParcPlace Hopes Smalltalk Makes It Big

**A**lthough BYTE devoted almost an entire issue to Smalltalk in August 1981, the object-oriented programming environment has remained relegated to academic and research institutions. In that issue 7 years ago, Dr. Adele Goldberg wrote that the "Smalltalk system is taking flight into the mainstream of the computer programming community." As president of ParcPlace Systems (Palo Alto, CA), a new company dedicated to promoting and enhancing Smalltalk, Goldberg hopes to make good on that claim, although somewhat belatedly.

ParcPlace is working on new features for the environment, including expanded libraries of "reusable parts" and "reusable frameworks" (a series of interacting reusable parts). These libraries will enable designers of user interfaces to select graphical objects or a sequence of activities involving objects for use in their designs, similar to how a

conventional programmer might call an existing function from a library for use in a program. "We're trying to provide tools for development of new interfaces, but we're dedicated to the standards of the vendors," Goldberg said. Objects consistent with AT&T's new Open Look version of Unix, for example, would be included in the Smalltalk reusable-parts libraries. "Our objective is to provide a malleable information environment where you can specify the user interface you want and find parts in libraries. Not everyone is a graphic artist or human factors expert," Goldberg said.

Other projects that ParcPlace is working on include graphical interfaces for Structured Query Language (SQL) database systems, and interfaces to object-oriented databases with extensible data types and "active objects" stored in the database. An active object can actually interact with the

*continued*

## Nanobytes

- The current shortage of 1-megabit single in-line memory modules (SIMMs)—chips that are widely used in Apple Computer's Macintosh and LaserWriter—is likely to continue for another year, an Apple executive says. Apple chief operating officer Del Yocam said it will take until the "middle of next year" for supply of the chips to reach acceptable levels for manufacturers. This could mean, sources said, that Apple will have to delay introduction of new machines, such as an enhanced Mac SE. Yocam said the scarcity of 1-megabit chips is due to Japanese failure to foresee the growth in demand for 1-megabit chips and the Reagan administration's trade embargoes. The memory chips Apple already has under contract will have to be used in units already in production. You can go into certain computer shops and buy the SIMMs, but you'll pay a pretty price for them.
- Only 2 percent of the computer software sold in the Arab Middle East is legitimate, according to Oliver Smoot, executive vice president of the Computer and Business Equipment Manufacturers Association. Smoot said the 98 percent piracy rate is largely among users working for governments and state-owned companies.
- Many users didn't like

*continued*

## NANOBYTES

it, but one software industry executive thinks it's time to bring back **copy protection** for certain types of programs. "I think copy protection for business software went away prematurely," said Ken Wasch, executive director of the Software Publishers Association. Wasch told a group of Amiga developers in Washington, DC that software companies gave in to user demands too easily. "All we have to protect ourselves is moral persuasion," he said. Wasch added that the SPA uses litigation as a second line of defense.

- In the future, **laser printer engines** with very high resolution may not be required, says president Luis Villalobos of Conographic (Irvine, CA), which makes PostScript-compatible printer controller cards that go in IBM PCs and compatibles. Villalobos said he has seen 300- to 600-dot-per-inch monochrome and color print engines, beyond the prototyping stage, that can vary dot size and/or intensity to produce apparent resolutions of 1000 to 3000 dpi. Color images produced on these systems can rival conventional optical-based printing techniques, Villalobos said.

- Meanwhile, CSS Labs (Irvine, CA) is coming out with a **laser printer controller card** that has its own INMOS **Transputer** and could, the company says, crank out 45 pages per minute. The GRIP board for IBM PCs and compatibles will work with several laser engines, the company said. When not working on printing tasks, the

*continued*

user when selected. For example, active objects could be used to monitor the database system to keep track of who's using it and for what purposes, or for more mundane tasks such as automatically sending electronic mail to other users of the database network. ParcPlace is also working on development tools for C++ (an object-oriented language based on C), which Goldberg said "complements Smalltalk-80 and gives C

programmers the chance to look at extensible data types."

In the last year, ParcPlace has made available a version of Smalltalk-80 for the Macintosh, and the company expects to have an MS-DOS version in beta testing this summer. Priced between \$695 and \$1295, the Smalltalk versions for the Macintosh and MS-DOS are fully compatible with the versions of Smalltalk running on Sun, Apollo, and

Hewlett-Packard workstations.

In any case, Goldberg has high hopes for Smalltalk. She points to software developers, such as Borland's Philippe Kahn, talking about incorporating "Smalltalk-like features" in their products. And she sees the move in the microcomputer world toward graphical interfaces and the need for portability across operating systems as golden opportunities for Smalltalk.

## Synchronous SCSI Seen as Coming Standard for Peripherals

**A**s CPU performance keeps increasing, the I/O speed of disks and other peripherals is becoming the major bottleneck in system performance. The best solution to the I/O bottleneck is the synchronous small computer system interface (SCSI), according to some product designers. Adaptec (Milpitas, CA), a major manufacturer of disk controllers, sees increasing use of embedded SCSI connections in hard disk and tape drives, as well as in other peripherals such as printers, said product manager Danial Faizullahoy. "In a year or so," he said, "SCSI

will be the de facto peripheral interface."

Synchronous SCSI is attractive because it is about 40 percent faster than asynchronous SCSI and also outperforms "native bus interfaces" such as the IBM PC AT bus and IBM's Micro Channel, proponents say. While the standard AT bus has a maximum data transfer rate of 1 megabyte per second and the Micro Channel transfers at about 3 megabytes per second, synchronous SCSI clocks in at about 5 megabytes per second. Although Faizullahoy does not see SCSI replacing native bus interfaces, he

said that Adaptec expects most major computer manufacturers, including IBM, to have built-in synchronous SCSI ports in the next product cycle, if they don't have them already.

Adaptec will soon be announcing new controller products using synchronous SCSI. According to Faizullahoy, the next phase in the development of SCSI will be moving up to 16-bit bandwidths. In the 1990s, he said, we'll see 32-bit-bandwidth SCSI interfaces. Meanwhile, ESDI will drop off, leaving primarily SCSI and native bus interfaces dominating the market, he said.

## AMD's Database Manager Chip Replaces Software Routines

**A** new microprocessor peripheral that could speed up database management tasks by replacing software with hardware has been developed by Advanced Micro Devices (Sunnyvale, CA). The Am95C85 Content Addressable Data Manager (CADM) coprocessor is designed to take over from the CPU such data-manipulation tasks as sorting, searching, inserting, and deleting

records. It could be used in networking and communications, file serving, high-speed graphics systems, and other areas that require fast data manipulation.

The Am95C85 uses 1.6-micron CMOS technology and contains 1K byte of RAM and a control unit. The control unit enables a single command to access the CADM's memory without having to provide physical

addresses. According to the company, the chip can provide content-addressable searches for 8-byte fields in less than 10 microseconds. The chip's architecture enables cascading up to 16 of the devices for large database systems.

AMD has been working on the processor for 4 years, said Dave Horton, a development manager for the chip.

*continued*



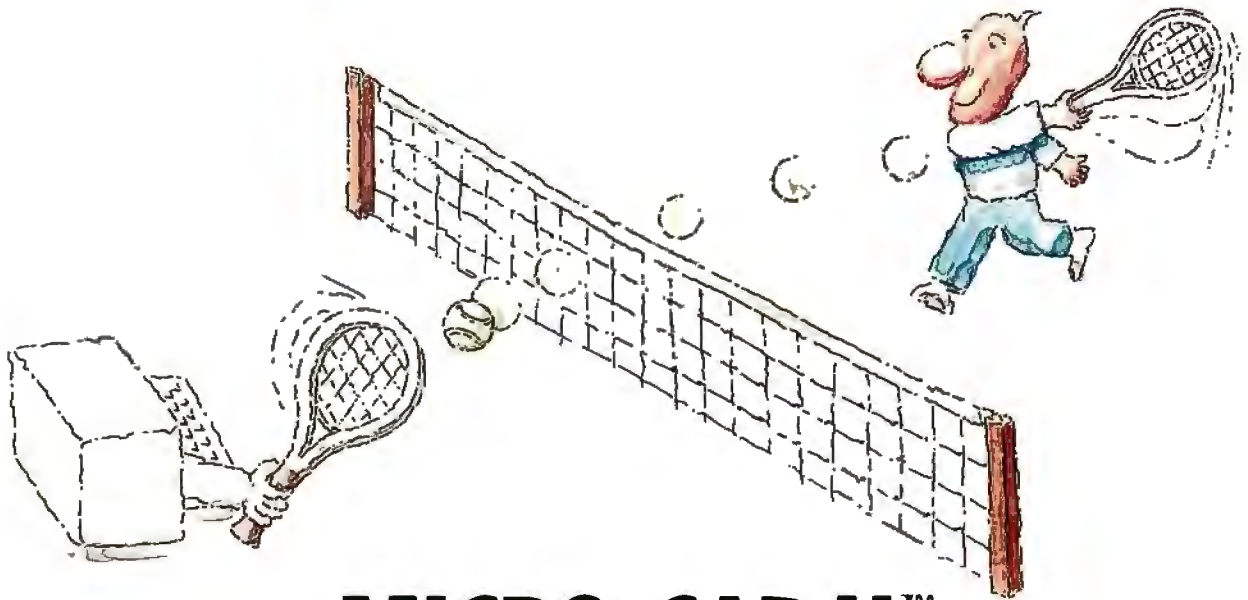

# MICRO-CAP II.™

## The CAE tool with fully interactive analog simulation for your PC.

Spectrum Software's MICRO-CAP II® is fast, powerful, and feature rich. This fully interactive, advanced electronic circuit analysis program helps engineers speed through analog problems right at their own PCs.

MICRO-CAP II, which is based on our original MICRO-CAP software, is a field-proven, second-generation program. But it's dramatically improved.

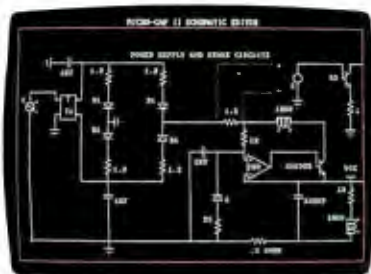

*Schematic Editor*

MICRO-CAP II has faster analysis routines. Better resolution and color. Larger libraries. All add up to a powerful, cost-effective CAE tool for your PC.

The program has a sophisticated integrated schematic editor with a pan capability. Just sketch and analyze. You can step

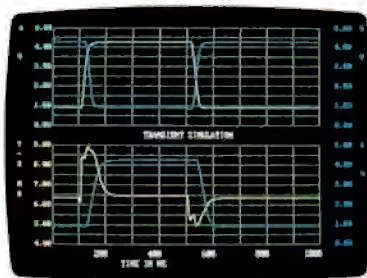

*Transient Analysis*

component values, and run worst-case scenarios—all interactively. And a 500-type\* library of standard parts is at your fingertips for added flexibility.

MICRO-CAP II is available for IBM® PCs and Macintosh.™ The IBM version is CGA, EGA, and Hercules® compatible and costs only \$895 complete. An evaluation version is available for \$100. Call or write today for our free brochure and demo disk. We'd like to tell you more about analog solutions in the fast lane.

- Integrated schematic editor
- Fast analysis routines
- High-resolution graphic output
- Standard parts library of 500\* types

\*IBM versions only.

- Transient, AC, DC, and FFT routines
- Op-amp and switch models
- Spec-sheet-to model converter\*
- Printer and plotter\* hard copy

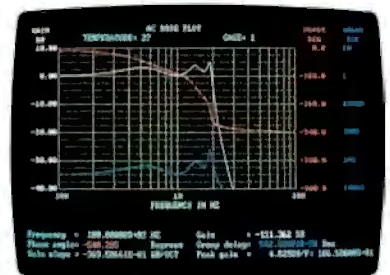

*AC Analysis*

**Spectrum**

1021 S. Wolfe Road, Dept. E  
Sunnyvale, CA 94087  
**(408) 738-4387**

MICRO-CAP II is a registered trademark of Spectrum Software.

Macintosh is a trademark of McIntosh Laboratory, Inc. and is being used with express permission of its owner.

Hercules is a registered trademark of Hercules Computer Technology

IBM is a registered trademark of International Business Machines, Inc.

## NANOBYTES

on printing tasks, the board could be used as a high-speed coprocessor.

- In a move seen as a crucial step in U.S. efforts to overtake Japan's leadership in the semiconductor industry, the Department of Defense will boost its **funding of Sematech** (Austin, TX), the chip-research consortium, by \$100 million a year through 1992.

Sematech chairman Sandy Kane responded to criticism that the Pentagon will pull the group's research into defense-oriented projects. "Our work is not going to be defense-related," he said. According to Kane, the Pentagon recognizes that "a healthy U.S. semiconductor industry will ultimately be good for the national defense."

- "If you ask me what the **future of the micro-computer** is, it is in multitasking and parallel processing," says Henri Rubin, chief operating officer of Commodore International (West Chester, PA). In an interview with BYTE, Rubin said that Commodore's use of coprocessor communications is an indication of where the company is going technologically. The Amiga maker has been a leader in supporting both Motorola and Intel processors within the same computer, he said. "Some people say we just have two computers in a box," he said, "but that's not true. It's more than that."

- Our trend signaler isn't blinking brightly yet, but we could be seeing a **drop in prices of gallium-arsenide chips**. GigaBit Logic (Newbury Park, CA) has cut prices of its high-speed GaAs

*continued*

"We saw the need to off-load some tasks from the system CPU," he said. "One of the problems we faced, though, was like the chicken and the egg: The hardware people didn't want to build boards when there was no software to access the chip, and the software folks didn't want to port their code when there was no hardware to use it."

The chip uses a new memory cell that's "sort of a cross between RAM and

FIFO," Horton said. "The cells enable us to split memory at a certain point, holding all memory above the split constant while letting us shift the remaining memory up or down, adding or deleting records." Horton theorized that the first PC application board probably would have one or two chips on-board, with sockets for a total of up to 16.

Currently, AMD has a demonstration board and software available. The

first commercial product that will use the chips will be a network bridge, from a European company, that will detect packet-address information in real time and direct it along the correct path in the network. In such an application, there is no time for the conventional lookup table approach.

CADM prices are \$49.20 for the 12-MHz version and \$66.50 for the 16-MHz version in quantities of 100. The chips are available now.

## The Electric Cadaver

**T**wo doctors at Stanford Medical Center have developed an electronic textbook for anatomy students that clearly demonstrates the potential power of hypertext and multimedia concepts in electronic publishing. The Electric Cadaver was developed by Dr. Robert Chase, a specialist in anatomy, and Dr. Steven Freedman, a physician with a long-standing interest in electronic publications for medical practice and training.

Built on a Macintosh II with Apple's HyperCard, the Electric Cadaver is a dynamic cross-referencing system that describes the structure and function of each part of the human anatomy. (Freedman built the first version 4 years ago on an IBM PC AT using Ashton-Tate's Framework). Images are displayed in digitized form on the computer screen and simultaneously in analog form on a videodisk player. The user can click on any part of the human body and then select from an index of topics on the screen.

Most parts of the anatomy are presented both in x-ray and bone structure form; many parts are shown from different angles and magnifications. In addition, results of physical injuries can be visually described. For example, clicking on

the facial nervous system displays a normal human face on the screen. By then clicking on indicated "injury zones" on the map of facial nerves, you can see the resulting types of paralysis in the face on the screen.

The HyperCard application includes an indexing system that can select any image on the videodisk player via serial communication. The Electric Cadaver has a "Frame Editor" that lets users customize the electronic textbook by adding or editing frames, adding text, and creating animated sequences. The system demonstrated to Microbytes included video movies, developed by Chase, of various anatomical functions, as well as still-frame images.

The still-frame images are derived primarily from a database of 1600 anatomical images (which was developed with the help of the man who invented the View-Master). The images were converted in two-dimensional format to a videodisk by photographing each frame on a high-quality video camera, adding captions with a character generator, and converting the videotape to videodisk.

According to Chase and Freedman, the Electric Cadaver is a tremendous timesaver as a teaching and

reference tool for medical students. "Traditionally," Freedman said, "students develop their own 'meta-books' by excerpting, compiling, and cross-referencing source material from multiple text books and other references. This is an incredible waste of time."

The electronic textbook eliminates the need for this kind of tedium and provides a much more visual and instructive presentation of the information to be learned, Freedman said. The system is also useful as a reference for physicians and surgeons; for example, a doctor could use the system to compare a CAT scan or x-ray of an unhealthy patient with a corresponding image of a normal anatomy in the Electric Cadaver.

Chase and Freedman hope to digitize the Cadaver's images in three dimensions, using a system like Digital Video Interactive, which would allow the graphics to be dynamic and adjustable so that students could change parameters (such as bone density). The doctors plan to add images from microscopic anatomy and are also exploring the use of bar code readers and other pointing mechanisms so that the system could be connected to a real cadaver.

*continued*

# Insist on a Sysgen 5<sup>1</sup>/<sub>4</sub>" drive for your PS/2.

*Here's why:*

**A** Sysgen™ Bridge-File™ gives a PS/2™ full access to your current data and software, with unparalleled 5<sup>1</sup>/<sub>4</sub>" disk drive performance and reliability. You get: A larger capacity drive. Two modes — a 360Kb and a powerful 1.2 Mb — assure you comprehensive transfer capabilities and convenience for total office needs. Others, like IBM®s, offer only 360Kb. Proven reliability. In fact, Sysgen is the choice of over 100,000 satisfied Bridge-File and tape back-up users. No slot loss. The Sysgen 5<sup>1</sup>/<sub>4</sub>" drive adapter card doesn't take any additional slot space. IBM's does. Built-in flexibility of an external connector. You can add another Bridge-File drive or Sysgen's high-performance tape back-up system, Bridge-Tape.™ (As a Bridge-File owner, you receive a total savings of \$135 on Bridge-Tape!) What's more,

Sysgen's footprint is smaller. A full 50% smaller than IBM's. For the best PS/2 access to 5<sup>1</sup>/<sub>4</sub>" disks, and the best value at only \$325, insist on Sysgen Bridge-File.

**Sysgen offers the only complete family of data transfer products:** Including the 3<sup>1</sup>/<sub>2</sub>" Bridge-File floppy disk drive, for transferring information from any PS/2 to any PC. And the Bridge-Tape subsystem that's

PC and PS/2 compatible, giving you total tape back-up and data transfer flexibility.

**Call for Sysgen literature or for the location of the Sysgen dealer nearest you.**



*INFO HOTLINE 1-800-821-2151*

**SYSGEN**  
INCORPORATED

*Circle 229 on Reader Service Card*

NANOBYTES

percent. GBL cut its 16G040 2-gigabit-per-second Clock and Data Recovery chip from \$180 to \$75, and its 12G014 1K-byte static RAM chip (2.5-ns cycle time) from \$92.80 to \$45.

• **MIDI Expo West** is set for September 10-11 at the Anaheim (CA) Marriott Convention Center. Last year's New York version attracted 3500 musicians, composers, software writers, and equipment designers. This year, the program's educational track will cover such topics as MIDI basics, computer music, and sampling techniques. For more information, contact Tc.ry

*continued*

## YARC Claims 50-MHz Operation for Mac II Booster Board

**Y**ARC Systems (Westlake Village, CA) has developed a coprocessor board for the Mac II that the company says can cause applications to run about 10 times faster than on a standard Mac II. The McCray board is based on Advanced Micro Devices' 32-bit Am29000 processor and Am29027 floating-point processor. YARC claims that a Mac II equipped with one of the \$4295 boards can outperform many expensive workstations.

The McCray takes advantage of the NuBus multiple-master capability that enables boards to access the bus directly, put addresses on the bus, and communicate with other boards to facilitate parallel processing, said YARC president Trevor Marshall. The standard Mac-

intosh interface remains intact, he said.

Marshall noted that the McCray's 50-MHz operation is beginning to strain the current printed-circuit-board technology. "While the board is only about 12 inches long, propagation delays at 50 MHz along the signal paths had to be accounted for when we were adjusting timing," said Marshall. When asked about potential radio-frequency interference from the McCray, Marshall said that because the board has no link to the outside, such as a serial connector, radiation would not be a problem.

The McCray has 2 megabytes of instruction RAM in a "mostly zero-wait-state" configuration and 512K bytes of one-wait-state data memory; a daughterboard

slated to be available soon will increase data memory to 2.5 megabytes.

The McCray requires a Mac II with 1 megabyte of memory, a hard disk drive, a color or monochrome display, the Apple 32-bit ROM upgrade (for early machines), and an average of 10 watts of power. The standard operating system is the Macintosh Finder. An assembler, linker, and debugger are also available.

You can load up all the available slots in the Mac II and expansion chassis with McCray boards and let the Mac's MultiFinder and 68020 assign parallel processing tasks.

YARC, which spells Cray backward, stands for Yet Another Ruddy Coprocessor, the firm says.

*continued*

The flowchart illustrates the process of handling invoices and checks. It starts with a 'Receiving Report' (a) and a 'Transmitted Invoice' (b). These lead to a central box (c) containing 'Price, Qty, Part# Matched' and 'Invoice Stamped & Coded'. From box (c), the process branches into 'Check Register' (e) and 'Open Accounts Payable' (e). Both (e) boxes lead to 'A/P Distribution', which then leads to 'General' and finally 'Checks Printed & Signed'.

**LOOK!**  
**It's Flow Charting™ II+!**

The ultimate fast track tool—for internal auditors, public auditors, secretaries, engineers, managers and line leads. Performance power WITH A PLUS, for even faster and easier construction, editing and printing of flowcharts and org charts.

- Text auto centering
- Smart line mode
- Internal mouse driver
- 10 text fonts
- Ega support
- Comprehensive, friendly manual

Give your charts the PLUS for only \$229\*. Contact your local software dealer—or call us.

**PATTON & PATTON**  
 Software Corporation

81 Great Oaks Blvd., San Jose, CA 95119  
 1-800-525-0082, Outside California  
 408-629-5376, California/International  
 \*plus shipping. In California add tax.

*Excellence in charting the flow of ideas*

## An Ounce of Innovation is Worth a Pound of Code.

As well as being an expert system tool, Intelligence/Compiler is a very high level language. Programs written in it are 20 to 50 times shorter than typical database or programming languages, and a lot more intelligent.

## Expert Systems as High Level Programming Tools.

Intelligence/Compiler gives you unprecedented power, flexibility and ease of use for building intelligent applications.

It is the first and only intelligent database system to uniformly combine logic programming, object oriented programming and intelligent interfaces.

“Intelligence/Compiler is an excellent product. Its unique and advanced features have proven extremely effective in our financial applications.”

Dr. Barry Glasgow, Vice President and Ms Elizabeth Graham, Knowledge Engineer, Shearson Lehman Hutton.

“After comparing many shells for the US Department of Transportation, we chose the Intelligence/Compiler. It was clearly the best choice.”

Dr. Jeffrey Dillingham, Vice President, Off-Shore Technology Corporation.

“The Intelligence/Compiler’s combination of rule-based programming and frame-based representation makes it a powerful state-of-the-art system for advanced real-world applications. Its intelligent editing and debugging facilities are a bonus.”

Review in AI Expert Magazine, February 1988.

“The Intelligence/Compiler tutorial is so well done that it should be released as a separate product. The development environment can save huge amounts of time otherwise spent on debugging.”

Review in Computer Language Magazine, March 1987.

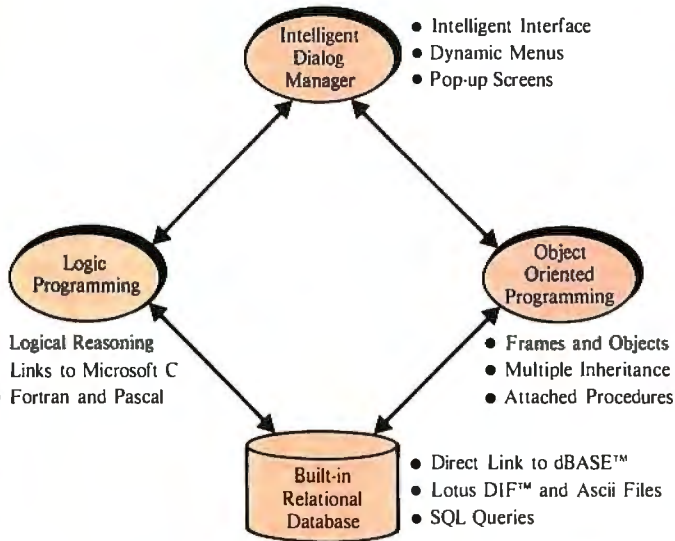

## An Open Architecture for Open Minds



The underlying technology of Intelligence/Compiler is so outstanding, we have written a book about it. It is being used in many leading universities as the standard text book. Ask for the book "Expert Systems for Experts" by K. Parsaye and M. Chignell, published by John Wiley, at your local book store.

## Painless Application Development

Don't look any further. Intelligence/Compiler is the tool you need to build royalty free applications. Find out how easy and painless it is to build intelligent applications, now!

# IntelligenceWare, Inc.

Leading in Artificial Intelligence Applications™

### YES! I WANT TO DEVELOP INTELLIGENT APPLICATIONS FAST.

Rush me \_\_\_ copies of Intelligence/Compiler at \$490 each.

Name: \_\_\_\_\_

Company: \_\_\_\_\_

Address: \_\_\_\_\_

Telephone: \_\_\_\_\_

Check or Money order is enclosed.

Visa  Mastercard  AMX

Number: \_\_\_\_\_

Expiration Date: \_\_\_\_\_

Shipping and handling: US: \$9.00, Canada/Hawaii Air: \$20.00, Overseas Air: \$50.00. California residents please add 6.5% tax.

System Requirements: IBM PC, PC/XT, PC/AT or PS2 with 640K memory.

Please send coupon to:

**IntelligenceWare, Inc.**

9800 S. Sepulveda Blvd. Suite 730, Los Angeles, CA 90045.

FAX: (213) 417-8897.

Telephone: (213) 417-8896.

## NANOBYTES

mation, contact Tony Scalisi at Expocon, 3695 Post Rd., Southport, CT 06490, (203) 259-5734.

- Discovery Systems (Dublin, OH) has cut the price of mastering CD-ROM disks to \$1500 and the cost of duplication to \$2 per platter. The optical disk manufacturer says the CD-ROM business is gaining momentum, what with Apple's CD-ROM drive and Tandy's decision to sell such drives in its retail stores.

- *Understanding Neural Networks: A Primer* is now available from Graeme Publishing (Amherst, NH). The publisher says the \$95 report is an "easy-to-read overview of scientific and commercial develop-

## Mac II Operating System Will Interface with NuBus

**A**pple Computer (Cupertino, CA) is readying a new operating system for the Mac II. Multitasking Realtime DOS (MR DOS) is a message-based operating system that can interface with the NuBus used in the Mac II. Apple is trying to avoid unnecessary NuBus interface work on the part of card makers by giving them a standard set of communication services to applications.

Apple first used MR DOS internally on the Mac-

APPC card, which performs LU 6.2 gateways to IBM machines. Diagnostics such as code downloaders and dumpers are included, as are the schematics for the board's hardware (which has its own 68000 processor and local memory). The card has 24 square inches of prototyping surface.

"We've taken the hard part of making a NuBus master and encapsulated it, providing an area where developers can add their value,"

said an Apple representative. "The more mundane things are done, so you now have a standardized platform. The operating system was released to help this standardization. It also allows us to move various products across different types of [Apple] cards. Communications stacks for different protocols can be ported easily now. We are committed to having intelligent cards. That may not be the only way to go, but that's the way we are going in the communications and networking environment at Apple."

Since source code to the operating system will not be released, developers will have to depend on Apple to maintain the operating system for them as the Mac hardware platform changes.

---

**TECHNOLOGY NEWS WANTED.** *The news staff at BYTE is always interested in hearing about new technological and scientific developments that might have an impact on microcomputers and the people who use them. We also want to keep track of innovative uses of that technology. If you know of advances or projects relevant to microcomputing and want to share that information, please contact the Microbytes staff at (603) 924-9281, send mail on BIX to Microbytes, or write to us at One Phoenix Mill Lane, Peterborough, NH 03458.*

## Computers For The Blind

Talking computers give blind and visually impaired people access to electronic information. The question is how and how much?

The answers can be found in "The Second Beginner's Guide to Personal Computers for the Blind and Visually Impaired" published by the National Braille Press. This comprehensive book contains a Buyer's Guide to talking microcomputers and large print display processors. More importantly it includes reviews, written by blind users, of software that works with speech.

This invaluable resource book offers details on training programs in computer applications for the blind, and other useful information on how to buy and use special equipment.

Send orders to:  
National Braille Press Inc.  
88 St. Stephen Street  
Boston, MA 02115  
(617) 266-6160

\$12.95 for braille or cassette, \$14.95 for print. (\$3 extra for UPS shipping)

NBP is a nonprofit braille printing and publishing house.

New Prices

OS/2

# WINDOWS FOR DATA®

MULTI-LEVEL MENU SYSTEM

NESTED POP-UP FORMS

SCROLLABLE REGION

CHOICE LIST

Invoices: Create Review Print Exit

INVOICE

Invoice No.: 000784 Date: 12/03/87 Time: 16:43:15

Customer: William Jones  
Innovative Software  
351 Bulletin Avenue  
Needham, MA 02194  
(617) 394-5512

Search for customer record? (Y/N): N  
Enter customer information? (Y/N): N  
Enter billing address? (Y/N): N  
Enter marketing information? (Y/N): N

No.	PRODUCT	DESCRIPTION	QUANTITY	PRICE	AMOUNT
5	WDMU	Windows for Data Microsoft	10	295.00	2950.00
6	WDLN	Windows for Data Lattice	5	295.00	1475.00
7	WDTG	Windows for Data Turbo C	5	295.00	1475.00
8	WDXE	Windows for Data XENIX	2	795.00	1590.00
9			0	0.00	0.00

Subtotal: 11325.00  
Shipping: 0.00  
TOTAL: 11325.00  
Payment: 0.00

Cursor keys scroll, ENTER selects and ESC exits choice menu

CLOCK

POP-UP WINDOW

RUNNING TOTALS

MESSAGE WINDOW

If you program in C, take a few moments to learn how Windows for Data can help you build a state-of-the-art user interface.

- ✓ Create and manage menus, data-entry forms, context-sensitive help, and text displays — all within windows.
- ✓ Develop window-based OS/2 programs right now, without the headaches of learning OS/2 screen management. Run the same source code in PC DOS and OS/2 protected mode.
- ✓ Build a better front end for any DBMS that has a C-language interface (most popular ones do).

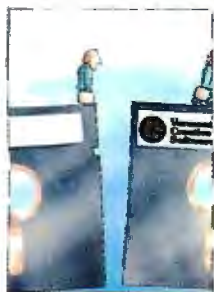

## FROM END TO BEGINNING

Windows for Data begins where other screen packages end, with special features like nested pop-up forms and menus, field entry from lists of choices, scrollable regions for the entry of variable numbers of line items, and an exclusive built-in debugging system.

## NO WALLS

If you've been frustrated by the limitations of other screen utilities, don't be discouraged. You won't run into walls with Windows for Data. Our customers repeatedly tell us how they've used our system in ways we never imagined — but which we anticipated by designing Windows for Data for unprecedented adaptability. You will be amazed at what you can do with Windows for Data.

## YOU ARE ALWAYS IN CHARGE

Control functions that you write and attach to fields and/or keys can read, compare, validate, and change the data values in all fields of the form. Upon entry or exit from any field, control functions can call up subsidiary forms and menus, change the active field, exit or abort the form, perform almost any task you can imagine.

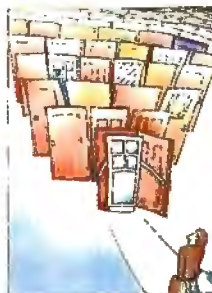

## OUR WINDOWS WILL OPEN DOORS

Our windows will open doors to new markets for your software. High-performance, source-code-compatible versions of Windows for Data are now available for PC DOS, OS/2, XENIX, UNIX, and VMS. PC DOS

versions are fully compatible with Microsoft Windows. **No royalties.**

## MONEY BACK GUARANTEE

You owe it to yourself and your programs to try Windows for Data. If not satisfied, you can return it for a full refund.

Prices: PC DOS \$295, Source \$295. OS/2 \$495. XENIX \$795. UNIX, VMS, please call.

**Call: (802) 848-7731**

Telex: 510-601-4160 VC SOFT

**ext. 51**

FAX 802-848-3502



**Vermont  
Creative  
Software**

21 Elm Ave.  
Richford,  
VT 05476

# This is for everyone too busy to get

If you're the type of person who's too busy to read an ad, read this ad.

Because you'll learn about a new tool that will help you manage people, ideas,



*Dump any random, unrelated thoughts or ideas into Agenda, and it'll help you turn that information into a stream of structured, actionable knowledge.*

projects, and information with incredible efficiency. A tool that will help you avoid slumping into your chair, shaking your head, and asking, "How on earth will I ever get this done?"

We call it Lotus® Agenda, the personal information manager.

Agenda allows you to dump random facts, thoughts, and ideas into your PC without having to structure the information in advance.

*Agenda's filing system is a more sophisticated version of this filing system. You can put items anywhere you want. View them any way you want. And have access to them anytime you want.*

You can record the thousands of tasks you need to address to put together a new product

line. Or the thousands of factors you need to put together a new bottom line.

Agenda will not only file these random items of information for you, it'll help you arrange them any way you want.

So you can understand them better, formulate new ideas better and extract all the answers you need better.

Which means, now you can concentrate

File	View	Item	Category	Print	Utility	System	Quit
New, Remove, Position, Assign, Discard, Undiscard							
Scratchpad				Who	Issues		
• Forward product comparison articles to Joan.				• Joan	• Competitive Tracking		
• Can we get the cost of goods sold under \$12?				• Tom	• Materials		
• Bob will present ten-point incentives program at sales conference.				• Bob	• Bonus Dollars		
• Tom will have his report in by a week from Friday; make sure it covers pricing, strategy, distribution, and implications of using outside vendor for typesetting and printing.				• Tom	• Distribution Vendors Pricing		
• Decision needed on research budget by end of this week—discuss options with Jim and Joan.				• Jim Joan	• Research		

*Items. Dump information in manually, import it or use our pop-up capability while in another program.*





# everyone who's any work done.

File	View	Item	Category	Print	Utility	System	Quit
Column, Section, Management, Info							
Issues	Product Ideas	Who	Department				
• Packaging	• Accept packaging bids until the end of October.	• Liz	• Operations				
• Materials	• Make sure synthetic materials are reliable.	• Sue	• Operations				
• Research	• Have Tom break down market research results into best case/worst case scenarios.	• Tom	• Marketing				
• Distribution Vendors Pricing	• Tom will have his report in by a week from Friday, make sure it covers pricing, strategy, distribution, and implications of using outside vendor for typesetting and printing.	• Tom	• Marketing				
• Distribution	• Do Tom and Bob think we need to adjust distribution mix?	• Tom • Bob	• Marketing • Sales				

Categories. Agenda files items in all relevant categories so you can always find the information you need.

File: C:\AGENDA\FILES\ISSUES				06/2/88	11:00
View: Issues by Person					
Issues	Joan	Priority	When		
• Research	• Decision needed on research budget by end of this week—discuss options with Jim and Joan.	• High	• 06/25/88		
• Competitive Tracking	• Forward product comparison articles to Joan.	• Low	• 07/07/88		
Issues	Bob	Priority	When		
• Distribution	• Do Tom and Bob think we need to adjust distribution mix?	• High	• 05/22/88		
• Bonus Dollars	• Bob will present ten-point incentives program at sales conference.	• Medium	• 06/29/88		

Views. Looking at the same information through different views gives you a more informed perspective.

different ways so you can pinpoint information that's important to you. Or discover new relationships you hadn't considered before. And anytime you change an item in a view, Agenda will

more on using and acting on your information. And less on processing it.

How does Agenda work?

First, enter your items of information



The whole idea behind Agenda is to get them all in a row.

into your PC and assign them to categories that you create.

Then Agenda will do all of your filing automatically. And thanks to Agenda's *multiple filing capabilities*, if the information is relevant in more than one place, Agenda will take it and put it in several categories at once.

This makes it easy to view your data in

automatically update all other categories where the item has been assigned.

In fact, you could say that Agenda recalculates your text the way a spreadsheet program recalculates numbers.

All of which means, from now on you'll be able to come in every morning, check your Agenda, and get right to work.

Because you'll immediately know what work needs getting to.

For \$15, we'll send you an Agenda demo kit or videotape. Call 1-800-345-1043 and ask for demo kit AGS-3058 for the 3.5" version or AGS-3053 for the 5.25" version. Or ask for videotape AGS-3063.



## Introducing Lotus Agenda

# LETTERS

## Efficient Recursion

In his article on benchmarks ("Problems and Pitfalls," June 1988, page 217), Alfred Aburto Jr. remarks on the significant performance difference between a simple loop to compute Fibonacci numbers and the recursive algorithm used in the benchmark. The inference he draws from this, that "Apparently, recursive function calls are highly inefficient," is a common misapprehension of such data. Instead, it is recursive *algorithms* that are often laughably inefficient and non-linear. A loop for the 24th number requires only 24 iterations, whereas a recursive algorithm for the same number involves 92,735 procedure calls, typically extravagant for recursive statements of simple problems. (Why are Lisp programs slow?) It seems that his function calls are in fact quite efficient if something done nearly 3900 times as often takes only 4500 times as long.

Greg Bailey  
Santa Barbara, CA

## Bit-Map Assistance

I have found "Better Bit-Mapped Lines" (March) very helpful in implementing an extremely fast line-drawing routine. While coding the Pascal into assembly language, however, I noticed that the `dx_diag` and `dy_diag` increments in octant 4 should be interchanged (see figure 4 on page 253).

This could have introduced a subtle bug, and I thought maybe others could avoid problems, especially when coding in assembly language, where it is tempting to turn these `dx` and `dy` increments into INCs and DECs.

David Miller  
Cedar Falls, IA

## Test Facilities

I was delighted to hear about your new testing facilities (Editorial, April). Benchmark comparisons and manufacturers' statements of Mean Time Between Failures are fine for choosing among a group of similar machines, but what an ever-increasing number of people in science and industry really need to

know about their potential purchase is, "Just how much abuse can this machine take?" Computers originally intended for home and the office are turning up in ever more exotic environments, with ever-decreasing margins between operation and failure. The big concern then becomes what kind of safety margin is left to work with.

WE WANT TO HEAR FROM YOU. *Please double-space your letter on one side of the paper and include your name and address. We can print listings and tables along with a letter if they are short and legible. Address correspondence to Letters Editor, BYTE, One Phoenix Mill Lane, Peterborough, NH 03458.*

*Because of space limitations, we reserve the right to edit letters. Generally, it takes four months from the time we receive a letter until we publish it.*

A lab of the type you describe could supply people with some much-needed information. The thought of running expensive computer equipment into the ground may seem a little drastic, but the savings in time, money, and equipment might well be worth it. I hope you aren't reluctant to push your tests to the limit. It could be of value to many of us.

Eric J. Pilger  
Honolulu, HI

## Clearly Fuzzy

The idea of "fuzzifying" Prolog as presented in "When Facts Get Fuzzy" by Bradley L. Richards (April) is certainly appealing. Unfortunately, the author's Prolog code lacks clarity and precision; rather than adding separate predicates such as `fuzzyy(TruthValue)` and `threshold(ThresholdValue)`, it is simpler to add an extra argument to each fuzzy fact.

For instance, rather than

```
scary(king_kong) :- fuzzy(0.5)
```

it is simpler to write

```
scary(king_kong,0.5)
```

and then pass the truth value as an argument, rather than performing obscure manipulations of the database with "assert" and "retract."

Stewart Rosenberg  
Troy, France

## Corrected Attribution

In Pete Wilson's otherwise interesting comparison of processor architectures ("The CPU Wars," May), there is an error.

The 6502 was not "originally designed by Mostek." It was designed by M.O.S. Technology, which did *not* later contract its name or otherwise become Mostek. As early as 1977, M.O.S. Technology had already been purchased by Commodore (copyright page and introduction to *The First Book of KIM*.) Mostek is still a separate company. The 6502 has been made by several companies, including Rockwell.

It is my understanding that the 6502 and M.O.S. Technology were created by a team that broke off from Motorola, I assume after losing some design arguments over the 6800. The team created a machine with one accumulator rather than two, but—far more important in the real world—two index registers, including one with the powerful capability of indexing indirectly from page zero for rapid (if not automatic) movement of gstrings and blocks. The first model (6500) was plug-compatible with the 6800 but priced at about one-fifth the 6800. The second model, the 6502, was much better because it had a built-in clock, reducing the chip count.

Perhaps most important, while Motorola was uptight and bureaucratic about samples of its \$90 chips, M.O.S. Technology gave away samples of the 6502 (\$20 each, list), including to two guys named Steve who put it in the Apple. It was also put in a lot of video games and controllers. (So maybe the comment on page 239 about 6502s being in closets is correct. I'm writing this letter on an

*continued*

# Who Says FoxBASE+ is Better than dBASE®?



## The Experts!

*The Best Just Got Better—Now Shipping New FoxBASE+ Version 2.10!*

**Nicholas Petreley**, *InfoWorld* Review Board:

"FoxBASE+ has outdone itself. Once again, FoxBASE+ earns an "excellent" in performance, with kudos for responding to user suggestions. For sheer productivity, there is no other choice."

**P.L. Olympia**, *Founder & President, National Dbase Users Group / Government Computer News*:

"FoxBASE+ is a supercharged dBASE, with all the features Ashton-Tate forgot. If you're into serious dBASE development and have not tried FoxBASE+, you are living in the dark ages and wasting your company's money."

**George F. Goley IV**, *Cont. Editor, Data Based Advisor*:

"The product is fast, very compatible, fast, easy to use, fast, relatively inexpensive, and very fast. In every test, FoxBASE+ outperformed the other products. And people who answer the phone at Fox know what they are talking about."

**David Irwin**, *Former President/CEO, Data Based Advisor*:

"From the dBASE compatibility standpoint, FoxBASE+ is flawless. From the speed standpoint, FoxBASE+ is unbelievable. From the "lazy factor" standpoint, FoxBASE+ is perfect."

**Glenn Hart**, *Contributing Editor, Magazine*:

"Initial tests of FoxBASE+ were simply stunning. In many ways, FoxBASE+ gives you the best of both worlds: all the benefits of interactive development and debugging, plus the speed and code protection of a compiler."

**Adam Green**, *Contributing Editor, Data Based Advisor, dBASE Author*:

"For the PC, FoxBASE+ has consistently set the performance standard for dBASE compatible languages. For the Macintosh, FoxBASE+/Mac will set standards for innovation and leadership in a new dBASE implementation."

**Don Crabb**, *Contributing Editor, InfoWorld*:

"You can expect blazing speed on the Mac. FoxBASE+/Mac breezes past tests that have proven stumbling blocks for Macintosh databases in the past. FoxBASE+/Mac combines complete dBASE compatibility with a genuine Macintosh user interface."

**This is what they said about Version 2.00 of FoxBASE+. Imagine what The Experts will say about New Version 2.10 with these added features: Menu-Driven Interface, Program Documentor, Screen Painter and Template-Based Application Generator . . . and Version 2.10 is even faster than 2.00!**

**Join The Experts. Get your copy of the New FoxBASE+ Version 2.10 today! Now available at your nearest, quality software retailer, or directly from us by calling (419) 874-0162 Ext. 320.**

**Because, when it comes to speed, compatibility and value, nothing runs like the New FOX—Version 2.10!**

## Fox Software

**Nothing Runs Like a Fox.**

Fox Software

118 W. South Boundary

Perrysburg, OH 43551

(419) 874-0162 Ext. 320.

FAX: (419) 874-8678

TELEX: 6503040827 FOX

Circle 91 on Reader Service Card

FoxBASE and FoxBASE+ are trademarks of Fox Software.  
dBASE and dBASE III PLUS are trademarks of Ashton-Tate.  
Macintosh is a trademark of Apple Computers, Inc.

# OUR PLUG-IN CARDS GIVE YOU PLUG-IN CONTROL.

Your IBM PC/XT/AT or compatible can control any IEEE-488 instrument.

You can:

- Plug-in to BASIC, C, FORTRAN, or Pascal.
- Use HP-IB plotters, printers, and instruments.
- Spend less time programming.
- Call (617) 273-1818 and put us to the test.

Complete hardware and software solutions for just \$395.



Capital Equipment Corp.  
99 South Bedford Street  
Burlington, MA. 01803



## FULL AT&T C++: ANNOUNCING VERSION 1.2

Guidelines announces its port of version 1.2 of AT&T's C++ translator. As an object-oriented language C++ includes: classes, inheritance, member functions, constructors and destructors, data hiding, and data abstraction. "Object-oriented" means that C++ code is more readable, more reliable and more reusable. And that means faster development, easier maintenance, and the ability to handle more complex projects. C++ is Bell Labs' answer to Ada and Modula 2. C++ will more than pay for itself in saved development time on your next project.

# C++

from **GUIDELINES** for the IBM PC: \$295

Requires IBM PC/XT/AT or compatible with 640K and a hard disk.

Note: C++ is a *translator*, and requires the use of Microsoft C 3.0 or later.

Here is what you get for \$295:

- The full AT&T v1.2 C++ translator.
- Libraries for stream I/O and complex math.
- The C++ Programming Language, the definitive 327-page tutorial and description by Bjarne Stroustrup, designer of C++.
- Sample programs written in C++.
- Improved installation guide and documentation.
- 30-day money-back guarantee.

To Order:

send check or money order to:

**GUIDELINES SOFTWARE, INC.**  
P.O. Box 749, Dept. BT  
Orinda, CA 94563

To order with VISA or MC,  
phone (415) 254-9183.  
(CA residents add 6% tax.)

C++ is ported to the PC by Guidelines under license from AT&T.  
Call or write for a free C++ information package.

Apple IIe with 192K bytes of memory, and AppleWorks with a bunch of memory is a wonderful tool: fast and easy to use. It's a pity Scully doesn't agree.)

Mike Firth  
Dallas, TX

### WORM Standards

I welcomed "A Quintet of WORMs" by Wayne Rash Jr. (February), but I was surprised that it said nothing about standards—or the lack of them. It seems to me that WORMs will not take off as a form of data storage until there is an agreed standard format, as has happened with the High Sierra format for CD-ROM. There has been a massive development of CD-ROM since the adoption of this standard, such that it could easily become a standard feature of PCs in the next few years.

I work in a social research unit, and in the near future I expect we'll be using desktop machines to analyze large data sets for which we currently use mainframes. For example, data from the next census in both the U.S. and the U.K. is likely to be distributed on CD-ROM. However, the initial mastering costs will probably make it prohibitively expensive to produce some of the smaller, less widely used data sets on CD-ROM, such as the U.K. General Household Survey or the U.S. Health Interview Survey. WORMs would be a convenient and relatively low-cost way of distributing such data sets. Yet this is unlikely to be attractive to either the users or the distributors of such datasets when there is no standard format. With no agreement on a standard, presumably IBM's own format will become a default standard, even though IBM produces only a one-sided WORM drive while others are producing double-sided drives.

The other drawback, from the user's point of view, is the proliferating number of drives that seem to be required—floppy disk drives, CD-ROM drives, and WORM drives—not all of which are likely to fit into one box. I have noticed that WORM cartridges look quite different from CD-ROM disks. Is it at all likely that there will be a single drive that will read both CD-ROMs and WORMs?

Charlie Owen  
London, England

### Hartley's Limitations

Before you discard the Fourier transform in favor of the Hartley, be aware of some serious limitations ("Faster Than Fast Fourier" by Mark A. O'Neill, April). The trivial nature of the so-called cas

*continued*

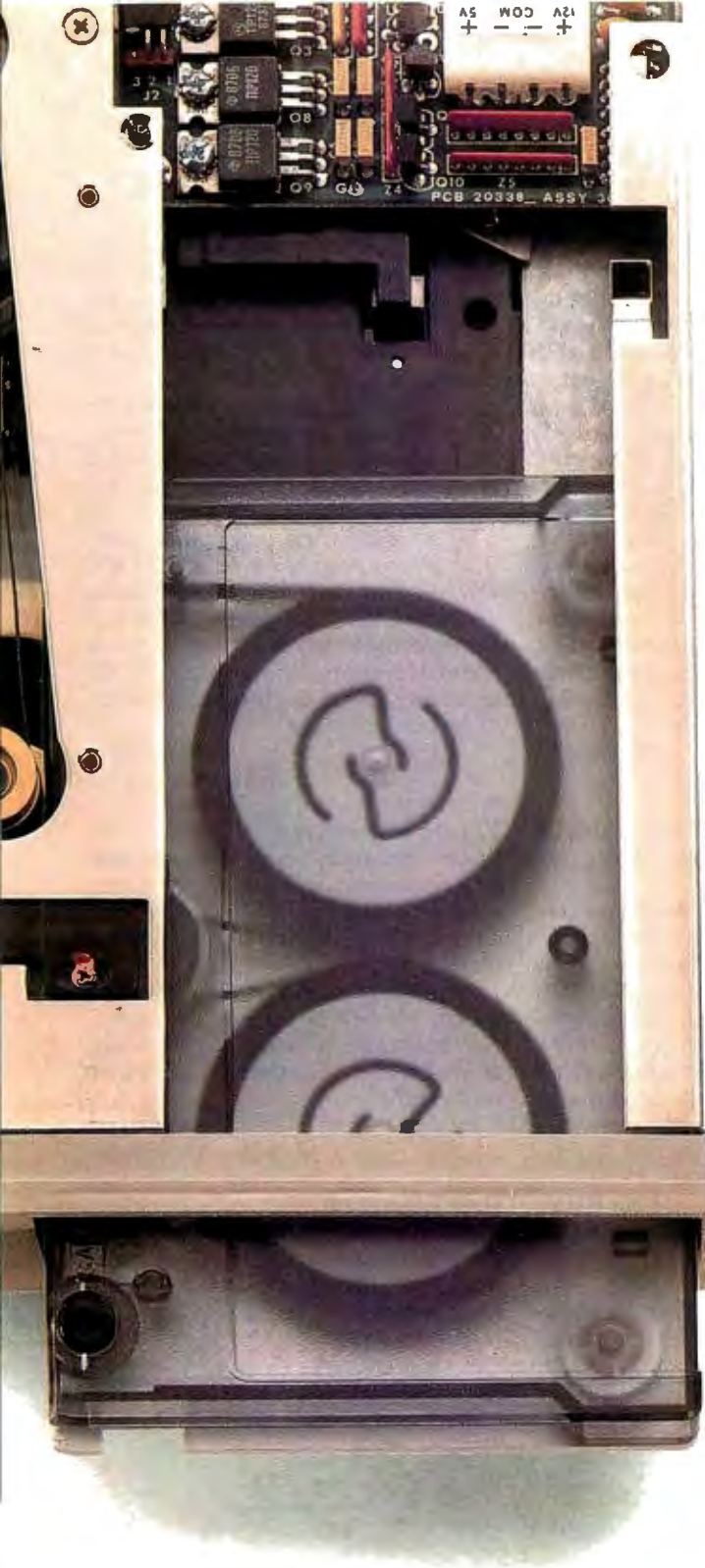

# It's A Matter Of Security

With Everex tape backup products, users of IBM® PC™/XT™/ATs®, compatibles or PS/2s™ can easily protect the valuable information stored on their systems. A variety of options are available including external and internal units with 40MB to 125MB of capacity in cartridge, cassette or mini-cartridge drives — all at affordable prices.

Everex has been an industry leader in tape backup systems since 1984. Our popular half-height, internal units are designed to fit inside 5 1/4-inch disk drive slots. There's even a mini-cartridge drive that fits right into a disk drive slot and runs off an existing floppy controller.

With Everex tape systems, you have the flexibility to save or restore all information on your hard disk, including DOS and all other operating systems. Backup can be done file-by-file or as an entire mirror image, and you can restore individual files from image backups. If you have an assortment of PC/XT/ATs, compatibles and PS/2s, you can cut down on costs by using one Everex tape backup unit and a controller card in each computer.

When you buy an Everex tape backup system you get everything you need. This isn't true with other tape units on the market today—their extra costs can add as much as \$250 to a system.

When it comes to securing your data, it's easy to see why **Everex has the answer.**

For more information or the name of your nearest Everex dealer please call:

in Calif. **1-800-821-0807**

in U.S.A. **1-800-821-0806**

**EVEREX**  
EVER for EXcellence®

Everex is a trademark and Ever for EXcellence is a registered trademark of Everex Systems, Inc. IBM and AT are registered trademarks and PC, XT and PS/2 are trademarks of International Business Machines Corp. ©1988 Everex Systems, Inc. All rights reserved.

415-498-1111 48431 Milmont Drive, Fremont, CA 94538

Circle 86 on Reader Service Card (DEALERS: 87)

AUGUST 1988 • B Y T E 25

# OUTSTANDING SOFTWARE

For IBM PC's and Compatibles

**\$3.50 PER DISK**

**\$3.00 PER DISK**

Small Quantities

For Ten or More

**SHIPPED WITHIN 24 HOURS!**  
Satisfaction Guaranteed or Money Back!

- BUSINESS 1**—EZ-FORMS business form generation, completion and printing program.
- CAD 3**—The PC-Flow 1.0 computer aided flow-chart generation program. Color graphics required.
- COMM 4a,b,c,d,e**—(5 disks) Join the world of sysops with RBBS Bulletin Board System 14.1D.
- DATABASE 1a,b**—(2 disks) File Express 3.8 menu driven general purpose database manager.
- EDUCATION 1**—Interactive DOS tutorial for new PC users. Makes learning DOS painless.
- FINANCE 1a,b**—(2 disks) PC Accountant 2.0 personal bookkeeping and finance management.
- GAMES 1**—3-D Pacman, Kong, Spacewar, Janit-Joe, futuristic Flightmare and more. Color required.
- GAMES 2**—Qubert, Pango, Centipede, dungeons and dragons style Zorro, etc. Color req.
- GAMES 3**—Blackjack with customizable rules, Armchair Quarterback (you call plays), and more.
- GAMES 4**—Star Trek, the Castle adventure game, and the original Colossal Caves Adventure.
- GAMES 5**—The Hack adventure game from the universities. Like Rogue, only much richer.
- GAMES 6**—Pinball, Othello, Dragons, Sopwith (fly a Sopwith Camel) and more. Color required.
- INFO 1a,b**—(2 disks) Cooking recipes database with keyword/ingredient retrieval. Add your own.
- MUSIC 2a,b**—(2 disks) PianoMan 3.0 polyphonic music recording and playback program.
- ORGANIZER 1**—DeskTeam, a Sidekick clone, and the Judy personal calendar program.
- PRINTER 1**—Resident print control and font utility, intelligent spooler, banner maker, and more.
- SIMULATION 1**—Maze making program, MIT's Life simulation, starfields, etc. Color graphics req.
- UTILITIES 1**—A collection of invaluable general purpose DOS utilities. An absolute must for all.
- UTILITIES 2**—More invaluable DOS utilities including screen burnout, ram disk, and more.
- UTILITIES 3**—A comprehensive set of debugging and diagnostic utilities for monitoring your computer.

BY 9/88

## NEW RELEASES/UPDATES

- BUSINESS 2**—Expressgraph business graphics. Chart your data and find trends. Color graphics req.
- CAD 1a,b**—(2 disks) Fingerpaint 1.2 advanced painting and Altamira object oriented design. Color.
- CAD 2a,b**—(2 disks) DanCad3d, an advanced 2D/3D drafting program w/animation. 640K, color.
- COMM 2a,b**—(2 disks) Procomm 2.42, an excellent modem program with terminal emulation.
- EDUCATION 3**—PC-Fastype 1.20 typing tutor, ideal for beginners and advanced students alike.
- FINANCES 3a,b**—(2 disks) Express Calc 3.12, a powerful and user friendly spreadsheet program.
- GAMES 8**—Striker helicopter attack and Risk, the game of world domination. Color required.
- GAMES 12**—Backgammon (play the computer) and Wheel of Fortune based on the gameshow.
- GRAPHICS 1**—Record and play back screen images! Excellent for demo, etc. Color required.
- GRAPHICS 2a,b,c**—(3 disks) An excellent 3-D surface modelling and shading program. Color.
- INFO 2a,b**—(2 disks) Zip-Phone, national areacode/prefix to zip-code cross reference.
- LANGUAGE 3a,b**—(2 disks) The A86 3.09 macro assembler and debugger for 8088/86/286s.
- SHELL 4a,b**—(2 disks) Automenu and HDM II 4.04 hard disk prog. for custom full-screen menus.
- UTILITIES 5**—Hard disk utilities for verifying, formatting, parking and optimizing your disk drives.
- UTILITIES 6**—Advanced utilities including Mark/Release (remove resident progs w/o reboot!)
- UTILITIES 7**—More advanced utilities including Masterkey (undeletes files from hard disks).
- WORD 1a,b**—(2 disks) PC Write 2.71, a powerful word processing system w/spell checker, laser supt.

Most software listed is shareware or user-supported.

3.5" format add \$1/disk. 125 page directory, add \$2.

MicroCom Systems Cost of items \_\_\_\_\_  
3673 Enochs Street Shipping **\$3.00**  
Santa Clara, CA CA res tax \_\_\_\_\_  
95051 Total encl. \_\_\_\_\_

**(408) 737-9000**

Mon-Fri 7am-9pm, Sat-Sun 8am-5pm



## LETTERS

function (cosine  $x +$  sine  $x$ ) should give rise to some suspicion: It is no more than a "colorized" sine function, with 45 degrees added to the angle and an amplitude equal to the square root of 2. The plain sine function would serve just as well.

The Fourier transform uses  $\cos x + j \sin x$ , which preserves all the original signal information in two orthogonal functions—but which the Hartley simply lumps together. Consequently, any attempt to take the inverse transform is fraught with hazard—the original information has been lost. (The sum of two numbers is 7—what are the numbers?)

Anyone considering using this transform should be aware of its limitations.

John C. Polasek  
Orlando, FL

### Bigram vs. N-Gram

I read Roy E. Kimbrell's "Searching for Text? Send an N-Gram!" (May) with interest.

I wonder whether the developers considered using a "least-common bigram" (LCB) approach similar to that described by E. Onderisin (*Proceedings of the ACM Annual Meeting, 1971*) and implemented at IITRI (LARC Reports, 7 (1), 1974). The LCB method yielded improvements over traditional methods. Perhaps an LCB or a "least-common trigram" approach would be simpler and less resource-intensive here, too.

Peter Halpin  
Great Falls, VA

### You Call That Fast?

Mark O'Neill ("Faster Than Fast Fourier," April) claims that the fast Hartley

transform (FHT) is twice as fast as the fast Fourier transform (FFT). The timings in table 1 compare O'Neill's algorithm with a simple (complex number) FFT for one forward and one reverse transform.

These timings show that there's more to speed than a smaller number of arithmetic operations. In particular, speed of array access is often crucial in "real" numerical applications.

In a comment on Bracewell's work, Bold (*Proceedings of the IEEE, 73 (12), 1863-4*) points out that a real FFT can be performed by a complex FFT on  $n/2$  points, considerably faster than the times above. If speed really is crucial, FFT algorithms can be tuned to the architecture of the machine in use.

B. D. Ripley  
Glasgow, Scotland

### Elusive Shareware

I have been given a copy of a very good backup program called Hardsave 1.0a. It has a message saying "Shareware from Andrew P. Wimple, Donations \$20 please."

I would like to send Mr. Wimple a donation, but he has not left his address anywhere in the software. Do you or any of your readers know where he can be contacted?

Jeremy Brown  
Leichhardt, Australia

### Data Liberation

I am writing this letter to request a new Freedom of Information Act. I am referring to the availability of data structures for software.

*continued*

**Table 1: Timings comparing O'Neill's algorithm with a simple (complex number) FFT for one forward and one reverse transform.**

	n = 256		n = 1024	
	FHT	FFT	FHT	FFT
IBM PS/2 60	5.16	3.62	23.51	19.56
Turbo Pascal 4.0 + 80287	0.88	1.09	4.02	5.54
RM Nimbus VX 16-MHz 80386 + 80387	2.47	1.76	10.98	9.28
Atari ST Prospero Pascal 2.12	0.33	0.33	1.54	1.81
Sun 3/160 + 68881 + 1164/5	5.36	4.01	24.75	21.03
VAX 8650	0.32	0.38	1.55	1.90
	0.25	0.18	1.17	0.83
	0.085	0.050	0.420	0.270



# The change to a pure language

Now, C programmers can move over to C++ with Zortech C++ – the world's first 'true' C++ compiler for MS-DOS machines.

Zortech C++ is a 'true' compiler and fully conforms to Bjarne Stroustrup's specification as outlined in his book 'The C++ Programming Language'.

Previous implementations of C++ were actually 'translators' – only able to translate C++ source code into C. Of course, this was unacceptable due to the long translating and compiling times.

Now, C++ comes of age with the introduction of the world's first true C++ compiler – from Zortech!

■ **Object Oriented Programming**  
C++ is to C what Modula 2 is to Pascal. C++ brings 'classes' to C, so you can create separate modules that contain their own data and data-related operations. These 'classes' then become new types that can in turn be used to create further modules – this allows you to practically create your own language.

■ **ANSI C Superset**  
You don't have to throw away your existing C programs – C++ is a superset of ANSI C. Now, you can take your Microsoft C or Turbo C compatible programs and easily migrate to C++ to take full advantage of the new C++ features.

■ **'Codeview' Compatible**  
Zortech C++ is compatible with 'Codeview' – Microsoft's industry standard source code debugger.

■ **Improved Program Structure**  
As stated in 'The C++ Programming Language', by using C++ "It would not be unreasonable for a single person to cope with 25,000 lines of code."

■ **Other benefits**  
Here's just a few: Operator overloading, overloading function names, default arguments to functions and better type checking.

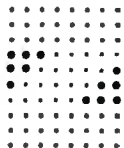

ZORTECH

ROSLINDEN LONDON FRANKFURT GENEVA

Circle 258 on Reader Service Card

YES!  
Rush me

below:

Zortech C++  C++ Book  
\$99.95 \$29.95  
VISA/MC/COD/CHECK ACCEPTED

Name.....  
Address.....

Phone.....

VISA or MC..... Exp. Date.....

To: ZORTECH INC. 361 Massachusetts Ave., Arlington  
Tel: 617-646-6703. Fax: 617-648-0603.

**CALL THE ORDER HOTLINE 1-800**



# A Number of Reasons A Number

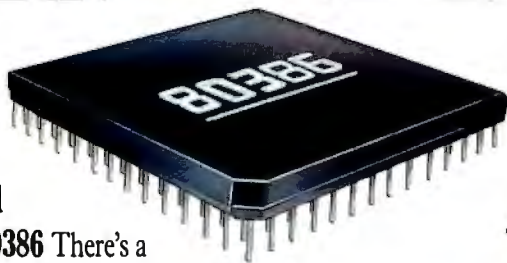

## 1. Designed for the 80386

There's a revolution taking place in desktop computing. A revolution that's been launched by a square wafer of silicon known as the 80386 microprocessor chip. It puts minicomputer potential at PC users' fingertips. It's a fact that virtually every leading PC manufacturer has built a "box" around this chip. And it's a fact that the "New Operating System" will, supposedly, even run on it. But, it's also a fact that *their* system wasn't designed for the 80386. Ours is. And it's called PC-MOS/386™.



compatible with the millions of PC-compatibles. Power without nothing less from the new standard bearer.

## 2. PC and PS/2 Compatible

In designing PC-MOS, we knew our first priority was to exploit the minicomputer capabilities of 80386-based PCs & PS/2s. But we went further, and developed a system which would be fully compatible with the millions of existing PCs, PC ATs, and PS/2s. You'd expect nothing less from the new standard bearer.

## 3. One, Five, Up to Twenty-five Users

From the beginning, PC-MOS/386™ was designed as a versatile operating system which could support twenty-five users as easily as it supports one. The system comes in single, five, and 25-user modules, so you're able to start with what you need and expand when you're ready.

In a multi-user setting, PC-MOS/386™ uses the computing power of the host PC to drive workstations linked to standard RS-232 ports.

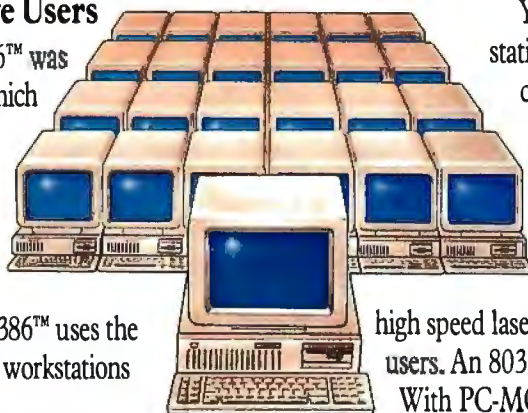

## 4. Thousands of DOS Programs

PC-MOS/386™ gives you the best of the past, and the best for your future. Which means that while PC-MOS/386™ totally replaces your old DOS, you won't have to replace the programs you've spent a lot of time learning.



And it all happens so effortlessly. You'll continue to reap the benefits of your favorite DOS programs, while entering a new arena of power.

Think of it! Programs like dBASE III, WordPerfect, Lotus 1-2-3 and Symphony, WordStar, MultiMate...literally thousands of DOS programs—all compatible and multi-user available.

## 5. Familiar Commands Like DIR and COPY

Just as you don't have to learn a whole new array of software to take advantage of PC-MOS/386™, neither do you have to learn an entirely new set of commands.

Instead, the system builds on the knowledge you already have. "COPY" still copies files, and "DIR" still gives you a directory listing. As you might expect, we didn't stop there. There's a wealth of features that have strengthened the commands you know, making them more powerful and easier to use.

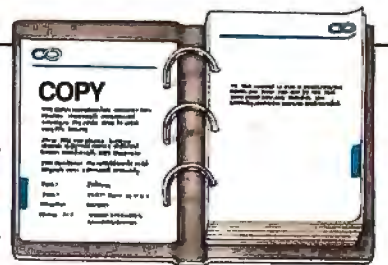

You can choose from a variety of workstations. Mix and match dumb terminals costing under \$500 each with PCs and PS/2s running our terminal emulation software.

All of the host's resources can be shared. Programs, data, hard disks, tape backup units & printers (including high speed laser printers) are suddenly available to all users. An 80386-PC has minicomputer potential. With PC-MOS/386™ you can "mini" your micro.



# of Users Will Choose PC-MOS/386™

## 6. Concurrently Supports Virtual 8086 and 80386 32-Bit Mode

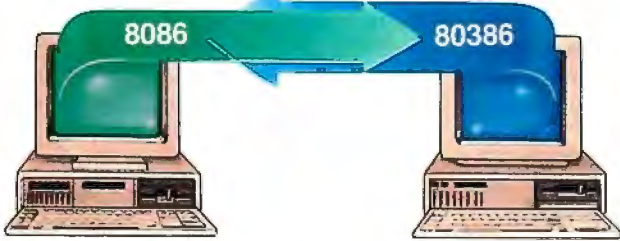

80386-based PCs & PS/2s are dual-personality computers. To run DOS programs, they act as PCs with a 640K memory limit. But to take advantage of their minicomputer capacity, they operate in true 80386 mode which lets them address up to four gigabytes of memory. PC-MOS enables the 80386-host and its workstations to independently switch between these modes—making DOS compatibility and 80386 power simultaneously possible.

## 7. Multi-Tasking

While it's true you could look elsewhere for multi-tasking, why would you want to? The *other* multi-tasking operating system is not now, nor is it planned to be, multi-user. It won't even run multiple DOS applications in multi-tasking mode.

Now consider PC-MOS/386™. At the touch of a key, you can switch between up to 25 different tasks. And if you have workstations connected to a host, they get multi-tasking, too. Finally...a system that won't hold you back.



And consider this.

## 10. The Price...

As you evaluate operating systems, ask yourself if it's reasons you're considering...or rhyme. Ask if you're getting a system for tomorrow, or one that was made for yesterday. See if you're being forced to buy new hardware because of *their* software.

Only one operating system in the world can give you the raw power, features, and functionality that you demand. Its name is PC-MOS/386™. And it's immediately available in one, five and 25-user versions starting at \$195.



## 8. File/Record Locking and Security

When you decide to implement either a network or a multi-user system, there's a two-fold problem which must be solved: protecting your work from accidental misuse and securing it from intentional theft.

PC-MOS/386™ solves both aspects of this problem. Password protected security allows you to assign file, directory, and task access to each user. Plus, files and records are locked using either PC-MOS' proprietary system or NETBIOS emulation.

## 9. Remote Access

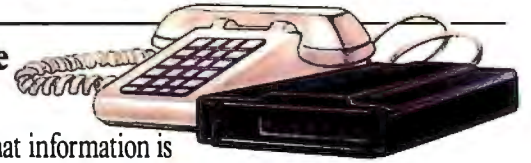

It's been said that information is power...which makes PC-MOS/386™ a deadly weapon to your competition. Imagine on-the-road salespeople being able to file call reports and access your latest inventory data. Picture executives being able to access your corporate database from across the country, or around the world—giving them the information they need, when they need it.

Visualize branch offices tapping time-critical data with nothing more than a modem and a workstation. Working at a home office in the evening or over the weekend suddenly gets awfully productive. And that makes good business sense. The kind of sense you can't afford to be without.

PC-MOS/386™ is a trademark of The Software Link, Inc. PS/2, PC AT, NETBIOS, dBASE III, MultiMate, WordPerfect, Lotus 1-2-3 & Symphony, & WordStar are trademarks of IBM Corp., Ashton-Tate, WordPerfect Corp., Lotus Development Corp., & MicroPro, respectively. Prices and technical specifications subject to change. Copyright © 1987. All Rights Reserved.

For the dealer nearest you, In Georgia: International/OEM Sales: Resellers/VARs:  
CALL: 800/451-LINK 404/441-2580 404/263-1006 404/448-5465



DEALER INQUIRIES INVITED

# PC-MOS/386™

MODULAR OPERATING SYSTEM

 THE SOFTWARE LINK

As a software developer and consultant, I am often called upon to aid individuals converting from one software package to another. The only problem is, very often it's difficult or impossible to obtain the data structure of the existing software package.

Recently I was asked to help a physician convert from one medical billing and insurance program, sold by one of the largest companies in the U.S., to a different package from a different ven-

dor. This physician had used the original program for several years and had accumulated several thousand patient accounts in the system.

Both a colleague and I contacted the vendor and requested a map of the program's data structure. We did not request source code or any proprietary information, and we were willing to pay any necessary costs. Our request was firmly refused, and no amount of pleading, cajoling, or threatening could pry

the data structure from this prestigious vendor. Needless to say, the resulting data conversion was difficult and expensive, and it involved a great deal of manually reentering data.

I honestly do not know why this company refused our request, but I have run across this response countless times with numerous software houses. Could it be that paranoia has become so widespread that it totally obscures the judgment of major software developers, or are they simply so petty that they will hold their existing users as unwilling captives so they can continue to milk them for upgrade and maintenance fees?

Whatever the reason is, it has no justification. It is inconceivable to me that any software vendor could refuse to furnish a data map, particularly when the data is as vitally important as accounts receivable.

Furnishing the data structure of a program is not at all comparable to furnishing source code. The data structure tells little, if anything, about how the program works—it merely shows the owner of the data just where and how it is stored. Furthermore, a map of the data structure is useful only to individuals who already own the program. In no way could furnishing data structures adversely affect the sales or proprietary rights of any software vendor. Quite the contrary: In my opinion, the failure to furnish data structures should serve as a strong deterrent to buying the program in the first place.

I think the time has come for all software vendors to furnish data structures with their programs. As more and more people become increasingly dependent upon computers for storing their vital data, they should have free access to that data. Even the most wonderful program might be obsolete next year, and even the largest vendor may be in Chapter 11 next week.

I strongly advise individuals considering the purchase of any software that may have a major impact on their lives to demand that the data structure of the program be furnished at the time of purchase. Whether they are programmers or not, if they need to convert to a different program in the future, they'll have to pay a programmer far less if the data structure is already available.

Evan P. Provisor  
Sharon, CT

### Quattro and Benchmarks

Your comparison review of Quattro and Surpass ("Double Threats to Lotus

*continued*

## If you think you can buy a better C compiler, don't. We'll buy it for you.

Buy Let's C<sup>®</sup> with csd<sup>™</sup> for just \$75. If you're not satisfied, get Turbo C or QuickC. Free.\*



Why are we making this incredible offer? Because we're absolutely certain Let's C and csd C Source Debugger are the best C programming tools you can own.

Rest assured that, like its competition, Let's C features incredibly fast in-memory compilation and produces extremely tight, high quality code. The differences lie in how much faster you can perform other programming chores.

Our debugger, for example, can cut development time in half. But that's not all:

*"csd is close to the ideal debugging environment... a definite aid to learning C and an indispensable tool for program development."*

—William G. Wong, BYTE

And comparatively speaking: *"No debugger is included in the Turbo C package... a serious shortcoming."*

—Michael Abrash, Programmer's Journal

Unlike our competition, Let's C includes its own full-featured assembler, features documentation with complete examples and technical support with complete answers—the first time you call.

#### LET'S C:

- Now compiles twice as fast
- Integrated edit-compile cycle: editor automatically points to errors
- Includes both small and large memory model
- Integrated environment or command line interface
- 8087 sensing and support

#### LET'S C AND csd FEATURES

- Full UNIX compatibility and complete libraries
- Many powerful utilities including make, assembler, archiver
- MicroEMACS full screen editor with source code included
- Supported by dozens of third party libraries

#### csd:

- Debug in C source code, not assembler
- Provides separate source, evaluation, program and history windows
- Ability to set trace points and monitor variables
- Can interactively evaluate any C expression
- Can execute any C function in your program
- Trace back function

So if you're thinking about buying any other C compiler, think again. But this offer is only available for a limited time. So think fast. And see your software dealer or call 1-800-MWC-1700 soon. (1-312-472-6659 in Illinois.)

To exchange Let's C and csd for Turbo C or QuickC, return registration card within 15 days of purchase date. Notify Mark Williams Company that you are returning products and receive a return authorization number. Products must be returned within 30 days of purchase date or within 30 days of shipping date on telephone orders.



1430 West Wrightwood, Chicago, Illinois 60614, 312-472-6659

© 1988 Mark Williams Company

# With Modems you can Get Smart ...or Get Smarter



## 2400etc

The Next Generation in Modems

■ **FAST** . . The ATI internal 2400 Baud PC modem uses data compression techniques providing data throughput speeds in excess of 4800bps.

■ **ERROR FREE** . . Uses high level MNP5 hardware error correction procedures to guaranty 100% error-free data.

■ **DEPENDABLE** . . Built by the manufacturer of the world famous **EGAWONDER** graphics cards, the 2400etc has full compatibility with popular communication software.

■ **SMART** . . Every modem includes a **FREE** copy of *Mirror II* communications software which allows users background tasking for receiving Electronic Mail or Data transfers concurrently with screen applications.



**TECHNOLOGIES INC.**

Technology you can Trust.

**\$239**

Suggested List Price

Smart price to pay for Smart technology

AVAILABLE FROM LEADING COMPUTER DEALERS.

ATI Technologies Inc., 3761 Victoria Park Ave. Scarborough, Ontario, Canada M1W 3S2  
Tel: (416) 756 0711, Tlx: 06-966640 (ATI TOR) Fax: (416) 756-0720

ATI is a registered trademark of ATI Technologies Inc. MNP is a trademark of Microcom Corporation. Mirror II is a trademark of SoftKone Distribution Corporation. Crosstalk - Digital Communications Associates Inc. Smartcom II - Hayes Micro Computer Products Inc.



!SPrev Page, !NNext Page, !QQuit/Prev Command, !QNext Command, !HHelp

1-2-3" by Diana Gabaldon, June) requires some amplification.

First, you didn't mention the two add-ins that are bundled with Quattro at no extra charge: Menu Builder and Transcript. Menu Builder lets users create menu trees that are customized to their specific needs. Quattro is shipped with both its own menu tree and one that emulates Lotus 1-2-3.

If your readers have ever lost valuable data, they'll appreciate Transcript. It

provides a log file of keystrokes and commands selected throughout the spreadsheet session. Errors can be handled easily with the undo command. Transcript also protects against power failure or system crashes and audits changes made to a spreadsheet.

Second, Quattro provides a macro record and debugging environment. The macro record is an excellent way to create macros quickly and easily. It simply records the user's actions as they are

performed. With the Quattro debugger, users can execute macros in slow motion (step by step), pausing as they go along, and set breakpoints that "freeze" a macro when it reaches a cell or satisfies a given condition. Users can execute a macro at full speed until it reaches a breakpoint, then continue either in slow motion or at full speed until the next breakpoint.

Your benchmark appears to be a historical "all cells dependent on one cell" model and is not representative of a real-world spreadsheet.

Lastly, your review summed up Quattro as being the first-time user's choice. On the contrary, our research shows that more than 50 percent of current Quattro users are previous Lotus 1-2-3 users.

Becky Jones  
Product Manager  
Borland International  
Scotts Valley, CA

*We're glad you mentioned the benchmarks: Our traditional spreadsheet benchmarks are deliberately not optimized for any one kind of operation—historically, we've made no assumptions about how a spreadsheet will be used. While this approach has the advantage of being open-ended and allows head-to-head comparisons of spreadsheets over time, these benchmarks certainly aren't perfect. For one thing, they lack fine detail that might allow readers to, for example, differentiate between performance in routine business matters versus performance in statistical number crunching.*

*We're changing our benchmarks: In our June issue, we rolled out BYTE's new system benchmarks for hardware. These, the first second-generation micro-computer benchmarks, produce results (from the most general to the most detailed levels) that are valid indicators of real-world performance in a variety of applications.*

*We're now in the process of doing the same thing for our suite of software benchmarks. Watch for our new, second-generation software benchmarks later this year.—Eds.*

---

## FIXES

---

### Sorry, Wrong Number

In the June What's New on page 88, we printed the wrong telephone number for Plu\*Perfect Systems. The correct number is (213) 395-4584.

# ONLY FORTRON COMES WITH ONE FULL YEAR OF SERVICE. FREE. ON-SITE.

When you buy any Fortron 286 and 386-based IBM-compatible, one full year of service at your site is part of the package. Just call the service hotline, and we'll take care of you from a network of 300 service locations throughout the country.

Because we design and build our systems right here, ourselves, you always know exactly who to call for any kind of support you need. And you'll get it. Fast.

Call toll-free for more information, and for the name of your nearest Fortron dealer: 800-821-9771. In California, (408) 432-1191.



Small Footprint 80286



80386, 16 MHz or 20 MHz



80286 12, 16, or 20 MHz

**FORTRON**  
2380 Qume Drive, Ste. F  
San Jose, CA 95131

# Accelerate.

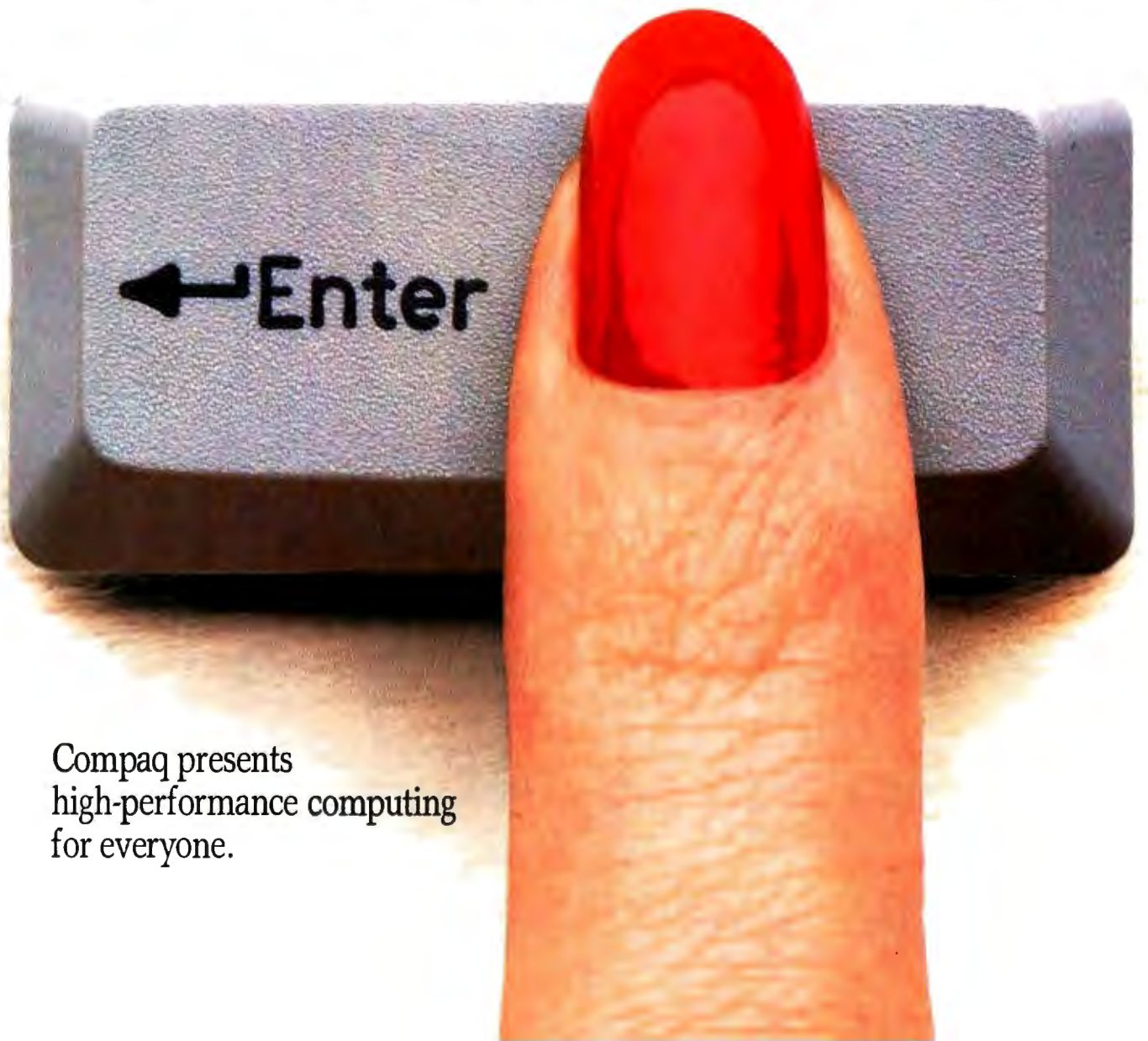

Compaq presents  
high-performance computing  
for everyone.

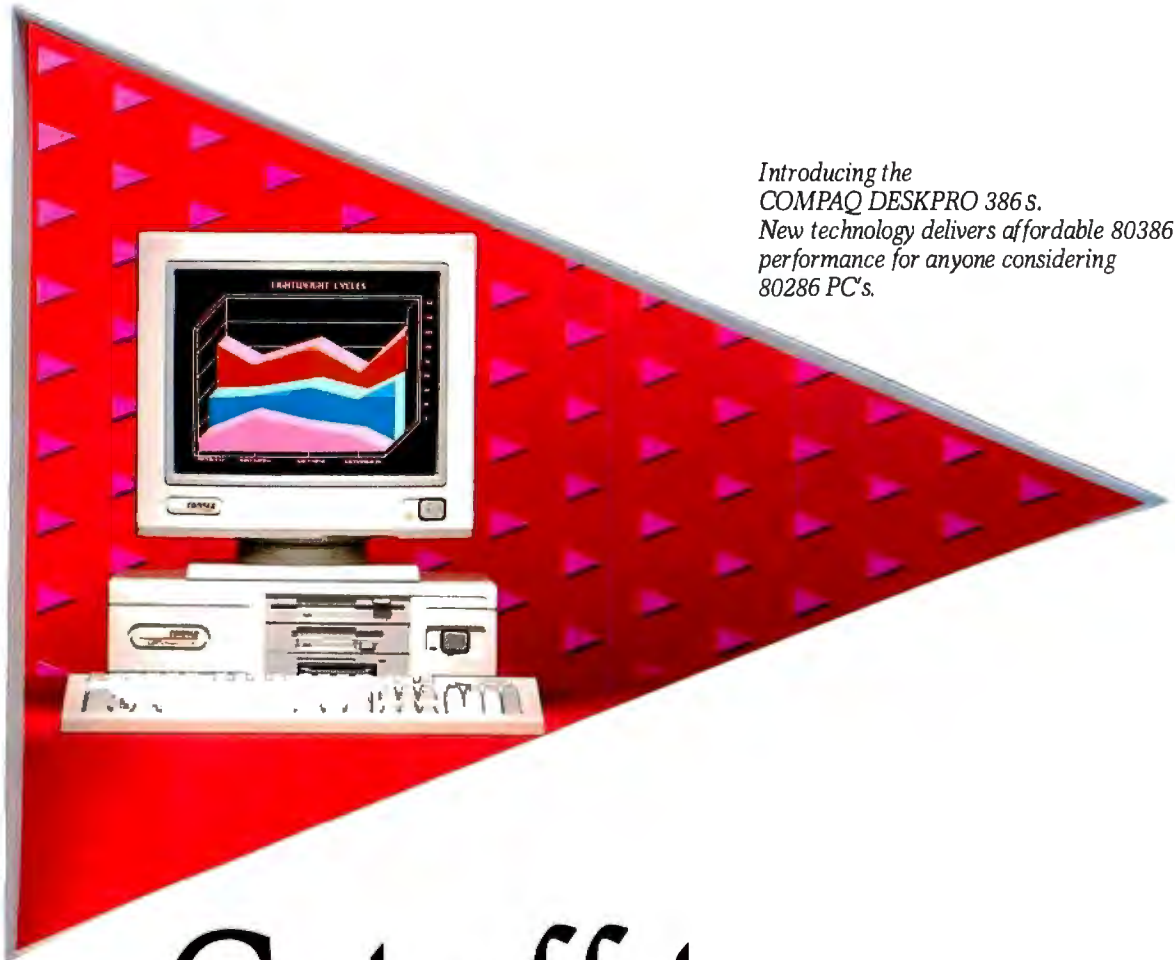

*Introducing the  
COMPAQ DESKPRO 386 s.  
New technology delivers affordable 80386  
performance for anyone considering  
80286 PC's.*

# Get off to a fast start.

Now, breakthrough technology from Compaq brings the power and potential of 80386-based personal computing to millions of business PC users.

Introducing the COMPAQ DESKPRO 386 s. It's the first personal computer powered by the revolutionary new Intel® 386SX\* microprocessor. It's also the first designed specifically as an affordable, high-performance alternative to 80286-based PC's.

The COMPAQ DESKPRO 386 s will run the software you have today—such as MS-DOS® and Microsoft® Operating System/2 from Compaq—up to 60% faster than most 10-MHz 80286 PC's. It will also run the 32-bit software that 80286 PC's won't run at all. Microsoft Windows/386, for example.

You can tailor the COMPAQ DESKPRO 386 s to your exact needs. Choose high-performance storage options such as 20-, 40-, or 110-Megabyte Fixed Disk Drives. Tape backup options. Even diskette drives in 5¼-inch and 3½-inch sizes.

VGA graphics are built in. So is one megabyte of high-speed memory, expandable to 13 megabytes without using a single expansion slot. You can also add a mouse, printers and more without using additional slots.

All these features and more are packed into a sleek new design that fits places the competition can't.

So get into the PC passing lane, and head for all the 80386 power and performance you really want, with the revolutionary new COMPAQ DESKPRO 386 s.



*Introducing the  
COMPAQ DESKPRO 386/25.  
The most powerful  
PC available.*

# Never look back.

Once again, Compaq introduces a PC that leaves every other in the dust. With its new Intel 25-MHz 386\* microprocessor and exclusive 32-bit COMPAQ Flexible Advanced Systems Architecture, the new COMPAQ DESKPRO 386/25 runs up to 60% faster than most 20-MHz 80386 PC's.

FLEX Architecture uses separate memory and peripheral buses operating in concert to maximize system performance, while maintaining compatibility with industry-standard hardware and software. The 25-MHz cache memory controller keeps data instantly accessible, so the processor works at 0 wait states 95% of the time.

With the addition of a 25-MHz Intel 387\* or Weitek™ coprocessor, you can match the numeric processing of a dedicated workstation, at a fraction of the cost.

You can go from one standard megabyte of high-speed RAM to 16 megabytes. And, for storage-hungry applications such as most networks and multiuser systems, you can get up to a massive 1.2 gigabytes of storage.† Internal tape backup options are also available.

For CAD/CAE, as a file server and for multiuser systems, the new COMPAQ DESKPRO 386/25 is the ultimate solution. And, for intense PC users who don't have a millisecond to spare, nothing less will do!

**COMPAQ**

It simply works better.

# Now there's room for everyone on the fast track.



When Compaq pioneered high-performance personal computing and introduced the industry's first 80386-based PC's, we gave performance-hungry business users, engineers, analysts and software developers the tools they needed to perform intense applications faster and better.

Now, with the new COMPAQ DESKPRO 386s and COMPAQ DESKPRO 386/25, we're not just pushing 80386 technology forward; we're *widening* it. So that PC users at every level can take advantage of the industry's highest performance—Compaq 80386 performance.

The new COMPAQ DESKPRO 386s lets anyone considering 80286 PC's head straight for 80386 per-

formance. The original COMPAQ DESKPRO 386 and COMPAQ DESKPRO 386/20 deliver even higher performance for more demanding applications. And now, at the top of our line is the new COMPAQ DESKPRO 386/25. The most powerful personal computer available.

Together, they create the highest-performing PC line available. In each one, our exclusive design lets every component run at optimum speed. This provides a substantial performance edge, while maintaining compatibility and connectivity with your current hardware and software.

Now, you'll run your current MS-DOS® applications at top speed. Plus new 80386 software, such as Microsoft Windows/386. With MS® OS/2, UNIX® or XENIX®, you'll simultaneously run multiple programs,

switching between them instantly. And, with a COMPAQ 80386 PC, you'll do it all *faster*.

Now, with legendary Compaq performance and quality available to *everyone*, the fast track is wider than ever. So *accelerate*. Call 1-800-231-0900, Operator 64. In Canada, call 1-800-263-5868, Operator 64. We'll give you the location of your nearest Authorized COMPAQ Computer Dealer and a free brochure for any COMPAQ 80386-based computer.

COMPAQ® and COMPAQ DESKPRO 386® are trademarks of Compaq Computer Corporation. Microsoft® MS-DOS®, XENIX® and MS® are trademarks of Microsoft Corporation. MS® OS/2 and MS® Windows/386 are products of Microsoft Corporation. Product names mentioned herein may be trademarks and/or registered trademarks of their respective companies. \*Registered U.S. Patent and Trademark Office. COMPAQ DESKPRO 386/25 graphics ©1988 Accent Software, Inc. ©1988 Compaq Computer Corporation. All rights reserved.

\*Hereafter referred to as 80386SX, 80386 and 80387 respectively.

†Using two optional COMPAQ 300-/600-Megabyte Fixed Disk Drive Expansion Units.

## COMPAQ

It simply works better.



# CHAOS MANOR MAIL

*Jerry Pournelle answers questions about his column  
and related computer topics*

## **BIX in Europe?**

Dear Jerry,

I'm a student of economics and computer science, studying at the University of Karlsruhe.

There are three reasons why I'm writing to you. First, I really enjoy reading BYTE, because it's one of the best (if not the best) available computer magazines.

My second reason for writing is because I'd love to take part on BIX, but as you know, the German Bundespost ("post" is the "abbreviation" for Public Organization for the Suppression of Technology) is very restrictive concerning computer communications and, of course, is charging fairly high fees for any long-distance call.

Perhaps BYTE or McGraw-Hill could encourage activities to bring BIX to Europe. I'm thinking of a BIX bulletin board somewhere in Europe, whose contents would be sent to America once or twice a day and vice versa. This would already be a big leap forward, although it would not be as interactive as the original BIX.

Perhaps—and now I might just be daydreaming—BIX could advance to become IBIX (International BYTE Information Exchange), bringing together computer users from all over the world.

My third reason to write to you is that I've recently bought an inexpensive add-on board for my IBM PC AT. To find out what kind of board I'd bought, I went through all my issues of BYTE to locate any reference to Definicon Systems, the name on the board. I was lucky to find a pointer to an older BYTE in which the DSI-32 coprocessor board had been reviewed. I was very glad to realize that I now own a "tiny VAX" to plug into my computer (a DSI-32 board running at 10 MHz, complete with memory management unit and 2 megabytes of RAM).

I've already written to Definicon Systems for further information and software, and I hope to get enough to help get the board running. Since BYTE tried to encourage buying this board by having arranged special prices for Green Hills software, I believe there still may be

many people who use the DSI-32 board. Perhaps some of them would be willing to exchange information or programs with me. Readers can get in contact with me at the address below.

Axel Mock  
Dahlienweg 8E  
7513 Stutensee 1

Federal Republic of Germany

*Thanks for the suggestions. I find Definicon stuff blazingly fast.*

*I passed your comments on to George Bond, executive editor of BIX, who had this to say:*

*"We're interested in worldwide participation in BIX, too. Already BIX has members from North and South America, Europe, Africa, Asia, and Australia. We do recognize the high costs of BIXing from outside the U.S., and we are continually looking for ways to help users reduce them.*

*"Incidentally, although BIX is not available directly in Europe, another BYTE service—BYTEnet Listings—is. BYTEnet Listings is a BBS with code described in BYTE articles in its download areas. There currently are BYTEnet Listings boards in more than 30 nations worldwide."—Jerry*

## **Solving Problems with ASK**

Dear Jerry,

Last year, you wrote about having troubles with your resident software and gave an example of a batch file that rewrites the AUTOEXEC.BAT file. That's one solution, but I think I've got a better one.

The advanced edition of the Norton Utilities includes the program ASK, which is very useful for solving such problems in a tidy way. With ASK, you can build menus in a batch file, input into the batch file, and set the errorlevel

*continued*

*Jerry Pournelle holds a doctorate in psychology and is a science fiction writer who also earns a comfortable living writing about computers present and future. He can be reached c/o BYTE, One Phoenix Mill Lane, Peterborough, NH 03458.*

**Four ways to build  
better C programs...**

## **NEW! POWER SCREEN \$129**

Screen I/O manager.

Features: • screen painter • virtual screens  
• data validation • context sensitive help  
• unlimited screens • definable keys  
• & much more!

## **C TOOLS PLUS \$129**

Full featured function library.

• For Microsoft C 5.0 and QuickC.  
Features: • TSR support • direct video access  
• VGA and EGA support • windows and  
menus • DOS memory allocation • interrupt  
service routines • & much more!

## **C ASYNCH MANAGER \$175**

Asynchronous communication manager.

Features: • speeds to 19.2K baud  
• XON/XOFF protocol • hardware  
handshaking • XModem file transfer • I/O  
buffers up to 64K • & much more!

## **TURBO C TOOLS \$129**

Full featured function library.

For Borland's Turbo C.

Features: • TSR support • direct video  
access • VGA and EGA support • windows  
and menus • DOS memory allocation  
• interrupt service routines • & much more!

We're Blaise Computing, manufacturers of high quality function libraries designed to reduce the time and technical expertise required for serious applications development.

All of our packages include a comprehensive user reference manual with extensive examples, and sample programs.

Satisfaction guaranteed or return within 30 days for a full refund.

We have a full line of products for C and Pascal. For a free brochure or to order call

**800-333-8087!**



**BLAISE COMPUTING INC.**

2560 Ninth Street, Suite 316 Berkeley, CA 94710 (415) 540-5441

AUGUST 1988 • B Y T E 33



# 11 Important Reasons C Programmers Use Our File Manager

## 1. It's written in C.

Clearly the growing language of choice for applications that are fast, portable and efficient. All of db\_VISTA's source code is written in C.

## 2. It's fast—almost 3 times faster than a leading competitor.

Fast access that comes from the unique combination of the B-tree indexing method and the "network" or direct "set" relationships between records. A winning combination for fast performance.

## 3. It's flexible.

Because of db\_VISTA's combination of access methods, you can program to your application needs with ultimate design flexibility. Use db\_VISTA as an ISAM file manager or to design database applications. You decide how to optimize run-time performance. No other tool gives you this flexibility without sacrificing performance. db\_VISTA is also well behaved to work with most any other C libraries!

## 4. It's portable.

db\_VISTA operates on most popular computers and operating systems like UNIX, MS-DOS and VMS. You can write applications for micros, minis, or even mainframes.

## 5. Complete Source Code available.

We make our entire C Source Code available so you can optimize performance or port to new environments yourself.

## 6. It uses space efficiently.

db\_VISTA lets you precisely define relationships to minimize redundant data. It is non-RAM resident; only those functions necessary for operation become part of the run-time program.

## 7. Royalty free run-time.

Whether you're developing applications for yourself or for thousands, you pay for db\_VISTA or db\_QUERY only once. If you currently pay royalties to someone else for your hard work, isn't it time you switched to royalty-free db\_VISTA?

### db\_VISTA™

#### Features

- ◆ **Multi-user** support allows flexibility to run on local area networks
- ◆ **File structure** is based on the B-tree indexing method
- ◆ **Transaction processing** assures multi-user consistency
- ◆ **File locking** support provides read and write locks
- ◆ **SQL-based db\_QUERY** is linkable
- ◆ **File transfer** utilities included for ASCII, dBASE optional
- ◆ **Royalty-free** run-time distribution
- ◆ **Source Code** available
- ◆ **Data Definition Language** for specifying the content and organization of your files
- ◆ **Interactive database access** utility
- ◆ **Database consistency check** utility

#### File Management Record and File Sizes

- ◆ Maximum record length limited only by accessible RAM
- ◆ Maximum records per file is 16,777,215
- ◆ Maximum file size limited only by available disk storage
- ◆ Maximum of 256 index and data files
- ◆ Key length maximum 246 bytes
- ◆ No limit on number of key fields per record
- ◆ No limit on maximum number of fields per record

#### Operating System & Compiler Support

- ◆ **Operating systems:** MS-DOS, UNIX, XENIX, ULTRIX, Microport, VMS, Macintosh
- ◆ **C compilers:** Lattice, Microsoft, IBM, Aztec, Turbo C, XENIX, UNIX and LightspeedC

## 8. SQL-based db\_QUERY

is the query and report writing program that provides a relational view of db\_VISTA databases. Use ad hoc or link into your C applications. Royalty-free. Source code available.

## 9. Free tech support.

60 days of free technical and application development support for every Raima product. Of course, extended support and training classes are also available at your place or ours.

## 10. Upward database compatibility

Start out with file management in a single-user PC environment—then move up to a multi-user LAN or a VAX database application with millions of records. You'll still be using db\_VISTA. That's why so many C programmers are choosing db\_VISTA.

## 11. WKS LIBRARY

The WKS LIBRARY PROVIDES THE MOST EFFICIENT WAY FOR C and BASIC programmers to interface with 1-2-3, Symphony and dBASE.

- ◆ Reads & Writes WKS & WK1 Files
- ◆ Reads & Writes DBF Files
- ◆ 1-2-3, Symphony & dBASE compatible
- ◆ Source Included
- ◆ No Royalties

## 30-day Money Back Guarantee!

### Price Schedule

	db_VISTA	db_QUERY
<input type="checkbox"/> Single user	\$ 195	\$ 195
<input type="checkbox"/> Single user w/Source	\$ 495	\$ 495
<input type="checkbox"/> Multi-user	\$ 495	\$ 495
<input type="checkbox"/> Multi-user w/Source	\$ 990	\$ 990
<b>NEW:</b>		
<input type="checkbox"/> WKS LIBRARY for Lotus 1-2-3	\$ 195	

## Call Today!

Ordering is easy — simply call toll-free. We'll answer your technical questions and get you started.

## 1 (800) db\_RAIMA

(800) 327-2462 or  
(206) 828-4636



### For international orders:

In the U.K. call	Systemstar Ltd.:	(0992)500919 FAX: (0992)554261
In Switzerland call	Comptronix AG:	01 725 04 10 FAX: 01 725 8777
In France call	ISE-CEGOS:	(1) 46 09 2828 FAX: (1) 46 09 2800
In Belgium call	Lemie S.A.:	(02) 720.96.57 FAX: (02) 721.12.00
In Germany call	ESM GmbH:	07127/5244



3055 - 112th NE, Bellevue, WA 98004 USA  
FAX: (206) 828-3131 Telex: 6503018237 MCIUW  
© 1988 Raima Corporation

# When you want to talk computers..

## ATARI COMPUTERS

65XE 64K Computer .....	109.99
130XE 132K Computer .....	149.00
520ST-FM Monochrome Syst. .	699.00
1040ST Color System .....	Call
SF124 Monochrome Monitor ..	169.00
SF1224 Color Monitor .....	329.00



### Atari 520 Color System \$799

Includes: 520ST-FM, 512K RAM with 3 1/2" Drive Built-In, Basic, RF-MOD, Atari Mouse, and SF-1224 Color Monitor.

## AMIGA SOFTWARE

<b>Mimetics</b>	
Amigen Gen Lock .....	159.00
<b>New Tek Inc.</b>	
Digi-View 2.0 .....	149.00
Digi-Paint .....	44.99
<b>Sub-Logic Corp.</b>	
Flight Simulator II .....	39.99
<b>Word Perfect Corp.</b>	
Word Perfect .....	199.00

## MACINTOSH PRODUCTS



### EVEREX 60MB Tape Backup \$899

<b>Hard Drives</b>	
<b>CMS</b>	
MacStack 60 .....	899.00
<b>Everex</b>	
40MB SCSI .....	999.00
<b>PCPC</b>	
MacBottom HD45 .....	1149.00
<b>Floppy Drives</b>	
<b>Central Point</b>	
Magnum 800k .....	209.00
<b>Mirror Technologies</b>	
800K Floppy External .....	199.00
<b>Monitors</b>	
<b>Network Specialties</b>	
High Top FPD .....	1199.00
<b>Radius</b>	
Full Page Display .....	995.00
Two Page Display .....	1595.00
<b>Sigma Designs</b>	
Laser View Display for II .....	1,749.00
<b>Memory Upgrades</b>	
<b>Dove Computer</b>	
Mac Snap 2SE .....	359.00
<b>Scanners</b>	
<b>AST</b>	
Turboscan .....	1,349.00
<b>Datacopy</b>	
730 Flatbed Scanner .....	1,199.00

## MS/DOS SYSTEMS

Ast Premium 286 & 386 .....	Call
Compaq Deskpro and Portbils. .	Call
IBM PS/2 25, 30, 50, 60, 80 .....	Call
Leading Edge .....	899.00

## MS/DOS SYSTEMS

NEC APC-IV Powermate .....	2,399.00
PC-TOO 80286 1.2MB, 512K ..	899.00
Toshiba T-1000 Laptop .....	799.00
Zenith Laptops .....	Call



### NEC Multispeed-HD \$2489

## MULTIFUNCTION CARDS

<b>AST</b>	
6-Pak Plus 576 Board .....	149.00
Hot Shot 286 Accelerator .....	349.00
<b>Hercules</b>	
Color Card .....	169.00
Graphics Card Plus .....	199.00
<b>Intel</b>	
Inboard 386 Board .....	799.00
<b>5th Generation</b>	
Logical Connection 256K .....	339.00
<b>Quadram</b>	
Quad386XT 80386 PC-Upgr. .	799.00
<b>Video 7</b>	
Vega V.G.A. Adapter .....	299.00
<b>Zuckerboard</b>	
Color Card w/Parallel Port ..	89.99

## MS/DOS SOFTWARE

<b>Ashton-Tate</b>	
d-Base III + .....	389.00
<b>Borland</b>	
Quattro .....	129.00
<b>5th Generation</b>	
Fastback Plus .....	84.99
<b>Fox Software</b>	
Fox Base & Development .....	219.00
<b>IMSI</b>	
Optimouse w/dr. Halo .....	89.99
<b>Logitech</b>	
Hi-Res Buss Mouse .....	99.00
<b>Lotus</b>	
Lotus 1.2.3 .....	299.00
<b>Software Publishing</b>	
First Choice .....	99.99
<b>Word Perfect Corp.</b>	
Word Perfect 5.0 .....	NEW

## ATARI ST SOFTWARE

<b>Access</b>	
Leaderboard Golf .....	24.99
<b>Antic</b>	
CAD 3D .....	29.99
<b>Avant Garde</b>	
PC Ditto (IBM Emulation) .....	64.99
<b>Batteries Included</b>	
Degas Elite .....	39.99
<b>Soft Logik Corp.</b>	
Publishing Partner .....	64.99
<b>Timeworks</b>	
Swiftcalc/Wordwriter .....	47.99
<b>VIP</b>	
Professional Gem .....	139.00
<b>Word Perfect Corp.</b>	
Word Perfect .....	189.00

## AMIGA SOFTWARE

<b>Absoft</b>	
AC Basic .....	139.00
<b>Aegis Development</b>	
Animator/Images .....	89.99
Draw Plus .....	149.00
Sonix .....	49.99
<b>Discovery Software</b>	
Marander II .....	31.99
<b>Electronic Arts</b>	
Deluxe Video 1.2 .....	89.99
<b>Gold Disk Software</b>	
Pagesetter w/Text ed. ....	89.99
<b>Micro Illusions</b>	
Dynamic Cad .....	349.00

WE SHIP 90%  
OF ALL ORDERS  
WITHIN 24 HOURS



SELECT FROM  
OVER 3000  
PRODUCTS

# COMPUTER MAIL ORDER

.....When you want to talk price.

**MONITORS**

**Amdek**  
Video 210A 12" Amber ..... 89.00  
Video 410 12" A/G/W ..... (ea.) 139.00

**Magnavox**  
7BM623 12" TTL Amber ..... 99.00  
CM8505 14" RGB/Composite . 189.00  
CM8515 14" RGB/Composite . 269.00  
9CM053 14" EGA ..... 379.00  
9CM082 14" VGA Display .... 459.00

**NEC**  
GS-1400 14" Monochr. TTL . 219.00  
JC-1402 Multisync-II ..... 599.00

**Packard Bell**  
PB-1418F 14" Flat TTL A/G/W .....  
..... (ea.) 119.00  
PB-1420CG 14" Mid-Res CGA 269.00  
PB-1422EG 14" Hi-Res EGA . 369.00  
PB-8426-MJ Uniscan Monitor . 399.00

**Princeton Graphics**  
Max-12 12" TTL Amber ..... 149.00

**Seiko**  
CM-1430 14" VGA Display .... 649.00



**Magnavox CM 8762  
14" RGB/Comp. \$269**

**DRIVES**

**Atari**  
AA314 DS/DD ST Disk ..... 219.00  
SHD204 20MB ST Hard Drive . 619.00

**C.LTD (For Amiga)**  
C.LTD 20MB (A2000) ..... 769.00  
C.LTD 33MB (A2000) ..... 879.00  
C.LTD 44MB (A2000) ..... 1099.00  
C.LTD 50MB (A2000) ..... 1139.00  
C.LTD A500 SCSI Controller . 179.00

**Indus**  
GT Disk Drive Atari XL/XE .... 199.00  
GTS-100 ST Drive ..... 219.00

**Racore**  
Jr. Expansion Chassis ..... 299.00

**Seagate Technologies**  
ST-225 20MB Drive ..... 249.00

**Supra**  
Atari ST 20MB Hard Drive .... 589.00  
Amiga 2000 20MB Hard/Drive . 629.00

**MODEMS**

**Anchor**  
6480 C64/128 1200 Baud ..... 99.99  
520 ST520/1040 1200 Baud . 129.00  
1200E 1200 Baud External ... 129.00

**Atari**  
XMM301 XL/XE 300 Baud ..... 44.99  
SX-212 St Modem ..... 99.99

**Avatec**  
1200 Hc External ..... 99.99  
2400 External ..... 189.00

**Best Products**  
2400 Baud 1/2 Card w/software 149.00

**Everex**  
Evercom 2400 Baud External . 209.00

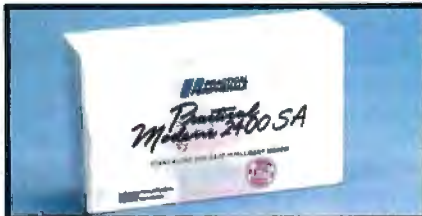

**Practical Peripherals  
2400 Stand Alone \$189**

**Hayes**  
Smartmodem 300 Ext. .... 159.00  
Smartmodem 1200 Int. .... 279.00

**Packard Bell**  
1200 External ..... 89.99  
2400 External ..... 169.00

**Practical Peripherals**  
1200 Baud External ..... 119.00  
1200 Baud Internal ..... 79.99

**Supra**  
2400AT 2400 Baud Atari ..... 169.00

**U.S. Robotics**  
Direct 1200 Baud External ... 109.00  
Direct 2400 Baud External ... 199.00

**DISKETTES**

**Maxwell**  
MD1-M SS/DD 5 1/4" ..... 8.49  
MD2-DM DS/DD 5 1/4" ..... 9.49  
MF1-DDM SS/DD 3 1/2" ..... 12.49  
MF2-DDM DS/DD 3 1/2" ..... 18.49  
MC-6000 DC-600 Tape ..... 23.99

**Sony**  
MD1D SS/DD 5 1/2" ..... 6.99  
MD2D DS/DD 5 1/2" ..... 7.99  
MFD-1DD SS/DD 3 1/2" ..... 11.99  
MFD-2DD DS/DD 3 1/2" ..... 16.99

**PRINTERS**

**Atari**  
XDM-121 Letter Quality XL-XE 209.00  
XM-M801 XL-XE Dot Matrix ... 199.00  
XM-M804 ST Dot Matrix ..... 199.00

**Brother**  
M-1109 100cps Dot Matrix .... 169.00  
M-1509 180cps 132col. .... 389.00  
HR-20 22cps Daisywheel ..... 379.00

**Citizen**  
120D 120cps Dot Matrix ..... 159.00  
Premier-35 35cps Daisywheel . 479.00

**Epson**  
LX-800 150cps, 80 col. .... 179.00  
FX-86e 240cps, 80 col. .... Call  
FX-286E 240 cps, 132 col ..... Call  
LQ-500 180 cps, 24-wire ..... Call  
LQ-850 330 cps, 80 col. .... Call  
LQ-1050 330 cps, 24-wire ..... Call  
FX-850, FX-1050 ..... New

**Hewlett-Packard**  
2225A Thinkjet ..... 369.00

**NEC**  
P2200 Pinwriter 24-wire ..... 379.00  
P660 Pinwriter 24-wire ..... 459.00  
P760 Pinwriter 132 col ..... 679.00

**Okidata**  
Okimate 20 color printer ..... 129.00  
ML-182 180 cps, 80 col ..... 249.00  
ML-320 300 cps, 80 col ..... 379.00  
ML-390 24 wire, 270 cps ..... 519.00



**Panasonic KX-P1080i  
144 cps, 80 col. \$169**

**Panasonic**  
KX-P1091i 194 cps, 80 col. .... 199.00  
KX-P1092i 240 cps, 80 col .... 339.00  
KX-P1595 200 cps, 132 col. .... 479.00

**Star Micronics**  
NX-1000 140 cps, 80 col ..... 179.00  
NX-1000C C64/128 Interface . 179.00  
NX-15 120 cps, 132 col ..... 329.00

**Toshiba**  
P321-SL 216 cps, 24-wire .... 499.00  
P351-SX 300 cps, 24-wire .... 999.00

In the U.S.A. and in Canada

**Call toll-free: 1-800-233-8950**

Outside the U.S.A. call 717-327-9575, Fax 717-327-1217

Educational, Governmental and Corporate Organizations call toll-free 1-800-221-4283

CMO, 101 Reighard Ave., Dept. A1, Williamsport, PA 17701

OVER 350,000 SATISFIED CUSTOMERS • ALL MAJOR CREDIT CARDS ACCEPTED • CREDIT CARDS ARE NOT CHARGED UNTIL WE SHIP

**POLICY:** Add 3% (minimum \$7.00) shipping and handling. Larger shipments may require additional charges. Personal and company checks require 3 weeks to clear. For faster delivery, use your credit card or send cashier's check or bank money order. Credit cards are not charged until we ship. Pennsylvania residents add 6% sales tax. All prices are U.S.A. prices and are subject to change, and all items are subject to availability. Defective software will be replaced with the same item only. Hardware will be replaced or repaired at our discretion within the terms and limits of the manufacturer's warranty. We cannot guarantee compatibility. All sales are final and returned shipments are subject to a restocking fee. We are not responsible for typographic or photographic errors.

A108

# ASK BYTE

*Circuit Cellar's Steve Ciarcia answers your questions on microcomputing*

## A Drive for All Seasons

Dear Steve,

I'm looking for a 3½-inch floppy disk drive capable of coping with the IBM 1.44-megabyte format as well as the Apple 800K-byte format. I have asked most of the major brand representatives in Europe about this, but so far I've been without luck. I think there must be quite a market for such a device, so I don't understand why it should not exist.

H. Anjou  
Gothenburg, Sweden

*There's an old saying in this country that there's an oddball in every crowd. In the computer crowd, the oddball is Apple Computer. Apple's disk system for all its computers uses an unusual data encoding method called group coding, whereas modified frequency modulation (MFM) encoding is the basis for the dominant industry standard dictated by IBM. Apple's method is very software-intensive, using a variable-speed 80-track drive to obtain its 800K-byte-per-disk capacity.*

*The IBM 1.44-megabyte disk drive uses industry-standard controllers. The differences between the systems make designing a single drive to work with both a bit adventurous. At least two companies have attempted to market controllers that permit industry-standard 40-track double-sided drives to be used with the Apple II series; both failed. It seems highly unlikely that anyone will design and market a disk drive that works with both kinds of controllers with acceptable reliability. I'm not saying it can't be done—just that no one is likely to do it.—Steve*

## Alive and Kicking

Dear Steve,

Do you know where I can get software to let me use my Osborne 1 with a hookup to an IBM PC XT? I've tried several sources without success.

Steven Takle  
Fridley, MN

*I don't know of any specific software package that links Osborne or other CP/M machines to IBM PCs. Maybe you*

*can find something on CP/M bulletin board systems (BBSes), CompuServe, or The Source. You can find a large list of user groups and BBSes in Computer Shopper magazine.*

*You can operate a PC from a remote computer of almost any type with some communications programs. Procomm, for example, has a host mode that provides many of the features of BBS control programs, and it has a shell-to-DOS function that allows the remote user full access to the PC. All I/O is redirected to the COM port. This would allow you to use Modem7 or some other program on your Osborne to run the PC remotely. Procomm is available on most local BBSes, or you can order it from Datastorm Technologies, Inc., 1621 Towne Dr., Suite G, Columbia, MO 65205. One advantage of downloading from a local BBS is that you can try it before you buy it.—Steve*

*IN ASK BYTE, Steve Ciarcia, a computer consultant and electronics engineer, answers questions on any area of microcomputing and his Circuit Cellar projects. The most representative questions will be answered and published. Send your inquiry to*

Ask BYTE  
One Phoenix Mill Lane  
Peterborough, NH 03458

*Due to the high volume of inquiries, we cannot guarantee a personal reply. All letters and photographs become the property of Steve Ciarcia and cannot be returned.*

*The Ask BYTE staff includes manager Harv Weiner and researchers Eric Albert, Tom Cantrell, Bill Curlew, Ken Davidson, Jeannette Dojan, Jon Elson, Frank Kuechmann, Tim McDonough, Edward Nisley, Dick Sawyer, Robert Stek, and Mark Voorhees.*

## Protocol Problems

Dear Steve,

My computer is a Hewlett-Packard IPC, a machine that is apparently a poor stepchild.

My problem concerns connecting an external disk drive. According to the manuals, any drive that uses the Amiga

or SS-80 protocol can be directly connected (via the HP-IB or IEEE-488) and operated using drivers in the operating system. Since I don't want to pay HP's price for its drives, I've been looking for another source. Unfortunately, no one has heard of the required protocols.

Do you know of a source of information? I've already tried HP and local dealers. I've also written to drive manufacturers, to no avail.

James A. Hazel  
Bremerton, WA

*A field that is evolving as rapidly as microcomputers creates its inevitable orphans and unsupported, expensive, and hard-to-find products.*

*For a number of reasons (but mostly by accident), the Seagate ST506 and ST412 hard disk drive interfaces have largely dominated, with a strong showing by the Shugart Associates system interface (SASI) and small computer system interface (SCSI). The HP-IB/IEEE-488 interface, though usable with hard disk drives, was developed to connect laboratory instruments to minicomputers; it is therefore less than optimal for hard disk drive applications. The newer, simpler Seagate and SCSI drives have dominated, with run length limited (RLL) coming on fast as a variant.*

*With this in mind, it should be no surprise to you that I haven't been able to locate any third-party drives that would be compatible with your system. Your choices would seem to be as follows: Go without a hard disk drive, buy HP's version, or get a different computer—such as a PC or PC compatible—for which bargain-priced drives are offered by dozens of suppliers.—Steve*

## Identical Printers

Dear Steve,

What is the difference between Epson and IBM-compatible printers with regard to the Centronics interface? Is this difference a hardware- or software-dependent feature?

Also, is it possible to interface an

*continued*



Integrand's new Chassis/System is not another IBM mechanical and electrical clone. An entirely fresh packaging design approach has been taken using modular construction. At present, over 40 optional stock modules allow you to customize our standard chassis to nearly any requirement. Integrand offers high quality, advanced design hardware along with applications and technical support *all at prices competitive with imports*. Why settle for less?

# Rack & Desk PC/AT Chassis

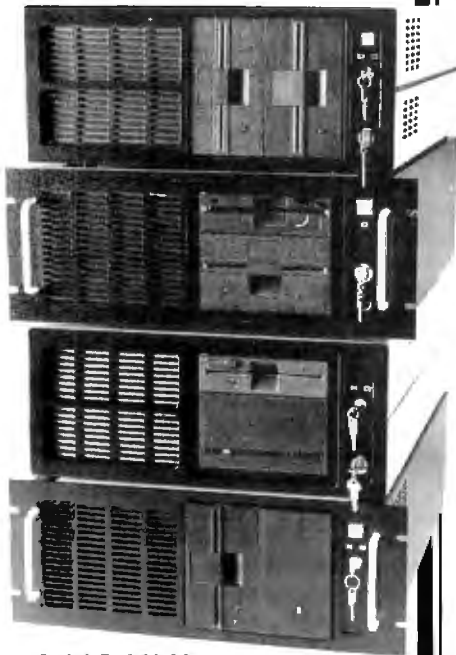

### Rack & Desk Models

Accepts PC, XT, AT Motherboards and Passive Backplanes

Doesn't Look Like IBM

Rugged, Modular Construction

Excellent Air Flow & Cooling

Optional Card Cage Fan

Designed to meet FCC

204 Watt Supply, UL Recognized

145W & 85W also available

Reasonably Priced

# INTEGRAND

RESEARCH CORP.

Call or write for descriptive brochure and prices:

8620 Roosevelt Ave. • Visalia, CA 93291

209/651-1203

TELEX 5106012830 (INTEGRAND UD)

EZLINK 62926572

We accept BankAmericard/VISA and MasterCard

IBM, PC, XT, AT trademarks of International Business Machines. Drives and computer boards not included.

## ASK BYTE

Epson-compatible printer with an IBM PC? If so, how is this done?

Finally, I'd like to know the intricacies involved if you use a serial interface (RS-232C) for the printer.

V. Shyamasunder  
Bangalore, India

*The hardware for an Epson interface is identical to an IBM-compatible printer interface. This interface was originated by Centronics. The commonly used signals include 8 data bits, an active-low data-available strobe, an active-low acknowledge strobe, an active-high level busy signal, and ground signals. The difference between the two types of printers lies in the graphics mode each supports; the graphics mode is controlled by the computer via the high bit of data sent to the printer.*

*In graphics mode—high bit set—an IBM-compatible printer will reproduce the high-ASCII screen graphics character of the IBM PC family; a non-IBM-compatible Epson will produce different characters. In text mode, high bit clear, the two printers will produce the same output. You can use an Epson-compatible printer with an IBM-type computer, if the IBM graphics characters are not required, simply by connecting the computer and printer with a cable that has suitable connectors at the ends, typically either a 36-pin Amphenol-type connector or a DB-25 connector.*

*You can use a serial printer with an IBM-type computer via a COM port and a suitable cable—usually with a DB-25 connector on the printer end and a DB-9 or DB-25 connector at the computer end. Since many serial printers follow DTE (data terminal equipment) protocol rather than DCE (data communications equipment), you'll need a null modem adapter or cable for successful operation. These adapters interchange the data and handshaking lines. While it's easy for experienced users to construct cables and adapters for serial interfacing, it is frequently frustrating and time-consuming for novices. Sources such as Jameco Electronics and JDR Microdevices (both advertise in BYTE) carry ready-made cables and adapters that will prevent or eliminate most problems.—Steve*

### Polylingual Clone

Dear Steve,

I'm interested in buying an IBM AT clone. However, I need the system to operate in English and Japanese (my keyboard has four character types: English, kanji, katakana, and hiragana). In Japanese mode, I need to be able to select the

character I need from a shift/function key and have this character displayed on the CRT or printer.

Many printers can print in different languages (e.g., the Epson can print in German and French), but Epson USA couldn't help me. I need this system to operate as a regular computer or word processor.

M. J. Cavanaugh  
Steger, IL

*A PC clone that writes in English and three different Japanese character sets sounds like a tough item to find in the U.S. market. The old Epson MX-80 printers sold in the U.S. a few years ago did include a katakana character set, but I haven't seen any other printers with this feature.*

*You may be able to use Microsoft Windows if you can get a copy of the Japanese version. Microsoft Systems Journal (March 1988) contains an article on implementing Windows for Japanese computers. The article vaguely implies that a Japanese version of the PC AT or clone is required. It is not necessary for the printer to have the Japanese characters, however, because Windows uses its own fonts and prints in graphics mode when you use a dot-matrix printer.*

*You may be able to find out if this approach is feasible by calling Microsoft at (800) 426-9400.—Steve*

### Computerized Slide Show

Dear Steve,

I am attempting to store some documents that are four to eight pages long on my IBM PC. The documents contain mostly text, but some have line drawings, graphs, and maps. I'd like to retrieve these documents and display them on the screen with as little extraneous display as possible. Most word processors and desktop publishing software display more than the document on the screen. What options do I have for storing and displaying documents in this manner?

I'm using an IBM PC AT with an EGA card.

Doyle L. Jones  
Clinton, MS

*If I understand correctly, you want to display documents page by page on your PC, but not necessarily for editing. In other words, you want a slide show.*

*There are a few programs that are designed especially for this kind of task. Two are Show Partner and Show Partner Professional by Brightbill-Roberts & Co., 120 East Washington St., Suite 421,*

*continued*



# NASA FLIES WITH PROTEUS PCs. AND SO CAN YOU

The National Aeronautics and Space Administration is a regular Proteus buyer. So are thousands of professionals, as well as small and large businesses nationwide. Including Xerox, GE, Dupont, the U.S. Government, MIT and Harvard. And with good reason:

## NATIONALLY ACCLAIMED PERFORMANCE AND SUPPORT.

"The Proteus is one of the fastest desktop computers we tested. Quality has not been compromised, yet this performance system par excellence was priced so low." Dec., 1987

**INFO WORLD**

"The Proteus 386/16MHz is markedly faster than any other PC we've worked with—including the Compaq Deskpro 386/20!" Jan., 1988

**PERSONAL COMPUTING**

## COMPATIBILITY GUARANTEED.

Every Proteus is American made from the ground up. And guaranteed compatible with all IBM PC/AT software and add-on products. As well as with DOS, OS/2, UNIX, XENIX, NOVELL and all major CAD systems. None is alien to Proteus!



## SATISFACTION GUARANTEED.

If you're not fully satisfied with your Proteus purchase, return it during the first 30 days for a full refund.

## THE MOST EXTRAORDINARY SUPPORT IN THE INDUSTRY.

We don't leave you out in orbit after we make the sale, either. Proteus has a contract with a nationwide computer maintenance company.

If something should go wrong with your Proteus system during the first 15 months, we'll send a qualified technician to your site to fix it. Free!

Just call our toll-free technical support hotline any time you have a question or need help. We'll take care of the rest.

STANDARD FEATURES:	386A	pro-CACHE 386	286 GTX	286E
INTEL CPU	80386	80386	80286	80286
SPEED MHZ	20/16/6	20/16/6	12/0	8/6
WAIT STATE	ZERO	ZERO	ZERO	1
SYSTEM MEMORY	1024K to 16MB	1024K to 16MB	640K to 16MB	640K to 16MB
CACHE MEMORY SIZE	64KB	64KB	32KB	—
KBD. SELECTABLE SPEEDS	YES	YES	YES	YES
COPROCESSOR SUPPORT	80287/387	80387	80287	80287
32-BIT SLOTS	—	1	—	—
16-BIT SLOTS	6	4	6	6
8-BIT SLOTS	2	1	2	2
SERIAL PORTS	2	2	2	2
PARALLEL PORT	1	1	1	1
HARD DISK/CD. CTRL.	YES	YES	YES	YES
1.2MB 5 1/4" OR 1.44MB 3.5" FD.	YES	YES	YES	YES
ROM BASED SETUP/DIAGNOSTICS	YES	YES	YES	YES
POWER SUPPLY	200W	200W	200W	200W
ENHANCED 101-KEY KBD.	YES	YES	YES	YES

SEAGATE, MINISCRIBE, MAXTOR HARD DISKS FROM \$279. VGA/EGA ADAPTORS: VIDEO 7, SIGMA, ATI, EVEREX FROM \$149. MEMORY UPGRADES, COPROCESSORS, MODEMS AT LOW PRICES.

## PROTEUS 386A opt. 20MHz



"A 16MHz, zero wait state 'hot rod'!" Among the top 100 products of the year!"

MONOCHROME SYSTEM WITH A 40MB, 28MS HARD DISK ..... \$2908

EGA COLOR SYSTEM WITH A 40MB, 28MS HARD DISK ..... \$3329

VGA SYSTEM (800x600) WITH A 40MB, 28MS HARD DISK ..... \$3966

## PROTEUS 286GTX



"IBM can keep its PC/AT and PS/2 computers; I'll take the Proteus 286GTX before those any time. I never want to be without it again!" Ernest Mau, Editor

**CompuServe**  
ON LINE TODAY

"Fastest machine in the comparison. A superb value!"

**INFO WORLD**

MONOCHROME SYSTEM WITH A 40MB HARD DISK ..... \$1995

EGA COLOR SYSTEM WITH A 40MB HARD DISK ..... \$2495

VGA SYSTEM (800x600) WITH A 40MB HARD DISK ..... \$2795

## PROTEUS 286E

"The Proteus 286E is the clear winner. We recommend it."

**INFO WORLD**

MONOCHROME SYSTEM WITH A 20MB HARD DISK ..... \$1612

EGA COLOR SYSTEM WITH A 20MB HARD DISK ..... \$2095

## ORDER BY PHONE. IT'S EASY.

You don't even have to leave your desk to order a Proteus system. Or systems. Just call us direct.

The exact configuration you want will quickly land on your doorstep. All you have to do is plug it in, turn it on and blast off into the wild, blue yonder!

## CUSTOM CONFIGURED WITH TOMORROW'S TECHNOLOGY.

Proteus computers were custom configured to meet NASA's specs. And whether you need only one system or a hundred, we'll custom configure to your exact specifications, too. From a long list of third party, brand name components.

Including 3.5" microfloppy drives, high-speed 1:1 interleave controllers with ESDI and SCSI hard disks and 800x600/640x480 resolution VGA graphics.

IN NJ: 201-288-8629  
For tech support: 1-800-541-8933

**1-800-782-8387**

**PROTEUS**  
THE INTELLIGENT CONCLUSION!

377 Rt. 17 So, Airport 17 Ctr, Hasbrouck Hts, NJ 07064 • Telex 510-610-0960 • FAX 201-288-9518  
Electronic catalog and 24-hour tech support: set your modem to 1200B/118/N dial 201-288-8577  
VAR/Reseller volume discounts available. Payment methods: credit card, COD, company P.O.s

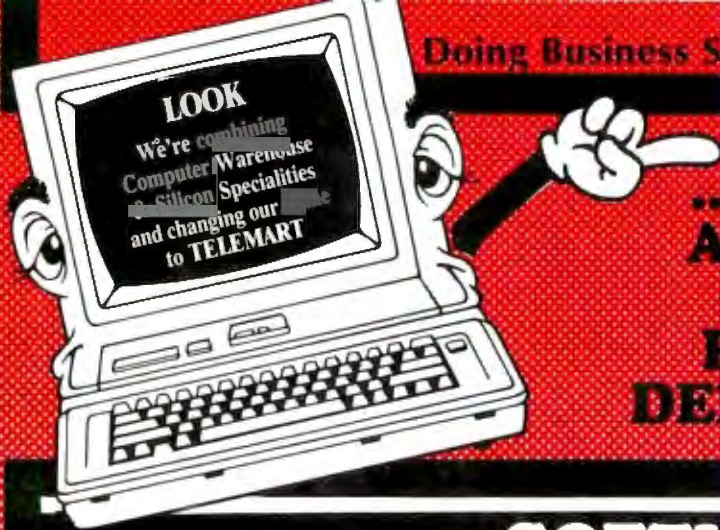

...AND IT ALL  
**ADDS—UP TO  
 THE BEST  
 PRICES AND  
 DELIVERY EVER!**



# SOFTWARE

## DATABASE MANAGEMENT

Clipper . . . . .	\$ 368
dBase III Plus . . . . .	369
dBase III LAN . . . . .	599
DB-XL Diamond . . . . .	105
Eureka . . . . .	88
Genifer . . . . .	188
Nutshell . . . . .	72
Paradox 2.0 . . . . .	415
PFS: Professional File . . . . .	119
Q & A . . . . .	185
Quickcode Plus . . . . .	129
Rapid File . . . . .	179
Revelation . . . . .	459
Revelation Bump Disk . . . . .	239
R:Base Clout (New Ver.) . . . . .	175
R:Base For DOS . . . . .	425
Reflex . . . . .	78
VP Expert . . . . .	Call
VP Info . . . . .	56

## PROJECT MANAGEMENT

Harvard Total Project Mgr. II . . . . .	\$ 309
Microsoft Project 4.0 . . . . .	287
Timeline 2.0 . . . . .	259

## WORD PROCESSORS

Easy Extra . . . . .	\$ 52
Word (Microsoft) . . . . .	185
Multimate Advantage II . . . . .	249
PFS: Professional Write . . . . .	102
Volkswriter 3 . . . . .	132
Volkswriter Deluxe Plus . . . . .	57
Webster New World Writer . . . . .	53
Webster Spell Checker . . . . .	32
Webster Thesaurus . . . . .	37
Word Perfect . . . . .	Call
Word Perfect Executive . . . . .	Call
Word Perfect Library . . . . .	Call
Wordstar Pro Pack 4.0 . . . . .	Call
Wordstar 2000 Plus Personal . . . . .	205

## DESKTOP PUBLISHING

Newsmaster II . . . . .	\$ 39
Pagemaker . . . . .	Call
PFS: First Publisher . . . . .	65
Ventura Publishing . . . . .	475

## GRAPHICS

Energraphics . . . . .	\$186
Freelance Plus . . . . .	309
Generic CAD w/Dot Plot 3.0 . . . . .	72
Harvard Graphics 2.1 . . . . .	239
In-A-Vision . . . . .	259
Microsoft Chart 3.0 . . . . .	229
News Room . . . . .	30
News Room Professional . . . . .	42
Printmaster Plus . . . . .	29
PrintShop . . . . .	32
Turbo Graphix Tool Box . . . . .	58
VP Graphix . . . . .	56
Windows Draw!! w/Clip Art . . . . .	159

## MICE

<b>PC Mouse w/Paint</b> (Buss or Serial) . . . . .	85
<b>PC Mouse</b> w/Autosketch (Buss or Serial) . . . . .	99
Microsoft Buss Mouse 1.0 . . . . .	92
Microsoft Serial Mouse 1.0 . . . . .	92
MS Buss Mouse w/CADD . . . . .	107
MS Serial Mouse w/CADD . . . . .	107
MS Buss Mouse w/Windows . . . . .	122
MS Serial Mouse w/Windows . . . . .	122
Optimouse (PC Mouse) w/Dr. Halo III . . . . .	78

## INTEGRATIVE SOFTWARE

Ability Plus . . . . .	\$ 137
Enable 2.0 . . . . .	352
Framework II . . . . .	349
MS Works . . . . .	113
PFS: 1st Choice . . . . .	76
Smart Software System . . . . .	Best Price
Symphony . . . . .	435

## ACCOUNTING

ACCPAC . . . . .	Call
Computer Associates . . . . .	Call
DAC Easy Accounting . . . . .	52
DAC Easy Payroll . . . . .	38
In-House Accountant . . . . .	105
One Write Plus 2.0 . . . . .	117
One Write A/R, A/P, Payroll . . . . .	117
Time Slips III . . . . .	109

## MONEY MANAGEMENT

Dollars & Sense w/Forecast . . . . .	\$ 92
Tobias Managing Your Money 4.0 . . . . .	114

## UTILITIES

1 DIR Plus . . . . .	\$ 46
Bookmark . . . . .	56
Brooklyn Bridge . . . . .	69
Carousel 2.0 . . . . .	38
Copy II PC . . . . .	18
Copywrite . . . . .	39
Corefast . . . . .	89
Cruise Control . . . . .	29
Cubit . . . . .	Call
Disk Optimizer 2.0 . . . . .	Call
Disk Technician . . . . .	56
Double DOS 4.0 . . . . .	Call
DS Back-Up Plus . . . . .	46
Fastback . . . . .	75
Fastback Plus . . . . .	86
Keyworks . . . . .	53
Mace Utilities . . . . .	47
Microsoft Windows 2.03 . . . . .	57
Norton Commander . . . . .	35
Norton Editor . . . . .	35
Norton Utilities 4.0 . . . . .	46
Note It Plus . . . . .	45
PC Tools Deluxe . . . . .	36
Printworks for Lasers . . . . .	67
Referee . . . . .	38
Sidekick Plus . . . . .	Call
Sideways . . . . .	37
Smart Notes . . . . .	43
SQZ Plus . . . . .	53
Superkey . . . . .	58
Take Two MGR . . . . .	66
Turbo Editor Tool Box . . . . .	58
Unlock AT . . . . .	36
Unlock D Plus . . . . .	49
XTree Professional . . . . .	61

## COMMUNICATIONS

Carbon Copy Plus . . . . .	\$ 105
CompuServe Subscription Kit . . . . .	19
Crosstalk XVI . . . . .	87
Crosstalk Mark IV . . . . .	109
Mirror II . . . . .	33
Remote . . . . .	87
Smartcom III . . . . .	136

## ACCESSORIES

Copy II Option Board Deluxe . . . . .	\$ 99
Masterpiece . . . . .	79
Masterpiece Plus . . . . .	92
Masterpiece Remote . . . . .	107

## LANGUAGES

Basic Compiler (Microsoft) . . . . .	\$ 175
C Compiler (Microsoft) . . . . .	259
Cobol Compiler (Microsoft) . . . . .	415
Fortran Compiler (Microsoft) 4.0 . . . . .	259
Latice C Compiler . . . . .	209
Macro Assembler (Microsoft) . . . . .	86
Pascal Compiler (Microsoft) . . . . .	175
Quick Basic 4.0 . . . . .	57
Quick C . . . . .	57
Ryan McFarlan Fortran . . . . .	379
Ryan McFarlan Cobol . . . . .	609
Turbo Basic . . . . .	58
Turbo C . . . . .	58
Turbo Pascal 4.0 . . . . .	58
Turbo Prolog . . . . .	58
Turbo Prolog Toolbox . . . . .	58

## TRAINING

Chuck Yeager Adv. Flight Simulator . . . . .	\$ 25
Lets C . . . . .	38
Mastertype . . . . .	23
Mavis Beacon Typing . . . . .	29
MS Learning DOS . . . . .	29
MS Flight Simulator . . . . .	29
PC Logo . . . . .	79
Turbo Tutor 4.0 . . . . .	42
Typing Instructor II . . . . .	27
Typing Tutor IV . . . . .	27

## SPREADSHEETS

Cambridge Analyst . . . . .	\$ 79
4 Word . . . . .	55
HAL . . . . .	89
Lotus 1-2-3 Ver. 2.01 . . . . .	295
Lotus Manuscript . . . . .	309
Lotus Report Writer . . . . .	67
MS Excel . . . . .	285
Multiplan 3.0 (Microsoft) . . . . .	113
PFS Professional Plan . . . . .	52
Quattro . . . . .	138
Supercalc 4 . . . . .	275
Twin Classic . . . . .	32
VP Planner . . . . .	47
VP Planner Plus . . . . .	Call



MEMBER  
**MMC**  
 MICROCOMPUTER  
 MARKETING COUNCIL  
 of the  
 Direct Marketing Association Inc.

- No Charge for VISA and Mastercard
- We Do Not Charge Your Card Until Your Order is Shipped
- You Pay the Ground Shipping \$6.00 (except Alaska and Hawaii)  
 We Pay the Air Difference
- Free Air applies ONLY to orders up to 10 lbs. & Over \$50.
- Add 5% for C.O.D. Orders

- All products carry only manufacturer's warranties. We do not honor guarantees, rebates, trial period privileges or promotional programs offered by manufacturers.
- No APO, FPO, or international orders, please.
- Call before submitting P.O.'s Ask for National Accounts
- Personal and Company Checks Will Delay Shipping 3 weeks
- Prices, Terms & Availability Subject to Change Without Notice

**HARDWARE**

**PRINTERS**

Alps All models . . . . .	Call
AST Turbo Lazer . . . . .	\$4310
C.I.TOH . . . . .	Call
<b>Citizen Printers</b>	
120D . . . . .	139
180D . . . . .	189
MSP 40 . . . . .	319
MSP 45 . . . . .	465
MSP 50 . . . . .	399
MSP 55 . . . . .	529
Premier 35 . . . . .	509
Diconix 150 . . . . .	309
300 . . . . .	480
Epson Printers . . . . .	Call
<b>Hewlett-Packard</b>	
Disk Jet . . . . .	779
Lazer Jet Series I . . . . .	1775
<b>NEC</b>	
P2200 . . . . .	329
850 Silent Writer . . . . .	1539
Other Models . . . . .	Call
<b>Okidata . . . . .</b>	
182+ . . . . .	209
192+ . . . . .	325
292 . . . . .	355
294 . . . . .	715
<b>Panasonic</b>	
1080 I M2 . . . . .	165
1091 I M2 . . . . .	199
1092 I . . . . .	325
1524 . . . . .	560
1592 . . . . .	409
1595 . . . . .	469
3131 . . . . .	305
3151 . . . . .	475
Lazer 4450 . . . . .	1635
Star Micronics . . . . .	Call
<b>Toshiba</b>	
321 SL . . . . .	489
341 SL . . . . .	655
351 SX . . . . .	945
Page Lazer . . . . .	2415

**DISK DRIVES**

<b>Bernoulli Box</b>	
10 Meg . . . . .	\$ 889
20 Meg . . . . .	1015
40 Meg . . . . .	1559
Beta Ext . . . . .	1015
Beta Int . . . . .	775
PC2 Card . . . . .	139
<b>Seagate</b>	
20 MG w/WD Controller . . . . .	275
251-1 . . . . .	469
AT 40 MEG Full Height . . . . .	550
Other Models . . . . .	Call
<b>Teac</b>	
1.2 MEG AT . . . . .	89
Floppy F55 BR . . . . .	79
<b>Toshiba</b>	
3.5 Dr 720K . . . . .	95
3.5 Dr 1.4MB . . . . .	115

**DISKETTES**

Maxell MD-2 Qty. 100 . . . . .	Call
Maxell MD-2HD Qty. 100 . . . . .	Call
Sony 5 1/4 Qty 100 . . . . .	\$ 65
Sony 3 1/2 Qty. 100 . . . . .	159

**MODEMS**

<b>Hayes</b>	
1200 . . . . .	\$ 280
1200B . . . . .	245
2400B . . . . .	385
<b>Prometheus</b>	
1200B w/Software . . . . .	75
2400B w/Software . . . . .	119
Other Models . . . . .	Call
<b>US Robotics</b>	
Password 1200 . . . . .	175
Courier 2400 . . . . .	289
Courier 2400E . . . . .	335

**KEYBOARDS**

<b>Keytronics</b>	
KB5151 . . . . .	\$ 119
KB5153 . . . . .	149
KB101 . . . . .	79

**BOARDS**

<b>AST</b>	
Hot Shot . . . . .	\$ 355
Six Pack Plus (256K) . . . . .	195
Xformer . . . . .	560
3G+ . . . . .	219
Other Models . . . . .	Call
<b>ATI</b>	
EGA Wonder . . . . .	175
VIP Plus . . . . .	265
<b>Hercules</b>	
Color Card . . . . .	145
Graphics Card Plus . . . . .	175
Incolor . . . . .	209
<b>Intel</b>	
Inboard 386 PC . . . . .	719
Inboard 386 w/cable . . . . .	979
4020 . . . . .	375
80287-6 . . . . .	175
<b>Orchid</b>	
Designer EGA . . . . .	299
VGA . . . . .	220
<b>Paradise</b>	
Autoswitch 350 . . . . .	130
VGA + . . . . .	239
VGA Professional . . . . .	355
<b>Video-7</b>	
VGA . . . . .	269
Vega Deluxe . . . . .	180
V-RAM . . . . .	475
<b>Wyse</b>	
30 . . . . .	285
50 . . . . .	369
85 . . . . .	439
<b>HARD CARDS</b>	
Plus 20 MG . . . . .	\$ 525
Plus 40 MG . . . . .	659

**TERMINALS**

30 . . . . .	285
50 . . . . .	369
85 . . . . .	439

**HARD CARDS**

Plus 20 MG . . . . .	\$ 525
Plus 40 MG . . . . .	659



**COMPUTERS**

<b>AST</b>	
Model 80 . . . . .	\$1695
Model 140X . . . . .	2609
Model 140 . . . . .	2815
Model 340 . . . . .	4205
Model 390 . . . . .	5839
Other Models . . . . .	Call
<b>NEC</b>	
Multispeed EL II . . . . .	1495
Powermate . . . . .	Call
<b>Toshiba</b>	
T-1000 . . . . .	749
T-1200F . . . . .	1565
T-1200FH . . . . .	2285
1200FB . . . . .	2415
T-3120 . . . . .	3068
T-3200 . . . . .	3789
T-5100 . . . . .	4899
<b>Wyse</b>	
386 . . . . .	2735
<b>MONITORS</b>	
Amdek Monitors . . . . .	Call
<b>NEC</b>	
Multisync II . . . . .	\$ 589
Monographic System . . . . .	1299
Other Models . . . . .	Call
Princeton Ultrasync . . . . .	485
Samsung . . . . .	Call
Sony Multiscan (1303) . . . . .	545
<b>Mitsubishi</b>	
Diamond Scan . . . . .	499
<b>Zenith</b>	
1490 . . . . .	609

\* To Place an Order: 1-800-528-1054  
 \* To Follow Up on an Order: (602) 944-2552  
 \* Order Line Hours: Monday-Friday 7:00 a.m.-6:00 p.m.  
 Saturday 9:00 a.m.-1:00 p.m.  
 \* Order Processing (602) 944-1037  
 10:00 a.m.-3:00 p.m. Mon.-Fri.  
 \* We Do Not Guarantee Machine Compatibility

**Mailing Address:**  
 8804 N. 23rd Avenue / Phoenix, Arizona 85021

**ORDER LINE**  
**1-800-528-1054**

Syracuse, NY 13202, (315) 474-3400.

Another is EGA Paint with EGA Slide by RIX Softworks, Inc., 18552 MacArthur Blvd., Suite 375, Irvine, CA 92715, (714) 476-8266.

These products are widely available from mail-order suppliers or in computer stores.—Steve

### Communication Problems

Dear Steve,

I recently purchased a Macintosh SE, and I was under the assumption that such a sophisticated machine would hook up to my printer, a Toshiba P1340. I also assumed that any software—such as Microsoft Works and Lotus's Jazz—would also operate with the printer. No such luck. Although I have just begun searching, I have had equally poor luck in unearthing any information that will help me solve the problem.

My Toshiba is a good product, and I'd like to continue to use it with the Mac. I have an Apple IIe and have had no problems with any of the printers I have used with it. I can't understand why a superior machine would present such a frustrating limitation.

I do have an Orange Micro C/Mac/GS linked between my Panasonic 1091 and the Mac. However, printing is so slow that I could write the documents by hand faster. I don't consider this a realistic solution. I'd appreciate any suggestions.

David T. Barrat  
Acton, MA

*The success of the Macintosh computer, after an under-powered beginning, has been one of the more interesting phenomena of the post-1985 computer scene (parallel with, and quite distinct from, the overwhelming continued dominance of the IBM line and its clones). Perhaps the most distinctive characteristic of the Mac is its penchant for doing nearly everything in a non-IBM way. What works with IBM won't work with the Mac, and vice versa.*

*The individuality, though perhaps somewhat interesting, creates problems that aren't easily solved. Attempting to use the Mac with other than its own specially designed printers graphically illustrates some of those problems.*

*Your desire to use your Toshiba printer with the Macintosh is understandable, but it may not be possible. The Macintosh uses software drivers to communicate with devices like printers; these drivers can be found in the system folder. Apple Computer supplies drivers only for its Imagewriter and LaserWriter printers. To use a different printer, the appropriate*

*driver must be installed in the system folder of the Macintosh. So far as I can determine, there is no driver available for your Toshiba printer. Unless you create your own driver (a nontrivial task), or one becomes available from another source, your Mac and Toshiba won't sing the same song or speak the same language.—Steve*

### Joyless Joystick

Dear Steve,

I'm trying to interface an external device to my Amiga 500 through the second joystick port. I have experimented and read a few books on the Amiga, but I can't find any way of doing output through the port. I've experimented with pokes and peeks, and I've found that I can input information through the port with the following code:

```
LOOP: PRINT PEEKW(14614540)
      POKEW 14614582,0
      GOTO LOOP
```

Could you show me how to do output through the port or refer me to some source?

Virender Dayal  
Hoboken, NJ

*I understand your desire to use an unused joystick port on your Amiga for output. Tinkering with hardware and exploring new applications is one of the true joys of computing. Your desire to get output, however, isn't practical.*

*There are essentially two kinds of connections to electronic circuits: inputs and outputs. Except in the case of specialized devices, like transceivers and analog switches, the two functions aren't interchangeable. The Amiga 500's joystick port is for input only, and there is no way—short of redesigning, cutting, soldering, and praying—that you can change this.—Steve*

### Do-It-Yourself CAD/CAM

Dear Steve,

I am an amateur engineer and designer with some professional experience in FORTRAN programming. I'm interested in knowing if I could construct a 1-megabyte computer that would have the capability for CAD/CAM operations and FORTRAN programming. I don't think I would need BASIC for my application.

My goal is to use CAD/CAM software to construct an item on the monitor, then cut the item in selected locations and use FORTRAN to make an engineering strength analysis. I could then redesign as necessary without removing the item

from memory or even from the screen.

I see various companies that sell computer components. Can I buy a keyboard, motherboard, monitor, and other components to put together a system to help me with my engineering? I don't need the extra space and chips that I guess are needed for BASIC or, say, Symphony—I would use those resources for CAD/CAM and FORTRAN.

Joseph Weiss Jr.  
South Hutchinson, KS

*While I think you could construct a computer along the lines that you describe, I think it would be far more practical to purchase a standard one. There are a few things you haven't considered that make the decision fairly simple.*

*It turns out that all computers are pretty much the same under the hood, so any machine that can run FORTRAN or CAD/CAM programs will also run BASIC and other languages. You don't need additional hardware gizmos for those other programs; as far as the computer is concerned, they're all just programs.*

*By the same token, Symphony and all the other programs will run on the same IBM PC clone that will handle FORTRAN or AutoCAD, simply because they're programs written to use that hardware. In fact, you'll find that the CAD programs tend to have more stringent hardware requirements, because they need high-resolution displays, plotters, printers, digitizing tablets, and mice to handle complex graphic I/O.*

*If you're interested in CAD work, plan to buy at least an IBM PC AT clone with a 40-megabyte hard disk drive, a VGA-compatible monitor, and a mouse. That's the minimum hardware for reasonable performance. Hard copy output can go to either a laser printer or a plotter; the former can handle word processing with ease. But the tab will run about \$5000 for all that hardware, and you won't realize significant savings by assembling parts from several vendors.*

—Steve

### Sounds in the Silence

Dear Steve,

I want to communicate by telephone with my cousin, who is hearing impaired. I'd like to be able to use my computer and a modem, but my cousin has only teletypewriter (TTY) equipment, and I understand that there is no modem that can connect to a TTY.

The president of the Maryland State Society for the Hearing Impaired tells

*continued*

# TALLGRASS BACKS YOU ALL THE WAY.



*Tallgrass makes  
internal and external  
tape backup systems  
for the IBM PC/XT/AT,  
PS/2 or compatibles,  
and an external  
unit for your Mac  
Plus, SE or II.*

## **We've got a whole new family of tape backup systems.**

Whether you've got an IBM, a compatible, or a Macintosh, you can count on Tallgrass. We back you with all the storage capacity you could ask for, plus all the features, all the support, and all the speed you'll ever need. And we make it easy to protect your valuable data. Since all operations are automatic

and unattended, you can just set it, and forget it.

## **Best of all, we stand behind our products with the industry's only 3-year warranty.**

But there's one other reason why so many more people are asking for Tallgrass. It's because the competition is asking so much more for their products.

Let Tallgrass start backing you up.  
Call 1-800-TAL-GRAS. Or write to:  
Tallgrass Technologies, Inc.  
11100 West 82nd St.  
Overland Park, KS 66214

 **TALLGRASS  
TECHNOLOGIES**

When it's worth saving, it's worth Tallgrass

© 1988 Tallgrass Technologies, Inc. "IBM" is a registered trademark of International Business Machines, Inc. "Macintosh" and "Mac Plus" are trademarks of Apple Computer, Inc.

**Circle 234 on Reader Service Card (DEALERS: 235)**

AUGUST 1988 • B Y T E 45



## Save Hundreds of Dollars When You Re-Ink Costly Printer Ribbons

Now you can re-ink fabric ribbons again and again—for just pennies each time! So, don't throw away expensive ribbons—re-ink them and save, save, save. Bede Tech Ribbon Inker comes with FREE 4-oz. bottle of black ink (lasts 50-100 re-inkings), FREE ink roller and FREE roller cover.

### **NEW** CUSTOM RIBBON INKER \$64<sup>95</sup>

Factory Set For Your Ribbon—Call with Printer Manufacturer and Model  
 EPSON PRINTER RIBBON INKER \$52.95  
 IMAGEWRITER PRINTER INKER \$49.00

### INK & RIBBONS

Black Ink, 4 oz. bottle \$ 4.50  
 Black Ink, Pint 16.50  
 ImageWriter ribbons, uninked 2/10.00  
 ImageWriter ribbons, inked 2/12.00  
 Colored Ink, Multi-Color Ribbons CALL



### HI-CAPACITY, LOW-COST DISK ORGANIZERS

Sturdy, stackable 200 lb. test corrugated cdb. dividers, lid. Specify High-Gloss White or Satiny Wood-Grain finish.

5 1/4" FLOPPY DISK ORGANIZER  
 Holds 100 disks \$5.45 4/\$19.95

3.5" DISK ORGANIZER  
 Holds 100 disks \$7.45 4/\$24.95

3.5" DESK TOP DISK ORGANIZER  
 Holds 50 disks \$4.45 4/\$14.95

COMPACT DISK ORGANIZER  
 Holds 50 C.D.s \$3.95 4/\$13.95

MacWorld Expo Booth #5056

SEE US AT THE WORLD TRADE CENTER

**FREE Illustrated Catalog With Many More Items**  
 • 24 Hour Shipment • 30 Day Money-Back Guarantee  
 • We Don't Bill You Until We Ship To You



**bede tech**

CALL 24 HOURS TO ORDER

**800-772-4536**

IN OHIO 216-631-4214 • FAX 216-631-1452

Division, Bede Industries, Inc. • Established 1976 • 8327 Clinton Rd. • Cleveland, OH 44144  
 ImageWriter is a trademark of Apple Computers, Inc. BY8

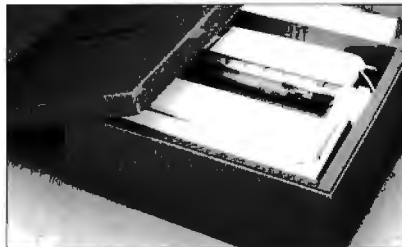

### PRINTER SILENCER \$29<sup>95</sup>!

Reduce irritating printer noise up to 90%! Attractive wood grain finish, 200 lb. test corrugated cdb. Ideal for light and medium use of printers up to 17.5" x 13.5" x 5".

### **NEW** ACCESSORIES

Keyboard Drawer \$32.95  
 Printer/Monitor Stand \$12.95  
 PC/Mac II CPU Vertical Stand \$19.95  
 Mac II Monitor & CPU  
 Ext. Cables \$32.95  
 Mac II Keyboard Ext. Cable \$25.95  
 PC Monitor/Keyboard Ext. Cables \$32.95  
 3 1/2" Disk Holder w/Velcro Mounting \$ 6.95  
 5 1/4" Disk Holder w/Velcro Mounting \$ 7.95  
 Mac, Mac Plus, Mac SE System Stand \$19.95  
 Apple/Mac Security Cable Kit \$32.95  
 Hard Keyboard Covers.  
 Specify: Mac, Mac Plus, Mac SE Mac II, Apple IIGs \$ 9.95  
 Mac SE or Mac II Extended \$12.95

### **NEW** EZ GLIDER™ PAD FOR YOUR TEFLON MOUSE

Designed specifically for the new Mac II and SE Teflon padded mouse. Will also put new life into your old mouse. Specify platinum, maroon or royal blue.

EZ GLIDER MOUSE PAD \$11.95  
 STANDARD MOUSE PAD (royal blue) \$5.95

me that the Bell Telephone System has a very expensive converter that will allow modems and TTYs to connect. He tells me further that the deaf community uses machines that are based on the TTY code because (a) such machines are readily and economically available, and (b) most of the members of the deaf community cannot afford the Bell System converter.

I think you can make an enormous contribution to the many people who are hearing impaired and to the microcomputer community as well. If such a converter exists, surely you can design equipment that will serve the same function and that can be made from economical and readily available parts.

George Allison  
 Essex, MD

*I've received many useful suggestions for Circuit Cellar projects from readers such as yourself. I will seriously consider your suggestions concerning modem/TTY compatibility.*

*There are definitely some possibilities that deserve consideration and exploration. The microcomputer world is frequently afflicted with incompatibilities, and the differences between current microcomputer modems and the older TTY-based equipment illustrate the situation nicely.*

*While there are viable markets for various computer modems and TTY equipment, there is a much smaller market for protocol converters for the two communications methods. The small size of the market limits the amount of development you can accomplish without going broke.*

*As you said, there seems to be no general-purpose equipment on the market, other than the expensive converters sold by the phone company, that permits communication between a typical microcomputer and a TTY unit used by hearing-impaired individuals. Modifying existing commercial equipment is usually impractical unless the TTY capability has been designed into it from the beginning.*

*At one time Novation made an internal modem called the Apple Cat for Apple II series computers. After a simple factory hardware modification, you could use it with special software (available on disk from Novation) to work with the 45.5-bit-per-second, Baudot-coded (5-bit) protocol used by TTY. However, Novation no longer makes it. Texas Instruments also has a software package available for the TI Professional that lets that computer emulate a TTY terminal, but it works in conjunction with unique TI hardware and thus has little generality.*

—Steve ■

# COMPLETE 12 MHz ZERO-WAIT 286 SYSTEM WITH 32MB HARD DRIVE!

Can you believe it? *Yes you can!*

32 MB hard drive. 12 MHz ZERO Wait State. Fully AT compatible. Our *complete* '286 system ready to plug in and fly right out of the box! At the amazing price of only \$1,295!

How is it possible? By buying direct from the manufacturer that's how. ZEOS International offers you the finest, best-backed fully AT compatible systems available... at *factory direct* prices.

We think you'll agree, this is the very best value you'll find anywhere.

And every ZEOS® system is fully assembled, burned-in and tested in our own laboratories. We would like to build one for you. Give us a call today!

#### OTHER ZEOS OPTIONS:

- Basic System Only: Everything except HDD/HDC. \$995
- Complete 64 MB hard drive system! Only \$1,595
- EGA Upgrade. 14" EGA color monitor with ZEOS EGA card. Fully tested. Add \$495
- Many other drives and options available. Call Toll Free for details, 800-423-5891.

#### ZEOS® Customer Assurance Program

Compare not only our features but the ZEOS® Customer Assurance Program as well: 1. Full refund within 30 days of shipment if you are not absolutely satisfied. 2. One full year limited warranty on parts and labor. 3. Federal Express replacement of any failed parts for your first year of ownership.

ONLY  
**\$1,295<sup>00</sup>**

#### NEW! ZEOS® '386 Tower System

Available now! Zeos® 386 Tower System! Complete with 64 MB HDD; Adaptec 2372 HDC, 1:1 interleave, 800 KB/sec transfer rate; 1 MB RAM, Zero-Wait, cache memory, 1.2 FDD, High Resolution tilt swivel monitor, 101 key keyboard, and more. Complete 20 MHz System \$3,495! 16 MHz \$2,995!

#### STANDARD FEATURES INCLUDE:

- 12" High Resolution Amber Screen TTL Monitor with Tilt & Swivel base. Easy on the eyes!
- 80286 CPU Zero-Wait State Motherboard with 8 I/O slots and socket for 80287 Math Co-processor.
- 6/12 MHz Dual Speed, Keyboard Selectable, Zero Wait-State. Phoenix BIOS!
- Deluxe AT-style Case, Security Keylock, Reset Button, LEDs.
- Full 101 key AT-style Keyboard, Mechanical Tactile with Pleasant "Click" Feel.

- Heavy Duty 200W Power Supply.
- Real Time Clock/Calendar with Battery Backup.
- 512K, 80ns Memory expandable to 1MB on the Motherboard.
- Hard and Floppy Drive Controller; 1:1, 800 KB/sec!
- Serial and Parallel/Printer Ports.
- 1.2 MB High Capacity Floppy Drive.
- 32MB hard drive.
- High Resolution Monochrome Graphic Card.
- FCC approved.
- Norton SI: 15.3



AT is a registered trademark of IBM Corporation.

Due to currency fluctuations and other factors beyond our control, prices are subject to change without notice.

Call for complete warranty details.

In Minnesota Call: 612-633-4591  
FAX Orders Dial: 612-633-2310



**ORDER NOW TOLL FREE  
800-423-5891**

**ZEOS**  
INTERNATIONAL, LTD.

530 5th Avenue NW, Suite 1000  
St. Paul, MN 55112

AUGUST 1988 • B Y T E 47

Circle 256 on Reader Service Card





# You Can Never Be Too Powerful Or Too Thin.

As portable PCs go, ours may look a bit on the skinny side. But they're by no means undernourished.

After all, each 286 and 386 powered Toshiba portable has an easy-to-read gas plasma screen. Each is IBM-compatible. And each gives you a wide range of features you'd expect only from a desktop PC.

The T3100/20, for example, weighs a scant 15 pounds, yet has an abundance of power. It comes with an 80286 microprocessor and 640KB of RAM that's extendable to 2.6MB. Plus, there's a built-in 20MB hard disk.

Our T3200 has the advantages of a 12MHz 80286 microprocessor, an EGA display system, a 40MB hard disk and 1MB of RAM expandable to 4MB. Also, its two IBM-compatible internal expansion slots let you connect your PC to mainframes, LANs and more. But what's even more impressive is how we managed to fit all this into a slim, 19-pound package.

Then there's our T5100. As amazing as it seems, we managed to squeeze a 16MHz 80386 microprocessor into a slim package that weighs less than 15 pounds. To that we added an EGA display system and a 29

msec 40MB hard disk. As your thirst for power grows, its 2MB RAM can be upgraded to 4MB. And for a limited time, your T5100 purchase entitles you to buy the powerful Paradox 386® database software for only \$299 (nearly \$600 off the retail price).

For more information on Toshiba computers and printers, call 1-800-457-7777. And rest assured that whichever Toshiba PC you choose, you'll be getting the kind of power once reserved for cumbersome desktop computers.

All of which proves you can maintain a position of great power without having to throw a lot of weight around.

Toshiba PCs are backed by the Exceptional Care program (no-cost enrollment required). See your dealer for details. IBM is a registered trademark of International Business Machines Corp. Paradox is a registered trademark of Borland Corp.



In Touch with Tomorrow  
**TOSHIBA**

Toshiba America Inc., Information Systems Division

# COMPUTEREXPO<sup>®</sup>

TEXAS #1 IBM<sup>™</sup> COMPATIBLE COMPUTER CENTER

**EXPO 286**  
**40 MB SYSTEM**  
  
**\$1497**  
 10MHZ 0 WAIT  
 APPROVED  
 • 80286 CPU FCC 12 MHZ THRUPT  
 • 512K (640K—Add \$75.00)  
 • 1.2 MB FLOPPY DRIVE  
 • 40 MB SEAGATE HARD DRIVE  
 • MONO/GRAPHICS/-  
 PARALLEL ADAPTER/CLOCK  
 CALENDAR  
 • HI-RES GREEN/AMBER  
 MONITOR  
 • AT KEYBOARD  
 • 1 YEAR WARRANTY  
 • 3 HOURS FREE TRAINING  
 NOW 80 MB SEAGATE IN STOCK

**ALR**  
**86/20**  
**386 Monochrome**  
**Systems**  
 • Intel 80386 processor 20 Mhz  
 • 1MB RAM  
 • 200 watt power supply  
 • AT 101 key enhanced keyboard  
 • 1.2 megabyte floppy disk drive  
 • Dual floppy/hard disk controller  
 • System clock/calendar & battery backup  
 • Serial/parallel port  
 • High resolution monochrome monitor  
 • Monographics printer adapter  
 (Hercules Compatible)  
 With 40 MEG Seagate Dr. \$3,095  
 With 60 MEG Seagate Dr. \$3395  
 With 80 MEG SEAGATE DR. \$3595  
 With 130 MEG DRIVE \$4095

**EXPO PORTABLE 286/10**  
**12 MHZ THRUPT**  
**\$1495**  
  
 U.S. MADE  
 • INTEL 80286/10 MHZ CPU  
 • 512K RAM (640K, Add \$75)  
 • COMPACT SIZE 9" AMBER  
 • MONOGRAPHICS 720x348 HI-RES  
 • 1.2 MB FLOPPY DRIVE  
 • 7 FULL-LONG INTERFACE CARD  
 SPACE  
 • 200 W. POWER SUPPLY (110/220V)  
 • LIGHTWEIGHT, RUGGED CHASSIS  
 • DIMENSIONS:  
 17.3"(2w)x8.2"(H)x16.9"(D)  
 • CLOCK CALENDAR  
 • WEIGHT 28 LBS.  
 • 3 HOURS FREE TRAINING  
 20 MB SYSTEM COMPLETE \$1695  
 40 MB SYSTEM COMPLETE \$1895

**EXPO PORTABLE IV**  
**286 12MHZ**  
**40MB**  
**SYSTEM**  
 0/1 WAIT  
 STATES  
**\$1975**  
  
 • 80286/12  
 • 512K RAM (1MB RAM—ADD \$195)  
 • HI-RES LCD DISPLAY  
 • 640 X 200 PIXEL (80 X 25 LINES)  
 • AUTOSELECT 110/220V  
 • FIVE EXPANSION SLOT  
 • EXTERNAL RGB/COLOR PORT  
 • DIMENSIONS 8¼(H) X 9½  
 (W) X 15¾ (D)  
 • 386 MODEL ALSO AVAILABLE

**Seagate HARD DRIVE SALE!**

**ST-225 20 MB KIT**  
 • 20 MB Hard Drive System includes  
 • Controller Cables  
 • Instructions  
**\$267**  
**ST-238 30 MB KIT**  
 • 30 MB ALL Hard Drive  
 System includes  
 • Controller Cables  
 • Instructions  
**\$320**  

**40 MB HI-SPEED**  
**ST-251**  
 • AT Drive  
 • (Controller is optional)  
**\$419**  
 • **ST-4038**  
 30 MB Drive  
 (Full Height 38 MSC.)  
**\$499**  
 • **ST-4096**  
 80 MB Drive  
 (Full Height 28 MSC.)  
**\$825**

**AST Premium/286**  
  
**\$2395**  
 10 MHZ/WAIT  
 40 MB  
 SYSTEM  
 • 1 MB RAM  
 • 1.2 MB Floppy Drive  
 • 40 MB Seagate (28 MSC) Drive  
 • Serial/Parallel/Clock  
 • 101 Enhance Keyboard  
 • MS DOS 3.2+ Basic  
 • 1 Year Nationwide Warranty  
**AST PREMIUM 386 — CALL NOW**

  
**PageMaker**  
 Version 3.0  
 Available Now!  
**\$545**  
 AUTHORIZED DEALER

  
**brother**  
**PERSONAL FAX**  
 • 4 Easy Controls  
 • PCC Approved  
 • Compatible  
 w/Group 3 Fax Machines  
 • Hands Free, non-monitored  
 operation  
 • Fine detail  
 FAX - COPIER - PHONE  
**\$985**

**MONITORS**  
 Mono TTL Amber  
 Samsung \$95  
 RGB Color (IBM  
 Compatible) \$275  
 Magnavox Multiscan  
 926x580 Res \$495  
 Mitsubishi  
 800x600 Res \$495  
 19" Monitor CALL

**MODEMS**  
 Everex 1200B Int. \$ 85  
 Anchor 1200B Int. \$ 75  
 Everex 2400B Int. \$179  
 Anchor 2400B Int. \$179  
**EVEREX EXTERNAL — CALL**  
**Practical Peripherals**  
 1200B Int. \$69

**MOUSE**  
 • Genius Mouse \$69  
 w/paint software ...  
 • Optimouse \$97  
 w/Dr Halo Paint ...

**Diamond** HANDY  
**SCANNER**  
 WITH DESKTOP SOFTWARE  
**\$249** PUBLISHING  
  
 • Compatible W/Your XT/AT or Clone  
 • 20 Sec. Printout  
 • Compatible Auto CAD  
 • Unlimited Point Sizes  
 • Support Desktop Publishing

WE SERVICE/REPAIR  
 GUARANTEED QUALITY SERVICE  
**IBM COMPAG AT&T**  
 Circle 54 on Reader Service Card

**NOVELL NETWORK**  
  
 WD STARCARD  
 ARCNET, PC SLAVE  
 On Site Installation Available.  
 4 user 8 user 12 user  
**AUTHORIZED DEALER. Come See Our Demo**

**IRWIN TAPE BACK UP**  
 10 MB XT/86 Model 110D ..... \$199  
 40 MB/286/386 Model 1450 ..... \$495  
 60 MB 286/386 Model 165D ..... \$595  

**INQUIRY LINE 713 784-0990** **TECH-SERVICE 784-7817**  
 HRS: M-F 8-6 SAT. 10-3 SUNDAY CLOSED  
**TOLL FREE ORDER ONLY 1-800-622-EXPO**

# BOOK REVIEWS

## The Armchair Universe

by A. K. Dewdney

W. H. Freeman & Co., New York: 1988, 330 pages, \$19.95 cloth, \$13.95 paper

Reviewed by Hugh Kenner

For nearly two years, a Turbo Pascal program I play with on my Zenith Z-100 has been accumulating short-cuts and speedups. It examines areas near the border of the famous Mandelbrot set and represents their detail with colored patterns. It began as a direct translation into Pascal of a program that, being in interpreted BASIC, was far too slow. The author of the BASIC program had been guided by a short algorithm in the August 1985 *Scientific American*. My copy of that issue was long ago swiped by someone, and the library copy I recently consulted had lost the article to a vandal's scissors. I was pleased to find it reprinted in this first collection of A. K. Dewdney's Computer Recreation columns.

I suspect that's not an uncommon scenario. Dewdney is very likely responsible for more filched and mutilated copies of *Scientific American* than any other current author. He has also prompted, worldwide, uncountable hours of coding time. That's because he doesn't list programs; he states some interesting theme and shows you how to think about implementing it. At the back of *The Armchair Universe* is a list of suppliers, and Dewdney's tone dissuades you from even thinking about buying such canned software—an altruistic act, given that Dewdney himself might be one of the suppliers. He'd like us all to get our feet wet and



our minds stretched by learning to program (i.e., think sequentially). He wants us to shed the chains of "software slavery," a state "inadvertently encouraged" by packagers.

This collection has something for almost everyone. If, like me, you're challenged by graphics, there are chapters

entitled "The Mandelbrot Set" and "Wallpaper for the Mind." Higher Math? Try "Golomb Rulers" or "Hyper-cubes." Artificial Intelligence? Try "RACTER," "Facebender," "Checkers," more. Life? Puzzles? Simulations? They're all here. And if your fantasies run to aliens

snuffing out benign systems, three pieces on "Core Wars" deal with plagues that propagate through memory, zapping anything they find except themselves.

### Good Medicine for Pros

The great merit of Dewdney's approach is his patient, genial concentration on how to define a project and relax and think about it. His book might even be good medicine for pros who scorn the very idea of recreational computing. Thus he cites the solution of Jon L. Bentley (Programming Pearls columnist for *Communications of the ACM*) to the problem of finding anagrams. Assume the computer has access to a dictionary (as it must, to know if what it has found is a word). The obvious way is to exhaust the permutations, checking each in the dictionary. At 120 permutations for just 5 different letters, that's slow. But here's Bentley's "Aha!" way: Sort the letters of each dictionary word in ascending order; sort the resulting list; and pair its entries with the parent words, like this:

aecrs acres  
aecrs cares  
aecrs races  
aecrs scare  
aectr cater  
aectr crate

That big but uncomplicated job once done, any anagram problem is reduced to a single-letter sort and a quick lookup. You want anagrams for *acres*? The sort is *aecrs*. The lookup finds *cares*, *races*, and *scare*. And that is all, so far as this dictionary knows.

One pleasure in *The Armchair Universe* problems is enjoying them in themselves (every day, in countless news-

*continued*

### ALSO REVIEWED

*In the Age of the Smart Machine:  
The Future of Work and Power*

*Programmer's Guide to the Hercules Graphics Cards*

*Manufacturing Intelligence*

*HyperCard Power*

NOTHING BEATS  
MADE IN THE  
U.S.A.

AND GTEK®, INC.  
MAKES IT THE  
BEST!



**NEW!**

**ROMX-2XL EPROM EMULATOR**

GTEK's® New ROMX-2XL Eprom Emulator surpasses any other product of its kind on the market today! The ROMX-2XL emulates 2716-27010 eproms and comes with communications software for PC/XT/AT type computers, plus supports 16 and 32 bit systems. So, if you want to save unnecessary programming hours and frustration, GTEK's® ROMX-2XL Eprom Emulator is just what you've been waiting for!



**MODEL 9000 EPROM PROGRAMMER**

If speed is what you want, GTEK's® Model 9000 Eprom Programmer will never let you down. This product has been proclaimed the **fastest** programmer on the market. What's more, its quick pulse and intelligent programming algorithms give you **SUPER FAST** speed, and you can program the chip of your choice, including MPUs and megabit parts.



**PCSS-8X MULTIPOINT SERIAL BOARD**

The PCSS-8X Multipoint Serial Board, brought to you by GTEK®, Inc., is definitely a programmer's dream come true! This board has 100% DOS compatibility on all 8 ports and an enhanced interrupt driven device driver. The PCSS-8X is available in RS232, RS422 8 port and 4 port versions.

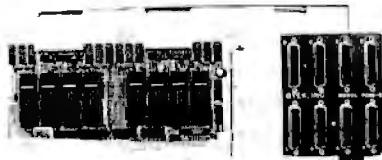

GTEK®, Inc. manufactures other programming devices and has a full line of development tools available. The line includes **eprom erasers, cross assemblers, logic programmers, emulators and simulators**. So, if you want "MADE IN THE U.S.A." give us a call today and let us put these products to work for YOU!



Development Hardware & Software  
P. O. Box 2310  
Bay St. Louis, MS 39521-2310

Order Toll Free 1-800-255-GTEK (4835)  
Fax: 1-601-467-0935 Telex 315814 (GTEK UD)  
MS & Technical Support 1-601-467-8048

PC/XT/AT is a Registered Trademark of IBM Corp.

papers, anagrams entrance the players of a game called Jumbles), and another is the light they can throw on deeper problems. A story I especially enjoy has Dewdney in a quarry marveling at a fossil trilobite, when a man named Smith, a professor of paleontology, happens by. Why, Dewdney asks him, did the trilobites become extinct? Why, Smith rejoins, is the name *Smith* so common? Those turn out to be the forms of the same question, and they prompt two related algorithms—PALEOTREE, in which genera and species survive, mutate, or die out; and NEOTREE, in which families (and their names) become extinct, leaving space for Smiths to flourish in. The chief difference is that NEOTREE has no parallel for new species evolving. (Though what about Smythe from Smith? In fine-tuning that program, I'd insert a Vanity Factor.)

Start with 1000 family names, and, by NEOTREE's showing, in about 23 generations three-quarters of them will be extinct. That's because it's the males who carry on the name, and the empirical probability is 0.317 that a family will produce no males destined to marry. Half the families are gone in some 3 generations, two-thirds in about 10. Thereafter, attrition slows down. Will the number ever shrink to 1? Perhaps in Googleplex years (that's 10 to the 10th to the 100th). Or more likely not. If Smiths are a tenacious tribe, so are Joneses.

Then there's the Voting Simulation dreamed up by two Britons. We start with a grid of randomly colored squares—say, blue for Republican, red for Democrat. We next assume that opinions follow those of forceful neighbors. Select a voter at random; select one of his eight neighbors at random; change his persuasion to that of the neighbor. Silently and rapidly, this simulates a lot of argument, a lot of malleability, and strange things happen. (Voters near an

edge of the grid still have eight neighbors because left wraps to join right, top to join bottom. Yes, that does make the country toroidal. I have a feeling this game could be implemented on a spreadsheet.)

"First, large blocks of votes develop within the grid. The blocks are geographic areas where everyone has the same opinion." (Recall FDR's old Solid South.) "Then the blocks migrate around the grid, and for a while two blocks struggle for dominance. Finally, the two-party system collapses as everyone ends up voting the same way. The smaller block vanishes as democracy votes itself out of existence—or does it? This is a neat philosophical question."

Dewdney hastens to remark that as a model of the political process, this is "admittedly simplistic." He also reports that even so simple a model leaves democracy looking pretty tough. Some readers reported that after an overnight run, considerable difference of opinion lingered. In Dewdney's own experience, achieving unanimity takes "the better part of a day": many million acts of random persuasion. (And what happens, he asks, if each beset voter crankily adopts an opinion the *opposite* of that random neighbor's? He doesn't tell, and I haven't tried it.)

**Simulation vs. Reality**

Many of Dewdney's chapters conjure up the besetting devil of Computer Simulations: Do I really gain insight into real-world events, or am I just amusing myself with a model so neat I can see how to program it? The chapter entitled "Sharks and Fish on the Planet Wa-Tor" is a good example. Fish die of being eaten by sharks; sharks die if they haven't eaten recently enough. Both have single offspring at fixed intervals (it works best when the sharks breed more slowly). Both move at random, point to point, north, south, east, west, with this complica-

*continued*



**dBASE III PLUS DEVELOPERS!**

# Cut loose from the LAN tangle with SCO XENIX and SCO FoxBASE+!

With industry-standard SCO™ XENIX® System V and SCO FoxBASE+™, you'll enjoy a *real* multiuser system that runs your existing dBASE III PLUS® code faster, easier, more reliably—and at half the cost!

**Greater Performance.** With only a single PC and none of the traffic overhead required by a LAN server, The SCO Solution is lean and fast. Users share SCO FoxBASE+, applications, and data files via inexpensive terminals—all with greater performance.

**Greater Profitability.** The SCO Solution gives you more for your money for greater profitability. An 8-user SCO XENIX system costs about half as much as an 8-user LAN—and adding each new user costs two-thirds less!

**Greater Reliability.** Because an SCO XENIX system is more reliable than a LAN, you'll spend less time solving LAN problems and more time creating SCO XENIX-based solutions.

**Easier to Administer.** SCO XENIX systems can be easily administered by end users. LANs are much more complicated—multiple PCs, multiple PC configurations, and multiple sources of failure.

**Enhanced dBASE III PLUS Functionality.** SCO FoxBASE+ works just like dBASE III PLUS, only better. It reads and writes the same data files, and runs your source code at compiled speed—without having to compile—for a shorter development cycle.

**Future Compatibility.** An SCO XENIX system protects your investment because future compatibility is built in.

By migrating your dBASE III PLUS applications to The SCO Solution, you can cut your costs and increase your profits—both today and tomorrow.

So cut loose from LANs and relax with a *real* multiuser solution — The SCO Solution—SCO XENIX and SCO FoxBASE+!

SCO FoxBASE+ is also available for larger UNIX® systems, and FoxBASE+ is available for DOS systems.



Relax with  
The SCO Solution



(800) 626-UNIX (626-8649)  
(408) 425-7222  
FAX: (408) 458-4227  
TWX: 910-598-4510 SCO SACZ  
uucp: ...decvax!microsoft!sco!info

Circle 211 on Reader Service Card

SCO XENIX System V and the SCO XENIX family of software solutions are available for all industry standard 80286- and 80386-based computers, and the IBM® Personal System/2™ Models 50, 60 and 80.

SCO and the SCO logo are trademarks of The Santa Cruz Operation, Inc. IBM is a registered trademark and Personal System/2 is a trademark of International Business Machines Corporation. dBASE III PLUS is a registered trademark of Ashton-Tate. XENIX is a registered trademark of Microsoft Corporation. FoxBASE+ is a trademark of Fox Software, Inc. UNIX is a registered trademark of AT&T.

©1988 The Santa Cruz Operation, Inc., 400 Encinal Street, P.O. Box 1900, Santa Cruz, CA U.S.A. 95061

The Santa Cruz Operation Ltd., P.O. Box 41YN, 18 Noel Street, London W1A 4YN United Kingdom, +44 1 439 2911, (FAX): +44 1 637 9381, TELEX: 917372 SCO LON

## How to get through traps with

# Quaid Analyzer

**Quaid Analyzer** is a powerful diagnostic tool that shows what is going on inside your computer. Since we developed **Quaid Analyzer** to unravel copy-protection, we had to include ways of tracing in spite of the countermeasures used to block us. Some common ones are:

*Overwrite the vector for interrupt 3, so you can't use breakpoints.* **Quaid Analyzer** can use any of the other 255 vectors for breakpoints instead.

*Overwrite the vector for interrupt 1, so you can't single step.* **Quaid Analyzer** scrupulously saves and restores interrupt cells when changing them. You won't notice changes to vector 1 except at the one instruction doing the change. Step over it with another command.

*Checksum the program to detect breakpoints.* **Quaid Analyzer** can report every interrupt call. Since DOS programs have to call interrupts for all system services, you get control frequently, and at revealing places. Single stepping is unaffected by checksums.

*Manipulate the t flag to stop single stepping.* Just avoid the single step key for one instruction. **Quaid Analyzer** has two ways to step over a few instructions.

*Point the stack over the interrupt vectors.* Just ask **Quaid Analyzer** to catch the next system service call interrupt. The program will have to fix everything first.

Of course, your own program probably doesn't have any tricks to block tracing. With a tool as powerful as **Quaid Analyzer**, it should be a simple matter to diagnose it.

**Quaid Analyzer** comes with a manual, and software on a 3 inch and a 5 inch diskette. If you are not satisfied with **Quaid Analyzer**, you can return it within 30 days for a refund. **Quaid Analyzer** is not sold by dealers in the United States or Canada. It is not copy-protected.

To order **Quaid Analyzer**, call us with your credit card, or send us a check for \$200 US funds. We ship within a day at our expense.

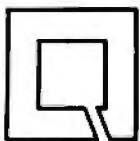

Quaid Software Limited  
Third Floor Dept B630  
45 Charles Street East  
Toronto Ontario Canada M5Y 1S2  
(416) 961-8243

**Warning!** For advanced programmers only.

tion: A shark will always move to (and eat) an adjacent fish when there is one.

I haven't tried this one, either, though the programming looks simple. What Dewdney reports is scenarios sensitive to geometry. Neither the initial distribution nor the actual movement seems important, but when a tight school of fish forms, then the sharks discover and destroy it, then die themselves for lack of food. Result: zero population of any kind. (Though sometimes a smaller school of fish, elsewhere on the screen, would go unnoticed until the sharks were extinct. Result: an ocean crammed with fish.)

An evident simplifying assumption is that nothing ever happens to fish, save getting eaten by sharks. Still, the game exhibits cyclic ups and downs that resemble the fluctuating numbers of predators and prey in situations that have been tabulated, as when Hudson's Bay Company counted a whole half-century's lynxes and hares. A lot of hares fed a lot of lynxes; then as hares drew near extinction lynxes died off, too, permitting a resurgent hare population. . . You see the pattern.

A graph of some very smooth things called the Lotke-Volterra equations looks rather similar, and they've been invoked to model predator-prey fluctuations. But by Dewdney's report, graphs derived from the *Water* game look more like the Hudson's Bay data than Lotke-Volterra curves do. He's puzzled, though, by certain long-term instabilities. I'll leave it at that. Computer modeling still awaits its Leibniz.

## BRIEFLY NOTED

**In the Age of the Smart Machine: The Future of Work and Power** by Shoshana Zuboff, *Basic Books, New York, 1988, 468 pages, \$19.95.* The television introduced to entertain may end up

shaping the very schedule of our days. The microwave bought for convenience may change the type of meals we eat. Thus, examining a technology only in light of its original intentions may obscure the actual effects. Such is the case with computers: They are installed in order to increase productivity, but, in fact, they fundamentally alter the work environment. Shoshana Zuboff takes a long, careful look at what happens to the workplace when computers are introduced.

Zuboff has two basic ways of looking. First, she uses her eight in-depth studies (1981 to 1986) of companies that had recently made the transition to computerization. Second, she puts observations about the current work environment in light of a history of work informed by her wide readings in philosophy, psychology, and sociology.

Zuboff takes the body as the focal point of her history of work. At first, work was physical labor that required bodily effort and bodily skills. As work has developed—or at least changed—throughout the centuries, it has been distributed, and the types of knowledge necessary have changed. (Zuboff's analysis of knowledge develops from her description of the different ways one's body inhabits one's environment, rather than beginning from an assumption that mind and body are fundamentally apart. This approach proves fruitful, in line with the work of the French phenomenologist Maurice Merleau-Ponty.)

Zuboff looks to her case studies to find the state of work today. Her findings are not surprising. For example, at a pulp mill where workers went from checking on the pulping process by sticking their hands into the vats to checking a digital readout on a computer console, the workers have traded bodily involvement and skillful knowledge for a more abstract relationship with their

*continued*

Order Status,  
 Technical & Other  
 Info. (602) 246-2222  
 FAX # (602) 246-7805  
 Call for programs not listed



No Charge for  
 MasterCard or Visa



**MICROSOFT PC Excel  
 SPECIAL \$279**

**TOLL-FREE ORDER LINE 1-800-421-3135**

**NOW AVAILABLE**  
**MICROSOFT MACH20 ..... \$309**  
**MICROSOFT WINDOWS 386 ..... \$110**  
**FREE SOFTWARE!**

Purchase over \$100 and receive one of these disks absolutely FREE! Purchases over \$250 get two free disks, over \$400 get three, or get all four disks when your purchase is over \$500! 1) MACH20 2) PC WRITE FONT SET 3) ABC LIST

**- SOFTWARE -**

**Accounting**

DacEasy Acct. ....	\$54
DacEasy Light .....	20
DacEasy Payroll .....	
Dollars & Sense .....	
In House Acct. ....	
Managing Your Inv .....	

**Communication Programs**

Brooklyn Bridge Universal .....	\$7
Carbon Copy Plus .....	10
Crosstalk XVI .....	89
Crosstalk MK4 .....	110
Flying Dutchman .....	64
PC Anywhere III .....	96

**Databases**

Clipper .....	\$370
Condor 3 .....	325
DataPerfect .....	Low Price
DBase III Plus .....	375
DB-XL Diama .....	115
Fox Base Plus .....	189
Genifer .....	189
Paradox 2.0 Plus .....	435
PFS: Pro File .....	139
Powerbase .....	169
Q&A 3.0 .....	22
QuickSilve .....	329
Revealer .....	485
R Base Fc .....	425
Reflex .....	90
Relate .....	112
VP Info .....	65

**Desktop Publishing**

Pagemaker Ver. 3.0 .....	\$549
PFS: First Publisher .....	55
Ventura Publisher .....	493

**Graphics**

Boeing Graphics .....	\$201
Chartmaster .....	191
Design Cad 2D & 3D .....	141
Diagram Master .....	101
Easy Cad .....	
Generic Cad .....	
In-A-Vision .....	
Microsoft Cf .....	
Newsroom F .....	
Printshop .....	

**II**

Ability Plus .....	\$145
Enable .....	352
Microsoft Works .....	116
PFS 1st Choice .....	79
Smart System .....	490
Symphony .....	

**Languages**

Lattice C Compiler .....	\$220
Microsoft C Compiler Ver. 5.0 .....	260
Microsoft Fortran Ver. 4.1 .....	260
Microsoft Macro Assembler 5.1 .....	RR

**Languages**

Microsoft Pascal .....	\$170
Microsoft Quick Ba .....	59
Microsoft Quick C .....	59
Ryan McFarlan For .....	390
Ryan McFarlan Col .....	612
Turbo Basic .....	50
Turbo C 1.5 .....	
Turbo Pasca .....	
Turbo Prolog .....	

**Multi-User Software**

Fox Base + .....	\$299
Microsoft Wo .....	195
'Word Perfect .....	310
MindPerfect .....	ea 75

**Project**

Microsoft Project .....	\$305
Super Project Plus .....	255
Timeline 2.0 .....	265
Total Havard .....	

**Spreadsheet**

Lotus 1-2-3 .....	\$295
Microsoft PC Excel .....	271
Quattro .....	143
Surpass .....	321
Twin .....	31
VP Planner Plus .....	81

**Utilities**

Core Fast .....	Low Prices
Copy II PC .....	\$19
Copywrite .....	20
Cubit .....	
Deskvi .....	
Direct .....	
Eureka .....	
Fastba .....	
Formtool .....	
Graph in .....	
Mace .....	
Microsoft Wind .....	
Norton Advant .....	
Norton Utilities .....	
PC Tools Delux .....	
Prokey 4.0 .....	70
Q DOS II .....	49
Rightwriter .....	75
Sidekick Plus .....	115
Sideways .....	20
Sqz Plus .....	55
Superkey .....	55
Lightening .....	79
XTree .....	35

**Word Processing**

Microsoft Word 4.0 .....	\$185
Multimate Advantage II .....	259
Q and A Write .....	110
Webster Spellcheck .....	37
Word Perfect Ver. 5.0 .....	204
Word Perfect Executive .....	106
Word Perfect Library 2.0 .....	65
Wordstar Pro .....	233
Wordstar 2000+ Personal Ed .....	104

**- HARDWARE -**

**Accessories**

Copy II PC Deluxe .....	\$101
Curtis Ruby .....	59
Logical Connectio .....	379
Mach III Joystick .....	20
Masterpiece .....	
Masterpiece + .....	
50 Watt Power .....	

**Boards**

AST .....	
Advantage Premium .....	\$319
Rampage 286 .....	379
Sixpac Plus w/64K .....	129
EVEREX .....	70
2MB Above PC/XT w/o Mem .....	
3MB Above AT w/o Mem .....	89
HERCULES .....	
Graphics Plus .....	179
INTEL .....	
Above PC 64K .....	225
Above 286 w/5 .....	379
Orchid Tiny Tur .....	289

**COMPUTERS**

**AZ 386**

80386-16 Micro Processor, 1 MB of Ram, Teac 1.2 MB disk drive, 220 watt power supply, 6 layer mother board, RT keyboard ..... \$2595

**AZ Turbo 286**

512K, 6 & 10 MHZ, keyboard, 200 watt power supply, one 1.2 teac drive, Phoenix Bios ..... \$999

**AZ Turbo 8088-2**

135 watt power supply, One 360K drive, 640K, keyboard ..... \$569

**AZ 10**

150 watt power supply, dual 360K drive, 10 MHZ mother board, 340K, keyboard ..... \$589

**AST 286 Premium or 386 Premium Computers**

512K, RAM, RT enhanced style keyboard, parallel, serial and clock, 1.2MB floppy disk drive, 7 expansion slots, DOS 3.3 & Basic Available Now ..... Best Prices

**EGA Boards**

ATI Ega Wonders .....	\$175
Genoa Hi-Res .....	186
Orchid Designer .....	259
Paradise Auto 480 .....	148
Paradise VGA Plus .....	
Paradise VGA Prof. ....	
Vena VGA .....	

Casper .....	\$410
Princeton Ultra Scai .....	539
Mitsubishi Diamond .....	499
NEC - Multisync II .....	222
Zenith 14" Flat Scree .....	

**Hard Cards**

Plus 20 MB .....	\$529
Plus 40 MB .....	650

**Hard Drives**

Seagate 20 MB w/cont .....	\$265
Seagate 30 MB w/cont .....	295
Seagate 40 MB AT 251-2 .....	399
Seagate 80 MB AT .....	659
Seagate ST-125 w/ .....	329
Seagate ST-138 w/ .....	391

**Modems**

AZ 300/1200 w/o Soft .....	\$69
Everex 300/1200 w/ Soft .....	60
Everex 2400 INT .....	
Hayes 1200 EXT w/o soft .....	
Hayes 1200B INT w/ Soft .....	
Hayes 2400 EXT w/o Soft .....	
Novation Parrot 1200 w/Sc .....	
US Robotics 2400 w/Sc .....	

**Mice**

Genius .....	\$49
Logitech .....	68
Microsoft Bus w/Paintbrush .....	92
Microsoft Serial .....	92
Optimouse w/Dr Halo .....	89
Optimouse w/DPE .....	185

**Monitors**

AMDEK 410 Amber .....	\$145
MAGNAVOX .....	
RGB .....	255
NEC .....	
GS Amber .....	190
SAMSUNG .....	
Flat Amber .....	82
TTL Amber w/tilt .....	76
Color w/tilt .....	249

**Printers**

CITIZEN .....	
MSP 40 .....	\$285
120 D .....	146
MSP50 .....	385
EPSON .....	
LQ500 .....	349
LQ850 .....	559
NEC .....	
P5XLP .....	869
P5200 .....	539
P2200 .....	339
LASSERS .....	
NEC 890 .....	3300
AST TURBO PS .....	3199
OKIDATA LASSERLINE 6 .....	1299
OKIDATA .....	
OKI 390 .....	
OKI 391 .....	
STAR MIC .....	
NX 1000 .....	
NX 1000 C .....	



**TOLL-FREE ORDER LINE 1-800-421-3135**  
**WAREHOUSE DATA PRODUCTS**  
 2701 West Glendale Ave. • Phoenix, AZ 85051  
 We do not guarantee compatibility

Servicing our PC buyers with low pricing and technical experience since 1979.

Phone Hours:  
 Monday thru Friday 7am-9pm.  
 Saturday 9am-5pm MST.

Computer of the Year.

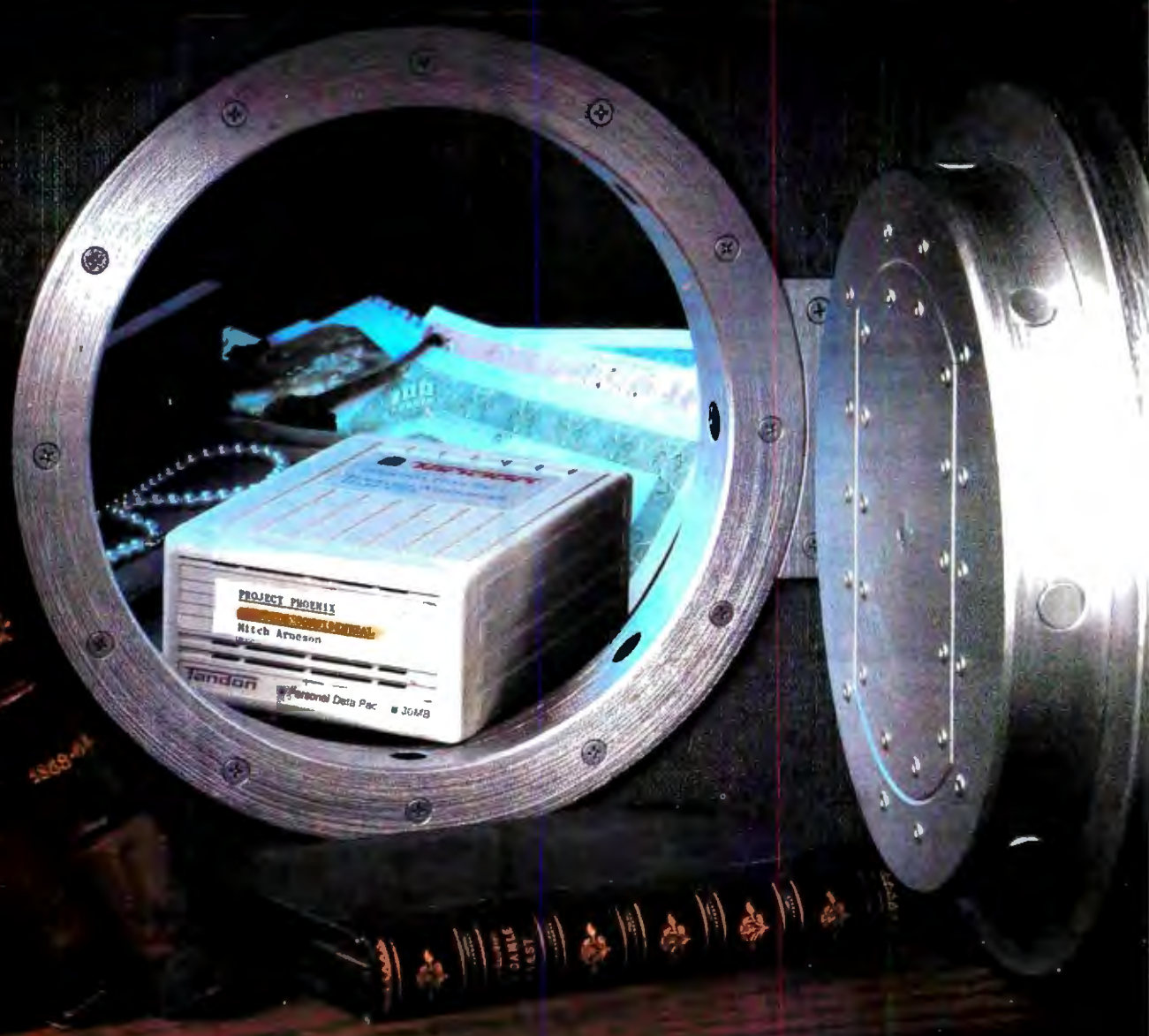



# “Secure.”

**si•kūr,** a. [L. securus]: *The ability to keep your confidential data and your whole personal computing environment away from prying eyes and meddling associates.*

Securing your personal computer files has, until now, been a complicated and mostly unreliable matter. Not any more.

The Tandon Personal Data Pac is the world's first truly removable, self-contained Winchester hard disk drive that pops in and out of its receptacle with the stroke of a key. You just lock the Personal Data Pac with your entire computing environment in your desk or your safe.

And when your business keeps you on the move, the Tandon Personal Data Pac lets you take your office with you. It fits easily in your briefcase or your garment bag. If the airlines lose it, don't



a hearty little traveller that can take a lot of abuse. It can cope with the rough and tumble world of the postal system, as well as take an occasional knock off your



desk. Your precious programs and data remain cradled inside. Safe, secure, and ready to use.

The Tandon Personal Data Pac shatters the storage limitations of your personal computer. When your first high-capacity Data Pac is full, pop in a fresh one and you're ready to go on. Infinitely.

If you need to share your PC, software and data, the Tandon Personal Data Pac offers the safest, cheapest and most reliable "network" possible for

transferring high-capacity files quickly and easily. And, you can make any computer your personal dedicated workstation, simply inserting your own Data

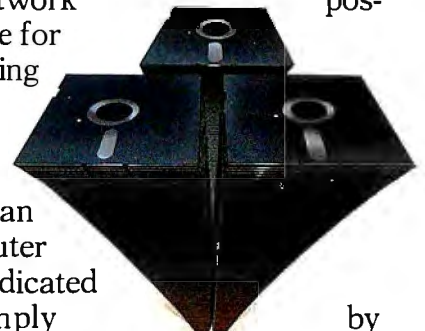

Let your Tandon Dealer show you how the Personal Data Pac can make living with your PC more economical and productive. See him today, or call us at 1-800-556-1234, Ext. 171 (in California 1-800-441-2345, Ext. 171). Security for a small price.



## Tandon

*We're redefining personal computing.*



**Finally! A Keyboard Protector That:**

- **PROTECTS CONTINUOUSLY - 24 HOURS A DAY** - Against computer downtime due to liquid spills, dust, ashes, staples, paper clips and other environmental hazards.
- **REMAINS IN PLACE** during the operation of your keyboard. SafeSkin is precision molded to fit each key - like a "second skin."
- **EXCELLENT FEEL** - The unique design eliminates any interference between adjacent keys, allowing smooth natural operation of your keyboard.
- **SafeSkin IS VIRTUALLY TRANSPARENT** - Keytops and side markings are clearly visible. In fact, SafeSkin is so clear, sometimes you may not know it's there!
- **DURABLE - LONG LASTING** - SafeSkin is not a "throw-away" item. Many of our protectors have lasted over 3 years under continuous daily use, without failure.

SafeSkin is available for most popular PC's and portables including: **IBM, APPLE, AT&T, COMPAQ, DEC, EPSON, KEYTRONICS, NEC, TANDY, TOSHIBA, WANG, WYSE, ZENITH.** Specify computer make and model. Send \$29.95, Check or M.O., VISA & MC include exp. date. Dealer inquiries invited. Free brochure available.

**Merritt Computer Products, Inc.**

4561 S. Westmoreland / Dallas, Texas 75237 / 214/339-0753

**MAXIT** increases your DOS addressable conventional memory beyond 640K

- Add up to 256K above 640K for programs like FOXBASE+ and PC/FOCUS.
- Short card works in the IBM PC, XT, AT, and compatibles.
- Top off a 512KB AT's memory to 640K and add another 128K beyond that.
- Run resident programs like Sidekick above 640K.
- Compatible with EGA, Network, and other memory cards.
- Add up to 96K above 640K to all programs.

Break through the 640 barrier. MAXIT increases your PC's available memory by making use of the vacant unused address space between 640K and 1 megabyte. (See illustrations)

Extend the productive life of your, IBM PC, XT, AT or compatible. The MAXIT 256K memory card and software works automatically. If you have questions, our customer support people will answer them, fast.

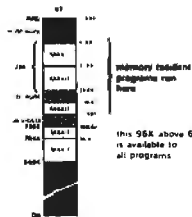

XT class machine (8088) w/640K and a CGA Color Monitor or a Compaq Type Dual Mode Display

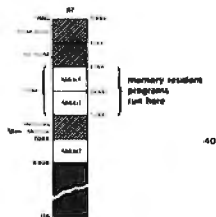

AT class machine (80286) w/640K and a Mono HERC Monitor

Order toll free 1-800-227-0900. MAXIT is just \$245 plus \$4 shipping, and applicable state sales tax. Buy MAXIT today and solve your PC's memory crisis. Outside the U.S.A. call 1-415-548-2085. We accept VISA, MC, American Express

MAXIT is a trademark of Osborne McGraw-Hill. IBM is a registered trademark of International Business Machines Corporation; Sidekick is a registered trademark of Borland International, Inc.; FOXBASE is a trademark of Fox Software; Hercules is a trademark of Hercules Computer Technology, Inc.; XT and AT are registered trademarks of International Business Machines Corporation; Compaq is a registered trademark of Compaq Computer Corporation.

work. Zuboff discovers that this has resulted in a certain amount of alienation. More interesting, she describes what happens to social relationships and work flow when employees are moved into cubicles to go one-on-one with a CRT.

Even when the results are not surprising, and even when the case study accounts go on too long, Zuboff keeps it interesting by putting the results into a larger historical and philosophical context. (She does, however, tend to suffer from the Academic Syndrome: She uses lots of jargon—"textualization" and "automaticity"—and discusses many marginally relevant authors.)

The second part of the book moves from the question of knowledge to that of power. Zuboff maintains that computerization changes the type and justification of managerial authority. Originally, a boss got the right to lord it over people because he or she was the owner. Then bosses received their legitimacy by virtue of having worked their way up the ladder. Now, bosses (or managers) have authority by dint of their mastery of the Science of Management.

Part Three discusses the techniques that "can shape and control behavior and so can be harnessed to the interests of those who employ them"—the techniques by which authority maintains itself in the computer-laden workplace. Frequently, computerization leads to increasingly centralized control, usually accomplished by centralizing knowledge (i.e., managers become information hogs). Yet Zuboff reports that several years after the transition, some companies were recognizing "the need for critical judgment at the information interface" and the value of "intellective skills" in analyzing and responding to digital information.

But the chief technique of control is "the information panopticon"—the omniscient, objective computerized

record of all that occurs in the workplace or plant. Zuboff is particularly good at disclosing what life under that unceasing eye is like for both workers and managers.

At the end, Zuboff offers a brief view of a nonhierarchical organization that more uniformly distributes knowledge and skill. She also includes a section entitled "Dissent from Wholeness," which describes the disadvantages of this seemingly more egalitarian environment: a loss of sense of definition, rights, and autonomy.

At times tendentious, at times based on too few examples, at times too long, *In the Age of the Smart Machine* remains an important work.

—David Weinberger

**Programmer's Guide to the Hercules Graphics Cards** by David B. Doty, Addison-Wesley, Reading, MA: 1988, 370 pages, \$24.95. This book delivers a comprehensive treatment of Hercules graphics cards. It is occasionally marred by a bit of hype and homage to Hercules Computer Technology, but it overcomes this with clear explanations of the architecture of each card, many solid programming examples, and some knowing advice on the design of graphics software. David B. Doty describes the original Hercules graphics card, the later RamFont card, and the latest InColor card in detail.

Because the Hercules cards are programmed without using the PC ROMBIOS, writing programs for them is decidedly different than programming for other IBM graphics adapters. Doty wrote his programming examples in Microsoft Assembler and Microsoft C, but the assembly language functions can be readily changed to work with the stack frame conventions of another compiler. The functions include detecting a Hercules adapter and its type, writing a dot, reading a dot, drawing a line, displaying text, drawing circles, filling a

*continued*

# SC Systems

# 1-800-669-9933

Serving Computer Buyers For  
Eight Years

Para Asistirle En Espanol  
Llame Al Tel 1-800-842-1777

**InComm**  
1200B Int Modem

**\$62**

w/Software

**Samsung**  
14" RGB Monitor

**\$215**

640 x 230  
.51 Dot Pitch

**Color'**  
Graphics Card

**\$44**

Parallel Printer Port

## HARDWARE

## SOFTWARE

### ACCESSORIES

CopyIIPC Brd Deluxe..... \$ 99  
Masterpiece+ ..... 95

### COMPUTERS

NEC  
Multispeed .....\$1429  
Multispeed EL II ..... 1525  
Toshiba  
T-1100 S/Twist..... 1455  
T-3100/20..... 3140

### BOARDS

AST Adv Prem 1mb ..... \$ 419  
AST 6Pac Prem 1mb ..... 525  
AST Sixpac..... 115  
Hercules Grph + ..... 182  
Intel Above 286..... Call

### EGA BOARDS

ATI EGAWonder ..... \$ 175  
Genoa SuperHiRes+ ..... 195  
Orchid Designer..... 272  
Paradise 480..... 155  
Paradise VGA +XT ..... 259  
Paradise VGA Prof ..... 385  
Vega VGA ..... 269

### EGA MONITORS

Princeton U/Sync ..... \$ 519  
NEC Multisync 2..... 599  
Samsung..... 359

### HARD DRIVES

Seagate 125 w/cont..... \$ 321  
Seagate 138 w/cont..... 411  
Seagate 30MB w/cont ..... 294  
Seagate 20MB w/cont ..... 269

### KEYBOARDS

Keytronics 5151..... \$ 127  
Keytronics 5153 ..... 161

### MICE

Logitech ..... \$ 68  
MSBus Mouse ..... 99  
Optimouse w/DrHalo ..... 92

### MODEMS

Hayes 1200 ..... \$ Call  
Hayes 1200B..... Call  
Incomm RPC1200 ..... 62  
Incomm RPC2400 ..... 147  
Incomm T1200 ..... 76  
Incomm T2400 ..... 167  
Incomm T2400EC..... 224

### MONITORS

Amdek 410 ..... \$ 145  
Princeton MAX15..... Call  
Samsung RGB ..... 215  
Samsung Amber..... 82

### 3COM

3C501 ELink ..... \$ 356  
3C503 ELink II..... 345  
3C523 ELink/MC ..... 432

### PRINTERS

Citizen  
120D ..... \$ Call  
180D..... 199  
MSP-15E..... 319  
MSP-40..... 285

### C.Itoh

ProWriter C715 ..... 925  
ProWriter Jr.+ ..... 255  
StarWriter D10 ..... 754

### NEC

P5XLP ..... 819  
P2200 ..... 335

### Okidata

Call on all models.

### Panasonic

1080I/M2 ..... 179  
1091I/M2 ..... 199  
1092I ..... Call

### Star

NX-1000 ..... 179  
NX-1000 Color ..... Call  
NX-15 ..... Call

### Toshiba

321SL ..... 500  
341SL ..... 674  
351SX ..... 1005

### ACCOUNTING

DacEasy ..... \$ 54  
Dollars & Sense ..... 95  
Managing Your \$..... 119

### COMMUNICATION

Carbon Copy Plus ..... \$ 106  
CrossTalk XVI ..... 89  
CrossTalk 4 ..... 115  
PC Anywhere ..... 57  
SmartCom II ..... 82

### DATABASE

Clipper..... \$ 370  
Data Perfect..... 255  
DBase III ..... 379  
DBXL Diamond ..... 109  
Fox Base + ..... 190  
Paradox 2.0 ..... Call  
Q and A..... 188  
Relate & Report ..... 100

### DESKTOP PUBLISHERS

Pagemaker ..... \$ Call  
PFS First Pub ..... 55  
Ventura..... 495

### GRAPHICS

Chartmaster ..... \$ 199  
Generic Cad 3.0..... 51  
Printshop ..... 33  
Scanmaster ..... Call

### INTEGRATED

Ability Plus..... \$ 139  
FirstChoice ..... 79

### LANGUAGES

MS QuickBasic ..... \$ 60  
MS Quick C ..... 60  
Turbo Basic ..... 59  
Turbo C..... 59  
Turbo Prolog ..... 59

### SPREADSHEETS

Lotus 123 ..... \$ Call  
Plan Perfect ..... 192  
Quattro ..... 150  
Surpass ..... 329

### UTILITIES

CopyIIPC ..... \$ 18  
Desqview ..... 71  
Duet ..... 48  
Fastback Plus ..... 88  
Formtool ..... 52  
Mace ..... 48  
Norton Advanced ..... 72  
PC Tools Deluxe..... 36  
Sidekick Plus..... 119  
Sideways Print ..... 39

### WORD PROCESSING

Word Perfect 5.0 ..... \$ 219  
Wordstar ProPack ..... Call  
Wordstar 2000 ..... Call



No Charge for  
Mastercard or Visa



**Call For Items Not Listed**

**SC Systems**

3000 Mariposa Hwy. Ste. B, Nogales, AZ 85621

Order Line 800-669-9933

Espanol 800-842-1777

Status Line 602-275-1395

FAX No. 602-273-0043

Order Line for Europe & Mexico 602-287-5347

**TERMS:** No charge for Visa or Mastercard. We do not charge your card UNTIL WE SHIP your order. Manufacturers warranty applies in all cases, all warranties are handled by the manufacturers. We accept Purchase Orders from authorized companies only, for 3.5% above cash price. No COD orders. No refund on opened software. All prices are subject to change. Allow 14 days for personal/company checks. Arizona orders add 6.7% tax. We do not guarantee Compatibility.

MODULA 2  
FOR MOTOROLA 68K FAMILY

**INTEGRATED  
DEVELOPMENT AND SYSTEM-SOFTWARE**

**M C D S**  
MODULA2-CROSS-DEVELOPMENT-SYSTEM

Compiler/Linker ● Interactive Real-Time-Cross-Debugger  
M2-compatible Cross-Assembler ● Host Systems ▶  
IBM PC + Compatibles ▶ Macintosh ▶ soon ▶ UNIX ▶ VAX VMS

---

**R T D S**  
REAL-TIME-DISTRIBUTED-SYSTEMKERNEL

Interprocess Communication: local and internode ● Messages and Mailbox  
Time- and Event-Handling ● Device-Driver Features

---

**H I F S**  
HIERARCHICAL-FILE-SYSTEM

Easy adaptable to your hardware  
RTDS-Interface

Development- and System-  
Software  
Prozess-Informatik  
Development in MODULA2 ADA C



HIWARE AG  
Gundeldingerstr. 432  
CH-4053 Basel  
Tel. 061/50 71 51 BRD:004161

closed shape, printing a screen, and saving and restoring an image to and from a file. The source code contained in the book is available directly from the author for \$30.

Today, Microsoft's C 5.0 and Borland's Turbo Pascal 4.0 provide comprehensive support for the original Hercules card, but Doty's book provides thorough background information, even for users of these languages. Whether the RamFont and In-Color cards will succeed in the market as well as the original is still unclear, but for someone who needs to program for either, the book is essential.

—Ben Myers

**Manufacturing Intelligence** by Paul Kenneth Wright and David Alan Bourne, Addison-Wesley, Reading, MA: 1988, 352 pages, \$40.95. This book is not only an excellent text for the engineer learning about factory automation, but it also serves as a good basis for an engineer about to specify an automation project. The authors ask all the necessary questions to determine what an automation project should accomplish. Written for the manufacturing engineer as well as the software engineer, *Manufacturing Intelligence* provides enough knowledge so that each can understand the mechanical and computational tasks required in factory automation.

The book is divided into four sections. The first describes the present and immediate future state of the machine tool industry. It also highlights one of the author's developments, Cell Management Language (CML), a software environment offering a high-level solution for controlling a number of incompatible machine tools and robots.

The second section goes over the different parts needed for intelligent machines to function. These include vision, machine control, and manipulators. The third section looks at how the knowl-

edge and talent of a skilled craftsman can be transferred to an intelligent machine. Included here are examinations of artificial intelligence, flexible fixtures, and sensor technology. The last section of the book speculates on the future of manufacturing technology.

The book offers both a glossary and a good bibliography. The chapters are well cited, so readers can pursue any issue that is presented.

—Keith H. Erskine

**HyperCard Power** by Carol Kaehler, Addison-Wesley, Reading, MA: 1988, 435 pages, \$17.96. This book is a review of the widely acclaimed Macintosh program for the novice and entry-level HyperCardian. Copiously illustrated, it has great breadth of subject matter, but little depth. Carol Kaehler devotes only paragraphs to concepts such as passing messages to the next handler, yet she supplies practical and indexed hints. For instance, she explains how to make sure a card inherits the correct background—not a trivial task in some situations. She provides utility scripts in one chapter, but leaves the reader to extend them.

The book covers some of the HyperTalk language at the introductory level in one brief appendix. *HyperCard Power* is at its best when it shows simply and step by step how to accomplish unified HyperCard tasks.—Larry Loeb ■

#### CONTRIBUTORS

Critic and author **Hugh Kenner** lives in Baltimore, Maryland. **David Weinberger** works for Interleaf and lives in Brookline, Massachusetts. **Ben Myers** designs and writes IBM PC graphics applications and lives in Harvard, Massachusetts. **Keith H. Erskine** is a program coordinator for Sun Microsystems in Billerica, Massachusetts. **Larry Loeb** is a dental surgeon in Wallingford, Connecticut.

## C\_talk™

### Object-oriented Extensions For C

*C\_talk, A SERIOUS TOOL FOR SERIOUS SOFTWARE ENGINEERS:*

- Adds encapsulation, inheritance and dynamic messaging to your C compiler.
- Smalltalk-like *Browser* for building objects.
- Semi-automatic *Make* for building applications.
- Preprocessor* for converting objects to standard C source code.
- Foundation classes to help you get started.
- Professional telephone support from our engineering staff.

Start building software components into your next application. Join the leading edge today.

**Order Now:**

CNS, Inc.  
Software Products Dept.  
7090 Shady Oak Road  
Eden Prairie, MN 55344  
Tel: (612) 944-0170  
Fax: (612) 944-0923  
30 day money back guarantee  
MasterCard, Visa

Shipping: \$ 5 - U.S.  
\$ 25 - Int'l.

C\_talk is designed for an IBM® PC (or compatible) with:  
Microsoft® C, Lattice C, Turbo C, or C86. A system with a hard drive and mouse is highly recommended.

IBM is a registered trademark of IBM Corp. MICROSOFT is a registered trademark of MICROSOFT CORP. C\_talk is a trademark of CNS, Inc.

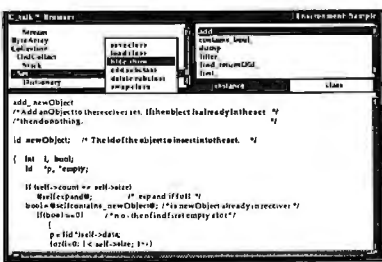

**STILL  
\$149.95**





## WHEN YOUR $\mu$ P CODE DEMANDS THIS KIND OF PERFORMANCE, SPEED IS OF THE ESSENCE.

**AVMAC™ assemblers can make your high-performance design a winner, too.**

In Formula 1 racing, performance is everything. And the sport's  $\mu$ P-based instrumentation is no exception.

That's why SRD Co., Inc. chose the AVMAC 8096 assembler to develop their state-of-the-art racing dynamometer — a device sophisticated enough to simultaneously calculate every parameter of Formula 1 performance — all before the vehicle has moved 4 inches!

In the critical assembly language phase of development, AVMAC "was a must."

**The race is on: in personal  $\mu$ P development tools, Avocet sets the standards.**

AVMAC's standard-setting speed and sophistication were needed to write the complex multi-tasking operating system at the heart of SRD's dynamometer (patent pending). When you need a macro assembler that really performs, AVMAC can give you the same advantage.

AVMAC supports all the most popular chip families and offers you enhanced compatibility with Intel, Motorola, Hitachi, and other chip makers.

What's more, every package comes complete with our AVLINK™ linker, AVLIB™ librarian, AVREF™ cross-reference generator, HEXFORM™ object file utility, plus a 250+ page user's guide.

**The last lap:  
Compatible simulation/debugging.**

When it's time to test your target code, choose our unique AVSIM™ simulator/debugger. It offers detailed, full-screen CPU simulation that eliminates the need for additional hardware.

Best of all, AVSIM is designed for compatibility with AVMAC and our new Avocet C Compilers—the ideal combination for cost-effective code development —from start to finish.



**AVOCET**  
SYSTEMS, INC.\*

THE SOURCE FOR QUALITY PERSONAL  $\mu$ P DEVELOPMENT TOOLS.

**Our Racy New Catalog  
FREE!**

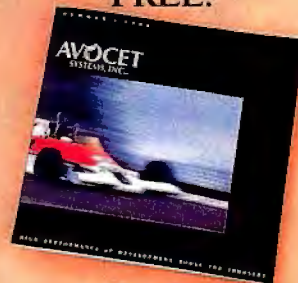

**Call Toll-Free  
1-800-448-8500\***

For your free catalog, to order, or for more information about AVMAC and other Avocet products.

**Getting to the finish line:  
try before you buy.**

When you order AVMAC or AVSIM, we'll include a special demo kit that you can try for 30 days.

If you're not satisfied for any reason, return the unopened software for a full refund—less the \$35 demo/documentation which is yours to keep.

Discover the power of AVMAC and the entire line of Avocet  $\mu$ P/ $\mu$ C development tools. Affordably priced. With comprehensive technical phone support. And delivery in 48 hours, even overnight.

If you're in the development race, we'll get you to the checkered flag in record time.

Avocet Systems, Inc., 120 Union Street

P.O. Box 490AT, Rockport, Maine 04856

\*In Maine, or outside U.S., call (207) 236-9055

TLX: 467210 Avocet CI • FAX: (207) 236-6713

©1988 Avocet Systems, Inc. All rights reserved. Avocet logo and name, AVMAC, AVSIM, AVLINK, AVLIB, AVREF, and HEXFORM are registered trademarks of Avocet Systems, Inc.

The new NEC  
desktop publishing monitors.  
For those getting started.  
And for those who can't stop.

*MultiSync GS*

*The ideal way to break into  
desktop publishing. For systems  
from PC/XT/AT/386 to PS/2.*



*MonoGraph System*

*1024 x 1024 resolution and  
1:1 aspect ratio for the  
dedicated desktop publisher.*

NEC has the perfect monitor for any desktop. For starters, there's our MultiSync® GS. It offers up to 64 gray scales for superior monochrome text and graphics, a flat 14" diagonal screen for minimal glare, and compatibility with just about any system you may be using, including PC/XT/AT/386 and PS/2.

Then there's our MonoGraph™ System, for the ultimate in desktop publishing. It includes a graphics board that works with PC/XT/AT/386 (or 100% compatibles) and runs software like Microsoft Windows, Ventura Publisher and PageMaker. Its square 16" screen offers 1024 x 1024 resolution and the best of both portrait and landscape-style displays; there's room for a whole page of material, with space alongside for menus, icons and scrap.

The GS graphic screen was created using Dr. HALO, which is a registered trademark, and is used courtesy of Media Cybernetics

Best of all, with either monitor you get a feature no one else can give you at any price: NEC. For literature or a dealer call 1-800-447-4700. For technical details call NEC Home Electronics

The MonoGraph System graphics board was powered by PageMaker® which is a registered trademark, and is used courtesy of Aldus Corporation

PC/XT/AT and PS/2 are registered trademarks of the International Business Machines Corporation

Ventura Publisher is a trademark of Ventura Software

(USA) Inc. 1-800-NEC-SOFT.

NEC is a registered trademark of NEC Corporation

**C&C**  
Computers and Communications

Circle 157 on Reader Service Card

**NEC**®

AUGUST 1988 • BYTE 63

# Double Your Productivity With Carbon Copy Plus



Carbon Copy Plus™—the industry standard in remote control software—easily lets two PCs share the same application program over ordinary phone lines.

So now you can share the same keyboard, screen and disk with a remote user thousands of miles away, allowing you to give effective product demonstrations, support remote customers or train new users—without ever having to leave your office!

## Remote control and much more!

Of course, Carbon Copy Plus offers other advanced remote communications features, including remote printing, remote access to a local area network and remote session capture and playback. But Carbon Copy Plus also offers many of the same features found in "standard" communications programs, such as file transfer, terminal emulation and complete scripting macros. And much more!

## Introducing Version 5.0

If you thought Carbon Copy Plus was powerful before—wait until you see the new Version 5.0. Carbon Copy Plus has always been able to transmit text or graphics, but

now our new universal graphics translator merges incompatible graphics formats. So you can jointly update a CAD diagram using your CGA, EGA, VGA or MCGA system with an associate who is using the Hercules™ standard.

Just as important is our new background file transfer capability. This lets you easily send or receive files, at any time, without exiting your current application. Now you can double your productivity by working on one spreadsheet file while an associate sends you another!

## Twice as easy

Find out why Carbon Copy Plus has become the industry standard in remote communications and is fast becoming one of the most popular communications programs overall. Call us today. We'll show you how easily you can increase your productivity.

**Carbon  
Copy plus**

*Fully translated foreign versions now available!*

**MERIDIAN TECHNOLOGY INC**

A SUBSIDIARY OF MICROCOM

7 Corporate Park Suite 100 Irvine, CA 92714 (714) 261-1199

A separate Carbon Copy Plus is required for each PC location. Carbon Copy Plus is a trademark of Meridian Technology. All other products referenced are trademarks of their respective companies.



# PRODUCTS IN PERSPECTIVE

- 67 **What's New**
- 89 **Short Takes**  
 Dell System 220  
 T-DebugPLUS 4.0  
 Cambridge Computer Z88  
 Grammatik III  
 Watcom C 6.0  
 Paradox OS/2
- Expert Advice:**
- 101 **Computing at Chaos Manor**  
*by Jerry Pournelle*
- 115 **Applications Plus**  
*by Ezra Shapiro*
- 121 **Down to Business**  
*by Wayne Rash Jr.*
- 125 **Macinations**  
*by Don Crabb*
- 131 **OS/2 and You**  
*by Mark Minasi*
- 135 **COM1:**  
*by Brock N. Meeks*
- First Impressions**
- 140 Compaq Deskpro 386/25,  
 Everex Step 386/25, Intel  
 SYP302, and SimpleNet's  
 Netpro 386/25
- Reviews**
- 148 Stand-alone communications  
 packages
- 162 Tatung TCS-8000, Proteus 386A,  
 and Everex Step 386/20
- 173 PC-Trac, FastTRAP, Trackball  
 Plus, and Felix
- 185 Unix for the Mac II
- 195 VersaCAD on a Mac
- 200 Review Update



# IT'S TIME TO DO SOME SERIOUS 386 BUGBUSTING!

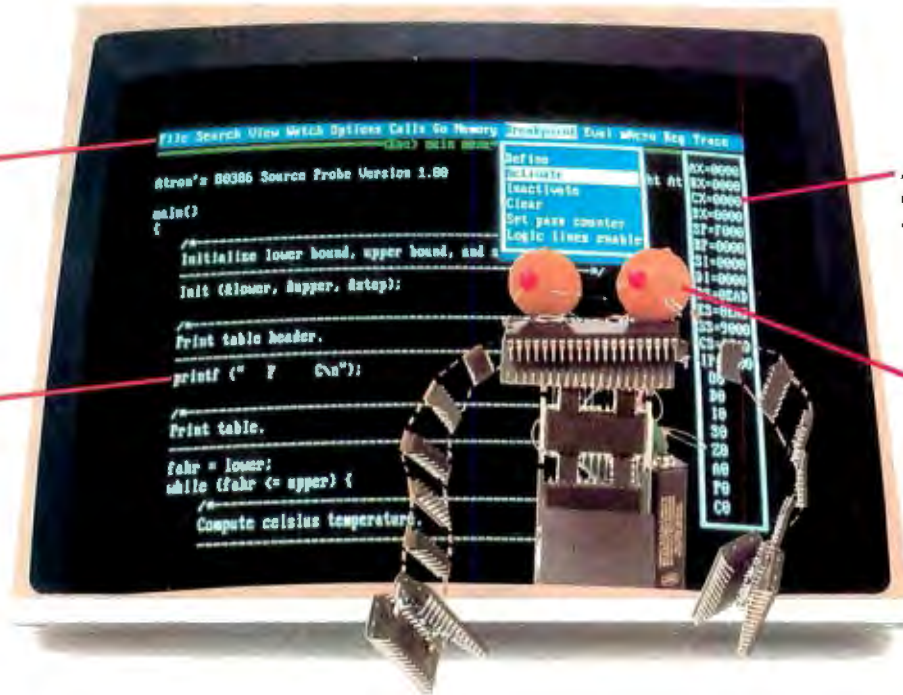

PROBE's menu bar and pull-down menus set a new standard for debugger interfaces.

POP registers up and down with a single key.

PROBE has source-level debugging to let you "C" your program.

This is an out-of-range memory-overwrite bug. Since it is interrupt related, it only appears in real time.

Welcome to your nightmare. Your company has bet the farm on your product. Your demonstration wowed the operating committee, and beta shipments were out on time. Then wham!

All your beta customers seemed to call on the same day. "Your software is doing some really bizarre things," they say. Your credibility is at stake. Your profits are at stake. Your sanity is at stake.

## THIS BUG'S FOR YOU

You rack your brain, trying to figure something out. Is it a random memory overwrite? Or worse, an overwrite to a stack-based local variable? Is it sequence dependent? Or worse, randomly caused by interrupts? Overwritten code? Undocumented "features" in the software you're linking to? And to top it off, your program is too big. The software debugger, your program and its symbol table can't fit into memory at the same time. Opening a bicycle shop suddenly isn't such a bad idea.

## THIS DEBUGGER'S FOR YOU

Announcing the 386 PROBE™ Bugbuster,\* from Atron. Nine of the top-ten software developers sleep better at night because of Atron hardware-assisted debuggers. Because they can set real-time breakpoints which instantly detect memory reads and writes.

Now, with the 386 PROBE, you have the capability to set a *qualified breakpoint*, so the breakpoint triggers only if the events are coming from the wrong procedures. So you don't have to be halted by breakpoints from legitimate areas. You can even detect obscure, sequence-dependent problems by stopping a breakpoint only after a specific chain of events has occurred in a specific order.

Then, so you can look at the cause of the problem, the 386 PROBE automatically stores the last 2K cycles of program execution. Although other debuggers may *try* to do the same thing, Atron is the only company in the world to dequeue the pipelined trace data so you can easily understand it.

Finally, 386 PROBE's megabyte of hidden, write-protected memory stores your symbol table and debugger. So your bug can't roach the debugger. And so you have room enough to debug a really big program.

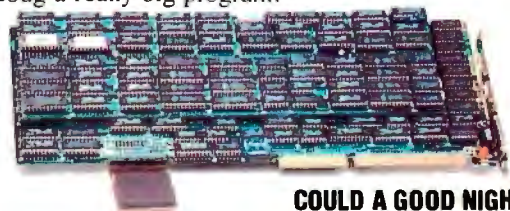

## COULD A GOOD NIGHT'S SLEEP PUT YOU IN THE TOP TEN?

Look at it this way. Nine of the top-ten software products in any given category were created by Atron customers. Maybe their *edge* is — a good night's sleep.

Call and get your free, 56-page bugbusting bible today. And i

of a nightmare right now, give us a purchase order number. We'll FEDEX you a sweet dream.



**Atron**

**BUGBUSTERS**

A Division of Northwest Instrument Systems, Inc.  
Saratoga Office Center • 12950 Saratoga Avenue  
Saratoga, CA 95070 • Call 408/253-5933 today.

# WHAT'S NEW

SYSTEMS

## The Incredible Shrinking System Unit

Claimed to be the "world's smallest," Advanced Logic Research's latest systems are the FlexNode 286 and the FlexNode 386. Both occupy 4½ by 15 inches of desktop real estate and perform at 20 MHz with zero wait states by using paged interleaved cache memory.

The systems have 1.44-megabyte PS/2-compatible 3½-inch floppy disk drives and industry-standard 101-key keyboards. Both have four full-length 16-bit expansion slots, as well as an optional expansion unit that provides an additional four slots and support for a second hard and floppy disk drive. Within those additional slots, you can place ALR-designed ARC-net, Ethernet, or token-ring adapter cards.

The FlexNode 286 comes standard with 512K bytes of RAM, expandable to 5 megabytes with add-in cards. The 386 comes standard with 1 megabyte of RAM and can be expanded to 13 megabytes with an optional ALR RAM-Pak. There is also room for an optional math coprocessor.

Both machines include a four-slot backplane with a single RS-232C serial port, a parallel port, and a floppy disk controller.

**Price:** \$1990 for basic 286; \$2549 with 30-megabyte hard disk drive and controller; \$2990 with 50-megabyte hard drive and controller; \$3490 for basic 386; \$3990 with 30-megabyte hard drive and controller; \$4449 with 50-megabyte hard drive and controller.

**Contact:** Advanced Logic Research, Inc., 10 Chrysler Ave., Irvine, CA 92718, (714) 581-6770. **Inquiry 751.**



The FlexNode system has a 5- by 15-inch base.

## Laptop Makers Shed Light on Their Screens

Mitsubishi's mp286L laptop features a fluorescent backlit liquid crystal display (LCD) and four slots for add-in capabilities. The 12-/8-MHz, one-/zero-wait-state machine comes standard with a 6½- by 9¼-inch display and 640- by 400-pixel resolution.

Features include dual 1.44-megabyte 3½-inch floppy disk drives and 640K bytes of RAM that you can expand to

2.6 megabytes.

The CGA controller is in one slot, additional memory is in a second, and a built-in Hayes-compatible 2400-/1200-/300-bit-per-second modem is in the third. The fourth slot could be used for a local-area-networking card.

Weight is 16 pounds, not including the optional 7-pound battery pack.

**Price:** \$3195; OS/2, \$325.

**Contact:** Mitsubishi Electronics America, Inc., Computer Systems Division, 991 Knox St., Torrance, CA 90502, (800) 556-1234; in California, (800) 441-2345. **Inquiry 752.**

## SEND US YOUR NEW PRODUCT RELEASE

We'd like to consider your product for publication. Send us full information, including its price, ship date, and an address and telephone number where readers can get further information. Send to New Products Editor, BYTE, One Phoenix Mill Lane, Peterborough, NH 03458. Information contained in these items is based on manufacturers' written statements and/or telephone interviews with BYTE reporters. BYTE has not formally reviewed each product mentioned. These items, along with additional new product announcements, are posted regularly on BIX in the microbytes.sw and microbytes.hw conferences.

## Multuser 386 Power in an 11-inch Cube

Housed in an 11-cubic-inch box, the Unix-based QB2 386 from Cubix has the advantage of being MS-DOS-compatible while acting as a file server for up to eight processors or terminals.

It runs with zero- or one-wait-state performance because of an alternative banking scheme. When configured with 4 megabytes of memory, it runs with zero wait states. When configured with 8 megabytes, it runs with one wait state. The standard package includes an 80387 coprocessor and an Ethernet controller.

The QB2 386, as the name implies, is based on Intel's 80386 processor. It runs Unix version 3.0 and comes standard with 2 megabytes of RAM, expandable to 8 megabytes. In a standard configuration, it includes an 80-megabyte hard disk drive, a 60-megabyte tape drive for backup, and a 1.44-megabyte 5¼-inch floppy disk drive.

The built-in power-fail system involves nickel-cadmium batteries for 10-minute on-line protection. If the power stays off for longer than 10 minutes, another battery subsystem kicks in for up to an hour. Software that automatically shuts the system down is activated next, but not before the system tells you it's time to quit because it's operating on batteries.

**Price:** \$8995.

**Contact:** Cubix Corp., 2800 Lockheed Way, Carson City, NV 89706, (702) 883-7611. **Inquiry 753.**

continued

## Compact Keyboard Conserves Desktop Real Estate

**B**y compressing row spacing, Mechanical Enterprises has designed an IBM PC AT- and XT-compatible 100-key keyboard that's 60 percent smaller than traditional AT-enhanced keyboards.

The microtype keyboard measures only 11 by 6 inches and weighs less than 2 pounds. Mechanical Enterprises says its studies show that touch typists achieve normal typing speed after a short familiarization period. **Price:** \$150.

**Contact:** Mechanical Enterprises, Inc., 461 Carlisle Dr., Herndon, VA 22070, (703) 435-9496.

**Inquiry 754.**

## End Those Scrolling Blues

**A**dual-page landscape monitor from Nutmeg Systems lets Macintosh desktop publishing aficionados view two complete pages



*Space-saving 100-key PC-compatible keyboard.*

when they write, edit, and prepare layouts.

The Nutmeg 19, available for the Mac Plus, SE, and II, has a 79-dpi resolution in a 1024- by 768-pixel paper-white phosphor display. The horizontal refresh rate is 63.65 kHz, and the vertical scan rate is 63.73 kHz.

The monitor measures 17 by 19 by 18 inches and weighs 42 pounds. Nutmeg also uses a proprietary video interface that lets you easily upgrade your monitor if you move up to a Mac II.

**Price:** \$1899 for use with the Mac II; \$1699 for use with either the Plus or SE.

**Contact:** Nutmeg Systems, Inc., 25 South Ave., New Canaan, CT 06840, (203) 966-3226.

**Inquiry 755.**

## A Passport to Portable Data

**P**lus Development's latest technological innovation is called the Plus Passport. It's a removable hard disk system that lets you insert 1 1/4-inch thick, 3 1/2-inch 20- or 40-megabyte hard disks into the company's custom chassis like you insert video cassettes into a VCR.

You then have an MS-DOS- and OS/2-compatible hard disk subsystem that works on all the IBM machines and compatibles, including systems with Micro Channel architecture.

The drives use 1-to-1 interleave for efficient data throughput and are rated for

shocks of up to 150 g's. If you use the Passport for booting up other drives, you can back up as much as 40 megabytes of data in less than 5 minutes, says Plus Development.

The drive cartridges fit into a drive subsystem that fits into a standard 5 1/4-inch half-height bay.

**Price:** 20-megabyte PC version, \$1250; 40-megabyte PC version, \$1450; 20-megabyte Micro Channel version, \$1350; 40-megabyte Micro Channel version, \$1550.

**Contact:** Plus Development Corp., 1778 McCarthy Blvd., Milpitas, CA 95035, (408) 434-6900.

**Inquiry 756.**

## Yes, We Have No DataDesk Keyboards

**D**ataDesk International keyboards were incorrectly associated with EECO keyboards in the June What's New section on page 70 ("123-Key Keyboard Remembers Macros").

DataDesk is an independent designer and manufacturer of two popular keyboards: the Turbo-101 for IBM PC compatibles, and the Mac-101 for Macintosh computers.

The two keyboards together are compatible with just about everything on the market, including the Tandy 1000, AT&T PC 6300, and IBM PCjr. The two keyboards are 101-key units with firm keys that produce a definite "bounce feeling" that many users prefer over PC-clone and Macintosh keyboards.

**Price:** Turbo-101, \$149.95; Mac-101, \$169.95.

**Contact:** DataDesk International, 7651 Haskell Ave., Van Nuys, CA 91406, (818) 780-1673.

**Inquiry 757.**

*continued*

## Put Up to 8.4 Gigabytes in the Palm of Your Hand

**W**hile the battle over digital audio tape (DAT) for recording music rages in both Congress and the music industry, a California company has adopted DAT technology for storing truly massive amounts of computer data.

Gigatape's Giga 1200 DAT subsystem writes from 1.2 to 8.4 gigabytes on a standard 4-millimeter digital tape cartridge. The company claims that the unit is compatible with all the IBM machines and compat-

ibles, including the PS/2s, as well as with the Macintosh, MicroVAX, and other workstations.

The Giga 1200 uses helical scan technology, originally developed for the VCR industry, and the latest digital recording techniques. Helical scan technology involves using two read/write heads on a drum that rotates at 2000 rotations per minute.

The tape speed is 0.32 inches per second, and the data transfer rate averages 192K bytes per second. But

read/write is sustained even through 1.5-megabyte-per-second bursts. That means an entire tape can be loaded with information in less than 2 hours. Error correction is handled with a proprietary code that the company claims keeps bit and burst errors to less than one in 10<sup>15</sup>.

**Price:** \$6500.

**Contact:** Gigatape, Inc., 5266 Hollister Ave., Santa Barbara, CA 93111, (805) 964-8990.

**Inquiry 788.**

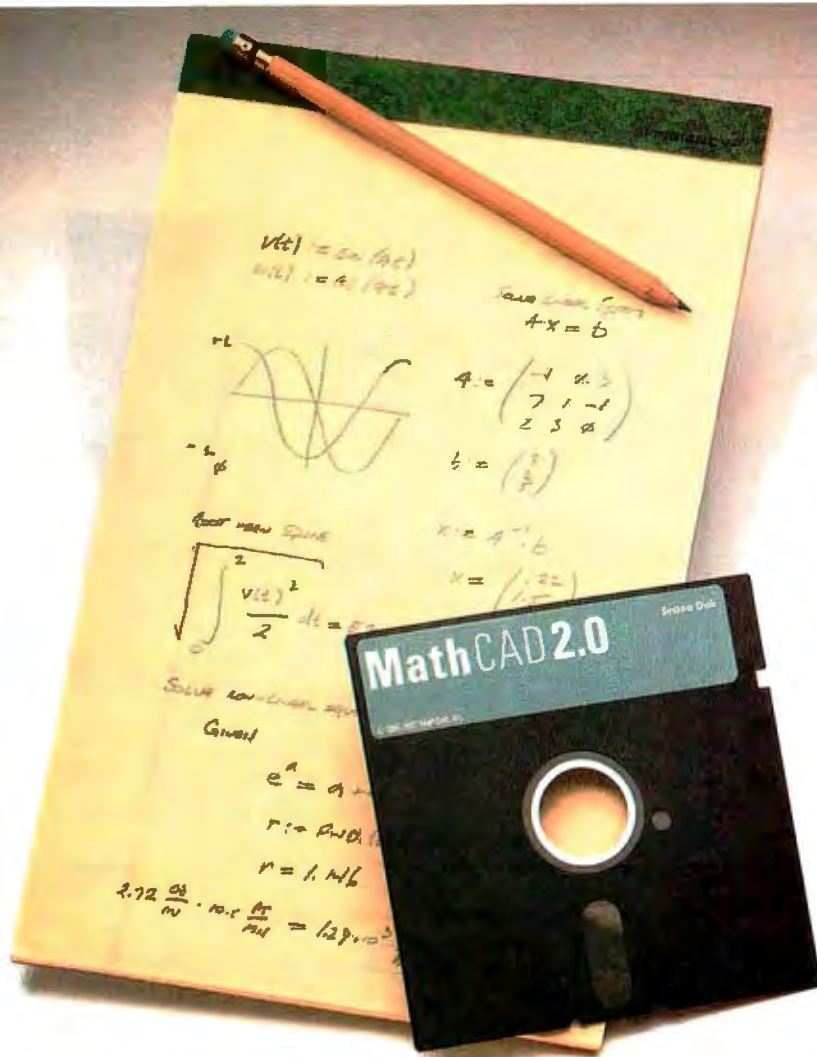

# Your pad or ours?

If you perform calculations, the answer is obvious.

MathCAD 2.0.

It's everything you appreciate about working on a scratchpad—simple, free-form math—and more. More speed. More accuracy. More flexibility.

Just define your variables and enter your formulas anywhere on the screen. MathCAD formats your equations as they're typed. Instantly calculates the results. And displays them exactly as you're used to seeing them—in real math notation, as numbers, tables or graphs.

MathCAD is more than an equation solver. Like a scratchpad, it allows you to add

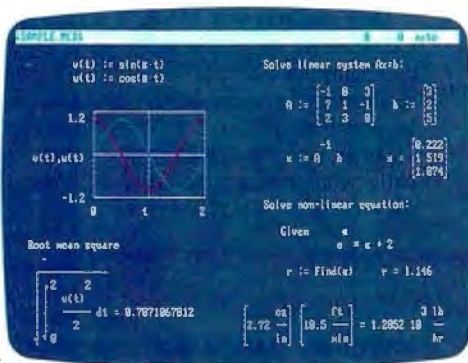

text anywhere to support your work, and see and record every step. You can try an unlimited number of what-ifs. And print your entire calculation as an integrated document that anyone can understand.

Plus, MathCAD is loaded with powerful

built-in features. In addition to the usual trigonometric and exponential functions, it includes built-in statistical functions, cubic splines, Fourier transforms, and more. It also handles complex numbers and unit conversions in a completely transparent way.

Yet, MathCAD is so easy to learn, you'll be using its full power an hour after you begin.

What more could you ask for? How about the exciting new features we've just added to MathCAD 2.0...

- Built-in equation solver
- Full matrix operations
- Two to four times increase in calculating speed
- Easier full-page text processing
- Auto-scaled plots
- Memory enhancements
- Additional printer and plotter support
- And more.

If you're tired of doing calculations by hand or writing and debugging programs, come on over to our pad. MathCAD. The Electronic Scratchpad.

Call for a detailed spec sheet and the name of a MathCAD dealer near you. **1-800-MathCAD** (In MA: 617-577-1017).

Requires IBM PC® or compatible, 512KB RAM, graphics card.  
IBM PC® International Business Machines Corporation.  
MathCAD® MathSoft, Inc.

# MathCAD®

MathSoft, Inc., One Kendall Sq., Cambridge, MA 02139

## Manipulate Video on Your Mac II

Now you can use your Mac II to display video captured from standard video sources, then manipulate that image and add graphics with the ColorCapture board by Data Translation.

The board allows real-time video that's been captured on video cameras, VCRs, and still-video equipment to be displayed on the Mac II. Two versions are available—one for the National Television System Committee (NTSC) standard in North America and Japan, and one for the Phase Alternate Line (PAL) standard in western Europe.

Once you capture the image, you can crop the picture, add text or graphics, export color images to other applications, sharpen and soften edges, adjust brightness and contrast, add or subtract images, print hard copies, animate, and output to a videotape.

Resolution is 640 by 480 pixels, and images can be displayed from a palette of 32,768 colors. The board fits into a single Mac expansion slot with a cable that extends from the board to plug into video cameras, VCRs, or elec-

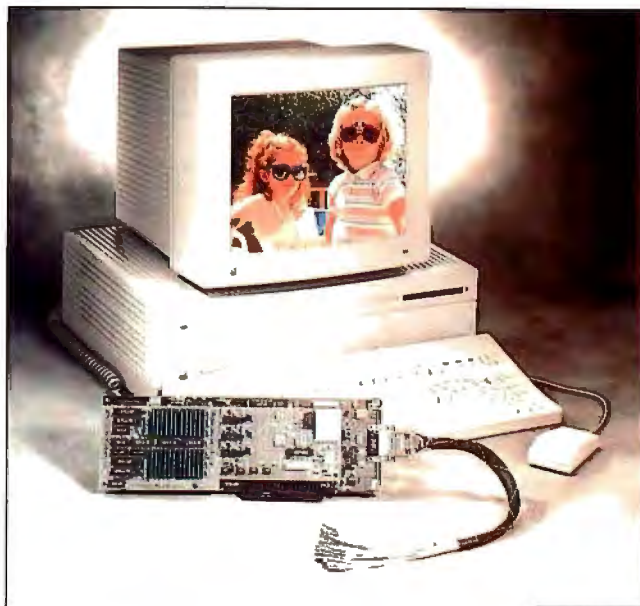

*Real-time Mac II video translation.*

tronic still-video equipment. For live display, you can attach composite or RGB monitors directly to the board.

Additional specialized functions include a zoom/pan/scroll controller, which allows instantaneous magnification and close-up examination of image regions. There's also a graphics memory plane for merging text and drawing lines, arcs, curves, boxes, icons, and so on.

**Price:** \$2995.  
**Contact:** Data Translation, Inc., 100 Locke Dr., Marlborough, MA 01752, (617) 481-3700.

**Inquiry 758.**

## Low-Cost, High-Speed Modem

The ATI Technologies 2400etc is a 2400-bit-per-second internal modem that allows for the equivalent of 4800-bps data transmission with its data-compression techniques.

Only modems with MNP Class 5 error correction will communicate with this modem at maximum speed, however. MNP Class 5 provides for what the company calls "100 percent error-free data transfer." This IBM

PC-compatible unit fits into a standard half slot and also operates at 1200 and 300 bps.  
**Price:** \$239.

**Contact:** ATI Technologies, Inc., 3761 Victoria Park Ave., Scarborough, Ontario, Canada M1W 3S2, (416) 756-0711.

**Inquiry 759.**

## Serial Mice Can Now Take the Bus

The Pointing Device Adapter (PDA) lets you convert your serial mouse to work on a standard PC bus, freeing up that serial port for other things.

This MicroSpeed product, a 1/2-length card with software for Microsoft, Logitech, Mouse Systems, and compatible rodents, is compatible with the IBM AT, XT, PS/2 Model 30, and compatibles.

The PDA's features are many. They include an I/O address that's the same as that for bus mice, and interrupt selection for IRQ 2, 3, 4, 5, or 7. MicroSpeed's MAP (multi-axis pointer) driver with ballistic gain support is included, allowing you to better control the pointer on the screen with the mouse. While the ballistic gain feature has been available on the Macintosh mice for some time, MicroSpeed says this is the first time you can buy a mouse for PC compatibles with variable speed control.

Finally, there's a device driver for Windows applications, an AutoDesk device interface driver for AutoCAD, and MicroSpeed's KeyMAP keyboard emulator software.  
**Price:** \$69.

**Contact:** MicroSpeed, Inc., 5307 Randall Place, Fremont, CA 94538, (800) 232-7888; in California, (415) 490-1403.  
**Inquiry 760.**

*continued*

The ConoDesk 6000, a PostScript-compatible printer controller, outputs PostScript code 10 times faster than competing units, the manufacturer claims.

Scalable fonts for Ventura Publisher, PageMaker, and Windows let you scale every typeface to all standard PostScript point sizes and rotate them to any angle.

The controller uses a proprietary 32-bit microproces-

sor and 2.5 megabytes of RAM and works with the IBM XT, AT, Compaq 386, and compatibles. It supports Hewlett-Packard LaserJet and Canon-engine printers.

There are 13 typefaces with PostScript-compatible metrics and a 228-character set for Ventura Publisher and PageMaker. Optional software includes ConoScript, the interpreter that allows the printer to print Post-

Script files. Optional hardware includes HP LaserJet Series II and Canon LBP-8II video interface boards.

**Price:** \$2995 for the base system with interpreters for Windows and PageMaker; \$695 for the ConoScript interpreter; \$100 to \$700 for a floating-point processor.

**Contact:** Conographic Corp., 16802 Aston, Irvine, CA 92714, (714) 474-1188.  
**Inquiry 789.**

# Get Sprint and you'll never be afraid of the dark!



Nothing holds a candle to Sprint!

Features	Sprint 1.0	WordPerfect 4.2	MS Word 4.0	WordStar 4.0	MultiMate Adv. 1.0
● = Yes   ○ = No					
Maximum file size	Disk	Disk	Disk	4MB	128K
Thesaurus (integrated)	●	●	●	●	●
Windows Open (maximum)	6	2	8	1	1
Files Open (maximum)	24	2	8	1	1
Cross-Reference (dynamic)	●	○	○	○	○
Indexing Options	7	1	3	3	○
Columns: Parallel	●	●	●	●	●
Snaking (chg. # same page)	●	●	Not same pg.	○	●
H-P LaserJet Support	Full	Partial	Full	Partial	Full
PostScript Support	Full	Text	Full	○	Text
Mouse Support (integrated)	●	○	●	○	○
Dynamic Shortcuts	●	○	○	○	○
Alternative User Interfaces	●	○	○	○	○
Verify Spelling as you type	●	○	○	○	○
Programmable Macro lang.	●	○	○	○	○
Save File <sup>1</sup>	5.9	41.1	9.7	4.4	1.0
Top to Bottom <sup>2</sup>	7.5	7.5	49.4	8.1	21.0
Search and Replace <sup>3</sup>	1.6	6.6	4.6	17.1	13.4
Find Unique Word	3.3	6.2	7.0	13.8	20.6
<b>Suggested List Price</b>	<b>\$199.95</b>	<b>\$495.00</b>	<b>\$450.00</b>	<b>\$495.00</b>	<b>\$565.00</b>

Time tests were performed on an Acer 286 (8 MHz), 640K RAM. <sup>1</sup>File size 103K. <sup>2</sup>1636 lines. <sup>3</sup>14 occurrences. Times shown are in seconds. (Benchmark details available upon request.)  
Prices and specifications subject to change without notice.

\*Customer satisfaction is our main concern: if within 60 days of purchase this product does not perform in accordance with our claims, call our customer service department, and we will arrange a refund.

All Borland products are trademarks or registered trademarks of Borland International, Inc. Other brand and product names are trademarks of their respective holders. Copyright ©1988 Borland International, Inc. BI 1237

Circle 30 on Reader Service Card (Dealers: 31)

Forgetting to "Save" is a fact of life as are power outages, and it used to be that a power outage could wipe out everything you've done. Not any more. Your work is always safe when you Sprint.®

Sprint's "Auto-Save" automatically saves your words as you type, so if the lights do go out, you may be in deep darkness but not deep trouble.

Sprint's Auto-Save is more than "insurance," it's also invisible. You know it's there, but it does its job without interrupting yours.

**Sprint: It's the word processor with everything!**

You name it, Sprint's got it. Incredible speed, Auto-Save, a customizable user interface, and professional output. Sprint even includes a bonus pack of alternative user interfaces that make it act like WordStar,® MultiMate,® WordPerfect,® Microsoft® Word, or other familiar word processors—a \$99 value free!

Sprint has all this and does all this for only \$199.95 instead of the up to \$600 that some companies demand. Sprint automatically saves your words; it also automatically saves your money. Sprint—The fast track to performance word processing.

60-Day Money-back Guarantee\*  
For the dealer nearest you  
Call (800) 543-7543



## An Affordable and Expandable Fiber-Optic Network

**E**ight XT- or AT-compatible computers, eight printed circuit boards, one networking hub, and fiber-optic cabling constitutes the simplest form of the new Ethernet local-area network (LAN) from 10Net Communications.

But you can expand that with more fiber-optic cabling, more boards, and more hubs. Each hub supports eight computers. To form a 392-computer, 10-megabit-per-second (mbps) LAN with as much as 6 kilometers between any two nodes, you'll need 54 hubs, 392 boards, and lots of cabling.

To expand the network even further, you can add a regenerative repeater and link two 392-computer networks. A second repeater allows you to link more than 1000 computers. The boards use Intel's 82586 Ethernet controller chip and have Hewlett-Packard LED sources and positive-intrinsic-negative (PIN) photodiode receivers to transmit and receive 850-nanometer light pulses through 62.5-micron multimode fiber-optic cabling with recommended SMA or ST connectors. Total delay between two hubs on 392-computer clusters is 25 nanoseconds.

Repeaters, which restore amplitude (like the hubs) and retime the signals, add 750 ns to transmissions. Repeaters also allow connection of fiber-optic to coaxial or cheaper net (thin coaxial) cabling.

If you add two more full-length cards to one of the computers, you have a bridge that will link clusters of 10Net 1-mbps LANs with several types of networks, including



*Ethernet local-area network from 10Net Communications.*

Ethernet, Token Ring, and ArcNet. The networking software is 10Net's existing package, 10Net 4.0, which includes an electronic mail courier from Consumers Software.

**Price:** PC board with software, \$1295; hub, \$2995; repeater, \$1395. (Fiber cabling and installation not included.)  
**Contact:** 10Net Communications, 7016 Corporate Way, Dayton, OH 45459, (513) 433-2238.

**Inquiry 765.**

## Ethernet Stalks the Twisted Pair!

**I**f you're considering installing Ethernet but the hassle of running coaxial cable through the walls and floors is giving you pause, Hewlett-Packard has a simple solution. Its newest product, HP StarLAN 10 PC Link, uses the already-installed telephone wiring in your building to network your PC or compatibles at 10 mbps.

PC Link includes a half-

length PC card and software called OfficeShare, which provide the transport mechanism between MS-DOS- or Unix-based systems, as well as the twisted-pair Ethernet network that HP introduced last year. With PC Link, you can locate as many as 12 PCs up to 100 meters from the networking hub. And those capabilities will increase when repeaters and bridges become available, since StarLAN 10 can support a total of 1024 PCs or Unix devices.

You can also connect your PCs using existing coaxial Ethernet networks with a device called the Twisted-Pair Media Access Unit. According to HP, before its all-twisted-pair products became available, such coaxial-to-twisted-pair devices were the only way to connect PCs to Ethernet.

**Price:** PC Link, \$695; hub, \$2995; Twisted-Pair Media Access Unit, \$295.

**Contact:** Hewlett-Packard Co., Customer Information Center, Inquiry Fulfillment Dept., 19310 Pruneridge Ave., Cupertino, CA 95014, or call the HP sales office listed in your telephone directory white pages.

**Inquiry 766.**

## Your PC or PS/2 Can Now Talk AppleTalk

**T**he first IBM PC- and PS/2-based AppleTalk file server supports up to 30 machines at 230 kilobits per second (kbps). It consists of a board and software for the host and the clients.

The Tangent Technologies card, dubbed the TangentShare, eliminates the need for a dedicated Macintosh file server or for individual hard disk drives at each workstation. As a nondedicated file server, it allows you to store files and applications from any IBM PC, PS/2, or Macintosh on the AppleTalk network host, to use the host as a local disk drive, or to transfer files between incompatible systems.

TangentShare provides both "administrator" and "super user" privileges from any IBM or Apple machine on the network. Administrator machines can perform such management functions as adding users to the network and changing passwords. The super user machines, designated by the administrator machines, have complete access privileges to all directories in the network. There can be multiple administrators and multiple super users on each network.

**Price:** \$700 for board and file server software; \$325 for board and IBM PC client software; \$400 for board and PS/2 client software.

**Contact:** Tangent Technologies, 5990-K Unity Dr., Norcross, GA 30071, (404) 662-0366.

**Inquiry 767.**

*continued*





# Cut yourself a better deal.

**Buy MICRO CADAM CORNERSTONE™ R. 1.3, send us your obsolete PC CAD software, and get a \$1,000\* check from CADAM!**

If you've always wanted real mainframe-based CAD power for your IBM® PS/2,™ PC/AT® or compatible system, here's a sharp new offer from CADAM®

Buy new MICRO CADAM CORNERSTONE R. 1.3 now. Compare its productivity, ease of use, and mainframe-

based features with your conventional PC CAD system. (You can go right to work with your existing CAD files, thanks to MICRO CADAM CORNERSTONE's new DXF data translator.)

Then cut up your obsolete software and send us the half with the label, along with your completed rebate coupon and proof of purchase for MICRO CADAM CORNERSTONE R. 1.3. We'll cut you a check for \$1,000.

CADAM's rebate offer is the ultimate deal on the "ultimate PC CAD production tool." But act fast. Rebate expires October 31, 1988. See your dealer today for

qualification details and rebate coupon. For the location of your nearest dealer, phone CADAM toll-free today: 800-255-5710.

**MICRO CADAM CORNERSTONE . . .  
The Ultimate PC CAD Production Tool**



**CADAM INC**  
A LOCKHEED COMPANY

\*This rebate may not be combined with any other special CADAM INC promotion or discounts and is available only in the United States to end users. Certain restrictions apply—see rebate coupon available from your MICRO CADAM CORNERSTONE dealer for details and restrictions. All sales will be verified with dealer of record.

CADAM is a registered trademark and MICRO CADAM CORNERSTONE is a trademark of CADAM INC. AutoCAD is a registered trademark of Autodesk, Inc. IBM and PC/AT are registered trademarks and PS/2 is a trademark of International Business Machines Corporation. ©1988 CADAM INC

ONCE IN A BLUE MOON.....

### SCANMAN™

Pop any image up to 4" x 11" straight into your IBM PC, XT, AT, PS/2 or 100% compatible system. Clip it, crop it, resize and rotate it, color it. Merge it. Save it. Store it. Choose between high contrast or high detail. Import images into any best-selling DTP application (PageMaker,™ Ventura,™ etc.). Use it in any major publishing program. All you need is \$299, a spare card slot, and five minutes to set up.

### HOW ON EARTH IS THIS POSSIBLE FOR \$299?

Be comforted. ScanMan carries Logitech's Customer Satisfaction Guarantee, and includes all you need to be up and running in minutes.

Choice of editing colors



Scanning window is over 4" wide (vs. 2.5" for most others)

# ... COMES A STROKE OF GENIUS.

*Scan directly into a graphics editor where a full range of paint utilities and tools are available.*

*200 dots per inch resolution*

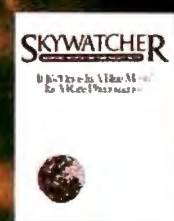
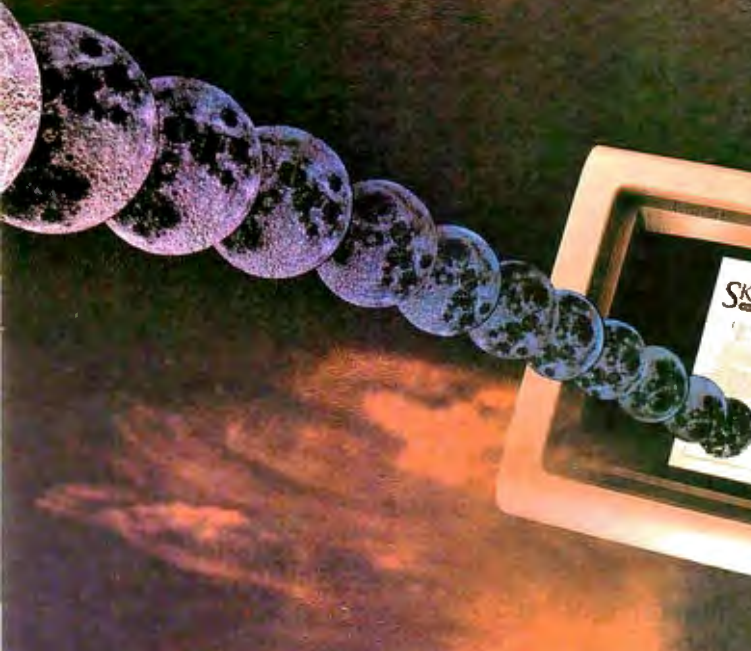

**CALL TOLL FREE: (800) 231-7717 OR (800) 552-8885 IN CALIFORNIA**

Please send me my ScanMan: BY888

- ScanMan for IBM PC, XT, AT, PS/2 models 25 and 30, and 100% compatibles \$299.00
- ScanMan for IBM PS/2 model 50 and above and 100% compatibles \$349.00
- Shipping and Handling (per item): \$ 6.50
- CA Residents add applicable sales tax: \$ \_\_\_\_\_

Total: \$ \_\_\_\_\_

Check or Money Order Enclosed     Visa     MasterCard

Card Number \_\_\_\_\_ Exp. Date \_\_\_\_\_

Cardholder Name \_\_\_\_\_

Authorized Signature \_\_\_\_\_ (Please print) \_\_\_\_\_

Ship to: Name \_\_\_\_\_ Phone \_\_\_\_\_

Address \_\_\_\_\_

City/State/Zip \_\_\_\_\_

Offer valid in the U.S. only. Allow 2-3 weeks for delivery. 30-day Money Back Guarantee. DEALER INQUIRIES WELCOME. Send to: LOGITECH, Inc., attn: Coupon Redemption Program, 6505 Kaiser Drive, Fremont, CA 94555

**ScanMan**  
Hand-Held Scanner from  
**LOGITECH**  
Personal Peripherals Worldwide.

PageMaker is a trademark of Aldus and Ventura Publisher is a trademark of Ventura Software Inc.

Circle 129 on Reader Service Card (Dealers: 130)

## Who Can Make a 4-inch Scan? The ScanMan Can

**W**ith 200-dpi resolution, ScanMan provides a way for you and your IBM PC, AT, XT, PS/2, or compatible to add graphics to desktop publishing, business presentations, and other documents. Then you can store the images in your personal database.

The ScanMan has a 4-inch-wide scanning window, and it can scan images that are up to 11 inches long. The scanner, interface board, graphics editor, and ScanWare software are included.

ScanWare allows for scanning directly into Microsoft Windows or to Logitech's Graphics Editor. The Graphics Editor allows many manipulations, including image sizing, cut and paste, color, reverse and rotate, insert, and magnify. Compatible application packages include Aldus PageMaker, Ventura Publisher, Logitech PaintShow, Logitech Publisher, PFS: First Publisher, and ZSoft PC Paintbrush.

**Price:** \$299.

**Contact:** Logitech, Inc., 6505 Kaiser Dr., Fremont, CA 94555, (415) 795-8500.  
**Inquiry 761.**



Logitech's 4-by-11-inch scanner.

## More HP DeskJet Memory for Soft Fonts

**E**xpansion memory cards for Hewlett-Packard DeskJet printers can expand your printer memory by 128K bytes with one cartridge or by 256K bytes with two cards.

Popular soft fonts such as Helvetica require as much as 256K bytes of memory. In fact, a single point size can use more than 50K bytes. These memory cards, therefore, provide for the necessary soft font memory. But in addition, the memory cards are compatible with hard fonts that fit into HP expansion slots.

Four 32K-byte by 8-bit static RAM chips are used in each 5-by-3-inch cartridge. Each cartridge is specifically designed for one of two option slots available on each HP printer.

**Price:** \$129.

**Contact:** Pacific Data Products, Inc., 6404 Nancy Ridge Dr., San Diego, CA 92121, (619) 552-0880.

**Inquiry 762.**

## Monitor Testing Made Simple

**O**ne tool now tests monitors and nothing else. It's called the Montest-A5D3, and it tests at least six types of

standard personal computer monitors: IBM PC monochrome, Color Graphics Display, Enhanced Graphics Display, Mac II, IBM PS/2, and IBM Professional Graphics Display. You use it to set alignment, convergence, and color balance.

The Montest-A5D3 generates four patterns—color bars, cross hatch, full raster, and a window—and has all the hardware and adapters needed to directly drive either analog or digital monitors. The Montest-A5D3 measures 8 by 6 by 2 inches and weighs less than 2 pounds.

**Price:** \$925.

**Contact:** Network Technologies, Inc., 19145 Elizabeth St., Aurora, OH 44202, (216) 543-1646.

**Inquiry 763.**

## Printer Ribbons That Won't Fade Away

**L**ong after most printer manufacturers began concentrating on desktop publishing applications, one company decided to reinvent the ribbon.

Chronos Computers now offers Sta-Blk reinking printer ribbons for more than 350 popular printers, including the Apple Imagewriter I and II, the C. Itoh ProWriter, and two Epson models. The reinking technology makes the ribbons last at least 20 times longer than conventional ribbons, the company claims. Besides that, the ribbons don't fade.

**Price:** \$49.95 for the Epson printer version; \$39.95 for the Imagewriter or ProWriter versions.  
**Contact:** Chronos Computers, 4186 Sorrento Valley Blvd., Suite H, San Diego, CA 92121, (619) 455-8200.  
**Inquiry 764.**

## The IEEE 488 Controller That Stands Alone

**A** new IEEE 488 controller from IOtech lets you control instruments and store data in 32K bytes of nonvolatile memory.

Called the Macro488, it allows up to 100 macros, or instruction sets, to be loaded into the unit's memory from any computer with an RS-232C or RS-422 data port.

You can control up to 14 instruments simultaneously

with the Macro488. It's ideal for applications, such as vehicle testing, where vibration, and excessive temperatures, and humidity can cause problems. Because it stands alone, its relative immunity to vibration problems places the Macro488 at an advantage over computers in the field. It also operates over a temperature range of with 0°C and 35°C and a

relative humidity range of between 0 and 70 percent.

A built-in clock with time and date stamping lets you collect data at precise times or at regular or irregular intervals.

**Price:** \$995.

**Contact:** IOtech, Inc., 25971 Cannon Rd., Cleveland, OH 44146, (216) 439-4091.

**Inquiry 790.**

*continued*



Feature:	dBASE	ORACLE
SQL	Promises, no dates	IBM DB2 Compatible
Mainframes	No Way	IBM MVS & VM/CMS
Minis	Nope	DEC, HP, Sun, etc.
PCs	All, PC Jr. too	286 & 386 PCs
MS/DOS	< 640K programs	> 640K programs
OS/2	Still waiting	Shipping
Multuser	Primitive	Mainframe quality
Networking	PC Nets only	PC, mini & mainframe
Fault Tolerant	You must be kidding	CPU & Disk Recovery

**THE LAST DBMS**  
**ONLY \$199**  
**CALL 1-800-ORACLE1**

<sup>1</sup> Revenue doubled in 9 of Oracle's 10 years. <sup>2</sup> Sales rate over \$200 million in current fiscal year. <sup>3</sup> For PC development use only. Requires a 286/386 PC plus 1-Mbyte extended memory. Offer valid only in US & Canada. © 1988 by Oracle Corp. ORACLE® is a reg. trademark of Oracle Corp. dBASE is a reg. trademark of Ashton-Tate. Microsoft & IBM own numerous reg. trademarks. TRBA

**O**racle Corporation, the world's fastest growing software company,<sup>1</sup> has just climbed past Ashton-Tate to become the world's largest supplier of database management software and services.<sup>2</sup>

**Why?**

- Because ORACLE® runs on PCs, plus mainframes and minicomputers from IBM, DEC, DG, HP, Prime, Wang, Apollo, Sun, etc. — virtually every computer you have now or ever will have. Ashton-Tate's dBASE runs only on PCs.
- Because ORACLE is a true distributed DBMS that connects all your computers — PCs, minicomputers and mainframes — into a single, unified computing and information resource. dBASE supports only primitive PC networking.
- Because Oracle has supported the industry standard SQL language since 1979. Ashton-Tate promises to put SQL into dBASE sometime in the indefinite future.
- Because ORACLE takes advantage of modern 286/386 PCs by letting you build larger-than-640K PC applications on MS/DOS that run unchanged on OS/2. dBASE treats today's 286/386 PCs and PS/2s like the now obsolete, original PC.

Don't go down in flames. Bail out from dBASE. Call 1-800-ORACLE1 and order your \$199-PC copy of ORACLE<sup>3</sup> today. Or just ask and we'll send you information on ORACLE, the number one selling DBMS on minicomputers and mainframes.

**ORACLE®**  
 COMPATIBILITY • PORTABILITY • CONNECTABILITY

**Call 1-800-ORACLE1,  
 ext. 149 today.**

**Dear Oracle,**

**PC ORDER PROCESSING**  
 Oracle Corporation  
 20 Davis Drive • Belmont, CA 94002

I want ORACLE to be THE LAST DBMS for my 286/386 PC. Enclosed is my  Check or  VISA  MC  AMEX credit card authorization for \$199 (California residents add 7% sales tax). I understand this copy is for PC development only. Offer valid only in the US and Canada.

Print Name \_\_\_\_\_ Date \_\_\_\_\_  
 Title \_\_\_\_\_  
 Company \_\_\_\_\_  
 Street (P.O. Box numbers not acceptable) \_\_\_\_\_  
 City \_\_\_\_\_  
 State \_\_\_\_\_ Zip \_\_\_\_\_  
 Phone \_\_\_\_\_  
 Credit Card Number \_\_\_\_\_  
 Card Expiration Date \_\_\_\_\_  
 Signature \_\_\_\_\_ BYTE  
 I am a value-added reseller (VAR):  YES  NO

## Dell Releases OS/2

**D**ell Computer reports that its version of Microsoft's OS/2 is a single-user multitasking operating system for 80286 and 80386 systems. It supports VGA video adapters based on Chips & Technologies, Video Seven, and Cirrus

Logic VGA controllers.

Dell's OS/2 lets you install Microsoft OS/2, MS-DOS, and Xenix on the same hard disk. Utility programs such as Etree and Speed are included. Etree displays a visual tree of the disk directory, and Speed

lets you change the processing speed and keyboard repeat rate.

**Price:** \$324.95.

**Contact:** Dell Computer Corp., 9505 Arboretum Blvd., Austin, TX 78759, (512) 338-4400.

**Inquiry 770.**

procedures. The compiler recognizes explicit register references through standard identifiers, the company reports. It also recognizes explicit branches to labels, procedures, and functions.

Source code for the code generator and library is included. You can compile the code generator with either Turbo Pascal 4.0 or Rascal. The Rascal-generated code is about 50 percent faster, according to the manufacturer.

**Price:** \$19.67.

**Contact:** Eugene Nelson, 1009 Vilas, Suite 3, Madison, WI 53715, (608) 257-7588.

**Inquiry 771.**

## 80386 C Compiler Creates Protected-Mode Code

**T**he NDP C-386 C compiler from MicroWay is a globally optimizing compiler that was designed for the Intel 80386. It generates native 80386 protected-mode 32-bit code that runs under DOS or Unix V.

The compiler is capable of running with arrays larger than 64K bytes and can run programs as large as 4 gigabytes.

NDP C-386 is a full implementation of PCC, Bell Lab's Portable C Compiler, whose syntax is a superset of Kernighan and Ritchie C. The compiler includes all standard PCC extensions along with supersets of ANSI C and Microsoft C extensions. The new extensions include a set of graphics and BASIC-like screen handling functions, in addition to hooks to the operating system.

Coprocessors supported include the MicroWay/Weitek mW1167 and the Intel 80387 and 80287 coprocessors.

MicroWay's C compiler runs on any 80386-based computer or AT compatible with an Intel Inboard or other 80386 add-on board. A floating-point coprocessor is required, as well as 2 megabytes of extended memory.

You'll also need a hard disk drive with at least 2 megabytes of free memory. DOS 3.2 or higher or Unix 386 System V Release 3 is also required.

**Price:** \$595.

**Contact:** MicroWay, P.O. Box 79, Kingston, MA 02364, (508) 746-7341.

**Inquiry 768.**

## Document It!

**T**o simplify the process of documenting C programs, Software Blacksmiths designed C-DOC, a set of documentation tools for C programmers. The tools also modify your programs and can insert documentation as a part of each individual module header.

C-Call documents the caller/called hierarchy of a group of programs. It creates graphic tree diagrams that show the flow structure. It also produces a table of contents of files versus modules, processes functions and macros with parameters, and generates cross-references of function definitions and usages.

C-Ref analyzes and documents the use of local/global parameter identifiers. It also produces summaries for individual modules for use in headers, and it produces a module- or system-level cross-reference of all identifiers, definitions, and usages.

C-List analyzes and displays the flow structure within modules. It will reformat a source program and produce structure outlines of the flow structure.

C-Hdr uses outputs from C-List to generate and update module headers.

The program runs on the IBM PC, XT, AT, and compatibles with DOS 2.0 or higher and 256K bytes of RAM.

**Price:** \$89.

**Contact:** Software Blacksmiths, Inc., 6064 St. Ives Way, Mississauga, Ontario, Canada L5N 4M1, (416) 858-4466.

**Inquiry 769.**

## A Rascal for Pascal

**A** Pascal compiler for \$19.67? Rascal (rhymes with Pascal) supports a 64K-byte code and a 64K-byte data segment, performs floating-point arithmetic with an 8087, and produces a .COM file in two passes. The company reports that the compiler is capable of compiling about 1000 lines per minute on an IBM PC and compares the object code produced to that of Turbo Pascal 4.0.

Rascal features 30 operators and 6 distinct classes. It also includes 156 standard

## Facelt Builds Menus

**I**nstead of drawing a window, typing in the text, and positioning it on-screen, Facelt automatically builds single windows and multi-menu systems from your database and ASCII files. It determines the window size based on the amount of text to be displayed. It also automatically positions the window on-screen, configures the spacing between choices, and determines the correct number of columns.

Virtual windowing and built-in scrolling are other features of Facelt. The program is compatible with dBASE III Plus, FoxBASE+, DBXL, Clipper, Quicksilver, and Borland and Microsoft languages. Language-specific modules are contained within FaceIt. It runs on PS/2s and compatibles.

**Price:** \$99.

**Contact:** Black and White International, Inc., 23 West 88th Street, New York, NY 10024, (212) 787-6633.

**Inquiry 772.**

*continued*

# Take a peek at Genoa's new PC graphics add-ons.



You've known Genoa as a developer of high performance graphics chips, and a leading manufacturer of graphics boards and tape backup. Soon you'll be able to depend on us for all your PC graphics add-on hardware.

Over the next year, we'll be unwrapping a series of graphics products. Each is designed to give you the most reliable, yet innovative engineering features. And above all, the highest performance possible.

Our SuperVGA HiRes family, featured here, is the first in our new product series. SuperVGA HiRes offers breathtaking color and resolution. From 16 colors in 1024x768. Up to 256 colors in 800x600. You'll see more of your spreadsheets at once with SuperVGA HiRes. 132 columns and 60 rows. You'll do Windows or OS/2. In fact, every SuperVGA HiRes feature is designed to turn your IBM PC/XT/AT and PS/2 models 25 and 30 into real graphics engines.

## Delivering SuperVGA HiRes™ now!



- 100% IBM VGA compatible
- Advanced features
  - 1024x768 in 16 colors and 800x600 in 256 colors/Model 5200
  - 512x512 in 256 colors/Model 5100
- 132 columns text
- For both analog and TTL displays

If you're looking for PC graphics add-ons, take a look at Genoa first. Our new line of products is starting delivery *now!*

For the Genoa dealer nearest you or to add your name to our mailing list contact: Genoa Systems Corporation, 75 E. Trimble Road, San Jose, CA 95131. Fax: 408/434-0997. Telex: 172319. Or phone: 408/432-9090. In the UK, contact Genoa Systems Limited, phone 01-225-3247. In the Far East contact Genoa/Taiwan, phone: 2-776-3933.

*Circle 94 on Reader Service Card*



**Delivering PC Graphics**

408/432-9090

## Data Analysis All Over Your Screen

**D**SP Development Corp. says the most difficult thing about DADiSP is pronouncing its name. It's pronounced "Day-Disp," and it stands for data analysis and digital signal processing.

You use the program after you've acquired data from a variety of instruments.

DADiSP 2.0 is a package that lets you import ASCII and binary single or multichannel data files into the database as a data set. The program has a menu-driven interface and lets you analyze your data graphically and numerically. The waveforms are represented in windows that are treated as cells in a spreadsheet. When you make a change to a waveform in one window, the program makes the necessary alterations to others.

The worksheet can hold up to 64 windows, with each offering graphics operations such as scrolling, zooming, expansion, compression, and cursor movement.

The program has over 160 analysis routines, including signal arithmetic, signal calculus, waveform generation, Fourier analysis, frequency domain analysis, correlations, and trigonometric and statistical routines. DSP reports that the size of waveforms is unlimited, as the program pages large waveforms to and from your disk during calculations.

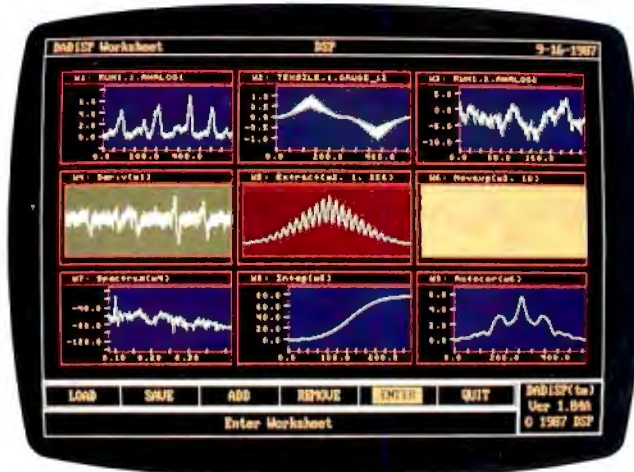

*DADiSP waveforms are presented in multiple windows.*

DADiSP runs on the IBM PC, XT, AT, and compatibles as well as on Sun and other workstations. It runs under DOS, Unix, and OS/2, according to DSP.

**Price:** DOS version, \$795; Unix version, \$2495.

**Contact:** DSP Development Corp., One Kendall Sq., Cambridge, MA 02139, (617) 577-1133.

**Inquiry 773.**

## Go Solo!

**S**olo 101 is a statistical program that features fill-in-the-blank-type panels that give you your statistical-analysis options. If you need help knowing what to put into a panel, you move the cursor to the field and a help message pops up.

With Solo you can calculate the mean, standard deviation, and percentiles, and

you can generate frequency tables and cross-tabulations. The program also performs multiple regression with residual analysis, stepwise regression, robust regression, weighted regression, and correlation analysis. You can store residuals, predicted values, confidence intervals, and other observation-type statistics in Solo's database. Forecasting techniques include trend analysis, single and double exponential smoothing, and seasonal adjustment. Analysis of variance procedures include general linear models, unweighted means, and repeated measures.

Solo includes a data-entry spreadsheet, database utilities, data import, report writing, and transformation capabilities. With the spreadsheet editor, you can cut and paste sections of the database, append data to existing information, and reorder columns for easier data entry and viewing.

The data-import facility lets you read and write ASCII files. You can also sort, merge, transpose, or make subsets of databases. A report writer also lets you output to a printer or ASCII file.

The program runs on the IBM PC, XT, AT, and compatibles with DOS 2.1 or higher, 512K bytes of RAM, and a VGA, EGA, CGA, or Hercules graphics card.

**Price:** \$149.

**Contact:** BMDP Statistical Software, Inc., 1440 Sepulveda Blvd., Los Angeles, CA 90025, (213) 479-7799.

**Inquiry 774.**

## Preview AutoCAD Drawings

**W**hether you're using AutoCAD or not, you can pop out of whatever program you're in and take a look at an AutoCAD (DWG) drawing with SoftWest Quick-See. Because it is a stand-alone program, you don't need AutoCAD to run it. The manufacturer reports that it displays a drawing at close to AutoCAD Redraw speeds.

SoftWest Quick-See runs on the IBM PC and compatibles with DOS 2.1 or higher, 256K bytes of RAM, and a Hercules monochrome display adapter, EGA, CGA, or VGA. A math coprocessor and a hard disk drive are not required.

**Price:** \$99.

**Contact:** The Great SoftWestern Company, Inc., 207 West Hickory St., Suite 202, Denton, TX 76201, (800) 231-6880; in Texas, (817) 383-4434.

**Inquiry 775.**

## AutoCAD on the Mac II

**A**utoCAD Release 10 runs on the Mac II and adds three-dimensional wireframe construction and surface modeling capabilities, along with new drawing and editing features. These include user-defined coordi-

nate systems, dynamic real-time zoom and three-dimensional rotation, and multiple view ports.

Release 10 is data-file-compatible with MS-DOS and Unix versions of the program, so you can read and

write drawing files interchangeably between two different machines.

**Price:** \$3000.

**Contact:** Autodesk, 2320 Marinship Way, Sausalito, CA 94965, (415) 332-2344.

**Inquiry 776.**

*continued*





# NO OTHER DESKTOP PUBLISHING SYSTEM OFFERS THIS FEATURE.

With the new Mannesmann Tally® Universal™ Publishing System, you can practically fly.

Thanks to a Raster Image Processor board that plugs directly into your PC or compatible, you'll process your pages at a speed limited only by the speed of your computer. Not—as is typical—at the speed of the printer. And you'll transfer ready-to-print data directly to the printer through a video interface at an incredible 3-million bits per second.

So when you're using the PostScript® compatible interpreter, you'll produce a printed page almost twice as fast as most other systems. But that's just ground speed.

If you use Aldus® Page-Maker or Ventura Publisher®, you'll



- Systems:
  1. Universal Publishing System (includes a PostScript compatible interpreter and Document Description Language (DDL))
  2. DDL Publishing System (DDL only).
- Resolution: 300 x 300 dpi.
- Emulations: Both systems include HP\* LaserJet.
- Memory: 2 Mg.
- Typefaces: UPS includes 35 typefaces, DDL System includes 22 typefaces.
- Speed: 10 pages-per-minute.
- Dual paper cassettes standard, 250 sheets each.
- Dual output bins standard, 250 sheets each.
- Manual feed handles single sheets, envelopes, transparencies, and labels.
- Workload: 10,000 pages-per-month.

really take off. Because when you select DDL instead of the PostScript compatible interpreter, you'll double that speed again. And with full page bitmap graphics, you can get printed output up to 17 times as fast.

So call the number below for the name of your nearest dealer and log in your time on the New Mannesmann Tally Universal Publishing System. A pilot's license is not required.

**MANNESMANN  
TALLY**  
**1-800-843-1347**

In Washington state, call:  
206-251-5524 Ext. 130

Ext. 130

Test results available upon request. PostScript is a registered trademark of Adobe Systems, Inc. DDL is a registered trademark of Imagen Corp. Ventura Publisher is a registered trademark of Ventura Corp. PageMaker is a registered trademark of Aldus Corp.



# 400%

Introducing our newest family of 9-wire dot-matrix printers. The re-engineered MSP series, featuring the latest advances in print technology.

To begin with, they're 50% faster. In the draft printing mode, the MSP-40 and 45 top out at 240 cps. And the MSP-50 and 55 have a maximum cruising speed of 300 cps.

Each model features a new, bidirectional print mechanism, that can generate brilliant graphics resolution. And the new MSP-50 and 55 can produce crisp, near-letter-quality print with even better throughput.

We also made it easier to load the MSP series.

The paper bale has been replaced with a built-in convertible push or pull paper tractor. And the sleek new redesign



# New.

now incorporates a rear or bottom feed. Real handy if you're printing labels, forms, cards or stationery.

As for convenience, you'll also appreciate the front panel controls, the outstanding compatibility and the wide selection of typestyles via available font cards. There's even color capability on the deluxe MSP-50 and 55.

All in all, the MSP series, with an 18-month warranty, represents an excellent value in precision-built printers. Which, considering Citizen's tradition, isn't all that new.

For the dealer nearest you, call 1-800-556-1234, Ext. 34.

In California, call 1-800-441-2345, Ext. 34.

©1988 Citizen America Corporation. Citizen and the Citizen logo are trademarks of Citizen Watch Co., Ltd.

 **CITIZEN™**  
Printers that run like clockwork.

## Slideshow on the Desktop

Now you can create slides with access to 16.8 million colors on a Mac II to use in your desktop presentations. Microsoft has enhanced PowerPoint 2.0 with templates that have built-in color schemes, background effects, and fonts. Other added features include a spelling checker and a find-and-replace command.

To take advantage of the preselected color schemes, you select a background color, and the program suggests contrasting colors. If you merge slides into other presentations, you can choose different color schemes, with all elements of the slide converting to the new color scheme.

The spelling checker comes with a main dictionary that you can supplement with your own words. Word-processing features of the program include tabs and decimal tabs, variable line and paragraph spacing, and five out-line-like levels for bulleted copy points.

The program also lets you import graphics from MacPoint, PICT, and EPSE file formats. Using the Macintosh Clipboard, you can incorporate graphics in any format, according to Microsoft. You can also incorporate black-and-white graphics and then color them.

PowerPoint 2.0 runs on the Mac Plus, SE, or II running System 4.1 or higher with 1 megabyte of RAM and two 800K-byte floppy disk drives or a hard disk drive. The software is compatible with AppleShare and MultiFinder. **Price:** \$395.

**Contact:** Microsoft Corp., 16011 Northeast 36th Way, P.O. Box 97017, Redmond, WA 98073, (206) 882-8080. **Inquiry 777.**



Sample desktop presentation slide from PowerPoint 2.0.

## Make Your Commodore 64/128 a Desktop Publisher

Create multiple-column page layouts on the Commodore 64 and 128 (in 64 emulation) with PaperClip Publisher from Electronic Arts.

You can create documents of up to 50 pages in length; manipulate text and graphics with ruler, margin, and column guides; enlarge pages with the magnify mode; and resize boxes and have text flow between them.

A text editor is included, and the font converter utility lets you convert fonts from popular word processors. You can also import text files from PaperClip II and other word processors.

The built-in graphics editor lets you import and edit graphics from other programs. You can also choose from a variety of box backgrounds and outlines, and you can work on pages from 3 by 3 inches to 8 by 14 inches with as many columns as you want. PaperClip Publisher also supports a wide variety of printers.

The program runs on the Commodore 64 and 128 with

64K bytes of RAM, a 1541 or 1571 floppy disk drive, and a mouse or joystick. **Price:** \$49.95. **Contact:** Electronic Arts, 1820 Gateway Dr., San Mateo, CA 94404, (415) 571-7171. **Inquiry 778.**

## 1-2-C Compiler

Compile 1-2-C converts your worksheets into C source code instead of BASIC. It also handles more than just Lotus files and will compile any .WKS files.

Once your worksheets are compiled, you don't need the original spreadsheet program, as the worksheets become stand-alone .EXE files.

Compile 1-2-C, formerly known as LTS2C, runs on the IBM PC, XT, AT, and compatibles with 640K bytes of RAM and a 1.5-megabyte hard disk drive. The program works with Lotus 1-2-3 releases 1A and 2.01 and works with all 1-2-3 commands except Graph and Window. The program is not copy-protected.

**Price:** \$299. **Contact:** Resource Analysis International Corp., 12581 Venice Blvd., Los Angeles, CA 90066, (213) 390-7661. **Inquiry 779.**

## A Helping Hand from Handi

The makers of Handi call it "information integration software." It's one program that combines a database manager, word processor, calendar, scheduler with alarms, and report generator. You can run it as either a stand-alone or a memory-resident program.

HandiBase is the database manager. Each database holds a maximum of 65,500 B-tree indexed records. Each record can contain up to 4090 bytes of structured and free-form data. Each database can support up to 20 structured fields.

HandiWord is a word processor that performs word wrap, text block manipulation, find/replace, cut/paste, import, export, and other text manipulation functions. It handles large documents of up to 60,000 characters.

The program's calendar module is called Handi-Scheduler, and it features an alarm that you can set to remind you of appointments or other events. When the alarm goes off, a small window pops up on the screen when you're in other programs, and some text reminds you of why the alarm has gone off.

HandiReport is the report generator, and it lets you print form letters, labels, business reports, invoices, and more.

Handi runs on the IBM PC, XT, AT, and compatibles with DOS 2.1 or higher and 74K bytes of free RAM.

**Price:** \$49. **Contact:** HandiCorp, Inc., 17080 142nd Place NE, P.O. Box 1263, Woodinville, WA 98072, (800) 451-3496; in Washington, (206) 481-7026. **Inquiry 780.**

*continued*



# Emulate The Best With The Brightest.

There's no denying the availability of some outstanding dedicated terminals to access Digital®, Hewlett-Packard, and Data General® host systems. Which makes the task of precisely emulating the performance of those dedicated terminals on an IBM® PC or compatible a rather significant challenge.

Based on the feedback we've received from SmarTerm® users, our family of terminal emulation software has met the challenge, passed every test, and surpassed, in the opinion of a host of enthusiastic users, the performance of the host system terminals being emulated.

The reasons why we shine are fundamental.

Every SmarTerm emulation is precise. So precise, in fact, that a dedicated terminal's SmarTerm counterpart fully emulates not only advanced performance features but also unique terminal quirks and bugs.

Every SmarTerm emulation is easy to use. It's one thing to make software do what hardware does. It's another challenge to minimize software's human wear. The people designing our products understand the nature of the people using them.

Every SmarTerm emulation is easy to learn. These days, training costs are a hot topic. Software intended to boost overall system efficiency must recognize the value of learning speed. We have.

It's also easy to learn more about how SmarTerm emulations can help you shine. Your software dealer can supply all the details. Or you can contact us at (608) 273-6000 to request complete specifications and a demonstration disk of the SmarTerm emulation that precisely matches your requirements.

**persoft®**

© 1988 Persoft, Inc., 465 Science Drive, Madison, Wisconsin 53711 U.S.A. Persoft and SmarTerm are registered trademarks of Persoft, Inc. All Rights Reserved. IBM is a registered trademark of International Business Machines Corporation. Digital is a registered trademark of Digital Equipment Corporation. Data General is a registered trademark of Data General Corporation.

**N**etBIOS compatibility, electronic mail, enhanced network software, and support for OS/2 are added to 10-Net Plus local-area-network (LAN) soft-

ware. Also added is Network Courier from Consumers Software.

works and has the ability to link various mail servers together. It also features network-monitoring tools and a

the software, making it available for IBM Token Ring and Ethernet systems. Applications written for pre-

**Price:** \$395 (IBM Token unbundled).

**Contact:** 10Net Communications, 7016 Corporate Way, Dayton, OH 45459. (513) 433-2251. **Inquiry 782.**

## Make Connections with Reunion

**R**eunion software lets you access and process information between an IBM PC, an asynchronous host mainframe, and minicomputers. It provides two-way communication between host computers and PC applications, terminal emulation, file transfer, multitasking, and program development. The program's multitasking ability lets you run it in the background of other application programs, transferring files, sending mail, or retrieving host information, while you continue to use the application program in the foreground.

The program is menu-driven and contains a dialing directory and help. To further simplify use of the program, you can redefine or re-map any key on your PC keyboard. You can also create macros with Reunion, automating repetitive tasks so that one keystroke can perform a series of commands.

A Writer facility lets you create, modify, compile, and test scripts. It also imports any ASCII editor for use within Reunion. A Learn facility

lets you automate communications sessions, allowing you to alter scripts. The Connect facility offers a modular structure for connecting to host computers and information services. It also includes a dialing directory.

Reunion's application language, Resource, contains about 75 commands that let you read and write to PC files, initiate and control other PC applications, call other scripts as subroutines, and let the host computer initiate PC applications.

Terminals emulated include the IBM 3101 Character Mode; DEC VT-220, VT-100, and VT-52; generic TTY; and PC7171 for protocol converters. Methods of file transfer include XMODEM and YMODEM, Kermit, Linkware, and nonprotocol ASCII.

To run Reunion you'll need an IBM PC or PS/2 with DOS 2.0 or higher and at least 384K bytes of RAM, with at least 512K bytes needed for Linkware file transfers. You also need an asynchronous COM1 port, a COM2 port, or a Net/One network adapter, and a CGA, EGA, VGA, or IBM monochrome adapter.

**Price:** \$175. **Contact:** Westford Harbor Co., 288 Littleton Rd., POB 240, Westford, MA 01886, (617) 692-9440. **Inquiry 781.**

## Networking with DataEase

**D**ataEase, a database management program, is now available in a network version. Applications you've developed with single-user DataEase can run on DataEase LAN with a single keystroke, the company reports.

The LAN version provides three record-locking and two file-locking strategies for viewing and editing shared data. It also has a MultiView feature, which shows you multiple related files with one keystroke.

With DataEase LAN 1.1, you can have 26 databases per directory, up to 255 files per database, and up to 255 reports per database. It also provides B-tree indexing, wild-card searches, and 99 predefined choice fields. You can import DataEase, Lotus, dBASE II and III, DIF, ASCII, and mail-merge files, and you can export to Lotus, DIF, Multi-Mate, ASCII, mail-merge, and GrafTalk file formats.

DataEase LAN 1.1 runs on the IBM PC, XT, AT, 3270 PC, PS/2s, and compatibles with at least 640K bytes of RAM. You also need an interface card supported by the

DOS 3.1 network interface or Novell Netware 86 or 286 version 2.0a or higher. The database management program runs with Banyan VINES 2.1, 3Com EtherSeries and 3+ 1.2, IBM PC LAN 1.1, Novell Netware 86/286 2.0a or higher, and the AT&T StarLAN.

**Price:** \$700; \$900 for the Workstation pack, which provides access for three additional PCs.

**Contact:** DataEase International, Inc., 7 Cambridge Dr., Trumbull, CT 06611, (800) 243-5123; in Connecticut, (203) 374-8000. **Inquiry 783.**

## Macintosh E-Mail System

**M**acintosh users can add the ability to communicate electronically over AppleTalk networks with QuickMail. This desk accessory offers an automatic log-in option, log-in/log-out, and password security.

With QuickMail you can have real-time private or public conferences; you can also generate a transcript of the conferences. A public bulletin board is included, and you can invoke a privacy feature for a specified length of time.

You can forward messages to other users, print them out, or save them to disk. You can also attach up to 16 files or clipboards per message and reply to or edit sent messages.

The program works on networks with the Macintosh 512KE systems and higher with at least one hard disk drive. It is compatible with AppleShare, TOPS, and Mac-Serve networks.

**Price:** \$300 per 10 users. **Contact:** CE Software, 1854 Fuller Rd., West Des Moines, IA 50265, (515) 224-1995. **Inquiry 784.**

*continued*

# FACT:

## MORE AND MORE PEOPLE

## ARE SWITCHING TO TOPSPEED MODULA-2

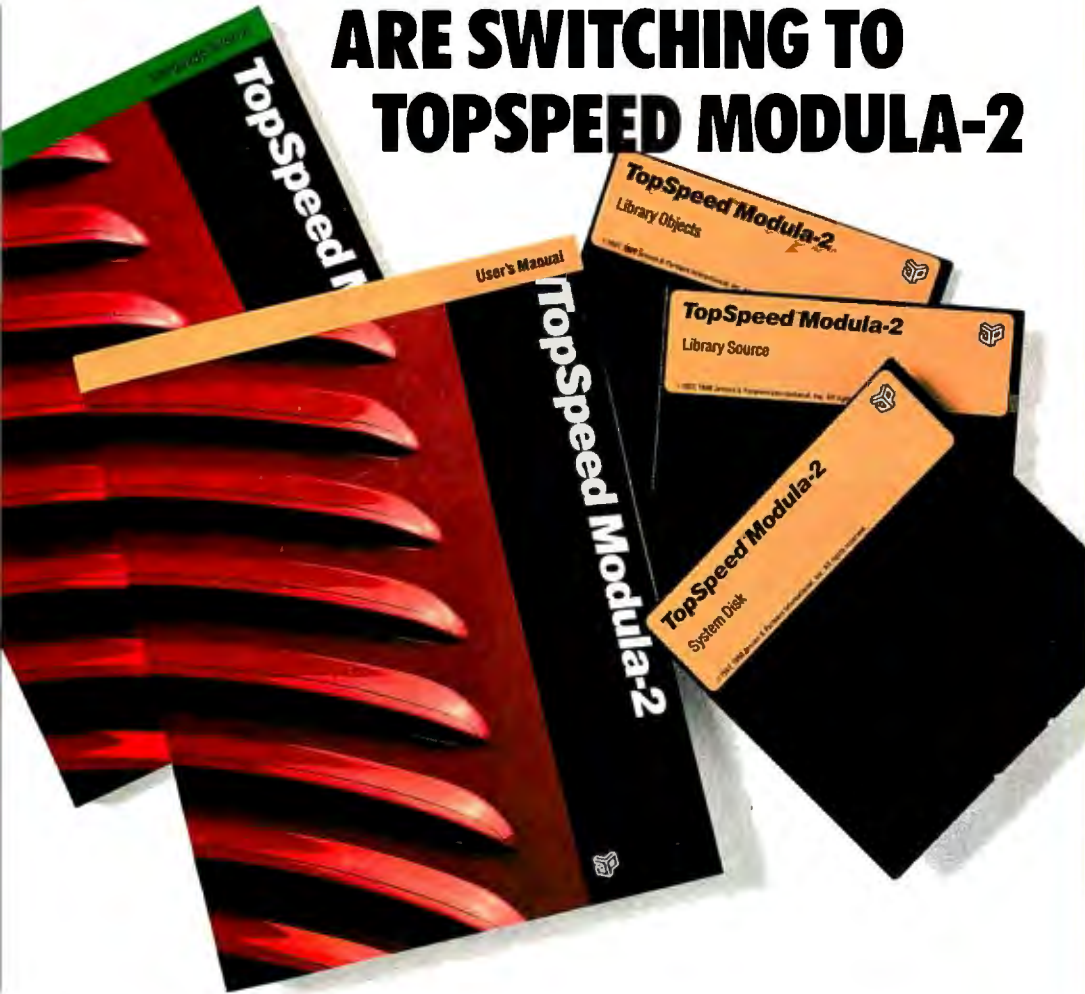

"JPI Modula-2 looks like another classic in the making. It generates code as good as or better than leading C compilers and the programming environment is a genuine pleasure to use. At the price it's a tremendous bargain, and with luck it just might do for Modula what Turbo has done for Pascal."

Dick Pountain  
Byte Information Exchange  
short.takes conference

"I liked all of the hard-disk space that was recovered after I deleted my BORLAND, MICROSOFT, and LOGITECH compilers, because with TopSpeed Modula-2 all the rest are obsolete."

Robert D. Randall  
Donnelley Marketing

**The successor of Pascal:** JPI TopSpeed Modula-2 produces better code than Microsoft C, Turbo C, Logitech Modula-2, and Turbo Pascal 4.0.

JPI TopSpeed Modula-2 is a professional Modula-2 development system with full support of memory models, multi-tasking, long data types, structured constants, long and short pointers, 80X87 inline code and emulator, separate compilation, direct BIOS/DOS calls, etc. The comprehensive library includes CGA, EGA and VGA graphics support, math functions, sorting, file handling, window management, a time-sliced process scheduler and more.

**The Compiler Kit includes:** High-speed optimizing compiler, integrated menu-driven environment with multi-window/multi-file editor, automatic make, fast smart linker. All Modula-2 sources to libraries included. **BONUS:** Complete high-speed window management module included with source. 258-page User's Manual and 190-page Language Tutorial.

**The TechKit includes:** Assembler source for start-up code and run-time library, JPI TopSpeed Assembler (30,000 lines/min), TSR module, communications driver, PROM locator, dynamic overlays, and technical information. 72-page manual.

**System Requirements:** IBM PC or compatible, 384K RAM, two floppy drives (hard disk recommended).



TopSpeed's seamlessly integrated environment.

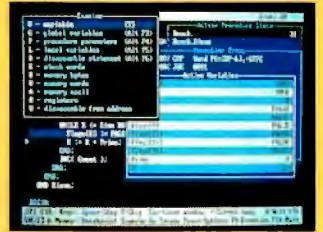

VID, the Visual Interface Debugger, coming soon.

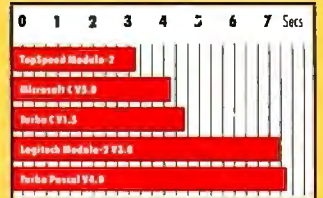

Sieve benchmark measured by the British Standards Institution (BSI)—25 iterations on an 8MHz AT.

**Compiler Kit \$99.95.**  
**TechKit \$59.95.**

### To Order:

In the US & Canada, call:  
**1-800-443-0100**

Ext 255, 24 Hours.

Or mail us your order with a check, money order, or VISA/MC information.

30-day unconditional money-back guarantee.

Shipping & handling charges:  
In North America: Add \$5.00 shipping & handling, plus \$2.00 for each additional product. Overseas: Add \$20.00 shipping & handling, plus \$8.00 for each additional product.



Jensen &  
Partners  
International

1101 San Antonio Rd, Suite 301  
Mountain View CA 94043  
Phone: (415) 967-3200

**In England and Europe contact:**  
Jensen & Partners UK Ltd., 63 Clerkenwell Rd., London EC1M 5NP. Phone: (01) 253-4333. Compiler Kit £59.95, (add £4.69 for VAT & handling in the UK; £4.00 handling in Europe). TechKit £34.95 (add £4.03 for VAT & handling in the UK; £4.00 handling in Europe).

TopSpeed is a trademark of Jensen & Partners International. Other brand and product names are trademarks or registered trademarks of their respective holders.

## Design Your Own Logo

Using an IBM PC with a TrueVision TARGA or VISTA graphics board and Flamingo's Logo Editor, you can create logos and illustrations.

The object-oriented drawing program lets you trace or create illustrations with smooth antialiased edges. The Logo Editor comes with object types such as curves, ovals, arcs, circles, lines, rectangles, irregular polygons, and text. You can choose objects from pop-up menus and manipulate them with a mouse or graphics tablet. You can also group, ungroup, rotate, flip, move, copy, scale, stretch, delete, and undelete objects.

You can edit the text that comes with the cubic spline outline definitions and incorporate the text into your logos. Eight outline fonts are provided.

Layout tools include flat, gradient, or TARGA image background styles; and grids, resident color palettes, and color creation models. You can render your work on-screen through an antialiasing process that smooths the curves and lines. You can also store your designs as logos or as fonts. Logo files are read back into the Logo Editor and printed onto any TARGA image file. Font files are compatible with Flamingo Graphics' RIO.

Logo Editor runs on the IBM PC AT and compatibles with at least 640K bytes of RAM and a 10-megabyte hard disk drive. You also need a TARGA frame buffer and an analog RGB or composite monitor. The company also recommends Expanded Memory Specification memory and a math coprocessor.



An illustration created with Flamingo's Logo Editor.

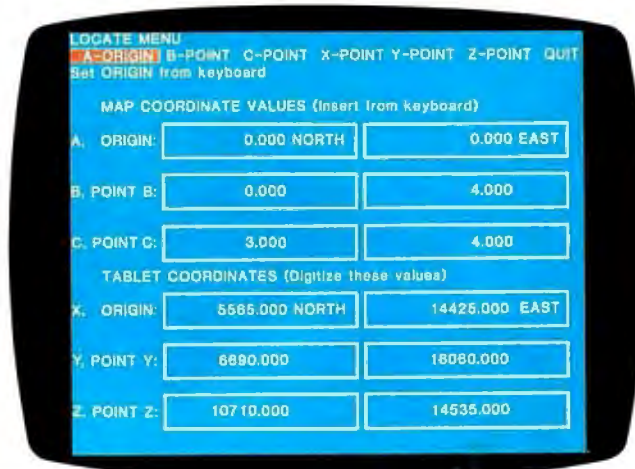

HotDij matches digitizer data to other programs.

Price: \$895.  
Contact: Flamingo Graphics, 875 Main St., Cambridge, MA 02139, (617) 661-1001.  
Inquiry 785.

## Digitize Me

Place data from a digitizer tablet directly into your word processor, spreadsheet, or other programs with HotDij, a memory-resident utility.

HotDij contains preprogrammed control characters to

match the digitizer data to your other programs. You can also define up to four additional sets of control characters. The program adds control characters to enter the data into columns on the monitor. It adjusts for drawing scale and corrects for drawing placement errors. HotDij keeps track of changes in scale or drawing location, as well as the application in use. Whenever you reboot, HotDij remembers your previous application and sets up for it. The program allows for keyboard input and accepts ASCII input to the digitizer.

HotDij is menu-driven. It also offers you a selection of

34 predefined digitizer interfaces. When you install the program, you must match the report format of the digitizer tablet to your computer.

Designed to run on the IBM PC and compatibles, you'll need at least 64K bytes of free RAM and an asynchronous communications port. The program comes with a wiring adapter to connect your system with a digitizer. Geocomp reports that the program works with any digitizer that sends ASCII. Price: \$335.

Contact: Geocomp Ltd., 749 Van Gordon Court, Golden, CO 80401, (303) 233-1250.  
Inquiry 786.

## Perk Up Your Output

If your standard 9-pin dot-matrix printer produces dull-looking output, The Image Printing Utilities may be able to help. The program achieves higher-quality output by making three print passes over each line, with a different pattern of dots each time. The dot density is 216 dots per inch vertically by 240 dpi horizontally.

The program includes 16 fonts, and all except the Graphics font include the entire character set of an IBM Graphics Printer.

The program takes up 35K bytes of RAM for each font loaded. It runs on the IBM PC and compatibles with DOS 2.0 or higher and at least 128K bytes of RAM. Price: \$89.95.

Contact: Image Computer Systems, P.O. Box 647, Avon, CT 06001, (203) 678-8771.  
Inquiry 787.





16 color VGA Support



RIX SoftWorks, Inc.

# EGA Paint 2005 Final Version



Dual Brush Modes



Smooth Command



Airbrush Command

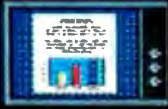

Grid Command

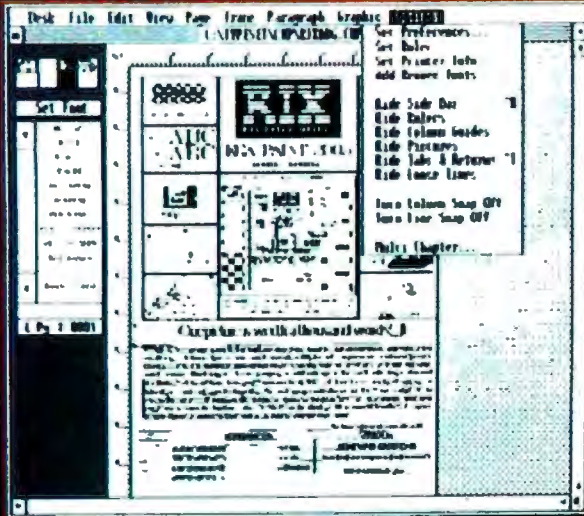

Publish any EGA Paint 2005 Graphics screen!  
The Final Version will convert any screen to  
.IMG or .PCX files for your desktop system!



360° Rotate Command

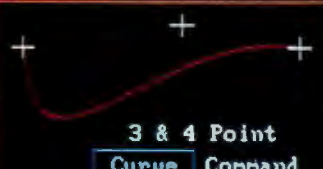

3 & 4 Point  
Curve Command



FullPage  
Printing

Screen  
Pan



Capture  
almost any screen



Area Command

## One picture is worth a thousand words!

Kiss those endless upgrade fees goodbye! After well over three years of development, RIX is pleased to announce the Final Version of our EGA specific graphics editor, EGA Paint 2005. RIX was the **first** (and still the only) graphics, software company to introduce an EGA specific graphics editor, the **first** to create a combination TARGA™ image translator and print package, the **first** to release a VGA specific hi-res graphics editor (in July), and now the **first to release a final version of any software program ... ever!** We at RIX had originally planned to release a separate package to implement desktop publishing capabilities but when the release date arrived, we felt our loyal users deserved a fully self-contained graphics package. Now RIX has made it possible for you to make a little history too with EGA Paint 2005 Final Version, At \$129.00, surely the best value in graphics programs ever! Find out why. Order today! RIX SoftWorks, always the best ... for less!

COMING IN JULY

### COLORIX VGA PAINT!

ColorIX VGA Paint is the cat's meow for your Hi-Res VGA system! ColorIX supports all modes of VGA, and has time saving features like: Automatic color graduation generation, block palette freeup, image drag for 3D effects, a completely self-contained presentation package which has animation capabilities, and much more. We'll be shipping in July, first come, first served so get your order in now! **Only \$199.00!**



RIX SoftWorks, Inc.

18552 MacArthur Bl. • Suite 375 • Irvine, CA 92715 • (714) 476-8266

CALL US TOLL FREE:

In CA (800) 233-5983 Outside CA: (800) 345-9059

## WHAT'S NEW

PACIFIC COAST

Data for Here,  
or to Go

The Disk Pack has two slots that hold removable hard disks (20 to 160 megabytes) and is fully compatible with Macintosh, Apple, IBM PC, XT, AT, and compatible computers, according to Mega Drive Systems.

The base, which contains the two slots for the removable hard disks, has a SCSI interface bus and a Mac-compatible connector. You can choose between several formatted capacities for the hard disks: 20, 45, 70, 120, or 160 megabytes. Each weighs about 2½ pounds, and you can daisy-chain disk packs to hold as much as 1 gigabyte



Disk Pack works with IBM PCs, Macs, and Apple computers.

of on-line data.

Disk Pack connects directly to the Mac Plus, SE, and II through the SCSI port. A SCSI board is required to connect the Disk Pack to an Apple IIe, IIc, IIGS or Mac 128K, 512K, or 512Ke. SCSI connector kits (\$469 for IBM PC, XT, AT, or compatibles and \$749 for the PS/2 series) are also available.

**Price:** Base (two-slot), \$699. Modules: \$849, 20-megabyte; \$1299, 45-megabyte; \$1599, 70-megabyte; \$1999, 120-megabyte; price not available for the 160-megabyte.

**Contact:** Mega Drive Systems, 1801 Avenue of the Stars, Suite 507, Los Angeles, CA 90067, (213) 556-1628 or (800) 322-4744.

**Inquiry 835.**

*continued*

## It's the Dawn of the Information Age...

The new modems with built-in data compression are all the rage. Trouble is, they use the Lempel-Ziv algorithm—something less than optimal!

The centerpiece of the **FlySpeed Collection** is **st/exp**, the first commercial implementation of Fly Coding. **st/exp** compresses text files typically to 30% or less of their original size, at rates of over 1000 words per second, allowing you not only to communicate faster, but also save valuable disk space.

But now that you can communicate and store information so much more efficiently, you need a more efficient way of creating it. So we created **Typing Demon**, a spin-off of our work on communication aids for the handicapped. Typing Demon partially automates typing, speeding word-processing by 25% or more. Nothing revolutionary—just the difference between finishing the afternoon's word-processing at 4:45, versus 6:00 p.m.

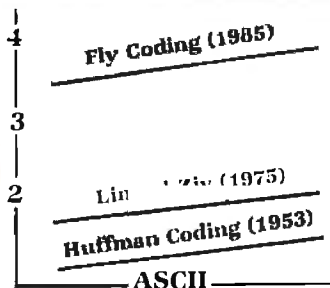

Do you know where your  
Optimal Representation  
of Language is?



**MicroComputer Square**

126 Hancock Avenue  
Spartanburg, S.C. 29302  
(803) 583-9655

With "d," FlySpeed's user-friendly directory program, you'll be able to look at your files sorted by file name, file date, etc. And you'll be able to page back and forth through long directories to your heart's content. (Say goodbye to directories scrolling off-screen.)

And when **Merlin**, the text-retrieval member of FlySpeed, debuts in January, you'll not only be able to create, communicate, and store information more quickly and efficiently, but you'll actually be able to find it later! *Instantly*, based upon any word or combination of words in a document. Because Fly Coding is inherently indexed.

You wouldn't expect computers of the 21st century to store and communicate information in the same inefficient format used in the 1950s. Now, for just 75 bucks, neither will yours.

# Great Software for your PC - \$2 per disk (Reg. \$6)

We are making this special offer to introduce you to membership in PC-SIG: The World's Largest Source of Low Cost Software for the IBM-PC and compatibles. PC-SIG disks are normally \$6 each (less with membership) and come packed full of Shareware - software marketed in the revolutionary new way that allows you to try out a program before registering it with the author. PC-SIG provides your gateway to this software with the bimonthly SHAREWARE Magazine, Hot sheets and a 424+ page software directory. All this for a yearly membership fee of \$20 (USA).

Some of the advantages of buying from PC-SIG: We are the oldest and largest Shareware vendor. Our disks are the latest versions. Free technical support by phone. Most complete library of Shareware: over 1000 disks. 48 hour shipping.



Join PC-SIG and receive 424 page directory, bi-monthly Shareware Magazine, Hot sheets and special discounts

Take any disk listed in this ad -  
\$2 each - when you join today!  
Offer expires August 31, 1988.

## Communications

- 499 PROCOMM: Extremely versatile telecommunications.
- 310,1022,1023 O-MODEM: A favorite. Let's your computer talk via phone.
- 212,334,621 RBBS-PC: Set up your own bulletin board.

## Computer Languages/Education

- 577, 578 C TUTOR: Learn C language.
- 965 PASCAL COMPILER: Full-screen editor, incremental compiler and more.
- 254 PC-DOS HELP: Gives you on-line help to remember those DOS commands.
- 105 PC-PROFESSOR: Learn beginning BASIC.
- 775-778 PSEUDOSAM: Macro assemblers & debuggers for many popular microprocessors, including 8088/86/286s.
- 481 STILL RIVER SHELL: Menueed DOS commands. Makes life easier.
- 403 TUTOR.COM: Learn beginning DOS.

## Databases

- 287,288 FILE EXPRESS: Customize, menu driven data base.
- 5, 730, 1015 PC-FILE+: The most powerful and popular data base.
- 830 WAMPUM: dBase III clone, but easier to use. (Hard disk req)

## Educational

- 844 ABC FUN KEYS: For ages 2-5. Teaches the alphabet.
- 612 FOREIGN LANGUAGES: Beginning Spanish, French, German & Italian.
- 229 FUNNELS & BUCKETS: Fun game teaches younger children arithmetic.
- 320 PC-TOUCH: Typing tutor. (Color Req)
- 477 WORDGAMES: Stimulates the intellect.

## Financial

- 164, 773 CASHTRAC: Manage checking accounts, track investments.
- 151 FINANCE MANAGER II: Double entry bookkeeping.
- 469,470 MR. BILL: Itemize invoices, age accounts, etc.
- 331 PC-GENERAL LEDGER: Written by a top financial manager.
- 575 PC-STOCK: Track & evaluate stock trends. (Color req)

## Games

- 452 AMULET OF YENDOR: Hack, a dungeons & dragons adventure game.
- 708 BACKGAMMON: You against the computer. Also, Wheel of Fortune.
- 780 BRIDGE PAL: Computer plays 3 hands.
- 228 CRIBBAGE: And a few other games as well.

- 457 GREATEST ARCADE GAMES: Flightmare, Jump Joe, Spacewar (Color req.)
- 476 PATRICK'S BEST GAMES: Bugs Centipede, 3-D Packman, Castle, Packgal, Spacevad.
- 557 PINBALL RALLY: 3 great games of dexterity and speed. (Color req)
- 120 PC-CHESS: Your move...
- 791 POKER: Play draw poker head to head. Or try some Blackjack.
- 694 SLEUTH: A murder has been committed...
- 197 TWO TREKS: Beam me up, Scottie!
- 891 WHEEL OF MISFORTUNE: Spin the wheel, win or go bankrupt!

## Graphics

- (Most require CGA or EGA Card)
- 701-704 DANCAD 3D (4 disks): Create and animate 3d drawings. (Hard disk req)
  - 828 EDRAW: Draw flowcharts, schematics, even printed circuits!
  - 763 FINGER PAINT: A 3d wire frame modeling program. (Runs also with Hercules Card.)
  - 870 HGCIBM: Run color graphics programs with your Hercules Card!
  - 788 IMAGE 3-D (EGA ver.): Create, view, edit 3d objects.
  - 762 IMAGE 3-D (CGA ver.)
  - 1001 MAC PASTE: Read, save, edit and print Readmac or Mac Paint pictures.
  - 344,345,1032 PC-KEYDRAW: Graphics and "slideshow" presentations.
  - 244 SLIDE GENERATION: Create slides/transparencies.

## Home & Hobbies

- 966 ASTROLOGY 94: Calculate and print charts.
- 361, 632 FAMILY HISTORY: Trace your family tree.
- 929 LOTTO: Will this really help you win the lottery?
- 395 HOME INVENTORY: Keep track of everything you own.

## Music

- 127 PC-MUSICIAN: Compose and play your song.
- 279 PIANOMAN: Plays your music or its own in chords.

## Office

- 608 AUTOMENU: Create easy access menus for your hard drive.
- 824 DESK COMMANDO: Tools to tame your hard drive.
- 404 EZ-FORMS: Create your own business forms.
- 388 FORM LETTERS: Variety of business letter formats.
- 483 MAILMONSTER: Add, edit, sort and print labels by categories.
- 405 PC-DESK TEAM: In memory calculator, calendar, phone dialer, alarm & more!

## Printers

- 517 IMAGE PRINT: Letter quality from your dot matrix.
- 718 LQ PRINTER: Print fancy fonts on your dot matrix.
- 523 SIDEWRITER: Print banners or wide spreadsheets.

## Religion

- 974 BIBLE QUIZ PLUS: Learn the Bible trivia game.
- 766-772 THE BIBLE (7 disks): King James version.
- 581, 582 WORD WORKER: Performs text searches of words in the Bible.

## Security/Hacking

- 598 MASTERKEY: Like Norton Utilities. Recover lost files, etc.
- 414 UNPROTECT/PROTECT: Copy a variety of copy protected disks.

## Spreadsheets

- 524,525 EXPRESS CALC: Powerful but friendly spreadsheet.
- 199, 1016, 1017 PC-CALC: Like Lotus 1-2-3 but easier.

## Word Processing

- 719 LETTER WRITER: Print out "personalized" letters.
- 528 NEW YORK WORD: Allows split screen, mail merge & more.
- 480 PC-OUTLINE: Like ThinkTank. Organize your ideas & thoughts.
- 455,681,682 PC-TYPE: Jim Button's own word processor. Has it all.
- 78, 627 PC-WRITE: Powerful, multi featured, spelling checker, laser support.

Please send the disks I have checked above.

\_\_\_\_\_ disks x \$2 each = \_\_\_\_\_

1 year PC-SIG Membership = **\$20.00**

3 1/2" add \$1 per disk = \_\_\_\_\_

FREE Shipping and Handling

**Amount enclosed \$ \_\_\_\_\_**

By:  Check  Visa  M/C

Card No: \_\_\_\_\_

Exp. \_\_\_\_\_ Sig. \_\_\_\_\_

Name \_\_\_\_\_

Address \_\_\_\_\_

City: \_\_\_\_\_ State \_\_\_\_\_ Zip \_\_\_\_\_

**PC-SIG** 746  
1030D East Duane Ave  
Sunnyvale, CA 94086  
Offer valid in USA only Dealer Inquiries Invited

**Order By Phone:**

**800/245-6717**

**(In Calif. 800/222-2996)**

## Borland's Turbo Prolog 2.0

**P**rolog 2.0 features a database system with tools for developing and maintaining large databases and an interpreter that you can build into applications that require metaprogramming capabilities. You can also modify the interpreter to handle a new logic programming language, inference engine, or expert shell system.

Other new features include customizable interface, support for multiple internal databases, and mechanisms for handling error situations and controlling user breaks. A separate Turbo Prolog Toolbox (\$99.95) includes support

for menus, business graphics, communications, screen and report layouts, file transfer, and parser generators.

Turbo Prolog 2.0 requires an IBM PC, XT, AT, PS/2, or compatible, 384K bytes of RAM (640K bytes recommended), DOS 2.0 or higher, and two floppy disk drives (hard disk drive recommended). Video card support includes monochrome, CGA, EGA, MCGA, VGA, 3270, 8514, Hercules, and AT&T 400-line. Turbo Prolog Toolbox requires Turbo Prolog 2.0.

**Price:** \$149.95.

**Contact:** Borland International, 4585 Scotts Valley Dr., Scotts Valley, CA 95066, (408) 438-8400. **Inquiry 836.**

## Page Preview Added to WordStar

**W**ordStar Professional 5.0 features page preview capabilities that let you view up to 144 pages in thumbnail form on a single screen. You can also view single and facing pages in WYSIWYG format. A zoom view lets you look at font and linebreak details.

An optional menu-driven interface is compatible with IBM's Systems Applications Architecture. Footnoting, automatic reformatting, macro, undo, and automatic save capabilities are also added.

WordStar Professional 5.0 lets you create newspaper-style

columns. You can edit two documents simultaneously. Brown Bag Software's PC-Outline, MailList, and Tel-Merge, a communications program, are also included.

WordStar Professional 5.0 runs on the IBM PC and compatibles with DOS 2.0 or higher, 384K bytes of RAM (512K bytes of RAM is required for page-preview and outlining capabilities), and two floppy disk drives or a hard disk drive. A graphics board is required for page preview.

**Price:** \$495.

**Contact:** MicroPro International Corp., Customer Service, 33 San Pablo Ave., P.O. Box 7079, San Rafael, CA 94901, (415) 499-1200 or (800) 227-5609.

**Inquiry 837.**

## Can you afford the time to build your own LaserJet Fonts?



Building your own fonts can be difficult and very time consuming. For Example: Building your own 24 point font could take as much as 59 minutes of your and your computer's valuable time, and that's just one font! To get the same typeface in a different weight (regular, bold, italic, etc.) will take you almost another hour, again, and again, and again. Most business people simply can't afford that much time. Can you?

### MERLIN MASTER FONTS

are affordable pre-engineered, easy to use, downloadable fonts for your HP-LaserJet or compatible printer. Our soft fonts are tried and tested, there's no guess work. You know what you're going to get. Best of all, they are ready to use as soon as you open their exclusive "pop-up" storage box.

MASTER FONTS are available in these typefaces:

American	Centum	New York
Block	MERLIN HeVL	
Chancelor	Roman	Garmon

Point sizes range from 8 to 34 point and 50 point headline. All font packages include the typeface in regular, bold, italic and two distinctive weights, Shadow and Reverse Shadow.

#### MERLIN MASTER Paks

Over 50 fonts in a variety of sizes and weights, both landscape and portrait and includes FREE DOWNLOAD and DISFONT font utility programs. All for

**only \$149.95**

Smaller Paks available, starting at \$79.95

For more information or to order call toll free:

**1 - 800 - MERLIN - 0**  
(1-800-637-5460)

Use your Visa, MasterCard, AmEx or COD



1240 Johnson Ferry Place ♦ Suite A 10 ♦ Marietta, GA 30068

*Because you really can't afford to build your own fonts!*  
This ad was produced using **Merlin Master Fonts**

Dealer inquiries always welcome.  
Authorized Dyan Dealer. Distributing exclusively on Dyan certified diskettes.  
LaserJet is a registered trademark of Hewlett Packard



**EPSON**  
(w/Nation-Wide Protection Plan)

**EQUITY I+**

- 360K Floppy
- 20 Meg Hard Disk
- 640K Ram
- Serial/Parallel Port
- Monochrome Card
- Monochrome Monitor
- MS DOS
- GW Basic

**\$1295**

**EQUITY II PLUS**

- 1.2 Meg Floppy
- 40 Meg Hard Disk
- 640K Ram
- Serial/Parallel/C/C
- 80286 CPU
- Monochrome Monitor
- Graphic Card
- MS DOS
- GW Basic

**EQUITY III+**

- 80286 CPU 6-8 j2 MHz
- 1.2 MEG Floppy
- 40 MEG Hard Disk
- DOS 3.2 Mono Monitor & Graphic Card

**\$2195**

In order to provide the best service, EPSON EQUITY is exclusively sold on location.

# LOW PRICE LEADER



**80386**

- 16/8/4.77 MHz switchable
- 8/16 MHz, no wait state (Upgradeable to 20 MHz)
- 1 parallel port, 1 serial port with c/c
- Socketed for optional math coprocessor
- 8 layer motherboard/8 full expansion slots
- High-resolution monochrome monitor. Hercules compatible.
- 1.2MB floppy drive
- 3 half-high internal device slots
- 200 watt power supply/101 keyboard
- CPC approved

**16 MHz**  
**\$2295**  
**20 MHz**  
**\$2895**



**80286**

- 10/6 MHz switchable
- 0 or 1 wait state
- 8 expansion slots to fill all of your expansion needs
- 512K memory—High quality pre-tested chips (upgradable to 1 MB on the motherboard.)
- FREE amber monitor and Hercules compatible graphics card.
- One high quality floppy drive, 1.2 Meg
- 200 Watt power supply/101 keyboard
- AT style keyboard with 10 function keys
- 1 parallel port with c/c battery backup
- Slot for math co-processor 80287
- FCC Class B approved.

**20 MHz**  
**\$1350**  
**12 MHz**  
**\$1250**

## COMPAQ

386 130 meg/20 MHz .....	<b>6695</b>
286 40 meg .....	<b>2395</b>
386 40 meg/16 MHz .....	<b>4195</b>
386 60 meg/20 MHz .....	<b>5650</b>
Portable III 40 meg/20 MHz .....	<b>4195</b>
CARD & MONITOR EXTRA	



PS/2 model 30/20 meg .....	<b>1775</b>
PS/2 model 50/20 meg .....	<b>2595</b>
PS/2 model 60/40 meg .....	<b>3250</b>
PS/2 model 60/71 meg .....	<b>3995</b>
PS/2 model 80/40 meg .....	<b>5100</b>
MONITOR EXTRA	

## LAP-TOP

Toshiba 3200-40 .....	<b>3795</b>
Toshiba 3100-20 .....	Call
Toshiba 1000 .....	Call
NEC Multispeed .....	<b>1395</b>
NEC Multispeed EL .....	<b>1595</b>
EPSON LT .....	Call

**WE STOCK**

CITIZEN  
OKIDATA  
EVEREX

TOSHIBA  
NEC  
WYSE  
HITACHI

PRINCETON GRAPHICS  
SONY  
ACER  
HOUSTON INSTRUMENTS

AMDEK  
HAYES  
SAMSUNG  
CALCOMP

PC MOUSE  
MICROSOFT MICE  
LOGITECH  
MITSUBISHI

IRWIN & ARCHIVE  
TAPE BACK  
TAXAN

## HARD DISK

Seagate 20 meg .....	<b>305</b>
Seagate 30 meg .....	<b>365</b>
Seagate 4096 80 meg .....	<b>795</b>
Seagate 251 .....	<b>395</b>
Miniscribe .....	Call
Micropolis .....	Call

## SOFTWARE

Microsoft Word .....	<b>239</b>
Word Perfect 5.0 .....	<b>249</b>
Lotus 1-2-3 .....	<b>297</b>
dBase III+ .....	<b>385</b>
Microsoft Works .....	<b>119</b>

**AND MANY, MANY MORE!**

## SPECIAL of the Month

Microsoft Mouse ...	<b>\$109</b>
Microsoft Excel ...	<b>\$309</b>
Aldus Pagemaker ...	<b>\$479</b>

## AST

AST 386 model 340 .....	<b>4395</b>
AST 286 model 80 .....	<b>1745</b>
AST 286 model 120 .....	Call
AST 286 model 140 .....	<b>2695</b>
CARD & MONITOR EXTRA	

## EPSON® PRINTERS

Epson FX850/1050 ...	<b>\$379/535</b>
Epson LQ850/1050 ...	<b>\$559/785</b>
Epson LQ500/2500 ...	<b>\$359/895</b>
Epson LX800/EX800 ..	<b>\$199/445</b>

## CITIZEN PRINTER

180D/15E .....	<b>\$179/385</b>
MSP40/45 .....	<b>\$299/439</b>
MSP50/55 .....	<b>\$399/509</b>
Tribute 124/224 .....	<b>\$529/679</b>
Overture Lazer .....	<b>\$1459</b>
<b>HP LASER Jet II</b> .....	<b>.\$1750</b>

WE ACCEPT LC, CASHIER CHECKS, MONEY ORDERS, VISA, MC, AmEx  
3% charge on VISA, MC & 5% on American Express

# COMPUTER LANE

HOURS:  
M-S 9-6

**1-800-526-3482 (Outside CA)**  
**(818) 884-8644 (In CA)**  
**(818) 884-8253 (FAX)**

22107 ROSCOE BLVD.  
CANOGA PARK  
½ BLOCK W. OF TOPANGA  
CA 91304

CORPORATE ACCOUNTS WELCOME  
CALL FOR VOLUME DISCOUNTS  
CONSULTANTS CALL FOR PRICING

Prices subject to change without notice

Compaq is a Registered Trademark of Compaq  
IBM is a Registered Trademark of International Business Machines

# VUTEK SYSTEMS ANNOUNCES FREEZFRAME II

- ▶ The Frame Grabber that runs with any software, anytime.
- ▶ Text/Graphics overlay on live video
- ▶ EGA/CGA text/graphics overlay on captured still-frame video
- ▶ T.V. quality images

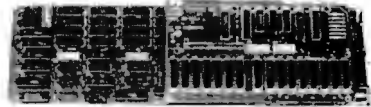

#### Software included:

- ▶ Video Editor – cut/paste, paint program
- ▶ Universal Interface Driver
- ▶ Printer Drivers

**FOR MORE INFORMATION  
CALL (619) 587-2800**

VUTEK SYSTEMS, INC.  
10855 Sorrento Valley Road  
San Diego, CA 92121



## Important TIPS\* for BYTE Subscribers: Receive Product Information 10 Days Earlier!

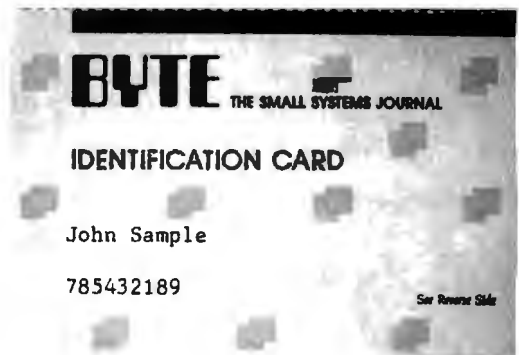

All you need is a touch-tone telephone and your subscriber I.D. number. See instructions facing the Reader Service Index in the back of this issue for outrageous time-saving opportunities!

\*BYTE's Telephone Inquiry Processing Service

# 3,000,000<sup>PCS</sup>

## MEANS QUALITY

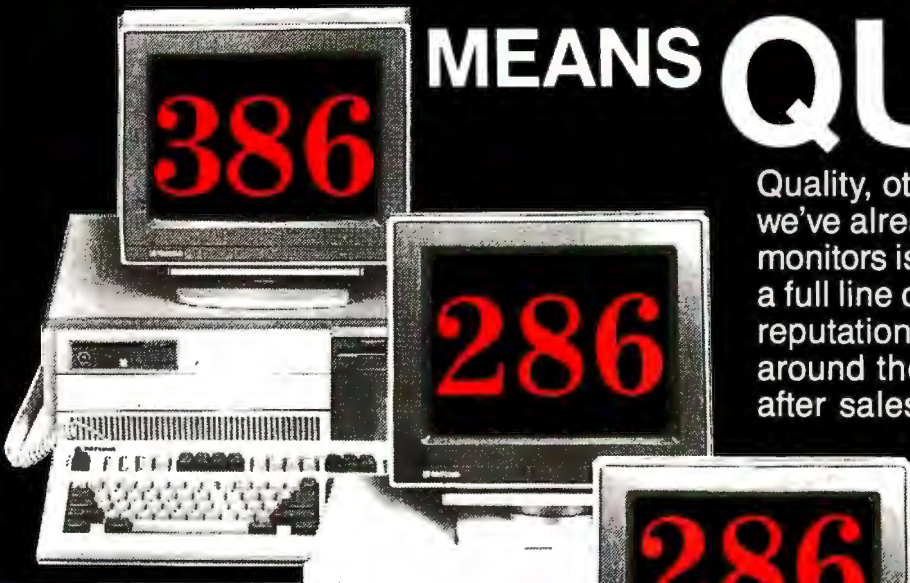

Quality, others promise, we deliver. The fact we've already delivered over 3,000,000 color monitors is the best proof. Tatung also makes a full line of computers and peripherals. Our reputation for superb quality is well known around the world. And we deliver complete after sales service to you.

### TCS 8000

16 MHZ, 0 WAIT - STATE  
32 BIT, EXPANDABLE 16MB

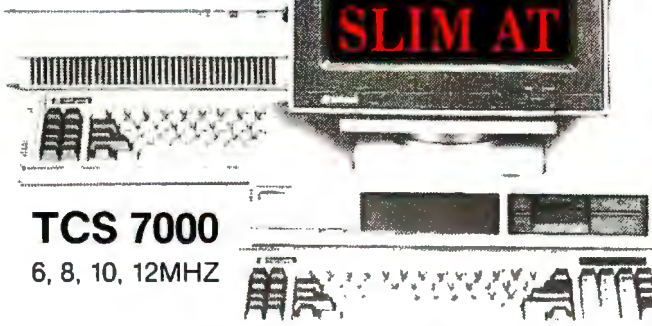

### TCS 7000

6, 8, 10, 12MHZ

### TCS 4000 (6/10MHZ)

EQUIVALENT OF 5 EXPANSION SLOTS

OMNISCAN

---

**COMPATIBILITY:**  
 IBM VGA™, MCGA\*  
 PGA, EGA, CGA  
 AT&T™ PCs  
 APPLE IIGS™  
 MACINTOSH II™\*

**14" Color Monitor**  
 RES: 800 x 560  
 4 MULTI-COLOR MODE

**12" Mono Monitor**  
 RES: 800 x 560

\* ALL TRADEMARKS ARE PROPERTY OF THEIR RESPECTIVE MANUFACTURERS

### COLOR MONITOR

### MONO MONITOR

### TERMINAL

MODEL	RES.
• CM 1322N	640 X 200
• CM 1370A	720 X 400
• CM 1380F	640 X 350
• CM 1495	800 X 560

MODEL	RES.
• MM 1222	800 X 350
• MM 1422	800 X 350
• MM 1295	800 X 560

ET - 10 SERIES
14" DARK - TINTED ANTI-GLARE FLAT CRT
H10 (AMBER)
H17 (PAPER/WHITE)

Circle 423 on Reader Service Card

VAR. DISTRIBUTORS. OEM  
INQUIRIES ARE WELCOME



# TATUNG

TATUNG SCIENCE & TECHNOLOGY INC.

## 408-435-0140

2060 RINGWOOD AVE., SAN JOSE CA, 95131

# VIRUS PROTECTION

Give your PC complete virus protection. Our products provide the most powerful and effective cures for computer viruses - and are simple to use.

Our Products will diagnose and attack viruses, as well as shield your system from harm - and remain transparent.

In addition, we attempt to search out and destroy those really tough viruses that are mailed to us. (This helps us maintain our software products so they are ready for any-

thing). This service is free of charge to our software customers.

Our products offer superior virus protection at low prices. Call today and we will ship your order immediately.

Villarreal Consulting  
4633 Capitola Avenue  
San Jose, CA 95111-2624  
(408) 972-0179

## VC-IMMUNE

Continually diagnoses your disks and files and alerts the user whenever an infection occurs. Not copy protected.....\$49

## VC-SHIELD

Protects your system from harmful virus actions and looks out for suspicious virul activities. Not copy protected.....\$49

## Disk Examination Service

Mail your disks suspected of infection to us. We will attempt to isolate and destroy the virus. There is no charge for unsuccessful attempts.....\$19



**ALTEC ZIP-386**  
**\$2,265**

- \* Intel 80386 microprocessor
- \* 1M high speed memory installed
- \* Expandable to 10 MB
- \* Phoenix 386 BIOS or Award 386 BIOS
- \* 4 speed (4.77/6/8/16 MHz)
- \* 200W power supply
- \* Case with re-set button
- \* Enhanced keyboard
- \* Hard disk/floppy disk controller card
- \* 12M floppy disk drive
- \* Monochrome/Graphics card with printer port
- \* HI-RES Monochrome Monitor
- \* User's manual
- \* 1 year warranty



**ALTEC-286 Enhanced System**  
**\$1,095**

- \* Intel 80286-10 microprocessor
- \* 640K RAM
- \* Dual speed 6/10 MHz
- \* 200W power supply
- \* AT style case
- \* Enhanced keyboard
- \* Hard disk/floppy disk controller card
- \* 1.2 M floppy disk drive
- \* Monochrome/Graphics card with printer port
- \* HI-RES Monochrome Monitor
- \* Phoenix BIOS
- \* User's manual
- \* 1 year warranty



**ALTEC-XT Turbo System**  
**\$685**

- \* 8088-1 microprocessor
- \* 4.77/10 MHz
- \* 640K RAM
- \* 150W power supply
- \* AT style keyboard
- \* Floppy controller card
- \* 360K floppy disk drive
- \* Monochrome/Graphics card with printer port
- \* HI-RES Monochrome Monitor
- \* Phoenix BIOS
- \* User's manual
- \* 1 year warranty



**ALTEC-286jr System**  
**\$1,075**

- \* Intel 80286-10 microprocessor
- \* 640K RAM
- \* 200W power supply
- \* ATjr style case
- \* AT style keyboard
- \* Hard disk/floppy disk controlled card
- \* 12M floppy disk drive
- \* Monochrome/Graphics card with printer port
- \* HI-RES Monochrome Monitor
- \* User's manual
- \* 1 year warranty

ADDITIONAL FEATURES	ADD	
Color System	: \$200.00	
EGA System	: \$400.00	
20M hard disk	: \$235.00 (386 & 286)	\$285.00 (XT)
40M hard disk	: \$405.00 (386 & 286)	\$465.00 (XT)
360K floppy disk drive	: \$80.00	
720K 3 1/2" floppy disk drive	: \$120.00	
1.44M 3 1/2" floppy disk drive	: \$175.00	



**ALTEC Technology Corporation**  
5751 Rickenbacker Road, Los Angeles, CA 90040  
Tel: 1-213-888-9100  
**Order Desk: 1-800-255-9971**

\* Intel is registered trademark of Intel Corporation.  
\* Phoenix is registered trademark of Phoenix Technologies Ltd.  
\* Award is registered trademark of Award Software Inc.  
\* AT is registered trademark of IBM Corporation.



# SERIOUS DEBUGGING AT A REASONABLE PRICE



All the speed and power of a hardware-assisted  
debugger at a software price

## Hardware-level break points

REAL-TIME break points on memory locations, memory ranges, execution, I/O ports, hardware and software interrupts. More powerful break points than ANY software-only debugger on the market. Soft-ICE gives you the power of an in-circuit emulator on your desk.

## Break out of hung programs

With a keystroke - no external switch necessary. Even with interrupts disabled.

## Breaks the 640K barrier

Soft-ICE uses ZERO bytes of memory in the first 1MB of address space. This is especially useful for those subtle bugs that change when the starting address of your code changes. With Soft-ICE your code executes at the same address whether the debugger is loaded or not.

## Works with your favorite debugger

Soft-ICE can be used as a stand-alone debugger or it can add its powerful break points to the software debugger you already use. You can continue to use your favorite debugger until you require Soft-ICE. Simply pop up the Soft-ICE window to set powerful real-time break points. When a break point is reached, your debugger will be activated.

## Solve tough systems problems too

Soft-ICE is ideal for debugging TSRs, interrupt handlers, self booting programs, DOS loadable device drivers, non-DOS operating systems, and debugging within DOS & BIOS. Soft-ICE is also great for firmware development because Soft-ICE's break points work in ROM.

## How Soft-ICE Works

Soft-ICE uses the power of the 80386 to surround your program in a virtual machine. This gives you complete control of the DOS environment, while Soft-ICE runs safely in protected mode. Soft-ICE uses 80386 protected mode features, such as paging, I/O privilege level, and break point registers, to provide real-time hardware-level break points.

*“Soft-ICE is a product any MS-DOS developer serious enough to own a 386 machine should have.”*

Dr. Dobb's Journal -- May 1988

NEW! NEW! NEW! NEW!

# RUN CODEVIEW IN ONLY 8K



CodeView is a great integrated debugger, but it uses over 200K of conventional memory. MagicCV uses advanced features of the 80386 microprocessor to load CodeView and symbols in extended memory. This allows MagicCV to run CodeView using less than 8K of conventional memory on your 80386 PC.

## Don't let 640K be your limit!

If you are closing in on the 640K limit and would like the power of CodeView, MagicCV is for you.

## Don't let the debugger hide the bug!

Even if you're not closing in on the 640K limit, running CodeView with MagicCV makes your debugging environment much closer to the end user's program environment. You can use CodeView to locate subtle bugs that only occur when there is plenty of free memory, or those difficult bugs that only occur when your program is running with a couple of TSRs loaded.

## How MagicCV works

MagicCV uses the 80386 to create a separate virtual machine for CodeView. MagicCV uses between 4K & 8K of conventional memory as a bridge between the DOS environment and CodeView.

## MagicCV is easy to use

If you are a CodeView user, you already know how to use MagicCV too. Just type MCV instead of CV; everything else is automatic.

Save \$86

MagicCV \$199  
Soft-ICE \$386

Buy Both and Save \$86

CALL TODAY  
(603) 888 - 2386

30 day money-back guarantee  
Visa and Master Card accepted

**NU-MEGA TECHNOLOGIES**

PO Box 7607  
Nashua, NH 03060-7607

Both require 80386 AT compatible or IBM PS/2 Model 80.  
MagicCV requires at least 384K of extended memory.  
CodeView is a trademark of Microsoft Corporation.

## MagicCV with Soft-ICE

Using Soft-ICE with CodeView gives you the features necessary for professional level systems debugging. MagicCV and Soft-ICE can work in concert with CodeView to provide the most powerful debugging platform you will find anywhere. As an extra bonus, by ordering both MagicCV and Soft-ICE together you save \$86.

Buy with

# Confidence

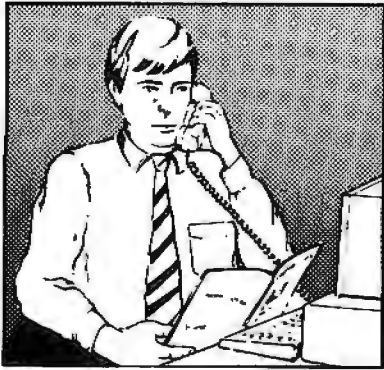

In an effort to make your telephone purchasing a more successful and pleasurable activity, The Microcomputer Marketing Council of the Direct Marketing Association, Inc. offers this advice, "A knowledgeable buyer will be a successful buyer." These are specific facts you should know about the prospective seller before placing an order:

## Ask These Important Questions

- How long has the company been in business?
- Does the company offer technical assistance?
- Is there a service facility?
- Are manufacturer's warranties handled through the company?
- Does the seller have formal return and refund policies?
- Is there an additional charge for use of credit cards?
- Are credit card charges held until time of shipment?
- What are shipping costs for items ordered?

Reputable computer dealers will answer all these questions to your satisfaction. Don't settle for less when buying your computer hardware, software, peripherals and supplies.

## Purchasing Guidelines

- State as completely and accurately as you can what merchandise you want including brand name, model number, catalog number.
- Establish that the item is in stock and confirm shipping date.
- Confirm that the price is as advertised.
- Obtain an order number and identification of the sales representative.
- Make a record of your order, noting exact price including shipping, date of order, promised shipping date and order number.

If you ever have a problem, remember to deal first with the seller. If you cannot resolve the problem, write to MAIL ORDER ACTION LINE, c/o DMA, 6 E. 43rd St., New York, NY 10017.

This message is brought to you by:

the MICROCOMPUTER  
MARKETING COUNCIL  
of the Direct Marketing  
Association, Inc.  
6 E. 43rd St.,  
New York, NY 10017

# MMC

MICROCOMPUTER  
MARKETING COUNCIL  
of the Direct Marketing Association, Inc.

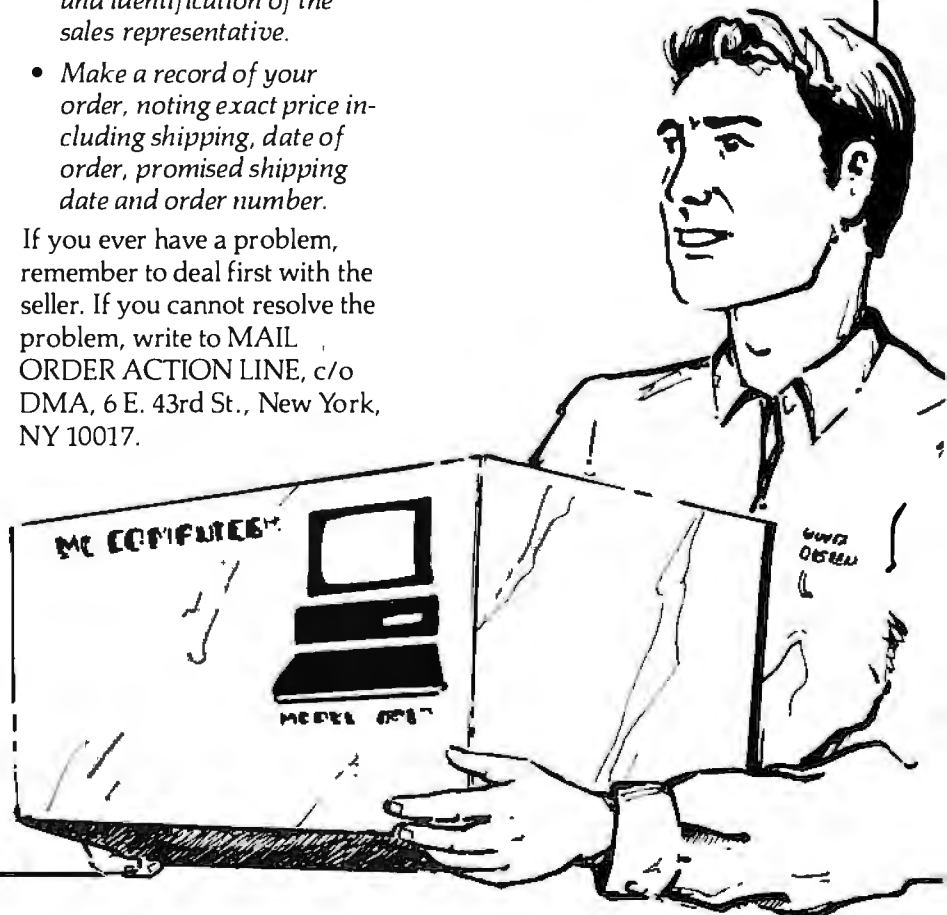

# Summer Savings!\*



SF-286	8MHz	10MHz	10MHz (0 WS)	12MHz (0 WS)	16MHz (386)
<b>Mono System</b>	<b>\$995</b>	<b>\$1119</b>	<b>\$1349</b>	<b>\$1499</b>	<b>\$1950</b>
<b>EGA System</b>	<b>\$1369</b>	<b>\$1569</b>	<b>\$1720</b>	<b>\$1870</b>	<b>\$2315</b>

## Basic System Features:

80286-16 bit CPU, 80287 socket, 512K RAM expandable to 1MB, fully compatible AMI BIOS, 1.2Mb Floppy Disk Drive, combined floppy/hard disk controller, Keytronics 101 enhanced keyboard, clock/calendar with battery backup, 195 watt power supply, 48 hour burn-in testing, operations manual, one year limited warranty and optional on-site maintenance agreement.

### SF-286-8MHz

**20Mb Mono Special.....\$1199**

Basic System features plus: Monographics board with printer port, Samsung 12" amber mono monitor and Seagate 20Mb hard drive.

### SF-286-8MHz

**20Mb EGA Special.....\$1569**

Basic System features plus: Everex EGA graphics board, Mitsubishi 1410-C or Evervision EGA color monitor and Seagate 20Mb hard drive.

### SF-286-8MHz

**20Mb VGA Special.....\$1849**

Basic System features plus: Everex EVGA graphics board (640 x 480, 800 x 600, up to 256 colors), Mitsubishi Diamond Scan multisync color monitor and Seagate 20Mb hard drive.

### SF-286-12MHz

**20Mb EGA Special.....\$1699**

Basic System features plus: Monographics board with printer port, Evervision 14" flat screen amber mono monitor and Seagate 20Mb hard drive.

Upgrade to 40Mb Seagate hard drive, Add \$160

Upgrade to 80Mb Seagate hard drive, Add \$500

## EGA Bundle.....\$459

Everex EGA autoswitch graphics board and Evervision EGA color monitor.

## Super EGA Bundle.....\$629

Everex EGA Deluxe autoswitch graphics board (640x480, 752x410), and Mitsubishi 1371-A Diamond Scan multisync color monitor.

## Super VGA Bundle.....\$769

Everex EVGA graphics board (640x480, 800x600, up to 256 colors) and Mitsubishi 1371-A Diamond Scan multisync color monitor

## Hard Disk Specials ( for PC )

Seagate ST225 20Mb + Controller.....\$265  
 Seagate ST125 20Mb + Controller.....\$329  
 Seagate ST238 30Mb + Controller.....\$289  
 Seagate ST251 40Mb + Controller.....\$449

## Hard Disk Specials ( for AT )

Seagate ST125 20Mb ( 40ms ).....\$269  
 Seagate ST138 30Mb ( 40ms ).....\$339  
 Seagate ST251 40Mb ( 40ms ).....\$369  
 Seagate ST251-1 40Mb ( 28ms ).....\$429  
 Seagate 4096 80Mb ( 28ms ).....\$729  
 Micropolis 1335 71Mb ( 28ms ).....\$599

## Everex Modems

Everex Evercom external and internal half-card modems ( fully Hayes compatible ) with Bitcom Communications software.

Internal 1200 Baud Modem.....\$CALL  
 External 1200 Baud Pocket Modem.....\$139  
 Internal 2400 Baud Modem.....\$149  
 External 2400 Baud with Mini I/O.....\$229

## Misc. Specials

Mini I/O ( PAR, SER, CLK, CAL ).....\$49  
 Mini I/O with Game Port.....\$55  
 Mini I/O + Logitech C7 serial mouse.....\$119  
 Mitsubishi 3.5" 720K floppy drive.....\$99  
 Mitsubishi 3.5" 1.4Mb floppy drive.....\$129  
 150 Watt Power Supply.....\$49  
 200 Watt Power Supply.....\$79  
 2Mb EMS memory board with OK.....\$80  
 3Mb EMS memory board with OK.....\$99

\*Special Prices valid only through 8/31/88

Seagate, Samsung, Miniscribe, Everex, Mitsubishi, Hayes, Micropolis, Bitcom, Logitech, are trademarks or registered trademarks of their respective companies.

SFMR04.2 8/14/88



1825 Lombard Street  
 San Francisco, CA 94123  
 California Orders, Information  
**(415) 929-1505**  
 National Order Desk (800) 237-5631  
 Technical Support (415) 929-1807  
 University P.O.'s and Dealers Inquiries  
 are Welcome  
 TERMS: We accept MasterCard, VISA (no  
 surcharge), American Express, CO's (Certified  
 Funds) and approved company P.O.'s, California  
 residents please add sales tax. 10% fee for  
 unauthorised returns (call for RMA number).  
 Returns must be shipped freight prepaid by  
 customer. Prices are subject to change without  
 notice. We reserve the right to substitute equivalent  
 items.



# MAKE COMPLEX DEC COMPUTING DECISIONS EASY

More Digital Equipment users will make more DEC computing decisions at DEXPO West than at any other event in the world. You'll do more to achieve maximum productivity from your DEC system in just three days than you'll do in the other 362 days of the year.

Compare 15,000 products, side by side. Save time and money when you evaluate all of your options, firsthand. Talk to hundreds of product specialists. They've all got solutions—find out who's got the best.

- More VAX, MicroVAX, and PDP-11 enhancements than any other show—ever!
- "Apple-DEC Connection" features 50 Mac-to-VAX exhibits.
- Hands-on instruction & expert advice—direct from 350 leading product developers.
- Communication products to integrate multi-vendor systems.

#### DECUS' Attendees: DEXPO West Is Free and Easy

DECUS Symposia attendees are admitted **FREE** to DEXPO West. (DECUS is not affiliated with DEXPO and requires separate registration).

#### Call Today for Free Show Preview & VIP Tickets

Call 800-628-8185 right away, and you'll receive special money-saving show tickets. Plus, get a preview of 100 products on exhibit at DEXPO West 88—a small sample of all you'll see when you attend.

## DEXPO<sup>®</sup> West 88

The World's Largest DEC<sup>®</sup> Computing Exposition  
Disneyland Hotel  
Anaheim, CA  
October 18-20, 1988

**800-628-8185.**

Call between 8:30 a.m. and 5:30 p.m., Eastern Time (in New Jersey, call (609) 987-9400).

Organized by:  
Expoconsul International, Inc.,  
3 Independence Way,  
Princeton, NJ 08540

\*Registered trademark of Digital Equipment Corporation. DECUS is not sponsored by or affiliated with DEXPO.

# More Than A Computer Store!

**Authorized Dealer!**



**AUTOCAD**



**TOPS**

Call for our Low Prices

**WYSE**

**286/386**

System  
In Stock



512 RAM,  
1.2 Floppy, 40 MB HD

Also in Stock:

**WYSE Terminals**

Call for Best Price!

**NEW!**

## LAPTOP SPECIALS



**181/183-20**

In Stock  
Flat Screen Monitor  
**CALL!**



## TOSHIBA

Toshiba 1000 .....\$749  
Toshiba 1200 .....\$2395  
Toshiba 3100/20 .....\$3099  
Toshiba 3200 .....CALL  
Toshiba 5100 .....CALL

## NEC

NEC Multispeed EL .....\$1595  
NEC Multispeed 20 MB ....\$2435

**AST**

**PREMIUM  
286/386**

512 RAM,  
1.2 Floppy,  
40 MB HD, Hi-Res  
Mono Card, DOS 3.2,  
GW Basic

**\$2395**

386 Model Also in Stock



**ACER**

**710/910  
Systems**

512K Memory, 20MB HD,  
6/10 0 Wait State

**In Stock Now**

**Call**

**For Lowest Prices!**



## Software & Printer Specials!

Word Perfect .....\$194  
Microsoft Word .....\$209  
Lotus .....\$305  
Epson LX800 .....\$209  
Epson EX800/1000 .....\$415/519  
Epson LQ800/1000 .....\$315/519  
Epson LQ500/2500 .....\$349/899  
Epson LQ 850/1050 .....\$549/749/729  
NEC P6/P7/2200 .....\$492/645/379  
Toshiba P321SL/P351SL .IN STOCK  
HP Laser Jet Series 2 .....CALL!  
Ast Turbolaser P/S .....\$3250  
NEC 890 with PS .....\$3195

Authorized Repair and Service Center. Fast Turnaround. Call for Service Contract Information.

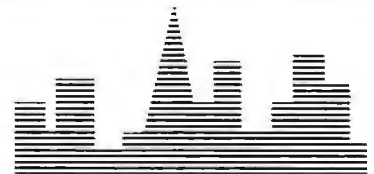

**COMPUTOWN**

**"More than a computer store"**

Pleasant Hill: (415) 682-TOWN  
San Francisco: (415) 956-TOWN  
Mountain View: (415) 962-TOWN  
(415) 682-8696 FAX (415) 989-8696 FAX (415) 969-8696

1527 Contra Costa Blvd.  
Pleasant Hill CA 94523

Phetan Bldg. #219 760 Market Street  
San Francisco CA 94108

2455 Old Middle Field Way  
Mountain View CA 94043

Authorized Dealer for Novell, Epson, AST, Samsung, Zenith, Toshiba, Autocad, AT&T, Leading Edge, Okidata, NEC, Canon, HAYES, Ashton Tate, Universal Data Systems, Microsoft, Ventura & Aldus. Call for our Low Prices!

Prices subject to change. Not responsible for typographic errors.

# Dealers Call For Complete Confidential Price List

## New Reduced Prices

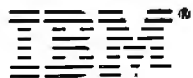

PS II Model 25 Mono/Color . . . \$969/1195  
 PS II M.25 Mono/Color+ 20MB \$1395/1650  
 PS II Model 30 2DR. + 20MB . . . \*\*\$1595\*\*  
 PS II Model 30-002/021 . . . \$1195/1645  
 PS II Model 50-021 . . . \*\*\$2395  
 PS II Model 60-44MB/70MB . . . \*\$3195/3595\*  
 \*\*PS II Model 80-115 20MHZ . . . \$6095\*\*  
 PS II Model 80-44MB/70MB . . . \*\*\$3995/4695  
 AT 339 (8MHZ, 512K, 30MB) . . . In Stock  
 AT 068 (6MHZ, 256K) . . . \$2395  
 PC/XT 2DR. 256K . . . \$995/1195  
 Mono. Disp. 8503/XT Style . . . \$189/225  
 Color Display 8512 . . . \$439  
 EGA Disp. 8513/XT Style . . . \$495/595  
 Ext. Drive F/PS2 (5¼) . . . \$285  
 Pro Printer II/XL . . . \$349/505\*  
 Pro Printer X24/XL24 . . . \$519/675  
 Quit Writer II/III . . . \$865/1095\*  
 IBM DOS 3.3 (min. 5) . . . \$85  
**NEW IBM 50 & 70's IN STOCK.**  
 \*Quantity Discount Available\*



**SEAGATE HARD DRIVES**  
 20MB/30MB W/Controller . . . \$259/289  
 30MB/40MB (4038/4051) . . . \$385/450  
 40MB (ST251)/40MB (4053) . . . \*\$349/449  
 80MB (4096)/80MB (277R) . . . \*\$649/445  
**MINISCRIBE**  
 40MB (3650)/40MB (3053) . . . \*\$319/535  
 40MB (6053) Full Height . . . 495  
 80MB Full Height (6085) . . . 679  
**HARD CARDS**  
 20MB/30MB for XT . . . 345/399  
 40MB Card F/XT 40MSC . . . 499  
 20MB/30MB For PS/2 . . . 399/435  
**MISCELLANEOUS**  
 COMPAQ 300MB HD . . . 2995  
 COMPAQ Portable 20MB . . . 495  
 COMPAQ 40/60MB F/DP386 . . . 745/895  
 10/20MB IBM Hard Disk . . . 145/195  
 130MB Compaq Hard Disk . . . 1695



**DESKPRO MODELS**  
 386/20 MHZ 60 MB HD . . . 4995\*\*  
 386/20 MHZ 130 MB HD . . . 6395\*\*  
 \*\*386/20 MHZ 300 MB HD . . . 7995\*\*  
 386 40MB 16MHZ Factory . . . 3895  
 386 130MB 16MHZ Factory . . . 5495  
 286 Model 1 . . . 1595  
 286 640K, 20MB/40MB HD . . . 2095/2295  
 286 Model 40 (Factory) . . . 2695  
 Deskpro 2DR. 256K/20MB . . . 1095/1395  
**PORTABLES**  
 \*\*New Portable 386/40MB . . . \*5395  
 \*\*New Portable 386/100MB . . . 6699  
 II Model 4 (Factory/Upgrade) . . . 2595/2395  
 II Model 2 2DR., 256K (80286) . . . 1895  
 \*\*\*III Model 40MB\*\* . . . 3895  
 \*\*\*III Model 20MB\*\* . . . 3375  
 Compaq Amber/Green Monitor . . . 195  
 Compaq Color/VGA Monitor . . . 525/555  
 Compaq EGA/VGA Adapter . . . 325/399  
 C. DOS 3.3/3.2/3.1 . . . 89/79/59  
**Call on Memory and Other Compaq Products**  
 \*\*Quantity Discounts Available\*\*

# Dealers & Consultants Only

Corporate & Retail Customers Call For Quotes

### INTEL

8087-3 XT/80287-6 AT . . . \*\*\$99/160  
 8087-2 XT/80287-8 AT . . . \$145/249  
 80287-10 AT 10MHZ . . . \$289  
 80387-16 for 80386 . . . \$455  
 80387-20 Base Systems . . . \$725

### OKIDATA

182/182S 120CPS, 30nlq . . . \$239/279  
 192 + /193 + 200CPS, 40nlq . . . \$329/419  
 292E/293E 200cps, 100nlq . . . \$359/489  
 393/393 Color 450 cps . . . \$945/1029  
 ML294/ML2410 . . . \$737/1695  
 Lazer Line 6 . . . \$1299

### IRWIN TAPE BACK UP

10 MB. Inter./External . . . \$255/379  
 20 MB. Inter./External . . . \$299/399  
 40 MB. Inter./External . . . \$379/535  
**Call for PS/2 Tape Back Up Units**  
**Call for Archive, Tecmar, Sysgen**

### TOSHIBA

321SL/341SL (216CPS) . . . \$465/645  
 351-SX/351-2 Color . . . \$995/1019  
 Toshiba T1000/T1100 . . . \$749/1450  
 T1200/T3120 . . . \$2295/2950  
 T3200/T5100 . . . \$3595/4495  
 Toshiba Modem/Compatible . . . \$279/249

### HEWLETT PACKARD

Laser Series II . . . Very Low  
 \*Desk Jet New 250 CPS . . . \$669  
 1MB F/HP II Compat/HP . . . \$329/369  
 2MB F/HP II Compat/HP . . . \$629/669  
 HP Plotter 7475A . . . \$1395  
 HP Scanjet Scanner w/Int . . . \$1195

### NEC NEC

Multispeed EL/HD . . . \$1455/2299  
 Multisync II/Plus + . . . \$579/875  
 Multisync XL 20 + . . . \$1995  
 LC860 + /LC890 . . . \$1899/3195  
 P760/P2200 . . . \$599/333

\*\*\*LOTUS 1-2-3 — \$289\*\*\*

\*\*\*LOTUS SYMPHONY 3 1/2" — \$259\*\*\*

# D-DATA

4742 Woodman Avenue  
 Sherman Oaks, CA. 91423  
 (818) 905-0994, (213) 859-3410  
 FAX # (818) 905-8869

American Express



Visa



MasterCard



One stop shopping for dealers & consultants

STB MULTIF CARD (OK) . . . \$49  
 DC 1000 TAPES . . . \$7  
 INTEL 8087-3 . . . \$79  
 MODEM 1200/2400 BAUD . . . \$69/95  
 IBM MONO/CLR/EGA . . . \$79/145/325  
 INTERDYNE T.B.U. 10/20MB \$75/95

THERE WILL BE A CHARGE ON ALL CREDIT CARD PURCHASES.  
 UP TO 2% DISCOUNT ON PREPAYMENT.

**DATA TRANSFER SWITCHES**

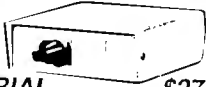

- AB SERIAL \$27.50
- AB PARALLEL \$28.50
- ABCD SERIAL \$39.50
- ABCD PARALLEL \$42.50
- AB CROSSOVER \$39.50
- ABCD DB9 TYPE \$43.50

**ISOLATING LINE STRIPS**

SURGE & RF NOISE SUPPRESSION BAR 6--1 \$19.95  
 6 OUTLETS  
 W/ 6' FT. CORD  
 12 @ 14.50 24 @ 12.25

THE PERFECT UPS by **ITT**  
 \$999. RETAIL  
**\$666. DEALER**  
VIP EXECUTIVE 400

**2 AT or 3 XT SYSTEMS**

True On-Line UPS designed for micro and mini power supplies. SINEWAVE output. Fits between CPU and CRT Only 20 Lbs. Size 1.9"H.x 15.8"Wx15"

**NEW KNAPCO UPS SYSTEMS**  
 Ez UPS THIN-LINE---



2.2" HIGH 24-28 LBS. RS-232 PORT FOR NOVELL. 200% IN-RUSH CAPACITY - SURGE, RFI, EMI. PROTECTION. TRUE ON-LINE SINE WAVE ±1%  
 525 / 1000Va. LIST DEALER  
 UPSC 525 \$995. \$645.

**LINE TAMER**

**FERRO POWER CONDITIONER**

Surge suppressors IEEE Standard 587 Rejection 120/60dB. 4 Outlets, 6ft. Cord Regulation ±3%

	Retail	Dealer
150 Va.	\$139.	\$ 99.
300 Va.	\$199.	\$149.
450 Va.	\$259.	\$197.
600 Va.	\$299.	\$225.
1000Va.	\$489.	\$349.
1200 Va.	549.	439.

**IMPORT**

**VOLTAGE REGULATORS**

TVR500	\$129.
TVR1000	\$199.
TVR2000	\$295.
TVR3000	\$395.

INPUT RANGE 85-135V. EMI-RFI - SURGE

**EURO-TRANSFORMERS**

**STEP UP/DOWN 110v.-220v.**

300 WATT	\$ 39
500 WATT	\$ 59
1300 WATT	\$ 85
*2000 WATT	\$125
*3000 WATT	\$215

\*Select Voltage 100/110/120v. U /Down 200/220/240v.

**SPIKE PROTECTORS**

MSP-1 \$12.25 12 @ \$10.95

**AMERICAN POWER CONVERSION**

TOSNIC TRUE MICRO-1100 ON-LINE UPS SYSTEMS

SELF CONTAINED GELL - CELL BATTERIES

SMALL PROFILE LIST DEALER

500 VA.	\$1499.	\$1199.
750 VA.	\$1899.	\$1425.
1 K VA.	\$2299.	\$1724.
2 K VA.	\$3999.	\$3199.
3 K VA.	\$6599.	\$5279.
5 K VA.	\$9379.	\$7499.

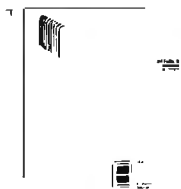

LAN's Best friend

	RETAIL	DEALER
<b>330 XT</b>	<b>\$399.</b>	<b>\$259.</b>
LOW COST UPS PROTECTION FOR NETWORK STATIONS		
<b>450 AT</b>	<b>\$599.</b>	<b>\$389.</b>
AT TYPE SERVERS, 3 COMSERVERS, AND CAD STATIONS		
<b>520 ES</b>	<b>\$699.</b>	<b>\$449.</b>
FOR SFT LEVEL 2 AND VINES FILE SERVERS RS 232 PORT		
<b>800 RT</b>	<b>\$1099.</b>	<b>\$709.</b>
LARGE FILE SERVERS WITH MULTIPLE HARD DRIVES		
<b>1200 VX</b>	<b>\$1399.</b>	<b>\$905.</b>

FOR MULTIPLE PC'S OR VERY LONG BACKUP TIME 1to2 Ms. transfer time, compact, quality engineered, runs diagnostics, RS232 port, prevents surges, sags, spikes, noise & interference

# ARCHITECTURE FOR THE 90'S

## SHAPE OF THE FUTURE

### THE ~~EVEREX~~ SYSTEM 386/20

#### Features

- Fully compatible with the IBM® PC/AT™
- Intel® 80386 microprocessor, running at speeds of 20, 10, 6.7 MHz with zero wait states. (16 and 8 MHz on the 386/16)
- Speed-selectable by keyboard, software or front-panel switch
- The bus operates at 10 or 6.7 MHz
- The machine uses write-back cache memory (64K, 128K or 256K of 25 ns static RAM)
- Socket for an 80387 math coprocessor option, running synchronously at 20, 10 or 6.7 MHz. (16 and 8 MHz on the 386/16)
- 1 Megabyte DRAM expandable to 8 Megabytes on the system board (120 ns DRAMs, 256 Kb or 1 Mb)
- Front panel LEDs for power-on, disk access and speed indication
- Alpha-numeric real-time diagnostic display (8-digit)
- 1.2 MB floppy diskette drive
- Six 16-bit and two 8-bit bus expansion slots
- One 32-bit memory expansion slot
- Special Everex very high performance (1:1 interleave) hard disk/floppy combination controller
- Front access to up to 5 half-height mass storage devices
- Enhanced 101-key keyboard
- System clock/calendar/configuration data in CMOS RAM with battery backup
- Everex enhanced BIOS
- Easy-to-use SETUP utility in ROM, supports over 45 drive types
- BIOS supports 3.5" 7270K diskette drives
- Front panel keylock to disable keyboard
- Front access reset switch
- Speaker: enable/disable switch
- Complete, easy to follow user manual
- UL listed power supply; switchable 120/240 VAC
- 13 months on-site warranty
- 1 serial and 1 parallel port

#### COMPATIBILITY TESTING RESULTS

The Everex System 386/20 was evaluated by XXCAL, an independent third-party testing house. The test objective, as stated in XXCAL's report of February 16, 1988, was "to reveal any problems or inconsistencies relative to a selected group of off-the-shelf commercial software, networks, and peripheral products" on the Everex System 386. XXCAL's technicians installed each application per documentation, then tested all functions, commands, and options directly related to a successful and thorough test of the product.

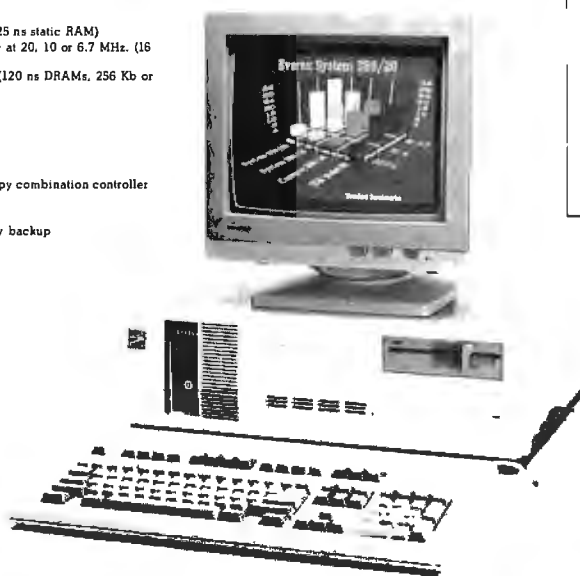

MADE IN USA

#### COMPETITIVE BENCHMARK TESTING RESULTS

Based on in-house testing, Everex Computer Systems Division has compiled the following benchmark test results:

Model	WordStar	Lotus 123	WordPerfect
Everex Step 386/20	4.81	35.0	24.3
Compaq Deskpro 386 20	4.59	34.5	24.2
Everex Step 386/16	3.99	27.0	19.5
Everex Step 286/16	3.77	21.4	16.4
AST Premium 386 20	3.04	25.0	—
Hyper 386/16	2.96	22.1	17.6
Acet 386 16	2.89	26.6	16.7
Compaq Deskpro 386 16	—	26.0	17.6
BM PS 2 Model 80, 16MHz	—	26.0	17.6
Everex Step 286/12	2.48	15.9	12.7
Compaq Deskpro 286 16	—	15.0	—
Compaq Deskpro 286 12	—	11.7	—
BM PS 2 Model 50, 6.6	3.8	9.6	—
Everex Step 286/8	0.80	8.0	—



With a 3F 286 or 386 computer, you can do desktop publishing, word processing, process control, networking, database applications, accounting spreadsheets, inventory control, circuit design, computer aided design engineering and manufacturing, and architectural design—the list goes on!

These computers will also run with OS/2, MS OS/2, Lotus 123, Dbase III, Unix, Xenix, Informix, AutoCAD, Smarttalk, Q&A, Sidekick, Gem, Turbo Pascal, Multimate, Word, Wordperfect, Wordstar, Ventura, Novell Netware 286, IRMA board, Modems, Bernoulli boxes, Network Cards

### OTHER EVEREX COMPUTERS

#### 3F 286 System

- 80286 CPU
- 1.2MB Floppy
- 512K Memory
- 101 Keyboard
- FL/HD Controller
- 6/8/10 Keyboard Selectable
- 195 Watt Power Supply
- Optional 80287 Socket
- FCC UL Approved

8MHz '1' Wait State 80286 Mono System .....	\$990
10MHz '1' Wait State 80286 Mono System .....	\$1239
10MHz '0' Wait State 80286 Mono System .....	\$1339
12MHz '0' Wait State 80286 Mono System .....	\$1575
For an EGA System .....	add \$350

#### 3F 386 System

- 80386 CPU
- 1.2MB Floppy
- 1MB Memory
- 101 Keyboard
- FL/HD Controller
- 64K Cache
- 16MHz CPU '0' Wait State
- 195 Watt Power Supply

16MHz '0' Wait State 80386 Mono System .....	\$1975
For an EGA System .....	\$2299

#### Hard Disk add on for above Systems:

20MB 65ms .....	\$249
40MB 39ms .....	\$399
80MB 28ms .....	\$710
144MB 16.5ms .....	\$1995

PRICES AND AVAILABILITY SUBJECT TO CHANGE WITHOUT NOTICE.

Call Us For Full Line of EVEREX Peripheral Products.

We Also Carry Hard/Floppy Drives, Monitors, Printers, Motherboards and All Major Software.

# 3F

3F Associates, Inc.  
44100 Old Warm Springs  
Fremont, CA 94538

(415) 659-0403  
FAX (415) 651-9190



# SHORT TAKES

BYTE editors offer hands-on views of new products

Dell System 220

T-DebugPLUS 4.0

Z88 Portable

Grammatik III

Watcom C 6.0

Paradox OS/2



## Dell Machine Sets 80286 Speed Records

You can sum up the new Dell System 220 in three words: small, powerful, and affordable. The new unit is one of the smallest desktop systems around, as well as the fastest 80286-based system available. And at \$1799, including a video graphics array (VGA) monochrome monitor, it is easily the best million-instructions-per-second-per-dollar value on the market.

The new system owes its prowess to a new 20-MHz CMOS 80286 processor, currently available only from Harris, and a high-speed chip-set from Chips & Technologies that saves plenty of board space.

The System 220's small size—it takes up about as much space as a briefcase—can be misleading. Inside, there are three IBM PC AT-compatible expansion slots, laid horizontally front to back. There are also sockets for up to 8 megabytes of fast 80-nano-second memory, a socket for an 80287 math coprocessor, two serial ports and a printer port, and space for a number

### THE FACTS

Dell System 220  
\$1799 with one floppy disk drive and VGA monochrome monitor;  
\$1999 with color monitor;  
\$2699 with 40-megabyte hard disk drive and color VGA monitor

Options:  
MS-DOS 3.3 with cache and disk utilities, \$119.95.  
1 megabyte of RAM, \$500.  
100-megabyte drive, \$1700.

Dell Computer Corp.  
9505 Arboretum Blvd.  
Austin, TX 78759  
(512) 338-4400  
Inquiry 851.

of hard disk options.

My preproduction unit came with a lively 29-millisecond 40-megabyte hard disk drive and two 1.44-megabyte floppy disk drives. Inside was an 80287 and a megabyte of memory. The system also came with a Mitsubishi color VGA monitor. In normal use, the Dell System 220 seemed immensely faster than my usual 6-MHz AT clone with a 20-megabyte drive. Also, both the floppy and the hard disk drives on the 220 were surprisingly quiet. My impression of the 220's speed was backed up by our benchmarks, which rated the 220 at about 1 percent faster than an IBM Model 80.

With all its features, the only thing the 220 might possibly lack is an 80386 processor. This could become a factor in the future, when an 80386 with a 32-bit memory bus might be required for certain high-performance software. But the 220 also lacks an 80386 machine's high price tag. And for the foreseeable future, the 220 will probably be the best number-crunching bargain on the market.

—Rich Malloy



## Squash Those Bugs

Whenever you write a program that does more than print "Hello World" on the screen, you're likely to run into bugs. When you have to squash those bugs, a good symbolic debugger like T-DebugPLUS 4.0 for Turbo Pascal 4.0 can make your life much easier.

Add-on programs for the Turbo Pascal environment have always found themselves

continued

in something of a quandary, since one of the main strengths of Turbo Pascal is its integrated set of editing, development, and debugging tools. To convince users to turn away from one of the Turbo tools, a product has to be pretty impressive. I think this debugger could turn a few heads.

T-DebugPLUS begins by offering features found in most symbolic debuggers. You can examine and alter variables using the names you gave them (instead of addresses), set permanent and conditional breakpoints, set watchpoints, and single- or multiple-step through a program. In addition, T-DebugPLUS lets you open watch windows on up to 8 variables at a time (12 at a time with EGA or VGA graphics), switch between debug and output

screens, switch between source code and assembly code views, and make use of expanded memory specification or extended memory to debug larger programs.

The instruction set in T-DebugPLUS is mnemonic to a good extent, and commands can be chained together in macros. Both when I worked through the example code provided with the package and when I used it on larger programs, I found that the features of the package were easy to learn and use, so that I was able to really use the software after a short time.

T-DebugPLUS comes with an installation program that patches TPC.EXE, TPMAP.EXE, and TURBO.EXE so that all will support local symbols. The patched versions of the programs create TPU and TPM files that are twice as large as

those created by unpatched versions, but are otherwise compatible with normal Turbo Pascal files.

Using T-DebugPLUS is a simple matter. You compile your code to an .EXE file, using the /\$T+ command-line option of TPC.EXE or by setting the "Turbo Pascal map file" option to On in TURBO.EXE.

After compilation, you must exit to DOS and run T-DebugPLUS as a separate program to debug your code. This marks a change from earlier versions of T-Debug, which ran as a part of the integrated Turbo Pascal environment. According to TurboPower Software, the change was made because of the increased memory requirements of Turbo Pascal 4.0.

Though the new version of T-DebugPLUS does not fit into the Turbo environment as

seamlessly as older versions, I found it to be a valuable, easy-to-use tool in debugging programs. Given the price and utility of the package, the slight increase in inconvenience is most forgivable.

—Curtis Franklin Jr.

#### THE FACTS

T-DebugPLUS 4.0  
\$45; with source code,  
\$90.

#### Requirements:

IBM PC, XT, AT, PS/2,  
or compatible with  
at least 256K bytes  
of RAM.

TurboPower Software  
P.O. Box 66747  
Scotts Valley, CA 95066  
(415) 322-3417  
**Inquiry 852.**

## A Z88 Portable to Go

The Cambridge Computer Z88 is a laptop portable that weighs less than 2 pounds and is scarcely larger than a copy of BYTE. Achieving this compact size involved compromises: the Z88 has no disk drives but uses RAM for mass storage; it has only an 8-line liquid crystal display rather than a 25-line one; and it's not IBM PC-compatible but comes with a complete suite of applications software in ROM, like the Tandy Model 100.

The processor is a CMOS Z80 with 32K bytes of internal RAM and 128K bytes of ROM. The 9-pin serial port works at speeds up to 38,400 bps. Power is supplied by four Walkman-size disposable dry cells that last about 20 hours. There are three slots at the front for memory cartridges.

My test machine came with 128K bytes of extra RAM and 128K bytes of EPROM. A built-in PROM programmer lets you use the EPROM as



#### THE FACTS

Cambridge Computer  
Z88 Portable Computer  
\$549.00

SSI Computer System Inc.  
424 Cumberland Ave.  
Portland, ME 04101  
(207) 761-3700  
**Inquiry 853.**

Options:  
32K-byte EPROM cartridge,  
\$45; 128K-byte RAM or  
EPROM cartridge, \$110;  
PC Link software and  
cable, \$75; serial printer  
cable, \$14; parallel printer  
cable, \$65; modem, \$225.

nonvolatile, write-once memory for semipermanent data like address lists; an optional ultraviolet eraser lets you reuse EPROM packs. 512K-byte RAM cartridges will be shipping soon, allowing up to 1.5 megabytes of RAM. The company is also promising 1-megabyte cartridges soon.

The keyboard is molded from a single sheet of black rubber and looks like a chocolate bar. Recent history has given rubber keyboards a bad name, but this one is different. It has a surprisingly positive action, and you can quickly begin to touch-type on it. The 64-key layout is of standard typewriter pitch, with a full-size space bar and four cursor keys.

The display is a supertwist LCD with dark blue characters on pale yellow. It shows 8 lines of 100 characters; the middle 80 are used for text, and each side is reserved for menus and indicators. It's deeply recessed to avoid damage, and the top edge throws a shadow that hinders viewing in some lightings.

*continued*

# STATGRAPHICS®

New Version—2.6  
Upgrades Available

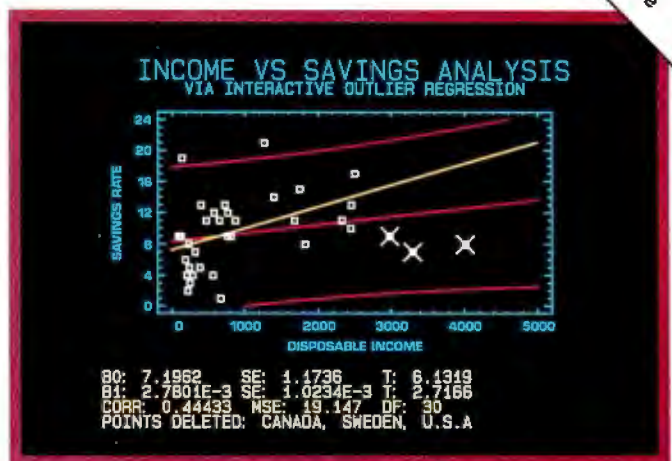
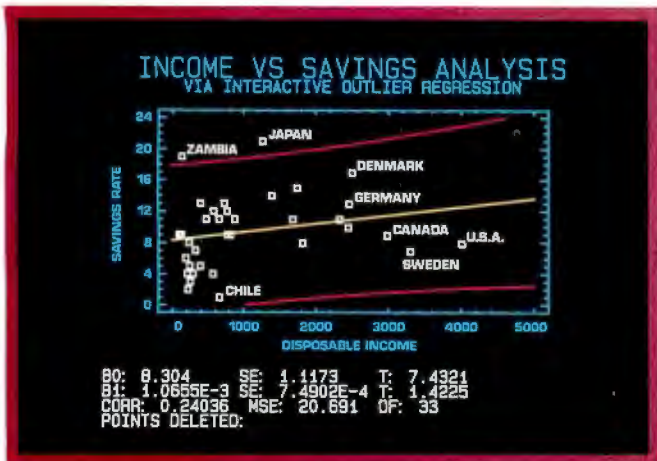

Select the points you want to remove from your regression model...

... Then press F6 to refit the model and recalculate the statistics.

## Because "Statistical Graphics" Is Better Than Just Statistics and Graphics

Most of today's PC statistical packages give you all the statistics you'll ever need. Some even give you a few graphics. But only STATGRAPHICS from STSC gives you integrated statistical graphics in an environment you control.

### Unique "What If" Interactivity

STATGRAPHICS lets you explore data relationships fully, producing higher quality, more timely solutions. Define your data and assumptions, run the procedure and review the results, modify data and assumptions repeatedly and take another look—and another. All without leaving the procedure or making permanent changes to your data.

### Integrated Statistical Graphics

Coupled with STATGRAPHICS' interactive environment are over 50 types of graphs—traditional pie and bar charts, histograms, 3-D line and surface plots, quality control charts, and more. All are integrated with the procedures so that they can be displayed instantly and modified repeatedly.

Query data points, do on-screen forecasting and model fitting, overlay graphs, or zoom-in on any area for a closer look. With flexibility like that, you can spot and investigate visual trends in your data—trends you may have missed if you looked only at the numbers.

### Over 250 Statistical Procedures

- Direct Lotus® and dBASE® interfaces
- ANOVA and regression analysis
- Experimental design
- Quality control procedures
- Multivariate techniques
- Nonparametric methods
- Exploratory data analysis
- Forecasting, time series analysis, and more.

### STATGRAPHICS—

#### The Best Way to Do Statistics!

Put the power of STATGRAPHICS to work for you today—all for only \$895\*. For our free convincer kit or the name of a dealer near you, call **(800) 592-0050 ext. 400**

In Maryland, (301) 984-5123;  
Internationally, (301) 984-5412.  
Telex 898085 STSC ROVE

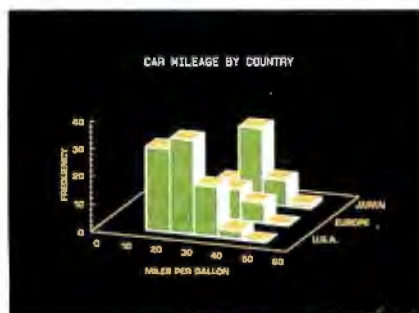

A wide variety of graphs supported on over 100 displays, printers and plotters, including the new IBM PS/2™ Series.

**STSC** STSC, Inc.  
2115 East Jefferson Street  
Rockville, Maryland 20852

\*Suggested retail price in U.S. and Canada. International prices vary. Available through dealers and distributors worldwide. STATGRAPHICS, Lotus, and dBASE are registered trademarks of Statistical Graphics Corporation, Lotus Development Corporation, and Ashton-Tate, respectively.

Want to save Time, Money,  
& Headaches?

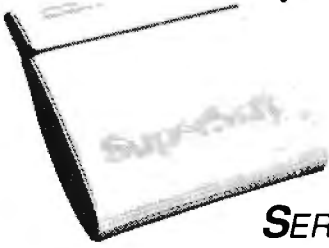

## GET SUPERSOFT'S SERVICE DIAGNOSTICS

All the software, alignment diskettes, parallel/serial wrap-around plugs, ROM POSTs and extensive, professional documentation to provide the most comprehensive testing available for IBM PCs, XT's, AT's and *all compatibles* under DOS or Stand Alone. No other diagnostics offers such in-depth testing on as many different types of equipment by isolating problems to the board and chip level.

**NEW:** SuperSoft's ROM POST performs the most advanced **Power-on-Self-Test** available for system boards that are compatible with the IBM ROM BIOS. It works even in circumstances when the Service Diagnostics diskette cannot be loaded.

**NEW:** 386 diagnostics for hybrids and **PS/2s!**

For over nine years, major manufacturers have been relying on SuperSoft's diagnostics software to help them and their customers repair microcomputers. End users have been relying on SuperSoft's Diagnostics II for the most thorough hardware error isolation available. Now versions of Service Diagnostics are available to save everyone (including every serious repair technician) time, money, and headaches in fixing their computers, even non-IBM equipment.

All CPUs & Numeric Co-processors	All Color Graphics & Monochrome Monitors
System Expansion & Extended Memory	Parallel & Serial Ports
Floppy, Fixed & Non-standard Disk Drives	Mono, CGA, Hercules & EGA Adapters
Standard & Non-standard Printers	All Keyboards & the 8042 Controller
System Board: DMA, Timers, Interrupt, Real-time Clock & CMOS config. RAM	

Join the ranks of XEROX, NCR, CDC, SONY, PRIME, ... who have bundled SuperSoft's diagnostics with their microcomputers at no risk because of our 30 day money back guarantee.

Service Diagnostics for PC, PC/XT, and compatibles only .....	\$169
Alignment Diskette for PC, PC/XT and compatibles (48 tpi drives) .....	\$ 50
Wrap-around Plug for PC, PC/XT and compatibles (parallel and serial) .....	\$ 30
Service Diagnostics for AT and compatibles only .....	\$169
Alignment Diskette for AT and compatibles (96 tpi drives) .....	\$ 50
Wrap-around Plug for AT (serial) .....	\$ 15
ROM POST for PC, PC/XT, and compatil .....	\$245
ROM POST for AT and compatibles only .....	\$245
<b>Service Diagnostics: The KIT (includes all of the above—save \$502) .....</b>	<b>\$495</b>
Service Diagnostics for all other CPUs (386, V20, V30, Harris, etc.) .....	\$195
Diagnostics II is the solution to the service problems of users of all CP/M-80, CP/M-86 and MS-DOS computers .....	
.....	\$125
ROM POST for PS/2 and compatibles only .....	\$245
Alignment Diskette for PS/2 and compatibles (3.5 inch) .....	\$ 50

To order, call 800-678-3600 or 217-359-2112, FAX 217-359-7225, or write SuperSoft.

*your microcomputer repair solution*

# SuperSoft

FIRST IN SOFTWARE TECHNOLOGY P.O. Box 1628 Champaign, IL 61820 (217)359-2112 Telex 270365

SUPERSOFT is a registered trademark of SuperSoft, Inc.; CDC of Control Data Corp.; IBM PC, AT & XT of International Business Machines Corp.; MS-DOS of MicroSoft Corp.; NEC of NEC Information Systems, Inc.; PRIME of PRIME INC.; Sony of Sony Corp.

92 B Y T E • AUGUST 1988

Circle 228 on Reader Service Card

The ROM software is powerful and cleverly integrated. A combined word processor/spreadsheet called PipeDream works like Lotus 1-2-3, using spreadsheet cells to hold document text, and acts as a simple database.

PipeDream is easy to use and permits quite sophisticated layouts. It supports underline, italic, and boldface, which are visible on the WYSIWYG bit-mapped display. To the right of the text area is a window that shows a 1-pixel-per-character page preview; as well as verifying layout, this helps you find your place in long documents.

You can interrupt any program and pop up another, and you may run as many copies of PipeDream, working on different files, as memory permits. The other programs include a good appointment diary/calendar, a calculator (with built-in unit conversions), a clock/alarm, a terminal program, and BASIC. There are also pop-up system services, including a file manager, setup options, and

Printer options. When you switch off the Z88, it saves the whole environment and starts back up where you left off.

The operating system supports hierarchical directories, I/O redirection, and proper batch files with an auto-execute option. RAM cartridges are treated as separate devices, like disk drives. You can print files directly to serial or parallel printers, but the best way to use the Z88 is to upload files to a desktop PC at your office or home. The PC Link package consists of a plug-in ROM, a cable, and a disk of PC software; uploading is controlled entirely from the PC screen via menus. The communications package consists of a 1200-bps matchbox-style modem plus a communications program in ROM.

Don't disdain the Z88 just because it lacks an 80386 or a hard disk drive; the clever software makes it a match for many a larger machine. And when you have to carry it around all day, small really is beautiful.

—Dick Pountain

## An Analyst for Your Writing

**G**rammatik III is a new version of Reference Software's IBM PC-compatible program for analyzing documents for grammatical and stylistic errors. Unlike Grammatik II, which checked documents against a fixed phrase dictionary, Grammatik III uses parts of speech and suffix analysis to provide more comprehensive grammar checking.

Not only does Grammatik III find possible errors, but it also offers suggestions for improvement. Grammatik III scans your document and finds basic errors like double words, unbalanced punctuation, or improper capitalization, as well as more subjective problems like use of the passive voice, pretentious expres-

sions and cliches, wordiness, and split infinitives. In addition, Grammatik III checks for subject-verb disagreement, double negatives, incomplete sentences, and other incorrect usages. Since writing "errors" are often subjective, you can customize Grammatik III to ignore certain types of phrases.

While Grammatik II worked best with ASCII files (it had problems with word-processing control codes), Grammatik III is designed to work with most major PC-compatible word-processing programs. When you first install the program, you select from a menu of word processors and text formats. You then run your document through Grammatik III, either interactively or in batch mode. When in interactive mode, it flags suspected problems on the

*continued*

# \$299 For 3-D CAD you can't beat by spending thousands more.

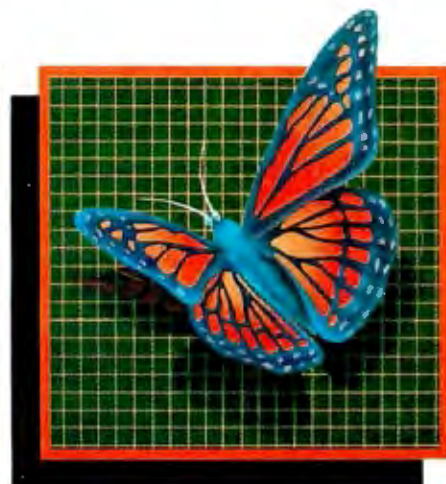
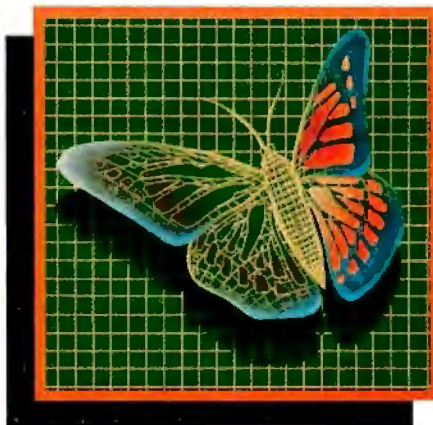
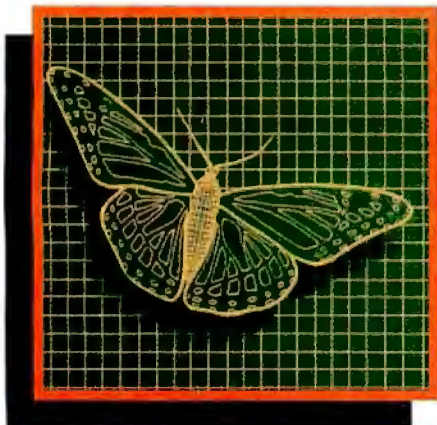

You can spend thousands of dollars for three dimensional CAD software and still not get the power and capability that DesignCAD 3-D offers for a remarkable \$299! DesignCAD 3-D is proof positive that you don't have to spend a fortune for quality.

## DESIGNCAD 3-D

DesignCAD 3-D allows you to develop and advance any design in 3 dimensional space, while providing you with features such as shading, hidden line removal, printer and plotter support. DesignCAD 3-D's extensive file transfer utilities allow you to: transfer documents to and from IGES, DXF HPGL, transfer to GEM and Post Script and to read ASCII text files and X, Y, Z coordinate files. It allows up to 4 simultaneous views (any angle or perspective) on the screen. Complex extrusions, extensive 3-D text capabilities, auto dimensioning and a host of other features are all included with DesignCAD 3-D, all at no extra charge.

The compatibility that DesignCAD 3-D offers you means that it can be used with almost any PC compatible system. It supports

more than 200 dot matrix printers, more than 80 plotters and most digitizers and graphic adapters. DesignCAD 3-D can read drawings from most other CAD systems.

The best reason to buy DesignCAD 3-D is not the low price, the performance or the compatibility. The best reason is the amazing ease of use. DesignCAD 3-D's powerful commands mean that you can produce professional 3-D drawings in less time than you thought possible. In fact, we think you'll agree that DesignCAD 3-D is easier to learn and easier to use than any 3-D CAD system for IBM PC, at any price!

See your local computer dealer for DesignCAD 3-D, or contact:

PC Resource Magazine  
has listed DesignCAD 3-D  
as one of the six  
new computer products  
worth watching in 1988.

**American**  
Small Business Computers, Inc.

327 S. Mill St., Pryor, OK 74361  
(918) 825-4844 FAX 918-825-6359  
Telex 9102400302

# New, Expandable Diskette Duplicator

Model 4D delivers 240 copies per hour, using any IBM PC/XT/AT or compatible.

- Multiple Formats, Including PS/2
- On-Screen Production Statistics
- Expandable Up to 8 Drives
- Multi-tasking

**\$1,995**



New Desktop and high-volume Production Autoloaders also available, for unattended operation. For more information or to order, call 415-651-5580.

## Datapath

Precision Media Duplication Products  
© 1988, Datapath Technologies, Inc., 46710 Fremont Blvd., Fremont, CA 94538.

screen. You can edit the problem phrase or sentence, ignore it, or instruct Grammatik III not to flag this type of problem in the future. After you've finished checking the document, Grammatik III saves the edited version and makes a backup of the original.

Grammatik III also provides a statistical summary of the document (number and type of errors found, a "readability index," and other statistics).

In batch mode, Grammatik III marks your document without your intervention, saves the marked file, and creates a backup of the original. You can then work with the marked document using your word processor. Grammatik III includes an optional spelling checker, but spelling checking more than doubles the grammar-checking time. If your word processor has a separate spelling checker, it's probably better to use it.

I tested a beta version of Grammatik III using an IBM PC XT with an Orchid 286 accelerator card (TurboEGA). In batch mode, a 10,000-word document took about 4 minutes to check. I tried the process using both a hard disk and a RAM disk and got about the same results (the CPU is the

bottleneck rather than the disk access speed).

In my tests, Grammatik III found a lot of errors but also missed some blatant ones. For example, it missed "many friends of mine lives in New York" and the incomplete sentence, "So should be fun." It did find "their going to have a party," and gave the message: [the context of "their" indicates you may have meant "there" or "they're."] Although it missed some errors and also flagged some correct grammatical phrases, the program is helpful in identifying possible stylistic or grammatical problems.

—Nick Baran

### THE FACTS

**Grammatik III**  
**\$99.00**

#### Requirements:

IBM PC, XT, AT, or compatible, 128K bytes of RAM, DOS 3.0 or higher, one floppy disk drive.

Reference Software  
330 Townsend St.  
Suite 123  
San Francisco, CA 94107  
(415) 541-0222  
**Inquiry 854.**

## Can You Stand Another C Compiler?

Start with your basic C compiler: ANSI C support, Make feature, symbolic debugger, editor, integrated development environment, overlay linker. Also give it support for the usual confusing array of memory models (small, medium, compact, large, and huge), and the ability to generate instructions compatible with the 80x86 processors, up to but not including the 80386. Plus support for the 8087, 80287, and 80387 math coprocessors.

You now have all the underpinnings of Watcom C 6.0. And most of the other C compilers that have hit the ground in the last year.

Now give it a price: \$495. A little steep? Not for what amounts to two compilers.

Here's where Watcom C begins to part company with the crowd. It actually consists of WCC, which operates with a 64K-byte data area; and WCGL, which makes use of all available memory (up to 640K bytes). The idea is that, though WCGL is slower than WCC, it can compile all the monstrous programs that would overflow WCC's memory allotment.

continued

## Compact Disk Products, Inc.

# CD-ROM/WORM

ALL PRODUCTS, LOWEST PRICES, EXPERT ADVICE

### INTRODUCTORY OFFERS

- Hitachi 1503S or 3500S CD-ROM Drive with your choice of:
- McGraw Hill Science and Technical Reference Set . . . \$895
  - Grolier Electronic Encyclopedia . . . \$895
  - Microsoft Bookshelf . . . \$895
  - PC5G Library (Disks 1 - 1000) . . . \$895

### CD-ROM SOFTWARE

- Oxford English Dictionary . . . **NEW** \$945
- Comstock Stock Photography On CD . . . **NEW** \$445
- Grolier or McGraw Hill or Bookshelf or PC5G . . . \$269
- The Bible Library . . . \$495
- Kirk-Othmer Encyclopedia of Chemical Technology . . . \$845
- Registry of Mass Spectral Data . . . \$2655
- Geovision U.S. Atlas and Mapmaker . . . \$795

TOLL FREE ORDER LINE • 800-MEGABYTE (634-2298)

### CD-ROM and WORM DRIVES

- Hitachi 1503S External CD-ROM Drive with Audio . . . \$729
- 1503S with Digital Audio Output . . . \$1229
- Hitachi 3500S Internal 1/2 Height CD-ROM Drive w/Audio . . . \$749
- Maxtor 800 MB WORM Drive . . . \$3799
- Optotech Laserbank 400 MB WORM Drive . . . \$3799
- Portable 286 with CD-ROM Drive . . . \$2795

CD-Capture (\$149) Capture Digital Audio Information from any CD to RAM or Disk. Also allows playback of music from RAM.

CD-Play (\$89) Pop-up utility that permits user to play all audio CDs on Hitachi and compatible drives. Output to headphones or amplifier.

CD-PlaySampler (\$149) Same features as CD-Play plus the ability to name two points on an audio CD and loop between them.

CD-AudioFile (\$149) Automatically creates database records of all your audio CDs. Allows you to store a preferred play sequence for each disk.

CDP Automatic recognition of CDs. Creates CDbase compatible records.

217 E. 85th St.  
Suite 216  
New York, NY 10029  
Tel. 212-996-6999  
Fax 212-439-9109  
CompuServe 75530214

Free 3 Month  
Subscription to  
CD-ROM Review  
with orders over  
\$300

INTERNATIONAL ORDERS  
A SPECIALTY  
Australian Agent: KEWIEL  
145 Cotham Rd.  
Kew, Victoria 3101  
Tel. (03) 817-5933

# Software Breakthrough: the RANDOM information processor

## New Concept

With all the software tools available, it is surprising that an important need has been overlooked—a way to deal with the countless bits of RANDOM information you spend hours with every day. Tornado will not only give you instant access to this important information ... it will help you make better decisions and even think more clearly. Try Tornado risk-free and discover the productivity software package for your PC that works wonders.



Limited  
Time Offer

ONLY \$49<sup>95</sup>

(Mini version)

30-DAY MONEY-BACK GUARANTEE  
(When ordered direct)

## ■ RANDOM Information

Did you ever realize that over half the information you deal with every day is the RANDOM type? Not databases nor spreadsheets nor long documents—but the information scattered around your workplace and in your head. Yet amazingly, until now there was no great software to help you—the tools were either too structured or without organization. But now, at last, there is a quick and easy solution—Tornado—acclaimed by rave reviews and accepted by corporations nationwide. Whether you are a business executive, consultant, engineer, or in any other profession, you need Tornado—it will save you endless time and effort every day—guaranteed—or your money back. Here is how it works:

## ■ Information Windows

With Tornado, you process information in stacks of superfast “intelligent” windows—several on your screen at once. You type into the windows; interconnect and prioritize them; and scan through them in remarkable ways.

## ■ Free Form

Tornado is FREE-FORM. It works the way you think. To start a new window you just press N, and enter information. No file names. No extra keystrokes. To retrieve information you just press G (for Get), with any word or phrase—you’ll watch Tornado zip through your windows like

lightning linking and opening those requested. You can even flip through your windows with the arrow keys and watch them instantly pile up and lift away. These are just three of 18 easy but powerful features.

## ■ Countless Uses

There are thousands of uses for Tornado. When Harry calls you on the phone, in two seconds flat you’ll display the six windows on Harry before he finishes his first sentence! No more embarrassing pauses or scrambling for information. Tornado is so versatile you can: write and print a letter faster than ever; track things to do; edit electronic mail; and plan a project or event quickly and easily. You can even build a sophisticated “knowledge” base or an unstructured data base without programming. And that’s not all. Track phone conversations, numbers, customers, and all your other RANDOM information. On a portable, Tornado is your ideal moving office. Best of all, you tailor Tornado to your own needs—easily!

## ■ 25,000 Windows

Instead of one window or ten, imagine up to 25,000! It’s like extra memory...for your brain! The uses are endless. If you can “type” it—you can “Tornado” it. And because it’s memory resident (if you choose) you can quickly jump in from other programs—even move information between them. All this power, yet reviewers agree you can start “Tornado-ing” in 15 minutes—not 15 days.

## ■ Three Versions

Choose the Tornado that’s right for you:  
**Mini Tornado—\$49.95—NEW!** Lowest cost version—limited capacity (up to 600 windows and 60,000 characters); does not have: cut & paste, window join, screen grab & put, time & date & sequence stamp, multiple forms, compound searches.

“Excellent Excellent Excellent Excellent”  
*PC World, Patrick Marshall*

“one of the niftiest ... programs I’ve ever seen.”  
*BYTE, Jerry Pournelle*

“Excellent value”  
*InfoWorld, Review Board*

“Editor’s Choice”  
*PC Magazine*

**Regular Tornado—\$99.95**—Full version with all commands and full information capacity (up to 25,000 windows and 2,500,000 characters).

**Library Tornado—\$149.95**—All commands, full capacity, plus “Library” of windows containing: free-form year logger, simple project planner, grid maker, city/state/area code/time zone translator, and more templates and references.

## ■ Productivity Tool

To reach your goals, you need tools that maximize your productivity and help you make your best decisions. Tornado fits the bill perfectly. In fact user surveys show you may well use Tornado more than any other software package! Order today risk-free.

To order call:

**(800) 342-5930**

Technical questions & NJ: (201) 342-6518  
24 hr. modem: (201) 342-8101

**YES, send me**

\_\_\_ Mini Tornado \$49.95  
\_\_\_ Regular Tornado \$99.95  
\_\_\_ Library Tornado \$149.95

Please add \$3.50 to help cover shipping costs (\$10 outside USA & Canada). NJ residents add 6% tax. No purchase orders. To order, mail coupon or call (800) 342-5930.

Payment: VISA MC CHECK

Credit Card Expiration \_\_\_\_\_

Card # \_\_\_\_\_

Not Copy Protected

30-Day Money-Back Guarantee

Name: \_\_\_\_\_

Address: \_\_\_\_\_

City: \_\_\_\_\_

State: \_\_\_\_\_ Zip: \_\_\_\_\_

Telephone: \_\_\_\_\_

5-1/4"  3-1/2" disk

**MICRO LOGIC CORP.**  
Dept T-160, 100 2nd St., POB 70  
Hackensack, New Jersey 07602

**Specifications:** FEATURES: free-form & predefined windows, scrolling within window, import & export to files & screens, cut & paste, auto word wrap, time & date stamp, move & join & dup windows, mono or selectable color, definable Hot-key or non-resident, unloadable, LAN support, context help, extended ASCII, smart fully adjustable windows, parallel text processing, progressive resolution and “and-or-not” like searching without keywords, and more. COMPATIBILITY: IBM-PC/XT/AT/PS2 and compatibles; mono, CGA, 80 col EGA, and Hercules displays; 60K minimum RAM CAPACITY: Up to 500 windows and 50K per pile - 50 piles. Not copy protected.

# Fast Microprocessor Development



## New Unilab 8620 analyzer-emulator— SAVE TIME, CUT COSTS

Don't waste days single-stepping through suspect code. Isolate trouble fast. Use our highspeed analyzer-emulator to trigger on symptoms—by data sequence, cycle type, address, data range. See program traces **before** and **after** trigger points as you record and display traces on the fly. Mop up via traditional breakpointing.

- Real time 8/16 bit universal emulator
- Advanced 48-channel bus state analyzer
- In-Place Emulation for 150 different  $\mu$ Ps
- 1  $\mu$ sec program time measurements
- Fast parallel interface: load 64K in 5 sec
- Stimulus generator included
- Continuous real time viewing of registers, ports
- Built-in EPROM programmer
- 2730 bus-cycle trace buffer
- Complete integrated toolkit

Call Toll Free 800/245-8500 or  
(in CA) 415/361-8883



702 Marshall Street, Redwood City, CA 94063

## SERIES 32000 MODULA-2 COMPILER

Program development system for Series 32000 based embedded systems running on IBM-PC/XT/AT and PS/2-30

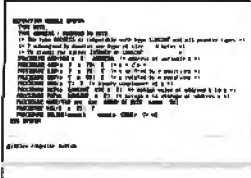
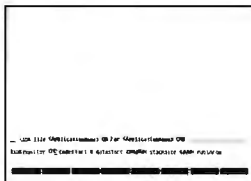
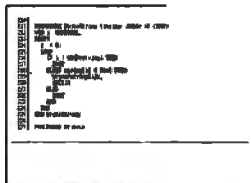

### Description:

- Add-in board consisting of Series 32000 chip set and ROM-resident EDITOR, COMPILER, LINKER, DECODER and MAKE UTILITY

### Host Hardware:

- IBM PC/XT/AT or compatible with free half card slot

### Host Software:

- DOS 2.0 or later

### Target Hardware:

- Any Series 32000 based embedded system

### Target Software:

- Runtime support is supplied in source form

### Key Product Features:

- This compiler enables you to use all the features of Modula-2 as described in Niklaus Wirth's *Programming in Modula-2* (2nd edition).
- The target runtime support module, supplied in source form, includes a floating point package which emulates the NS32081 chip, if necessary.
- The system's command-line-based user interface is on-screen supported and leads the user through the command entering process.
- The information display makes constant reference to a manual unnecessarily by providing the user with the information needed to run the system.

- Only a single command line is needed to convert a set of source modules into an executable file.
- Any individual application can consist of up to 400 modules written entirely in Modula-2.

### Key Product Benefits:

- Manual-free use
- Programs can be written entirely in Modula-2
- Easy handling of very large program packages
- Convenient transfer of Modula-2 programs written for other processors to Series 32000 environment
- Reasonably priced development system for the entire family of Series 32000 microprocessors

### Product Vendor:

Alain Schönbächler, Freischützgasse 14, CH-8004 Zürich/Switzerland

Tel.: 41-1-241-0514

## SHORT TAKES

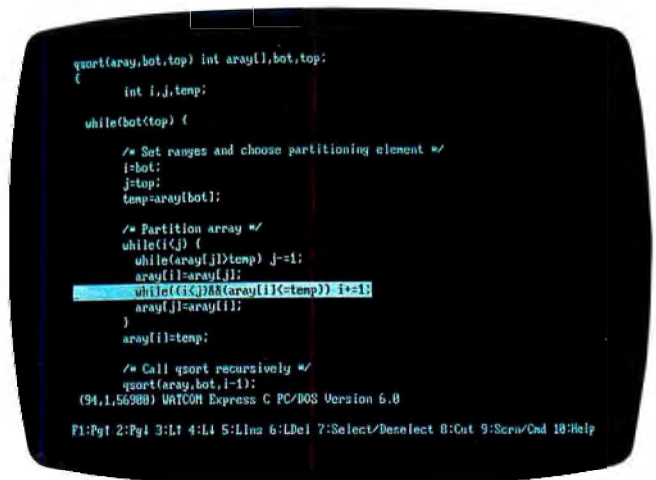

### THE FACTS

Watcom C 6.0  
\$495 (includes  
Express C)

Options:  
Watcom Express C, \$125  
(if purchased separately)

Requirements:  
IBM PC, XT, AT, PS/2,  
or true compatible, DOS  
2.0 or higher, and 512K  
bytes of memory  
recommended.

Watcom  
415 Phillip St.  
Waterloo, Ontario  
Canada N2L3X2  
(800) 265-4555  
**Inquiry 855.**

I performed some informal tests on the Watcom compiler, stacking it up against Microsoft C 5.0 on my 10-MHz AT clone. I modified our new Sort benchmark to create an array whose elements were in reverse order, and I hand-timed the execution speed of the result. (I used small models for both compilers and set no compile switches—I handed identical copies of the source code to each compiler.) The Watcom compiler's version completed in 11.3 seconds, while Microsoft's took over 15 seconds. However, the executable file Watcom created was over 12K bytes in size, while Microsoft C created an 8K-byte executable file. I figure it's the same old equation: speed at the cost of space.

And, yes, you'll find yet another editor supplied with the Watcom disks. The editor is simple enough to use, allows you to work on more than one document simultaneously via multiple workspaces, can operate in either line mode or

screen mode, and supports editing macros.

Watcom's answer to Turbo C and Quick C is Express C. As you might guess, you can operate Express C with Watcom's editor in an integrated environment so that all development functions—compiling, linking, editing—occur in memory.

What you might not guess is that Express C also includes a memory-resident source-level debugger that allows you to trace program execution, view and modify variable contents, set breakpoints, and display your program's output. If you launch Express C with the /d option, the debugger automatically fires up when you compile and run your program. While experimenting with the debugger, I stumbled onto a bug in the benchmark program I was creating. But that's what it's there for, right?

When I pitted Express C against Turbo C (using yet another variant of the Sort

*continued*



# When your basic quantum leap is just not enough:

## **PROBAS™** Professional Basic Programming Library

PROBAS is a library of routines that kicks QuickBASIC and BASCOM into 5th gear and gives you powers and abilities far beyond those of mortal men. It's the greatest thing since sliced bread and if you don't get it today, your hard disk will crash in retaliation. So much for the hype, now down to brass tacks:

- 832 routines (226 in Assembly)
- 600 page 3-part manual
- Full-featured windowing
- Screen snapshots
- Virtual screens in memory
- Lightning-fast file I/O
- Access EMS as files or arrays
- Full mouse support

Plus 200 essential services from directory and equipment routines to handy string, date, time, and input routines.

Sick of running out of string space? Store hundreds of K in numeric arrays or megabytes in EMS arrays. Tired of using a kludgy SHELL to DIR to read a directory? Scan subdirectories using wild-cards and store thousands of file names, dates, and times. Wish you could drag a window containing text or a menu around the screen with a mouse? It's easy!

PROBAS virtual screens allow you to draw full or partial screens to memory, and then snap them on in an eyblink-- faster and without the limitations of PCOPY. Draw and store hundreds of pull-down menus or help screens, each in its own array, ready to be displayed anywhere on the screen at assembly speeds-- you just can't get any faster.

PROBAS gives you a complete set of blazingly-fast file routines. Read or write up to 64k chunks of data at a clip, with file locking and error handling so that you can even use them in subprograms. You'll never want to use BASIC's file I/O again! No royalty and not copy protected. For all versions of QuickBASIC and BASCOM including BASCOM 6.0 for OS/2. **Just \$99.00!**

## **PROBAS™** TOOLKIT

The TOOLKIT is a collection of assembly and BASIC modules that use the PROBAS library to save you even more hours of grunt work. Call a ring, bar, pop-up, or pull-down menu. Pop up a mini-word processor with word-wrap in a window. Make file I/O faster with b-tree indexing. You get:

- Dozens of Menu Generators
- Fast B-tree indexing
- Mini-editor with word-wrap
- Patch .EXE files
- Protected storage areas
- Display text files in windows
- Julian date routines
- Documented BASIC source

Plus dozens of powerful, easy to use routines that help conserve the most valuable asset of all, time! Requires PROBAS. **Just \$99.00!**

## **PROSCREEN™** Professional Screen Management System

PROSCREEN is a full-featured screen generator /editor that will save you more design and coding time than you ever thought possible. PROSCREEN works with screens like a word processor works with text to provide complete control over screen characters, placement and colors. Edit up to 3 screens at a time and perform block moves, block copies, merge and cut and paste operations-- even between screens-- with ease.

Use PROSCREEN to prototype designs, create full or partial screens for import via PROBAS, or create input screens that have up to 130 edit fields per screen. You can even take snapshots of other applications, edit them, and produce demos and working tutorials. PROSCREEN comes with subroutine source, extensive on-line help and a 285 page manual with tutorial and reference. **Just \$99.00!**

## **PROBAS™** TELECOMM TOOLKIT

The PROBAS TELECOMM TOOLKIT is a collection of high-level communications modules that you plug into your code to provide popular file transfer protocols, terminal emulations, auto-dialing, phone data base, login scripts and more. Plug just the routines you need into your programs.

- Xmodem/Modem7/Xmodem-1k
- Ymodem (single and batch)
- CRC-16 and Checksum
- VT52, VT100, ANSI BBS etc.
- Auto Dialer & data base
- Script language support
- Full terminal program
- Documented BASIC source

The TELECOMM TOOLKIT comes with a detailed manual and a full terminal program in BASIC. Requires PROBAS. **Just \$75.00!**

## **PROREF™** On-Line Help FOR PROBAS™

PROREF is three products in one-- a pop-up help system for the 232 routines in PROBAS, pop-up help for your routines, and an extension of the QuickBASIC programming environment. See the calling syntax and help for any PROBAS routine, or any of your routines, with just a few keystrokes or mouse clicks. Pop-up an ASCII chart, calculator, keyboard scan code module or almost any DOS program via hot-key. **Just \$50.00!**

Our money-back guarantee assures you the highest quality and our technical support staff is always ready to help. Try our BBS at **(301) 953-7738** or give us a call at:

**(301) 953-2191**

Add \$3.00 per item (\$7.00 Canada) for shipping. Trademarks: ProBas, ProRef, ProScreen: Hammerly Computer Services, Inc. QuickBASIC, BASCOM: Microsoft Corp.

 **HAMMERLY**

...the first completely integrated Ada Programming Support Environment priced for the individual programmer on a PC. Designed for the novice as well as the software engineer.



- Validated Production Compiler
- Use on 8086,80186,80286,80386.
- Full 640KB .EXE Programs
- No Extra Memory Required
- No Math Coprocessor required.
- On-Line Library Management
- Math, Text, Console Packages included
- Multiple File Code Retrieval
- Full-Color, Full Featured Editing
- Selectable Function Keys
- Ada Subprogram and Package Generation
- Ada Type Generation
- Ada Sensitive Cursor
- Interactive Cursor Error Correction
- Interface to Ada Design Language (ADADL)
- Ada Standard Pretty Printer
- DoD 2167 Documentation Features
- Optional On-Line Ada Training Course
- No Run-Time Royalties

Aetech, Inc., 380 Stevens Ave. Solana Beach, CA 92075.

(619) 755-1277

Name \_\_\_\_\_  
 Company/Title \_\_\_\_\_  
 Address \_\_\_\_\_  
 Phone \_\_\_\_\_

**AETECH**

Introductory Offer **\$495**

benchmark with a smaller array size), I found that Turbo C chalked up a compile-and-execute time of 9 seconds against Express C's 28 seconds. I thought I could attribute Express C's poor showing to the fact that it performed array- and pointer-bounds checking unless told otherwise. But even when I told it otherwise, it still hit the wire

at about 27 seconds.

Watcom delivers a high bang-for-the-buck ratio when compared to Microsoft C 5.0. Watcom C is a class act, and the source-code debuggers for both the high-end C 6.0 and the integrated Express C make the whole package a real possibility for doing heavy-duty development work.

—Rick Grehan

## Paradox Takes on OS/2

If you've used the MS-DOS version of Paradox, Paradox OS/2 will be immediately familiar. Except for the OS/2 line on the opening screen, the actual user interface is identical, and it works *exactly* the same; it is compatible with files, scripts, and reports from earlier versions.

The differences showed up when I started doing some actual work. Because Paradox OS/2 runs in 80286 protected mode, it directly addresses all your system memory. That eliminates the time-consuming disk reads and memory swapping that take place under the MS-DOS version.

This immediately translates into speed. Database access, moving around tables, and doing usual work like sorting and generating reports is noticeably faster, though your mileage will vary depending on the type of database you're using and what you're doing with it.

You can run multiple Paradox OS/2 sessions at the same time, and even share data and utilities among them. This is heady stuff for those of us used to the one-task-at-a-time limitation of MS-DOS.

Paradox OS/2 uses the same concurrency controls to coordinate multiple sessions that Paradox 2 uses to coordinate multiple users on a network. There are, of course, some limitations. You can't physically make changes to two sessions concurrently, so Para-

dox OS/2 has the same abilities as its MS-DOS brother to lock tables and set what the program calls "private directories."

If you're new to OS/2, you'll soon find that there's a boundary to the apparent magic, especially if you have limited memory. Each session you start exacts its cost in processing time and RAM. While Paradox OS/2 can use up to 16 megabytes of RAM, my PC AT clone had only 3 megabytes, the minimum you need to run the program. Things started to slow down appreciably by the time I started the third Paradox session.

Paradox OS/2 is far from the ultimate OS/2 application. It's really just a sophisticated port from the MS-DOS version, which already had its own multiple-session hooks in its network support. But it's a tantalizing glimpse of the possibilities that OS/2 will offer.

—Stan Miastkowski

### THE FACTS

Paradox OS/2  
 \$725

**Requirements:**  
 IBM AT, PS/2 or compatible, 3 megabytes of RAM, OS/2 Standard Edition 1.0 or higher, and a hard disk drive.

Borland International  
 4585 Scotts Valley Dr.  
 Scotts Valley, CA 9501  
 (408) 438-8400  
 (800) 543-7543



# Leprecard

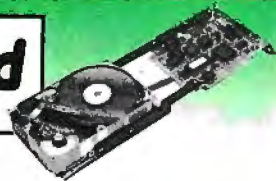

Leprecards feature components utilizing the latest technology from Seagate & Western Digital. You get a 1 year warranty, & illustrated user's guide.

Low power drives mean less strain on the power supply, lower operating temperatures, and longer component life. **FREE SOFTWARE** including **TakeTwo**, the backup utility, PC MAGAZINE Editor's Choice in 1986 & 1987, & **PC-KWIK** disk cache software from Multisoft.

21MB 85ms	30MB 85ms	30MB 40ms	40MB 70ms*	49MB 28ms*	65MB 16ms*
<b>\$299</b>	<b>\$339</b>	<b>\$389</b>	<b>\$449</b>	<b>\$549</b>	<b>\$649</b>

\*Average access speed per partition  
**TANDY 1000/A/5X/TX Leprecards add \$20**

## 3.5" Floppy Kits



Instant laptop & PS/2 compatibility. All kits include bracket to mount in 5 1/4" drive bay, black & grey face plates, and AT rails.

Now included: **TakeTwo**, the backup utility PC MAGAZINE named as their Editor's Choice.

<b>\$109</b> 720K Internal for PC/XT/AT Requires DOS 3.2 or optional \$19 driver software.	<b>\$139</b> 1.44 MB Internal for AT only. Includes driver software.	<b>\$199</b> 1.44MB Internal for PC/XT. Includes high speed floppy Controller & cables. Supports two drives.
---	---	---

## PC/XT Disk Kits

- Pretested & formatted
- Western Digital short controller
- 30 page installation guide & reference manual
- Cables, mounting screws, full & half-height face plates
- **TakeTwo** backup software, PC MAGAZINE "Editor's Choice"
- **PC-KWIK** disk cache software by **Multisoft**
- 1 year Warranty, 30 day Money Back Guarantee
- Optional: 150 watt, UL/FCC approved power supply for IBM PC's **\$69**



**TANDY 1000 kits add \$20**

<b>20MB kit</b> Seagate ST225 21.4MB/65ms/Half-Height/14.8 watts	<b>\$289</b>
<b>30MB kit</b> Seagate ST238 32.7MB/65ms/Half-Height/14.8 watts	<b>\$309</b>
<b>40MB kit</b> Seagate ST251 42.8MB/Half-Height/11 watts pre-formatted into a pair of 21MB/28ms partitions	<b>\$459</b>
<b>65MB kit</b> Seagate ST277R 65.5MB/Half-Height/11 watts pre-formatted into a pair of 32MB/28ms partitions	<b>\$549</b>

## 286<sup>10</sup> Computer

80286 processor at running at 6/10 Mhz with 0 wait states provides a Norton SI rating of 11.5. 8 slots - Room for 1 full height and 3 half - height drives - 200 watt power supply - Clock calendar - Choice of 1.2 or 1.44MB floppy drive - Combination Hard Disk/Floppy drive controller - Maxiswitch 84 or 101 key Keyboard - 512K RAM standard expandable to 1 MB - Award BIOS - 1 year warranty - 30 day money back guarantee.



**\$895**

### Complete Systems with Serial/Parallel/Game Ports:

Monographics Card & Monitor	<b>\$1095</b>	Orchid 512K VGA & Multisync II	<b>\$1995</b>
with 20MB/65ms Seagate	<b>\$1289</b>	with 20MB/65ms Seagate	<b>\$2189</b>
with 40MB/40ms Seagate	<b>\$1429</b>	with 40MB/40ms Seagate	<b>\$2329</b>
with 65MB/40ms Seagate	<b>\$1549</b>	with 65MB/40ms Seagate	<b>\$2449</b>

## 1.5 MB Laser Printer

"One of the Laserjet's strongest competitors."  
INFOWORLD October 5, 1987

512K RAM	1.5MB RAM
<b>\$1295</b>	<b>\$1595</b>



- 100% HP Laserjet, & Laserjet + compatible
- 1.5MB RAM Gives Full Page 300dpi graphics
- Vector graphics capability improves speed on programs like Autocad up to 93%
- 9 resident & 5 downloadable soft fonts standard
- Printer utility software
- Serial & Parallel interfaces
- 120 day TRW on site maintenance
- 1 year Warranty
- Options: All HP style font cartridges  
Toner Cartridge **\$29**

## AT Hard Disk Kits

- Includes IBM AT rails & cables
- **SpeedStor** or **OnTrack** large drive software
- Formatted, Partitioned & Tested

Size	Model	Speed	Capacity	Price
HH	Seagate ST251	40ms	42.8MB	<b>\$399</b>
HH	Seagate ST251-1	30ms	42.8MB	<b>\$489</b>
FH	Seagate ST4096	28ms	80.2MB	<b>\$669</b>
FH	Micropolis 1333	30ms	44MB	<b>\$555</b>
FH	Micropolis 1335	28ms	71MB	<b>\$699</b>
FH	Maxtor 1140	27ms	117MB	<b>\$1669</b>

## Orchid

512K <b>\$299</b>	256K <b>\$249</b>
Tiny Turbo 286 <b>\$289</b>	
Twin Turbo <b>\$409</b>	



2524B Townsgate Rd, Dept. B / Westlake Village, CA 91361

To order, or get our free catalog, call:

Toll Free  
**800-722-AT-XT**  
California  
**805-373-7847**



- ★ No extra for Visa/Mastercard (AMEX add 3%)
- ★ Prices include UPS surface shipping.
- ★ Federal Express shipping just \$1.50 per pound.
- ★ 30 Day Money Back Guarantee.
- ★ Corporate & Institutional PO's accepted.

## 2400 MNP Modems

**\$239/\$229**

- Hayes Compatible, 300/1200/2400
- MNP level 4 error correction
- **FREE MIRROR II** Software, a \$69 value
- Internal model \$229, fits in short slot

**Internal with MIRROR II (non MNP) \$119**

## 1200 Modem

**\$69**

- 300 or 1200 bps speed
- Hayes Smartcom II compatible
- Line-busy detect, auto redial
- **FREE MIRROR II** software
- Made in USA, 1 year warranty



# Train Your PC to Read...

...the Same Things You Read!

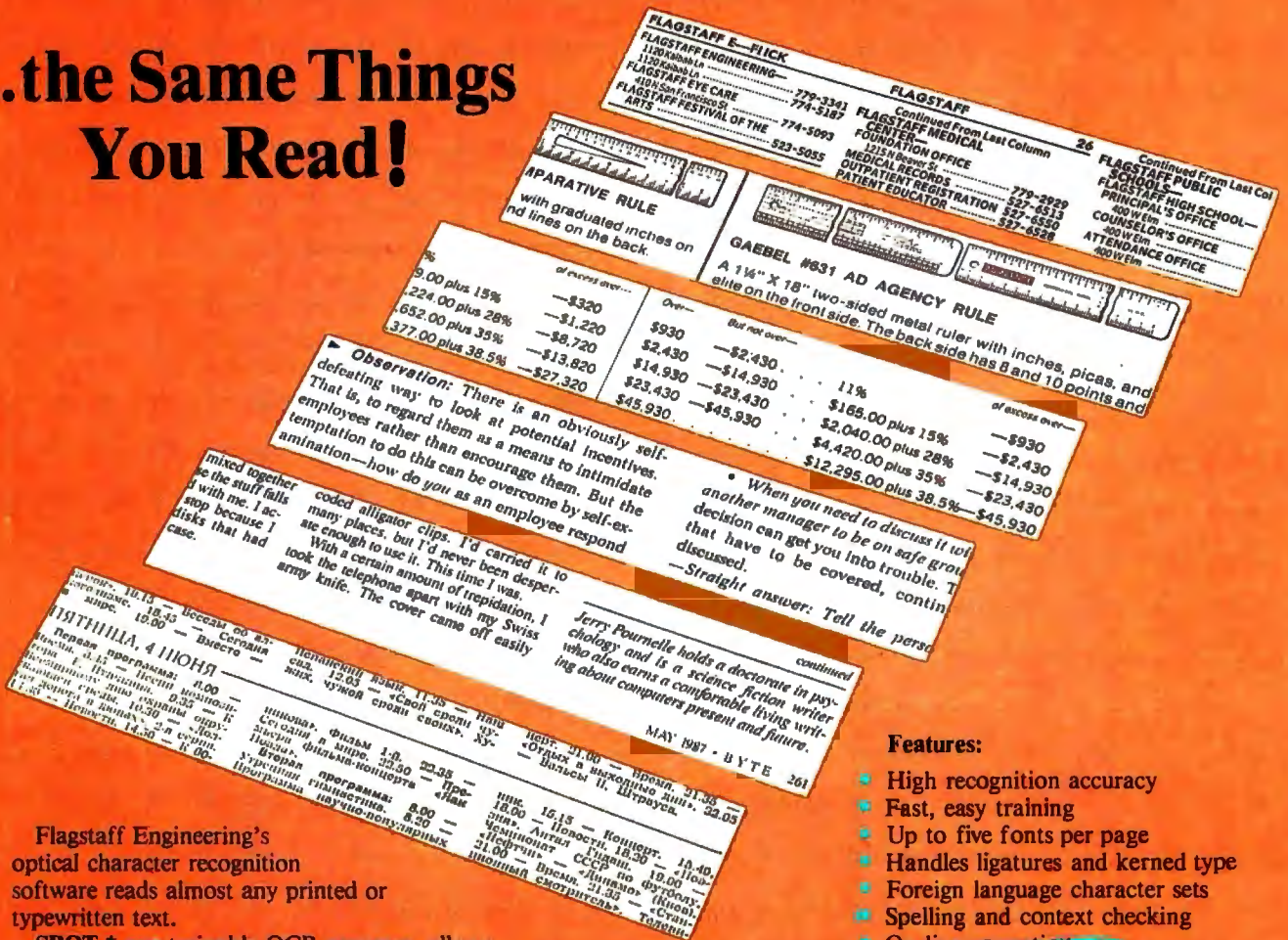

Flagstaff Engineering's optical character recognition software reads almost any printed or typewritten text.

**SPOT**,\* our trainable OCR program, allows you to compile information from books, magazines, typewritten records, genealogical data, directories, catalogs, and public documents, including foreign-language material. The data captured by **SPOT** can be used by database, word processing, desktop publishing and typesetting applications.

**SPOT**'s flexible output options allow you to preserve the original page format, including columns and margins. Reformatting options include the choice of DCA or ASCII output files, with options to generate single-column output from multiple-column text.

### Features:

- High recognition accuracy
- Fast, easy training
- Up to five fonts per page
- Handles ligatures and kerned type
- Foreign language character sets
- Spelling and context checking
- On-line correction
- Affordable at \$995.00

Flagstaff Engineering leads the PC industry in desktop conversion systems for 9-track tape and 8-inch diskette data files. We have already supplied thousands of customers worldwide with our OCR systems. Call for the best prices on Panasonic, Hewlett-Packard, and Canon scanners. Dealer and volume discounts are available.

Flagstaff Engineering can modify the software code to meet your custom applications. For details, call us at (602)779-3341.

\*Syntactic Pattern Optical Translator



1120 Kaibab Lane • Flagstaff, AZ 86001  
(602)779-3341 • Telex 705609 • FAX (602)779-5998

Circle 88 on Reader Service Card (DEALERS: 89)



# A FOND FAREWELL

Is Jerry's old friend Zeke II retiring to greener pastures?

**T**his is a shameless commercial. As I write this, *Legacy of Heorot* by Larry Niven, Jerry Pournelle, and Steve Barnes is on the best-seller list in England. About the time you read this, the paperback version will be out from Pocket Books. If every BYTE reader goes out and buys one, it will hit the best-seller list here. If you all buy another for a friend—

Well, anyway, it's a good book about the first interstellar colony (sent out by the National Geographic Society), it has a nice computer in it, and you can buy the book at your favorite bookstore. Meanwhile, there's a lot happening at Chaos Manor.

Writers are superstitious about all kinds of things. Goethe had to have a drawer full of rotten apples. Schiller wanted cats in the room. Some need a particular brand of coffee or a favorite coffee mug.

Not all writers worry about furniture, but many do. I confess I'm one of them. Of course, I don't think of it as superstition, just good organization.

What I want is a big desk, the bigger the better, that I can get right up close to, and high enough for drafting work. For years, I used a 4- by 8-foot piece of half-inch mahogany plywood screwed to the top of an ancient student desk that stood on little feet to raise it; the result was overhangs on all four sides deep enough that I could scoot a chair right up to the desk. It was a little odd getting to the drawers, but the system worked.

Of course, I didn't do my writing on that structure, because it was too high to set a typewriter on. Instead, I set my Selectric on a regular typing table, one

large enough to hold not only the typewriter, but pages to be retyped or a few books. The typing table was at right angles to the desk, so I had only to swivel around to get at it. That way, I could lay out notes and research work on the big desk, turn left to the Selectric when I was writing, and turn back to the desk to review notes.

When I got Ezekial, my old friend who happened to be a Cromemco Z80, I set things up the same way, with Zeke taking the place of the Selectric. Of course, an S-100 system with 8-inch disk drives wouldn't fit on a normal typing table, and I ended up building a furniture system that had the computer itself near the floor, the disk drives on a counter, and the 15-inch monochrome Hitachi monitor on top of the disk drives.

The keyboard first went on the Selectric's old typing table; later, I got a larger table that would hold the keyboard and a bunch of notebooks and stuff. The monitor was at eye level and 30 inches away, just far enough that I didn't need the reading element of my bifocals to read the large text put up by the Processor Technology VDM board. There were only 16 lines of 64 characters, but that was enough.

I wrote on that system for years. Ezekial himself evolved into Zeke II: a CompuPro S-100 "boat-anchor" box and CompuPro 8-inch disk drives, but the same Hitachi 15-inch monitor driven by the same VDM memory-mapped video board. Larry Niven bought an exact duplicate of Zeke II. We wrote a number of books on those two machines. I also wrote these columns and everything else I did, a total of several million words.

I tried the IBM PC when it first came out. I even bought one, but for research only. I had no temptation to use it to write books. PC text editors weren't good enough. Their only advantage was that a PC would put up 24 lines of text as opposed to Zeke's 16, but against that the PC was *very* slow compared to Zeke. In

particular, it scrolled slower. With Zeke I could instantaneously flip back and forth by pages, which more than made up for the 16-line limitation. Also, it took a lot longer to read and write IBM 5¼-inch disks than 1.2-megabyte CompuPro 8-inch disks. For the first 5 or 6 years after the PC came out, there was just no incentive to change over from Zeke.

Slowly, though, PCompatibles got faster and better. EGA video put up readable text in color. New PCompatible thesaurus and spelling programs came out—although Oasis Systems' The Word Plus was for a very long time the best spelling program around (it's still the basis for the spelling checker in many well-known word processors). Writing utilities like Grammatik II (and now III) and the Readability program would work only with PCompatibles. Editor programs sprouted features not available for my old CP/M system. I found I was using the PC more and more.

Eventually, the only things I was writing on Zeke II were books in collaboration with Larry Niven. When we brought in Steve Barnes to work on *Legacy of Heorot*, we had another problem: Steve was using WordStar on a Kaypro PCompatible, and his files had to be translated from PC-DOS to CP/M.

Fortunately, we had the means to do it: the Golem, my big CompuPro Dual Processor (80286 master, Z80 slave board), can read and write 360K-byte 5¼-inch DOS disks, and it also sports a pair of 8-inch floppy disk drives (as well as a 40-megabyte Priam hard disk drive). We could feed Steve's disks into the Golem, run his files through a filter, and write them out on 8-inch disks that Zeke II could read into our CP/M text editor.

When we finished *Legacy of Heorot*, I decided enough was enough. Niven was working on a new book with David Drake, and Drake uses a Toshiba T1000 PCompatible with 3½-inch disks. Getting Drake's stuff onto the CP/M system

*continued*

and Larry's onto Drake's Toshiba was no easy job. It was time for a change.

Niven was persuaded to go buy a PCompatible: a Zenith Z-386 with a hard disk drive, a 19-inch Electrohome monitor, and both 5¼- and 3½-inch floppy disk drives. That took care of the Drake collaboration. I converted our latest stuff over to PCompatible format. Now I was doing all my writing on PCompatibles.

I had long since set up a PCompatible on the opposite side of my desk from Zeke; swivel left to the PCompatible, swivel right to Zeke (and also to a terminal that controls the Golem). Which PCompatible it was changed from time to time: first Big Kat the Kaypro 286, then Fast Kat the Kaypro 386, and now Zanna Lee the Zenith Z-386. Zeke II sat there watching in silence. He had nothing to do, and we turned him on only when a visitor wanted to see him.

Then BYTE wanted a column for the special Macintosh edition. Apple sent a Mac II. About then, Cheetah put together the Big Cheetah, a 20-MHz 80386 with a Priam 330-megabyte internal hard disk drive and a Maximum Storage APX-3200 WORM (write once, read many) drive. Commodore sent the Amiga 2000. Atari sent a Mega ST. Every one of those machines had to be set up on test stands far away from my desk, making it very inconvenient to use them—and after all, the point of this column is to write about stuff I've used for practical work.

Something had to be done, and I did it.

Three weeks ago, Zeke II retired. We had a little ceremony and wheeled him out.

At the moment, the poor old fellow is sitting in the storeroom. All his parts are there—disk drives, Hitachi monitor, keyboard, and all the cables—but they aren't assembled. I haven't really had the heart to do it. As far as Zeke knows, he was turned off one day and hasn't been awakened again. Suppose I connect him up and he sees where he is? Unthinkable.

I confess I don't really know what to do with him. What I'd like is to find him a good home. Oh, sure, there are some mad hobbyists who'd like to have all his parts, but I can't allow that. What I want is someone who will use him—but who? Who, after all, is likely to want an ancient Z80 machine that's physically larger than a two-drawer file cabinet, has 8-inch disk drives that spin all the time, and has a 16-line by 64-character display driven by the world's last operating Processor Technology VDM board? He's a wonderful old guy, but he's also a museum piece.

I know from my mail that I have very

clever readers, and some seem as devoted to old Zeke as I am. I've decided to have a contest: I'm soliciting the best suggestion as to what to do with Zeke, the CompuPro S-100 Z80. I'm not sure what the prizes will be. Something appropriate, like dinner at a COMDEX or West Coast Computer Faire for the best half dozen letters, and something a bit more special for the winner.

The rules are simple: I'll consider any suggestion provided that Zeke will be kept intact and there's some chance of

**T**he Mac  
has a well-deserved  
reputation for being  
easy for utter beginners  
to use.

implementing it. If you want to tell me why Zeke ought to be given to you, or your family, or some favorite institution, feel free. If you think he belongs in the Smithsonian, you'll have to show me some evidence that the Smithsonian would be interested. If you think he ought to be sent to the center of the galaxy, you'll have to explain how that could be accomplished.

The decision of the judge—me—is final, all entries become part of the general chaos in Chaos Manor, and some will be returned but others won't be because they're lost or the dog ate them. Contest closes on Thanksgiving Day.

### The Furniture Dilemma

When I first got Zeke, there wasn't any commercial computer furniture. In those days, you either made do with typing tables or designed and built your own "workstation." In the early 1980s there was a flood of the stuff, most badly designed. Gradually, evolution and the market took care of the situation, so that now you can get quite a bit of computer furniture designed for PCompatibles. There's also some for the Macintosh.

Alas, there is absolutely nothing satisfactory for the Mac II; and what has evolved for PCompatibles isn't going to be useful much longer. The problem is mice.

Until recently, PCompatible users

didn't need mice. You couldn't operate a Mac without one, but many considered a mouse for the PC to be a pretentious bit of luxury. Slowly, though, PC users began to change their minds. Some programs require mice—it's possible to use Microsoft Word without one, but you won't like it much. Others weren't designed for mice but work better if you have them: WordPerfect with either Mouse Perfect or a properly written script for Logitech's Menu mouse support package is a good case in point, being much easier to use with a mouse.

Also, the Mac has a phenomenal (and well-deserved) reputation for being easy for utter beginners to use, and much of the Mac's design philosophy is drifting over into PCompatible software designs. The upshot, in my judgment, is that mice are taking over the computer world, and pretty soon none of us will feel at home without them.

That's where the furniture problem comes in. With the exception of a few special items jiggered for the Mac and dependent on the old Mac's small footprint and weird keyboard, there isn't any computer furniture designed for mouse users.

One of the best kinds of computer desk starts with a more mundane item—office desk or credenza or even a solid counter-top—and puts a keyboard drawer underneath. There are a number of keyboard drawers, and while many of them are overpriced, all the ones I've seen work quite well and are easy enough to install. All the keyboards I've used fit well in the drawer tray, and the system is solidly built so things don't wobble when I type. However, every one of those keyboard drawers, without exception, is too narrow to hold both a keyboard and a mouse.

I suppose it's only a matter of time until someone gets smart and makes a computer desk with a keyboard area large enough for both keyboard and mouse, but that hadn't happened by Spring COMDEX; I looked at every computer furniture display in Atlanta, and except for one desklike system that's a full 4 feet wide, there wasn't a thing. Sigh.

### Amiga Progress

One of my high points of COMDEX was a demonstration of new developments for the Amiga given by Dr. Harry Rubin, chief operating officer of Commodore America. Rubin's enthusiasm for the Amiga is unmatched; he reminds me of some of the company executives back in the early days of microcomputers.

One thing they showed me was Unix

*continued*

# THE PROGRAMMER'S SHOP

helps save time, money, and cut frustrations. Compare, evaluate, and find products.

## Real-time Programmers:

Build multitasking into your applications, add communications and interfaces easily, write blazing code with a C-like assembler.

Choose a real-time multitasking O/S, work with a classic real-time toolbox.

**Call a Tech Rep TODAY!**

Order before August 31, 1988 and mention "BY888" for these special prices

**C Sharp Real-time Toolkit** – includes graphics \$495 \$479 **\$399**  
**DESQview API Tools** – multitasking, interfaces \$550 \$449 **\$419**  
**Greenleaf Comm Library** – complete, for C \$185 \$129 **\$105**  
**QNX** – real-time multitasking O/S \$650 \$629 **\$599**  
**Risc** – high level ASM C-like \$80 \$75 **\$59**  
**Timeslicer** – multitasking \$295 \$265 **\$239**

List Normal SPECIAL

386 Assembler/Linker	PC	\$ 389
386 Debug - by Phar Lap	PC	\$ 129
386/DOS Extender	PC	\$ 919
DESQview PS/2	PC	\$ 109
F77L-EM - by Lahey	MS	Call
FOXBASE + /386	PC	\$ 419
High C - by MetaWare	PC	Call
OS/286 & 386 by AI Architects	PC	Call
Paradox 386	MS	Call

## C Language-Compilers

AZTEC C86 - Commercial	PC	\$ 499
C86 PLUS - by CI	MS	\$ 359
High C Optimizing Compiler	PC	Call
Instant-C/16M	PC	Call
Lattice C - V3.3	MS	\$ 259
Microsoft C 5.1 - with Codeview	MS	\$ 299
Microsoft Quick C	MS	\$ 69
NDP C-386 by MicroWay	MS	\$ 529
Turbo C by Borland	PC	\$ 67
Watcom C6.0	MS	\$ 259

C-terp by Gimpel - full K & R	MS	\$ 219
C Trainer - by Catalytic	PC	\$ 89
Interactive C by IMPACC Associates	PC	\$ 189
Run/C Professional	MS	\$ 145
Run/C	MS	\$ 79
Turbo C-terp	PC	\$ 119

## C Libraries-Files

BTree/ISAM - Single user	MS	\$ 99
CBTREE - Source, no royalties	MS	\$ 109
c-tree by Faircom - no royalties	MS	\$ 309
r-tree - report generation	PC	\$ 239
dB2C Toolkit V2.0	MS	\$ 259
db_VISTA - Source	MS	Call

## C Libraries-General

Blackstar C Function Library	PC	\$ 99
C Tools Plus - V5.0	PC	\$ 99
C Utilities by Essential	PC	\$ 119
Greenleaf C Sampler	PC	\$ 69
Greenleaf Functions	PC	\$ 129
LIGHT TOOLS by Blaise	PC	\$ 69
Turbo C Tools by Blaise	PC	\$ 99

## C-Screens, Windows, Graphics

C Display Manager	PC	\$ 109
C-Worthy Interface Library	PC	\$ 249
dBASE Graphics for C	PC	\$ 69
ESSENTIAL GRAPHICS - fast	PC	\$ 235
GraphiC - new color version	PC	\$ 279
Greenleaf Data Windows w/source	PC	\$ 259
Quick Window/C	PC	\$ 75
Terminal Mapping System	PC	\$ 279
TurboWINDOW/C - for Turbo C	PC	\$ 75
VC Screen	PC	\$ 119
View Manager by Blaise	PC	\$ 199
Vitamin C - source, menus	PC	\$ 159
Windows for C - fast	PC	Call
Windows for Data - validation	PC	Call

Note: All prices subject to change without notice. Mention this ad. Some prices are specials. Ask about COD and POs. Formats: 3" laptop now available, plus 200 others. UPS surface shipping add \$3 per normal item.

**THE PROGRAMMER'S SHOP**  
 Your complete source for software, services, and answers

5-B Pond Park Road, Hingham, MA 02043  
 Mass: 800-442-8070 or 617-740-2510 6/88

Call for a catalog, literature, and solid value

**800-421-8006**

## Fortran-C Translator

**For\_C** by Cobalt Blue - complete F77 to C optimizing translator, 99% efficiency, MIL-STD-1753 and common F77 extension support. Runtime libraries with complete C source. MS \$ 659

**dBASE IV** - features new user interface "Control Center," Multiuser file/record locking, "ANSI + " SQL, Query By Example, 255 field records, 99 files open, Parent-child file relations. DOS shell. PC \$ 499

## DataBase & File Management

Advanced Revelation	PC	\$ 779
CLARION - complete environment	PC	Call
DataFlex by Data Access	PC	\$ 595
DataFlex multiuser	PC	\$ 1049
Magic PC - visual database	PC	\$ 169
Paradox V2.0 List. \$725	PC	\$ 499
Paradox Network Pack	PC	\$ 719
XDB-SQL Database	MS	\$ 449

Clipper compiler	PC	\$ 389
dBASE III Plus	PC	\$ 399
dBASE III LANPack	PC	\$ 649
DBXL Interpreter by Word Tech	PC	\$ 99
FoxBASE + V2.0	MS	\$ 259
Quicksilver Diamond	PC	\$ 369

dBRIEF with BRIEF	PC	Call
dBXC III by Lattice	MS	\$ 169
Documentor - dFlow supersets	MS	\$ 229
Genifer by Bytel - code generator	MS	\$ 249
Integrated Development Library	MS	\$ 129
Networker Plus	MS	\$ 229
QuickCode III Plus	MS	\$ 189
R&R Report Writer	MS	\$ 139
Seek-It - Query-by-example	PC	\$ 79
Silver Comm Library	MS	\$ 139
Tom Rettig's Library	PC	\$ 79
UI Programmer - user interfaces	PC	\$ 249

## Other Products

ASMLIB - 170 + routines	PC	\$ 125
Back-It by Gazelle	MS	\$ 119
Baler	PC	\$ 459
CO/SESSION - remote access	PC	\$ 229
Dan Bricklin's Demo II	PC	\$ 169
Disk Technician - smart upkeep	PC	\$ 89
Fast Back Plus	PC	\$ 149
Flash-Up	PC	\$ 69
Easy Flow V5.0	PC	\$ 125
Link & Locate	MS	\$ 309
Mace Utilities	MS	\$ 85
MKS RCS	MS	\$ 155
PC/Tools Deluxe by Custom	PC	\$ 69
Plink 86 PLUS - overlays	MS	\$ 275
PVCS Corporate - by Polytron	PC	\$ 339
PVCS Personal	PC	\$ 135
R-DOC/X	MS	\$ 135
Show Partner F/X	PC	\$ 328
Seidl Version Manager	MS	\$ 269
Source Print - V3.0	PC	\$ 75
TLIB	PC	\$ 89
Tree Diagrammer	PC	\$ 65
Visible Computer: 8088	PC	\$ 65
WKS Library by Raima	PC	\$ 179

## BRIEF™ Users:

productive environment.

Over 5,000 of you were forced to make sacrifices to use BRIEF, The Programmer's Editor. Advanced compilers and new programming environments, like Turbo C and QuickBASIC, took up so much RAM that BRIEF could not fit in the same 640k.

If you wanted to retain BRIEF's uniquely powerful features while working with larger programs, you had to sacrifice speed and continuity. Instead of a tight Edit-Compile-Edit loop, you had to slog through an obsolete Edit-Exit-Compile-Exit-Edit loop.

Now you no longer have to make that sacrifice.

You can enjoy the features<sup>1</sup> that have made BRIEF the best-selling and the best regarded<sup>2</sup> programmer's editor without sacrificing environment integration.

Version 2.1 of BRIEF can be swapped in and out with a single keystroke — ng immediate compilation with even the largest compilers: Microsoft C5.0, QuickC, Turbo C, Lattice C, dBase, FoxBASE+ v2.0, Clipper, etc.

<sup>1</sup> For example: real multi-level Undo (not simply Undelete), flexible windowing, unlimited file size, unlimited number of simultaneous files, automatic language sensitive indentation.

<sup>2</sup> For example:  
 "The quintessential programmer's editor." — *Dr. Dobbs' Journal* "Right out of the box, it's a versatile, extremely powerful editor that handles most any programming task with aplomb." — *Computer Language* "Simple to learn and use and extremely sophisticated. Strongly recommended." — *PC Magazine* "Not only the best programmer's text editor I've ever seen, but it is also a tour de force in the way it was conceived and implemented." — *Computerworld* "So far surpasses users' expectations that it is revolutionary." — *MicroTimes Magazine* "BRIEF is truly outstanding." — *Microsoft Systems Journal*

## Current BRIEF Users:

Call Ann for details on 4 other important enhancements. Registered users of versions 2.0 or 2.01 update for only \$35.

## Haven't tried BRIEF yet?

BRIEF retails for \$195. Call Ann today for a no-risk, 60-day trial with a full, money-back guarantee.

Call toll-free today  
**800-821-2492**

**Solution Systems**

841 Main Street, Suite 410  
 South Weymouth, MA 02190  
 617-337-6963

running on what appeared to be an Amiga 2000. This was full System V Unix, no compromises, and, even loaded down with several simultaneous tasks, it certainly looked fast enough. Fair warning: this is a show report. I'll have more on it when it's running here at Chaos Manor and I can turn Alex loose on it. I can only say that what I saw at COMDEX impressed the heck out of me.

Meanwhile, at the Amiga developers' conference held just before COMDEX,

they distributed new ROM chips for the 2000. Joanne Dow was given a copy for installation in my machine, and about an hour ago she came over and did the job.

ROM installation in the Amiga is simple but tedious. You have to remove about eight screws so that you can move the hard disk drive, floppy disk drive, and power supply. The good news is that they're all mounted on a rigid frame that moves as a unit, so once the screws are removed, the whole assembly lifts off to

expose the ROM chip. After that, things are simple.

AmigaDOS is not simple. I watched Joanne do her magic for a while, but I soon lost track. What I can say is that after about half an hour of work she had set up the Amiga 2000 so that on power-up you must boot it with a floppy disk—it still won't entirely boot from the hard disk drive—but that process is considerably faster than it used to be. The good news is that once that's done, the Amiga can be reset and rebooted from a RAM disk. That takes only a few seconds.

I don't know of any other computer that can boot from its own RAM disk.

There are other developments. There's a new version of the Amiga operating system, which is said to speed up disk operations. There were certainly plenty of software developers at the COMDEX Amiga booth. A number of "standard" PC programs, including WordPerfect, have been ported over to the Amiga and work fine there.

All in all, the Amiga seems to be improving steadily. More when I learn more. I'm supposed to have Unix for the Amiga coming in the next week or so.

**Scanners Live in Vain**

Spring COMDEX wasn't very exciting if you were looking for something new. There were almost no new products, and not much more new technology. There was, however, considerable excitement among dealers, a general feeling that the doldrums are over and the computer industry is ready to take off again.

The most exciting new hardware product I saw was the Logitech ScanMan. This is a small hand scanner that interfaces with a Logitech printed circuit board. You run the scanner over text or pictures or whatever, and it makes a bit-mapped image similar to a PC Paint file.

Meanwhile, over in the Apparel Center—where all the newcomers to COMDEX are sent—Flagstaff Engineering was exhibiting a program that takes scanned text images and turns them into machine-readable files. I suppose I'd better explain that.

Computers can store text in two different ways. The most familiar way is as actual text files, in which the machine "knows" what's there. Each letter, number, and punctuation mark is stored as a uniquely recognizable binary number, so that the machine can not only reproduce the text, but also manipulate it in orderly ways. It can make alphabetic sorts, look at words and compare them to dictionaries, and in general act as though it

*continued*

**RESIDENT EXPERT  
POP-UP REFERENCE GUIDES...**

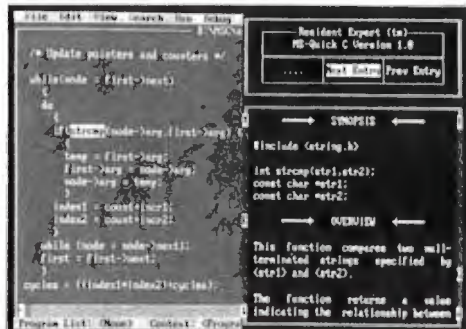

**STARTING AT \$19.95!**

Need help with your favorite programming language or business application but don't want to interrupt your work to fumble through a bulky user's manual? Consult RESIDENT EXPERT...our pop-up "super-help" utility containing all the reference material normally found in programming language reference guides and user's manuals.

Start with our lightning fast shell program (including our free PC-DOS/MS-DOS reference guides) and select your own custom library from our extensive list of titles.

The shell program uses only 58K of memory, supports auto look-up, keyword string searches, and full cross indexing. Our optional compiler lets you develop your own reference guides (or context sensitive help systems).

**Summer '88 Pricing...**

<i>Resident Expert Shell</i> . . . . .	\$19.95
<i>Resident Expert Compiler</i> . . .	39.95
<i>Reference Guides for...</i>	
dBase III Plus ( <i>new</i> ) . . . . .	\$39.95
Microsoft C (5.0) . . . . .	39.95
Microsoft Quick C (1.0) . . . .	19.95
Lattice C (3.2) . . . . .	39.95
Lotus 1-2-3 Rel 2 ( <i>new</i> ) . . . . .	39.95
Turbo Pascal (3.2/4.0) . . . . .	19.95
Turbo C (1.5) . . . . .	19.95
PC Prgrmr's Reference . . . . .	39.95
<i>(BIOS/DOS/80286/MASM Guide)</i>	

**1-214-727-9217**

Santa Rita Software  
1000 E. 14th St., Suite 365  
Plano, Texas 75074





# Use it or lose it!



## Use DataSaver

standby uninterruptible power supply, and protect your microcomputer against costly data loss and hardware damage.

- Constant AC line protection against power disturbances and interruptions.
- Built-in spike/transient suppression and EMI noise filtering.
- Powerful sizes to protect any system from the earliest Apples to the latest PS/2's. International models, also.

For more information, call:  
**TOLL-FREE 800/332-3440.**  
 In California, call 805/541-4160.  
 Or write to us at the address below.  
**GSA No. GS 00K-87-AGS5393 PS01**  
 Dealer/VAR inquiries invited



**Cuesta Systems Corporation**  
 3440 Roberto Court  
 San Luis Obispo, CA 93401

"knows" what the files contain.

The other way machines can store text images is as bit-mapped images. In this case, the computer doesn't know that what it has stored is text; as far as the machine is concerned, this may be a picture of the planet Jupiter, a random drawing made with a paint program by a 3-year-old, a line drawing of the Washington Monument, a Gary Larson cartoon, or anything else. The machine isn't expected to know anything about the image: its only obligation is to faithfully reproduce it when called upon. The fact that this particular image happens to be a picture of a page of text is completely irrelevant.

As an example: Mrs. Roberta Isdell Pournelle's father, the late Frank Isdell, was one of the early union organizers in the copper mines in Idaho. Those were rough times: his house was dynamited by the Pinkertons in retaliation for his union activities. Frank Isdell kept a journal, handwritten on yellow lined paper. It makes fascinating reading. Mr. Isdell died long enough ago that most of his grandchildren don't remember him well, and Mrs. Pournelle and I have decided to use our considerable computer resources to publish that diary so the kids will know just what their grandfather was like.

The first part of that job is easy. We simply use an image scanner to make copies of his manuscript pages. Once we have those, we can reproduce them in any way we like, on paper with a laser printer or even as page images to be stored on a CD-ROM. What we'll have is the electronic equivalent of photocopying or photographing those pages.

The problem with that is, you can't do anything with the images other than reproduce them. Since the machine can't read those notes, it can't do spelling correction. It can't index. We can't search for key words. Like a camera, it can only produce a new image copy; and that's not quite what we had in mind. Our intent is to produce an annotated work embedding Frank Isdell in his times, with notes and maps. To properly do what we want, we'll need true text files. The only way to get those is to have someone type them in. No computer is smart enough to take handwritten text and turn it into machine-readable text.

### The Trouble with Kerning

If Frank Isdell had typed his notes, we wouldn't have such a problem. There are hardware scanners with programs that recognize typescript letters, one letter at a time. If they encounter a typeface they

haven't seen before, they can be taught that one, too. These machines are called optical character readers (OCRs).

When an OCR sees the symbol ';', it is clever enough to recognize that as a semicolon and store it in memory as the binary equivalent of number 59. Similarly, an *A* is assigned the number 65, *a* is stored as 97, and so forth. The numbers are ASCII. ASCII is an arbitrary scheme that assigns a unique number to every letter, number (from 0 to 9), and punctuation mark. ASCII isn't the only such scheme—IBM sometimes uses a system called extended binary-coded decimal interchange code (EBCDIC), which assigns quite different numbers to each letter and punctuation mark—but it's the one used by all microcomputers.

OCRs have been with us for a long time, and they're quite good for what they're intended for, which is typescript. The trouble arises with printed text. Whereas typescripts (with exceptions like the IBM Executive, but let's not complicate matters) allow the same width to each letter—the *i* takes up just as much room as the *m*—printed text doesn't work that way. Not only is the space allocated to the *i* less than that given the *m*, but some letters actually overlap, as for example when they typeset the letter combination *WA*. This process is known as kerning, and it has been around for centuries, because kerned text is more readable and just plain looks better than typescript. The trouble is that kerning confuses the computer.

For years, we've heard announcements of OCR scanners that could read kerned text, and every now and then one comes out; but none of them has been worth much. At COMDEX, Flagstaff Engineering was demonstrating the Spot program that can take image-scanned text from either the Hewlett-Packard or the Panasonic scanner and turn that into machine-readable ASCII files.

The program isn't perfect. It has to be taught each typeface, and every time it runs into a kerned pair it has never seen before, it complains until you teach it what it means. You have to tell it that the symbol *WA* is to be interpreted as two ASCII characters rather than one. Once it learns that, it remembers. Eventually, it will know all the kerning pairs in that particular book, after which it can read the book.

I have a bunch of books I wrote on a typewriter before I got old Zeke. I either don't have the typescripts of those books, or they were so marked up in editing as to be unscannable; in any event, I have no

*continued*



## Items Discussed

<b>APX-3200</b> .....	\$2675	<b>Grammatik II</b> .....	\$89
Maximum Storage		<b>Grammatik III</b> .....	\$99
5025 Centennial Blvd.		Reference Software	
Colorado Springs, CO 80919		330 Townsend, Suite 123	
(719) 531-6888		San Francisco, CA 94107	
<b>Inquiry 937.</b>		(415) 541-0222	
		<b>Inquiry 941.</b>	
<b>Battery Watch</b> .....	\$39.95	<b>Readability</b> .....	\$59.95
Traveling Software		Scandinavian PC Systems	
18702 North Creek Pkwy.		51 Monroe St., Suite 707A	
Bothell, WA 98011		Rockville, MD 20850	
(206) 483-8088		(800) 628-2828 ext. 982	
<b>Inquiry 938.</b>		(301) 738-8826	
		<b>Inquiry 942.</b>	
<b>Cheetah 386 Motherboard</b> .....	\$1195	<b>SideKick Plus</b> .....	\$199.95
Cheetah International		Borland International, Inc.	
107 Community Blvd., Suite 5		4585 Scotts Valley Dr.	
Longview, TX 75602		Scotts Valley, CA 95066	
(800) 243-3824		(408) 438-8400	
<b>Inquiry 939.</b>		<b>Inquiry 943.</b>	
<b>ForComment:</b> .....	\$995	<b>Spot</b> .....	\$9.95
<b>Print Shop</b> .....	\$34.95	Flagstaff Engineering	
Broderbund Software		1120 Kaibab Lane	
17 Paul Dr.		Flagstaff, AZ 86001	
San Rafael, CA 94903		(602) 779-3341	
(415) 492-3200		<b>Inquiry 944.</b>	
<b>Inquiry 940.</b>			

machine-readable copies of my early works, and no easy way of making any.

That's all changing. Flagstaff Engineering has enough confidence in their programs that they're arranging to get me the loan of a Hewlett-Packard scanner, which they say will work with their software so that when we put printed copies of my old books in, we'll get machine-readable language out.

I can't wait to try that.

### Traveling Strikes Again

Mark Eppley of Traveling Software doesn't seem to know the rules: he held a press conference (his first ever) at COMDEX to announce a product they're actually shipping. I understand that seven different PR agencies were so horrified they tried to straighten him out: you hold press conferences to announce stuff that you're going to ship Real Soon Now, not something that you've actually got out the door.

Anyway, Traveling has a small memory-resident program for laptops that keeps track of battery use. By doing Shift-Alt-B, you get a "fuel gauge" display that estimates the time remaining before the batteries in your particular

laptop (you tell it which one you have during setup) go dead.

This is one of those utilities Traveling developed largely for their own use, then partway through decided it was a salable product. You can live without it—I have for several years—but it's certainly a convenience if, like me, you have a faulty memory. I have several times got on an airplane with a partially charged Z-183 and run out of juice before the flight was over. My fault, but very annoying. Traveling's Battery Watch program would have prevented that.

I can't testify to its accuracy for all laptops, but I did test a prerelease version on my Z-183, and it's pretty good on that: it reported I had 2 hours left when in fact the machine ran for 2 hours and 10 minutes. An hour later it reported 1.1 hours remaining, so it was in fact updating its prediction by watching my use pattern.

Battery Watch has a "deep discharge" option designed to really run down your nickel-cadmium battery. Running it down until it's complete discharged and then recharging it maintains the capacity and increases the life span of the battery. Otherwise, the battery develops a "mem-

ory"; if not completely discharged, it only partially recharges. The deep discharge option may be useful for some laptops, but it certainly isn't needed for the Z-183. When I tried the program, it did continuous reads on both the hard disk and floppy disk drives.

Moreover, after I'd been running the deep discharge option and listening to it grind my hard disk and floppy disk drives for a while, the backlit screen turned itself off. The prerelease version of Battery Watch didn't know how to take control of that, which is odd, because you set the time-out constant (how long the screen will stay lit between keystrokes) in software, meaning that number has to be stored somewhere in the machine's memory. The backlit screen uses plenty of power, and if you can keep it on, that surely would be the most harmless way to deep discharge your battery. As it happens, Norman Spinrad discovered a way to do just that on the Z-183: simply give the machine the SHIP command.

SHIP is supposed to park the hard disk drive head in a landing zone, after which you turn off the computer. If you don't turn it off after issuing SHIP, the Z-183's screen backlighting stays on until the battery is gone, which is surely a more benign way than grinding the disk drives.

Mark Eppley says that the production version of Battery Watch does keep the backlight on during a deep discharge. And, although using SHIP is a gentler method to discharge the batteries, using the deep discharge option speeds up the entire discharge/recharge operation.

The fuel-gauge part of Battery Watch works fine, and anyone who does a lot of traveling with a portable will be better off for it.

### Peep Shows

One reason COMDEX wasn't very exciting was that about half the new stuff on display has been vaporware for a very long time: products announced but not yet demonstrated, much less shipping. No matter how exciting a product is, after you hear about it long enough you lose interest.

Some companies know this, and they have a policy of not making public announcements until they've really got a product. On the other hand, they also know that writers have an insatiable appetite for new things to write about, which presents them with something of a dilemma.

One way out of that is what's known in the trade as a peep show: your booth on the show floor has only shipping prod-

*continued*



## Why build a printhead that can punch through aluminum, when all you need is a clear impression on a 5-part form?

The answer is uncompromising quality.

We built our new 300 Series 9-pin and 24-pin printers tougher and more reliable than they have to be. With printhead pins of carbaloy/tungsten, one of the hardest metals known, they're tough enough to make a crisp impression on a sheet of aluminum. So you can imagine how sharp they'll look driving clear to the bottom of a 5-part form.

**Even after printing on aluminum, we look this good on paper.**

Our engineers call this "championship specs." More than 3 million loyal users call it rugged reliability. And it shows in the quality and performance of every printer and modem we make.

Call 1-800-OKIDATA for the dealer nearest you.

*Circle 160 on Reader Service Card*

Demonstration above made using a 24-pin MICROLINE 391 printer without ribbon on a sheet of .003 inch gauge aluminum. Actual, unretouched photograph.

OKIDATA is a registered trademark of Oki America, Inc.  
Marque déposée: de Oki America, Inc.

**OKIDATA®**  
an OKI AMERICA company

We put business on paper.

ucts, but you also have a hotel suite where you bring selected distributors, dealers, and customers for private showings; and if there's any time left over in your schedule, you bring in reporters and columnists you can trust to respect information-release embargoes. As an example, I saw the Zenith laptop computers almost a year before they were announced to the public—I'm rather proud that they incorporated a couple of my suggestions into the final product—and the Zenith Flat Technology Monitor long before it was shown to the industry in general.

When I first began writing for BYTE, there was a full 4-month delay between my draft and the actual publication. Over the years, they've whittled that down a lot: I'm writing this on May 20, just before the Science Fiction Writers of America's annual Nebula Awards banquet, and it will be in the August issue, meaning that it will be on the stands in mid-July. Of course, I should have had this in a week ago. . . .

Anyway, one of the COMDEX peep shows was held by Intel, and I have their permission to say this much: Intel has a new PCompatible communications system, hardware and software, that will knock your eye out. I've been saying for years "one user, at least one CPU," and Intel has taken that to heart. I guarantee you'll hear more about this one.

#### **ForComment:**

I first saw Broderbund in San Francisco's Brooks Hall at one of the early West Coast Computer Faires. They had a tiny booth over against one wall, and they were showing the best computer games I'd ever seen. The next year they had a larger booth, and the year after that they had one of the biggest in the show, all built around computer games.

If you know computer games, you're likely to know something about computer graphics, and the temptation for games companies is to use that expertise in an attempt to penetrate the business market. Sometimes that doesn't work—few even remember the name of Infocom's business programs—but sometimes it works spectacularly, as witness Broderbund's Print Shop low-end desktop publishing programs and utilities for the IBM PC.

I recently received a report that Print Shop was the best-selling PCompatible program of 1987, and I've no reason to doubt that. I've covered it in other columns; in the unlikely event you don't know about it and you have the slightest interest in using a PC for simple bread-and-butter print work, check it out. It's

not as elegant as some of the high-end programs, but it's easy to get into and good enough for a heck of a lot of jobs.

Anyway, Broderbund hasn't abandoned games, but they have become a serious contender in the business and education markets.

One of their better efforts is ForComment: (despite the cutesy-pie name). This is a program that lets from a few to a whole bunch of people take text files, examine them, and make editorial comments complete with date and initial stamps. The commented version can then be sent on to someone else, either by disk or through a local-area network (LAN). Either way, there are simple ways for the final editor to collate the comments and either implement or remove them. One of the neatest features is selectivity: if one of the people making comments turns out to be a complete idiot, you can set the system so that you'll never see those remarks.

Despite the fact that Niven and I are about the most successful writing team since Nordoff and Hall, I'm no great fan of collective writing; realistically, though, most corporate documents are necessarily collaborative efforts. Policy memos have to be vetted by several departments. Letters often must be reviewed by a number of specialists. All this can be expensive, especially if it's done in face-to-face meetings.

ForComment: can take up some of that burden. It's easy to learn and easy to use, and it's not overdeveloped for the job it's supposed to do. It supports about a dozen word-processing programs (including, of course, straight ASCII text files). My only complaint about ForComment: is that it doesn't recognize Q&A Write, which is the editor Niven and I are using for our next novel.

#### **SideKick Plus**

Readers of this column will know that I'm a longtime addict of SideKick; indeed, one of the reasons I abandoned old Zeke was that there was nothing like SideKick for CP/M. I can't imagine there's anyone out there who doesn't know what SideKick is, but just in case: it's a memory-resident program that gives you instant access to a notebook, calendar/datebook, desk calculator, phone book and dialer, and ASCII conversion table. It's a program you can get totally dependent on, as Mrs. Pournelle discovered after I installed a copy on her AT&T 6300 Plus machine.

The only real problem with SideKick was that it ate too much memory; and since it was one of the earliest of the

memory residents, it didn't cooperate too well with other such programs. If you loaded it last, though, it worked quite well; and if you used it in its own DESQ-view window, the memory requirements were no problem at all. Consequently, although I've had SideKick Plus for some time, I was in no hurry to install it. Better is the enemy of good enough, and SideKick was good enough. . . .

That was foolish of me. SideKick Plus does a lot more than address SideKick's problems.

It does take care of those. True, it uses *more* memory than SideKick did, but unlike its predecessor, SideKick Plus knows how to load most of itself into Lotus/Intel/Microsoft EMS 4.0 expanded memory. Of course, you must have an expanded memory board, but that's no problem: a whole bunch of vendors will be happy to sell you one. Alas, that will be expensive. A year ago, memory was essentially free. Now, given the U.S. Department of Commerce's success in creating and enforcing a memory chip cartel—I guess the government thought Japan, Inc., was at a competitive disadvantage and wanted to level the field—I don't know what a good expanded memory board will cost.

The important thing is that SideKick Plus has a whole bunch of new features, including an outline processor that competes with Ready!. For the past couple of years, I've used both SideKick and Ready! (Ready! has always had the ability to stuff most of itself into expanded memory, so it doesn't take up too much prime memory space); now, I'll probably eliminate Ready! entirely.

There are also alarm clocks, lots of enhancements to the calculator, real improvements to the calendar/scheduler, and enough more that it's pointless to go on. If you liked SideKick, you'll love SideKick Plus. If you don't use SideKick, you probably ought to rethink your situation. It was that good, and SideKick Plus is even better.

Strongly recommended.

#### **Developer's Dreams**

There's been a recent spate of news about a design defect in the Intel 80386/80387 chip combination; sometimes when doing 32-bit calculations, the two chips get into an Alphonse/Gaston situation, each expecting the other to do something first, and the system is locked up.

The latest major system here is a big 20-MHz Cheetah 386, with a Priam 330-megabyte hard disk drive. The neat thing about the Cheetah 386 motherboard is

*continued*

If you need or are accustomed to the throughput of a 32-bit mini, including any of DEC's VAX series, MicroWay has great news for you. The combination of our NDP compilers and our mW1167 numeric coprocessor gives your 386 PC, VAX speed! If you don't own a 386 PC, we provide a number of economical PC and AT upgrade paths.

Many of our NDP Fortran-386 users are reporting turn around times that are two to six times faster than their VAX. The exact times are a function of the VAX processor being used, the speed of the 386, the number of users being served by the VAX, and the coprocessor being used with the 386. There are currently over 400 developers using our NDP tools to port 32-bit applications. To help the 386/1167 engineering standard emerge, MicroWay is co-marketing several mainframe applications that have been ported by our customers. In addition, this ad-

*Dr. Robert Atwell, a leading defense scientist, calculates that NDP Fortran-386 is currently saving him \$12,000 per month in rentals of VAX hardware and software while doubling his productivity!*

*Fred Ziegler of Aspen Tech in Cambridge, Mass. reports "I ported 900,000 lines of Fortran source in two weeks without a single problem!" AspenTech's Chemical Modeling System is in use on mainframes worldwide and is probably the largest application to ever run on an Intel processor.*

*Dr. Jerry Ginsberg of Georgia Tech reports "My problems run a factor of six faster using NDP Fortran-386 on an mW1167 equipped 386/20 than they do on my MicroVAX II."*

roduces the first of many utilities that will ease the porting of your favorite in-house programs. These include tools like NDP-Plot, which provides CalComp compatible screen and printer graphics, and NDP Windows.

MicroWay has mW1167 boards in stock that run on the Compaq 386/20, IBM PS/2/80, Tandy 4000, AT&T 6386, Acer 386/20, Everex Step 386/16(20), H.P. Vectra RS/16(20) and others. We now have a new board for the Compaq 386/20 which combines an 1167 with VGA support that is register compatible with IBM — the "SlotSaver". It features an extended 800x600 high res mode that is ideal for 386 workstations.

Finally, we still offer the 16-bit software and hardware which made us famous. If you own a PC or AT and are looking for the best 8087/80287 support on the market, call (508) 746-7341 and we'll send you our full catalog.

### 32-Bit Compilers and Tools

NDP Fortran-386™ and NDP C-386™ Compilers generate globally optimized mainframe quality code and run in 386 protected mode under PharLap extended MS-DOS, UNIX, or XENIX. The memory model employed uses 2 segments, each of which can be up to 4 gigabytes in length. They generate code for the 80287, 80387, or mW1167. Both compilers include high speed EGA graphics extensions written in C that perform BASIC-like screen operations ..... \$595 each

- **NDP Fortran-386™** Full implementation of FORTRAN-77 with Berkeley 4.2, VAX/VMS and Fortran-66 extensions.
- **NDP C-386™** Full implementation of AT&T's PCC with Microsoft and ANSI extensions.

#### NDP Package Pricing:

**387FastPAK-16:** NDP Compiler, PharLap, and 80387-16 Coprocessor ..... \$1299

**1167FastPAK-16:** NDP Compiler, PharLap, and mW1167-16 Coprocessor ..... \$1695

**NDP Windows™** — NDP Windows includes 80 functions that let you create, store, and recall menus and windows. It works with NDP C-386 and drives all the popular graphics adapters. Library ..... \$125, C Source ..... \$250

**NDP Plot™** — Calcomp compatible plot package that is callable from NDP Fortran. It includes drivers for the most popular plotters and printers and works with CGA, Hercules, EGA and VGA ..... \$325

**NDP/FFT™** — Includes 40 fast running, hand coded algorithms for single and double dimensioned FFTs which take advantage of the 32-bit addressing of the 386 or your hard disk. Callable from NDP Fortran or NDP C with 1167 and 387 support ..... \$250  
387FFT for 16-bit compilers ..... \$250

**387BASIC™** — A 16-bit Microsoft compatible Basic Compiler that generates the smallest .EXE files and the fastest running numeric code on the market ..... \$249

## MicroWay® 80386 Support

### Parallel Processing

#### Monoputer™

The world's most popular Transputer development product runs all MicroWay Transputer software using either a T414 or T800. The T800 processor has built-in numerics and provides performance comparable to an 80386 running at 20 MHz with an mW1167. The new 3L Parallel C and Fortran Compilers makes this an especially attractive porting environment. Can be upgraded to 2 megabytes.

Monoputer with T414 (0 MB) ..... \$995  
Monoputer with T800 (0 MB) ..... \$1495

#### Quadputer™

This board for the XT, AT, or 386 can be purchased with 2, 3 or 4 Transputers and 1, 4 or 8 megabytes of memory per Transputer. Two or more Quadputers can be linked together to build networks with mainframe power which use up to 36 Transputers. One customer's real-time financial application has gone from 8 hours on a mainframe to 16 minutes on a system containing five Quadputers. .... from \$3495

#### Transputer Compilers and Applications

MicroWay and 3L offer Parallel languages for the Monoputer and Quadputer.

MicroWay Parallel C ..... \$595  
MicroWay Occam2 ..... \$495  
3L Parallel C ..... \$895  
3L Parallel Fortran ..... \$895

**μField** — A specialty finite element analysis package targeted at Transputer networks. Ideally suited to take advantage of the 6 Megaflop speed of the Quadputer. .... \$1600

**Call (508) 746-7341 for our free catalog!**

### Numeric Coprocessors

**mW1167™** — Built at MicroWay using Weitek components and an 80387 socket.

mW1167-16 ..... \$995  
mW1167-20 ..... \$1595  
mW1167/VGA-20 "SlotSaver" ..... \$1995  
8087 ..... \$99  
8087-2 ..... \$154  
80287-8 ..... \$239  
80287-10 ..... \$295  
80387-16 ..... \$475  
80387-20 ..... \$725  
287Turbo-12 (for AT compatibles) ..... \$450  
DRAM ..... CALL  
(All of our Intel coprocessors include 87Test.)

### PC and AT Accelerators

MicroWay builds a number of 8086 and 80286-based PC accelerators that are backed up by the best customer support in the industry.

**Number Smasher™** (8087 & 512K) .. \$499  
**FastCACHE-286/9 MHz** ..... \$299  
**FastCACHE-286/12 MHz** ..... \$399  
**SuperCACHE-286/12 MHz** ..... \$499  
**Intel Inboard™ PC (1 MB)** ..... \$950

### Intelligent Serial Controllers

MicroWay's **AT4™**, **AT8™**, and **AT16™** are the fastest 80186-based intelligent serial controllers on the market. They come with drivers for UNIX, XENIX, and PC MOS.

AT4 ... \$795 AT8 ... \$995 AT16 ... \$1295

### 32-Bit Applications

**COSMOS-M/386** — SRAC's finite element package for the 80386 with an 80387 or mW1167 provides mainframe speed and capacity. Turn around times rival the VAX 8650 and are 6 to 15 times that of an AT: from \$995

**PSTAT-386** — This mainframe statistics package has been used by government and industry for 20 years. The full version was ported. Requires 4 to 6 megabytes of memory: \$1495

**NDP/NAG™** — Features a library of 800 engineering and scientific numerical algorithms. Callable from NDP Fortran ..... \$895

**MicroWay**

**The World Leader in PC Numerics**

P.O. Box 79, Kingston, MA 02364 USA (508) 746-7341  
32 High St., Kingston-Upon-Thames, U.K., 01-541-5466  
St. Leonards, NSW, Australia 02-439-8400





**Just Released**

# STATISTICS MADE EASY.

**Microstat-II will have you up and running in 5 minutes  
or your money back.**

**O**perating Microstat-II couldn't be easier. No matter what your statistical needs are. Simply select the options you need from the menu system with a keyboard or a mouse and your answer is available instantly. No complex command languages to learn. On-line help is only a keystroke away! Plus, it only takes three disks to operate the program. Microstat-II is simple to use and fast!

### The #1 Selling Micro Statistical Package is Even Better!

Microstat is by far the most popular micro statistics package of all time. Tens of thousands of satisfied customers have relied on Microstat since 1979 for all their statistical needs. Microstat has been used for every application imaginable from checking the brine content of tuna fish to keeping game statistics for an NFL football team. Already 64 of the Fortune 100 companies have purchased Microstat. Virtually every major university is presently using Microstat and over 10,000 copies have been sold to the US government. Microstat-II is even better!

### The Coverage You Need

Microstat-II has the statistical tests you need. Just some of the areas of coverage are descriptive statistics, ANOVA, correlation and regression (with stepwise), time series, hypothesis testing, nonparametrics, crosstabs and chi-square, probability distributions, scatterplots, plus a lot more!

### Easier Installation

Microstat-II provides all this power with only 3 disks and can run on a hard disk or a floppy disk system with two drives. Our competitors use up to 21 disks and most require a hard disk. Plus Microstat-II is not copy protected.

### Even Greater Flexibility

We have completely redesigned the data management section to include features our users have requested. You can have unequal cases in the same file, aliased variables, missing data, range checking, and built-in scalars on data entry, plus other new features. You can even use a mouse!

### Improved Speed and Interface

Microstat-II is 8 times faster than our own Microstat version 4.0 and almost twice as fast as the competition. This exceptional speed was achieved without any loss of accuracy. When running descriptive statistics the results were staggering (can be even faster with a numeric co-processor):

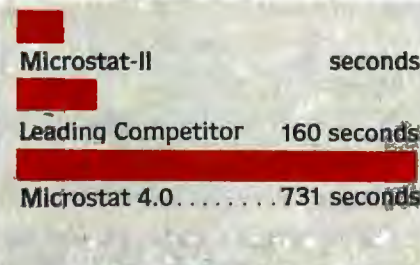

The user interface has also been greatly improved. A full-model regression on the infamous Longley data takes only 9 strokes with Microstat-II. One competing package, which claims to have the easiest command structure, requires 88 strokes. Plus, a specifically designed reversible scrolling feature has been added to save you even

more time. You don't have to rerun a test to see output that has scrolled off the screen.

### Introductory Price Just \$395 until September 1, 1988

Microstat-II is being offered at the low introductory price of just \$395 complete. Want just a peek at Microstat-II? We'll send you a demo disk and manual for just \$19.95. Also, a generous update program is available for our loyal Microstat customers. Just inquire.

### Absolutely Guaranteed

We are so sure that Microstat-II will satisfy all your statistic needs that we will offer a 30-day no risk money-back guarantee.

**Make statistics easy, order  
Microstat-II today!**

**1-800-952-0472**

**Ecosoft Inc. Circle 83 on Reader Service Card**

6413 N. College Ave., Suite 101,  
Indianapolis, IN 46220

**Yes!**

**1-800  
952-0472**

- Please send me \_\_\_\_\_ copy(s) of Microstat-II and a complete manual at the low introductory price of \$395.00
- Please send me \_\_\_\_\_ copy(s) of Microstat-II Demo Disk and summary manual for just \$19.95.  
Add \$4 per package for UPS shipping charges. Indiana residents add 5% sales tax.  
Format:  5¼" IBM     3½" IBM     5¼ 1.2 meg
- Please send me a Microstat-II brochure.
- Please send me information on upgrading my Microstat package to Microstat-II.

Name: \_\_\_\_\_

Organization: \_\_\_\_\_

Address: \_\_\_\_\_

City: \_\_\_\_\_ State: \_\_\_\_\_ Zip: \_\_\_\_\_

Phone: \_\_\_\_\_

Bill my credit card.     VISA     MC     American Express

Account Number: \_\_\_\_\_ Expiration Date: \_\_\_\_\_

**ECOSOFT**



# Everything you see here...

12 MHz 80286  
AT-Compatible  
1Mb on-board DRAM  
Full set of AT-compatible controllers:  
EGA/CGA/MDA/  
Hercules compatible  
HD/FD controllers  
... and more

## you see here. THE AMPRO LITTLE BOARD™/286

### Big power for smaller systems.

Little Board/286 is the newest member of our family of MS-DOS compatible Single Board Systems. It gives you the power of an AT in the cubic inches of a half-height 5 1/4" disk drive. It requires no backplane. It's a complete AT-compatible system that's functionally equivalent to the 5-board system above. But, in less than 6% of the volume. It runs all AT software. And its low-power requirement means high reliability and great performance in harsh environments.

**Ideal for embedded & dedicated applications.** The low power and tiny form factor of Little Board/286 are perfect for embedded microcomputer applications: data acquisition, controllers, portable instruments, telecommunications, diskless workstations, POS terminals... virtually anywhere that small size and complete AT hardware and software compatibility are an advantage.

### Compare features.

Both systems offer:

- 12MHz CPU
- 512K or 1Mbyte on-board DRAM
- 80287 math co-processor option
- Full set of AT-compatible controllers
- 2 RS232C ports
- Parallel printer port
- Floppy disk controller
- EGA/CGA/MDA/Hercules video options
- AT-compatible bus expansion
- A wide range of expansion options
- IBM-compatible Award ROM BIOS

**But only Little Board/286 offers:**

- 5.75" x 8" form factor

- EGA/CGA/MDA/Hercules on a daughterboard with no increase in volume
- SCSI bus support for a wide variety of devices: Hard disk to bubble drives
- On-board 1Kbit serial EPROM. 512 bits available for OEMs
- Two byte-wide sockets for EPROM/RAM/NOVRAM expansion (usable as on-board solid-state disk)
- Single voltage operation (+5 VDC only)
- Less than 10W power consumption
- 0-60°C operating range

Trademarks: AT&PC—IBM Corp.; Hercules—Hercules Comp. Tech., Inc.; MS-DOS—Microsoft Corp.; Little Board—Ampro Computers, Inc.

### Better answers for OEMs.

Little Board/286 is not only a smaller answer, it's a better answer... offering the packaging flexibility, reliability, low power consumption and I/O capabilities OEMs need... at a very attractive price. And like all Ampro Little Board products, Little Board/286 is available through representatives nationwide, and worldwide. For more information and the name of your nearest Rep, call us today at the number below. Or, write for Ampro Little Board/286 product literature.

## 408-734-2800

Fax: 408-734-2939 TLX: 4940302

**AMPRO**  
COMPUTERS, INCORPORATED  
1130 Mountain View/Alviso Road  
Sunnyvale, CA 94089



# NEW DIRECTIONS

The column and a shareware classic get a "Plus," and GrandView defines a new class of software

**U**nderstanding why we've changed the name of the column from "Applications Only" to "Applications Plus" requires a little historical perspective. When I began writing it, BYTE had no equivalent of today's Short Takes, and application reviews in general were in short supply. The name "Applications Only" was a signal to readers interested in software that here, at least, they could find reactions to lots of programs.

Times change, and BYTE's coverage of software has expanded noticeably. There is no longer quite the pressing need for short reviews. I've also found that the name has caused me grief when I've found myself writing about hardware or—heaven forbid!—programming. Every time I've digressed into those areas, I've had to concoct some strained rationale for the excursion.

So we've borrowed a gambit from the software business by giving the column a "Plus." It sounded better than "Enhanced." The major change will be a little breathing room for the author, yours truly. The core material will remain software-oriented, but I won't feel sheepish if I write about industry issues or trackballs. I'm also hoping to add more head-to-head comparisons of products and maybe a few application projects. Expect any changes gradually, and let me know if they work.

## Beyond ThinkTank

When I first heard about GrandView (Symantec, \$295), I had no idea what to

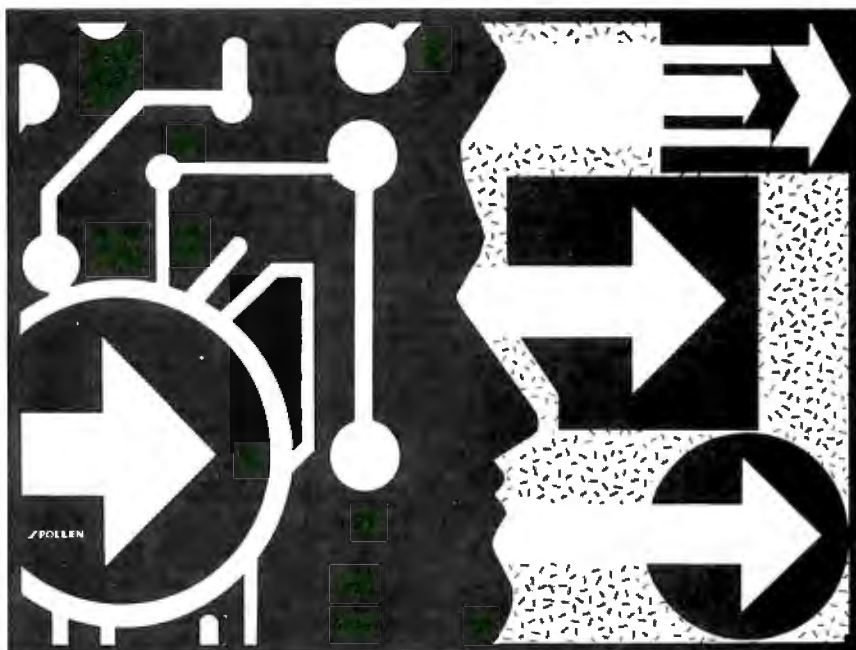

expect. The name sounded more appropriate for a street, or possibly a suburb, than it did for software. Also, I had been betting that the next product from the Living Videotext Division of Symantec would be an MS-DOS version of More, the state-of-the-art Macintosh outliner. So when I plugged in GrandView, I was wondering whether I would find More . . . or less.

In fact, GrandView could probably be called "too much of a good thing." It's billed as "Desktop Planning, Writing, and Information Management," and there's a lot to it. It is not merely an upgrade to ThinkTank. This is a new type of software, and on first glance it combines aspects of an outliner with solid word processing, project tracking, and categorization. It strikes me as being a comprehensive blend of ThinkTank, Q&A Write, InstaPlan, and possibly SideKick Plus, though it does not borrow all the features of each of those products.

If you're familiar with the long devel-

opment history of Living Videotext outline packages, you've noticed a steady movement from pure outlining to, well, information management (for want of a more precise term). The company has done a superb job of listening to its customers, and GrandView represents the latest attempt to serve the needs of the business executive. ThinkTank users have been crying for better word processing, and they have slavered at More. They've used the outliners to develop to-do lists, plan projects, store databases of names and addresses, develop agendas, and so on.

Living Videotext staffers have been amazed at the odd tasks their programs have been forced to perform. And gradually, the sample files included with the rest of the product line have changed to reflect this trend, to the point where the examples could be called "A Manager's Guide." If you were to develop generic documents by sweeping all the paper off

*continued*

an executive's desk and analyzing the contents, you'd get the idea.

Anyway, you start by developing an outline, but you can switch instantly to a document view with full-power word processing (and spelling checking, I might add), or to a category view, where you can attach keywords and priorities to items. Thus, you can produce a more personally styled output document than you could with ThinkTank, and you can easily home in on important tasks.

The outliner, which can be seen as the organizing spine of the program, lets you perform all the usual Living Videotext operations: cloning, hoisting, marking and gathering, time stamping, and so on. You've got keyboard macro capacities, and GrandView lets you construct installable templates so you can quickly zap a preset form into your outline.

Aside from a few minor annoyances, such as the fact that once you've asked the installation program to set up a sec-

ond printer you can't back down from that decision, the program is as solid as Living Videotext's other offerings, and the company has one of the best records in the business for shipping hassle-free products. I encountered no oddities, but the 3 weeks I've been testing have been far from enough to hit all the options.

But I have found the program rather Byzantine. You can't just plug it in and go; gotta read the manual or you're lost. Good documentation and on-line help provide a big assist, but you won't learn the program without a few hours of hard study. While the integration is smooth and painless—you can switch quickly among the various views—it's also confusing at first go. Once they've mastered it, GrandView enthusiasts will spend most of their time living in the software, only coming up for air to fiddle with a spreadsheet or database.

For the quick-and-dirty outline person, like me, who likes to have Ready! around so that I can jot quick notes, GrandView is simply overkill. But I have to say that this is a first impression. I'm still flustered by the category view, and I need to experiment in depth.

One of the problems facing people who evaluate software is the need to write about new products as soon as possible after they hit the street. GrandView demands much more study. I suspect that, as with any complicated piece of software, I'm going to have to ease into it and work with it for a while before passing final judgment. Think of WordStar, XyWrite, dBASE, or most spreadsheets; you can get the rudiments in a few weeks, but the programs seem tough at that point. It's not until you've explored the nooks and crannies that you appreciate their real power.

Though my first reaction is somewhat negative, I'm positive that the product will succeed in management applications and that anybody who is looking for a tool that goes beyond simple outlining will be delighted by GrandView. So I'm going to hold off, take some time, and give you an extended-use report in a few months. GrandView is intriguing and important enough to demand at least that much attention.

**A Way with Words**

It certainly isn't the greatest word processor ever sold, but Professional Write 2.0 (Software Publishing, \$199) is without question a solid and workable MS-DOS program. There's something comfortable about the Software Publishing interface; you know what you're

*continued*

California

**FREWARE**

ONLY \$2.99 PER DISK ONLY \$2.99 PER DISK

Public Domain & Shareware for IBM and Compatibles - DOS 2.1 or higher Programs and utilities for all your computing needs



**BUSINESS**

- EZ-FORMS Rev. D15 (66) - Menu driven forms generator, misc. skeleton forms.
- SBAS V1.3 (270) - Small Business Accounting System. Menu-driven. Best avail
- PRO PC-ACCT V3.0 (826) - Integrated G/L, A/R & A/P. Menu-driven. Help.
- EASY PROJECT V1.2 (440) - Complete project management system. Excellent.
- REAL ESTATE ANALYST (83) - Menu driven, mortgages, interest, etc.
- CE - CHECKBOOK V3.1 (79) - Full featured checkbook program with reports.
- BIDS 'N' QUOTES V0.9 (483) - Prepares cost estimates & proposals. Does labor, material, sub-contractor costs, etc.
- BUSINESS LETTERS (303 & 304) - (2 disk set) 650 business letters to fit all your needs. Edit w/ any word processor.
- MR. BILL V3.2 (311 & 312) - (2 disk set) Time & billing package; costs, credits, reports, audit trail, etc.
- PC-PAYROLL V2.3 (464) - Menu driven payroll system; 100 employees or less.
- RENTAL PROPERTY (318) - Keeps track of rental activity. Menu driven.
- SLICWOBS (321) - Framework clone. Integrated database, spreadsheet, word processor, & communications.
- PARTS INVENTORY CONTROL (479) - Tracks inventory of a parts & service business; qty. ordered, supplier, etc.
- DOCKET MASTER V1.2 (448) - Maintain docket for lawyer or law firm.
- FINANCE MANAGER V4.0 (77) - Accounting package for business or personal finances. Double entry system.
- SOAR V1.92 (449 & 450) - (2 disk set) Accounts receivable program. Handles a variety of services or products.

**COMMUNICATIONS**

- RBBS BULLETIN BOARD V15.1 (290-292) - (3 disk set) Turn your computer into a RBBS. Industry standard.
- GMODEM V3.1 (293 & 294) - (2 disk set) Full featured modem program.
- PROCOMM V2.42 (83 & 84) (2 disk set) Menu driven modem program.

**DATABASE**

- FILE EXPRESS V4.14 (33 & 34) - (2 disk set) Menu driven, easy to use database for beginners to experienced.
- WAMPUP V3.1B (37 & 38) - (2 disk set) Menu driven dBase III clone, supports functions of dBase. Knowledge of dBase suggested. Latest update.
- PC-FILE + V2.0 (493 - 495) - (3 disk set) Full-featured database; help screens, menus, macros. One of the best.
- DGENERATE V1.0 (511) - Screen & source code generator by Tom Rettig. dBase III required.

**EDUCATION**

- COMPOSER (3) - Create, save, edit, play, & print your music. Nice...
- LETTERFALL V1.1 (119) - Improve your touch typing skills; 16 levels.

- THE WORLD 3D (127) - Display maps of the world. CGA required.
- FUNNELS & BUCKETS V 2.0 (130) - Great learning game; add, subtract, multiply, & divide. Ages 5 - 10.
- ERYNS ABC'S (131) - Teaches alphabet & numbers. Computerized Etch-a-Sketch. Ages 2 - 6. Basic required.
- AMY'S FIRST PRIMER (133) - Alphabet, numbers, counting, shapes, matching, etc. Ages 4 - 8. CGA & Basic req.
- POLYGLOT V6.01 (139) - Vocabulary builder. Grades 7 - college. Excellent.

**GAMES**

- BLACEJACK (95) - Advanced blackjack game with tutor, multiple players. Best one yet. CGA or Hercules.
- MONOPOLY V6.7 (106) - Just like the board game, 2 to 4 players. CGA req.
- DUNGEONS & DRAGONS V1.1 (205) - The Classic Game. Can you survive?
- LAS VEGAS (116) - Craps, Roulette, Poker, & more. CGA req. Basic on some.
- 3D CHESS V1.01 (215) - Excellent chess game. Switch between 2D & 3D.
- BOLTAIRE (211) - 4 different games. Nice graphics. CGA required.
- SUPER PINBALL (212) - 5 different games. CGA required.
- WORDPLAY (367) - Wheel of Fortune clone. You provide the prizes. CGA req.
- DIGITAL LEAGUE BASEBALL (344) - Pick your team & players. Nice graphics.
- MINIATURE GOLF (605) - 18 hole golf course with graphics.

**GRAPHICS**

- FINGERPAINT V2.0 (282) - Paint program; 6 fonts, 81 sizes. Desktop publishing & slide-show. CGA, EGA, or Hercules.
- CALENDAR CREATOR (350) - Create & print your own monthly calendar.
- DANCAD 3D V2.0B (424 & 425) - (2 disk set) Advanced 2D/3D drafting program. Stereoscopic 3D wire frame animation. EGA, CGA, Hercules. 640k req.
- CITY DESK V6.0 (197) - Desktop publisher with graphics capability.

**LANGUAGE**

- TURBO 'C' TUTOR (489 & 490) - (2 disk set) 14 lesson tutorial; learn to program in 'C' language.
- 'C' LANGUAGE V2.1 (299 & 300) - (2 disk set) Complete programming environment. Source, compiler, samples.
- TURBO PASCAL TUTOR (20) - 17 lesson tutorial with samples, etc.

**MISCELLANEOUS**

- STRESS & SHRINE (74) - Stress stress test. Shrink - personality analysis.
- FASTBUCKS (191) - Menu-driven home finance package. Easy to use.
- HEALTH RISK (331) - Diagnose your own ailments.
- LITTLE BLACK BOOK (441) - Creates pocket sized address book. Prints mini-alphabetized pages.
- TIME SAVER (442) - Create daily,

monthly calendar of appointments.

**SPREADSHEET**

- LOTUS 123 PROGRAMS (28 - 32) - (5 disk set) Contains as many applications and utilities that we could find. Requires Lotus 123 program.
- LOTUS LEARNING SYSTEM (468) - Beginning tutorial for Lotus 123.
- AS EASY AS V3.0 (302) - Lotus clone. 52 column sheet, graphing, supports functions of 123, "WKS" files, etc.

**UTILITIES**

- DOS HELP (255) - Helpscreen for DOS commands, functions & batch files at your fingertips. For DOS 3.XX.
- DOS TUTORIAL V4.2 (256) - Menu driven, learn to use your computer.
- LG V2.1 (509) - Produces high quality text on dot matrix printers. Multiple fonts with print spooler.
- LASERJET FONTS / II (471 & 472) - (2 disk set) More downloadable fonts for HP Laserjet Plus/II, Helvetica, Script, etc.
- LASERJET FONTS/UTILITIES (328) - Contains 'Pamphlet' (sideways printing) & misc. other utilities & fonts.
- PRINTPRO V1.2 (468) - Change printer operation from within ANY application at ANY time.
- DESKMATES V1.01 (278) - Sidekick like utility plus more features.
- AUTOMEND V4.01 (280) - Access programs, batch files, commands, etc.

**WORD PROCESSING**

- SIDEWRITER (6) - "Sideways" printing.
- PC-WRITE V2.71 (9 & 10) - (2 disk set) Full featured word processor; all the features of the expensive one's.
- LETTERHEAD (89) - Create and print your own letterhead on letters and envelopes. IBM/Epson comp. printer req.
- GALAXY V2.3 (111) - Easy to use word processor; menus & quick keyboard commands. Lots of features.
- PC TYPE + (373 - 375) - (3 disk set) A powerful word processor. Buttonware.

**ORDER FORM**

NAME \_\_\_\_\_

ADDRESS \_\_\_\_\_

CITY \_\_\_\_\_ ST \_\_\_\_\_ ZIP \_\_\_\_\_

PHONE \_\_\_\_\_

# of 5.25" disks @ \$2.99 = \_\_\_\_\_

CA Res. Sales Tax (6.5%) = \_\_\_\_\_

Shipping & Handling = 3.00

TOTAL = \$ \_\_\_\_\_

Mail order form & check or money order to:  
**California FREWARE**  
 1466 Springline Drive Dept. B7  
 Palmdale, CA 93550  
 (805) 273-0300

Call or write for free catalog containing over 500 disks of quality software.  
 Hours: M-F 9am - 5pm PST  
 3.5" media - \$3.99 ea.  
 Sorry no Credit Card Orders.

# MODEL 24

*high performance*

## DATA EXCHANGE SYSTEM

UP  
TO  
4½MB  
BUFFER

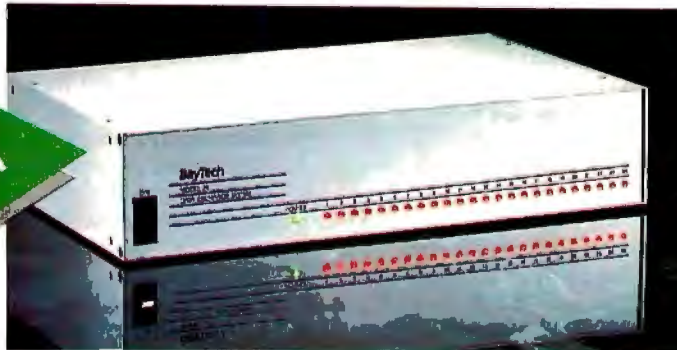

# Engineered for speed, flexibility and expandability

**BayTech**

Bay Technical Associates, Inc., Data Communications Products Division  
200 N. Second St., Bay Saint Louis, MS 39520 USA  
Telex 910-333-1618 BAYTECH, Telephone 601-467-8231 or toll-free

**800-523-2702**

### CHECK THE SPECS

- The Data Exchange System, Model 24, allows high speed exchange of data between computers, printers and other peripherals.
- Powerful 16-bit CPU plus multiple high performance I/O processors allow super high speed transfer of data demanded by new faster computers and software.
- Optimum flexibility: Select the right combination of serial and parallel ports, and set *any* of these ports as a peripheral port or as a computer port.
- Basic unit expandable to 24 ports by 4-port modules offered in serial/parallel combinations.
- Standard 512KB buffer expandable to 4½ megabytes, to handle big print/plot jobs and many small ones.
- Buffer memory dynamically allocated to maximize buffer utilization.
- Simultaneous data input and output on *all* ports, so no devices are kept waiting.
- Computer-to-computer communication concurrent with all other operations.
- Full duplex communication allows file transfer capability with many communications software packages.
- Compatible with virtually all computers, printers, plotters, modems and other peripherals.
- Pop-up RAM resident PC support software allows peripheral selection via hot key.
- Super fast throughput allows data to pass through with no apparent processing delays.
- Many user-definable parameters including separate baud rates, flow control and parity for each port.
- Internal serial-to-parallel and parallel-to-serial conversion.
- Cascading capability to increase available number of ports.
- Unlimited hotline tech support.
- Designed and manufactured in the U.S.A.

Circle 23 on Reader Service Card

doing from the start, and you rarely have to consult the excellent manual.

I had almost forgotten how pleasant it is to work with this company's products. Software Publishing is another of the few big companies that rarely releases buggy software, and it aims at the businessperson who's intent on getting to work rather than the computer guru who's in love with technicalities.

By now, the interface itself has become something of a standard. You've seen it in PFS:Write, Q&A, and a host of imitators. Function-key menu bar across the top of the screen, boxed center area for your typing, ruler and two status lines across the bottom. Hit one of the function keys, and a longer menu pops down. Default selections in menus are always highlighted, and the default choices make sense.

Most commands can be selected either from the menus or by hitting a Control sequence (Alt combinations are reserved for macros). Nothing fancy, and good correlation with printed output. It will probably offend the purists who prefer an absolutely blank screen, but the rest of us will find it unobtrusive. You've got three pleasant color schemes to choose from, and all of them are easy on the eyes (especially on an EGA monitor or better).

Here's what you get with Professional Write 2.0: a spelling checker with a 77,000-word main dictionary and a 5000-word personal dictionary. A 20,000-word thesaurus. A built-in calculator and column math. An address book for mail merge that has a nice entry screen and room for 2000 entries. Automatic envelope printing (nice, if your printer can handle it). Macro recording. Line drawing, and access to the extended character set. Support for expanded memory. File encryption. A wide selection of printers and multiple font capability, including PostScript. Context-sensitive help.

Nothing spectacular in that list, but Professional Write does offer a couple of tricks worth mentioning. Not only can you save a 40-character description of each file, but you can search the complete text of all your Professional Write documents, directory by directory, looking for a specific search string. And the program imports files from major word processors, Lotus 1-2-3, and dBASE III without any headaches.

Using the program takes absolutely no brains, and I couldn't break it as hard as I tried. My quibbles with it are relatively minor: I'd prefer a larger user dictionary, and the 2000-entry limit on address books seems low, even though you

## Items Discussed

**GrandView**.....\$295

Symantec Corp.  
Living Videotext Division  
117 Easy St.  
Mountain View, CA 94043  
(415) 964-6300  
**Inquiry 934.**

**Procomm Plus**.....\$75

Datastorm Technologies, Inc.  
P.O. Box 1471  
Columbia, MO 65205  
(314) 449-7012  
**Inquiry 935.**

**Professional Write 2.0** .....\$199

Software Publishing Corp.  
P.O. Box 7210  
Mountain View, CA 94039  
(415) 962-8910  
**Inquiry 936.**

can create as many as you require.

I do, however, question the use of the word "Professional" in the program's name. This product strikes me as a basic word processor, fine for everyday use but probably not the best available for industrial-strength applications. You could probably write a book with it, but I wouldn't want to use it for a doctoral dissertation in math or physics. Likewise, it lacks legal line numbering and multiple-column printout. So it's not really a top-echelon package.

Professional Write 2.0 is a good answer to Q&A Write, with a few features not available there, but I do recommend checking out the Symantec product if Professional Write sounds interesting to you. In fact, you probably ought to get demonstrations of a few other midlevel word processors at the same time. You won't be disappointed with Professional Write, but it's kind of a Ford. Depending on taste, you might do just as well with a Chevrolet.

### Shareware to Commercialware

This column is not the only thing to add a "Plus" to its name; Procomm, that venerable shareware workhorse, has gone commercial and has become Procomm Plus (Datastorm, \$75). The only way to get your hands on this new revision of the product is to buy it from a dealer or order it directly; you won't find the Plus version on your local bulletin board. Tom Smith and Bruce Barkelew, the authors

of the program, are two of the nicest guys in the business, and I hope the change in the program's status lets them earn a decent living at last.

Procomm was definitely one of my favorite telecommunications packages: full-featured, clean, and fairly easy to understand. Procomm Plus adds some new stuff: support for more file-transfer protocols than I knew existed (including Kermit and a couple for error-correcting high-speed modems), emulation of any terminal you'd ever want to emulate, split-screen mode for CB-style on-line chat, host mode for interactive dial-in operations, and a simple text editor.

The neatest addition is a decent script language that can be mastered easily; the team's earlier efforts required you to write in gibberish. The program already had a good interface for setting keyboard macros, exit to DOS as a shell operation, automatic session logging if desired, and a one-keystroke screen capture.

There are two other advantages to buying the private version. The first is the printed manual. Procomm Plus has some complex aspects, and step-by-step documentation is a big help. The second advantage is the support files you get in the package, which include scripts for every major on-line service and widespread bulletin board software; and dialing directories for bulletin boards in Atlanta, Austin, Boston, Chicago, San Francisco, and Washington, DC. The package also includes long lists of both U.S. and international bulletin boards. This is the kind of nicety that is almost never provided with shareware.

The program is certainly the equal of many packages already on the market, and it can legitimately compete with the category leaders. Note, however, that there is no provision for background operation, and that the script language falls short of some of the more extensive packages, like Mirror II, the latest Crosstalk, and Framework.

But on the whole, you won't go wrong purchasing and using Procomm Plus unless your requirements are sophisticated in the extreme. For day-to-day telecommunications, this is highly recommended. ■

*Ezra Shapiro is a consulting editor for BYTE. You can contact him on BIX as "ezra." Because of the volume of mail he receives, Ezra, regretfully, cannot respond to each inquiry.*

*Your questions and comments are welcome. Write to: Editor, BYTE, One Phoenix Mill Lane, Peterborough, NH 03458.*

# ONE CHIP PLUS™

... “Makes building PS/2 boards simple”  
Electronics

... “Quickens Micro Channel board design”  
Electronic Products

... “Integrates all IBM PS/2 Micro Channel control needs”  
Electronic Design

... “(CEC is) making it easier to soup up the PS/2”  
BusinessWeek

... “Their chip is the most flexible we’ve seen”  
Microprocessor Report

ONE CHIP PLUS is a complete Micro Channel interface on a chip, plus a development package that lets you build memory, I/O or multifunction boards in less time for less money.

ONE CHIP PLUS is a product of Capital Equipment Corp., a proven supplier of hardware and software for engineers. Call today. We can help you whether you’re building one board or a million.

**Literature 1 800 234 4CEC**  
**Technical assistance (617) 273-1818**

PS/2 and Micro Channel are trademarks of International Business Machines  
ONE CHIP PLUS is a trademark of Capital Equipment Corp.  
99 South Bedford Street, Burlington, MA. 01803

# Make your programs millions of times smarter

More and more, programmers and workstation builders are using DESQview 2.0 as a development tool. The reason is simple. They can create powerful, multitasking solutions today for the millions of DOS PCs in use today. Solutions comparable to those promised for tomorrow by OS/2.

## The API Advantage

Programmers who take advantage of DESQview's API (Application Program Interface) get access to the powerful capabilities built into DESQview—multitasking, windowing, intertask communications, mailboxes, shared programs, memory management, mousing, data transfer, menu-building and context sensitive help.

## Bells and Whistles

A program taking advantage of the DESQview 2.0 API can spawn subtasks for performing background operations or new processes for loading and running other programs concurrently. It can schedule processing after an interval or at a certain time. It can use DESQview's intertask communications to rapidly exchange data between programs, share common code and data; or interrupt at critical events. It can use DESQview's menuing and mousing capabilities to create menus. And there's lots more it can do.

Some of the applications under development right now using DESQview 2.0 API Tools: CAD, Medical systems, insurance, 3270 mainframe communications, network management, real estate, typesetting, point of sale, education, commodity trading, stock trading and online voting.

## 80386 Power

80386 programmers can take advantage of the 80386's protected mode for large programs, yet run on DOS and multitask in DESQview—side by side with other 80386 and DOS programs. The breakthroughs that make this possible: DOS Extenders from PharLap Software and AI Architects and DESQview support of these DOS extenders.

## DESQview Developer Conference

So if you are a developer, looking to create programs with mainframe capabilities, but wanting to sell into the existing base of millions of DOS PCs, come to Quarterdeck's first DESQview API Developers Conference, August 16-18, 1988 at the Marina Beach Hotel, in Marina del Rey, California. For more information call or write us.

Come learn about the DESQview 2.0 API and 80386 DOS Extenders. Meet 80386 experts as well as those smart people who are creating DESQview 2.0 API workstations solutions.

And if you want to get a leg up before the conference, ask us about the DESQview API Tools for assembler or C programmers.

# Bringing New Power to DOS. DESQview 2.0 API Toolkit.

The logo for Quarterdeck, featuring the word "Quarterdeck" in a bold, red, sans-serif font. To the left of the text is a stylized graphic consisting of several parallel, slanted lines of varying lengths, creating a sense of motion or a wing-like shape.

Quarterdeck Office Systems 150 Pico Blvd., Santa Monica, CA 90405  
(213) 392 9851





# STAKING OUT THE TERRITORY

What's best for your office? This new column offers real-world answers.

**I**n many ways, business users of small computers are just like any other user. We have the same problems with hardware that breaks, software that isn't shipped when promised, and salespeople who know less than we do about the machines they sell.

But there are differences. We may buy hundreds of computers, risking hundreds of thousands of dollars if we make the wrong decision. We may have an office floor with 60 people who need to share the same information. Or we may have a VAX in the basement that we need to connect our personal computers to.

This is why I'm writing a business column about small computers for BYTE. It will approach personal computers from a business viewpoint, but without the bias you find in the "single machine" magazines. No one type of computer is the solution to all problems, so no one computer will dominate this column.

That's not to say that I won't write about IBM and clone machines or about Macintoshes. They are the most heavily used by the BYTE readership, and I will devote a lot of space to them. On the other hand, I won't ignore the Unix world or the less popular, specialty machines either. All these areas show great promise, and the future of your business may lie with one of these machines.

## The PC Guru

If you're reading this magazine, there's a good chance that you're the person in your organization who is the "Corporate Techie," or the "PC Guru." While you may or may not be in the organization chart as a computer staff resource, you

serve as one. When people find out that they can't format a floppy disk, or that they *did* format their hard disk, you're the person who gets the call. You're also the person who seems to have a constant stream of visitors to your desk, all asking the same question: "I've been thinking about getting a personal computer. What kind should I get?" In many companies, you're also the person who wields a lot of the influence about what the company buys and how it uses small computers.

One of the best ways to decide what will work in your office is to look at the experiences of others. It's a lot cheaper to let someone else take the risk while you learn from their experiences. Sometimes you can't do that, though, so the next best thing is to read about them.

For this reason, I'll try to illustrate my examination of the business small computer user with case histories where they're appropriate. I'll also tell you about trends I see that are important to business users, and I'll report on hardware, software, and services that might affect your business. What I won't do is give conventional, safe answers where another answer is better, nor will I deal with information you can find out from a quick read of the manual.

## Networking

One question that inevitably crops up each week or so concerns networks. Now that local-area networks (LANs) are known to exist, everybody wants one. Usually, the rationale is as simple as, "We have to be able to talk to each other." This means that there is a need for some portion of an organization to share some common data. Normally, the first application that comes to mind involves a database, although word processing tends to follow closely.

Often, the request for a LAN comes without a full understanding of whether that is the correct solution. Your colleague or client has read about these wonderful networks and thinks a LAN is the

answer to the organization's information flow. It can be, of course, but it can also do a lot to impede that flow.

The software you choose can play a big role in making the LAN work properly—especially when many users on the LAN need to use the same database. Choosing the wrong database can make your network seem to come to a stop.

I ran across an example of this problem with a network that was using dBASE III Plus on a number of workstations to access a single large database on the file server. At the same time, other users were trying to use WordPerfect. As soon as more than three or four people began to use the database, performance dropped drastically.

This happened, of course, because all the database users were trying to use the file server's disk at the same time. The first user to try got control, and the others waited in a queue. Since many single-user databases running on a network, including dBASE, treat the LAN as a disk channel, all the work for all the stations was being done by a single drive. The drive churned away, searching and indexing, while the other users waited. Of course, the repeated disk accesses added to the network traffic, slowing things even more. Response time was well over a minute on some screens.

Clearly, a number of actions can be taken to improve response time when using a database on a network. Some network operating systems, including Novell NetWare, allow very flexible arrangements of hard disks. Likewise, adding more network server cards to the file server can help improve throughput. Probably the best solution, though, is to pick a DBMS that's designed as a multi-user system in the first place.

## The Database Server

Network performance problems with databases that were originally designed for single users have led a few manufac-

*continued*

turers to develop new solutions. One of the best is the database server. This is a database engine that resides on a CPU dedicated to database use. Queries come to the database engine, and results are returned to the users. Ashton-Tate, developer of dBASE, has announced that, with Microsoft, it will develop just such a database server, but it has yet to deliver.

Meanwhile, a few other companies have said that they will bring out server-based database engines. XDB Systems of College Park, Maryland, has one.

A server database engine such as XDB works by dividing the DBMS into a front-end processor and the data engine itself. The front-end processor resides on the user's workstation. It provides the user interface and translates the user's actions into SQL commands. These commands are then sent to the database server.

When the database server receives an SQL command from a workstation, it performs the requested operation and returns the result. The constant traffic of disk accesses is removed from the network, and the file server is freed from the need to support the database as well. As a result, functions not related to database management continue unimpeded, and your file server can be smaller.

### Powerful Engine

There is a down side to all this, of course. In the first place, XDB requires that you dedicate at least one CPU as the database server. Although you can use any IBM PC clone as the server, the capability of the server directly affects the speed of the database operations. Dr. Bing Yao, president of XDB, told me that an 80286-based machine should be considered for serious database use, and that he would tend to recommend an 80386.

There's also the need for disk space. In addition to buying a large-capacity disk for the file server, you also need one for the database server. Because this disk will be doing all the network's database work, it should be pretty fast. If performance gets to be a problem with a single database server, XDB allows you to add additional servers.

### Fast and Easy

There is a silver lining. XDB uses industry-standard SQL to communicate with its database engine. This means that you can move your mainframe data to your microcomputer and take along the queries that you used with DB2 as well. You can also go in the other direction, using queries from XDB to extract information from a mainframe database.

Setting up most applications is quick

## Products Mentioned

XDB Server .....	\$1995
XDB-SQL	
Developers .....	\$495
Run-time .....	\$195
XDB Forms	
Developers .....	\$295
Run-time .....	\$95

XDB Systems, Inc.  
7309 Baltimore Ave., Suite 220  
College Park, MD 20740  
(301) 779-6030

**Inquiry 846.**

and easy. XDB provides a fourth-generation query language for writing custom applications. In addition, there is a forms manager that allows you to define the database as you design the forms. Experienced developers can make use of C and COBOL libraries for creating applications that can't be developed in other ways. Finally, experienced SQL users can enter queries directly into an interactive SQL system.

Once the applications are developed, the user has no way of knowing whether the system is using the database engine on the network, or a single-user database on the local workstation. Indeed, XDB will work equally well in either case without changing the applications. That way, you can create an application for all your users without worrying whether it will ultimately find itself on a network or a stand-alone computer.

If you've already made the decision to invest in the hardware, software, physical plant, and personnel necessary to operate a LAN that carries a significant database processing load, the additional server and disk capacity you need to assure adequate performance is worth the cost. When you couple its fast operation and industry-standard query language, XDB is a good deal for the serious database installation.

### What's New for Business?

The network version of XDB was one of the pieces of good news at Spring Comdex. In some ways, though, this does not look to be an exceptional year for innovation in the world of IBM-compatible computers. When I checked with the firms claiming to have OS/2 products at Comdex in May, only 22 products were shipping. A few more were due out this

summer, but many will not arrive until after Comdex in the fall, or even into 1989. If you use IBM PCs or compatibles and need software, you probably should plan on looking to the DOS world instead. There, products seem to be gaining maturity and functionality.

A number of Comdex vendors told me they were still waiting to see what would happen to the market before they committed resources to OS/2. Hardware development likewise seems stunted, with most manufacturers simply creating new versions of add-on boards that already exist for PCs or PC ATs and clones. There were some significant efforts demonstrated to give the PC/AT world the same capabilities as the PS/2. These included VGA cards and hard disks and controllers with 1-to-1 interleave.

The Macintosh II continues to woo business buyers away from manufacturers of IBM and compatible machines. Informix promised that its new super-spreadsheet, Wingz, would finally make it to market. WordPerfect for the Macintosh finally shipped just before Comdex. Autodesk announced a version of its AutoCAD for the Mac. Bolstered by the widespread belief that the Mac is faster and easier to use, these products are gaining interest from executives, especially now that Presentation Manager for OS/2 seems to be so far away.

Unix is making a push as the business standard for microcomputers. While at Comdex, I watched as Commodore's chief operating officer Henri Rubin used a mouse to click open windows on Unix, MS-DOS, and Amiga DOS on his Amiga 2000 equipped with a 100-megabyte disk. Dr. Rubin told me that the Amiga would soon be available with additional ports to support multiuser operation. He also showed me an Amiga with a screen resolution of 1008 by 800 pixels. I wonder if Commodore is aiming at the lucrative workstation market.

On the IBM side of business, things have slowed down a little just now. Perhaps this is the time for a breather. On the other hand, perhaps it will give some of the other architectures a chance for a little more market share. ■

*Wayne Rash, Jr. is a member of the professional staff of American Management Systems, Inc. (Arlington, Virginia), where he consults with the federal government on microcomputers. You can reach him on BIX as "waynerash."*

*Your questions and comments are welcome. Write to: Editor, BYTE, One Phoenix Mill Lane, Peterborough, NH 03458.*





Embedded systems designers have already used CrossCode C in over 172 different applications.

# Introducing CrossCode C for the 68000 Microprocessor Family

## Finally, a 68000 C Compiler that's tailor-made for ROMable applications

**CrossCode C** is designed *specifically* to help you write ROMable code for all members of the Motorola 68000 family.

### A ROMable C Compiler?

To get truly ROMable code, you have to start with a truly ROMable compiler. Here are three **CrossCode C** features that you won't find in any ordinary C compiler:

- Compiler output code is split into five independent memory sections that you can assign into ROM or RAM as you please.
- You can optimize the code for your application because *you* control the sizes of data types. For example, you can optimize for speed by using two byte *ints*, or get maximum versatility by using four byte *ints*.
- You can easily write assembly language routines that call C functions and vice-versa, because the compiler uses simple, well documented parameter passing conventions.

### How About Low Level Control?

**CrossCode C** comes with an assembler that has all the features that assembly language programmers require. In fact, you could write

your whole application with it:

- The assembler features an advanced macro language, conditional assembly, "include" files, and an unlimited size symbol table.
- Detailed cross references show you where you've defined and referenced your symbols.
- After a link, you can actually convert your "relocatable" assembler listings into "absolute" listings that contain absolute addresses and fully linked object code.

### Can It Handle The Link?

The **CrossCode C** linker is designed to handle truly huge loads. There are no limits on the number of symbols in your load or on the size of your output file. And you can always count on full 32 bit target addressability, because the linker operates comfortably in the highest ranges of the 68020's address space.

### How Does It Get To ROM?

**CrossCode C** comes with a *downloader* that puts you in touch with all EPROM programmers and emulators. It can convert your load into Motorola S-Records, Intel Hex, Tek Hex, Extended Tek Hex, and Data I/O ASCII Hex. You can also produce a binary

image and convert that image into any format you might want. In all formats, bytes can be split into EPROMs for an 8, 16, or 32 bit data bus.

### Why Wait?

Once you start using **CrossCode C**, you may just wonder how you ever got the job done before! It's available under MS-DOS for just \$1595, and it runs on all IBM PCs and compatibles (640K memory and hard disk are required). Also available under UNIX & XENIX.

CALL TODAY for more information:

**1-800-448-7733**

Inside Illinois or outside the United States, please dial

PHONE: 1-312-971-8170

FAX: 1-312-971-8513

SOFTWARE DEVELOPMENT SYSTEMS, INC.  
3110 WOODCREEK DRIVE  
DOWNERS GROVE, ILLINOIS 60515 USA

CrossCode™ is a trademark of SOFTWARE DEVELOPMENT SYSTEMS, INC. MS-DOS® is a registered trademark of Microsoft. UNIX® is a registered trademark of AT&T. XENIX® is a registered trademark of Microsoft.



# WHAT'S UP WITH APPLE?

Late shipments, abandoned products, and blown promises are driving the rest of us crazy

**A**s I write this column, it is the third week of May. I am still waiting for Apple to release its System Tools 6.0 software for the Mac. I had hoped to report on the updated released versions of the System, Finder, and MultiFinder. Apple promised members of the Apple University Consortium (AUC) in March that the revised System software would be available on AppleLink, CompuServe, GENie, MacNET, and elsewhere by the end of April, with complete shrink-wrapped kits (à la System Tools 5.0) and printed documentation soon after.

Late, incomplete, and confused distribution has plagued the release of Mac system software since the first update in 1984. In the last year, though, the confusion and problems have spread to other Apple software products, growing almost in parallel with Apple's impressive fiscal performance. As Apple has grown from an entrepreneurial enterprise to a more traditionally managed technology company, several important products have either fallen between management cracks or been released woefully incomplete.

The fact is, Apple has blown a lot of promises lately. Two more examples will serve to clarify my point: MacPascal and A/UX.

## MacPascal

Ever wonder what happened to MacPascal? Did you know that you can't currently buy it from Apple (or anyone else)? I first discovered the "MacPascal problem" in January. It was then that I had

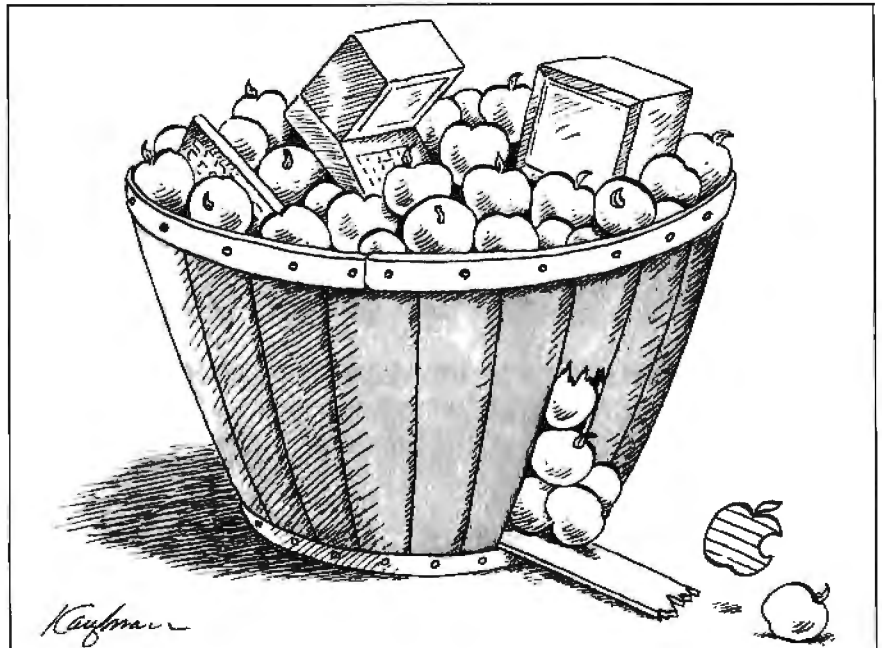

Apple's new System Tools 5.0 software installed on our laboratory Macs. One of the primary uses for these machines is to teach introductory programming. Because of its friendly interface and novice-centered development environment, along with its multiple-window approach to interpreted execution and debugging, MacPascal is a perfect environment for learning. It's safe to say that MacPascal helped sell a lot of Macs to universities.

Almost as soon as the System Tools 5.0 was installed, we started having serious problems with MacPascal 2.1 (the latest version). Program files became corrupted, printing failed, working programs refused to run, and so on. To make an excruciating story short, after considerable effort I found that Apple had simply dropped MacPascal. No more versions. No bug fixes. No more MacPascal. Nothing. Apple recommended that we either run MacPascal 2.1 with old system software or migrate to another Pascal. What was even more frustrating

was that no one at Apple could point to whose decision it was to drop MacPascal.

It's now 5 months later, and the only good news is that Apple is near an agreement with Symantec/Think Technologies (the original authors) to take MacPascal back into its fold for an eventual rewrite and rerelease next fall. Are they kidding? People who are using MacPascal can't put their work on hold until the autumn of 1989. Most Pascal users will probably adopt our strategy: migrate to Think's Pascal compiler, Lightspeed Pascal, even though it's not as good a product for learning programming.

## A/UX

Apple's much-ballyhooed Unix for the Mac II, A/UX, is another of Apple's software mistakes. The product missed its initial ship date (August 1987) by more than 6 months. When it finally shipped in February of 1988, Apple had not done its homework in addressing one

*continued*

of its largest groups of potential A/UX customers: users of System V and BSD 4.2/4.3 Unix.

As announced, A/UX was simply not competitive with Unix offerings from Sun, Apollo, and AT&T. It was too expensive, and could be purchased only on an Apple 80-megabyte hard disk; tape distribution was not available. Apple had made no provisions for distributing the source code for A/UX. Dedicated Unix users simply *must* have the source code.

And despite earlier promises to the contrary, A/UX deflated the hopes of a large segment of its intended market by being mostly plain vanilla System V. A/UX definitely was *not* Unix for the rest of us.

To be fair, we should be able to forgive Apple for this last failing, especially since A/UX 1.0 is its first Unix release. Apple got a lot of technical things right with 1.0. It also broke new ground by making it easier to recover from Unix file-system errors and install new de-

vices. But the other A/UX problems point to a larger management problem: an inability to announce and deliver software on schedule and as described. Apple's spin-off company, Claris, will help somewhat (by taking applications like MacWrite away from Apple), but the management difficulties remain for Apple's languages and system software.

Apple's mistakes make a disturbingly long list; I hope the folks there are learning from the errors. All the lawsuits in the world won't help retain or increase market share if the way it has handled A/UX, MacPascal, and system software becomes a trend.

**System Tools 6.0**

I've worked with a beta version of System Tools 6.0 for several weeks. About all I can say is that it lives up to its beta designation. It didn't work properly on the Mac II, SE, or Plus I used for testing. Whether I copied the files to clean hard disks or used the Installer to update an existing System, the stuff just didn't work right. Screens froze for no reason, the mouse went dead, and bombs with just about every ID number known to *Inside Macintosh* cropped up. Since this is labeled an "early beta," I hope the problems are fixed before release.

The new software included a couple of interesting new features worth remembering: a notification manager and a new font format. The notification manager is supposed to notify foreground applications running under MultiFinder when a background application (e.g., a telecommunications program) needs direct attention. As it stands now, the notification manager should be useful if you expect to upload or download several files in the background while working on something else in the foreground. I hope software publishers will take advantage of this capability to allow other functions that need occasional attention to operate in the background (e.g., program compilation or hard disk backup).

The new font format, NFNT, allows up to 16,000 fonts to be loaded into a system, up from the 256 you can load now (without using a third-party DA/font manager like AlSoft's Font DA/Juggler Plus). You can also install up to 32,000 individual fonts in your system with the new format. The increased limits come from NFNT assigning font numbers to entire font families rather than to individual fonts. Unfortunately, NFNT fonts are not compatible with the existing ones, and Apple does not yet have any software to convert the old fonts to the new format

*continued*

**WHY SETTLE FOR THIS? ...**

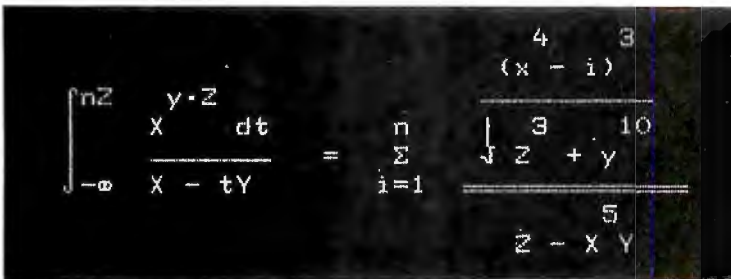

**...WHEN WHAT YOU REALLY WANT IS THIS.**

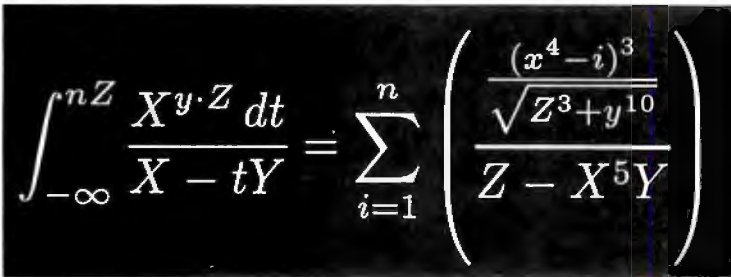

**TRY THIS:**



Quality work should look high-quality. What better reason to try **PC<sup>T</sup>EX<sup>®</sup>**—the full implementation of Prof. D. Knuth's revolutionary TeX formatting/typesetting program.

PC<sup>T</sup>EX offers professional typesetting capabilities & advantages to PC users. It gives you control—of format, type, symbols, quality—for complex mathematical &

engineering material, statistical tables or straight matter.

So whether you're writing the next starshot manual or a thesis on relativity, you get camera/publisher-ready manuscripts to be proud of, quick & simple. Don't settle for less.

From Personal TeX, Inc., starting at \$249; VISA/MC welcome. Satisfaction guaranteed.

To order or for information, call: **415/388-8853** or write: Personal TeX, Inc. 12 Madrona Avenue Mill Valley, CA 94941 USA

TeX is a registered TM of Personal TeX, Inc. TeX is an American Mathematical Society TM. Manufacturers' product names are their TMs.

**PC<sup>T</sup>EX FORMATTING/TYPESSETTING SYSTEM** • FINE TYPESET QUALITY from dot matrix or laser printers, or phototypesetters. • A COMPLETE PRODUCT. Includes • our specially written PC<sup>T</sup>EX Manual that lets you use TeX immediately • custom 'macro package' formats for letters, manuals, technical documents, etc. • the L<sup>A</sup>TeX document preparation system (with user's manual) macro package for article, book, report preparation • AMS-TeX, developed by the American Mathematical Society for professional mathematical typesetting. • OUTPUT DEVICE DRIVERS available for Epson FX, LQ • Toshiba • HP LaserJet Series • Apple LaserWriter • Screen preview, with EGA, VGA or Hercules card. • REQUIREMENTS: IBM PC/XT, AT or compatible, DOS 2.0 or higher & 512K RAM; hard disk for printer drivers & fonts.

This ad's typeset & composed using PC<sup>T</sup>EX, Bitstream® fonts & laserprinter. Logotype & black backgrounds done photographically.

# An inside look at the best 386 value around.



The more you look into 386 compatibles, the more you realize that well thought-out design innovations (that really work) are few and far between.

That's why our engineers set out to design the GV-386. They realized they could unlock more of the chip's potential, if only they could speed up data retrieval, without affecting system reliability.

## INNER POWER

Here's how they did it: a high-speed RAM cache circuit—a full 64K of superfast memory—that puts your most frequently accessed data right at your fingertips. If you're ever involved in processing complex databases, long spreadsheets, or detailed engineering drawings, you'll see the value of this innovation in a second...literally.

Best of all, the cache circuit actually makes the GV-386 more reliable than other high-speed machines, by sparing integrated circuits from harsh overloading.

Our BBS is on-line 24 hours.  
Call The SoftStop at 918-252-9137.

Prices subject to change.

## QUALITY THROUGHOUT

Of course, our most important criterion when designing our super compatible wasn't speed—it was quality. Take a look inside the GV-386 and you'll see it everywhere: from the highest quality components available to the intelligent use of special CMOS RAM to store system set-up information. On the outside, the fit and finish of the GV-386 would make Big Blue green. Even the user's manual has impressed users and reviewers alike.

We'd like to tell you more about what went into the GV-386. Give us a call and we'll give you the whole story. We'll also tell you about our exclusive 30-Day Compatibility Guarantee, our full One-Year Warranty and our toll-free support service.

The GV-386 from PC Designs. With design innovations this advanced, at this price, it's an open and shut case.

## GV-386 Specifications

- Available with 16MHz or 20MHz CPU
- Zero Wait States
- 64K Cache (keyboard enabled)
- 1 MB RAM on-board, expandable to 4MB
- Socketed for 80287 or 80387
- I/O Bus runs at 8MHz for hardware compatibility
- Six 16-bit slots; Two 8-bit slots
- Price: 20MHz systems start at \$2,750; 16MHz systems as low as \$2,375

## PC Designs

Call us now at 1-800-32-BIT PC  
(800-322-4872)

2500 N. Hemlock Circle, Broken Arrow, OK 74012  
• 918-251-5550 (Fax: 918-251-7057)  
19 Rector Street, Suite 2705, New York, NY 10006  
• 212-514-7280 (Fax: 212-797-3973)



Do you have PCs and a VAX?  
Then you need

## ZSTEM TERMINAL EMULATION

The ZSTEM series includes high performance DEC, Tektronix, and DG terminal emulators featuring ZSTEM 240, ZSTEM 220, ZSTEM 100, ZSTEM 4014, and ZSTEM D400.

Take advantage of advanced features including VT340 color and resolution, file transfer, softkeys, network support and much, much more . . . all with a 30 day money-back guarantee!

Call today for details. (800) 663-8702

### KEA Systems Ltd.

#412 - 2150 West Broadway  
Vancouver, B.C. CANADA, V6K 4L9  
Tel: 604-732-7411 Telex: 04-352848 VCR  
FAX: 604-732-0715



## MACINATIONS

(the beta version of the Font/DA Mover 3.8 that I tested in the System 6.0 package lacked a conversion feature).

The beta 6.0 System disks I tested, despite taking up four 800K-byte disks, also lacked any NFNT fonts. Still, Apple would not have created the new font format if it didn't plan to use it, so NFNT utility software and fonts might appear as early as the Boston '88 MacWorld Expo. I expect that vendors like Adobe, who have substantial investments in existing libraries of typefaces, will eventually convert some or all of their fonts to the new NFNT format.

### FoxBASE +/Mac

I've been working with FoxBASE +/Mac, a relational database, since December 1987, when it was a low-numbered beta. I've had the initial released version (1.0) for about a month now, and I'm impressed. FoxBASE +/Mac is *fast*. Not just a little bit fast, but a lot fast. In the 1000-, 10,000-, and 50,000-record flatfile tests I've run, it's faster than any other Macintosh database, relational or not. The same blazing speed held up in the limited multifile relational tests I tried (relating 3 files of 10,000, 5000, and 2500 records each). FoxBASE +/Mac outruns 4th Dimension, McMax, dBASE Mac, FileMaker Plus, Reflex Plus, Omnis 3 Plus, Double Helix II, and others at the basic tasks of creating, importing, modifying, sorting, retrieving, and deleting database information.

FoxBASE +/Mac is a dBASE III Plus-compatible database for the Mac. It can run any dBASE III Plus code directly (once you've ported it over to the Mac using TOPS, or through a serial connection, or by using the Apple File Exchange software and a PC-compatible Mac disk drive). It can also read dBASE data files without modifications. FoxBASE +/Mac also read the PC FoxBASE files I tried.

FoxBASE +/Mac, however, is not the first software to offer complete dBASE III Plus compatibility on a Mac. The dMacIII program, first published by Format Software (a West German company), and rewritten and rereleased in 1987 by Nantucket Software as McMax, claims that honor. McMax is fast too, although slower than FoxBASE.

If FoxBASE +/Mac were just a faster version of McMax, its market would be limited primarily to developers who want to port their dBASE III applications over to the Mac. Happily, speed is just part of the appeal of FoxBASE +/Mac.

Unlike McMax, FoxBASE +/Mac includes a set of command extensions and additional features that go way beyond

## LAHEY SETS NEW FORTRAN STANDARDS

LAHEY PERSONAL FORTRAN 77 \$95

Low cost, Full 77 Standard, Debugger, Fast Compilation

F77L FORTRAN LANGUAGE SYSTEM \$477

For porting or developing, this is the critics' choice.

"Editor's Choice" . . . . . *PC Magazine*  
". . . the most robust compiler tested." . . . . . *Micro/Systems*  
". . . the most efficient and productive FORTRAN development tool  
for the DOS environment" . . . . . *David W. Burleigh, BYTE 11/87*

F77L-EM/16-bit \$695 F77L-EM/32-bit \$895

Break through the DOS 640K barrier. The most powerful PC Fortran Language Systems for downloading or writing large programs.

### PRODUCTIVITY TOOLS

Profiler, ULI Mathematical Functions Library, Overlay Linker, Toolkit, Utility Libraries, Windows, Memory Boards, 80386 HummingBoard.

IF YOU DEMAND THE VERY BEST. THEN YOU SHOULD BE USING LAHEY.  
CALL US TO DISCUSS YOUR PC FORTRAN NEEDS.

**CALL FOR NEW FEATURES INCLUDING MATH COPROCESSOR EMULATION**

30 DAY MONEY-BACK GUARANTEE

FOR INFORMATION OR TO ORDER:  
**1-800-548-4778**

Lahey Computer Systems, Inc.  
P.O. Box 6091, Incline Village, NV 89450  
TEL: 702-831-2500 TLX: 9102401256  
FAX: 702-831-8123





dBASE. FoxBASE can build applications that incorporate many familiar Macintosh software features, such as pull-down menus, radio buttons, scrollable and editable text windows, dialog and alert boxes, resizable and scrollable output windows, font and font-size control, icon-style menus, and color on the Mac II. These features give FoxBASE +/Mac much more utility as a Macintosh-only database applications development system than McMax. FoxBASE +/Mac's direct competition is Acius's 4th Dimension. It easily beat 4D 1.04 in my benchmark speed tests (4D 1.04, the current release as of May 1988, suffers from a number of speed problems), and I suspect that even the improved 4th Dimension, version 1.1, will still be drubbed by FoxBASE in speed testing.

FoxBASE +/Mac also costs \$300 less than 4D. But speed and price are not the only concerns for database developers and users. The total development and user environment is just as important as any performance and value rating based only on speed and list price. In this more complete comparison, FoxBASE still has a lot of catching up to do. 4D provides more features, more development aids, and a better overall environment than does FoxBASE +/Mac. 4D also offers a run-time version for developers, and it supports multiple users (with proper file and record locking) over AppleShare.

Fox Software expected to release a run-time version of FoxBASE +/Mac in June for \$300. By that time, the company should also have released a LAN version compatible with the file and record locking utilities of AppleShare and 3Com's 3+Share.

Given how rapidly Fox Software has gotten a serious Mac relational database into the market, I'd keep a close eye on it. I expect version 2.0 will keep its speed and add more development tools.

### FullWrite Professional

Here's a program that looked like quintessential vaporware. First announced at the January 1987 MacWorld by Ann Arbor Softworks (the FullPaint people), its release was repeatedly postponed. Ashton-Tate finally bought it in February and began shipping it at the end of April. I've tried version 1.0 for a week and have some initial impressions.

At \$395 it's competitively priced with Microsoft Word 3.02, although Microsoft's aggressive volume and educational discount purchase program often drops Word's price to less than \$90. In contrast, I paid \$219 for my copy of FullWrite Professional from a local Chicago

## Items Discussed

<p><b>Apple Macintosh System Tools 6.0</b> ..... \$39</p> <p>Apple Computer Inc. 20525 Mariani Ave. Cupertino, CA 95014 (408) 996-1010 <b>Inquiry 905.</b></p> <p><b>A/UX 1.0</b></p> <p>Apple Computer Inc. 20525 Mariani Ave. Cupertino, CA 95014 (408) 996-1010 Price not set at press time <b>Inquiry 906.</b></p>	<p><b>FoxBASE +/Mac 1.0</b> .....\$395</p> <p>Fox Software, Inc. 118 West South Broadway Perrysburg, OH 43551 (419) 874-0162 <b>Inquiry 908.</b></p> <p><b>FullWrite Professional</b> .....\$395</p> <p>Ashton-Tate Corp. 20101 Hamilton Ave. Torrance, CA 90502 (213) 329-8000. <b>Inquiry 920.</b></p>
--	--

computer store (not a chain franchise).

Version 1.0 is slow. In fact, as a basic editor, it is annoyingly slow. I tried writing this column using FullWrite but gave up because the screen scrolled too slowly, and search-and-replace operations crept along (I finished the column using MindWrite 1.1). I used a 1-megabyte Mac Plus in these tests. Brief testing on an 8-megabyte Mac II showed that

tures that Word lacks, such as review notes and revision journaling.

Like many beta testers, I had problems with FullWrite reading Word files, but my system didn't crash. Instead, the file would open with corrupted text. The released version doesn't have this problem.

Despite FullWrite's slowness compared to Word and MindWrite, I still liked the program. It's very easy to figure out and use. If I was in the habit of creating long structured documents with some graphics elements in them, I'd probably choose FullWrite over a combination of PageMaker and Word, because it would be simpler to learn and use and still produce an acceptable result.

As a basic full-screen editor/word processor, though, FullWrite Professional is just too slow on a 1-megabyte Mac Plus, and it requires too many machine resources (at least 1 megabyte of memory, preferably 2 megabytes, and as fast a hard disk drive as you can afford). For my basic writing needs, I'll stick with MindWrite 1.1 and Word 3.02, because I don't need all the DTP features of FullWrite. MindWrite's wonderful outliner is reason enough for me to rely on it, while Word's scrolling speed and global updating acumen more than make up for its other flaws. ■

| 'm  
*impressed. FoxBASE is  
not just a little bit fast,  
but a lot fast.*

FullWrite performed well. Therefore, on a fully configured Mac II, FullWrite is a good editing choice.

There's no question about FullWrite's credentials as a high-end word processor, though. It surpasses Word's desktop publishing (DTP) features by adding page-layout and drawing functions (although it's no match for the page-layout capabilities of a complete DTP program like PageMaker 3.0). Besides the basic DTP capabilities, FullWrite has a slew of editing and formatting features just like Word: a spelling checker, an outliner (yes, a usable integrated outliner, unlike Word's useless one), automatic hyphenation, automatic indexing and table of contents creation, and floating footnotes. FullWrite also has some nice editing fea-

*Don Crabb is the director of laboratories and a senior lecturer for the computer science department and the college at the University of Chicago. He is also a consulting editor for BYTE. He can be reached on BIX as "decrabb." The views expressed are his own.*

*Your questions and comments are welcome. Write to: Editor, BYTE, One Phoenix Mill Lane, Peterborough, NH 03458.*

# Mendelson Electronics Inc.

1-800-422-3525

## CONTROL YOUR HOME OR BUSINESS FROM YOUR IBM\*PC OR PC/AT COMPATIBLE

This card is what you need to TURN ON & OFF lights, machinery, and other electrical or electronic equipment.

**IBM PC\* DATA ACQUISITION AND CONTROL ADAPTER & DISTRIBUTION PANEL** provides the capability to control and

monitor processes within a sensor base system.

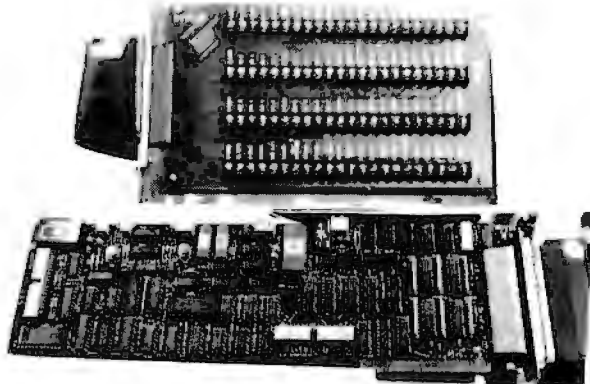

**IBM PC\*DATA ACQUISITION AND CONTROL ADAPTER**

provides an easy to use interface for accessing the ANALOG and DIGITAL I/O.

Integrates analog, binary and time/counter devices on a single adapter card.

### THIS IS AN ORIGINAL IBM\* PRODUCT !!!

Up to four IBM DATA ACQUISITION AND CONTROL ADAPTERS can be attached to an individual PC or AT Compatible

- The Adapter has
  - Four analog input channels (12-bit resolution)
  - Two analog output channels (12-bit resolution)
  - 16-channel digital input port
  - 16-channel digital output port
  - Programmable sampling rates provided by a 32-bit timer
  - Event counter programmable rate generator or programmable time delay provided by a 16-bit user timer/counter

- The Distribution Panel has
  - Screw terminals provided to attach devices to the distribution panel
  - Multiple grounds for twisted pair terminations
  - Shielded construction to minimize noise interference

- USES
  - Chromatography, Electrochemistry, Energy management, Electronic testing, Process control, Data logging, Robotics
  - Some parameters commonly monitored or controlled include Pressure, Flow, Displacement, Voltage, Light intensity, Rotational speed
  - Some instruments or devices that may utilize the Adapter are Chromatographs, Spectrophotometers, Pressure gauges, Relay controls, Thermocouples, Gas analyzers, Humidity sensors, Valve actuators, Level gauges, Load cells, Conductivity cells, pH Meters

- TECHNICAL DATA
  - ANALOG INPUT: The analog input functions of the adapter operate in either programmed or interrupting mode. The analog input functions provide 12-bit relative accuracy
  - RESOLUTION - 12 bits
  - INPUT CHANNELS - four differential

INPUT MODES:	unipolar or bipolar user-selectable
INPUT RANGES	unipolar 0 TO $\pm 10$ volts user-selectable $\pm 5$ and $\pm 10$ volts user-selectable
bipolar	
OUTPUT MODE	straight binary offset binary
INPUT IMPEDANCE	> 100 megohms with 100 picofarads
INPUT CURRENT	limited to less than $\pm 4$ mA
INPUT VOLTAGE	Normal mode $\pm 30$ volts maximum without damage power on or power off $\pm 11$ volts maximum
Common mode	
COMMON MODE	
Rejection ratio	72 dB
Integral linearity error	$\pm 1$ LSB maximum
DIFFERENTIAL Linearity	
Error	$\pm 1/2$ LSB maximum
Stability	$\pm 5$ ppm/degrees C of FSR (max)
GAIN	
Error:	$\pm 0.1\%$ between ranges (max) any range adjustable to 0
Stability	$\pm 32$ ppm/degrees C of FSR (max)
OFFSET	
Error:	adjustable to 0
Unipolar stability	$\pm 24$ ppm/degrees C of FSR (max)
Bipolar stability	$\pm 24$ ppm/degrees C of FSR (max)
MONOTONICITY	0 to 50 degrees C
THROUGHPUT to memory	15,000 conversions/second min

The analog output functions of the adapter operate in programmed I/O mode. The analog output functions provide 12-bit relative accuracy

RESOLUTION	12-bits
Number of output channels	2
OUTPUT modes	unipolar or bipolar, user-selectable
OUTPUT ranges	
Unipolar	0 to $\pm 10$ volts user-selectable
Bipolar	$\pm 5$ and $\pm 10$ volts user-selectable
INPUT CODE	
Unipolar	straight binary offset binary
Bipolar	
OUTPUT Current	$\pm 5$ milliamps, min with normal loading and protection from damage with line output shorted to common 20 mA max 0.5 microfarads max
OUTPUT impedance	
CAPACITIVE loading	
GAIN	
Error	0.1% between ranges (max) any range adjustable to 0 $\pm 2$ ppm/degrees C of FSR (max)
Stability	
OFFSET	
Error unipolar	$\pm 3.25$ millivolts max adjustable to 0
Error bipolar	$\pm 8$ ppm/degrees C of FSR (max)
Unipolar stability	$\pm 24$ ppm/degrees C of FSR (max)
Bipolar stability	0 to 50 degrees C
MONOTONICITY	10 microseconds max to within 0.1% FSR for a 10 volt step with 1000 ohm load
SETTLING TIME	
PROTECTION	
OVERSHOOT	Protect diode short to common $\pm 1\%$ of FSR max
THROUGHPUT	
from memory	25,000 conversions/second

### OUR LOW! LOW! PRICE FOR BOTH UNITS



# \$195

INCLUDES TURBO PASCAL DEMO SOFTWARE W/SOURCE CODES, ADDRESSES, ANALOG & BINARY INPUT & OUTPUT MODULES

## PER SET

Shipping & Handling \$6.50

IBM\* DATA ACQUISITION AND CONTROL ADAPTER #6451502 ORIGINAL COST \$1275  
 IBM\* ADAPTER DISTRIBUTION PANEL #6451504 ORIGINAL COST \$245

MENDELSON'S ADVANCED DEMO IN TURBO PASCAL AVAILABLE FOR \$25

Part No. #200-108 Demo Turbo

**Mendelson Electronic Co., Inc.**

STORE HOURS 8:30 - 5:00 Monday thru Saturday.  
 \*IBM PC/XT is a registered trademark of IBM corp.  
 TERMS: MasterCard/Visa/Discover Card, Check or Money order (checks allow two weeks for clearance), C.O.D. add additional \$3.00.  
 Ohio residents add 6% State Tax.

Above shipping/handling are rates for UPS ground in Continental U.S. only  
 340 East First Street Dayton, Ohio 45402  
 1-800-422-3525

513/461-3525

FAX 513/461-3391

20% Restocking Fee on Non-Defective Returns





# WHY OS/2?

It was the El Dorado of DOSes, lying beyond multitasking, beyond 640K bytes. This new column takes a practical approach to understanding—and living with—the reality of OS/2.

One of the big selling points of the original 1981 IBM PC was its large (for the time) 256K-byte memory and greater speed. Several microcomputers in the PC's price class, like the North Star Horizon II and the Altos machines, offered multiuser and multitasking capabilities. These capabilities were offered on machines with slower CPUs and less memory, so multitasking capabilities seemed (to me and to other IBM PC buyers at the time, that is) a reasonable feature for the PC's operating system. In fact, at the time, Digital Research offered a multitasking version of CP/M for the PC. DOS 1.0 *wasn't* multiuser or multitasking, but at \$40 it was the cheapest available operating system, so 96 percent of the early PC owners chose it over the other options, CP/M or the p-System.

By late 1982, everyone at the local PC user's group had heard of a rumored DOS 2.0. Some of the rumors said that it would be multiuser and multitasking.

DOS 2.0 arrived, *sans* multiuser and multitasking. Ah, well, we told ourselves, the next version would redress these deficiencies. In 1984, IBM fired our hopes by offering a new and more powerful computer. The initial press releases showed a computer with dumb ter-

minals on it and made reference to a 4-megabyte memory capacity. The new "multiuser" AT had powers and abilities beyond that of the PC, we were told. A new DOS, version 3.0, came with it, but it didn't really do anything new save take up an extra 10K bytes or so. IBM said that a DOS to exploit this new machine's powers would be released "soon."

The rumors continued. DOS 4.0 would be bypassed altogether for DOS 5.0, the El Dorado of DOSes: Beyond multitasking, and memory *beyond 640K bytes*—the once-monstrous 640K bytes had become a strait jacket. The trade rags said Microsoft figured that it could knock it out by early 1986. DOS 5.0 then tried to go undercover, assuming new names seemingly each week: CP-DOS, A(dvanced) DOS, 286DOS. We didn't care *what* they called it. We wanted more memory and multitasking.

Finally, on April 2, 1987, IBM announced a whole slew of new hardware and software. DOS 5.0 was finally announced, calling itself OS/2.

The attractive features of OS/2 are multitasking, access to larger memory, a graphical user interface, an improved local-area network manager, legal terminate-and-stay-resident programs, better harmony among programs, a rich system interface, and compatibility with many familiar DOS commands, and, with the Presentation Manager, OS/2 provides a device-independent platform. I'll examine the first three this month and take the rest up next month.

## Multitasking

OS/2 is designed to be a single-user, Unix-like operating system for 80286 and 80386 PCs. A dozen or more (12 for OS/2 1.0, 17 for OS/2 1.1) programs can run at the same time, all loaded into memory and executing.

This *concurrent* multitasking goes beyond many simple systems currently available under DOS that load several programs into memory but give actual

CPU attention only to the one that you are currently interacting with. In these simple systems, no background processing occurs. Such systems' main values are that they let you cut and paste between applications and that they eliminate the time required to load and unload a program. A good and inexpensive example of these programs is Software Carousel from SoftLogic Solutions.

Gordon Letwin, Microsoft's chief architect of OS/2, says that it is fundamentally different from minicomputer operating systems like Unix. Multiuser systems, he says, must appear to fairly allocate computer resources among multiple users. OS/2, on the other hand, need not appear fair to the multiple programs running in the system. In fact, Letwin argues, you really want to give the lion's share of the CPU time to the program in the foreground—the one the user is currently interacting with. Letwin claims that OS/2 does this.

OS/2 has a relatively sophisticated task-switching algorithm, incorporating a 189-level priority scheme and a dynamic adjustment algorithm for those priorities that takes into account things like how long a task has been CPU-starved and whether or not the task is just waiting for I/O. In a future column, I'll show you how to manipulate these priorities for optimum performance.

## Large Memory

"Breaking the 640K-byte barrier" has become a cliché, but OS/2 does it. The 80286 and 80386 have, of course, always had the ability to address large amounts of memory, but not while in the "real mode" (are the other modes "unreal"?) that DOS requires. Access to more memory is allowed under "protected mode"—16 megabytes of memory, in fact.

OS/2 even goes beyond 16 megabytes. It can use extra disk space where there is insufficient RAM. If you try to run, say, a 3-megabyte program where only 2

*continued*

megabytes of RAM are free, OS/2 will transparently store 1 of the 3 megabytes on disk, treating it as if it were RAM. This scheme, called "virtual memory," is OK in a pinch, but access to disk is so much slower than access to memory that you'll want to avoid this one where possible.

Another reason to avoid virtual memory under OS/2 is that the virtual memory manager is buggy. The process of moving memory blocks temporarily to disk and back is called "swapping." The swapper program will use *all* the free space on your hard disk drive—you can't tell it to use only *x* megabytes for swapping. The swapper under 1.0 is moderately stable, although I've crashed it a few times. The swapper under the current 1.1 beta release is very fragile. If you want a stable OS/2 platform for your programs, disable the swapper by adding `MEMMAN=NOSWAP,MOVE` to your `CONFIG.-SYS` file. Bugs like this are fairly common in a new system, and they will no doubt be fixed in a future release.

As the largest disk addressable by OS/2 is the familiar 32 megabytes (yes, the old DOS limitation on disk size is still with us), and the maximum RAM addressable by OS/2 is 16 megabytes, a program using *both* RAM and virtual memory could theoretically be as large as 48 megabytes.

The virtual memory scheme could be very useful were it not for the fact that OS/2 seems unable to swap *itself*. An IBM PC AT with 2.5 megabytes of RAM cannot boot the Presentation Manager code that Microsoft shipped to developers in April, as it must have at least 2.7 megabytes to boot. Apparently, *all* of OS/2 must reside in RAM.

Another disappointment about OS/2's use of large memory is not Microsoft's fault, but Intel's. Even in protected mode, the 80286/80386 chips are designed to address the 16 megabytes in terms of 64K-byte segments. Going across segments requires more code and is slower. Many compiler writers, dismayed at how much more slowly a program runs when doing a lot of segment swapping, have simply limited static data areas to 64K bytes—one segment.

It would be a real shame if inexpensive compilers maintained this now antediluvian constraint. There are, of course, no inexpensive compilers for OS/2 currently. But an expensive one, the BASIC compiler, *still* has the 64K-byte limitation on static data.

For OS/2 to get beyond the 64K-byte segments, it would have to put the chip in a different, incompatible mode, the "32-

## Items Discussed

**Microsoft OS/2 System Development Toolkit**..... \$3000  
Microsoft Corp.  
16011 Northeast 36th Way  
Redmond, WA 98073  
(206) 882-8089  
**Inquiry 945.**

**Software Carousel**..... \$60  
SoftLogic Solutions  
One Perimeter Rd.  
Manchester, NH 03103  
(603) 644-5555  
**Inquiry 946.**

bit" protected mode, but this is only available on the 80386 chip.

### Graphical User Interface

Whether you like them or not, WIMP (windows, icons, mice, and pointers) interfaces are chic these days. The Mac has established a solid market, and the well-dressed PC these days looks like a Sun engineering workstation with a small screen. The hardware for WIMP is now in place—VGA is as good as Mac graphics, and the PS/2 comes with a rodent interface built right in. OS/2 supports EGA and VGA, as well as a variety of mice. Unfortunately, the current OS/2 releases do not support Hercules graphics.

The "point and click" ease of a graphical user interface makes using applications easier and reduces training time. The Mac can be described as not an application platform, but rather an application *funnel* in the sense that all Mac applications not only *can* look the same, but pretty much *must* look the same. The downside of this uniformity is that it grinds programmers' gears: All of us who have ever touched a compiler to code fancy ourselves artists in the field of user interface design.

The graphical user interface is handled by an optional program called the Presentation Manager (PM). The PM is to OS/2 as Windows is to DOS: Windows is not necessary under DOS, and the PM is not necessary under OS/2. Including Windows/PM, however, opens the doors to some interesting applications.

It's hard to say too much good or bad about the PM, as the current beta code (early June 1988) is very, well, unstable. In his letter to developers, Microsoft's Steve Ballmer basically said, "Here's what we've got so far, it's not reliable,

better stuff is coming. . . ."

I can't see how Microsoft will have a shippable final product by October—the date Microsoft and IBM have promised release to the general public—but I wish them luck. It's easy to take potshots at Microsoft for everything being so late, but I don't see how it *couldn't* have been late. According to Microsoft, it took 35 programmers 4 years to write OS/2. That's a mighty large programming project to manage—larger, I'd guess, than anything the company has tried before.

If you know Windows, you'll spot a lot of it in the PM. The Control Panel is the same, the Alt-spacebar character does similar things, and, as in Windows 2.0, it can be managed without a rodent by using Alt keys. Applications can still communicate via the Clipboard.

However, you'll also miss a few things. As of this writing, Microsoft does *not* provide the desk accessories that Windows has—the clock, calculator, Reversi game, notepad, paint program, and terminal. This is a serious flaw, and it points to a major deficiency in OS/2: The frills are gone. Where DOS generally came with a BASIC interpreter and the all-purpose DEBUG, neither is supplied with OS/2 despite its \$400 price tag. Come on, now. Would giving us DEBUG and GWBASIC really hurt sales of those \$500 compiler/CodeView combinations?

### OS/2 Tip of the Month

If you're going to use a serial printer under OS/2, OS/2 won't talk to the printer if it doesn't see some activity on the CTS line of the serial port, line 8 on an AT's 9-pin port or line 5 on a standard 25-pin port. The following minimum cable worked to let me "print" from my desktop OS/2 machine with a 9-pin serial connection to my 9-pin laptop (a sneaky way to capture screens for use in text):

Side 1	Side 2
2-----	3
3-----	2
5-----	5
7	7
8	8

*Mark Minasi is a managing partner at the firm of Moulton, Minasi & Company, a Columbia, Maryland, which specializes in technical seminars. He can be reached on BIX as "editors."*

*Your questions and comments are welcome. Write to: Editor, BYTE, One Phoenix Mill Lane, Peterborough, NH 03458.*

# See DOS run.



Look at DOS. It looks back at you. It makes you do all the work. You need the Norton Commander.



See this user-defined menu. It runs your favorite programs and routines at a keystroke.



View two directories—from one or two disks—at once. And move your files around quickly.

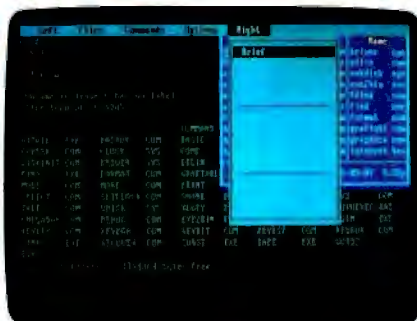

Pull down a menu for quick, easy access to the full power and features of the program.



Want a tree view? Just pop up a window. You can scroll, mouse or Speed Search for directories.



To see your files, pick a directory on the left and see the contents on the right.



Remember your last 15 commands? Our Command History does. Take your pick and run them again.



View your dBASE® II or III data without having to run dBASE. It's as close as a keystroke.



Another keystroke shows Lotus® 1-2-3® or Symphony® files—without running 1-2-3 or Symphony.

See DOS run like you've never seen it before. Like you won't see it run with any other DOS enhancement shell. See version 2.0 of the Norton Commander™—a dramatically advanced version of the program *Infoworld* called “tops in its class... a new level of convenience for MS/DOS users.” The new Norton Commander combines the functions of a hard disk manager with all the features you need to support and enhance the DOS command line. Yet it's flexible enough to get out of your way when you don't need to see it. Novice or expert, you'll want to see your dealer right away. And see how fast DOS can run.

**Peter Norton**  
COMPUTING



Circle 176 on Reader Service Card (DEALERS: 177)

Designed for the IBM® PS/2™ and PC families and 100% compatibles. Available at most software dealers, or direct from Peter Norton Computing, Inc., 2210 Wilshire Blvd., #186, Santa Monica, CA 90403. 213-315-2000. Visa and MasterCard welcome. ©1988 Peter Norton Computing.



# Tomorrow's LAN Solutions – Today.

## EtherLAN Plus™/The Affordable Ethernet Solution

In today's LAN world, every new LAN manufacturer seems to have a new idea of what a network should be. Standards for the industry are few and far between, but are there if you want to pay for them. Wouldn't it be nice if for once you could buy a LAN system, at a price you can afford, and be fully compatible with the ethernet standard? Well now you can!

### Turn Key Ethernet

EtherLAN is here to give you everything you need to set up an ethernet LAN system. You'll receive the EtherLAN network adapter, 25 feet of thinwire ethernet coax cable, T connector and easy to understand Installation and User's Guides, all for one low price. In addition to this, you'll also receive complete software needed to get your new EtherLAN system up and running quickly. You'll get NETBIOS software and also a complete network operating system to make using your new EtherLAN system even easier.

### SimpleWARE™ Makes EtherLAN Unbeatable

The operating system you'll get works as a shell above DOS, so all your normal DOS programs will run on EtherLAN as well as locally.

Even better yet, you can use standard DOS commands to control your network, so you are not stuck spending hours to learn a new set of commands. The operating system functions transparently, so you won't even know you're on a network.

### Features You Can Rely On.

- Fully ethernet and cheapernet compatible (IEEE 802.3).
- Fast — a full 10,000,000 bit per second.

- Low memory requirements.
- NETBIOS compatible.
- Everything you need is included at one low price.

**The best news of all is the price.**

At only \$699.95 per node, you get all hardware, software, cabling and manuals needed.

### Introductory Offer

Four Node Kit for only \$2499.00. Save over \$300.00.

**With features like these, and an affordable price per node, how can you lose?**

**Call Toll Free**  
**1-800-262-8010**  
 1-714-529-8850 (in CA)



VISA, M/C, COD, or Prepaid orders accepted.



### Simple Net Systems, Inc.

545 W. Lambert Rd., Suite A  
 Brea, CA 92621  
 FAX: (714) 529-2413

Requires IBM PC/XT/AT or compatible, running DOS 3.10 or higher. EtherLAN is a registered trademark of Simple Net Systems, Inc. Other brand and product names are trademarks of their respective holders.

Circle 17 on Reader Service Card (DEALERS: 18)

<b>EtherLAN 6 Node Comparison</b>		
500 Kbytes	Read and Write	Retail
EtherLAN	11 and 10 seconds	\$4199
3Com®	14 and 12 seconds	\$5670*
Novell SFT®	10 and 9 seconds	\$8265*

\*Figures from PC Magazine.

- NO dedicated servers are required.
- Transparent operation —operates as a shell above DOS.
- Easy to use DOS type commands or pop up menus.
- Share disks, subdirectories, printers and plotters.
- DOS file and record locking.
- Up to 5 printers per server.
- Time and Date sharing.
- Electronic Message System.



# THE WIRED SOCIETY

## Surveying the electronic communications landscape

**C**yrus Field never imagined in his wildest dreams the global effect of his accomplishment in 1866: the laying of the Atlantic cable. Ten years later, Secretary of State William Evarts spoke the following words at a ceremony commemorating that event:

"Columbus said, 'There is one world, there shall be two.' Cyrus W. Field said, 'There are two worlds—there shall be one.'"

Welcome to the wired society.

Telecommunications is the infrastructure of the computer industry, the lifeline of a wired society. Whether you're pushing binary files across the country on a dedicated line or simply typing in a comment on BIX over voice-grade telephone lines at 1200 bits per second (bps), some form of communication is taking place.

Consider this electronic communications landscape: Local-area networks (LANs) are the city streets; computer conferencing systems are the interstate highways; packet-switched networks are the global trade routes; and bulletin board systems are the rambling country roads that stitch communities together.

### A Technological Misfit

The world's economy flows across an electronic global highway every day, much of its information base at the beck and call of a simple carrier tone. Yet, for all its importance, telecommunications is a bastard child: merely acknowledged, begrudgingly accepted, never quite fitting in.

For example, a BYTE survey shows that 60 percent of you own a modem and



18 percent plan to buy a modem in the near future. However, use of communications software ranks a distant fourth behind the "big three" of applications: word processing, spreadsheets, and database programs.

My love affair with PC-based communications began with a Commodore Vic-20, a 9-inch black-and-white TV, and a 300-bps direct connect modem. After some 6 years on-line, half of that spent writing about telecommunications topics ranging from pirate bulletin boards to security issues to governmental attempts to strangle free access to public information, my blind love affair has matured into a clearer understanding of and a healthy respect for telecommunications.

A good friend and fellow communications writer, Art Kleiner, told me he hit a "curmudgeon stage" with the technology a couple years back. This stage entailed an uneasy satisfaction with the overall environment of "being on-line." So, instead of merely defending the tech-

nology to critics, he began asking questions. And demanding answers.

Why is the technology so difficult to understand? Why is it so difficult to get a modem and communications software package to successfully dial a remote computer? Why, why, why?

My own curmudgeon stage shortly followed Art's. But this isn't a bad thing. As Art told me, "It's made me look for answers and explore ways to push the technology, instead of just accepting whatever came along as well and good." His philosophy is an information-age extension of the old dictum "Question authority."

So I'm a bit skeptical when I hear that telecommunications is just about to take off, poised to become the "next wave" of computer productivity. It hasn't happened, folks. And for good reasons.

For example, people still oversell the technology. It's good for some things, but bad for others. And there are built-in

*continued*

problems with every application, but that should come as no surprise; few things more technologically advanced than a disposable lighter work dependably.

For all the above grousing, however, I believe the real advancements and advantages of telecommunications are indeed just around the corner (the trouble comes in defining just how far up the street that corner lies).

In this column I'll look at the complex factors driving the communications industry today and tomorrow. To do that, I'll examine three broad areas of the industry: technology, issues, and effects.

### Technologies

For the purposes of this column, communications technology deals with the nuts and bolts of pumping bits and bytes from the desktop to other intelligent devices. Access may be via a direct connection, a local-area network, or dial-up communications.

My discussions will focus on topics such as modem technology. Modems are becoming more sophisticated, capable of pushing data faster and more efficiently. How is this being accomplished, and why

isn't it being done on a larger scale?

The burgeoning modem market is beginning to demand dial-up 9600-bps modems, and the industry is starting to respond. One small catch, however, is compatibility, the plague of the computer industry. For example, many 9600-bps modem manufacturers use the Microcom Networking Protocol (MNP) for error correction, but each implements it in a slightly different way.

The telecommunications environment, as a whole, is no different. The drive for faster, faster, faster creates a fractured marketplace with incompatible implementations of "standards" in a kind of free-market "to each his own" mentality.

There are signs of a "coming together" on these issues, however, and I'll keep a close watch on those developments. One good sign is the growing acceptance of the X.400 electronic message exchange standard among providers of electronic mail services.

Then there's communications software, which is like any other piece of software: The one you're reared on is the one you'll most likely die for. Trying to

get people to change their brand of communications software is like trying to get the Dalai Lama to change his religion.

When are communications software developers going to learn that the quintessential user isn't the quintessential programmer? And that the user doesn't want to learn a programming language that may as well be Urdu, just to write advanced script files?

For telecommunications to become as indispensable as the word processor, programmers are going to have to concentrate on truly seamless approaches to telecommunicating. The program should take care of most of the work so you can just boot up and go on-line.

I'll be looking at the best and brightest of the future communications packages here. I don't expect miracles right away, but I'm impressed with rumblings I hear coming just over that horizon.

Another aspect of the technology is the systems—the networks and information services—with which the modems and communications software interact. These include computer conferencing systems like BIX, consumer information

*continued*

# Travel Companions.



The WorldPort 2400™ and the WorldPort 1200™ modems are the perfect travel companions for your portable computer. They work virtually anywhere in the world, including hotel rooms and phone booths, allowing you to connect in a few million more locations than other modems.

With features superior to internal units, the WorldPort line of modems is the smart choice for all your communication needs. WorldPort modems operate from their own internal battery,

drawing no power from your laptop. Cutting edge technology brings you features such as Bell and CCITT standards, direct connect and acoustic interface (300 and 1200 bps), tiny size and a tiny price. The WorldPort 1200™ can be easily upgraded to 2400 bps and both the WorldPort 2400™ and the upgrade come with Carbon Copy PLUS™ communications software.

Find out more about the travel companions that won't tie down your portable computer. Call us

today for more information about the WorldPort line of modems, or the name of your nearest dealer, at **800-541-0345**. (In New York, 516-261-0423.)



Touchbase Systems, Inc.  
160 Laurel Avenue  
Northport, NY 11768  
(516) 261-0423  
TELEX: 6502848020  
FAX: (516) 754-3491

WorldPort 1200 and WorldPort 2400 are trademarks of Touchbase Systems, Inc., Carbon Copy PLUS is a trademark of Meridian Technology Inc.





## Which would you like to see first? The world's fastest dBASE compiler or the most powerful database development language?

Surprise. Now you get both in the same package. New **Clipper™** from Nantucket®.

Our **latest** version — Summer '87 — is still the best-performing compiler ever. It lets users run dBASE® applications up to 20 times faster. But there's a lot more to it than raw speed.

Because new Clipper is one of the most powerful, full-featured development languages ever. And gives you more control over your applications than any release of dBASE ever will. Now or in the future.

Instead of designing Clipper as an add-on, we've structured it as an extended database language that uses dBASE as a subset. In addition to emulating the dBASE language, we've added commands for menus, screens, windows and extended functions. As a result, you get dBASE compatibility and an entirely new level of power and versatility.

And with Clipper's open architecture, you can write functions in Clipper, C, Assembler or other languages, and integrate them into one seamless application. Which helps you create more sophisti-

cated applications in less time. And by using our full-featured debugger, you'll be done even **faster**.

We also **give** you source code security that **keeps** users from **damaging** your application. And **sophisticated** record and file locking capabilities that make networking applications easier to create. But no matter what you create, you don't have to buy runtime modules or additional software. You don't even have to pay licensing fees.

If you haven't tried Clipper yet, just call (213) 390-7923 today. We'll send you full information and a free demo diskette. Or the complete program, if you'd rather.

But call today. And see how easy it is to find the best dBASE development language. Just get the fastest compiler. And open the box.

# Clipper™

Nantucket, 12555 W. Jefferson Boulevard  
Los Angeles, CA 90066 Telex: 650-2574125



utilities like CompuServe, LANs, electronic mail (E-mail), and international packet-switched networks. It's in these "hot spots" of telecommunications that the technology comes alive, or should come alive.

Tom Mandel, a futurist and senior analyst at the Stanford Research Institute in Palo Alto, California, is completing a landmark study entitled *Interactive Telecommunications Services: Precursors of the Wired Society*. He says, "Direct consumer access to information through electronic means is going to grow dramatically in the next 5 years. I think we'll see a growth rate, in terms of users, of anywhere between 25 and 30 percent."

Although Mandel is optimistic about the growth of interactive systems like BIX, CompuServe, and E-mail, he says, "We won't see a true mass market emerge." Instead, several niche markets will spring up and profit.

Such niche markets include services like NewsNet, which offers the full text of some 300 specialized newsletters and publications; on-line services like BIX, which cater primarily to a more technical crowd; or Quantum Link, an on-line entertainment service for owners of Commodore computers. In essence, there isn't likely to be one service for all people in the near future.

"To create sufficient demand for a mass market, people are going to have to be given a reason to go outside their normal media requirements: TV, the newspaper, and magazines," says Mandel. "To create sufficient demand for new services at levels attractive to the everyday Joe, the design, delivery, and pricing of consumer services will have to improve significantly."

Here, I'll examine these "niche markets"—what's hot, what's not, and why.

## Issues

Congress, in grappling with the effects of new technologies on today's society, has issued several reports out of the Office of Technology Assessment (OTA). The bottom line for the OTA is that any kind of electronic communications systems, with the possible exception of E-mail services, is actually a publishing medium. When you place something on-line, you become an author; the system becomes the publisher.

This author/publisher relationship raises issues of copyright, intellectual property rights, free speech, and the rights of privacy. A 1986 OTA report states, "Electronic dissemination creates some very complex issues with respect to the public interest, and involves the intel-

lectual property system in other issues such as communications, antitrust, and freedom of speech." A broad brush, indeed.

I've  
had students from  
around the world take  
my class, and I've never  
set foot in a classroom.

Beyond these thorny issues are those of governmental regulation and legislation. Earlier this year, the Federal Communications Commission (FCC) withdrew a proposal that would have dramatically increased the rates that on-line service subscribers would have to pay. The FCC withdrew it, in large part, because of a tremendous grass-roots coalition between service providers and their subscribers: you and me.

It was an issue near and dear to all users of on-line services. And they won. But only because the entire issue was hashed out on every imaginable system from the basement BBS to BIX.

In 1986 Congress saw the need to pass the Electronic Communications Privacy Act, an amendment to the Wiretap Act of 1968. This landmark legislation gave at least some basic privacy rights to private electronic correspondence. And earlier this year, the first lawsuit under the ECPA was filed in an Illinois court.

Such issues can't be separated from discussions about communications, because after the smoke of technological advancement clears, the issues are still smoldering. I'll look at these, too.

## Effects

Any technology that directly affects the way humans interact creates unexpected results. A historical example is the telephone. Thought of as merely a business tool when first brought into the public, a way for the boss to stay in touch with the remote worker, it quickly became a social tool and has largely remained so, relegating its original intent to a secondary level.

Electronic communications change the way people work, how they work, and the very structure of organizations that implement such systems (ask Oliver

North—who destroyed paper documents but didn't understand that deleted E-mail messages on a PROFS system are archived—about the effects of electronic communications). For example, communications technology is changing how educational systems accomplish tasks, and new methods of teaching are springing up.

I teach graduate-level courses for Connected Education, a program for the Media Studies department under the auspices of the New School for Social Research in New York. And although I've had students from around the world take my courses, I've never set foot in a classroom; the courses are all taught via the EIES conferencing system located on the campus of the New Jersey Institute of Technology.

Nonprofit organizations are beginning to use computer communications to extend their effectiveness—and their budgets. And the presidential candidates are relying on telecommunications to help them coordinate campaigns and keep statewide campaign offices informed of new strategies.

These effects are crucial to the success of communications because they offer tangible results that you can point out to the critics of the technology.

This column will also highlight noteworthy applications of communications and keep you informed on how they affect various segments of the world.

## Future Stock

In the coming months, I'll take a look at aspects from each of these various areas. From the bumpy back roads of BBSes to the superhighways of computer conferencing systems, the global highway will be well traveled.

My regular "watering holes" are: BIX ("brock"), MCI Mail ("bmeeks"), and CompuServe (7036,1355). For those of you who are hooked into the more esoteric Usenet (you know who you are), I can be reached on the WELL via the pathway "ihnp4!ucbvax!cogsci.berkeley.edu!well!brock."

As well-traveled as I am across this electronic landscape, I don't stop everywhere. If there's an issue, a topic, or a technology that you think deserves a stop along the way, let me know. ■

*Brock N. Meeks is a San Diego-based freelance writer who specializes in high technology. You can reach him on BIX as "brock."*

*Your questions and comments are welcome. Write to: Editor, BYTE, One Phoenix Mill Lane, Peterborough, NH 03458.*



The Farther Away You Get,  
the Better We Look.



## Introducing REMOTE<sup>2</sup>

**It's never been so easy to do so much  
in distant PC operation.**

Until now, to have this kind of flexibility and control over a host PC, you'd have to be in the same room.

Now, even if you're thousands of miles away, REMOTE<sup>2</sup> allows you to operate a host PC's application software with total control and exact mapping of the host keyboard... fast file transfers even while an application program is running... remote printer redirection... an error-checked, data-compressed link even with conventional modems... and CGA color graphics.

REMOTE<sup>2</sup> comes in two parts—R2HOST and R2CALL—available together or separately, so you can create the combination to meet your exact needs. R2HOST is also accessible from most terminals and terminal emulators.

Circle 65 on Reader Service Card

REMOTE<sup>2</sup> is packed with features users have asked for. A choice of three distinct automatic and manual answering modes. Directory-to-directory file transfers using a half-screen display of host files. Proprietary file transfer protocol with redundant file skipping and partial file recovery (other popular protocols also supported). A "Phone Book" that facilitates one-entry calls from listings of names, numbers, and passwords. Host call-back capability. Integrated, context-sensitive help system. LAN access. Mainframe access to an IBM host with IRMA. And more.

Discover the new remote control program from the makers of CROSSTALK. Ask your dealer about REMOTE<sup>2</sup> or write us.

# REMOTE<sup>2</sup>

CROSSTALK COMMUNICATIONS/1000 Holcomb Woods Parkway,  
Roswell, Georgia 30076/(800) 241-6393

A Division of Digital Communications Associates, Inc. **dca**

CROSSTALK is a registered trademark of Digital Communications Associates, Inc./CASL. IRMA and Smart Alloc are trademarks of Digital Communications Associates, Inc./CompuServe is a registered trademark of CompuServe, Inc., an H&R Block Company

# 25-MHz Computing Buzzsaws

## She Canna Go Much Faster Than This, Captain!

**T**he 80386 system builders have cranked the dial up another notch. And from Compaq, Everex, Intel, and SimpleNet, here they come: the first of the 25-MHz 80386-based AT clones. Several other companies, including IBM, Advanced Logic Research, and Everest Computer have also announced 25-MHz machines.

Judging from the preproduction systems I just looked at, "AT clone" is not a precise term. It's probably more accurate to say that these machines have AT parts grafted onto them. Like the Six Million Dollar Man, with his frail, biologic human parts stitched together with superhuman bionic limbs, these machines marry a significant portion of an 8-MHz AT that limps alongside a high-speed, 32-bit 80386 system. Each machine accomplishes this dual personality in different ways, yet there are striking similarities—at least on the surface.

All four machines have a number of 8-MHz AT-compatible expansion

slots that you can feed from the market's never-ending supply of peripheral boards. Each machine also has a 32-bit expansion bus for a high-speed memory board supplied by the company (sort of a similarity and a difference—since each machine's 32-bit expansion bus is proprietary). This leaves you in a predicament: If you want to upgrade memory beyond what you can place on the motherboard, you can either buy a slow, less-expensive AT-bus memory board from any number of sources, or a fast, more expensive 32-bit memory board from the company that made your machine.

### Compaq Deskpro 386/25

Compaq's Deskpro 386/25 looks so much like the Deskpro 386/20, you'd swear all the company did was jack up the CPU to 25 MHz and jack up the price to over 10 grand. But if you examine the motherboards, there has been some redesign: Most of the remaining dual in-line package (DIP) chips have been replaced with surface-mount technology.

However, Compaq refers to most of the design and options of the Deskpro 386/25 as "current technology." Current, that is, with respect to the 386/20. (For a review of the Deskpro 386/20, see the February BYTE.)

The only new options for the 386/25 are new hard disk

drives (up to 600 megabytes in an expansion unit), a new 80386 hardware technical manual, and sockets for the new 25-MHz versions of the 80387 and Weitek 1167 coprocessors. Interestingly, you can install both coprocessors in the same machine. They will coexist peacefully, and your software can choose between them. (A 25-MHz Weitek processor was not available at the time I was writing this. I did, however, benchmark the machine with a 25-MHz 80387).

The Flex architecture is still there (see the February review for details), only now it's running at a higher clock speed. As with the 386/20, you can download the BIOS (including the video BIOS) to RAM for faster execution. The CPU and math coprocessor sit on a local high-speed bus with cache memory and are managed by an 82385. Compaq continues to deliver the high level of quality the company is famous for. The chassis is well built, with plenty of attention to radio-frequency-interference shielding.

My test system was loaded: a 300-megabyte ESDI (enhanced small device interface) hard disk drive, 3 megabytes of RAM, a 1.2-megabyte 5¼-inch floppy disk drive, a 135-megabyte tape backup unit, Compaq's Video Graphics Controller board (VGA-

compatible) and more standard peripherals than I

Compaq  
Deskpro 386/25

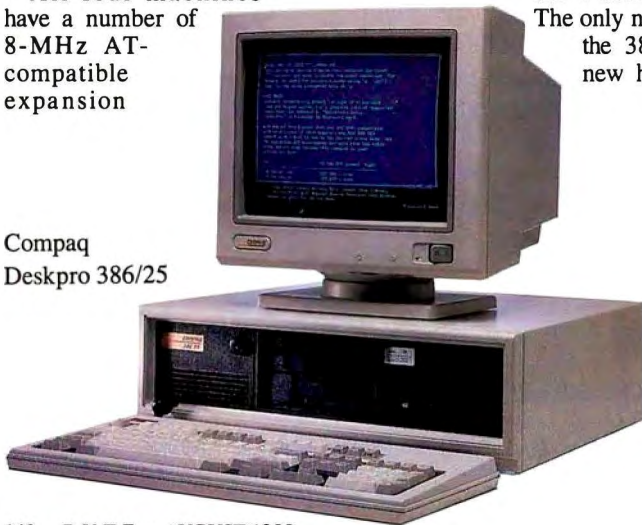

Everex  
Step 386/25



have space to mention. You can purchase the Deskpro 386/25 in one of two models that differ only in mass storage. The Model 300 has a 1.2-megabyte 5¼-inch floppy disk drive and a full-height 300-megabyte hard disk drive and sells for \$13,299; the Model 110 has a half-height 110-megabyte hard disk drive and a price tag of \$10,299. You can add combinations of 1- and 4-megabyte memory-expansion boards to bring the system's total memory up to 16 megabytes.

### Everex Step 386/25

What really attracts me to the Everex is the tinted-glass window on the front panel that slides open to reveal a miniature starship's control panel. This 2½ by 5-inch area is a tiny paradise of switches and lights. Across its top is an amber alphanumeric LED panel that keeps you abreast of equipment checks at boot-up (it says things like "DMA OK") and which disk, cylinder, and head is accessed during normal operation ("C:0017 0" means drive C, cylinder 17, head 0). Beneath the LED is a power light and a hard disk access light. Farther down is a three-position toggle switch beside three lights, one each for 8-, 12-, and 25-MHz operation. The next panel down holds the turnkey lock for locking your keyboard, and moving lower you come to a pair of push buttons: one for shutting off the speaker and another for rebooting the system.

Inside, the Everex is all business. It houses eight expansion slots: six AT-style, one 8-bit "drop-slot," (for 8-bit boards that have added to their real estate by extending below the lip of the connector) and one 32-bit slot. The 32-bit slot in the review machine held a 2-megabyte RAM card. On the motherboard were eight 256K-byte single in-line memory modules (SIMMs) (filling all the SIMM slots available) and 256K bytes of high-speed static RAM (SRAM) for

the cache. The review system also had an 80-megabyte full-height hard disk, a 1.2-megabyte 5¼-inch half-height floppy disk drive, and a 1.44-megabyte 3½-inch floppy disk drive. For video, Everex supplied one of its EGA boards and an Eversion MN-200 monitor.

Everex also provides extensive utility software, including a hard disk utility package and RAMdisk software. The hard disk utility software includes an extensive diagnostic section, as well as software for creating either Extended DOS partitions, which allow you to create logical drives of up to 32 megabytes each on a single physical drive, or Super DOS partitions, which allow you to create a single partition of up to 285 megabytes on one drive.

You must be careful about one thing on the Everex, though: The configuration program (you get to it by a hot-key sequence—I stumbled into it via a bug in the ROMs that an engineer at Everex assured me would be eliminated on future machines). The program asks you a lot of questions. Unless you have the manual to explain what they all mean, and unless you are intimately familiar with the options you have tacked onto your system, you can really bunge things up.

The cost for a minimum Everex 386/25 system—case, power supply, motherboard, keyboard, 1 megabyte of memory, DOS 3.3, and a 1.2-megabyte floppy disk drive and controller—is \$5999. The configuration I tested has a price tag of just over \$9500.

### Intel SYP302

Here's a machine for OEMs only. I've included it here because it will show up on the shelves as the basis for systems from other manufacturers. The System SYP302 from Intel's OEM Platform division gets you a motherboard (populated

with a range of memory amounts), power supply, and hard and floppy disk drives (optional). The OEM has to supply the frivolities of computing... such as a keyboard, video boards, CRTs, and whatever additional peripherals you need. (For a motherboard with 2 megabytes, a chassis, and a power supply, an OEM can expect to pay \$6449.)

My Intel system came with a half-height 44-megabyte hard disk drive, with a pop-out to either add another one or replace the current one with a full-height drive. It also had a 1.2-megabyte 5¼-inch floppy disk drive and pop-outs for three more half-height drives under that. Between the power supply and I/O sockets, I found 4 megabytes of memory in 4 SIMM packages, with room for 4 more. (You can take the machine to 24 megabytes with plug-in memory cards.) Hidden somewhere on the motherboard (I looked, but couldn't find it—I suspect it was in the darkness beneath the drives) is 64K bytes of 35-nanosecond SRAM used as processor cache memory. There's also a socket for a 25-MHz 80387. Fortunately, the socket was occupied on the machine I tested.

There is no Intel 82385 cache controller chip on the SYP302, though I fully expected to see one. In conversation with an Intel engineer, I was told that this is because at the time the engineers were designing the SYP302 system, Intel was unsure that a 25-MHz version of the 82385 would be available in time for the SYP302. Consequently, the engineers of the 302 set about creating a cache controller from discrete components. The caching system is posted write-through (more on this later) and uses a direct-mapping scheme; that is, there is no sophisticated algorithm—such as a least-recently used formula—used to update main memory from the cache.

Arranged along the back of the motherboard is a lineup of eight I/O

*continued*

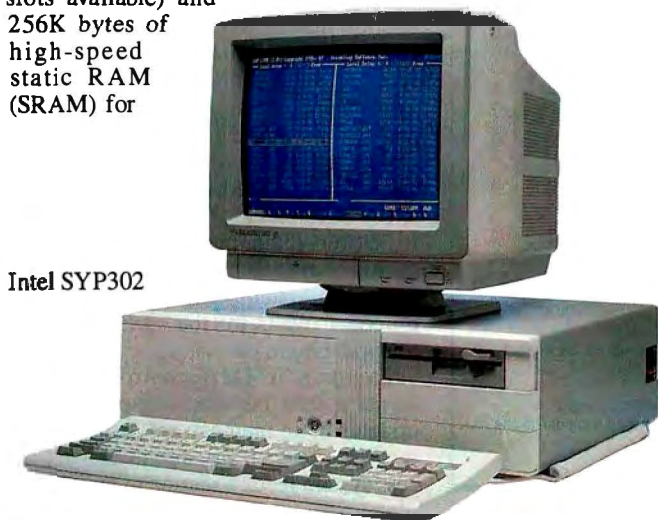

Intel SYP302

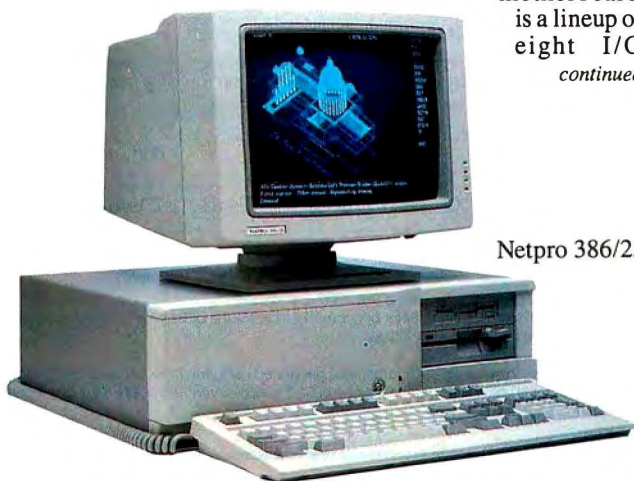

Netpro 386/25

connectors. You can use seven of these as 16-bit AT slots (they operate as though attached to an 8-MHz AT machine), and the eighth as an 8-bit drop slot. Two of the seven AT-compatible slots are lined up with 86-pin AT32 32-bit expansion slots that operate at full 25-MHz processor speed. Currently, the AT32 slots will accept only an Intel AT MEM8 8-megabyte expansion board.

The Intel SYP302 uses the Phoenix BIOS. You can have the BIOS downloaded to RAM at boot-up time (the BIOS routines execute faster out of RAM than out of ROM), and a jumper on the motherboard chooses either DOS or Unix operation. Unix operation maps the ROM to the very top of the physical memory-address space so that Unix sees a large contiguous RAM space.

The Intel machine has to take the prize for being the most unattractive of the group. Its left front panel juts out in a way that suggests either a design afterthought or an engineering kludge and is actually an artistic attempt to hide the intake vents that span the front underside of the chassis. Keep in mind, however, that this is an OEM machine. Anything that

might be even remotely mistaken for a frill took a back seat to function.

### Netpro 386/25

SimpleNet's Netpro 386/25 is one of the first systems based on the Intel SYP302 box. On the outside, the Netpro 386/25 looks just like the Intel system. When you remove the cover and look inside, the Netpro 386/25 looks just like the Intel system. Then, when you run the benchmarks, the Netpro 386/25 performs—if you allow for statistical errors in timings—just like the Intel system.

The only possible performance differences you will see depend on the peripherals you plug in. In the case of my Netpro machine, I received an Orchid Designer VGA board and a combination hard/floppy disk drive controller hooked to an 80-megabyte hard disk drive, a 1.2-megabyte 5¼-inch floppy disk drive, and a 1.44-megabyte 3½-inch floppy disk drive.

At the time of this writing, the Netpro 386/25 is available in two models: The Model 1 is a 4-megabyte monochrome system with an 80-megabyte hard disk drive, a 1.2-megabyte 5¼-inch floppy

disk drive, an EtherLan adapter, and a retail price tag of \$12,499; the Model 2 sports a VGA display, an extra 3½-inch floppy disk drive, a 102-megabyte hard disk drive, and a price of \$13,499.

As an aside, the monitor I received with the Netpro was an RE5515 multi-scan monitor from Relisys. For the most part, it worked quite well, but during the benchmarking, the BYTE Lab personnel noticed that whenever the system changed graphics modes, they had to adjust the horizontal width of the display. This did no damage to the hardware or program execution, but the effect was unbearably annoying.

### All the Difference in the World

These machines' claim to fame is speed. Caching obviously plays an important role in this area; when I inadvertently disabled the cache on the Intel machine, its performance dropped to what I would expect from a 16-MHz AT. Many manufacturers of these (and other) high-speed systems spend much of their time touting their caching system's high "hit rate" and low "effective wait states." What about these systems?

The Everex uses a proprietary Advanced Memory Management Architecture (AMMA) that—according to the company—gives the system a performance boost beyond standard cache systems. First, AMMA permits you to expand the cache memory from 64K bytes (the minimum) to 256K bytes as your system memory expands. Second, processor cache systems based on the Intel 82385 cache controller chip—the Compaq uses the 82385—are *write-through*, which means that as the processor writes data into the cache memory, it also writes the data to the system memory so that system memory is kept up to date with cache memory. A write-through cache will experience a performance reduction during write operations that access the slower main memory. (To be specific, Intel refers to the 82385's cache implementation as *posted write-through* and claims that a posted write-through allows the 80386 to issue a write to the cache and proceed with the next operation without having to wait for the update to slower main memory. However, if multiple write operations occur back-to-back, the system can bottleneck as the processor waits for the cache controller to update main memory.)

Everex's AMMA controller implements a true buffered-write cache that updates main memory only when necessary (e.g., when the direct memory access system reads a section of main mem-

**Table 1: Speed differences between 20- and 25-MHz 80386-based systems range from about 50 percent improvement to more than double, when running such standard tests as BYTE's Matrix inversion.**

CPU	IBM PC AT	IBM PS/2 Model 80	Compaq Deskpro 386/20	Everex Step 386/25	Compaq Deskpro 386/25	Intel SYP302	Netpro 386/25
<b>Matrix String Move</b>							
Byte-wide:	11.69	4.75	3.06	2.44	2.47	2.25	2.56
Word-wide:							
Odd-bnd.	80.41	39.51	26.11	16.02	25.01	21.59	21.57
Even-bnd.	80.41	39.09	31.01	20.01	25.65	23.64	23.60
<b>Sieve</b>	40.26	19.66	13.07	8.02	12.51	10.80	10.80
<b>Sort</b>	73.65	29.11	23.18	15.25	15.25	16.33	16.34
	84.39	33.11	26.89	11.44	11.45	12.19	12.19
<b>CPU Index:</b>	<b>1.00</b>	<b>2.27</b>	<b>3.13</b>	<b>5.08</b>	<b>4.20</b>	<b>4.44</b>	<b>4.35</b>
<b>FLOATING-POINT<sup>1</sup></b>							
<b>Math</b>	46.46	10.77	7.01	5.71	5.64	5.86	5.82
Error <sup>2</sup>	0.00E+00	0.00E+00	0.00E+00	0.00E+00	0.00E+00	0.00E+00	0.00E+00
<b>Sine(x)</b>	20.05	4.61	3.29	2.65	2.58	2.64	2.66
Error	2.00E-09	2.00E-09	2.00E-09	2.00E-09	2.00E-09	2.00E-09	2.00E-09
<b>e<sup>x</sup></b>	17.20	4.50	3.06	2.54	2.47	2.56	2.57
Error	1.00E-09	1.77E-02	1.77E-02	1.77E-02	1.77E-02	1.77E-02	1.77E-02
<b>FPU Index:</b>	<b>1.00</b>	<b>4.15</b>	<b>6.10</b>	<b>7.47</b>	<b>7.64</b>	<b>7.40</b>	<b>7.38</b>

<sup>1</sup> The floating-point benchmarks use 8087-compatible instructions only.

<sup>2</sup> The errors for the floating-point benchmarks indicate the difference between expected and actual values, correct to 10 digits or rounded to 2 digits.

All times are in seconds. All figures were generated using the 8088/8086 version of Small-C (16-bit integers). Figures for 80386 machines do not use 80386-specific instructions. For a full description of all the benchmarks, see "Introducing the New BYTE Benchmarks," June BYTE.

ory that corresponds to memory updated in the cache) and does so in blocks of up to 128 bits at a time.

Is the AMMA worth its salt (or silicon)? My guess is that the best indicator of the AMMA's speed advantage over an 82385-based cache would be the String Move benchmark (see table 1), and in fact the Step 386/25 does turn in times that are noticeably faster than the other systems for that benchmark. Whatever the reason—larger cache size or smarter cache management—the Everex does seem to be able to move data between the CPU and memory more quickly than the other machines. For the other benchmarks, the Everex shows no clear win over the Compaq, and only a marginal lead over the Intel and Netpro.

### A Dual Personality

As sophisticated as these machines are, I cannot help pointing out how similar their philosophy is to that of the Apple IIGS. The IIGS used the 65816, a processor that was an upgrade to the 6502, with larger registers and a wider address range. Compare this with the 80386's improvements over the 80286/8086. The IIGS had internal fast RAM, but the system was slowed to 1 MHz during access to the IiE-compatible I/O slots. Compare this with how these machines must reduce execution speed during access to the AT-compatible slots. Finally, the IIGS had a special fast-RAM/ROM memory-expansion slot. Compare this with each of the 25-MHz machines' proprietary 32-bit high-speed memory expansion slots. It seems that compatibility plagues the hardware engineers of the PC world as well as the Apple world. Are these dual-personality machines the only possible response in the demanding face of compatibility? And how much trouble are we getting into with all the proprietary 32-bit buses?

My personal choice among these machines is a toss-up between the Everex and the Compaq. The Everex does appear to have a leg up on the Compaq and the Intel-based machines in terms of raw speed, but the Compaq comes from a fine heritage of dependable workhorses, and there's certainly plenty of Compaq peripherals to draw from.

Ultimately, you have to ask yourself whether or not the extra speed is worth the extra cost. Is there enough software out there that makes use of the 80386 that you need right now? The 80386 should begin showing its real power as more multitasking applications appear, and a serious Xenix or Unix user might have no other choice. For those who use these

## The Compaq 386s

Though not a 25-MHz machine, I find the new Compaq 386s to be more interesting than the other ones reviewed here. Why? Because the Compaq 386s uses the new Intel 80386SX processor, a 16-MHz CPU that is related to the 80386 in the same way the 8088 is related to the 8086.

Internally, the 80386SX and 80386 look identical, externally the 80386SX uses a 16-bit data bus. For the manufacturer, this translates to simpler board design, lower chip cost, and smaller package size. For us, it means we can get a good 80386 system for less money.

Another attraction of the Compaq 386s is its integration of much of the peripheral hardware onto the motherboard. Not only will you find the expected: real-time clock and calendar, parallel printer port, and serial port; there's also the unexpected: VGA controller (with a 16-bit data path that software may one day take advantage of), and a mouse port. Compaq also throws in some welcome utilities: their expanded memory manager (CEMM) package for support of the Lotus/Intel/Microsoft Expanded Memory Specification (LIM/EMS) and Compaq's own disk-caching software.

Compaq serves the 386s in a variety of flavors. You have your choice of no internal hard disk drive (the Model 1 at \$3799), a 20-megabyte hard disk drive (the Model 20 at \$4499) or a 40-megabyte hard disk drive (the Model 40 at \$5199). All three models include 1 megabyte of memory, a 5¼-inch 1.2-megabyte floppy disk drive, and 4 AT-style expansion slots as standard. If backup is one of your sensitive areas, you might check into their tape backup systems: 40 or 135 megabytes. Be careful when exploring the memory-upgrade paths for the Compaq 386s, though. There are four memory expansion options available in a variety of permutations that take the system to a maximum system memory of between 4 megabytes and 13 megabytes. Inside the Compaq 386s are four AT-style slots and one high-speed memory expansion slot.

I'm also giving the Compaq 386s



Compaq 386s

Compaq 386s	
<b>CPU Sieve:</b>	32.73
<b>Sort:</b>	27.04
<b>Matrix:</b>	5.38
<b>String Move:</b>	
Byte-wide:	52.24
Word-wide:	
Odd-bnd.:	44.05
Even-bnd.:	26.14
Doubleword-wide:	
Odd-bnd.:	29.42
Even-bnd.:	19.70
<b>Floating Point</b>	
<b>Math:</b>	
Error:	11.12
<b>Sine(x):</b>	
Error:	0.0
<b>e<sup>x</sup>:</b>	
Error:	4.63
	2E-9
	4.53
	1.77E-2

high marks for external appearance—particularly when placed next to the Bauhaus design of the Intel box. It has a smaller footprint than an AT (15 by 16 inches), so it fits nicely onto typing tables that the other 80386 systems would topple.

For an idea of the machine's performance, the table above shows the benchmark results for our 80386 low-level tests. The Compaq 386s runs at about half the speed of its bigger brother (the Deskpro 386/20) for the CPU and FPU tests. The Compaq 386s is not a barn-burner in the speed category, but if your plans include a solid 80386 machine it's worth a closer look.

machines as MS-DOS applications boxes, it may well be that a specimen from the apparently endless supply of faster-and-faster AT clones will do. Still, it's nice to put on your goggles, black flight jacket, and Red Baron scarf and sit down in front of all those megabytes and

megahertz to whip through an application in a morning instead of a whole day. ■

*Rick Grehan is a BYTE senior technical editor. You can reach him on BIX as "rick\_g."*

# The Dell System 220. Once again the critics stole the words right out of our mouth.

*"The Dell System 220 runs most PC Labs system benchmark tests at speeds that would make you think you're running a 386."*

—PC MAGAZINE

*"the Dell machine is renewed evidence that the price of 286-based desktop equipment continues to drop rapidly, making such machines very attractive for daily work under MS-DOS even as they hold out the promise of running OS/2 in the future."*

—WILL FASTIE, PC WEEK

*"...includes a year's on-site support...in the price of the computer. This is the sweetest support deal offered by any computer vendor in the industry."*

—ERIC KNORR, PC WORLD

*"The hot item from a technical point of view is the System 220. This machine runs a 286 processor at 20 MHz, which is its major claim to fame."*

—WILL FASTIE, PC WEEK

*"the System 220 has more going for it than just speed."*

—PC WORLD





The reviews are beginning to pour in. And they read like a wish list for every power user looking to exceed the ordinary limitations of a 286 computer.

The computer everyone is praising in such glowing terms is the Dell System 220.

The first 286 computer with a clock speed of 20 MHz.

It's totally MS-DOS® and MS® OS/2 compatible. Yet it sells for much less than you may pay for a 386 computer.

Because you buy it direct from us.

Eliminating the mark-ups and margins of computer stores.

We design and build every Dell computer right here in Austin, Texas.

We put each and every one through a comprehensive burn-in and a battery of diagnostic tests before we ship it.

And after we ship, we give you the best technical support you'll find anywhere in the computer industry.

Our technicians are on the phone from 7AM to 7PM every business day.

Almost any question you may have about a Dell system can be answered over the phone.

And, in the rare case, that your question can't be answered by an on-line technician, we'll send a Honeywell Bull technician by the next business day.

A full year of on-site Honeywell Bull service is included within the purchase price of your Dell system.

Your Dell computer also comes with a thirty-day money back guarantee.

And we back every one of our computers with a one year limited warranty on any defective parts or workmanship.

For more information about Dell computers, read the reviews in the trade press, turn the page, review our product offerings, and call us at (800) 426-5150.

You'll like what we have to say.

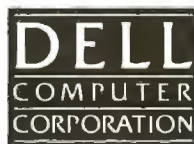

TO ORDER, CALL  
**800-426-5150**  
IN THE U.S. AND CANADA

# The Dell Computer Store.

Welcome to our store.

We believe you'll find this an extremely pleasant shopping experience.

Our sales staff is on hand to serve you from 7AM to 7PM (CST) from Monday thru Friday.

Just call (800)426-5150 and we'll give you the technical assistance and information you need to make sure you're buying the system that's right for your needs.

Then you have the option of either a direct purchase or your company can take advantage of our Leasing Plan.\*

Once you've made your choice, our Total Satisfaction Guarantee gives you thirty days from the day you receive your system, to decide if you are absolutely, totally satisfied with the product.

If you're not, simply return the system and you'll receive a full refund. No questions asked.

Your Dell computer is supported by a team of technical experts that can be reached every business day, from 7AM to 7PM (CST), simply by calling (800) 624-9896.

In most cases, any question you may have about your Dell system can be answered by one of our technicians on the phone.

Our technicians are also supported by Honeywell Bull service engineers who can be sent to your office by the next business day, should on-site service be required.

This optional service contract is available in over 95% of the United States, with over 1,000 engineers in 198 service locations.

We also offer a One Year Limited Warranty, which warrants each system we manufacture to be free of defects in materials and workmanship for one full year. During that period we will repair or replace any defective products properly returned to our factory.

Feel free to call or write for the complete terms of our Honeywell Bull Service Contract, Guarantee and Warranty. Dell Computer Corporation, 9505 Arboretum Blvd., Austin, Texas 78759-7299

Dell products are available on GSA contract. Call us to get GSA pricing.

## THE NEW 20 MHz 386 SYSTEM 310.

The top of the line. It's our highest performance computer available, faster than the IBM<sup>†</sup> PS/2<sup>†</sup> Model 80 and the Compaq<sup>†</sup> 386/20. It runs at 20 MHz with the latest 32-bit architecture. Since it also has Intel's Advanced 82385 Cache Memory Controller, and high performance disk drives, the System 310 is ideal for intensive database management, complex spreadsheet development, CAD/CAM, desktop publishing or performance as a network file server.

### Standard Features:

- Intel<sup>†</sup> 80386 microprocessor running at 20 MHz.
- 1 MB of 80 ns 32-bit RAM expandable to 16 MB without using an expansion slot.
- Advanced Intel 82385 Memory Controller with 32 KB of high speed static RAM.
- Socket for 20 MHz 80387 coprocessor.
- 5.25" 1.2 MB or 3.5" 1.44 MB diskette drive.
- Dual diskette and hard disk drive controller.
- Enhanced 101-key keyboard.
- 1 parallel and 2 serial ports.
- 200-watt power supply.
- 8 expansion slots.

### Options:

- 1 MB RAM upgrade kit.
- 20 MHz Intel 80387 math coprocessor.
- 2 MB or 8 MB memory expansion boards.

\*Lease for as low as \$148/Month.

System 310	With Monitor & Adapter			
	Hard Disk Drives	VGA Mono	VGA Color	VGA Color Plus
40 MB - 28 ms	\$4,099	\$4,299	\$4,399	
90 MB - 18 ms ESDI	\$4,899	\$5,099	\$5,199	
150 MB - 18 ms ESDI	\$5,399	\$5,599	\$5,699	
322 MB - 18 ms ESDI	\$7,399	\$7,599	\$7,699	

## THE NEW 20 MHz 286 SYSTEM 220.

As fast as most 386 computers, at less than half the price—more power for the money than any other system. An 80286 system that runs at 20 MHz, with less than one wait state. Completely compatible for both MS-DOS<sup>®</sup> and MS<sup>®</sup> OS/2 applications (it runs faster than IBM PS/2 Model 80), and with a remarkably small footprint, the System 220 is the ideal executive workstation. The system uses page mode interleaved memory resulting in a performance increase of about 15 percent.

### Standard Features:

- 80286 microprocessor running at 20 MHz.
- 1 MB of RAM expandable to 16 MB (8 MB on system board).
- Integrated diskette and VGA video controller on system board.
- One 3.5" 1.44 MB diskette drive.
- Integrated high performance hard disk interface on system board.
- Enhanced 101-key keyboard.
- 1 parallel and 2 serial ports.
- LIM 4.0 support for memory over 1 MB.
- Real-time clock.
- Three full-sized AT<sup>†</sup> compatible expansion slots.
- Socket for 80287 coprocessor.

### Options:

- 3.5" 1.44 MB diskette drive.
- Intel 80287 coprocessor.
- 1 MB RAM upgrade kit.

\*Lease for as low as \$85/Month.

System 220	With Monitor		
	VGA Mono	VGA Color	VGA Color Plus
One Diskette Drive	\$2,299	\$2,499	\$2,599
40 MB - 29 ms Hard Disk	\$2,999	\$3,199	\$3,299
100 MB - 29 ms Hard Disk	\$3,799	\$3,999	\$4,099

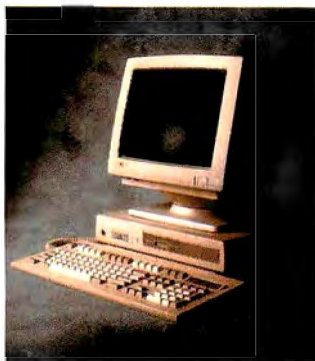
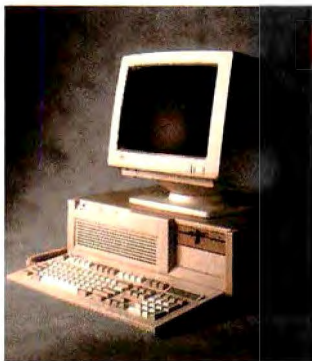

# THE 12.5 MHz SYSTEM 200.

A great value in a full-featured AT compatible. An 80286 computer running at 12.5 MHz, this computer is completely MS-DOS and MS OS/2 compatible. The System 200 offers high speed drive options, industry standard compatible BIOS and on-site service. As Executive Computing said of this computer's predecessor, "If faster processing speed and low cost are two key issues affecting your purchase decision, this machine might be the ideal choice for your office."

#### Standard Features:

- Intel 80286 microprocessor running at 12.5 MHz.
- 640 KB of RAM expandable to 16 MB (4.6 MB on system board).
- 5.25" 1.2 MB or 3.5" 1.44 MB diskette drive.
- Dual diskette and hard disk drive controller.
- Enhanced 101-key keyboard.
- 1 parallel and 2 serial ports.
- 200 watt power supply.
- Real-time clock.
- 6 expansion slots. (4 available with hard disk drive controller and video adapter installed).
- Socket for 8 MHz 80287 coprocessor.

#### Options:

- 512 KB RAM upgrade kit.
  - 8 MHz Intel 80287 coprocessor.
- \*Lease for as low as \$78/Month.*

System 200 Hard Disk Drive	With Monitor & Adapter			
	Mono	VGA Mono	VGA Color	VGA Color Plus
20 MB	\$2,099	\$2,299	\$2,499	\$2,599
40 MB - 40 ms	\$2,299	\$2,499	\$2,699	\$2,799
40 MB - 28 ms	\$2,499	\$2,699	\$2,899	\$2,999
90 MB - 18 ms ESDI	\$3,299	\$3,499	\$3,699	\$3,799
150 MB - 18 ms ESDI	\$3,799	\$3,999	\$4,199	\$4,299
322 MB - 18 ms ESDI	\$5,799	\$5,999	\$6,199	\$6,299



# A Full Line Of Computers With A Full Line Of Configurations.

At Dell, we understand that different users have different needs. So we tailor each system to the user's individual requirements.

We offer monitors, graphics boards, tape backups, dot matrix and laser printers, hard disk and diskette drives, expanded memory boards, serial mice and more.

We also offer third party software applications for virtually

every business application including: accounting, communications, desktop publishing, graphics, word processing, integrated applications and user training.

So when your Dell System arrives, you can do productive work the minute you unpack the box.

We can build you the system you've been looking for.

### COMMON TO THE SYSTEM 310, SYSTEM 220 AND SYSTEM 200:

The Dell System Analyzer. MS-DOS and OS/2 compatible. Security lock with locking chassis. 12 month on-site service contract (Available on complete systems).

**PRINTERS/SOFTWARE.** *We offer a full-line of printers and popular software. All printers come with our 30-day money-back guarantee and one year warranty.*

### LASER PRINTERS.

LASER SYSTEM 150; \$5,995.  
15 pages per minute, text and full-page graphics.  
Dual 250 sheet-input trays.

LASER SYSTEM 80; \$3,295.  
8 pages per minute, text and full-page graphics.

LASER SYSTEM 60; \$2,195.  
6 pages per minute, text and full-page graphics.

### DOT MATRIX PRINTERS.

PRINTER SYSTEM 800;  
\$699.95.  
Highest resolution text and graphics from a 24-wire dot matrix printer.  
Draft quality at 200 cps.  
Correspondence quality at 132 cps.  
Letter quality at 66 cps.  
Standard parallel and serial interfaces.  
Wide carriage.

PRINTER SYSTEM 600;  
\$499.95.  
9-wire dot matrix.  
Draft quality at 240 cps.  
Near-letter quality at 60 cps.  
Standard parallel interface.  
Wide carriage.

PRINTER SYSTEM 300;  
\$199.95.  
9-wire dot matrix.  
Draft quality at 144 cps.  
Near-letter quality at 36 cps.  
Four standard fonts.  
Paper parking.  
Standard parallel interface.

### SOFTWARE.

Operating System Software.  
Dell Enhanced MS-DOS 3.3 with disk cache and other utilities; \$119.95.  
Dell Enhanced MS OS/2 Standard Edition 1.0 \$324.95.



# TO ORDER, CALL 800-426-5150 IN THE U.S. AND CANADA

All prices and specifications are subject to change without notice. Please inquire for current details. Dell cannot be responsible for errors in typography or photography. In Canada, leasing is not currently available and configurations and prices may vary. Microsoft® MS® and MS-DOS® are owned by Microsoft Corp. †Signifies registered or unregistered trademarks owned by entities other than Dell Computer Corporation. \*Payments based on a 36-month open-end lease. Please inquire for further details.  
© 1988 DELL COMPUTER CORPORATION.

AD CODE NO. 11EH8



The BYTE Lab  
tests communications  
programs that can  
go to work  
when you go home

---

Steve Apiki and Stan Diehl

Carbon Copy Plus

Crosstalk Mk.4

Crosstalk XVI

HyperACCESS

Instant Terminal

MaxOnline

Mirror II

Move-It

PC BLAST II

Procomm Plus

Relay Silver

Smartcom III

Softterm PC

# Communications

If you were stranded on an island with a bottle of aspirin, a personal computer, and a modem, what communications package would you most like to have along? Make the wrong decision and you're likely to need the aspirin. Finding software that lets you use your modem may be easy, but the package with the speed, automation, and flexibility to let you make the most of your system is a rare find indeed.

Data communications is often the same procedure from day to day. But say you just got a new 19,200-bit-per-second modem and you need to find a package that can handle it. You may want something that can run in the background without a multitasking operating system. Or maybe you're just tired of running through the same log-on procedure by hand, over and over again. The best thing about new software is the performance increase you can get for a relatively small amount of money.

The subjects of this month's product focus are MS-DOS-based, stand-alone communications software packages that have a script language—a feature that can relieve you of hours of tedium and hours of connect time. Generally, a script language lets you program your system to handle a communications session unattended. Programmed with a sophisticated script, your computer can recognize prompts from the host systems and act accordingly—say, sending queries or transferring files.

The packages we reviewed vary, however, in their ability to save you from sinking that saved time back into learning a cumbersome script language or a difficult command sequence. They also range in maximum transfer speeds from 2400 to 115,200 bps, and in price from about \$70 to about \$250—but you don't always get what you pay for.

System requirements are generally the same: Most run under DOS 2.0 on a single 3½-inch or 5¼-inch floppy disk drive and in 192K bytes of RAM. All the

packages let you use BIX, CompuServe, or other information services, and they let you upload and download files from your company's mainframe. However, many of them will perform at their top transfer rate only when they're talking to a computer running the same software. We'll highlight differing requirements in the individual sections that follow (also see table 1).

## Carbon Copy Plus 5.0

Meridian Technology's Carbon Copy Plus 5.0 is a good example of a package that is strong overall and provides unique features for specialized needs. It requires an unusually large (256K-byte) section of memory, but it exchanges code size for speed by loading its configuration program directly into memory. It includes 224 pages of documentation.

Carbon Copy is more than a utility for communicating with mainframes—it's also a remote PC control package. Because of this, it is broken down into two executable programs, CC for the host and CHELP for the remote side. The remote user can access host command files to read or write, control the host's graphics screen, and send output to the host's printer. Disk access is made possible through CCDOS, a DOS look-alike that gives host file control to the remote user through an almost transparent additional program layer. For example, CHELP is able to specify the host's drive C by entering HC:. Actual file transfers are accomplished with a simple COPY command and are conducted using Carbon Copy's own error-checking protocol.

The host can limit file access by disabling CCDOS. As an added security measure, the host can dial a preset callback number upon receipt of a valid password from an inquiring computer. CC can also be run in a resident (background) mode so the host user can continue to run applications while file transfers are taking place.

*continued*

# According to Script

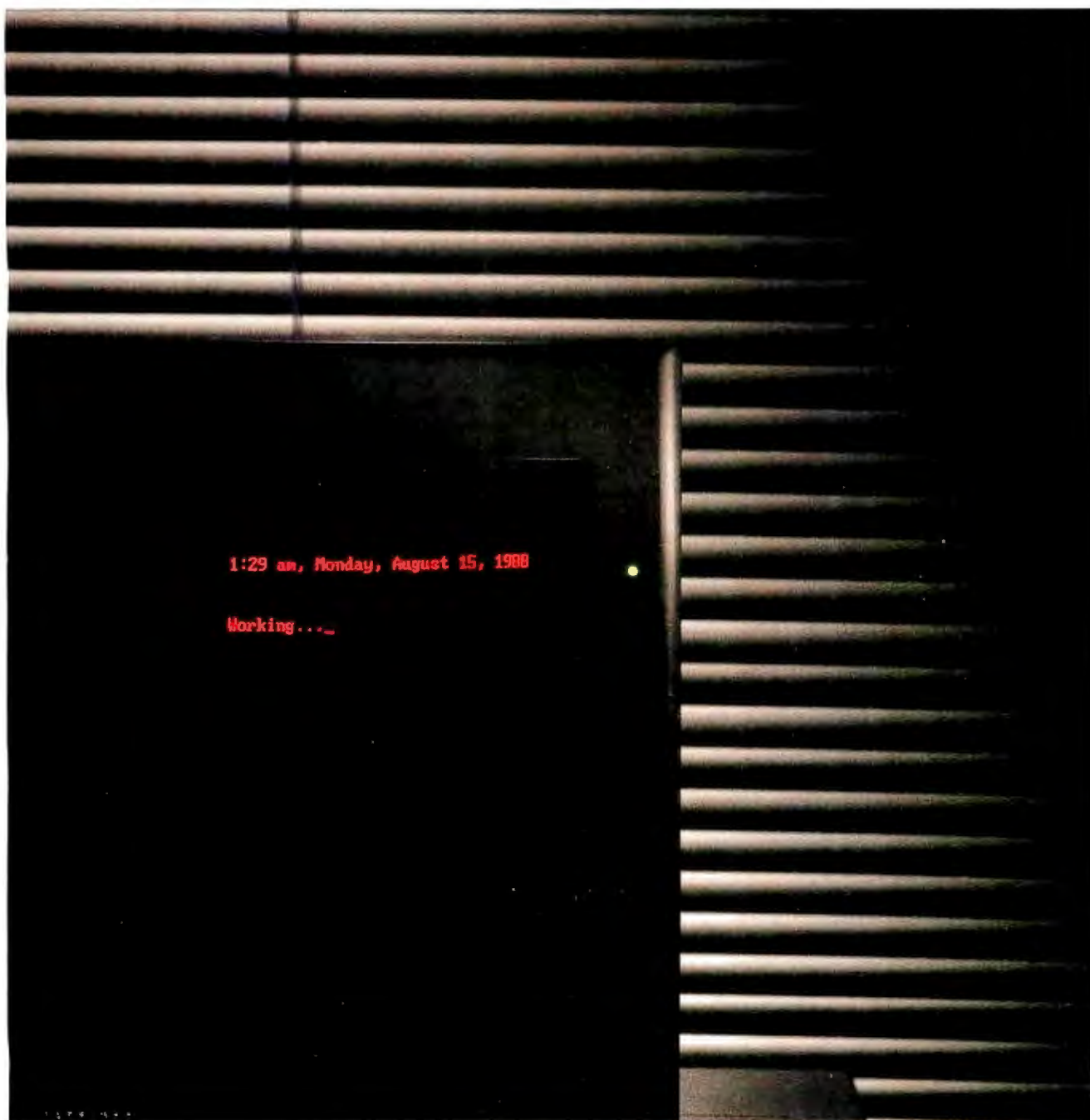

**Table 1: Features and price are unrelated in the packages we tested (● = yes; ○ = no).**

Package name	Price	Copy-protected <sup>2</sup>	Documentation	Minimum RAM (bytes)	Maximum data transfer rate (bps)	Learn mode	Text editor	Background operation
Carbon Copy Plus 5.0	\$195	●	224 pages	256K	38,400	○	○	●
Crosstalk Mk.4 1.01	\$245	○	424 pages	256K	115,200	●	●	○
Crosstalk XVI 3.61	\$195	○	199 pages	96K	115,200	○	○	○
HyperACCESS 3.28	\$149	●	232 pages	192K	57,600	○	○	○
Instant Terminal 1.1	\$ 95	○	71 pages	192K	19,200	○	○	○
MaxOnline 2.4	\$ 70	○	222 pages	256K	19,200	●	○	○
Mirror II 3.6.12	\$ 70	○	368 pages	192K	115,200	●	○	●
Move-It 4.02	\$150	○	155 pages	128K	19,200	○	○	○
PC BLAST II	\$250	○	322 pages	256K	38,400	○	●	○
Procomm Plus 1.1A	\$ 75	○	340 pages	192K	115,200	●	●	○
Relay Silver 1.0 <sup>1</sup>	\$150	○	591 pages	192K	19,200	●	●	●
Smartcom III 1.08	\$249	○	218 pages	512K	115,200	●	●	●
Softterm PC 3.0	\$195	○	728 pages	256K	115,200	●	●	●

<sup>1</sup> Requires two floppy disk drives.

<sup>2</sup> Disks can be copied, but duplicates will not work together.

All this host mode power doesn't come at the expense of terminal-emulation capability. Carbon Copy can hold its own against dedicated mainframe links, with transfer speed that puts it right up with Crosstalk Mk.4, support for the most common transfer protocols, and emulation support for five popular terminals.

The terminal commands are clear and efficient, mostly Alt-key combinations. In fact, Carbon Copy was the best at our manual keystroke benchmark, and, though the commands are short, they are by no means cryptic. The compilable script language is similarly tight, although it does not contain the advanced decision-making structures of some packages.

If you're interested primarily in MS-DOS-based communications and need a package that will enable very intimate data sharing over the telephone, then this may be the one you're looking for. Keep in mind, however, that all the specialized features require at least two copies (one for the host and one for the remote terminal) at nearly \$200 apiece.

#### Crosstalk Mk.4 version 1.01

A real communications software Cadillac, Crosstalk Mk.4 version 1.01 from Digital Communications Associates (DCA) is a hefty package that requires two 360K-byte floppy disk drives and the assimilation of a 424-page user's manual. It includes a comprehensive script language and a top-drawer price of \$245. The list of terminals it can emulate is as long as your arm (see table 2); you can

edit text with a built-in editor; and, in addition to supporting every major file-transfer protocol, it introduces one of its own, called DART.

DART is essentially an upgrade of the older Crosstalk protocol, with new features that include crash recovery and time and date stamping. Crash recovery enables file transfers to continue after an error is corrected, appending new data onto that already sent.

If, despite all the protocol options available, you still must do an ASCII transfer, you won't have to worry about speed. With a rate of 115,200 bps supported and the ability to send and receive with only limited line waits, Crosstalk turned in an excellent time on our file-transfer benchmark.

The command mode is built on the Crosstalk system of loading command modules for making preset calls. The modules can contain connection settings, protocols, and terminal emulations. This system is relatively easy to use once you get familiar with it, although keeping track of all the two-letter commands often requires hunting through the manual. Crosstalk Mk.4 had an average showing on our keystroke benchmark; it suffered from the need to send an attention signal before any commands.

Most outstanding of all its features is its CASL script language. CASL uses multiple decision loops, has specialized disk-access commands, and can create much more than script files. Because of its command specialization and its size (over half the manual is dedicated to CASL commands), writing simple

scripts like our script benchmark can be difficult for those unfamiliar with the language. Fortunately, Crosstalk Mk.4 provides a learn script that lets you record a session into a script file that can simply be edited. With the learn script, what would have taken nearly 500 keystrokes to program by hand was reduced to the 197 indicated in table 3.

Although Crosstalk Mk.4 is a very powerful package, its price puts it in a range (shared by Smartcom III, as discussed later) reserved for only those in real need of its most advanced features.

#### Crosstalk XVI 3.61

Crosstalk XVI, though the standard by which other communications packages are measured, falls short of the mark itself in our tests. Version 3.61 requires only 96K bytes of RAM and costs \$195.

The software emulates nine popular terminals, but it supports fewer protocols and is more difficult to learn than most modern packages. The common way to run command mode is to load command files containing directory information. You can supplement this by following script menus or by entering two-letter commands. As with Crosstalk Mk.4, the process takes some getting used to but can be efficient once you are familiar with the language. There is a status table that you can access with a single key to find your connect options; however, finding the table with less commonly used information (like the modem commands) can take several commands. The system had an average score on our

*continued*

# You can rely on your file server for LAN communications...



## All you need is patience. And faith.

**Y**ou're getting the drift of this message already. File servers aren't designed to solve the PC user's communications problem. But now there's a system that is.

### **Now there's COMMIX™ 32.**

It's a general purpose local area network for PCs and minicomputer hosts. It connects you with the host, other PCs, and peripherals such as printers, plotters, or modems through simple, pop-up menu commands.

For file transfer and E-mail as a background task. For printer spooling and sharing directly from your applications programs. For terminal emulation that's automatic. COMMIX 32 will let anyone perform common LAN tasks—without the need for expert assistance.

### **Install it quickly. Expand it easily.**

Almost any PC user can install and connect with COMMIX. With each connection, you're saving time and money. Because each COMMIX connection costs as little as \$125.

Then take advantage of expansion possibilities. With our optional Ethernet® Link Module, you can create larger LANs with thousands of users. And through our optional Wide Area Network Module, distant COMMIX LANs can appear as one network.

### **If you're lost at sea.**

And looking for solid LAN. The COMMIX 32 is available now. Send us a message: ITRON, a Division of Infotron Systems Corporation, 130 Gaither Drive, Suite 116, Mount Laurel, NJ 08054.

TEL: (609) 722-5575 FAX: (609) 234-0451

**1-800-423-8044**



COMMIX is a trademark of Infotron Corporation. Ethernet is a registered trademark of Xerox Corporation.

Table 2: You should check a package carefully to make sure it supports the protocols and emulations you need (● = yes; ○ = no).

Package name	Protocols																		
	CrossTalk	CompuServeB	Hayes	IMODEM	Kermit	Proprietary	SuperKermit	SeaLink	Telink	WXMODEM	XMODEM	XMODEM1	XMODEMbatch	XMODEMw/CRC	YMODEM	YMODEMG	ADDS Viewpoint	AMPEX D80	ANSI TTY
Carbon Copy Plus 5.0	○	○	○	○	●	●	○	○	○	○	●	○	●	●	○	○	○	○	●
Crosstalk Mk.4 1.01	●	●	○	○	○	○	○	○	○	○	○	○	○	○	○	○	○	○	○
Crosstalk XVI 3.61	●	○	○	○	○	○	○	○	○	○	○	○	○	○	○	○	○	○	○
HyperACCESS 3.28	○	○	○	○	○	○	○	○	○	○	○	○	○	○	○	○	○	○	○
Instant Terminal 1.14	○	●	○	○	○	○	○	○	○	○	○	○	○	○	○	○	○	○	○
MaxOnline 2.4	○	○	○	○	○	○	○	○	○	○	○	○	○	○	○	○	○	○	○
Mirror II 3.6.12	●	○	●	○	○	○	○	○	○	○	○	○	○	○	○	○	○	○	○
Move-It 4.02	○	○	○	○	○	○	○	○	○	○	○	○	○	○	○	○	○	○	○
PC BLAST II	○	○	○	○	○	○	○	○	○	○	○	○	○	○	○	○	○	○	○
Procomm Plus 1.1A	○	●	○	○	○	○	○	○	○	○	○	○	○	○	○	○	○	○	○
Relay Silver 1.0	○	○	○	○	○	○	○	○	○	○	○	○	○	○	○	○	○	○	○
Smartcom III 1.08	○	○	○	○	○	○	○	○	○	○	○	○	○	○	○	○	○	○	○
Softerm PC 3.0 <sup>5</sup>	●	○	●	○	○	○	○	○	○	○	○	○	○	○	○	○	○	○	○

<sup>1</sup> Character mode only.  
<sup>2</sup> Requires additional hardware (e.g., IRMA and SmartAlec).  
<sup>3</sup> Requires 7171 protocol converter or equivalent.  
<sup>4</sup> DEC emulators included; 40 others available at additional cost.  
<sup>5</sup> Supports 33 additional terminals not listed here.

manual keystroke test.

Writing a script file is simply a matter of listing commands, and there are no shortcuts except for abbreviated command strings. Decision loops based on received strings must be implemented using the when construct—a technique that can lead to errors with unexpected input.

Only the XMODEM error-checking protocol is supported in addition to Crosstalk's own. Data transfer rates are supported to 115,200 bps, but our ASCII transfer test shows the severe performance hits that you get when flow-control characters and character waits are necessary for error-free transmission. Crosstalk XVI was one of the few packages we tested that took longer to send a file to a faster machine than to receive it—a clear indication of high software overhead.

Overall, Crosstalk XVI is an average package at an above-average price. Crosstalk look-alike programs are easy to come by, but many of them have added features and flexibility that Crosstalk has not.

### HyperACCESS 3.28

Hilgraeve's HyperACCESS is a versatile communications package with solid file-transfer ability and unique features that

make it useful for widely varying applications. Version 3.28 sells for \$149.

HyperACCESS supports XMODEM, Kermit, and its own Hyper protocol. Despite its moderate maximum transfer rate, HyperACCESS compared favorably to higher-rated packages in our throughput tests, with low overhead and flawless XON/XOFF synching. The software features optional data compression capability for both XMODEM and the Hyper protocol.

But speed is not HyperACCESS's only asset. It also has a powerful host mode that allows remote control over DOS and DOS programs. Remote user access can be limited to read only, DOS only, or one program only.

One weakness in an otherwise good package is its use of a menu-driven command mode. Although the manual keystroke score was average, the commands involve constant flipping through layers of menus. Transferring files is especially taxing.

HyperACCESS features Hyper Pilot, a compilable script language that lets you check for syntax errors before you're actually on-line. Unfortunately, the script language itself does not allow many shortcuts, and it fared poorly on the programming keystroke test. In addition, if you're used to other software's

script languages, which are all similar, you'll find that learning Hyper Pilot requires some adjustments.

### Instant Terminal 1.1

Take our advice: When the Instant Terminal manual mentions that a little file on the supplemental disk is intended only for a "computer engineer, technician, or programmer," don't listen. Print the file. Using the sparse 55-page reference manual that came with the package, we assumed Instant Terminal was a cheap Procomm clone. In fact, the sign-on screen tells you that Datastorm Technologies, the Procomm people, licensed the software to Softronics. But with a little digging, we found a full scripting language and features that are only hinted at in the published documentation.

Instant Terminal even ran a Procomm script, including GOSUBS and conditionals, without an edit or a hitch. Still, it's not a full implementation, the most notable omission being a learn facility.

One other problem with the "cheap Procomm clone" assumption: Procomm costs less. With a single emulation, Instant Terminal will run you \$95.

As the name suggests, Instant Terminal touts its terminal-emulation features. Our review copy included a software module and documentation supplement



Terminals Emulated																								
AT&T 513	DEC VT-52	DEC VT-100	DEC VT-102	DEC VT-220	DG D210	DG D211	Esprit III	Heath/Zenith 19	HP 2392A	IBM 3101	IBM 3270	IBM 3278	IBM 5250	Lear-Siegler ADM-3A	TI 940	TVI 910	TVI 912	TVI 920	TVI 925	TVI 950	VIDTEX	Wang VS210	WYSE 100	
○	●	●	○	○	○	○	○	○	○	● <sup>1</sup>	○	○	○	○	○	○	○	○	○	○	○	○	○	
●	●	●	●	●	○	○	○	○	○	●	○	○	○	○	○	○	○	○	○	○	○	○	○	
○	●	●	○	○	○	○	○	○	○	○	○	○	○	○	○	○	○	○	○	○	○	○	○	
○	●	●	○	○	○	○	○	○	○	○	○	○	○	○	○	○	○	○	○	○	○	○	○	
○	●	●	○	○	○	○	○	○	○	○	○	○	○	○	○	○	○	○	○	○	○	○	○	
○	○	○	○	○	○	○	○	○	○	○	○	○	○	○	○	○	○	○	○	○	○	○	○	
○	○	○	○	○	○	○	○	○	○	○	○	○	○	○	○	○	○	○	○	○	○	○	○	
○	○	○	○	○	○	○	○	○	○	○	○	○	○	○	○	○	○	○	○	○	○	○	○	
○	○	○	○	○	○	○	○	○	○	○	○	○	○	○	○	○	○	○	○	○	○	○	○	
○	○	○	○	○	○	○	○	○	○	○	○	○	○	○	○	○	○	○	○	○	○	○	○	
○	○	○	○	○	○	○	○	○	○	○	○	○	○	○	○	○	○	○	○	○	○	○	○	
○	○	○	○	○	○	○	○	○	○	○	○	○	○	○	○	○	○	○	○	○	○	○	○	
○	○	○	○	○	○	○	○	○	○	○	○	○	○	○	○	○	○	○	○	○	○	○	○	
○	○	○	○	○	○	○	○	○	○	○	○	○	○	○	○	○	○	○	○	○	○	○	○	
○	○	○	○	○	○	○	○	○	○	○	○	○	○	○	○	○	○	○	○	○	○	○	○	
○	○	○	○	○	○	○	○	○	○	○	○	○	○	○	○	○	○	○	○	○	○	○	○	
○	○	○	○	○	○	○	○	○	○	○	○	○	○	○	○	○	○	○	○	○	○	○	○	
○	○	○	○	○	○	○	○	○	○	○	○	○	○	○	○	○	○	○	○	○	○	○	○	
○	○	○	○	○	○	○	○	○	○	○	○	○	○	○	○	○	○	○	○	○	○	○	○	

**Table 3:** The packages varied widely in ease of programming and throughput. (All times are in seconds.)

Package	Keystrokes to create BIX script	Keystrokes for manual BIX session	1-megabyte send at highest bps	1-megabyte receive at highest bps	Perfect-line 1200-bps send	Perfect-line 1200-bps receive	Typical-line 1200-bps send	Typical-line 1200-bps receive
Carbon Copy Plus	286	19	310	722	590	588	592	589
Crosstalk Mk.4	197	26	318	770	595	592	589	591
Crosstalk XVI	237	24	873	618	592	591	588	589
HyperACCESS	479	26	296	770	589	592	593	597
Instant Terminal	343	19	885	884	596	597	596	595
MaxOnline	158	26	579	549	619	597	606	598
Mirror II	117	25	475	926	594	598	597	597
Move-It	145	44	1653	1660	589	590	587	593
PC BLASTII	419	38	435	1259	596	592	600	594
Procomm Plus	142	22	452	542	587	587	590	588
Relay Silver	117	30	740	656	593	592	594	595
Smartcom III	162	23	98	262	582	584	587	585
Softerm PC	195	33	950	954	667	665	655	661

for DEC VT-220 emulation. An order form enclosed with the package lists 40 additional emulator modules. Although most of the telecommunications packages reviewed here include a variety of common emulations, documentation was almost invariably poor. Instant Terminal fills this gap. So if you need to emulate an obscure terminal, or if you have a spe-

cific application on only one or two terminals, look into Instant Terminal. However, if you access multiple hosts, take note: The first emulation goes for \$15; after that, they're \$50 a shot.

**MaxOnline 2.4**

Though sometimes bogged down by multiple menus, this \$70 package offers

abundant features for its price. The menus are well designed, making MaxOnline a very easy package to use, especially for novices. The operations you need most show up on the first screen. And if anything's missing, you can add new functions by editing USER.MNU.

MaxOnline reaches a maximum data

*continued*

# “Give me one good reason to give up C.”

## “How about 43?”

**Modula-2 saves more time and money than any other programming environment.**

1. High-level language
2. Readable, maintainable code
3. Ideal for team programming
4. Supports multi-tasking
5. Emerging international standard
6. Pascal or C programmers learn it in hours
7. Language for modern engineering
8. Consistency checks across modules
9. User control over exported/imported objects
10. Traps most programming errors
11. Fewer bugs in final code
12. Easy low-level access

**The LOGITECH Modula-2 programming environment goes far beyond the language.**

13. Faster project throughput
14. Corporations rely on it
15. Adds a rich set of tools to the language
16. Best debuggers for any language
17. Configurable, easy-to-use text editor
18. Integrated environment
19. Powerful windowing interface
20. Compiles twice as fast as MS-C
21. Code as fast as the best C compilers
22. Mature and reliable
23. Extended library
24. Standard object format
25. C libraries can be used
26. Supports EGA 43-line mode
27. Automatic MAKE
28. Flexible overlays
29. Price/performance leader

transfer rate of only 19,200 bps, but it scored credibly on our benchmarks, timing under 10 minutes on both 1-megabyte transfers. Adequate scripting and a functional learn mode combine for easy automation, while the 222 pages of documentation include plenty of instructive programming routines and command examples. The distribution disk also contains demonstration scripts.

MaxOnline touts a windowing feature that supports simultaneous file transfer from two COMM ports. It falls short of true background mode, but it can speed up extensive file-transfer tasks. While one window downloads from a remote host, the other port can process files over a direct line. You can customize each window and easily jump back and forth. Remote operation excels for a program in this price category. Simple commands set passwords, restrict log-ons to specific users, allow varying levels of access, and trigger an interactive chat mode. Easy file management is also available.

The compact scripting language handles most basic commands. It would not, however, support an IF WAITFOR statement, counting instead on a time-out error to break from the mail loop. Parameters are easy to change, with an overview screen and menus available for most entries. MaxOnline illustrates how far communications software has come: A little money buys a professional package with plenty of power.

### Mirror II 3.6.12

Being accustomed to a given command system and script language may be your only reason for sticking with an otherwise weak communications product. SoftKlone's Mirror II 3.6.12 solves that problem by letting you use the familiar Crosstalk system while adding a learn command, background mode, text editor, strong terminal emulation, and some friendly screen displays. All this, including 368 pages of clear documentation, will run you a mere \$70.

Although the command structure is virtually identical to Crosstalk's and is not any easier to learn, Mirror II's screen displays present your connect information clearly and let you scroll through all the parameters you have set. It performed at Crosstalk's level in the manual keystroke test, the only difference being an added stroke to get past the initial screen display without waiting it out.

Running Mirror II in the background is easy, requiring only a hot-key toggle to switch between itself and another application. It can handle the difficult task of simultaneously receiving a file and

doing disk-intensive operations with only about a 5 percent performance hit, and without errors. Be warned that Mirror's 192K bytes plus your operating system take up a big chunk of a 640K-byte memory, and you may be severely limited as to the other applications you can run.

If you're not used to the Crosstalk script language, there is a learn facility to help get you started. Using it enabled us to cut the programming keystrokes down to an excellent 117, including editing. Mirror adds the ability to access a command completion register to the standard Crosstalk command set, which makes possible decision loops based on 22 separate conditions.

The software supports all common protocols, including Crosstalk. It scored very well in our ASCII send test, but lower than average on our ASCII receive. In this case, the flow control necessary to properly send the file from the Compaq 386/20 to the AT at 115,200 bps was unusually sluggish.

Mirror II is a very good, strong, and flexible package for less than half the price of Crosstalk. Those comfortable with the Crosstalk command file format may well find a new favorite here.

### Move-It 4.02

When you boot up Move-It, all you get back is an asterisk. After delving through so many programs with reams of overlapping menus and multiple keystrokes for one simple command, that lonely command prompt was refreshing. Of course, you have to rely on the 155 pages of documentation—without an index—and a few help screens to get you through the learning phase. The stark screen display disguises a powerful program with a full scripting language.

Though simple in concept, the program's price tag (\$150) puts it in a class where it must match the performance of some tough competition. Unfortunately, it lacks the basic features required to meet that goal. Take the phone book, for example: It is a raw ASCII file, where each line contains an entry, and a comma separates each argument of an entry (e.g., phone number, data transfer rate, and parity). Again, the simplicity appealed to us, but for the price of this package, you should not have to exit the program and run up a word processor each time you add a phone entry. And during XMODEM transfers, you should get more of a status update than just a row of dots across the screen.

Move-It's elegant scripting almost makes up for the lack of a learn facility. Even without automatic generation of

code, it took only 145 keystrokes to program the full BIX session. Move-It handles the BIX mail loop with typical efficiency. It first looks for the read/action prompt (meaning mail is in the box), then jumps to one label if the prompt is encountered, or to another label if it is not; thus:

MA read/action:

```
JU no_more_mail FALSE
JU more_mail
```

Unlike many of the programs we reviewed, you don't have to wait for a timeout to fall through the mail loop. This structure not only produces efficient code but also handles a variety of complex chores.

Still, when the program drifts away (an affliction all too common during telecomputing), you start to miss the menus and status prompts so common in the other packages. And this program drifts off more than others. It hung when it couldn't detect a dial tone, it hung when connected to a Hayes-compatible modem it didn't think was compatible enough, and it even hung when an invalid data transfer rate was entered. There's nothing more infuriating than a hung program that stares back at you with only that lonely asterisk.

## PC BLAST II

In a category with Smartcom III and Crosstalk Mk.4, the \$250 PC BLAST II faces some brutal competition. Even with 300-plus pages of documentation and some powerful features, it just doesn't achieve top-of-the-line status. The manual lacks coherent organization, and the sparse index skips the first two sections. BLAST scripts handle complex chores, but they run erratically—a fatal flaw when automating on-line procedures. BLAST also comes up short on maximum data transfer rate (38,400 bps) and number of protocols supported (only XMODEM and the functional, though nonstandard, BLAST protocol).

BLAST reverts to some cryptic scripting language. Unfortunately, the documentation covering the command structure doesn't help much. While most programs use the Wait For standard to await specific prompts, BLAST uses a TTRAP command. Still, even after employing numerous traps and delays, BLAST insisted on flooding BIX with a burst of commands. Although BIX handled it, some services won't. For protocol transfers, you've got to access the on-line menu and then send local keystrokes to automate the menu selections. This in-

efficient method invites trouble. The TUPLOAD and TCAPTURE commands support only text transfer. On top of that, BLAST lacks a learn facility.

The setup file enhances automation by triggering script files and loading variables such as @logfile and @password, but this doesn't make up for the inefficiencies. A keystroke count exposes the problem: The manual session took 38 keystrokes to complete, while the command script required 419. For the price BLAST demands, it should be doing more of your work. Other programs in BLAST's price category deliver elegant scripting, full features, and smooth operation—an enviable standard, and one that BLAST simply does not meet.

## Procomm Plus 1.1A

Procomm Plus offers the best of both worlds: cheap yet powerful, easy to use yet rich with features. At first glance, it appears plain enough for public domain, and yet it supports almost any telecomputing application: 11 standard protocols, 14 terminal emulations, every common configuration up to 115,200 bps, host mode, split-screen chat mode, an automated phone book, macros, and a surprisingly powerful script language. In the old price (\$75) versus performance ratio, Procomm leads the field.

Procomm employs the familiar PC-Talk key sequences to get the job done. The key combinations are, for the most part, logical; and for those that aren't, one keystroke calls a comprehensive overview screen. The 340-page manual, well-organized and indexed, does not leave you ripping out pages with one hand and hair with the other. Page references at the beginning of each chapter supplement a detailed table of contents and a complete index.

Although some compatibility quirks are to be expected in the world of telecommunications programs, Procomm did better than some. A few of the packages could not handle the POPCOM modem, a purported Hayes compatible, but Procomm had no trouble with it at all. Another Hayes compatible incessantly reported Carrier Detect High, and most of the programs had problems with this. Some dealt with it on boot-up by flashing a warning or initiating a reset. Some even dropped into terminal mode, fully on-line, refusing to believe that no one was home. Procomm Plus simply ignored it. Perhaps this exposes a lack of sophistication, but it can be a blessing. Telecomputing causes enough headaches without your program getting picky.

*continued*

## Announcing Modula OS/2. The operating system finally catches up with the language.

30. Support for dual mode operations
31. Dynamic link libraries
32. For standard/extended version of OS/2
33. Multiple threads
34. Virtually unlimited program size
35. Makes mixing languages easy
36. Most powerful editor under OS/2
37. Background compilation while editing
38. Run-time checks
39. Stack checks even in threads
40. OS/2 uses Modula-2 parameter passing mechanism
41. Upgrade available for Modula-2 DOS users
42. Direct Hotline and free Bulletin Board support for all Modula-2 products

## 43. It's affordable!

Call toll-free:  
800-231-7717  
In California:  
800-552-8885

### Please send me:

- |   |            |
|---|------------|
| <input type="checkbox"/> Modula-2 Compiler Pack (DOS)                                     | \$ 99.00   |
| <input type="checkbox"/> Modula-2 Toolkit (DOS)   | \$ 169.00  |
| <input type="checkbox"/> Modula-2 Development System (DOS, includes Compiler and Toolkit) | \$ 249.00  |
| <input type="checkbox"/> Modula OS/2  | \$ 349.00  |
| <input type="checkbox"/> Modula-2 VAX/VMS version   | \$2,500.00 |
| Shipping & Handling (per item)  | \$ 6.50    |
| CA residents add applicable sales tax   | \$ _____   |
| Total   | \$ _____   |
| <input type="checkbox"/> Check/money order included                                       |            |
| <input type="checkbox"/> Visa <input type="checkbox"/> MasterCard                         |            |

Card Number \_\_\_\_\_ Exp. Date \_\_\_\_\_

Cardholder Name \_\_\_\_\_

Authorized Signature \_\_\_\_\_

Ship to: \_\_\_\_\_

Name \_\_\_\_\_

Address \_\_\_\_\_

City \_\_\_\_\_ State \_\_\_\_\_

Zip \_\_\_\_\_ Phone \_\_\_\_\_

Offer valid in U.S. Only Dealer inquiries welcome. Educational prices available. BY888

Send to:

 **LOGITECH**

Logitech, Inc.  
Attn: Coupon Redemption Program  
6505 Kaiser Drive, Fremont, CA 94555

In Europe, contact:  
LOGITECH SA in Switzerland  
Tel: ++41 (0) 21-869-96-56  
In the United Kingdom, contact:  
LOGITECH UK  
Tel: ++44 (0) 525-22-22-11  
AUGUST 1988 • B Y T E 155

## The Tests

Our tests seek to evaluate communications software performance in two broad categories: throughput and ease of use. To this end, we devised benchmarks to pinpoint performance ability in eight separate areas.

The first is our manual keystroke test, where we record the number of keystrokes necessary to carry out a defined session on the BIX conferencing system. It provides a quantitative measure of the relative complexity of using the command mode. The session consists of logging on, filing and downloading mail, filing and downloading messages, and logging off. Keystrokes that are used for commands in terminal mode (i.e., commands for BIX's use only) are not counted. We made every effort to use keyboard shortcuts where these were available. The count begins on the first stroke after the program is started and ends when we have returned to DOS.

For our second test, we wrote a script language program to automate the same BIX session, and we determined the

keystrokes needed to enter and execute the script. Since BIX's mail subsystem requires that you file memos individually, and the amount of messages can vary from day to day, the program must have some kind of input-based decision structure to work properly.

We chose to use the language's best structure, not necessarily its most compact, for handling unexpected conditions. If abbreviated commands were possible, we used them. If the package had a learn facility, we counted only the keystrokes needed to use the learn mode and to edit the resulting script.

Throughput was measured using two data files (a 64K-byte file and a 1-megabyte file), transferred between a standard IBM PC AT and a Compaq Deskpro 386/20 under fixed conditions. The terms *send* and *receive* are always referenced to the AT. The 1-megabyte ASCII transfer test times the send and receive timings of one million *A* characters via a null modem connection and using no error checking. We pushed for the greatest error-free transfer rate we

could get, which is not merely a function of data transfer rate; it often meant adjusting flow control and line or character wait parameters. At 115,200 bps, we should see 1-megabyte transfer times of about 90 seconds (1 megabyte/(115200/10)), but typical times were more on the order of 10 minutes, which was the fastest transfer time the software (and the disks) could correctly handle.

To determine how the software reacted under everyday conditions, we measured the transfer rate of a 64K-byte data file at 1200 bps over two simulated phone lines. The first line, simulated by our modem testing equipment, was a "perfect" line, with virtually no noise and no line impairment. The connection was made using two 1200-bps Hayes-compatible modems. The second line simulated was a "typical" line, with typical noise, attenuation, and phase jitter. These parameters were determined by the preliminary draft of EIA-496, a specification for universal communication equipment tests.

As for the script language, Procomm boasts a complete command set: *if...then...else* looping, case structures, a Shell command for DOS operation, sub-routines, and advanced screen handling. This power does not come at the cost of simplicity. For instance, Procomm handled the BIX mail loop with ease:

```
WAITFOR "read/action" ;BIX prompt
                                ;when you have mail
IF WAITFOR      ;if you have mail,
  GOTO more_mail ;go get it
ENDIF
```

Sure, it looks obvious; but few packages handle the loop so easily. For all but the most complex programming projects, Procomm scripting will do the job. Only the lack of a true background mode dampens our endorsement. The Shell command allows you to escape to DOS while still on-line, but file transfers will not proceed until Procomm returns to the foreground.

Procomm meets a software designer's most stringent standard: Pack in the features, but keep the interface simple. It doesn't intimidate, but it can still handle complex applications. Above all, it strives for invisibility, flashing menus at you only when asked and remaining as

unobtrusive as possible. A noble achievement, and a goal all too often neglected.

### Relay Silver 1.0

Relay Silver 1.0 is a fully featured communications software package that requires 192K bytes of RAM and two floppy disk drives. It includes two manuals with over 500 pages of well-referenced documentation, and it sells for \$150. Relay Silver is weak in throughput, ease of commands, and terminal emulation, and the unusual extra features it adds are not enough to make up for these basic lacks.

Among the added features are a sophisticated background mode, a text editor, and a script language learn facility. The background mode allows Relay Silver to run as a true terminate-and-stay-resident (TSR) program, always accessible through a hot-key combination. Unfortunately, background file transfers were quite slow when running a disk-intensive application in the foreground.

ASCII transfers were quick enough, but hard to get going. At high speeds, the software occasionally locks when using XON/XOFF, apparently because the receiver doesn't catch all the data and never sends the next XON. For hard-wired connections, Relay Silver needs a null modem cable configuration that differs

from that of almost every other package.

The command mode is menu-driven beyond reason, and to accomplish any file transfers with the menu, you must edit an entire directory specification. A command entry mode of sorts is available through an attention key, but that handy bit of information is buried well within the documentation. Once you find it, you can enter script commands directly from the keyboard. Even with this shortcut, Relay Silver had a lower-than-average score on manual key counts.

On the plus side, Relay has a powerful script language and a good learn facility. Relay also finished with an excellent keystroke count in our programming test. The commands are simple and intuitive, and editing a learned script can take remarkably little effort. In addition, Relay includes an application program interface—software hooks that let you easily incorporate Relay scripts into your own programs. The manufacturer says a new release of Relay Silver with script enhancements and additional terminal emulations will be available this fall.

### Smartcom III 1.08

For elegant scripting, full features, and pure telecomputing power, you just can't

*continued*

# How to look good from start...

A paper shop  
Club

WINNERS



**Devco Parts  
PACIFIC**

For Sales Order  
No Order or  
Invoice to Print

Dear Sir:

Please refer to our catalog for information regarding our products. We are now offering a special discount on all products ordered in quantities of 10 or more. This offer is available only to customers who have placed an order with us in the past 12 months. To take advantage of this offer, please contact your account manager or call us at 1-800-835-8888. We will be happy to assist you.

Sincerely,  
R. Hubbard  
Regional Manager  
Sales Representative

**Bayless Parts Pacific  
Order Report**

For Month: 1988

Part Number	Description	April	May	June	Total	1987
1000-1	Piston	100	150	200	450	300
1000-2	Rod	50	75	100	225	150
1000-3	Crank	25	35	50	110	75
1000-4	Case	150	200	250	600	400
<b>Total</b>		325	460	600	1385	925

**Grand Total 1385 1988**

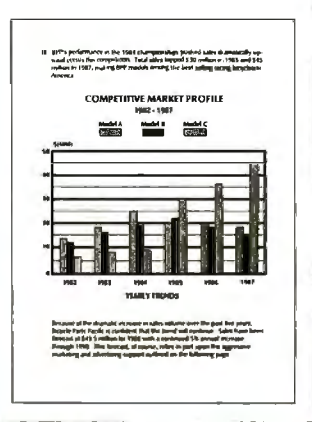

**RXC Brake System**

**PLEASE NOTE:** This system is designed to provide maximum braking power with minimum wear on the pads and discs. It is a significant advance in bicycle brake technology. The RXC Brake System is available in three models: the RXC 100, RXC 200, and RXC 300. Each model offers different adjustment options to suit your riding style.

**CONTACT US TODAY!**

800-835-8888

**Devco Parts  
PACIFIC**

**Mail Order Price Sheet**

**ORDERING INFORMATION**

To place your order, please call 1-800-835-8888 or write to Devco Parts Pacific, 10000 W. Highway 101, Suite 100, Portland, OR 97201. Payment may be made by check or money order. Delivery is available in the contiguous United States. Delivery charges apply to all other areas.

**CURRENT PRICES**

Part Number	Description	Price
1000-1	Piston	\$1.50
1000-2	Rod	\$0.75
1000-3	Crank	\$0.44
1000-4	Case	\$4.00
1000-5	Belt	\$1.00
1000-6	Chain	\$2.00
1000-7	Hub	\$5.00
1000-8	Rim	\$10.00
1000-9	Tire	\$5.00
1000-10	Wheel	\$15.00
1000-11	Fork	\$10.00
1000-12	Seat	\$5.00
1000-13	Handlebar	\$5.00
1000-14	Stem	\$2.00
1000-15	Headset	\$5.00
1000-16	Bottom Bracket	\$5.00
1000-17	Pedal	\$5.00
1000-18	Spoke	\$0.25
1000-19	Nipple	\$0.10
1000-20	Lock Washer	\$0.10

**PATH**

**CYCLIST JAN BELL  
BRINGS HOME  
THE GOLD**

In the 1988 Olympic Games of Seoul, South Korea, the Pacific Northwest Cycling Club's Jan Bell won the Gold medal in the Women's Time Trial. Bell's success was due to her dedication to training and her use of the RXC Brake System. The RXC Brake System provides maximum braking power with minimal wear on the pads and discs. It is a significant advance in bicycle brake technology. The RXC Brake System is available in three models: the RXC 100, RXC 200, and RXC 300. Each model offers different adjustment options to suit your riding style.

**DRAKE SYSTEM PULLS OUT ALL STOPS AT RPP CLASSIC.**

**TRIP CYCLING WITH THE RXC**

**PRODUCTS:** Bell Bottom, Pin Light, Drop Kick-Through, Spring Chainset, Bell, Sprockets, Pin Set, Chain, Shimano Derailleurs, Shimano Shifters, Shimano Cassette, Shimano Front Derailleur, Shimano Headset, Shimano Bottom Bracket, Shimano Pedals, Shimano Spokes, Shimano Nipples, Shimano Lock Washers, Shimano Headset, Shimano Bottom Bracket, Shimano Pedals, Shimano Spokes, Shimano Nipples, Shimano Lock Washers.

**FOR MORE INFORMATION, CONTACT:** Devco Parts Pacific, 10000 W. Highway 101, Suite 100, Portland, OR 97201. Phone: 1-800-835-8888.

## to finish.

### The HP LaserJet Series II Printer.



With additional memory you can even print sophisticated 300 DPI full-page graphics. And with HP's ScanJet scanner, you can also easily add photographs, illustrations and text.

Nothing brings your ideas to life like the HP LaserJet Series II Printer—from office memos to forms to newsletters. As the leading laser printer, it works with all popular PCs and PC software packages. And, with a wide range of fonts, you get more options to create superior looking documents.

No wonder more people choose the original over all other laser printers combined.

So call 1 800 752-0900, Ext. 900D for your nearest HP dealer.



## Company Information

**Communications Research Group**  
5615 Corporate Blvd.  
Baton Rouge, LA 70808  
(504) 923-0888  
**Inquiry 900.**

**Datastorm Technologies, Inc.**  
1621 Towne Dr., Suite G  
Columbia, MO 65202  
(314) 474-8461  
**Inquiry 901.**

**Digital Communications Associates, Inc.**  
1000 Holcomb Woods Pkwy.  
Roswell, GA 30076  
(404) 998-3998  
**Inquiry 894.**

**Hayes Microcomputer Products, Inc.**  
P.O. Box 105203  
Atlanta, GA 30348  
(404) 441-1617  
**Inquiry 903.**

**Hilgraeve, Inc.**  
P.O. Box 941  
Monroe, MI 48161  
(800) 826-2760  
**Inquiry 895.**

**Maxon Systems, Inc.**  
353 Vintage Park Dr., Suite B  
Foster City, CA 94403  
(415) 377-0269  
**Inquiry 897.**

**Meridian Technology, Inc.**  
7 Corporate Park, Suite 100  
Irvine, CA 92714  
(714) 261-1199  
**Inquiry 893.**

**Relay Communications, Inc.**  
41 Kenosia Ave.  
Danbury, CT 06810  
(800) 222-8672  
**Inquiry 902.**

**SoftKlone**  
336 Office Plaza Dr.  
Tallahassee, FL 32301  
(904) 878-8564  
**Inquiry 898.**

**Softronic**  
7899 Lexington Dr., Suite 210  
Colorado Springs, CO 80918  
(800) 225-8590  
**Inquiry 896.**

**Woolf Software Systems, Inc.**  
23842 Archwood St.  
West Hills, CA 91307  
(818) 703-8112  
**Inquiry 899.**

beat the Old Guard. Smartcom III requires a hefty 512K bytes of RAM, an 80-column display, and a hard disk drive, but the package includes everything: a full-functioned editor, file compression and data encryption, on-line disk management, a complete command set, an integrated compiler, simultaneous sessions, remote access capability, and an excellent learn facility. The four-disk set is not for the casual user, as the \$249 price tag attests, but if you have heavy-duty uses in mind, Smartcom III will do the job.

Multiple menus and excessive help screens can be annoying and inflexible, but Smartcom III's implementation of those features works. You can find your way around the system and experiment with only occasional glances at the ample (218-page) documentation.

The editor, unlike many integrated editors, is fairly painless, and, when

editing script files, it offers some helpful debugging tools. Debugging the scripts of other packages can become tiresome because most errors are only discovered on-line. The Smartcom compiler, accessible from within the editor, catches many errors; and when problems do arise, you can avoid the headache of switching from one module to another or, worse, from one program to another. After Smartcom detects a compilation error, it puts you right where you need to be: back in the editor.

Hayes has included a complete programming environment with multiple conditional structures, windowing, speed optimization, and full error trapping. The language is verbose (even with a learn facility, it took 162 keystrokes to edit the automated session). But the selling point here is power. With the less expensive packages, you usually employ a generic routine and hope all unfolds as

expected, but Smartcom lets you pick the right command for each application. Start the learn facility and watch Smartcom create your script in an upper window as the session churns along on the main screen. It even scrambles your password. Slick.

Smartcom blazed through our 1-megabyte benchmarks. Unlike almost every other program, Smartcom could truly handle its advertised maximum data transfer rate. Sending the file from the AT to the Compaq, Smartcom scorched along at 115,200 bps with no delays at all and broke the tape in 98 seconds. Of course, the AT can't capture that fast, but Smartcom let us know about character errors right up front. Instead of waiting for the 1-megabyte transfer to complete, only to find errors in the file, we simply aborted the process, popped down to 38,400 bps, and sent the file to the AT in a record 262 seconds.

If you need a full range of features, or if you plan an extensive programming project (such as a bulletin board system or a complex sequence of unattended sessions), the Smartcom investment pays off quickly.

### Softterm PC 3.0

Although Softterm did not excel at our benchmarks, registering 954 seconds on the important 1-megabyte receive test, it did run through them with admirable ease. The configuration parameters were not only comprehensive but easy to find and modify. When a problem did occur, the excellent documentation (over 700 pages packed in two manuals) covered it. And there's lots to cover: a complete script language, learn mode, background operation, direct remote access, six popular protocols, queue scheduling, and a text editor.

For terminal emulation, Softterm breaks away from the pack. Chapter 4 of the reference manual lists 45 terminals, and each is well documented. That chapter alone runs 200 pages. In an area where most of the packages come up woefully short, Softterm deserves special accolades.

Unique resident features are also noteworthy. Softterm's Communication Agent, coupled with an unattended host mode, enables true background operations. A hot-key toggle lets you queue a script file containing the MONITOR command, turning control to the remote terminal while the local computer runs DOS operations or application programs. Resident menus also offer disk management and sophisticated host ac-

*continued*

# Small cash input for laser-quality output.



Dear Reader:

This letter was printed on one of the finest printers available today.

The HP DeskJet Printer.

It prints text and graphics more crisp and clear than 24-pin printers. And as you can see from the chart, it's a lot quieter than 24-pin printers, too.

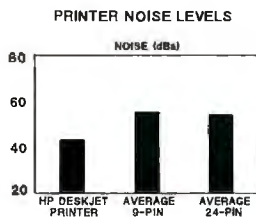

It's also easy to use. It does your important office tasks, but it's small enough to fit on your desk. Everything considered, it's the perfect personal printer.

And one of the most amazing features of all is its price. It's under \$1,000.

Call us for the name of your local HP Dealer at 1-800-752-0900 Ext. 908B. Then go see for yourself why we call it laser-quality printing.

Sincerely,  
  
Richard Snyder

## The HP DeskJet Printer. Laser-Quality Output for Under \$1000.



## A MESSAGE TO OUR SUBSCRIBERS

FROM TIME TO TIME WE MAKE THE BYTE SUBSCRIBER list available to other companies who wish to send our subscribers material about their products. We take great care to screen these companies, choosing only those who are reputable, and whose products, services, or information we feel would be of interest to you. Direct mail is an efficient medium for presenting the latest personal computer goods and services to our subscribers.

Many BYTE subscribers appreciate this controlled use of our mailing list, and look forward to finding information of interest to them in the mail. Used are our subscribers' names and addresses only (no other information we may have is ever given).

While we believe the distribution of this information is of benefit to our subscribers, we firmly respect the wishes of any subscriber who does not want to receive such promotional literature. Should you wish to restrict the use of your name, simply send your request to the following address.

### BYTE MAGAZINE

ATTN: SUBSCRIBER SERVICE  
P.O. Box 7643  
TEANECK, NJ 07666-9866



cess. The File Agent uses configurable device specifiers, letting you access remote computers as if they were local disk drives.

Softerm's learn mode creates only macros; you've got to enter script code manually. The editor saves you some keystrokes by generating commands and by catching entry errors, but it can be inflexible. In fact, the script language itself suffers from a rigid structure. Not an open programming environment, but the kind you may appreciate at debugging time or when coding complex sessions.

The menu structure is somewhat confusing. For instance, F4 from the Softerm Functions menu, labeled File Transfer, does *not* let you transfer files; for that feature, you must call the Utility Functions menu. A better design would save keystrokes and enhance clarity.

With so many features and admirable power, Softerm deserves its place alongside the expensive communications packages. It can do the job, but it's not a program you can go to work on right out of the box. A steep learning curve, annoying rigidity, and poor performance in our benchmark tests thwart the promise of this full-featured package.

### The Big Picture

Today's communications software has come a long way. Learn modes, easy macro definition, and context-sensitive help make telecomputing simpler than ever. With powerful scripting and abundant features, the best programs don't sacrifice sophistication. If you have a quick and easy session to run, complex features stay out of your way; but if you need more power, it lies in wait. By gleaning the features and checking benchmarks, you should pick a package that is most closely aligned to your application.

For instance, if you have limited hardware and perform long file transfers, background operation becomes vital. It frees your local keyboard and enhances productivity. It also limits your choices considerably: While most programs can access DOS without logging out, they lack true background. On the other hand, if you desire simultaneous transfers, a program like MaxOnline or Mirror II can do the job by accessing both COMM ports.

Our line simulator benchmarks show all packages performing XMODEM transfers equally well. Clearly, though, with 1-megabyte transfer rates ranging from over 20 minutes to less than 2 minutes, software affects throughput. And a high data transfer rate does not necessarily ensure performance; software over-

## "IT MAKES C-C-CROSSTALK SEEM T-T-TONGUE-TIED."

If you're talking to a DEC mainframe, no communication software emulates the VT220, VT100 or VT52 terminal more accurately, easily, or eloquently than VTERM.\*

Hot keys. Kermit. Automatic reformatting for spreadsheets and databases. VTERM has it all.

Why not join the 60,000 users of VTERM (many of whom moved up from Crosstalk). And try the DEC terminal emulation package that has everyone in the business buzzing.

### FREE EVALUATION KIT.

Yes, send me a free time-limited, *full-blown working copy* of VTERM/220, which is mine to keep.

Name \_\_\_\_\_

Title \_\_\_\_\_

Company \_\_\_\_\_

Address \_\_\_\_\_

Telephone (\_\_\_\_) \_\_\_\_\_

I am a user  dealer . Mail to:

### Coefficient Systems Corporation

611 Broadway, New York, New York 10012 (212) 777-6707 BYC-8/88

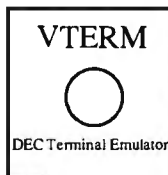

\* VTERM refers to VTERM/220, VTERM/4010, etc. products from Coefficient Systems Corporation. Crosstalk is a trademark of Digital Communications Associates, Inc.

Questions? Want faster action? Call (212) 777-6707, ext. 420.



COMMUNICATIONS SOFTWARE

head and line waits can significantly hamper transfer speed. Crosstalk XVI and Smartcom III both tout maximum data transfer rates of 115,200 bps, yet their 1-megabyte transfer times differ by as much as 13 minutes—very significant when tying up a valuable resource.

Proprietary protocols can make a difference. Carbon Copy compressed our file of 64,000 A characters and sent it in 12 seconds. The BLAST protocol handles noise exceptionally well. Each package emphasizes specific features, but a couple of them bring it all together.

**Top of the Line**

For overall performance, Smartcom III leads the field. It set the standard for 1-megabyte transfer, the most telling of our benchmarks. It includes all necessary features and throws in all those little extras that make the job easier—such as recalling filenames from the first couple of keystrokes, encrypting files and scrambling passwords for added security, and allowing simultaneous on-line sessions.

Smartcom's scripting also sets the pace. When faced with ever-changing prompts and the vagaries of on-line communications, you need a language that has full error trapping and can handle all the anomalies. You'll still run into programming limits, but, for an application language, Smartcom attains the state of the art.

**Price vs. Performance**

Here Procomm Plus wins our endorsement. Unobtrusive and easy to use, it still includes all major features and supports an enviable set of protocols and terminal emulations. It achieves simplicity with standard Alt-key combinations and with a comprehensive menu that's a single keystroke away. Its power comes from a surprisingly strong scripting language. And it's highly flexible—an indispensable feature for telecomputing tasks. Although it lacks the sophistication of Smartcom III or Crosstalk Mk.4, Procomm Plus does the job admirably well at a reasonable price.

Generally, we were impressed by the overall quality of all the packages tested. Once lagging behind the telecomputing revolution, communications software has filled the gap with full programming capability and creative proprietary features. Going on-line has never been easier. ■

*Steve Apiki and Stan Diehl are testing editors for the BYTE Lab. They can be reached at One Phoenix Mill Lane, Peterborough, NH 03458, or on BIX as "apiki" and "sdielh."*

# ELIMINATE COSTLY WIRING AND MODEMS!

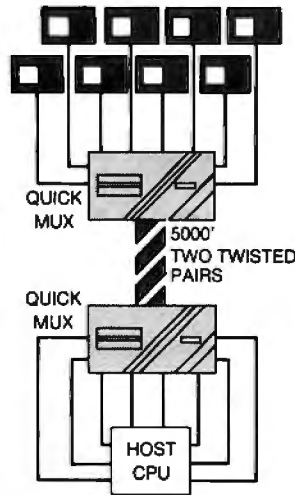

**THE MODEL 570 QUICK MUX**

- 8 full duplex ports
- 19,200 baud all ports simultaneously
- 5000' link distance
- No configuration switches
- Built-in surge protection
- Bi-directional control signal for each port
- Includes 8 25' cables
- Complete diagnostics
- Channel activity indicators
- Male or female connectors
- \$548 with cables

Contact us today at  
**Telebyte Technology Inc.,**  
 270 E. Pulaski Road,  
 Greenlawn, New York  
 11740, (516) 423-3232.

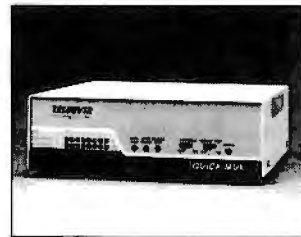

Ask for our free  
**Datacom Cookbook**  
 1-800-835-3298

**TELEBYTE**

# "IT MAKES PROCOMM LOOK LIKE AMATEURCOM."

If you talk to a DEC mainframe, no software emulates the VT220, VT100 or VT52 terminal more accurately or professionally than VTERM.\*

Hot keys. Kermit. Automatic reformatting for spreadsheets and databases. VTERM has it all.

Why not join the 60,000 users of VTERM (many of whom moved up from Procomm). And try the DEC terminal emulation package that's in a totally different league.

**FREE EVALUATION KIT.**

Yes, send me a free time-limited, full-blown working copy of VTERM/220, which is mine to keep.

Name \_\_\_\_\_

Title \_\_\_\_\_

Company \_\_\_\_\_

Address \_\_\_\_\_

Telephone ( ) \_\_\_\_\_

I am a user  dealer . Mail to:

**Coefficient Systems Corporation**

611 Broadway, New York, New York 10012 (212) 777-6707 BYP-8/88

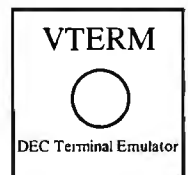

\* VTERM refers to VTERM/220, VTERM/4010, etc. products from Coefficient Systems Corporation. Procomm is a trademark of Datastorm Technologies, Inc.

**Questions? Want faster action? Call (212) 777-6707, ext. 419.**



# Variations on the 20-MHz Theme

The Tatung TCS-8000, Proteus 386A, and Everex Step 386/20 take different paths to high performance

Ed McNierney

As more 80386-based computers become available, you'd think they'd be as similar as peas in a pod. But that's not the case. As computers based on the 80386 move beyond the initial 16-MHz wave to 20 MHz, design variations between different systems become more prominent. Those variations show up clearly as differences in performance.

The 20-MHz systems reviewed here—the Tatung TCS-8000, Proteus 386A, and Everex Step 386/20—follow different design philosophies. The three systems show a remarkable range of performance and operational capabilities for a set of machines that are superficially so similar. Each couples its CPU with an enhanced AT-style keyboard, a reasonable-size hard disk drive, and an EGA display subsystem. Yet on closer inspection and testing, each shows unique performance features, and the group as a whole shows a variation in performance of more than 100 percent on some of the benchmarks.

## Fast Cache

The most prominent factor in an 80386-based system's performance is the memory architecture. Since the 20-MHz 80386 is an exceptionally memory-hungry processor with a instruction prefetch queue to keep filled, its demands

on memory access are severe. Unfortunately, memory costs are such that the several megabytes of sub-50-nanosecond static RAM (SRAM) required to give the 80386 unimpeded memory access would make any system prohibitively expensive. But that much fast memory isn't necessary; good performance can be obtained for a fraction of the cost by using a well-designed memory system. Each of the three systems reviewed uses a different approach to memory architecture.

The Tatung TCS-8000 takes the simplest approach. The CPU accesses all the 80-ns memory through a 16-bit data path and requires no proprietary 32-bit extension bus. The resulting system runs with two wait states at all times, and you can add more memory with any conventional memory-expansion board. Unfortunately, this simple solution almost always results in a performance penalty that puts the TCS-8000 at the bottom of this three-system heap in memory-intensive operations. However, that fast RAM makes the Tatung TCS-8000 almost as

fast as the Compaq Deskpro 386/20, which uses 100-ns RAM.

The Proteus 386A takes an intermediate approach with a motherboard that can support 4 megabytes of 100-ns memory with a 32-bit data path. This dynamic RAM (DRAM) is supplemented by a 64K-byte 45-ns SRAM cache. Since most applications do not require more than 4 megabytes of RAM, this system provides a reasonable performance compromise. This system also does not use a proprietary 32-bit expansion slot, so if you add more memory, it must be accessed through a 16-bit bus. The cache system caches all memory, however, not just the memory on the motherboard; as a result, the performance degradation that the 16-bit memory produces is moderated. Testing showed that this caching had little effect on the performance of the system, which ran memory-intensive operations just slightly faster than the Tatung TCS-8000.

The Everex Step 386/20's memory system is perhaps the most unusual of the



*Not peas in a pod: From left to right, the Tatung TCS-8000, Proteus 386A and Everex Step 386/20 travel different paths to improved performance.*

group, but it produces the best overall performance. You can install up to 8 megabytes of 120-ns DRAM on the system board, with another 8 megabytes available in a full 32-bit expansion slot. To boost the performance of this DRAM, a 64K-byte SRAM cache (expandable to 256K bytes) is also used—but with a twist.

Most PC cache systems are the write-through type. If data is in the cache, it's read from there; otherwise, it's read from main memory. But when data is written, it's always written to the cache first and then "through" the cache into main memory. As a result, the cache offers little benefit on memory writes. However, since the bulk of a CPU's work consists of reading instructions to execute, this write penalty does not seriously affect performance.

But Everex, deciding to squeeze all possible speed out of its system, has implemented a write-back cache instead. In this cache system, if a data write occurs to a memory location in the very fast 25-ns cache, that write occurs only to that memory and not to main memory. It then marks the cache location as "dirty" because its value differs from the main memory location it is caching. When that same location is read again, it is read directly from the cache until a new memory access causes that cache location to be overwritten. When new memory is moved into the cache, the current contents of the cache are checked to see if they are dirty. If so, those contents are

written out to main memory before they're overwritten. Thus, a memory location that is frequently written to gets written much more quickly than in a conventional "write-through" system.

### Tatung TCS-8000

The TCS-8000 as reviewed lists for \$5288, not including a math coprocessor. The system supports a 10-MHz 80287 or 80387 coprocessor, neither of which Tatung supplies; the review system was equipped with a 10-MHz 80287. You can't vary the coprocessor speed, but you can switch the system CPU speed between 20 MHz and 8 MHz from the keyboard using the Ctrl-Alt-Minus keys. The system always powers up in the slower 8-MHz speed. If you really get into trouble, a convenient hardware reset switch is provided on the front panel of the system unit.

The motherboard of the review unit held 2 megabytes of 80-ns RAM on SIMM (single in-line memory module) chips, with sockets for up to 4 megabytes. You can add more memory with an AT-style memory card. There are eight slots: two 8-bit and six 16-bit. The serial/parallel card and the EGA card take up both 8-bit slots, and the floppy/hard disk drive controller takes one 16-bit slot, leaving five 16-bit slots free.

The review unit had one 1.2-megabyte 5¼-inch floppy disk drive and one full-height hard disk drive. There is room for two other half-height devices. The Mini-Scribe 6053 40-megabyte hard disk drive

performed well and reliably, but it fell behind the performance expected of a drive in this class. According to the Coretest, it had a data transfer rate of 169.9K bytes per second, an average seek rate of 33.7 milliseconds, and a track-to-track rate of 5.7 ms. As a result, all the Tatung's disk-based benchmark results were the poorest of the three machines.

Although a disk support software package was included with the system, it did not include a disk-cache utility, as the other two systems did. Disk-cache utilities are becoming standard equipment on 80386 machines, and one could improve the Tatung TCS-8000's general performance.

The display adapter is an ATI EGA-compatible short card with additional support for Hercules graphics modes and several enhanced EGA modes, including 800 by 560, 640 by 480, and 752 by 410 pixels. Tatung supplied its own EGA CM-1480 monitor, which features an additional monochrome mode: When the monitor is operating in text mode, a switch can change the normal white-on-black display to amber on black, green on black, or bright white on blue.

The Tatung system suffers from a poor keyboard. Although the feel of the keys is similar to that of many of the softer keyboards, the lack of a firm touch is overshadowed by the poor layout. The layout resembles the new IBM Enhanced 101-key layout at first glance, but there are

*continued*



# Everex Step 386/20, Proteus 386A, Tatung TCS-8000

## APPLICATION-LEVEL PERFORMANCE

WORD PROCESSING				DATABASE			
	Everex 386/20	Proteus 386A	Tatung TCS-8000		Everex 386/20	Proteus 386A	Tatung TCS-8000
<b>XyWrite III+ 3.52</b>	Med/Lrg	Med/Lrg	Med/Lrg	<b>dBASE III+ 1.1</b>			
Load (large)	:14	:13	:13	Copy	:51	:50	1:42
Word count	:02/:16	:02/:17	:03/:22	Index	:19	:19	:23
Search/replace	:04/:20	:05/:22	:05/:23	List	1:52	2:56	3:44
End of document	:02/:13	:01/:13	:02/:14	Append	1:40	1:35	2:03
Block moves	:10/:10	:10/:10	:11/:11	Delete	:02	:02	:03
Spelling check	:07/:47	:07/:50	:09/1:02	Pack	1:19	1:36	2:30
<b>Microsoft Word 4.0</b>				Count	:17	:16	:19
Forward delete	:11	:11	:14	Sort	1:16	1:15	1:23
<b>Aldus PageMaker 1.0a</b>				<b>Index:</b>	<b>1.55</b>	<b>1.45</b>	<b>1.06</b>
Load document	:11	:05	:16	<b>SCIENTIFIC/ENGINEERING</b>			
Change/Bold	:21	:23	:28				
Align right	:16	:20	:21	<b>Everex 386/20</b>	<b>Proteus 386A</b>	<b>Tatung TCS-8000</b>	
Cut 10 pages	:16	:17	:19	<b>AutoCAD 2.52</b>			
Place graphic	:04	:05	:05	Load SoftWest	:38	:57	2:01
Print to file	1:40	1:44	2:02	Regen SoftWest	:26	:45	:47
<b>Index:</b>	<b>3.06</b>	<b>2.73</b>	<b>2.31</b>	Load StPauls	:10	:19	:15
<b>SPREADSHEET</b>				Regen StPauls	:05	:09	:09
	Everex 386/20	Proteus 386A	Tatung TCS-8000	Hide/redraw	8:48	14:37	15:22
<b>Lotus 1-2-3 2.01</b>				<b>STATA 1.5</b>			
Block copy	:02	:03	:03	Graphics	1:27	1:17	2:17
Recalc	:01	:01	:01	ANOVA	:14	:23	:28
Load Monte Carlo	:15	:16	:16	<b>MathCAD 2.0</b>			
Recalc Monte Carlo	:04	:03	:03	IFS 800 pts.	:12	:22	:23
Load rlarge3	:04	:04	:04	FFT/IFFT 1024 pts.	:13	:26	:25
Recalc rlarge3	:01	:01	:01	<b>Index:</b>	<b>3.68</b>	<b>2.26</b>	<b>1.94</b>
Recalc Goal-seek	:03	:03	:03	<b>COMPILERS</b>			
<b>Microsoft Excel 2.0</b>							
Fill right	:04	:04	:05	<b>Everex 386/20</b>	<b>Proteus 386A</b>	<b>Tatung TCS-8000</b>	
Undo fill	1:26	1:28	2:01	<b>Microsoft C 5.0</b>			
Recalc	:01	:01	:01	XLisp compile	3:33	4:20	4:51
Load rlarge3	:20	:22	:26	<b>Turbo Pascal</b>			
Recalc rlarge3	:01	:01	:01	Pascal S compile	:04	:05	:06
<b>Index:</b>	<b>3.37</b>	<b>3.20</b>	<b>2.98</b>	<b>Index:</b>	<b>2.75</b>	<b>2.22</b>	<b>1.92</b>

All times are in minutes:seconds. Indexes show relative performance; for all indexes, an 8-MHz IBM PC=1.

## LOW-LEVEL PERFORMANCE<sup>1</sup>

CPU	Everex 386/20	Proteus 386A	Tatung TCS-8000	DISK I/O	Everex 386/20	Proteus 386A	Tatung TCS-8000	VIDEO	Everex 386/20	Proteus 386A	Tatung TCS-8000
<b>Matrix</b>	3.04	3.19	3.54	<b>Hard Seek<sup>4</sup></b>				<b>Text</b>			
<b>String Move</b>				Outer track	3.33	3.28	3.31	Mode 0	9.12	16.53	22.02
Byte-wide	20.05	31.25	29.42	Inner track	3.31	3.33	3.30	Mode 1	9.09	16.51	22.01
Word-wide				Half platter	10.00	6.64	13.29	Mode 2	8.59	16.55	21.68
Odd-bnd.	25.05	25.29	29.59	Full platter	12.56	8.35	16.64	Mode 3	8.57	16.55	21.68
Even-bnd.	10.00	15.65	14.74	Average	7.30	5.40	9.13	Mode 7	N/A	16.87	N/A
<b>Sieve</b>	19.10	20.00	22.50	<b>DOS Seek</b>				Test			
<b>Sort</b>	14.29	21.48	25.00	1-sector	11.97	8.25	18.47	average	8.84	16.60	21.85
<b>Index:</b>	<b>4.07</b>	<b>3.22</b>	<b>3.01</b>	32-sector	41.90	41.82	64.30	<b>Graphics</b>			
<b>FLOATING POINT<sup>2</sup></b>				<b>File I/O<sup>5</sup></b>				CGA:			
	Everex 386/20	Proteus 386A	Tatung TCS-8000	Seek	0.11	0.13	0.11	Mode 4	1.70	1.56	2.00
<b>Math</b>	7.18	32.52	27.99	Read	1.09	1.16	0.98	Mode 5	1.65	1.54	2.01
Error <sup>3</sup>	0.00E+00	0.00E+00	0.00E+00	Write	1.01	1.14	1.14	Mode 6	1.67	1.65	2.01
<b>Sine(x)</b>	3.30	14.37	11.17	<b>1-megabyte</b>				EGA:			
Error	2.00E-09	2.00E-09	2.00E-09	Write	6.89	7.33	8.55	Mode 13	3.48	3.35	3.98
<b>e<sup>x</sup></b>	3.19	12.10	9.76	Read	7.03	7.66	8.22	Mode 14	3.59	3.65	4.27
Error	1.00E-09	1.00E-09	1.00E-09	<b>Index:</b>	<b>1.41</b>	<b>1.44</b>	<b>1.17</b>	Mode 16	3.70	3.70	4.12
<b>Index:</b>	<b>5.96</b>	<b>1.42</b>	<b>1.74</b>					Graphics			
								average	2.63	2.57	3.06
								<b>Index:</b>	<b>1.59</b>	<b>1.17</b>	<b>0.94</b>

N/A = Not applicable; mode not supported by graphics adapter.

<sup>1</sup> All times are in seconds. All figures were generated using the 8088/8086 version (1.1) of Small-C (16-bit integers).

Figures for 80386 machines do not use 80386-specific instructions.

<sup>2</sup> The floating-point benchmarks use 8087-compatible instructions only.

<sup>3</sup> The errors for the floating-point benchmarks indicate the difference between expected and actual values, correct to 10 digits or rounded to 2 digits.

<sup>4</sup> Times reported by the Hard Seek and DOS Seek are for multiple seek operations (number of seeks performed currently set to 100).

<sup>5</sup> Read and write times for the File I/O benchmarks are in seconds per 64 Kbytes.

<sup>6</sup> For the Livermore Loops and Dhrystone tests only, higher numbers mean faster performance.

## CONVENTIONAL BENCHMARKS

	Everex 386/20	Proteus 386A	Tatung TCS-8000
LINPACK	172.03	623.40	507.90
Livermore Loops <sup>6</sup>			
(MFLOPS)	0.17	0.04	0.05
Dhrystone (MS C 5.0)			
(Dhry/sec)	6793	5945	5291



Everex Step 386/20 **14.4\***

Proteus 386A **11.9**

Tatung TCS-8000 **10.2**

Compaq 386/20 **18.0**

IBM PS/2 Model 80 **11**

IBM PC AT **5**

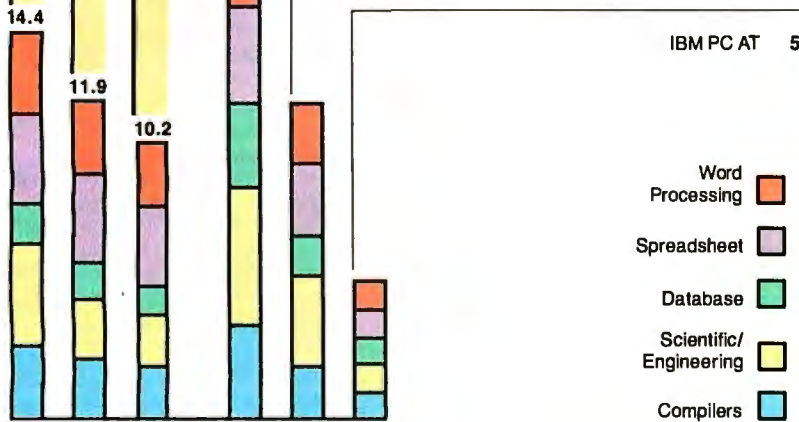

\*Cumulative applications index. Graphs are based on indexes at left and show relative performance.

Everex Step 386/20

Proteus 386A

Tatung TCS-8000

Compaq 386/20

IBM PS/2 Model 80

IBM PC AT

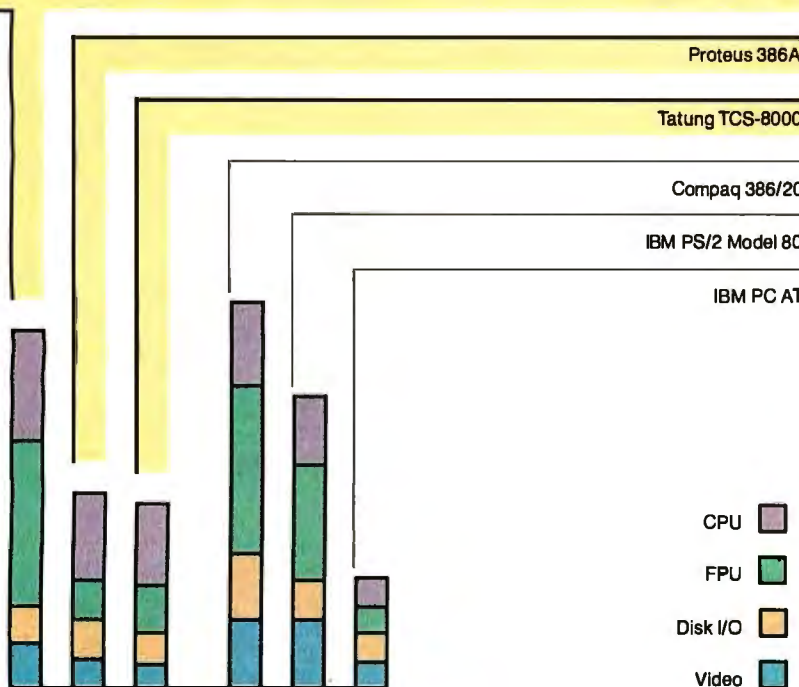

some variations in key positions.

The system's documentation includes four binders of material, two of which are supplied by Microsoft for the Tatung version of MS-DOS 3.21 and for GW-BASIC. The other two manuals are the Tatung user's guide and technical reference; these two suffer severely from confused English, spelling and grammatical mistakes, and poor organization and indexing. Information is scrambled throughout the manuals, and not much effort was spent keeping complex and technical information separate from the standard user information required to set up and operate the system.

A poor set of documentation makes it difficult to take a computer system seriously. The cost of writing documentation is small compared to developing and distributing an 80386-based computer system, yet better documentation would produce a big benefit for both the manufacturer and the user.

The TCS-8000 has a 1-year parts and labor warranty; service is provided by Tatung.

In general, while the Tatung system did not fail or break down, it didn't have any outstanding features. Its quirky keyboard and generally ordinary performance put it near the bottom of the list when compared to the other systems available. A new manual, better support software, and a new keyboard could make the system a reasonable, if unremarkable, 20-MHz 80386 choice.

### Proteus 386A

The Proteus approach to personal computers is to be a hardware supermarket. Its catalogs include a wide variety of hardware options, and you order them in whatever combination you want. Proteus offers support and service with a 15-month on-site warranty with each of its systems. For users who don't have the courage or the time to take the cover off their system units every time something goes wrong, a comprehensive support system like Proteus's can be very welcome.

The Proteus 20-MHz 80386 system comes with a socket for an optional 80287 math coprocessor. The keyboard controls the system's operating speed and cache memory controller. The Ctrl-Alt-Plus and -Minus keys switch the operating speed between 20 MHz and 6 MHz, and the Ctrl-Alt-Left-Shift-Plus and -Minus keys enable or disable the SRAM cache memory when the system is running at 20 MHz. The cache is always disabled at 6 MHz, because at that speed

*continued*

R E V I E W  
VARIATIONS ON THE 20-MHZ THEME

	<b>Tatung TCS-8000</b>	<b>Proteus 386A</b>	<b>Everex Step 286/20</b>
<b>Company</b>	Tatung Co. of America, Inc. 2850 El Presidio St. Long Beach, CA 90810 (213) 979-7055	Proteus Technology Corp. 377 Route 17 Airport 17 Center Hasbrouck Heights, NJ 07604 (201) 288-8629	Everex Computer Systems Division 48431 Milmont Dr. Fremont, CA 94538 (800) 356-4283
<b>Components</b>	<p><b>Processor:</b> 80386 running at 20 MHz, switchable to 8 MHz; socket for optional 10-MHz 80287 or 80387 math coprocessor</p> <p><b>Memory:</b> 1 megabyte of 16-bit two-wait-state DRAM standard on motherboard, expandable to 16 megabytes</p> <p><b>Mass storage:</b> 1.2-megabyte 5¼-inch floppy disk drive; optional 40-megabyte 5¼-inch hard disk drive</p> <p><b>Display:</b> Optional Enhanced EGA card with Hercules emulation; optional Tatung CM-1480 EGA monitor</p> <p><b>Keyboard:</b> 101-key Modified Enhanced keyboard</p> <p><b>I/O interfaces:</b> One DB-25 parallel port; one DB-9 serial port; six 16-bit and two 8-bit expansion slots</p> <p><b>Other:</b> Phoenix Technologies BIOS with ROM-based Setup utility; hardware reset switch</p>	<p><b>Processor:</b> 80386 running at 20 MHz, switchable to 6 MHz; socket for optional 10-MHz 80287 math coprocessor</p> <p><b>Memory:</b> 4 megabytes of 32-bit zero-wait-state DRAM on motherboard, expandable to 16 megabytes; 64K bytes of 45-ns SRAM cache memory</p> <p><b>Mass storage:</b> 1.2-megabyte 5¼-inch floppy disk drive; optional 720K-byte 3½-inch floppy disk drive; optional 320-megabyte 5¼-inch hard disk drive</p> <p><b>Display:</b> Optional Everex EVGA enhanced EGA with Hercules emulation and high-resolution EGA display modes; optional NEC MultiSync II display monitor</p> <p><b>Keyboard:</b> 101-key Modified Enhanced keyboard</p> <p><b>I/O interfaces:</b> One DB-9 and one DB-25 serial port; one DB-25 parallel port; six 16-bit and two 8-bit expansion slots</p> <p><b>Other:</b> American Megatrends BIOS with ROM-based Setup utility; hardware reset switch</p>	<p><b>Processor:</b> 80386 running at 20 MHz, switchable to 10 or 7 MHz; optional 20-MHz 80387 math coprocessor</p> <p><b>Memory:</b> 2 megabytes of 32-bit zero-wait-state DRAM on motherboard, expandable to 16 megabytes; 128K-byte 25-ns SRAM cache memory, expandable to 256K bytes</p> <p><b>Mass storage:</b> 1.2-megabyte 5¼-inch floppy disk drive; optional 80-megabyte hard disk drive</p> <p><b>Display:</b> Optional Everex EGA card; optional Everex EGA monitor</p> <p><b>Keyboard:</b> 101-key Modified Enhanced keyboard</p> <p><b>I/O interfaces:</b> 1-to-1 interleave floppy/hard disk drive controller; one DB-9 serial port; one DB-25 parallel port; six 16-bit, one 8-bit, and one dual 32-bit or 8-bit expansion slot</p> <p><b>Other:</b> Front-panel LED status display; hardware reset switch; speaker disable switch; Everex Enhanced American Megatrends BIOS with ROM-based Setup utility</p>
<b>Size</b>	6¾ × 22½ × 18½ inches; 59½ pounds	6¾ × 21½ × 17½ inches; 54 pounds	7 × 22 × 17½ inches; 58 pounds
<b>Software</b>	MS-DOS 3.21; GWBASIC 3.2; Tatung display drivers; MiniScribe disk management and diagnostic software	MS-DOS 3.30; GWBASIC 3.3; Everex EVGA utilities; SpeedStor disk caching and utility software	MS-DOS 3.3; GWBASIC 3.3; Everex Magic I/O support software; Everex EGA display adapter support software
<b>Options</b>	Monochrome display adapter: \$99 Hercules/EGA card: \$189 VGA card: \$595	720K-byte 3½-inch floppy disk drive: \$98 20-megabyte to 320-megabyte hard disk drives: \$261 to \$2895 Everex EGA card: \$139 Everex EVGA card: \$269 14-inch monochrome monitor: \$129 EGA monitor: \$375 NEC MultiSync II monitor: \$675	80387-20 coprocessor: \$1495 Weitek 1167 math coprocessor board: \$1995 40-megabyte hard disk drive: \$550 80-megabyte hard disk drive: \$795 Everex EGA card: \$169 Everex EGA monitor: \$399
<b>Documentation</b>	Tatung TCS-8000 User's Manual; Tatung TCS-8000 Technical Manual; MS-DOS User's Guide; GWBASIC Manual	MS-DOS User's Guide; GWBASIC Manual; Everex Magic I/O Adapter reference; Everex EVGA Display Adapter reference; SpeedStor disk utility software reference; Proteus User's Guide	Everex System 386 User's Guide; NEC Everex Magic I/O operating manual
<b>Price</b>	Standard system with 1 megabyte of RAM, 1.2-megabyte 5¼-inch floppy disk drive, and floppy/hard disk drive controller: \$3500 System as reviewed: \$5288	Standard system with 1 megabyte of RAM, 64K-byte cache, floppy/hard disk drive controller, and 1.2-megabyte 5¼-inch floppy disk drive: \$3190 System as reviewed: \$8522	Standard system with 1 megabyte of RAM, 64K-byte RAM cache, floppy/hard disk drive controller, and 1.2-megabyte floppy disk drive: \$4399 System as reviewed: \$6437
	<b>Inquiry 883.</b>	<b>Inquiry 884.</b>	<b>Inquiry 885.</b>

# VGA

## Princeton's Very Good Answers.

Without question, Princeton's PSC-28 and PSM-03 monitors will bring you the ultimate in VGA performance. Princeton was the first to offer truly compatible VGA dedicated monitors. Our PSC-28 is a 770 × 570, .28mm dot pitch, high resolution analog color monitor that can display an infinite number of colors. The PSC-28 also features a convenient color button for green, amber or cyan text. The PSM-03, a high resolution analog monochrome monitor gives you outstanding 800 × 630 resolution, and the ability to display infinite shades of gray. Plus sharp crisp graphics and character definition from its dynamic focusing circuitry.

Both monitors are compatible with IBM PC\*, XT\*, AT\*, PS/2, Apple Macintosh SE\* and compatible personal computers. Each gives you full compatibility with the leading VGA adapter cards including the QuadVGA and VEGA VGA. So if VGA meets all your needs (and you don't require the additional flexibility of our famous ULTRASYN and MAX-15 autosynchronous monitors), investigate the cost/performance value of the

PSC-28 and PSM-03.

Unsurpassed quality, service and performance make it hard to beat Princeton monitors. We offer better value than our competition. We call it the Visible Edge. For answers to all your questions about VGA compatible monitors, contact us at 601 Ewing Street, Building A, Princeton, New Jersey 08540 (609) 683-1660, x 810.

*\*Requires proper adapter card*



PSM-03

PSC-28

**PRINCETON**  
GRAPHIC SYSTEMS  
AN INTELLIGENT SYSTEMS COMPANY

THE VISIBLE EDGE

# TURN-POINT AMERICA

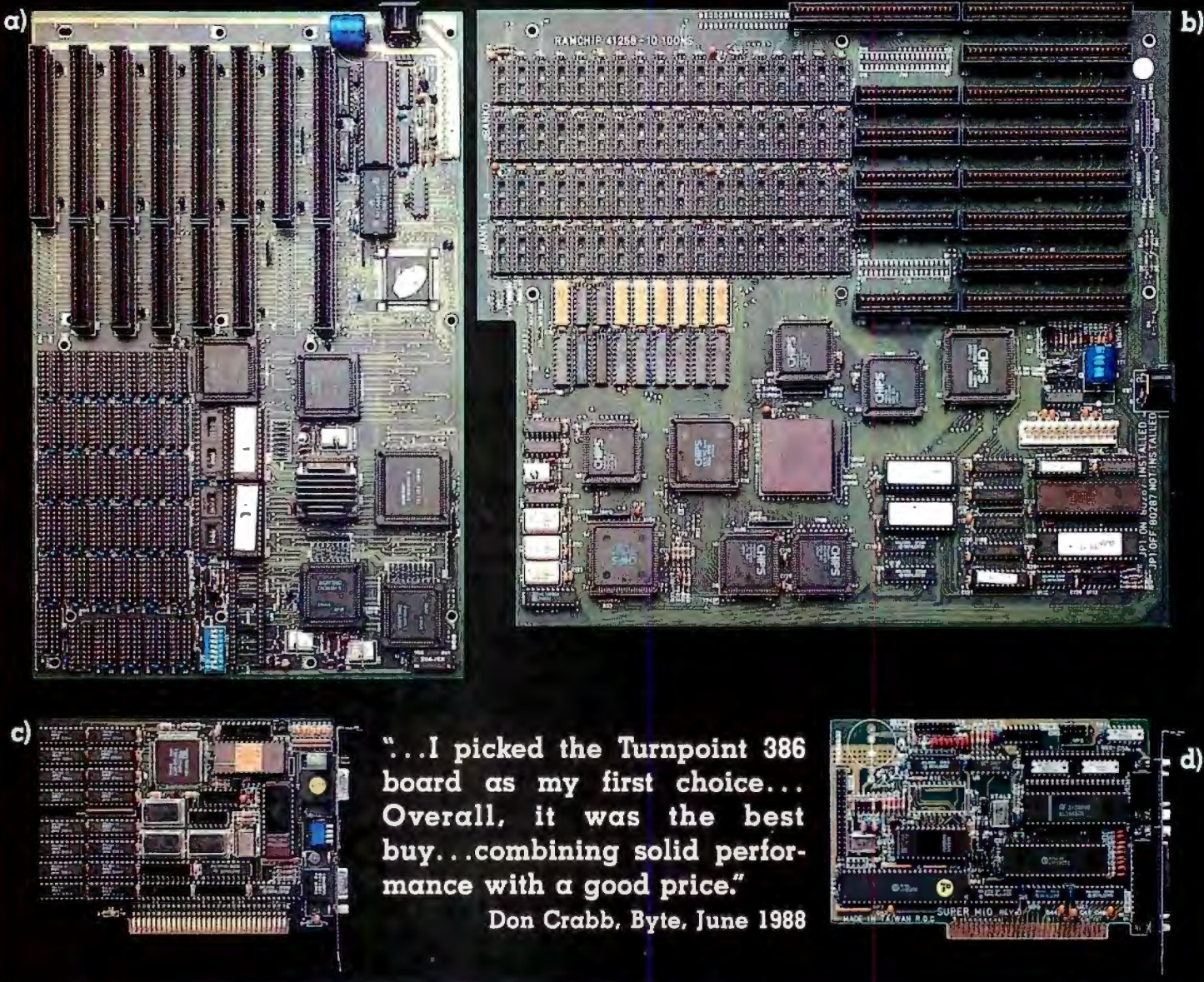

- a) 80286 Motherboard — 12.5 Mhz 0 wait state, Norton SI 15.3, socketed for 4 Mb DRAM, EMS software included.
- b) 80386 Motherboard — Available in 16/20 Mhz and 20/25 Mhz versions, full AT size or XT size, socketed for 2 Mb or 8 Mb DRAM.
- c) VGA Card — 100% register compatible with IBM, resolutions up to 1024x768x16 colors, hardware zoom, pan, and scan, application driver software included.
- d) Super Multi I/O — Floppy controller for 1.44Mb thru 360k, 2 serial, 1 parallel, 1 game port.

Please call our toll free line for distributor pricing. All of Turn-Point America's products carry a one year parts and labor warranty. Visa, MasterCard, and COD accepted.

Circle 245 on Reader Service Card

TRADEMARKS and REGISTERED TRADEMARKS: IBM - International Business Machines

**Sales 1-800-247-6413**  
**Tech Support (702) 746-1818**



Turn-Point America  
éclat corporation

3495 N. McCarran Blvd.  
Reno, NV 89503  
Telex: 650 308 4898 MCI  
Fax: (702) 746-2306



VARIATIONS ON THE 20-MHZ THEME

the standard DRAM is fast enough to keep up with the processor at all times. The front panel features a hardware reset switch for desperate moments. The system Setup program is in ROM and can be accessed during boot-up.

In the review system, the Proteus motherboard came with 4 megabytes of 100-ns DRAM for the main memory and 64K bytes of 45-ns SRAM for the cache memory, both in DIP chips installed in sockets. Additional system memory requires an AT-style expansion card. The motherboard has eight slots: six 16-bit and two 8-bit. The EGA/VGA and parallel/serial cards take both 8-bit slots, and the floppy/hard disk drive controller card takes a 16-bit slot. This leaves five 16-bit slots free. As configured, the review system lists for \$8522.

The computer has space for five half-height disk drives. The review unit included a standard 1.2-megabyte 5¼-inch floppy disk drive and an optional 720K-byte 3½-inch floppy disk drive. The hard disk drive was a full-height Maxtor XT-4380E 320-megabyte ESDI (enhanced small device interface) drive. The Coretest rated this drive as having a data transfer rate of 212.5K bytes per second, an average seek rate of 13 ms, and a track-to-track rate of 3.7 ms.

Although the Proteus 386A uses a hardware cache memory system, its performance on memory-intensive benchmarks is not appreciably different from the Tatung system, which does not have a cache. Disk-intensive tests, however, show excellent performance due to the high-performance ESDI hard disk drive. This disk comes with SpeedStor disk management and caching software, which allows the entire disk to be split up into only three DOS partitions, two of which are larger than 32 megabytes.

With the SpeedStor software cache installed in extended memory, the disk benchmark times dropped dramatically, some running as much as 25 times faster; but even without the cache, the disk's 13-ms average access time greatly boosted system performance. For someone investing in a 20-MHz 80386 system, a high-speed hard disk drive is an essential, and the disk drives that Proteus supplies are more than worth the money.

The Proteus 386A uses an Everex EVGA card that can generate either TTL (EGA-style) or analog (VGA-style) output signals and is an extremely flexible display device. In addition to the standard device drivers, the EVGA software utilities include a wide selection of installable font files that replace the EGA's standard fonts with either more attrac-

tive, more decorative, or more compact fonts, including one suitable for 132-column text displays. The card comes with device drivers to support a variety of high-resolution display modes for AutoCAD and Microsoft Windows. Proteus supplied a very nice NEC MultiSync II monitor with the review unit.

The Proteus User's Guide comes in a small three-ring binder and is well organized and easy to read. It includes a "New Users" section for beginners and a "For Advanced Users" section for more experienced owners.

The Proteus keyboard is another "clone keyboard." Its layout resembles the IBM Enhanced keyboard, except that the Backspace and backslash/vertical bar keys assume their older AT positions. The keyboard offers no tactile feedback at all, and the keys offer so little resistance to pressure that it's a wonder they spring back again. A better keyboard design would help this system a lot.

If it's used with a replacement keyboard or as a file server on which the keyboard gets little use, the Proteus 386A is a reasonable performer with a solid backing of warranty support and repair service. It is worthy of serious consideration in disk-intensive operations, provided you can tolerate the minor annoyances in the system.

**Everex Step 386/20**

In several respects, the Everex Step 386/20 is the outstanding member of this group of machines. Its appearance sets it apart right from the start, with a flashy front-panel LED text display, speed and control switches, and a collection of indicator LEDs all protected by a sliding transparent cover. The text display tracks the progress of the system's power-on self-test and boot procedure, and from then on it continuously displays the disk drive, cylinder, and head most recently accessed by the disk drive controller system.

The front panel provides three control switches for selecting the system's operating speed at power-up, turning the system speaker on or off, or causing a hardware reset to occur. The system can operate at either 20, 10, or 7 MHz, and the Ctrl-Alt-Plus and -Minus key combinations allow you to speed up or slow down the processor. The system includes an optional 20-MHz 80387 math coprocessor whose speed matches the CPU and which is synchronized with it at all times.

The review system has a list price of \$6362; it came equipped with 2 mega-

*continued*

The best  
**Modula-2**

compilers for PCs and compatibles

**Taylor Modula-2**

The professional high-performance compiler for PCs: the fastest compiler in the world!

- \* unrivalled speed of compilation  
7,000-10,000 lines per minute (80286, 8 MHz).
- \* excellent code  
Mini-computer standard global optimisation. Code performs 1580 Dhystone tests per second! (80286, 8 MHz)
- \* ultra-compact  
high code density and a library of unrivalled compactness (23 modules in a total of 13K!)
- \* completely standard implementation  
Follows N. Wirth's standard for Modula-2. BIOS independent - uses MS/PC DOS exclusively.
- \* easy to use  
Straightforward user interface. Comprehensive documentation for system programmers.
- \* Guarantee and support  
One year guarantee. Maintenance contracts available. Swiss quality product.

**TaylorModula-2** \$ 900  
**Demo disk** \$ 10

**M2SDS** \$ 99

The professional Modula-2 software development system M2SDS comprises the following features in an easy-to-use window environment:

- modern, syntax-driven editor
- fast compiler
- linker producing EXE programs
- unique library manager
- comprehensive standard library

There are a vast number of tools, toolboxes, demo disks, public domain programs and books for M2SDS - probably more than for any other development system! M2SDS was used for the writing of the Farsight integrated business software package!

**Demo disks** \$ 10

**JPI-Modula-2** \$ 149

A reasonably-priced Modula-2 compiler with a configurable environment, integrated Make function and highly optimising code generator.

We have Modula-2 compilers for the Amiga, HP9000/300, and other systems. This list is constantly growing!

Texas residents add 6% sales tax. International Orders add \$ 20 shipping.

The Modula-2 people:



3336 Richmond, Suite 323  
Houston, TX 77098-9990 (713) 523 8422

Dealer inquiries welcome

International	United Kingdom: 01/6567333
Austria: 0222/4545010	Germany: 02983/8337;
Belgium: 071/366133	0731/26932;
France: 20822662	0821/85737;
Italy: 02/405174	04106/3998;
Scandinavia: +45/3/512014	0531/347121
Switzerland: 01/9455432	



A. + L. Meier-Vogt  
Im Späten 23  
CH-8906 Bonstetten/ZH  
Switzerland  
Tel. (41)(1) 700 30 37

# The Official Endorsed Books On Quattro®

Over 175,000 Copies In Print



"Borland•Osborne/McGraw-Hill offers you the only full line of endorsed books on Quattro. These titles combine Borland's own technical expertise with Osborne/McGraw-Hill's publishing savvy. With these official Quattro titles, you'll have a comprehensive library that keeps pace with you as you develop greater skills with Quattro."

**Philippe Kahn**, President & CEO, Borland International, Inc.

**Quattro Made Easy**  
by Lisa Biow

Guides you through a step-by-step introduction  
\$19.95 600 pp.  
ISBN: 0-07-881347-6

**Using Quattro: The Professional Spreadsheet**  
by Stephen Cobb

Gets you up and running fast with basic to more advanced techniques.  
\$21.95 584pp.  
ISBN: 0-07-881330-1

**Quattro: Secrets, Solutions, Shortcuts**  
by Craig Stinson

Unveils a clever selection of Quattro tricks.  
\$21.95 650pp.  
ISBN: 0-07-881400-6  
Available: 8/88

**Quattro: Power User's Guide**  
by Stephen Cobb

Unlocks Quattro's full power for serious business.  
\$22.95 600pp.  
ISBN: 0-07-881367-0

**Quattro: The Complete Reference**  
by Yvonne McCoy

Details every Quattro feature, command, and function.  
\$24.95 666pp.  
ISBN: 0-07-881337-9

**Quattro: The Pocket Reference**  
by Stephen Cobb

Puts essential commands and features at your fingertips.  
\$5.95 128pp.  
ISBN: 0-07-881378-6

## ORDER TODAY!

Available at Fine Book Stores and Computer Stores Everywhere or

**CALL TOLL FREE**

**800-227-0900**

Visa, MasterCard, & American Express Accepted

BORLAND•OSBORNE/McGRAW-HILL

BUSINESS SERIES

Quattro is a registered trademark of Borland International, Inc. Copyright © 1988, McGraw-Hill, Inc.



Osborne/McGraw-Hill  
2600 Tenth Street  
Berkeley, CA 94710

VARIATIONS ON THE 20-MHZ THEME

bytes of 120-ns DRAM on SIMMs and 64K bytes of 25-ns SRAM in socketed DIP chips for the cache memory. You can add additional memory via a proprietary 32-bit expansion slot; up to 16 megabytes of memory can be added at exactly the same performance level as the original system-board RAM. The motherboard has eight slots—six 16-bit and two 8-bit. The floppy/hard disk drive controller uses a 16-bit slot, and the Everex EGA and parallel/serial cards both use 8-bit slots. One 8-bit slot shares space with the 32-bit memory-expansion connector.

The system uses a very fast SRAM cache, and the resulting performance shows a noticeable improvement over the other two systems (which were quite close to each other in system speed). The benchmark results show clearly superior performance across the board. The Everex memory system definitely makes a difference.

The Step 386/20 has room for five half-height devices. Data storage in the review system consisted of a standard 1.2-megabyte 5¼-inch floppy disk drive and a Toshiba MK-56FB 72-megabyte hard disk drive with an RLL (run-length-limited) controller. The Coretest indicated that the Toshiba drive had a data transfer rate of 490K bytes per second, an average seek time of 27.5 ms, and a track-to-track time of 5.6 ms.

Video display was handled by an Everex EV-659 EGA/parallel card. I used an NEC MultiSync II monitor with the review system.

The system came with a number of utilities, but without an operating system; I used the MS-DOS 3.3 shipped with the Proteus system. The company says that it is now shipping DOS 3.3 with the system. The utility software includes test and diagnostic programs and a RAM disk and disk-cache utility. The system Setup program is in ROM and is accessed during boot-up.

The keyboard itself appears to be identical to the one used by Proteus, with the same soft feel and poor tactile feedback.

The Everex Step 386/20 comes with a 1-year on-site warranty for parts and labor. Service is handled by National Computer Service and covers the U.S. and Canada.

The manual for the system was available only in a prerelease photocopy form, but it was a well-organized document. A printed version is now available. The manual contains little extraneous material and gets to the point clearly and quickly. Additional documentation supplied for the monitor (from NEC) and the

I/O adapter card was also up to the same standard.

**On the Bench**

I tested all three computers with a variety of software: Microsoft Windows 1.03, SideKick 1.56, Turbo C 1.0, Quick C 1.0, and BRIEF 2.0. For hardware tests, I used my Everex Evercom 1200-bit-per-second modem and the Microsoft Bus Mouse. Everything worked fine with each computer.

The Small-C and Application benchmarks tell the whole story. The Everex Step 386/20 took the honors in the CPU test. This speed difference can be attributed to the SRAM cache combined with the fast 100-ns main memory. The Proteus 386A put in a good second-place performance, with the Tatung TCS-8000 showing a respectable third.

The FPU tests went hands down to the Everex Step 386/20—not surprisingly, since it was equipped with a 20-MHz 80387 while the other machines were running 10-MHz 80287 coprocessors. The File I/O test went to the Proteus 386A. It was running a 320-megabyte Maxtor with a very fast (13-ms) access time. The Video test gives the relative speed of the video cards; in this case, the Everex Step 386/20 (running—what else—an Everex card) was the leader.

The Application tests ranked the three in this order: Everex Step 386/20, Proteus 386A, and Tatung TCS-8000. The Everex Step 386/20 pulled ahead with the combination of its SRAM cache, fast math coprocessor, and efficient hard disk drive. The Proteus 386A placed a close second, with the Tatung TCS-8000 trailing the pack.

**Everex Step 386/20 Pulls Ahead**

If you're comparing machines by price, the Proteus 386A and Tatung TCS-8000 offer good value. The Proteus 386A has the advantage of a superior warranty, and you can order the computer with the options you want. But if you're betting on a performance and value horse race, the Everex Step 386/20 wins by several lengths. It features good performance and a convenient front panel, and it is manufactured and supported in the U.S. As these early entries into this high-speed market show, a careful selection of well-coordinated components can produce a true high-speed powerhouse system. ■

*Ed McNierney is a principal engineer at Lotus Development Corp. and lives in Groton, Massachusetts. He can be reached on BIX as "mced."*

**Tools and Toolboxes**  
**Modula-2**

**Applications Generator**

**Amadeus** \$ 395  
Generate Modula-2 programs directly from your own input, and save yourself hours of coding!

**Graphics**

**M2Graph\*** \$ 65  
Controls Hercules cards in Modula-2.

**M2EGA\*** \$ 65  
Controls EGA cards in Modula-2.

**Modula Graphics Toolbox I\*** \$ 112  
A collection of extremely fast graphics routines for CGA cards written in Modula-2.

**Modula Graphics Toolbox II\*** \$ 188  
Comprehensive package of Modula-2 procedures for all currently available graphics cards. Includes graphics window system, font generator, sprite handler, mouse driver, maths routines, as well as pie chart, histogram and line graph functions etc.

**Input/Output**

**LCR-Window Manager\*** \$ 133  
Fast, compact window system.

**M2Windows\*** \$ 188  
Fast, professional window system. Small, high-performance library with integrated menu system and simple mask generator.

**Modula Mask & Menu Generator\*** \$ 360  
Development system for creating masks and menus in Modula-2 source code. Mask, menu and frame editor. Supports all colours and attributes.

**Other Tools**

**M2 Prolib** \$ 495  
The professional library

**B-Tree ISAM** \$ 290  
Ultra fast database

**Pascal-Modula Converter** \$ 59  
Converts Turbo-Pascal to Modula-2.

**RTA-Utility Disk** \$ 30  
2-10x faster I/O, extended MathLib.

**EMS-Utilities\*** \$ 188  
Make full use of your Megabytes of memory expansion.

**M2IEEE-Interface\*** \$ 144  
Modula-2 interface to National Instruments IEEE interface.

This is only a small selection from our comprehensive list of tools for Modula-2. Demo disks are available for products marked with an asterisk. Send \$ 10 for three demo disks, \$ 20 for seven. There is also a wide choice of compilers and utilities for Modula-2.

Also available: Modula-2 compilers for the Amstrad 486, IBM/370, IBM/PC, IBM/PS/2, IBM/AT.

Texas residents add 8% sales tax. International Orders add \$ 20 shipping.

**The Modula-2 people:**



3336 Richmond, Suite 323  
Houston, TX 77098-9990 (713) 523 8422

**Dealer inquiries welcome**

International	
Austria: 0222/4545010	United Kingdom: 01/6567333
Belgium: 071/366133	Germany: 02983/8337;
France: 20822662	0731/26932;
Italy: 02/405174	0821/85737;
Scandinavia: +45/3/512014	04106/3998;
Switzerland: 01/9455432	0531/347121



A. + L. Meier-Vogt  
Im Späten 23  
CH-8906 Bonstetten/ZH  
Switzerland  
Tel. (41)(1) 700 30 37

# How fast is *Fast*?

Ten Times Faster\*

KONAN'S **TenTime™** Intelligent Caching Disk Controller

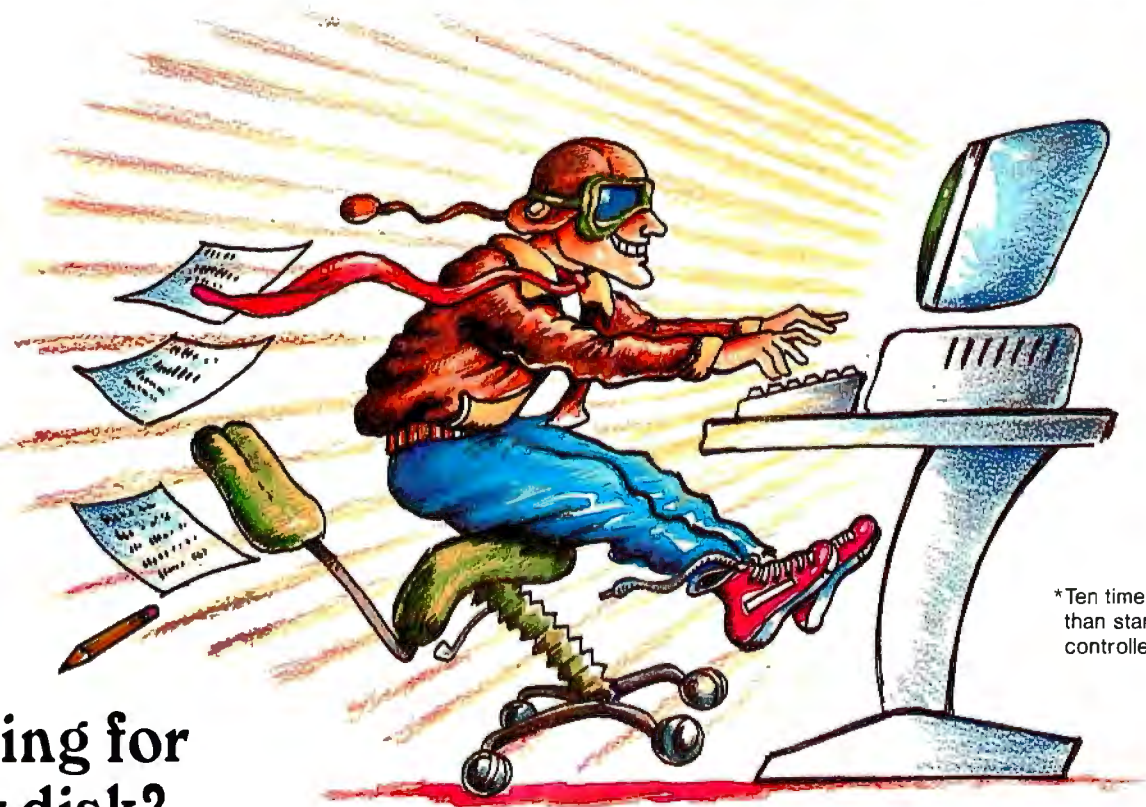

\*Ten times faster than standard AT 16 bit controller cards

## Waiting for your disk?

The *TenTime™* Controller eliminates disk bottlenecks.

- Zero Latency Time
- 1 to 1 Interleave
- Elevator Seeks
- Automatic Pread
- Optional Floppy Control

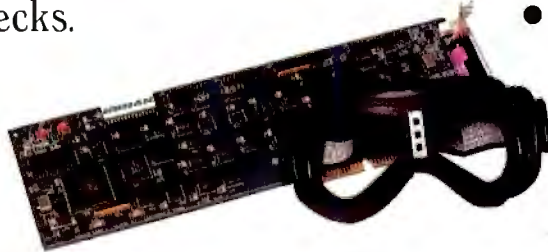

- 10X Faster Access Speed\*
- 3X - 10X Faster Throughput
- 4Mb/sec Transfer Rate+
  - 16 Bit AT Controller
  - On-board Cache Ram
  - DOS/Unix Compatible
- Intelligent Cache Routine

+data transfer from controller to PC

(goggles not included)

Available for IBM AT, Tandy AT and compatibles

Circle 122 on Reader Service Card  
(DEALERS: 123)

Leading Innovator Since 1978

# KONAN™

1829 West Drake Drive, Suite 103, Tempe, Arizona 85283, FAX 602-345-2829, (602) 345-1300

(602) 345-1300



# Four Surrogate Mice



Trackballs  
and trackwheels  
are becoming common  
for manipulating text  
and data

---

Jeff Holtzman

Clockwise from top left: the MicroSpeed PC Trac, MicroSpeed FastTRAP, Fulcrum Trackball Plus, and Lightgate Felix.

**I**ntrigued by graphic interfaces but hate mice? Then you might try one of the following four pointing devices to get the functionality of a mouse without the hassle. PC-Trac, FastTRAP, and Trackball Plus utilize optomechanical trackball technology; the fourth, Felix, employs a new optical data-tablet technology. I tested serial versions of these four devices on IBM and compatible equipment; PC-Trac and FastTRAP also come in bus versions, and a Macintosh version of Felix is available.

Generally speaking, mice have some advantages over trackballs, including smaller size and, often, better bundled software. Trackballs, however, are usually easier to control, so you may like them better than mice for more detailed operations. If you're used to a mouse, it may take a while for you to get used to a trackball. But after overcoming your ini-

tial resistance, chances are you'll enjoy using it.

MicroSpeed, the company that got its start in the DOS world with a clock-speed-enhancement accelerator, designed and manufactures both PC-Trac and FastTRAP (which stands for fast tri-axis pointer). These two devices are similar internally and externally—and they even use the same CMOS microcontroller. PC-Trac combines an optomechanical trackball with three buttons; to that configuration, FastTRAP adds an additional vertically oriented wheel, called a trackwheel, that also drives an optomechanical system. PC-Trac and FastTRAP sell for \$119 to \$169, depending on the version you choose.

The Fulcrum Trackball Plus, put out by Fulcrum Computer Products, is the Volkswagen of trackballs for personal computers. It combines low price (\$95) with many mouse and digitizing pad emulations, and less-than-perfect support for text modes. Budget-conscious buyers and those who require multiple emulations will find this a satisfactory, if uninspiring, product.

Cats hate mice, and Lightgate's electronic Felix is supposed to be a mouse killer. The documentation is full of near-religious fervor about Felix's merits. Hype aside, it turns out that Felix works acceptably for navigating text and graphics screens. Its software is a little rough, however: Depending on the application you're running, you must load various RAM-hungry drivers via a large batch file. And the documentation does little to help you figure out how to streamline the process of loading the drivers. But you will like the fact that Felix comes with a special Lotus 1-2-3 driver that makes it practical to use a pointing device with that program.

## PC-Trac and FastTRAP

The serial version of PC-Trac is available for \$119, the bus version for \$139. Fast-

*continued*

REVIEW  
FOUR SURROGATE MICE

Name	PC-Trac	FastTRAP	Trackball Plus	Felix
<b>Type</b>	Trackball	Tri-axis pointer	Trackball	Pointing device
<b>Company</b>	MicroSpeed, Inc. 5307 Randall Place Fremont, CA 94538 (415) 490-1403	MicroSpeed, Inc. 5307 Randall Place Fremont, CA 94538 (415) 490-1403	Fulcrum Computer Products 459 Allan Court Healdsburg, CA 95448 (707) 433-0202	Lightgate 6202 Christie Ave. Emeryville, CA 94608 (415) 596-2350
<b>Features</b>	Microsoft Mouse emulation in hardware, three buttons, ballistic-gain-control software, 200-dot-per-inch resolution; 10K bytes of memory used	Microsoft Mouse emulation in hardware, 2- and 3-axis operation, three buttons, ballistic-gain-control software, 200-dpi resolution; 10K bytes of memory used	10 mouse and digitizing tablet emulations, six buttons, power pack, 100-dpi resolution; 8K bytes of memory used	Two emulations, one button, 1-to-1 pointer-to-screen mapping, 1-2-3 and AutoCAD support, power pack, 320-dpi resolution; 40K bytes of memory used
<b>Size</b>	7½ x 4¼ x 2½ inches; 12 ounces; 6-foot cord	7½ x 4¼ x 2½ inches; 12 ounces; 6-foot cord	4½ x 5¾ x 1¾ inches; 4½ ounces; 4-foot cord	6 x 6 x 1 inches; 12 ounces; 7-foot cord
<b>Hardware Needed</b>	IBM PC, XT, AT, PS/2, or compatible with one floppy disk drive	IBM PC, XT, AT, PS/2, or compatible with one floppy disk drive	IBM PC, XT, AT, PS/2, or compatible with one floppy disk drive and a serial port	IBM PC, XT, AT, PS/2, or compatible with one floppy disk drive
<b>Software Needed</b>	MS-DOS 2.0 or higher	MS-DOS 2.0 or higher	MS-DOS 2.0 or higher	MS-DOS 3.1 or higher
<b>Documentation</b>	PC-Trac User's Guide; KeyMap User's Guide; "50 Things to Do with a Used Mouse"	FastTRAP User's Guide; KeyMap User's Guide; "50 Things to Do with a Used Mouse"	3-page installation instructions; 30-page technical manual	15-page installation guide; 17-page Lotus 1-2-3 guide
<b>Price</b>	Serial version: \$119 Bus version: \$139	Serial version: \$149 Bus version: \$169	\$95	IBM version: \$199 Macintosh version: \$149
	<b>Inquiry 889.</b>	<b>Inquiry 890.</b>	<b>Inquiry 891.</b>	<b>Inquiry 892.</b>

**Note:** The Macintosh version of Felix does not include Hot Spots. Versions for the Mac II and SE were due in July.

TRAP costs \$149 for the serial version; the bus version is \$169. Both devices use the same case, which is about 2½ inches high at the highest point. The feel of the trackball in both PC-Trac and FastTRAP is smooth and solid. I wish, though, that the FastTRAP trackwheel had more resistance and its switches required less pressure; these alterations would give it a more consistent overall tactile sense.

Because of their overall similarity, I'll discuss the two devices as one, distinguishing between them only when necessary.

When you rotate the trackball, in either the text or graphics mode, the position of a special on-screen cursor varies accordingly. When the cursor moves to a menu title bar or icon, you press a button to make the functions represented by that

menu or icon available for use. Further trackball movement lets you traverse the list of menu items; pushing a button then executes the currently selected function.

Text-mode programs seldom include drivers for pointing devices, so many pointer vendors include programs that enable their devices to at least emulate cursor-key motion. MicroSpeed, for example, includes a utility called KEYMAP.COM that allows trackball motion to send the cursor up, down, left, and right. This utility also lets you program each of the device's three push buttons to deliver a single keystroke. Each button can also be used alone or in combination with the Shift, Alt, or Control keys, giving you a total of 12 programmable button combinations to provide functions such as traversing the menu system of your spread-

sheet. However, there aren't enough button combinations to map every function of your word processor or spreadsheet. KEYMAP.COM would be much more useful if you could program multiple keystrokes for each button-key combination.

An editor also lets you define as many as 32 named sets of programmed key substitutions, which are maintained in KEYMAP.COM. To define more than 32 templates, you can create and save programs under different names, such as KEYMAP1.COM, KEYMAP2.COM, and so forth. MicroSpeed supplies key sets for WordStar, Lotus 1-2-3, Turbo Pascal, and several others.

You can operate both PC-Trac and FastTRAP either in a Microsoft Mouse-

*continued*

# COMPUTERS FROM IOWA?

Gateway 2000 is centrally located in order to efficiently serve the entire country. We are honest, hard working, well educated people, committed to succeeding and growing in the highly competitive micro-computer market.

Gateway 2000 is a full-service and support organization that realizes the key to our success lies in a satisfied customer base.

One look at the configuration we have listed below and you will see that we have high quality equipment at an incredible price. We have many different configurations available, so call one of our knowledgeable sales people, if you have any questions.

We look forward to doing business with you, and establishing a long term business relationship.



## 16 Mhz 286 EGA SYSTEM

80286-16 Processor  
1 Meg 80NS Ram  
1.2 Meg Floppy  
1.44 Meg Diskette Drive  
40 Meg Seagate ST251  
Samsung EGA Monitor w/Card  
2-Parallel/2-Serial Ports  
101 Key Enhanced Keyboard  
DOS 3.3 w/GWBasic  
1 Year Warranty  
30 Day Money Back Guarantee

**\$2295.00**

## 20 Mhz 386 VGA SYSTEM

80386 Processor Running at 20MHZ  
1 Meg 60 NS Ram (Expandable to 8 Megs)  
1.2 Meg Floppy Drive  
1.44 Meg Diskette Drive  
80 Meg Seagate ST4096 (28MS)  
WD 1006 Controller (1 to 1 Interleave)  
Samsung Multisynch Monitor w/VGA Board  
VGA/EGA/CGA/MDA/Hercules and 800x600 Modes  
2-Parallel/2-Serial Ports  
101 Key Enhanced Keyboard  
Tower Case w/275 Watt Power Supply  
80287 and 80387 Sockets  
DOS 3.3 w/GWBasic  
1 Year Warranty  
30 Day Money Back Guarantee

**\$3995.00**



Gateway 2000 • P.O. Box 2414 • Sioux City, IA 51107

**800-233-8472 / 712-255-7899**

Due to the volatility in the DRAM market, all prices are subject to change.

emulation mode or in native mode. With native mode, you can utilize FastTRAP's tri-axis capabilities. Microsoft mode is the default, but you can alter a DIP-switch setting to force booting in native mode. In Microsoft mode, you can program the middle button to emulate simultaneous depression of the two outer buttons.

Both devices provide an emulated drag mode. Without this feature, you might find it hard to drag a trackball, pressing the button with one finger while you rotate the ball with others. For example, to choose a block of numbers for formatting in Excel, you position the cursor at one corner of the desired range, initiate drag mode by pressing the middle button, move the trackball to select the desired spreadsheet cells, and terminate drag mode by pressing the middle button again.

The trackball is handy for navigating even a standard text-mode spreadsheet, such as VP-Planner. You can move by row or column much faster with the trackball than even by holding a cursor key down. And with FastTRAP, you can use the trackwheel to page up, down, left, or right, very quickly.

If you use WordStar 4.0, the trackball cursor movement is somewhat jerky. You will have better luck with other editors, such as the one in Turbo Pascal that allows the cursor to roam freely about the screen.

You can use FastTRAP's trackwheel in several ways. You can traverse menus without moving the cursor from the current position, traverse the third (z) axis in a CAD program, or, in conjunction with a utility supplied by MicroSpeed, page up and down in a spreadsheet or word processor.

Even if you're not doing three-dimensional CAD work, the trackwheel can come in handy. In AutoCAD, for example, to get at the command menus, normally you must move the drawing cursor (cross hairs) from wherever you are to the far right edge of the screen, make your selections, and then move the cross hairs again to wherever you need the cursor. With FastTRAP, simply rotating the trackwheel activates the menu; you can traverse it by using more rotation, selecting items as usual with the left button. When you move the trackball again, you pick up where you left off with the cross hairs. You must load a separate driver, however, to use AutoCAD and Windows in this mode.

### Software Drivers

You can install either device easily since they both emulate the Microsoft Mouse

## Test Setup

I tested each device in this review on two machines: an AST Premium/286 (10 MHz, zero wait states) with 1.5 megabytes of Expanded Memory Specification (EMS) 3.2 memory, a 40-megabyte hard disk drive (ST-251), an Orchid Designer VGA card, and an NEC MultiSync monitor; and an IBM PC XT with 1.5 megabytes of EMS 4.0 memory, a 20-megabyte hard disk drive (ST-225), a Hercules monochrome graphics card, and a Microsoft Mach 20 accelerator board.

On the AST, I used the following software to test each device: AutoCAD 9.0 (VGA mode), Windows 2.0 (in Orchid's proprietary 800- by 600-pixel, 16-color mode), and AutoSketch (EGA mode); under Windows, I tested several of the desktop accessories, as well as PageMaker 1.0a and Excel. On the IBM, I tested each device with VP-Planner, AutoSketch, and WordStar 4.0, all running under DESQview 2.01. I also tested compatibility with DESQview itself.

in hardware. If you have a Microsoft or compatible mouse, you just unplug the mouse and plug in FastTRAP or PC-Trac; the existing mouse driver will allow you to use it just as you would your mouse.

For best performance, you should take advantage of MicroSpeed's software drivers. You can load the drivers via CONFIG.SYS using MAP.SYS, or via AUTOEXEC.BAT using MAP.COM. With either driver, you can specify which serial port the device is connected to, among other parameters.

Driver versions 2.0 and higher allow ballistic gain control, a feature that provides dynamic speed and distance management. For example, when you rotate the trackball slowly, the pointer traverses only half the screen. But if you rotate the ball quickly over the same distance, the pointer traverses the whole screen.

FastTRAP's documentation consists of a well-written, well-organized 40-page manual that contains both an index and a table of contents. Beginners will find the information presented clearly and logically; advanced users will not find it insulting. Approximately half the book contains technical information on

how FastTRAP works, software protocols and functions, and even a wiring diagram for 9-pin and 25-pin serial ports. (Microsoft charges \$25 for this type of optional technical information.) A separate manual discusses how to use KEYMAP.COM.

Documentation for PC-Trac was not complete when I wrote this review. The review device came with the FastTRAP manual and semifinal PC-Trac-specific documentation. MultiSpeed says the finished version will be shipping by the time you read this review, and it will not include the FastTRAP manual.

A booklet of cartoons called "50 Things to Do with a Used Mouse" is sent free to PC-Trac and FastTRAP owners when they send in their warranty registration card.

### Trackball Plus

Although Trackball Plus is about the same height as the MicroSpeed devices, it has only about half the footprint. The device has a grand total of six push buttons, only some of which are available in any given emulation mode. You change modes by pressing various combinations of buttons, or by using STB.COM from the DOS command line.

Emulations include: mice from Microsoft and Mouse Systems; graphics tablets from Houston Instruments, Retrographics, Tektronix, Hitachi, and Summagraphics (ASCII and binary); and the USI Optomouse. Separate software drivers provide the proper program interface for the Microsoft and Mouse Systems emulations; for the others, the target application must have a built-in driver.

The Trackball Plus plugs into an RS-232 serial port; versions are available with both 9-pin and 25-pin connectors. A separate cable runs from the serial port connector to a wall-mount transformer that supplies the unit with power. After plugging in the hardware, you set the desired mode and then (if necessary) install the Microsoft or Mouse Systems driver. Both .COM and .SYS drivers are supplied for these two emulations. Fulcrum's drivers are unlike most mouse drivers that load at the DOS command line: You cannot remove them from memory without rebooting. When you try to install a different driver, you receive a Driver already installed message.

The trackball itself functions fairly well in graphics applications. It has a good feel, and on-screen motions are smooth. However, there is no way you

*continued*



# "An exceptional value."

Tom Badgett, *PC Clones*

"I was impressed.  
It wins the cost-effective award."

John Dvorak, *PC Magazine*

"This program has all the features and capabilities of money management programs costing 10 times as much."

Leonard Hyre, *PCM Magazine*

We appreciated those kind words. They helped make **MONEYCOUNTS® 4.0** one of today's most popular **accounting/money management programs** for home and business. But we couldn't leave well enough alone. So we're introducing new

## **MONEYCOUNTS® 5.0** ...an unbelievable buy at just \$29!

**MONEYCOUNTS® 5.0** balances your checkbook... prepares your budget... manages your cash, checking, savings, credit cards... prints 5 types of financial statements including net worth...3 types of inquiry reports... general ledger, accountant's trial balance, and graphics. Its fast financial data base handles up to 999 accounts and 100,000 transactions a year.

**MONEYCOUNTS® 5.0** is a CPA-designed money management/accounting system you can use for home or business. It's easy to use, requires no accounting knowledge, is menu-driven with on-line help, has a fast financial calculator, works with monochrome or color monitors, comes with a **printed manual** and is **not copy protected**.

**SAME DAY SHIPPING.** Order today and own **MONEYCOUNTS® 5.0** for only \$29! Add \$5 shipping/handling (outside North America, add \$10). Iowa residents please add 4% sales tax.



375 Collins Road NE  
Cedar Rapids, IA 52402

## **MONEYCOUNTS® 5.0** now also...



- prints any type of pin-feed check and updates your records automatically
- estimates your 1988 income tax
- analyzes financing options, savings programs...computes interest rates, loan payments...prints amortization schedules
- manages mail lists—zip and alpha sorts—and prints labels and index cards
- provides password protection, fiscal year support, and pop-up notepad.



VISA, MASTERCARD & COD ORDERS CALL

# 1-800-223-6925

(In Canada, call 319/395-7300)

			
Dept. B 375 Collins Road NE Cedar Rapids, IA 52402		<b>\$29 + \$5 shipping</b>	
NAME _____			
ADDRESS _____			
CITY _____			
STATE/ZIP _____		PHONE _____	
CHECK <input type="checkbox"/> MONEY ORDER <input type="checkbox"/> VISA <input type="checkbox"/> MASTERCARD <input type="checkbox"/>			
CARD # _____		EXP. DATE _____	
No. of Copies	Product	Price Each	Total
	MONEYCOUNTS® 5.0 (Needs IBM or compatible computer, at least 256k memory, DOS 2.0 or more, two disk drives or hard disk)	\$ 29.00	
	Shipping & Handling	\$ 5.00	\$ 5.00
TOTAL AMOUNT			\$ _____

## Inside the Trackballs

Both PC-Trac and FastTRAP use 24-pin CMOS microcontrollers from National Semiconductor's COPS (Controller Oriented Processor System) family. They contain the program, data, and temporary storage, as well as system timing and I/O control. Inputs to PC-Trac include three push buttons and two slotted optical encoders; FastTRAP is similar but has a third encoder plus a trackwheel and a shaft-mounted encoder wheel. The devices have identical cases, but a panel covers the unused trackwheel slot in PC-Trac.

Four transistors on a printed circuit board interface the input devices to the microcontroller; except for the push buttons, all the electronics are mounted on one other small printed circuit board. The two boards are interconnected by a four-conductor flex circuit. All subassemblies—the PC boards, encoder shafts, switch caps, and cable—are press-fit into the base of the case. Everything is nicely arranged, and the overall impression is one of quality design and manufacture.

Because of the devices' low power re-

quirements (a few milliamperes), they do not need a separate power transformer; as with most mice, they draw the power they require directly from the control lines of the port to which they are connected.

The COPS microcontroller is not interrupt-driven; rather, it continuously scans the six input ports. When it detects a switch opening or closure, or a trackball or trackwheel motion, it formats a message that it sends to the host computer via the serial port. In mouse mode, it sends a standard 3-byte message that contains button status and an 8-bit relative x,y displacement. In native mode, it adds a fourth byte that allows the transmission of third-button status and z-axis information from the trackwheel.

At the programming level, interface with the mouse driver is accomplished via the standard interrupt 33 hexadecimal. MicroSpeed's driver recognizes the standard Microsoft function calls (0 to 19), and it adds 11 extended functions of its own (64 to 74).

A look at the inside of Trackball Plus

showed that it was built with less elegance and economy than the MicroSpeed devices. The PC board is hand-soldered, and traces of flux were evident all over the board. An Intel 8051 running at slightly over 7 MHz provides the unit's intelligence. A separate 2764 (8K-byte) EPROM contains the control program and data. Like the MicroSpeed devices, the 8051 works on a polled (not an interrupt-driven) basis.

Lightgate was notably tight-lipped about Felix's internal operation. However, by both inspecting the device and talking with technical-support personnel, I was able to gather some information. Two orthogonal plastic slides with precision-etched slots serve to interrupt the beams between a pair of orthogonal optical encoders. A proprietary microprocessor then processes that information, formats it, and sends it to the host computer. The microprocessor senses changes in the pointer's velocity and alters the outgoing message rate, thereby varying on-screen response.

Layout, materials, and construction in Felix are all first-rate.

can adjust sensitivity, nor can you use ballistic gain control.

In the Microsoft mode, I found the sensitivity satisfactory under Windows and AutoCAD, but unsatisfactory under AutoSketch. In addition, in the Summagraphics Bit Pad One mode under the version of AutoCAD (9.0) used for testing, I got no results from operating the alternate cursor button, which should allow you to move the cursor between two locations. According to the manufacturer, this version of AutoCAD precludes the efficient use of the alternate cursor button. Like the MicroSpeed devices, the Fulcrum Trackball Plus supports a drag-emulation mode.

A separate program, SETCUR.COM, is supposed to allow the trackball to emulate cursor keys in text applications, but I found this emulation erratic when used under WordStar. It did work with XyWrite, however. The installation document states, "Use of this function with word-processing programs, where precise horizontal control is needed, may be unsatisfactory." It is. On the other hand, when I used just the supplied Microsoft-emulation driver, I had no trouble navigating DESQview's menus with Trackball Plus.

Ergonomically, the buttons aren't up to today's standards. They are awkwardly located and definitely biased toward right-handed users. In fact, I can't see how a left-handed person would be able to use them at all. You also have to use too much pressure to activate them.

A 30-page technical manual and a 3-page installation guide are included. Neither is written or produced in the style of most of today's manuals, and nontechnical users may have trouble finding the necessary installation information. However, the company says the documentation and the packaging are being redone, and by the time you read this, the updated documentation and packaging should be available.

### Felix

Protruding through the Felix low-profile hardware case is a single button mounted on a moving shaft. This button normally functions as the left mouse button; the right button is simulated by moving the shaft to the upper-left or upper-right corner and double-clicking. Right-handed and left-handed users will find it easy to use Felix since both corners are provided. When you double-click in the lower-right corner, Felix enters a "preci-

sion" mode in which cursor movement is restricted to just a portion of the screen. However, you have to press the button farther down compared to similar devices, and there is no tactile feedback to inform you when contact has been made. Thus, I found double-clicking under Windows to be slightly tiring.

Felix's software lets you change the button assignments and even move the buttons to the keyboard (i.e., using Felix just for positioning, and using keyboard keys to perform button functions). The software is supplied in both 5¼-inch (360K-byte) and 3½-inch (720K-byte) formats.

Felix's chief claim to fame is a 1-to-1 mapping with the screen (in nonprecision mode). When you move the pointer shaft to the upper-left corner of the 1.1- by 1.1-inch active portion of the device, the cursor will be in the upper-left corner of the screen. When you move the pointer to the lower-right corner, the cursor follows suit. In precision mode, a smaller portion of the screen is mapped to Felix, thereby allowing more accurate positioning in that portion of the screen.

Felix's secondary claim to fame is a feature called "Hot Spots." Hot Spots

*continued*

# This Software Won't Run.



## Without This.

And that's the way California Software Products, Inc. wants it. And a host of other big and not-so-big software developers who use our Software Sentinel. To make sure their successful software is protected. So it stays successful.

We've become used to being seen with top-notch software. A lot of the reason is how our engineers designed the Software Sentinel family. For the developer and the user. To make it the most technologically foolproof yet easiest to use software protection key you or CSPI can get.

For users of BABY/36 and the thousands of other programs we're protecting, it's a cinch to get up and running. They simply plug the Software Sentinel into the PC's parallel printer port. That's it. How much easier can it get?

Users can even make unlimited backup copies. And run them wherever and whenever they need to—as long as they have the Software Sentinel key.

As long as we're talking success, there's something else you should



know. Right now, our engineers are putting the finishing touches on a new microprocessor that we'll use in a whole new generation of software and data protection products. With the same high-performance and high-reliability of our past successes but with many new features. Which no doubt is going to make life even easier for you and CSPI.

The Software Sentinel. Making sure software developers stay successful with the successful software they've developed.

For more information on the Software Sentinel family, contact Rainbow Technologies, 18011-A Mitchell South, Irvine, California 92714; or call (714) 261-0228.

---

### **Software Sentinel Features:**

- Runs under DOS and Xenix
  - Uses algorithm technique, never a fixed response
  - Minimal implementation
  - Higher level language interfaces included
  - Transparent operation
- 

**\* The New SentinelPro™ – Half The Former Size, All The Features.**



**RAINBOW TECHNOLOGIES**

18011-A Mitchell South, Irvine, CA 92714 • (714) 261-0228 • TELEX: 386078 • FAX: (714) 261-0260

©1988 Rainbow Technologies, Inc. Software Sentinel and SentinelPro are trademarks of Rainbow Technologies, Inc.

BABY/36 is a trademark of California Software Products, Inc.

are locations at the perimeter of the pointing area that provide keyboard macro functions. By moving the pointer to a Hot Spot and clicking, you can insert a number of keystrokes into the currently running application.

There are 12 Hot Spots. You can activate each alone or in combination with the Control, Alt, or left or right Shift key, for a total of 60 Hot Spots. Felix comes with a number of predefined sets of Hot Spot macros, an editor for creating your own, and a print utility for displaying and printing them. The Lotus and AutoCAD Hot Spot macros are extremely useful for getting at often-used functions quickly.

You can utilize Lotus macros remarkably well, so it is practical, and even desirable, to use Felix with the spreadsheet. For example, moving the pointer into the upper-right corner sends a slash (/) keystroke, activating 1-2-3's familiar horizontal menu.

Other Hot Spots let you move to the beginning or end of the spreadsheet, scroll by row or column, or make large jumps to distant areas of the spreadsheet. Hot Spots that you activate in conjunction with the Alt key let you execute common Lotus functions (e.g., learn and recall modes, and paging up, down, left, and right). You can add 36 custom macros to the other Hot Spot layers.

According to the manufacturer, cursor positioning is erratic under DESQview and programs running under it, so I ran my test software directly from DOS. Lightgate is presently working on drivers for Microsoft Windows/386.

Except for the less-than-desirable tactile feedback for the push button, Felix's overall feel is quite nice. The pointer slides easily, and I had no trouble positioning it accurately on the 800- by 600-pixel enhanced VGA screen. Lightgate is correct when it says that the 1-to-1 pointer/cursor mapping can aid productivity.

### Running an Application

To run an application with Felix, you move to the application's subdirectory and load Felix drivers, followed by the application itself. For example, to load AutoCAD, you would move to its subdirectory and type `C>FELIX ACAD`. This Felix command actually invokes a fairly lengthy batch file—more than 100 lines in the version tested—that does conditional testing to determine which application you're loading, and then loads the appropriate drivers.

MOUSE.EXE is used for most applications, but FLXACAD.EXE loads drivers for

AutoCAD and AutoSketch, and FLX-123.EXE loads the Lotus (or 1-2-3) driver. Another program loads the Hot Spot macro file for the selected application. Then the application itself is run.

Processing a long batch file is inefficient; a shorter batch file for each application would be an improvement. To speed things up, you can move the appropriate lines for your application to a separate batch file. To avoid unnecessary waiting, Lightgate should have either supplied separate batch files to load each application or written a single software driver that supports all—or at least most—applications. The supplied drivers generally occupy about 40K bytes of memory, about 3 to 5 times as much as most mouse and trackball drivers use.

You install Felix by plugging the cable into your 25-pin serial port (or into the supplied 9-pin-to-25-pin adapter, which is then inserted into the port), plugging a small power transformer into an AC outlet, and then inserting the coaxial power plug into the rear of the 25-pin connector.

An installation program copies files to a subdirectory called \FELIX on the user's disk. The program also adds that directory to the path statement in your AUTOEXEC.BAT file. The old version is saved as AUTOEXEC.OLD.

According to the manufacturer, a new version (1.05) is due out by the time that this article is in print. Lightgate says the new version will feature support for relative mode, for programs such as Dr. HALO.

The quality of the documentation is not as good as the quality of the device itself. Here's an example of the gibberish that permeates the main manual: "Felix buttons use an innovative technology which is about to change your pointing life. Their operation is based on the kinesthetic space created by the little square which is Felix's travel area. The implementation is our ergonomically informed solution to the challenges and hazards of input device use."

Even the sections in which the company really is trying to present useful information are difficult because of the verbose, self-conscious writing style. To get the device working, I found the READ.ME file and the FELIX.BAT file to be more useful. All in all, the manual needs to be thoroughly reworked to make it easier to understand how to set up and use Felix.

A separate manual covers using the special 1-2-3 driver software. You will find it more informative and less filled with rhetoric than the main manual.

### Trackball versus Mouse

If you need a pointing device, first you must choose between a mouse and some other device. The main disadvantage of a mouse is that you must have some clear space on your desk on which to operate it. All the devices discussed here overcome that problem. A trackball can also be advantageous for fine, detailed work, because it's easy to control the ball with your fingertips. Some mice, however—the new Microsoft Mouse in particular—are light enough to make fingertip control possible. Overall, I prefer a mouse because it's smaller and easier to handle.

If you decide against a mouse, Fulcrum's Trackball Plus is easy to set up and use, and it is the least expensive device of its type. A developer desiring information on the software protocols of the emulated devices might buy one for the documentation alone, because software protocol data regarding the various devices is all conveniently collected in this one manual. However, Trackball Plus suffers from its lack of support for text modes, its nonergonomic buttons, and its right-handed bias.

Despite its problems, Felix is an intriguing device. Its positioning system and Hot Spot macro system are top-notch. You will find the push button less than perfect, however, as is the collection of software drivers. With more compact and elegant drivers, rewritten documentation, and some form of tactile feedback on the button, Felix will be a product to contend with.

Currently, however, the MicroSpeed devices are my favorites. Both are well designed, engineered, and manufactured, and neither requires a bulky and inconvenient external power transformer. The documentation is excellent, the plug-in-and-go Microsoft emulation makes it easy to get started, and the ballistic-gain-control drivers provide a long-missing capability for MS-DOS machines.

FastTRAP costs \$30 more than PC-Trac. Viewed simply as a mouse replacement, it may not be worth the extra expense. But if you are working with AutoCAD or want a fast way of paging through your word processor or spreadsheet, it is worthwhile. Other developers are working on FastTRAP drivers that may also justify the extra expense. ■

---

*Jeff Holtzman owns Publishing Concepts, a firm that specializes in evaluation, verification, and documentation of high-technology products. He lives in Ann Arbor, Michigan, and can be reached on BIX as "editors."*



Unretouched Screen Images

## Buy The One On The Left And You'll Have To Put It Where The Sun Don't Shine.



The monitor on the right, however, can be placed anywhere you like. Even in direct sunlight. It's the new *Flat Technology Monitor* from Zenith Data Systems—winner of *PC Magazine's* coveted "Technical Excellence Award" in the hardware category for 1987.

### You Have To See Zenith To Believe It

So clear. So precise. So lifelike. It's the only monitor with a completely flat screen. A breakthrough that has redefined monitor quality forever. Industry experts are already convinced. And once you see it in person, you'll be a believer, too.

### Bigger, Brighter, Glare-Free

Our Flat Technology Monitor has an impressive 14-inch display. And even though it's bigger, it's 50% brighter than conventional CRT's and it has 70% greater contrast. So you get colors with greater depth and definition that make your reports, charts and graphs come alive like never before.

The Flat Technology Monitor is virtually glare-free. So you can work longer without the usual headaches

and eyestrain. And that means greater productivity. But to get the whole picture, you have to see it with your own eyes.

### Backward And Forward Compatibility

You also get full compatibility with the high resolution VGA Video generated by IBM's new PS/2® computers. And with Zenith's Z-449 or other VGA-class video cards, you can enjoy CGA, MDA, Hercules and EGA graphics as well.

### Experience Zenith's Latest Technology Breakthrough

Obviously, a mere picture can't do justice to our new Flat Technology Monitor. It demands a face-to-face evaluation. For a hands-on demonstration, call today for the name of your nearest authorized Zenith Data Systems dealer—the Flat Technology Monitor is available in quantities right now.

**1-800-553-0305**

**ZENITH** | **data systems**

THE QUALITY GOES IN BEFORE THE NAME GOES ON\*

# PICK BIX BRAINS

## ... With a 10 Day Trial Membership

If you've thought about joining BIX before but weren't sure it was what you needed, now is the time to try it. Because now for a limited time, we're inviting you to try BIX for 10 days. If at any time during this 10 day trial period you don't feel BIX has made you a more knowledgeable microcomputer user, we'll refund your entire registration fee. You pay only for time spent on the system.\* (See log-on instructions for hourly rates).

Explore BIX in your home or office. Put its power to work for you and unleash your full microcomputer potential — programming, designing, specifying, researching — and more.

Try BIX for 10 full days and see what it can do for you. Explore more than 160 conferences. Access vendor support. Speak to expert consultants. Research new products and systems, and download public domain software.

### Prepare yourself for success

It takes a sharp mind and hard work to stay ahead, and having the right tools helps.

Today, you can put one of the most powerful instruments for career advancement to work for you: BIX.

- Learn about new products before they hit the market.
- Get quality marketplace feedback on the products you're thinking of purchasing before you invest.
- Research problems and find the solutions that no one else has been able to render.
- Access some of the most advanced public domain software available in the industry.
- Increase your working knowledge of micros to make more confident purchasing decisions and recommendations.

### Join BIX and arm yourself with the latest in microcomputer-related information

BIX's exclusive *Microbytes* newswire gives you complete, daily, up-to-date computer industry information. You'll gain insight from BYTE editors and writers who analyze new products and their potential impact, inform you of the latest mergers and acquisitions, and report late-breaking news from important seminars and conferences.

### Talk to colleagues worldwide

You'll stay on top of your company's

business with BIX's electronic mail service.

"Talk" to your east coast, west coast — even European — contacts all in the same day.

Or, simply communicate with other BIX users worldwide. Share information and ideas privately, or in conference.

### Choose any option for online access with a one time \$39 membership fee

- Use MasterCard, VISA or American Express and begin your 10 day trial use of BIX right now.
- The 10 day trial also applies if you open an individual pre-paid account on BIX. Trial commences once we open your account and notify you.
- Other billing options including qualified corporate accounts are available. (Sorry, our 10 day trial is not available for these accounts.) Call or write BIX for details.

Use credit cards for immediate access or call the BIX Helpline for information on any other payment option at, 1-800-227-2983 (from U.S. and Canada) 603-924-7681 (in New Hampshire and elsewhere).

Act now! Our 10 day trial offer is subject to cancellation at any time.

\*To notify BIX that you wish to discontinue service at any time during the trial period, call the BIX Helpline, and your entire membership fee will be refunded.

\*\*BIX can be accessed via Tymnet throughout the U.S. and Canada. For the Tymnet number nearest you, call the BIX Helpline or Tymnet at 1-800-336-0149.

†If your local Tymnet number is a toll call you will receive additional charges from your local phone company at their prevailing rate.

††Continental U.S. Tymnet rates. Rates from other areas are available from BIX.



### BIX is easy to join

To log-on to **BIX**, simply:

Set your computer's telecommunications program for full-duplex, 8-bit characters, no parity, 1 stop bit OR 7-bit characters, even parity, 1 stop bit. Use 300 or 1200 baud.

Call your Tymnet number \*\* and respond as follows:

<b>Tymnet Prompt</b>	<b>You Enter</b>
Garble or request for "terminal identifier"	a
login:	bix<CR>
<b>BIX</b> logo/name:	bix.038 <CR>

Callers outside the U.S. who have a communicating computer or terminal and a packet switching account with their host country phone system

can reach **BIX** by entering 310690157800. To commence registration, enter the code listed at the **BIX** logo/name: prompt.

After you register, you'll automatically be taken to the **BIX** Learn Conference, an online tutorial that will show you how to begin using the system immediately. Time spent in the Learn Conference is FREE. Complete system documentation will be sent to you within a few days.

Access time will be billed at the following hourly rates.†

**Off-Peak Time** \$11/hr. (\$9 **BIX**, \$2 Tymnet)††  
(7 PM - 6 AM weekdays, all day weekends and holidays)

**Peak Time** \$20/hr. (\$12 **BIX**, \$8 Tymnet)††  
(6 AM - 7 PM weekdays)

# **BIX**

BYTE INFORMATION EXCHANGE

One Phoenix Mill Lane  
Peterborough, NH 03458

# MIRROR II™ MIBBOB II™

Crosstalk XVI®  
Users Call 1-800-634-8670  
For A Unique Upgrade Offer

## YOU WILL

**L**ike this Russian Doll, a careful inspection of MIRROR II will reveal layer upon layer of carefully crafted features designed to provide you with the best solution to today's and **tomorrow's** data communication problems.

MIRROR II (the Crosstalk® SuperKlone) provides a superior reflection of the best in Crosstalk XVI®, at a fraction of the cost. MIRROR II comes complete with a superset of the Crosstalk XVI® Script language. This Scripting capability and MIRROR II's background communications mode gives you the power to fully automate your PC communications, and the freedom to use your PC for other tasks while sending or receiving data.

- Background communications mode (call or answer)
- File transfer protocols including Xmodem (Batch, CRC or Checksum), Crosstalk®, Hayes®, Ymodem and Kermit
- Terminal emulations for DEC VT-100 / 52, IBM 3101 (character or block mode), Televideo 910 / 920 / 925 (character or block mode), Adds Viewpoint, ADM-3A, Data General D210, ANSI and Honeywell VIP7200
- Learn mode for the automatic creation of auto-logon Scripts
- Full screen Wordstar-like text editor
- Site License (the cost effective way to standardize)
- 60-Day, No Questions Asked Money-Back Guarantee

**\$69.95** To order, call Toll-Free:  
**1-800-634-8670**

(In Florida call 904-878-8564). Visa / MasterCard / COD. \$5.00 for Shipping and Handling (\$8.00 for COD orders) Florida residents please add 5% sales tax.

MIRROR II and SoftKlone are trademarks of SoftKlone Distributing Corp. / IBM is a registered trademark of International Business Machines Corp. / WordStar is a registered trademark of MicroPro International / Crosstalk and Crosstalk XVI are registered trademarks of Digital Communications Associates Inc. / Hayes is a registered trademark of Hayes Microcomputer Products Inc.



## MIRROR II™

*A Better Reflection*

**SOFTKLONE™**

336 Office Plaza Drive  
Tallahassee, Florida 32301  
Telephone: (904) 878-8564  
Telex: 6714280 KLON

MIRROR II is designed for use on IBM and 100% compatible microcomputers (including the IBM PS/2 line) running MS-DOS / PC-DOS 2.0 or higher and is not copy protected.





# Unix for the Mac II

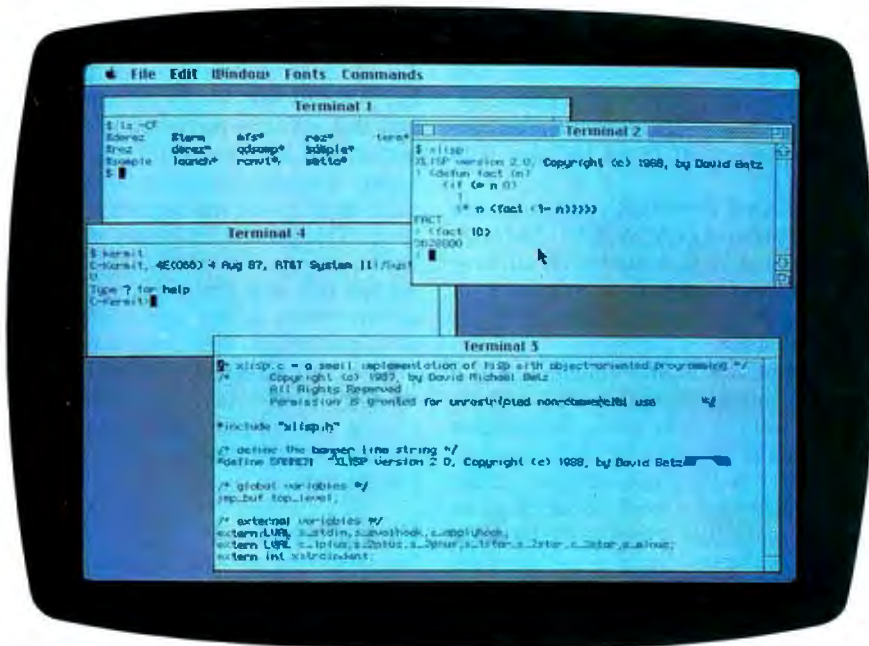

With A/UX,  
the Mac II becomes a  
low-end workstation

David Betz and Eva M. White

**S**ure, the Macintosh II's hardware is as powerful as some workstations, and it even uses a 16-MHz 68020 like the Sun and Apollo workstations. But before you call the Mac II a real workstation, you need to add a powerful operating system that supports multitasking, virtual memory, and networking to a variety of machines: one like Unix, for instance.

That's exactly what Apple's A/UX 1.0 is all about. It's a port of AT&T Unix

System V Release 2 for the Mac II. However, A/UX differs from most other workstation versions because it is based on AT&T System V instead of Berkeley 4. To maintain compatibility with other workstations, A/UX includes important Berkeley Standard Distribution (BSD) 4.2 and 4.3 extensions, such as signals and sockets.

A/UX supports up to two additional users (using the Mac II's serial ports) and the ability to network across an Ethernet using NFS (Network File System) and TCP/IP (Transmission Control Protocol/Internet Protocol).

What really makes A/UX different from most other versions of Unix is that it gives you the ability to run Mac applications and to access the Mac's user interface Toolbox ROM routines. With these routines, you can write a Unix application with a Mac windowing interface. Unfortunately, this initial release does not provide a point-and-click windowing interface to Unix similar to that of the

Mac operating system. In A/UX 1.0, you can run only one Mac application at a time, and the Toolbox routines don't yet support the Finder, desk accessories, or the printing manager (see "Unix and the Mac Interface" by Rick Daley on page 89 of the *Macintosh Special Edition*.)

To run A/UX, you need a Mac II with a minimum of 2 megabytes of memory and a paged memory management unit (PMMU). A/UX comes installed on an Apple 80SC 80-megabyte hard disk drive. You can get it on either an internal (\$4879) or external (\$4979) drive. If you buy it on an external drive, you'll also need an Apple small-computer-system-interface cable system to attach it to the Mac. Also, if you plan to use A/UX as a multiuser system, Apple recommends adding 2 megabytes of memory for each additional simultaneous user. You will also need an EtherTalk card.

The 80-megabyte hard disk drive comes preformatted into five partitions: a small Mac Hierarchical File System (HFS) start-up partition (2 megabytes), a large (56-megabyte) partition that comprises the root (/) and user (/usr) Unix file systems, and a 14-megabyte partition that Unix uses as swap space. The remaining two 3-megabyte partitions hold duplicate copies of the eschatology file system, which are used by the auto-recovery utility.

## Using A/UX

Starting A/UX involves booting the Mac operating system from the start-up partition and then launching the sash stand-alone shell application. You can choose to either make sash the start-up application or just double-click on the sash icon. Sash opens a window and starts a countdown timer that, if allowed to complete the 10-second count, will then start the Unix boot sequence. Interrupting the counter will drop you into the stand-alone shell.

While the main function of sash is to

*continued*

## A/UX 1.0

### Type

Multitasking operating system

### Company

Apple Computer, Inc.  
20525 Mariani Ave.  
Cupertino, CA 95014  
(408) 996-1010

### Format

Apple 80SC 80-megabyte hard disk

### Language

C and assembly

### Hardware Needed

Mac II with a minimum of 2 megabytes of memory and a 68851 PMMU

### Documentation

Getting Started with A/UX  
A/UX System Overview  
A/UX Installation Guide  
A/UX Command Reference (A-L)  
A/UX Command Reference  
(M-Z and Games)  
A/UX Programming Languages  
and Tools, Volumes 1 & 2  
A/UX Programmer's Reference  
A/UX Local System Administration  
A/UX System Administrator's  
Reference  
A/UX Text Editing Tools  
A/UX Text Processing Tools  
A/UX Communications User's Guide  
A/UX User Interface  
A/UX Toolbox: Macintosh ROM  
Interface

### Price

Monochrome system: \$9297  
Color system: \$9897  
Internal upgrade: \$4879  
External upgrade: \$4979

### Inquiry 904.

load Unix, you can also use it to manipulate the files in the A/UX file systems, or the files in either of the two eschatology file systems. Sash provides a subset of the standard Unix file manipulation tools, including mv, cp, and ed, as well as the file system checker fsck and the file system debugger fsdb. Other uses for sash are to partition hard disks, to build A/UX file systems, and to change kernel-tuning parameters.

### Standard Unix

A/UX comes with all the standard Unix tools for software development, text

processing, and communications. The software development tools include compilers for C and FORTRAN, an assembler and linker, a source code control system (scs), a program maintenance utility (make), a parser generator (yacc), and a lexical analyzer generator (lex).

The text-processing tools include the vi text editor and the nroff and troff text formatting utilities. Apple also includes a utility license from Adobe to convert the output of troff to PostScript.

For communications, A/UX provides uucp, the Unix-to-Unix copy program, and its associated utilities, which allow multiple Unix systems to communicate through ordinary dial-up connections as well as by hard-wired serial links. The uucp software is the basis of the worldwide Usenet network. However, the Usenet software itself is not included with A/UX.

The system comes with public domain software source code for GNU EMACS, Kermit, and Unix compression utilities. This software takes up 9 megabytes of disk space, and you can delete it if you need the space.

A couple of features unique to A/UX are the auto-configuration and auto-recovery utilities. The auto-configuration utility simplifies the normal Unix procedure for installing new devices. Under Unix, installing a new device requires editing make files, copying the required drivers, and rebuilding and installing the kernel. To install an A/UX-supported device, you need to shut down A/UX, power off the Mac, install the hardware, bring the system back up using the device's installation disk, and run the installation program on the disk. This installs the driver software and reboots A/UX. When A/UX comes back up, the auto-configuration utility rebuilds the Unix kernel to add the new device driver software and then reboots again with the newly created kernel.

The auto-recovery mechanism is intended to guarantee that you can boot Unix into multiuser mode even after fairly severe file system damage has occurred. This mechanism uses the eschatology file systems to maintain backup copies of all critical Unix files. If, during the boot process, the recovery program detects that any of these files are missing from the main Unix file systems, it replaces them with copies from the recovery file systems. The auto-recovery program also checks for bad blocks on the disk and fixes file protection and ownership on critical files.

The sash utility handles the auto-recovery features of A/UX. If sash has

trouble performing the Unix boot sequence, it invokes an auto-recovery procedure. The full auto-recovery takes about 45 minutes, but you can reduce this time significantly by disabling the block check portion of the auto-recovery process. Even in the case of an abnormal shutdown, like a power failure, the Unix fsck utility that runs as part of the start-up sequence can usually fix most problems without having to resort to the lengthy auto-recovery process.

To test the auto-recovery utility, we renamed the kernel (/unix) to /unix.save and attempted to reboot the system. When the reboot failed, we invoked the auto-recovery program, which restored the kernel from one of the recovery file systems. We found out the hard way that any time you rebuild the kernel, you should be sure to run the two programs /etc/eu and /etc/eupdate to update the files on the recovery file systems. This procedure is only mentioned in the ReadMe file on the hard disk. We missed this step the first time, and the auto-recovery utility was unable to restore the kernel. Also, somehow in the process, we managed to delete the backup copy. Fortunately, we were able to use the sash copy utility to move the kernel manually from one of the recovery file systems.

### Backup strategies

The auto-recovery mechanism is not a substitute for making regular backups, since it can restore only critical system files. It makes no attempt to restore user data files or programs. Auto-recovery is intended only to get the system back up and running after serious failures so that you can use normal backups to reconstruct the complete system.

Another good reason for making a backup is that when A/UX boots for the first time, it starts out in what is known as single-user mode. In this mode, all the Unix file protection is disabled, and it is very easy for an inexperienced user to do significant damage to crucial files. The safest approach would be to make a backup copy of the 50-megabyte Unix file system using one of the several Unix backup utilities supplied, such as CPIO.

Unfortunately, performing a backup isn't easy. The only backup medium A/UX 1.0 supports is the 800K-byte floppy disk drive (version 1.0 does not support the cartridge tape drive). Since there are about 45 megabytes of files on the system as distributed by Apple, a full backup requires approximately 56 800K-byte floppy disks.

*continued*

# We Just Made Choosing Your Graphics Card



## As Easy As 1,2,4.

You've probably seen our TrueVista products, or you've heard about their powerful features like the real-time frame capture, on-board TI 34010 coprocessor, large frame buffer, NTSC/PAL compatibility and more. Recently, we announced several new products in the series, each with unique potential for your

applications from video to digital pre-press to image processing. So now, whether your choice is an AT-class platform or the Macintosh® II, you only need one source for your graphics needs, the TrueVista series. The chart below outlines several key differences in the 5 products.

### TrueVista Series

FEATURES	ATVista 1M	ATVista 2M	ATVista 4M	NuVista 2M	NuVista 4M
<b>BUS</b>	AT	AT	AT	NuBus	NuBus
<b>MAXIMUM</b> 32 bits/pixel	512 x 512	1024 x 512	1024 x 1024	1024 x 512	1024 x 1024
<b>ADDRESSABLE</b> 16 bits/pixel	1024 x 512	1024 x 1024	2048 x 1024	1024 x 1024	2048 x 1024
<b>RESOLUTIONS</b> 8 bits/pixel	1024 x 1024	2048 x 1024	2048 x 2048	2048 x 1024	2048 x 2048
<b>VMX EXPANSION</b>	2-10 Mbytes	2-10 Mbytes	2-10 Mbytes	TBA	TBA
<b>PRICE</b>	\$2995.	\$4250.	\$5995.	\$4250.	\$5995.

### Now There's Software You Can Count On, Too.

To complete the equation, add in STAGE™, our comprehensive graphics environment for the 34010. Since STAGE is host-independent, it allows you to access the coprocessor directly, regardless of the bus. So your program on the AT can be quickly ported to the Macintosh II. Customers will not be tied to one platform either, as files and programs will be compatible across both hosts. STAGE is currently available for the ATVista series, and will be available soon for the NuVista as well.

With the new members of the TrueVista family and the release of STAGE, you now have everything you need to develop exciting new products for the next generation of computer graphics. And many applications are already appearing to assist you in your immediate needs. Contact us to learn more about our products or our third-party developer program and the support available to you. You'll soon see how you can count on Truevision to provide all your graphics solutions.



**TRUEVISION** INC.

7351 Shadeland Station, Suite 100, Indianapolis, IN 46256 800/858-TRUE

INTERNATIONAL: Canada 416/499-9400 France 33-13-952-6253 Italy 39-2-242-4551 Switzerland 41-1-825-0949  
U.K. 44-1-991-0121 West Germany 49-89-612-0010 Other 617/229-6900

Prices quoted are US Domestic suggested retail prices. Macintosh is a registered trademark of Apple Computer, Inc. **Circle 244 on Reader Service Card**

### Macintosh Toolbox Support

Apple supplies several tools with A/UX to support developing applications that use the Mac interface. You use a utility called `mfs` to move files between the Mac operating-system environment and

A/UX. This utility is not capable of handling HFS floppy disks, so you must format 800K-byte floppy disks as Macintosh File System (MFS) volumes. The launch utility runs applications that were built in the Mac operating system and

moved over with `mfs`. You can debug Mac applications using the standard Unix debuggers `adb(1)` and `sdb(1)`.

The launch utility successfully ran MacPaint 2.0 and MacDraw 1.9.5, but MacWrite 5.0 bombed, giving a memory-fault error. However, the error didn't disable the machine in any way.

A/UX comes with a resource compiler (`rez`) and decompiler (`derez`) whose source files are compatible with their counterparts in the Mac Programmers' Workshop (MPW). The `rez` utility translates resource description files to binary files that resource-manager functions in the Toolbox ROM can use. These resources describe the windows, menus, and dialog boxes that are familiar parts of all Mac applications. The decompiler translates binary resource files back to source form. It is useful for making alterations in existing resource files without having to reconstruct the entire file from scratch if no source is available for it.

There are two approaches to developing A/UX applications that use the Toolbox. You can develop them under the Mac operating system using the tools there, transfer them to A/UX using `mfs`, and run them using the launch. Or, you can develop, debug, and run them using A/UX tools. Figure 1 shows the library and header files that make up the Toolbox and, graphically, how you construct the code portion of an application under A/UX. Figure 2 shows how you construct the resource file. (Under the Mac operating system, the code portion and resource portion are stored together; under A/UX, these two pieces are in separate files.)

To build an A/UX application, you must include the appropriate header files in your program source and then link with the Toolbox files `libmac.a`, `low.ld`, `low.o`, and `macrt0.o`. The library `libmac.a` contains the entry points for the Toolbox functions and variables; `low.ld` and `low.o` arrange access to the Mac low-memory globals; and `macrt0.o` initializes the Toolbox interface and the trap dispatch tables and then invokes the main routine of the application.

The initialization code also opens a special device driver, called `/dev/uinter0`, that sets up access to the screen buffer, handles events in a manner similar to the event manager in the Toolbox ROM, tracks the cursor, and sets up the A-line trap handler.

Applications access the Mac Toolbox ROM by issuing A-line trap instructions. A/UX handles these trap instructions by

*continued*

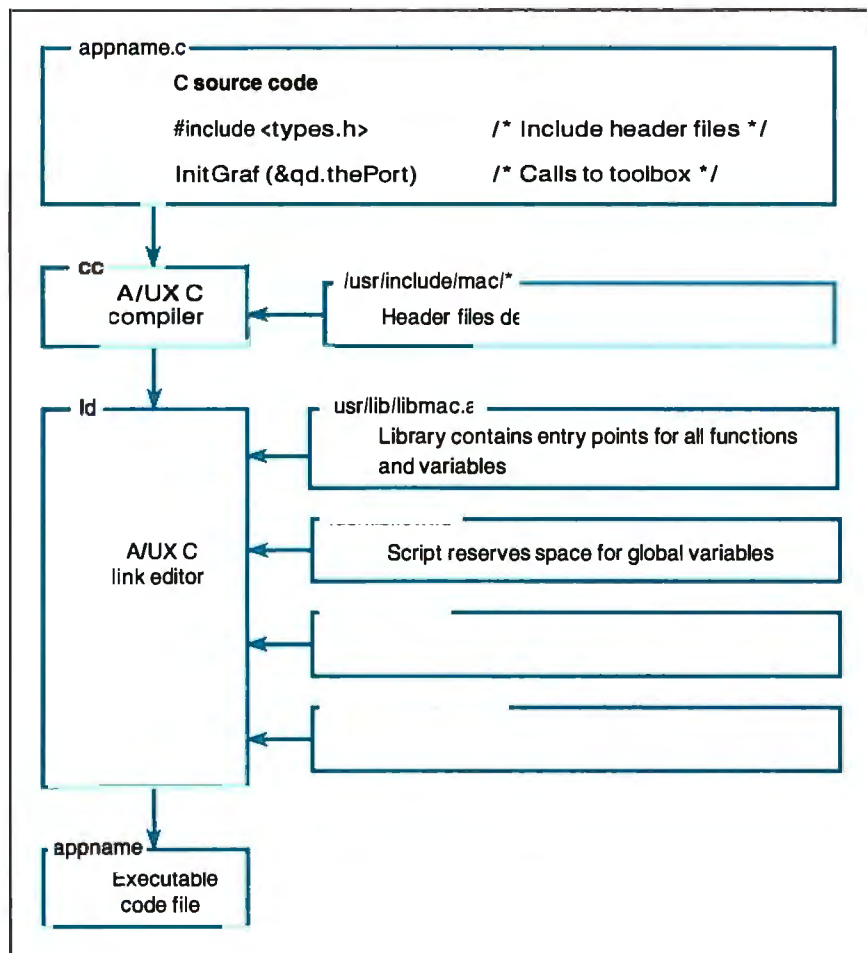

**Figure 1:** The steps involved in creating an A/UX application that uses the Mac ROM.

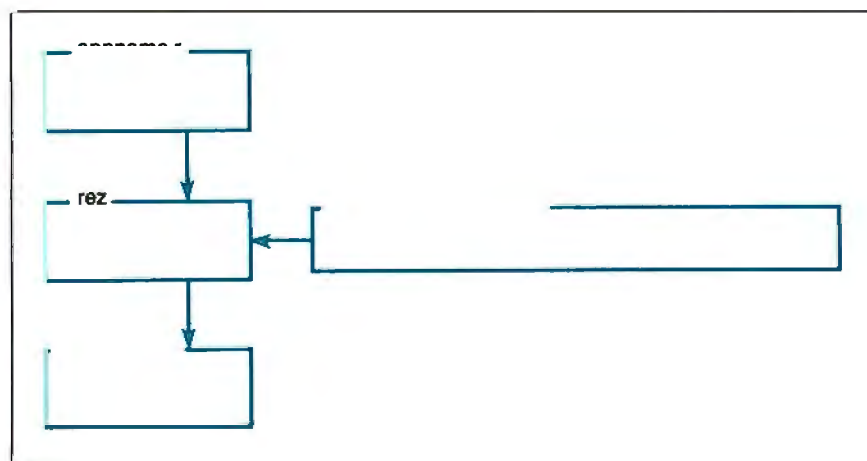

**Figure 2:** The steps involved in creating a resource file.

# Systat. Because other statistics and graphics packages are not enough.

Systat now offers more statistical graphics than any other PC or mainframe package. And we still give you less bulk with more statistics.

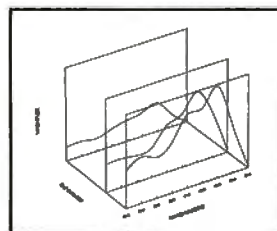
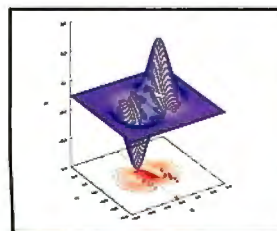
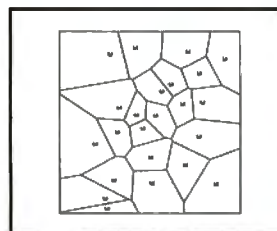
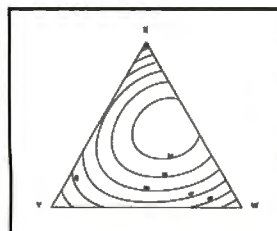
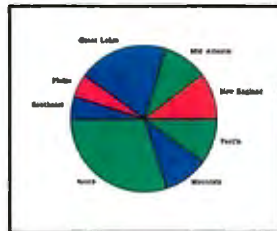
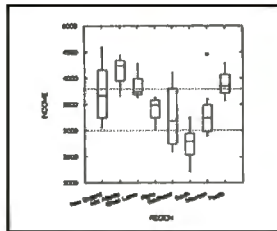
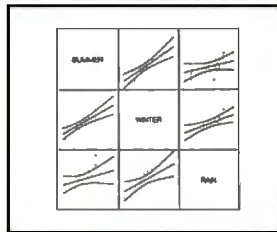
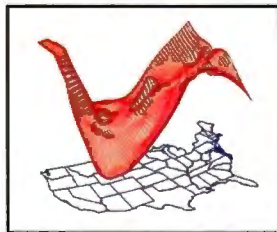
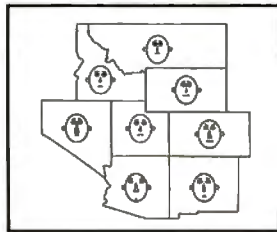
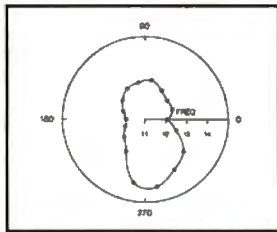
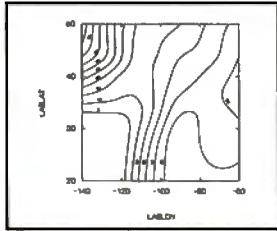
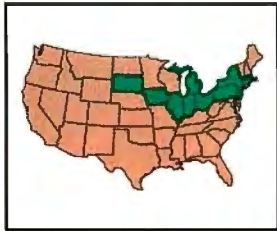

## Statistics

Basic statistics, frequencies, t-tests, post-hoc tests  
 Multiway crosstabs with log-linear modeling, association coefficients, PRE statistics, Mantel-Haenszel, asymptotic standard errors  
 Nonparametric statistics (sign, Runs, Wilcoxon, Kruskal-Wallis, Friedman two-way ANOVA, Mann-Whitney U, Kolmogorov-Smirnov, Lilliefors, Kendall coefficient of concordance)  
 Pairwise/listwise missing value correlation, SSCP, covariance, Spearman, Gamma, Kendall Tau, Euclidean distances, binary similarities  
 Linear, polynomial, multiple, stepwise, weighted regression with extended diagnostics  
 Multivariate general linear model includes multi-way ANOVA, ANOCOVA, MANOVA, repeated measures, canonical correlation  
 Principal components, factor analysis, rotations, components scores  
 Multidimensional scaling  
 Multiple and canonical discriminant analysis, Bayesian classification  
 Cluster analysis (hierarchical, single, average, complete, median, centroid linkage, k-means, cases, variables)  
 Time series (smoothers, exponential smoothing, seasonal and nonseasonal ARIMA, ACF, PACF, CCF, transformations, Fourier analysis  
 Nonlinear estimation (nonlinear regression, maximum likelihood estimation, and more).

## Graphics

Overlay plots  
 Drivers for most graphics devices  
**Two dimensional:** Error Bars  
 Scatterplots  
 Line and Vector Graphs  
 Vector, Dot, Bubble and Quantile Plots  
 Bar Graphs (single, multiple, stacked, range)  
 Box plots (single and grouped)  
 Stem-and-leaf diagrams  
 Linear, quadratic, step, spline, polynomial, LOWESS, exponential smoothing  
 Confidence Intervals and ellipsoids (any alpha value)  
 Smooth mathematical functions  
 Rectangular or polar coordinates  
 Log and power scales  
 ANOVA interaction plots  
 Histograms (regular, cumulative, fuzzy)  
 Stripe and jitter plots  
 Gaussian histogram smoothing  
 Scatterplot matrices  
 Voronoi Tessellations  
 Minimum spanning tree  
 Maps with geographic projections (U.S. state boundary file included)  
 Chernoff faces  
 Star plots  
 Fourier plots  
 Pie charts  
 Contour plots on regularly and irregularly spaced points  
 Control charts and limits  
**Three dimensional:** Data plots  
 Smooth function plots  
 Vector plots  
 Linear, quadratic, spline, least squares surface smoothing  
 Three-dimensional type fonts.

## Data Management

Import/export Lotus, dBase, and DIF files  
 Full screen data editor  
 Full screen text editor  
 Unlimited cases  
 Missing data, arrays, character variables  
 Process hierarchical, rectangular or triangular files, irregular length records  
 Character, numeric, and nested sorts  
 Merge and append large files  
 Unlimited numeric and character variable transformations  
 Subgroup processing with SELECT and BY  
 Value labels and RECODE Statements  
 Macro processor with programming language, screen control, file manipulation, applications generation, and report writing.



Systat operates on IBM PCs and compatibles, MS-DOS and CP/M machines, several UNIX minicomputers, and the VAX/Microvax. Menu/windowed Macintosh version also available. Single copy price \$795 USA and Canada, \$895 Foreign. Site licenses, quantity prices and training seminars available. No fees for technical support. Statistics and graphics available separately.

For more information, call 312 864.5670 or write Systat Inc., 1800 Sherman Avenue, Evanston, IL 60201.

The following are registered trademarks: CP/M of Digital Research, Inc., IBM PC of IBM, Inc., MS-DOS of Microsoft, Inc., Macintosh of Apple Computer Inc., UNIX of AT&T and VAX of Digital Equipment Corporation.

## Systat. Intelligent software.

**Table 1:** While the Sun 386i/250 is significantly faster than the Mac II running A/UX, in this configuration, the Sun costs about twice as much.

	Number of Tasks			
	1	2	4	8
Mac II with A/UX	2.9	4.9	8.2	15.7
SUN 386i/250	2.0	3.0	6.0	12.0

**Note:** In both cases, the real execution time is reported. The SUN 386i uses a 25-MHz 80386, and the Mac II uses a 16-MHz 68020.

switching to supervisor mode and dispatching to code within the A/UX kernel. Once this code determines that the trap was a Toolbox ROM call, it invokes the trap handler and switches back to user mode. The user-mode trap handler then uses the dispatch tables to call either a ROM-based routine or a RAM-based patch. RAM-based patches update ROM code, as in the standard Mac operating system, and redirect Mac operating-sys-

tem calls to routines that translate them to equivalent Unix calls.

You must then create the resource file containing definition objects such as windows, menus, and dialogs, and compile it with the rez resource compiler.

Finally, to run any programs under A/UX that use the Mac interface, you must have the program `toolboxdaemon` running as a background process. This program is responsible for setting up the shared memory structures that all Toolbox applications use. It is also responsible for cleaning up after a Toolbox process when it exits. This includes removing shared memory structures and windows from the screen. In version 1.0, the shared memory contains mostly cursor data.

### Missing Mac User Interface

In A/UX, there is no facility like the Mac Finder to launch applications and manage files. A/UX provides three different shells (command interpreters)—the traditional Bourne shell (`sh`), the Berkeley C shell (`csh`), and the Korn shell (`ksh`). Each of these shells uses a command-line interface.

The closest A/UX comes to having a windowing interface is a sample program, called `Term`, that lets you open multiple windows, each running the Unix command-line interface. Since this is a sample program, full source code is provided so that you can modify it to suit your own needs.

As you would expect with a Mac application, `Term` lets you move or resize each window. One nice feature is a history mechanism that makes it possible to scroll back through a session to review output that has already scrolled out of the window. Unfortunately, you cannot cut and paste in these windows.

Each window acts as a terminal emulator implementing a subset of the DEC VT-100 control codes. You can also select the font and size of the text in each window.

Since A/UX allows only one Toolbox application to run at a time, it isn't possible to run any other program that uses the Toolbox from within the `Term` program. This means that to run another Toolbox program, you need to close down whatever is going on in each of the windows and exit from the `Term` program. This

# OOPS LITE. LESS FILLING. GREAT TASTE.

Object Oriented Programming (OOPS) is the most refreshing development ever to hit PC computing because it makes programming natural and easy. And if you've got a thirst for the world's best selling OOPS, get your hands on OOPS Lite, Smalltalk/V.

Thousands of scientists, engineers, programmers and educators have chosen Smalltalk/V because it's less filling. Unlike other OOPS which require deep-pocket workstations and a zillion bytes of RAM, Smalltalk/V runs on box-stock PC/XTs and clones with 512K and still has room to develop full-bodied applications.

Thousands more have chosen Smalltalk/V because it's the fastest, easiest way to get a great taste of OOPS. And that taste has led to satisfying results in everything from finance to medicine to space.

These people found that the real value of

personal computing isn't just manipulating a word processor, a spreadsheet or a modern user interface. It is using their PC as a sculptor uses clay. And Smalltalk/V with its unique design clarity, natural parallel between problem and solution, and forgiving nature gets you there with gusto.

Smalltalk/V is only \$99.95 and comes with the best object oriented programming tutorial money can buy. And when you're ready for something even more potent, move up to new Industrial Strength OOPS, Smalltalk/V 286 for just \$199.95. Both come with our 60 day money-back guarantee.

Check out Smalltalk/V at your dealer. If he doesn't have it, order toll free: 1-800-922-8255. Or write to: Digital, Inc., 9841 Airport Blvd., Los Angeles, CA 90045. OOPS Lite. Everything you've ever wanted in a great OOPS. For less.

## Smalltalk/V

limits the usefulness of the program as a standard interface to A/UX.

### Expanded Networking

If you want to go beyond the three users that can be accommodated by the console and the two serial ports, you can buy an Ethernet card and use the networking software that comes with A/UX.

A/UX supports Sun Microsystems' NFS, which allows a Mac II running A/UX to participate in a network of workstations and hosts and to share files. NFS makes it possible to treat files on other systems as if they were resident on your local machine.

There is also support in A/UX for the TCP/IP network protocol. This protocol and a number of utilities included with A/UX let you copy files between nodes on a network and establish remote log-in sessions with other nodes.

A/UX doesn't support AppleTalk, so if you want to connect a LaserWriter printer, you have to use an asynchronous link to one of the serial ports.

Even though the system comes with networking software, the documentation does not include the A/UX Network Ad-

ministration manual that you need to set up a network. This manual is available for \$18.50 to APDA (Apple Programmer's and Developer's Association) members.

To measure the multitasking performance of A/UX, we ran the multitasking-shell benchmark published in the August 1984 BYTE on page 406. For comparison, we ran the same benchmark tests on a Mac II with 5 megabytes of memory and A/UX on an external 80-megabyte hard disk drive, and on a Sun 386i/250 with 8 megabytes of memory and a 327-megabyte hard disk drive running Berkeley Unix 4.3. In the benchmark results, A/UX on the Mac II ran notably slower than the Unix implementation on the Sun system (see table 1). However, performance may be acceptable when you consider that the Sun system costs about twice as much.

### Close, But No Cigar

Apple's A/UX is a good first step toward transforming the Mac II into a Unix workstation. It's good because it gives you multitasking, virtual memory, and access to a network. But it is not yet well

integrated with the Mac user interface. Also, the limitation of running only a single Toolbox application at a time makes it difficult to use even the Term program as a standard interface.

You might expect A/UX to make the Mac II into a true workstation, but it doesn't quite measure up. Although it does provide the ability to connect to a network, it does not provide the kind of interactive interface that is familiar to users of other workstation products. While the Mac interface is available from within A/UX, the primary interface is the Unix command-line shell.

However, A/UX is a good implementation of Unix System V and should be useful where there is a need for a system that allows Unix applications to run in a network environment and where the ability to run Mac applications is required. A/UX will be easier to use when and if Apple provides a Finder-like interface that will truly transform the Mac into a point-and-click Unix machine. ■

*David Betz is a Unix consultant and a former senior editor for BIX. Eva M. White is a BYTE technical editor.*



**ARTS &  
LETTERS**

**ARTS &  
LETTERS**

**ARTS  
LETTERS**

**ARTS &  
LETTERS**



*Clown drawn using the  
Arts & Letters Graphics  
Editor and printed on a  
Linotronic L-300.*



# If You're Serious About Graphics.

## Why Clown Around

*Arts & Letters* is a family of products with an unsurpassed assortment of object-oriented clip art, typefaces, composition aids, and freeform drawing tools. And *Arts & Letters* runs on your IBM or IBM compatible personal computer.

## Can't Draw a Straight Line?

For those of us with little artistic skill, the *Arts & Letters Composer* comes complete with thousands of professionally-drawn clip art images you can size, stretch, twist, bend, flip, and rotate.

Compose diagrams, maps, flow charts, word charts, and organization charts. Cut, copy, and paste your compositions into any of the popular desktop publishing applications that support Windows, or print directly to any laser printer (a PostScript-equipped printer is not required).

## Draw Your Own

Depending on your level of artistic ability, use the *Arts & Letters Graphics Editor* to modify predrawn clip art, trace scanned images, or draw complex illustrations.

Even if you're a skilled artist, modifying predrawn clip art can save lots of time when you're working against a deadline.

## Editing Features

The *Graphics Editor* allows you to adjust the direction and shape of each curve interactively by clicking on the control points and fine tuning the curve. You can split a shape at a point, delete segments, join shapes, snap to points, move a point or group of points, and much more.

## Exchanging Data

*Arts & Letters* supports a variety of techniques for exchanging data between Windows applications and non-Windows products such as Ventura Publisher. *Arts & Letters* supports TIFF, EPS, WMF and CGM.

For more information about *Arts & Letters* and a FREE Publisher's Typescale, call or write today.

## Computer Support Corporation

15926 Midway Road  
Dallas, Texas 75244  
(214) 661-8960

## Suggested Retail

*Arts & Letters Composer* — \$395  
*Graphics Editor* — \$595

Circle 56 on Reader Service Card

IBM is a registered trademark of International Business Machines Corporation. *Arts & Letters* is a trademark of Computer Support Corporation. Ventura Publisher is a trademark of Ventura Software, Inc. PostScript is a registered trademark of Adobe Systems, Inc.

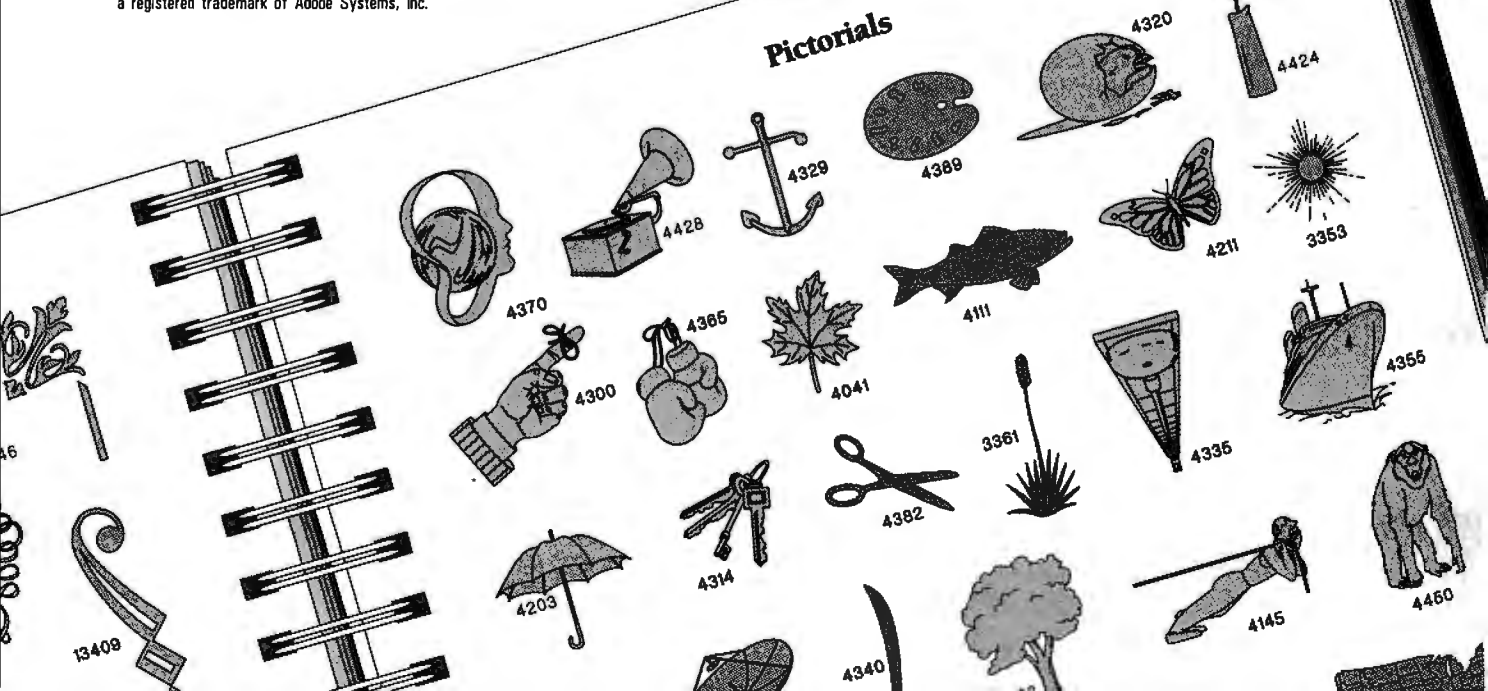



# PSpice

## The Standard for Analog Circuit Simulation Now Available on the Macintosh II

Since its introduction just over four years ago, MicroSim's PSpice has sold more copies than all other commercial Spice programs combined. In addition to running on the IBM PC family, including the new PS/2, the Compaq 386, the Sun 3 workstation and the VAX/VMS family, PSpice is now available on Apple's Macintosh II.

All these features which have made PSpice so popular are available:

- Standard parts libraries for diodes, bipolar transistors, power MOSFET's, opamps, voltage comparators, and transformer cores.
- GaAs MESFET devices.
- Non-linear transformer devices modeling saturation, hysteresis, and eddy current losses.
- Ideal switches for use with, for example, power supply and switched capacitor circuit designs.

Please call or write today for a free evaluation copy of PSpice. Find out for yourself why PSpice is the standard in analog circuit simulation.

In addition, all these PSpice options are available on the Macintosh:

- Monte Carlo analysis to calculate the effect of parameter tolerances on circuit performance.
- The Probe "software oscilloscope", allowing interactive viewing of simulation results.
- The Parts parameter extraction program, allowing you to extract a device's model parameters from data sheet information.
- The Digital Files interface, allowing you to transfer data from your logic simulator to (or from) PSpice. The interface performs the necessary D to A or A to D conversions.

Each copy of PSpice comes with our extensive product support. Our technical staff has over 50 years of experience in CAD/CAE and our software is supported by the engineers who wrote it. With PSpice, expert assistance is only a phone call away.



**MicroSim Corporation**

23175 La Cadena Drive, Laguna Hills, CA 92653 U.S.A. • (714) 770-3022 (800) 826-8603 • Telex 265154 SPICE UR

PSpice is a registered trademark of MicroSim Corporation; Macintosh II is a trademark of Apple Computer, Inc.; Compaq 386 is a trademark of Compaq Computer Corporation; IBM PC, PS/2 are registered trademarks of International Business Machines Corporation; Sun is a trademark of Sun Microsystems, Inc.; VAX and VMS are trademarks of Digital Equipment Corporation.

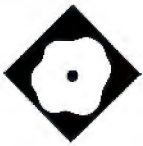

# VersaCAD on a Mac

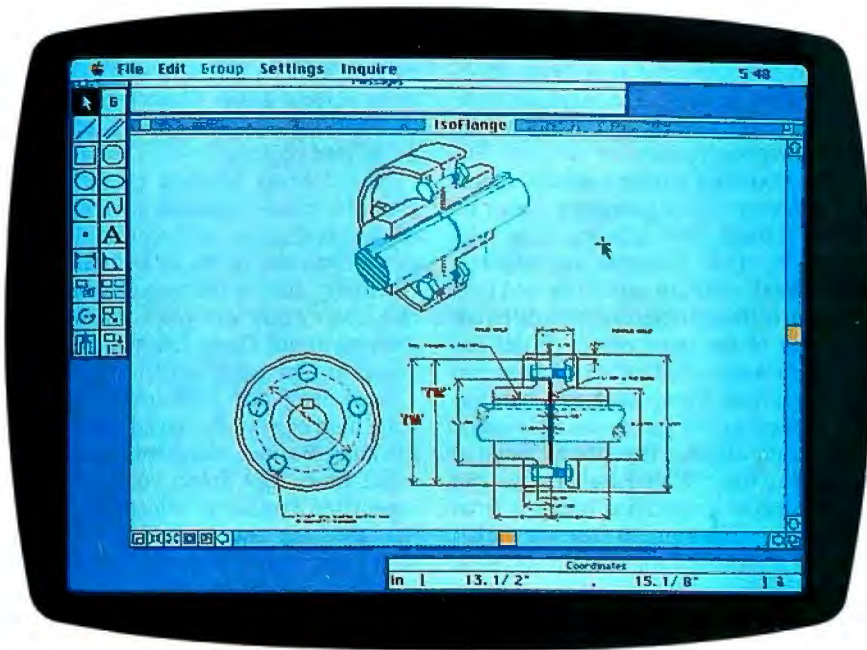

## A CAD package for PCs finds its way to the Macintosh

Paul Tuten

**B**orn with an established name in the MS-DOS world, VersaCAD Macintosh Edition is a comprehensive two-dimensional drafting and design system for creating accurate working drawings for a variety of disciplines. The VersaCAD package comes with a 247-page user's manual that includes a tutorial section, a "tour" disk that contains a demonstration program, and a disk with a HyperCard Help stack. These also serve as valuable training aids.

VersaCAD Macintosh Edition retails for \$1995. It requires a Mac Plus or SE with 1 megabyte of RAM or a Mac II with a minimum of 2 megabytes of RAM, an Apple monochrome or color monitor, and Finder 5.5 or higher. You'll need extra memory to use large monitors and to make use of Multi-Finder. If you have a Mac Plus or SE, you should equip it with an accelerator board with a 68881 math coprocessor to take full advantage of VersaCAD's speed. Finally, you'll need a minimum of 4 megabytes of hard disk space for programs, temporary workfiles, and drawings.

VersaCAD 1.1, the version I tested, supports a comprehensive list of output devices, including the Apple ImageWriter and LaserWriter for nonscale hard copies. For accurate drawings, it supports plotters from Bruning, Calcomp, Data Products, Enter Computer, Hewlett-Packard, Houston Instrument, United Innovations, Mutoh, Numonics, Roland, and Western Graphtec.

A VersaLINK application converts VersaCAD drawings to and from ASCII text, Initial Graphics Exchange Specification (IGES), and .DXF files. In these formats, you can exchange drawing information not only between different CAD applications but even between different computer systems.

### The Working Area

The main display consists of a drawing window bordered by the familiar Macintosh title bar, close, resize, and scrolling buttons. In addition, five window-option icons are embedded along the bottom left scroll bar. Clicking on these window icons lets you magnify any area of the drawing for detail work, or back away for a bird's-eye view of the entire drawing, regardless of its size.

Beneath the menu bar is a Message window that prompts you for input during object construction and editing. At the screen's bottom is a Coordinates window that shows the location of the drawing cursor in absolute, relative, or polar coordinates. To the left is a Tools window—a palette of icons for object creation and manipulation tools. You can toggle all these windows (plus two hidden Constraints and Construct palettes) open and closed from the Settings menu bar selection.

I found that I was using the Constraints and Construct palettes more than the Message and Coordinates windows, so I closed the latter two to save room on my SE's screen. For SE users, a more productive, but also more expensive, solution would be to add an external monitor to display the drawing window. Then you could display the support functions windows on a second screen while using a multimonitor program, such as E-Machines' Double Feature.

### A Pick of Tools

The two choices on the top of the Tools palette are Selection and Group. The Se-

*continued*

## VersaCAD 1.1

### Type

Two-dimensional CAD package

### Company

Versacad Corp.  
2124 Main St.  
Huntington Beach, CA 92648  
(714) 960-7720

### Format

Six 3½-inch floppy disks

### Hardware Needed

Macintosh Plus or SE with 1 megabyte of RAM, or Macintosh II with 2 megabytes of RAM, and a hard disk drive

### Software Needed

Finder 5.5 or higher

### Language

C

### Documentation

247-page user's manual

### Price

\$1995

### Inquiry 907.

lection tool lets you pick individual objects for editing and manipulation. Each object that Selection calls up displays its associated, movable, pivot-and-handle point. The Group tools let you build aggregates of objects.

The palette has 12 more tools, which you use to add objects to your drawing. The Line tool lets you create a single or continuous line, and Multiline draws two or more parallel lines simultaneously. Rectangle lets you draw squares and rectangles by designating opposite corners or three points. Polygon draws regular polygons with 3 to 180 sides.

To draw a circle, you choose a center and a radius or designate a diameter and its two endpoints. You can make an ellipse by picking the axes or a center and the axes. You create an arc from two endpoints and an arbitrary point on the arc, or from a center point and two endpoints. With Bézier, you can create three-point Bézier curves and multipoint spline curves. You handle point entry by screen position, grid snap, object snap, or coordinate entry (this is also the case with all the tools mentioned previously).

You can write on the drawing, either in

individual lines or in blocks, using the Text tool. Character height and width, as well as line spacing, may be varied. You can assign font numbers to your built-in LaserWriter fonts for PostScript output. VersaCAD can automatically apply linear and angular dimensions, either singly or as baseline or chain dimensions.

The last six tools on the palette are for object manipulation. You can move and stretch objects and groups of objects. You can copy in one or two directions, or circularly, leaving one or more copies. Rotate lets you move objects about their associated pivot points. Scale shrinks or expands objects or groups of objects, either proportionally or unproportionally. Mirror flips objects or copies of objects about an axis. The Explode command breaks objects and symbols into their component parts.

The Construct palette contains important tools for precise geometric constructions. Extend/Trim lets you trim elements to other elements and objects. With Break, you can split a line and trim it to two different objects or two different portions of the same object. Fillet lets you draw a specified radius between two self-trimming lines, as does Chamfer. Perpendicular lets you create right-angle lines at any distance from the endpoint of a normal line. With Parallel, you can draw lines at a specified distance from each other. The Tangent function makes lines at a specified angle to circles, arcs, and ellipses, or tangent to arcs and perpendicular to lines. You can use Isometric to create an isometric view from three orthographic views.

The tools in the Constraints palette are used in conjunction with those in the Tools and Construct palettes. Constraints tools help you make your drawings more precise. Besides Free (or unconstrained) input, there is Rotation, X Lock, and Y Lock, which let you fix input to a specified angle, or to an *x* or *y* axis.

The Grid and Increment snap tools set up a grid with incremental points. These points then attract the cursor to the nearest specified location for geometric input. This is nice in some ways, but it often dramatically slows repainting when the grid is displayed. The No Snap function switches this option off. The Intersection, Object, and Equation tools are excellent for accurate placement of objects in relation to each other, during both construction and later manipulation.

In most cases, the tools have additional options that you can obtain by double-clicking on each tool's icon.

### Picks from the Menu

The menu bar displays the Apple symbol with whatever desk accessories you have installed, along with About VersaCAD and Help. The Help item contains a drawing of the three palette windows mentioned previously, with labels that describe each tool function.

The Files menu contains New Drawing, which is for creating an empty drawing that retains the current settings of the properties, units, and window. Open Drawing retrieves drawings and also allows them to merge with the current drawing (at the same drawing units). Close stores the drawing window. Save Drawing and Save Drawing As put the current work on disk arranged by objects or by current group. Crunch compresses the workfile by permanently removing all deleted objects.

New Library lets you create special files of symbols. Symbols are collections of objects that are used repeatedly, such as windows and doors, or bolts and nuts. Obviously, having them predrawn as part of a library can save you a good deal of drawing time. Open Library gives you access to your symbols files.

Page Setup and Print give you a non-scale hard copy of displayed drawings on a printer. Besides a long list of plotters to select from, Plot Select contains an encapsulated PostScript selection; this option lets you use VersaCAD drawings with page layout programs. Plot Setup and Plot produce accurate output of the entire drawing, to any scale, on laser printers and plotters. Quit closes the VersaCAD program.

The Edit menu selection has the usual Macintosh Undo, Cut, Copy, and Paste options, plus Clear Last Entry, Restore Last Entry, Select All Objects, and Show Clipboard Contents. It also has additional items to aid you in editing objects. A Properties item lets you edit the level number, pen number, color, line density and width, line style, and top and bottom *z*-coordinate values of objects. A powerful Geometry item lets you look at and edit almost every geometric attribute of an object on the drawing; you can also invoke Geometry by double-clicking on the object. Handle moves the handle point of the selected object to alternate locations or back to the object's default location.

The Group menu contains options that you use in conjunction with the Group selection from the Tools palette. Clear Current Group removes all objects from the current group. Build by Inverse creates a group by replacing all objects in the current group with all other objects.

*continued*

# Never Lose Your Work Again!

## Introducing Cocoon,<sup>®</sup> A Genuine Breakthrough.

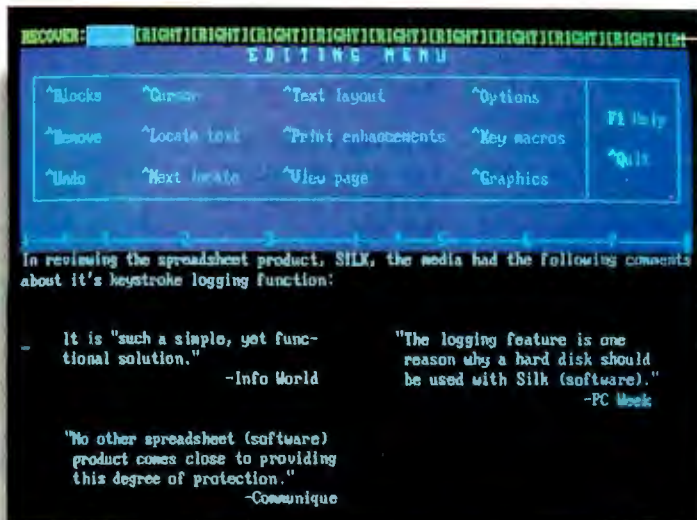

*Cocoon's Recover Mode Brings Back Every Key Stroke.*

You'll find Cocoon indispensable in a wealth of applications, including... Lotus<sup>®</sup> 1-2-3<sup>®</sup> and Symphony<sup>®</sup>, WordStar 2000<sup>®</sup> and WordStar Professional<sup>®</sup>, WordPerfect<sup>®</sup>, Codesmith<sup>®</sup>, P-fix<sup>®</sup>, Enable<sup>®</sup>, IBM<sup>®</sup> PE-II<sup>®</sup>, Ability Plus<sup>®</sup>. And many, many more!

**Special Introductory Offer — Just \$49.95!** No other PC utility offers you Cocoon's solid protection and worksaving features.

Enjoy these unequalled advantages soon — and save with our special publisher-direct introductory offer. Order by mail through September 30, 1988 for just \$49.95. (After that, Cocoon retails for \$99.00)

Credit card holders can call toll-free — or use the coupon today. Act now — you really need Cocoon, and you'll save by getting it right away. Fact is, Daybreak's "work insurance policy" pays for itself the first time you recover a session!

Remember all those times you've had an important work session disappear from the computer? Well, that's one problem you can forget for good!

**Instant Disaster Recovery** Cocoon, a uniquely powerful utility from Daybreak Technologies, protects your work from power failures, system failures, assorted accidents and just plain human error.

Cocoon is virtually invisible as it logs each keystroke to hard disk. It stays in the background, with no sacrifice of system or software speed. And your key log file takes up just 10K on your disk!

**Document Your Work And Review Your Logic** Cocoon captures your train of thought while it's recording your work. You can easily get an instant replay of entire session to reconstruct your logic and assumptions.

**Create Custom Tutorials And Demos** It's easy to train and sell with Cocoon. Play back one keystroke at a time. Or use fast-forward to skip ahead.

**Create Keyboard Macros** Versatile Cocoon translates keystrokes into macros that you can transport to your application program for use later.

**Debug Programs** Software developers can resimulate the problem or bug — again

and again — while reading the program map through the debugging utility to locate the difficulty.

**Truly A Must-Have Utility** Daybreak first introduced this remarkable function in the Silk<sup>®</sup> spreadsheet. PC Magazine put our recovery capabilities high on their "1-2-3 WISH LIST." "At most, this feature is a life-saver; ... it can save the day (and maybe a job). — J. Blake Lambert, *Computer Age*, August, 1987. Well, we say this is the second most important piece of software you can buy, right after DOS.



**DAYBREAK**  
TECHNOLOGIES, INC.

Charge to your credit card and call toll-free: **1-800-443-0100**, ext. 361E

Toll-free number is for credit card orders only. For product information, call Customer Service at (213) 542-5888.

System Requirements: IBM or compatible with DOS 2.0 or higher and hard disk.

Rush My Cocoon Today!

Name \_\_\_\_\_

Organization \_\_\_\_\_

Address \_\_\_\_\_

City \_\_\_\_\_ State \_\_\_\_\_ Zip \_\_\_\_\_

Phone \_\_\_\_\_

Mail To: Cocoon Introductory Offer, Dept. 361E  
Daybreak Technologies, Inc., P.O. Box 5629,  
21213B Hawthorne Blvd., Torrance, CA 90509

Do not enclose cash. Offer valid through September 30, 1988. Please allow 4-6 weeks for delivery.

\_\_\_\_\_ copies of Cocoon @ \$49.95 \_\_\_\_\_

Add \$5 per copy if you want 3.5" diskette \_\_\_\_\_

Add shipping & handling (\$5.00 each for U.S. & Canada, \$20.00 each all other countries) \_\_\_\_\_

Calif. residents add 6.5% sales tax \_\_\_\_\_

Total \$ \_\_\_\_\_

Payment Method

Check or money order enclosed, made payable to Daybreak Technologies. (Sorry, no CODs!)

Charge my  Visa  Master Card \_\_\_\_\_

Acct. # \_\_\_\_\_ Expir. Date \_\_\_\_\_

Signature \_\_\_\_\_

Cocoon and Silk are trademarks of Daybreak Technologies, Inc. IBM and PE-II are registered trademarks of International Business Machines Corporation. Lotus, 1-2-3 and Symphony are registered trademarks of Lotus Development Corporation. Microsoft and MS-DOS are registered trademarks of Microsoft Corporation. WordPerfect is a registered trademark of WordPerfect Corporation. WordStar 2000 and WordStar Professional are registered trademarks of MicroPro International Corporation. Enable is a registered trademark of the Software Group. Ability Plus is a registered trademark of Mijent Software Inc. Codesmith is a registered trademark of Visual Age. P-fix is a registered trademark of Phoenix Computer Products Corporation.

Circle 70 on Reader Service Card (DEALERS: 71)

Build by Properties lets you create or edit groups by all objects that do or do not have specified properties in common. Build by Fence creates groups by specifying objects either inside or outside a rectangular area, and Build by Objects lets you add or subtract specific object types to the current or new group.

The Settings menu contains valuable features, such as Input, which lets you directly input absolute, relative, or polar coordinates for geometric creation and manipulation. Besides the usual decimal degree and degrees-minutes-seconds options in the polar mode, bearing is also available. Properties lets you set such object attributes as level number, pen number, color, line density and width, up to eight line styles, and top and bottom z-coordinate values. VersaCAD is sometimes referred to as a two-and-one-half-dimensional system because it can record z-coordinate values but not display them. This ability to record z coordinates can be useful if you are using drawing-coordinate data in CAM.

You can add arrows or center markers to objects, and you can set template property to objects being added. These objects could serve as construction lines for layout development, and they can be turned off for displaying or plotting.

With the Units item, you set the drawing's unit of measure when you begin. There can be only one unit of measure per drawing. VersaCAD works on the concept of real-world modeling. That is, if you are going to lay out a schematic of a new interstate highway, for example, you might make miles the unit of measure and choose polar coordinates in bearing format. On the other hand, if you were designing an assembly jig for an airplane wing, you would make inches your unit of measure and choose absolute coordinates in decimals of an inch. For an E-size plot of both drawings, you can set the plot scale so that 1 unit equals 0.125 inch.

All the necessary units are available, including decimals and fractions of inches and feet, and fractions of miles, millimeters, centimeters, meters, and kilometers. If you want, you can also define your own units of measure.

Levels lets you specify up to 250 levels to display and plot. Levels are not self-protecting; for example, you can trim lines to each other even if they are in different levels. You protect levels by turning them off, thus making them invisible.

Configuration sets the size of temporary Hatch files needed to calculate hatch boundaries. Preferences lets you

set a drawing's background, grid, selected object, and cursor color (if available). Show Marker, Template, and Symbol turn the display of these items on and off. The workfile has a running clock of usage time that can be stopped with a Pause option.

Also under the Settings menu are Constraints, Coordinates, Message, Tools, and Construct items, all of which I've previously discussed. Symbols opens the symbols library from which the currently selected symbol was placed. Hatch lets you add hatching lines to any enclosed boundary; it also calculates areas and cross sections. Many of Settings' option windows can be left open for more convenient access.

The Inquire menu contains Drawing, which shows all the level numbers and pen numbers used on a drawing, along with the total number of objects, symbols, and time used. Workfile displays the storage that all the objects and symbols use, the total number of different symbols, and the corresponding storage you have left; it also indicates total drawing time and the elapsed time since your last file operation.

VersaCAD's workfile can contain 6000 objects, 2000 symbol components, and 200 unique symbols. This should be adequate storage for most drawings, but if it isn't, the workfile storage space can be expanded by an experienced programmer. Keyboard equivalents for almost all icons and menu options are present.

### Stackware Utilities

Bill of Material is a HyperCard stack that counts all symbols used on a drawing. Descriptive data such as name, size, unit cost, unit weight, labor, and grade for each symbol in your library is entered in the Bill of Material stack. A Count function automatically counts the symbols, and Create Report prepares a materials-list type of report that shows the totals of each symbol and all the descriptive information.

You can edit any part of the report and save it as a text file for use in a word processor or spreadsheet, or you can convert it to VersaCAD format for use on the face of the drawing.

Bill of Material also contains a utility for calculating the total length of lines and rectangles on the drawing. For example, in a plumbing drawing, if all drain pipes are represented by lines of the same color, or on a certain level or pen number, Bill of Material can automatically add the total length of these lines.

The FileDump stack provides a conve-

nient way to examine and edit the contents of drawing and library files. The source code for getVcad and putVcad are provided. These script functions extend HyperCard and let it read/write VersaCAD files; they also let you create customized VersaCAD HyperCard utilities. Sample drawings and libraries are included in the VersaCAD and Bill of Materials tutorials.

### Drawing Conclusions

The most serious of VersaCAD's few limitations is the lack of an auxiliary view system for creating drawings with views of different scales. For example, if you want a drawing with a quarter-scale main view and a half-scale section view, you have to either draw both views at their respective scales and plot full-size, or draw the main view at half size and the section view at full size and plot at half-scale, or draw the main view full-size and the section view twice-size and plot at quarter-scale. In any case, you have a model with one or more views that are not real-world size. Perhaps a better alternative in this example would be to keep the views in two different models and overplot them on the same paper at the different scales—but VersaCAD has no built-in provisions to do this.

A vital feature of VersaCAD is its workfile. When you are working on a drawing, all work is done in a temporary workfile that VersaCAD automatically saves on disk. Thus, even if you are working on a new drawing that you have not saved, you will probably not lose all your work if a system error occurs, which I did occasionally experience.

VersaCAD seems to have all the necessary tools and options that a draftsman needs to get the job done. However, I would not buy VersaCAD for an out-of-the-box Mac Plus or SE. Without a coprocessor accelerator board in the system, VersaCAD's slowness is a limiting factor. For example, I constructed a model with about 100 objects. On a vanilla Mac SE, a repaint of the model took well over a minute. On a Mac II, the same drawing took less than 3 seconds.

VersaCAD Macintosh Edition is a full-featured drafting tool that is well suited for a broad range of applications. But if you're going to spend almost \$2000 for the program, do yourself a favor and run it on a machine that won't make you long for your drafting board. ■

*Paul Tuten of Wichita, Kansas, is a tool engineering contractor for the aircraft industry and uses a CAD system daily. He can be reached on BIX as "editors."*

# Can Your Spreadsheet Do Any Of This For \$69.95?

Javelin®-type time series model  
in your conventional spreadsheet

Live help

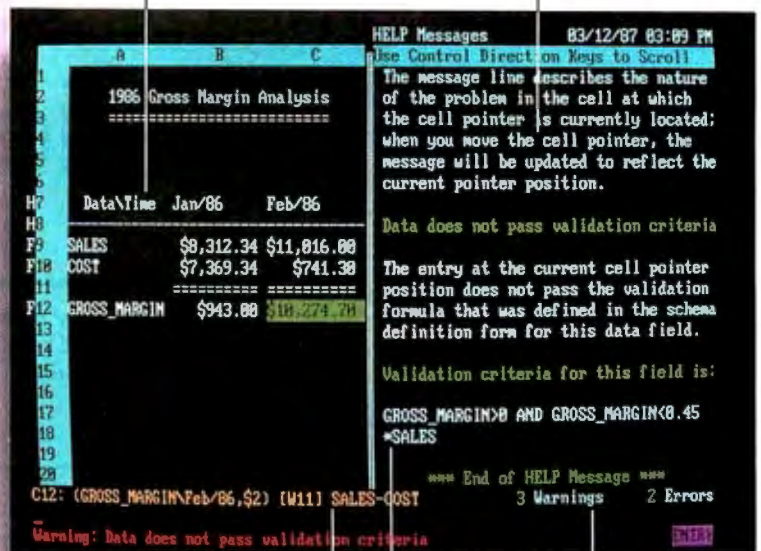

English language  
formulas

User-defined  
validation criteria

Spreadsheet  
validation



"Silk's improved graphics, fine use of function keys, interactive help, global search and replace, and easy-to-rearrange worksheets are reason enough to buy... At some point, you have to think about moving onward and upward (from Lotus). Silk gives you reason enough." — PC Magazine

- Twice as fast as Lotus® with 8087/80287 coprocessor installed
- Keystroke logging prevents the loss of your worksheet sessions
- Fast, productive forms processing — just fill in the blanks
- Allocation models — cut the pie any way you want
- Excellent use of function keys
- Global search and replace
- Enhanced graphics
- Easy-to-rearrange worksheets
- Goal seeking, i.e. what price to charge to make X% profit?
- Two foreign exchange formats

## And That's Just The Start Of Silk's® Exciting Features...

With all this — and more — going for Silk, Jim Gultinan of Cordata concludes "On a scale of 1 to 10 with Lotus being a 10, Silk is a 12." Soft Sector sums it up by saying "Silk is one of the most complete spreadsheet packages on the market today."

Yes, here's your spreadsheet wish list come true. At a price you dreamed of!

## Special Introductory Offer — New Version 1.1 Is Just \$69.95!

In reviewing the original Silk spreadsheet, Seybold Outlook said "this is a lot of software for the money." And we say "with this special introductory offer, it's a lot less!" Enhanced Silk 1.1 is just \$69.95 when you order directly from the publisher, now through September 30, 1988. After that, it's still an exceptional value at \$298.00 retail.

Why not order right now? And see for yourself why Orange Bytes Magazine says "Try Silk, but be careful, you may find your copy of 1-2-3 collecting dust."



**DAYBREAK**  
TECHNOLOGIES, INC.

Charge to your credit card and call toll-free: **1-800-443-0100**, ext. 361E. Toll-free number is for credit card orders only. For product information, call Customer Service at (213) 542-5888.

System Requirements: IBM® PC or compatible with PC-DOS® or MS-DOS® 2.0 or higher, with 512KB memory; hard disk recommended.

Silk is a registered trademark of Daybreak Technologies, Inc. IBM and PC-DOS are registered trademarks of International Business Machines Corporation. Lotus and Lotus 1-2-3 are registered trademarks of Lotus Development Corporation. Microsoft and MS-DOS are registered trademarks of Microsoft Corporation. Javelin is a registered trademark of Javelin Software Company.

Circle 72 on Reader Service Card (DEALERS: 73)

Rush My Silk 1.1 Today!

Name \_\_\_\_\_

Organization \_\_\_\_\_

Address \_\_\_\_\_

City \_\_\_\_\_ State \_\_\_\_\_ Zip \_\_\_\_\_

Phone (\_\_\_\_) \_\_\_\_\_

MAIL TO: Silk 1.1 Introductory Offer, Dept. 361E  
Daybreak Technologies, Inc., P.O. Box 5629,  
21213B Hawthorne Blvd., Torrance, CA 90509

\_\_\_\_\_ copies of Silk 1.1 @ \$69.95

Add \$10 per copy for 3.5" diskettes

Add shipping & handling (\$6.50 each for U.S. & Canada. \$40.00 each all other countries)

Calif. residents add 6.5% sales tax

Total \$ \_\_\_\_\_

Payment Method

Check or money order enclosed, made payable to Daybreak Technologies. (Sorry, no CODs!)

Charge my  Visa  Master Card

Acct. # \_\_\_\_\_ Expir. Date \_\_\_\_\_

Signature \_\_\_\_\_

Do not enclose cash. Offer valid through September 30, 1988. Please allow 4-6 weeks for delivery.

# Review Update

## Fine-Tuning the Benchmarks

The June issue saw the introduction of BYTE's new system benchmarks. The August issue marks the first, and probably not the last, revision. Version 1.1 of the low-level Small-C benchmarks incorporates several changes, all in the Disk I/O tests.

A bug fix for the DOS Seek 1- and 8-sector test came first. In the original test, checks for the end of disk failed because the test stored the sector variables in integer format. We quickly ran into sector sizes too large for Small-C to deal with as integers. We fixed the problem by changing the integer format to character pointers.

This fix uncovered an additional problem with the 8-sector part of the test. Basically, the 8-sector read was too sensitive to the effects of disk buffering. In version 1.1, we've enlarged the 8-sector read test to 32 sectors.

Finally, we changed the method of recording the results for the File I/O test. We've switched from seconds per K byte to seconds per 64K bytes for reporting the disk throughput times.

Apart from these changes, we've also made a couple of additional revisions. For the application-level benchmarks, we've dropped the Cursor Move test from the word-processing suite because of unreliable results. Second, we've switched from using an arithmetic mean to a geometric mean for calculating both the application-level and low-level indexes.

In light of these changes, we've rerun all the benchmarks for Advanced Logic Research's FlexCache 20386, which we reviewed in June, as well as for our baseline systems. The revised disk results are shown in the table above. The changes in the application benchmarks give the FlexCache a cumulative application index of 18.0. Application indexes for comparative systems are as follows: 18.0 for the Compaq Deskpro 386/20, 11 for the IBM PS/2 Model 80, and 5 for the 8-MHz IBM PC AT. The review of three 20-MHz 80386 systems on page 162 this month also reflects all these changes.

In upcoming reviews of 80386 systems, we'll be using a newly ported 32-bit version of the BYTE Small-C com-

*The results for the revised Disk I/O benchmarks still show that ALR's FlexCache 20386 comes in slightly ahead of the Compaq Deskpro 386/20 in disk performance.*

	FlexCache 20386	Compaq 386/20	IBM PS/2 Model 80	IBM PC AT (8 MHz)
<b>DOS Seek</b>				
1-sector read	8.48	10.68	14.98	14.95
32-sector read	17.00	19.08	32.79	65.18
<b>File I/O</b>				
Seek	0.11	0.13	0.12	0.29
Read (sec/64K bytes)	0.42	0.45	1.11	1.33
Write (sec/64K bytes)	0.79	0.78	1.07	1.23
<b>Disk I/O Index</b> (relative to PC AT)				
	2.50	2.23	1.46	1.0

Note: All times are in seconds, except as noted.

piler for low-level benchmarks. For details on the 80386 version of the benchmarks, see the text box "80386 Benchmarks" by Rick Grehan on page 142 of this issue.

One last note: The graphs for the system reviews in June—ALR's FlexCache 20386, NEC's MultiSpeed HD, and

Hewlett-Packard's Vectra CS Model 20—were labeled incorrectly. The application indexes, cumulative application indexes, and low-level indexes were correct, but the keys for the graphs were labeled in reverse order. We apologize for the error.

—Cathryn Baskin

## Deviance with Concurrent DOS 386

Sometimes benchmark tests give you alarming results, and it's difficult to pin down the problem. That's just what happened with my review of Digital Research's Concurrent DOS 386 in the July issue.

The BYTE Lab ran the single-task benchmark for Concurrent DOS 386 on several different systems and obtained essentially the same results (which were printed with the review)—that it performed about as well as MS-DOS. But the test results obtained using my own ARC 386i were quite different, at least at first. In fact, my preliminary findings showed a single task under Concurrent DOS 386 to be about 3 times slower than the same task running under MS-DOS.

I initially ran the benchmark tests on my ARC 386i with 3 megabytes of 16-bit 120-nanosecond memory on an Everex 159 memory card installed "above" the 512K bytes of 32-bit memory on the

ARC's motherboard. With the 16-bit memory installed, Concurrent DOS 386 barely pattered along, taking 40 seconds to perform one iteration of the benchmark in one window, while the same task ran in only about 13.5 seconds under MS-DOS.

Because the test program was only about 5K bytes, I decided to try the test without the 16-bit memory board installed. Admittedly, running even a 5K-byte program in only the 512K bytes of 32-bit base memory makes for a tight squeeze since Concurrent DOS 386 is so large. And certainly, most *real* applications cannot fit in so little memory. Nonetheless, without the 16-bit memory, performance improved noticeably. A single task actually ran faster than under DOS, taking 12.5 seconds to complete an iteration.

The explanation for the anomaly is painfully obvious: Running tasks in 16-bit memory on an ARC 386i slows performance down dramatically.

—Alex Lane



# BYTE

Bonus All-Mac Supplement

## Macintosh Special Edition



Inside MultiFinder  
Mac Networks • Color QuickDraw  
HyperCard • A/UX • Short Takes

# dBASE® Users — Attack the Mac with FoxBASE+/Mac

## New Frontiers, No Fears.

FoxBASE +/Mac gives you the unprecedented ability to run your dBASE programs on the Macintosh immediately—without changing a single line of code! But there's much more. **With FoxBASE+/Mac you can create beautiful, robust applications that are truly Mac-like—using the familiar dBASE language!**

## Speed and Power.

FoxBASE +/Mac gives you speed to burn—plus the power and performance you've come to expect from Fox. In fact, FoxBASE +/Mac is *by far* the fastest database system available on the Mac today—up to 200 times faster!

## View Window.

The View Window is the master control panel for FoxBASE +/Mac's graphical, non-programming interface. Use it to open and close files, set up indexes, establish relations, access BROWSE, and even to modify database structures!

## BROWSE.

FoxBASE +/Mac's BROWSE feature brings new convenience and power to database display and editing! You're in complete control—BROWSE lets you dynamically adjust the size and order of fields displayed, add or delete records, and split the window to show different database sections side-by-side. Together, BROWSE and View Windows *eliminate* the need to write programs for common database operations!

## Integrated Graphics.

Copy and paste graphs, charts, diagrams and even pictures into your database—instantly! FoxBASE +/Mac gives you the power to display these graphics, or merge them into reports and documents!

FoxBASE and FoxBASE+ are trademarks of Fox Software. dBASE and dBASE III PLUS are trademarks of Ashton-Tate. Macintosh is a trademark of McIntosh Laboratory, Inc., licensed to Apple Computer, Inc.

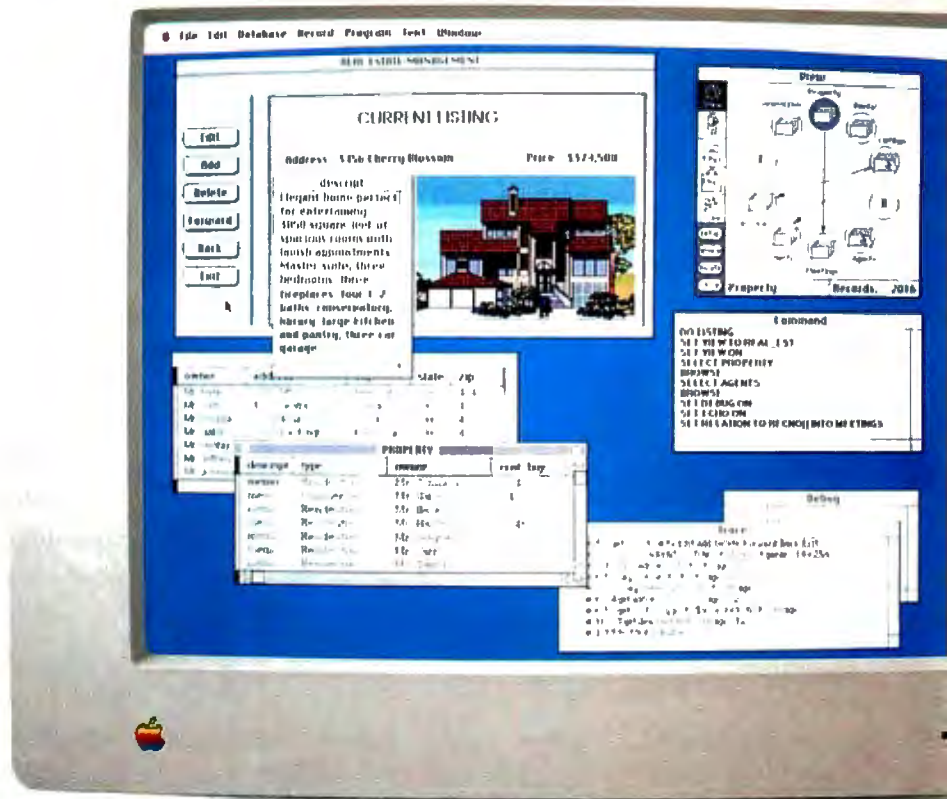

You can create stunning screens like this with FoxBASE +/Mac—*immediately!* This actual FoxBASE +/Mac screen photo illustrates the View Window, Command Window, Integrated Graphics, Memo field editing, Trace and Debugging Facilities, and the BROWSE feature.

## Command Window.

FoxBASE +/Mac's Command Window gives both experienced developers and novice user ultra-convenient access to the dBASE command language—just type a command into the Command Window, and it's executed!

## Get The FoxBASE +/Mac Facts Now!

Call (419) 874-0162 Ext. 320 for more information about FoxBASE +/Mac. Or visit your local software retailer.



FoxBASE +/Mac is part of the award-winning family of products from Fox Software. For two years in a row, FoxBASE+ has been given the prestigious Editor's Choice award by *PC Magazine*, and scored an impressive 9.2 out of a possible 10 when tested by *InfoWorld's Review Board!*

**Fox Software**  
Nothing Runs Like a Fox.

Fox Software, Inc. (419) 874-0162 Ext. 320  
118 W. South Boundary FAX: (419) 874-8678  
Perrysburg, OH 43551 Telex: 6503040827

# BYTE

## *Macintosh Special Edition*

Editorial: Microcomputing's Vanguard <i>by Fred Langa</i>	4
Short Takes	7
Twelve All-Time Favorites <i>by Ezra Shapiro</i>	21
Macintosh Redux <i>by Bruce Webster</i>	29
Take a Walk on the Mac Side <i>by Jerry Pournelle</i>	35
MultiFinder Revealed <i>by Phil Goldman</i>	46
The Well-Connected Mac <i>by Janet J. Barron and Robert L. Mitchell</i>	57
HyperCard: What Is It? <i>by Brian L. Dear</i>	71
HyperCard: How Does It Work? <i>by Laurence H. Loeb</i>	75
Using Color QuickDraw on the Mac II <i>by Jan Eugenides</i>	83
Unix and the Mac Interface <i>by Rick Daley</i>	89
Editorial Index by Company	95

---

BYTE (ISSN 0360-5280) is published monthly with an additional issue in October by McGraw-Hill Inc. Founder: James H. McGraw (1860-1948). Executive, editorial, circulation, and advertising offices: One Phoenix Mill Lane, Peterborough, NH 03458, phone (603) 924-9281. Office hours: Monday through Thursday 8:30 AM-4:30 PM, Friday 8:30 AM-1:00 PM, Eastern Time. Address subscriptions to BYTE Subscriptions, P.O. Box 7643, Teaneck, NJ 07666-9866. Postmaster: Send address changes, USPS Form 3579, undeliverable copies, and fulfillment questions to BYTE Subscriptions, P.O. Box 7643, Teaneck, NJ 07666-9866. Second-class postage paid at Peterborough, NH 03458 and additional mailing offices. Postage paid at Winnipeg, Manitoba. Registration number 9321. Subscriptions are \$22.95 for one year, \$39.95 for two years, and \$55.95 for three years in the U.S. and its possessions. In Canada and Mexico, \$25.95 for one year, \$45.95 for two years, \$64.95 for three years. \$75 for one-year air delivery to Europe. Y28,800 for one-year air delivery to Japan, Y14,400 for one-year surface delivery to Japan, \$40 surface delivery elsewhere. Air delivery to selected areas at additional rates upon request. Single copy price is \$3.50 in the U.S. and its possessions, \$3.95 in Canada, \$4.50 in Europe, and \$5 elsewhere. Foreign subscriptions and sales should be remitted in U.S. funds drawn on a U.S. bank. Please allow six to eight weeks for delivery of first issue. Printed in the United States of America.

Address editorial correspondence to: Editor, BYTE, One Phoenix Mill Lane, Peterborough, NH 03458. Unacceptable manuscripts will be returned if accompanied by sufficient postage. Not responsible for lost manuscripts or photos. Opinions expressed by the authors are not necessarily those of BYTE.

Copyright © 1988 by McGraw-Hill Inc. All rights reserved. Trademark registered in the United States Patent and Trademark Office. Where necessary, permission is granted by the copyright owner for libraries and others registered with the Copyright Clearance Center (CCC) to photocopy any article herein for the flat fee of \$1.50 per copy of the article or any part thereof. Correspondence and payment should be sent directly to the CCC, 29 Congress St., Salem, MA 01970. Specify ISSN 0360-5280/83, \$1.50. Copying done for other than personal or internal reference use without the permission of McGraw-Hill Inc. is prohibited. Requests for special permission or bulk orders should be addressed to the publisher. BYTE is available in microform from University Microfilms International, 300 North Zeeb Rd., Dept. PR, Ann Arbor, MI 48106 or 18 Bedford Row, Dept. PR, London WC1R 4EJ, England.



Subscription questions or problems should be addressed to: BYTE Subscriber Service, P.O. Box 7643, Teaneck, NJ 07666-9866.

# How Macintosh of the safest deci

The business computing world has recently undergone some fairly radical changes.

Consequently, so has the entire concept of "safety."

Because, at present, only one computer offers all the promise for the future, and delivers on it today: the Macintosh® II personal computer.

## First, we met your standards.

Serious business has some serious standards, and Macintosh II is prepared to meet every one.

Like breakneck speed. Full expandability. Vast memory. A choice of monitors. A wide range of sophisticated programs for every business use. And the capacity to store even the most intimidating mountain of information.

Its own power aside, Macintosh II is also more than prepared to meet the standards of other machines. Whether they speak MS-DOS, UNIX® or assorted dialects of mainframes, from IBM to DEC.

So it can work with files from — and run — MS-DOS programs like Lotus 1-2-3 and WordPerfect.

Connections are perfectly painless via the AppleTalk® network system, using a wide variety of cabling, including Ethernet®.

## Then, we raised them.

Of course, there's more to business than simply meeting standards. Which is why we've put such effort into exceeding them.

Macintosh II is an entirely new generation of computer, building on the graphical interface pioneered by Macintosh. It's working at full strength today, with an operating system that exploits every bit of its astonishing power.

The latest part of that system, MultiFinder™, adds multitasking capabilities. The result being, you can switch effortlessly between applications or do a number of different things at the same time.

This higher standard leads to a new world of possibilities.

For example, you can now use advanced programs for Apple® Desktop Publishing — the standard we created over two years back — right alongside your business programs. So it's much easier to integrate differ-

ent efforts into a single document.

In the Macintosh tradition, what you see on screen is exactly what you can expect on paper. And every program works very much the same way, helping to cut training costs drastically.

It's a technology that can actually raise the standard of how you get all your information. Because with Macintosh, all your computers (including mainframes) can be accessed in the same intuitive way.

But why read about it when you can be an eyewitness. See the whole family of Macintosh computers and LaserWriter® II printers at an authorized Apple dealer. Call 800-446-3000, ext. 300, for a location nearby.

Then you'll understand why so many business people feel the same way about getting a Macintosh II:

Better safe than sorry.



The power to be your best.™



# It came to be one sions in business.



**Multitasking.** *It's a fact, not a promise. Our MultiFinder lets you run multiple programs simultaneously.*

**Compatibility.** *Digests data from — and even runs — MS-DOS programs. Works with minis and mainframes, too.*

**Applications.** *New-generation programs for every business use. Not next year. Today.*

**Display.** *Choose any size or shape, including color and large-screen.*

**Graphical Interface.** *We pioneered the intuitive graphics-based operating system others are only now beginning to imitate.*

**HyperCard.** *A revolutionary way to customize your office's information — using associations instead of commands.*

**Expandability.** *With six slots, Macintosh II is open to just about anything.*

# Microcomputing's Vanguard

More and more, it's a Blue and Red world out there. BYTE readers have seen it coming for years.

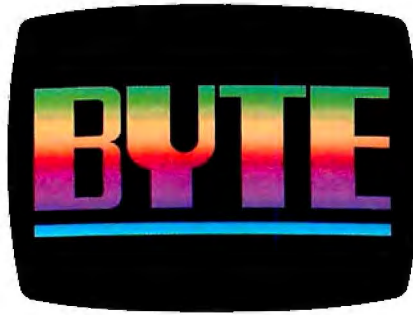

**Q**uick! Name the only magazine whose coverage of the Macintosh II won an award for editorial excellence in an international competition that was sponsored by the Society for Technical Communication.

Need a hint? It's a large publication, routinely reaching over 147,000 Macintosh users, far more than publications like *MacWeek*, *Macazine*, *Macintosh Today*, and the like.

Another hint: In addition to being one of the world's largest magazines for Mac users, it's one of the very few that has been there from day one back in 1984; it has covered every Mac in detail, from the first fledgling machine through the world-class power of today's Mac II.

Still stumped? Well, it's about the only magazine for Mac users that doesn't have a "Mac" in its title.

You're holding it in your hands: **BYTE**.

BYTE's readers were among the earliest and most enthusiastic adopters of the Macintosh. Year by year, as the Mac's power and expandability have grown—as it has finally delivered on that early bright promise—the installed base of Mac users among BYTE readers has climbed steadily. Today, over 35 percent of BYTE's 420,000 readers use Macs, and that number is still growing fast.

What amazes me is that almost all BYTE's Mac users are also IBM PC users. These readers are truly the van-

guard of microcomputing—proficient on more than one type of machine and completely comfortable in the increasingly common office environment where Macs and PCs sit cheek by jowl. Like all BYTE readers, these folks are a versatile, pragmatic group, not at all locked into a single mold, or constrained by arbitrary philosophical blinders. Faced with a given task, they'll use whatever hardware and software will get the job done well, religious debates about microcomputing purity be damned. They're the corporate gurus who can assist any user on any machine anywhere in their organization.

But you already know this: It's *you* I'm talking about.

For some 4 years now, BYTE has covered the Mac as part of our "regular" coverage. No, that won't change. For example, the August issue of BYTE carries a full review of A/UX—Apple's interesting implementation of a "semigraphical" Unix for the Mac II.

But from time to time we want to do more, to concatenate our coverage and focus attention on the Mac in a major way.

The result is the Mac supplement you're now reading. If you use a Mac, you'll find plenty of useful information on Mac technology and applications in BYTE's best tradition—information that no Mac-specific magazine gives you.

If you're not currently a Mac user, you'll find a rich vein of interesting, perspective-building information that

can broaden your microcomputing horizons and help prepare for the day when—count on it—you're called upon for advice in a Macintosh matter.

For example, "MultiFinder Revealed" isn't just a glossy list of features or a simplistic user's guide to MultiFinder. Instead, Apple's Phil Goldman—one of MultiFinder's creators—provides a true insider's look at how the Mac's multitasker works.

Another Apple employee, Rick Daley, explains some of the design decisions underlying A/UX, and he offers insights that can help make your use of or programming for A/UX more effective.

A very meaty piece on networking the Mac will fill you in on Mac-to-Mac, Mac-to-PC, Mac-to-VAX, and other connectivity options to allow the Mac to peacefully coexist with other hardware in almost any setting.

Two articles on HyperCard explain its strengths and weaknesses (as one author points out, there are times, after all, when a word is worth a thousand pictures). They go on to show you how to build practical, workable stacks, and point to some of the best sources for obtaining user-written stackware.

Jerry Pournelle, Ezra Shapiro, and Bruce Webster all offer their own unique perspectives on how far the Mac has come, where it's going, and what it's like to make the switch from the DOS world to that of the Mac.

A hands-on article on Color QuickDraw shows you how to make use of the Mac II's color capabilities.

And (of course) lots more.

We're pleased to bring you this high-quality bonus reading, and we welcome your feedback by mail (Write to: Editor, One Phoenix Mill Lane, Peterborough, NH 03458), by BIX, by MCI Mail, or by telephone.

Enjoy.

—Fred Langa  
Editor in Chief  
(BIX name "flanga")

# Borland's new Turbo Pascal Family makes programming fast and easy

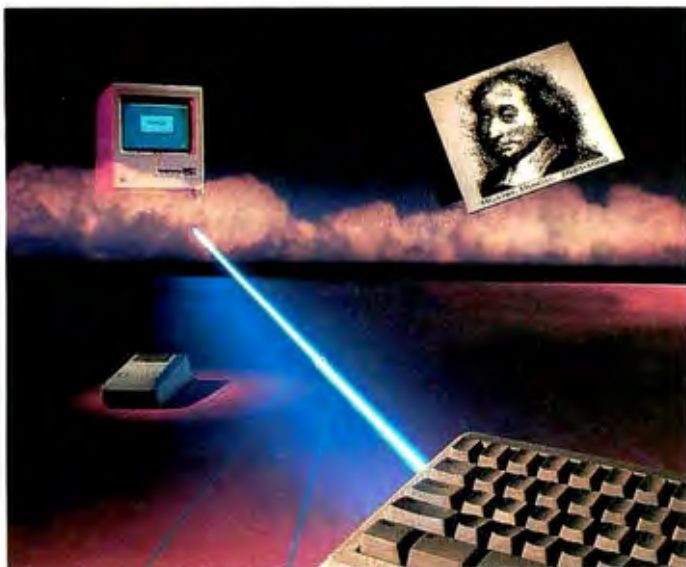

**T**urbo Pascal® code compiles and runs at better than a sizzling 12,000 lines per minute. Its clear, logical design makes it easy to learn and use.

Turbo Pascal is truly compatible with Inside Macintosh, which means that you're on familiar ground—that's why so many Mac users have made it their standard. Best of all, it's only \$99.95!

**NEW!**

***The Turbo Pascal Tutor is just for you!***

A companion to Turbo Pascal, Turbo Pascal Tutor quickly teaches you how to program your Mac in Pascal! This interactive tutorial on disk and 700-page manual really show you how—from the basics to advanced programming on the Mac—in Turbo Pascal, MPW Pascal or any version of the language you're using.

## *You get . . .*

- A concise history of Pascal and step-by-step concepts for the beginning programmer.
- A Programmer's Guide taking you through all the specifics you'll need from Pascal program structure to data types, records and files.
- An advanced programming section covering linked lists, stacks, sorting and searching algorithms and more.
- A full guide to using the power of the Macintosh in Pascal, from use of the visual interface to memory management and debugging.
- Source code on disk you can use in your own programs without paying royalties.

***Only \$69.95!***

**NEW!**  
***Turbo Pascal Numerical Methods Toolbox™***

Numerical analysis at your fingertips! This complete collection of state-of-the-art routines and programs solves all the most common problems in science and engineering. And you're free to include the source code in your own programs. Includes:

- Solutions to equations
- Interpolations
- Matrix operations: inversions, determinants and eigenvalues
- Differential equations
- Least squares approximations
- Fourier transforms

***Only \$99.95!***

**NEW!**

***Turbo Pascal Database Toolbox®***

Provides you with the search and sort routines you need for your Pascal database applications.

- Turbo Access locates, inserts or deletes records using B+ trees, and does it fast.
- Turbo Sort uses the Quicksort method to sort data on single items or multiple keys.
- You get source code on disk and a free sample database using the Mac interface that you can tailor to your specific needs.

***Only \$99.95!***

**“ Turbo Pascal is fast: 12,000 lines of good, compiled Pascal code in 60 seconds.**

***Howard Katz, MACUSER ”***

All products require a Macintosh with at least 512K.

All Borland products are trademarks or registered trademarks of Borland International, Inc. or Borland/Analytica, Inc. Other brand and product names are trademarks or registered trademarks of their respective holders. Copyright ©1987 Borland International BI-11278



**Circle M9 on Reader Service Card (DEALERS: M10)**

For the dealer nearest you  
or to order by phone

**Call (800) 543-7543**





# When The Price Counts As Much As The Performance

A picture is worth a thousand words. But should it cost you thousands of dollars to scan one into your Macintosh™ generated documents? We think not! Announcing the new super hero of scanning technology – VisionScan™.

## VISIONSCAN – A FULL FUNCTION OPTICAL SCANNER FOR \$695.00

VisionScan is easy to use. Our unique flat bed design will allow you to quickly and quietly scan virtually anything. VisionScan does not require an additional investment in hardware, nor does it monopolize your ImageWriter™ like the other lower priced scanner. In fact, VisionScan software operates as a desk accessory and will allow you to continue using the computer while scanning. VisionScan is shipped complete with all of the hardware, software and connecting cables needed to allow your Macintosh to begin scanning immediately. And it works in the ambient light found in most office environments.

## GREAT WITH GRAPHICS

VisionScan is the perfect companion to your desktop publishing program. Included with every VisionScan is DeskPaint™, the graphics editor desk accessory. DeskPaint will allow you to edit the captured image by cropping, re-sizing, redetailing, lightening, darkening or otherwise embellishing it to suit the design of the page. And all of this can be done without exiting from your desktop publishing programs like PageMaker™, Quark XPress™ and Ready,Set,Go!™, to name just a few. VisionScan with

DeskPaint is also compatible with other popular paint programs like Illustrator™ and Freehand™.

## WE ALSO HAVE A WAY WITH WORDS

For an additional \$200.00 a specially developed version of Read-It!™ O.C.R. by Olduvai Corporation is also available. Read-It! is a trainable software program that will allow your Macintosh to read and store the printed word.

## VISIONSCAN – TECHNOLOGY MADE AFFORDABLE

Call us! Mike and Lisa are ready to ship your VisionScan today.

## 30 DAYS TO LOVE IT

*We are so confident that you will love your VisionScan that we will give you 30 days to use it. If at the end of that time you don't think that VisionScan is a great buy, call us and send it back for a full refund.*



# VISIONSCAN

TOLL FREE 800-654-5294  
IN MINNESOTA 612-633-3255



2644 Patton Road, Roseville, MN 55113

Circle M51 on Reader Service Card

VisionScan is a trademark of Warp Nine Engineering, Inc. Macintosh and ImageWriter are trademarks of Apple Computer Company. DeskPaint is a trademark of Zedcor, Incorporated. Pagemaker and Freehand are trademarks of Aldus Corporation. Quark XPress is a trademark of Quark, Incorporated. Ready,Set,Go! is a trademark of Letraset USA. Read-It! is a trademark of OLDUVAI Corporation. Illustrator is a trademark of Adobe.



# SHORT TAKES

*BYTE editors offer hands-on views of new products*

Spectrum/24

MacRecorder

PageMaker 3.0

scriptExpert

Gofer for the Mac

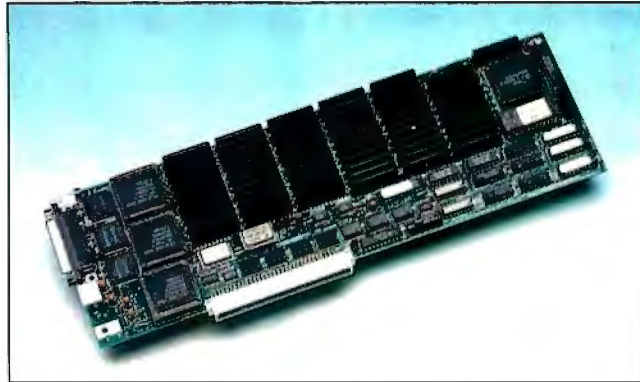

## The SuperMac Spectrum/24 Video Board

If you try to use a Macintosh II with a standard video board to do image processing, you'll soon discover that having only 256 colors available for a digitized picture is pretty limiting. No longer: Not only does SuperMac Technology's **Spectrum/24** video board provide you with a 1024- by 768-pixel display on a 19-inch monitor, but each pixel can have 24 bits of color information. Put another way, while standard video boards use 1 byte per pixel for color information and give you a choice of only 256 colors out of a palette of 16,777,216 colors, the Spectrum/24 uses 3 bytes per pixel in a "chunky-planar" color format that lets you use the *entire* color palette. The Spectrum/24 also supports Apple's 13-inch AppleColor RGB monitor. Because Apple has recently announced 32-bit indexed and "chunky" direct color formats that are incompatible with the Spectrum/24's color format, it's sold only to developers. When Apple issues its system using the new color formats, SuperMac plans to release an INIT that will patch QuickDraw to properly drive the Spectrum/24.

The Spectrum/24 comes with an adapter cable and a 3½-inch floppy disk. The adapter cable matches the video board's DB-25 connec-

tor to the DB-15 connector of either a 19-inch SuperMac Color Trinitron monitor cable or an AppleColor RGB monitor cable. On the disk, a Monitors CDEV file lets you set the display's depth (1, 2, 4, 8, or 24 bits) and size (640 by 480 pixels, 1024 by 768 pixels, or in the 1-bit mode [4096 by 1536 pixels]) from the Control Panel. The SMT-Images application displays 24-bit color images. Several digitized images are on the disk for use with SMT-Images and show off the board's capabilities. The source code for SMT is included, so a developer can write applications to use the board's color capabilities.

Board installation is quick and easy: You simply turn off the Mac II, pop the hood, and plug the Spectrum/24 into a NuBus slot. Then close the hood, connect the cables, switch on the power, and drag the software files from the floppy disk to the hard disk,

making sure to place SuperMac's Monitors CDEV into the System Folder to replace Apple's Monitors file.

In the 1-bit color (black-and-white) mode, you can configure the Spectrum/24 for a 4096- by 1536-pixel display, which comfortably holds a MacDraw document that's two pages tall and seven pages wide. Hardware panning, where the image automatically scrolls vertically or horizontally when the mouse pointer reaches the screen edge, is supported for this extended display. This panning feature worked smoothly.

If you find 8-bit color images breathtaking, 24-bit color images will knock you out. In this mode, digitized pictures retain their photographic quality. There is no granularity to the image: You cannot see any fringing or "boundaries" in areas of subtle color changes at all. On the down side, you'll need

more memory: a minimum of 2 megabytes of RAM is required, and you'll do lots better with 5 megabytes or more. Screen updates are noticeably slower, if not downright sedate, but that's because there is 3 times as much color information to manage. However, you can set the display to the usual 8-bit color mode and work as before and use the 24-bit color mode only when your work requires it. Finally, 24-bit color image files are a lot larger than their 8-bit color counterparts: A typical 24-bit color file often fills an entire 800K-byte floppy disk. Plan to budget for a large hard disk along with the extra memory.

Although the Spectrum/24 demands more memory and limits display performance, the results are well worth it. The ability to use a virtually unlimited choice of colors with this board makes the Mac II a serious image-processing engine.

—Tom Thompson

## Digitize Sound, Put It in HyperCard

**M**acRecorder is one of those great products that lets you be constructive and also have some fun. It's a hardware/software combination for inputting sounds into a Macintosh and then manipulating them with a sound-editing program. The package comes with a small recording device, the MacRecorder itself, and the editing/enhancing software, called Sound-Edit. And if that's not enough to justify paying out \$199, Farallon has tossed in the neatest HyperCard applica-

*continued*

### THE FACTS

Spectrum/24 video board  
\$2000

*Requirements:*  
Macintosh II with 2 megabytes of RAM and color monitor

SuperMac Technology  
295 North Bernardo Ave.  
Mountain View, CA 94043  
(415) 962-2900  
**Inquiry M141.**

# Save Big Bucks On Mac Hardware

**MEMORY UPGRADES** SuperMac  
 1 Megabyte CMOS SIMMs .Call!  
 68020 Accelerator Boards .Call!  
**HARD DRIVES** **MONITORS**

**Hardware House**  
 Internal 3 1/2" Drives for SE/II:  
 MAX 30 (30mb Seagate, 33ms) ..\$477  
 MAX 40 (40mb Quantum, 12ms) ..647  
 MAX 80 (80mb Quantum, 12ms) ..977

**CMS**  
 30 MB "MacStack" .....\$589  
 60 MB "MacStack" .....777  
 60 MB Tape Backup .....697  
 Call for other CMS products:  
 Prices too low to print!

**Microtech Int'l (5-Year Warranty)**  
 Nova 20 MB External .....\$597  
 Nova 30 MB External .....697  
 Nova 50 MB External .....997  
 Nova 80 MB External .....1397

**PCPC**  
 MacBottom 21 MB SCSI ....\$747  
 MacBottom 32 MB SCSI ....847  
 MacBottom 45 MB SCSI ....1147  
 Internal 1200 baud modems available

**Classic II**  
 13" Mac II Color Monitor ..\$399

**Moniterm**  
 Viking I (19" SE/II) .....\$1549

**Radius**  
 Full Page Display (MacPlus) \$1449  
 Full Page Display (SE/II) .....1549

**Sony**  
 13" Multiscan color .....\$677

**Sigma Designs**  
 Laserview 19" (SE/II) .....\$1695

**APPLE HARDWARE**  
 Mac SE 30mb System:  
 (2 800k Floppies, 30mb Internal  
 Seagate, Keyboard) .....\$2695  
 Mac II w/Keyboard .....3099  
 Laserwriter II SC .....2249  
 Laserwriter II NT .....3699  
 Laserwriter II NTX .....5199

**CALL TOLL FREE: 800-356-2892**

*Hardware House, Inc.*

3637 Locust St., Phila., PA 19104 (215) 386-2208

MC/VISA. You will not be charged until shipped. Prices subject to change without notice.

## SHORT TAKES

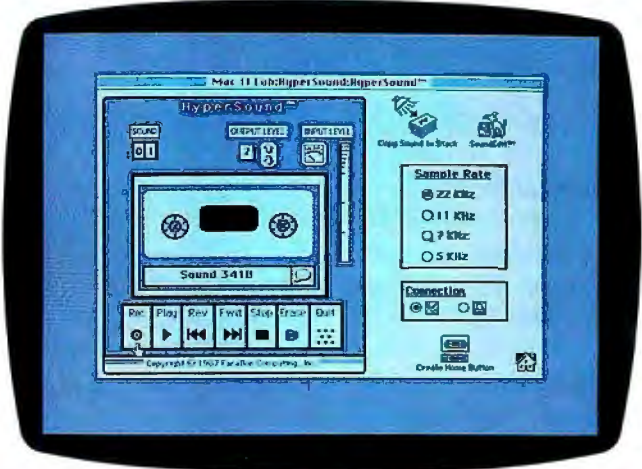

### THE FACTS

**MacRecorder**  
**\$199**

**Requirements:**

Any Mac with at least 512K bytes of memory; Farallon recommends at least 1 megabyte and two 800K-byte floppy disk drives for working with SoundEdit; HyperSound requires at least 1 megabyte of memory, at

least 128K bytes of ROM, a hard disk drive, and HyperCard; users of older Macs will need a cable with male DB-9 and female DIN-8 connectors.

Farallon Computing  
 2150 Kittredge St.  
 Berkeley, CA 94704  
 (415) 849-2331  
**Inquiry M142.**

## FORTRAN PROGRAMMERS

If you are serious about your FORTRAN on the Macintosh, you should be using DCM's **MACTRAN PLUS**.

MACTRAN PLUS is a fully integrated development system comprising of:

- an *Editor* with multiple files capability
- a native code optimising *Compiler* with the option to generate in-line 68020/68881 code
- an on-line Symbolic, Source Level *Debugger*
- a *Linker* with Library facilities

### Featuring:

- \* simplified interface and full access to Mac Toolbox
- \* full ANSI 77 standard with extensions from VAX and ANSI 8X for easy porting of mini and mainframe applications: including Namelist, DOWHILE, IMPLICIT NONE and long variable names (31 chars)
- \* generate clickable, stand alone applications
- \* IEEE 754 floating point conventions including double precision complex
- \* execution time array bound, arithmetic overflow/underflow checking option
- \* batch mode of operation, bit manipulation functions, cross reference listings
- \* library manager to organise relocatable modules into libraries

Visit us at the Mac Expo  
 Booth #420 and avail  
 special show discounts.



1710 Two Tandy Center  
 Fort Worth, TX 76102  
 (817) 870-2202  
 Tlx 756916

Macintosh is a trademark of Apple Computer, Inc. MACTRAN PLUS is a trademark of DCM Ltd. Other brand and product names are trademarks of their respective holders.

tion yet—a program for putting recorded sounds into HyperCard stacks.

The MacRecorder digitizer, about the size of a big mouse, has a built-in microphone, microphone-in and line-in jacks, and a volume knob. It plugs into either the modem or the printer port. If you've got an older Mac with DB-9 ports, you'll first have to find an adapter cable; the digitizer connector has an 8-pin male plug. You can record sound live or from an audio system. With two MacRecorders, you can record two channels simultaneously. The built-in microphone isn't bad; I recorded live sounds and taped music with it, and the results were free of distortion.

The device samples sound at 22 kHz, but if you want to save space, you can set it as low as 5 kHz (where you can store as much as 3 minutes in a megabyte of RAM or disk

space; at 22 kHz, the maximum is 45 seconds). When each second at 22 kHz takes up 22K bytes of memory, you have to decide between sound quality and storage. Farallon says MacRecorder will "accurately" record frequencies of up to 10 kHz.

After you've gotten the sounds into the Mac, you can work with them using SoundEdit. The program displays a window of waveforms; below it are the function icons (e.g., record, playback, and input level) and indicators (e.g., a box that shows the length of a waveform). You work with the waveform as you would a piece of text: selecting, editing, cutting and pasting, and changing characteristics. Sound strings can be stored in formats for other applications, such as Studio/Jam Session, SoundCap, and VideoWorks.

The powerful editor has a

*continued*

# REAL CADD FOR YOUR MAC... JUST \$99.95!



## Affordable CADD. And it's only the beginning.

The CADD stands for Computer Aided Design and Drafting. With a suggested retail price of just \$99.95, Generic CADD Level 1 makes the power of real CADD affordable. And it's just part of a family of Generic CADD products that will make you more productive than ever before.

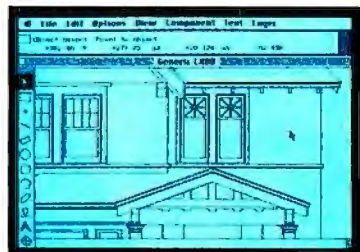

## Standard Mac interface for ease of use.

Now you can produce accurate drawings with real world scale on the Mac Plus, Mac SE, or Mac II. You can edit multiple drawings in separate windows and cut and paste between them. CADD Level 1 is also multifinder compatible.

## Symbol Libraries boost productivity.

From office furniture to specialized electronics symbols, our Symbol Libraries save you the time of redrawing repetitive elements every time you need them.

## Add the power of real CADD to your Mac.

Move your Macintosh drawings into the real world. Call us at 1-800-228-3601 for your free CADDalog or the name of your Generic dealer. And find out why we say the only thing generic about us is the price.

© 1988 Generic Software, Inc. Generic CADD Level 1 is not copy protected and comes with a 60-day money back guarantee. Registered users get free technical support from Generic.

Level 1 and Generic CADD are trademarks of Generic Software, Inc. Macintosh is a trademark of the Apple Computer Corp.

11911 North Creek Parkway South, Bothell, WA 98011

Circle M27 on Reader Service Card  
(DEALERS: M28)

**Generic**  
S O F T W A R E

## "VAX-to-the-Macs" Specialists—With A Respected Family Tree!

White Pine Software offers a complete family of products for total two-way Macintosh™/VAX™ communication: text, graphics, file transfers and program access.

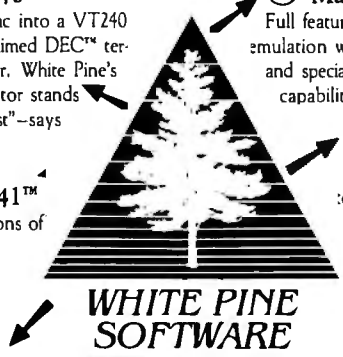
- 
- ① Mac240™**  
Turn your Mac into a VT240 with our acclaimed DEC™ terminal emulator. White Pine's "VT240 emulator stands among the best"—says Digital News.
- ② Mac241™**  
All the functions of Mac240 PLUS COLOR.
- ③ Mac220™**  
Full featured VT220™ emulation with expanded text and special character capabilities.
- ④ VMacS™**  
Share Macintosh :ext, data and program files among users.
- ⑤ Reggie™**—Convert MacPaint™, MacDraw™, and Clipboard™ images into ReGIS™ or SIXEL™ formats.

**WHITE PINE  
SOFTWARE**

CALL (603) 886-9050  
for your desktop communication solutions.

Mac240, VMacs, and Reggie are trademarks of White Pine Software, Inc., DEC, VT, VAX, are trademarks of Digital Equipment Corporation; MacDraw, MacPaint, and Clipboard are trademarks of Apple Computer, Inc.; Macintosh is a trademark licensed to Apple Computer, Inc.

## USED Mac STUFF!! We Buy, Sell & Horsetrade Popular Computers!!

### Mac CPU'S

Mac SE.....Call  
Mac Plus.....Call  
Mac 512e.....Call  
Mac 512.....\$750.

### Exchanges

SE20 Internal to:  
45 meg. Int....575.  
100 Meg.....1375.  
Mac mouse to  
Kensington turbo  
mouse.....55.  
400k External.75.

### Printers

Image II.....400.  
Image I.....300.

### Mac Stuff

Mac+ Roms....100.  
Keyboards....Call  
Mother B'ds....Call  
Power Sply...225.  
800k Drives...Call  
Hard Drives...Call  
Carry Bag.....45.  
Mouse.....65.

### We Buy Apple Parts & Acc.

Shreve Systems  
2421 Malcolm St.  
S, port, La. 71108  
Fax 318-865-2006

**\*\* 318-865-6743 \*\***

## SHORT TAKES

good box of special effects that let you do all kinds of things to the sounds you've recorded, including adding reverb, changing pitch and volume, filtering, and flanging. The program can also generate frequency-modulated signals and tones.

One of my favorite effects turns recordings backward; we could have used something like this 20 years ago to run Beatles songs backward and find out if Paul was really dead, without ruining our record players.

SoundEdit also has a mixer that lets you work with input from four different channels. I don't know if professional studio engineers would use this program (and I'm sure Farallon doesn't expect them to), but you could use it at home to do some interesting things with music tracks.

HyperSound is where you can get really constructive with this package. It's an innovative program for recording mono sounds and then painlessly copying them into HyperCard stacks, from which you can play them back. The possibilities for developers working on music instruction or history stacks, for just ongesample application, are intriguing. And it really works.

Getting graphics into Hyper-

Card is simple; Farallon has made getting sound into it just as easy. You just record the sound or music or voice using MacRecorder and then copy it to the stack that you want it in; you don't have to do any HyperTalking. Due to HyperCard limitations, output has to be in mono.

HyperSound's interface looks like a cassette tape deck; you don't have to be a recording engineer to figure this thing out. The accompanying manual has a good section on sound and recording, explaining things like waveforms and frequencies, samples and cycles, and envelopes and mixers.

This is one of the best Mac packages out there because it's innovative and inexpensive; it lets you work with sound and play with sound. For people developing stackware, it's a low-cost way to add sounds to stacks, which is no little feat. My one complaint is that I wish Farallon would sell a version that comes with the adapter (male DB-9 and female DIN-8 connectors) needed to hook MacRecorder to older Macs. Finding such a cable is not easy in some parts of the world, like New Hampshire, for example.

—D. Barker

## Aldus Makes a Fine Program Even Finer: PageMaker 3.0

Having done time in a newspaper production room, I'm partial to the paste-up approach to page makeup. You know: Take the typeset galley, run it through the hot wax, slap it down on the gridded layout sheet, and hack at it with an X-acto knife until it fits the design (or at least seems to fit). I took an instant liking to Aldus's PageMaker because it uses the paste-up metaphor, an intuitive approach that makes sense to me, and it means no more cranky typesetters, hot wax-

ers, and deadly knives.

But I had enough problems with the first version of the program to make me start shopping around for another desktop publishing package. The 1985 edition of PageMaker sometimes just did weird things. Text wouldn't flow properly into the columns, chunks of type would disappear, and sometimes the program just wouldn't do what it was supposed to do. These inexplicable problems didn't occur consistently, which

*continued*

# Mac II/PC Workstation

## Recapture Valuable Desk Space!

Everyone who needs the power of a Personal Computer or Mainframe also needs the space that the Monitor and Processor occupy. With no desk space to organize work and lay out projects, the computer's effectiveness is limited. The Mac II/PC Workstation by Ergotron takes a totally new approach to workstation ergonomics. It provides a unique arm suspension system and shelf area giving the operator the ultimate in adjustability and space savings.

The Radial Arm raises the monitor off the desk and an adjustable Shelf takes the Processor out of the way, but still within reach of the operator.

The list of features includes:

- A sturdy tubular frame that is positioned on the side of or behind your desk or work area.
- 6" vertical Monitor adjustment with the simple touch of a hand.
- 20" horizontal Radial Arm adjustment - the monitor can be pushed into a "park" position.
- The Mechanism on the end of the Radial Arm provides unequalled 360° rotational and 20° tilt adjustment for the CRT.
- Adjustable Processor shelf.
- Compatible with Macintosh, PC's & compatibles, Mainframes, and other CRT's and graphics systems that have monitors weighing up to 65 lbs.
- Ideal for Businessmen, Engineers, Graphics Designers, & Desktop Publishers.

For more information, contact Ergotron or your local Computer Dealer.



## ERGOTRON®

3450 Yankee Drive, Suite 100

Eagan, MN 55121

612/452-8135 • 800/888-8458

## Make Your Mac Into a Forecasting Wizard!

### RATS

#### Time Series/Econometrics

RATS is your key to an integrated environment for analysis, forecasting and graphics with time series data. Generate forecasts using Box-Jenkins (ARIMA), exponential smoothing, large model simulations, and others. Use the wide variety of regression procedures to analyze your data. Almost unlimited power is yours for only \$300!! Call or write for more information today!

### EZ-X11

#### Seasonal Adjustment

With EZ-X11 and your Mac, seasonal adjustment has never been easier. It handles both quarterly and monthly adjustments, and includes trading day and holiday options. You can adjust series singly or set up EZ-X11 to adjust hundreds at a time. The full Mac interface makes X11 comprehensible. At \$150.00, it's a program you must have. (Works with or without RATS).

**VAR Econometrics** (800) 822-8038  
 P.O. Box 1818 (312) 864-8772  
 Evanston, IL 60204-1818

## SHORT TAKES



### THE FACTS

PageMaker 3.0  
 \$595 (\$75 upgrade for registered owners of 2.0)

Aldus Corp.  
 411 First Ave. S  
 Seattle, WA 98104  
 (206) 622-5500  
**Inquiry M143.**

**Requirements:**  
 Macintosh Plus, SE, or II  
 with a hard disk drive;  
 System 4.1 and Finder  
 5.5 or higher



## Pack your Mac in seconds

Padded Cordura case holds either Macintosh Plus or SE. Padded interior compartments protect and organize your Mac's keyboard, mouse and external drive. It's easy to carry with leather handle grip and adjustable non-slip shoulder strap.

Six colors: Black, Burgundy, Charcoal, Navy, Royal and Platinum

New version also holds extended keyboard.

For a dealer near you call toll free

**1-800-548-0053**

**West Ridge Designs**

1236 N.W. Flanders • Portland, OR 97209



made them even more frustrating. But the fact that they weren't consistent makes me wonder if some Mac weirdness was to blame. (I've seen Mac users with EE degrees shrug and say, "Well, the Mac just does screwy things sometimes.") I came close to being unemployed once when a long document was delayed because of my problems with PageMaker.

Aldus fixed all that with version 2.0. I've pushed that program hard and not run into any snags. With **PageMaker 3.0** for the Mac, PageMaker got even better.

The biggest change to 3.0 is a feature Aldus calls "autoflow." In the older editions, you have to place text on the page column by column. You click the mouse, and the text pours onto the page, stopping when it gets to the bottom of the first column. You then click on a little thing that looks like a window-shade handle to get the rest of the text, move to the next column, and pour in some more text. You keep doing this clicking and load-

ing/clicking and pouring, column after column, until the whole story is on the page.

Well, with autoflow, you have to click only to get the text pouring out; the program will then snake it into subsequent columns and not stop until the whole threaded file is down on the page. This automatic flowing of text doesn't work with complicated or fancy layouts—for that, you have to use the old manual approach or the new semiautomatic approach—but it works swell with basic pages. This might not sound like a big deal, but if you're working on a long document that involves laying down lots of files on multi-column pages, autoflow can save you hours.

If you need to wrap text around graphics, the semiautomatic text-flow mode is adequately fast and easy to use. In general, PageMaker is now considerably better at placing text in unusual ways and gives a designer more flexibility in laying out a page.

Aldus has also added publi-

*continued*

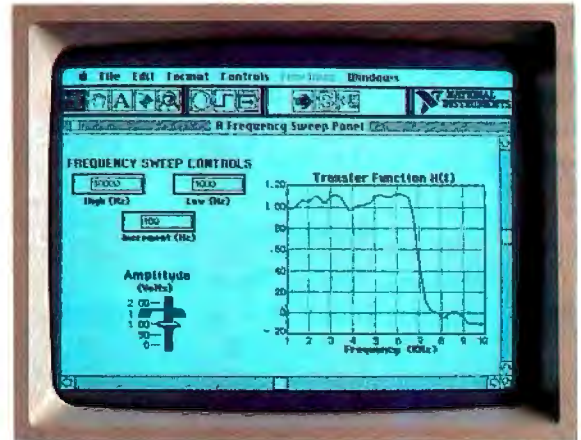
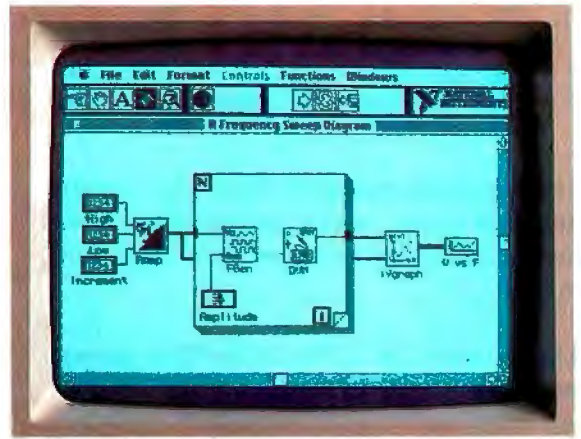

# YOU CAN WRESTLE WITH A FEW THOUSAND LINES OF CODE TO PROGRAM YOUR EXPERIMENTS.

Developing scientific experiments takes creativity. Writing code to run them takes sweat. At least it used to. But no longer. Because we've just solved the scientific and engineering programming problem.

# OR YOU CAN USE LabVIEW.

Picture the perfect programming language. Imagine software where diagrams are really executable programs.

Imagine running experiments and simulations through front panels that look and act just like instruments. On screen!

Imagine reusable software modules that can control your instruments, *in any application*. Programs for data acquisition, data reduction, signal processing, analysis, conversion, and display.

Imagine a programming environment so powerful that productivity is measured in **hours** instead of days.

The Macintosh made it possible. LabVIEW made it happen. Automated testing, measurement, and simulation has never been easier or faster.

Call for details. 800/531-4742.

**DESKTOP ENGINEERING HAS ARRIVED.**



12109 Technology Blvd.  
Austin, TX 78727  
800/531-4742 512/250-9119

# Computers For The Blind

Talking computers give blind and visually impaired people access to electronic information. The question is how and how much?

The answers can be found in "The Second Beginner's Guide to Personal Computers for the Blind and Visually Impaired" published by the National Braille Press. This comprehensive book contains a Buyer's Guide to talking microcomputers and large print display processors. More importantly it includes reviews, written by blind users, of software that works with speech.

Send orders to:

National Braille Press Inc.,  
88 St. Stephen Street, Boston, MA 02115  
(617) 266-6160

NBP is a nonprofit braille printing and publishing house.

cation templates to Page-Maker. These are predefined layouts for different kinds of documents, such as a newsletter, a brochure, a business report, or a product spec sheet. Chic designers wouldn't dare use such things, but if you're in a hurry to produce a document that looks clean and readable, these templates are useful. You just delete the text that's on the prefashioned pages and dump in your own from your word-processing package. Minor adjustments depend on how fussy you are, and you can make major adjustments to these templates if you're so inclined.

I can't do justice to Page-Maker's capabilities and features in this space. I've got enough room to say that 3.0 is a

better package and is worth every penny of the \$75 upgrade from 2.0. I've yet to find a bug. The manuals are some of the best I've read; Aldus does a fine job explaining how to use what could be a very complicated program. If you don't like reading manuals, you can work your way through this program just by jumping into it. But I wouldn't recommend that.

Although I've got a list of things I'd love to see incorporated in the next version, my only complaint with 3.0 is that it requires a hard disk drive, which means another expense for some users and (here comes the bottom line) means I can't run it on my Mac at home.

—D. Barker

## Push-Button Programming for HyperCard

While you can use HyperCard without doing any programming, the HyperTalk scripting language allows you to customize HyperCard buttons, cards, and fields. Unfortunately, Apple's HyperCard user manual provides little information on how to use HyperTalk. So, to learn it, you must turn to other sources. One is *scriptExpert*, written by Dan Shafer and distributed by Hyperpress Publishing.

The *scriptExpert* program is a push-button code generator for HyperTalk. You can

write HyperTalk scripts by simply selecting commands and messages that are displayed on the screen in the form of buttons. As you select commands, *scriptExpert* prompts you for appropriate messages, arguments, and loop constructs. For example, say you want to add a button to a card that beeps and displays a message. From the *scriptExpert* command screen, you select the Beep command and enter the number of beeps you want. Then you select the Answer command and enter the message and user responses desired. As you enter correct HyperTalk commands, the resulting script appears in a window in the right corner of the screen. An on-line help library is included that provides help and examples for any HyperTalk command. You can also zoom into the script window for full-screen editing of your script. After saving your script, you can return to the appropriate stack and paste the script into a button.

### THE FACTS

*scriptExpert*  
\$79.95

Requirements: Macintosh Plus, SE, or II with 1 megabyte of memory and HyperCard

Hyperpress Publishing  
P.O. Box 8243  
Foster City, CA 94404  
(415) 345-4620  
Inquiry M144.

continued

## Equations Made Easy

### Expressionist™ 2.0

The Personal Mathematical Equation Editor

2-Way TeX Interface

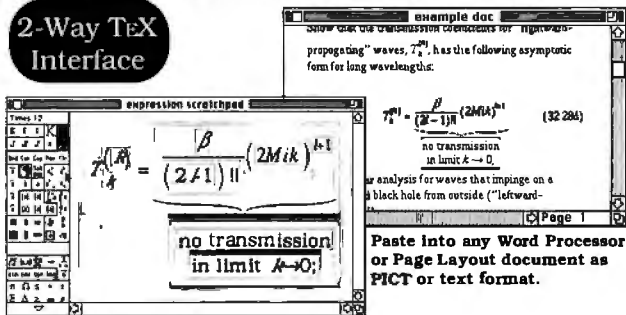

All mathematical symbols available from an editable palette.

Expressionist 2.0 is a powerful application and desk accessory that enables mathematical equations to be quickly and easily placed into your word processor or page layout documents. If you use equations, and you have a Macintosh, you will find Expressionist very useful. All you do is create, copy, paste, and get results like this:

$$\sin^{-1}(x) = \int_0^x \frac{dt}{\sqrt{1-t^2}}$$

$$\frac{1}{p!} A_{\alpha_1 \dots \alpha_p} \delta_{\gamma_1 \dots \gamma_p}^{\alpha_1 \dots \alpha_p \beta_1 \dots \beta_q} = \sum_{\alpha_i < \alpha_j} A_{\alpha_1 \dots \alpha_p} \delta_{\gamma_1 \dots \gamma_p}^{\alpha_1 \dots \alpha_p \beta_1 \dots \beta_q} = A_{\alpha_1 \dots \alpha_p} \delta_{\gamma_1 \dots \gamma_p}^{\alpha_1 \dots \alpha_p \beta_1 \dots \beta_q}$$

"An excellent toolkit that all technical people should have..."  
—Jean Louis Gassée, Apple Computer Inc.

Send \$129.95 to:  
allan bonadio associates  
814 Castro Street #54  
San Francisco, CA 94114-2809  
(415) 282-5864



# New

# Tempo II™

Available now!

## It's about time.

**New features make Tempo II smarter, easier, faster!**

**Smart controls.** Menu, dialog box, check box and window actions replay as intended, even when conditions change.

**Play macros by name.** It's your choice—play a macro by its key code or by typing its name in a popup dialog box. And, specify how many times to repeat the macro when you play it!

**Autopaste.** Turn any selected text or graphics into a macro, to insert paragraphs, artwork, etc., with a keystroke.

**Universal macros.** Macros you record in one program can play in all programs.

**Popup menu.** The Tempo II menu is *always* available, even when other menus cannot be selected.

**Plus features from Tempo 1.2...**

**Pause** for a given time, until a preset time, or for user entry. Include your own dialog box to guide a new user.

**Link** macros together, either directly or conditionally, based on any text that may be copied via the Clipboard. Nest macros, too, virtually without limits.

**Repeat** for any number of times, or repeat if or until a condition is met.

**Real Time**—replay cursor movements and delays exactly as you recorded them.

**Tempo 1.2 owners**—Upgrade to Tempo II for only \$49! Call us, or send check or credit card order today!

For Macintosh Plus, SE and Mac II. Great with MultiFinder, works wonders with windows on large or multiple screens, ideal for hard-driven Macs (and their masters).



**The next step in Macintosh automation.**

Save time...

**"I couldn't use my Macintosh without Tempo."**

—V.P., Food Processing Industry  
Commerce, California

Save effort...

**"Has made my medical reports a joy to compile!"**

—Consultant Obstetrician  
London

Save money...

**"Tempo saves us 30 payroll hours a week."**

—CPA  
San Francisco

## Simply record your actions for instant replay

Tempo II watches and records while you work, then goes to work for you. In any program. Instantly.

From a repetitive font and size change, to a series of complex data base entries, record them once, replay with a single command. Tempo II saves you time, which makes your work faster, easier, *fun* even.

One click starts recording. Even macros that automatically repeat and branch to others are recorded with point-and-click simplicity.

New features make your work easier. Transfer instantly between programs

and files. Autopaste text or graphics. Perform hundreds of search and move operations. All with a keystroke.

See for yourself. Let Tempo II put all of your manual labors on automatic.

**\$149.95 with a 90-day money-back guarantee.** Buy Tempo II today—you'll start saving time and effort immediately, every time you use your Macintosh. Call us for the name of a Tempo II dealer nearest you.

**Call 800-367-6771 today!**



**Affinity Microsystems, Ltd.**  
1050 Walnut Street, Suite 425  
Boulder, CO 80302  
303-442-4840  
800-367-6771

# EXPANSION CHASSIS for the Macintosh

Accelerators  
Large Screen Monitors  
Communications  
Data Acquisition  
Transputers  
MS-DOS

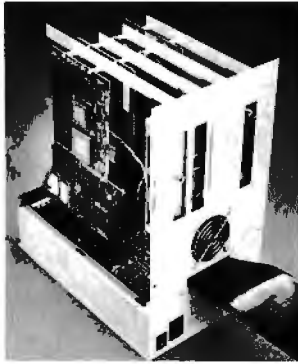

Second Wave expansion chassis come complete with an interface card, cables, and the chassis with SE or NuBus slots, a power supply and fan.

ExpanSE, ExpanSE Plus, & Expanse II, expansion chassis from Second Wave, Inc., enable your Macintosh SE, Plus, & II to work with a full array of option boards.

**Users:** Make your Macintosh a powerful personal workstation with a Second Wave expansion chassis full of option boards.  
**Dealers:** Increase add-on sales with option boards and a chassis. Demonstrate option boards in your store by using a chassis in your showroom.  
**Developers:** Use the chassis as a research & development tool for hardware design & debug.  
**Manufacturers:** Use the chassis as a burn-in rack or test bed.



To order a chassis, contact: Second Wave, Inc. 9430 Research Blvd. Echelon II, Suite 260 Austin, TX 78759 (512) 343-9661

At first glance, scriptExpert seems very inflexible. When you start a script, you have to either finish it or start over. The scriptExpert program insists on correct syntax and won't let you add invalid commands to your script. You can't save partially completed scripts and then come back later and edit them. But the purpose of scriptExpert is to help you generate working scripts, and the inflexibility actually helps novice HyperTalk programmers avoid bugs. Experienced programmers will find scriptExpert useful because it reduces the amount of typing you have to do. For example, say you want to create an IF...THEN...ELSE loop. The scriptExpert program sets up the If loop, and you just fill in the conditional statements and variable values. The program automatically indents the appropriate code within the loop to make your script easy to follow.

If your script does have logical bugs, you can edit the script using HyperCard's built-in editor.

My only complaint is that scriptExpert does not recover well from user errors. I lost a couple of scripts by making mistakes when editing the script window on my own.

The 50-page scriptExpert user manual is primarily a tutorial that takes you step-by-step through the process of developing a HyperCard stack application. Knowing virtually nothing about HyperTalk programming, I found the tutorial extremely helpful in understanding the basic concepts of developing a HyperCard application on my own. Although experienced programmers may find scriptExpert useful, it is really aimed at beginners learning HyperTalk. A good complement to the program is Dan Shafer's book, *HyperTalk Programming*.

—Nick Baran

## Protect Your Copies of BYTE

**NOW AVAILABLE:** Custom-designed library files or binders in elegant blue simulated leather stamped in gold leaf.

**Binders—Holds 6 issues, opens flat for easy reading.**  
\$9.95 each, two for \$18.95, or four for \$35.95.



**Files—Holds 6 issues.**  
\$7.95 each, two for \$14.95, or four for \$27.95.



### Order Now!

Mail to: Jesse Jones Industries, Dept. BY, 499 East Erie Ave., Philadelphia, PA 19134

CALL TOLL FREE (24 hours):  
1-800-972-5858

Please send \_\_\_\_\_ files; \_\_\_\_\_ binders for BYTE magazine.

Name: \_\_\_\_\_

Enclosed is \$\_\_\_\_\_

Address: \_\_\_\_\_  
(No Penn Office Box)

Add \$1 per file/binder for postage and handling. Outside U.S.A. add \$2.50 per file/binder (U.S. funds only please).

City: \_\_\_\_\_

Charge my: (minimum \$15)

State: \_\_\_\_\_ Zip: \_\_\_\_\_

\_\_\_\_ American Express  
\_\_\_\_ Visa \_\_\_\_\_ MasterCard  
\_\_\_\_ Diners Club

Satisfaction guaranteed. Pennsylvania residents add 6% sales tax. Allow 5-6 weeks delivery in the U.S.

Card # \_\_\_\_\_

Exp. Date \_\_\_\_\_

Signature \_\_\_\_\_



## Text Retriever Pops Up on the Mac

**G**ofer, that handy little pop-up program for finding text buried in a file somewhere, has helped me out countless times on my MS-DOS machine. Because I also use a Macintosh, I was interested when Microlytics brought out a Mac version of the search-and-retrieve program. We've got a densely populated 80-megabyte hard disk in the BYTE Lab Mac II; there are so many files and folders on it that it's tough to quickly find whatever it is you're looking for.

The program works as a desk accessory. After you call it up, you tell Gofer what you want it (Microlytics insists on calling it "him") to find, where you want it to look, and how you want it to look. The program will search for any combination of characters or numbers, which you specify in a text-entry box. You then

tell Gofer where to go, and it will look in any or every file or folder on any floppy or hard disk. The program goes on its search and keeps you posted in a window, in which you can see where Gofer is looking and how many finds it's hitting. The program will flash the finds on the screen as it flies through files or will stop at each find, depending on how you've set up the search.

You can get very specific about what you send Gofer after; you can instruct it to find exact matches or "close" matches. Asking for close matches can be risky, though. On a search of document files for anything close to OS/2, for example, Gofer turned up hundreds of finds, including just about every word that began with O. Microlytics says this approach will be fine-tuned for the next version.

If you want to be really pre-

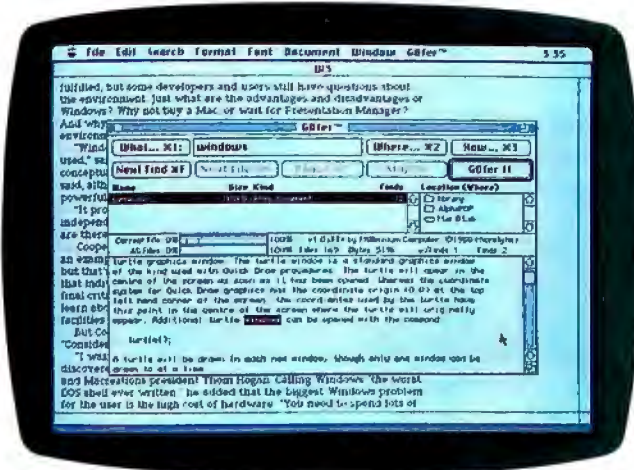

Gofer  
\$79.95

**Requirements:**  
Mac 512Ke with System  
4.1/finder 5.5 or higher

Microlytics, Inc.  
300 Main St.  
East Rochester, NY 14445  
(800) 828-6293  
(716) 377-0130  
**Inquiry M145.**

cise and thorough, you can set up Boolean searches using the logical operators AND, OR, NOT, or NEARBY; for example, you could tell Gofer to look for *Shapiro* NEARBY *Pournelle*, and it should find all the places where *Shapiro* and *Pournelle* are mentioned within a certain specified distance of each other.

Gofer will copy files to the Clipboard or write them to an application. If you want a hard copy of what you find, you can send the retrieved text to a printer. This capability wasn't implemented in the beta version I used, which was called 1.0a33, but Microlytics says it will be ready soon. The program can also work as a file browser, letting you scan selected files without having to set up a search.

I used Gofer to look through tons of Word and PageMaker documents, scattered across hard and floppy disks. In its simple search mode, it almost always found what I asked it to look for. When I polished up the search using the operators, it always found the text I asked it to look for. The only oddness was the scrambling of

PageMaker files. In Gofer's display window, they were readable but filled with gibberish text and hieroglyphics. This should be corrected when Microlytics (or developer Millennium Computer Corp.) adds new "handlers" for different storage formats.

It's asking for trouble to compare the MS-DOS version of a program with the Mac version, but I'll do it anyway. While both programs are good, reliable, fast text retrievers, the Mac version is easier to use. The whole Mac approach—windows, menus, and dialog boxes—makes it easier to set up a search. On the other hand, it took me a while to get comfortable with the MS-DOS version.

After Microlytics implements the features mentioned in the prerelease documentation (such as letting you be more specific as to which files to look in) and makes the "close match" unit more discriminating as to what it turns up, Gofer will be a fine desk accessory for anyone who has to go through lots of crowded places to find something.

—D. Barker

# ATHANA 3.5" DISKETTES

# 108

DSDD

Line same quality diskettes used by software publishers. 100% certified, Lifetime warranty.

Order in 50's. Add \$ 3 per 50 for UPS.

**1-312-433-8796**

**MacOnly, Inc.**

**PO Box 256**

**Highland Park IL 60035**

# IMAGEWRITER RIBBONS

# 3

# 50

Each

Shipped in  
6's.

Brand new. Not reinked. Imagewriter I or II. Black only. Add \$ 2 for shipping per 6 ribbons.

Color ribbons \$ 7.75 each in packs of 6.

**1-312-433-8796**

**MacOnly, Inc.**

**PO Box 256**

**Highland Park IL 60035**

# Macintosh Typeface/ Clip Art Encyclopedia

A complete encyclopedia of all typefaces and clip art currently available for the Mac. See what they're offering before you buy.

The encyclopedia is FREE, but there is a \$ 2 shipping charge.

**1-312-433-8796**

**MacOnly, Inc.**

**PO Box 256**

**Highland Park IL 60035**

# FREE

**1-312-433-8796**

**MacOnly, Inc.**

**PO Box 256**

**Highland Park IL 60035**

# People who deal with "baud" of McGraw-Hill information.

Nobody understands the value of good information better than the people who work in computers and communications.

And for those people, no information carries more weight than McGraw-Hill's. We provide the databases, analyses and news that computer and communications professionals rely on to illuminate the workings of their industries.

Everyone in the business keeps up with the latest developments by reading McGraw-Hill maga-

zines. BYTE, Electronics and Data Communications are all required reading in the field. So are books from Osborne/McGraw-Hill.

For MIS/EDP and communications professionals, Datapro's print and on-line directories and reports cover every aspect of computer hardware and software from mainframes to micros, as well as communications and office automation.

For people who manufacture or sell microcomputers and microsoftware, Future Computing is the

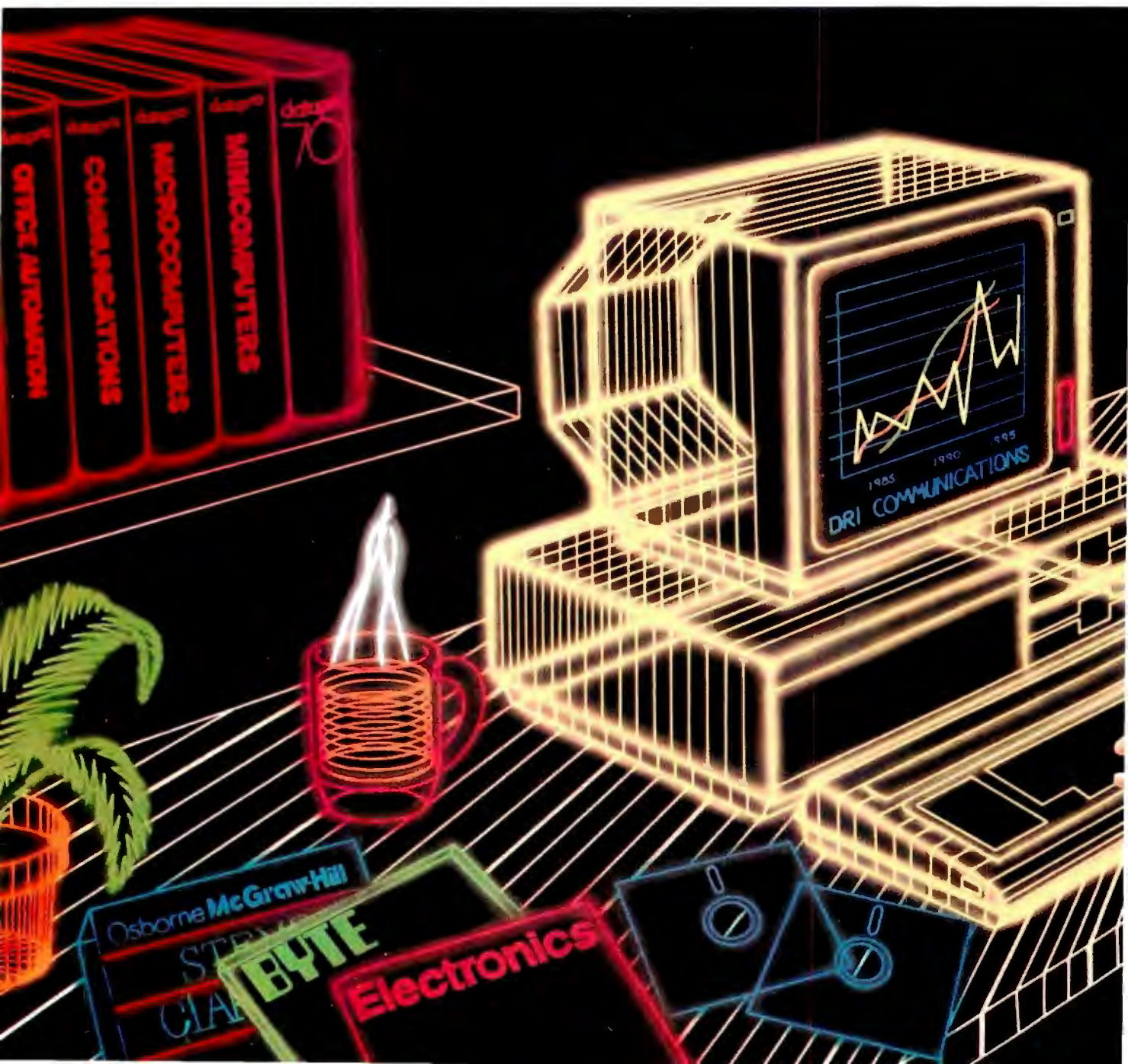

# and "byte" use every bit

number one information source for product tests, analyses and comparisons.

People who specialize in communications are wired into CCMi/McGraw-Hill, to receive not only the hard facts on communications tariffs, but also in-depth analyses and bottom-line recommendations via print, software and on-line products.

And when telecommunications and computer companies plan for the future, they rely on DRI Communications to provide them with forecasts

of economic forces and industry trends.

When it comes to turning megabytes into megabucks, nothing computes like McGraw-Hill information.

McGraw-Hill, Inc., 1221 Avenue of the Americas, New York, N.Y. 10020.

**McGraw-Hill.**  
Information that leads to action.

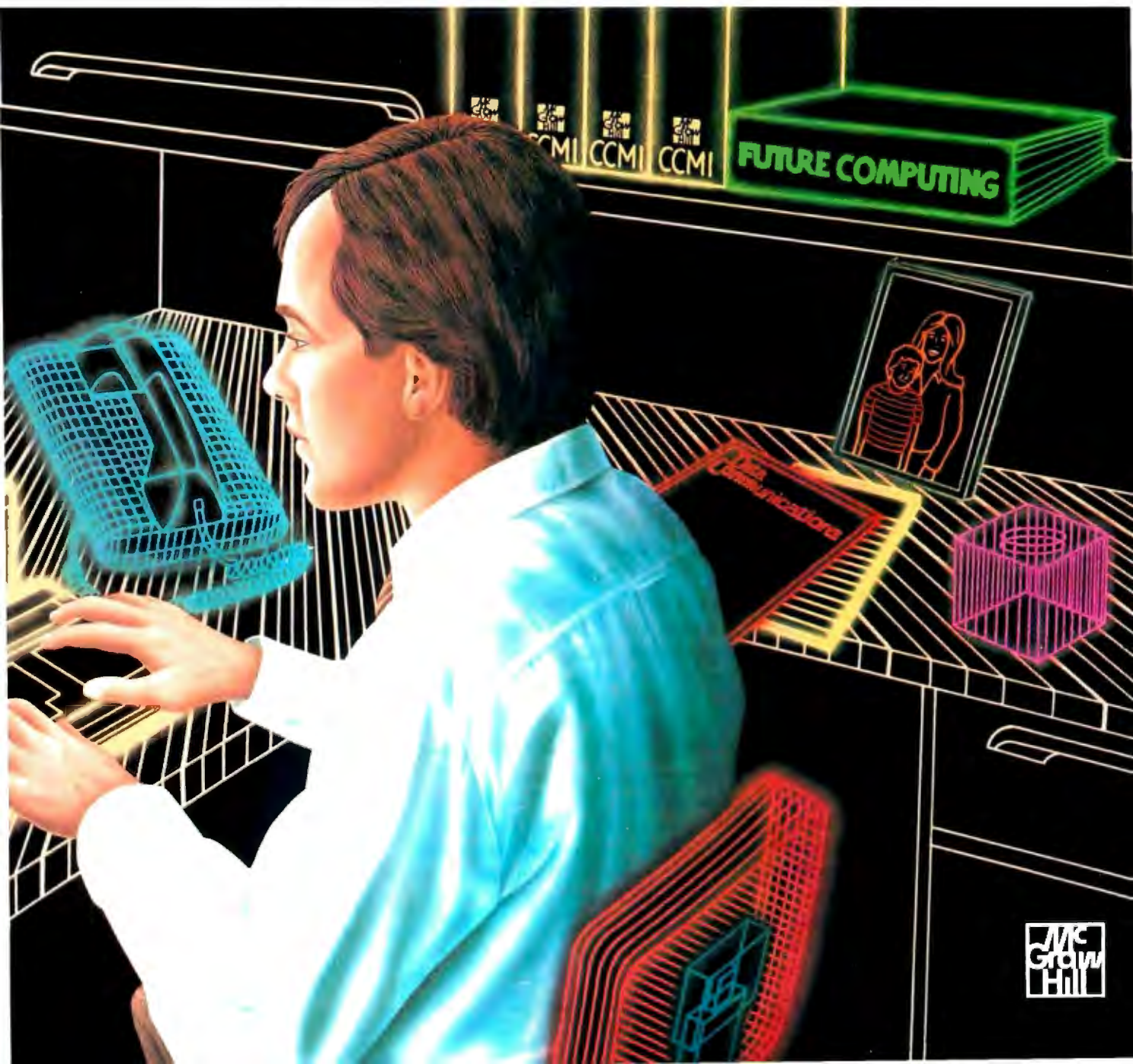

# Enter The New Age of Electronic CAD

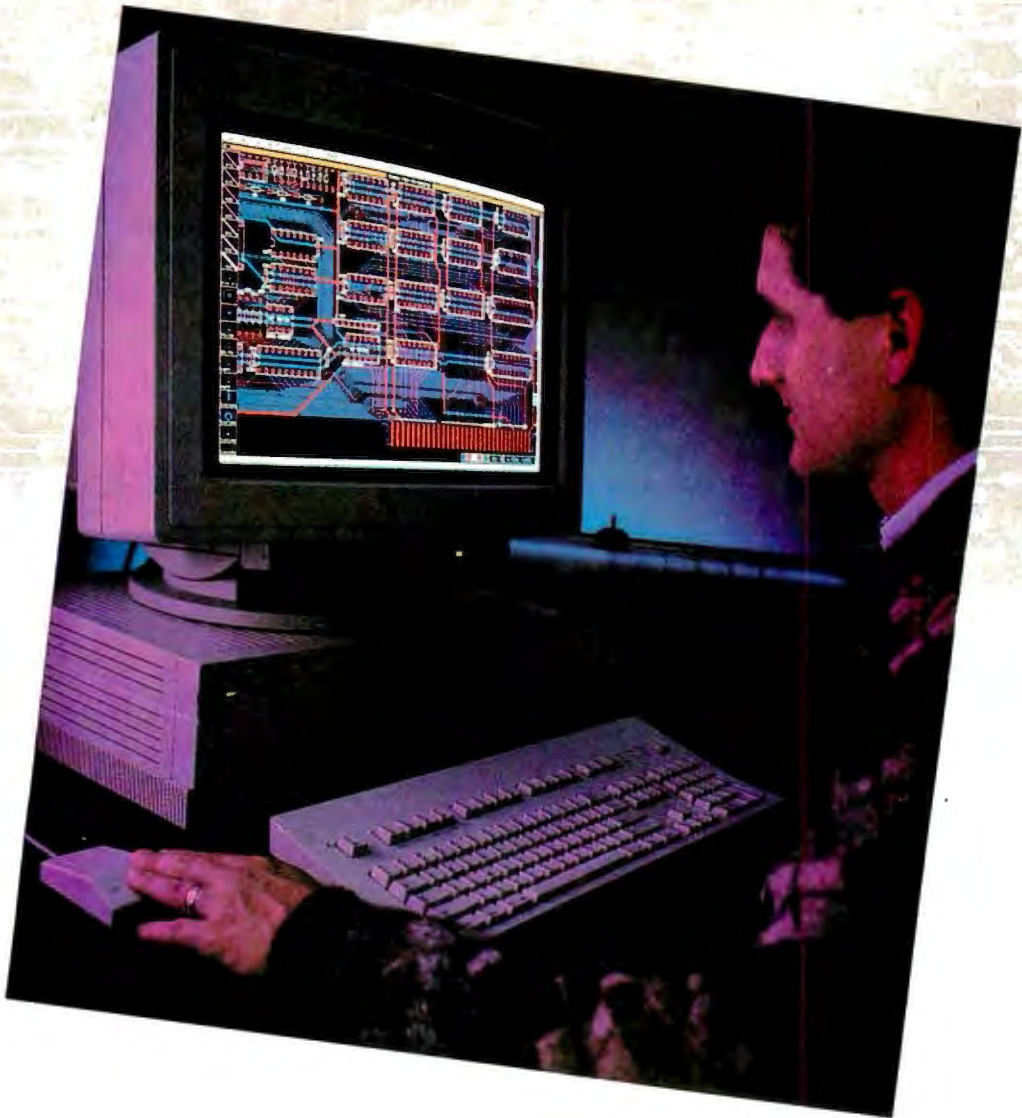

The wait is over for a powerful, easy to use electronic design workstation.

With the new Douglas CAD/CAM Professional System, you can now experience computer-aided design without going over budget and without sitting through months of tedious training. Running on the Apple Macintosh Plus, SE and II, the Professional System from Douglas Electronics excels in price/performance, short learning curves and ease of use.

As the newest addition to the Douglas CAD/CAM line of printed circuit board design and manufacturing systems, the Professional System is a fully integrated engineering tool that will take you from the schematic drawing to the final routed board. The software features full color, unlimited multi-

layers and .001" control which makes surface mount technology (SMT) and other difficult tasks a snap. Professional Layout includes a parts placement facility. Schematic includes fully interactive digital simulation and net list generation. A flexible, multi-pass router completes the design cycle with a 16 layer routing capability.

The new age of electronic CAD has come with the high resolution and speed of a Macintosh engineering workstation. You'll be designing your first circuit board just minutes after the Professional System software has been loaded into your computer. In addition, the Macintosh's graphics capa-

bilities allow for powerful features such as the ability to transfer Professional System drawings into final engineering documentation.

Computer-aided design wasn't meant to be time consuming and complicated. If your present CAD system has got the best of you, it may be time you enter the new age of electronic CAD with the powerful, easy to use Douglas CAD/CAM Professional System.

Take your first step by ordering a full-feature Demo. All three programs are included for just \$25.

Call or write for more information and to place your order.

Circle M22 on Reader Service Card

**Douglas**  
Electronics

718 Marina Blvd.  
San Leandro, CA 94577  
(415) 483-8770

# Twelve All-Time Favorites

Ezra Shapiro

*Ezra recounts the  
 Mac's history  
 and names his dozen  
 top programs*

Let's say you were going to be shipwrecked on a desert island for the rest of your life, and someone offered you a twist on the classic question. Instead of the traditional 10 favorite books or records, you would be allowed to bring your 10 most prized software packages for your Macintosh (yes, it's a very refined desert island, with three-pronged electrical outlets all over the place). What would you choose, and why?

The above is a therapeutic exercise that was suggested to me by Bruce Webster as a way to help me narrow my focus when I was beginning to work on this article. I dutifully sweated over my list, cheated a little ("Does it have to be 10? How about 14?"), and came up with my own personal Mac favorites. Some of the choices were predictable—and some were a little weird—but I had concocted my list.

I proceeded to put it away and ignore it for a week; when I returned to it, I noticed that it made a pretty good assessment of the state of refinement, or lack thereof, in the Macintosh universe. It also recapitulated my history with the Mac, a long story of alternately falling in and out of love with the machine.

## In the Beginning

These days, it's not very fashionable to advocate a computing environment based on a closed system architecture. In many ways, however, today's open Macintosh owes its rich universe of software—if not its very existence—to the authoritarian nature of its initial design. Ask any member of the original Macintosh design team, from Jef Raskin on down, and you'll get the same answer: The Mac seduced developers into using a standardized interface.

The difficulty of writing meaningful code in the limited memory space of the first 128K-byte Mac made the interface routines provided in the machine's ROM so attractive to programmers that they adopted the standard Macintosh "look" without too much grumbling. The Tool-

box ROM turned out to be far more than a collection of shortcuts for programmers; it became the guiding force in all Mac software. The combination of the Toolbox, a modular program structure, and extensive use of bit-mapped graphics proved to be a fertile ground indeed for the development of new software.

And it was new software, too, built around graphics rather than text. The Mac was the first successful personal computer that pumped out pixels rather than characters (though characters could be made from pixels easily enough). Looking back, it's not surprising that MacPaint was the program that propelled the Mac into consumers' hearts, while MacWrite evoked little enthusiasm, particularly from business buyers. But as the Mac slowly matured, the software base grew with it. The gaps began to be filled with spreadsheets, database managers, and other prosaic applications. It took a few years, but the Mac became a "real" computer at last.

But in the beginning, the Mac was something of a dog. Intriguing, yes. Easy to use, yes. But boy, was it frustrating to do any serious computing on the machine.

When I first joined the staff of BYTE in 1983, I found a Lisa on my desk. After playing with it for a few days, noting its slowness and inflexibility, I embarked on a serious project to unload the machine on anyone in the office who would

take it off my hands. I worked out a trade and was relieved to replace the Lisa with a stock IBM PC. Nothing fancy, but software availability alone made the exchange worthwhile.

The Lisa spawned the Macintosh, and in 1984 a few Macs began filtering into the office. What caught my fancy—and indeed made everyone take notice of this new machine—was MacPaint. On a character-oriented machine like the IBM PC, I pushed words and numbers. On the Mac, I could doodle or even produce legitimate artwork. I was enchanted. So here we have the first program category for one of my Mac favorites—design.

Today, I vote for SuperPaint from Silicon Beach Software. It's a direct descendant of MacPaint, but it allows for much greater refinement. You can create with all the MacPaint tools, perform distortions, swap graphics with a wide range of other programs, edit at laser-printer resolution, magnify and shrink your work area with pinpoint control, and, in general, have a real good time. SuperPaint also lets you work on a second plane of draw-type artwork, so you also get much of the functionality of MacDraw.

I have to give a nod of appreciation to GraphicWorks, which is equal in many respects to SuperPaint, though more confusing and tougher to learn. GraphicWorks was originally named ComicWorks, and it's designed to integrate text and graphics into the sort of panels you'd have in a comic strip. The airbrush tool is more adjustable than SuperPaint's, and you can work on multiple layers. Another nod goes to Adobe Illustrator, Aldus FreeHand, and Cricket Draw, all excellent programs at the higher end of professionalism for the serious artist. But the all-around winner is SuperPaint.

One aside: I have to promote one other art program to my list, Fontographer from Altsys. With it, you can create your own laser fonts. It predates any other program that manipulates the Bézier

*continued*

curves that make up PostScript outlines, and it contains the germ of the technology on which they're all based. If you're patient, you can do wonderful things with this product.

### Back to the Story

Even though I fell in love with MacPaint, I did not fall in love with MacWrite, Apple's companion word-processing program. The typefaces were nice, but I could run rings around it with grubby old WordStar on the IBM PC. So I held back; I was not yet ready to become a Mac convert.

The program that started to convince me that the Macintosh might be a tool for more than creative doodling was ThinkTank 128 from Living Videotext. This gem of an outliner ran perfectly well on those early memory-poor Macs. Writing an outline, then moving branches of it from place to place, made perfect sense as a mouse operation. It was exciting to realize that text manipulation could, in fact, be a very visual process.

ThinkTank 128 was rudimentary compared to the version for MS-DOS machines; many of the spiffier editing features were nixed due to memory constraints. But as soon as the Macintosh was fattened to 512K bytes, there was ThinkTank 512, which was more than enough to fulfill the promise of its predecessor. ThinkTank 512 had a host of new features, including a convenient text editor that let you create long text sections as part of an outline, and the ability to import graphics. ThinkTank 512 was suddenly far more than an outliner; it was a word processor, a database for artwork, and a spectacular tool for constructing tightly organized reports.

The reigning heir is called More (though Living Videotext has become part of Symantec), and it defines the state of the art in outline processing. More remains true to the visual outliner from which it grew, but it's almost an operating system in and of itself—an operating system within the context of indented outlines. You can use the program to sketch ideas, flesh them out with the word-processing functions in the editor, create databases with installable outline templates, dial phone numbers, convert your outlines to tree diagrams or bullet charts, and on and on and on.

More was one of the first programs to launch the discipline of desktop presentation, and it is so good a program that I almost forgot to include it in my list. It's such a natural, I assume everyone has it; I have to remind myself that it isn't sold as a part of the Mac package.

### The Next Phase

Shortly after the arrival of the 512K-byte machine, dubbed the Fat Mac, my head was turned even farther by PageMaker from Aldus and Microsoft's Excel spreadsheet. PageMaker was responsible for that all-consuming concept of desktop publishing. It lets you gather text and artwork created with other programs and pull them into finished layouts. It's based on the metaphor of the paste-up artist's drawing board, and you cut and paste on the screen as you would in a graphics studio, only you can dispense with the scissors and the rubber cement.

PageMaker began as a sophisticated piece of program design, and Aldus has continued to improve it. We're now up to version 3.0, which finally lets you create humongously long publications without having to perform every little design operation one at a time. It fully supports style sheets (in fact, it can exchange named styles with Microsoft Word 3.01), and it is a pleasure to use.

I have to nod at Quark XPress and Ready-Set-Go! 4.0, PageMaker's worthy competitors, but PageMaker was my first love in this category. Also, PageMaker was the program that convinced me that the Mac was a real machine, one that I could both use *and* love.

Excel proved that the Macintosh interface was ideal for spreadsheets. Though I wouldn't have thought so before, it turned out that zooming around on a grid of numbers was made easier with a mouse. And Excel allowed linked worksheets to avoid the bloat of large worksheets fenced into smaller regions for printing. The program also has an exceptionally powerful macro language. Excel was the spreadsheet that finally began to get the Mac into business workplaces.

However, I haven't included Excel as one of my top choices, but only due to my personal habits. Though I like spreadsheets, I'm not a number cruncher by trade. I vote for Microsoft Works, a nice integrated package with spreadsheet, word processor, database, and telecommunications modules. Nothing spectacular, but solid and reliable. With the addition of two add-in programs from Tim Lundeen, WorksPlus Spell (one of the slickest spelling correctors I've ever used) and WorksPlus Command (an awe-inspiring macro package that completes the job of integration), Works handles just about everything I need to do. Needless to say, it's also my winner in the word-processing category.

If you need super power in any of Works' areas, I'd recommend going with a stand-alone program (Works is a mite

slow), but for overall flexibility, Works with the Lundeen additions is my pick.

### This Year's Craze

"Hypertext," the current buzzword in Macintosh application design, has come to be a term that's at least as ill-defined as desktop publishing, the former titleholder in the ambiguity department. As near as I can figure, hypertext means "interrelated text and graphics organized by the creator into a structure not necessarily bound by the limits of hard-copy output." In other words, hypertext is an attempt to exploit the abilities of the computer itself as a presentation device. Typically, hypertext programs let you link screen areas (called buttons) that can be clicked with a mouse to reveal new regions of data.

Rather than nominating HyperCard, Apple's hypertext Erector-Set-in-a-box, or Guide, a solid implementation of the concept, I find myself leaning toward TeleRobotics' Course Builder, a program that lets instructors manufacture self-contained teaching programs that implement many of the core ideas of hypertext. Written by the prolific Bill Appleton, Course Builder lets you link artwork, sound, text, and animation into the framework of a teaching system. A student can move from item to item at his or her own pace, answer multiple-choice or specific-answer quizzes, and refer to related materials in a neatly structured environment.

What's so beautiful about Course Builder is that you don't have any need to program; you define the course using a straightforward "logic editor" (that's my phrase, not Appleton's). You simply link blocks representing elements of your course in a kind of flowchart, and then Course Builder does the rest for you.

The other prong in my mild attack on HyperCard is provided by 4th Dimension, the database development system from Acius. If you're going to have to program, you might as well go for top power. This is a full-featured relational database that gives the developer absolute control of the interface. You want your own menus, click boxes, entry forms, whatever? Fine, you got 'em. You can program and debug in a programmerish way, or you can build a flowchart (much like Course Builder), and away you go. This is my choice for databases.

My third hypertext-like favorite is a game, Chris Crawford's Balance of Power. Working with maps, menus, graphs, and descriptions, Balance of Power lets you play out a global political

*continued*



# While Others Talk Of The Future, We Deliver It. QuickMail™...Available NOW!

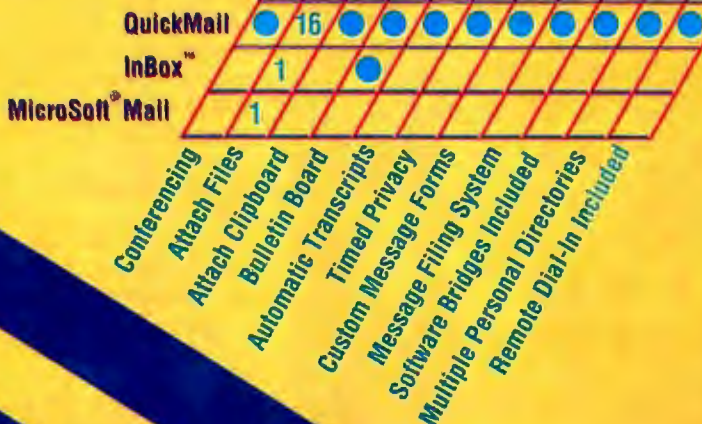

Whether you have  
 a few Macintoshes®  
 with a LaserWriter® or hundreds  
 connected through zones,  
 bridges, gateways and modems...  
 you need QuickMail!

Our radically new design  
 is complete and intuitive.  
 It will forever change  
 the way you view  
 electronic mail.

Now, send mail seamlessly  
 to wide area networks,  
 hardware devices and other  
 software systems.

Send mail across the hall  
 or around the world  
 with a click!

\$300 per 10 users.

See your dealer today.



**CE SOFTWARE** INC

1654 Fuller Road, P.O. Box 65580, West Des Moines, IA 50265. Ph: 515-224-1995

QuickMail, QuickMail logo & CE Software logo are trademarks of CE Software, Inc. Macintosh & LaserWriter are registered trademarks of Apple Computer, Inc. Microsoft is a registered trademark of the Microsoft Corporation. InBox is a trademark of Symantec.

# Hey Mac, Nisus™ Is Not Just Another Word Processor.



Here's why.  
 Want to draw a picture without ever leaving the program? *Easy.*  
 Want to wrap text all the way around it or let the text flow right through? *Easy.*  
 Want to see it all in glorious color? *Easy.*  
 Need a particular word or phrase by searching through all files, open or not? *Easy.*  
 Need to use our superior dictionary, thesaurus, hyphenation or outlining? *Easy.*  
 Want to undo what you just did,

or any number of things you did before? *Easy.*  
 Want to use the fastest word processor on the market? *Easy.*  
 Line numbers? Envelopes? Auto-save? Column selection? Adjustable page preview? Ten clipboards that can be edited and printed? Your favorite page layout ready when you open a new file? *Easy.*  
 It's all easy when you have Nisus.



Nisus is a trademark of Paragon Concepts, Inc.

confrontation between the U.S. and the USSR. Click your mouse on Mexico on the map, and you get a display of the status of your relations with that country. Select menu items to adjust your policies, read newspaper reports, or dig for historical or quantitative analysis. Very hyper, and one hell of a game.

### Finally, Some Fun

VideoWorks II from MacroMind is another impressive example of pushing the Mac interface to its limits. It's an animation package that lets you mix sound and graphics into your own Macintosh movies. You have to write a script (called a "score"), which takes some time to learn, but once you get the hang of it, you're in the motion picture business. VideoWorks II even provides a nice shortcut if you're pressed: You can place an object on the screen in one position, place it again in a second spot, and VideoWorks II animates the transition.

It could very well be next year's hyper-text; if not, it still represents a great area for creative exploitation. Even if you don't want to make your own cartoons, you can use it to animate your bar-graph or pie-chart presentations. Imagine an exploded diagram that actually explodes!

### Not All Roses

Of course, depending on whom you talk to, the Macintosh interface is far from perfect. It lacks a number of the amenities we've come to associate with more traditional computer systems. The icon-based environment is certainly easy to learn, but some users eventually resent the way the Mac's simplicity gets in the way of real operating speed. I have rounded out my set of favorite programs with three utilities that extend the power of the Macintosh's operating system to cover some of the gaps.

One of the Mac's most lamented deficiencies is the absence of a good keyboard macro facility. Fast touch-typists find the constant interruption of mouse movements to be both distracting and time-consuming, particularly during text entry. Though most menu functions can be abbreviated to a combination of shortcut keystrokes, mouse actions (e.g., scrolling and selecting) are not usually automated from the keyboard. Enter QuickKeys from CE Software, a keyboard enhancing utility that lets you attach any single Mac operation to a one-keystroke combination command. You can still mouse along if you want to, but judicious assignment of functions to keystrokes will keep your fingers on the keyboard

*continued*

# V.I.P.

## The First Family of Macintosh Programming

Getting the most from your Macintosh means taking control --- programming! Creating full-featured Mac programs used to be difficult. Not any more! Programming a Mac is as easy as using one.

### Visual Programming

The idea is to use the visual power and intelligence of the Mac to make it easy to program. You program visually and the Mac interacts with you, preventing mistakes. Thus the name Visual Interactive Programming™ or V.I.P. for short.

V.I.P. is a new type of language where a graphic interface replaces a text editor. Traditionally, programming is done by typing program statements into an editor following the rigid rules of a language's arcane syntax.

Visual programming, on the other hand, is done by pointing, clicking icons and entering expressions and arguments into an on-screen diagram.

A V.I.P. program is composed of graphic elements which can be cut, copied and pasted. The program is automatically structured with classical logic forms such as *if...then...else* or loops such as *while...do* and *for...next*. These are presented graphically. **The program becomes visual!**

V.I.P. provides more than 220 pre-compiled procedures, greatly simplifying programming. On-line help is always there, keeping you on track.

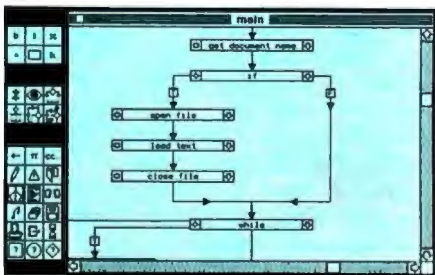

V.I.P. 's Graphic Editor

### Beginners Love It

V.I.P. , an interpreter, provides quick feedback. It's ideal for learning. Create programs with full Mac features thirty minutes after opening the package. A separate tutorial, *Macintosh Introductory Programming*, explains the basics.

V.I.P. is also great for experienced programmers who are seeking a painless introduction to the Mac.

### Experts Are Amazed

V.I.P. forms the nucleus of a powerful development system. A family of products offers amazing versatility.

Managers, sold separately, add new procedures facilitating spreadsheets, databases and vertical applications.

Translators, also sold separately, turn a V.I.P. program into "C" or "Pascal" source code, ready for compilation.

Imagine the benefits of developing in a friendly, interactive environment and with a few mouse clicks, having a stand-alone application.

### Extend HyperCard & 4D

V.I.P. programs, translated to "C", can be automatically compiled to HyperCard XCMDs or XFCNs or Fourth Dimension external procedures. These can offer added features such as multiple windows or full color on a Macintosh II .

### Write Programs Faster

V.I.P. improves productivity. In tests at Fortune 500 corporations, programs were finished ten times faster. V.I.P. also means linear progress; the last 10% of a project won't take 50% of the time. Other benefits are structured programs and automatically documented modules.

### The Press Agrees

V.I.P. received overwhelmingly positive reviews. **MacUser** called it "the wave of the future", while **MacWorld** described it as a "Very Important Program".

**MacTutor** characterized V.I.P. as "The Next Generation" .

### Features

Icon-based programming. Simplified interface to Mac toolbox. Visual, source level debugger. Fast, interpreted with many pre-compiled routines. 200 page tutorial/reference manual. 20 example programs (2 disks). Run-time package. No license fees. Not copy-protected.

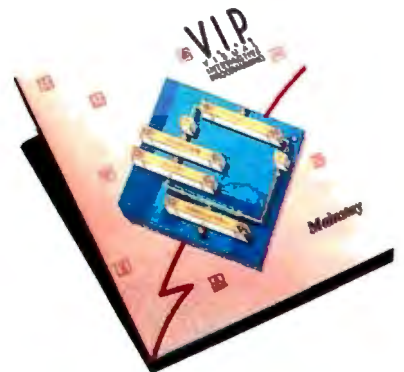

### V.I.P. only \$149.95

**Managers:** Speech \$49.95, Grid \$59.95, Matrix \$95, Advanced I \$95, Advanced II \$125, Communications \$125, Database/Form \$295. **Translators:** to Light-speed C or Pascal, MPW C or Pascal, or to Turbo Pascal \$89.95 each. **Tutorial:** *Macintosh Introductory Programming* Book (2 disks/275 pages) \$49.95

### Order V.I.P. Today

To order, see your dealer or call Mainstay at (818) 991-6540. MasterCard, VISA, AMEX and COD are OK. Add \$5 for shipping/handling. CA residents add 6.5% sales tax.

For more information, write or call Mainstay, 5311-B Derry Ave. Agoura Hills, CA 91301 (818) 991-6540.

In Europe, contact Mainstay at 71 rue des Atrebat, Brussels, Belgium (02) 733 97 91, Telex 62239.

# Mainstay

Visual Interactive Programming is a trademark of Mainstay. Lightspeed is a trademark of Symantec. MPW and HyperCard are trademarks of Apple Computer. Fourth Dimension is a trademark of ACIUS.

## Items Discussed

<b>Balance of Power</b> ..... \$49.95 Mindscape 3444 Dundee Rd. Northbrook, IL 60062 (312) 480-7667 <b>Inquiry M241.</b>	<b>Suitcase</b> ..... \$59.95 Software Supply 599 North Mathilda Ave. Sunnyvale, CA 94086 (408) 749-9311 <b>Inquiry M248.</b>
<b>Course Builder</b> ..... \$395 TeleRobotics International 8410 Oak Ridge Hwy. Knoxville, TN 37931 (615) 690-5600 <b>Inquiry M242.</b>	<b>SuperGlue</b> ..... \$89.95 Solutions International 29 Main St. P.O. Box 989 Montpelier, VT 05602 (802) 229-9146 <b>Inquiry M249.</b>
<b>Fontographer</b> ..... \$395 Altsys Corp. 720 Avenue F, Suite 108 Plano, TX 75074 (214) 424-4888 <b>Inquiry M243.</b>	<b>SuperPaint</b> ..... \$149.95 Silicon Beach Software 9770 Carroll Canyon Center, Suite J San Diego, CA 92126 (619) 695-6956 <b>Inquiry M250.</b>
<b>4th Dimension</b> ..... \$695 Acius 20300 Stevens Creek Blvd., Suite 495 Cupertino, CA 95014 (408) 252-4444 <b>Inquiry M244.</b>	<b>VideoWorks II</b> ..... \$195 MacroMind 1028 West Wolfram St. Chicago, IL 60657 (312) 871-0987 <b>Inquiry M251.</b>
<b>More</b> ..... \$295 Living Videotext 117 Easy St. Mountain View, CA 94043 (800) 441-7234 (800) 626-8847 in California <b>Inquiry M245.</b>	<b>Works 1.1</b> ..... \$295 <b>Excel</b> ..... \$395 Microsoft 16011 Northeast 36th Way P.O. Box 97017 Redmond, WA 98073 (206) 882-8080 <b>Inquiry M252.</b>
<b>PageMaker</b> ..... \$595 Aldus 411 First Ave. S Seattle, WA 98104 (206) 622-5500 <b>Inquiry M246.</b>	<b>WorksPlus Command</b> ..... \$99.95 <b>WorksPlus Spell</b> ..... \$79.95 Lundeen & Associates P.O. Box 30038 Oakland, CA 94604 (800) 233-6851 (800) 922-7587 in California <b>Inquiry M253.</b>
<b>QuicKeys</b> ..... \$99.95 CE Software 801 73rd St. Des Moines, IA 50312 (515) 224-1995 <b>Inquiry M247.</b>	

and your train of thought intact. You can even chain keyboard macros into long sequences, thus automating a whole string of commands.

My second utility, one that is fast becoming everyone's favorite, is a little program from Steve Brecher of Software Supply called Suitcase. The original Mac design allows for only 16 desk accessories and a limited number of fonts

(the maximum varies from program to program). If you like to have a large collection of memory-resident desk accessories, or if you want wider access to the growing panoply of Mac typefaces, you need Suitcase. Though there are theoretical limits, installing Suitcase gives you as many accessories and typefaces as any mortal normally needs. You're more likely to run out of RAM and/or disk

space before you make Suitcase choke.

The third utility, Solutions' SuperGlue, is a print-to-disk driver that lets you look at formatted output on the screen without requiring the originating program. If you send a file to disk using SuperGlue, the saved image can then be manipulated by any other program as if it were a graphic. Thus, you can capture a page of a spreadsheet, drop the image into a layout program, shrink it, and make marginal notes before printing it out. You can build a report with a word processor that uses the output of any sophisticated analytical tool you have.

In many cases, the SuperGlue image is smaller than the original file, which is handy for data transfer and true electronic publishing. The program lets you crop, resize, reposition, and extract text from images to your heart's content. Why Apple didn't see a need for such a utility built into the operating system is beyond me, but this little gem is an essential addition to the Mac arsenal.

I wish I could add one more capability to this list of remedial utilities—batch files, some sort of concise language to pipeline a series of operations that involves a number of programs and a number of files. I'd settle for the ability to add a shell to the Mac interface that could give me (dare I say it) a command line with batch handling that is not based on icons. I realize that this flies in the face of the icon-and-mouse dogma, but the more you work with computers, the more you appreciate ways to slice off a few seconds, even if it involves procedures that are not quite so easy to learn.

### The Wrap-Up

There you have it, an even dozen recommendations spanning the range of Macintosh applications: SuperPaint, Fontographer, More, Works (with WorksPlus Spell and WorksPlus Command), PageMaker, Course Builder, 4th Dimension, Balance of Power, VideoWorks II, QuicKeys, Suitcase, and SuperGlue. If you ask another Mac aficionado for his or her top dozen selections, you probably won't get the same list, but I guarantee you'll get several duplicates. The Mac is getting its share of excellent software. ■

*Ezra Shapiro is a consulting editor for BYTE. You can contact him on BIX as "ezra." Because of the volume of mail he receives, Ezra, regretfully, cannot respond to each inquiry.*

*Your questions and comments are welcome. Write to: Editor, BYTE, One Phoenix Mill Lane, Peterborough, NH 03458.*

# The Breakthrough Used To Be ATs And Macs In The Same Room.

## Now They're In The Same Computer.



It was getting pretty crowded. As more and more Macintoshes started showing up at work, the duplication of computers, monitors, printers and keyboards was simply getting out of hand.

And while there was still a need to use vital programs like Lotus® 1-2-3® and dBASE®, there was also an ever increasing demand for the Macintosh. Would the two computer environments be able to work together?

Times have changed. Now Macintosh™ IIs can run MS-DOS® software just as easily as Macintosh applications. With AST's Mac286™, the AT-compatible, 80286 computer-on-a-board that runs inside the Macintosh II. Its advanced hardware design actually runs faster than an IBM® PC AT.

With Mac286, familiar MS-DOS programs take advantage of many of the elements of the Macintosh environment. Copy and paste text, print on an Apple® LaserWriter®, store your files on the Mac hard disk and share DOS files with other users. It's that easy.

Of course, the future is built in, too. By installing an advanced hardware solution for MS-DOS compatibility, you're insuring a home for the best of today's, and tomorrow's, software programs.

Because there's one thing you can always count on in the world of personal computers. Times will change.

If you're interested in putting an AT-compatible computer inside your Mac II, call AST at (714) 863-0181 or fill out the coupon, and we'll tell you how you can have the best of both worlds.

Now With  
Improved Video  
Performance.

- Yes, send me information on the Mac286.  
 Yes, have an AST representative call me.

Name \_\_\_\_\_

Title \_\_\_\_\_

Company \_\_\_\_\_

Address \_\_\_\_\_

City \_\_\_\_\_ State \_\_\_\_\_ Zip \_\_\_\_\_

Phone \_\_\_\_\_

Send to: AST Research, Inc. 2121 Alton Ave.  
Irvine, CA 92714-4992. Attn: M.C. BYTE 8/88

**AST**  
RESEARCH INC.

### Times Have Changed.

AST markets products worldwide—In Europe and the Middle East call: 44 1 568 4350; in the Far East call: 852 5 717223.

AST and AST logo registered and Mac286 trademark of AST Research, Inc. IBM and AT registered trademarks International Business Machines Corp. Apple and LaserWriter registered and Macintosh trademark of Apple Computer, Inc. MS-DOS registered trademark Microsoft Corp. Lotus and 1-2-3 registered trademarks of Lotus Development Corp. dBASE registered trademark Ashton-Tate. Copyright © 1988 AST Research, Inc. All rights reserved.



**Create a 3.5"  
Micro Diskette  
with unlimited  
protection against  
a hostile world.**

You're covered. BASF molds the rigid plastic jacket of its 3.5" Micro Diskette to its own specifications, providing unsurpassed protection for the flexible disk within. Call 800-343-4600 for the name of your nearest supplier.

**The Spirit of Innovation.**



**BASF**

# Macintosh Redux

Bruce F. Webster

*The path from  
then to now  
was anything but  
easy for the Mac*

It's mid-April as I write this, and a lot of water has gone under the bridge since last I wrote for BYTE. I've moved back to California, penned a number of articles for other publications, written some manuals for a certain unnamed software firm, and have even started work on my first honest-to-goodness book. So, why am I here? Because, in light of my extensive and consistent coverage of the Macintosh from 1984 to 1987, BYTE has graciously invited me back for the first-ever BYTE Macintosh supplement. They figured I might have a few things to say, and, true to form, I am *not* at a loss for words.

The still-warm (but cooling) news is, of course, the lawsuit by Apple against Microsoft and Hewlett-Packard for "violation of audiovisual display copyright," because Apple thought that the New Wave user interface from HP looked too much like the Mac Finder. And, of course, Microsoft has filed a countersuit. The merits and issues of this case are best discussed elsewhere (and, in fact, I think I will), but it indicates the direction Apple's attitude has taken since the Mac burst upon a skeptical world 4½ years ago.

## Evolution in Action

I first saw the Macintosh in Guy Kawasaki's office at Apple, in December of 1983, a month or so before its announcement. Wayne Holder and I were there, representing Oasis Systems/FTL Games as president and vice president, respectively. Our ostensible purpose was to consider porting our word-processing utilities (spelling, punctuation, and style checkers) to the Mac. Our real purpose was to see the Mac ahead of time. I was initially disappointed at the lack of slots, but Guy assured me that schemes were underway to use the high-speed RS-422 ports as "virtual slots."

Three weeks after the Mac was announced (February, 1984), I bought one, off the shelf, with money out of my own pocket. It had 128K bytes of RAM, 64K bytes of ROM, a 512-by 342-pixel mono-

chrome display, a single 400K-byte floppy disk drive, no slots (virtual or otherwise), and an 8-MHz 68000 processor. It was slow, crashed a lot, required multiple disk swaps to copy a file, and had little software available. But it was mine, and I was thrilled to have it.

The Macintosh I use today is a Mac II, with 5 megabytes of RAM, 256K bytes of ROM, two displays (AppleColor high-resolution RGB monitor with a fully expanded Mac II video card, and a Sony GDM-1952 19-inch Trinitron RGB monitor with the SuperMac Spectrum video card), a 40-megabyte hard disk drive, an 800K-byte floppy disk drive, six NuBus slots, a 16-MHz 68020 processor, and a 16-MHz 68881 math coprocessor. It's fast, seldom crashes, has thousands of software titles available, and copies files with no extra disk swapping. Unfortunately, it's not mine, and I'm not sure when I'll be able to come up with the money to buy such a system.

Apple has come a long, long way in the past 4 years, as has the Macintosh. The Mac was initially derided as a toy or dismissed as a curiosity. And through the last 4 years, it's always been a major source of controversy and contention. The Mac versus IBM debates have been hot and heavy, reaching a level of intensity reserved for such classic issues as calculators (RPN vs. algebraic notation), languages (Pascal vs. C, BASIC vs. Pascal, and assembly vs. high-level), and

operating systems (Unix vs. anything else).

Now, the Macintosh is the system that everyone either wants or wants to imitate, IBM included. That's something of an amazing feat.

## How Apple Got There

The path from then to now was anything but easy for the Mac. It's hard to remember now, and seems incredible in retrospect, but it was several *months* after the Mac's introduction before external disk drives (much less hard disk drives) were generally available. After an initial spurt of sales, fueled by technophiles like me, the Mac went into a slump for almost a year, a slump that many believed was not only the end of the Mac but the end of Apple as well. Some of Apple's decisions along the way (anyone remember the \$1000 RAM upgrade from 128K to 512K bytes?) did little to help things. Even the emergence of the "Fat" Mac with 512K bytes didn't help that much; software and operating system alike were space hogs, and the memory and disk configurations of the Macintosh just weren't sufficient to handle their demands.

The real breakthrough, in retrospect, was the Mac Plus. With 1 megabyte of RAM and an 800K-byte floppy disk drive as standard, plus a small-computer-system-interface port for hard disk drives and significant speed improvements in the operating system and ROM, it was the first Mac system that had the resources and horsepower to do serious work. Sales took off, surprising everyone (including, I suspect, Apple); for a while there, the Mac Plus was the single best-selling model of computer in the U.S. The enlarged basic configuration and improved sales drew in a lot of software development firms that had been watching from the sidelines.

The final steps toward success were the introductions of the Mac SE and the Mac II. Like a lot of other folks, I fo-

*continued*

cused mostly on the Mac II (an open Macintosh, at last!) and dismissed the Mac SE as just another “toaster,” in a platinum case instead of beige. However, it was the SE that shot off in sales this time, displacing the Mac Plus. The key was the capacity for an internal hard disk drive. Sales reports I’ve seen indicate that about 80 percent of all Mac SEs are sold with a hard disk drive.

Meanwhile, the Mac II established an open architecture for the Mac family. Hardware developers now had a standard upon which to base their efforts, and owners had a machine that could be expanded with special tools and bizarre cables. And, despite the hefty price tag, Mac II sales have been strong.

### What Apple Does Right

Given its strong financial condition and growth of market share, Apple has done many things right. But what the company does best isn’t something that shows up directly on the balance sheets, though ultimately it’s reflected there. Its greatest strength is that *Apple operates from a place of vision.*

Before I get accused of succumbing to Apple evangelism, let me explain. I’ve visited a lot of computer firms, talked with their leaders and employees, read their press releases, and used their products. It’s obvious that a lot of them have an attitude of “sell the iron and move on.” Most of those companies just get by, despite (in some cases) having significant or innovative products. The ones that succeed the most are the ones with a vision, whatever it may be.

Apple, from what I can see, has a very well defined vision of the future and its role in that future. Its vision is reflected in its internal documents, in the talks given by its people, and by its communications with developers. The company is planning now for products that will be released in 5 years, based on how it thinks things will (and should) be then. Apple sees its products as a force for social change—hence the almost religious fervor at times. But this imbues the company with a desire for innovation not often found at firms concerned only with the bottom line.

That innovation gives Apple an important place in the market; it is the leader and everyone else is following, even IBM and Microsoft. What else can you say after an IBM spokesman, at a press conference about the forthcoming Presentation Manager, explains the product’s need by pointing to the relatively brief time required for learning how to use the Macintosh? Would products like Presen-

tation Manager, GEM Desktop, and Amiga’s Workbench really exist if it weren’t for the Macintosh? The fact is, Apple has some hot ideas and technology, and others want it for their systems.

In the ancient Chinese game of Go, there is a term, *sente*, which refers to one player having control of how the game is being played. I have *sente* if every move I make forces you to respond. I may have a

**A**pple has  
a very well defined  
vision of the  
future and its role  
in that future.

weaker position overall, but for now, I get to control how the game goes, because you perceive each of my moves as being too threatening to ignore.

Apple right now has *sente* in the computer market. Apple plays the user-interface move; pretty soon, everyone is trying to come up with a Mac-like user interface (while, of course, avoiding a lawsuit). Apple plays the desktop publishing move; pretty soon, everyone says they’re into desktop publishing. As other moves come into play, the rest of the players must react. That may be overstating the situation, but not by much. Just look at all the nifty “new” concepts in hardware and software on MS-DOS systems and ask yourself: How many of these showed up on the Mac first? Apple leads instead of following.

This is not to say that Apple doesn’t derive ideas and concepts from elsewhere; its heritage from the Xerox PARC and other such places is well known. But the Xerox PARC stuff was around for years; why didn’t anyone else use it before Apple? As it was, IBM (and Microsoft) waited until the Mac user interface was well established (and well proven) before tentatively following suit. No pun intended. It’s easy to see how many concepts pioneered or developed on the Mac have migrated to other systems; there is little evidence of concepts flowing the other way.

One more thing that Apple does right, at least from the viewpoint of its employees and stockholders: It makes money.

Lots of it. True, that’s not always popular with consumers. I’ve grouched for years about Apple’s standard product pricing policy: Start it out high, let it drift down as needed to keep supply and demand matched, make one last official price cut to make room for its replacement product, then (at some point) halt production and let the remaining inventory sell off. And it works, especially with good products. The result is that Apple had \$1 billion in sales during the last quarter of 1987, with net profits double those of a year earlier. On top of that, Apple has no real debts. Adjusting for the 2-to-1 stock split that took place last year, Apple stock currently sells for about \$82 a share, whereas 3 years ago it hit bottom at around \$13 a share. And that cash allows Apple to continue its innovation.

### What Apple Does Wrong

I was tempted to make this section “What Apple *Did* Wrong,” but it’s too easy to pick over Apple’s past mistakes, and, besides, it’s been hashed over too many times already. What’s more, Apple has fixed many of those problems. The real question is, what is Apple doing wrong now?

First, Apple is squandering its advantage. *Sente* works only as long as you are willing to avoid responding directly to your opponent’s moves. Once you decide to turn and fight, there’s a good chance of *sente* shifting to your opponent. And I think that’s what may very well happen with the Apple lawsuit against HP and Microsoft.

Let me stop here to say that I am not as unsympathetic to Apple’s suit as others are. Apple has a copyright on the Mac user interface; to fail to defend that copyright could mean losing it. And, as I’ve pointed out, it is Apple who spent the money and took the risk, and the company is less than thrilled about other folks jumping on the bandwagon after the fact, especially when some of those folks have the initials *IBM*. Apple has fought long and hard to get into corporate offices; its penetration is based largely on the strength of its user interface and its desktop publishing abilities. The IBM/MS-DOS domination is based on a substantially inferior user interface; how much of Apple’s gains will disappear if the Other Side comes up with something even half as good as the Mac?

Having made Apple’s case, I must now assert my feelings that the lawsuit will ultimately cost the company more than it saves. Reaction among industry, press, and users (including a lot of Mac users)



has been overwhelmingly negative. Some have even pointed out how good IBM looks by comparison. This, of course, ignores IBM's litigious history, as well as its subtle hints about landing with both feet on anyone cloning PS/2s without a license; I'm not sure the comparison is valid.

I don't think the lawsuit is unfounded, but I do think that it won't slow up the competition as much as Apple hopes, and it will cost the company more in goodwill than it's worth. Ultimately, the only way for Apple to continue to succeed is to continue to innovate. Rightly or wrongly, many interpret the lawsuit as a tacit admission by Apple that it doesn't have much else going for it.

The second thing that Apple is doing wrong is ignoring the home market. MS-DOS clones have gotten so inexpensive that they are making a substantial penetration into households, hurting sales of Apple IIs (especially the overpriced IIGS), Amigas, and Atari STs. Apple has taken a step in that direction by dropping the price of the Mac Plus some, but the drop isn't enough; you won't see significant home market penetration of the Mac until it hits the critical \$999 price point. Given how little it costs to make a Mac Plus at this point (even with the rise in RAM prices), Apple could afford to sell the Mac Plus that cheap. True, margins on the Mac Plus itself might be a bit thin, but anyone who buys a Mac is going to buy an Imagewriter and probably an external floppy or hard disk drive.

Besides, Apple is ignoring the influence that the home market can have on business purchases. If I buy a cheap MS-DOS clone for home, I have a strong incentive to have an MS-DOS system at work as well. If I have a Macintosh at home, chances are I'm going to want one at work, too, both because I can bring work home and because it's a heck of a lot easier to use all the way around. Folks have a way of getting hooked on the Mac; having an inexpensive home system could well be another foot in the office door.

Third, Apple is getting a bit too complacent, smug, and fat. Complacent, in that it is slow to correct design flaws and bugs in its products and has sometimes been unwilling to even acknowledge their existence. Smug, in that the company goes around telling everyone its vision and seems terribly sure that no one else has an equal (much less superior) vision; that no one else might pass it up in the race for leadership. Apple might be in for a surprise. Fat, in that its current growth is explosive and appears to bog

down operations somewhat. I've had friends interview at Apple recently who have commented on how nobody seems to know fully what's going on, that they aren't willing to take action or make a decision. A recent article in the *San Jose Mercury News* (Business Section, March 17, 1988, by Alex Barnum) stated that the group within Apple that is responsible just for finding and buying real estate consisted of over 100 people. The symptoms of corporate obesity are starting to appear.

### Apple's Current Problems

On top of what I think are its current mistakes, Apple also has a number of problems to face. The biggest problem is the aging of its system software. John Sculley has publicly stated that Apple is doing a slow rewrite of the entire operating system. Good. MultiFinder is, from a user's viewpoint, nicer than the original Finder, but it's still not a true multitasking system. Ultimately, it's going to require a from-the-ground-up rewrite of the Mac operating system to transform it from what was developed for that original, crippled 128K Mac to something capable of truly supporting a multimegabyte, multitasking system with large mass-storage devices. The question is, can Apple do that without making all the current software obsolete? The answer is, possibly, but it ain't gonna be easy.

Another problem is the challenge of developing applications for the Macintosh. Apple has done little (if anything) to make the Macintosh easier to program. In fact, with the introduction of color, sound, and MultiFinder, programming the Mac has become even more difficult. Look at all the major companies that have had delay after delay in release dates for Macintosh software, in some cases over a year. A fair amount of criticism has been leveled at those firms (and sometimes justly so), but the trend has gotten too broad for it to be strictly a problem of the firms themselves.

A case in point: the WordPerfect Corporation. I happen to be good friends with one of the lead programmers on the team that developed the Macintosh version of WordPerfect. Back when I was living near the company in Orem, Utah, I used to ask him regularly how things were going. The response I usually got was a rueful grin, a shake of the head, and a brief discussion on the newest obstacles presented by the Mac operating system and ROMs. These were bright, talented, knowledgeable programmers; they were just frustrated by a system that was difficult to code for. The common

wisdom about programming the Mac is that there is a steep learning curve at first, then it tapers off. In truth, there are two steep curves, the second showing up as you try to get an application ready for market. In other words, once you get the knack of it, it's very easy to produce Mac software that's 75 percent reliable. It's that last 25 percent (especially the last 10 percent) that's a killer.

Finally, lawsuit or no lawsuit, Apple can't keep its competitors from being innovative. Even IBM appears to have learned some things from Apple and seems to be taking steps to foster creativity in PC development and to market its products more aggressively. The problem with being the leader is that everyone has a clear shot at your back. If Apple can't respond quickly and effectively, it may find itself falling behind.

### Future Directions

Ezra Shapiro made a cogent observation about predicting the Macintosh's future: Those who know what's really being developed won't talk, and those who are free to speak don't really know what's going on. I'm in that latter group, but, heck, I've never let a lack of hard information stop me before.

In the MS-DOS world, you have an almost continuous spectrum of systems from under \$1000 to over \$7000; in many cases, you can use the same expansion cards (and certainly the same software) on both extremes of that range. In fact, it's easy to start out with a system in the sub-\$2000 range and upgrade it, piece by piece, to the over-\$6000 range, with commensurate improvement in power, speed, and flexibility.

By contrast, you've got four basic Macintosh systems: Mac Plus; Mac SE with floppy disk drives; Mac SE with a hard disk drive; and Mac II with a hard disk drive. (Yeah, you could buy a Mac II with just floppies, but that's like buying a Ferrari with a two-gallon gas tank.) The Plus, SE, and II have three different standards for hardware expansion; the Plus has different ROMs than the SE and the II; and only the II supports color (officially). In other words, you basically have three subfamilies within the Macintosh line, with little ability to recycle hardware as you upgrade.

Apple needs something to bridge the gap (in money, size, compatibility, and performance) between the Mac SE and the Mac II. Two possibilities come to mind. One is an "SE-in-a-box": a system that looks somewhat like a Mac II, though possibly smaller, with just a 16-

*continued*

1	Exxon	25	Standard Oil (Ohio)	49	Consolidated Foods
2	General Motors	26	AT&T Technologies	50	Lockheed
3	Mobil	27	Boeing	51	Georgia-Pacific
4	Ford Motor	28	Dow Chemical	52	Monsanto
5	IBM	29	Allied	53	W.R. Grace
6	Texaco	30	Eastman Kodak	54	Signal Companies
7	E.I. du Pont	31	Unocal	55	Anheuser-Busch
8	Standard Oil (Ind.)	32	Goodyear	56	Nabisco Brands
9	Standard Oil of Cal.	33	Dart & Kraft	57	Johnson & Johnson
10	General Electric	34	Westinghouse Elec.	58	Coastal
11	Gulf Oil	35	Philip Morris	59	Raytheon
12	Atlantic Richfield	36	Beatrice Foods	60	Honeywell
13	Shell Oil	37	Union Carbide	61	Charter
14	Occidental Petroleum	38	Xerox	62	General Mills
15	U.S. Steel	39	Amerada Hess	63	TRW
16	Phillips Petroleum	40	Union Pacific	64	Caterpillar Tractor
17	Sun	41	General Foods	65	Aluminum Co. of Amer.
18	United Technologies	42	McDonnell Douglas	66	Sperry
19	Tenneco	43	Rockwell Int.	67	Gulf & Western Ind.
20	ITT	44	PepsiCo	68	Continental Group
21	Chrysler	45	Ashland Oil	69	Bethlehem Steel
22	Procter & Gamble	46	General Dynamics	70	Weyerhaeuser
23	R.J. Reynolds Ind.	47	3M	71	Ralston Purina
24	Getty Oil	48	Coca-Cola	72	Colgate-Palmolive

MHz 68000 on-board and a socket for a 68881. It would have room for two floppy disk drives, or a floppy and a 3 1/2-inch hard disk drive. It would also have, say, four slots. Such a box could sell for around \$2000, the current street price for an SE with two floppies. Yet it would allow users to make use of multiple video cards, color displays, and other Mac II expansion cards. And it would be a great add-in box, encouraging owners to expand in a way the Mac SE doesn't.

The second possibility is a mini-Mac II, essentially a Mac II in the box described for the Mac SE above. It would create a Mac II that didn't take up quite so much space or cost quite so much. It would have fewer slots, but the smaller box would be more popular in corporate desktop settings. A motherboard upgrade from the SE-in-a-box to the mini-Mac II would be yet another source of revenues for dealers and Apple alike. It would be priced to sell for about \$1000 less than a equivalent Mac II system.

Finally, there's probably a Mac III in the future—essentially a Mac II with a 68030 processor, an 80-megabyte internal hard disk drive, and lots of memory. It might even have some direct memory access support and a graphics coprocessor, though Apple has shown a sad reluctance to unburden the CPU from doing just about everything. The Mac III will be a good \$1500 to \$2000 more than an equivalent Mac II system and will be aimed at the workstation market.

### From Scorn to Success

Apple has done a great job of taking a system that so many scorned and making it a rousing success. However, success can lead to complacency, complacency to caution, and caution to stagnation. The Macintosh has replaced the Apple II as Apple's breadwinner. Is Apple working on the Macintosh's replacement?

As for me, the ride's been fun. The Macintosh has long been my system of choice, and the shots I've taken at Apple over the years have been out of a desire to see things improve, not out of any intent to harm or tear down. I hope that things do continue to improve at Apple; I'll be interested to see what steps the company takes over the next year or so. In the meantime, I've got work to do, so I'll get off my soapbox and get to it. ■

*Bruce F. Webster is a freelance writer living in Soquel, California. You can reach him on BIX as "bwebster."*

*Your comments are welcome. Write to: Editor, BYTE, One Phoenix Mill Lane, Peterborough, NH 03458.*

## 27 million Americans can't read. And guess who pays the price.

While American business is trying to stay competitive with foreign companies, it's paying an added penalty. The penalty of double-digit illiteracy.

Believe it or not, 27 million American adults can't read and write. Another 47 million are literate on only the most minimal level. That adds up to almost one third of our entire population... and probably a disturbing number of *your* employees.

What does illiteracy cost you? Get out your calculator. Illiterate adults make up 50%–75% of our unemployed. Every year they cost us an estimated \$237 billion in lost earnings. They swell our welfare costs by \$6 billion annually and diminish our tax revenues by \$8 billion.

Illiteracy costs you through your community, too. It robs the place where you work and live of its resources. It undermines the potential of the people who make your products and the people who buy them. No dollar figure can be assigned to this. But over the years, this may be the costliest loss of all.

What can your company do about this? It can join in local efforts to fight illiteracy. It can volunteer company dollars and facilities for better school and tutorial programs. It can invest in a more literate community.

The first step is to call the Coalition for Literacy at **1-800-228-8813** or fill out the coupon below. Do it today. You may find it's the greatest cost-saving measure your company has ever taken.

**A literate  
America  
is a good  
investment.**



Coalition for Literacy

I want my company to join the fight against illiteracy  
Please send brochure with additional information

We want to discuss funding the Coalition for Literacy  
Please have a representative contact me

Name \_\_\_\_\_

Title \_\_\_\_\_

Company \_\_\_\_\_

Address \_\_\_\_\_

City \_\_\_\_\_ State \_\_\_\_\_ Zip \_\_\_\_\_

Phone \_\_\_\_\_

Please return to: Coalition for Literacy  
Business Division  
PO Box 81826  
Lincoln, NE 68501 1826

# WINGZ™

DALLAS SEPT. 14-15  
BOSTON SEPT. 21-22  
PALO ALTO OCT. 5-6

## DEVELOPER SEMINAR

### PUT THE POWER OF WINGZ BEHIND YOUR APPLICATIONS.

In two days, you can learn to program powerful custom applications using this much-anticipated new software for the Macintosh.

The Wingz Developer Seminar: we will show you how to build applications with all the

power, speed, capacity and incredible graphics that Wingz has to offer.

Learn how to fully exploit HyperScript, the new powerful command language specifically designed to unleash the full potential of Macintosh workstations.

The two-day Wingz developer seminar costs \$495. It's a hands-on intensive training program. We recommend that attendees have some prior programming experience.

Seminar fee includes:

- Two Days Classroom Instruction,
- A Fully-Functioning First Release of Wingz Software,
- Including HyperScript Development Language and Sample Files,
- Wingz Souvenir Flight Bag,
- Wingz Developer Sportshirt.

Return the postage paid application card.

If the card is missing, please call 1-800-331-1763 ext. 3800.

WINGZ FROM  
INFORMIX  
SOFTWARE, INC.

# McCAD<sup>®</sup>:

## POWERFUL. SIMPLE. AFFORDABLE.

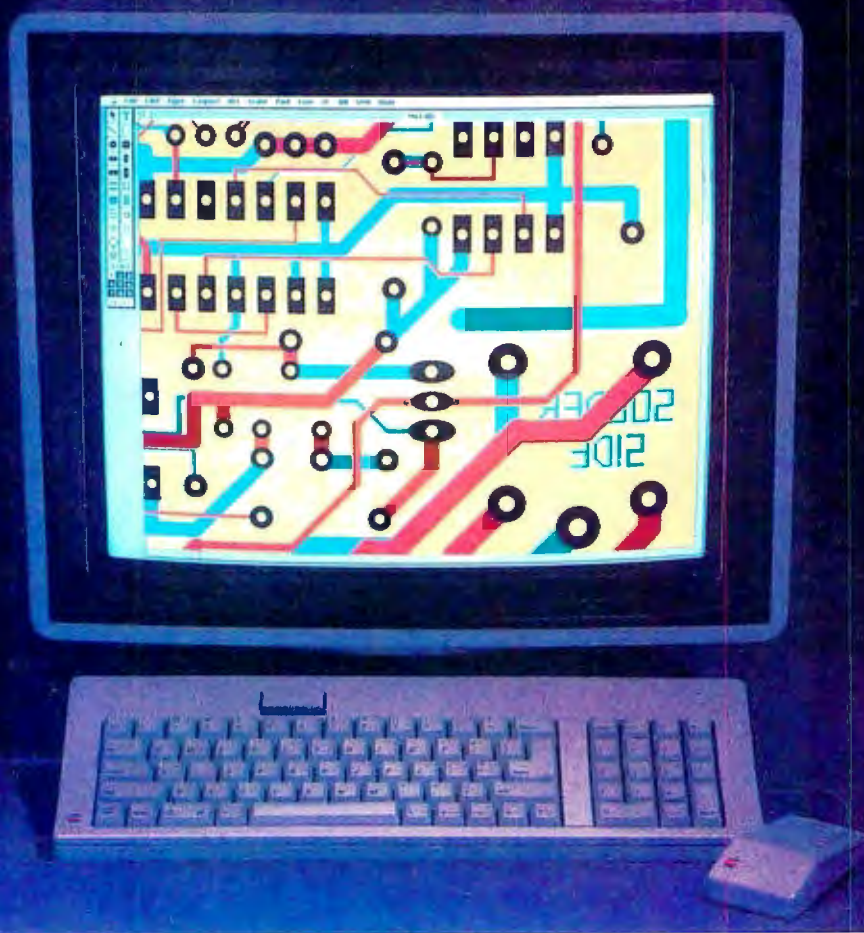

### **High-Performance Electronic Design Software**

It's a whole new ballgame for electronic CAE/CAD.

MAC II has given the EE powerful new tools to work with. And McCAD — the world's leading desktop engineering software for the Macintosh — gives you the way to press those advantages when designing PCB's. Put it all together, and you have a CAD system that's faster, that has more memory, more storage and filing... *and color.*

Remember, McCAD is a true integrated system. We have modules that take you from schematics to PCB design to fabrication, with a lot of stops in-between. Buy one stand-alone component or the whole package. It's up to you. Mix and match for your own workstation needs.

And easy? If you're tired of user-friendly promises that turn sour with incomplete systems, complicated manuals and convoluted procedures, McCAD is your answer.

McCAD is so easy to understand and use, the engineer can start operating it immediately with no break in his work.

You ask about economy? This might just be the best part. Not only does McCAD have one of the most enticing price tags around, it also gives you the best price-for-performance in the industry. For example, our integrated EDS system — including PCB, schematic, router and Gerber output — costs only \$1,495. And our stand-alone modules start as low as \$395.

*When it comes to engineering software for the Macintosh, McCAD cannot be underpriced and outperformed by anyone. Period.*

So, it's simple. All you have to do is make the best investment of your professional life, and then sit back and relax. McCAD does the rest.

**MACWORLD  
EXPOSITION**

VISIT US AT  
MACWORLD EXPOSITION  
BAYSIDE EXPO CENTER, BOSTON  
AUGUST 11-13, 1988  
Booth #816

McCAD is a registered trademark of VAMP, Inc./ Macintosh is a trademark of Apple Computer, Inc.

# McCAD

Published by VAMP, Inc.

6753 Selma Ave., Los Angeles, CA 90028  
(213) 466-5533 FAX: (213) 466-8564  
Telex: 650-262-3069 Answer Back: 650-262-3069-MCI

# Take a Walk on the Mac Side

Jerry Pournelle

## *Jerry unleashes a Macintosh II on his treasure trove of software*

I'd worked until quite late and was trying to sleep in, when I was awakened by hysterical laughter. Roberta was standing at the foot of the bed whooping, "Now they've done it!"

"Uh? What?" I demanded.

"Now they've done it!"

No matter what I said, she cackled insanely and repeated her line. I got up and padded to the front door, where I found they'd indeed done it: I was greeted by a pile of boxes higher than my head. In fact, several piles of boxes, all wedged together. Enough boxes that it was impossible to get past them. We were barricaded by boxes of computers.

"Now they've done it," Roberta giggled. I had to admit things had gone a bit far. Just then the UPS truck drove up with more boxes, only there wasn't any way for him to get past the ones Federal Express had delivered—and the mailman was coming.

Eventually, we got the stuff sorted out and brought inside. It wasn't all computers. Some was stuff we had ordered from Sears. Some was software—it's amazing what all Microsoft sends in their OS/2 package.

Most, though, was from Apple: a Macintosh II, a color monitor and monitor stand, two enormous boxes of software, a LaserWriter, and another box of accessories for the LaserWriter, including cables for AppleTalk. There was also Priam's new 330-megabyte MacDisk and some other stuff I've forgotten. All told, it nearly filled the front room.

Each box from Apple was topped off with a paper threatening dire consequences if I lost anything: machine, software, boxes, packing material (including plastic worms); Apple wants *everything* back. The letter is stiff enough that I contemplated packing everything back up and getting it out of here the same day, but of course I didn't. Eventually, we had everything upstairs and unpacked, and I sent the boxes out to our public storage locker.

### Setting Up

Everyone has the problem of computer furniture, but with me it's worse than most because we have so many systems here: not just computers, but also printers and monitors. Although there are always one or two main machines I'm using constantly, most systems are here just for testing. There's not enough space for everything, so some machines have to be brought out, used awhile, then put away until new software or boards arrive and they're needed again.

I looked at commercial computer enclosures, and I even bought one from Yield House, but it was too expensive and too large.

Then I bought several heavy-duty, two-shelf, lab-equipment rolling carts and fastened keyboard drawers under their top shelves. These were large enough for big machines like CompuPro S-100 "boat-anchor" systems with 8-inch disk drives. The only problem was that the carts were *too* big; it wouldn't take many to fill the storeroom.

Then the local Builder's Hardware had a sale on microwave carts. These come with casters and three shelves. There's even an enclosed bottom compartment, where I can store system documents and software. The tops of these carts were too high for comfortable typing, but I solved that by making a plywood shelf that I attached at the proper height and putting a keyboard drawer under that.

These carts worked so well that Roberta is using one as the permanent place for her AT&T computer.

Those were fine at first. The carts were nearly perfect for early IBM computers. Alas, they're no good at all for Macintoshes. There's no room in those keyboard drawers for a mouse to operate. You can put the mouse on the shelf above the keyboard, but reaching across the keyboard for the mouse gets tiresome in a big hurry.

After many experiments, I set up my Mac Plus on an oversize typing table. The Plus sits on the AST-2000 hard disk drive, the DataDesk 101-key keyboard sits in front of that, and the mouse rests next to the keyboard on a genuine Apple mouse pad thoughtfully provided by Apple's Bruce Chamberlain. All in all, it works quite well.

I've also seen a computer desk called a Mac Station from Hubbard Furniture. This comes on casters and has a drop-down keyboard shelf that's wide enough for keyboard and mouse. Alas, neither the Mac Station nor a simple typing table will work with a Mac II. The machine is too large, and you don't want to sit as close to the Mac II monitor as to that of the Mac Plus.

Hubbard also has a two-shelf system on casters. This isn't bad, and it would be more than good enough for most offices; but due to severe space limits, I need the area under the table for manuals, and the Hubbard system wasn't designed for that. I could see that the Mac II was going to need a lot of space for manuals—at least at first—and I'd also need a place to put the MacDisk.

I temporarily solved the problem by putting the Mac II on one of the rolling lab carts and setting the keyboard and mouse on a typing table in front of it. This works pretty well, but it makes for an awfully big station.

The furniture problem isn't made any easier by the Mac II's basic design. The

*continued*

keyboard port is on the back, on the right side as you face the Mac II. The cable has to be plugged into the *left* side of the Mac II keyboard, because, although there's a cable socket on the keyboard's right side, you have to plug the mouse into that.

I suppose if you're left-handed everything would be fine. Well, maybe not. Even if you plug the mouse into the left side of the keyboard, you won't want to route the keyboard cable along the right side of the Mac II because that's where

the hardware reset button is. Sometimes you just can't win.

Once you decide where to put the Mac II, setting it up is a snap. The monitor is clean and crisp. Its stand is worth commenting on, too. Most monitor stands are clearly afterthoughts, but the Mac II's tilt/swivel stand was clearly designed for the system and is about the best-working one I've ever seen.

After you get everything installed, you won't have to reach behind the ma-

chine very often, either. Although there's an on/off switch back there, the Mac II has a shutdown command in *software*. When you use it, both the Mac II and the monitor are completely powered down. There's a switch right on the keyboard that turns them back on. This is an idea whose time has come.

Incidentally, it's just as well that the shutdown procedure turns off the Mac II's monitor; it gives off more heat than my 19-inch Electrohome monitor.

### Getting Started

When the Mac II came, I was in the middle of doing my taxes. Tax time at Chaos Manor used to be pretty grim, but lately it's been much better. First, over the years I've refined my accounting program—written in compiled CBASIC for CP/M and later transferred to an IBM PC—to the point where it does most of the work.

There's still a flurry of year-end entries into the journal, but that's more tedious than difficult; and once all the entries are made, the accounting software posts them to over a hundred ledger pages, keeping track of what was family expense and what was business expense, then posts the proper percentages of family items like electricity and house insurance into the appropriate ledger pages. I did have to go in and manually correct entertainment to match the new tax law's 80 percent requirement, but that was no problem.

The second reason I don't go mad trying to do my taxes is SoftView's MacInTax. I've said before that MacInTax is worth buying a Mac for—and I haven't changed my view. Taxes are traumatic enough, though, that I didn't want to be learning to use the Mac II while I was doing them, so I set MacInTax up on the Mac Plus.

Everything worked fine until I wanted to print my tax forms. Then I discovered that the Mac Plus had forgotten how to use the Imagewriter.

I don't normally have a printer attached to the Mac Plus. The Imagewriter, a very early one bought (along with the 128K-byte Mac that eventually was upgraded into a Mac Plus) about a month after Apple brought out the Macintosh, normally resides in my youngest son's room. Richard Stefan is on the Notre Dame debate team—they're going to both the state and national competitions this year—and has his own Mac that he uses to support the debate team activities. Every year, though, I borrow the Imagewriter to print my taxes, and it has always worked until now; thus, it was

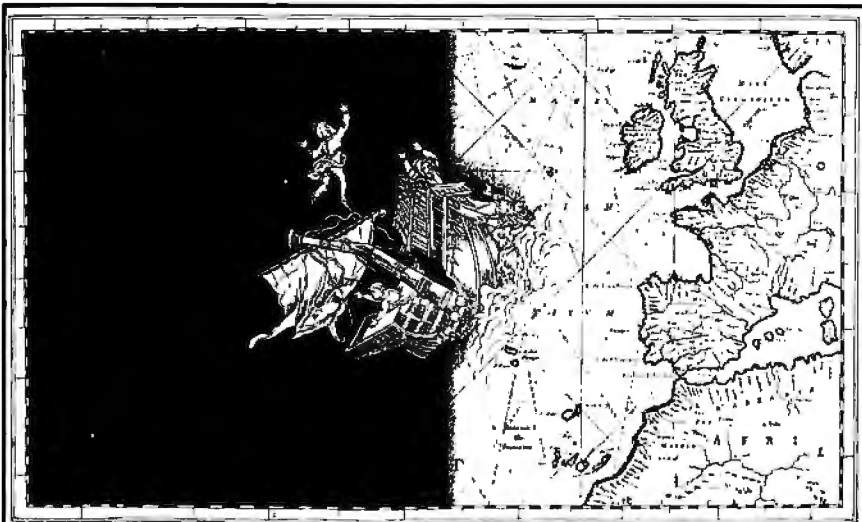

## Don't Laugh, To This Day There Are Still People Who Look At Data In Two Dimensions.

May we respectfully suggest that you forget what you "know" about your spreadsheet full of data.

Because now there's MACSPIN™ 2.0.

Which means that trends, patterns, relationships and information, that until now have been virtually impossible to see, will suddenly become perfectly clear.

MACSPIN r only adds a new dimension to your

data, but also to your thinking. You'll discover new things, and make new decisions.

MACSPIN uses powerful tools to manipulate the data on screen, allowing you to analyze the display in an infinite variety of ways. You can alter perspective, simulate and in the most advanced multi-



So, whether you're in marketing, finance

or particle physics, when it comes to data analysis, there really is another world out there.

MACSPIN.

See your dealer or call D<sup>2</sup> Software at (512) 454-SPIN.

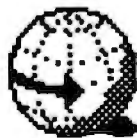

**MACSPIN 2.0**  
Three-Dimensional  
Data  
Analysis

MACSPIN is fully compatible with the Macintosh 512, Plus, SE & II and comes with a 60-day money-back guarantee. MACSPIN is a trademark of D<sup>2</sup> Software, Inc. 5609-B Adams Avenue, Austin, Texas 78756. Macintosh is a trademark of Apple Computer, Inc.

quite a shock when it wouldn't print.

Since it was after 6 p.m. on April 15th, I was more than a bit concerned. Then I remembered the Mac II. Surely it would know how to print. In something of a panic, I unpacked the Mac II and set it on one of my test stands. I didn't read any papers. I just plugged the cables into the obvious places and turned it on.

It came up just fine. I used the Mac Plus to download MacInTax and all my tax forms onto a 3 1/2-inch floppy disk and brought that over to the Mac II; made a new folder on the Mac II's hard disk drive and labeled it "Taxes 1987"; and copied everything into it. MacInTax came up fine when I double-clicked it. For about a minute I contemplated setting up the LaserWriter, but I thought that might be pushing my luck. I connected up the Imagewriter and tried to print.

I forget the error message, but it was considerably more informative than the one I got with the Mac Plus; it said something about driver not installed, I think. Whatever it said drove me to open the Mac II manual for the first time. That told me that on disk II of the System Tools I would find the Imagewriter

driver, and I should copy that into the System Folder on the Mac II's start-up disk. Then I should use the Chooser, which I'd find by pulling down the Apple Logo, to install the Imagewriter, after which everything ought to work fine.

It did. In a couple of minutes I had the satisfactory sound of the printer going wheep! wheep!, and I could go to dinner. It took about an hour to print out the forms, but so what?

I figured out the next day that if I'd followed the same procedure—copying the driver into the System Folder and using the Chooser to select it—on the Mac Plus, that would have worked, too. I think what happened is that sometime in the past year, one of the boys updated the system software on the Plus and didn't bring over the printer driver.

Anyway, once the taxes were done, it was time to set up the Mac II properly. As I said earlier, the modified microwave carts were totally inadequate, so I found a new and better workstation; the Mac II is now right next to my desk.

The Mac II is shipped with a booklet that says "DON'T DO ANYTHING UNTIL YOU'VE READ THIS." Natu-

rally, I didn't see it until long after I had the Mac II up and running; if I had, I wouldn't have had to go to the thick Mac II manual to get my taxes printed. The booklet is pretty complete on how to set it up and get going. A pity I didn't see it earlier, but there was no harm done.

On the other hand, I did learn that you really can get these things going with a minimum of fuss and bother. Most of the setup is intuitive, and where it's not, the manuals are very clear and well indexed. Usually. There are exceptions, as we'll see; but my pleasant introduction to the Mac II certainly prejudiced me in its favor.

### Priam MacDisk

I have a Priam 330-megabyte hard disk drive on my big Cheetah 386, and I love it. While I was on the phone to Priam's Pat Kline, I mentioned that I was getting a Mac II.

"We make the same disk for the Mac that you have on your PC." She laughed. "Want to try one?"

That decision didn't take long. As it happens, the MacDisk came in the same

*continued*



# MathType

## The Mathematical Equation Editor for the Macintosh

Edit equations like this:

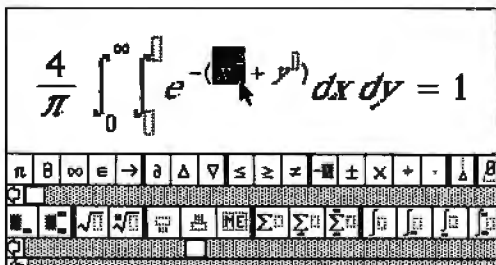

And get printer output like this:

$$\frac{4}{\pi} \int_0^{\infty} \int_0^{\infty} e^{-(x^2+y^2)} dx dy = 1$$

### Tired? Frustrated?

Still struggling to construct equations using MacDraw or MacPaint? Then you're ready for MathType™ - a new tool for putting mathematical equations in your documents.

### Equations by Clicking

MathType is visual and intuitive, the way Macintosh applications were meant to be. All you do is click on symbol and template icons - no codes or Option/Shift key combinations to remember. And by nesting templates within templates, you can build even the most complex expressions quickly and easily.

### Working Together

Use the familiar Cut and Paste functions to move MathType equations into word processing or desktop publishing documents. MathType works with MacWrite, Microsoft Word, PageMaker, Ready, Set, Go and any other programs that accept graphics from the clipboard.

### Two-way T<sub>E</sub>X Interface

MathType can also translate equations to T<sub>E</sub>X and back, allowing it to serve as an easy-to-use front-end to the T<sub>E</sub>X language. Stop counting braces and cut down on training time.

MathType is available now for only \$149. Call or write for a free demo disk and brochure with sample ImageWriter and LaserWriter output. 10% educational discount available. Credit cards accepted.



## Design Science

See us in booth 542 at the  
MACWORLD Expo

6475-B East Pacific Coast Highway, Suite 392  
Long Beach, CA 90803 • (213) 433-0685

MathType is a trademark of Design Science, Inc. Trademarks are - Macintosh, MacWrite, MacDraw, ImageWriter, LaserWriter: Apple Computer Inc. - Microsoft Word: Microsoft Corp. - PageMaker: Aldus Corp. - T<sub>E</sub>X: American Mathematical Society. - Ready, Set, Go - Letraset

# 125 Stacks for HyperCard™

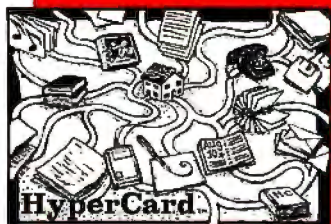

## 150 Games

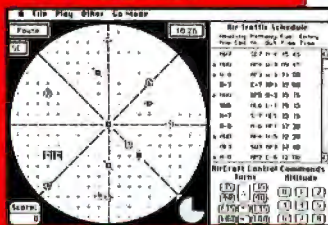

## 250 DAs

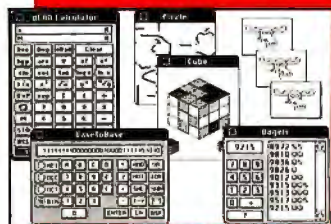

## 225 Fonts

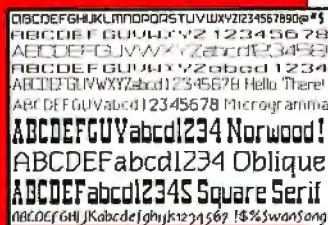

## 250 Pictures

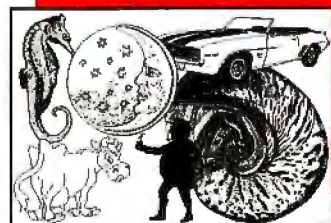

For a limited time only!  
**\$19.95 per set!**

All five sets: Only \$89.95!

All sets on double-sided disks. Add \$5/set for single-sided.

Call 800-843-9497 (800-654-5181 in CA)

Order yours today!

Ask for our FREE 180-page catalog!



**Educomp Computer Services**  
742 Genevieve, Ste. D  
Solana Beach, CA 92075

shipment as the Mac II. I didn't install it on Panic Night—at the time I wasn't interested in anything but getting my taxes out the door—but when it came time to set up the Mac II, I had the MacDisk ready.

The first problem was that the documentation, while quite complete, never mentioned the Mac II at all. It told how it could be connected to a Mac Plus or an SE, but that's all. But it was clearly a small-computer-system-interface (SCSI) device. I called Priam just to be sure; but if I hadn't managed to get anyone, I was prepared to go ahead and connect it to the Mac II anyway. As it happens, I got a technician who told me I'd guessed right—installation is the same for the Plus, SE, and II.

The MacDisk is a self-contained box about the size of a ladies' shoe box. It has two lights on the front and a little window on the back. The lights are the usual power-on and disk being accessed. There are buttons above and below the little window. By pushing these buttons, you can make any number between 0 and 7 appear. If you intend to boot your machine from the MacDisk (as you might if you have a Plus or an SE with no other hard disk drive), the number must be set to 1; otherwise, it can be anything but 1 or 7 (7 is reserved by Apple for internal use).

The little buttons are close to the power switch on the back, so it's easy to hit one by accident. If you do, there's no permanent harm done, but your Mac may not be able to find the MacDisk until you put the setting back the way it was.

Installing the MacDisk is the simplest thing in the world. Set the priority number in the little window; connect the SCSI cable to the Mac II and the MacDisk; plug the SCSI terminator (supplied in the box with the MacDisk) into the other slot on the back of the MacDisk; and turn on the power switch. Now turn on the Mac, insert the disk that comes with the MacDisk, and transfer the Priam file into your start-up System Folder. Reset the Mac.

Once that's done, you're in business. The MacDisk is already formatted, and it has 330 megabytes available. It's blazingly fast: an 11-millisecond average seek time, meaning it's about as fast as RAM disks were in the old CP/M days. Like all Priam disk drives, it's rugged. I've had one in my old CompuPro 8/16 Dual Processor since 1982. It's in use just about every day, and while I always tell people to back up their data, the fact is that I have never lost a byte from any Priam disk drive.

When you turn off the power to the MacDisk, it automatically parks the heads in a safe landing zone. You can then carry it to another machine, like a Mac Plus or an SE, plug it in, and—provided that you've installed the disk-access driver—the new machine will be able to get at all the files on the MacDisk. I've been using the MacDisk for painless data transfer from the Plus to the Mac II.

Also, since the MacDisk has two SCSI ports on the back, you can daisy chain it with any other SCSI device, including another MacDisk. In my case, I chained it with the AST-2000 that resides under my Mac Plus. The AST-2000 does *not* have two SCSI ports, but it doesn't mind being downstream of the MacDisk.

I have two minor complaints about the MacDisk. First, it has a more high-pitched noise than I prefer. It happens that though I am nearly deaf in the lower frequencies, I hear high frequencies better than most people, so I may be ultra-sensitive; no one else seems even to have noticed the sound. Also, I don't want to make too much of this. The MacDisk is certainly no noisier than the fan in the Mac II, and after a few minutes, I don't notice either one of them.

The second complaint is the cable's length. The cable Priam supplies is just long enough to let you put the MacDisk next to your Mac II. If you put it on the right-hand side, it will block access to the hardware reset switch. It would go nicely on the left side, but as it happens, I have the Mac II all the way over to the left side of its lab cart.

A better place for the MacDisk is on a shelf underneath the Mac II, and that's where mine is, but it has to sit on a box because the blooming cable isn't long enough to let it rest on the lab cart's lower shelf.

The odd part, incidentally, is that the AST-2000, which sits underneath the Mac Plus a mere 3 inches away from the Plus's SCSI port, comes with a cable about 3 feet long. One day I'll swap those cables.

Anyway, those are minor irritations, easily worth putting up with for what I get: blinding speed, utter reliability, and enough disk space that even I won't fill it up soon. Highly recommended.

### Keyboards

I've been using DataDesk 101-key keyboards on all my PCompatible computers for some time. I was never much impressed with the original Macintosh keyboard, and the one they installed when they upgraded the machine to a Plus wasn't a lot better; so when DataDesk of-



## THE MAC SIDE

ferred me a Mac Plus keyboard, I jumped at it.

I've been using it for months now, and I'm very fond of it. True, after I spilled Grand Marnier in it the keys began to stick, but I cured that by washing it in the kitchen sink; about 100 dead ants floated out. I dried it with a hair dryer, and it has worked fine ever since. DataDesk keyboards are rugged, and I like their feel.

Naturally, I supposed that the Mac II keyboard would be the usual Apple clunker, so even before I got the Mac II, I got DataDesk to send me their Mac II keyboard.

I was wrong.

You can save money by buying a DataDesk keyboard and getting your Mac II with no keyboard at all, and that may well be worth doing. There's nothing wrong with the DataDesk keyboard. Indeed, it's pretty good. It even has the sockets for the keyboard cable and mouse in the center of the board, which is a much better place for them than where Apple has them. DataDesk also gives you free software to configure your function keys; Apple makes you pay extra.

The feel of the DataDesk keyboard for the Mac II is *not* the same as those for the Mac Plus and PCompatibles; it's more like the original IBM PC keyboard's feel. It's also about that noisy. If you loved the old IBM keyboard, you'll love this.

The thing is, though, the Apple Mac II keyboard is more than pretty good. It's very good indeed. It's sculpted. The keys have a good feel—for my money, better than the DataDesk Mac II's (but not as good as the DataDesk for the Mac Plus or PCompatibles). The only odd thing about Apple's Mac II keyboard is that the little bumps to indicate home keys to a touch-typist aren't on the *f* and *j* keys where you'd expect them, but on the *d* and *k* keys. This can take getting used to.

Apple's Mac II keyboard does cost more, and you'll also have to buy configuration software; whether it's worth the difference in cost is something for you to decide. For me, the bottom line is that I've installed the Apple keyboard on the Mac II and put the DataDesk keyboard in the closet; but then, I'm not paying for it. (I still use the DataDesk keyboard on the Mac Plus.)

### Software

After I got the Mac II set up with the 330-megabyte MacDisk, I went poking about in nooks and crannies turning up Mac software. There was a lot. After a while, I happily sat down to a perfect orgy of software installation.

Alas, a lot of stuff won't work with the Mac II.

It's particularly sad that I can't run Strategic Conquest Plus on the Mac II. This was my runner-up Game of the Year for 1987, and it's in contention for 1988 as well; it's one of those games that's fun to play many more times than once. You can save games in progress on the AST-2000 hard disk drive on the Mac Plus; to actually run the game, you need the copy-protected hard disks. (You can run the game from copied disks, but if the game detects that, it sets the difficulty level impossibly high and proceeds to blow you away.)

You can start the game from the hard disk drive, but it looks to the floppy disk drive; if the game's disk 1 is in the internal drive, the floppy disk drive trundles for a moment, then ejects disk 1 with a message asking for disk 2. Disk 2 contains all (and only) the files concerned with sound effects. After they're loaded into memory, the disk is ejected and the machine asks for disk 1 again.

If you try running the game on the Mac II, though, it loads and appears to be running; but disk 1 never pops out, and you are never asked for the sound-effects disk. The game plays, but there are no sound effects. I then tried transferring both game disks to the hard disk drive and starting up from here (with the original disk 1 in the Mac II's floppy disk drive), but I got the same result. It never sees the sound effects.

On the other hand, the Mac II's screen is bigger than the Plus's—and the game shows more of the game map on the Mac II's screen than it did on the Plus. Also, when it generated a map, it made the *strangest* one I've ever played on (and I've played a lot of Strategic Conquest Plus, I'm ashamed to say). I played it for a while; the game seems to play fine, except for the lack of sound effects. Eventually, I saved the game onto a floppy disk and transferred it to the Mac Plus. It runs fine there. I'm even winning; I wasn't winning on the Mac II, which I suspect thought I was playing with a pirated copy.

On the other hand, Reach for the Stars, another game much played here, not only runs fine on the Mac II but comes up automatically in color. You see more of the star map, and it's certainly faster. Of course, it's not copy-protected, either.

### Compatibilities

There's no predicting what will run on the Mac II and what won't. Dark Castle—one of the most visually impressive

*continued*

If you see a naked CRT...



## SCREEN FOR HELP!

No need to squint and strain trying to read the data displayed on your screen! Sher-Mark Products introduces the Anti-Glare Magnification Screen, developed for your protection and convenience.

- Circular polarizing filter made by Polaroid® Corporation improves contrast, reduces glare up to 99%.
- Lightweight Magnification Lens enlarges characters and images to **TWICE THEIR SIZE**.
- Attaches to your Macintosh SE, Plus, 512K or 128K in less than 30 seconds.
- At just \$89.95, an economical alternative to an external monitor—and sized for easy portability.

Order your Anti-Glare Magnification Screen today—and put an end to computer fatigue forever.

**1-800-323-1776**

Ext. 71

**SHER-MARK  
PRODUCTS, INC.**

521 East 83rd Street—Suite 2R

New York, NY 10028

(212) 249-0494 (212) 988-7045

Please send me \_\_\_\_\_ Anti-Glare Magnification Screen(s) of \$89.95 each plus \$3.00 shipping and handling per unit. New York State residents add appropriate State & Local sales tax per unit.

Check or  Money Order for \$ \_\_\_\_\_ enclosed, or  Charge to my American Express  MasterCard  Visa

PLEASE PRINT

Acct. # \_\_\_\_\_ Exp Date \_\_\_\_\_

Name \_\_\_\_\_

Address \_\_\_\_\_

City \_\_\_\_\_

State \_\_\_\_\_ Zip \_\_\_\_\_

© 1988 Sher-Mark Products, Inc. Patent Pending B

games ever done—won't run; whether it's started from the hard disk drive or the floppy disk drive, it gives the following message:

"Sorry, Dark Castle cannot run because there is a problem with the way memory is allocated (77588878 high bytes).

"This could be due to other software that is already installed in memory (for example, Switcher, Tempo, RAM disks, print spoolers, network software, etc.).

"The simplest way to avoid this type of problem is to turn off the Macintosh and start up using Dark Castle disk number one."

Needless to say, following that advice only produces that same message.

MindWrite is a rather good word processor and outline program that I have grown rather fond of on the Mac Plus. It isn't copy-protected, either: it runs fine off the Plus's hard disk drive. However, not only wouldn't it work on the Mac II,

it failed disastrously: when I tried to run it, the machine hung so thoroughly that I had to use the hardware reset to recover.

Apparently the MindWrite folks had the same problem I did when I tried to run MindWrite 1.1 on the Mac II. They wrote MindWrite 1.1 to Apple's specs and released it shortly before Apple released MultiFinder. They tell me that Apple changed the MultiFinder just before they released it, in a way that causes MindWrite 1.1 to crash. They're providing a free update that corrects the problem.

On the other hand, WriteNow, an easily learned and very "Mac-like" word processor/text editor that was written before the Mac II ever came out, works fine on every Mac I have, from the old 512K-byte Mac through the Plus to the II (and is perfectly adequate for most of my word-processing jobs).

Epyx's Sub Battle, which is also not copy-protected, almost works, but some of the visuals are distorted, there's no sound, and eventually the machine hangs and has to be reset. Mac Attack, a tank battle game, has to be started from the floppy disk drive; when you do, it first displays a logo, then a message that the sound effects won't work on a Lisa (!), then finally gives you bombs and a system error message, after which the machine goes so dead you have to use the power switch to restart it.

I could go on listing things that do and don't work, but surely the point is made: you simply can't know what Mac Plus software will run on the Mac II. In general, it's less likely to work if it's copy-protected, but that's no infallible guide, as witness MindWrite. All I can really tell you is to experiment.

### LaserWriter and AppleTalk

The Apple philosophy is to make things simple. That's fine as long as everything works. But as soon as something goes wrong, it's a different story.

Setting up the Mac II was simple enough that I didn't think there'd be any problem installing the LaserWriter. After all, the directions were clear. I went through them step by step, installing first the hardware, then the software. In 5 minutes both were done, and it was time to test the printer.

It wouldn't work. The Mac II couldn't find the printer. Unfortunately, the error message wasn't any more helpful than that, either.

I went back through the printer documents and carefully followed the installation procedure again. When that didn't work, I read everything I had about

# Our Copier Comes With A Fancy Wrapper.



CopyMaker Plus

In these days of plain wrap labels, it's nice to know that somebody still lets you dress things up.

Applied Data Communications' new CopyMaker Plus 3.5-inch diskette duplication system is a master at the finishing touch: creating and applying custom-printed labels as fancy as you like in flat or wrap-around styles.

In one very quick operation, the CopyMaker Plus copies diskettes, prints up to 15 lines of custom type on your labels, and applies the labels to the diskettes. With easy-to-use software running on your Macintosh or PC that automatically turns out hundreds of the

fanciest copied and labeled diskettes around. Day after day.

The CopyMaker Plus makes you look good in other ways too. With accuracy that places labels within 1/32 of an inch and white glove handling that keeps your diskettes factory-fresh and scratch-free.

Fast-and-fancy copying and labeling skills make the CopyMaker Plus the best-dressed duplication system going for software manufac-

turers and large companies that distribute data on diskettes.

For more information on how you can dress up your 3.5-inch diskettes, call Applied Data Communications today toll-free at 1-800-221-5486.



Applies flat and wrap-around labels.

ADC APPLIED DATA COMMUNICATIONS

14272 Chambers Road • Tustin, CA 92680-6998

800/221-5486

California: 800/334-5486 • 714/731-9000

©1988, Applied Data Communications, Inc.

CopyMaker Plus is a trademark of Applied Data Communications, Inc. Macintosh is a trademark of Apple Computer, Inc.

AppleTalk. Alas, that wasn't much, but it was enough to show I'd connected all the cables properly.

Finally, I tried setting up the Mac Plus to run the LaserWriter. I got the same results as with the Mac II. That printer just wasn't talking to computers. It was time to call Apple. I suppose I could have used this as an opportunity to test Apple's technical-support system, but BYTE was in a tearing hurry for this column, so I called the office that sent me the Mac II in the first place.

The people there know their stuff. I described what I'd done. I was conducted through a few tests. I'd guessed them from the documents, but I was glad to have my guesses confirmed. The diagnosis was positive: either a cable was bad, or the electronics board in the LaserWriter had gone south in shipment. I was offered a choice: they'd send new cables and a new electronics board by Federal Express, or I could take the printer to a local Apple dealer. I opted to have the parts sent to me.

By this time, I was really desperate. This was a Wednesday afternoon. Thursday at noon I was due to catch an airplane to Colorado Springs to take part in some activities at the Air Force Academy. On Saturday morning, I was due to catch an airplane that would get me back here just in time to attend Larry Niven's 50th birthday party—and this column had to be in New Hampshire by the following Monday morning.

Apple was true to their word: on Thursday morning, the new cables and board arrived. It took me precisely 1 minute to replace the LaserWriter's electronics board. (I'll admit that I rehearsed by removing and reinstalling the original the night before.) Then I plugged in the new AppleTalk cables and turned on the system. It still didn't print, but that was because I'd skipped a step in the reinstallation; when I called in the Chooser and set things up properly, everything was fine.

### Cables

After I got back from Colorado Springs, I left the new cables in place and reinstalled the old board in the LaserWriter; not only wouldn't it print, but I got the same symptoms as before. So that board definitely was defective; it wasn't the cables at all.

On the other hand, it might have been. I've had some experience in cable design: I was once in charge of human factors for a good part of Boeing, and designing cable ends so that they can't be plugged in backward or to the wrong place is one

task of the human factors group. Thus, I can say with some authority that the Apple cabling system is a miserably poor design.

The original Macintosh—all the way up to the Mac Plus—used standard DB-9 plugs for the printer and a different plug system entirely for the keyboard. Under the new system (Mac Plus, SE, and II), all Apple cables terminate in tiny round cable ends about 3/8 inch in diameter. Some of these cables have 8 or 9 active

pins in them. Others have only 3 or 4.

They're supposed to have small plastic keys that make it impossible to plug the wrong cable into the wrong socket, but in fact that doesn't work. It's not only physically possible, it's also fairly easy to jam an AppleTalk (9-pin) cable into a socket intended as the auxiliary keyboard socket. Worse, since these are on the back of the machine and are labeled only with ambiguous (and tiny) icons,

*continued*

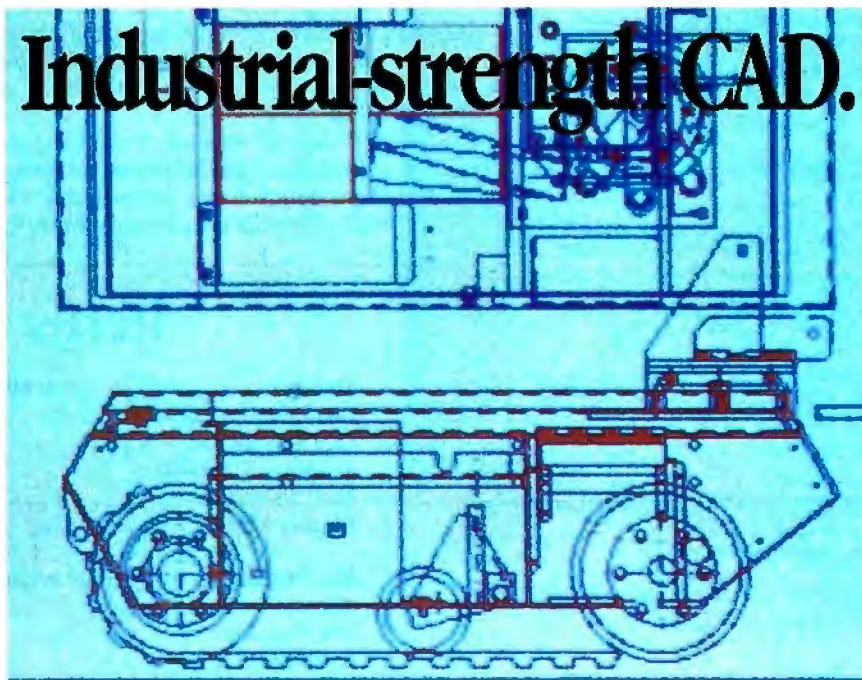

## With all the advantages of the Macintosh.

The Macintosh promises enormous benefits to engineers and other designers.

All it takes is the right software to take advantage of the superior ease of learning and speed of the Macintosh. Not just drawing programs, but real CAD.

MGMStation™ is real CAD. It's part of a fast, sophisticated, cost-effective CAD/CAM package developed for engineers and designers. It offers capabilities equal to mainframe CAD packages, with floating point precision up to 16 decimal places. Unlimited zoom. Color or black-and-white output. Auto dimensioning. Multiple layers, multiple windows. Hatching and filling of arbitrary shapes. Sophisticated functions like filleting and chamfering. Display precision beyond that of QuickDraw™ (note the smooth curves). And built-in plotter drivers. Options include symbol libraries and an IGES conversion utility.

If you're designing mechanical parts, you may be interested in our CAM package, too. It handles milling, turning, sheet metal cutting and wire EDM.

See your dealer for your HyperCAD™ demo stack or write us on your letterhead for a free disk.

If you are serious about creating producible designs quickly and efficiently, you can't afford to waste your time on anything less.

MGMStation. Real CAD.



MacUser  
Eddy Award  
Winner  
1 9 8 8

**MGMStation**  
from Micro CAD/CAM Systems, Inc.

5900 Sepulveda Blvd., Van Nuys, CA 91411 (818) 376-0008 AppleLink D0572 Telex: (650) 310-7078 MCI-UW

Macintosh is a Registered Trademark and QuickDraw is a Trademark of Apple Computer, Inc.

# IEEE-Z

IOtech offers the widest selection of **easy-to-use** IEEE 488 (GPIB) interfaces for the Macintosh.

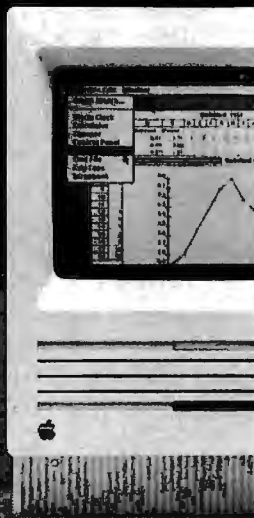

- NuBus IEEE board for the Macintosh II
- SCSI / IEEE controller for the Macintosh Plus, SE & II
- Serial / IEEE controller for long-distance applications
- Serial / IEEE plotter converter for HPIB plotter interfacing
- Desk accessory software for IEEE control from any application
- Language drivers for IEEE control from Basic, C, Fortran, Pascal, Hypercard and more
- Menu-driven software for scientific analysis and graphics
- **30 day money-back guarantee**
- **2 year warranty**
- **Call or send for your FREE Technical Guide**



*IOtech...the choice is easy*

# IOtech

**(216) 439-4091** Telex 6502820864 Fax (216) 439-4093

25971 Cannon Road • Cleveland, Ohio 44146  
 London (0734) 86-12-87 • Paris (1) 34810178 • Zurich (01) 821 944  
 Milan 02-4120360 • Linköping 013 11 01 40 • Gorinchem 01830-35333  
 Sidney (2) 452 3831 • Seoul 784-9942 • Munich and other European,  
 North African and Middle East countries not listed (089) 710020.

## THE MAC SIDE

that's easy to do even if you're trying to be careful. I managed to do it, with the result that the machine did some very *odd* things until I set it right.

Worse, though, if you do jam the cable into the wrong socket, you may well damage the cable. The pins in a male Apple cable are tiny and are easily pushed deep into the cable end. I ruined two AppleTalk cables. One was repairable with needle-nose pliers and a lot of patience. The other had the wires pushed so far back into the cable that nothing would get them out again. Since it's also impossible to take the cable housing apart, once that plug is damaged, you're probably going to have to buy a new cable.

Except for potential profits to Apple in cable sales, I see no reason for going to these delicate and unreparable cable ends. I predict considerable profit for a

third-party outfit ready to supply better cables for Apple computers.

### WriteNow Nonsense

WriteNow is not a bad editor, but its publisher, T/Maker, has done something that could drive you crazy if you're not careful.

T/Maker provides you with two disks, one containing the WriteNow program, and another with a demo version called Sample WriteNow, which you're free to copy and pass on to friends who want to try it out. Sample WriteNow works just like the regular version, with one exception: it prints "CREATED WITH SAMPLE WRITENOW" across the top and bottom of every page of every document you create.

Here's the problem: if you have Sample WriteNow anywhere on your hard

*continued*

## Items Discussed

<b>Mac-101</b> .....\$169.95 DataDesk International 7651 Haskell Ave. Van Nuys, CA 91406 (818) 780-1673 Inquiry M254.	<b>Reach for the Stars</b> ..... \$40 Strategic Studies Group 1820 Gateway Ave. San Mateo, CA 94404 (415) 571-7171 Inquiry M259.
<b>Mac Station</b> ..... Price not available Hubbard Furniture 1946 Raymond Northbrook, IL 60062 (312) 272-7810 Inquiry M255.	<b>Strategic Conquest Plus</b> ..... \$59.95 PBI Software, Inc. 1163 Triton Dr. Foster City, CA 94404 (415) 349-8765 Inquiry M260.
<b>MacDisk</b> ..... \$4895 Priam Corp. 20 West Montague Expy. San Jose, CA 95134 (408) 434-9300 Inquiry M256.	<b>VideoWorks II</b> .....\$195 MacroMind, Inc. 1028 West Wolfram Chicago, IL 60657 (312) 871-0987 Inquiry M261.
<b>MacInTax</b> .....\$119 SoftView 4820 Adohr Lane, Suite F Camarillo, CA 93010 (805) 388-2626 Inquiry M257.	<b>WriteNow</b> 1.07 .....\$175 2.0.....\$195 T/Maker Co. 1973 Landings Dr. Mountain View, CA 94043 (415) 962-0195 Inquiry M262.
<b>MindWrite</b> .....\$195 Access Technology Access/MindWork Division 200G Heritage Harbor Monterey, CA 93940 (408) 648-4000 Inquiry M258.	

# The Problem

is not a lack of text,  
it's a lack of  
Information

Introducing

# Arch*i*Text

TRUE, Relational Hypertext  
The Difference Between Text and INFORMATION

- Quickly transform raw text into useful information
- Inherent graphic interface for ease of use
- Quickly build, search and link nodes of information
- Manage text from many different sources

**Arch*i*Text™** is a revolutionary text analysis, management and presentation package for researchers, educators, writers, marketing professionals and anyone who needs to organize large quantities of textual information.

**Arch*i*Text** manages text originating from diverse sources such as keyboard entry; word processing files (text format); scanned data from OCR devices; files imported via modem or from other applications (databases, spreadsheets, outliners, etc.); and files imported from optical disk storage systems.

**Arch*i*Text**, \$349.95, from Brainpower, Inc.  
24009 Ventura Blvd, Calabasas, CA 91302  
800-345-0519 • (CA) 818-884-6911



- **FREE** run-time application for viewers, complete with unique activity tracking system
- Full-feature, stand-alone program that requires less than 400k of memory to operate
- Powerful tool for the analysis and synthesis of textual information

Circle 111 on Reader Service Card  
Call now for a free brochure!

Come see us at booth 5655 during the August MacWorld Expo/Boston.

disk when you click on a WriteNow document, it could come up in the Sample version.

That is and isn't T/Maker's fault. When you click on a Macintosh document of any kind, the Finder will locate the appropriate application no matter where you've got it ferreted away (unlike DOS machines, which won't look outside of the current directory unless you explicitly tell them to). In the case of WriteNow, the version you get depends on which one you most recently fiddled with—even moving a version to another folder seems to be enough to reset the default to that version.

It happened that Larry Niven's birthday came just after I got the Mac II. Now that I had a LaserWriter, I thought I'd make a really fancy card to go with the present. I'd used WriteNow on the Plus, and since I was more or less familiar with it, I tried it first. Alas, I hadn't eliminated Sample WriteNow before I did that, and my 3 hours of composition were completely wasted, since I couldn't print the card without the "CREATED WITH SAMPLE WRITENOW" idiocy.

Surprise: so diligently does the Finder search for that idiotic Sample version that even with the Sample version on *another hard disk*, the Finder will go find it and bring it in when you invoke WriteNow by clicking on a document.

After eliminating all traces of Sample WriteNow from the MacDisk, I wrote a new birthday card by invoking WriteNow. It printed fine; but the next time I called it in, that damnable message printed across top and bottom.

I was about to erase all copies of WriteNow and go to MacWrite or Ready-Set-Go!, when I got suspicious and used the Mac II's Find File desk accessory to search for the word *Sample* in a filename. Sure enough, it told me there was a copy of Sample WriteNow on the internal hard disk drive. When I erased that and tried to bring in my birthday card, the system told me I should get the application file out of the Trash.

In rage, I turned off the machine. When I turned it back on, I was finally rid of the Sample Curse: now I can bring in documents and print them without the horrible "CREATED WITH SAMPLE WRITENOW" printed top and bottom.

For all that, WriteNow is a good editor that is easy to use—once you've *permanently* eliminated all traces of the Sample program.

### Locked!

The real reason for getting a Macintosh isn't languages (although if you're an

APL addict, you'll find that works better on a Mac than it's likely to on a PC-compatible). When Excel was available only on a Mac, you might have been seriously tempted to get one just for that; but now they've got Excel available running under Windows, and it's at least as good on PCs with EGA as it is on the Macin-

**T**he real  
reason to get a Mac is  
that it can run  
programs and do things  
few other machines can  
do. *VideoWorks II* is a  
spectacular program for  
the Mac.

tosh. MacInTax also runs about as well on PC-compatibles with EGA as it does on the Macintosh.

You might get a Mac because of its ease of operation. Unfortunately, there are problems. I personally find it as easy to get around in PC-DOS as to manipulate icons, and indeed, I can get awfully sick of dragging little pictures to the Trash. Worse, though, the Mac can do strange things to you.

Example: in trying to test the MacDisk, I created an enormous file by copying into one folder named Foo everything else on both the MacDisk and the Mac's internal hard disk drive. Then I moved the files back and forth. Eventually, I was through playing and needed to eliminate the Foo folder.

I dragged it to the Trash, but it wouldn't erase. The Mac kept telling me the folder contained locked files. To make it worse, after the machine told me it wouldn't do what I wanted, it made me click on "OK," even though it wasn't OK at all.

Study of the Mac II manual eventually showed me how to determine whether a file is locked or not: you have to find the file, select it, then go up to the menu bar and "Get INFO" on it. After that, you can unlock it.

Unfortunately, the Mac operating system has no other way to tell you which

files are locked, so you have to go through them one at a time. I had over 70 different files in Foo, and I had to look at each one before I could erase the thing. I can't say I appreciated that.

### VideoWorks II

The real reason to get a Mac is that it can run programs and do things few other machines can do. VideoWorks II is one of the most spectacular programs for the Mac. This is a program for creating and displaying animated graphics. It will also do sound effects.

I've only started playing with VideoWorks II, and I already love it. The tutorial programs are good enough that I haven't much needed the manual. The manual is good enough to remind you of what you learned in the tutorials. VideoWorks II can take advantage of color monitors and other features of the Mac II; indeed, it's one of the best demonstrations of the Mac II's capabilities. Recommended.

### Winding Down

I'm out of space, and there's still scads of Mac II stuff lying on my desk. I haven't discussed HyperCard, which is another program you might consider getting a Mac for.

There's no room for Owl International's Guide, a program that's a serious match for HyperCard. What with the Apple/Microsoft lawsuit, one wonders how hard Microsoft will work on Mac software in the future, but even so there's a pile of it now.

The Mac game of the month is PBI Software's Strategic Conquest Plus. I hope they come up with a version that works on the Mac II.

I expect it's obvious that although I started off with serious reservations, I like the Mac II quite a lot. The bottom line is that I've moved Old Zeke, my original CompuPro Z80, off to the store-room, and I'm using a CAD program to help me design furniture to put the Mac II in his place. ■

---

*Jerry Pournelle holds a doctorate in psychology and is a science fiction writer who also earns a comfortable living writing about computers present and future. Jerry welcomes readers' comments and opinions. Send a self-addressed, stamped envelope to Jerry Pournelle, c/o BYTE, One Phoenix Mill Lane, Peterborough, NH 03458. Please put your address on the letter as well as on the envelope. Due to the high volume of letters, Jerry cannot guarantee a personal reply. You can also contact him on BIX as "jerry."*

# MacWORM Arrives!

Optical  
Elegance

US

Floppy  
Chaos



## COREL Macintosh WORM Drives

### ■ Huge Storage Capacity

COREL WORM drives have the capacity of 1,000 floppies with the speed of a hard drive - ideal to get your ever-increasing storage needs under control.

### ■ Total Mac Compatibility

COREL WORM drives are engineered to be 100% MAC compatible so you don't have to learn any new commands or routines. Use them with all your existing applications just like your floppy or hard drive.

### ■ "Plug and Play"

Everything you need is included: Drive, Software, Cable, and Manual.

### ■ Low cost/Mbyte

Under \$15/Mbyte of on-line capacity. This is almost as low in cost as tape but with random access, greater reliability, and much longer life media.

### ■ Dozens of Applications

- Hypercard databases
- Archiving (15 yr. min. life)
- Back-up copies
- Multiple copies
- Graphics libraries
- CAD-CAM libraries
- Image files
- Software libraries
- LAN File servers
- Audit trails
- CD-Rom development
- Data distribution
- Unix applications
- Workstation back-up
- Tape replacement
- Bernoulli replacement

### ■ Proven Software

COREL has led the way in PC compatible WORM drives with the leading installed base of over 3,000 units. Now it brings the benefits of this experience to the Macintosh.

### ■ Proven Hardware

COREL uses proven drive mechanisms from the leaders of the industry such as Panasonic, Ricoh and Maxtor.

### ■ Optional Developers Kit

For users & OEM's that want to modify the normal optical disk software for their own special applications.

### ■ Hot Line & Bulletin Board

Just in case you have any problems, COREL provides total support to find the solution quickly and efficiently.

### ■ Two Choices of Drive

Each COREL drive is a complete, ready-to-go subsystem.

- **COREL 400** \$2,895  
400 Mbyte capacity (2 x 200/side)  
Cartridges \$99 each.
- **COREL 800** \$3,995  
800 Mbyte capacity (2 x 400/side)  
Cartridges \$160 each.

### ■ Shipping In Volume Now

No delays, you will receive your drive within a few days of your order.

### ■ Call Us For More Details

COREL specialists are ready to answer any questions you have on this exciting new technology. Call or Fax us now.

# MultiFinder Revealed

Phil Goldman

*One of MultiFinder's  
coauthors provides  
clues to  
the mysteries  
of MultiFinder*

MultiFinder is a first-generation multitasking operating system for the Macintosh. It runs on all machines from the Macintosh 512Ke up to the Mac II.

The phrase "first generation" has two important meanings. First, it highlights the fact that MultiFinder has been added to the system software at a time when the Mac environment is relatively stable and well defined. Therefore, it was necessary to support all the features of the systems, some very subtle, that applications have come to depend on.

"First generation" also implies that there will be successive generations. MultiFinder is released every six months as a part of the Apple system-software update. As a result, MultiFinder is an evolving product; yet, at the same time, it must guarantee that applications continue to work across releases.

## The Look of MultiFinder

MultiFinder doesn't markedly change the look and feel of the Macintosh. When a Mac boots up, the only indication that MultiFinder is running is the small icon located on the far right-hand side of the menu bar. The look does change, however, in one small but important way: When you open an application from the Finder (the application you see when you start up the Mac), the Finder itself doesn't disappear. Before MultiFinder, you could execute only one application at a time, and only one application could be visible at a time.

With MultiFinder, multiple applications can be visible at once. Each application is represented by its set of windows, known as its *layer*. As a user, you interact with only the frontmost layer (i.e., the application in the top layer receives all the user events, such as mouse and keyboard clicks), the same way you typically interact with only the frontmost window of a given layer. Other layers can be visually active, but the actions of the corresponding applications don't occur in direct response to your actions. The

application in the frontmost layer also owns the menu bar.

You can switch between applications in three ways. First, clicking the mouse in any window of a layer brings the application in that layer to the front. Second, the apple menu includes a list of the currently running applications; choosing a particular item with an application's name brings that application's layer to the front. And third, clicking on the icon in the menu bar cycles through the applications in each layer.

## Cooperation, Not Competition

At the very heart of MultiFinder lies its task-switching mechanism. This mechanism implements an operating-system technique known as *cooperative multitasking*, which allows the tasks themselves to completely control the mechanism. In MultiFinder, a task is simply one instance of an application program. There is no policy to which applications must adhere; each task determines exactly when it wishes to yield control of the CPU—it will never return control until it explicitly decides to do so.

Cooperative multitasking has its advantages and its disadvantages. As an applications developer, you can assume your application has complete control over the machine while it runs. Thus, you can make many simplifying assumptions,

especially when you want real-time control. If the operating system itself decides when to switch between tasks, as in preemptive multitasking, it can't always know exactly when is the best time to switch; it simply doesn't know as much about a task as the task itself does.

On the other hand, cooperative multitasking requires correct responses from every task. If a single task decides that it won't yield the CPU, then the entire system will appear to hang. Even if a task just holds the CPU for too long a period, the response time of the system can suffer dramatically.

The entire structure of the Macintosh application model revolves around the assumption that an application will constantly call the Toolbox traps, `_GetNextEvent`, `_WaitNextEvent`, and `_EventAvail`, to retrieve an event and respond to it. It's relatively painless to switch between applications when those calls are made.

For these same reasons, cooperative multitasking would be a disaster in a generic Unix environment. In this case, there is a real loss of transparency as Unix tools are command-line-driven rather than event-driven, and thus don't necessarily make certain calls with any known frequency. Also, when you use such an environment, you're more likely to create your own quick-and-dirty applications, which might crash but shouldn't hang the entire system if they do. Of course, if you use only shell scripts as tools, then it would be simple to build the necessary cooperation into the shell interpreter.

The moral of this is that cooperative multitasking is very useful, but only when you can make certain assumptions about the run-time environment. However, there wasn't much of a choice for the Macintosh. Although the existing application model could theoretically support preemptive multitasking, it would involve a great deal of rewriting of Tool-

*continued*



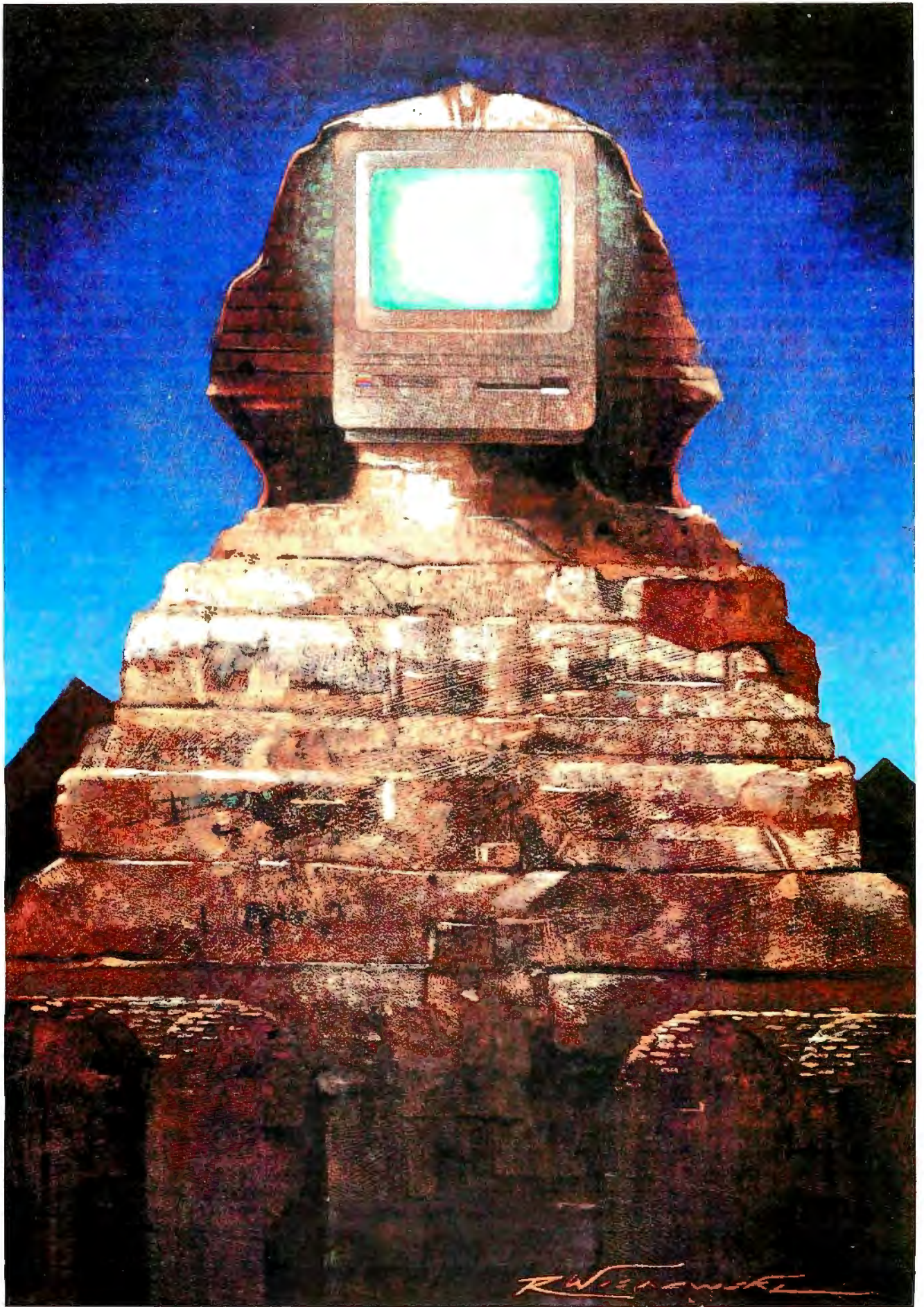

box and operating-system code, code that is currently in ROM. In addition, there would be greater compatibility problems.

**Heaps of Memory**

Before explaining the hows and whys of cooperative multitasking under MultiFinder, let's discuss the backdrop against which task switching occurs: the memory model provided by MultiFinder.

MultiFinder doesn't radically change the Macintosh interface that a user sees, but instead extends that model in a logical manner. This is also true of the model that the applications developer uses. The memory model, for example, changes little except to support multiple applications in memory at one time.

The basic Macintosh memory model consists of one application heap (a heap is a large chunk of memory partitioned and managed by the Memory Manager) and one system heap. MultiFinder has multiple application heaps (see figure 1). These heaps are created as nonrelocatable blocks in the MultiFinder heap, which is located in the same place as the single application heap is in the basic model—directly above the system heap.

MultiFinder still uses a single system heap. The basic Macintosh model has a somewhat arbitrary partitioning of memory and resources between the system and application heaps. With the new model, one of the primary purposes of the system heap is to share resource blocks among the applications (resources are blocks of data that are read from resource files and tracked in memory using resource maps).

This design works out nicely for three reasons. First, sharing naturally saves space, which is critical on a system with 1 megabyte or less of RAM. The space needed by a single application can be a very large percentage—sometimes 100 percent—of the machine's total memory.

Second, moving system resources out of the application heap implies that significantly fewer system-memory requirements will be made of the heap. An application that attempts to do a complete accounting of memory usage in its heap has problems when the system allocates blocks behind its back. The new scheme alleviates this problem to a great extent.

Finally, since all the shared resources are located in the system heap, they don't

need to be reinitialized each time an application launches. Much of the time spent in the original system's launch code, and in the initialization code of the application itself, was spent reloading the resources from disk. Some of these resources, such as fonts, can be very large.

However, MultiFinder's sharing creates a much greater, and much more dynamic, need for space in the system heap. Early in the development effort, the system heap was significantly enlarged when MultiFinder itself started up. However, it became obvious that this was too great a space penalty to pay. The Memory Manager was modified to allow the system heap to grow and shrink (at the expense and gain of the MultiFinder heap) as memory needs dictated, thus allowing extra space for both system-memory requests and new application heaps.

Although the changes to the memory model are fairly subtle, some applications make assumptions that are no longer valid. Some applications assume that the system and application heaps are contiguous. Others assume that certain resources will be put in the application heap rather than the system heap. The latter assumption is particularly dangerous because of the actions that an application might take based upon it. For example, one application has a procedure that continually purges such resources when there is no free space in the application heap. Under MultiFinder, the application is actually freeing space in the system heap, and not alleviating the problem at all. Worse, the application actually ends up deadlocked in a loop, continually purging these resources but never freeing up enough memory.

This entire situation is a result of certain strong implicit assumptions about the "classic" Mac's memory model. Fortunately, very few applications make such assumptions.

**Context Switching**

MultiFinder employs cooperative multitasking, switching contexts only when the application calls the trap `_WaitNextEvent`, `_GetNextEvent`, or `_EventAvail`. The scheduler does a context switch in three cases: as part of a layer switch, as a switch into a background application, or to let an application update its windows.

A context switch is a fairly large operation on a Macintosh. The environment is so rich that the context belonging to a task is potentially very large. Fortunately, on average, most applications avoid creating huge contexts for themselves (except for the many low-memory locations that are

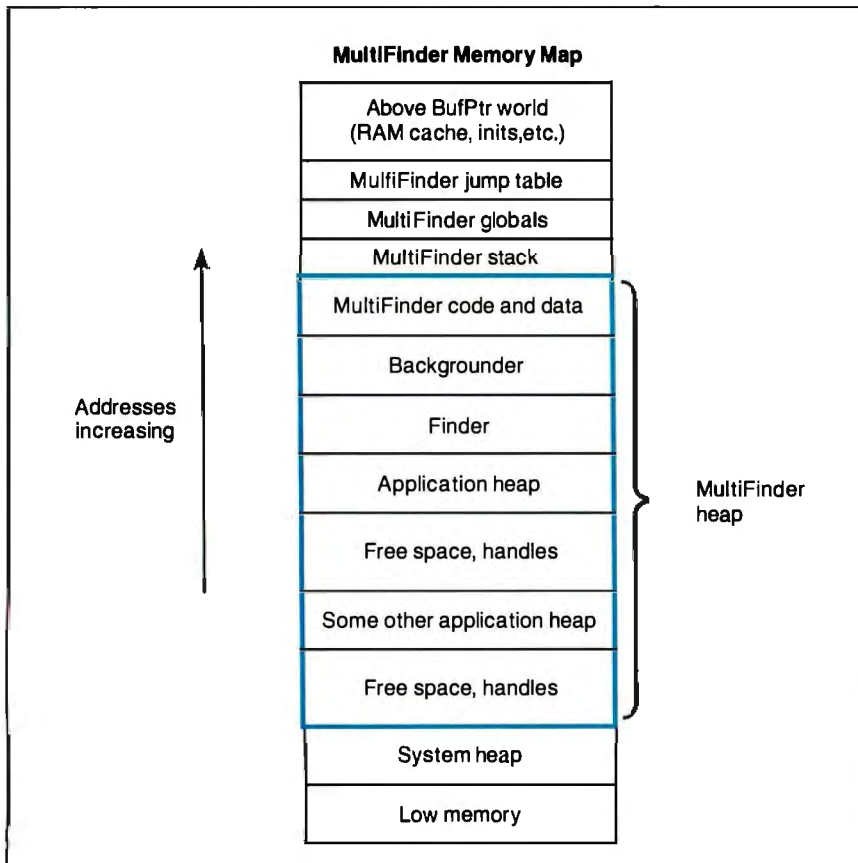

**Figure 1:** The MultiFinder memory map. Notice that MultiFinder has more than one application heap.

accessed on their behalf) by making use of the memory-saving features below.

In general, a context switch consists of saving the context of the task being switched in (known as the source task) and then restoring the context of the task being switched out (the destination task). In the Mac, the switch also requires removing (and saving) application-specific entities from system data structures from the source task, and restoring those entities from the destination task. These entities include:

- *Device-control entries (DCEs)*: The Unit Table is an array of handles to device-control entries, located in low memory. Each DCE corresponds to a local driver, one that belongs to the application. The driver's resources come from the application's resource file. (Although it might come from a different file, it can never be the system file.) The memory for the driver is located in the application's heap.

When a task is switched out, the system must remove all the DCE handles for its local drivers from the Unit Table and save them in a structure local to the task. When the task is switched back in, the system restores its drivers from its local structure. When an application quits, either with dignity or because of a crash, the system again removes its DCE handles from the table.

Most applications don't employ local drivers. An application's own desk accessory (such as a word processor with a spelling checker) is simply a special type of driver on the Mac.

However, most of the drivers come from the system file, including the system desk accessories, AppleTalk drivers, and default print drivers. These drivers are never switched; therefore, it's very important that the unit number (i.e., the index into the Unit Table) of a particular local driver not match that of any system driver. If it does, then when the local driver is switched in, its local DCE handle will clobber that of the system driver in the Unit Table. Worse, when the task is switched out, there will be an empty hole in the Unit Table, and you won't know which system driver should be restored.

- *Trap patches*: Trap patching is the method by which the routine associated with a given A-line trap is replaced by a new routine. (An A-line trap captures those instructions whose first byte is A.) Pointers to these routines are kept in two tables in low memory known as the operating-system and Toolbox trap tables. The A-line dispatcher indexes into the

appropriate table based on the number of the trap executed.

While most applications never need to patch traps, there are some that do. For example, an application might patch out all the Memory Manager traps that allocate master pointers (MPs). When the Memory Manager runs out of MPs in a heap, it allocates a new block of them. This new block is nonrelocatable, so it could easily cause fragmentation. Therefore, the trap patches would just make sure to compact the heap if there are no MPs left when the trap call is made.

MultiFinder tracks the traps that each application patches. When the application is switched out, its patch-routine pointers are removed from the trap table and replaced by the pointers to the previous routines. When the application is switched back in, its routines are restored. Patches are also permanently removed when the application quits.

In order to track patches by the applications, MultiFinder itself must patch the trap `_SetTrapAddress`, which is the mechanism by which other traps are patched. At the time the trap is called, a record is saved denoting the new trap routine, the old routine (i.e., the one that is currently being used), and the trap number.

One of the problems with patching is that the application's patch must jump to the old routine; it can't call the old routine as a procedure. This is necessary because system patches often look back up the stack to see who called them. They will activate only if they see a particular return address on the stack. Therefore, you have to call these routines without changing the stack. The only way to do this is to jump to them.

This has two major implications. First, it's not possible to do patch code entirely from a high-level language. At the very least, you'll need assembly language *glue* (a glue routine is one that converts between the different calling conventions of other languages and the Pascal that the Macintosh ROM expects). Second, it's illegal for an application to have a patch that does post-processing—that is, that has code after the call to the old routine.

- *Vertical-blank tasks (VBLs)*: VBLs are small routines that run during the vertical-retrace interrupt on the Macintosh. This is the interrupt that signifies that the Mac screen has just been completely redrawn from the screen memory. It is used for creating flicker-free animation and also for any type of quick, repetitious tasks.

Under MultiFinder, VBLs are treated much like DCEs; that is, they are switched in and out of the VBL queue as their corresponding application is switched in and out. MultiFinder doesn't track these VBLs in the same way it does trap patches. Instead, during the context switch, it walks down the VBL queue, looking for tasks that fall within the application's heap; the VBLs are saved and removed like the DCE handles. They are restored in the same manner. The VBLs belonging to an application are also removed when it quits.

This method provides a way for applications to have persistent VBLs. That is, if an application installs its VBL in the system heap rather than its application heap, the VBL is never removed, not even if the application itself quits.

- *Resources*: The Resource Manager has been changed under MultiFinder so that all resources from the system file are placed in the system heap. This is necessary in order to share these resources among the applications. It's impossible to share a resource in another application's heap; the data for the resource will be destroyed if that other application quits.

Originally, MultiFinder used an algorithm for resources similar to those for VBLs, patches, and DCEs. That is, it would walk through the system map, saving and restoring resource entries belonging to each application. Besides the wasteful redundancy of data involved, using this method greatly damaged the application-initialization and context-switching times. The latter time was so poor that background tasking seemed too inefficient to implement if a context was to be provided to the background application.

The sharing itself is easily implemented by allowing all the applications to share the system resource map in their resource chains. A resource chain is a linked list of resource maps used as a search path for resources (see figure 2a). Therefore, the old picture of a resource chain has been transformed into a resource wheel (see figure 2b), with the system heap as its hub and each chain as a spoke. The arrows illustrate the search order for resources. They also represent the only order in which the list comprising each spoke is linked. It's impossible for any application to traverse from its spoke to another, so each application still sees only its resource chain.

- *Low memory*: Toolbox and operating-

*continued*

system low-memory locations are conceptually divided into those locations that are application-specific and those that are system-wide. For the most part, these correspond to the Toolbox and operating-system locations, respectively, but there are many exceptions. Under MultiFinder, the application-specific locations are saved and restored between low memory and a copy of those locations (one per application) when the task is switched out and then back in.

You must take special care when switching certain memory locations. Some must be switched in a prescribed order relative to others. For example, there is a system VBL, called the "stack sniffer," that constantly checks to make sure the bottom of the application's stack is above the top of the application's heap. Its purpose is to detect collisions between the two—if detected, a system error is generated, and the application quits. Therefore, it's necessary to actually set the variable named `StkLowPt` to 0 (disabling the stack sniffer), and then

switch out the variable that points to the application heap. You must restore this variable, called `App1Zone`, from the new application *before* you restore `StkLowPt`, because as soon as the latter becomes nonzero, the stack sniffer is reenabled. When this occurs, the system had better be in a consistent state.

• *Registers:* Each application must have its own set of registers, so the context switch remains transparent in this regard as well. However, since MultiFinder knows that context switches occur only inside calls to particular traps, it needs to save only those registers that, by convention, a trap routine won't destroy: data registers D3 through D7 and address registers A2 through A7.

Some of these registers indirectly contain more context information that is switched when the register itself is. For example, register A7 points to the application's stack. Therefore, when A7 is switched, so is the run-time stack being used, even when processing is still in the

heart of the MultiFinder switching code. Likewise, register A5 typically points at an application's global variables, which are referenced as negative offsets from this pointer; for this reason, they are known as A5 globals. When register A5 is switched, references to globals are switched as well.

If the machine has a floating-point unit (FPU), as the Mac II does, then the floating-point registers and context are also saved and restored. Here, the term "context" refers to the internal state of the FPU itself.

**Moving Between Layers**

A layer switch is the process by which another layer of windows comes to the front, ahead of the current top layer. The process is rather lengthy compared to a context switch (it occurs across several calls to `_WaitNextEvent` or `_GetNextEvent`), and actually includes it as part of the layer-switch process.

Layer switching is not transparent to the application. In fact, the switch requires the explicit cooperation of the applications being switched, whether they know it or not. They must accomplish such activities as changing the active state of their topmost window, converting their local Clipboard format to and from the global one if necessary, and desisting from attempting to control the cursor or the menu bar.

It's difficult to persuade older applications (written before MultiFinder) to do all these things, so a little subterfuge is in order. MultiFinder uses a technique known as *scrap coercion* to fool an application into believing that you have chosen a desk accessory (with a window that's very far off-screen) and the copy item (from the edit menu) from the source task; it convinces the destination task that you have chosen the paste item and then closed the desk accessory. (*Scrap* is data that you want to transfer between applications.)

The motivation for employing this process is twofold. First of all, it forces the source application to deactivate its frontmost window (usually deactivating its scroll bars) in its layer when moving *from* the front, and vice versa for the destination task, which is coming *to* the front. Without this, the visual effect of multiple layers would be confusing—the frontmost window of every layer would appear to be active. Worse, some applications take advantage of the fact that no other window lies on top of the frontmost window, and do semilegal drawing that wouldn't work if the application weren't

*continued*

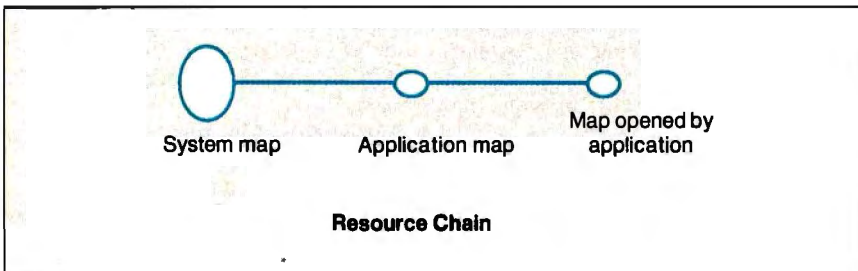

**Figure 2a:** The original MultiFinder plan for sharing resources involves searching a resource chain like this one.

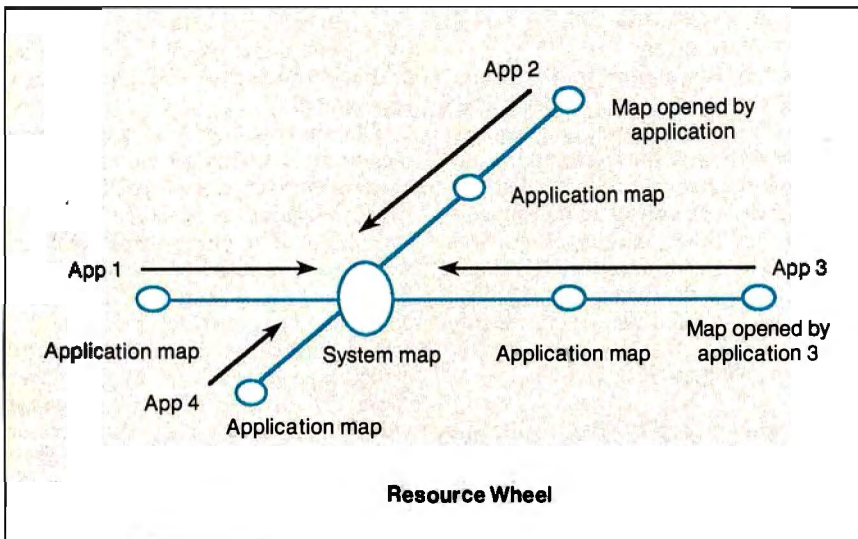

**Figure 2b:** A more efficient plan has been implemented using a resource wheel. The resource chain still exists for each application, but the plan adds the system heap as the hub of the wheel.



New Source  
Debugger  
Works  
On All Macs.

Macintosh SE

## Aztec C's NEW Source Debugger Takes The Work Out Of Debugging!

Stop entering print statements and re-compiling over and over. Stop spending your time looking at assembly language and hex dumps. Stop agonizing over features you need but can't find...Start using Aztec C's NEW Source Debugger (SDB). It has all the features you expect and more!

### UNIQUE SDB FEATURES

- Debug your code at the Source Level
- Set Breakpoints and Single Step by Source Line
- Access all Global and Local Variables by Name
- Evaluate and Print the Value of Any C Expression
- Displays all Structure Element Names and Values
- Assembly Language Debugger for intermixed routines
- Debug drivers and desk accessories
- Separate Windows for Source, Data and Commands
- Supports 68010, 68020 and 68881 processors

Take Advantage of the Introductory Special / Call Today

**1-800-221-0440** (outside N.J.)

201/542-2121  
(NJ and Outside U.S.)

Telex: 4995812MANX  
Fax: 201/542-8386

Aztec C now supports MPW! It compiles blocks of more than 64k for larger applications — which always breaks other compilers. And it produces tighter and faster code. The only logical choice for the Mac is Aztec C and its New SDB.

### Macintosh II Benchmarks

Dhystone	Aztec C	MPW-C	Lightspeed
Build Time (sec)	16	25	22
Object Size	4k	4k	107k
Code Size (bytes)	9824	10976	17090
Run Time	258	299	299

Optimizer (Released May 1) gives even Better Performance!  
See for Yourself — Demo Disk Available.

### SDB introductory Special through August 31, 1988 30 Day Satisfaction Guaranteed

Source Debugger (Reg \$199) . . . . . **ONLY \$ 99.**  
Aztec C68k/Mac Prof. Sys (Reg \$199) . . . . . **ONLY \$99.**  
Package of Both . . . SAVE OVER 50% . . . . . **ONLY \$179.**  
Reseller and Distributor Inquiries Welcome  
COD, VISA, MC, Wire (domestic & intl.) & terms

**Aztec by MANX**

1 Industrial Way, Eatontown, New Jersey 07724

in the frontmost layer. An application can't see the window list of other applications, so the scrap-coercion desk-accessory window can be viewed as a reminder to the application that there are other windows above it, even if it can't quite see them.

In another way, the desk accessory acts as a marker for the rest of the world, and this is its primary role in the scrap-coercion process—to “coerce the scrap.” That is, it must persuade an application to convert its private scrap to the global scrap (the data for the Clipboard). This is important because the application's private scrap could be located anywhere, in any form, in memory or on disk. When the application converts to the global scrap, it puts the data in a well-defined location (in a file named clipboard or in memory referenced from low-memory global ScrapHandle) in a well-defined format. Thus, MultiFinder can copy the data to the global scrap of the destination application.

The premise behind scrap coercion is that once you have cut or copied work with desk accessories, it's necessary for an application to convert to the global scrap when you wish to paste the Clipboard into a desk accessory. Likewise, the application must convert the global scrap to its private one when it thinks you have chosen paste with the frontmost desk-accessory window. The application thinks that the desk accessory has altered the contents of the global scrap; thus, the private one must be refreshed.

If applications are somewhat more MultiFinder-friendly, you don't need to go through the entire charade. If an application can handle Suspend and Resume events, then it knows when it's being layer-switched to and from (for which it receives Resume and Suspend events, respectively, as notification). However, in this case, it's still necessary to convince the application of the desk-accessory activity, so it will deactivate its top window. Therefore, an application can actually set a flag that officially deems it MultiFinder-friendly, meaning that it will deactivate its front window when it receives a Suspend event and activate it again when it receives a Resume. In this way, you don't need any of

**Figure 3:** MultiFinder's method of optimized scrap coercion. Note that you can keep the number of states down by using Suspend and Resume events and if your application has the most recent data in its scrap. This method eliminates the process of copying between global scraps.

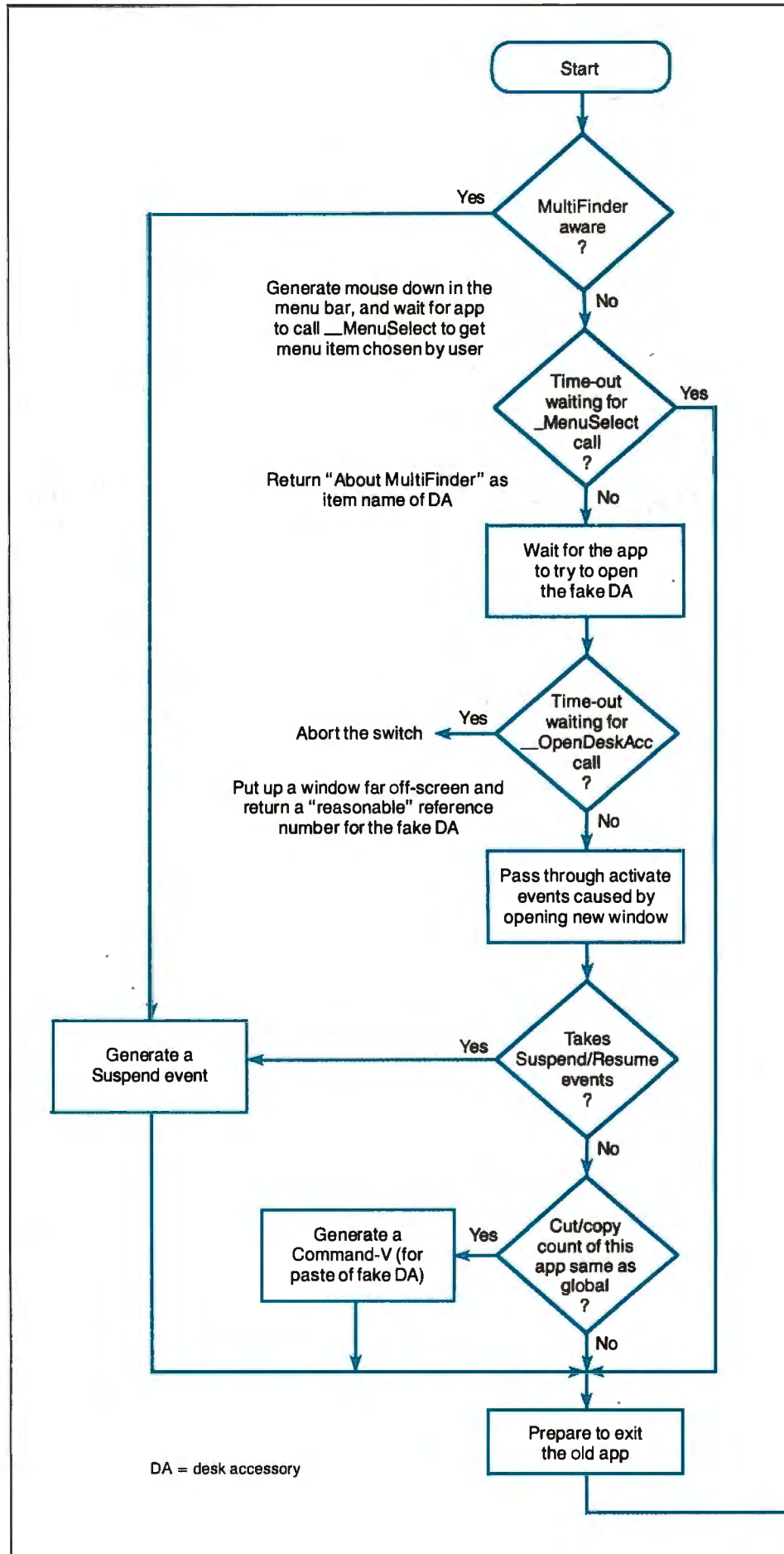

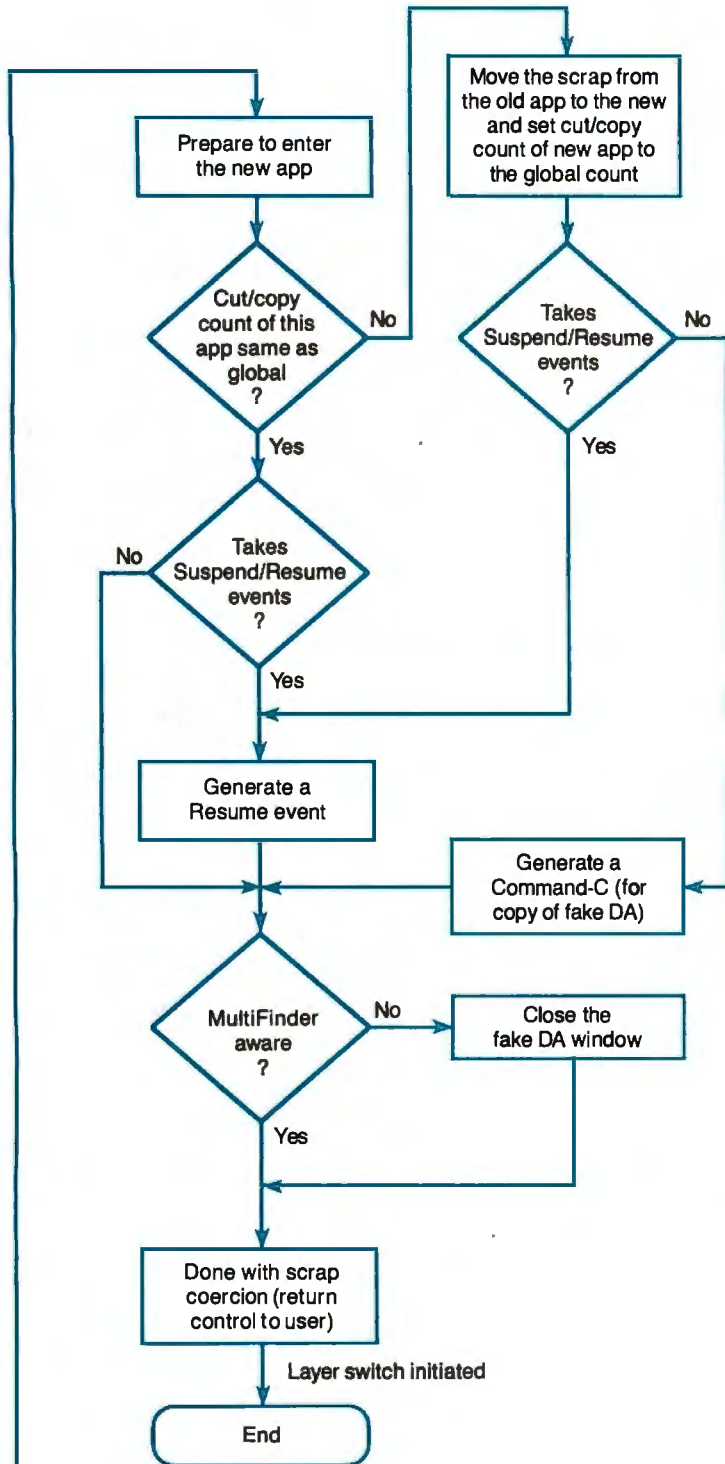

the machinery for the desk-accessory charade, thus speeding up the layer switch.

MultiFinder uses a state machine in order to implement scrap coercion. Each state represents the accumulation of all the expected actions the application has accomplished during the process, and the arcs between states represent the correct or expected action to get closer to getting the desk accessory opened and eventually closed again. An action basically consists of a call to some Toolbox trap, most likely `_GetNextEvent` or `_WaitNextEvent`, or a time-out caused by not calling the expected trap soon enough.

The state machine is really known as optimized scrap coercion (see figure 3). The original notion of scrap coercion came from Switcher, an application from Apple to switch applications, allowing one application at a time on the screen. Much of the time in Switcher's scrap coercion was spent copying the scrap between applications. Therefore, MultiFinder keeps track of whether you have done a cut or copy, and thus changed the Clipboard, and it copies handles only when the application being switched to has stale data. This is reflected in the flowchart. Notice that the number of states entered is much smaller if the application receives Suspend and Resume events and is MultiFinder-friendly. The number of states is also smaller if the application already has the most recent data in its scrap, and the potentially time-consuming process of copying between global scraps is completely eliminated.

**What's New**

One of MultiFinder's goals was application-level transparency, as evidenced by the machinery described for context and layer switching. However, in certain areas, providing new services creates major optimizations in time and space. Thus, only those applications that use the new services break the transparency; for them, it's obviously beneficial.

*WaitNextEvent:* One example of the new services is the new Toolbox trap `_WaitNextEvent`. This trap is similar to `_GetNextEvent`, in that it can be used as the event dispatcher at the heart of any event loop. In addition, it provides a way for an application to sleep for a specified time if no events are pending. This allows the trap to move away from the polling behavior implicit in the use of `_GetNextEvent`, which is called as often as possible.

*continued*

NEW VERSION!

For solving  
QuickDraw mysteries,  
call on the one and only...



## Turns any PICT file into its C or Pascal source!

You know how difficult solving PICT incompatibilities can be. Most major Macintosh developers use *PICT Detective* to solve those mysterious problems—you should, too!

### Version 2.0 Features

- Stand-alone application
- Analyzes any PICT
- Displays symbolic description of each picture element
- C, Pascal, Rez output
- Examines damaged pictures
- Full Color QuickDraw support
- Parses picture comments—both standard and your own
- Complete with MPW tools

ONLY **\$125\***

Ask your local dealer, or order direct with Visa/Mastercard:  
Call (619) 721-7000

**Palomar Software, Inc.**  
2964 Oceanview Blvd. • P.O. Box 120 • Oceanside, CA 92054

PICT Detective is a trademark of Palomar Software, Inc.  
Macintosh is a trademark of Apple Computer, Inc.

\* California residents add 7% sales tax.  
Nominal shipping and handling charges extra.

SEE US AT MACWORLD EXPO/BOSTON

## MULTIFINDER REVEALED

Another service provided by `_WaitNextEvent` is to return a new event, `mouse-moved`, when the cursor has moved outside a bounding region provided by the application. This again makes polling unnecessary, as in the case where an application needs to change the cursor as it passes over different areas on the screen. This need might occur, for example, when an application wants to change the cursor from the arrow to the I-beam cursor shape while the cursor moves into a region that contains editable text.

A final need for polling in the classic Mac model was to give drivers time to run. This was accomplished by requiring the application to call the trap `_SystemTask` as often as possible, which, in turn, would dispatch time to the drivers as appropriate. This requirement is eliminated by using `_WaitNextEvent`. The trap routine is responsible for scheduling the drivers.

The Pascal calling convention for the trap is as follows:

```
FUNCTION WaitNextEvent(mask: INTEGER; VAR event: EventRecord; sleep: LONGINT; mouseRgn: RgnHandle): BOOLEAN;
```

The mask and event parameters are the complete set of arguments for `_GetNextEvent`. The sleep parameter is the number of clock ticks until the system should awaken the application (and return a null event to it) if no events have been returned beforehand. `MouseRgn` is a handle to a region that should bound the cursor.

*Temporary memory calls:* MultiFinder provides a service by which it can, for example, allocate or deallocate blocks in its heap just as it would handles in other heaps. This is useful when an application has a short but memory-intensive need. There is a new set of traps for accessing these services—different from the direct Memory Manager traps available. These traps allow for a level of indirection that will prove useful for MultiFinder. For example, they would allow memory to be found in places where it wasn't originally located (perhaps not even in a heap). This might be useful, for instance, if a Mac II NuBus card provides extra RAM, but the RAM isn't contiguous with main memory; with these new traps, it would be possible to build another heap from which to allocate temporary memory.

More importantly, the explicit calls for the temporary memory allow MultiFinder to track memory use by all appli-

cations. Therefore, if an application quits without deallocating its memory, or if it crashes, then MultiFinder can clean up after it and not orphan the temporary memory blocks that the application didn't release. Also, it would be desirable to do more stringent error checking on the blocks, as an inconsistent MultiFinder heap could easily cause the entire system to crash.

*Launch:* The original operating-system trap `_launch` terminates the current application and then executes the new application. Recent systems have provided an additional feature to `_launch` known as `sublaunch`. Basically, in `sublaunch`, an application sets a certain launch flag that tells the operating system that it expects to be relaunched after the new application terminates. This provides a degree of automation when the launchee is to be used for a brief, specific purpose. However, it suffers from all the obvious problems inherent in a unitasking model. Also, the launcher's context (e.g., the documents that are open, the window sizes, and the positions) is lost when the application is relaunched, unless it explicitly saves and restores it itself. Even then, this is a fairly time-consuming process to sit through.

With MultiFinder, the application can set yet another launch flag that tells the operating system that the application expects to return from the launch trap itself; it doesn't automatically wish to be terminated. In this way, the application avoids the loss of context caused by the `sublaunch`, as it just sticks around.

In its development stages, MultiFinder always allowed `_launch` to return to the launching application, rather than terminating it. This offered a great deal of leverage to many applications in that they automatically could take advantage of the new launch capabilities without having to be programmed for them explicitly. Unfortunately, some applications implicitly assume that the `_launch` trap will never return. Usually, the problem is that there is simply no more code in the program after the call to `_launch`; after the return, the application runs wild. Thus, it was necessary to force applications to prove that they were ready to continue running. They prove it by setting the `TwitchLaunch` flag in the extended `_launch` parameter block.

Under MultiFinder, the call to `_launch` is simply a request to launch and execute an application. In the trap itself, memory is allocated for the application from the MultiFinder heap, and the system data structures necessary to sup-



port the application are initialized. However, the first instruction of the application code isn't actually executed until the layer switch, which was also initiated in `_launch`, is completed. In newer versions, MultiFinder determines if the launchee already exists. If it does, MultiFinder merely initiates a layer switch to the application; it doesn't create a new copy.

*Open document and quit events:* When the user chooses Shutdown from the Finder's Special menu, the Finder will try to quit all the other running applications first. It does this by passing a special event to MultiFinder, one per application, which MultiFinder converts into the actions necessary to persuade the application to quit gracefully.

Basically, these actions are used to inform the application that the user has decided to quit. More specifically, they convince the application that the Quit item has been selected from its File menu. Then control returns to the user for responses to any ensuing dialogues, such as requests to save changed documents before quitting.

A problem arises if the application has no File menu or Quit item, or if they are spelled slightly differently. Therefore, the Finder doesn't actually pass these strings explicitly in the Quit event that it sends to MultiFinder. Instead, the Finder specifies two resource IDs, numbers 100 and 101. These are used to find string resources of type 'mstr' where the two IDs refer to the File-menu name string and the Quit-item name string, respectively.

MultiFinder first looks in the application for these resources. If it doesn't find them, then it will use the default ones located within its own resource map. This allows applications with nonstandard versions of these strings to still be quitable before shutdown. For example, HyperCard has its own resource ('mstr', 101) set equal to the string "Quit HyperCard." Using the resources also solves the one problem posed by using applications in other languages. You can customize older applications with different menu strings by using ResEdit or some other tool to put the 'mstr' resources in the application's resource file. MultiFinder itself can be modified so that its default 'mstr' resource is in the language most commonly used by the applications it runs.

In much the same way as with the Quit event, the Finder also sends an Open event through newer MultiFinders when you open the document of an already

existing application (usually by double-clicking on its icon). The Open event is converted to the actions necessary to convince the application that you have chosen the Open item from the File menu, but it really looks for the resources ('mstr', 102) and ('mstr', 103), respectively, for the title and item strings. Unlike the situation with the quit actions, in this case MultiFinder doesn't return control to the user quite yet.

Most applications at this point bring up the Standard-File dialog box to allow you to choose which document to open. MultiFinder already knows which docu-

**E**xplicit  
calls for temporary  
memory will allow  
MultiFinder to track  
memory use by all  
applications.

ment it wishes to open (the Finder has told it), and, therefore, it convinces the application that it has indeed put up the dialog box (by patching out `_SFGetFile` and `_SFPGetFile`), and that the user has chosen the particular document. Since the dialog box is never made visible, what you see after the double-click in the Finder is a layer switch to the document's creator application, followed by the application magically opening a window for the document.

### Building and Burning Bridges

During the development of MultiFinder, we were amazed at how many applications worked with it, no matter what twist or turn we were experimenting with at the time. These applications were so resilient that they seemed to be impossible to break, even while MultiFinder itself was unstable.

Unfortunately, certain other applications were much more fragile. While the number of incompatible applications eventually became very small, this was due largely to explicit fixes within MultiFinder to fix problems within the applications themselves, bugs that the MultiFinder environment revealed.

For example, a couple of applications

would crash unless they were loaded into the first megabyte of the MultiFinder heap. Therefore, we had to "special-case" these applications and make sure that the launch-time memory allocation kept the blocks for these applications within the first megabyte. This was difficult because the Mac's Memory Manager has no concept of absolute addresses; the memory-allocation traps grab memory from wherever they can find it. You have to play some ugly tricks on the Memory Manager to get the bounded block.

Another problem with the allocation is that because the application's heap block must lie so low in the MultiFinder heap, it might have to be launched into a block lower than the system heap can shrink, and thus these applications might be unlaunchable even when there's plenty of memory above 1 megabyte. In any case, they definitely stunt the system heap's growth.

Another application assumes that the value of low-memory global `CurrentA5` never changes during asynchronous file reads and writes. This variable is so named because it serves as a static pointer to an application's globals; you could reload register A5 from this global if for some reason the register's contents had changed. Unfortunately, the asynchronous file-completion routine supplied by the application runs at interrupt time, so it might execute after another application that has a different value for `CurrentA5` is already running. Therefore, MultiFinder waits for a pending asynchronous file operation to complete before context switching.

There are many more examples of such hacks in MultiFinder. From one point of view, they are ugly, application-specific pieces of code that shouldn't be part of an operating system. But, from another point of view, they can be seen as bridges between the liberties permitted applications in the original Macintosh operating system and the more restrictive rules necessary in the MultiFinder environment. Newer applications must obey these rules, so no new hacks will be added. In addition, as applications are revised and fall into disuse, it will be possible to remove the hacks for them. Thus, these bridges will eventually be burned—but not until the entire application base has crossed them. ■

*Phil Goldman is coauthor of MultiFinder and a member of the Macintosh OS Group with Apple Computer in Cupertino, California. You can reach him on BIX as "editors."*

# FLEXSCAN™ 9070S, PC Hi-Res That Looks Like a Million.

The FLEXSCAN 9070 Multiple Scan monitor is of course compatible with other multi-scans, but includes improvements that will give you the professional edge which is the mark of a good investment. You can extend your multi-scan range from 20kHz to 50kHz in practical terms. This means that, at the 48-50 kHz range, you can make use of PC CAD/CAE capabilities at a resolution of up to 1024 dots × 768 lines. The FLEXSCAN 9070 takes advantage of non-interlace high resolution signal as high as 1024 × 768 to provide you with a flicker free display at much brightness. You can also use the 9070 with IBM PS/2 or VGA compatible boards at a high resolution mode like 800 × 600 and 1024 × 768 (non-interlace). The FLEXSCAN 9070 provides a 16-inch screen, large enough for CAD/CAE and 3-D projections, yet small enough to fit comfortably into your home work space.



1024 dots × 768 lines Graphics (Non-interlace)  
AutoCAD

Also, for your convenience, all controls and switches, including the alternate video input, are located within easy reach on the front panel. The FLEXSCAN 9070 is compatible with a wide range of IBM, Apple, and other products, allow you to use all of today's popular programs---at a resolution that looks like a million.

## FLEXSCAN™ MODEL 9070S

- IBM VGA(PS/2), 8514/A, PGC, EGA compatible and CAD/CAE use.
- Apple Mac II and SuperMac Spectrum compatible
- Max. 1280 dots × 800 lines high resolution
- 1024 dots × 768 lines display on Non-Interlace signal delivers flicker-free high-res graphics
- 20kHz to 50kHz horizontal scan automatic adjustment. 50Hz to 80Hz vertical scan automatic adjustment
- 16 inch, 0.31mm dot pitch and newly developed XF(Extended Field) Gun to obtain both brightness and sharp focus.
- Front mounted controls including the input signal select switch between 2 video input.
- Selecting white or Amber displays colored application in shades of gray or amber
- Tilt-Swivel stand standard

Specifications are subject to change without notice.

APPLE, Macintosh II are registered trademarks of Apple Computers Inc. ARTIST, ARTIST 1 Plus, ARTIST 10, ARTIST 10/16 are trademarks of Control Systems Inc. IBM, IBM PC, XT, AT and PS/2 are registered trademarks of International Business Machines Corporation. SuperMac is a trademark of SuperMac Technology. SuperEGA HiRes, SuperVGA and SuperVGA HiRes are trademarks of Genoa System Corporation. Orchid Designer VGA, Orchid Designer VGA-2, TurboEGA and TurboVGA are trademarks of Orchid Technology. Paradise VGA Professional Card, Paradise VEGA Plus Card and Autoswitch EGA are trademarks of Paradise Systems, Inc. Paradise Systems is a registered trademark of Paradise Systems, Inc. VEGA Deluxe and VEGA VGA are trademarks of Video-seven Inc. Metheus is a registered trademark of Metheus Corporation. Imagraph is a trademark of Imagraph Corporation. AutoCAD is a registered trademark of Autodesk Inc. GEM is a registered trademark of Digital Research Inc. Lotus and 1-2-3 are registered trademarks of Lotus Development Corporation. SigmaVGA and SigmaEGA are trademarks of Sigma designs, Inc. FLEXSCAN is a trademark of NANA O CORPORATION. NANA O is a registered trademark of NANA O CORPORATION.

# NANA O®

**NANA O USA CORPORATION**

23510 TELO AVE., SUITE 5 TORRANCE, CA 90505  
PHONE (213) 325-5202 FAX (213) 530-1679

# The Well-Connected Mac

Janet J. Barron and Robert L. Mitchell

## *A guide to networking on the Macintosh*

What constitutes a network? Everyone has a different opinion. Essentially, a network is any hardware or software configuration that interconnects computers and other intelligent devices to allow a meaningful exchange of data.

A network can comprise a simple set of connections that allow two Macintoshes to share a laser printer. It may be a more sophisticated local-area network (LAN) that supports application, file, and peripheral sharing, or it may include microcomputer-to-host links that let the Mac access mainframe resources, such as the corporate database.

The success of the Mac has helped Apple get its foot in the corporate door. Now, with an increasing number of Macs in the office, the next step is to integrate them with other computing resources. Macs, IBM PCs, minicomputers, and mainframes can share the same building, but they can't always share the same applications or data. Fortunately, much of the technology necessary to network these disparate environments is already in place.

The foundation of Mac networking is the LAN: the physical and logical connections that assemble data into packets and route it through a cabling system to its proper destination. Upon this platform, higher-level functions such as file sharing, electronic mail (E-mail), and internetwork communications occur.

### **Applecentric Networking**

Because networks have never been easy to implement, most people probably think of LANs as being quite complicated, consisting of a bunch of jerry-rigged wires connecting groups of similar, local machines. The ease with which you can construct an AppleTalk network may go far to change that image.

Anthony Cagle, Apple's manager of Communications Product Development, breaks networking into two basic models: a simple AppleTalk Personal Network configuration in which you can

share peripherals among multiple workstations, and a more sophisticated, more recent model that, via Appleshare file-server software, centralizes file storage to let networked Macs share resources and control file access.

At the heart of the company's communications strategy is AppleTalk, a proprietary seven-layer communications architecture that's similar to the International Organization for Standardization's Open Systems Interconnection (OSI) reference model. AppleTalk comprises a suite of networking protocols built into the Mac that serve as the foundation of the AppleTalk Personal Network and that determine every aspect of Macintosh communications, from the type of LAN interconnections that is used to how applications communicate between workstations (see figure 1).

What sets an AppleTalk LAN apart from its PC LAN counterparts is that it supports peer-to-peer communications between devices. Unlike a 3Com or Novell PC LAN, there is no controlling node in an AppleTalk network; all communications are of equal importance and all commands are processed sequentially.

An AppleTalk network is also relatively easy to set up because the network is self-configuring. This is made possible by the AppleTalk Name Binding Protocol (NBP), which dynamically assigns a name and address to each node as it's connected to the network. By contrast, adding a new node to a typical PC LAN requires the system administrator to bring the network down and then make

the necessary hardware and software changes to reconfigure it.

AppleTalk's Printer Access Protocol (PAP) provides the connections necessary to allow shared access to a laser printer, and AppleTalk Filing Protocol (AFP) determines how file sharing takes place over the network. AppleTalk runs over a proprietary shielded twisted-pair cabling scheme called LocalTalk at 230.4 kilobits per second (kbps). Since AppleTalk is part of the Mac operating system, network operating-system software is not required. The AppleTalk design also includes a LocalTalk interface that's built into the Mac serial port, eliminating the need for a LAN interface card.

LocalTalk supports up to 32 users over distances of up to 1000 feet between nodes. However, bridge devices, such as Hayes's NetBridge, let you interconnect distinct AppleTalk LANs to expand the total number of users. Repeaters amplify the AppleTalk signal to extend maximum cabling distances; the TOPS repeater, for example, increases the maximum cabling distance to 2000 feet.

### **Alternatives to LocalTalk**

AppleTalk is not limited to LocalTalk connections: You can configure it to operate over a variety of other media. One alternative is to use less expensive unshielded twisted-pair wire. Farallon Computing's PhoneNet, for example, replaces LocalTalk with telephone wire and RJ-11 telephone jacks. You can daisy chain the devices together or use existing telephone wire in a star configuration. In the latter, a hub controller routes data between devices. Another, more expensive implementation is Northern Telecom's LANStar AppleTalk, which supports up to 1344 Mac IIs, IBM PCs, and other devices at 2.56 megabits per second (mbps) over existing telephone wiring. A central controller can directly connect all devices, or it can

*continued*

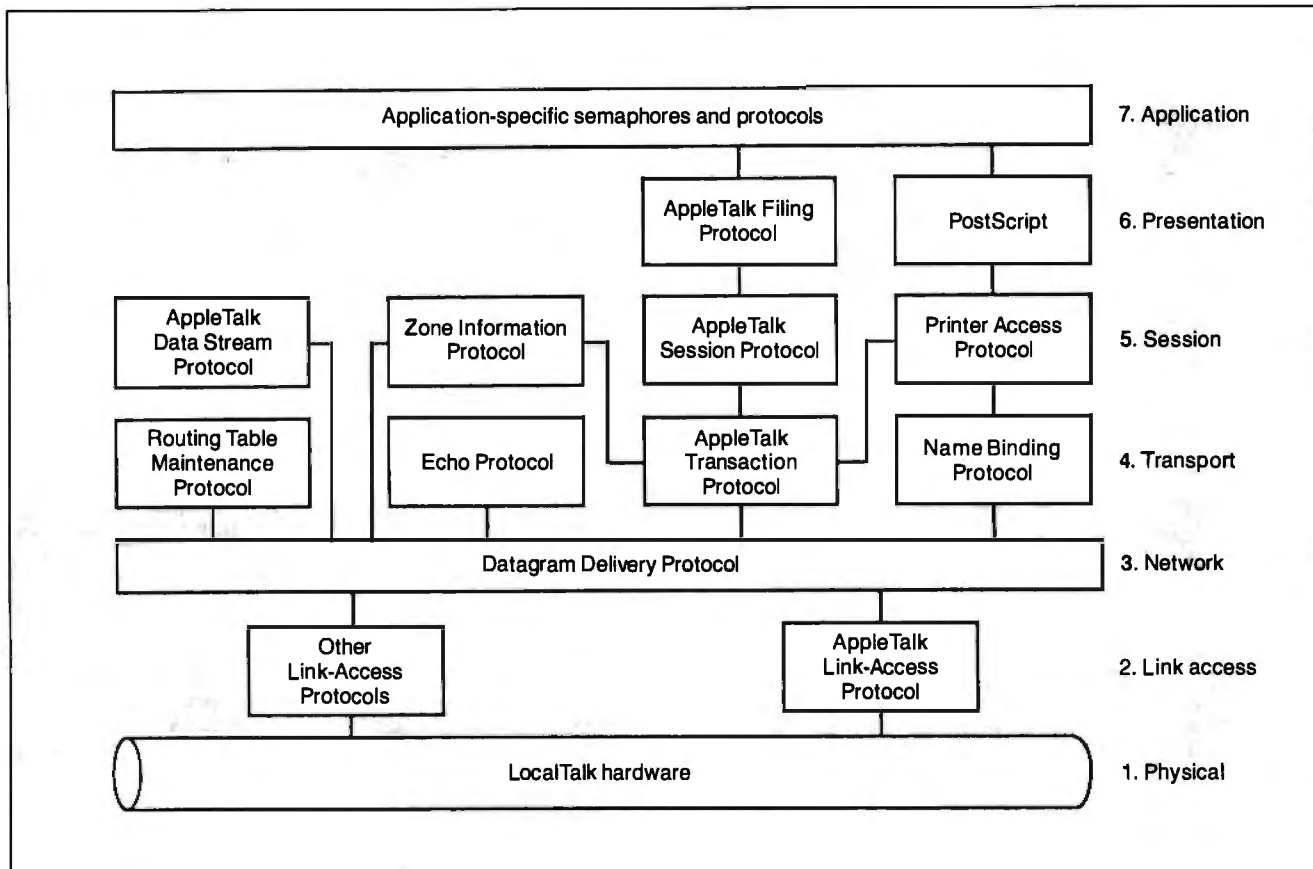

**Figure 1:** AppleTalk's seven-layer architecture is similar to that of the OSI reference model. The protocols, however, are proprietary.

act as a bridge between AppleTalk LANs throughout a building.

If electrical interference or network security is a problem, another alternative is to run AppleTalk over a fiber-optic cabling system, such as that supplied by DuPont Electronics of New Cumberland, Pennsylvania. Fiber isn't easily tapped, it's impervious to electromagnetic interference, and you can run it up to 4900 feet between devices. On the other hand, fiber cabling systems are expensive, and the medium's high bandwidth (in the hundreds of megabits) usually makes it more cost-effective as a backbone for interconnecting multiple AppleTalk LANs. Dupont's scheme currently supports transmissions at LocalTalk speeds (230.4 kbps), far short of fiber's potential. Dupont is working on a system that will support AppleTalk at higher speeds.

If LocalTalk speeds are too slow, you can run AppleTalk over a 10-mbps coaxial-cable Ethernet network. Ethernet is key to connecting the Mac to many other computing environments. Apple's implementation, EtherTalk, is a NuBus Ethernet interface card for the Mac II that replaces AppleTalk's physical and link-

access protocols with the IEEE 802.3 coaxial-cable Ethernet specifications. Other vendors, like Kinetics, offer an Ethernet interface card for the Mac SE or an external box that works with the Mac's small computer system interface (SCSI) port.

An alternative to connecting Macs directly to Ethernet is to provide an AppleTalk-to-Ethernet gateway, such as Kinetics' FastPath. Macs on LocalTalk access Ethernet through a device that converts between LocalTalk and Ethernet protocols.

A recently approved standard for running Ethernet over unshielded twisted-pair wire offers the advantages of Ethernet speeds without the expense of installing coaxial cable. A Mac interface card that supports Ethernet over standard telephone wire should be available from Kinetics by the time you read this.

LocalTalk simply provides basic connectivity between Macs. You'll need additional software to support services such as file sharing. Apple's Appleshare file-server software lets you share files stored in a central location. Designed around AFP, Appleshare runs on a dedi-

cated Mac Plus with a hard disk drive and lets you restrict access to files you create. You must first log on to Appleshare before you can access the server. You own each file that you create, and you determine who has access to each file and at what level. Each person on the network can have no access, read-only access, or read-and-write access. Another security feature is Appleshare's drop folder; anyone on the network can deposit documents into it, but files in the drop folder are invisible to everyone except the folder's owner.

In addition to file-sharing capability, file- and record-locking capabilities are necessary to ensure that two users don't attempt to write to the same file at the same time. Each application must handle this function for its own files; most conform to the AFP specifications.

The main drawback of Appleshare is that you have to dedicate a Mac Plus as a file server. One alternative, TOPS, takes advantage of AppleTalk's peer-to-peer communications capability to provide distributed file service; all nodes act as both file servers and requesters (see the

*continued*

# MAC NIFICENT

Introducing our new Macintosh™ Communications Package™: 2400bps modem, MicroPhone™ software, cable, and a price that makes it all worthwhile.

This one's just for the Macintosh. Even the color is Mac-compatible. And you'll look a long time for a more complete value...a value that begins with our Practical stand-alone 2400 modem. Feature for feature the PM2400SA is way out in front of anything comparable. Hayes™ compatibility is 100%. Even the Macintosh version of Hayes' Smartcom™ can't tell the difference. But there's more to the PM2400SA than that...

- 2400, 1200, or 0-300bps operation.
- Automatic adaptive equalization for error-free operation over common phone lines.
- LED displays for all functions.
- Full or half-duplex operation.
- Pulse or touch-tone dialing.

- User modifiable, non-volatile, RAM stores modem configurations.
- Automatic answer mode.
- Complies with Bell 212A, 103, FCC Part 68, etc.

We've made a great deal greater! By itself the PM2400SA is a great value. But, along with the modem, our Communications Package includes both the cable you need and MICROPHONE™.. the communications program

that goes beyond any program available for the Mac...FREE. The complete package is an absolutely irresistible \$299! Improved technology. Performance. Value. And the best guarantee in the business...a performance guarantee that's 5 full years long. Hardware, software, a rock solid guarantee, and superior value...we'll say it again, "macnificent!"

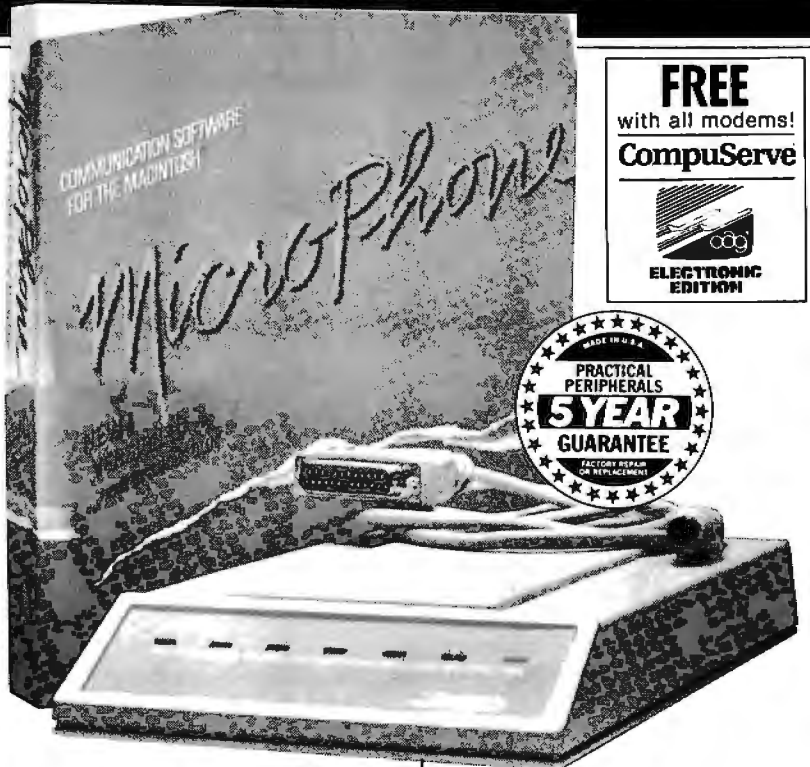

**PRACTICAL PERIPHERALS®**

31245 La Baya Drive, Westlake Village, CA 91362

Sales Office: 1-800-442-4774

Corporate Headquarters: 1-818-706-0333 FAX: 1-818-706-2474

All products and names trademarked are properties of their respective manufacturers.  
© 1988 Practical Peripherals, Inc. All rights reserved.

MODEMS • BUFFERS • IBM & APPLE ENHANCEMENTS • INTERFACES

## It's TOPS

Nicholas M. Baran

**T**OPS is an AppleTalk-compatible distributed network operating system that lets Macintoshes and IBM PCs share files, hard disks, and laser printers. Unlike Appleshare, however, TOPS does not require a dedicated central file server, but distributes this function between all workstations. TOPS consists of software for each Mac and IBM PC, and it runs over LocalTalk or telephone-wire cabling, such as Farallon Computing's PhoneNet. It's compatible with applications that support the AppleTalk Filing Protocol (AFP), and it can also support Sun workstations.

If you're using TOPS/DOS on the PC, you'll also need the TOPS FlashCard or another AppleTalk PC interface card. FlashCard supports standard 230.4-kilobit-per-second (kbps) LocalTalk speeds for laser printer and PC-to-Mac communications, but it can also transmit PC-to-PC at 770 kbps. By the time you read this, a similar product may be available for the Mac, according to TOPS. FlashCard includes a standard plug-in card with software drivers and an installation guide.

### Distributing File Service

TOPS is a distributed network operating system. When you use TOPS, you don't need to dedicate a Mac as a file server,

as you do with Appleshare, Apple's centralized file-server software. Each machine in the network acts as both a "client," using the resources of other machines, and as a "server," providing its resources to other computers on the network.

For example, if your workstation is an IBM PC XT, once you run TOPS/DOS and log on to the network, you can "publish" local file folders, volumes, or an entire hard disk, so any networked Mac or PC can access it. Only those files that you publish are available to other network clients. On the Mac desktop, the XT's hard disk appears as an icon representing another Mac hard disk. The Mac can also transfer files from the XT for local storage.

A key issue with every network is security. TOPS uses a password scheme that you can apply to any published folder, volume, or disk on the network. You can also specify that the files be read-and-write or read-only access, and that only one user access the volume at a time. It's not possible, however, to let some users have limited access and some have no access to a file, as you can with Appleshare.

By contrast, Appleshare lets you set access privileges with a desk accessory, and security is more stringent. You must log on to the network to access the file

server. You own the folders (or sub-directories) that you create, and you determine which users have access to those folders and what level of access each user has.

### Setting Up

I set up a TOPS network that consisted of a Mac SE, an IBM PC XT, and an Apple LaserWriter IINTX, arranged in a typical daisy-chain configuration. I connected the devices to each other via Farrallon's PhoneNet connectors, which consist of two RJ-11 plugs: one input jack, and one output jack. The daisy-chain end connectors have only one RJ-11 connection; a special resistor provided with the connector kit terminates the other plug.

Getting TOPS up and running is simple. You connect each Mac by plugging a LocalTalk connector into the Mac's printer port. If you're connecting PCs to the network, you install FlashCards, connect the RJ-11 cables supplied with the PhoneNet RJ-11 connectors, and install the software on each system, and you're ready to go. TOPS on the PC is a RAM-resident program that you load from the DOS prompt or via an AUTOEXEC.BAT file. The program requires 170K bytes to 230K bytes of RAM, and it is copy-protected, so you must buy a copy of TOPS for each workstation.

text box "It's TOPS" by Nicholas M. Baran). Another way to avoid buying a dedicated server is to allow a Mac to act as both a central file server and a workstation. Tangent Technologies' Mac-Serve, for example, offers the benefits of centralized file storage for up to 16 users on a Mac hard disk. You can designate the hard disk of any Mac as a shared disk and divide it into private or shared volumes. This arrangement works best with a few nodes; as network activity increases, the server workstation's performance rapidly decreases.

### Mac to PC

Unlike the Mac, there is no de facto communications architecture built into the IBM PC. Rather, each LAN vendor has developed its own proprietary set of networking protocols. While these companies use industry-standard LAN topologies, such as Ethernet and Token Ring at

their lowest levels, each one has its own method of providing higher-level functions. The result is a fragmented approach to interconnecting Macs and PC LANs.

There are two ways to integrate Mac and PC LAN environments: You can integrate PCs into an AppleTalk network, or you can extend the PC LAN environment to support the Mac. The latter may not be an option if your PC LAN doesn't support the Mac, however. On the other hand, if all you need to do is perform simple file exchanges between Macs and PCs or occasionally access a PC application, you may want to look into several LAN alternatives (see the text box "Exchanging Data" by Cynthia W. Harri-man on page 62).

PCs can participate on an AppleTalk network via an AppleTalk PC interface card, which fits into a standard expansion slot on the IBM PC. However, this

still limits PCs to printing documents on a networked laser printer. Appleshare PC, an extension of Appleshare, lets PC users access an Appleshare file server. Other software packages, such as TangentShare from Tangent Technologies, let you configure an IBM PC or PS/2 to participate on an AppleTalk network as an AFP-compatible file server.

Another way to network Macs and PCs is by linking the Mac to a PC LAN. However, PC LANs are generally more complicated and more expensive than AppleTalk LANs, and they may be less cost-effective for small work groups. The dominant vendors are 3Com, Novell, and Banyan. As a participant on the LAN, a Mac may have access to a range of services, including E-mail, file sharing, gateways to hosts, and other LANs.

3Com offers an extension to its 3+Share network operating system that allows the Mac SE or II to participate as a

On the Mac, the TOPS system resides as a desk accessory that automatically loads when you start the Mac. (You can bypass TOPS installation by holding down the Command and Option keys when you start up.)

**Making an Impression**

Aside from file sharing, perhaps the greatest incentive for using TOPS is being able to share a laser printer. But using a laser printer on the network has some limitations. PCs can't print directly to the laser printer unless you buy a copy of NetPrint software for each PC. If you don't have NetPrint, you can send a file to the laser printer from the DOS prompt using the TPRINT command, which is similar to the DOS PRINT command. With TPRINT, you have to first print the file to disk using your word processor or some other application and then send it to the laser printer via TPRINT. This two-step printing process can prove to be a bit cumbersome.

NetPrint intercepts output that has been directed to the PC's printer port and sends it instead to the laser printer on the network. It supports PostScript files and includes a translator for printing IBM ProPrinter or Epson-compatible files. NetPrint operates in the background so that you can continue with other work after you've sent the file to the print queue.

Another feature allows Mac or PC users without hard disks to share hard disks in other workstations. I created a

separate directory on my PC's hard disk for Mac files, installed several Mac programs on the PC, and ran them from the Mac without a hitch.

The major consideration when sharing a hard disk is data compatibility. Obviously, you can't use a Mac file in a PC application unless it has a compatible data format. TOPS provides a set of translator programs on the Mac that converts between many popular Mac and MS-DOS application files. For example, you can translate a WordStar file to MacWrite or a Lotus 1-2-3 file to Jazz. Many other applications use common data formats on the PC and the Mac or include conversion utilities.

My only complaint with the TOPS system is the documentation, which could explain some details more clearly. I had to make several calls to TOPS's technical-support line before I had things running smoothly. However, TOPS's technical support was excellent. TOPS also provides on-line technical support on BIX.

The cost for TOPS is about \$250 for each Mac, \$59 per laser printer, and \$430 for each PC without NetPrint. Including NetPrint, which I highly recommend, the cost per PC rises to almost \$620. Although the price per PC is a bit steep, TOPS is an elegant and simple solution for small networks of PCs and Macs.

*Nicholas M. Baran is a BYTE technical editor. He can be reached on BIX as "nickbaran."*

**TOPS 2.0**

**Type**

AppleTalk networking software for Macintosh and IBM PC

**TOPS/Macintosh**

Price: \$249

Requirements: Mac 512K, Plus, SE, or II

**TOPS/DOS**

Price: \$189

Requirements: IBM PC or compatible with DOS 3.1 or higher; 512K bytes of RAM recommended; one expansion slot for FlashCard

**TOPS FlashCard**

Price: \$239

Requirements: IBM PC and one available expansion slot

**TOPS NetPrint**

Price: \$189

Requirements: Same as TOPS/DOS

**TOPS Teleconnector**

Price: \$59

**Company**

TOPS, a Sun Microsystems Co.  
950 Marina Village Pkwy.  
Alameda, CA 94501  
(415) 769-9669

**Inquiry M151.**

3Com network node. As such, it can share peripherals and access PC or Mac files stored on a central file server. An Appleshare file server can also support Mac workstations over a 3Com network; however, 3Com's file server does not support AFP. Appleshare file servers on LocalTalk can be linked directly to a 3+Server, which acts as a gateway to 3Com's Ethernet network. Macs with an Ethernet interface card can also operate on a 3Com network directly. A product is also in the works that will allow the Mac to communicate with the 3+Open file server, which runs OS/2 Extended Edition.

Once linked to a 3Com network, Mac participants can access gateways to other LAN environments, such as a token-ring network. Many large corporations also use 3Com's internetwork bridges and gateways to construct wide-area networks (WANs) that connect geographi-

cally dispersed LANs via Tymnet or other packet-switched networks.

Novell recently introduced NetWare Macintosh, an AppleTalk-compatible version of its NetWare LAN operating system. In contrast to 3Com's approach, Novell does not require that an extension of its network operating system reside on each Mac. Instead, Novell has mapped the AppleTalk protocols to NetWare. All protocol translation occurs on the Novell file server, which provides the Mac with transparent access to Novell LAN resources. To Macs attached to a NetWare LAN, the NetWare server appears to function as an Appleshare device. You can connect the Mac to a NetWare server via Ethernet or LocalTalk connections. Once linked to the Novell LAN, you can access resources on DEC and IBM hosts and can take advantage of X.25 interfaces to packet-switched services and WAN bridges.

At the time of this writing, Banyan had not introduced its much rumored software that would extend its VINES network operating system to the Mac. However, Macs can indirectly access files on a Banyan server via a TOPS network. A PC attached to both a TOPS and a VINES network acts as a gateway between the two environments.

**Mac to DEC**

Early last spring, Apple and DEC announced a joint development effort to integrate AppleTalk and DECnet networks. While products have yet to emerge, areas for potential product development include terminal emulation, file sharing and network management, and services such as E-mail. The Apple/DEC alliance strengthens AppleTalk's credibility in the corporate world and may provide users with network-man-

*continued*

## Exchanging Data

Cynthia W. Harriman

If a simple exchange of data between Macs and IBM PCs and compatibles is what you're looking for, several inexpensive alternatives to constructing a LAN are available: establishing a direct connection, performing disk-format conversion, and adding PC coprocessing to your Mac.

Direct-connection schemes use file transfer software to send data between the Mac and PC over dial-up lines or through an RS-232C or small computer system interface (SCSI) link. Disk-format conversion requires adding a third disk drive to your Mac that can read and write PC disk formats. PC coprocessing boards and software let you run PC applications on the Mac. Depending on your needs, a combination of these options may be appropriate. You may also need file-translation software to allow Mac applications to read PC files.

### Direct Connection

The easiest approach to exchanging data is to cable the Mac and PC machines together for quick file transfers. If you choose this approach, you can connect the serial ports on the two machines with an appropriate cable (if you already own one, Apple's Imagewriter I printer cable has the right pin-outs), and you can use standard communications software to send files back and forth.

A more basic approach is to buy a turn-key package like MacLink Plus. This product comes with a serial cable and easy-to-use custom file-transfer software for both the Mac and the PC. The drawback of serial connection, however, is that you'll have to transmit at a relatively slow speed: 57.6 kbps is the current limit.

You can overcome this constraint by using the Mac Plus, SE, or II's SCSI. This requires a SCSI PC board and a connecting cable to the Mac's SCSI port. Transmission speed ranges from 1.4 mbps (Mac SE to PC) to 4.2 mbps (Mac II to AT)—substantially faster than serial connections. QuickShare is one product that supports SCSI Mac-to-PC file transfer.

If your machines aren't close enough to allow direct connection, you can use a modem to establish a dial-up connection. For example, MacLink Plus offers a modem option that includes password protection. You can boot MacLink Plus on your office PC, then dial in from a Mac at home, enter the password, and download a Lotus 1-2-3 worksheet. You can then work on it using Excel (which accepts 1-2-3 files) and send it back to the office PC when you're finished. The remote Mac controls the session; you don't need someone at both ends. In addition, MacLink Plus translates many PC application files to Mac application formats.

### Adding a Drive

Another popular file-transfer solution is to add a special disk drive that lets the Mac read and write DOS-formatted disks. Several options currently exist that let you add an MS-DOS drive to the Mac, and at least one product, MatchMaker, provides a Mac drive on the PC. While all three MS-DOS drives let the Mac read PC disks, each differs in its hardware requirements, its user interface, its file-translation capability, and the PC media it supports.

Dayna Communications' DaynaFile

connects to the SCSI port on any Mac Plus, SE, or II and handles both PC-to-Mac and Mac-to-PC conversions. It's available in configurations that support either 360K-byte and 1.2-megabyte 5¼-inch floppy disks, or 720K-byte and 1.44-megabyte 3½-inch floppy disks. DaynaFile interacts with the Mac's operating system and other software to appear as another Mac drive. In Finder, you can transfer files to and from your PC disk just as you would between Mac floppy disks. Within applications, you can access PC files transparently with the usual Open and Save commands. DaynaFile also includes translation software that converts between PC and Mac application files.

Apple's PC 5.25 Drive is similar to DaynaFile, but it requires a special interface board that makes it usable on only the Mac SE and II. You can transfer files in both directions, but the floppy disk drive reads only 360K-byte PC disks and requires a special transfer program (included with the Mac) to move files; Mac Finder and Mac applications can't access the PC disk directly.

A third alternative is Peripheral Land's Infinity I, a high-capacity 5¼-inch floppy SCSI drive intended as a mass-storage device for Mac files. It reads 360K-byte and 1.2-megabyte PC disks, but you can't write Mac files to it.

If you primarily use a PC, you can install MatchMaker, a half-size drive controller board and software that lets you connect a single- or double-sided Mac external floppy disk drive to your PC. The software supports five commands: COPY, DIR, DELETE, TYPE, and

agement capabilities under Ethernet that AppleTalk currently lacks.

The venture also benefits DEC, which has had limited success with its personal computer offerings. Integrating the Mac into DECnet will be good news for the many firms that use both Macs and VAXes. DEC's research has shown that 36 percent of its VAX users also have Macs and need ways to integrate and enhance these systems.

In the meantime, there are several ways to connect Macs and VAXes. These include VT-100 and VT-200 terminal emulation, DECnet software for the

Mac, and AppleTalk file-server software for the VAX (see figure 2). The latter two alternatives require a Mac connection to DECnet's Ethernet backbone via an Ethernet interface card or an AppleTalk/Ethernet gateway.

Terminal-emulation packages, available for the Mac Plus, SE, and II, perform the necessary protocol translation to allow the Mac to act as a DEC terminal. Terminal emulation requires software for the Mac and the host, and an RS-232C cable to link the two machines. In addition to remote-terminal capabilities, many terminal-emulation packages

also provide file transfers and other functions. Pacer Software's PacerLink, for example, supports file transfer, virtual disk, and print spooling.

Unfortunately, terminal emulation does not take advantage of the Mac's intelligence; all processing takes place on the host. One solution is to install DECnet software, such as Technology Concepts' CommUnity-Mac, which lets a Mac function as a DECnet end node. Such packages support the Mac interface so that attached Macs can share host resources and access files transparently. Unlike terminal emulation, however,



INIT (format). [Editor's note: *For more information on QuickShare, DaynaFile, and MatchMaker, see "PCs and Macs Working Together" by Emil Flock in the May BYTE.*]

**Coprocessing**

If you need to run PC programs as well as access PC data on your Mac, consider adding PC coprocessing. You can choose either of two coprocessor boards from PerfectTek and AST Research, or you can select software from Insignia, which emulates MS-DOS on the Mac. Mac coprocessing is currently unavailable for the PC.

When comparing coprocessing options, look into the way each product emulates various PC video options (CGA, Hercules, and monochrome are available); how it allows for keyboard differences between the two machines; whether it can access DOS data files and programs from a PC floppy disk drive attached to the Mac; and whether MS-DOS files can share a Mac's hard disk drive. Further, check out how much memory this two-for-one approach eats up, and how performance compares to that of a stand-alone PC or AT.

Whatever system you use to exchange data between Macs and PCs, keep in mind that transferring data between the two machines may be only half the battle; files often need to be translated between Mac and PC application formats before they're usable. Luckily, the current trend is toward greater file compatibility between Mac and PC programs. For example, Microsoft's Excel can accommodate Lotus 1-2-3 spreadsheets, and Mac and PC versions of Excel,

## Products Mentioned

<p><b>DaynaFile</b>                  single-drive unit ..... \$650-\$850                  two-drive unit.....\$810-\$1205                  Dayna Communications, Inc.                  50 South Main St., Suite 530                  Salt Lake City, UT 84144                  (801) 531-0600  <b>Inquiry M182.</b></p> <p><b>Infinity I</b> ..... \$1095                  Peripheral Land                  47800 Westinghouse Dr.                  Fremont, CA 94538                  (415) 657-2211  <b>Inquiry M184.</b></p> <p><b>Mac + PC</b>                  for MacPlus ..... \$995                  for Mac SE ..... \$1095                  PerfectTek Corp.                  726 South Hillview Dr.                  Milpitas, CA 95035                  (408) 263-7757  <b>Inquiry M188.</b></p> <p><b>Mac286</b> ..... \$1499                  AST Research, Inc.                  2121 Alton Ave.                  Irvine, CA 92714                  (714) 863-1333  <b>Inquiry M186.</b></p>	<p><b>MacLink Plus</b> .....\$195                  DataViz, Inc.                  16 Winfield St.                  Norwalk, CT 06855                  (203) 866-4944  <b>Inquiry M180.</b></p> <p><b>MatchMaker</b> .....\$149                  Micro Solutions                  132 West Lincoln Hwy.                  DeKalb, IL 60115                  (815) 756-3411  <b>Inquiry M185.</b></p> <p><b>PC 5.25 Drive</b> .....\$528                  Apple Computer, Inc.                  20525 Mariani Ave.                  Cupertino, CA 95014                  (408) 996-1010  <b>Inquiry M183.</b></p> <p><b>QuickShare</b> .....\$465                  Compatible Systems Corp.                  P. O. Drawer 17220                  Boulder, CO 80308                  (303) 444-9532  <b>Inquiry M181.</b></p> <p><b>SoftPC</b> .....\$595                  Insignia Solutions, Inc.                  1255 Post St., Suite 625                  San Francisco, CA 94109                  (415) 885-4455  <b>Inquiry M187.</b></p>
---	--

Microsoft Word, and other applications are available. But many other programs still require file-translation software that may or may not be included with the data exchange option you choose.

*Cynthia W. Harriman of Portsmouth, New Hampshire, is the author of The MS-DOS—Mac Connection (Brady/Simon & Schuster, 1988). She can be reached on BIX as "editors."*

DECnet node emulation allows the Mac to function as an intelligent peer device and requires no special host software. Connection to the DECnet backbone requires an Ethernet interface card or Ethernet gateway. CommUnity software for MS-DOS computers and Sun workstations also provides connectivity with the Mac via DECnet.

A third option is to buy software, such as Alisa Systems' AlisaTalk, that lets a VAX operate as an AFP-compatible file server. A similar alternative is Pacer Software's PacerShare, which is an implementation of Appleshare for the VAX.

These packages let the Mac access VAX files and laser printers, and they are based on AppleTalk for VMS, a developer's tool that implements the AppleTalk protocol suite on the VAX.

Once Mac-to-VAX network links are set up, application-level communications can occur. One promising development in Mac-to-VAX communications is Network Innovations' CL/1, an SQL-based connectivity language that programmers can use to transparently link Mac and VAX databases. Mac databases that support CL/1 can automatically retrieve data from a VAX database. Access of re-

mote data is transparent to the user, to whom all transactions appear to be happening locally. An Apple subsidiary, Network Innovations plans to extend CL/1 to support other host computers in the future. A few Mac database programs, such as HyperCard, are already providing VAX links through CL/1.

**Mac to IBM Host**

The primary method of connecting the Mac to an IBM mainframe is through terminal emulation. Several configurations are possible (see figure 3). A co-

*continued*

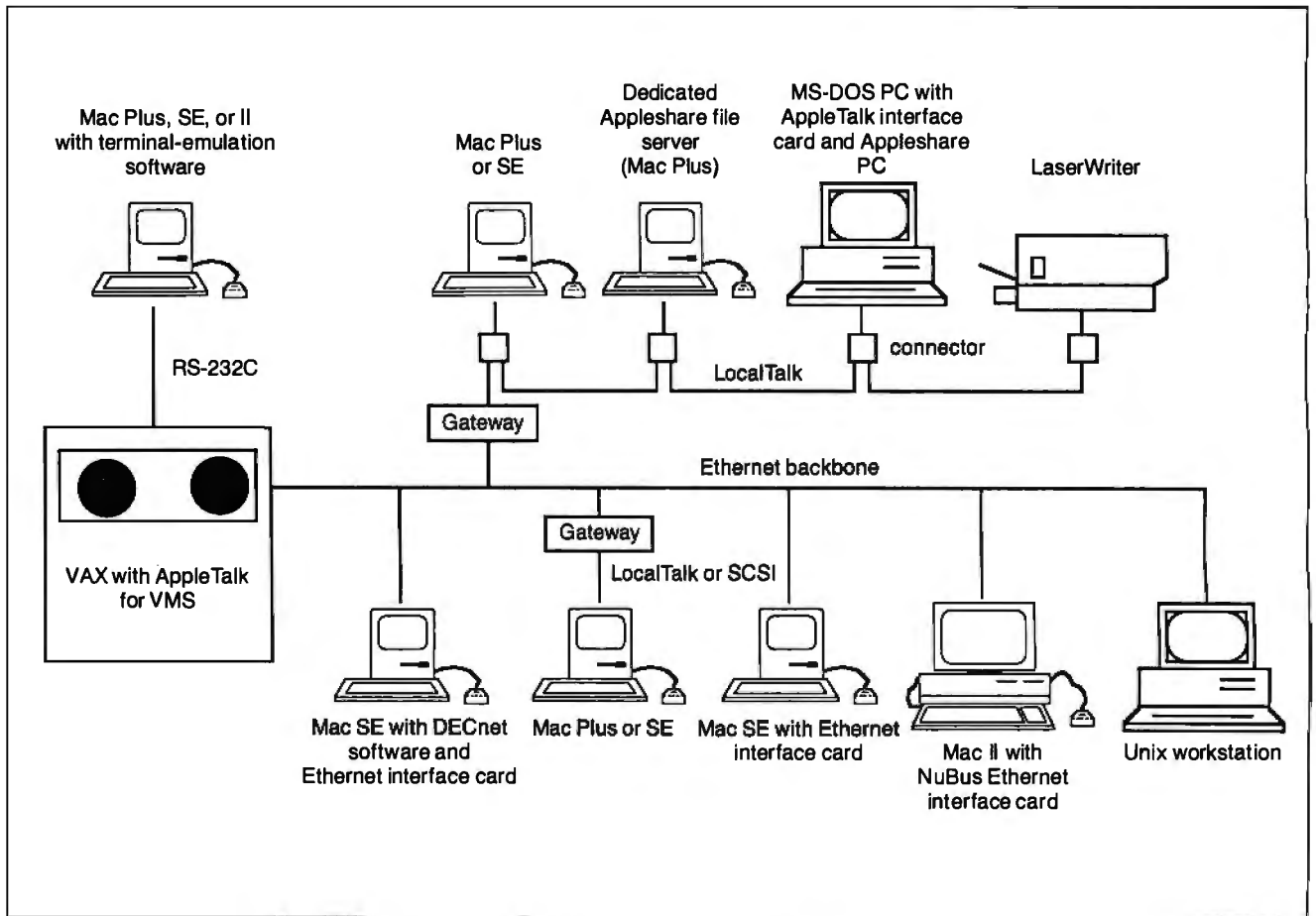

**Figure 2:** Macs connected to DECnet's Ethernet backbone can function as DECnet nodes, or the VAX can act as an AppleTalk file server.

axial cable can connect the Mac to an IBM 3174 cluster controller, which assembles terminal input into packets and forwards them to the mainframe.

A similar approach is to install an AppleTalk-to-IBM 3270 gateway such as Tri Data Systems' Netway 1000. The Netway acts like an IBM 3274 cluster controller to let multiple workstations on AppleTalk establish concurrent 3270 terminal-emulation sessions (Netway supports up to 16 simultaneous sessions). Most 3270 terminal-emulation packages also support file transfer, but the Mac is still a dumb terminal: It simply acts as a window to processes occurring on the host.

The third option is far more powerful. It's a peer-to-peer approach in which Mac applications support MacAPPC, a developer's tool that implements IBM's Advanced Peer-to-Peer Communications or Logical Unit (LU) 6.2 architecture on the Mac. Unlike terminal emulation, MacAPPC lets the Mac interact transparently as an intelligent node with any computer supporting LU 6.2.

In an APPC environment, the user may know nothing about the network and need not be aware of when a connection to the network or to another computer occurs. The application running on the Mac handles this automatically. Applications supporting MacAPPC operate on behalf of the user to transparently provide connection to the network.

MacAPPC comprises a set of APPC functions that reside on a Mac II acting as a nondedicated LU 6.2 gateway on AppleTalk. MacAPPC includes a 68000-based intelligent communications card installed in the Mac II, and an LU 6.2 server utility that supports LU 6.2/Node Type 2.1 functions and acts as the LU 6.2 gateway.

The system administrator controls the APPC gateway. Once activated, the gateway downloads all the LU 6.2 and Node Type 2.1 protocols onto the 68000 card, which distributes sessions over AppleTalk to Macs running special driver software. The Mac's Chooser lets you select from one or more LU 6.2 gateways on the network.

With the advent of MacAPPC, the stage is set for distributed processing between Macs and IBM mainframes. You'll have to wait for the development of applications that take advantage of this new platform, however.

### Mac to Others

Apple's push is in the areas of DEC and IBM connectivity; however, the Mac can link to many other systems, as well. For example, several methods are available for connecting Macs with Unix workstations and hosts. Here, the standard Macintosh operating system, which supports AppleTalk, requires a different approach than the A/UX Mac, Apple's Unix workstation. A/UX supports the Transmission Control Protocol/Internet Protocol (TCP/IP) and Sun Microsystems' Network Filing System (NFS)—the de facto network transport and file-sharing standards in the Unix environment (see "Unix and the Mac Interface" by Rick Daley on page 89).

Since the A/UX Mac supports NFS and TCP/IP, connecting to a Sun or other

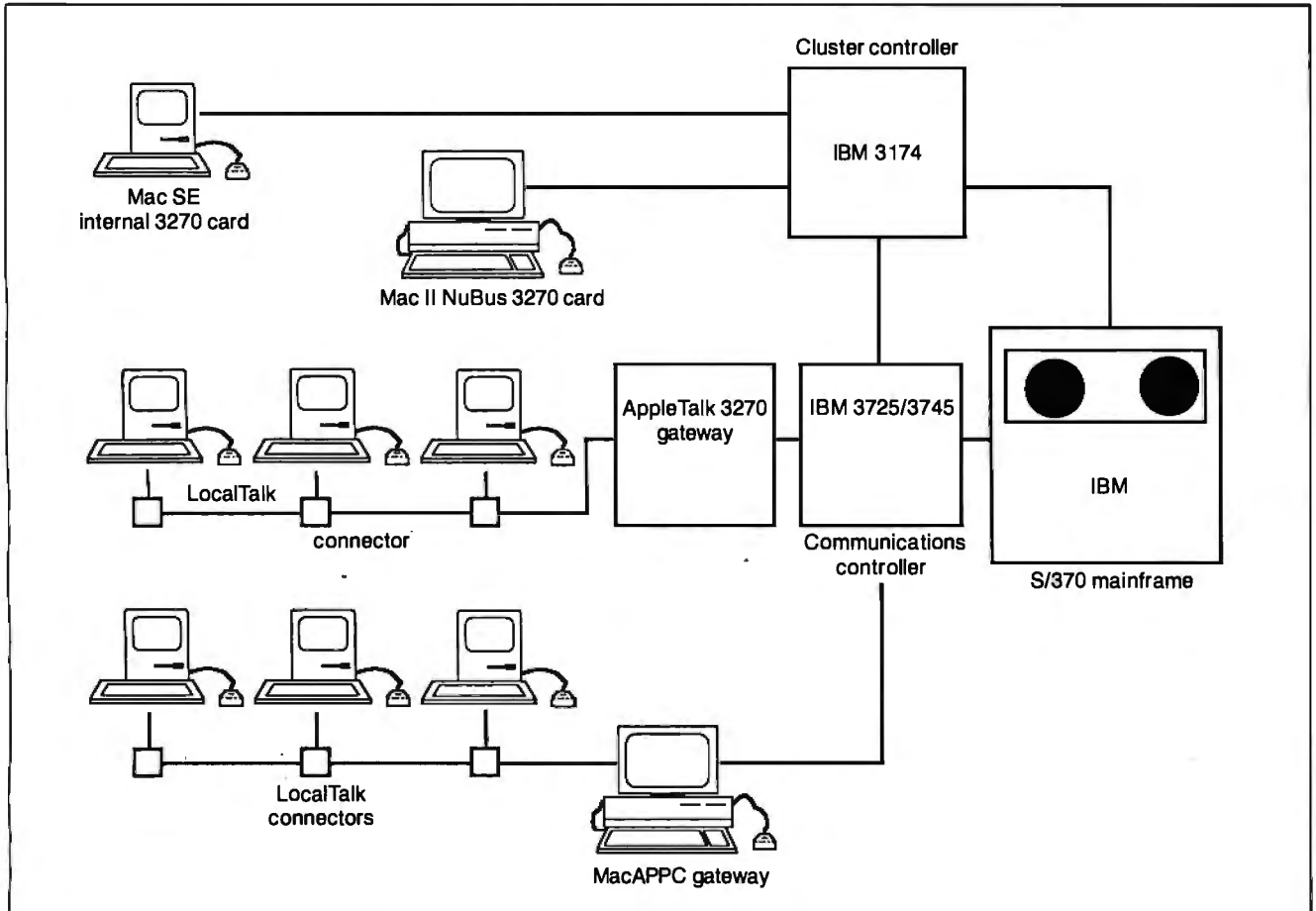

Figure 3: MacAPPC goes beyond 3270 terminal emulation and 3270 gateways to let the Mac act as an intelligent peer node on an IBM SNA network.

Unix workstation is simply a matter of buying an Ethernet interface card to establish the LAN connection. For the standard Mac operating system, TOPS/Sun workstation software lets a Sun workstation act as a TOPS network file server. Macs can access both PC and Sun files on the file server, and can indirectly access host files through an NFS network. The Sun workstation connection to the TOPS network requires an AppleTalk-to-Ethernet gateway.

Information Presentation Technologies offers even broader connectivity with Unix-based systems. Its product, uShare, connects Macs, A/UX Macs, PCs, and Apollo workstations, and it provides gateways between AppleTalk, Ethernet, and Apollo Domain token-ring networks. Macs can also take advantage of gateways between Apollo, DEC, and IBM environments.

The uShare software lets the A/UX Mac or an Apollo Unix-based workstation function as a nondedicated AppleShare-compatible file server on an AppleTalk LAN, or the Mac can emulate a

Unix workstation to access and run Unix applications. To the Mac, the Unix workstation appears as an ordinary AppleShare server. Connection is via an AppleTalk interface card in the Unix host or an Ethernet interface card in the Mac. Other services supported include E-mail, virtual disk, and print-spooling capabilities.

Beyond the Unix environment, links to other hosts are limited to terminal emulation. Packages are available to connect the Mac to Prime, Pyramid, Data General, Stratus, Tandem, Wang, Hewlett-Packard, and Cray hosts.

### Coming Attractions

In addition to supporting AppleTalk, Apple has stated its commitment to develop links to IBM's Systems Network Architecture (SNA), the OSI protocols, and the TCP/IP internetworking protocol suite. Apple has also committed itself to supporting the OS/2 environment, and the company is developing a Micro Channel-compatible AppleTalk interface card for PS/2s.

When it comes to support for internetworking, Apple is being pragmatic; it plans to support both OSI and TCP/IP. Apple already supports TCP/IP on the A/UX Mac and plans to support it under the Mac operating system. Regarding OSI protocols, Apple is also working on X.400 and X.25 gateways. An X.400 gateway would provide LocalTalk connectivity to other networks supporting the X.400 E-mail interchange standard. An X.25 gateway would provide a direct interface between AppleTalk and public packet-switched networks such as Tymnet. Support for token-ring LANs is also in the works. However, Apple has not announced when these products will be available.

Apple owns a minority stake in Touch Communications, an OSI software vendor that implements the full suite of OSI protocols in a variety of computing environments. Touch's OSI Mac Developer's Kit ports the OSI protocol stack to the Mac. Developers who write applications for Touch's OSI Mac can link them to

*continued*

# A Sampling of Mac Connectivity Products

## 3+ for the Mac

3+ for the Mac .....\$495  
 3+Share and 3+Server ..... \$7995  
*Extension of 3+Share network operating system that connects the Mac to 3Com's 3+Network*  
*Requirements: 3+Share, Ethernet interface card or LocalTalk, 3+Server*  
 3Com Corp.  
 3165 Kifer Rd.  
 Santa Clara, CA 95052  
 (408) 562-6400  
**Inquiry M152.**

**3+Mail for the Mac** .....\$595  
*Lets Mac send E-mail to other Macs or PCs over 3+Network*  
*Requirements: 3+Share, 3+ for the Mac*  
 3Com Corp.  
**Inquiry M153.**

**EtherLink/NB**.....\$595  
*Ethernet interface card*  
*Requirements: Mac II*  
 3Com Corp.  
**Inquiry M154.**

**AlisaTalk**..... \$4700 to \$14,400, depending on VAX CPU  
*Software lets DEC VAX function as AFP file server*  
*Requirements: AppleTalk/Ethernet gateway or Ethernet interface card*  
 Alisa Systems, Inc.  
 221 East Walnut St., Suite 175  
 Pasadena, CA 91101  
 (818) 792-9474  
**Inquiry M155.**

**TSSNet** .....\$495  
*DECnet terminal-emulation and file-transfer software for the Mac*  
*Requirements: AppleTalk/Ethernet gateway or Ethernet interface card*  
 Alisa Systems, Inc.  
**Inquiry M156.**

## MacMainframe

Mac II card .....\$995  
 Mac SE card .....\$795  
 External unit ..... \$1195  
*3270 terminal-emulation card*  
*Requirements: Mac 512Ke or higher (external unit)*  
 Avatar Technologies, Inc.  
 99 South St.  
 Hopkinton, MA 01748  
 (617) 435-6872  
**Inquiry M157.**

**Constellation III for the Mac**  
 Constellation III .....\$495  
 Mac network interface card.....\$249  
 20-megabyte Omnidrive ..... \$2795  
*Mac network operating system that runs on Omninet twisted-pair LAN*  
*Requirements: Omninet, Mac interface card, Omnidrive disk server*  
 Corvus Systems, Inc.  
 160 Great Oaks Blvd.  
 San Jose, CA 95119  
 (800) 426-7887  
**Inquiry M158.**

**MacIRMA** ..... \$1195  
*IRMA card for Mac 3278, 3279*  
*Requirements: Mac II or SE*  
 Digital Communications Associates  
 1000 Alderman Dr.  
 Alpharetta, GA 30201  
 (404) 442-4000  
**Inquiry M159.**

**FastNet**.....\$899 and up  
*Ethernet controller products for the Mac SE, Plus, and II (SCSI version also available); includes Technology Concepts, Inc.'s CommUnity-Mac software*  
*Requirements: Mac SE, Plus, or II*  
 Dove Computer Corp.  
 1200 North 23rd St.  
 Wilmington, NC 28405  
 (919) 763-7918  
**Inquiry M160.**

**InterBridge** .....\$799  
*Bridge device interconnects AppleTalk networks via remote or direct connection*  
*Requirements: Mac 512Ke or higher*  
 Hayes Microcomputer Products, Inc.  
 P.O. Box 105203  
 Atlanta, GA 30348  
 (404) 449-8791  
**Inquiry M161.**

## PhoneNet

Per Mac .....\$59.95  
 StarController ..... \$1695  
*Cabling system supports up to six AppleTalk nodes over twisted-pair.*  
*Optional StarController links up to 12 PhoneNets*  
*Requirements: None*  
 Farallon Computing, Inc.  
 2150 Kittredge St.  
 Berkeley, CA 94704  
 (415) 849-2331  
**Inquiry M162.**

**uShare**  
 Mac .....\$149  
 Host ..... \$395 to \$2995  
 AppleTalk interface card .....\$395  
*AFP-compatible file-server software for A/UX Mac II, Apollo, and other Unix machines. Supports AppleTalk, Ethernet, and Apollo Domain token-ring environments*  
*Requirements: Mac Plus, SE, or II; Unix to Appleshare connection requires AppleTalk/Ethernet gateway, Ethernet interface card, or AppleTalk Interface Card (for Unix hosts).*  
 Information Presentation Technologies, Inc.  
 23801 Calabasas Rd., Suite 2011  
 Calabasas, CA 91302  
 (818) 347-7791  
**Inquiry M163.**

**Liaison** .....\$295  
*Software bridge that interconnects LocalTalk networks via RS-232C or dial-up links. Liaison also connects LocalTalk and EtherTalk networks and lets remote Macs access AppleTalk or EtherTalk networks*  
*Requirements: Mac 512Ke or higher, RS-232C cable, or Hayes-compatible 1200-bps modem on each network*  
 Infosphere, Inc.  
 4730 Southwest Macadam Ave.  
 Portland, OR 97201  
 (503) 226-3515  
**Inquiry M164.**

**MacServe**.....\$250  
*Software converts Mac on AppleTalk to disk and print server; read-access file sharing only; runs in background mode*  
**Requirements:** AppleTalk  
 Infosphere, Inc.  
**Inquiry M165.**

**FastPath** ..... \$2495  
*AppleTalk to Ethernet gateway*  
**Requirements:** Mac 512Ke  
 Kinetics, Inc.  
 A Division of Excelan  
 2540 Camino Diablo  
 Walnut Creek, CA 94596  
 (415) 947-0998  
**Requirements:** Mac Plus or higher.  
**Inquiry M166.**

**EtherPort**  
 EtherPort II .....\$695  
 EtherPort SE.....\$695  
 SCSI connection..... \$1150 to \$1250  
 EtherPort SEL.....\$695  
*Network interface controllers for direct Mac-to-Ethernet connections. EtherPort II and SE are internal cards for the Mac SE and II. EtherSC is a stand-alone device that uses any Mac SCSI port. The SEL is an interface to Synoptics' Lattisnet*  
**Requirements:** Mac SE, Plus, or II  
 Kinetics, Inc.  
**Inquiry M167.**

**Series II, Series III Twinax**  
 Series II (multiport) ..... \$1495 to \$3495  
 Series III (single port)..... \$1195  
*Mac to IBM System 34, 36, and 38 protocol-conversion and file-transfer software*  
**Requirements:** Any Mac  
 KMW Systems Corp.  
 6034 West Courtyard Dr.  
 Austin, TX 78730  
 (512) 338-3000  
**Inquiry M168.**

**MacMenlo**.....\$395  
*Tandem 6520 and 653X terminal-emulation and file-transfer software*  
**Requirements:** Any Mac  
 Menlo Business Systems, Inc.  
 201 Main St.  
 Los Altos, CA 94022  
 (415) 948-7920  
**Inquiry M169.**

**PacerLink**..... \$2000 and up  
*Software performs terminal emulation, file transfer, and resource sharing between Mac and DEC VAX (VMS and Ultrix), Prime, Pyramid, Cray, and Stratus hosts. Connection is via Ethernet (AppleTalk/ Ethernet gateway or Ethernet interface card), RS-232C, or modem*  
**Requirements:** Mac 512Ke or higher  
 Pacer Software, Inc.  
 7911 Herschel Ave., Suite 402  
 La Jolla, CA 92037  
 (619) 454-0565  
**Inquiry M170.**

**PacerShare**..... \$400 and up  
*Turns VAX/VMS into an Appleshare file server and lets the Mac access VAX files*  
**Requirements:** PacerLink, Ethernet  
 Pacer Software, Inc.  
**Inquiry M171.**

**NetBridge**.....\$399  
*AppleTalk network device bridge*  
**Requirements:** Mac 512Ke or higher  
 Shiva Corp.  
 222 Third St., Suite 100  
 Cambridge, MA 02142  
 (617) 864-8500  
**Inquiry M172.**

**InBox**  
 Software for three Macs.....\$350  
 Each additional Mac .....\$125  
 Per PC .....\$195

*E-mail software for AppleTalk networks*  
**Requirements:** AppleTalk  
 Symantec Corp.  
 Think Technologies Division  
 135 South Rd.  
 Bedford, MA 01730  
 (800) 648-4465  
**Inquiry M173.**

**TangentShare Server** .....\$700  
*AFP file-server software for IBM PCs or PS/2s*  
**Requirements:** IBM PC or PS/2 with 512K bytes and a hard disk drive  
 Tangent Technologies, Ltd.  
 5990 K-Unity Dr.  
 Norcross, GA 30071  
 (404) 662-0366  
**Inquiry M174.**

**CommUnity-Mac**  
 Per license.....\$495 to \$350  
 Media/documentation fee .....\$200  
*DECnet-compatible software; includes VT-100 and VT-220 emulation*  
**Requirements:** Mac Plus, SE, or II  
 Technology Concepts, Inc.  
 A Bell Atlantic Co.  
 40 Tall Pine Dr.  
 Sudbury, MA 01776  
 (800) 777-2323  
 (617) 443-7311  
**Inquiry M175.**

**TOPS Terminal**.....\$189  
*Terminal-emulation software that links to any host supporting TCP/IP*  
**Requirements:** Mac 512K or higher,  
 AppleTalk/Ethernet gateway or Ethernet interface card  
 TOPS, a Sun Microsystems Co.  
 950 Marina Village Pkwy.  
 Alameda, CA 94501  
 (415) 769-9669  
**Inquiry M176.**

**Netway 1000** ..... \$3995  
*AppleTalk-to-3270 gateway device provides IBM 3270 terminal emulation and file transfer for up to 16 Macs*  
**Requirements:** Mac 512Ke or higher,  
 AppleTalk  
 Tri Data Systems, Inc.  
 1450 Kifer Rd.  
 Sunnyvale, CA 94086  
 (408) 746-2900  
**Inquiry M177.**

**Reflection 1 for the Mac** .....\$249  
*Hewlett-Packard 2392A terminal-emulation and file-transfer software*  
**Requirements:** Mac 512K or higher  
 Walker Richer & Quinn  
 2825 EastLake Ave. E  
 Seattle, WA 98102  
 (206) 324-0350  
**Inquiry M178.**

**Mac 240**.....\$199  
*DEC VT-100, VT-200, VT-220, VT-240 terminal-emulation software*  
**Requirements:** Mac 512Ke  
 White Pine Software, Inc.  
 94 Route 101A  
 Amherst, NH 03031  
 (603) 886-9050  
**Inquiry M179.**

# Apple's Macintosh Connectivity Products

## Network Interface Cards

### LocalTalk PC Card

AppleTalk interface card for the IBM PC that provides basic connectivity to a LocalTalk network; it lets the PC access a networked laser printer.  
Price: \$249

### EtherTalk Interface Card

An Ethernet interface card for the Mac II.  
Price: \$699

## Terminal Emulation

### AppleLine

A protocol converter that translates between AppleTalk and IBM 3270 protocols to establish Mac-to-IBM mainframe communications.  
Price: \$1295

### MacTerminal

Multifunction terminal-emulation software that lets a Mac emulate a DEC VT-52 or VT-100 terminal or an IBM 3278 Model 2 terminal when used with an AppleLine protocol converter.  
Price: \$125

### AppleLine 3270 File Transfer

Software that works with the AppleLine protocol converter to transfer files between the Mac and an IBM 3270 mainframe.  
Price: \$99

## Software Development

### AppleTalk for VMS

An implementation of AppleTalk that runs on a VAX.  
Price: \$5000 per site license

### CL/I

Database connectivity language from Apple subsidiary Network Innovations Corp. Mac database applications supporting CL/I can transparently access data in VAX databases.  
Price: \$3000 to \$23,750 per host

### MacAPPC

Hardware and software that lets Mac applications support IBM's Advanced Program-to-Program Communications architecture. APPC allows for distributed transaction processing between Macs and other computers supporting APPC. Available late 1988.  
Price: \$2500 per site license

### MacWorkstation

Software that lets minicomputer and mainframe host software developers create applications that support the Mac user interface.

Price: \$2500 per site license, \$5000 per developer's license

## LAN Software

### Appleshare

Apple's file-server software that runs on a Mac Plus. The Mac Plus becomes a dedicated file server.

Price: \$799

### Appleshare PrintSpooler

Print-spooler software that runs on Appleshare.

Price: \$299

### Appleshare PC

Software that lets PCs participate on an Appleshare file server. It requires an AppleTalk interface card.

Price: \$149

### Interpol

Network-management utility; troubleshooting and fault isolation.

Price: \$99

DEC VAX and IBM PC environments through Touch's OSI implementations for those systems.

Another promising development is Apple's MacWorkstation, which lets host software developers and programmers build a Mac user interface into host-based applications. MacWorkstation goes a step beyond terminal emulation in that it gives host applications access to the Mac interface without requiring host processing time. In addition, MacWorkstation "Exec" software modules let programmers migrate some host-processing tasks to the Mac.

One benefit of MacWorkstation is that it makes network use more efficient. By allowing MacWorkstation to handle the user interface, Apple claims that some beta users have reduced network traffic by 75 percent. MacWorkstation will run

over a variety of connections, including AppleTalk, Ethernet, serial, and IBM SNA networks.

## What's Missing

Ultimately, to have a complete range of networking capabilities for the Mac, companies such as Apple, DEC, IBM, and others must agree on ways to make their systems work together. Progress toward this goal is being made through Apple's joint development project with DEC and through commitments to OSI and to providing links to IBM's SNA. However, to a large extent, Apple depends on other companies to provide connectivity products for the Mac.

Apple plans to meet with many of these companies to present a complete set of specifications and interfaces for which developers will be invited to build prod-

ucts. The point, as Apple's Cagle puts it, is to develop products that go beyond simply allowing the Mac to emulate dumb terminals. "Are we doing anything more useful than would be done by putting a dumb terminal on a desk?" Cagle asks. "If not, for the same amount of money [that you'd spend on a Mac], you can get several dumb terminals."

Developers need to do more than just provide a window to the mainframe, Cagle says. "Electronic mail is a beginning, but there are a lot of vertical applications that are very important. We intend to be more focused from the perspective of the user's needs." ■

Janet J. Barron is a technical editor and Robert L. Mitchell is an associate technical editor for BYTE. They can be reached on BIX as "neural" and "r.mitchell."

## THE WELL-CONNECTED MAC

## Glossary

### AFP

*AppleTalk Filing Protocol allows file sharing to take place by controlling file access on an AppleTalk network.*

### APPC

*Advanced Program-to-Program Communications, also known as Logical Unit (LU) 6.2, is IBM's SNA session protocol. In an SNA network, APPC allows direct, peer-to-peer communications between applications, eliminating the need for a host to act as an intermediary.*

### AppleTalk

*Apple's proprietary communications architecture for the Mac. AppleTalk's seven-layer structure is similar to that of the OSI Reference Model (see the text box "Overview of AppleTalk," on page 164 of the July 1987 BYTE).*

### Bridge

*A device that interconnects similar local-area networks, such as two AppleTalk LANs. Both LANs must share a common addressing scheme. No protocol conversion is necessary.*

### CSMA/CD

*Collision Sense Multiple Access with Collision Detection. LAN access protocol used in Ethernet and the IBM PC Network. Nodes listen to the bus and wait until the network is quiet before transmitting. When two nodes attempt to transmit simultaneously, each detects the resulting collision and waits a random time interval before attempting to retransmit (see the text box "IEEE 802 LAN Standards," on page 150 in the July 1987 BYTE).*

### CSMA/CA

*Collision Sense Multiple Access with Collision Avoidance. Network access scheme used in AppleTalk's link access protocol. As with CSMA/CD, the node waits until the bus is quiet before attempting to transmit, but rather than detecting collisions, CSMA/CA attempts to minimize their occurrence by using request-to-send and clear-to-send packets before sending data (see the text box "Overview of AppleTalk," on page 164 in the July 1987 BYTE).*

### Gateway

*An intelligent device that interconnects dissimilar networks; it performs necessary protocol conversion to allow communication between both environments.*

### LocalTalk

*The physical network components and link-level protocols for sending data across an AppleTalk network. These protocols are built into the Mac and can run over shielded twisted-pair or telephone wire at 230.4 kbps.*

### LU 6.2

*See APPC.*

### Node Type 2.1

*Also called Physical Unit 2.1. IBM SNA network-node specification that allows direct physical links between peer nodes. Previously, SNA specified a master/slave relationship in which two nodes couldn't establish a session without going through a mainframe.*

### SDLC

*Synchronous Data Link Control. Link-level protocol that forms the foundation of IBM's SNA.*

### SNA

*Systems Network Architecture. IBM's communications architecture that defines physical connections, protocols, and procedures for all IBM computers and devices.*

### TCP/IP

*Transmission Control Protocol/Internet Protocol. A set of internetworking protocols originally developed by the Department of Defense for ARPANET; now an industry standard.*

### X.400

*International standard for E-mail exchange specified by the CCITT.*

## YOUR MACINTOSH™ CAN READ BAR CODES & MAGNETIC STRIPES



## with TPS ELECTRONICS' WEDGE READERS

- Connects on ADB or in series with keyboard cable
- Does not affect keyboard operation
- No additional port needed
- No card slot needed
- No extra software needed
- Completely transparent to any program; looks like keyboard input
- Most formats available
- Also available:
  - Bar code printing software
  - Magnetic encoders
  - Portable bar code readers
  - Readers for other micros and terminals

### TPS ELECTRONICS

4047 Transport Street  
Palo Alto, CA 94303

415-856-6833

Telex: (Graphnet)

371 9097 TPS PLA

FAX: 415-856-3843

# 120 MINUTES OF SPAGHETTI WESTERNS. OR 80 MEGABYTES OF BACKED-UP DATA.



Did you ever dream that you could record data as well as movies on an ordinary, inexpensive videocassette? That, after the shoot-em-ups leave you laughing, a head crash doesn't have to leave you crying?

Pinch yourself. And start keeping those precious megabytes safe and sound with the newest version of our ingenious Videotrax<sup>®</sup> system. Now featuring a controller and software for the Macintosh<sup>™</sup> Plus, Macintosh SE, or Macintosh II computer.

The system utilizes our enhanced Videotrax VCR—or any old VCR for that matter—to back up data on standard VHS or Beta cassettes. Hooks up to your Mac's SCSI port with standard cables. And—by reason of exhaustive

testing, self-monitoring, and the long-term experience of tens of thousands of microcomputer users—is more reliable than any other backup option. Not to mention easier.

Because a VCR, you already understand. And our pull-down menus tell you everything else you need to know. How to copy or restore an entire hard disk, specific files, or just the files that have been

added or changed since the last backup.

Could anything be simpler?

As a matter of fact, yes. With our “smart” Videotrax VCR, everything happens automatically.

You can see it for yourself by visiting your nearest Videotrax dealer. And you can get the name of your nearest dealer by calling 800-992-9779 (in California, 800-821-0612).

We strongly suggest you do that.

Because if your data means anything to you, acquiring Videotrax protection is a thought you should definitely entertain.

**VIDEOTRAX**  
DATA BACKUP FROM  
**alpha micro**



Corporate Headquarters: 3501 Sunflower, P.O. Box 25059, Santa Ana, CA 92709. ©1988 Alpha Microsystems. All rights reserved. Videotrax is a registered trademark of Alpha Microsystems. Macintosh is a trademark of Apple Computer, Inc.

For a demonstration of Videotrax see us at Booth #636.



# HyperCard

## What Is It?

Brian L. Dear

*Sometimes a word  
is worth a  
thousand pictures*

Finally, the Macintosh has a friendly environment for programmers. HyperCard has been called a hypertext system, a relational database manager, a game, and an "information handler." Despite all proclamations, however, it's none of these; rather, it's a tool for developing any and all of them. Undeniably, it's a fun way to work, but what exactly is it, and why the fuss? HyperCard is an *authoring system*, and it is significant because it is the first authoring system to reach the general public.

Classifying HyperCard as an authoring system opens the door to all the issues, implications, and problems that have come to be associated with such systems. For example, one of the strongest temptations for an author is to overuse available special effects: too many colors or fonts, too much text, too many graphics, too much audio. Much of the stackware currently available for HyperCard suffers from these kinds of problems. Perhaps, if we understand what is already known about authoring, we can lessen the likelihood of repeating history.

### Authoring Systems

An authoring system is an integrated software toolkit used to create interactive applications that communicate knowledge. Typically, the goal of these applications is to impart knowledge, and the purpose behind using them is to *learn*. In computer-based learning applications, for example, this knowledge falls into a particular academic or training domain: The application takes the role of tutor; the user takes the role of student. Increasingly, authoring systems have been used to develop other kinds of applications as well. With an authoring system like HyperCard, the knowledge is likely to be of a more practical nature, such as name and address lists, appointment calendars, and travel and business information.

Authoring systems are not new. There is an old and well-established authoring

community, whose scope, historically, hasn't spread much beyond the bounds of educational institutions. Authoring systems originated out of a need to generate large amounts of computer-based learning materials, or courseware, in a shorter period of time than it would take with a traditional programming language.

Educators have many long-standing reasons for favoring authoring systems over more traditional programming languages. Key among them is the emphasis on interactivity, or give and take, with the machine. In computer-based learning situations, it's crucial that the computer actively stimulate and involve the student. Stimulation requires a wisely chosen blend of outputs—graphics, text, and, when appropriate, color, audio, and video. Involvement requires the same wise selection of available inputs—keyboard, mouse, touch-sensitive screen, digitizing pad, speech, and so on.

Good courseware is, by definition, highly interactive. A good authoring system typically features a variety of tools, providing a rich assortment of possibilities for stimulating and involving the student. While the number and sophistication of these tools varies greatly from system to system, experienced authors agree on the "essential" ingredients.

- *Branching.* An authoring system must support direct, conditional, and user-controlled movement through the application.
- *Creating, storing, and displaying bit-mapped graphics.* For most applications,

you need a resolution of at least 512 by 350 pixels; the system should support such resolutions.

- *Response analysis.* Since interactivity is the key to success in an authoring system, it should support a powerful set of string functions to examine a user's input and match it against a list of correct alternatives. The system should also check for correct spellings and let you set a *threshold* level for misspellings; that is, it should accept minor misspellings if you wish.

- *Audio and video support.* The system should support the software routines required to control random-access audio and videodisk devices.

- *Multiple levels of authoring.* Because expertise varies greatly from author to author, the system must be able to support a range of authoring skills. The lowest level is typically menu-driven and the easiest to use. A more experienced author would probably access a higher level, which should include an editor for writing source code in an authoring language.

- *Standard programming features.* The authoring language should support the constructs found in a standard programming language, such as IF...THEN...ELSE, REPEAT...UNTIL, FOR...NEXT, and so on.

- *File manipulation.* The authoring system should support the necessary tools to manipulate (e.g., create, read, write, and destroy) files; in other words, it should support database management.

- *Other language support.* You should be able to write your own routines in a general-purpose language, like Pascal, C, or assembly language, and include them in the authoring language.

### Strengths and Weaknesses

When you need to develop a highly interactive application, an authoring system is probably your best bet. A good authoring system often turns out to be especially

*continued*

amenable to developing materials that have nothing to do with education. Over the years, many people have discovered that such a system proved to be just the right tool for creating presentation programs or developing games (except for those that require assembly language, such as arcade games). Authoring systems save time because you don't need to program a specific set of response-analysis, display, and branching routines for each application. These functions are built in and usually much more flexible than those available in a traditional language library.

On the other hand, applications developed with an authoring system almost always run more slowly than their traditional counterparts. Sometimes the increased flexibility is worth the cost in speed and efficiency, but it's a choice you have to make. Applications developed with an authoring system are also likely to consume more disk space and memory, due to the larger overhead required. HyperCard, for instance, requires a great deal of overhead to keep track of cards, buttons, and scripts.

### Three Ways of Seeing

The Macintosh interface is based on solid psychological theory that can be traced to the work of psychologist Jerome Bruner and his colleagues. In Bruner's book *Toward a Theory of Instruction* (Cambridge: Harvard University Press, 1966), he identified three types of mental representation: enactive, iconic, and symbolic.

The first, *enactive* representation, involves how we remember action, movement, and coordination—the “psychomotor” skills. Learning the latest dance, how to swing a baseball bat, or how to operate a stick shift, we represent these skills enactively. When we want to “tear off” HyperCard's Tools menu, we call upon enactive representations of various actions with the mouse: clicking, dragging, and releasing.

The second type of mental representation is *iconic*; it refers to the mental summarization of visual and other sensory stimuli. We call on iconic representations to fill in, complete, or extrapolate. Icons and bit-mapped graphics are two examples of the Macintosh's heavy use of iconic representation.

The highest levels of abstraction involve the third type, *symbolic* representation: This refers to words and language. When we name a card in a HyperCard stack, write a HyperTalk script, or say the word HyperCard itself, we are using symbolic representations.

## M any nonprogrammers are quickly becoming HyperTalk experts.

The Macintosh is considered a user-friendly machine because it appeals to all three forms of mental representation. It's easy to learn, and its software is easy to use because of the heavy dose of enactive and iconic representation, forms we are most likely to resort to when learning something new. The success of the Macintosh user interface is largely due to its rich mix and constant cycling of the enactive, iconic, and symbolic.

In contrast, we could classify IBM PC software—dBASE III, WordStar, and the command-line style of MS-DOS itself, for example—as more symbolic than Mac software. One theory might be that preference for a Mac over an IBM PC or vice versa is due at least in part to how comfortable you are with heavily symbolic representation.

Recent software developments reveal some intriguing trends. The IBM PC world is paying more and more attention to enactive and iconic representations: Witness Microsoft Windows, Excel, and OS/2. The Macintosh world, on the other hand, is now adding more symbolic kinds of representation to its repertoire: Consider A/UX, Apple's implementation of Unix.

HyperCard takes advantage of the various capabilities of the Macintosh interface. It resides in the Mac's very flexible operating environment, whose design is sensitive to all three modes of mental representation. HyperCard incorporates highly advanced concepts in computer science, many of which originated in the research on object-oriented programming environments such as SmallTalk. Many people who have never programmed before are quickly becoming experts in HyperTalk and stack development because of its ingenious *context*. Everyone knows what a button is.

Older authoring systems, especially those on time-shared minicomputers or mainframes, were limited in their ability to meet an author's demands. The speeds at which you could display text, graphics, and animated sequences on older hard-

ware had a great impact on the possibilities available. In a way, this was a blessing, because the limitations forced you to consider your options more carefully.

As these hardware and software limitations disappear, the range of options widens tremendously. HyperCard is merely a hint of the future for authoring systems. But as the range of options expands, we will have to be increasingly careful with our designs.

### Creating Stacks

Stack developers need to be especially careful in designing stacks. There is a strong temptation to overdo it and get carried away with all the options available. Designing and developing interactive computer applications is an exciting and engrossing task, but it requires restraint, temperance, and constant consideration of the user for whom the stack is intended. Here are some points for you to consider, based on lessons learned by authors of computer-based learning materials.

- *The right tool.* Is HyperCard the right tool for the job? Or would a conventional Macintosh programming language be more appropriate for this application? HyperCard isn't the solution to every problem.
- *Time.* How much time do you have to develop the stack? Applications take time, and you're just as likely to find bugs in your HyperTalk scripts as you are in a C or Pascal program. The authoring process is very similar to the life cycle of creating any programming product; good programs require constant testing and refinement.
- *Goals.* Why are you using HyperCard? What do you hope to achieve? Does your goal meet the user's needs; for example, will it increase the user's productivity?
- *Usefulness.* Will the stack serve some genuinely useful purpose? Or are you writing it simply as an exercise, as programming practice? Experienced authors always ask, “Why does this application need to be on-line?” You should make a list of all the reasons why it should be on-line and compare it to one showing all the reasons it would work fine off-line—in print, for instance.
- *Audience.* Who will be using the stack? Is it for personal use, or do you plan to sell it commercially or offer it as shareware? Even if it's just for your own use, you should be sensitive to how its design appeals to the three levels of mental representation. Pictures get old fast. Sometimes, as Bruner said, a word is

*continued*

# Low prices, great service

## Hard Drives

### CMS Mac Stack SD Series

(Mac Plus, SE, II)

SD 20 Megabyte	\$549
SD 30 Megabyte	\$649
SD 43 Megabyte	\$789
SD 60 Megabyte	\$825
SD 80 Megabyte	\$1249
SD 102 Megabyte	\$1289
SD 140 Megabyte	\$1389

### CMS Pro Series Internal Mac SE/II

20 Megabyte SE rear	\$489
30 Megabyte SE rear	\$529
45 Megabyte SE rear	\$689
43 Megabyte Mac II	\$645
60 Megabyte Mac II	\$699
80 Megabyte Mac II	\$1145
100 Megabyte SE rear	\$1489
102 Megabyte Mac II	\$1189
140 Megabyte Mac II	\$1389
150 Megabyte Mac II	\$1879
300 Megabyte Mac II	\$2799

## Everex

External 20D	\$509
External 40D	\$929
91D (II, SE, Plus only)	\$1445

## Zero Footprint

20 DLX	\$575
40 DLX	\$989
91 DLX	\$1549
40/60 DTL	\$1795

## Everex Internal for Mac II

20 ID	\$445
40 ID	\$845
91 ID	\$1395

## Tape Back-up

### Everex 60 Megabyte External

60T	\$895
-----	-------

### CMS 60 Megabyte External

TS-60	\$729
-------	-------

### 800K External

Disk Drive	\$175
------------	-------

## Epson Printers

FX-86e, FX-286e, LQ-500, LQ-850  
LQ-1050, LQ-2500, Call for prices

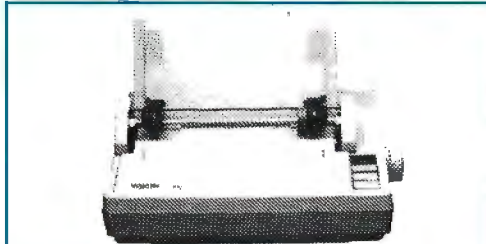

### Epson LX-800

9 pin, 180 cps	\$199
Grappler C/Mac	\$65

### Epson LQ-500

24 pin, 180 cps	\$369
Grappler LQ	\$79

## General Computer

PLP Laser	\$1598
-----------	--------

## Hewlett Packard

DeskJet	\$728
---------	-------

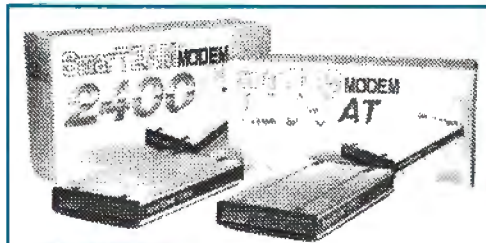

### SmarTeam

External 1200	\$149
External 2400	\$229

## Beverly Hills

External 1200	\$99
External 2400	\$189

## Everex

2400 with cable	\$229
-----------------	-------

## Migent

Pocket Modem	\$115
--------------	-------

## DCA

Mac Irma-Mac II or SE	\$795
-----------------------	-------

## SE Silencer

Ultra quiet internal fan Keeps it cool & quiet	\$39
--	------



## SHIPPING

All items in stock will ship in 24 hours. We offer daily service from Federal Express, UPS, U.S. Postal Service. UPS ground shipments, please add 50¢ per pound. UPS Air shipments, please add 1¢ per pound. Minimum shipping and handling charge \$4.00.

## Dove Computer

MacSnap Tool Kit	\$15
MacSnap 524	\$170
MacSnap 524S	\$215
MacSnap 548	\$395
MacSnap 548S	\$450
Mach II/SE Accelerator	\$589

## Co-Processor

68881	\$295
-------	-------

## Call for SIMM prices

## Data Desk Keyboard

101-key layout, 15 Function keys, separate numeric and cursor pads, positive Tactile feel . . . \$139

## Accessories

### Mouse Systems

A+ Mouse	\$65
A+ ADB Mouse	\$79

### Dust Covers

Mac+/SE	\$14
Mac Keyboards (specify type)	\$9
Mac II CPU only	\$10
Mac II with mono monitor	\$19
Mac II with color monitor	\$19
Apple Laserwriter	\$23
Apple Imagewriter	\$9
Apple Imagewriter LQ	\$12

### Carrying Cases

CM7 Tall Bag for extended keyboard	\$75
CM6 for standard +/SE keyboard	\$69

### Kensington Microware

System Saver	\$63
System Saver SE	\$52
Tilt & Swivel	\$22
Superbase	\$33
Masterpiece Mac II	\$105
System Stand Mac II	\$19
Printer Stand	\$15
Mouse Pad	\$8

### Aldus

Pagemaker	\$395
-----------	-------

Please call for competitive system pricing.

## OUR POLICY

- Plain and simple. Hardware: your satisfaction guaranteed or your money back.
- Software: defective software will be replaced immediately. Manufacturers policies prohibit us from offering refunds on opened software.
- We accept most major credit cards with no surcharge added.
- Your credit card is not charged until we ship.
- Please allow 10 days for personal and company checks to clear.
- C.O.D. orders accepted.
- We gladly accept purchase orders from most major institutions.
- California, Texas and Georgia residents please add the appropriate local sales tax.
- To place orders call Monday thru Friday 7AM to 6PM P S T
- Prices and Availability subject to change



Computer professionals since 1975.

# 1-800-426-8166

From Beverly Hills Fax Machine  
(213) 273-3710 (213) 675-2522

279 South Beverly Drive, Suite 1200, Beverly Hills, California 90212



worth a thousand pictures. If you're designing the stack for many users, then you need to be extra sensitive to the broad range of user preferences.

For example, suppose you're designing a personal financial-planner stack that ends with a simple electronic check-book. Which would be better for its users: making them use the mouse to click on a bunch of buttons in a fancy graphic representation of a calculator (emphasis on the enactive and iconic), making them type their arithmetic expression into the HyperCard message box (emphasis on the symbolic), or giving them the option to do either?

• **Sound.** The Macintosh can generate fairly decent digitized and synthesized sound. You should use sound resources with restraint. Ask yourself whether the stack's users will really benefit from those digitized audio clips of Captain Kirk's voice.

• **Title pages.** Do you really need one? How often do you expect users to access

the stack? Will they use it all the time, or only once in a great while? Most software packages deliberately lack a title page. Consider what the users really get out of looking at your title page every time they enter the stack.

• **Shadowing.** Shadowing two adjacent sides of a box may indeed enhance the three-dimensional illusion. But are you trying to highlight the box, or the information in the box? If you're only shadowing for aesthetics, you may be better off without it.

• **Fonts.** Using too many different fonts is almost always worse than using just a few. If the design calls for using unusual fonts in a stack intended for other users, remember that many users may not have your font files on their systems; if you use them, you may have to include them as resource files in your stack.

• **Foreground vs. background.** A relatively recent feature of authoring systems is the ability to designate some portions of the screen as foreground and others as

background. Sharing the same background among a sequence of cards reduces both the amount of new information on the screen and the amount of storage required for the stack.

• **Visual effects.** One of HyperCard's more interesting—and fun—features is its collection of visual effects. When designing your application, however, be careful about using them. Effects like barn door, iris, dissolve, and venetian blind may be stimulating and attention-getting, but they may also be distracting. An application that uses a lot of visual effects tends to call attention to itself; in other words, too many or too complex visual effects can make what should usually be a transparent interface all too apparent.

• **Degree of realism.** If there's one thing authors of computer-based learning materials face every day, it's the balance between realism and practicality. How realistic do graphics have to be to get the point across? Unfortunately, many Mac-

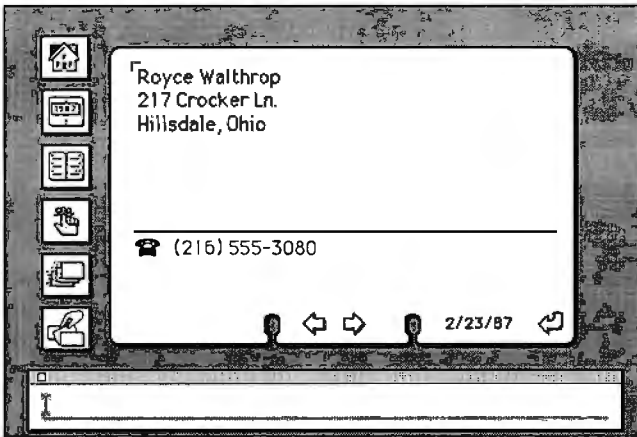

Figure 1: Do the Rolodex card-file notches really add to the understanding of the information in this stack?

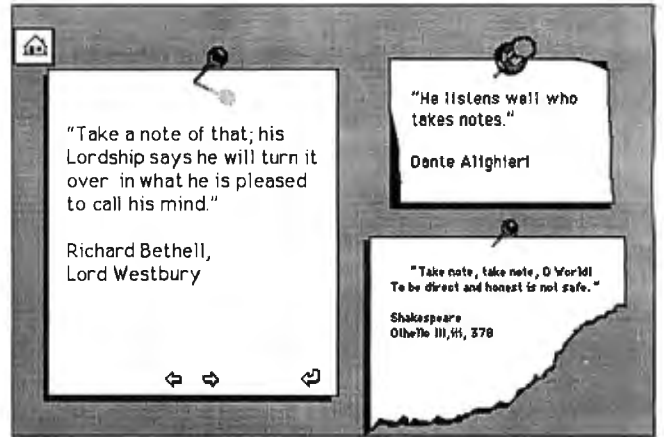

Figure 2: Torn scraps of paper and memo pins look realistic, but what purpose do they serve on a computer screen?

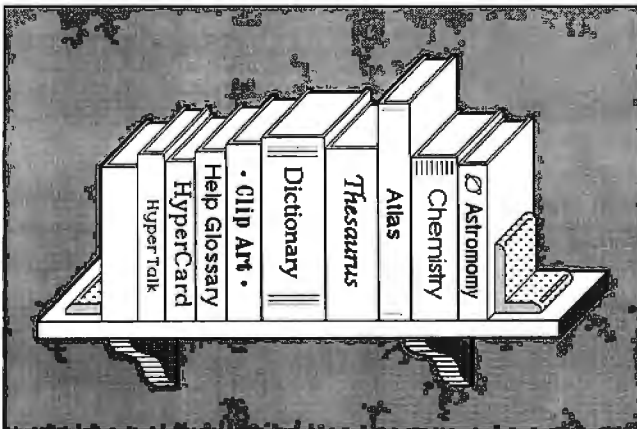

Figure 3: The books make a pretty menu, but is it an appropriate user interface?

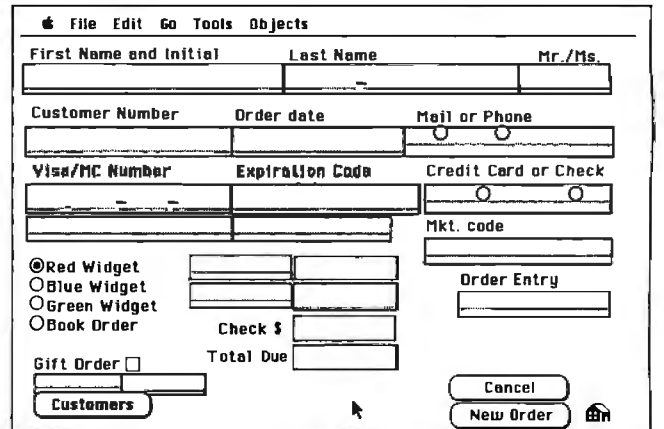

Figure 4: Forms like these may work fine on paper, but online they impede the user's productivity.

intosh developers can't resist the temptation to over-simulate physical reality: In effect, they try to make hardware out of software.

Stackware developers need to ask themselves these kinds of questions over and over again: Do I really need that pretty, digitized image of a telephone? Will the users really benefit from pictures of Rolodex cards so faithful to the real thing that even the card's notches are present? Real Rolodex cards have those two notches for a reason. Think long and hard before putting them on-line. Remember, in stackware (as in courseware), graphics gobble up disk space fast. Consider the degree to which your HyperCard displays facilitate or impede the user's abilities to mentally process what you have presented (see figures 1, 2, and 3).

• **Forms.** When designing fill-in-the-blank forms on a computer display, first consider how faithful the form must be to its paper equivalent. Some forms, like the 1040 tax form, work well when faithfully transferred on-line. Users are quite familiar with the paper versions of the 1040 forms; thus, a faithful computer rendition is important. But most paper forms demand a better design when put on-line. Remember that paper forms are designed primarily for the benefit of the clerk who must read them. Since on-line forms eliminate that drudgery, the design of such forms should consider its users (see figure 4).

### A New Standard

In its short lifetime, HyperCard has become the standard against which all others must now compete. Its ease of use and intuitive interface have captured the imagination and boosted the confidence of many novice programmers.

But we must remember that HyperCard is the latest in a long line of authoring systems. Many lessons have been learned over the years, and stackware developers should strive to consider the issues, both good and bad, that authoring systems raise. With an understanding of the design principles of authoring systems, we are less likely to make the same mistakes again. ■

#### ACKNOWLEDGMENT

*I am grateful to Apple Fellow Alan C. Kay for a discussion of Bruner's theory and the Macintosh.*

*Brian L. Dear is director of product development at Coconut Computing, Inc., in San Diego, California. He can be reached on BIX as "whofan."*

# HyperCard

## How Does It Work?

Laurence H. Loeb

*Make it work  
the way  
you want it to*

What I remember most from the Boston MacExpo in August 1987 is Bill Atkinson's smile as he showed off HyperCard's tear-off menus for the first time. He waited as the implications of using tear-offs started to percolate through the room. As more and more people started to comprehend what their eyes were telling them, Bill broke out into this great, loopy grin that said, "Isn't it nice to have something work the way you want it to?"

This new tool forced me to do some serious questioning about how I'd been using the Macintosh in my dental business. I had been using several discrete programs to do the business functions, in a manner that had remained basically the same since 1984. I generated information for each patient with a database and a word processor, and I used the Finder to sort by date for accounts receivable. A simple system, true, but it worked.

I had tried to make an electronic patient chart with MacPaint. While I could save the graphical information I needed, I hadn't used it very much. I needed different kinds of information while I was working, not just graphics; I needed the text as well. Moreover, I didn't want to have to reenter data I already had in electronic form. I needed the maximum return for each input.

HyperCard lets me combine graphics with text—it's MacPaint with buttons that do things. (I use a mouse better than a keyboard when I have gloves on, anyway.) A HyperChart can bring up detailed areas of interest without a fixed sequence. That's the point of the navigation

features: to let HyperCard keep track of where you've been. It does housekeeping—and windows, to boot. They're called cards, but you can do things with them that are "windowlike."

The patient chart is a common denominator in dental treatment: It's a graphical record that's pretty standard in content. Specific implementations of it may vary, but the information tends to be similar. If I could devise a way to present this record on a Mac's screen, I could refer to it, as I do to paper records, during treatment. And while I was at it, I thought I'd make it user-extensible; that is, if I wanted to change the symbols I used to mean various kinds of treatments, or add new ones, I could—without a major effort.

### Customizing with HyperCard

HyperCard gives me the paint tools that let me customize an application any way I see fit—and they're built in. I don't need any complicated calling sequences. Eventually, I used the background of a card the same way I had used the MacPaint document earlier; that is, the background contains the basic graphical information I need on all charts (see figure 1). I can then overlay whatever symbols I want on top of this, ending up with a graphical record that is the equivalent of a drawing on a preprinted form (see figure 2). If I need a reminder about something specific, I can attach a Post-it note at the touch of a button (see figure 3). More "paper simulation," sure, but that's what I'm comfortable with.

After deciding on the basic paradigm, I had to decide how the stack should "flow." In this application, I need to move from the general to the specific—from the basic chart to a specific tooth. And what simpler way to get there than to click over its position on the chart? HyperCard lets me do this with a "transparent" background button—one that a patient-information card can inherit. If I click on the button, it tries to do what its

*continued*

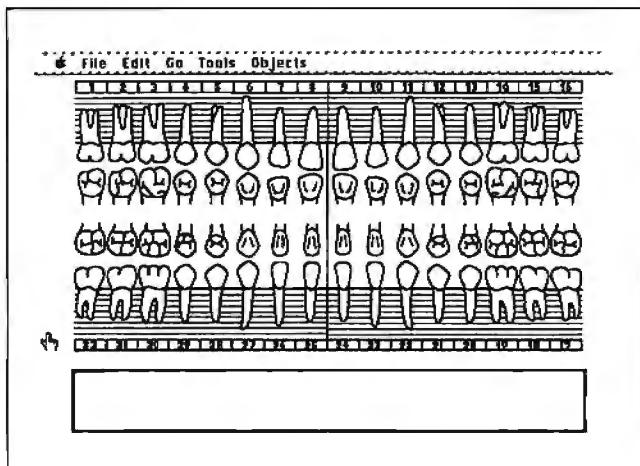

Figure 1: The basic graphical information needed for a dental chart.

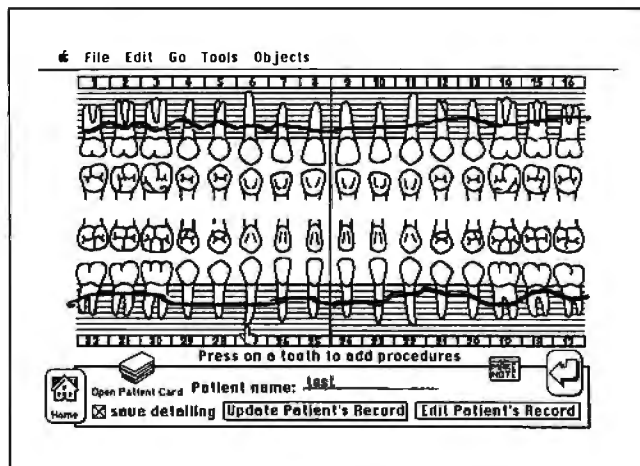

Figure 2: This chart contains bone-level information drawn with a brush tool.

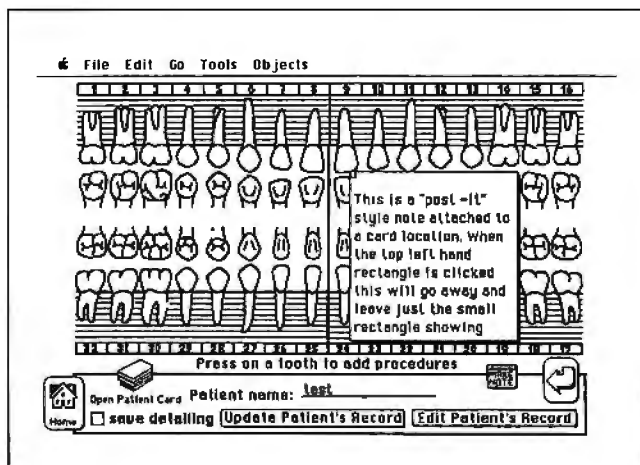

Figure 3: A Post-it note serves to remind me of anything unusual.

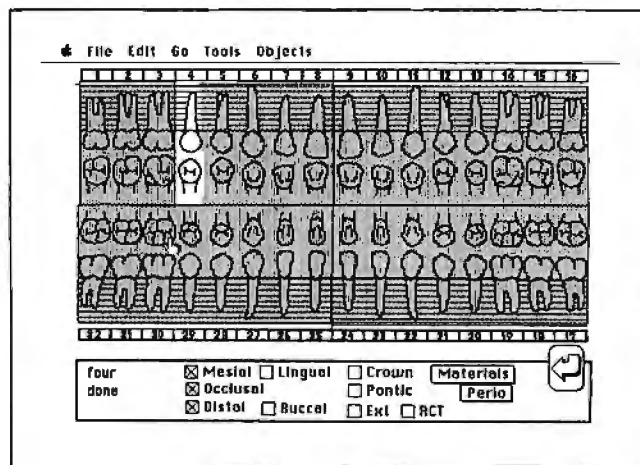

Figure 4: I can put in the treatment for a specific tooth by pushing the applicable buttons.

script tells it. Since it's "transparent," all I see is that I'm pointing at and clicking on a specific tooth. In the background button's script, I set up the card I want to go to next. Once I select a specific tooth—and, by implication, the card as well—I can either record current information or call up a history of what has occurred in the past.

I find that the simplest way of showing history is to have a procedure record in English that I can display as I need it. To make the integration work well, the stack has to create this record as each treatment is recorded. To input the information, I simply click on the applicable buttons (see figure 4), and the stack creates a text container with this information in it. To do this, the stack checks the highlight property of each of the buttons when the card is closed by the action of the return button. (A fragment of the closeCard routine I used is shown in

listing 1.) If the highlight of a detail button is true, that button has been clicked. The stack then builds a text container that has the name of the clicked button in it.

When I have recorded all the treatment information, a button click updates the appropriate text file with all the text containers for a particular date. (It would be easy, for example, to use tabs in building the text file if I later wanted to use this file in Excel or another database that recognizes tabs.)

### Adding the Extras

One protection I wanted to build into the stack was to have it remind me if I forgot to save my changes. Almost all Macintosh programs do this, so why not a stack? The script to do this is deceptively simple (see listing 2) and is performed when control leaves the patient's card. (The variable changedRec is set to true when one of the hold variables has some-

thing other than empty in it. The name of the current patient, currenttpt, is also the name of the patient's card.)

This script shows HyperTalk's ability to send messages that HyperCard can actually *perform*. Instead of having to goto a line of a script, you can pass an activating message to a particular object, and it will perform its own script. For instance, in this script, sending the mouseUp message to the button has the same effect as clicking on the button with the mouse. This kind of system message is an elegant way to program "top down." Each object can potentially be accessed as a executable module. (Yes, this is object-oriented programming.)

But HyperTalk can't deal with everything: It can't put up a standard Mac file-select dialog box, for example. For this, HyperCard's designers left a "back-door" entry, called XFCNs, which provide a way to link code generated by an-

**Listing 1:** *This routine checks the highlight property of the buttons when the card is closed.*

```
on closeCard

    [omitting global setups and the like]

    put empty into buildline
    --you can't use a container without letting
    --HyperCard know about it first
    put empty into flagger

    --check each button
    get the hilite of background button id 4
    if it is true then
        put "L" before buildline
        put true into flagger
    --let our end know we have
    --something in the buildline
    end if

    get the hilite of background button id 5
    if it is true then
        put "B" before buildline
        put true into flagger
    end if

    [more similar code omitted]

    if flagger is true then
        put "--5--" & return & buildline &&
        restmat & return into hold5
        --holding area for tooth 5
    end if
end closeCard
```

**Listing 2:** *This script puts up a typical Macintosh reminder so I don't forget to save my changes.*

```
on closeCard
    global changedRec
    get the hilite of button 3
    if it is true then
        --indicates the save check box is clicked
        if changedRec is true then --put up dialog box
            answer "Save changes to patient record?"
            with "OK" or "Cancel"
            --exit now if they don't want to save changes
            if it is "Cancel" then exit closeStack
            send mouseUp to card button id 45 of this card
            --press the "update patient record" button
            --just as if the mouse had clicked it
            put false into changedRec
            --since we wrote the patient's record,
            --reset the flag
        end if --end the first if construct
    end if --end the check box construct
end closeCard
```

other programming language (like C or Pascal) into HyperTalk-accessible verbs. Steve Maller of Apple wrote a nice XFCN to put up the file-select dialog box. In my text-editor card, I use this widely available XFCN, along with

Dewi Williams's HyperTalk function for getting only the last part (the true filename) out of a full path name; that's what the FileName XFCN puts into a container (see listing 3).

*continued*

## Subscription Problems?



**We want  
to help!**

*If you have a problem with your BYTE subscription, write us with the details. We'll do our best to set it right. But we must have the name, address, and zip of the subscription (new and old address, if it's a change of address). If the problem involves a payment, be sure to include copies of the credit card statement, or front and back of cancelled checks. Include a "business hours" phone number if possible.*

**BYTE**

Subscriber Service

P.O. Box 7643

Teaneck, NJ 07666-9866



# Back, by popular demand.

Just a few years ago, illegal hunting and encroaching civilization had all but destroyed the alligator population in the south. They were added to the official list of endangered species in the United States.

Now alligators have made a comeback.

Conservationists intent on preserving this legendary reptile helped the alligator get back on its feet. Once again some southern swamps and marshes are teeming with alligators.

With wise conservation policies, other endangered species have also made comebacks... the cougar, gray whale, Pacific walrus, wood duck, to name a few.

If you want to help save our endangered species, join the National Wildlife Federation, Department 106, 1412 16th Street, NW, Washington, DC 20036.

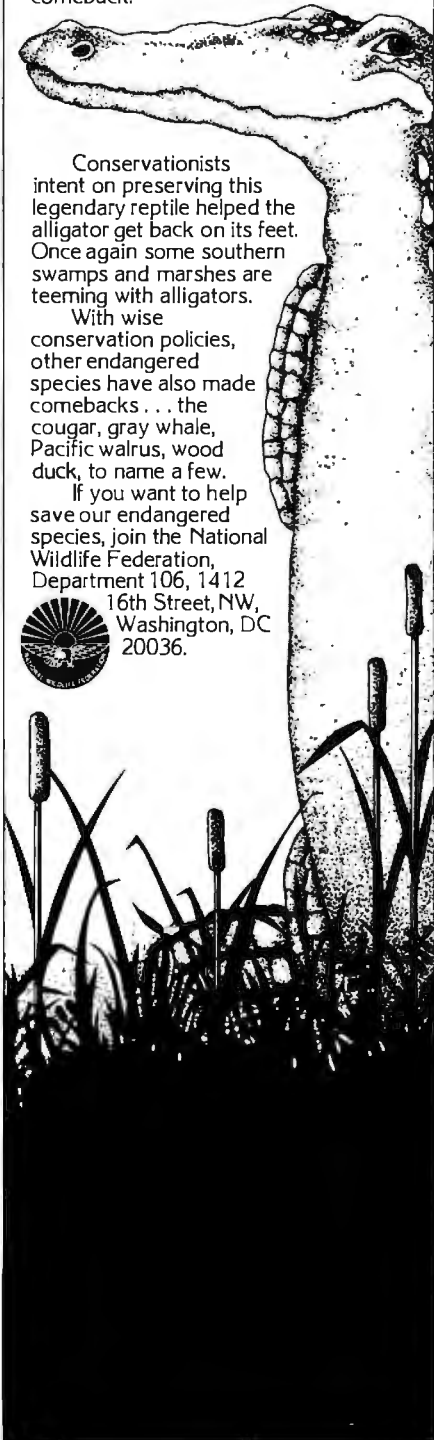

## Listing 3: This routine gets the real filename out of a full path name.

```

on mouseUp
  put FileName("TEXT") into theFile
  --invoke the FileName XFCN only showing TEXT files
  set lockscreen to true
  if theFile is not empty then -- cancel hasn't been pressed
    open file theFile
    read from file theFile for 16384
    --take the entire file in at once; up to the EOF
    put it into card field "Text Box"
    --display file in text box on card
    set the scroll of card field "Text Box" to 0
    --set to the top of the field
    close file theFile
    put LastPathComponent(theFile) into card field "File Name"
    --file name from full path
    put "Patient Record" into card field "whatKind"
    --force feed this, so the edit card can be reused
  end if
  set lockscreen to false
end mouseUp

-- LastPathComponent: given a file pathname, returns the last
-- component (i.e., whatever comes after last colon, if anything).
-- From Dewi Williams

function LastPathComponent name
  --scan backwards for the last colon.
  repeat with i = the length of name down to 1
    if character i of name is ":" then exit repeat
  end repeat

  if i is 1 then
    -- Name was of the form ":thing" or "thing". Check for leading
    -- colon, and adjust if necessary. Done for generality.
    if first character of name is ":" then
      put 2 into i
    end if
  else
    add 1 to i -- skip the colon
  end if

  -- Name was of the form "Thing:otherthing". Return "otherThing".
  put empty into lastpath
  repeat with j = i to the length of name
    put character j of name after lastpath
  end repeat
  return lastpath
end LastPathComponent

```

One of the tools I used during development was a stack that had most of the available public domain HyperCard tools available on it. You don't need to reinvent the wheel. The creator of the Developer Stack is Steve Drazga, who organized the information in a HyperCard-like manner. This is an extremely well done stack. He even put HyperTalk syntax in it for a quick on-line reference, similar to Steve Capps's *Programmer's On-Line Companion*. I found it easier to have the syntax available within HyperCard for the odd quick reference than to have to search through a book. (I probably could

have used the Help stack that is included with HyperCard, but the arrangement in the Developer Stack was much more compact.) Updating the stack is also done in an ingenious manner that doesn't require downloading the entire stack again and again. You can transmit just the changes, and the stack updates itself.

### System Details

I finally came up with a "master record" card that I could clone into specific patient records. This is the first card you encounter upon opening the stack. I wanted to allow only three actions at this



**Listing 4:** This script creates an employee card by hiding and showing a card field.

```
--"edit the employee data" button
on mouseUp
  set lockscreen to true
  set the scroll of card field 4 to 0
  show card field 4
  show card button id 9
  set lockscreen to false
end mouseUp

--when done editing click this button
on mouseUp
global nopush
  put true into nopush
  send openCard to this card --surprise! send an openCard message
end mouseUp

--what happens when you open an employee card?
on openCard
global nopush
  if nopush is true then
    --otherwise the openCard message
    --would scramble the popping order
    put false into nopush
  else
    push recent card
  end if
  set lockscreen to true
  hide card field 4 --hide the history field
  put card field 4 into record --put the text into a variable
  if offset("****",record) > 0 then
    --"****" is a marker for end of
    --employee's address information
    put char 1 to (offset("****",record) -2)
    of record into card field 3
    --put up to the "****" into a visible LOCKED field,
    --so user can't mess with the data
  else
    put "Error encountered in opening card" into msg
    play boing
    show msg
    wait for 3 seconds
    hide message
    pop card
    exit openCard
  end if
  set lockscreen to false
end openCard
```

point—go back home, make a new card, and open an existing one. So I wouldn't alter the master card, I covered it with buttons in the forefront that will do these tasks when clicked. Most HyperCard novices overlook the manner of arranging buttons (or other objects) so that an intended overlap occurs. The Home Card button overlaps all the other buttons on my stack, for instance. If two HyperCard objects occupy the same space, one will overlap the other. To get the desired overlap, you select the button and invoke the bring closer/send back HyperCard commands. This is similar to what you

might do in MacDraw with objects, except that in HyperCard each type of object has its own layer.

If I select the open button, a dialog box appears asking for a name. At this point, an implicit shift in the card handling may occur. You can define a special name to mean that a different kind of record—for instance, an employee record—should be retrieved rather than a patient record. That employee card may include employee data, such as address and phone number, or you could use it as a payroll system if appropriate HyperCard func-

*continued*

## MacRobotics™



- Connect our LAB 40 Controller to serial port on Mac or any PC. Add these available modules: 2 axis Servo, 4 axis Stepper, 8 or 12 bit A/D, Digital I/O, Proto-card.
- Controller w/Forth language ROM, A/D, 68HC11, LAB 40 port for adding modules or ASICS, complete docs, software for Mac or IBM 3345.
- Opportunity for programmers or developers. Customer exchange network. Call our BBS (415) 755-1524. For catalog & Tech Support call (415) 755-1978

75 Southgate,  
Daly City, CA 94015

**Computer Continuum**  
(415) 755-1978 Telex: 3727438

Advertise your  
computer products  
through  
**BYTE BITS**  
(2" x 3" ads)

For more information  
call Dan Harper at  
**603-924-6830**

**BYTE**  
70 Main St.  
Peterborough, NH 03458

Circle M57 on Reader Service Card

## Add-Ons for the Blind

What you add on to your computer, if you're a blind operator, is almost more important than the computer itself.

Scanners, modems, braille printers, speech synthesizers, braille output devices and a host of other peripherals are described in "Add-Ons: The Ultimate Guide to Peripherals for the Blind Computer User."

The product reviews contained in this book are written by those who know them best—blind computer users.

\$16.95 for braille or cassette  
\$19.95 for print.

Send orders to:

National Braille Press Inc.  
88 St. Stephen Street, Boston, MA 02115  
(617) 266-6160

NBP is a nonprofit braille printing and publishing house

## Some Available HyperCard Stacks

**Focal Point**..... \$99.95  
 Activision, Inc.  
 3885 Bohannon Dr.  
 Menlo Park, CA 94025  
 (800) 345-2888  
**Inquiry M211.**

**DentalStack**.....\$395  
 PBC Enterprises  
 P.O. Box 925  
 Wallingford, CT 06492  
 (203) 269-6903  
**Inquiry M212.**

**Electronic Call Screening** ..... \$49.95  
 Kanode Associates  
 4709 East Sandra Terrace  
 Phoenix, AZ 85032  
 (602) 482-3155  
**Inquiry M213.**

**HyperCard**..... \$49  
 Apple Computer, Inc.  
 20525 Mariani Ave.  
 Cupertino, CA 95014  
 (408) 973-2222  
**Inquiry M214**

**Typefaces of DT Publishing**... \$24.95  
 with book..... \$39.95  
 Publishing Resources, Inc.  
 1785 Pearl St.  
 Boulder, CO 80302  
 (303) 442-1100  
 (800) 553-1666  
**Inquiry M215.**

An assortment of public domain stacks is available on BIX in the stackware area of the listings

tions are embedded in it.

I made a HyperText employee card simply by hiding and showing a card field. (A card field works for this rather than a background field, because it can store individual information as well as display it. If you used a background field common to all employee cards, there would be more overhead to make sure the correct information was being shown.) Listing 4 contains the script for the buttons that do all the work for this field.

### Create Your Own

What possible use would you have for a dental stack? Perhaps a lot, if you're a dentist; probably none if you're not. But HyperCard as a tool can, with a dose of ingenuity and creativity, help you make something that you need. I certainly couldn't have created this application as simply without it, and DentalStack has helped me a great deal. ■

*Laurence H. Loeb is an electrical-engineer-turned-dental-surgeon in Wallingford, Connecticut. He is comoderator of the macintosh conference on BIX. He can be reached on BIX as "lloeb."*

## The Macintosh as an Engineering Workstation

DesignWorks™ brings you electronic schematic and simulation capabilities formerly available only in systems 10 - 100 times the price. This design capability is integrated with the Macintosh's well-known text and graphics capability to give you an amazingly easy to use and low cost engineering workstation for digital circuit designers.

### DesignWorks Features:

- fully interactive, 13-state digital logic simulation.
- simulation output through on-screen "probes" or a logic-analyzer style timing diagram.
- individual device delays can be from 0 to 32767 units.
- laser, dot-matrix and pen plotter output support
- simulation support for PROMs, PLAs and RAMs.
- many editing features including full Cut/Copy/Paste clipboard support, device dragging with full rubber-banding, symbol rotation and mirroring, etc.
- includes libraries with hundreds of common logic devices with full simulation.
- supports bussing and multipage drawings with off-page connectors.
- interfaces with Douglas CAD/CAM PCB layout.
- full price, including libraries and simulation: \$685.00
- low-cost educational versions also available.

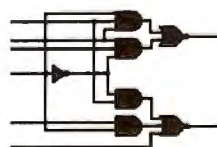
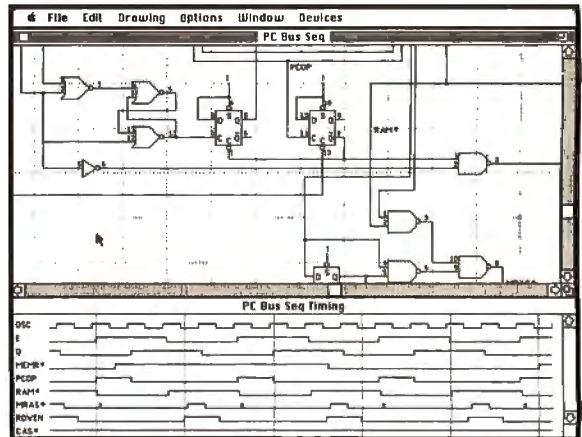

## Capilano Computing

545 - 108th NE, Suite 6, Bellevue WA 98004  
 (604) 669-6343

Macintosh is a trademark of Apple Computer, Inc. DesignWorks is a trademark of Capilano Computing Systems Ltd. Douglas CAD/CAM is a trademark of Douglas Electronics

# Introducing Bit Pad Plus. No Matter What You Do On Your Macintosh™ ...



Desktop Publishing



CAD/CAM/CAE

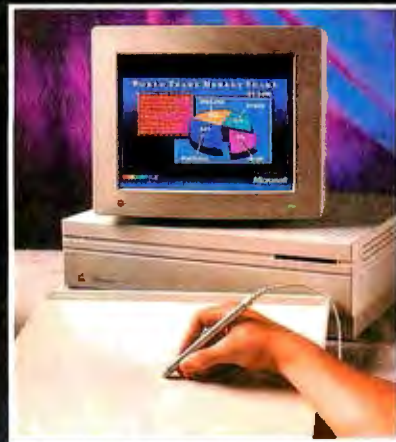

Business Graphics



Drawing/Tracing

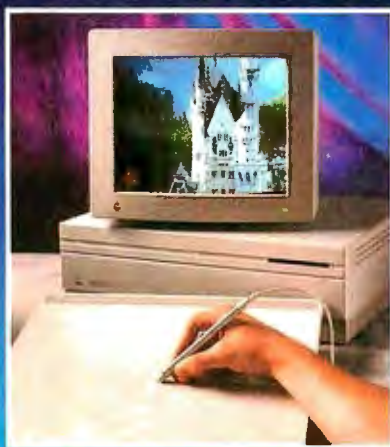

Design Graphics



Menu Selection

## Now You Can Do It Better.

*Summagraphics Bit Pad Plus*

Bit Pad Plus is the latest tablet from Summagraphics—the world's leading supplier of graphics tablets. This versatile, 12" by 12" input device greatly enhances the graphics capabilities of your Macintosh to create a more productive, more professional graphics workstation.

Our Bit Pad Plus comes with a four-button cursor, stylus, and an Apple® Desktop Bus™ interface to connect to your computer—no separate power supply is needed. It performs menu selection and steering functions as well as a mouse. Plus it allows you to trace and draw naturally. Provides better accuracy through higher resolution. And it's compatible with all Macintosh II and SE software.

Why settle for less from another tablet or mouse? If you're really serious about graphics, move up to Bit Pad Plus today.

**Summagraphics**® See us in MacWorld Expo Booth #5546.

Draw on our experience® 203-384-1344

© 1988 Summagraphics Corporation. All rights reserved.

Circle M47 on Reader Service Card

### I'M SERIOUS ABOUT GRAPHICS

Send me more information on the Bit Pad Plus graphics tablet.

Type of industry: \_\_\_\_\_

Type of application: \_\_\_\_\_

( ) I'm interested in OEM information.

Name: \_\_\_\_\_ Title: \_\_\_\_\_

Company: \_\_\_\_\_

Address: \_\_\_\_\_

City: \_\_\_\_\_ State: \_\_\_\_\_ Zip: \_\_\_\_\_

B8/88

Mail to: Summagraphics Corporation  
777 State Street Extension, Fairfield, CT 06430

Images courtesy of: Pagemaker from Aldus Publishing, VersaCAD, Powerpoint from Microsoft, PixelPaint from SuperMac Technologies, True Vision and Apple Computer, Inc.

# The Joystick Ousts the Mouse

## A Professional Mouse/Joystick for all Apple Users

The new MACH IV plus (mouse/joystick) from CH Products is a professional mouse replacement and joystick for all Apple II and Macintosh computers. Engineered for use with all mouse intensive applications software. At the flip of a switch the MACH IV plus can shed its serious work ways and be ready for use with your favorite simulation or game software.

The MACH IV plus has many advanced features over its predecessor, the MACH IV, including an absolute mode that tracks and acts like a mouse, as well as three rate modes. It also provides greater reliability and is 100% compatible with all mouse and joystick driven software.  
**Suggested Retail - \$89.95**

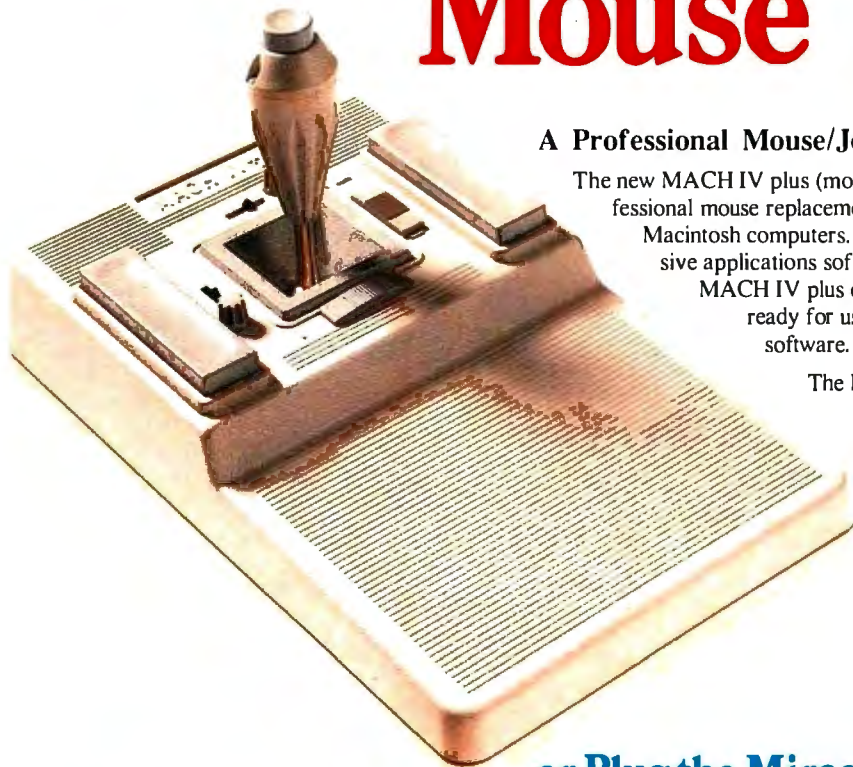

## or Plug the Mirage into Your Existing Apple Computer and Use Your Existing CH Joystick

### MIRAGE™ – Joystick/Mouse Interface for all Apple Computers

The new MIRAGE from CH Products is a multi-featured interface for using CH Products' Apple compatible joysticks with all Apple II and Macintosh computers and programs which use a mouse for input. MIRAGE turns your joystick into a high performance mouse alternative that is 100% compatible with all Apple mouse ports and software. Installation is a snap, just connect the MIRAGE connector where you usually plug your mouse, plug your joystick (Mach II, Mach III or FlightStick) into the MIRAGE and you're ready to mouse around!

**Suggested Retail - \$54.95**

#### COMPATIBILITY:

MACH IV plus – Quad and MIRAGE – Quad for: Apple II, IIE, IIC, Mac 128, Mac 512 (Apple II, IIE require Apple mouse card to use in mouse mode).  
MACH IV plus – ADB and MIRAGE – ADB for: Apple IIGS, Mac SE, Mac II.



A Joystick Technologies, Inc. Company

A Division of Joystick Technologies, Inc.  
1225 Stone Drive, San Marcos, CA 92069  
See your Dealer today, or  
for credit card orders, call:  
USA 1-800-624-5804; CA 1-800-262-2004.  
For more information, call: (619) 744-8546.

# Using Color QuickDraw on the Mac II

Jan Eugenides

I have to admit it: I didn't think color on the Macintosh was important. But when I began to explore my new Mac II, I saw I was wrong. Color adds vitality and clarity; it's no mere frill. Best of all, it's not that difficult to add color to your own programs, using Color QuickDraw.

I obtained an early beta draft of *Inside Macintosh Volume V* (1987, Apple Programmer's and Developer's Assoc.), which contains information on the various color routines. After much experimentation, I worked out an interesting method of color animation. The technique involves constantly modifying the color lookup table contained in the video RAM. It works with any AppleColor monitor and video card, and should work with any third-party video board as long as it supports a 256-color mode. This application produces absolutely stunning, almost mesmerizing, effects, so I've named it Mesmer (see photo 1). The C listing is fairly long, so only fragments of it appear here. [Editor's note: *The complete listings for this article are available in a variety of formats. See page 3.*]

I'll briefly explain some of the features of Color QuickDraw and how these are used to produce Mesmer's effects. A detailed description of Color QuickDraw is beyond the scope of this article, but it is available in *Inside Macintosh Volume V* or you can check out Scott Knaster's *Macintosh Programming Secrets* from Addison-Wesley. We're only going to cover the groundwork we need to understand what Mesmer does, and dive right in for a close look at the code. At the end of this article I'll explain some caveats to using this technique, but Mesmer provides several working examples of how to access and use Color QuickDraw for your own needs.

## Color QuickDraw

If you are familiar with QuickDraw, Color QuickDraw holds few surprises. Most of the same drawing commands are available, except that you can now speci-

*Here's a working example of a Mac II color animation*



Photo 1: Mesmer in operation.

fy the color to be used for the operation. The standard Macintosh drawing interface, the grafPort, supports the eight original QuickDraw colors: black, yellow, magenta, red, cyan, green, blue, and white. Since Mesmer uses 256 colors to produce its effects, this requires you to draw in a color grafPort (cGrafPort) instead. The structure of a cGrafPort is practically identical to a grafPort, and both structures are the same size. Apple was able to pack more information into a cGrafPort by changing several fields (bkPat, pnPat, and fillPat) from bit-pattern data to handles pointing to color information. Also, the portBits field no longer points to a BitMap structure that itself points to the grafPort's bit-mapped data, but has a handle to a color pixel map that contains information on the color image. The easiest way to allocate a cGrafPort is to simply call NewCWindow() in your application. This ROM call is similar to the old NewWindow() call, but instead creates a color window using a cGrafPort.

All colors in Color QuickDraw are manipulated in an *RGB space*. The RGB space serves as a common ground where applications can use color in a consistent, hardware-independent manner. Color values are represented by an RGBColor data structure that specifies the red, green, and blue components of a color. (See code fragment 1.) Each of the three components are short integers (16 bits) that can have values from 0000 hexadecimal for the lowest intensity to FFFF hexadecimal representing the highest intensity. If all three components are zero, the color is black. If all three are FFFF hexadecimal, the color is white. Whenever all three components are equal to one another, the result is a shade of gray. All other combinations result in colors. You should note that although RGBColors store each component as a short integer, Color QuickDraw currently uses only one byte of information per color compo-

*continued*

**Code fragment 1: RGBColor data structure.**

```
typedef struct RGBColor{
    unsigned short  red;      /* magnitude of red component */
    unsigned short  green;    /* magnitude of green component */
    unsigned short  blue;     /* magnitude of blue component */
} RGBColor;
```

**Code fragment 2: ColorTable data structure.**

```
typedef struct ColorTable{
    long           ctSeed;    /* unique identifier for table */
    short          ctFlags;   /* flags describing the spec array */
    short          ctSize;    /* number of entries - 1 */
    CSpecArray     ctTable;   /* array [0..0] of ColorSpec */
} ColorTable, *CTabPtr, **CTabHandle;
```

**Code fragment 3: The Environs structure.**

```
short machine, rom;

Environs(&rom, &machine);
```

**Code fragment 4: Using GetGDevice to extract the pixel depth**

```
GDHandle          gH;
PixMapHandle      pH;

gH = GetGDevice(); /*get a handle to main graphics device*/
pH = (**gH).gdPMap; /*get a handle to its PixMap*/
if((**pH).pixelSize == 8) /*examine the pixelSize field*/
    /*a pixel size of 8 indicates 256 colors are available*/
```

**Code Fragment 5: Inner drawing loop for Mesmer.**

```
for(theta = 0.0; theta < 480.0*v; theta += v)
{
    RGBForeColor(&color); /* set the drawing color */
    r = theta/v;
    x = midx+r*cos(theta); /* make some patterns */
    y = midy+r*sin(theta);
    LineTo(x, y); /* draw a line from the last point to
                  this one */
    index++; /* cycle thru all 256 colors in the clut */
    if(index>=255) index = 0;
    Index2Color(index, &color);
}
}
```

**Code fragment 6: Using SetEntries( ).**

```
for(n = 0; n < 512; n++)
{
    tempval = temptable[255]; /* shift all entries down one */
    for(j=254; j>=0; j--)
        temptable[j+1] = temptable[j];
    temptable[0] = tempval;
    SetEntries(0,255,temptable); /* install the new clut */
    Delay(1L, &ticks); /* slow rotation slightly */
}
}
```

ment, which gives you a palette of  $2^{24}$  or 16,777,216 colors.

How is an RGBColor presented on, say, a monitor? Color QuickDraw uses a lookup table mechanism that translates RGBColors into values that a video board then uses to index into its own map of color information. The information in this map, or color lookup table (CLUT), is used by the hardware to drive the monitor. This arrangement effectively hides the messy hardware details from programmers and allows them to focus on developing products rather than worry about compatibility problems.

Color QuickDraw groups a cGrafPort's colors into a data structure called a ColorTable. Its structure is shown in code fragment 2. As you can see, each entry in the color table is not simply an RGBColor but a ColorSpec. A ColorSpec data structure consists of a value field (short integer) followed by an RGBColor. This value field is nothing more than 3 to 5 of the most significant bits of each component of the RGBColor record. These values are used to index into the video board's color map to determine what colors you see. My output device was a color monitor, but these values could index into a color map whose values describe the "best-fit" colors for a color printer. These values are used internally by Color QuickDraw (actually the Color Manager) and shouldn't be modified by your application. I'll show how this mechanism works in the "Using the Color Manager" section.

In place of the old familiar BitMap used by a grafPort is the PixMap, a structure that defines the cGrafPort's pixels. The first three fields of a PixMap are the same as those of a BitMap: a pointer to the pixel image (baseAddr), an offset that determines the number of bytes from one row of pixels to the next (rowBytes), and the boundaries of the image (bounds). A PixMap contains additional fields that define the horizontal and vertical resolution of the image (hRes and vRes); the image's depth, or physical bits per pixel (pixelSize); and other information. In its current incarnation, Color QuickDraw uses a "chunky" pixel image format that has all of a pixel's bits stored consecutively in memory, and all of a row's pixels stored consecutively as well.

Although QuickDraw works with RGB colors, it also provides other ways to define a color. Color QuickDraw has conversion routines for HSV (hue, saturation, and value), HLS (hue, lightness, and saturation) and CMY (cyan, magenta, and yellow) color models. The

Color Picker package contains routines to display a color wheel that lets you select a particular color from it (see photo 2), and routines to convert between the various color definitions.

There's more to Color QuickDraw, of course: color cursors, color patterns, new drawing modes, a new picture format, and new text-handling routines. But, in general, Color QuickDraw can be regarded as an enhancement to the old QuickDraw, not a departure from it. Programs written with the original QuickDraw still run under Color QuickDraw, as long as they don't make any assumptions about an image's pixel depth or memory requirements.

### Checking Your Machine Environment

When writing a color application, it's a good idea to add code that checks whether Color QuickDraw is available on the Macintosh executing your program. Since these routines are written in 68020 code, attempting to run them on a Mac Plus or Mac SE will produce a system bomb—a clearly undesirable result. Fortunately, it's easy to have your application check what type of machine is running it. The `Environ()` function returns information about the machine and the ROM; it is shown in code fragment 3. If a Mac II is running your application, machine will be equal to 2.

Currently, only the Mac II has color capabilities, so this is a sufficient check. However, for future compatibility, it's better to check directly for the availability of Color QuickDraw itself, using the

`SysEnviron()` call. Apple's Technical Note #129 explains how to do this.

Once you have determined that the color calls are available, you should determine the current pixel depth; put another way, how many colors are currently available? This question arises from the fact that the number of colors displayed can be set by the user via the Control Panel.

For simplicity, I designed Mesmer to

require 256 colors. This is not a great idea for a commercial application, which should be capable of running with any number of colors, but it's fine for a short demonstration application. To ensure that the display is using 256 colors, Mesmer examines the pixel depth of the main graphics device, which is the display that encompasses that part of the Desktop with the menu bar.

*continued*

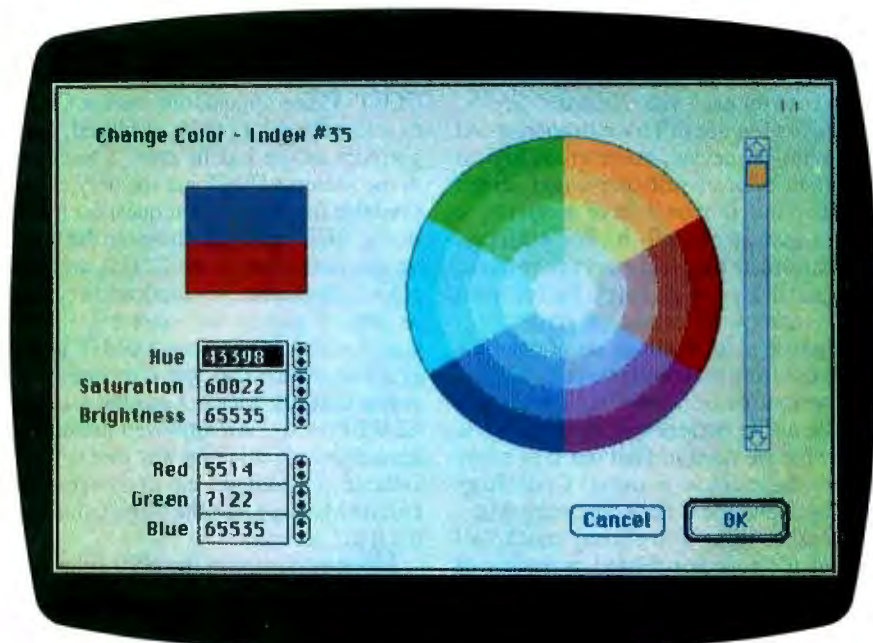

**Photo 2:** *The Color Picker Dialog box. You can select a color by pointing and clicking on the color wheel or by typing values into the text field boxes. Values for a color can be entered as an RGB color model or an HSV color model.*

**Listing 1:** *The gDevice data structure. Mesmer extracts information about the depth of the screen from `gdPMap`, which is a handle to the `PixMap` associated with this `gDevice`.*

```
typedef struct GDevice
{
    short      gdRefNum;      /* reference number of driver */
    short      gdID;         /* client ID for search procedures */
    short      gdType;       /* device type */
    ITabHandle gdITable;     /* handle to inverse lookup table */
    short      gdResPref;    /* preferred resolution of GDITable */
    SProcHndl  gdSearchProc; /* list of search procedures */
    CProcHndl  gdCompProc;   /* list of complement procedures */
    short      gdFlags;      /* grafDevice flags word */
    PixMapHandle gdPMap;     /* PixMap for displayed image */
    long       gdRefCon;     /* reference value */
    GDHandle   gdNextGD;     /* handle of next gDevice */
    Rect       gdRect;       /* device's bounds in global coordinates */
    long       gdMode;       /* device's current mode */
    short      gdCCBytes;    /* rowBytes of expanded cursor data */
    short      gdCCDepth;    /* depth of expanded cursor data */
    Handle     gdCCXData;    /* handle to cursor's expanded data */
    Handle     gdCCXMask;    /* handle to cursor's expanded mask */
    long       gdReserved;   /* future use. MUST BE 0 */
} GDevice, *GDPtr, **GDHandle;
```

### Graphics Devices

Because the Mac II supports a variable-size screen, different pixel depths, and even multiple screens, we need a way to keep track of and manipulate whatever video devices are attached. Color QuickDraw uses a structure called a `gDevice`, or graphics device, that describes each device's characteristics. The structure of a `gDevice` is shown in listing 1.

When you start up the Mac II, it determines the number of installed video boards, reads the device-specific information on each (such as screen size and pixel depth), and creates a linked list of `gDevices` for each video board.

A `gDevice` doesn't have to correspond to a physical device, however. A logical `gDevice` behaves just like a real screen device, but it won't have a software driver associated with it. For example, you can create a logical `gDevice` in memory, and draw into it. This is useful when you want to write into an off-screen `PixelFormat` whose pixel depth or set of colors is different from that of the screen.

The routine `GetGDevice()` returns a handle to the current `gDevice`, which is just what we need to find out how many colors the monitor is using. Code fragment 4 shows the C code for doing this.

Another thing you should check, although it's not color-related, is the size of

the screen. The QuickDraw global `screenBits.bounds` contains the rectangle of the main screen. Mesmer uses this information to open a full-screen-size window. If your application needs to figure out the shape and size of a Desktop that spans several screens, the low-memory global `GrayRgn` (at address 9EEh) contains the `RgnHandle` (region handle) to a standard QuickDraw region that describes the Desktop.

### Creating a Color Look-Up Table

To achieve its swirling animation effects, Mesmer requires a customized CLUT. Color QuickDraw uses a CLUT to select the colors to be displayed; each graphics device has its own. The colors in the screen's CLUT are the only colors available for display. A request for a particular RGB value is matched to the nearest available color in the CLUT, and that color is displayed. An application cannot be sure of getting the exact color it requests unless it provides a CLUT to the graphics device that specifies the exact values it needs. Mesmer sets the screen's CLUT directly. An approved method of accomplishing this in a way that is more suitable in a complex environment is the Palette Manager (see the "The Good and the Bad" section).

I took advantage of the HSV color def-

inition to calculate a "rainbow" of colors (that is, colors that blend smoothly from one hue to another). By leaving the saturation and value parameters at their highest values and varying only the hue, it's easy to get colors that are evenly spaced all around the rim of the color wheel. These are the most brilliant colors available, which is just what I wanted for Mesmer. The Color Picker's `HSV2RGB()` routine converts each HSV color to its RGB equivalent, and these values are then stored in an array. Listing 2 shows a part of the code I used to create Mesmer's CLUT. It generates an array of 256 evenly spaced colors that are then written into a `clut` resource of an arbitrarily named resource file. After creating the file, I used ResEdit to copy and paste the `clut` resource into Mesmer's resource file.

### Using the Color Manager

The Color Manager is a set of routines designed to work directly with graphics hardware, providing RGB color space information to Color QuickDraw or instructing the hardware to modify its color map as required to display a new set of colors. Macintosh graphics devices convert arbitrary pixel values in their frame (display) buffer into actual RGB values, as determined by the CLUT for the device. Changing the CLUT changes

**Listing 2:** *LightspeedC code to generate the color look-up table (CLUT) resource for the Mesmer application. A CLUT that contains a "rainbow" of smoothly blended colors is generated and written into a resource file called Fred.*

```

/*color table generator*/
MakeCLUT()
{
    CTabHandle    ctabH;
    HSVColor      hColor;
    short         refNum;

    ctabH = (CTabHandle)NewHandle((long)sizeof(ColorTable)); /*allocate space
                                                                for color table*/
    hColor.saturation = 65535; /*set saturation to max*/
    hColor.value = 65535; /*set value to max*/
    for(n = 0; n < 256; n++) /*for 256 colors*/
    {
        hColor.hue = n*256; /*create 256 evenly spaced hues*/
        HSV2RGB(&hColor, &(**ctabH).ctTable[n].rgb);
        /*the value field is just the most significant bits of the RGBColor*/
        (**ctabH).ctTable[n].value = 0; /*just set it to zero, color manager does
                                         the rest*/
    }
    (**ctabH).ctSeed = GetCTSeed(); /*use the current version identifier*/
    (**ctabH).ctSize = 255;
    /*size of color table minus one*/
    CreateResFile("\pFred"); /*create a resource file*/
    refNum = OpenResFile("\pFred");
    AddResource(ctabH, 'clut', 200, "\pFred");
    /*add our new clut to it*/
    CloseResFile(refNum);
}

```



the colors displayed without changing the pixel values stored in the frame buffer. This is the secret of Mesmer's animation effects: Once an image is created, the colors can be changed by modifying the device's CLUT without redrawing the image. By carefully selecting the sequence of colors in the CLUT and shifting the index to them around, you can generate a wide variety of special effects. Mesmer's graphics, as nice as they are, really just scratch the surface.

There are three sets of Color Manager routines that Mesmer uses to produce the animation effect: `Color2Index()`, `Index2Color()`, and `SetEntries()`. `Color2Index()` finds the best match to a random starting `RGBColor` for each drawing sequence. It returns the index value into the CLUT for that color, which becomes the starting color. For each iteration of the inner drawing loop, this index is incremented. It wraps around at 255 so that all 256 colors of the CLUT are used in sequence, starting with the random color. This produces a rainbow-colored drawing. The pattern itself is randomized as well, so it produces many combinations of colors and patterns.

As the index is incremented, the `Index2Color()` routine is used to retrieve the `RGBColor` corresponding to that index from the CLUT. The Color QuickDraw call `RGBForeColor()` sets the drawing color, and `LineTo()` does the actual drawing. This inner drawing loop is shown in code fragment 5. The variable `v` is set randomly before the loop begins, as is the starting index value, `index`. The variables `v`, `theta`, and `r` are

all float-type variables, while `index`, `x`, and `y` are short integers.

Once the rainbow-colored pattern has been drawn, the real fun begins. `SetEntries()` changes the current `gDevice`'s CLUT (in this case, it's the screen). You can change the entire table, or just specified entries. Mesmer uses `SetEntries()` to swap the whole CLUT. First, a copy of the CLUT is made. Next, each table entry is rotated up one position, with the contents to the top entry moved to the bottom. Then the screen is set to the new CLUT using `SetEntries()`. The result is that each color on the screen changes to the color that was adjacent to it in the CLUT. Because the colors are selected sequentially around the color wheel, it appears as though the colors themselves move to the next line in the pattern. Since the patterns move in a circular way outward from the center of the screen, the colors appear to swirl outward as well, blending and changing as they go (see photo 1). The C code fragment 6 shows how this is done. After the CLUT rotates a couple of times in one direction, it reverses direction for another two full rotations.

There is one caveat to using the `SetEntries()` routine. You must be careful to set the CLUT back to its original state before leaving your application. Otherwise, you can wind up with some very strange and even illegible displays produced by subsequent applications that rely on the screen CLUT having the standard set of colors. Mesmer does this by using its own copy of the standard CLUT, saved as a resource. A better way

would be to save and restore the current CLUT each time the application runs.

### The Good and the Bad

The main disadvantage to Mesmer's approach is that it uses the Color Manager directly, instead of the Palette Manager, to animate colors. The Palette Manager routines operate more or less transparently across multiple screens, while the Color Manager routines do not. Thus, Mesmer is limited to operating on the main screen only. Apple strongly recommends that color animation be accomplished through the Palette Manager to avoid potential problems that result from manipulating colors at the Color Manager level. In a multitasking environment, changing the screen CLUT directly can confuse other applications that are running concurrently with your own, since there is no way for them to sense that the colors have changed. Nothing will crash, of course, but the displays may be less than optimal.

The advantage to Mesmer's animation scheme is that it's relatively easy to implement, while the Palette Manager routines are more complex. Since most of us have only one screen, Mesmer still serves as a good example of how to use Color QuickDraw, and it shows the interaction between Color QuickDraw, the Color Manager, and the video hardware. ■

*Jan Eugenides is a senior software engineer at Solutions Inc. in Montpelier, Vermont. He has written articles for several Macintosh-specific magazines. He can be reached on BIX as "j.eugenides."*

*"the richest and most expressive programming language I've ever used"*

# AlphaPop

## Pop-11 for the Macintosh

*"the ideal language... an artful blend of Pascal, Lisp, and Forth with a dash of Smalltalk and Prolog"*

Quotes: Dick Pountain, BYTE May 1988

For orders, information, and free Hypercard stack about AlphaPop, please contact:  
 Computable Functions Inc. • 35 South Orchard Drive, Amherst, MA 01002 U.S.A. • 413-253-7637

# DATAPRO Means Accurate.

*Information. We base our purchases on it. Formulate opinions from it. Make intelligent decisions with it.*

*Provided . . . it is correct. Inaccurate information is oftentimes less useful than none at all. It leads to misinterpretation. And in making a poor choice.*

*Datapro means accuracy. Our information services contain up-to-date documented reports on products and services in microcomputers, information processing and data and voice communications. Reports that help you separate truth from fiction. And in today's ever-changing industry, that requires constant research and review. Our product and pricing comparisons are carefully developed. Technology reports are documented. User ratings are statistically analyzed. Competitive reports are scrutinized. And How-to-Advice columns are meticulously edited.*

*Start making your decisions based on the facts. To receive your free literature pack on Datapro's subscription services, call us today at 1-800-DATAPRO (1-800-328-2776) or use the reader service card.*

**datapro** 

Circle M58 on Reader Service Card



# Unix and the Mac Interface

Rick Daley

*The A/UX Toolbox  
 for the Mac II  
 gives you the  
 potential for a  
 point-and-click Unix*

A/UX 1.0 is Apple's version of AT&T Bell Laboratory's Unix System V version 2 for the Macintosh II. What makes A/UX stand out from other Unix systems is the A/UX Toolbox (software that gives A/UX programs access to the Mac user interface ROM routines). With the Toolbox, applications developers can give their programs the familiar look and feel of the Mac user interface. (For further details on A/UX 1.0, see "Unix for the Mac II" by David Betz and Eva M. White on page 185 of this issue.)

The Toolbox is a set of tools and libraries that let you run existing "well-behaved" Mac applications under A/UX, or write new A/UX applications that can use the Mac user interface.

There are two main components in the Toolbox: It has a program named `launch` for executing existing Mac binaries, and a C library named `LIBMAC.A` for creating new A/UX programs that can access the user interface toolbox as well as standard Unix libraries.

Table 1 shows which Mac operating system routines the Toolbox 1.0 supports. In this first release, you can run only one A/UX Toolbox application at a time, and the finder, desk accessories, and printing manager are not supported. Nor does the Toolbox support custom device drivers. The A/UX Toolbox in A/UX 1.1 (which should be in beta version by the time you read this) will support the desk manager, the printing manager, the color manager, and the palette manager.

## Compatibility Issues

The main compatibility issues are in the areas of memory management, process scheduling, and file management. To understand what is involved in integrating these environments, you must first understand the differences between A/UX and the Mac operating system. A/UX is a multitasking, 32-bit virtual memory operating system; the Mac is a single-tasking operating system that uses

a handle-based memory manager. A/UX requires a 68851 paged-memory-management unit (PMMU) for multitasking and virtual memory support as well as protection of one task from another. Virtual memory lets a process access more memory than the machine physically has. Unfortunately, these features isolate you from the hardware, and you are expected to make requests to the operating system kernel to manipulate the hardware. This is important, because it means that a bug in one program won't inadvertently crash the entire system.

While the Mac operating system provides an interface to the hardware, it cannot prevent you from accessing hardware and memory directly. Other conflicts between the Mac operating system and A/UX are caused by the fact that the Mac's handle-based memory manager assumes only 24 bits of significance. The A/UX library takes care of the 24- to 32-bit problem for programs that used the prescribed interface, but some programs go around the Mac operating system's interface to gain speed. You must modify these so-called "ill-behaved" applications for them to run under A/UX.

## A/UX and the Mac ROM

The Mac ROM contains a large library of routines that an application can call. These routines are broken into two sec-

tions. The first section is the user interface toolbox, which contains code to present the standard Mac user interface. These include routines to draw text and graphics, to create and manipulate windows and menus, and to get input from the user through the mouse and keyboard. The second section of the Mac ROM contains the operating system calls. These are routines to read and write files, to allocate memory, and to manipulate various devices, such as the serial ports.

Figure 1 shows the strategy that A/UX uses to communicate between an A/UX C program and the Mac ROM: When you make a call to the Mac operating system, the Toolbox routes the call to one of A/UX's operating system calls; when you make a call to a Mac user interface routine, the Toolbox translates it to a call in the Mac user interface ROM code.

The A/UX Toolbox sets up a memory map that is close enough to the one used by the native Mac operating system that it fools the code in ROM and in applications. Because the PMMU's job is to keep programs from accessing anything but their own code and data, Apple had to provide a means to get around some of the protection facilities of A/UX so that programs can get to the screen's frame buffer and the Mac ROM. Before transferring control to a program, the Toolbox library makes several calls to the A/UX kernel to change the memory map making the ROM and the screen's frame buffer accessible. Also, it creates a small memory segment at virtual address 0 to contain Mac low-memory globals. The ROM code maintains these globals, and some applications can even access them directly. The resulting memory map is shown in figure 2.

The recommended way for an application to access the Mac ROM routines is through the 68000 CPU family's 1010 emulator trap mechanism, often called an A-line trap. A 1010-emulator trap oc-

*continued*

**Table 1: A list of the Macintosh operating system calls that the Toolkit 1.0 supports.**

ROM library	Implemented?
Apple desktop bus	No
AppleTalk manager	No
Binary-decimal conversion package	Yes
Color manager	Dummy routines only
Color picker package	Dummy routines only
Control manager	Yes
Deferred task manager	No
Desk manager	Dummy routines only
Device manager	Some dummy routines
Dialog manager	Yes
Disk driver	Some dummy routines
Disk initialization package	Dummy routines only
Event manager, OS	Partially
Event manager, toolbox	Yes
File manager	Partially
Font manager	Yes
International utilities package	Yes
List manager	Yes
Memory manager	Partially
Menu manager	Yes
Package manager	Yes
Palette manager	Dummy routines only
Printing manager	No
QuickDraw	Yes
Resource manager	Yes
SANE package	Yes
Scrap manager	Yes
Script manager	No
SCSI driver	No
Segment loader	Partially
Serial driver	No
Shutdown manager	Yes
Slot manager	No
Sound manager	Some dummy routines
Start-up manager	Not needed
Standard file package	Yes
System error handler	Partially
TextEdit	Yes
Time manager	Partially
Utilities, operating system	Partially
Utilities, toolbox	Yes
Vertical retrace manager	Partially
Video drivers	No
Window manager	Yes

curs when the CPU executes an instruction that begins with the hexadecimal digit A. The CPU then transfers through an exception vector to a routine that handles the A-line trap. A/UX also uses the A-line trap mechanism to access the Mac ROM.

Under the Mac operating system and the A/UX Toolbox, the A-line trap routine uses the low 12 bits of the A-line trap word and a dispatch table, found in the low-memory globals, to locate the address of the routine that actually performs the requested function. Initially, the entire dispatch table is loaded with pointers to functions in ROM. However, under the Mac operating system, many entries in the dispatch table are replaced with pointers to functions in RAM. These patches are installed to fix bugs and to add new features. Consequently, Apple had to install these same patches under the A/UX Toolbox. And, of course, calls made to the Mac operating system are replaced with equivalent Unix system calls.

For example, A-line traps that call the file manager are replaced with code that uses A/UX system calls, such as open, close, read, and write. A-line traps that call the vertical retrace manager are replaced with code that uses the A/UX system calls setitimer and signal.

**Memory Manager**

The differences between the two memory managers require the most adjustment. These differences mainly stem from the fact that A/UX is a 32-bit virtual memory system while the Mac is a 24-bit handle-based system.

Apple implemented A/UX's virtual memory by making calls to the C library's malloc, free, and realloc routines. These routines simply maintain a circular list of memory blocks. When an application makes an allocation request, the system searches the list to find the first free block that is large enough. If there is no free block large enough, the sbrk system call asks the kernel to extend the heap, thus creating more virtual memory. If this fails, which only happens if the area of the disk reserved for paged-out memory is full, then so does

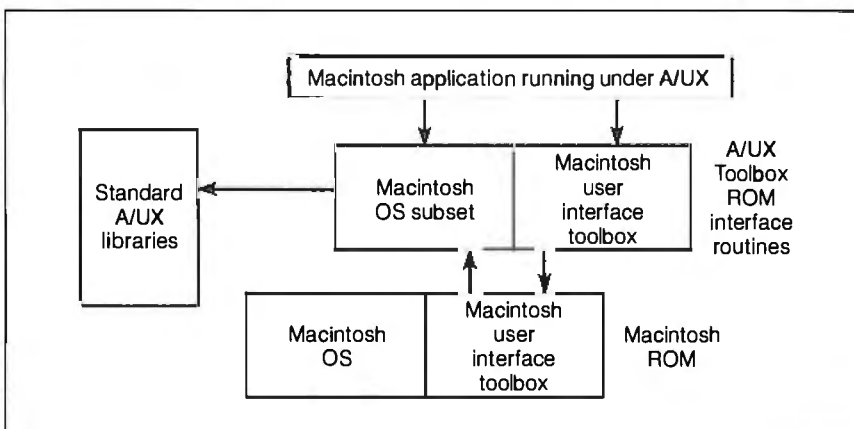

**Figure 1: The strategy A/UX uses to communicate between an A/UX C program and the Mac ROM. If the C program makes a call to the Mac operating system, the Toolbox routes the call to an equivalent A/UX kernel function; if the program calls a Mac user interface routine, the Toolkit does an A-line trap to the Mac ROM.**

the request. These routines don't perform memory compaction, so they are much simpler than the algorithms that the memory manager uses in the Mac operating system.

Without compaction, memory fragmentation can cause paging even though there is actually enough physical memory. Applications can start paging and run more slowly even if they allocate less memory than the system has.

However, there are also some advantages to A/UX's memory-allocation scheme. It does not spend time moving blocks around in an effort to compact the heap. A common bug in a Mac application is to dereference a handle, then call a memory manager routine using the dereferenced handle. Since the block can move due to heap compaction, the dereferenced handle is no longer valid. These bugs will not occur under the A/UX Toolbox because memory blocks are moved only when their size increases. Applications also have trouble recovering from out-of-memory conditions; many don't even try to recover, but some try and fail. Even if the application recovers, it's still likely that it won't be able to do what you request. With virtual memory, running out of memory is very rare.

Some of the Mac memory manager functions don't make sense under virtual memory. In a virtual memory environment, it's not clear what value the call to determine the amount of free memory available should return. The current implementation returns 1 megabyte minus the amount of memory already allocated. However, the amount of memory an application can allocate is typically much more than this. This seems to keep existing applications running well. Still, developers of future applications should really try not to use these calls; it's better to allocate the amount needed and check to see if the request succeeds.

**Significant Bits**

The most common reason a Mac application fails to run under the A/UX Toolbox is if it stores extra data in the high bits of pointers. Having only 24 bits of the 32-bit handles be significant was a limitation designed into the 68000 CPU. However, the 68020 CPU used in the Mac II can use all 32 bits of addresses. The current version of the Mac operating system, to maintain backward compatibility, uses the PMMU to ignore the high 8 bits of addresses. Under A/UX, all 32 bits of addresses are significant.

Some current Mac applications go around the memory manager routines to

gain speed. The memory manager routine `NewHandle` allocates a relocatable storage block. Instead of returning a pointer to a memory block, like the C routine `malloc`, `NewHandle` returns a pointer to a master pointer, which points to the memory block (see figure 3a).

This extra level of indirection lets the memory manager compact memory by moving these relocatable memory blocks. The application can still find the data because the memory manager will update the master pointer when it moves the block. The memory manager stores some flag bits in the high-order bit of the handle, telling the memory manager whether the corresponding block is relocatable or temporarily locked (and therefore can't be moved).

Storing these flag bits in the high-order bits of the master pointer works in the Mac operating system, but not in A/UX where all 32 bits of the address are significant. So the memory manager version that runs under the A/UX Toolbox stores the flag bits in a second longword of memory, just after the master pointer (see figure 3b). This works fine as long as the application uses the access routines to manipulate these flag bits. Unfortunately, many applications currently bypass the access routines. For example, rather than calling the `HLock` routine, some applications just set the appropriate bit in the master pointer. These applications will not run under A/UX without modification.

Another example of access routines

that applications often bypass is access routines to low-memory global variables. These variables are automatically updated via hardware interrupts in the Mac operating system, but not under A/UX. For example, under the Mac operating system, some applications directly ac-

*continued*

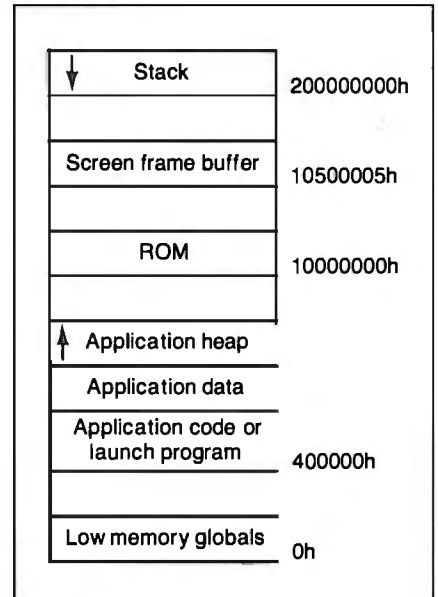

**Figure 2:** Except for the low-memory globals, none of the addresses that A/UX uses are the same as the ones used by the native Mac operating system. This doesn't matter, since everything is referenced through pointers in memory.

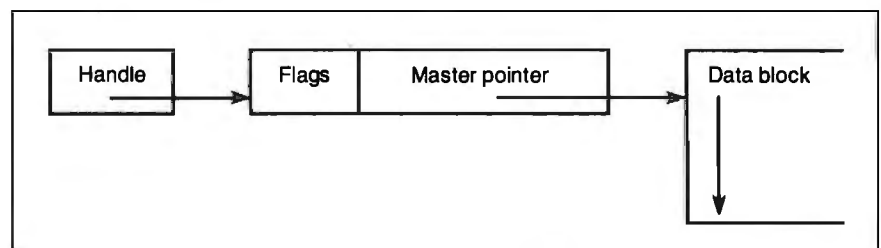

**Figure 3a:** A relocatable memory block under the Macintosh operating system. Flag bits are stored in the high bits of the master pointer. This saves space, but it doesn't work in a 32-bit environment.

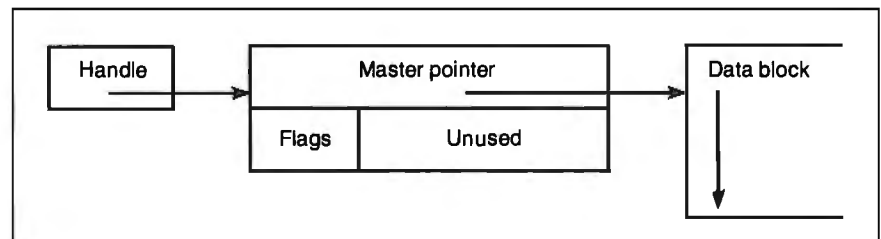

**Figure 3b:** Under the A/UX Toolbox, the flag bits are stored in a separate longword. Some space is unused, but this is 32-bit clean.

cessed the Ticks variable, which contains the number of clock ticks since the last reboot. This variable never gets changed under the A/UX Toolbox; you should use the TickCount access routine, instead. Other such variables include Time and EventQueue.

Application developers are sometimes concerned about the extra CPU time the A-line trap mechanism uses. The overhead is not very large, but it can make a difference in some tight loops. In those cases where the A-line trap overhead is significant, you should consider using the GetTrapAddress trap to get a pointer to the access routine. Then you can call the routine directly, without the overhead of the A-line trap. In the case of a trap like HLock, it is not quite as fast as setting the bit directly, but it will work on all future systems.

### Process Scheduling

Mac applications are event-driven. Typically, the main body of an application is a loop that uses the GetNextEvent trap to look for events, such as keystrokes or mouse clicks. If there are no events pending, GetNextEvent returns null.

The busy-looping model worked fine in the original Mac system. However, it is a waste under a multitasking operating system such as A/UX. Busy looping takes time away from any other processes that are currently running. Also, the process scheduler makes scheduling decisions based on how much CPU time a process has recently used.

To solve this problem, a new trap, named WaitNextEvent, will be added in A/UX 1.1. WaitNextEvent is similar to GetNextEvent, but you use it to yield the CPU until an event is available. This trap is available under the A/UX Toolbox, MultiFinder, and even under the Mac operating system, if you use a recent system file. All future applications should use WaitNextEvent when possible. WaitNextEvent is defined in C like this:

```
short WaitNextEvent(eventMask,
                    theEvent, timeOut, mouseRgn)
short eventMask;
EventRecord *theEvent;
long timeOut;
RgnHandle mouseRgn;
```

The eventMask and theEvent parameters are just like the parameters to GetNextEvent. The eventMask specifies a set of events the application is interested in, and theEvent is a pointer to a record that will get filled in with information about the event. The timeOut parameter defines how long (in sixtieths of a sec-

ond) WaitNextEvent should wait before returning a null event. The mouseRgn specifies a QuickDraw region that contains the mouse. If the mouse moves out of this region while WaitNextEvent is waiting, an event of type app4Event is returned with a value of FA000000h in the message field. This allows an application to use WaitNextEvent even if it is tracking the mouse position.

### Storing Macintosh Files

Another area where A/UX differs greatly from the Mac operating system is in file structure. An A/UX file is just a sequence of bytes. Some information about the file is also stored apart from the data. This information includes the file's name, length, owner, permissions, and creation date. A Mac file has two sequences of bytes: a data and a resource fork. Typically, the data fork contains the same sort of data you would find in an A/UX file. The resource fork contains a list of resources. Resources can store a wide range of things. For example, they often contain templates that describe windows or menus. Often, resources contain code fragments. The segments that make up a Mac application are stored as code resources. You refer to a resource by a resource specification, which is a four-character type, and either an ID number or a name. Resources are manipulated by the Mac resource manager. In addition to the two forks, a Mac file contains information that the Mac Finder uses. This information includes the file's type, creator, and icon location.

Apple has defined two closely related formats for storing Mac files on non-Mac file systems. The formats are called AppleSingle and AppleDouble. The A/UX Toolbox supports both these formats.

In the AppleSingle format, both of the forks and the finder information are all stored in a single Unix file. In the AppleDouble format, the data fork is stored in a separate file. The file containing the resource fork and the finder information has the same name as the file containing the data fork, but it is prepended with a % character. The AppleSingle format is generally more convenient; it is easier to rename, move, and manipulate files in this format. However, the AppleDouble format also has several advantages. First, this is the only way to store resources in an application built under A/UX. The executable code must be stored in a separate file. Second, it is often desirable to access a file's data fork using Unix utilities. This is simple with the AppleDouble format, since the data

fork is in a separate file. Finally, the AppleDouble format files can be more efficient to manipulate than AppleSingle format files. Since both forks are stored in one file with the AppleSingle format, the second fork gets moved whenever the first one increases in size.

A/UX's filenames are 14 characters long. You can use a backslash instead of a colon to separate directories, and the filenames are case sensitive, whereas the Mac does not differentiate between uppercase and lowercase. Also, in ASCII files in the Mac environment, lines are terminated with a carriage return (0Dh); under A/UX lines are terminated with a line feed (0Ah). This difference is usually masked by the C language's newline character.

Another issue unrelated to the file system is that the Toolbox is run as a process in user mode, so privileged instructions are not available. This means you must use move ccr <ea> to access the condition code bits. The instruction ccr is available on the 68020 but not on the 68000, so you will have to check which CPU your code is running on. Because the finder is not available under the Toolbox routines, you must call the InitDialogs and TEInit routines yourself, or use the -i option with the launch command.

### Not Here Yet

Unfortunately, A/UX 1.0 is really only the foundation for a point-and-click Unix. It makes it possible for you to write applications using windows and menus, but you still have to use the same command-line interface and telegraphic commands to use A/UX. A novice can't sit down and execute A/UX commands from windows and menus.

The version of the A/UX Toolbox that shipped with A/UX 1.0 was really only useful for developers. Applications could use the user interface toolbox, but several key features were missing. The most notable omission was access to the printing manager. However, version 1.1, when it becomes available, will fill in these holes by adding support for printing, desk accessories, and color devices.

Ultimately, A/UX will be a Unix that a naive user can use without ever seeing anything but the mouse and window-based user interface that has made the Mac so successful. At the same time, a programmer will still be able to use all the tools that make Unix so powerful. ■

*Rick Daley of Cupertino, California, is a software engineer at Apple Computer. He can be reached on BIX as "editors."*

Only  
\$4.00  
Per Disk

California

# FREEWARE

For  
Mac™

Public Domain and Shareware Software for Macintosh™ Computers  
Programs and Utilities to meet all your computing needs.

## NOVELTY

- **Novelty 1 (M101)** - Contains 3 Blorhythm programs, a diet helper, Morse code and I-Ching astrology.
- **Novelty 2 (M102)** - Contains Macbaby, an educational program written with Videoworks, that teaches the evolution of a baby in the womb. Does not require Videoworks to run, a VW player is included on the disk.



## BASIC PROGRAMS

- These programs require Microsoft Basic (Mbasic) version 2.0 or later to run.
- **Basic Programs 1 - 5 (M103 - M107)** - (5 disk set) Contains over 200 miscellaneous Basic programs. Includes games, business, utilities & more. All the Basic programs we could find on 5 disks.

## GRAPHICS TOOLS

- **Screen Graphics #1 (M108)** - Contains 17 various graphic programs that show on your screen. Hours of fun.
- **Graphic Tools / Printer Utilities (M111)** - Several printer utilities and tools for creating slide shows, editing and making screens and much more.
- **Paint Tools (M112)** - Contains many files for viewing, printing and manipulating paint files. Can be used to view Mac-paint graphics.



## MACPAINT GRAPHICS

These graphics can be printed, viewed or changed by using Mac-paint, Fullpaint or similar bit-mapped paint packages

- **Star Trek Graphics (M115)** - Contains miscellaneous Star Trek graphics. Includes Kirk, Spock, McCoy and more. Great for Star Trek fans.
- **Famous Women #1 & #2 (M116 & M117)** - (2 disk set) Contains miscellaneous famous women graphics. Includes Madonna, Brooke, Marilyn, Tina, Natalie & more.
- **Car Graphics (M118)** - Contains Porsche, BMW, car logos, Mercedes and other car graphics.
- **Holidays Graphics (M119)** - Contains Christmas, 4th of July, Thanksgiving & more holiday graphics.



- **Miscellaneous Objects (M121)** - Contains miscellaneous objects graphics like arrows, aspirin, ban-

dads, cameras, cards, dollar bills, eyeglasses & many more.

- **Disney Characters (M126)** - Contains Minnie, Mickey, Scrooge, & other Disney characters.
- **Animals #1 & #2 (M127 & M128)** - (2 disk set) Contains miscellaneous animal graphics including cheetah, bear, racoon, lion, horse, jaguar, owl, pigs & many more.
- **Planes (M129)** - Contains graphics of planes featuring F-14, F-15, F-16, DC-10, helicopter & others.
- **Fantasy Graphics #1 & #2 (M130 & M131)** - (2 disk set) Contains miscellaneous graphics. Includes: Conan, dragons, castle, ghosts, knights, minotaur & more.



- **Borders (M132)** - Contains miscellaneous borders including thick, thin, gothic, & others.
- **Icons / Clip Arts #1 (M133)** - Contains miscellaneous icon/clip art graphics. 15 various files containing a multitude of small graphics.
- **Icons / Clip Arts #2 (M134)** - Contains miscellaneous icon/clip art graphics. 14 more files of art.



- **Sports (M135)** - Contains miscellaneous sports graphics of baseball, skler, football, tennis, running & others..
- **Space (M136)** - Contains miscellaneous space graphics with Ad Astra, comet, earth, Lost, NASA, Space dock, Space race & more.
- **Famous Men #1 (M138)** - Contains miscellaneous graphics of famous men, includes Beatles, Bogart, Rambo, R2D2, the Coz & more.
- **Comic Book Characters (M140)** - Contains Garfield, Bill the Cat, Opus & others.
- **Miscellaneous Graphics #1 (M141)** - Contains miscellaneous graphics that could not be categorized. Features Batman, billboard, ghostbusters, robots, jack in the box & others.

## FONTS

- **Laser Fonts #1 (M144)** - Contains fonts that require an Apple Laser-writer. Anti-particle, Avant Garde, Bookman, New Helvetica, New Century & Zapf Dingbats. Also 2 utility folders.
- **Laser Fonts #2 (M145)** - Contains fonts that require an Apple Laser-writer. Palatino, Thin Times, Tiny Helvetica & Zapf Chancery. Also has Postscript Worker & PS Tester utilities.

## UTILITIES

- **Editor Utilities #1 (M166)** - Contains miscellaneous text editor utilities
- **Editor Utilities #2 (M167)** - Contains more miscellaneous text editor utilities
- **Communications #1 (M168)** - Contains Red Ryder modem utility.
- **Communications #2 (M169)** -

Contains miscellaneous modem utilities.

- **Communications #3 (M170)** - Contains miscellaneous modem utilities & programs.
- **Copy Utilities (M171)** - Contains miscellaneous copy and initialization utilities Format disks faster, copy disks quickly & easily.



## DESK ACCESORIES

- **DA's #1 (M182)** - Contains screen saver desk accesories.
- **DA's #2 (M183)** - Contains business desk accesories.
- **DA's #3 (M184)** - Contains desktop desk accesories.
- **DA's #5 (M186)** - Contains miscellaneous keyboard & printer desk accesories.
- **DA's #6 (M187)** - Contains miscellaneous paint & word processing-desk accesories.
- **DA's #9 (M190)** - Contains humorous or games desk accesories.

## BUSINESS

- **Business #1 (M207)** - Contains Inventory, Depreciation, Auto expense, amortize, bill payer & mortgage calc.
- **Business #2 (M208)** - Contains scheduler, New Rolodex, rolodex, Pcalc, reminder, directory, Address & Idea Liner.
- **Business #3 (M209)** - Contains miscellaneous Pagemaker templates, Requires Pagemaker to use or modify.
- **Business #4 (M210 - M214)** - (5 disk set) Contains miscellaneous Multiplan/Excel templates. All the templates we could find. Requires Multiplan/Excel to use or modify.



## EDUCATION

- **Math #1 (M216)** - Contains Mac-Grapher, MathMaster, Number Investigator & two other programs. Ages 10 - adult.
- **Math #2 (M217)** - Contains Mac-Graph, MacMath™ Demo & Math 21 3D grapher.
- **Spelling Aids (M219)** - Contains Word Drill, Spelling Tutor, Spin & Spell, Word Search, Typing Tutor & Venn. Can be modified for all ages.
- **Childrens (M220)** - Contains Animals, Dot 2 Dot, Flashcards & Laura's Letters. Ages 5 and up.



- **Teachers Aids (M221)** - Contains Gradesdatabase & Quizmaster.

## GAMES

- **Board, Breakout & Flight Games (M223)** - Contains Yahtzee, Connect 4, Pente Tic Tac Toe, Blocks, Bricks, Stuntcopter & many more..

- **Trivia & Maze Games (M224)** - Contains MacPuzzle, Maze, Mr. Cycloid, Trivia & others.
- **Mind Games (M225)** - Contains Concentration, Destroyer, Eliza, GoMoku, Master Guess and several others.
- **Novelty Games (M226)** - Contains Blorhythm, Climber, Cookie, Juggler, Lotto 6/49, Mac Attack & more.



- **Space Games (M227)** - Contains Asteroids, Pierre Molle, Space Artillery, Space Invaders & others.
- **Card & Casino Games (M228)** - Con-

- tains Blackjack, Casino, DrawPoker, Hearts & several more.
- **Word Games (M229)** - Contains Ars Magna™, Storymaker, Websters Revenge (DEMO), & Wheel.
- **Arcade Games (M230)** - Contains Bash Big Blue, Centipede, Daleks, Mac Bugs & others.
- **Star Trek (M232)** - Also contains miscellaneous adventure games.
- **Adventure Games #1 (M233)** - Contains Crystal Quest adventure game--DEMO.



## ORDER FORM

Please write disk numbers.

-----  
 -----  
 -----  
 -----  
 NAME \_\_\_\_\_  
 ADDRESS \_\_\_\_\_  
 CITY \_\_\_\_\_ ST \_\_\_\_\_ ZIP \_\_\_\_\_  
 PHONE ( ) \_\_\_\_\_ - \_\_\_\_\_

Multiple disk sets are calculated at the number of disks in the set at \$4.00. IE: 2 disks @ \$4.00 = \$8.00.

# of disks \_\_\_\_\_ @ \$4.00 = \_\_\_\_\_  
 CA Res. Sales Tax (6.5%) = \_\_\_\_\_  
 Shipping & Handling = 4.00  
 All orders sent UPS ground.

TOTAL = \_\_\_\_\_  
 All monies to be in US funds only. International orders require \$10.00 for Shipping & Handling. Please send check or money order to:

## CALIFORNIA FREEWARE

1747 E. Ave Q, Unit C-1  
 Department M  
 Palmdale, CA 93550  
**(805) 273-0300**

Hours M-F 9 am - 5 pm PST.  
 COD orders placed before 1pm PST sent same day.  
 Sorry we do not accept Credit Cards at this time.

Call or write for free catalog.  
 All diskettes are formatted single sided (400k).

# HOW DO YOU GET A JOB WITHOUT EXPERIENCE? AND HOW DO YOU GET EXPERIENCE WITHOUT A JOB

Most young people have one answer to this problem. They avoid it until they're out of college. But they could be getting solid work experience while they're still in college. With your company's help. And ours.

We're Co-op Education. A nationwide program that helps college students get real jobs for real pay, while they're getting an education.

But we can't do it without you.

Those real jobs have to come from real companies. Like yours.

For more information on how you can participate in this valuable program, write Co-op Education, Box 775E, Boston, MA 02115.

Not only will you be giving students a chance to earn money and pick up the most valuable kind of knowledge, you'll be giving yourselves a chance to pick up the most valuable kind of employee.

## Co-op Education.

You earn a future when you earn a degree.



A Public Service of This Publication ©1987 National Commission for Cooperative Education



# EDITORIAL INDEX BY COMPANY

Index of companies covered in articles, columns, or news stories in this issue  
Each reference is to the first page of the article or section in which the company name appears

INQUIRY #	COMPANY	PAGE	INQUIRY #	COMPANY	PAGE	INQUIRY #	COMPANY	PAGE
M258	ACCESS TECHNOLOGY	35		PRODUCTS	57	M212	PBC ENTERPRISES	71
M244	ACIUS	21	M255	HUBBARD FURNITURE	35	M260	PBI SOFTWARE	35
M211	ACTIVISION	71	M144	HYPERPRESS PUBLISHING	7	M188	PERFECTEK	57
	ADDISON-WESLEY	83	M163	INFORMATION PRESENTATION TECHNOLOGIES	57	M184	PERIPHERAL LAND	57
M143	ALDUS	7, 21	M164	INFOSPHERE	57	M256	PRIAM	35
M246			M165			M215	PUBLISHING RESOURCES	71
M155	ALISA SYSTEMS	57	M187	INSIGNIA SOLUTIONS	57	M172	SHIVA	57
M156			M213	KANOBE ASSOCIATES	71	M250	SILICON BEACH SOFTWARE	21
M243	ALTSYS	21	M166	KINETICS	57	M257	SOFTVIEW	35
M183	APPLE COMPUTER	57, 71	M167			M248	SOFTWARE SUPPLY	21
M214			M168	KMW SYSTEMS	57	M249	SOLUTIONS INTERNATIONAL	21
M186	AST RESEARCH	57	M245	LIVING VIDEOTEXT	21	M259	STRATEGIC STUDIES GROUP	35
M157	AVATAR TECHNOLOGIES	57	M253	LUNDEEN & ASSOCIATES	21		SUN MICROSYSTEMS	57
M247	CE SOFTWARE	21	M251	MACROMIND	21, 35	M141	SUPERMAC TECHNOLOGY	7
M181	COMPATIBLE SYSTEMS	57	M261			M173	SYMANTEC	57
M158	CORVUS SYSTEMS	57	M169	MENLO BUSINESS SYSTEMS	57	M262	T/MAKER	35
M254	DATADESK INTERNATIONAL	35	M145	MICROLYTICS	7	M174	TANGENT TECHNOLOGIES	57
M180	DATAVIZ	57	M252	MICROSOFT	21	M175	TECHNOLOGY CONCEPTS	57
M182	DAYNA COMMUNICATIONS	57	M185	MICROSOLUTIONS	57	M242	TELERBOTICS INTERNATIONAL	21
M159	DIGITAL COMMUNICATIONS ASSOCIATES	57	M241	MINDSCAPE	21	M152	3COM	57
M160	DOVE COMPUTER	57		NETWORK INNOVATIONS	57	M153		
	DUPONT ELECTRONICS	57		NORTHERN TELECOM	57	M154		
M142	FARALLON COMPUTING	7, 57	M170	PACER SOFTWARE	57	M176	TOPS	57
M162			M171				TOUCH COMMUNICATIONS	57
	HARVARD UNIVERSITY PRESS	71				M177	TRI DATA SYSTEMS	57
M161	HAYES MICROCOMPUTER					M178	WALKER RICHER & QUINN	57

## BYTE ADVERTISING SALES STAFF:

Dennis J. Riley, Director of Sales, One Phoenix Mill Lane, Peterborough, NH 03458, tel. (603) 924-9281

**NEW ENGLAND**  
ME, NH, VT, MA, RI, ONTARIO  
CANADA & EASTERN CANADA  
John C. Moon (617) 262-1160  
McGraw-Hill Publications  
575 Boylston Street  
Boston, MA 02116

**ATLANTIC**  
NY, NYC, CT, NJ (NORTH)  
Leah G. Rabinowitz (212) 512-2096  
McGraw-Hill Publications  
1221 Avenue of the Americas—  
36th Floor  
New York, NY 10020

(203) 968-7111  
McGraw-Hill Publications  
Building A—3rd Floor  
777 Long Ridge Road  
Stamford, CT 06902

**EAST**  
PA, NJ (SOUTH),  
MD, VA, W. VA, DE, D.C.  
(215) 496-3833  
McGraw-Hill Publications  
Three Parkway  
Philadelphia, PA 19102

**SOUTHEAST**  
NC, SC, GA, FL, AL, TN  
Carolyn F. Lovett (404) 252-0626  
McGraw-Hill Publications  
4170 Ashford-Dunwoody Road  
Suite 420  
Atlanta, GA 30319

**MIDWEST**  
IL, MO, KS, IA, ND, SD, MN,  
KY, OH, WI, NB, IN, MI, MS  
Bob Denmead (312) 751-3740  
McGraw-Hill Publications  
Blair Building  
645 North Michigan Ave.  
Chicago, IL 60611

**SOUTHWEST,  
ROCKY MOUNTAIN**  
CO, WY, OK, TX, AR, LA  
Karl Heinrich (713) 462-0757  
McGraw-Hill Publications  
7600 W. Tidwell Rd.—Suite 500  
Houston, TX 77040

**SOUTH PACIFIC**  
SOUTHERN CA, AZ, NM,  
LAS VEGAS  
Jack Anderson (714) 557-6292  
McGraw-Hill Publications  
3001 Red Hill Ave.  
Building #1—Suite 222  
Costa Mesa, CA 92626

Tom Harvey (213) 480-5243  
McGraw-Hill Publications  
3333 Wilshire Boulevard #407  
Los Angeles, CA 90010

**NORTH PACIFIC**  
HI, WA, OR, ID, MT,  
NORTHERN CA,  
NV (except LAS VEGAS), UT,  
W. CANADA  
Mike Kisseberth (415) 362-4600  
McGraw-Hill Publications  
425 Battery Street  
San Francisco, CA 94111

Bill McAfee (415) 349-4100  
McGraw-Hill Publications  
951 Mariner's Island Blvd.—  
3rd Floor  
San Mateo, CA 94404

**BYTE BITS (2x3)**  
Dan Harper (603) 924-6830  
BYTE Publications  
One Phoenix Mill Lane  
Peterborough, NH 03458

**The Buyer's Mart (1x2)**  
Mark Stone (603) 924-3754  
BYTE Publications  
One Phoenix Mill Lane  
Peterborough, NH 03458

**Regional Advertising**  
(So. CA, Mid-Atlantic,  
New York/New England)  
Elisa Lister (603) 924-6830  
BYTE Publications  
One Phoenix Mill Lane  
Peterborough, NH 03458

**Regional Advertising**  
(Southeast, Southwest)  
Denise Vernier (603) 924-9281  
BYTE Publications  
One Phoenix Mill Lane  
Peterborough, NH 03458

**Regional Advertising**  
(Pacific NW, Midwest,  
New York/New England)  
Scott Gagnon (603) 924-6830  
BYTE Publications  
One Phoenix Mill Lane  
Peterborough, NH 03458

**BYTE Deck Mailings  
National**  
Ed Ware (603) 924-6166  
BYTE Publications  
One Phoenix Mill Lane  
Peterborough, NH 03458

**A/E/C Computing Deck  
Computing for Engineers**  
Mary Ann Goulding  
(603) 924-9281  
BYTE Publications  
One Phoenix Mill Lane  
Peterborough, NH 03458

## International Advertising Sales Staff:

Mr. Hans Csokor  
Publimedia  
Reisenstrasse 61  
A-1037 Vienna, Austria  
222 75 76 84

Mrs. Gurit Gepner  
McGraw-Hill Publishing Co.  
PO Box 2156  
Bat Yam, 59121 Israel  
3 866561 321 39

RosWeyman  
Serving Germany, Austria, & Switzerland  
McGraw-Hill Publishing Co.  
34 Dover St.  
London W1X 4BR  
England 01 493 1451

Mrs. Maria Sarmiento  
Pedro Teixeira 8, Off. 320  
Iberia Mart I  
Madrid 4, Spain  
1 45 52 891

Michael Karnig  
Andrew Karnig & Associates  
Finnbodavagen  
S-131 31 Nacka, Sweden  
8-44 0005

Mr. Alain Faure  
McGraw-Hill Publishing Co.  
128 Faubourg Saint Honore  
75008 Paris  
France  
(1) 42-89-03-81

Karen Lennie  
McGraw-Hill Publishing Co.  
34 Dover St.  
London W1X 4BR  
England 01 493 1451

Emilio Zerboni  
McGraw-Hill Publishing Co.  
Via Flavio Baracchini 1  
20123 Milan, Italy  
(2) 89010103

Seavex Ltd.  
400 Orchard Road, #10-01  
Singapore 0923  
Republic of Singapore  
Tel: 734-9790  
Telex: RS35539 SEAVEX

Seavex Ltd.  
503 Wilson House  
19-27 Wyndham St.  
Central, Hong Kong  
Tel: 5-260149  
Telex: 60904 SEVEX HX

Hiro Morita  
McGraw-Hill Publishing Co.  
Overseas Corp.  
Room 1528  
Kasumigaseki Bldg.  
3-2-5 Kasumigaseki,  
Chiyoda-Ku  
Tokyo 100, Japan  
3 581 9811

Mr. Ernest McCrary  
Empresa Internacional de  
Comunicacoes Ltda.  
Rua da Consolacao, 222  
Conjuntio 103  
01342 Sao Paulo, S.P., Brasil  
Tel: (11) 259-3811  
Telex: (100) 32122 EMBN

# READER SERVICE

To get further information on the products advertised in BYTE, fill out the reader service card by circling the numbers on the card that correspond to the inquiry number listed with the advertiser. This index is provided as an additional service by the publisher, who assumes no liability for errors or omissions.

## Alphabetical Index to Advertisers

Inquiry No.	Page No.	Inquiry No.	Page No.	Inquiry No.	Page No.
M1 1ST DESK SYSTEMS, INC. ....	CIV	M16 COMPUTABLE FUNCTIONS INC. ....	87	M34 MANX SOFTWARE SYSTEMS .....	51
M2 AFFINITY MICROSYSTEMS .....	15	* COMPUTER CONTINUUM .....	79	* MCGRAW-HILL INFORMATION, ...	18,19
M3 ALLAN BONADIO ASSOC. ....	14	M18 COREL SOFTWARE .....	45	M35 MICRO CAD/CAM INC. ....	41
M4 ALPHA MICRO .....	70	M19 D2 SOFTWARE .....	36	M36 NANA0 .....	56
M5 ALPHA MICRO .....	70	M58 DATAPRO .....	88	M37 NANA0 .....	56
* APPLE COMPUTER .....	2,3	M20 DCM DATA PRODUCTS .....	13	M38 NATIONAL INSTRUMENTS .....	13
M56 APPLIED DATA COMMUNICATION ..	40	M21 DESIGN SCIENCE .....	37	M39 PALOMAR SOFTWARE INC. ....	54
* AST RESEARCH INC. ....	27	M22 DOUGLAS ELECTRONICS .....	20	M40 PARAGON CONCEPTS INC. ....	24
M7 BASF .....	28	M23 EDUCOMP COMPUTER SERVICES ..	38	M42 PRACTICAL PERIPHERALS .....	59
M8 BEVERLY HILLS COMPUTER .....	7	M24 EDUCOMP COMPUTER SERVICES ..	38	M43 SECOND WAVE INC. ....	16
M9 BORLAND INTERNATIONAL .....	5	M25 ERGOTRON .....	11	M44 SHER-MARK PRODUCTS .....	39
M10 BORLAND INTERNATIONAL .....	5	M26 FOX SOFTWARE .....	CII	M45 SHREVE SYSTEMS .....	10
M11 BRAINPOWER .....	43	M27 GENERIC SOFTWARE .....	9	M47 SUMMAGRAPHICS .....	81
M57 BYTE BITS .....	79	M28 GENERIC SOFTWARE .....	9	M48 TPS ELECTRONICS .....	69
* BYTE SUB SERVICE .....	77	M29 HARDWARE HOUSE .....	8	M49 VAMP INC. ....	34
M41 CALIFORNIA FREEWARE .....	93	* INFORMIX SOFTWARE .....	33	M50 VAR ECONOMETRICS .....	12
M12 CAPILANO COMPUTING .....	80	M30 IO TECH .....	42	M51 WARP NINE ENGINEERING .....	6
M13 CE SOFTWARE .....	23	M31 MACONLY, INC. ....	17	M52 WEST RIDGE DESIGNS .....	12
M14 CH PRODUCTS .....	82	M32 MACDOCTOR ELECTRONICS .....	CIII	M53 WHITE PINE SOFTWARE .....	10
M15 CH PRODUCTS .....	82	M33 MAINSTAY .....	25		

\* Correspond directly with company

## Index to Advertisers by Product Category

Inquiry No.	Page No.	Inquiry No.	Page No.	Inquiry No.	Page No.	Inquiry No.	Page No.
<b>HARDWARE</b>							
M60	ADD INS	M66	MONITORS	M50	VAR ECONOMETRICS .....	12	M9 BORLAND INTERNATIONAL .....
* AST RESEARCH INC. ....	27	M36 NANA0 .....	56	M72	APPLE2/MAC APPLICATIONS		M10 BORLAND INTERNATIONAL .....
		M37 NANA0 .....	56		Miscellaneous		M19 D2 SOFTWARE .....
M61	DRIVES	M44	SHER-MARK PRODUCTS .....	M23	EDUCOMP COMP. SERVICES ..	38	M34 MANX SOFTWARE SYSTEMS ..
M18 COREL SOFTWARE .....	45	M67	PRINTERS/PLOTTERS	M24	EDUCOMP COMP. SERVICES ..	38	M39 PALOMAR SOFTWARE INC. ...
M32 MACDOCTOR ELECTRONICS . CIII		M30	IO TECH .....	M73	APPLE2/MAC APPLICATIONS		M78
M62	INSTRUMENTATION	M68	SCANNERS		Word Processing		M42 PRACTICAL PERIPHERALS .....
* COMPUTER CONTINUUM .....	79	M48	TPS ELECTRONICS .....	M40	PARAGON CONCEPTS INC. ...	24	M53 WHITE PINE SOFTWARE .....
M30 IO TECH .....	42	M51	WARP NINE ENGINEERING ....	M74	APPLE2/MAC—CAD		
M63	KEYBOARDS/MICE	M69	SYSTEMS	M22	DOUGLAS ELECTRONICS .....	20	<b>M79</b>
M14 CH PRODUCTS .....	82	* APPLE COMPUTER .....	2,3	M27	GENERIC SOFTWARE .....	9	<b>MAIL ORDER/</b>
M15 CH PRODUCTS .....	82			M28	GENERIC SOFTWARE .....	9	<b>RETAIL</b>
M47 SUMMAGRAPHICS .....	81			M35	MICRO CAD/CAM INC. ....	41	M8 BEVERLY HILLS COMP. ....
M64	MASS STORAGE			M49	VAMP INC. ....	34	M41 CALIFORNIA FREEWARE ....
M4 ALPHA MICRO .....	70			M75	APPLE2/MAC—LAN		M29 HARDWARE HOUSE .....
M5 ALPHA MICRO .....	70			M13	CE SOFTWARE .....	23	M31 MACONLY, INC. ....
M7 BASF .....	28			M20	DCM DATA PRODUCTS .....	8	M45 SHREVE SYSTEMS .....
M18 COREL SOFTWARE .....	45			M76	APPLE2/MAC—LANGUAGES		
* MISCELLANEOUS				M9	BORLAND INTERNATIONAL .....	5	<b>M80</b>
M56 APPLIED DATA COMM. ....	40			M10	BORLAND INTERNATIONAL .....	5	<b>EDUCATIONAL/</b>
* AST RESEARCH INC. ....	27			M16	COMPUTABLE FUNCTIONS INC.87		<b>INSTRUCTIONAL</b>
M43 SECOND WAVE INC. ....	16			M20	DCM DATA PRODUCTS .....	8	M58 DATAPRO .....
M44 SHER-MARK PRODUCTS .....	39			M33	MAINSTAY .....	25	* INFORMIX SOFTWARE .....
M65	MODEMS/MULTIPLEXORS			M34	MANX SOFTWARE SYSTEMS ..	51	* MCGRAW-HILL INFO .....
M42 PRACTICAL PERIPHERALS .....	59			M77	APPLE2/MAC—UTILITIES		18,19
				M2	AFFINITY MICRO SYSTEMS ...	15	

\* Correspond directly with company

To receive free information on Macintosh products and advertisers in this special supplement, just follow steps 1, 2 and 3.

# 1

Circle numbers on reply card which correspond to numbers assigned to items of interest to you.

# 2

Check all the appropriate answers to questions "A" through "F".

# 3

Print your name and address and mail.

Circle for FREE INFORMATION:

M1	M2	M3	M4	M5	M6	M7	M78	M79	M80	M81	M82	M83	M84	M155	M156	M157	M158	M159	M160	M161	M232	M233	M234	M235	M236	M237	M238
M8	M9	M10	M11	M12	M13	M14	M85	M86	M87	M88	M89	M90	M91	M162	M163	M164	M165	M166	M167	M168	M239	M240	M241	M242	M243	M244	M245
M15	M16	M17	M18	M19	M20	M21	M92	M93	M94	M95	M96	M97	M98	M169	M170	M171	M172	M173	M174	M175	M246	M247	M248	M249	M250	M251	M252
M22	M23	M24	M25	M26	M27	M28	M99	M100	M101	M102	M103	M104	M105	M176	M177	M178	M179	M180	M181	M182	M253	M254	M255	M256	M257	M258	M259
M29	M30	M31	M32	M33	M34	M35	M106	M107	M108	M109	M110	M111	M112	M183	M184	M185	M186	M187	M188	M189	M260	M261	M262	M263	M264	M265	M266
M36	M37	M38	M39	M40	M41	M42	M113	M114	M115	M116	M117	M118	M119	M190	M191	M192	M193	M194	M195	M196	M267	M268	M269	M270	M271	M272	M273
M43	M44	M45	M46	M47	M48	M49	M120	M121	M122	M123	M124	M125	M126	M197	M198	M199	M200	M201	M202	M203	M274	M275	M276	M277	M278	M279	M280
M50	M51	M52	M53	M54	M55	M56	M127	M128	M129	M130	M131	M132	M133	M204	M205	M206	M207	M208	M209	M210	M281	M282	M283	M284	M285	M286	M287
M57	M58	M59	M60	M61	M62	M63	M134	M135	M136	M137	M138	M139	M140	M211	M212	M213	M214	M215	M216	M217	M288	M289	M290	M291	M292	M293	M294
M64	M65	M66	M67	M68	M69	M70	M141	M142	M143	M144	M145	M146	M147	M218	M219	M220	M221	M222	M223	M224	M295	M296	M297	M298	M299		
M71	M72	M73	M74	M75	M76	M77	M148	M149	M150	M151	M152	M153	M154	M225	M226	M227	M228	M229	M230	M231							

Fill out this coupon carefully. PLEASE PRINT. Requests cannot be honored unless the zip code is included. Supplement inquiries cannot be requested via TIPS. This card is valid for 6 months from cover date.

**A. Do you have management responsibilities within your company?**

- Senior-level management
- Other management
- Non-management

**B. Reason for request: (Check all that apply.)**

- Business use for yourself
- Business use for your company
- Personal use

**C. For how many Macintosh personal computers do you currently buy, specify or approve brands of products?**

- 10 or less
- 11-25
- 26-99
- 100 or more

**D. For how many Macintosh personal computers will you buy, specify or approve brands of products within the next two years?**

- 10 or less
- 11-25
- 26-99
- 100 or more

**E. In total, how many Macintosh personal computers is your entire organization considering for purchase within the next two years?**

- 10 or less
- 11-25
- 26-99
- 100-499
- 500 or more

**F. What type of personal computer do you primarily use?**

- IBM AT or 80286-based compatible
- Compaq 386 or 80386-based compatible
- IBM PS/2 (with Micro-Channel) or compatible
- Apple Mac (except Mac II)
- Apple Mac II
- Other

Name \_\_\_\_\_  
 Title \_\_\_\_\_ Business Phone (\_\_\_\_) \_\_\_\_\_  
 Company \_\_\_\_\_  
 Address \_\_\_\_\_  
 City \_\_\_\_\_ State \_\_\_\_\_ Zip \_\_\_\_\_



NO POSTAGE  
NECESSARY  
IF MAILED  
IN THE  
UNITED STATES

## BUSINESS REPLY MAIL

FIRST CLASS MAIL PERMIT NO. 176 DALTON, MA

POSTAGE WILL BE PAID BY ADDRESSEE

# BYTE

READER SERVICE  
 PO Box 5110  
 Pittsfield, MA 01203-9926  
 USA

# Macintosh Supplement Free Information

receive free information on Macintosh products and advertisers in this special supplement, just follow steps 1, 2 and 3.

- 1** Circle numbers on reply card which correspond to numbers assigned to items of interest to you.
- 2** Check all the appropriate answers to questions "A" through "F".
- 3** Print your name and address and mail.



NO POSTAGE  
NECESSARY  
IF MAILED  
IN THE  
UNITED STATES

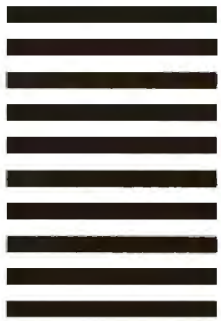

**BUSINESS REPLY MAIL**  
FIRST CLASS MAIL PERMIT NO. 176 DALTON, MA

POSTAGE WILL BE PAID BY ADDRESSEE

**BYTE**  
READER SERVICE  
PO Box 5110  
Pittsfield, MA 01203-9926  
USA

Circle for FREE INFORMATION

M1	M2	M3	M4	M5	M6	M7	M78	M79	M80	M81	M82	M83	M84	M155	M156	M157	M158	M159	M160	M161	M232	M233	M234	M235	M236	M237	M238
M8	M9	M10	M11	M12	M13	M14	M85	M86	M87	M88	M89	M90	M91	M162	M163	M164	M165	M166	M167	M168	M239	M240	M241	M242	M243	M244	M245
M15	M16	M17	M18	M19	M20	M21	M92	M93	M94	M95	M96	M97	M98	M169	M170	M171	M172	M173	M174	M175	M246	M247	M248	M249	M250	M251	M252
M22	M23	M24	M25	M26	M27	M28	M99	M100	M101	M102	M103	M104	M105	M176	M177	M178	M179	M180	M181	M182	M253	M254	M255	M256	M257	M258	M259
M29	M30	M31	M32	M33	M34	M35	M106	M107	M108	M109	M110	M111	M112	M183	M184	M185	M186	M187	M188	M189	M260	M261	M262	M263	M264	M265	M266
M36	M37	M38	M39	M40	M41	M42	M113	M114	M115	M116	M117	M118	M119	M190	M191	M192	M193	M194	M195	M196	M267	M268	M269	M270	M271	M272	M273
M43	M44	M45	M46	M47	M48	M49	M120	M121	M122	M123	M124	M125	M126	M197	M198	M199	M200	M201	M202	M203	M274	M275	M276	M277	M278	M279	M280
M50	M51	M52	M53	M54	M55	M56	M127	M128	M129	M130	M131	M132	M133	M204	M205	M206	M207	M208	M209	M210	M281	M282	M283	M284	M285	M286	M287
M57	M58	M59	M60	M61	M62	M63	M134	M135	M136	M137	M138	M139	M140	M211	M212	M213	M214	M215	M216	M217	M288	M289	M290	M291	M292	M293	M294
M64	M65	M66	M67	M68	M69	M70	M141	M142	M143	M144	M145	M146	M147	M218	M219	M220	M221	M222	M223	M224	M295	M296	M297	M298	M299		
M71	M72	M73	M74	M75	M76	M77	M148	M149	M150	M151	M152	M153	M154	M225	M226	M227	M228	M229	M230	M231							

Fill out this coupon carefully. PLEASE PRINT. Requests cannot be honored unless the zip code is included. Supplement inquiries cannot be requested via TIPS. This card is valid for 6 months from cover date.

- A. Do you have management responsibilities within your company?**
- 1 Senior-level management
  - 2 Other management
  - 3 Non-management
- B. Reason for request: (Check all that apply.)**
- 1 Business use for yourself
  - 2 Business use for your company
  - 3 Personal use
- C. For how many Macintosh personal computers do you currently buy, specify or approve brands of products?**
- 1 10 or less
  - 2 11-25
  - 3 26-99
  - 4 100 or more

- D. For how many Macintosh personal computers will you buy, specify or approve brands of products within the next two years?**
- 1 10 or less
  - 2 11-25
  - 3 26-99
  - 4 100 or more

- E. In total, how many Macintosh personal computers is your entire organization considering for purchase within the next two years?**
- 1 10 or less
  - 2 11-25
  - 3 26-99
  - 4 100-499
  - 5 500 or more

- F. What type of personal computer do you primarily use?**
- 1 IBM AT or 80286-based compatible
  - 2 Compaq 386 or 80386-based compatible
  - 3 IBM PS/2 (with Micro-Channel) or compatible
  - 4 Apple Mac (except Mac II)
  - 5 Apple Mac II
  - 6 Other

Name \_\_\_\_\_

Title \_\_\_\_\_ Business Phone (\_\_\_\_) \_\_\_\_\_

Company \_\_\_\_\_

Address \_\_\_\_\_

City \_\_\_\_\_ State \_\_\_\_\_ Zip \_\_\_\_\_

# If you think all memory upgrades are created equal, let us make a few points of distinction

FREE  
with Brainstorm:  
HyperCard™ with 4 Meg  
MultiFinder™ with 2 or 4 Meg

**B**efore you buy a memory upgrade, it pays to really examine what you're getting for your money.

We can show you what to look for by making these points of distinction on Brainstorm,™ the complete memory expansion kit from Mac Doctor Electronics.

## GUARANTEED EXPANDABILITY

All memory upgrades are expandable, right? Wrong. Only Brainstorm guarantees full expandability up to 4 megabytes. When you try to expand the others, they require you to insert memory chips that they don't even provide! Or they tell you to remove the Mac's motherboard and wait 8 weeks to get your upgrade back.

Brainstorm lets you upgrade quickly and easily by simply exchanging a plug-in memory module. You can even do it yourself.

## SOFTWARE THAT OUTPERFORMS THE REST

We're pointing out the fact that Brainstorm comes with a complete set of Performance Software™. Of course, most upgrades include utility software.

But what really sets us apart is our user's *Guide To Increased Mac Performance*.

This guide tells you in plain English how to squeeze every byte of usefulness out of your memory increase—and that's a definite distinction.

able motherboard space. In fact, it's so compact that even at 4 megabytes, Brainstorm accommodates both internal hard drives

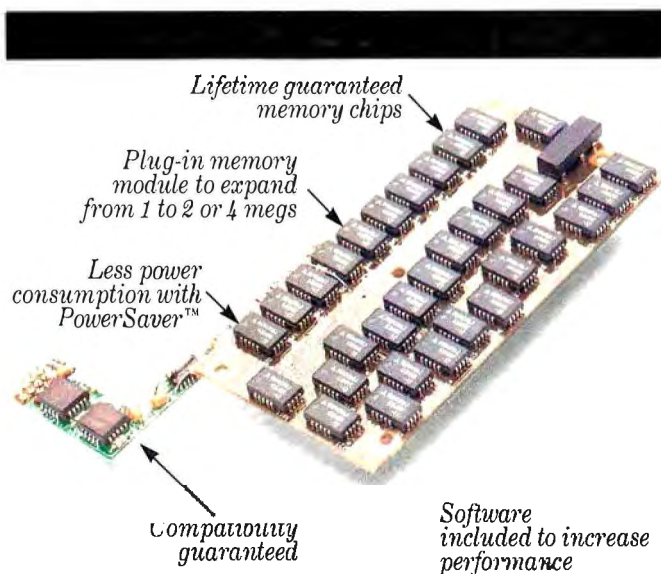

## NO FAN NEEDED

Brainstorm doesn't require a fan to keep its cool, because it uses special PowerSaver™ and CMOS memory chips that reduce memory energy consumption over 50%.

That's why you can increase memory size up to four times and run as cool as before! Just ask the others to do the same trick...

## THE SMALLEST UPGRADE GIVES YOU MORE

The Brainstorm memory kit doesn't penalize you by taking all of your avail-

able motherboard space. And even allows you to install the daughterboards of accelerators.

## GUARANTEES THE OTHERS CAN'T TOUCH

Mac Doctor guarantees that Brainstorm will function without defect or we will repair or replace it free for one year. The memory chips are guaranteed for a lifetime—free replacement for as long as you own your Macintosh. And, you get the special guarantees of both expandability and compatibility.

## 100% COMPATIBILITY WITHOUT FAIL

Use whatever Apple software and accessories you want with Brainstorm, because it's fully compatible with both old and new Apple ROMs, the 400K and 800K disk drives and all software for Macintosh computers.

## FREE NEWSLETTER ON INCREASING MAC PRODUCTIVITY

Call today and get a free subscription to *Brainstorming*, the bimonthly newsletter that explains how memory upgrades work and gives you tips on getting the most from your Mac.

See how Brainstorm can improve your Mac's productivity at a price you can afford; only \$779 for a Brainstorm with a two megabyte module for a Mac 512E. Order Brainstorm now by calling (415) 964-2131, extension 25.

And learn the distinction between a quality memory upgrade—and all the rest. Mac Doctor Electronics, 1145 Terra Bella Avenue, Mountain View, CA 94043.

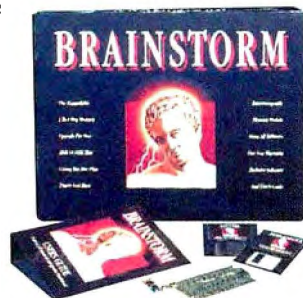

# Easy-To-Use Macintosh® Vertical Market Databases for Every Size Business.

Macintosh is a Registered Trademark of Apple Computer, Inc.

## Accessory Programs:

1stDESK accessory programs increase data productivity, versatility, and appearance.

- **1stPORT-4: File Transfer and Conversion.**

1stPORT is the only productive method to transfer and convert any data, formatted or unformatted, from any computer or other data source. 1stPORT features our exclusive graphic interface that reformats column boundaries easily. Optional HyperAccess automation.

LINE WELL where you get the new "lines". Drag a LINE to add or change a boundary.

Part	Area	Company	#	Price
AXLES	NORTH	Ajax Co.	1	2113.35
AXLES	SOUTH	Harris Motor Co.	1	83362.02
AXLES	NORTH	Edison Tools Co.	4	65397.10

- **1stSCAN-4: Graphic Forms**

1stSCAN automatically creates an exact reflection of your printed form as a database entry screen in 90 seconds from any MacPaint file. The file created is a standard 1stDESK file, ready to enter up to 2 billion records and print with Laser quality fonts.

HEALTH INSURANCE CLAIM FORM (CHECK APPLICABLE PROGRAM BLOCK BELOW)			
<input type="checkbox"/> CHAMPUS (SPONSOR'S SSI)	<input type="checkbox"/> CHAMPVA (VA FILE NO.)	<input type="checkbox"/> FECA BLACK LUNG (SSN)	<input type="checkbox"/> OTHER (CERTIFICATE SSI)
PATIENT AND INSURED (SUBSCRIBER) INFORMATION			
1. PATIENT'S DATE OF BIRTH		3. INSURED'S NAME (LAST NAME, FIRST NAME, MIDDLE INITIAL)	
5. PATIENT'S SEX MALE <input type="checkbox"/> FEMALE <input type="checkbox"/>		6. INSURED'S I.D. NO. FOR PROGRAM CHECKED ABOVE	

- **1stMERGE Level-3 and -4: Professional Mail Merge.**

1stMERGE is a stand-alone list manager that creates a standard 1stDESK file and outputs directly to your word processing program with three mouse clicks. Create a form letter in any word processing program that can Save-as-MacWrite. 1stMERGE inserts the names just as though it were personally typed. Just use "[ ]" brackets to define the data insertion points.

### Alligator Acres

[First Name] [Last Name]  
[Str. Address]  
[City], [State] [Zip Code]

Dear [Title] [Last Name],

Imagine yourself enjoying all these attractions as a landowner in sunny south central Florida at an unbelievable price! The [Last Name] family can be the envy of everyone in [City], [State] when you announce you're moving from [Str. Address] to Alligator Acres!

- **1stBBS: Remote Bulletin Board.**

- **1stGATE: BBS, Gateway, and Remote Database.**

1stDESKS' simple, unique, long term solution to global information exchange applications is accomplished remotely by combining both distributed processing and distributed database.



## Application Generation Programs:

- **1stTEAM and 1stFILE; Relational database engines.**

1stTEAM and 1stFILE are stand-alone central processing programs that merge, analyze, report, join, append, and convert TEXT, while performing productively in a mini-mainframe environment. They are each complete information management systems capable of maintaining mailing lists, lead tracking, order entry and inventory. Both feature MACROS that provide in-depth analysis by producing new datafiles and reports using extremely simple techniques. Each performs automatic mail-merge by adding data to your letters and print free-form reports and multiple labels with click-only ease. 1stTEAM and 1stFILE have nearly identical interfaces enabling you to use them interchangeably. The screen set ups are automatic once the field names and types are chosen. Formats can be easily changed any time.

- **Level-3 vs. Level-4; Single-User vs. Power-User**

1stFILE-3 is the single-user, low-end version of the Level-4 offerings having fewer fields and characters, no pre-programmed time and date MACROS, and lacking certain other power-user features. The choice of 1stFILE-4 or 1stTEAM-4 depends primarily on how much repetitive work you do. These multi-user programs look and feel similar and can produce identical output. 1stTEAM-4 offers the significant advantage of creating our exclusive HyperAccess Icons for data automation and transparent data exchange with HyperCard. These icons are actual command documents that can be launched from the finder singularly, or "linked" to perform an unlimited number of steps. In addition, HyperCard can be used to transparently run these HyperAccess icons. 1stFILE-4 can run HyperAccess icons, but cannot create them.

- **Multi-User System; Easy to use, high productivity.**

A typical multi-user system would have a copy of 1stTEAM for each administrator to design and control the system. Clerical personnel use 1stFILE-4 to run HyperAccess and access data.

**1stDESK Systems, Inc**  
 FREE 68 Page Color Catalog and DEMO Disc - See us at MacWorld, Boston, World Trade Center  
 7 Industrial Park Road, Medway, MA 02053  
 1-800-522-2286  
 Circle M1 on Reader Service Card

*continued from page 34*

or bottom of screen; top or bottom of document.

- Screen: one screen forward or back; scroll 12 lines up or down.
- Delete: character; next or previous word; to end or beginning of line; sentence (cursor anywhere in the sentence); paragraph (cursor anywhere in the paragraph).
- Other: underscore from cursor to end of line; change case (uppercase to lowercase or lowercase to uppercase); directory; certain other DOS functions; automatic paragraph numbering.

And that's only a partial list.

If you want these things laid out as in WordStar, you can come close. In fact, with that in mind, someone has written a keyboard file for XyWrite called XyStar. Many other functions are available, and all are called by two-letter codes that can be installed or rearranged within the keyboard file at any time you wish. You can have more than one keyboard file and load the alternates for use at any point in a document.

You can create style sheets, or their equivalent, save them as save/gets, and load them at boot-up or any other time, including in the middle of a document.

Text reformats instantly as you make insertions or deletions.

The spelling checker can either do a whole document at once or correct you as you go along.

Be assured that I have no connection with XyQuest other than my faith in its product.

Peter H. Weil  
Larchmont, NY

*My original introduction to XyWrite was from my friend and publisher Jim Baen, who told me I'd love it. Alas, by*

*then I was addicted to SideKick, and in those days XyWrite wouldn't run with SideKick or, indeed, with any other memory-resident program.*

*The latest XyWrite does work nicely with memory-resident programs, and it even runs under DESQview, so there aren't any real barriers to my using it; but by the time they got it to do that, I was in the middle of a book with something else.*

*I'll get at XyWrite Real Soon Now, I promise. I know that a lot of my colleagues use it, and it does a neat job of interfacing with Atex, which most publishers like. —Jerry*

### OS/2 Makes It Easier

Dear Jerry,

You've missed some of the major points concerning OS/2. These include the following:

- *Hardware independence.* OS/2 has the potential of blowing the roof off the software industry. Instead of having to write device drivers for video, printers, and input devices, programmers can concentrate on improving algorithms, adding features, and better debugging. Developing new products and upgrades to old ones can thus be speeded. By the way, there is absolutely no reason OS/2 won't support EGA. All someone has to do is write a display driver for it. Once. The issue of device independence also applies to Microsoft Windows, which is part of the proving ground for these ideas.

- *OS/2 does not replace MS-DOS.* OS/2 will not be available to end users until sometime this year. Applications will start to trickle out about that time. It won't be until 1989 that OS/2 applications will start putting pressure on the MS-DOS market. Millions of 8088/86 machines will be able to run only MS-DOS. Many of these machines will never

need OS/2. Microsoft has announced its continuing support of MS-DOS.

- *You don't have to buy a PS/2.* IBM would like you to believe that the PS/2 is the wave of the future. Fortunately, because OS/2 frees applications from being hardware-dependent, we will be saved from enslavement to Big Blue. All you will need to run OS/2 with Presentation Manager is an 80286 or higher processor, 2 or more megabytes of memory, a hard disk drive, and a graphics adapter. These are my recommendations, not necessarily the listed requirements. These features are increasingly common these days. It's not as if you are required to buy the most expensive configuration available. Many 8088 machines will be upgradable to OS/2 compatibility.

If you can run CP/M until your Z80s grow moldy, then I'm sure there will be those who are still running MS-DOS when I crumble to dust. Operating systems are tools for applications; applications are tools for users. In the "old days," users shopped for software and then bought the computer that ran it. Now that computers have become somewhat commodity items, users will shop for software and buy the operating system that runs it. If you don't need OS/2, then don't buy it.

Dennis Williamson  
Memphis, TN

*We'll just have to see what happens; the key to OS/2 will be how many software developers write programs making use of it. I do hope you're right about the operating system making things easier; I also hope that someone gets a good Modula-2, or even Ada, for OS/2, since I am not about to try programming in C, particularly the C that comes with the OS/2 Developer's Kit. —Jerry ■*

# PC voice mail, now only \$199.



**INCLUDES  
HAYES®  
COMPATIBLE  
MODEM!**

Watson®, hailed by one reviewer as "the premier voice mail station" at \$498, is an even better value at \$199. Watson eliminates telephone tag and gives you system features like auto speed-dial, auto answer, message forwarding, and built-in 300/1200 bps modem. For an ear-opening business applications demo,

call **1 (800) 6-WATSON** (in Mass., (617) 651-2186). To order, call **1 (800) 533-6120** (in Mass., (617) 655-6066). Credit Cards Accepted.

# Watson®

Natural MicroSystems Corporation

# The C Language

- 205 The State of C**  
by Brian W. Kernighan and  
Dennis M. Ritchie
- 215 A Better C?**  
by Bjarne Stroustrup
- 219 It's an Attitude**  
by Jonathan S. Linowes
- 226 Resource Guide**

**P**rogramming languages—what can you say about them? They're supposed to let you write software that can be understood more easily than machine language, and in fairness they do. But many are so terse and cryptic that you wonder how machine language could be any more difficult to read.

And choosing the right language for a particular task is becoming as complex as knowing which dialect of which tongue the people speak in a remote area of Botswana. If you're writing artificial-intelligence applications, you want one language; for scientific formulas, you want another; and the choices multiply almost by the number of variables in your system. On-line business applications might require one language, while the off-line ones should be written in yet another.

One constant that arises out of this apparent chaos is the choice of the C language for system programming. From its inception, C has lifted the system programmer out of the constant bit-twiddling of assembly language—a welcome relief. And now C is expanding its influence to applications programming as well. But C has its limitations. While you can program around most of them, you have to do just that.

C++ was designed to be C's successor. It overcomes many of the limitations of the C language, it offers object-oriented programming, and it presents a more comprehensive applications-programming language.

This month, we are proud to offer two articles by noted experts in the C language. First, the famed team of Brian W. Kernighan and Dennis M. Ritchie ex-

plains how C is evolving in "The State of C." They delve into what C can do—and what it can't—and provide a look at the elements involved.

Then, the guru of C++, Bjarne Stroustrup, explains how C++ differs from C and describes the object-oriented approach to applications programming in "A Better C?"

But C devotees are not to be outdone. In "It's an Attitude," Jonathan S. Linowes shows how object-oriented programming can indeed be accomplished in C, although that's not its natural habitat. This article discusses the OOPC conventions.

The battle between C and C++ is just heating up. There are quantities of C compilers and interpreters available for both the Macintosh and the IBM PC worlds. More and more companies are announcing C++ compilers and translators. C has seized control of the system-programming field, but only time will tell whether C or C++ will win the fight for the applications arena.

—Jane Morrill Tazelaar  
Senior Technical Editor, *InDepth*



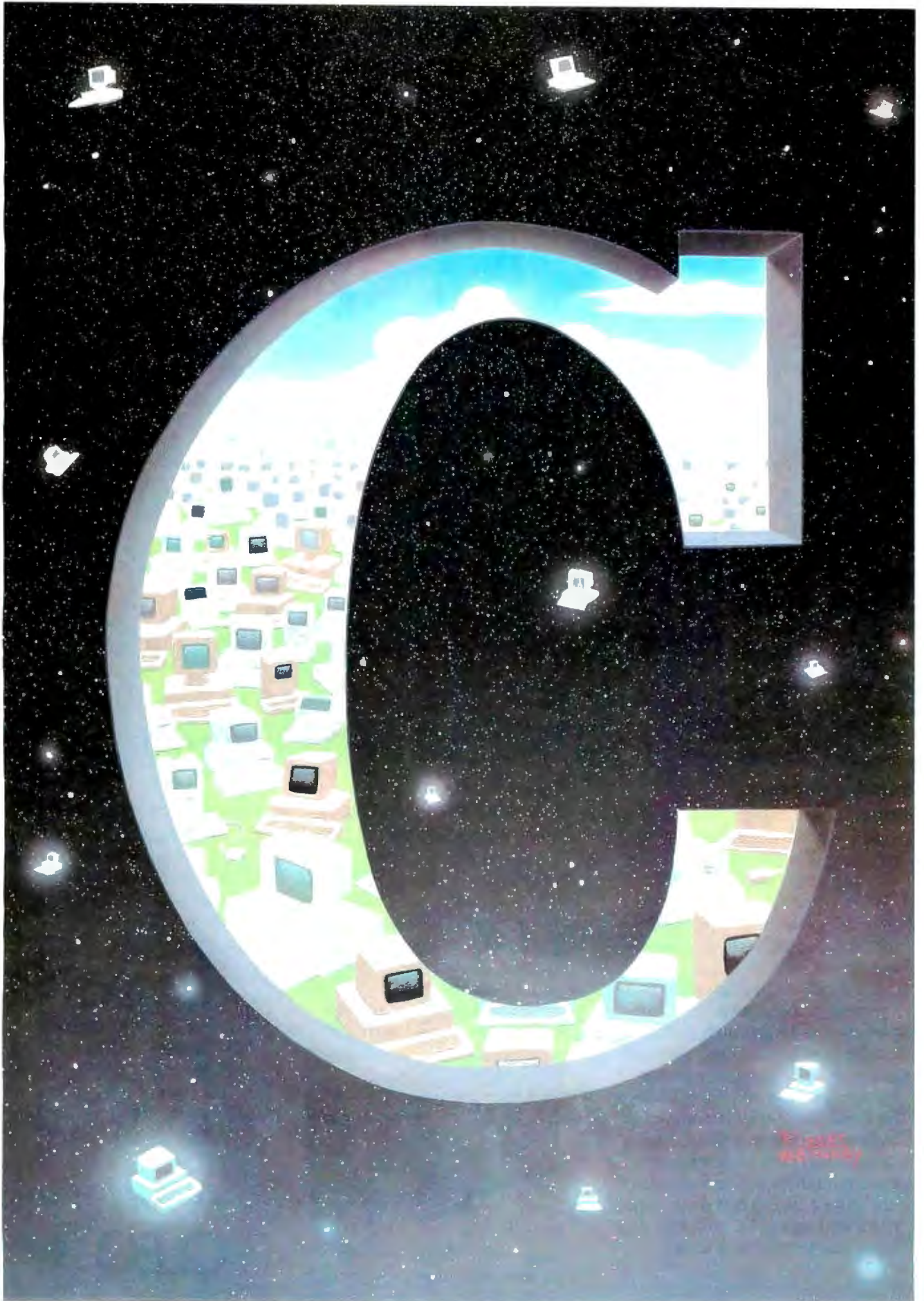

# CLEO is your SNA, BSC and Coax Gateway



VMS  
UNIX  
XENIX  
PC-DOS  
Macintosh  
NetBios LAN

## Sharing Information

Whatever your industry, your computers need to share information with your mainframe. Or, they need to exchange data with other computers. In either case, you need a total communications solution. You need software, hardware interfaces and modems that all work together smoothly. You need CLEO!

CLEO software products allow your computer to communicate with mini-computers and mainframes, and to emulate their workstations. Since 1981, CLEO has provided communications between micros, minis, and mainframes for the automotive, insurance, medical and banking industries. Today over 78,000 CLEO users worldwide are running on all major computer brands. The greatest number of these users run CLEO software on IBM Personal Computers and NETBIOS LANs.

## Complete Software/Hardware Package

Every CLEO package contains all the software and hardware accessories you'll need. Your selected CLEO SNA, BSC, or Coax software is packaged with 1) an internal modem card for dial-up applications, or 2) an interface card and cable for use with your existing modem, or 3) a Coax card for local connectivity. There's no waiting for non-CLEO add-ons. And, you get prompt, single-source service.



Package prices range from \$795.00 for most stand-alone packages, up to \$1,995.00 for the 32-user SNA gateway.

Call us today to discuss your application.

**CLEO Software**  
1639 North Alpine Rd.  
Rockford, IL 61107  
Telex 703639  
FAX 815/397-6535

## Headquarters:

USA: **1-800/233-2536**  
Illinois: 1-800/422-2536  
International: 815/397-8110

## Sales and Distribution:

Benelux: 31 (0) 33-948888  
Canada, East: 800/361-3185  
Canada, West: 800/361-1210  
Canada, Montreal: 514/737-3631  
Colombia, S.A.: 12172266  
Denmark: 02 94 81 19  
France: 146861136  
Italy: (0331)634 562  
Mexico City: 596-5539  
Sweden: 468311780

**CLEO** 

# The State of C

*It's not just for  
system programming anymore*

*Brian W. Kernighan and Dennis M. Ritchie*

**C** is a general-purpose programming language that was originally designed and implemented around 1972 by Dennis Ritchie at Bell Labs. Its early growth was closely associated with the Unix system where it was developed, since both the system and most of the programs that run on it are written in C. In recent years, C has become popular in a much wider variety of environments, and it is no longer tied to any one operating system or machine.

The C language was originally designed for "systems programming"—that is, for writing programs like compilers, operating systems, and text editors. But it has proven quite satisfactory for other applications as well, including database systems, telephone-switching systems, numerical analysis, engineering programs, and a great deal of text-processing software. Today, C is one of the most widely used languages in the world, and C compilers exist for almost every computer.

## Where Did It Come From?

C has its roots in the language BCPL, designed by Martin Richards around 1967.



BCPL is a "typeless" language: It operates only on a single data type, the machine word. As such, BCPL was an excellent match to the hardware of word-oriented machines. In 1970, Ken Thompson designed a stripped-down version of BCPL for use with the first Unix system on the PDP-7; this language was called B. It too is typeless.

With the advent of the PDP-11, on

which the next version of Unix was written, it became clear that a typeless language did not match this hardware nearly as well. The PDP-11 provided several different sizes of fundamental objects—1-byte characters, 2-byte integers, and 4-byte floating-point numbers—and B provided no way to even talk about these different-size objects, let alone operators to manipulate them.

The C language was originally an attempt to deal with a variety of types of data by adding the notion of data type to the B language. In C, as in most languages, each object has a type as well as a value; the type determines the meaning of the operations that can be applied to the value, and how much storage is occupied. For example, declarations like `int i, j;`, `double d;`, and `float x;` determine the operations and space requirements of the variables. In the statement `d = x + 1 * j;`, the compiler uses the type information to determine that integer multiplication is adequate for `1 * j`, but the result must be converted to floating point before it is added to `x` and then converted to double precision for assignment to `d`.

*continued*

Although C was originally implemented for a PDP-11, it was used on other machines as early as 1975. Steve Johnson implemented a "portable compiler," designed to be relatively easy to modify, to generate code for different machines. Since then, C has been implemented on most computers, from the smallest microcomputers to machines as large as the CRAY-2. The C language is sufficiently well standardized, even without a formal standard, that with some care you can write C programs that will run without change on any machine supporting the language and a minimal run-time environment.

C began on a small machine and was derived from a sequence of small languages; its designer preferred simplicity and elegance to features. Furthermore, C has, from the beginning, been meant for system-programming applications, where efficiency matters. Accordingly, it's not surprising that C is a good match for the capabilities of real machines. For example, it provides as its basic data types only those objects that are directly supported by typical hardware: characters, integers (perhaps of several sizes), and floating-point numbers (again in several sizes).

You can create more complicated objects like arrays, structures, and so forth, but C provides few operators for manipulating them as a unit; you must write the functions that compare strings, assign one array to another, and so on.

Somewhat more unusual, C doesn't provide input and output operations as part of the language. This is not to say that C programs can't do I/O, of course, but simply that I/O is done by functions defined by the user or in a library, and not by built-in statements of the language. This is in contrast to, for example, FORTRAN's READ and WRITE, and the INPUT and PRINT of BASIC, which are parts of those languages.

To complete the list of things that C might provide but doesn't: It has no storage management, like Pascal's new function, and no facilities for concurrent processing, such as Ada's rendezvous mechanism. You can easily write these capabilities in C, but they are provided by function libraries, not as part of the language. Function calls are notationally clumsier than direct operators; for example, compare BASIC's string comparison

```
IF A$ = B$ THEN ...
```

to the way you might write it in C:

```
if (equal(a, b)) ...
```

Function calls also involve more overhead than in-line code.

In any case, the degree to which features are omitted from C is one of its distinguishing characteristics.

### Linguistic Elements

**Control flow:** Control flow in C is quite conventional, although richer than in FORTRAN or BASIC. C contains two decision-making statements: `if...else` and `switch`. In the statement

```
if (expr) stat1 else stat2
```

*expr* is evaluated; if it's true (nonzero), *stat1* is executed; otherwise, *stat2* is executed. The entire `else` part of the statement is optional. In

```
switch (expr) {
  case const1: stat1
  case const2: stat2
  ...
  default: stat
}
```

*expr* is evaluated and its value compared against the various *consts*. If it finds a match, the corresponding *stat* is executed. If it doesn't, the *stat* for the default part is executed. The default is optional. The `switch` statement is like Pascal's case statement, except that Pascal has no default.

C also contains three loops: `while`, `for`, and `do`. In the statement

```
while (expr) stat
```

*expr* is evaluated; if it's true, *stat* is executed, and *expr* is evaluated again. When *expr* becomes false, the loop terminates. The statement

```
for (stat1; expr; stat3) stat2
```

is equivalent to the `while` loop:

```
stat1
while (expr) {
  stat2
  stat3
}
```

The `do` statement is like Pascal's `repeat...until` except for the sense of the termination test. In the statement

```
do stat while (expr)
```

*stat* is executed, and *expr* is tested. If it's true, the loop repeats.

The statement `break` causes an immediate exit from an enclosing loop or

`switch`; the statement `continue` causes the next iteration of a loop to begin. C also provides a `goto` statement, but it's infrequently used.

In all these examples, a *stat* can be a single statement like `x = 3` or a group of statements enclosed in braces, which are like `begin...end` in other languages. Statements end in semicolons.

**Data types:** The basic data types in C are `char` (a single byte); `int`, `short`, and `long` (integers of various lengths); and `float` and `double` (floating-point numbers of two different lengths). The `char` data and the various integers can be signed or unsigned.

You can combine these objects into an infinite (in principle) set of "derived" data types using arrays, structures, unions, and pointers. Arrays are familiar:

```
char msg[100];
```

defines an array `msg` of 100 bytes, accessed as `msg[0]` through `msg[99]`. C doesn't provide a string data type; it uses arrays of `char` instead, with the end of the data marked by a 0 byte. This is what the compiler generates for a string constant like "hello world\n". Within a string, certain "escape sequences" like `\n` are used to represent special characters like newline. This string contains 12 characters and a terminating 0 byte.

A structure is a collection of related variables that need not have the same type (like a record in Pascal). For example,

```
struct object {
  int x, y; /* position */
  float v; /* velocity */
  char id[10]; /* identification */
};
struct object obj;
```

declares a structure called `object` and defines a variable `obj` of type `struct object`. Individual members of the structure are referred to as `obj.v`, and so on. Notice that the `object` structure includes an array `id`, whose components are `obj.id[0]` through `obj.id[9]`. You can have arrays of structures, as well.

C provides pointers, or machine addresses, as an integral part of the language, in a much less restricted form than in Pascal and Ada. The declarations

```
char *pc;
struct object *pobj;
```

declare `pc` to be a pointer to `char`, and `pobj` to be a pointer to an `object` struc-

ture. The value that a structure points to is accessed by `*pc` or `*pobj`, as suggested by the form of the declaration; the "dereferencing" operation `*` is equivalent to the caret (`^`) in Pascal. Individual members of the structure are accessed by, for example, `pobj->v`.

If `p` is a pointer to an object of type `T` and currently points to an element of an array of `T`s, then `p+1` is a pointer to the next element in that array. Similarly, if `p` and `q` point to elements of the same array, and `p` is less than `q`, then `q - p` is the number of elements from `p` to `q`. In short, arithmetic operations on pointers are scaled by the size of the object to which they point; the actual size is usually irrelevant as you program. When it is relevant, a `sizeof` operator exists to compute it, so the program doesn't specify the explicit size for any particular machine. C's complete integration of pointers and address arithmetic is one of the strengths of the language.

**Operators and expressions:** C has a rich set of operators compared to most conventional languages. Besides the usual arithmetic operators `+`, `-`, `*`, `/`, and `%` (remainder), several other groups deserve special mention.

First, C provides operators for manipulating bits within a word (see table 1). For example, the function in listing 1 counts the 1-bits in its argument by repeatedly testing the rightmost bit, then shifting the argument one position to the right until it becomes 0. The declaration unsigned means that `n` will be treated as a logical quantity, not an arithmetic one.

The function `bitcount` illustrates a second group of operators. Any operator such as `>>` that takes two operands has a corresponding "assignment operator," such as `>>=`, so that the statement

```
v = v >> expr
```

can be written more concisely as

```
v >>= expr
```

This notation is easier to read, particularly when `v` is a complicated expression instead of a single-letter variable.

A third group of operators deals with logical conditions. The operators `&&` and `||` are evaluated left-to-right, and evaluation stops as soon as the value of the expression is known. In a construction like

```
if (i < N && x[i] > 0) ...
```

if `i` is greater than or equal to `N` (which is presumably the size of the array `x`), then the test involving `x[i]` will not be made. This behavior of logical operators is

called "short-circuit evaluation."

**Functions:** The overall structure of a C program is a set of declarations of variables and functions. These definitions are often kept in separate files if the program is large; you can compile them separately and link them together with a linking loader.

Within a function, variables are normally "automatic"—that is, they appear when the function is entered and may disappear when it is left, as in the `bitcount`. However, if you declare a variable as `static`, it retains its value from one call to the next. Variables declared outside of any function are global; they can be referred to anywhere in the program.

Functions are recursive; the standard (and hackneyed) example is the factorial function (see listing 2). The arguments to a function are passed by value, which means that the function receives a copy of the argument, not the original object. (Notice that the function `bitcount` modified its argument; this is safe because it's actually a copy.) You can always obtain the effect of call by reference when necessary by passing a pointer to the object. Function arguments and return values can be any of the basic types—pointers, structures, or unions. To pass an array, you pass a pointer to its first element.

### The ANSI Standard

For many years, the definition of C was the reference manual in the first edition of *The C Programming Language*. In

1983, ANSI established a committee to provide a modern, comprehensive definition of C. The result, the ANSI standard, or ANSI C, is expected to be approved late in 1988. Modern compilers already support most of the features of the standard.

The language has changed relatively little since 1978; one of the goals of the standard was to make sure that most existing programs would remain valid, or, failing that, that compilers could produce warnings of new behavior.

Basically, the most important change is a new syntax for declaring and defining functions. A function declaration can now include a description of the function's arguments; the definition syntax changes to match. This extra information makes it much easier for compilers to detect errors that are caused by mismatched arguments; in our experience, it's a very useful addition.

*continued*

**Table 1:** *The C operators for manipulating bits within a word; these are necessary for many system-programming applications.*

<code>&amp;</code>	bitwise AND
<code> </code>	bitwise OR
<code>^</code>	bitwise exclusive-OR
<code>~</code>	one's complement
<code>&lt;&lt;</code>	left shift
<code>&gt;&gt;</code>	right shift

**Listing 1:** *The bitcount function counts the 1-bits in its argument by repeatedly testing the rightmost bit, then shifting the argument one position to the right until it becomes 0.*

```
bitcount(n) /* count 1 bits in n */
unsigned int n;
{
    int b;
    for (b = 0; n != 0; n >>= 1)
        if (n & 1)
            ++b;
    return b;
}
```

**Listing 2:** *The classic example of a recursive function—the factorial function—written in C.*

```
fact(n) /* returns n! (n >= 0) */
int n;
{
    if (n <= 0)
        return 1;
    else
        return n * fact(n-1);
}
```

To illustrate, consider this typical fragment of C as it would once have been written:

```
int n;
double x, sqrt();
x = sqrt(n);
```

The `sqrt` function expects an argument of type `double`, but `n` is an `int`. This error is not detected, and the results are guaranteed to be nonsense. With the new *function prototype* syntax from ANSI C, you would write the fragment this way:

```
int n;
double x, sqrt(double);
x = sqrt(n);
```

Here the compiler has been informed about the type that `sqrt` expects, so it generates code to convert the integer `n` to floating point. If you inadvertently wrote an expression that couldn't be converted to `double`, such as `x = sqrt(&n);`, the compiler would catch the error.

The syntax of function definitions changes to match; formal parameters are listed between parentheses after the function name. Thus, the function `bitcount` would become:

```
bitcount(unsigned int n)
{
    ...
}
```

There are also other small-scale language changes. Structure assignment, enumerations, and the `void` data type, all of which had been widely available, are now officially part of the language. You can initialize automatic structures and arrays, and you can do floating-point computations in single-precision; this may lead to more efficient computation on smaller machines.

The properties of arithmetic conversions are spelled out more carefully. There are now hexadecimal constants and escape sequences as well as the octal ones. The C preprocessor, which does textual macro substitution, is much more elaborate; it gives substantially more control over the macrogeneration process. Most of these changes will have only minor effects on your programming.

A second significant contribution of the standard is the definition of a library to accompany C. It specifies functions for accessing the operating system (e.g., to read and write files), formatted input and output (`scanf` and `printf`), memory allocation (`malloc`), string ma-

nipulation (e.g., `strcmp`), mathematical computations (e.g., `sin` and `log`), and the like.

A collection of standard header files to be included with user-written programs provides uniform access to declarations of functions and data types. Programs that use this library to interact with a host system are assured of compatible behavior. Most of the library is closely modeled on the Unix system's "standard I/O library," and similar routines are widely available on other systems as well. Again, you won't see much change.

Because most computers directly support the data types and control structures that C provides, the run-time library required to implement self-contained programs is tiny. The standard library functions are only called explicitly, so you can avoid them if you don't need them. Most of them can be written in C and, except for the operating-system details they conceal, are themselves portable.

### An Assessment of C

C is a compact, efficient, and expressive language. Indeed, C is good enough that it has almost completely supplanted the use of assembly language programming on many systems. The use of a clean, readable high-level language has overwhelming advantages; one is simply that it becomes possible to *read* programs, which is excruciatingly difficult in some languages.

C is a relatively "low level" language. This characterization is not pejorative; it simply means that C deals with the same sorts of objects that most computers do—namely, characters, numbers, and addresses. These can be combined and moved about with the arithmetic and logical operators implemented by real machines.

Since C is relatively small, it can be described in a small space and learned quickly. You can reasonably expect to know and understand and, indeed, regularly use the entire language.

Another advantage is its portability. Although C matches the capabilities of many computers, it is independent of any particular machine architecture. With a little care, it's easy to write portable programs that can be run without change on a variety of machines. The standard makes portability issues explicit and prescribes a set of constants that characterize the machine on which the program is run.

Another of C's strengths is its absence of restrictions. A popular trend in programming languages is "strong typing," which (roughly speaking) implies that

the language undertakes to check carefully that the program contains only valid combinations of data types. Strong typing sometimes catches bugs early, but it also means that some programs just can't be written, because they inherently require violations of the type-combination rules.

A storage allocator is a good example: You can't write Pascal's new function—which returns a pointer to a block of storage—in Pascal, because there's no way to define a function that can return an arbitrary type. But it's easy and safe to write it in C because the language lets you state that a specific violation of the type rules is intentional.

C is not a strongly typed language, but as it has evolved, its type checking has been strengthened. The original definition of C frowned on, but permitted, the interchange of pointers and integers; this has long since been eliminated, and the standard now requires the proper declarations and explicit conversions that good compilers had already enforced. The new function declarations are another step in this direction. Compilers will warn of most type errors, and there is no automatic conversion of incompatible data types. Nevertheless, C retains the basic philosophy that programmers know what they are doing; it only requires that you state your intentions explicitly.

C has even proven to be a good language for other languages to compile into. One of the best examples is the Yacc-compiler compiler, which converts the grammar specification for a language into a C program that is used to parse statements in that language. Naturally, one language specified this way is C itself.

What's wrong with C? At the lowest level, there are some poor choices of operator precedences. Some users feel that the `switch` statement should be changed so that control doesn't flow through from one case to the next, as it does now. The concise syntax is sometimes daunting to newcomers; complicated declarations are often hard to read. One of the new examples in the second edition of *The C Programming Language* is a pair of programs to convert C declarations into words and back again.

Portability problems sometimes arise if you rely on undefined or implementation-defined properties. For example, the order in which function arguments are evaluated is not specified, so it's possible to write code that depends on that order and will thus execute differently on

*continued*

# How to create high-performance programs without wasting your time or money



**Power**  
The High-Performance C Compiler

MDX Software

**C Source Window**

```

30  addr->zip = 76442;
31  printf("The structure member\n");
32  printf("%d\n",addr->zip);
33  addr->street, addr->city
34  size = sizeof(struct MEMB);
35  printf("The structure size\n");
36  printf("%d\n",sizeof(struct MEMB));
37  pr
38  pr
39  pr
40  }
                
```

**Watch Point Window**

```

A watch int has matured.
size > 0
Old value was 8
New value is 122
Space bar will clear notice & watchpoint
                
```

**Variables Window**

```

1126:01139
addr->name array 0x0416:0000
addr->street array "Joe Bob's Tr
addr->city array "Fort Worth"
addr->state array "TX"
addr->zip 76442
Size 120
lab[0] pointer 0x022c
lab[0] struct 0x022c
lab[1] pointer 0x022d
                
```

**Output Window**

```

Space for struc
starting at address 5416:0000
Assigning values to members.

The structure member values...

Joe Bob's Texas
1251 Cow Chip Trail
Fort Worth TX 76442
                
```

**Power Trace Debugger**

## Step 1: The \$19.95 Power C compiler

Power C is the new ANSI compatible C compiler that runs faster than Microsoft C and has more functions than Turbo C®. Power C combines high-performance software with superb documentation, all for less than the price of most C books alone. It's your fast route to fast programs without the fast bucks. Compare Power C to the competition and see how much time and money you'll save.

Performance/Price Chart (execution times in seconds)			
	Power C	Quick C*	Turbo C*
1) fib	23.8	53.4	26.4
2) sieve	27.6	43.2	25.5
3) tdbl	3.5	9.0	9.6
4) diskio	13.5	14.4	14.3
5) report	11.0	71.7	60.7
6) drystone	36.6	41.6	31.8
Compile/Link	73.9	113.5	81.4
EXE File Size	25120	32092	27184
Compiler Price	\$19.95	\$99.00	\$99.95
Debugger Price	\$19.95	N/C	N/A
Library Source	\$10.00	\$150.00	\$150.00
Total Cost	\$49.90	\$249.00	\$249.95

N/C no charge - N/A not available  
Benchmarks compiled using Make utility, command-line compiler, and medium memory model



**The Assembly Window**

## Step 2: The \$19.95 Power Ctrace debugger

Power Ctrace is the new state-of-the-art C debugger that makes Microsoft's Codeview look like old technology. Power Ctrace will reduce the time you spend debugging your C programs by at least a factor of 10. With Power Ctrace, you'll be working smarter instead of harder. Actually, you'll be having so much fun that it won't even feel like work anymore.

Unlike other debuggers, Power Ctrace lets you debug graphics programs on a single monitor. You can even debug programs that write directly to video memory. However, the major advantage of Power Ctrace is simple operation. You won't waste any time trying to understand or remember cryptic commands. With Power Ctrace, a single keystroke is all it takes. Help screens show you which key to press and pop-up menus list your options. Invest just 10 minutes with Power Ctrace now and you'll save hours from now on.



### Technical Specifications

Power C includes: Power C compiler with integrated Make, Power C Linker, Power C Libraries (450 functions), the Power C book (680 pages), and support for...

- ✓ ANSI standard
- ✓ IEEE floating point
- ✓ 8087/80287 coprocessor
- ✓ auto-sensing of 8087/80287
- ✓ automatic register variables
- ✓ unlimited program size
- ✓ mixed model (near & far pointers)
- ✓ graphics on CGA, EGA, VGA, & Hercules

**Optional Products:**

- ✓ Power Ctrace debugger
- ✓ Library source code
- ✓ BCD business math

Order now by calling our toll free number or mail the coupon to Mix Software, 1132 Commerce Drive, Richardson, TX 75081.

## 1-800-333-0330

For technical support call: 1-214-783-6001

Minimum System Requirements:  
DOS 2.0 or later, 320K memory, 2 floppy drives or hard drive.  
Runs on IBM PC, XT, AT, PS/2 and compatibles.

### 60 day money back guarantee

Name \_\_\_\_\_  
Street \_\_\_\_\_  
City \_\_\_\_\_  
State \_\_\_\_\_ Zip \_\_\_\_\_  
Telephone \_\_\_\_\_

Paying by:  Money Order  Check  
 Visa  MC  AX  Discover  
Card # \_\_\_\_\_  
Card Expiration Date \_\_\_\_\_  
Computer Name \_\_\_\_\_ Disk Size  5 1/4"  3 1/2"

**Product(s) (Not Copy Protected)**

Power C compiler (\$19.95) \$ \_\_\_\_\_  
 Power Ctrace debugger (\$19.95) \$ \_\_\_\_\_  
 Library Source Code (\$10.00) \$ \_\_\_\_\_  
 (includes assembler & library manager)  
 BCD Business Math (\$10.00) \$ \_\_\_\_\_  
 Add Shipping (\$5 USA - \$20 Foreign) \$ \_\_\_\_\_  
 Texas Residents add 8% Sales Tax \$ \_\_\_\_\_  
 Total amount of your order \$ \_\_\_\_\_

Power C & Power Ctrace are trademarks of Mix Software Inc  
Quick C & Codeview are registered trademarks of Microsoft Corp  
Turbo C is a registered trademark of Borland International

# Computers For The Blind

Talking computers give blind and visually impaired people access to electronic information. The question is how and how much?

The answers can be found in "The Second Beginner's Guide to Personal Computers for the Blind and Visually Impaired" published by the National Braille Press. This comprehensive book contains a Buyer's Guide to talking microcomputers and large print display processors. More importantly it includes reviews, written by blind users, of software that works with speech.

Send orders to:

National Braille Press Inc., 88 St. Stephen Street  
Boston, MA 02115, (617) 266-6160

NBP is a nonprofit braille printing and publishing house.

different machines. This is not a grave problem, since it's easy to detect the dependency, but people still overlook it from time to time, with unfortunate effects.

## What's Next?

Over the past decade, C has evolved, although the rate of change has been slow. The ANSI standard formalizes these changes and adds a few of its own. There has been a steady increase in the amount of error-checking by the compilers: Although there are still few restrictions on what you can say, you now need to be more explicit when you're doing something strange.

Where is C likely to go in the next few years? The most likely evolution is to continue this slow but steady improvement, with new features added cautiously. Caution is necessary simply because of the importance of maintaining compatibility with the huge body of C code already in use. Changes cannot be made gratuitously.

Realistically, C itself isn't likely to change to a major degree; rather, new languages will come from it. One example is C++, which provides facilities for data abstraction and object-oriented programming while remaining almost completely compatible with C (see "A Better C?" on page 211). In the meantime, C wears well as your experience with it grows. With 15 years of C experience, we still feel that way. ■

Editor's note: Adapted with permission from Potentials, December 1983, pages 26-30. Copyright 1983 IEEE.

## BIBLIOGRAPHY

Kernighan, Brian W., and Dennis M. Ritchie. *The C Programming Language*. 1st ed. Englewood Cliffs, NJ: Prentice-Hall, 1978. This is the standard reference on C.

Kernighan, Brian W., and Dennis M. Ritchie. *The C Programming Language*. 2nd ed. Englewood Cliffs, NJ: Prentice-Hall, 1988. This edition describes ANSI C.

Stroustrup, Bjarne. *The C++ Programming Language*. Reading, MA: Addison-Wesley, 1986.

Brian W. Kernighan and Dennis M. Ritchie are members of the Computing Science Research Center at AT&T Bell Laboratories in Murray Hill, New Jersey. Dennis is the designer of the C language. Together they wrote the standard reference on C. They can be reached on BIX as "editors."

## FULL POWER AT YOUR FINGERTIPS.

DISCOVER TWO WORLDS WITH THE ADVANCED SCREEN GENERATING FACILITY FOR "C" PROGRAMMING ENVIRONMENTS, **STAGEHAND**, and its COMPREHENSIVE DEMO FACILITY, **PLAYWRITE**.

### Create your screens with STAGEHAND:

- Full screen editor.
- User defineable edit function keys.
- Set multiple color text & prompts.
- Define window borders, size and position.
- Create full screen & context sensitive help.
- Extensive printouts for documentation.
- Define valid function keys, pageup, pagedown.
- Define internal/external help screens.
- Idle and active input field color.
- Fully defineable input sequence.
- Define default prompt values.
- Full input field definitions including:
 

Printed	Auto Clear	Cursor Type
Must Fill	Key stroke Edit	Cursor Positioning
Transparent	Upper Case	Data Types
No View	Lower Case	Sequencing
Required	You/No	Auto Move

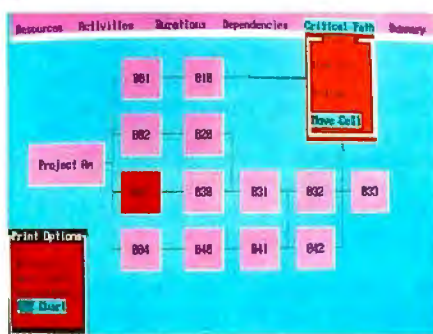

### Full runtime support with STAGEMANAGER:

- Full library support routines w/ source code.
- Multiple overlapping windows.
- Scrollable regions.
- Auto scrolling windows.
- User idle time routine support.
- User prompt routine support.
- User keystroke routine support.
- User function key routine support.
- User pageup/pagedown routine support.
- Hot key to user printer handler.
- Hot key to DOS.
- Auto screen timeout.

### Powerful demo generating PLAYWRITE:

- Screen quick display demos.
- Create quick interactive demos.
- Create powerful full featured interactive demos.

### Total product support for:

- Microsoft 4.x, 5.x, Quick C, Turbo C.
- No royalties or runtime fees.
- FREE updates to registered users.
- FREE telephone support.
- FREE STAGEMANAGER source code.
- Comprehensive manual including library routine definition and examples.

**SPECIAL PACKAGE PRICE \$199.00!**

**TO ORDER CALL 1 800-DATA CODE**  
OR (516) 331-7848 - C.O.D. OR AMER. EXPRESS.  
DEALER INQUIRES WELCOME.  
LOOK FOR MS-DOS, UNIX AND VAX VERSIONS THIS SUMMER!

**DATA CODE INCORPORATED**

1065 ROUTE 112, PORT JEFFERSON STATION, N.Y. 11764



# Test Drive InfoWorld's Best 386 Value!

Of the 24 80386-based machines tested by InfoWorld only 3 received "Excellent Value" ratings. Micro 1 received the highest rating of the group.

## NOW AVAILABLE WITH NATIONWIDE ON-SITE SERVICE

Micro 1

### MICRO 1 POWER 388

The speedy Power 386 by Micro 1 is among the five fastest systems for CPU speed. It features solid performance scores and a competitive price tag.

The Power 386 clocked an impressive 5.20 CPU in our Autobench testing. This speed surpasses the Compaq Deskpro 386/20 by .21 and rates a well-deserved excellent score. The system's 80-megabyte Seagate hard drive had a sequential access of 2.86 for a very good score. With a rating of 3.21, hard disk random access also receives a very good score.

Neither software nor hardware compatibility was a problem for the Power 386. Micro 1 claims Microsoft OS/2 compatibility. Software compatibility is very good; hardware compatibility earns an excellent score.

The Micro 1 machine met all the expandability requirements, earning an excellent score in this category.

Micro 1 packs manuals for hard disk, 80387, I/O, monitor, and V-Cache in one common binder. The user's manual includes step-by-step operation and installation guidelines for beginners. Documentation earns a good score.

A one-year warranty is offered on the Power 386. Micro 1 also offers a 30-day money-back guarantee on the system. Repairs are handled by the vendor or authorized dealers. A five-year extended warranty is available. Support policies are good.

In short, we consider this an excellent value.

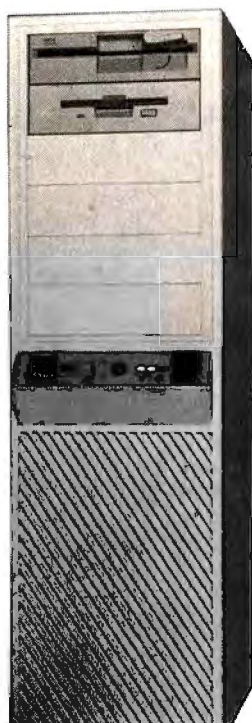

## \$3095

16MHz, 50MB system  
Tower add \$190

### Call for a free consultation.

For 3 years, we've been the choice of Corporate America:

American Express	Federal Communications Com.	Lucas Film	Siemens
Anheuser-Busch	Ford Aerospace	Martin-Marietta	Tandem Computers
Associated Press	Heath Zenith	MasterCard	TRW
Boeing Aerospace	Honeywell	McDonnell Douglas	United Airlines
Clorox	Intel	MCI	University of Calif.
Coca-Cola	Itel	NASA	Wells Fargo
Dean Witter	ITT	Pacific Bell	Westinghouse
Ernst & Whinney	Lockheed Missiles & Space	Rockwell International	

Call to discuss your custom configuration.

# 1-800-338-4061

In California, call (415) 974-5439

Circle 274 on Reader Service Card

## Pay only \$1395

with trade in of your  
IBM AT. Only \$52/mo!

20MHz add \$595. 80MB add \$495  
110MB add \$595. RAM to 10MB call for quote.  
UNIX systems available.

#### PRODUCT SUMMARY

### MICRO 1 POWER 388

**Company:** Micro 1 Inc., 557 Howard St., San Francisco, CA 94105; (800) 338-4061, (415) 974-5439 in CA.

**List Price:** \$6,145.

**Features:** 20-MHz, zero-wait-state 80386 CPU; EGA board and monitor; one serial port; one parallel port; 80287 coprocessor support; optional card available for 80387 support.

**Peripherals:** Enhanced keyboard; 200-watt power supply; battery-powered clock/calendar.

**Storage and Memory:** 80-megabyte MFM hard disk; 1.2-megabyte floppy drive; 4 megabytes of RAM.

**Support:** One-year limited warranty; 30-day money-back guarantee.

**Pros:** Second highest performance scores overall.

**Cons:** Technical support difficult to reach.

**Summary:** Low price and solid performance make this system hard to beat.

Note: Micro 1 has increased our customer service department staffing by 100%. Try our direct line and see for yourself! (415) 974-6997

## MICRO

557 HOWARD ST.  
SAN FRANCISCO, CA 94105  
(415) 974-5439  
TECH SUPPORT: (415) 974-6997  
FAX: (415) 974-6996



# Introducing the fastest possible way to create the fastest MS-DOS programs possible.

For Personal Computers Running the MS, OS/2 or MS-DOS Operating System

## Microsoft C 5.1

Optimizing Compiler



New! Includes OS/2 system support

Microsoft

### Microsoft C Optimizing Compiler 5.1 Techbox

#### Compiler

- Optimizations that generate the fastest code for DOS and OS/2 systems.
  - In-line code generation.
  - Loop optimizations.
  - Elimination of common subexpressions.
- Full OS/2-system support to break the 640K barrier. New.
- Family API programs that run under DOS and the OS/2 systems. New.
- Write multithreaded programs and Dynamic Link Libraries. New.
- Small, medium, compact, large, and huge memory models.
- Mix models with NEAR, FAR, and HUGE keywords.
- Fast compilation (10,000 lines/minute) with Microsoft QuickC.
- Fastest math, in-line 8087/80287 instructions, and floating-point calls.
- More complete support of proposed ANSI standard.
- Over 350 library functions, including a graphics library.

#### Microsoft CodeView

- Full OS/2 systems support. New.
- Debug applications of up to 128 MB under the OS/2 systems. New.
- Debug multithreaded programs and Dynamic Link Libraries. New.
- Source-level debugging for precise control over programs.
  - Dynamic breakpoints in the source.
  - Debug programs written in a variety of Microsoft languages. New.
  - Full symbolic display of C structures. New.
  - Interactively follow linked lists and nested structures. New.
  - Watch variables, memory, registers, and flags.

#### Other Utilities

- Fast linking (twice as fast as the C 4.0 version linker).
- OS/2 incremental linker—up to 20 times faster than a full link. New.
- OS/2- and MS-DOS reconfigurable programmer's editor. New.

Everything about Microsoft® C Optimizing Compiler version 5.1 is dedicated to the professional programmer.

Fast code. Fast development. Fast debugging. And full support for both MS-DOS® and the OS/2 systems in a single package.

There's no faster C code on a PC, because powerful optimizations, such as in-line code generation and loop enregistering, generate executables that are compact and efficient. The documentation even teaches

you special coding techniques to squeeze every last bit of speed out of your code.

Fast code isn't all you get. Under MS® OS/2, the 640K barrier is gone so you can write C programs as large as a gigabyte. You can call the operating system directly. Create more responsive programs (multiple threads allow program operations to overlap). And build Dynamic Link Libraries (DLLs) that can be shared, saving valuable memory. DLLs also allow your main programs to be smaller, so they load faster.

# Introducing the fastest possible way to create the fastest MS OS/2 programs possible.

For Personal Computers Running the MS OS/2 or MS-DOS Operating System

## Microsoft C 5.1

Optimizing Compiler

```

File View Search Run Watch Options Language
0) i : 217
1) p : 23383:5936
125:      int i
126:
127:      set_cursor
128:      p = scrnbuf;
129:
130:      /* Draw top of box. */
131:
132:      *p = 218;
133:      p += 2;
134:      for (i = 0; i < COLS; p += 2, i++)
135:          *p = 196;
136:      *p = 191;
137:      p += 2;
138:
139:      /* Draw side of box. */
    
```

Special offer. Programmer's editor and Microsoft QuickC, compiler included. FREE!

Now includes OS/2 systems support!

Microsoft

### Microsoft C Optimizing Compiler 5.1 Techbox

#### Compiler

- Optimizations that generate the fastest code for DOS and OS/2 systems.
  - In-line code generation.
  - Loop optimizations.
  - Elimination of common subexpressions.
- Full OS/2-system support to break the 640K barrier. New.
  - Family API programs that run under DOS and the OS/2 systems. New.
  - Write multithreaded programs and Dynamic Link Libraries. New.
- Small, medium, compact, large, and huge memory models.
- Mix models with NEAR, FAR, and HUGE keywords.
- Fast compilation (10,000 lines/minute) with Microsoft QuickC™
- Fastest math, in-line 8087/80287 instructions, and floating-point calls.
- More complete support of proposed ANSI standard.
- Over 350 library functions, including a graphics library.

#### Microsoft CodeView

- Full OS/2 systems support. New.
  - Debug applications of up to 128 MB under the OS/2 systems. New.
  - Debug multithreaded programs and Dynamic Link Libraries. New.
- Source-level debugging for precise control over programs.
  - Dynamic breakpoints in the source.
  - Debug programs written in a variety of Microsoft languages. New.
  - Full symbolic display of C structures. New.
  - Interactively follow linked lists and nested structures. New.
  - Watch variables, memory, registers, and flags.

#### Other Utilities

- Fast linking (twice as fast as the C 4.0 version linker).
- OS/2 incremental linker—up to 20 times faster than a full link. New.
- OS/2- and MS-DOS reconfigurable programmer's editor. New.

You can even write a single Family API program that runs under both MS-DOS and MS OS/2.

Microsoft Editor is the first reconfigurable text editor for programmers that lets you develop under MS-DOS and MS OS/2. Under MS OS/2, multitasking lets you edit one file while you compile another, which cuts development time. You can even generate multiple compiles that report errors directly back into your source code.

Microsoft CodeView® is the highly acclaimed

window-oriented source-level debugger that makes debugging fast and efficient. You can view program execution while you watch variables and register values change. And under MS OS/2 you can debug multithreaded applications, DLLs, and programs as large as 128 MB.

New Microsoft C Optimizing Compiler 5.1 for the professional programmer. It's all the speed you need. Call (800) 541-1261, Department I53.

**Microsoft**

# Get your work done before 1991

The future of personal computing is clear. More powerful PCs. Easier to use PCs. With graphics and character-based programs working side by side. Talking to each other. Multitasking. Windowing. Menuing. Mousing. Getting your work done easier and faster.

labels while you're writing a report in Word Perfect, or laying out a newsletter in Ventura Publisher, or designing a building in AutoCAD. DESQview even lets you transfer text, numbers, and fields of information between programs.

## Have it all now.

DESQview™ is the operating environment that gives DOS the capabilities of OS/2.™ And it lets you, with your trusty 8088, 8086, 80286, or 80386 PC, leap to the productivity of the next generation. For not much money. And without throwing out your favorite software.

Add DESQview to your PC and it quickly finds your programs and lists them on menus. So you can just point to the program, using keyboard or mouse, to start it up. DESQview knows where that program lives. And what command loads it.

For those who have trouble remembering DOS commands, it adds menus to DOS. It even lets you sort your files and mark specific files to be copied, backed-up, or deleted—all without having to leave the program you're in.

Best of all, DESQview accomplishes all this with a substantial speed advantage over any alternative environment.

## Multitask beyond 640K.

When you want to use several programs together, you don't have to leave your current program. Just open the next program. View your programs in windows or

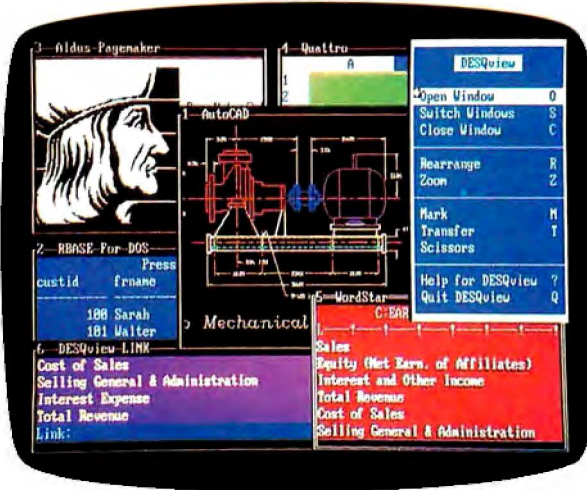

full screen. Open more programs than you have memory for. And multitask them. In

For programmers, DESQview's API, with its strengths in inter-task communications and multitasking, brings a quick and easy way to adapt to the future. With the API's mailboxes and shared programs, programmers are able to design programs running on DOS with capabilities like those of OS/2.

640K. Or if you own a special EMS 4.0 or EMS memory board, or a 386 PC, DESQview lets you break through the DOS 640K barrier for multitasking. If you have other non-EMS memory expansion products like AST's Advantage or the IBM® Memory Expansion Option, we have a solution for you, too. The ALL CHARGE-CARD™ 'unifies' all your memory to provide up to 16 megabytes of continuous workspace. DESQview lets you use this memory to enhance your productivity. You can start 1-2-3 calculating and tell Paradox to print mailing

## Fulfill the 386 promise.

For 8086 PC users, DESQview becomes a 386 control program when used in conjunction with Quarterdeck's Expanded Memory Manager (QEMM)-386—giving faster multitasking as well as virtual windowing support.

And when you use DESQview on an IBM PS/2™ Model 50 or 60 with QEMM-50/60 and the IBM Memory Expansion Option, DESQview gives you multitasking beyond 640K.

## Experts are voting for DESQview. And over a million users, too.

If all of this sounds like promises you've been hearing for future systems, then you can understand why over a million users have chosen DESQview. And why PC Magazine gave DESQview its Editor's Choice Award for "The Best Alternative to OS/2," why readers of InfoWorld twice voted DESQview "Product of the Year"



why, by popular vote at Comdex Fall for two years in a row, DESQview was voted "Best PC Environment" in PC Tech Journal's Systems Builder Contest.

DESQview lets you have it all now.

**DESQVIEW SYSTEM REQUIREMENTS:**  
IBM Personal Computer and 100% compatibles (with 8086, 8088, 80286, or 80386 processors) with monochrome or color display, IBM Personal System/2+ Memory: 640K recommended; for DESQview itself 0-145K\* Expanded Memory (Optional): expanded memory boards compatible with the Intel Aboveboard; enhanced expanded memory boards compatible with the AST RAMpage; EMS 4.0 expanded memory boards\* Disk: two diskette drives or one diskette drive and a hard disk\* Graphics Card (Optional): Hercules, IBM Color/Graphics (CGA), IBM Enhanced Graphics (EGA), IBM Personal System/2 Advanced Graphics (VGA)\* Mouse (Optional): Mouse Systems, Microsoft and compatibles\* Modem for Auto-Dialer (Optional); Hayes or compatible\* Operating Systems: PC-DOS 2.0-3.3; MS-DOS 2.0-3.2\* Software: Most PC-DOS and MS-DOS application programs; programs specific to Microsoft Windows 1.03-2.03, GEM 1.1-3.0, IBM TopView 1.1\* Media: DESQview 2.0 is available on either 5-1/4" or 3-1/2" floppy diskette.

**YES!**  
I need increased productivity now!

Name \_\_\_\_\_  
Address \_\_\_\_\_  
City \_\_\_\_\_ State \_\_\_\_\_ Zip \_\_\_\_\_  
Payment Method  Visa  MasterCard Expiration \_\_\_\_/\_\_\_\_  
Account # \_\_\_\_\_

Qty	Product	Format	Price Each	Totals
	DESQview 2.0	□ 5-1/4 □ 3-1/2	\$129.95	
	QEMM-386	□ 5-1/4 □ 3-1/2	\$59.95	
	QEMM-50/60	□ 5-1/4 □ 3-1/2	\$59.95	
	ALL CHARGE CARD (Special for DESQview owners)		\$200.00*	

Shipping & Handling: \$5 in USA / \$10 outside USA

Calif Residents add 6.5%

Grand Total

**Quarterdeck**

150 Pico Boulevard, Santa Monica, CA 90405  
(213) 392-9851

\*This ALL CHARGE CARD is designed for the IBM PC AT and PS/250 and 60. If you have another type of 80286-based PC, there's a version for you, too. Please call 1-(800) 387-2744 for special ordering information. Offer expires August 31, 1988. Trademarks are property of their respective holders: IBM, OS/2, PS/2, 1-2-3, Paradox, Word Perfect, Ventura Publisher, AutoCAD, Intel, Above Board, AST, RAMpage, Advantage, Hercules, Mouse Systems, Hayes, Microsoft, Windows, TopView.

# A Better C?

*This child of C goes its parent one better  
in compatibility and portability*

*Bjarne Stroustrup*

**T**he C++ language is a general-purpose programming language that is, except for minor details, a superset of C. It improves on C through its support of data abstraction and object-oriented programming. The main influences on its design, in addition to C, were Simula-67 and Algol68 (see references 1 and 2).

C++ was first installed 5 years ago. Today, it has several independent implementations and many thousands of installations. It is being used for major university research projects and for large-scale software development in companies such as Apple, Apollo, AT&T, and Sun.

It has been applied to most branches of programming, including banking, CAD, compiler construction, database management, image processing, graphics, music synthesis, networking, programming environments, robotics, simulation, scientific computation, switching, and very-large-scale-integration design.

## A Better C

C++ improves the notational convenience of C and provides greater type



safety. It compensates for C's weaknesses without compromising C's strengths. In particular, there is no program that can be written in C but not in C++, nor is there a program that can be written in C so that it achieves greater run-time efficiency than it does in C++ (see reference 3).

C is clearly not the cleanest language ever designed nor the easiest to use, but it

owes its current pervasiveness to several key strengths:

- *Flexibility:* You can apply C to almost every application area and use almost every programming technique with it. The language has no inherent limitations that preclude writing particular kinds of programs.
- *Efficiency:* C's semantics are "low-level." That is, its fundamental concepts mirror those of a traditional computer. Consequently, it's relatively easy, both for you and for a compiler, to efficiently use hardware resources for a C program.
- *Availability:* Given any computer, from the tiniest microcomputer to the largest supercomputer, chances are that there's an acceptable-quality C compiler available for it, and that such a compiler supports an acceptably complete and standard C language and library. There are also libraries and support tools available, so you rarely need to design a new system from scratch.
- *Portability:* While a C program may not be easily or automatically portable from one machine (or operating system) to another, such a port is usually possible.

*continued*

# The Origin of C++

Rich Malloy

**C**++ (pronounced "C plus plus"), like many other languages, began life as a tool to solve a specific problem. Bjarne Stroustrup, a Bell Labs researcher, needed to write some simulation programs. Simula67, the first real object-oriented language, would have been ideal for these programs except for its comparatively slow execution speed. Dr. Stroustrup chose instead to write a new version of C, which he called "C with Classes." By 1983, the language had evolved considerably and the name was changed to C++.

After further evolution, Bell Labs' parent company, AT&T, began offering

the language as a product in 1985.

The name C++, like the language itself, is terse but meaningful. The name, coined by an associate of Stroustrup's named Rick Mascitti, concisely describes the evolutionary nature of the language. The term "++" is, of course, the increment operator in C, suggesting that the language C++ is "a bit more than C." A possible alternative name, C+, is not only less inspired but also liable to generate a syntax error.

*Rich Malloy is an associate managing editor at BYTE. You can reach him on BIX as "rmalloy."*

ble. The level of difficulty is also usually low enough that even porting software that contains inherent machine dependencies is both technically and economically feasible.

C++ preserves these strengths and remedies some of C's most obvious problems. For example, function arguments are type-checked in C++, and coercions are applied where they are found to be appropriate:

```
extern double sqrt(double);
// declare square-root function
...
double d1 = sqrt(2);
// fine: 2 is converted to
// a double
...
double d2 = sqrt("two");
// error: sqrt() does not
// accept a string
```

The // notation was introduced into C++ from BCPL (see reference 4) for comments starting at the // and ending at the end of the line.

As shown, C++ makes you specify a function's argument types in a function declaration so that the standard type conversions (such as int to double) can be implicitly applied, and type errors (such as calling a function requiring a double with a char\* argument) can be caught at compile time. With minor restrictions, the draft ANSI C standard accepts the C++ function-calling rules and the syntax for function declarations and function definitions (see reference 5).

C++ provides in-line substitution of functions:

```
inline int max(int a, int b)
{ return a>b?a:b; }
...
int x = 7;
int y = 9;
...
max(x,y);
// generates: x>y?x:y
max(f(x),x); // generates:
// temp=f(x); temp>x?temp:x
```

Unlike the macros commonly used in C, in-line functions obey the usual type and scope rules. Using in-line functions can lead to apparent run-time improvements over C. In-line substitution of functions is especially important in the context of data abstraction and object-oriented programming. With these styles of programming, very small functions are so common that function-call overhead can become a performance bottleneck.

In addition, C++ provides typed and scoped constants, operators for free store (dynamic store) manipulation, and many other features.

When the ANSIC committee finishes its work, the definition of C++ will be reviewed to remove gratuitous incompatibilities. This will not be a major task, though, because C++ and ANSI C have already absorbed most of the "new ANSI C" features from each other.

For example, the notion of a pointer to "raw storage," void\*, was incorporated into C++ from ANSI C, as were notational conveniences such as the suffix u indicating an unsigned literal (e.g., 12u) and hexadecimal character constants (e.g., '\xfa'). However, the most important features of C++ relate to the support of data abstraction and object-

oriented programming and are thus outside the scope of ANSI C and unaffected by changes in the draft ANSI C standard.

## Data Abstraction

Data abstraction is a programming technique in which you define general-purpose and special-purpose types as the basis for applications (see reference 6). These user-defined types are convenient for application programmers since they provide local referencing and data hiding. The result is easier debugging and maintenance and improved program organization.

In C++, you can define types that you then can use as conveniently as, and in a manner similar to, built-in types. Common examples are arithmetic types such as rational and complex numbers.

```
class complex {
double re, im;
public:
complex(double r, double i)
{ re=r; im=i; }
complex(double r)
{ re=r; im=0 }
// float->complex conversion
friend complex
operator+(complex, complex);
friend complex
operator-(complex, complex);
// binary minus
friend complex
operator-(complex);
// unary minus
friend complex
operator*(complex, complex);
friend complex
operator/(complex, complex);
};
```

The declaration of class complex specifies the representation of a complex number and the set of operations on it. The keyword class is C++'s term for *user-defined type*. The declaration of class complex has two parts.

The initial part specifies the representation of a complex number and is by default private. This representation (consisting of the two double-precision floating-point numbers re and im) is accessible only to the functions defined in the declaration of class complex.

The second part of the declaration specifies how a user can create and manipulate complex numbers. It is called the public part of the declaration because it provides an interface to the general public. It consists of two constructors and the usual arithmetic operations. A constructor is a function that constructs a value of a given type. The first constructor for complex creates a com-

*continued*

# WARP SPEED



**30 Day Risk-Free Trial • On-Site Service Available**  
The Fastest PC's in the Galaxy, at down to Earth Prices

## 12 Slot Power 286/386

We put the 80286 on a card so you can upgrade to the 80386 whenever you're ready. Most of our corporate accts. prefer this American-designed, industrial quality machine. Why? 12 slots, 240 watt power supply, 4 drive openings & ruggedized construction. Tower, rack-mounted and motherboard versions available.

50MB, mono, system

**\$1895**

## 386 Speed, 286 Price

12MHz, zero wait states with 1 to 1 controller and Power Optimiser software makes this AT compatible the fastest at any price. Landmark speed Test rates this 286 at 15.6MHz! The data transfer rate is 4 times faster. A complete system with 1MB RAM, monitor and 50MB, 33ms hard disk is only:

50MB

**\$1950**

12MHz 1 wait state, 640K, 50MB,

101 Keyboard, 1.2MB

**\$1695**

Ask our customers about our quality, service and prices:

American Express  
Anheuser-Busch  
Associated Press  
Boeing Aerospace  
Clorox  
Coca-Cola  
Dean Witter  
Ernst & Whinney  
Federal Communications Com.  
Ford Aerospace  
Heath Zenith

Honeywell  
Intel  
IteL  
ITT  
Lockheed Missiles & Space  
Lucas Film  
Martin-Marietta  
Master-Card  
McDonnell Douglas  
MCI

NASA  
Pacific Bell  
Rockwell International  
Siemens  
Tandem Computers  
TRW  
United Airlines  
University of Calif.  
Wells Fargo  
Westinghouse

## Passport 286 & 386

*New large screen.*

Micro 1 introduces the Passport 286 & 386 portables that keep pace with the best Compaq has to offer. 12, 16 or 20MHz and up to 8MB of zero wait state memory gives you more power than most desktop computers. Both the 11", 640 x 480 resolution backlit, supertwist, LCD screen and gas plasma screen are far more readable than typical laptop screens. External EGA and VGA output optional, 1 to 1 interleave controllers and 50 to 150MB drives optional, 200 watts, 6 slots standard.

386-16MB, 20MB

**\$3295**

286-12 640K, 20MB

**\$1995**

*"Micro 1's clones are designed for industrial use. . . none are so well made."*

Paul Muller, Ford Aerospace, Palo Alto, CA

## 30MHz Performance

The Power 386 outruns the IBM Model 80 and Compaq Deskpro 386/20. How do we do it? 20MHz, zero wait state with 64K of static RAM cache and ultra-high speed ESDI hard disks with 1 to 1 interleave buffered controllers. Add to this our special Power Optimiser software that accelerates reads and writes by 300% and you've got the best that money can buy, at 2/3 the price! Landmark, Speed Test rating 30MHz.

UNIX systems with DOSMERGE now available. Ask about our Tower!

16MHz (24MHz Landmark) 1MB Complete system with 50MB and monitor.

**\$2895**

Call for price on 20MHz and other configurations.

**MICRO**

**1**

557 Howard St.  
San Francisco, CA 94105  
Tech Support: (415) 974-5997  
Fax: (415) 974-6996

Summit Computer System  
12A Chapel St. North  
Colchester Essex  
CO2 7AT UK  
(0206) 761950  
FAX: (0206) 761941  
Telex: 940 11232

To order call toll free:

**1-800-338-4061**

In California call  
**(415) 974-5439**

plex number given a coordinate pair; the second creates a complex number given a single floating-point number (using the obvious mapping of the real line into the complex plane). Together they provide the two obvious ways of initializing a complex variable. For example:

```
complex a = complex(1.2);
// a becomes (1.2,0)
complex b = complex(3.4,5.6);
```

The arithmetic operations are defined by friend functions: Specifically, these functions are completely ordinary except that they are granted access to the otherwise inaccessible representation of complex numbers by the friend declarations. The notation operator+ is used to name a function defining the addition operator, +. The number of arguments determines whether an operator function implements a binary or a unary operator. For example, operator-(complex, complex) defines subtraction of complex numbers, whereas operator-(complex) defines unary minus.

Such functions can be defined as

```
complex operator+(complex a1,
                  complex a2)
{
    return complex(a1.re+a2.re,
                  a1.im+a2.im);
}
```

and used like this:

```
main()
{
    complex a = 2.3;
    complex b = complex(1/a, 7);
    complex c = a+b+complex(1,4.5);
}
```

Here, a receives the value (2.3,0) by implicit application of the constructor complex(double); b receives the value (1/2.3,7); and c becomes the value (2.3+1/2.3+1,7+4.5)—that is, about (3.7,11.5).

The constructors and the operator functions let you use complex numbers just as if they were built into the language. In-line functions let the run-time efficiency of a user-defined type come close to an equivalent built-in type.

Hiding the representation is the key to modularity. It allows the representation of a class to be changed without affecting users. For example, you might decide to change the Cartesian representation of complex used above to a polar one. Such a change would affect *only* the functions listed in the class definition. User code, such as main(), is unaffected. Debug-

ging can also be greatly simplified by proper use of such data hiding.

Programming with classes shifts the emphasis from the design of algorithms to the design of classes (user-defined types). Each class is a direct representation of a concept in the program; each object the program manipulates is of some specific class that defines its behavior. In other words, every object in a program is of some class that defines the set of legal operations on that object. This lets you program in a language with a set of types, or concepts, appropriate to the application. An engineer might use complex numbers, matrices, and fast Fourier transforms, while the telephony-software designer might prefer types such as switch, line, trunk, handset, and digit buffer.

In C++, this style of programming is supported by a general and flexible set of mechanisms for data hiding, by constructors providing optional guaranteed initialization, by destructors providing optional guaranteed cleanup (termination), and by operator overloading and user-defined coercions providing a convenient and conventional notation for many kinds of applications. All these features are cleanly integrated into the language, and all uses are checked for type violations and ambiguities at compile time to catch errors as early as possible and to avoid unnecessary run-time overheads.

### Object-Oriented Programming

Concepts do not usually come as self-contained entities. On the contrary, most concepts relate to other concepts in a variety of ways. For example, the concepts of airplane and car relate to those of vehicle and transport; the concepts of mammal and bird relate to each other through the more general concept of vertebrate animal, through the concept of food, and so forth; and the concepts of a circle, rectangle, and polygon involve the general concept of a shape.

Therefore, representing concepts directly as types in a program also requires ways of expressing the relations between types. C++ lets you specify hierarchically organized classes. This is the key feature supporting object-oriented programming. Hierarchical organization is an extremely important way of coping with complex issues in many fields and has, not surprisingly, also proven to be a good way of organizing programs in a wide variety of application areas.

Consider defining a type shape for use in a graphics system. The system has to support circles, triangles, squares, and many other shapes. First, you spec-

ify a class that defines the general properties of all shapes:

```
class shape {
    point center;
    color col;
    // ...
public:
    point where() { return center; }
    void move(point to)
        { center = to; draw(); }
    virtual void draw();
    virtual void rotate(int);
    // ...
};
```

You can define the calling interfaces for draw() and rotate(), but you cannot yet define their implementation. They are, therefore, declared virtual (the Simula67 and C++ term for "to be defined later in a class derived from this one"). They will be defined for each specific shape. Given this definition of class shape, you can write general functions manipulating shapes:

```
void rotate_all(shape* v[],
                int size, int angle)
// rotate all members of
// vector "v" of size "size"
// "angle" degrees
{
    for (int i = 0; i < size; i++)
        v[i]->rotate(angle);
}
```

For each shape v[i], the proper rotate() function for the actual type of the object will be called. That "actual type" is not known at compile time.

To define a particular shape, you must say that it is a shape and specify its particular properties:

```
class circle : public shape {
// a circle is a shape
    int radius;
public:
    void draw() { /* ... */ };
    void rotate(int) {}
// yes, the null function
};
```

A class is said to be *derived* from another class, which is then called its *base* class. Here, circle is derived from shape, and shape has a base class of circle. A derived class is said to inherit the properties of its base. In addition to such inherited properties, a derived class has its own specific properties. For example, class circle has the member radius in addition to the members col and center that it inherited from class shape.

Note that the new shape center was

*continued*



# Command.

CompuServe Navigator speaks your language.

If you're accustomed to the friendly Mac® computing style, you no longer have to compromise when you go online.

Because now CompuServe Navigator™ software gives you user-friendly, Mac-like icons and the kind of familiar display formats you prefer.

You're in command. Search Forum Message Boards and Data Libraries faster than humanly possible, automatically. Retrieve files using the latest and fastest version of B Protocol. Write and answer EasyPlex® and Forum correspondence, offline.

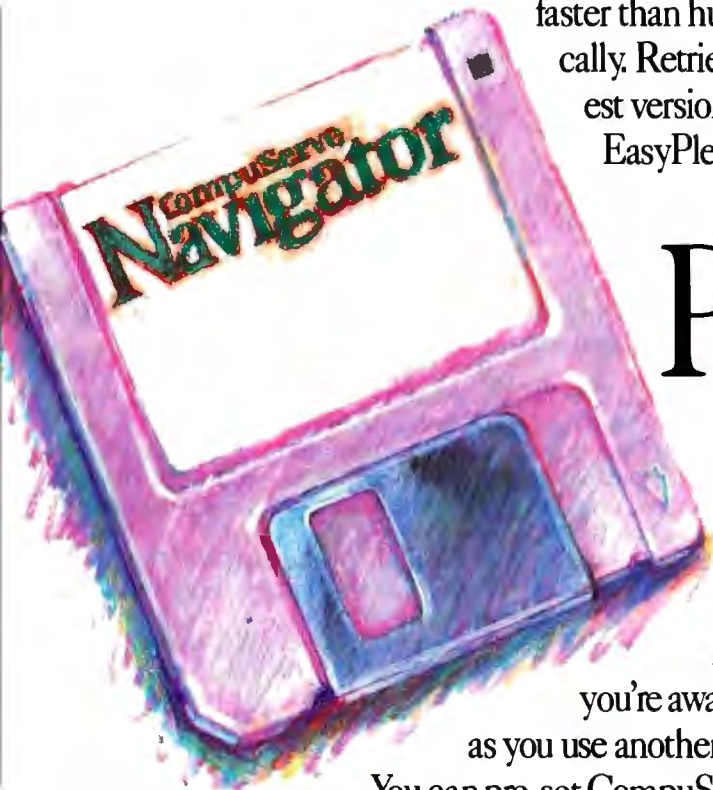

# Performance.

Run your Mac on auto-pilot.

CompuServe Navigator makes the most of every second you spend online. It logs on, takes care of your Forum business and pending electronic mail, and logs off. It can even run unattended, while

you're away or in the background as you use another program.

You can pre-set CompuServe Navigator to go online during off-peak hours. And of course there's a terminal mode for easy conventional access.

No other software gets more out of CompuServe Forum resources. All for just \$59.95. Regularly \$79.95.

To order online, type GO ORDER at any ! prompt, or call 1-800-848-8199. In Ohio and Canada, call 614-457-0802.



## CompuServe®

Information Services, P.O. Box 20212  
5000 Arlington Centre Blvd., Columbus, Ohio 43220

An H&R Block Company

Circle 52 on Reader Service Card

added without modifying "old code," such as the `rotate_all()` function and other shapes. The ability to extend a program by adding new variations of a basic concept (i.e., adding new derived classes given a base class) without touching old code is a major boon. Using traditional techniques, such additions require access to the source code of the system you want to extend, require understanding of the key implementation details of the old code, and carry the risk of introducing errors in the already-tested old code. Furthermore, using derived classes, improvements and bug fixes done to a base class are automatically "inherited" by every class derived from it.

I chose the "shape" example because everyone understands about shapes, not because object-oriented programming has anything particular to do with graphics. Graphics is a good area for object-oriented techniques, but most uses of such techniques in C++ have nothing to do with graphics. Other examples are compilers, operating-system kernels and device drivers, switching software, and network simulations.

In many contexts, it is important that the C++ virtual-function mechanism be nearly as efficient as a "normal" function call. The additional run-time overhead is about five memory references (depending on the machine architecture and the compiler), and the memory overhead is one word per object plus one word per virtual function per class.

C++ provides multiple inheritance (see reference 7), or the ability to derive a class from more than one direct base class. For example, if you have a class `task` representing the concept of a concurrent activity, and a class `displayed` representing the concept of something displayed on the screen, you might write:

```
class displayed_task
: public displayed, public task
{ ... }
```

Now a `displayed_task` is really both a `displayed` and a `task`, so a `displayed_task` can be used wherever a `displayed` or a `task` is required:

```
void wait(task*, int);
// do something to a task
void update(displayed*);
// do something to a displayed
```

```
f()
{
// make a displayed_task:
displayed_task* dtp =
new displayed_task(
/* appropriate arguments */ );
```

```
wait(ctp, 10);
// use displayed_task as a task
update(ctp);
// displayed_task as displayed
}
```

Naturally, the usual type-checking rules, ambiguity rules, and encapsulation mechanisms are applied to multiple inheritance to ensure the usual degree of safety and efficiency.

### Why C++?

What distinguishes C++ from other programming languages? C++ was designed under severe constraints of compatibility, internal consistency, and efficiency. No feature was included that would cause a serious incompatibility with C at the source or linker levels; would cause run-time or space overheads for a program that did not use it; would increase run time or requirements for a C program; would significantly increase the compile time compared with C; or could only be implemented by making more demands than in a traditional programming environment.

Traditional languages such as C, FORTRAN, Pascal, and Modula-2 don't provide anything comparable to C++'s features for data abstraction and object-oriented programming. This gives the C++ programmer a strong advantage when it comes to understanding, writing, and maintaining programs. It's often important that the improved structure of C++ programs be achieved without sacrificing efficiency or restricting the range of areas for which the language is suitable.

Ada provides facilities for data abstraction that may not be as elegant as C++'s but should be about as effective in actual use. But Ada doesn't provide an inheritance mechanism to support object-oriented programming, so C++ has greater expressive power in this area.

C++ is distinguished among languages that support object-oriented programming, such as Smalltalk, by a variety of factors: its emphasis on program structure; the flexibility of encapsulation mechanisms; its smooth support of a range of programming paradigms; the portability of C++ implementations; the run-time efficiency (in both time and space) of C++ code; and its ability to run without a large run-time system.

C++ is a programming language in the traditional sense and is not a complete program development system or a complete execution environment. It can be installed easily into an existing C program development or execution environment,

and C++-specific tools can then be added as needed. In addition, several C++-specific environments are being built to suit specific needs (see references 8 and 9).

The emphasis on explicit static structure (as opposed to a weak type-checking, as in C, or purely dynamic type-checking, as in Smalltalk) is particularly important for projects involving many programmers and for individual programmers using large libraries written by others. C++'s strong type-checking and encapsulation mechanisms have repeatedly proven themselves by dramatically reducing integration time for larger projects. Similarly, C++ provides a good base for designing libraries with precisely defined, elegant, and statically checked interfaces.

C++ has a single, very flexible, type system. This makes it possible to use hybrid programming styles without violating the C++ type system. It also lets you choose a style of programming closely matching individual application areas. ■

### REFERENCES

1. Birtwistle, Graham, et al. *SIMULA BEGIN*. Studentlitteratur, Lund, Sweden, 1971. Chartwell-Bratt Ltd., U.K., 1980.
2. Woodward, P. M., and S. G. Bond. *Algol 68-R Users Guide*. London: Her Majesty's Stationery Office, 1974.
3. Stroustrup, Bjarne. *The C++ Programming Language*. Reading, MA: Addison-Wesley, 1986.
4. Richards, Martin, and Colin Whitby-Stevens. *BCPL—The Language and its Compiler*. New York: Cambridge University Press, 1980.
5. Prosser, David F. Draft Proposed American National Standard for Information Systems—Programming Language C X3 Secretariat, CBEMA, Washington.
6. Stroustrup, Bjarne. "What Is 'Object-Oriented Programming'?" *IEEE Software Magazine*, May 1988.
7. Stroustrup, Bjarne. *The Evolution of C++: 1985–1987*. Santa Fe, NM: Proc. USENIX C++ Workshop, November 1987.
8. Linton, Mark A. "Distributed Management of a Software Database." *IEEE Software*, November 1987, pp. 70–76.
9. Stroustrup, Bjarne. *Possible Directions for C++: 1985–1987*. Santa Fe, NM: Proc. USENIX C++ Workshop, November 1987.

*Bjarne Stroustrup is the designer and original implementor of C++. He works at AT&T Bell Labs, Murray Hill, New Jersey. You can reach him on BIX as "bstroustrup."*

**Only NRI teaches you to service all computers as you build your own, fully PC-compatible micro—now with 20 meg hard disk drive!**

The Department of Labor ranks computer service high on its list of top growth fields, with accelerated demand creating more than 30,000 new jobs within the next 10 years.

You can cash in on this opportunity—either as a full-time corporate technician or an independent service-person—once you've learned all the basics of computers the NRI way.

**Get inside the latest, fully IBM PC-compatible Sanyo computer—now with hard disk drive**

As an NRI student, you'll get total hands-on training as you actually build the latest-model Sanyo 880 Series computer from the keyboard up. It's fully IBM PC-compatible, plus you now go on to install a 20 megabyte hard disk drive to complete your total computer system. Throughout your training, you'll perform demonstrations and experiments that will give you a total mastery of computer operation and servicing techniques.

**Understanding you get only through experience**

You need no previous knowledge to succeed with NRI. You start with the basics, rapidly building on the fundamentals of electronics with bite-size lessons. You perform hands-on experiments with your NRI Discovery Lab® and then move on to master advanced concepts like digital logic, microprocessors, and computer memories.

**Learn at home in your spare time**

You train in your own home at your own convenience, backed at all times by your own NRI instructor and the entire NRI staff of educators and student service support people. They're always ready to give you guidance, follow your progress, and help you over the rough spots to keep you moving toward your goal.

Get all the facts from NRI's 100-page catalog.



**Your incomparable total systems training includes all this:**

NRI's unique Discovery Lab® to let you design and modify circuits, diagnose and repair faults • NRI's digital multimeter, complete with "talk-you-through" instructions on audio cassette • Digital logic probe that lets you visually examine computer circuits • The latest Sanyo 880 Series computer with "intelligent" keyboard and 5¼" floppy disk drive • 20 megabyte hard disk drive you install internally • 8K ROM, 256K RAM • Bundled software including GW-BASIC, MS-DOS, WordStar, CalcStar • Reference manuals, programming guidelines, and schematics.

See other side for highlights of NRI's "hands-on" computer training →

**SEND CARD TODAY FOR FREE NRI CATALOG**



**COMPUTER ELECTRONICS**

training prepares you to service all computers as you build your own fully IBM PC compatible computer. Total systems training includes 5¼" floppy disk drive, 20 meg hard disk drive, monitor, test equipment, software, and NRI Discovery Lab®.

**Check one FREE catalog only.**

- Computer Electronics
- TV, Audio, and Video Servicing
- Electronic Music Technology
- Basic Electronics

Name \_\_\_\_\_ (Please Print) \_\_\_\_\_ Age \_\_\_\_\_

Street \_\_\_\_\_

City \_\_\_\_\_ State \_\_\_\_\_ Zip \_\_\_\_\_

For career courses approved under GI Bill  Check for details

169-088

# Learn Computer Servicing Skills with NRI's "Hands-On" Training



Using NRI's unique Action Audio Cassette, you are talked through the operation and practical application of your hand-held digital multimeter—the basic, indispensable tool for the computer specialist.

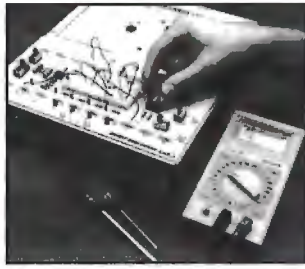

You'll set up and perform electronics experiments and demonstrations using your NRI Discovery Lab<sup>®</sup>. You'll even interface the lab with your computer to "see" keyboard-generated data.



After you build this digital logic probe, you'll explore the operation of the Sanyo detached "intelligent" keyboard and its dedicated microprocessor.



Next, you install the disk drive. You learn disk drive operation and adjustment, make a copy of the MS-DOS operating disk, and begin your exploration of the 8088 CPU.

## Total Computer Systems Training, Only From NRI

No computer stands alone... it's part of a total system. And if you want to learn to service and repair computers, you have to understand computer systems. Only NRI includes a powerful computer system as part of your training, centered around the new, fully IBM PC-compatible Sanyo 880 Series computer.

As part of your training, you'll actually build this powerful Sanyo 880 Series IBM PC-compatible computer. It has two operating speeds: the standard IBM speed of 4.77 MHz and a remarkable turbo speed of 8 MHz.



## Mastery is "built-in"

You'll assemble the Sanyo "intelligent" keyboard, install the power supply and 5¼" floppy disk drive, and attach the high-resolution monitor. But that's not all. You'll go on to install a powerful 20 megabyte hard disk drive—today's most-wanted computer peripheral—now included as part of your hands-on training.

The many demonstrations and experiments you perform as you build your Sanyo computer will give you a total mastery of computer operation, based on a thorough knowledge of the intricacies of computer theory.

**SEND TODAY FOR FREE CATALOG**

**100-page, free catalog tells more... send today**



**BUSINESS REPLY MAIL**

FIRST CLASS MAIL PERMIT NO. 10008 WASHINGTON, D.C.

POSTAGE WILL BE PAID BY ADDRESSEE

**NRI** SCHOOLS

McGraw-Hill Continuing Education Center  
3939 Wisconsin Avenue  
Washington, D.C. 20077-9265

NO POSTAGE  
NECESSARY  
IF MAILED  
IN THE  
UNITED STATES



Send the postage-paid reply card today for NRI's 100-page catalog that gives all the facts about computer training, plus career training in robotics, data communications, TV/audio/video servicing, and many other fields. If the card is missing, write to NRI at the address below.

**NRI** SCHOOLS

McGraw-Hill Continuing  
Education Center  
3939 Wisconsin Avenue  
Washington, D.C. 20016

We'll give you tomorrow.



Buy with

# Confidence

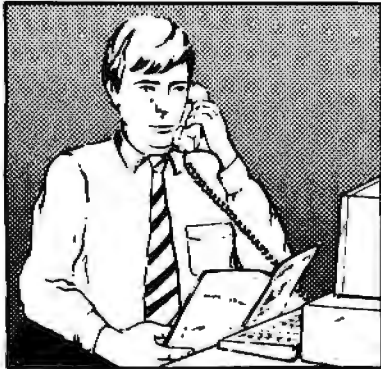

In an effort to make your telephone purchasing a more successful and pleasurable activity, The Microcomputer Marketing Council of the Direct Marketing Association, Inc. offers this advice, "A knowledgeable buyer will be a successful buyer." These are specific facts you should know about the prospective seller before placing an order:

## Ask These Important Questions

- How long has the company been in business?
- Does the company offer technical assistance?
- Is there a service facility?
- Are manufacturer's warranties handled through the company?
- Does the seller have formal return and refund policies?
- Is there an additional charge for use of credit cards?
- Are credit card charges held until time of shipment?
- What are shipping costs for items ordered?

Reputable computer dealers will answer all these questions to your satisfaction. Don't settle for less when buying your computer hardware, software, peripherals and supplies.

## Purchasing Guidelines

- State as completely and accurately as you can what merchandise you want including brand name, model number, catalog number.
- Establish that the item is in stock and confirm shipping date.
- Confirm that the price is as advertised.
- Obtain an order number and identification of the sales representative.
- Make a record of your order, noting exact price including shipping, date of order, promised shipping date and order number.

If you ever have a problem, remember to deal first with the seller. If you cannot resolve the problem, write to MAIL ORDER ACTION LINE, c/o DMA, 6 E. 43rd St., New York, NY 10017.

This message is brought to you by:

the MICROCOMPUTER  
MARKETING COUNCIL  
of the Direct Marketing  
Association, Inc.  
6 E. 43rd St.,  
New York, NY 10017

**MMC**  
MICROCOMPUTER  
MARKETING COUNCIL  
of the Direct Marketing Association, Inc.

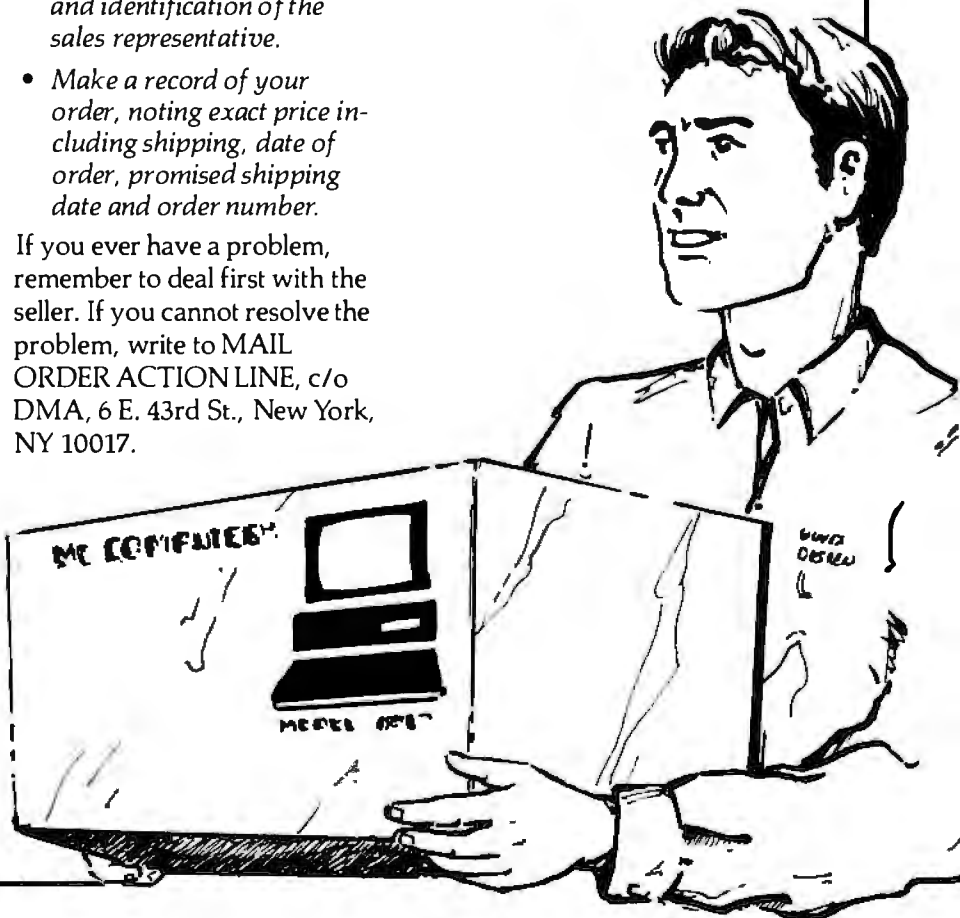

# KEY INTO OUR LANGUAGE TECHNOLOGY

*Microlytics is the Leading Supplier of Linguistic Technology in Software & Firmware.*

We offer spelling verifier/correctors in English (U.S. and U.K.) and nine European languages. Our **Word Finder**• thesaurus is the best selling electronic thesaurus on the market, with over 1.5 million copies sold. The *New York Times* recently called it "The finest electronic thesaurus available."

We use a powerful compression technology, developed at the Xerox Palo Alto Research Center (PARC), to squeeze the entire Word Finder thesaurus into only 92K of ROM space (15,000 main word entries and 220,000 synonyms - 3X this amount if you count all inflected forms). Our 100,000 word English spelling lexicons (U.S. and U.K.) take only 120K of ROM or disk space. Our 400,000 word Italian lexicon takes 123K bytes (source: Zingarelli). Unlike other compression techniques, ours require under 10K of lookup code, and under 1K of RAM. Decompression is instantaneous. Our new phonetic correction algorithms are unsurpassed in the industry.

Our customers include Ashton-Tate, Claris, Lotus, MicroPro, Microsoft, Symantec, Xerox, XyQuest, and many others. Word Finder is the thesaurus bundled in Microsoft Word, WordStar 4.0, FullWrite, Manuscript, and XyWrite. Our speller won *PC Magazine* Editor's Choice in 1987 for the implementation in XyWrite III Plus, compared to a field of 32 products with spelling technology from every vendor in the industry. It is also used in FullWrite and MacWrite 5.0.

We provide the technology in the SelecTronics WordFinder WF-220 handheld dictionary/thesaurus. Other applications of our technology include OCR and speech recognition verification. We can customize for any requirement.

**GOfer**™, the high speed text retrieval program that works without indexing on the IBM PC and Macintosh is another of our products. A powerful grammar checking system outperforming anything else on the market, and requiring far less overhead, will be available soon.

We offer our products in turnkey implementations in both software and firmware, and welcome OEM and distributor inquiries. We support the IBM PC, Macintosh, Intel 8031, 8051, 8088/8086, the Z-80, and 68000 machine code.

**For further information contact:**

**Mr. Robert Atkins**, Vice President, Sales/Marketing  
**Mr. Roger Fearing**, Western Regional Sales Manager

**MICROLYTICS, INC.**  
300 Main Street, Suite 1592  
East Rochester, New York 14445  
(716) 248-9150

FAX: (716) 248-3868

Telex: 6503021536



# Microlytics, Inc.

Word Finder is a registered trademark of Microlytics, Inc. Spell Finder, GOfer and Microlytics are trademarks of Microlytics, Inc. Other brand and product names are trademarks or registered trademarks of their respective holders.

©1988, Microlytics, Inc. All rights reserved.

# It's an Attitude

*There's a lot of extra coding, but you can do object-oriented programming in conventional C*

*Jonathan S. Linowes*

Object-oriented programming is not dependent on any given programming language; it's an attitude. Structured programming asks you to answer the questions, "How is my data transformed?" and "What are my inputs and outputs?" Object-oriented programming asks, "What are the things I will be working with?" and "What do I expect these things to do?" It is becoming a popular alternative to conventional structured techniques for organizing and thinking about programs.

OOPC is a mechanism for object-oriented programming using standard C. It's not a programming language in itself, nor is it a preprocessor. Rather, it's a collection of conventions and programming techniques that, if followed, give you many of the benefits of today's object-oriented programming languages—benefits such as data encapsulation, modularity, and inheritance.

Through OOPC, I introduce the concepts of object-oriented programming in a practical and familiar context, rather than complicating the issue with a new language and a new syntax. To demonstrate OOPC techniques in action, I have



implemented the MyShape example adapted from *The C++ Programming Language* by Bjarne Stroustrup (Addison-Wesley, 1986), pages 213 to 221.

Object-oriented programming techniques are very good for prototyping applications. In fact, OOPC was developed for the MIT Media Laboratory UseIT project, a user-interface test-bed system. The UseIT system lets you easily build

components of a user interface, modify an interaction technique (such as changing a pop-up menu into a pull-down), and quickly program entirely new objects. This was a fairly complex project with multiple programmers and required the ability to make quick code modifications. Using object-oriented programming techniques made the UseIT system easy to understand and modify.

## **Objects as Virtual Devices**

You can think of object-oriented systems as a collection of independent virtual devices communicating with each other, each with its own internal structure. These virtual devices, called *objects*, consist of *properties* (private data) and *methods* (the operations applied to that data).

The internal structure of an object is not accessible to any other object or program. This concept of data encapsulation is key to object-oriented programming, as it separates the object's implementation from its use.

Objects communicate with other objects through *messages*. You send messages to create new objects, to modify and inquire about an object's property

*continued*

values, and to request the object to perform specific actions. In a sense, messages are like op codes to the object. An object can send messages to any other object, including itself.

You create objects by instantiating classes. Classes act as templates for objects, which have a particular set of properties and methods. All instances of a given class have the same properties and methods, although the values of each property will vary.

The distinction between object classes and instances is analogous to the relationship between structure definitions and structure variables. For example, in C, `struct sname { ... };` declares a template for structure `sname`, and `struct sname varname;` declares `varname` as an instance of `sname`.

Object classes are organized into a hierarchical taxonomy of subclasses and superclasses. With subclasses you can define increasingly specialized object types. Superclasses let you share generalizations among separate classes.

An object inherits all the properties and methods of its superclass. A class can distinguish itself from its superclass by assigning different default property values, substituting methods for specific messages, and adding new properties, methods, and messages.

When you send a message to an object, the object's message handler receives the message and checks for a local method for that message. If it has none, the message is forwarded to the object's superclass message handler, and the method there is used. If the superclass doesn't recognize the message, it sends the message along to its superclass, and so forth, until a method is found. The message is declared invalid if no method is found.

### Using OOPC Objects

The OOPC programmer interface consists of a header file, the functions `New` and `Send`, and a library of message-handler functions. Message handlers receive messages and invoke the corresponding methods. Every object class in the object library has a message handler.

The header file, `OOPC.H`, contains common definitions for standard data types in OOPC, such as class message-handler function declarations and message definitions.

Instance objects are identified with a reference, or handle, of type `Object`, defined in `OOPC.H`, returned when a new instance is created. You must use this identifier whenever you reference the object—for example, when sending it messages. When you use the `Object` handle,

**Listing 1: OOPC code for the *MyShape* example program. This code creates several shapes—a rectangle, a line, and a face (*MyShape*)—and then stacks them on top of each other.**

```

stack_on_top( p2, p3 );
stack_on_top( p1, p2 );

/* re-draw */
refresh_shapes( screen );
}

stack_on_top( q, p )
Object q, p;
{
    Msg_North_Result north;
    Msg_South_Result south;
    Msg_Move_Param move;

    Send( p, MSG_NORTH_r, NULL, &north );
    Send( q, MSG_SOUTH_r, NULL, &south );

    move.dx = north.x - south.x;
    move.dy = north.y - south.y + 1;
    Send( q, MSG_MOVE_p, &move, NULL );
}

refresh_shapes( screen )
Object screen;
{
    extern Object shape_list[];
    extern int shape_count;
    Msg_Draw_Param draw;
    int i;

    Send( screen, MSG_CLEAR, NULL, NULL );
    draw.screen = screen;
    for (i=0; i<shape_count; i++)
        Send( shape_list[i], MSG_DRAW_p, &draw, NULL );
    Send( screen, MSG_REFRESH, NULL, NULL );
}

```

applications need never know the internal structure of the object.

`object = New( handler );`

You create a new instance with the function `New`:

where `handler` is the message-handler function for the class of the object you

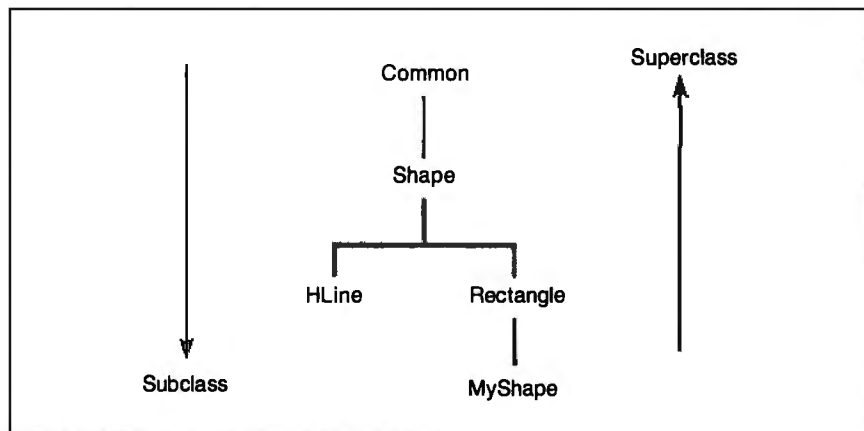

**Figure 1: Class hierarchy in the *MyShape* example.**



```

#include <stdio.h>
#include "oopc.h"

main()
(
    Object          screen;
    Object          p1, p2, p3;
    Msg_Set_Rectangle_Param  set_rect_p;
    Msg_Set_Hline_Param      set_hline_p;
    Msg_Set_Myshape_Param     set_myshape_p;
    Msg_Draw_Param           draw_p;
    Msg_Move_Param           move_p;
    int                     i;

    /* create screen buffer */
    screen = New( Screen );

    /* create shapes */
    p1 = New( Rectangle );
    set_rect_p.xmin = 0; set_rect_p.ymin = 0;
    set_rect_p.xmax = 10; set_rect_p.ymax = 10;
    Send( p1, MSG_SET_RECTANGLE_p, &set_rect_p, NULL );

    p2 = New( Hline );
    set_hline_p.x = 0; set_hline_p.y = 15; set_hline_p.length = 17;
    Send( p2, MSG_SET_HLINE_p, &set_hline_p, NULL );

    p3 = New( Myshape );
    set_myshape_p.xmin = 15; set_myshape_p.ymin = 10;
    set_myshape_p.xmax = 27; set_myshape_p.ymax = 18;
    Send( p3, MSG_SET_MYSHAPE_p, &set_myshape_p, NULL );

    /* draw them */
    refresh_shapes( screen );

    /* re-arrange the shapes */
    move_p.dx = -10; move_p.dy = -10;
    Send( p3, MSG_MOVE_p, &move_p, NULL );

```

are creating. The function `New` returns the handle of the instance into whatever variable name you've specified for the object. When you create an object, `New` allocates memory for the object's properties and initializes this memory to default values. It returns a null object if it can't create the instance.

Objects are sent messages with the `Send` macro function:

```
error = Send( object, message,
&parameters, &result );
```

where `object` receives the message, `message` enumerates it, and the last two arguments are pointers to the parameter and result blocks whose contents depend on the particular message specified (they could be null). The function `Send` returns an error code (0=ok).

A message is actually just an enumerated integer type, such that each message

has a unique value. Some examples include `MSG_SET_RECTANGLE_p`, which sets a rectangle's corner coordinates; `MSG_ASK_NORTH_r`, which requests the top-center point of a rectangle; and `MSG_DRAW_p`, which tells the object to draw itself. The name extensions `_p`, `_r`, and `_pr` remind you that the object requires a parameter block, result block, or both, along with the message.

When a message requires parameters, it has an associated data structure for stuffing the parameter values, named, by convention, `message_Param`. For example, `Msg_Draw_Param` is the parameter block for the `MSG_DRAW_p` message (`Msg_Draw_Param` specifies the screen on which to draw the object). Similarly, results are returned in the structure `message_Result`. For example, structure `Msg_North_Result` contains the point returned by `MSG_NORTH_r`. These parameter and result blocks are the same

regardless of which object receives the message.

Unfortunately, because OOPC requires that you be able to send different data structures to the same function, you can't perform type checking to verify that the correct blocks are specified for a given message. However, the message-naming convention, combined with the parameter- and result-block structures, form a satisfactory interim solution without a preprocessor. The naming conventions make it easier to visually verify the code, and the C compiler will verify the types of each specific parameter/result field within the blocks.

### An Example

The class hierarchy in figure 1 shows the superclasses and subclass used for the `MyShape` example. The class `Rectangle` includes coordinates defining its two corners. `MyShape` is a subclass of `Rectangle` that implements a picture of a face. It uses the `Rectangle` properties to define its border and adds properties for the eyes and mouth (defined as horizontal lines). Messages and methods regarding the border of a `MyShape` object are inherited from its superclass, `Rectangle`; other messages are handled by the local method, `MyShape`. In OOPC, all objects are subclasses of class `Common`.

The main program, shown in listing 1, creates three shapes—a rectangle, a horizontal line, and an instance of `MyShape` (a face)—and draws them on the screen. Then, the line is stacked on top of the face, the rectangle is stacked on top of the line, and the drawing is refreshed.

When an instance of a class is created, its properties are set to default values, leaving it to the application to set them to desired values. For example, new rectangles are created at (0,0)-(0,0), which is not very useful. The new object must then be set, such as at (0,0)-(10,10), as in the example.

The `MyShape` example shows how you can write procedures that manipulate objects without knowledge of the objects they will be manipulating. For example, the `stack_on_top` function rearranges arbitrary objects, as long as they understand the messages `MSG_NORTH`, `MSG_SOUTH`, and `MSG_MOVE`, to get their top-center and bottom-center points and to change their positions. Similarly, the function `refresh_shapes` sends `MSG_DRAW` to the objects in the display list, without knowing anything about the objects there. In fact, you can code and compile these functions before writing the object classes they are manipulating.

*continued*

**Listing 2:** *The chain of inheritance for the rectangle class. If a rectangle object is not able to recognize a message, the Base macro will pass it up to a superclass, Shape, to see if the message is defined there. If Shape can't decode the message, it will pass it up to Common. If Common can't understand the message, an error is returned.*

```

/*-----
 * excerpt from file: rectangle.c
 * definition of rectangle object structure
 *-----*/

typedef struct {
#   include "rectangle.p"
} Rectangle_Object;

/*-----
 * file: rectangle.p
 * properties for Rectangle class (subclass of Shape)
 *-----*/

#include "shape.p"      /* inherited properties */

/* local properties */
int xmin, ymin;       /* northeast corner */
int xmax, ymax;       /* southwest corner */

/*-----
 * file: shape.p
 * properties for Shape class (subclass of Common)
 *-----*/

#include "common.p"    /* inherited properties */

/* no local properties */

/*-----
 * file: common.p
 * properties for Common class
 *-----*/

/* Common is top level, has no parent */

/* properties common to all objects */
Functionp dispatch; /* message handler function */

/* other properties may include a class
   identifier, archive file name, etc.*/

/*-----
 * excerpt from file: rectangle.c
 * methods for Rectangle class (subclass of Shape)
 *-----*/

#include <stdio.h>
#include <malloc.h>
#include "oopc.h"

/* base class dispatcher */
#define Base(this,msg,par,res)
                Shape(this,msg,par,res)

/*-----
 * message dispatcher */
/*-----*/

```

*continued*

## Implementing OOPC Objects

OOPC uses an #include chaining technique that requires that each object be compiled separately. Each class is made of at least two source files: class.C and class.P. The .C file contains the message handler and individual methods. The .P file contains the class properties. You must include the header file OOPC.H at the top of every source (.C) file in addition to the object's class property file.

Using nested file inclusion, the .P files provide the mechanism for property inheritance. For example, listing 2 shows the Rectangle\_Object data structure. The fields of this structure are included from the RECTANGLE.P file. The first statement of the file is another include file, SHAPE.H, containing the properties from Rectangle's superclass.

Superclass properties appear in memory before subclass properties, as shown in figure 2, which facilitates method inheritance. When a message is deferred by a class to its superclass, the object's handle is passed. Since this handle is actually a pointer to the object's property data, the superclass can access the properties it knows of, yet need not (and should not) access the subclass properties.

Each object class has a single message-handler function having the same name as the object itself. Thus, rectangles have a message handler called Rectangle.

The handler is a "switch" statement with cases for each message recognized locally by the class, calling the corresponding method—a static local function. If the message handler does not recognize the message, the message is forwarded up to the superclass message handler. Listing 2 is an excerpt of the file RECTANGLE.C, showing the chain of inheritance an unrecognized message will follow.

Even if an object has a method for a message, it can still inherit the superclass method and then augment the result. In the initialization method, for example, the object first inherits its superclass method to initialize the superclass properties and then initializes its own properties.

Because the topmost class is Common, the first property of every object is a pointer to the object's message-function handler. The Send macro function takes advantage of this fact by simply accessing the first field of the object. The following is an excerpt from OOPC.H showing how Send is implemented:

```
typedef int (*Functionp)();
```

*continued*

# New diskdoubler™

## *doubles the storage capacity doubles the storage capacity of your hard disk*

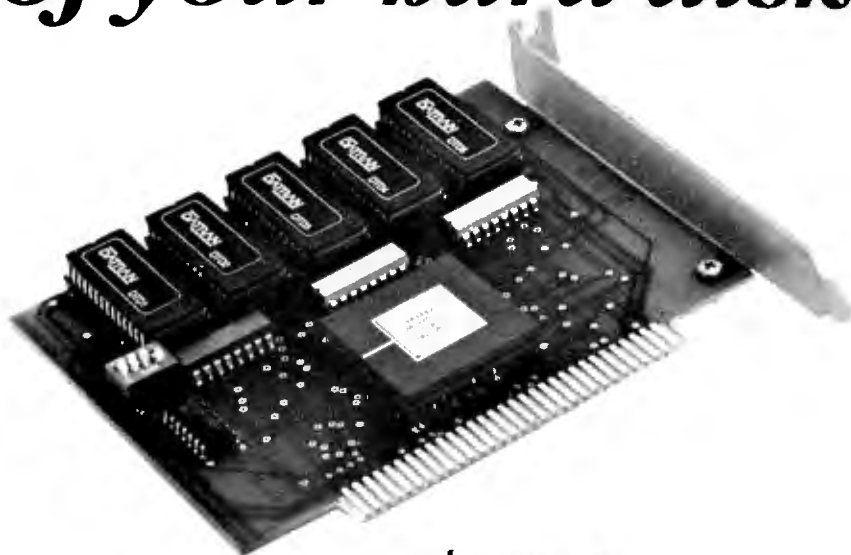

## *for \$189*

### Upgrade the disk drive in your PC the easy way!

Datran's new DiskDoubler dd2000 is a short card that simply fits into any available slot on an IBM, PC, XT, AT, 386 or compatible, DOS 2.0 or greater.

**Upgrade a 20 MB disk into a 40 MB.** The DiskDoubler lets you double the storage capacity of any hard disk *without loss of performance*. No matter what size hard disk you have, the DiskDoubler will double it.

**Works With All Data.** The DiskDoubler compresses data stored on a hard disk, including application programs, program files, COM and EXE files. You will appreciate the doubling of capacity for word processing, spreadsheets, and database files.

**Powerful dBASE Capacity.** The DiskDoubler is especially powerful when handling dBASE II, III and III Plus files, storing on the average *three times* as much data on your hard disk, i.e., your 20 MB hard disk will perform like a 60 MB disk . . . an 80 MB disk will act like a 240 MB model. It works equally well for any size hard disk . . . and for only \$189.00.

**Principle of Operation.** At the heart of the DiskDoubler is a new, powerful high-speed data compression micro-processor that incorporates Datran's state-of-the-art data compression technology, which represents years of research and development.

**Totally Transparent Operation.** Datran's high speed data compression technology coupled with our extensive operating software allows the DiskDoubler to process data at speeds compatible with disk operating speeds. It looks as though you've added a disk drive of double the capacity to your PC.

**Breaks the 32 MB DOS Barrier.** Because the DiskDoubler doubles the amount of data your disk drive stores, it effectively increases the 32 MB DOS barrier to 64 MB without any special software.

**Simple Installation.** Once the simple, fast installation is complete, the DiskDoubler operates in the background and is completely user transparent. The dd2000 works with yours existing hard disk controller.

**No Formatting Required** as is necessary with RLL controllers. DiskDoubler will even double the capacity of a drive already using RLL technology.

**Low Power Consumption.** The 1/2 watt DiskDoubler eliminates the need for upgrading your power supply, as would be needed if an additional disk drive were added pulling 15 to 30 watts.

**Long Life Performance.** With a long three-year limited warranty, DiskDoubler is a simple, inexpensive and reliable way to double your disk storage.

**Satisfaction Guaranteed.** Datran backs the DiskDoubler with a 30-day no questions asked money back guarantee.



FOR THE DEALER NEAREST YOU OR  
TO ORDER DIRECT BY PHONE:

**1-800-332-0456**



**DATRAN**

*Leadership in Data Compression Technology*

```

int Rectangle( this, msg, param, result )
Rectangle_Object*  this;
Message           msg;
Caddr            param;
Caddr            result;
(
    int error = 0;

    switch (msg) {
    case MSG_NEW_r:
        error = Rectangle_new( result );
        break;

    case MSG_INITIALIZE:
        error = Rectangle_init( this );
        break;

    case MSG_SET_RECTANGLE_p:
        error = Rectangle_setrect( this, param );
        break;

    case MSG_MOVE_p:
        error = Rectangle_move( this, param );
        break;

    case MSG_DRAW_p:
        error = Rectangle_draw( this, param );
        break;

    case MSG_NORTH_r:
        error = Rectangle_north( this, result );
        break;

    case MSG_SOUTH_r:
        error = Rectangle_south( this, result );
        break;

    default:
        error = Base( this, msg, param, result );
        break;
    }

    return error;
}

/*-----*/
/* rectangle class methods */
/*-----*/

static int Rectangle_move (this, param)
Rectangle_Object *this;
Msg_Move_Param *param;
{
    this->xmin += param->dx;
    this->ymin += param->dy;
    this->xmax += param->dx;
    this->ymax += param->dy;
    return 0;
}

```

```

typedef struct { Functionp
    dispatch; } *Object;

#define Send(obj,msg,param,
    result)\
((*(obj->dispatch))(obj,msg,
    param,result))

```

To implement Send, I first define the data type Functionp, which is a pointer to a function. Then I define a data structure that declares as its member an item called dispatch, which is of type Functionp. Finally, I give this structure the tag \*Object, so that Object is a data type that is a pointer to a structure whose first member is a pointer to a function. In the Send macro, obj is of type Object, so obj->dispatch will fish out the pointer to the desired function. The rest of this line executes the function.

Finally, the function New is an interface for sending a MSG\_NEW message to a dispatch function. New creates an instance for an object class that you can then use with the function Send.

```

typedef struct { Object object; }
    Msg_New_Result;

Object New( dispatch )
    Functionp dispatch;
{
    Msg_New_Result new;
    (*(dispatch)( NULL,
        MSG_NEW_r, NULL, &new );
    return new.object;
}

```

### Limitations of OOPC

As you can see, there is a lot of extra coding you must tend to yourself, such as setting up the include chain and making sure that you pass the correct parameters to an object. These are details that an object-oriented language can manage for you. Object-oriented languages differ in their support for memory management.

The advantage of using a conventional language is that it doesn't require the additional investment of buying and learning a new language. Plus, it's code-compatible with any existing libraries and tools you currently use. ■

Editor's note: *The source code for the OOPC object classes and the MyShape example are available in a variety of formats. See page 3 for further details.*

*Jonathan S. Linowes is a founding partner of Sirlin Computer Corp. in Hudson, New Hampshire, specializing in database and computer graphics systems. He can be contacted on BIX as "editors."*

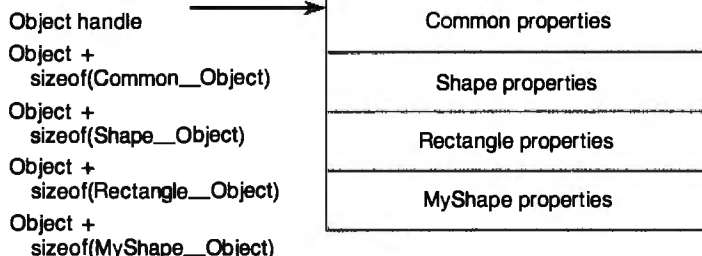

**Figure 2:** Memory organization of MyShape class properties.

# Bring to your DTP systems a new style and give your HP series II™ a second life.



Same PageMaker™ file printed using a normal IBM PC/AT™ connected to an HP LaserJet Series II.

Same PageMaker file printed using an IBM PC/AT with PageStyler™ connected to an HP LaserJet Series II.

## Destiny's low-cost PageStyler adds 100% PostScript™ compatibility to your HP series II without sacrificing your printer's current capabilities.

With PageStyler from Destiny Technology you can go either way—in style with PageStyler, the PostScript language compatible sub-system, or with HP PCL.™ You choose, from your keyboard to your printer.

Destiny offers full PostScript compatibility from any software package with PostScript drivers, with enough memory to handle full-page graphics, font selection, and image transfers. PageStyler, the only way to go, if you go in style.

### COMPATIBLE SOFTWARE

- Ventura Publisher™
- PageMaker™
- Harvard Graphics™
- Designer™
- Other software based on Windows™
- WordPerfect 5.0™
- The Office Publisher™
- MicroSoft Word 4.0™ & Excel™
- Manuscript™
- Destiny has tested these software packages. More software packages will be tested and announced.



#### Destiny Technology Corporation

930 Thompson Place • Sunnyvale, California 94086

Phone: 800-874-5553 • 415-537-9044 (inside CA)

FAX: 408-733-0870 TLX: 3729687

## Resource Guide

- Advantage C++** .....\$495  
*PC, XT, AT, and compatibles*  
**Run/C Interpreter**.....\$120  
*PC, XT, AT, and compatibles*  
**Run/C Professional** .....\$250  
*PC, XT, AT, and compatibles*  
Lifeboat Associates  
55 South Broadway  
Tarrytown, NY 10591  
(800) 847-7078; in New York,  
(914) 332-1875  
**Inquiry 947.**
- Aztek C68K-r B-shell** ....\$120  
**Aztek C68K/MPW-p** .....\$175  
**Aztek C68K/MPW-d** .....\$299  
*Mac*  
Manx Software  
P.O. Box 55  
Shrewsbury, NJ 07701  
(201) 542-2121  
**Inquiry 948.**
- C Compiler**.....\$495  
*PC, XT, AT, and compatibles*  
**C/2** .....\$560  
*PC, XT, AT, and compatibles*  
IBM Corp.  
Old Orchard Rd.  
Armonk, NY 10504  
(914) 765-1900  
**Inquiry 951.**
- C Compiler**..... \$99  
*PC compatible*  
Supersoft, Inc.  
510 West Park Ave.  
P.O. Box 1628  
Champaign, IL 61820  
(800) 678-3600; in Illinois,  
(217) 359-2112  
**Inquiry 952.**
- C Compiler (one user)**....\$895  
*PC compatible*  
Wintek Corp.  
1801 South St.  
Lafayette, IN 47904  
(800) 742-6809; in Indiana,  
(317) 742-8428  
**Inquiry 953.**
- C Native Compiler**.....\$1000  
*PC-DOS for 8088, 8086, 80186,  
and 80286 machines*  
Whitesmiths, Ltd.  
59 Power Rd.  
Westford, MA 01886  
(617) 692-7800  
**Inquiry 954.**
- Consulair 68020 C  
Development System**.....\$600  
*Mac*  
**MacC**.....\$425  
*Mac*  
**MacC Jr**.....\$79.95  
*Mac*  
Consulair Corp.  
P.O. Box 2192  
Ketchum, ID 83340  
(208) 726-5846  
**Inquiry 977.**
- CrossCode C for the  
68000** .....\$1595  
*PC compatible*  
**UniWare Z80 C  
Compiler** .....\$1595  
*PC compatible*  
Software Development Systems,  
Inc.  
3110 Woodcreek Dr.  
Downers Grove, IL 60515  
(800) 448-7733; in Illinois,  
(312) 971-8170  
**Inquiry 955.**
- C\_\_Talk**..... \$149.95  
*PC compatible*  
CNS, Inc.  
Software Products Dept.  
7090 Shady Oak Rd.  
Eden Prairie, MN 55344  
(612) 944-0170  
**Inquiry 956.**
- C-terp**  
*MS-DOS version*.....\$298  
*Xenix version* .....\$398  
Gimpel Software  
3207 Hogarth Lane  
Collegeville, PA 19426  
(215) 584-4261  
**Inquiry 957.**
- The C Workshop**.....\$69.95  
*PC compatible*  
Wordcraft  
3827 Penniman Ave.  
Oakland, CA 94619  
(800) 888-0852 ext. 955;  
in California,  
(415) 534-2212  
**Inquiry 958.**
- C68**.....\$795  
*PC compatible*  
**C68/020**.....\$995  
*PC compatible*  
Alcyon Corp.  
6888 Nancy Ridge Dr.  
San Diego, CA 92121  
(619) 587-1155  
**Inquiry 959.**
- C-8096** .....\$995  
*PC compatible*  
Archimedes Software, Inc.  
2159 Union St.  
San Francisco, CA 94123  
(415) 567-4010  
**Inquiry 960.**
- C-86 Plus C Compiler** ....\$497  
*PC, XT, AT, and PS/2  
compatible*  
Computer Innovations, Inc.  
980 Shrewsbury Ave.  
Tinton Falls, NJ 07724  
(201) 542-5920  
**Inquiry 961.**
- C 86/88 RTX866**.....\$1295  
*XT and AT compatible*  
Real-Time Computer Science  
Corp.  
1390 Flynn Rd., Unit E  
Camarillo, CA 93010  
(805) 987-9781  
**Inquiry 962.**
- Definitive C**  
*XT under THEOS* .....\$395  
*AT under THEOS* .....\$499  
**THEOS C**.....\$599  
*AT, 80386 machines under  
THEOS*  
Theos Software Corp.  
1777 Botelho Dr., Suite 360  
Walnut Creek, CA 94596  
(415) 935-1118  
**Inquiry 963.**
- Delta-C** .....\$495  
*NC4016*  
**SC-C** .....\$695  
*PC, XT, AT, and 80386  
machines*  
Silicon Composers  
210 California Ave., Suite K  
Palo Alto, CA 94306  
(415) 322-8763  
**Inquiry 964.**
- Designer C++** .....\$495  
*MS-DOS and PC compatible;  
80386 Unix, 80386 Xenix*  
Oasys  
230 Second Ave.  
Waltham, MA 02154  
(617) 890-7889  
**Inquiry 965.**
- DeSmet DC88** ..... \$99  
*PC compatible*  
C Ware Corp.  
P.O. Box 428  
Paso Robles, CA 93447  
(805) 239-4620  
**Inquiry 966.**
- Eco-C** .....\$59.95  
*Mac and Z80 CP/M  
ECO-C88 C  
Compiler*.....\$99.95  
*MS-DOS*  
Ecosoft, Inc.  
6413 North College Ave.  
Indianapolis, IN 46220  
(317) 255-6476  
**Inquiry 967.**
- Guidelines C++** .....\$295  
*PC, XT, AT, and compatibles*  
Guidelines Software, Inc.  
P.O. Box 749, Suite B  
Orinda, CA 94563  
(415) 254-9183  
**Inquiry 968.**

- High C** .....\$595  
*PC compatible*
- High C for the 80386** .....\$895  
80386  
MetaWare, Inc.  
903 Pacific Ave., Suite 201  
Santa Cruz, CA 95060  
(408) 429-6382  
**Inquiry 969.**
- Hyper-C** .....\$100  
*Mac*  
Spectra Micro Development  
P.O. Box 41795  
Tucson, AZ 85717  
(602) 884-7402  
**Inquiry 970.**
- Instant-C** .....\$495  
*PC, XT, AT, and compatibles*  
Rational Systems  
P.O. Box 480  
Natick, MA 01760  
(617) 653-6194  
**Inquiry 971.**
- Lattice AmigaDOS C Compiler** .....\$200  
*Amiga*
- Lattice AmigaDOS C Development System** .....\$375  
*Amiga*
- Lattice C Compiler** .....\$450  
*MS-DOS and OS/2*
- Lattice C++** .....\$500  
*Amiga*  
Lattice, Inc.  
2500 South Highland Ave.  
Lombard, IL 60148  
(312) 916-1600  
**Inquiry 972.**
- Let's C/csd** .....\$75  
*PC and PS/2 compatible*  
Mark Williams Co.  
1430 West Wrightwood  
Chicago, IL 60614  
(800) 692-1700; in Illinois,  
(312) 472-6659  
**Inquiry 973.**
- Lightspeed C** .....\$175  
*Mac*  
Think Technologies, Inc.  
135 South Rd.  
Bedford, MA 01730  
(617) 275-4800  
**Inquiry 974.**
- Living C Plus** .....\$199.95  
*PC, AT, XT, and PS/2 compatible*  
Living Software, Inc.  
P.O. Box 1188  
Framingham, MA 01701  
(617) 881-6343  
**Inquiry 975.**
- "LPI-C"** .....\$695  
*80386 and 68000 compatible*  
Language Processors, Inc.  
959 Concord St.  
Framingham, MA 01701  
(617) 626-0006  
**Inquiry 976.**
- Mac-to-IIGS C Compiler** .....\$500  
*Apple IIGS*
- Megamax C** .....\$199.95  
*Mac*  
Megamax, Inc.  
P.O. Box 851521  
Richardson, TX 75085  
(214) 987-4931  
**Inquiry 978.**
- Microsoft C (includes QuickC)** .....\$450  
*PC compatible; OS/2, MS-DOS*
- QuickC** .....\$99  
*PC, AT, and compatibles*  
Microsoft Corp.  
16011 Northeast 36th Way  
P.O. Box 97017  
Redmond, WA 98073  
(206) 882-8080  
**Inquiry 979.**
- Mix C Compiler** .....\$19.95  
*PC compatible*
- Mix C Works** .....\$39.95  
*PC compatible*  
Mix Software  
2116 East Arapaho, Suite 363  
Richardson, TX 75081  
(214) 783-6001  
**Inquiry 980.**
- MPW C** .....\$150  
*Mac*  
Apple Programmers and Developers Association  
290 Southwest 43rd St.  
Renton, WA 98055  
(206) 251-6548  
**Inquiry 981.**
- NDP C-386** .....\$595  
*PC and 80386 compatible; MS-DOS and Unix*  
MicroWay, Inc.  
P.O. Box 79  
Kingston, MA 02364  
(617) 746-7341  
**Inquiry 982.**
- Objective-C (per user)** ...\$495  
*PC/MS-DOS*  
The Stepstone Corp.  
75 Glen Rd.  
Sandy Hook, CT 06482  
(203) 426-1875  
**Inquiry 983.**
- Optimum-C** .....\$139  
*PC compatible*  
Datalight  
17505 68th Ave. NE, Suite 304  
Bothell, WA 98011  
(206) 367-1803  
**Inquiry 950.**
- QC88 C Compiler** .....\$90  
*PC compatible*  
The Austin Code Works  
11100 Leafwood Lane  
Austin, TX 78750  
(512) 258-0785  
**Inquiry 949.**
- Sierra C (68000 cross compiler)** .....\$2000  
*AT compatible*  
Sierra Systems  
6728 Evergreen Ave.  
Oakland, CA 94611  
(415) 339-8200  
**Inquiry 984.**
- Small-C**  
*PC compatible*  
A variety of shareware and public domain versions are available.  
**Inquiry 985.**
- Toolworks C** .....\$49.95  
*PC compatible; MS-DOS and CP/M*  
The Software Toolworks  
13557 Ventura Blvd.  
Sherman Oaks, CA 91423  
(818) 907-6789  
**Inquiry 986.**
- Turbo C** .....\$99.95  
*PC, XT, AT, and compatibles*  
Borland International, Inc.  
4585 Scotts Valley Dr.  
Scotts Valley, CA 95066  
(408) 438-8400  
**Inquiry 987.**
- Watcom Express C** .....\$125  
*Introductory offer* .....\$75  
*PC compatible*  
**Watcom C (includes Watcom Express C)** .....\$495  
*Introductory offer* .....\$295  
*PC compatible*  
Watcom  
415 Phillip St.  
Waterloo, Ontario  
Canada N2L 3X2  
(519) 886-3700  
(800) 265-4555 (U.S. and Canada)  
**Inquiry 988.**
- Zortech C** .....\$49.95  
*MS-DOS; PC compatible*
- Zortech C++** .....\$99.95  
*MS-DOS, PC compatible*  
Zortech, Inc.  
366 Massachusetts Ave.,  
Suite 303  
Arlington, MA 02174  
(800) 848-8408; in  
Massachusetts or international,  
(617) 646-6703  
**Inquiry 989.**

# NATURAL LANGUAGE INTERFACE



## THE COMPUTER CHRONICLES MAKES KEEPING UP WITH THE INFORMATION AGE EASY

Stewart Cheifet and Gary Kildall are your co-hosts for a weekly half-hour television program aimed at computer users, owners, educators and computer industry professionals. If you're looking for help in finding out what's new and what's news, tune in to THE COMPUTER CHRONICLES every week on your local public television station.

Regular commentators are Jan Lewis, President of Lewis Research Corporation and publisher/editor of



JAN LEWIS



GEORGE MORROW

*The Computer Chronicles is funded in part by McGraw-Hill's BYTE magazine. The Computer Chronicles is a co-production of WITF/Harrisburg and KCSM/San Mateo.*

HyperAge magazine, and George Morrow, founder of Morrow Designs.

Topics this season include: CD ROMS — Shareware — Multitasking — Business Graphics — Investment Software — PC Imaging — PC Networks — Decision Support Software — Laser Printers — Hypercard - Input Devices — and MUCH MORE.

Each week THE COMPUTER CHRONICLES looks at the top stories of the week in Random Access, a news segment designed to keep you informed about the latest developments in the computer industry.

THE COMPUTER CHRONICLES, a weekly half-hour of public television that just might be the help you need.

### THE COMPUTER CHRONICLES IS NOW ON BIX

Bix, the Byte Information Exchange, now has a conference for the Computer Chronicles.

Now you can communicate directly with the staff of the Computer Chronicles to suggest topics for future shows or to request information or details on past shows.

Once on Bix, just type "join comp.chron" at the colon (:)  
prompt.



# MAKING THE MOVE TO OS/2

*Top programmers from Borland, Norton, and Lotus talk about converting a database, TSR, and spreadsheet from MS-DOS to OS/2*



With all the talk about OS/2—its multitasking features, the heritage it brings from MS-DOS, the problems it leaves behind, complaints that it costs too much or takes up too much memory—the question foremost in the minds of most personal computer users is: Should I bother? Granted, OS/2 has some powerful features, but how many programs will actually run under it, and how many of those will take full advantage of its capabilities? If only a few programs run under OS/2, or if they run only in the DOS-compatibility box, why not just stick with MS-DOS?

Whether or not a critical mass of OS/2 programs becomes available depends on two things: how hard it is to write new OS/2 programs, and how hard it is to port established MS-DOS programs to OS/2. Given the time it takes to develop an application program, we can expect that the first OS/2 programs will be updates of MS-DOS programs.

So, how hard is it to port a program from MS-DOS to OS/2? To find out, we asked top programmers from Borland, Norton Computing, and Lotus Development to tell us about their experiences in converting a popular program to run under OS/2. Their thoughts should be valuable if you're considering upgrading to OS/2—and wondering whether the number of available programs will justify the cost and effort—or if you're thinking about porting your own programs to OS/2.

## AN OS/2 PARADOX

*Robert E. Shostak*

You might expect that with its gaggle of new features, including multitasking and interprocess communication, porting a DOS program to OS/2 might be a big job. Indeed, if you plan to take advantage of these new features, a port could

involve significant redesign and implementation work. On the other hand, if you don't need fancy multitasking capabilities and your program has minimal direct interface to the operating system or BIOS, you might only need to recompile and relink your source code.

Paradox is a high-end relational database management system. It is quite a large and elaborate program, so we ended up dealing with many of the issues that would arise in porting other applications.

These issues fall into two categories: external and internal. External issues arise by virtue of new or different features in OS/2 that are apparent to the user. Internal issues, by contrast, are implementation concerns that have no bearing on functionality or performance and are therefore transparent to the user of the program.

### External Issues

The more interesting considerations in porting to OS/2 have to do with taking advantage of its new functions, such as multitasking. These are the ones that users will notice; they're also the ones most likely to vary from application to application.

In the case of Paradox, we wanted a user to be able to run multiple copies (called *instances* in OS/2 parlance) of the program simultaneously. In fact, we wanted to make it possible for these instances to access the same tables simultaneously. For example, a user should be able to query a table at the same time that the program is printing a report for that table in the background.

OS/2's session manager automatically handles scheduling among multiple instances of a program(s). It does not, however, automatically manage concurrent access to data. But since Paradox 2.0 was written as a multiuser (i.e., networked) application, it already had the built-in mechanisms needed to synchronize multiuser access to tables. We had only to adapt these mechanisms so that multiple sessions would be treated in the same way as multiple users.

*continued*

The most difficult technical problem we needed to resolve to obtain this effect involves Paradox's "private directory" machinery. In a multiuser configuration of Paradox, each user designates a certain directory as his private directory. It stores temporary tables (such as the Answer table) that other users cannot access. It is essential that no two users specify the same private directory, and, in fact, this directory is usually chosen to reside on each user's local hard disk.

## An OS/2 program must be better behaved than a DOS program.

In order to handle multiple sessions in addition to multiple users, we needed to provide a unique private directory for each session. To obtain maximum transparency to the user, we opted to use a mechanism that would automatically create a new sub-directory for each session a user initiates. The mechanism depends on OS/2's support of global shared memory, allowing different program instances to communicate with one another.

Other external issues we needed to deal with had to do with sharing memory and CPU resources among OS/2 tasks. Under DOS, applications (other than terminate-and-stay-resident [TSR] programs) typically grab all the memory when they're loaded. Applications also assume, of course, that they have exclusive use of the CPU. Under OS/2 and other multitasking or multiuser operating systems, programs must be better behaved. In particular, they must be careful to allocate only as much memory from the operating system as they actually need. They must also be written in a way that does not tie up the CPU unnecessarily; for example, a tight keyboard-check loop could needlessly hog the CPU. Under OS/2, you need to give control back to the operating system periodically so it can dispatch other tasks while your task is waiting for input.

### Internal Issues

The most obvious difference between programs written for OS/2 and those written for DOS is the way programs make calls to the operating system. In DOS, an operating system call is made by loading up some registers with arguments to the call, then issuing INT 21h (hexadecimal). In OS/2, programmers must replace these INT 21h calls with calls to a set of named routines known as the OS/2 Application Programming Interface (API). You can think of the API as a function library of the kind normally provided with languages such as C and Pascal. The main difference is that references to functions in the API are resolved not at program-link time, but at load time, using OS/2's dynamic-linking capability. Arguments pass to the API routines on the stack, just as with high-level languages.

Most DOS function calls have an exact correspondent in the API, though the arguments or error-handling conventions may be somewhat different.

The API also has functions to replace the BIOS interrupts that DOS applications typically call. Owing to its multitasking capabilities, OS/2 needs much more control over devices such as the screen and keyboard than does DOS, so tasks don't interfere with each other. Indeed, these devices and the mouse are

treated as first-class system devices. With OS/2, gone are the days when you could write directly to screen memory at B800. Of course, this is a benefit rather than a restriction, because it resolves the compatibility issues associated with BIOS-level primitives and provides greater device independence.

Be aware that OS/2 programs use Pascal calling conventions to call API functions, with the consequence that the arguments are popped off the stack by the API function itself, not by the caller. Many C compilers use the "caller pops" convention as the default, which means you might need to use a compiler option to get the right effect. You should also make sure your compiler does not truncate the names of external references to eight characters, since many of the API functions have longer names.

If, like Paradox, your program is written at least partly in assembly language, you need to be aware of a number of other minor internal issues. Assembly language for OS/2 needs to be written more carefully than for DOS in a number of respects. First, OS/2 requires that every segment be given a class name of either CODE, DATA, or STACK; in DOS, on the other hand, class names are largely unimportant.

Another restriction is that segments in class CODE cannot contain self-modifying code. The reason is that OS/2 permits code segments to be shared among different instances of the same program, or even different programs. If the first instance of an already-loaded program changes its code, the second instance (which will be a copy of the instance already residing in memory) would not be a true copy of the original code.

A further constraint is that segment registers cannot be used as general-purpose scratch registers for 16-bit quantities, as they can under DOS. Since OS/2 programs run in protected mode, you can load the segment registers only with valid memory handles, called *selectors*. If you load a segment register with an arbitrary 16-bit datum, you are likely to trigger a protection violation.

Still another internal issue we came across in porting Paradox is the difference in how the system handles the Control-Break key combination. Under DOS, applications that detect Control-Break typically trap interrupt 1Bh, which is triggered by the BIOS when that key combination is pressed. Under OS/2, a Control-Break key press generates a *signal*. Signals are asynchronous event notifications, much like software interrupts, which an application can trap using the `DosSetSigHandler` API primitive. OS/2 will also generate signals when the user presses Control-C or when a process is terminated.

### Better Than Expected

As you can see, our port required the consideration of many technical issues, though most of them were fairly minor in scope. The process was greatly facilitated by the protection features of OS/2, which make debugging C code much easier. Since references to invalid memory addresses are caught instantly by the operating system, bugs manifest themselves in OS/2 much sooner than they do in DOS.

Upon completing the job, we were delighted to discover that the resulting product—Paradox for OS/2—performed even better than we expected. Not only does it offer true multitasking, but it also runs faster than the DOS version, owing to OS/2's support for large amounts of physical and virtual memory.

---

*Robert E. Shostak, formerly chief scientist for Borland International, is the cofounder of a new company, Mira Technology. He is the co-creator of the popular Paradox database management system, and cofounder of the product's parent company, Ansa, a subsidiary of Borland. He can be reached on BIX as "editors."*

*continued*

# SPECIAL TURBO SALE

Get \$5.00 Off Every Turbo Pascal 4 Book

Get \$3.00 Off Every Turbo C<sup>®</sup> & Turbo Basic<sup>®</sup> Book



## Using Turbo C<sup>®</sup>

by Herbert Schildt

For all C programmers, beginners to pros, this excellent guide helps you write Turbo C programs that get professional results.

~~\$28.95~~ Paperback, ISBN: 0-07-881279-8, 431 pp., 7 $\frac{3}{8}$  x 9 $\frac{1}{4}$   
Borland-Osborne/McGraw-Hill Programming Series

\$16.95

## Advanced Turbo C<sup>®</sup>

by Herbert Schildt

Unveils Turbo C power programming techniques to serious programmers. Covers Turbo Pascal conversion to Turbo C and Turbo C graphics.

~~\$28.95~~ Paperback, ISBN: 0-07-881280-1, 397 pp., 7 $\frac{3}{8}$  x 9 $\frac{1}{4}$   
Borland-Osborne/McGraw-Hill Programming Series

\$19.95

## Turbo C<sup>®</sup>: THE COMPLETE REFERENCE

By Herbert Schildt

Covers Version 1.5

Programmers at every level of Turbo C expertise can quickly locate information on Turbo C functions, commands, codes, and applications—all in this handy encyclopedia.

~~\$45.95~~ Paperback, ISBN: 0-07-881346-8, 850 pp., 7 $\frac{3}{8}$  x 9 $\frac{1}{4}$   
Borland-Osborne/McGraw-Hill Programming Series

\$21.95



## Turbo Pascal<sup>®</sup> THE COMPLETE REFERENCE

Covers Version 4  
by Stephen O'Brien

The first single resource that lists every Turbo Pascal command, function, and feature, all illustrated in short examples and applications. Ideal for every Turbo Pascal programmer.

~~\$24.95~~ Paperback, ISBN: 0-07-881290-9, 814 pp., 7 $\frac{3}{8}$  x 9 $\frac{1}{4}$   
Borland-Osborne/McGraw-Hill Programming Series

\$19.95

## Using Turbo Pascal<sup>™</sup> VERSION 4

by Steve Wood

Build the skills you need to become a productive Turbo Pascal 4 programmer. Covers beginning concepts to full-scale applications.

~~\$19.95~~ Paperback, ISBN: 0-07-881356-5, 546 pp., 7 $\frac{3}{8}$  x 9 $\frac{1}{4}$   
Borland-Osborne/McGraw-Hill Programming Series

\$14.95

## Advanced Turbo Pascal<sup>™</sup> VERSION 4

by Herbert Schildt

The power of Turbo Pascal 4 will be at your fingertips when you learn the top-performance techniques from expert Herb Schildt.

~~\$21.95~~ Paperback, ISBN: 0-07-881355-7, 416 pp., 7 $\frac{3}{8}$  x 9 $\frac{1}{4}$   
Borland-Osborne/McGraw-Hill Programming Series

\$16.95

## Turbo Pascal<sup>™</sup>

### PROGRAMMER'S LIBRARY, SECOND EDITION

by Kris Jamsa and Steven Nameroff

Take full advantage of Turbo Pascal, and the newest versions of Turbo Pascal, with this outstanding collection of programming routines. Includes routines for the Turbo Pascal toolboxes.

~~\$22.95~~ Paperback, ISBN: 0-07-881368-9, 600 pp., 7 $\frac{3}{8}$  x 9 $\frac{1}{4}$   
Borland-Osborne/McGraw-Hill Programming Series

\$17.95

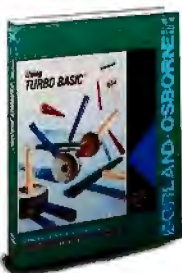

## Using Turbo Basic<sup>®</sup>

by Frederick E. Mosher  
and David I. Schneider

Introduces Turbo Basic to novices and seasoned pros alike. Learn about the Turbo Basic operating environment and the interactive editor.

~~\$18.95~~ Paperback,  
ISBN: 0-07-881282-8,  
457 pp., 7 $\frac{3}{8}$  x 9 $\frac{1}{4}$

Borland-Osborne/McGraw-Hill Programming Series

\$16.95

## For A Limited Time Only

**ORDER TODAY! CALL TOLL-FREE 800-227-0900**

Use Your Visa, MasterCard,  
or American Express

 Osborne McGraw-Hill  
2600 Tenth Street  
Berkeley, California 94710

Turbo Basic, Turbo C, and Turbo Pascal are registered trademarks  
of Borland International. Copyright © 1988 McGraw-Hill, Inc.

# GUIDES TO PORTING, PORTING GUIDES

John Socha and Linda Dudinyak

Our first impressions of OS/2 weren't exactly positive. After all, here was an operating system whose manuals filled 2 feet of shelf space, compared with the single manual for MS-DOS 2.0. We weren't thrilled at having to master such a complex operating system. But once we cracked the manuals, we changed our minds.

Our task was to convert the Norton On-Line Programmer's Guides—a pop-up reference program for programmers—from a TSR program running under MS-DOS to a protected-mode OS/2 program that could run concurrently with other programs. TSR programs like the Norton Guides are often difficult to write under DOS. But not under OS/2.

## TSRs under OS/2

OS/2 handles most of the hard work of writing a pop-up program under OS/2, making such programs almost a joy to write. There are three main areas where OS/2 proves quite helpful: monitoring the keyboard for the hot key, saving the current screen contents, and switching screen modes. Since MS-DOS is not a multitasking operating system, TSR programs for MS-DOS need extra code to switch screen modes and to determine when the programs can make DOS calls. Both problems vanish entirely under OS/2 because they're handled by the operating system, which leaves only the issue of how to monitor the keyboard.

Under OS/2, this function is supported by *device monitors*, which allow programs to monitor raw keystrokes before they're passed on to the keyboard services. Any program that registers itself as a device monitor can monitor the keyboard buffer (looking for a hot key), change key sequences, or add key sequences (which is useful for macro programs). The Norton Guides monitors the buffer looking for Shift-F1 and pops up on the screen as soon as it sees this key combination.

Writing the device monitor for a single screen group was easy. What we wanted, however, was to register the Norton Guides as a global device monitor, which can monitor keystrokes in all screen groups. In this way the Guides could pop up in any screen group, not just the screen group from which Guides was installed. We discovered several interesting things about screen groups in the process.

## Now Appearing on Multiple Screens

OS/2 has 16 independent screen groups; this allows multiple programs to run at the same time, each with its own virtual screen. Strictly speaking, a screen group refers to all the threads that are attached to a given virtual screen. The physical screen (the monitor) displays only one virtual screen and can be switched between the different screen groups at will. So far, so good.

What isn't obvious is that the first four screen groups (0 through 3) are reserved for use by OS/2: 1 is unknown, 2 is for the session manager, 3 is for the DOS-compatibility box, and 4 is for detached processes. Registering a device monitor with all these screen groups can cause OS/2 to lock up. Only screen groups 4 through 15 are available for OS/2 programs.

As it turns out, we were able to register our device monitor with screen group 1 without any ill effects; the Guides popped up over the session manager. But registering with screen groups

2 or 3 caused OS/2 to lock up. Registering with screen group 0 caused no visible problems, but we still weren't able to determine what it's for. In the end, we decided to register the Guides with only screen groups 4 through 12. This allows you to run the Guides as a pop-up on top of an application in any of those windows.

## A Problem with Threads

Another sticky issue had to do with the thread priorities. The Norton Guides starts a separate thread for each of the 12 screen groups it monitors. Each thread goes through a very tight loop that reads one character (from its screen group), checks to see if it's the hot key (in which case it calls `pop_up_ng`), and writes the character to the next keyboard monitor in the chain (or `KbdCharIn` and `KbdPeek` if there are no more monitors).

We had a problem, however. When we typed characters on the keyboard, they appeared very slowly on the screen. We soon found that the individual threads didn't have high enough priorities. For some reason, the 12 threads weren't receiving enough of the system time to be able to pass on keystrokes efficiently.

Our first thought was to increase the priority on each of the 12 threads we created to *time-critical*. We suspected that increasing each thread's priority shouldn't slow down the system, since each thread would receive CPU time only when a new keystroke became available. We tried this method, and it seemed to work—that is, until we ran a program that used the mouse.

Programs that use the mouse can't afford to sit around until `KbdCharIn` returns a keystroke, since they must also constantly poll the mouse. As a result, they must loop until either there is a mouse event, or there is a keystroke waiting in the buffer. This looping consumes more CPU time than a program that simply waits until `KbdCharIn` returns a keystroke. This means that less CPU time is left over for background tasks. We didn't understand why this should cause a problem; having set the priority of our 12 threads to *time-critical*, we assumed that our threads would receive time when—and only when—new keystrokes became available. But for some reason, this wasn't the case for programs that used the mouse.

Thanks to Microsoft's technical support, we finally found a solution that seems to work in all cases: We set the priority on the main thread (thread 1), rather than the individual threads, to *time-critical*. This in turn set all the child threads used to monitor the 12 screen groups to *time-critical* as well. We still don't understand why the other method didn't work and this method does, though it almost certainly has to do with the algorithms used in the OS/2 scheduler, which Microsoft has not made public.

## Optimizing Screen Performance

The other area that required some attention was optimizing screen performance. Most programs in the DOS world write directly to the screen to obtain fast screen updates because both the DOS and ROM BIOS calls for writing to the screen are very slow. OS/2, on the other hand, provides a number of different procedures for writing to the screen that are fairly fast—as long as you follow a few basic rules. These procedures include writing to the physical screen (which is possible, but discouraged), writing to a logical screen, and using the `ViOwrTxxx` calls.

We first considered writing directly to the physical screen, since our code was fine-tuned for writing directly to screen memory, but we quickly abandoned this idea since OS/2

*continued*

# TRY THE NEW GENERATION FOR \$30

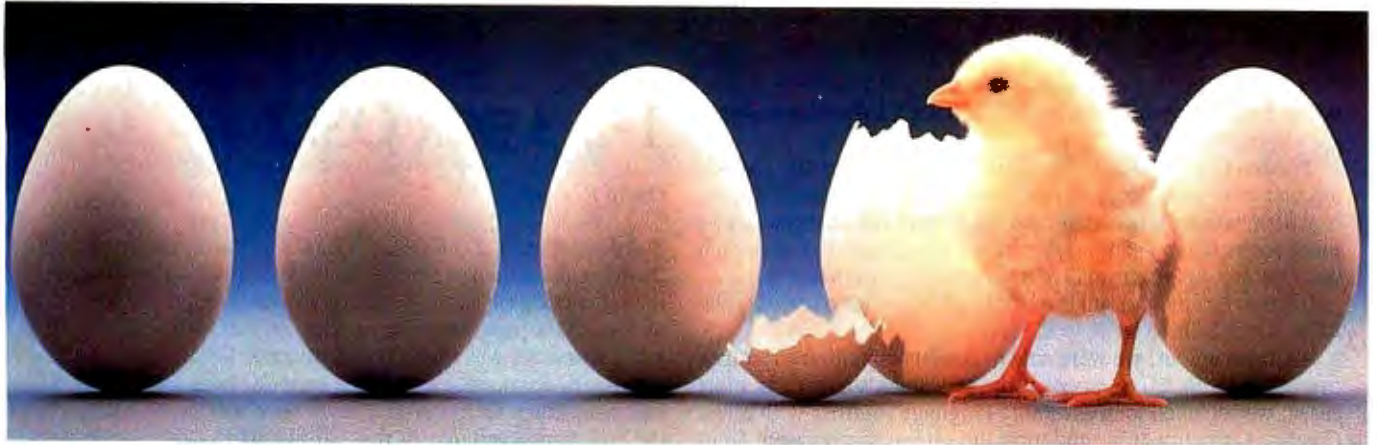

## KNOWLEDGPRO

KnowledgePro uses Topics to store "chunks of knowledge." Topics can contain data, **hypertext** procedures, calculations, rules, lists and pictures. Using a dozen simple commands, non-programmers can use topics to explain complex procedures, rules or recommendations. Using the other 100 plus commands, professional programmers can create sophisticated expert system tools and applications quickly and easily.

## HYPertext

Hypertext can be a powerful tool for organizing text, graphics and data, but without an underlying structure the user becomes lost in a maze of information. KnowledgePro adds structure, control and intelligence to create an exciting new teaching medium.

Once you've used **KnowledgePro** you'll never go back to your shell!

### Q. Who's using it?

**A.** Engineers, Educators, Lawyers, Scientists, Managers, Authors, Bankers, Software Developers, Expert System Developers, Computer VARs and VADs, Trainers, Consultants, Experts in Agriculture, Manufacturing, Insurance, Petroleum, Government and many many more.

### Q. What are they doing with it?

**A.** Intelligent tutorials, smart manuals, procedure guides, rule books, computer aided instruction, sales and promotion, data analysis, non-linear documents, text analysis, diagnostics, software front-ends, expert systems, training and education, hypertext authoring, case studies, insurance claim determination, investment analysis, intelligent forms - there seems to be no limit to the diversity of applications.

### Q. What can I do with the demo system?

**A.** The KnowledgePro demonstration system comes with a 100 page manual and lots of examples to get you started. You can create and save small working knowledge bases. The only commands that you can't use are those for handling external files or chaining knowledge bases. We even credit your \$30 toward the cost of the full system.

### Q. How much is the full development system?

**A.** KnowledgePro costs \$495 and there are no run-time charges, so you don't have to pay more when you distribute your applications. The Database Toolkit (for access to dBASE and Lotus 123 files) costs \$49 and the Graphics Toolkit (for access to PC Paintbrush pictures) costs \$89. Our KnowledgeMaker induction system (for creating rules from data) costs \$99. KnowledgePro runs on IBM PC, AT and PS/2 compatible machines with 640K memory.

**TO ORDER Call 518-766-3000** (Amex, Visa, M/C accepted) or send \$30 + \$5 shipping & handling for the demo (\$38 total foreign) or \$495 + \$8 shipping & handling for the full system (\$553 total foreign) to Knowledge Garden, Inc., 473A Malden Bridge Road, Nassau, NY 12123. In NY State please add 7% sales tax.

**KnowledgePro**<sup>®</sup>  
By Bev & Bill Thompson  
The first Knowledge Processor.

published  
by



In  
association  
with



KnowledgePro is a registered trademark of Knowledge Garden, Inc., Lotus 123 is a registered trademark of Lotus Development Corp., dBASE is a trademark of Ashton Tate. IBM is a registered trademark of International Business Machines Inc., KnowledgeMaker is a trademark of Knowledge Garden Inc. Photo Tcherevkoff ©

doesn't allow pop-up programs (which use `VioPopup`) to access the physical screen.

The next option was to use the logical screen buffer, which lets you write to a screen buffer as if it were the physical screen. You then have to call `VioShowBuf` to display the changes you've made to the logical screen. Again, we abandoned this approach because pop-up programs are not allowed to use these calls.

In other words, pop-up programs are allowed to use only the `VioWrtxxx` calls to write to the screen.

As it turned out, we were able to convert our library routines over to calls to `VioWrtxxx` easily and quickly since, in most cases, we replaced long assembly language routines with a few C calls. Unfortunately, updating the screen display went from very fast (in the DOS version) to painfully slow. Something was wrong.

### The Case of the Missing Cursor

The original assembly language code for the Norton Guides used a virtual cursor for writing characters and strings to the screen—the system kept track of where the virtual cursor was last positioned, and it recalled this offset from the screen buffer when placing new characters on the screen. This let us write one character at a time almost as quickly as writing a string.

OS/2, on the other hand, has no virtual cursor for writing. Instead, whenever you want to write a character or string to the screen, you have to pass the row and column where you want to start writing on the screen. So when we converted our assembly language routines in the Guides over to OS/2 calls, we often asked OS/2 to write a single character at a time. Each time we asked it to do that, it had to calculate the offset in the screen buffer from the row and column values. This calculation takes time, which accounted for the slow screen updating in our initial conversion of the Guides.

The solution was to write an entire line (or at least large chunks of a line) at a time, rather than a single character at a time. Once we rewrote several routines to buffer their output for transfer in large chunks, screen performance increased to the point where the OS/2 version of the Guides was nearly as fast as the DOS version.

### Helping Ourselves

We were delighted with the ease of converting the Norton Guides from a TSR program running under MS-DOS into an OS/2 protected-mode pop-up program. The conversion was much smoother and quicker than we could have hoped for; it took a total of about 2 months from first opening the OS/2 box until we shipped the OS/2 version of the Norton Guides.

Thanks to OS/2's DOS-compatibility box, we were able to use the Norton Guides itself to help us convert the Guides to OS/2. As we were starting the conversion, we had a 900K-byte Guides database to the OS/2 API that was nearing completion. The database has a DOS-to-OS/2 equivalency chart that helped us learn OS/2 and convert the Guides software. To access the database, we ran the original version of the Guides in OS/2's DOS-compatibility box. The database is cross-referenced electronically, and we found using it to be faster than looking things up in the manual.

---

*John Socha is director of R&D at Peter Norton Computing and creator of the Norton Commander and the Norton Guides software. He is also coauthor of Peter Norton's Assembly Language Book. Linda Dudinyak, a programmer with Norton Computing, converted the Norton Guides into an OS/2 program. Before joining Norton Computing, she worked at Lotus Development on Lotus Metro. They can be reached on BIX as "editors."*

## 1-2-3 FOR OS/2

David P. Reed

In developing 1-2-3 Release 3 for OS/2, the development team at Lotus learned a number of useful things about programming for OS/2 that would benefit anyone about to embark on a serious OS/2 programming project. One of our objectives for 1-2-3 Release 3 was that it be the ultimate Family API application—with common, compatible code for both DOS and OS/2 versions, down to the binary level—without being limited by the functions available in the Family API. Other objectives, such as high quality, performance, and portability, made the picture more complex.

Realizing these objectives required, first, that we go beyond the standard Family API by emulating OS/2 functions in DOS to enhance the Family API and bring it closer to OS/2's functionality; second, that we get directly at the graphics functions of the EGA, VGA, and other special devices; and finally, that we use OS/2's dynamic-link library (DLL) facility for configurability.

### The Family Way

The Family API, a subset of the OS/2 system API, is designed to allow construction of applications that run equally well in DOS (versions 2.0 and higher) and OS/2. The Family API subset lets you do nearly anything you would have done in MS-DOS and BIOS calls.

One advantage this facility provides to the designer is that programs that stick to the Family API can be linked and bound into "dual-mode executable" files that can run either in MS-DOS or in OS/2. The `BIND` utility combines the OS/2 program with a special stub loader that takes over at program start-up in MS-DOS, replacing the calls to OS/2 system routines with stubs that emulate those calls with their MS-DOS equivalents. An additional advantage is that each system loads only those portions of the bound executable file that are of interest to that particular system.

These dual-mode programs are great for those little (and not so little) utilities, such as installation programs and file utilities, that you don't want to maintain separately on each operating system.

But there's more value to this mechanism than might be obvious right away. For example, suppose you want to write a program that behaves well in DOS but, when running in OS/2, uses some of the new features of OS/2, such as starting up a program as a background task, loading a DLL, or changing the size of memory segments. You can still tell whether these features are available at run time by using the `DosGetMachineMode` call (included in the Family API subset), which returns a 0 if you are running under DOS, and a 1 if under OS/2.

Or, you can extend the Family API. Imagine a typical OS/2 call (say, `DosSetMeUpAndKnockMeDown`) that wasn't included in the Family API subset. You can add new routines to the library of emulators that are substituted by OS/2. All you need to do is write your own `DosSetMeUpAndKnockMeDown` call that works in DOS and add it to a library that you bind in with your program. When you run the program in OS/2, it will call the OS/2 version, and when you run in DOS, it will call the substitute version.

In 1-2-3 Release 3, we built our own simple multitasking system that is implemented in OS/2 by using threads (which are not in the Family API), and in DOS by hooking various BIOS inter-

*continued*

# MICROMINT'S Gold Standard in Single Board Computers and Industrial Controllers

## BCC180 — \$395.00

Multitasking Controller

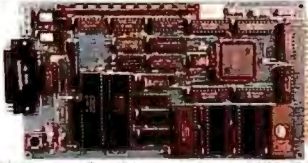

The BCC180, only 4.5" x 8.5" uses the same 64180 CMOS Z80 instruction compatible processor as Micromint's SB180 and SB180FX single board computers. Configured primarily for process control w/ 384K of memory, 6 parallel I/O ports, console serial port, RS-232/422/485 selectable auxiliary serial port, and an interrupt driven ROM-resident multitasking BASIC-180 compiler, the BCC180 uses the same 44-pin I/O expansion bus as Micromint's BCC52 controller board.

- PROCESSOR**
- CMOS 11054180, 9.216MHz 8-bit CPU, 48-pin PLCC package
- MEMORY**
- Up to 384K bytes total memory on-board
  - 128K of either static RAM (62256) or EPROM (27256)
  - 256K dynamic RAM SIMM
  - Full-function 8K ROM monitor included
- INPUT/OUTPUT**
- Console RS-232 serial port with auto baud rate select to 19,200 baud
  - Peripheral serial port, 180-19,200 baud, selectable RS-232, RS-422, or RS-485
  - 48 bus bidirectional parallel I/O
  - 64K I/O available through the BCC bus edge connector
- DI MENSIONS and CONNECTIONS**
- Dual 22-pin (0.156") edge connector
  - Compatible with all Micromint BCC-series I/O expansion boards
  - Two 26-pin headers for six bidirectional parallel ports
  - 25-pin DIN-25 for RS-232 console I/O
  - 20-pin header for RS-232 auxiliary serial port
  - 8 screw terminals for RS-422/485 connection

BCC180-1-20 9MHz assembled and fully socketed BCC180 Computer/Controller with 32K bytes of static RAM, ROM Monitor, BASIC-180 development software and user's manual For Additional 256K DRAM add \$100.00

BCC180-1 100 Quantity w/32K RAM w/o ROM Monitor \$209.00

## BCC52 — \$189.00

BASIC-52 Computer/Controller

The BCC52 Computer/Controller is Micromint's hottest selling standalone single board microcomputer. Its cost-effective architecture needs only a power supply and terminal to become a complete development or end-use system, programmable in BASIC or machine language. The BCC52 uses Micromint's new 80C52-BASIC CMOS microprocessor which contains a ROM resident 8K byte floating point BASIC-52 interpreter.

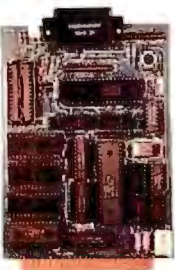

The BCC52 contains sockets for up to 48K bytes of RAM/EPROM, an "intelligent" 2764/128 EPROM programmer, 3 parallel ports, a serial terminal port with auto baud rate selection, a serial printer port, and it is bus compatible with the full line of BCC-bus expansion boards. The BCC52 bridges the gap between expensive programmable controllers and hard-to-justify price sensitive control applications. BASIC-52's full floating point BASIC is fast and efficient enough for the most complicated tasks, while its cost effective design allows it to be considered for many new areas of implementation. It can be used both for development and end-use applications.

Since the BASIC-52 is bus oriented, it supports the following Micromint expansion boards in any of Micromint's card cages with optional power supplies:

- |   |   |
|---|---|
| BCC22 Smart terminal board                        | BCC40R 8-Channel relay output board               |
| ADP500 User vocabulary, digitized speech board    | BCC53 Memory and 6 port I/O expansion board       |
| BCC25 LCD display board                           | BCC13 8-bit and BCC30 12-bit A/D converter boards |
| BCC33 3 port I/O expansion board                  | BCC18 Dual channel serial I/O board               |
| BCC40D 8-Channel optoisolated I/O expansion board |   |

BCC52 BASIC 52 Controller Board \$189.00  
 BCC-SYST.5 "52 PAK" Starter System includes: BCC52, ROM A&B UTIL., C001, MB08, UPS10 \$449.00  
 BCC52 OEM 100 Quantity Price -- \$149.00

BCC52C Lower power all CMOS version of the BCC52 \$199.00  
 NOTE: The BCC52 series is available in Industrial Temperature Range, fully tested at temperature. Prices start as low as \$294.00 in single quantities. Be sure to call for a quote on your specific Industrial OEM requirements.

## BCC11 — \$139.00

Z8 BASIC Computer

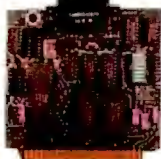

- Features:**
- Uses Z8 single chip microcomputer
  - On-board tiny BASIC interpreter
  - 2 on-board parallel ports & serial port
  - 6 interrupts (4 external)
  - Just connect a terminal and write control programs in BASIC
  - 6K bytes of RAM or EPROM memory on-board
  - Baud rates 110-9600 bps
  - Data and address bus available for 56K memory and I/O expansion
  - Consumes only 1.5 watts at +5, +12, and -12V

BCC11\* BASIC System Controller \$139.00

OEM 100 Quantity Price \$89.00

\* Now Available In Industrial Temperature Range

## Announcing BCC40D — \$139.00

8-Channel Optoisolated I/O Expansion Board

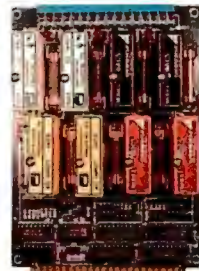

The Micromint BCC40D is an 8-channel optoisolated input/output expansion board designed for use with Micromint's family of BCC-bus Computer/Controllers. Using industry standard optoisolated I/O modules, the BCC40D provides on/off control and input monitoring of eight 115-230VAC or 5-48VDC devices used in data acquisition and control applications.

Up to 16 BCC40D boards can be used together in a single system to provide a total of 128 input and output channels. Individual channels can be read or updated by reading from or writing to a single I/O address. The BCC40D can be directly controlled from BASIC or it can function completely in the background under an application program using high-speed interrupt-driven ROM C firmware. This firmware sets aside a table in memory which reflects the status, setpoints, and change-of-state flags of the I/O modules. Interaction among programs within a multiboard BCC40x system merely consists of reading or setting these memory table values.

Each optoisolated channel is fused and has screw contacts for direct connection to the controlling device and/or the power source. Both input or output modules, and AC or DC functions can be intermixed on the same BCC40D board.

**New**



- SPECIFICATIONS**
- Latched outputs
  - Uses industry-standard OACs, ODCs, IACs, IDCS type modules
  - Dual-ported modular addressing
  - LED on/off indicator on each channel
  - Can be used concurrently with BCC40R and other BCC-bus products
  - Operates on +5V
  - Operating conditions: temperature: 0-50°C (32-122°F); relative humidity: 10-90% non-condensing
  - 4.5" x 6" board
  - dual 22-pin (0.156") edge connector
  - 16-terminal screw connector (#14 wire)

BCC40D/0 without modules \$139.00 OEM 100 Quantity  
 BCC40D/4 with 4 modules \$189.00 pricing starts at \$95.00  
 BCC40D/8 with 8 modules \$229.00



## Announcing BCC40R — \$169.00

8-Channel Relay Output Board

The Micromint BCC40R is an 8-channel relay output expansion board designed for use with Micromint's family of BCC-bus Computer/Controllers. Using efficient mechanical relays, the BCC40R provides contact-closure on/off control of eight AC- or DC-powered devices for data acquisition and control applications.

Up to 16 BCC40R boards can be used together in a single system to provide a total of 128 relay output channels. The relays are controlled by writing to a board-specific I/O address. The relays on a BCC40R board can be controlled either as a set of eight relays at a single I/O address or individual relays at eight separate I/O addresses.

The BCC40R can be directly controlled from BASIC or it can function completely in the background under an application program using high speed interrupt-driven ROM C firmware. This firmware sets aside a table in memory which reflects the status and setpoints of the relays. Interaction among programs within a multiboard BCC40x system merely consists of reading or setting these memory table values.

The eight relay outputs have screw contacts for direct connection to the controlling device and/or the power source. Four of the relays have single-pole-double-throw (SPDT) output connections and four relays have single-pole-single-throw (SPST) output connections.

- SPECIFICATIONS**
- Contacts rated for 1/10 HP, 3A 120V resistive, or 3A 30VDC
  - Latched relay outputs
  - LED on/off indicator on each channel
  - Power on/off failure: No arbitrary closure on power up/down
  - Can be used concurrently with BCC40D and other BCC-bus products
  - Operates on +12V
  - Operating conditions: 0-50°C (32-122°F); relative humidity: 10-90% non-condensing
  - 4.5" x 6" board
  - dual 22-pin (0.156") edge connector
  - 20-terminal screw connector (#14 wire)

BCC40R 8-Channel relay output board \$169.00  
 OEM 100 Quantity price \$124.00

## Announcing BCC18 — \$175.00

Dual-Serial Board



The BCC18 is a general-purpose dual-serial-port interface board for use with the Micromint BCC-bus. Optional support software is available for the BCC52 and BCC180 computer/controllers.

The BCC18 Serial Board contains two serial interfaces. Each interface can be either a 110/300/1200-bps modem, or a hard-wired RS-232C/RS-422/RS-485 interface. The modem interface uses a Xecom XE1201/XE1203 MOSART (Modem Synchronous/Asynchronous Receiver/Transmitter), capable of 110, 300, or 1200 bps communication and compatible with Bell 103 and Bell 212A standards. The hard-wired serial interface uses an industry-standard 8251A USART (Universal Synchronous/Asynchronous Receiver/Transmitter), capable of supporting asynchronous serial communications at speeds up to 19.2 kbps and synchronous serial communications at speeds up to 64k bps.

The BCC18 can be configured with two MOSARTs, two 8251As, or one of each. Up to 16 BCC18s can be used in a single system (for a total of 32 serial ports).

- MOSART**
- Connects directly to any phone line
  - DTMF or pulse dialing
  - DTMF reception and decoding
  - Call progress monitoring
  - Parity generation/checking
  - Sync byte detection/insertion
  - Extensive built-in diagnostics
  - Telephone line diagnostics
  - Synchronous and asynchronous operation
  - Voice synthesis capability (XE1203 only)
- 8251A**
- Full-duplex, double-buffered transmitter/receiver
  - Fully programmable with several modes and character modes
  - Error detection for parity, overrun, and framing
  - False start bit detection; automatic break detect and handling
  - Supports Baudot
  - Bit rate is software programmable using an on-board 8253 counter/timer
  - RS-232C, RS-422, and RS-485 supported
- Software**
- MOSART and 8251A use the same program interface, so most software will work with both
  - Optional support software for the BCC52 and BCC180 is available that makes it easy to access and use most of the features of the MOSART and 8251A from within user-written programs

BCC18S OEM configuration fixed dual 8251 RS-232 only \$175.00 serial port board

BCC18S OEM 100 Quantity Price \$134.00

BCC18U-1 8251/8251 Dual RS-232/485 serial \$209.00  
 BCC18U-2 8251/1201 Modem and serial port \$359.00  
 BCC18U-3 1201/1201 Modem/Modem board \$499.00  
 BCC52/18 BCC52 serial port utilities software \$75.00

## BCC-BUS

Expansion Products

	Single Qty.	Price
BCC08	Single Channel UART Serial Board	\$149.00
BCC13	8-bit, 8 Channel A/D Board	\$129.00
BCC30	12-bit, 16 Channel A/D Board	\$197.00
BCC22	25-line, 80 Character Terminal Board	\$249.00
BCC25	LCD Board (4x20) or (8x40*)	\$159.00
BCC55	Fully Decoded & Buffered Prototyping Board	\$ 79.00
BCCxx	X-10 Power Line Controller	\$ 59.00
BCC53	Multifunction Expansion Board	\$160.00
MB04	4 Slot Mini-Motherboard	\$ 69.00
MB08	8 Slot Full Motherboard	\$ 85.00

\* Call for current pricing

## REPRESENTATIVES

### ACCESS TECHNOLOGIES

1408 Richmond Dr  
 Placentia, Ca. 92670 Tel:(714) 996-3917

### MICROFUTURE

41040 Comac Terrace  
 Fremont, Ca. 94538 Tel:(415) 657-0264

## DISTRIBUTOR

### J.B. DESIGNS & TECHNOLOGIES LTD.

15 Market Place  
 Cirencester, Glos. GL7 2PB  
 England  
 Tel: 0285-68122 Fax: 0285-68859

To order call

**1-800-635-3355**

TEL: (203) 871-6170

TELEX: 643331

FAX : (203) 872-2204

## MICROMINT INC.

4 PARK STREET  
 VERNON, CT. 06066



rupts. Using the Family API and dual-mode executable file tools made it a straightforward project.

### A Peripheral Issue?

The wide variety of peripheral equipment, such as printers, plotters, video displays, and math coprocessors, made possible by the IBM PC's open architecture is a boon to users. However, dealing with that variety in a programming environment involves a great deal of planning. For Release 3, we decided to break the code up and have one major portion—the *core*—that would always be the same no matter what peripherals were present, and a set of replaceable parts—the *drivers*—that could be chosen by the core, depending on the environment. For example, depending on the presence or absence of a math coprocessor, the core could load a hardware-optimized or software-emulated math library.

OS/2 provides a nice tool for implementing these replaceable modules in the form of DLLs. Although OS/2 provides several different ways to use DLLs, our development team chose one that was particularly appropriate for handling the case of replaceable modules.

One form of dynamic linking allows you to use *ordinal entry points* to select the entry points of a DLL. To define the interface to a replaceable module, we assigned ordinal numbers to each of its entry points (e.g., 1=INIT, 2=TERMINATE, 3=ADD, 4=SUB, and so on). Then each version of a replaceable module received its own unique name: FLT87.DLL, FLTSOFT.DLL, and FLT1167.DLL, for example.

At start-up time, we decide which modules to use (depending on which peripherals are available) and load them. To use a particular version of the module, we initialize a table of pointers to each of the ordinal entry points of the desired module. First, we call `DosLoadModule` to get a module handle for the module of the right name. Then for each integer *n* from 1 to *N*, we call `DosGetProcAddress` to get the address of the entry point to put into the entry-point table.

Finally, to call the entry point at run time, we use the C macro facility to make the procedure look just like a regular C call:

```
#define floating_add(  
    *((void(*) (void)) entrypoint[2]))
```

where `entrypoint[2]` is the pointer to the desired floating-point add procedure that we obtained. The user of `floating_add()`, then, never needs to know that it is a DLL.

One more key point: If a DLL must be written in C (only a few of ours were in the Microsoft Macro Assembler [MASM]), it must be compiled with special options under the Microsoft C 5 (or IBM C/2) compiler. The option `/Au` specifies that entry points are to load the 80286 segment register DS with the DGROUP group address belonging to the DLL itself, and that the segment register SS will not equal DS. Few of the standard C libraries can be safely called from such DLLs because of this special memory option. See the C compiler manual for further details.

### Minimal-Fuss Graphics

Although OS/2 will eventually have the full graphics functionality available in the Presentation Manager, OS/2's initial support for graphics is limited. On the other hand, 1-2-3 has always had graphics, so we had to find a way to make graphics work under OS/2—something that is not obvious at first.

The major block to doing graphics right is that I/O operations (IN and OUT instructions) to EGAs and VGAs must be done fre-

quently (every few instructions) in the course of drawing lines, symbols, and characters. In OS/2 protected mode, IN and OUT instructions cause an illegal instruction trap. However, you can bypass this restriction by using the linker's definition (.DEF) file facility to make one or more code segments run at the processor's I/O privilege level (IOPL).

In this situation, the required graphics code will usually be written in assembly language. Since the code cannot be debugged with a debugger and can cause the whole operating system to crash (just like a device driver), it is a good idea to keep these IOPL routines short and simple. We recommend passing arguments in registers (though you can use the stack if you specify the right information in the .DEF file). For example, a routine that does an OUT to port 3D5h of the current value of AL might be written as follows:

```
RISKY SEGMENT BYTE PUBLIC 'CODE'  
PUBLIC OUT3D5  
OUT3D5 PROC FAR  
    MOV DX, 3D5H  
    OUT DX, AL  
    RET  
OUT3D5 ENDP  
RISKY ENDS
```

The segment RISKY would be declared as an IOPL segment in the .DEF file, and the entry point OUT3D5 would be declared as IOPL as well.

With all the work done at assembly and link time, the payoff comes when OS/2 loads this program. OS/2 loads the segment RISKY so that it runs at IOPL level, and an 80286 call gate is set up for the procedure OUT3D5. When some program calls OUT3D5, it actually calls the call gate, which causes the processor to switch modes to the IOPL, switching to a new stack reserved for that purpose. Here, it is perfectly acceptable to execute OUT instructions, and so forth. Then, when the RET instruction is executed, another mode switch and stack switch happens, so that you are now back at the caller's level.

One more note about saving and redrawing: If you create your own graphics, you lose OS/2's screen-group switching features and have to spawn a separate thread to handle saving and redrawing the screen. Unfortunately, such a thread is nearly impossible to debug!

### Lots to Learn, Lots of Benefits

Fashioning 1-2-3 Release 3 so that it will run equally well under OS/2 and DOS has, thus far, been easier than we expected. OS/2 has fewer bugs than we anticipated from the initial release of a major operating system. Its documentation is also better than we thought it would be—certainly better than the first generation of MS-DOS manuals—though still lacking in its tutorial aspects.

The programmer who wants to explore OS/2 will find lots to learn, discover, and invent with this new environment. OS/2 has a tremendous amount of power and flexibility that we're all only just learning to use. Over time, we'll learn even more sophisticated things to do with it, from which users and programmers alike stand to benefit. ■

---

*David P. Reed, vice president for R&D with the Software Products Group at Lotus Development, heads up the team that designed the forthcoming 1-2-3 Release 3. He has an MS and a Ph.D. in computer science from MIT. Dr. Reed came to Lotus from Software Arts, the developers of the original VisiCalc spreadsheet. He can be reached on BIX as "editors."*



# THE FASTEST WAY TO 'C'

*PRO-C. The first complete 'C' application tool that produces 'C' code. Programming can now be easier and routine coding problems are now eliminated. The **only** source code generator that runs on MSDOS, QNX, XENIX and UNIX, PRO-C has the facilities to produce the normal functions of complex application software.*

#### ● DATA DEFINITION

*Utilizing the integrated PRO-C generators to create menu, screen and report programs or batch processes.*

#### ● INTEGRATED GENERATORS

*Screens Menus Reports  
Batch processes. Combined  
they can generate any business  
or database applications.*



## PRO-C

*Call today for more information. Toll free*

**1-800-265-8887** North America Only.

**Chancelogic Inc.**  
Allen Square, 180 King St. South  
Waterloo, Ontario, Canada  
N2J 1P8.

Tel: 519-746-4800.

Fax: 519-746-1613.

#### ● CONTEXT - SENSITIVE HELP

*Complete context sensitive help is available at the touch of the help key.*

#### ● UTILITIES

*Professional utilities allow the selection of your development environment on line help for generated programs and full program documentation.*



## An Incredible Display Of Power And Versatility.

For just \$599\* the new 965 gives you ASCII, ANSI and IBM® PC compatibility in one terminal.

The new 965's versatility is unparalleled. It supports 23 terminal emulations, more than any other model in its class. You even get your choice of ASCII, ANSI or IBM Enhanced PC keyboard styles.

There's a 14" flat display in green or page-white with crisp, clear characters in a high-resolution 10x16 matrix. A 2-position keyboard with a true accounting keypad, 20 user-

programmable editing keys, and 128 programmable function keys.

The 965 can display up to 49 data lines, enough to show large spreadsheets or two normal display pages of text at the same time. No other terminal this affordable can do that.

The 965's state-of-the-art single board design uses a 16-bit CPU and sophisticated gate array to give you a high-performance, very reliable terminal with a full one-year end-user limited warranty.

The 965. A whole new look in terminals from TeleVideo. Call us toll-free or write today for more information.

TeleVideo Systems, Inc.,  
1170 Morse Ave., Sunnyvale, CA  
94088-3568.

Circle 270 on Reader Service Card

 **TeleVideo®**  
THE VISION YOU NEED TO SUCCEED

Call 1-800-835-3228

## Part 1

# WHY MICROCONTROLLERS?

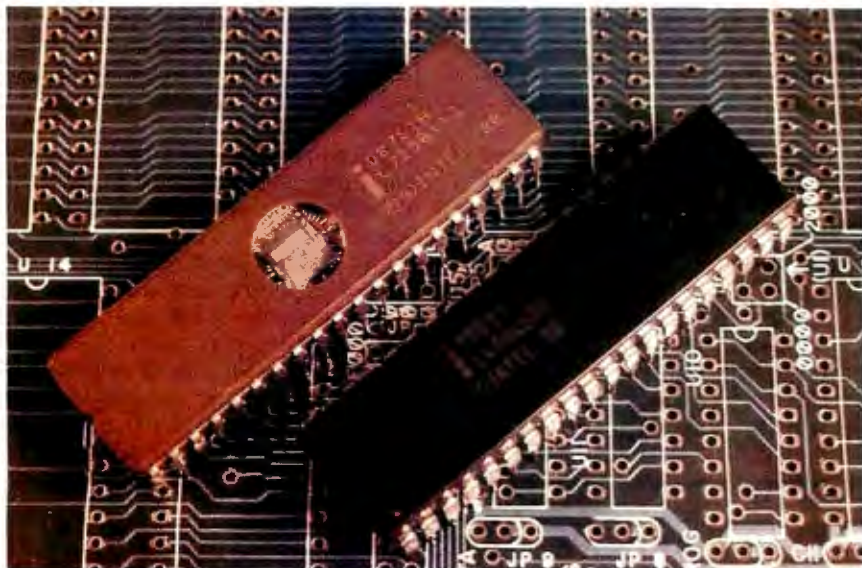

Microcontrollers are used in keyboard and disk interfaces and in numerous other devices. Here's a tutorial on the 8031/8051 microcontroller family.

**Photo 1:** Two versions of the Intel MCS-51 family: the 8031 ROMless microcontroller and the 8751 programmable (EPROM on-chip through the quartz window) microcontroller.

One are the days when a complex project required a suitcase full of TTL ICs and a wire-wrap gun. As with most of the recent Circuit Cellar designs, under the hood there are a few carefully chosen discrete ICs controlled by a microprocessor. The trade-off is simple: Hardware is expensive and software is cheap—once you get it right.

Many of you have noticed that I have been using two popular microcontrollers from Intel—the 8031 and the 8051—as the control elements in Circuit Cellar designs. I've received many requests for general information about these microprocessors and for guidance in applying them elsewhere. With that as an incentive, I decided to present this combination tutorial/development system project.

In this first part of a two-part article, I'll introduce the members of the 8031/8051 chip family and describe using them as embedded microcontrollers. The second part will present all the elements of a useful development system intended to simplify the process of designing systems using the 8031/8051 family.

## The Difference in a Name

It's important to be clear on the distinction between microcomputers, microprocessors, and microcontrollers. That way, you'll understand where the 8031/8051 family fits in the big picture.

A microprocessor is just the CPU part of a computer, without the memory, I/O, and peripherals needed for a complete system. For example, 8088 and 80286 chips are microprocessors (the "micro" prefix designates that this CPU element is at the chip level). All other chips in an IBM PC are there to add features not found within the microprocessor chip itself. The hardware designer can choose different chips to implement those features in different ways, although a designer has little room for choice if the end result is supposed to be an IBM PC clone.

When a microprocessor is combined with I/O and memory peripheral functions, the combination is called a microcomputer. Of course, vendors anxious to designate that their computer is more powerful than others often shed the "micro" prefix, but it's still a microcomputer given today's definition. Ultimately, good economic sense suggests that all computers, including minicomputers and mainframes, will utilize the same basic elements, just differentiated by quantity.

The fact that combining a CPU with memory and I/O produces a microcomputer also holds true at the chip level. Many companies add these peripheral functions onto the same substrate with the CPU to make a complete microcomputer. These devices are called single-chip microcomputers to differentiate them from their big-cousin desktop microcomputers.

Generally speaking, microcomputer chips are designed for very small computer-based devices that don't need all the functions of a full computer system. In cost-sensitive control applications,

*continued*

even the few chips needed to support a CPU like an 8088 or Z80 are too many. Instead, designers often employ a single-chip microcomputer (or a slightly expanded circuit using one) to handle control-specific activities. When single-chip microcomputers are designed or used in industrial control systems, they are often called single-chip microcontrollers. Basically, there is no difference between microcomputers and microcontrollers; the name depends on how we use them.

Frequently, microcontrollers are used to replace circuit functions that ordinarily require many low-level chips or need the main CPU's attention each time the circuit is active. The IBM PC keyboard-interface circuit is a prime example of the use of a microcontroller chip. In the PC, a half dozen chips (excluding I/O addressing and decoding) are necessary to

receive and decode the serial clock and data bit stream from the keyboard. In the IBM PC AT (and the CCAT I presented in September and October 1987), this low-level circuitry is replaced with an 8742 microcontroller that completely simulates the old circuit and incorporates additional features in one chip.

### The Intel 8051 Family

The Intel 8051 is a classic microcontroller (a generation more advanced than the 8742) and a true single-chip microcomputer containing parallel I/O, counter/timers, serial I/O, RAM, and EPROM or ROM (depending on the part type). The 8051 family contains several members (Intel refers to it as the MCS-51 family), each adapted for a specific type of system.

The different versions are outlined in table 1, and a block diagram of the 8051

is shown in figure 1. The 8051 has two close relatives, the 8751 and the 8031 (see photo 1), and a cousin, the 8052. All versions contain the same CPU, RAM, counter/timers, parallel ports, and serial I/O. The 8051 contains 4K bytes of ROM, which must be custom-masked when the chip is manufactured. In the 8751, the ROM is replaced with EPROM that you can program (the schematic for an 8751 programming adapter for the Circuit Cellar serial EPROM programmer presented in October 1986 is available by writing to me).

The 8031 is meant for expanded applications and uses external memory. The 8031 uses three of the four on-chip parallel ports to make a conventional address and data bus with appropriate control lines.

You might wonder why you'd choose a single-chip microcomputer in the first place if you end up converting it back to function as a CPU with other peripheral chips. Basically, it depends on the degree of expansion required. Since the 8031 still contains RAM, a parallel port, and a serial I/O port—even when functioning as the CPU core of an expanded circuit—the eventual number of chips necessary to expand the I/O or memory is still considerably less for the same ultimate capability than with a straight

**Table 1:** Members of the 8051 microcontroller family tree.

Device name	ROMless version	EPROM version	ROM bytes	RAM bytes	16-bit timers
8051	8031	(8751)	4K	128	2
8051AH	8031AH	8751H	4K	128	2
8052AH	8032AH	8752BH	8K	256	3

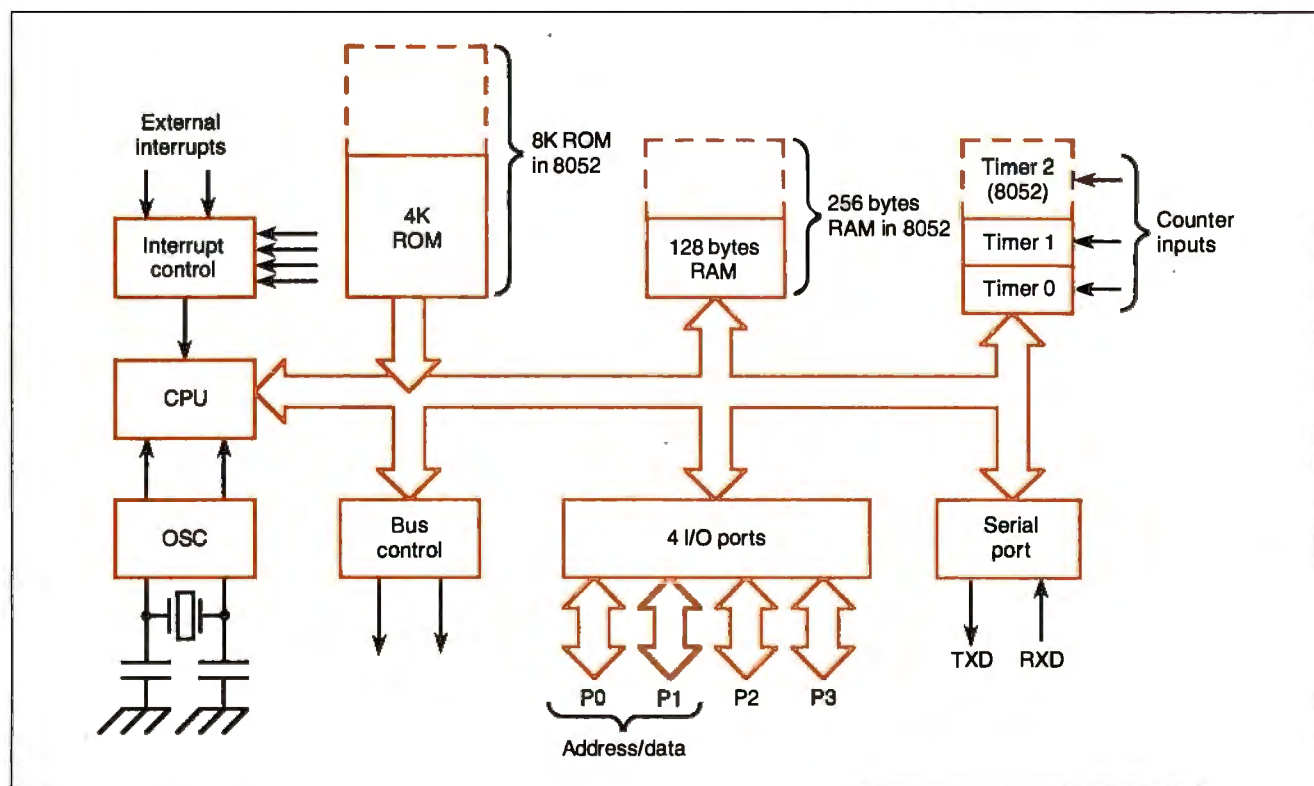

**Figure 1:** Inside the 8051.

microprocessor and peripheral chips. I'll go into the possible expansion techniques later.

Intel and other companies sell variations of the 8051 family with more internal memory, more I/O, lower power, and so forth. An 80C31 is a CMOS low-power version of the 8031, for example. The 8052, which I have also used in projects, is the same as the 8051, except that it has another counter/timer and additional RAM and ROM.

Using an 8051 is as simple as hooking up the power supply and clock crystal. Unlike the 8031, however, you have to supply Intel with a program for the 8051 so it can create a chip mask defining the internal ROM. (If your program is not quite right, it's time for another mask.)

As you might expect, both mask making and chip building take time and money. (Since I did this for a recent project, I thought you might be interested in some manufacturing information. If you plan on making an 8051 microcontroller and need to mask your own chip, the one-time masking charge is about \$3000, with a minimum order of 1000 chips.) Mask programming makes sense for an application that uses thousands of identical 8051s a year, but it is not practical for low-volume systems and prototypes.

The 8751 has all the features of the 8051, except that an on-chip EPROM replaces the ROM program storage. Making a program change is as simple as erasing the EPROM with ultraviolet light and burning another program. Many developers use 8751s until the code works, then commit to a large 8051 order with the program in ROM. If the product volume is low enough, it's often worthwhile to use 8751s in the final product. An 8051 costs about \$4 to \$5 apiece in thousands; an 8751 is about \$25 to \$40.

The 8031 has no on-chip program storage at all. The system must include an external EPROM and an address latch. Considering the falling prices of EPROMs and the heavy costs of using either 8051s or 8751s in low volumes, the 8031 is a viable alternative despite the additional chips. For many small systems, the 8031/EPROM combination is far more cost-effective than an 8051. (This is the type of system I'll describe in my examples.)

As I mentioned before, all members of the 8051 family have the same core hardware and therefore use the same core instruction set. While some members have one or two additional instructions for features unique to the particular chip, I'll use the term "8051" to describe the "8051 chip family," unless I'm talking

about a specific version with unique requirements.

### Making It Real

With all that in mind, let's look at configuring a usable "computer/controller" using an 8031 microcontroller chip as part of the system. Remember that in a single-chip microcontroller, internal hardware replaces all the digital logic you'd normally add for control, timing, and so forth. You need add only the keyboard, display, relays, switches, and user-specific I/O that actually makes up the final product.

Figure 2a shows the bare-bones 8031 microcontroller system: the 8031, a 2764 EPROM to hold 8K bytes of program, and a 74LS373 latch to demultiplex the address/data bus. The system has 128 bytes of RAM on the 8031, a bidirectional parallel I/O port, a bidirectional serial port, two counter/timers, and two external interrupt inputs. With a 12-MHz crystal (most often, we select 11.0592 MHz for communications rate compatibility), it executes most instructions in one machine cycle—a peak rate of 1 million instructions per second. Not bad for three chips, is it?

A single I/O port can scan a 16-key matrix. With an additional output bit, it can drive a 2-line by 20-character smart liquid crystal display at the same time. The remaining I/O bits can handle triacs or power field-effect transistors for AC or DC control. Burn a program into the EPROM, and you have a real-time power controller. Run the serial port through a MAX232 RS-232C level converter, and you have a standard serial port for remote control or status monitoring at your master computer.

If you don't need the serial port, counter/timers, and external interrupts, the 8031 can use those special bits as a second parallel I/O port, so the minimum system can have up to 16 I/O bits. Each bit can be tested, set, and cleared individually under program control.

If one or two parallel I/O ports aren't enough for your application, figure 2b (an expansion of figure 2a) shows what's needed to get three more: Add a single 8255 programmable peripheral interface. The 8255's port C can be set up for automatic handshaking, so now you have the basis for a serial-to-parallel (and back) format converter or 24 more I/O bits for a bigger controller. Notice that no "glue" chips are needed between the 8031 and the 8255.

Because the 8255 uses the RD\ and WR\ bits, the second I/O port isn't completely free. The 6 remaining bits can

still handle either general I/O or their individual special functions, though.

If your application requires more than 128 bytes of RAM, figure 2c (figure 2a expanded to include 2b and 2c) shows how to get 8K bytes of RAM by adding a 6264 static RAM chip. Now you can build a fancy buffering format converter, a data logger, or a serial-programmable power controller. A 62256 RAM would give 32K bytes with no more effort, still with no glue chips!

Finally, for those of you who need lots of RAM and I/O, figure 2d (figure 2a expanded to include the circuitry of 2b, 2c, and 2d) shows how to connect multiple I/O chips. The 74LS138 decoder generates chip select signals from the 8031's output addresses, with each select covering an 8K-byte range. The system shown has 16K bytes of RAM and seven bidirectional I/O ports. Pretty nice for seven chips.

The point of all this is that the "computer" part of your control system need not require elaborate hardware. For a unit of any reasonable size, you'll spend most of your hardware design time on the I/O devices rather than on the 8031 circuits, which is exactly as it should be.

Perhaps now you understand why I have been using the 8031 frequently. The main benefit of a microcontroller is the ease of adding new features to your system, just by changing the program, not changing the circuit-board connections. A new EPROM can give the hardware a completely new personality. Try doing that by rewiring a board of TTL control logic!

### The Software Swamp

Every microprocessor has an instruction set exhibiting the conflict between all the instructions that could possibly be useful and the few that fit on the chip. The 8051 has many bit-manipulation instructions and few general instructions, reflecting its design as a controller rather than as a computer.

Most 8051 instructions are 1 or 2 bytes long, with the remainder requiring 3 bytes. All instructions except MUL and DIV execute in one or two instruction cycles. An instruction cycle is 1 microsecond ( $\mu$ s) at a 12-MHz clock rate. MUL and DIV lag along at 4  $\mu$ s.

If you've written assembly language programs for any other microprocessor, you'll find some of the same instructions in the 8051's code. To understand the 8051's instructions, you must be familiar with the three main address spaces defined on the chip: 64K bytes of pro-

*continued*

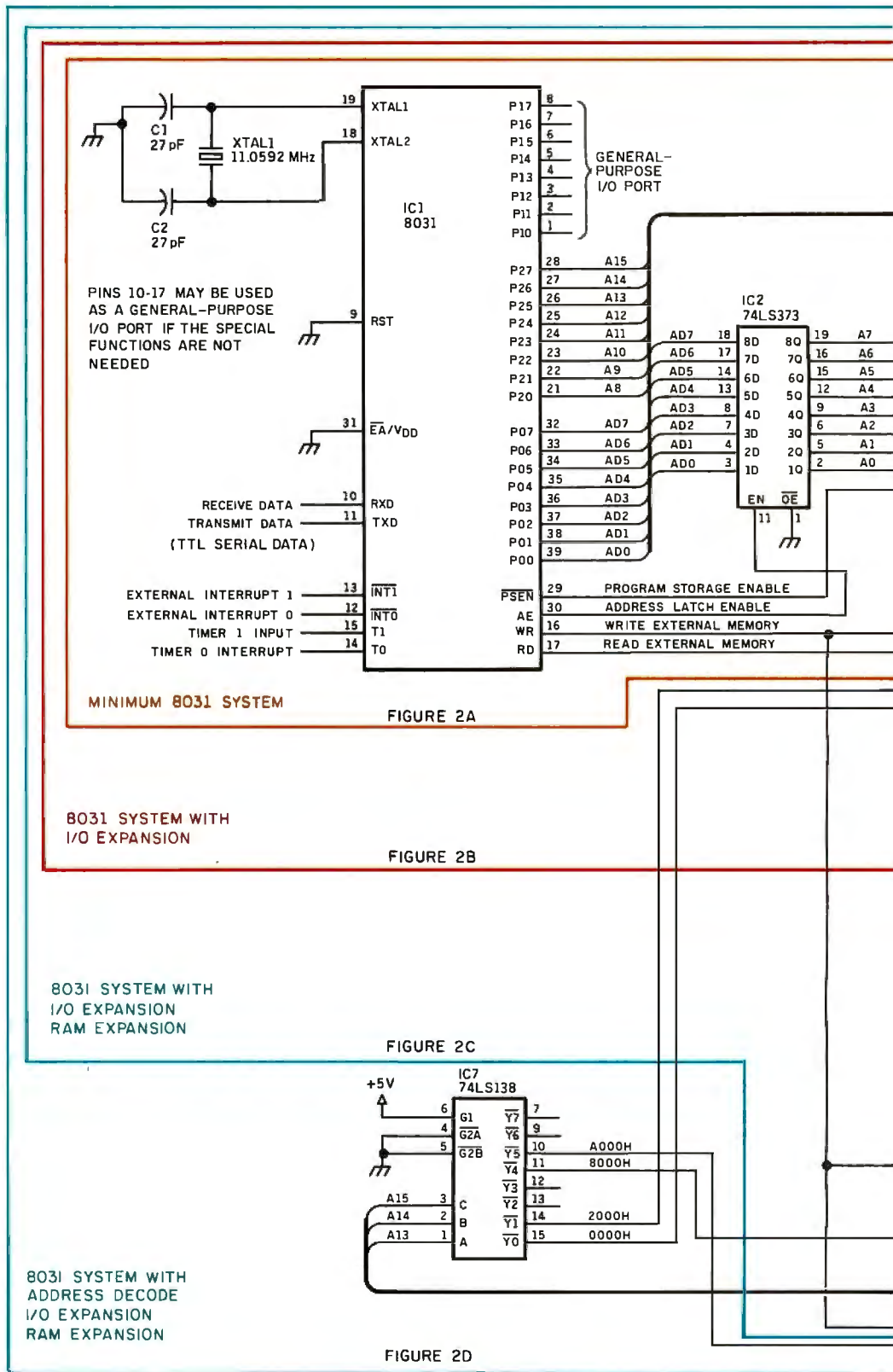

**Figure 2:** Growing an 8031 system. (a) A minimum configuration, (b) minimum system with I/O expansion, (c) system with I/O and RAM expansion, and (d) system with address decode logic and even more RAM and I/O.

HANDS ON  
CIARCIA'S CIRCUIT CELLAR

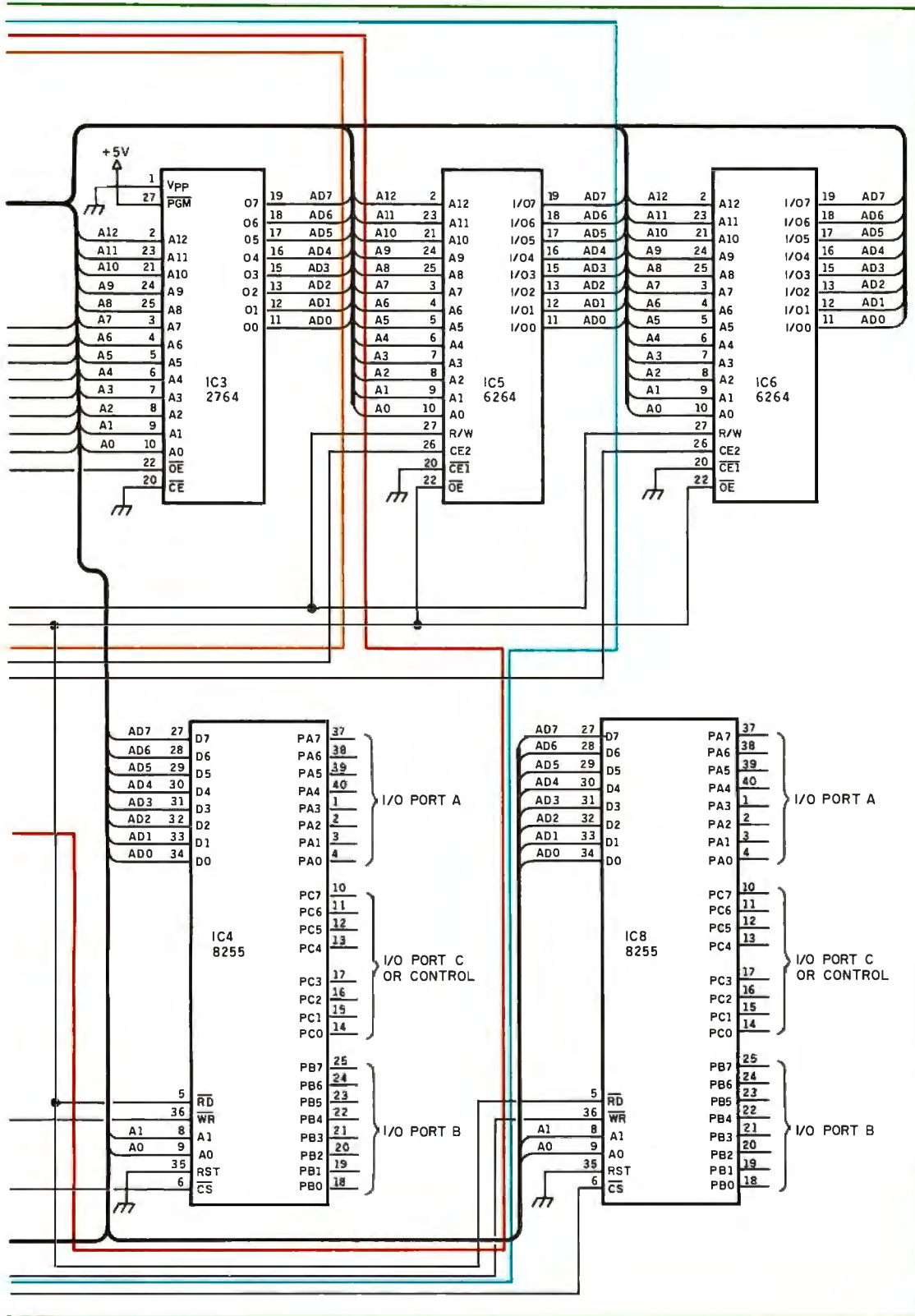

gram memory addressed by the program counter (PC), 64K bytes of external data memory addressed by the data pointer (DPTR), and the on-chip internal data memory addressed in several different ways. Each instruction implies a particular address space, so you have to know where your data resides to select the right instruction.

There is a sharp distinction between internal and external data addresses. Internal addresses refer to locations on the 8051 chip, which can be accessed in a variety of ways. External addresses are located off the chip, in the 64K bytes of external data memory, and can be accessed only with MOVX instructions.

The four main internal data memory-addressing modes are direct, immediate, register, and register indirect. Direct mode embeds an internal RAM address in the instruction. Immediate mode uses the data value itself. Register and register indirect modes use a register number, with indirect addressing taking the contents of that register as a direct address to access the data.

The MOVX instructions transfer a single byte between the accumulator and external data memory. The DPTR register contains a 16-bit external data memory address, which can be either loaded by a single MOV or incremented. Unfortunately, there aren't any other 16-bit instructions.

The 8051 has a single accumulator, called ACC or A depending on the instruction. Nearly all instructions use the accumulator in one way or another. An auxiliary accumulator (called B, of

course) is used by MUL and DIV. Many data-manipulation instructions can move data to or from one of the active banks of eight "working registers" in internal RAM. Four register banks are available.

Because most controller applications require handling at least a few I/O bits, the 8051 has a rich selection of bit-manipulation instructions that are completely separate from the standard byte instructions. A single instruction can set, clear, complement, or copy any bit in internal data memory. The on-chip I/O ports show up in that address space, so there's no need for the "read, mask, set, combine, write" instructions found in most other microprocessors.

Unlike the Intel 8088 or Z80 microprocessor families, the 8051 has no explicit I/O instructions. The on-chip I/O ports are mapped into the internal data memory-address space and accessed with the same MOV instructions used for other transfers. You have to map off-chip I/O into the external data memory-address space and access it with MOVX instructions.

Rather than belaboring the various instructions in detail, I'll introduce them next month in short chunks of code that do useful tasks as we build some hardware. With those examples as a base, you should have little trouble designing your own system.

### Ugly Reality

The trade-off for not wiring up a board of TTL gates is writing a program for the EPROM. That program tests the inputs, computes the outputs, and handles all the

timing to make the system work correctly. Unless you are much better than average, your program won't do the right thing the first time you try it out.

The ugly reality of microcontroller systems is getting the software to work. It's made considerably more ugly by microcontrollers buried inside specialized systems—those never intended to look or act even vaguely like a computer.

For example, which system would you rather debug: an IBM PC AT with a full keyboard, EGA display, hard disk drive, and state-of-the-art editors and debuggers, or a microcontroller in a 3- by 5- by 4-inch box with four push buttons and two LEDs, cabled to a heater in a vat of photographic solution?

The traditional way to debug microcontroller programs is called "burn and crash." You burn the program into EPROM, plug it in, turn it on... and then try to figure out why it crashed. Doing a Sherlock Holmes on the listing is the only way to find bugs in the program, although a logic analyzer and an oscilloscope help a lot.

The major problem with burn-and-crash debugging is the damage caused by a crash if you are trying to debug a program when the controller is attached to actual machine hardware. Imagine what happens when your new 10-story hammerhead crane controller goes "full speed counterclockwise" and refuses to reset.

Obviously, burn and crash has its limitations. An 8051 simulator program running on a host computer development system removes most problems and simplifies finding program bugs. The simulator reads the EPROM's data and interprets the 8051's registers, I/O ports, and memory are provided by simulator variables, you can display and modify memory contents at will. Even better, because the simulator's software replaces the 8051's hardware, there's no way that an errant program can damage anything.

With the simulator, you can use program breakpoints to stop execution at specific 8051 instructions or when a given condition occurs. Also, since the simulator records how the 8051 program got to a particular instruction, you can undo each step back to the source of the problem at the press of a key.

Unfortunately, while a simulator is a great step up from burning and crashing, it is not a true real-time test. Because the execution of each 8051 instruction requires the execution of many program instructions in the development system, the

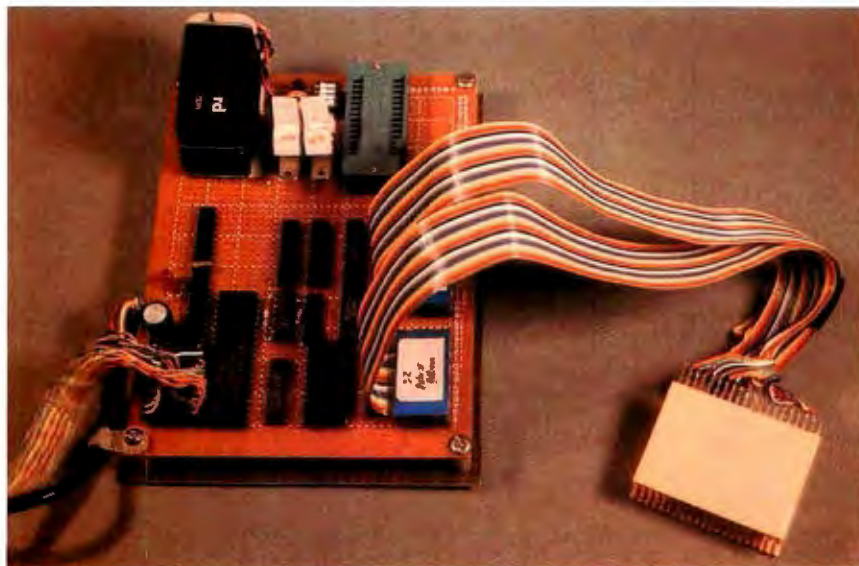

Photo 2: A prototype of the DDT-51 development system. Note the DIP clip at the end of the cable for attaching onto the target system's processor.



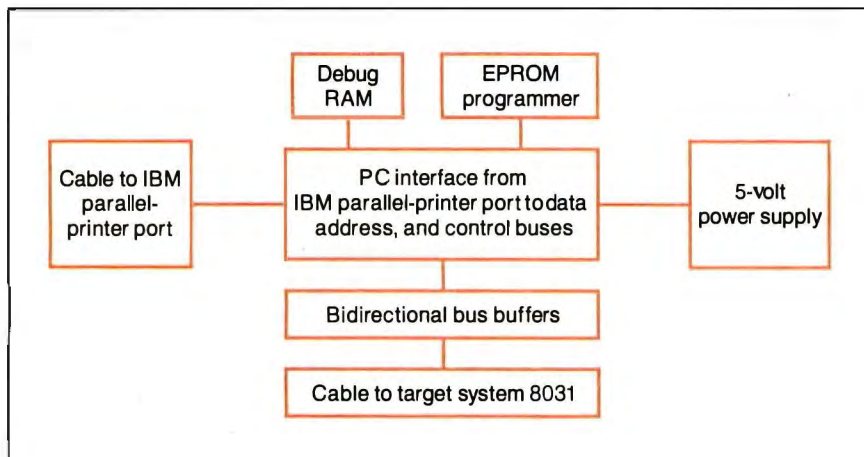

Figure 3: A block diagram of the DDT-51 8031/8051 development system.

simulated run time is much slower than the real-time rate on the actual hardware. A further complication is that interrupt timing is not easily duplicated on a simulator.

The ultimate solution is an in-circuit emulator (ICE), which is a special development system peripheral plugged into the 8051's socket in the actual hardware (called the target system). From the target's point of view, the ICE is an 8051 running at full speed. From the user's perspective, the ICE provides many of the features of a simulator, along with the ability to run programs at full speed using the real hardware.

Ideally, an ICE will have no effect on the target system, because all the 8051's features are provided in high-speed hardware. The 8051's internal registers and I/O ports are visible because the ICE uses discrete logic rather than a single chip. The development system directly monitors what's going on, logic comparators control the breakpoints, and there's no interference until the ICE stops at the selected instruction.

All this hardware makes ICE systems rather expensive. If you are developing many 8051 designs, an ICE is the only way to go. As a practical matter, however, an ICE is far beyond the typical user's budget and is generally reserved for the corporate lab.

#### A More Modest System

There is a middle ground between personal computer-based software simulators and hardware ICE systems. It's often enough to stop at a breakpoint and single-step through instructions while watching the target system's LEDs blink and relays click. By trading off some speed and hardware for time and money, a much simpler program development

system can provide many features of an ICE at a fraction of the cost.

The DDT-51 system is an IBM PC-based 8031/8051 development and dynamic debugging tool (see photo 2). It uses a modified parallel printer port and a small circuit board to give the IBM PC complete control over the target system's hardware. The DDT-51 downloads the 8051 program into 8K-byte static RAMs, thus eliminating the need to burn an EPROM for each program change. An on-board 2K-byte static RAM holds the small amount of 8051 code required to support single-stepping and breakpoints. A disassembler shows the current 8051 instruction on the IBM PC's display while single-stepping, as well as the current 8051 registers and internal data memory values.

This system connects between the IBM PC and the target system (see figure 3). It has only about a dozen chips, including the world's simplest (and slowest) 2764 EPROM programmer.

The DDT-51 won't handle all possible 8051 target systems, but it will give you a good start. With that in hand, we can continue on with other interesting Circuit Cellar project designs.

#### Experimenters

As is the custom with Circuit Cellar projects, the software for the DDT-51 development system is available for downloading from my multiline bulletin board free of charge. The number is (203) 871-1988. Of course, this downloaded software is limited to noncommercial personal use unless licensed otherwise.

#### Next Month

The hardware and software specifics of the DDT-51. ■

continued

# Capital Gain.

Time and again, you've heard it said, "To make money, you have to have money."

The truth is, you have to know how to save money before you can think about making more.

That's why more and more people are joining the Payroll Savings Plan to buy U.S. Savings Bonds. That way, a little is taken out of each paycheck automatically.

In no time, you'll have enough Bonds for a new car, your child's education, even a dream vacation.

Whatever you save for, Bonds are the safest, surest way to gain capital.

Take stock in America.

When you put part of your savings into U.S. Savings Bonds you're helping to build a brighter future for your country and for yourself.



A public service of this publication and The Advertising Council.

# Spot the Top Dot.

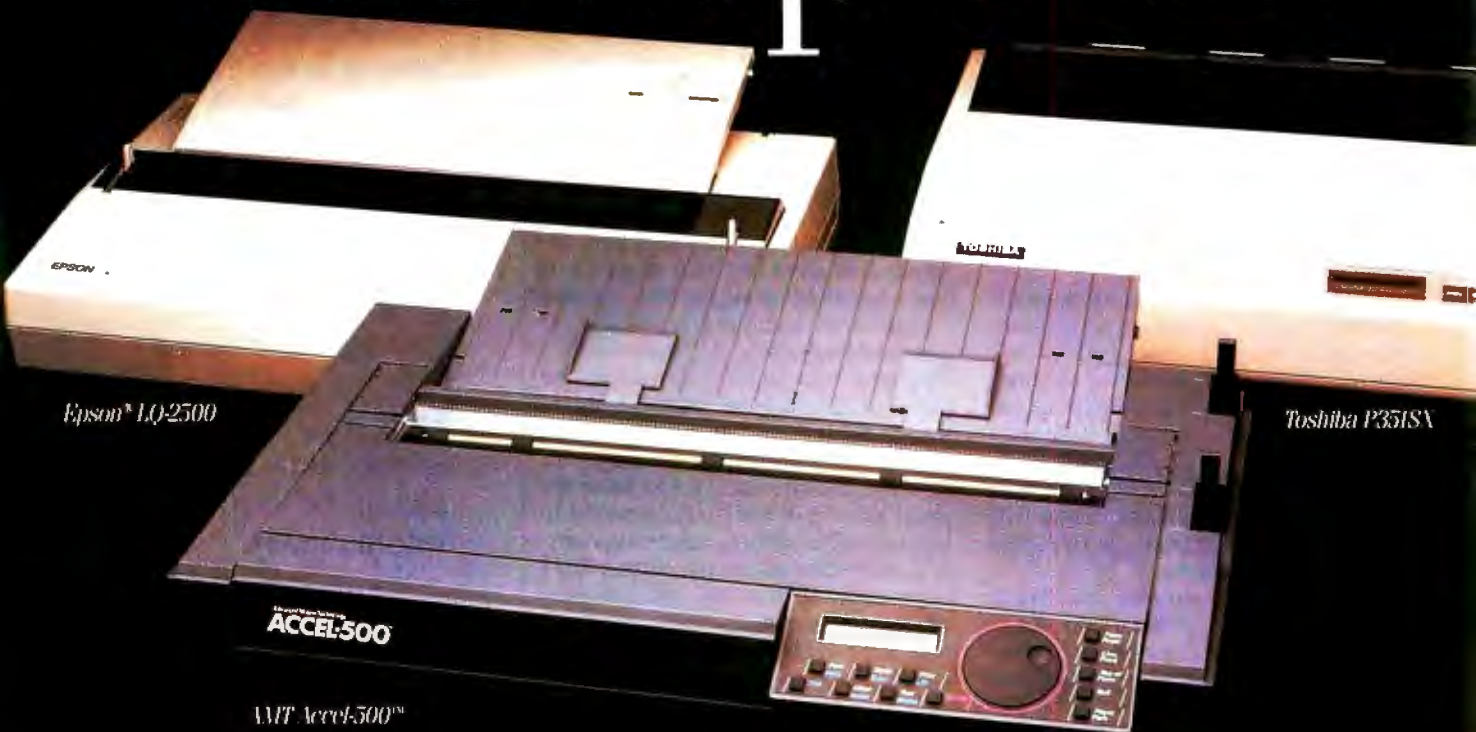

Epson® LQ-2500

Toshiba P351SX

AIT Accel-500™

And we'll ship it to you **FREE** for 30 days.

The bad news is, this is a quiz. The good news is, we're going to make it easy.

All three of these 24-pin dot matrix printers are versatile, rugged office-quality printers. They all provide a variety of type styles and compatibility with most popular software. But there's only one Top Dot. And all the clues you need to find it are right here in this ad.

Top Dot's high performance features include combined letter-

quality text and graphics, color printing, and a sizzling 480 cps draft speed.



Select-Dial puts total printer control at your fingertips.

A unique Select-Dial™ feature gives Top Dot effortless, fingertip control. And plug-in Intelli-Cards™ provide instant software upgrades.

Top Dot's \$985 price is a remarkable \$500 below comparable printers. Even more remarkably, it includes toll-free hotline support, a 2-year warranty, an unheard-of full year of on-site service, and a Quick-Start kit packed with \$150 worth of supplies, software, documentation and more.

## CIARCIA'S CIRCUIT CELLAR

your choice of finish: Executive Black or traditional Ivory.

You have to visit a dealer to buy two of the printers on this page. But you can get Top Dot delivered to your door by UPS.<sup>®</sup>

Just call 1-800-637-7878, correctly identify the Top Dot, and

## COMPARISON CHART

	AMT Accel-500	Epson LQ-2500	Toshiba P351 SX
Print speed (12cpi)			
Draft Mode	480 cps	324 cps	300 cps
Memo Mode	200 cps	N/A	N/A
LQ Mode	80 cps	90 cps	100 cps
Plug-in fonts	card	card	cartridge
Color printing	standard	N/A	optional†
Warranty	24 mo	18 mo	18 mo
On-site service	1 yr	N/A	N/A
Price	\$985	\$1449*	\$1499*
Starter Kit	standard	N/A	N/A

\*\*manufacturer's suggested list price †\$239

we'll ship it to you. FREE.\* If after 30 days, the Top Dot hasn't become indispensable to your office, just send it back. Otherwise, do nothing. We'll charge \$985 to your credit card or bill you against your purchase order. That's all there is to it.

If you're still not sure of the answer, don't worry. Our operators will give you three chances to get it right.



Quick-Start Kit contains supplies, cable, software, documentation—even transparency materials. A \$150 value FREE with Top Dot.

# ACCEL-500™

## 1-800-637-7878



*Special thanks for the technical contributions provided on this article from Jeff Bachiochi and Ed Nisley.*

*Diagrams specific to the Intel 8031/8051 architecture are reprinted by permission of Intel Corp.*

## ces

One advantage of using an industry standard like the 8031 is that it's easy to obtain. The following companies are a few possibilities:

...p., P.O. Box 677, Thief River  
5701, (800) 344-4539  
...55 Shoreway Rd., Belmont, CA  
1592-8121  
...levices, 110 Knowles Dr., Los  
5030, (800) 538-5000  
...hology, Inc., 2219 South 48th  
AZ 85282, (800) 245-2235

The 8051 family doesn't have the wealth of publications you're used to seeing for the IBM PC. Fortunately, Intel prints a few useful and surprisingly readable manuals covering the tricky hardware and software details. These manuals are available from your local Intel office for a reasonable fee, or contact Intel Corp., Literature Dept., 3065 Bowers Ave., Santa Clara, CA 95051.

The order numbers include the latest revision after the dash, so you may find that here's a new edition out:

*Embedded Controller Handbook*, number 210918-005: The straight dope on all Intel's microcontrollers, from the 8096 to the 8048, including the 8051 family. It includes many hardware details, along with quite a bit on 8051 software and applications.

*Microsystem Components Handbook*, number 230843-004: This two-volume set gives assorted Intel microprocessor and peripheral chip data sheets. These are the definitive words on how the chips are supposed to work: heavy-duty specs, not for beginners.

## Hardware

Although the DDT-51 development system includes a simple 2764 EPROM programmer, you'll eventually need a "real" EPROM burner. You need look no further than the Circuit Cellar serial EPROM programmer available from CCI, 4 Park St., Suite 12, Vernon, CT 06066, (800) 635-3355.

## Software

The single most essential program is a cross assembler that runs on your IBM PC, eats assembly language files, and spits out hexadecimal files for the EPROM burner. You can spend as much or as little on these as you see fit, but doing assemblies by hand is not much fun. I speak from experience.

The shareware Pseudo-SAM 8031 cross assembler is available on the Circuit Cellar BBS under the name PS51A123.ARC. It has most of the useful features, few frills, and is quite

serviceable. A newer version is available from PseudoCode, P.O. Box 1423, Newport News, VA 23601, BBS phone (804) 898-7493.

Avocet Systems (120 Union St., Rockport, ME 04856, (207) 236-9055) produces excellent "industrial-strength" assembler and simulator programs for a variety of microprocessors and microcontrollers. The AVMAC51 assembler and AVSIM51 simulator have contributed to many recent projects. They give excellent results. I recommend using one or both of these as the best way to optimize the performance and cost benefits of the DDT-51 development system and an excellent way to get a system up and running in a short time.

**Editor's Note:** Steve often refers to previous Circuit Cellar articles. Most of these past articles are available in book form from BYTE Books, McGraw-Hill Book Co., P.O. Box 400, Hightstown, NJ 08250.

*Ciarcia's Circuit Cellar, Volume I* covers articles in BYTE from September 1977 through November 1978. *Volume II* covers December 1978 through June 1980. *Volume III* covers July 1980 through December 1981. *Volume IV* covers January 1982 through June 1983. *Volume V* covers July 1983 through December 1984. *Volume VI* covers January 1985 through June 1986.

## Circuit Cellar Ink

It's virtually impossible to provide all the pertinent details of a project or cover all the designs I'd like to in the pages of BYTE. For that reason, I have started a bimonthly supplemental publication called Circuit Cellar Ink, which presents additional information on projects published in BYTE, new projects, and supplemental applications-oriented materials. For a one-year subscription (6 issues), send \$14.95 to Circuit Cellar Ink, P.O. Box 3378, Wallingford, CT 06494. Credit card orders can call (203) 875-2199.

There is a multiline Circuit Cellar bulletin board system (running TBBS 2.0M) that supports past and present projects in BYTE and Ink. You are invited to call and exchange ideas and comments with other Circuit Cellar supporters. The 300-/1200-/2400-bps BBS is on-line 24 hours a day at (203) 871-1988.

To receive information about the Circuit Cellar Ink publication for hardware designers and developers, please circle 100 on the Reader Service inquiry card at the back of the magazine.

*Steve Ciarcia (pronounced "see-ARE-see-ah") is an electronics engineer and computer consultant with experience in process control, digital design, nuclear instrumentation, and product development. The author of several books on electronics, he can be reached on BIX as "sciarcia."*

*Your questions and comments are welcome. Write to: Editor, BYTE, One Phoenix Mill Lane, Peterborough, NH 03458.*

# BYTE's Subscriber Benefits Program

Your BYTE subscription brings you a complete menu of the latest in microcomputer technology every 30 days. The kind of broad-based objective coverage you read in every issue. *In addition*, your subscription carries a wealth of other benefits. Check the check list:

## BONUSES

✓ **Annual Separate Issues:** In addition to BYTE's 12 monthly issues, subscribers also receive our annual IBM PC issue free of charge, as well as any other annual issues BYTE may produce.

✓ **BYTE Deck:** Subscribers receive five BYTE postcard deck mailings each year—a direct response system for you to obtain information on advertised products through return mail.

✓ **Reader Service:** For information on products advertised in BYTE, circle the numbers on the Reader Service card enclosed in each issue that correspond to the numbers for the advertisers you select. Drop the post-paid card in the mail and we'll get your inquiries to the advertisers.

✓ **TIPS:** BYTE's Telephone Inquiry System is available to subscribers who need *fast response* from advertisers. After obtaining your Subscriber I.D. Card, dial TIPS and enter your inquiries. You'll save as much as ten days over the response to Reader Service cards.

✓ **Free Programs Via BYTENet:** You get access to the BYTENet Bulletin Board Service, which allows you to download, via



modem, valuable program listings. There is no connect charge for this service.

✓ **Subscription Service:** If you have a problem with, or a question about your subscription, you may call our service department toll-free at 800-423-8272 (in New Jersey call 800-367-0218) during regular business hours (Eastern Time). You can also use Subscription Service to obtain back issues. Should you care to correspond, use the following address: P.O. Box 6821, Piscataway, N.J. 08855.

✓ **Editorial Indices:** Available through our customer service department P.O. Box 328, Hancock, New Hampshire 03449.

## PAID SERVICES

✓ **BIX:** BYTE's Information Exchange puts you on-line 24 hours a day with your peers via computer conferencing and electronic mail. All you need to

sign up is a microcomputer, a modem, and telecomm software. For further information and cost, call 1-800-227-BYTE.

✓ **Program Listings:** Listings of programs that accompany BYTE articles are now available on BIX, on disks or in quarterly printed supplements (see reply cards in this issue for cost information), or call 1-800-258-5485.

✓ **Microform:** BYTE is available in microform from University Microfilm International in the U.S. and Europe. See Contents page for cost information.

## DISCOUNTS

- ✓ One-year subscription at \$22.95
- ✓ Two-year subscription at \$39.95
- ✓ Three-year subscription at \$55.95
- ✓ One-year group subscription for ten or more at \$18.95 each. (Call or write for details.)

## TOLL-FREE NUMBERS FOR YOUR CONVENIENCE:

**Subscriptions & Back Issues:**  
1-800-423-8272  
(in N.J., 1-800-367-0218)

**BIX:** 1-800-227-BYTE

**Program Listings Orders:**  
1-800-258-5485

# BYTE



*It's indispensable.*

# BYTE LISTINGS YOUR WAY!

It's easy. Now there are three ways to get source-code listings that go with BYTE articles—on disk, in print or on line.

## LISTINGS ON DISK

BYTE listings on disk are right for you if you want to compile or run programs quickly. Also included on disk are the month's BIX highlights specific to your machine format.

## LISTINGS IN PRINT

This print supplement contains source-code listings described in the issues of BYTE.

## LISTINGS FROM BIX

(BYTE Information Exchange) By joining BIX, you can download BYTE source-code listings at standard BIX rates. See BIX informational ad listed in Reader Service index in this issue.



**FOR DIRECT ORDERING CALL TOLL FREE: 800-258-5485**

**Call: M-F, 8:30 a.m. to 4:30 p.m. Eastern Time**

**(603-924-9281 for New Hampshire residents)**

**For credit card orders only.**

## ON DISK - \* Including the Month's BIX Highlights Specific To Your Machine Format.

Disks of listings from December 1985 to present are available at the prices stated at right. Please mark the appropriate format and note the issue date below. If you are ordering a subscription, please note the issue date on which you would like it to begin.

Month \_\_\_\_\_

Year \_\_\_\_\_

	IN USA:		OUTSIDE USA:	
	Single Month (one disk)	Annual Subscription (13 disks)	Single Month (one disk)	Annual Subscription (13 disks)
<b>5 1/4 inch:</b>	<input type="checkbox"/> \$8.95	<input type="checkbox"/> \$69.95 (Save \$46.40)	<input type="checkbox"/> \$10.95	<input type="checkbox"/> \$89.95 (Save \$52.40)
<input type="checkbox"/> IBM PC*				
<input type="checkbox"/> Apple II				
<input type="checkbox"/> Kaypro 2 CP/M				
<input type="checkbox"/> MS-DOS 8 Sector*				
<input type="checkbox"/> TI Professional				
<b>3 1/2 inch:</b>	<input type="checkbox"/> \$9.95	<input type="checkbox"/> \$79.95 (Save \$49.40)	<input type="checkbox"/> \$11.95	<input type="checkbox"/> \$99.95 (Save \$55.40)
<input type="checkbox"/> Apple Macintosh*				
<input type="checkbox"/> Atari ST*				
<input type="checkbox"/> Amiga*				
<input type="checkbox"/> IBM PS/2*				

## IN PRINT

### 1988 Supplement Issues

- January through March  
\$6.95 in USA \$7.95 outside USA

Monthly supplements replace quarterly supplements starting in April. Indicate the month you're ordering in the space below.

Month \_\_\_\_\_

Year \_\_\_\_\_

\$2.50 per issue in USA  
\$3.50 per issue outside USA

**Annual Subscriptions:**  
\$19.00 in USA  
\$22.00 outside USA

Please note month and year you would like the subscription to begin.

Month \_\_\_\_\_

Year \_\_\_\_\_

### 1987 Supplement Issues

#### IN USA:

- January through March 1987 for only \$6.95.  
 April through June 1987 for only \$6.95. (Includes 1986 index).  
 July through September 1987 for only \$6.95.  
 October through December 1987 for only \$6.95.  
 1987 subscription only \$18.00.

#### OUTSIDE USA:

- January through March 1987 for only \$7.95.  
 April through June 1987 for only \$7.95.  
 July through September 1987 for only \$7.95.  
 October through December 1987 for only \$7.95.  
 1987 subscription only \$21.00.

### 1986 Supplement Issues

#### IN USA:

- January through June 1986 for only \$8.95.  
 July through September 1986 for only \$6.95.  
 October through December 1986 for only \$6.95.  
 1986 Annual Subscription for only \$18.00.

#### OUTSIDE USA:

- January through June for only \$9.95.  
 June through September for only \$7.95.  
 October through December for only \$7.95.  
 1986 Annual Subscription for only \$21.00.

## COMBINED DISK AND PRINT SUBSCRIPTION

Bundled together, giving you the convenience of disk-based source-code plus the ease of reference of print.

If you are ordering a subscription, please note the issue date on which you would like it to begin.

	IN USA: Annual Subscription	OUTSIDE USA: Annual Subscription
<b>5 1/4 inch:</b>	<input type="checkbox"/> \$89.95 (Save \$58.35)	<input type="checkbox"/> \$109.95 (Save \$75.35)
<input type="checkbox"/> IBM PC		
<input type="checkbox"/> Apple II		
<input type="checkbox"/> Kaypro 2 CP/M		
<input type="checkbox"/> MS-DOS 8 Sector		
<input type="checkbox"/> TI Professional		
<b>3 1/2 inch:</b>	<input type="checkbox"/> \$99.95 (Save \$61.35)	<input type="checkbox"/> \$119.95 (Save \$78.35)
<input type="checkbox"/> Apple Macintosh		
<input type="checkbox"/> Atari ST		
<input type="checkbox"/> Amiga		
<input type="checkbox"/> IBM PS/2		

Please complete in full.

AUGUST

Name \_\_\_\_\_

Address \_\_\_\_\_

City \_\_\_\_\_ State \_\_\_\_\_ Zip \_\_\_\_\_

County or Parish \_\_\_\_\_ Country \_\_\_\_\_

Credit Card # \_\_\_\_\_

Exp. Date \_\_\_\_\_ Signature \_\_\_\_\_ Date \_\_\_\_\_

- Check enclosed  
 MasterCard  
 VISA  
 U.S. Funds enclosed (If ordering from outside the U.S. please remit in U.S. funds drawn on a U.S. bank. Thank you.)

Please allow 4-8 weeks for delivery.

**BYTE**

FOLD  
HERE



NO POSTAGE  
NECESSARY  
IF MAILED  
IN THE  
UNITED STATES

**BUSINESS REPLY MAIL**  
FIRST CLASS MAIL PERMIT NO. 10 PETERBOROUGH, NH

POSTAGE WILL BE PAID BY ADDRESSEE

**BYTE Listings**

One Phoenix Mill Lane  
Peterborough, NH 03458-9990



FOLD  
HERE



## Part 2

# THE PITFALLS OF PORTING

Moving from an MS-DOS “glass teletype” into the windowed world of the Macintosh

**T**he IBM PC grew up in a text-oriented world. Its confusing array of video modes and the fact that you have to settle for text or graphics but not both make it seem like graphics on the PC was an afterthought—and programmers are still paying for it. A program on an MS-DOS machine must create its own environment, and that environment may be as simple as a series of commands entered a line at a time, or as complex as mouse-activated windows and pull-down menus.

In contrast, the seamless integration of graphics and text was most important from the Mac’s very inception. . . and programmers are still paying for it.

On the Mac, a program’s environment has largely been predefined. This situation is fine for the Mac user, who can expect a high degree of consistency in the user interfaces of all Macintosh programs. For programmers, it’s a mixed bag: You don’t have to work out the details of how user interface components (such as windows and menus) operate—the Mac designers have done that already. But you do have to deal with starting friction that’s orders of magnitude greater than that found on MS-DOS machines. In other words, the Mac has all these built-in tools, and the programmer has to figure out how they work.

The programmer’s travails are exacerbated when faced with porting an existing MS-DOS application to the Macintosh. You don’t have the luxury of designing the program from scratch with the Mac’s user interface in mind. To

avoid a massive redesign of the entire program (unless you can afford it), you must perform reconstructive surgery and graft Macintosh windows and menus onto your program. Such was the case as Small-C made its journey across the gulf from MS-DOS to the Macintosh.

### On an Even Keel

The two largest problems in taking Small-C to the Macintosh were the 68000 processor and the Finder. Once I had located code for a run-time library, the latter was easy compared to the former (see the text box “Small-C Run-Time Library” on page 250). Dealing with the 68000 meant coping with one feature that I knew would be a pleasure and another I knew would be a problem. Let’s get the problem out of the way first; it’s called alignment.

If the 68000 accesses a word or a doubleword in memory, it *must* do so at an even address. When a program on the Macintosh attempts to grab anything other than a byte from an odd address, you get that infamous system-error bomb box with ID=2 in the corner.

Now, keep that “feature” in mind as you consider that Small-C dynamically reserves space on the stack for a function’s local variables. What happens if you define a function with a mix of int and char variables as local variables? Examine the following code:

```
func1()
{
  int a;
  char b;
  int c;
  ..code...
}
```

Variables a, b, and c are local and require 9 bytes of space on the stack. Their offsets into the local block of storage are 0 for a, 4 for b, and 5 for c. See the speed bump coming up? Since Small-C sets aside only 1 byte for b, c ends up at an odd address. And c is an integer (i.e., a

doubleword). Oops.

The way out of this dilemma requires adding an unused byte here and there to keep local int variables on an even byte alignment. The Small-C compiler’s declloc() routine determines how much stack space a given function’s local variables require. As declloc() scans the list of a function’s local variables, it adds to an accumulating variable (called declared) an amount that depends on the variable’s type (1 byte if char, 4 bytes if int or pointer) and whether or not the variable is an array.

The declloc() routine also has the job of keeping track of each local variable’s offset into the function’s local stack space (so when an expression references a local variable, the compiler knows what code to emit). To correct for alignment, I modified declloc() so that, if it is reserving space for an int variable, it checks the total space that has already been reserved for local variables. If declloc() determines that it has already reserved an odd amount of space (so the int variable would end up at an odd address), it adds 1 byte to the local variable space, correctly aligning the integer.

Actually, the alignment problem gets much more subtle. You cannot set the 68000’s stack pointer—the A7 register—to an odd address; you can only push and pop words and doublewords. Consequently, if a function defined only a char as a local variable, Small-C would emit SUBQ.L #-1, SP to reserve 1 byte on the stack—and blooey. I corrected that by modifying the compiler so that it does not allow a function’s local variables to allot a net odd amount on the stack.

All this means that you can end up with some wasted bytes in a function’s local variable space. How many depends on how int and char definitions are interleaved. Minimizing wasted bytes would involve adding more intelligence to the compiler than I thought necessary.

*continued*

## Small-C Run-Time Library

The amount of effort that you must put into simply displaying a character on a Macintosh is simply staggering. This is thanks to the complexity of the Mac's ROM routines; it is as though you have to crack a software barrier in order to execute the most rudimentary operations, but once you've crossed that threshold, even complex graphic and disk I/O operations become simple.

I knew that if I began working from scratch to create screen I/O routines, file I/O routines, event handlers, a window handler, and so on, porting Small-C would be just a dream (or maybe a nightmare). I therefore invoked that most sacred of all programming dicta, "Don't reinvent the wheel," and went in search of a set of packaged routines. That's when I discovered Steve Wil-

liams's book *Programming the Macintosh in Assembly Language* (Berkeley, CA: Sybex Books, 1985).

This book contains the complete source code listings for the run-time library routines I needed: window handling, text display, disk I/O, and more. (There are functions in Williams's library that Small-C never uses; I kept them in, anyway, in case you wanted to extend the language in some direction that I haven't thought of.) I set about modifying those routines to interface with Small-C, and I had a working run-time library in weeks' less time than I would have if I had started from scratch. In addition to all this, it's a great book, and it's worth the \$24.95 price if you're serious about Macintosh assembly language.

(It would actually mean having the compiler rearrange the order in which char and int variables are stored in the local stack space. Some Macintosh C compilers, having run into the same problem, add this technique of variable rearrangement as an option. It's an option because rearranging variables makes debugging harder: You can't look at the source code and get a clear picture of where variables are stored.)

On the subject of variables, let's talk about initialization. Most C compilers let you initialize a variable at declaration time with instructions like these:

```
int j=4;
int k[3]={0,1,2};
char c='F';
```

These instructions would compile to assembly language that, for the 8088, might look like the following:

```
j DW 4
k DW 0,1,2
c DB 'F'
```

This is fine for the 8088/80286. When the executable file for this program is brought into memory, the proper values for j, k, and c are automatically loaded. Not so for the Macintosh.

When you launch an application on the Mac, the system moves the code into memory and makes data space available to the application in a global data area

(normally set to 32K bytes). Unfortunately, you cannot initialize the contents of this area; you can only reserve space in it. (If you're using the Macintosh Development System [MDS] assembler, you use the DS directive to define storage space in the global data area.)

You can initialize locations in the code space (the memory where the application's executable file resides) using the DC directive. However, you should use the DC directive only for defining constants, so that the code segment stays read-only. (Strictly speaking, you can use DC to define variables, but this gets you into a host of problems, particularly on future processors such as the 68030, where the separation of code and data is strictly enforced.)

What this all boils down to is that BYTE's 68000 Small-C does not let you initialize variables at declaration time. This can get messy if you have, say, a large array to initialize and you're faced with having to create a long string of assignment statements. A good solution is to create a fast assembly language routine that reads from a table and "mass-loads" the array from the table entries.

### The Good Part

The real blessing I was looking forward to in porting Small-C to the Mac was that the 68000 would allow me to break the 64K-byte barrier: 32-bit registers meant 32-bit integers and 32-bit pointers. It's true that there would be a limit of 32K

bytes to global data space, but there was no theoretical limit to data storage local to functions, or storage you could acquire through malloc() and related functions. Besides, 32K bytes is nothing to sniff at for any language called "small."

The jump to 32-bit integers required only that I alter routines in the compiler that dealt directly with the size of integers in the target code. In other words, I had to change those parts of the compiler that handled code like the following:

```
int i,j,k[14];
...
j=k[1*3];
```

For the int declaration code, the 68000 compiler reserved  $4 \times 16 = 64$  bytes: 4 bytes of code per integer, rather than 2 as on the 8088 version. Also, when the compiler encounters the assignment statement and generates code for the index portion (1\*3), it has to add code to multiply the result by the number of bytes per integer so the index into the array is resolved into a true byte offset. The 8088 version of Small-C simply doubled the index (as did the original Small-C); the 68000 version quadruples it.

### Memory Management

Remember the memory map last month? The MS-DOS version of BYTE Small-C handled the memory management functions (alloc() and free()) by simply reserving space in physical memory above the user's program. This scheme was simple and consequently resulted in an obvious restriction on alloc() and free()—namely, that you had to free blocks of memory in reverse order to how they were allocated (see figure 1).

Well, the Macintosh memory manager routines \_NewPtr and \_DisposPtr changed all that. If you're already familiar with these trap routines, you'll see the connection right off: They do exactly what alloc() and free() are supposed to do. Consequently, whereas the MS-DOS version of BYTE Small-C must maintain the run-time library variable \_Umemptr to keep track of free memory, the Macintosh handles everything automatically. And for gravy, the Macintosh routines regularly compact memory, so Macintosh Small-C programs needn't free memory blocks in reverse order.

Let's be careful here. Notice that the memory management routines I'm using allocate *pointer* blocks, not *handle* blocks. As programs make calls to the Mac memory management system, the operating system will, as required, purge

*continued*



## Case History #60302



"With branches in North America, England, Switzerland, Australia, New Zealand, and Hong Kong, we needed a database solution that could run on a world of different PCs, LANs and minicomputers," said Eva Nohra of Drake International, one of the world's most successful personnel service agencies. "We chose DataFlex for all our in-house programming because it gave us this needed capability while providing a standard interface that looks and performs the same on a stand alone PC as it does on a LAN or MicroVAX."

### No programming changes required from system to system.

"DataFlex delivers, by far, more combinations of hardware and operating systems than any of the competition, and DataFlex source code is transportable, without

change, to every supported system. That's very important to Drake International because it gives each office the flexibility to acquire the computer hardware that is best suited to a situation without worrying about re-inventing the wheel and spending a fortune on program development. All we need to do is install the run-time module for the desired system and we're up and running immediately with proven, standardized programming."

### Easy to use for even the least technical operators.

"A major component of our recruitment and placement operations involves mailing lists. DataFlex's capability to quickly generate reports utilizing a wide range of variables is extremely important," explains Nohra. "DataFlex's intuitive 'Point and Shoot' Query technique makes it easy for non-technical operators, even those lacking previous knowledge of programming or query language syntax, to be productive after only minimal training. There are a lot of products which promise the world, but for Drake, DataFlex has really delivered."

Take the first step to more efficient program development today. Return the coupon below for your free DataFlex Demonstration Diskette.

Toll Free Sales Lines:  
Nationwide 1-800-451-FLEX  
In Florida 1-800-331-3960

# "Lots of DBMS/4GL products promise the world... DataFlex delivered it for Drake International."

*Eva Nohra, Drake International, Toronto, Ontario*

# DATA FLEX<sup>®</sup>

**Data Access Corporation**  
14000 S.W. 119th Avenue  
Miami, Florida 33186  
(305) 238-0012  
TELEX: 469021 Data Access CI  
FAX: (305) 238-0017

For more information, call from your modem 1-800-444-8080 (300-1200 baud, 8 bit, no parity 1 stop bit) and enter the access code FLEX3 when prompted.

Circle 68 on Reader Service Card

### FREE SELF-RUNNING DATAFLEX DEMO (PC-DOS/MS-DOS ONLY) BYTE 8/188

Find out more about DataFlex's ease of use and programming power. Mail this coupon today for your free self-running demonstration diskettes.

Name \_\_\_\_\_  
Company \_\_\_\_\_  
Address \_\_\_\_\_  
City \_\_\_\_\_ State \_\_\_\_\_ Zip \_\_\_\_\_  
Phone ( \_\_\_\_\_ ) \_\_\_\_\_

How many computer systems are in use at your company? \_\_\_\_\_  
Do you use a Local Area Network or Multi-User computer? \_\_\_\_\_

Data Access Corporation, 14000 S.W. 119 Avenue, Miami, Florida 33186

unused blocks and move relocatable blocks to create large contiguous free space (a process referred to as "defragmentation"). Blocks accessed via handles are relocatable unless you specifically tell the operating system otherwise (by "locking a memory block"). Since the handle is a double-indirected pointer, the block can be moved and the second pointer modified without affecting the

handle. However, blocks accessed via pointers are nonrelocatable, because moving the block would require modifying the pointer.

Since BYTE Small-C's `alloc()` function reserves nonrelocatable blocks only, it is conceivable that a BYTE Small-C program that makes repeated calls to `alloc()` and `free()` might deplete memory by fragmenting it so badly

that the operating system can't create a usable free block (see figure 2). In spite of this restriction (and for most programs you can ignore it), the Macintosh version's memory management routines are far better than the MS-DOS version's.

### Life with the Finder

There's a fundamental difficulty in crowbarring a language originally developed on the "glass teletypes" into the windowed world of the Macintosh. In my port, the difficulty appeared cloaked in the guise of the system variables `argc` and `argv[]`. C programmers will recognize `argc` as the system variable that indicates the number of arguments on the command line; `argv[]` is an array of pointers to each of the argument strings.

But wait: This is on the Macintosh. You don't execute programs, you launch them by double-clicking on an icon. There is no command line. What, then, do you do with `argc` and `argv[]`?

Macintosh C compilers use various ways to skirt the problem of the command-line arguments. For example, Lightspeed C simply does not support them; Aztec C provides a shell program that creates a Unix-flavored line-oriented environment. I took a hybrid route. When you launch a BYTE Small-C program, it opens a window and prompts with `Command line:`. Whatever you type in response to this prompt is passed on to `argc` and `argv[]`.

I realize that, although this approach makes porting programs from MS-DOS Small-C to the Mac easier, the technique is slightly inelegant. However, the source code for the compiler is available in *Programming the Macintosh in Assembly Language* (see the text box on page 250). If you don't like the way I've handled command-line arguments, you're welcome to alter the compiler appropriately.

### Exit(0)

Throughout the porting of Small-C to the Mac, I asked myself over and over what compromises I was willing to live with. I'm sure that, for a commercial product, these questions translate to the determination of trade-offs between deadlines and lost features. The silver linings are whatever additional goodies a new architecture lets you attach to your program. ■

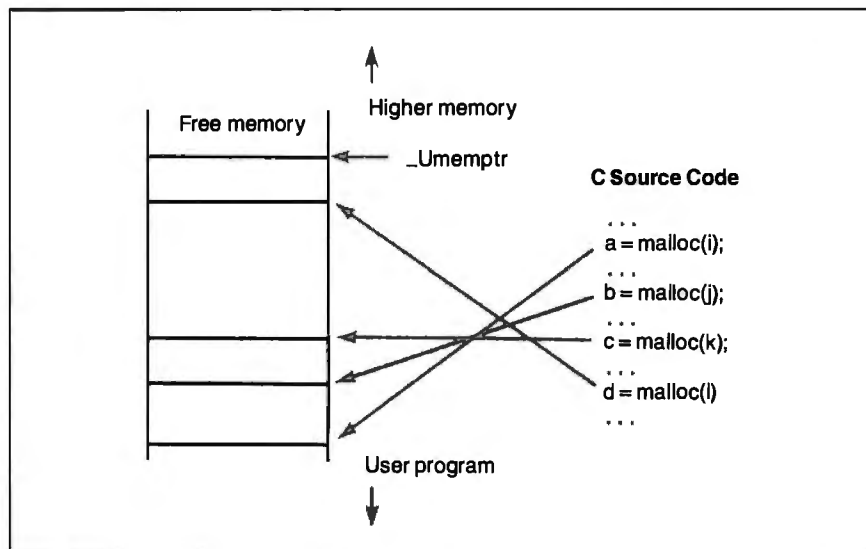

**Figure 1:** The 8088 version of BYTE Small-C handles memory allocation as an upward-growing stack tracked by the global variable `_Umemptr`. Memory blocks (left) allocated by the source code (right) must be freed (using the `free()` function) in the reverse order to how they were allocated (i.e., the block that `d` points to must be released before the block that `c` points to). BYTE's Small-C for the Mac removes this restriction.

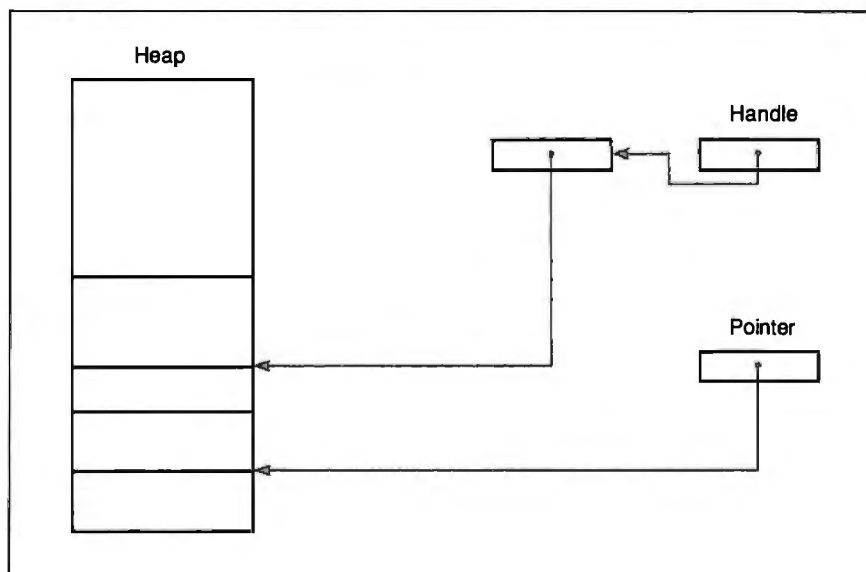

**Figure 2:** On the Mac, a pointer is a 32-bit entity that holds the address of a block of memory. A handle is a pointer to a pointer to a block. Notice that the system can relocate the upper block without altering the contents of the handle; not so with the lower block.

*Rick Grehan is a BYTE senior technical editor at large. He has a BS in physics and applied mathematics and an MS in computer science/mathematics from Memphis State University. He can be reached on BIX as "rick.g."*

# PUT 420,000 MICRO MENTORS TO WORK.

Advertise in the new BYTE magazine and let the people other people come to for advice help spread your message. We have a total of 420,000 paid readers who are powerful because they're knowledgeable. Each one is a leader in personal computer decision-making at his company. And each one believes that ads in BYTE are a valuable source of information.

- **93%** provide advice about *acquiring* micros, peripherals and software, an average of 25 times a month.
- **85%** are directly involved in purchasing decisions about microcomputers and related equipment for their company.
- **96%** work for a company that currently owns or uses microcomputers.
- **75%** of these companies plan to buy an average of 145 microcomputers in the next 12 months.

In short, when it comes to making a purchase decision, people listen to BYTE readers. So if you're not planning on advertising in BYTE, you may be planning an advertising schedule without teeth.

**THE  
NEW  
BYTE**

# THE BUYER'S MART

## A Directory of Products and Services

THE BUYER'S MART is a monthly advertising section which enables readers to easily locate suppliers by product category. As a unique feature, each BUYER'S MART ad includes a Reader Service number to assist interested readers in requesting information from participating advertisers.

**RATES:** 1x—\$475 3x—\$450 6x—\$425 12x—\$375  
Prepayment must accompany each insertion. VISA/MC Accepted.

**AD FORMAT:** Each ad will be designed and typeset by BYTE. Advertisers must

furnish typewritten copy. Ads can include headline (23 characters maximum), descriptive text (250 characters is recommended, but up to 350 characters can be accommodated), plus company name, address and telephone number. Do not send logos or camera-ready artwork.

**DEADLINE:** Ad copy is due approximately 2 months prior to issue date. For example: October issue closes on August 11. Send your copy and payment to THE BUYER'S MART, BYTE Magazine, 1 Phoenix Mill Lane, Peterborough, NH 03458. For more information call Mark Stone at BYTE 603-924-3754.

### ACCESSORIES

#### FREE CATALOG

Thousands of parts and new surplus electronic parts at super low prices. FAST ORDER PROCESSING AND SHIPPING (95% of all orders shipped within 48 hours).

CALL OR WRITE FOR A FREE CATALOG...

#### ALL ELECTRONICS CORPORATION

P.O. Box 567, Van Nuys, CA 91408-0567

1-800-826-5432

Inquiry 576.

### ACCESSORIES

#### SMART PRINTER STAND

##### UNDERSTAND

is an attractive printer stand with switchable data conversion, surge suppression & power switch. Saves space & avoids clutter!

##### UNDERSTAND-PP:

\$295 (2 parallel in, 1 parallel out)

##### UNDERSTAND-PS:

\$395 (1 parallel & 1 serial in, 1 parallel out)

##### MAS Inc.

15941 S. Harlem Ave., Suite 333, Tinley Park, IL 60477  
(815) 469-4501

Inquiry 581.

### ARTIFICIAL INTELLIGENCE

#### muLISP™ 87 for MS-DOS

Fast, compact, efficient LISP programming environment. muLISP programs run 2 to 3 times faster & take 1/2 to 1/3 the space of other LISPs. 450 Common LISP functions, multi-window editing & debugging, flavors, graphics primitives, lessons & help, demo programs, comprehensive manual.

#### Soft Warehouse, Inc.

3615 Harding Ave., Suite 505, Honolulu, HI 96816  
(808) 734-5801

Inquiry 585.

### ARTIFICIAL INTELLIGENCE

#### FREE AI DEMO DISK

Our eye-opening 20 page catalog features Expert System Shells & Toolkits plus over fifty other AI Programs. Please send large SASE with one dollar postage for your free demo and catalog so we can keep disk prices low. Expert System Six Pack—six Expert System Shareware Shells with sample rulebases and full documentation just \$59.95.

#### THINKING SOFTWARE, INC.

46-16 Sixty-fifth Place, Woodside, NY 11377

Inquiry 577.

### BAR CODES

#### BAR CODES & BIG TEXT

On EPSON, IBM, OKI dot matrix or LaserJet. Design any formatize on ONE easy screen. 1-120 fields/label. 13 text sizes to 1" — readable at 50 ft. AIAG, MIL-STD, 2 of 5, 128, UPC/EAN, Code 39, etc. Color, Reverses, File Input, FAST—\$279. Other menu-driven bar code programs from \$49. 30 day \$ back.

#### Worthington Data Solutions

417-A Ingalls St., Santa Cruz, CA 95060  
(800) 345-4220 In CA: (408) 458-9938

#### HOW TO PROTECT YOUR COMPUTER and make it last longer.

Call (800) 356-5794 Ext 1002 for a FREE catalog from the world's largest manufacturer of uninterruptible power systems.

Call or write today!

#### BEST POWER TECHNOLOGY, INC.

P.O. Box 280, Neosho, WI 54646  
In Wis. (608) 565-7200 Ext. 1002  
(800) 356-5794 Ext. 1002

Inquiry 577.

#### CUT RIBBON COSTS!

Re-ink your printer ribbons quickly and easily. Do all cartridge ribbons with just one inker! For crisp, black professional print since 1982. You can choose from 3 models:  
Manual E-Zee Inker — \$39.50  
Electric E-Zee Inker — \$89.50  
Ink Master (Electric) — \$159.00

1000's of satisfied users in 5 years. Money back guarantee.

#### BORG INDUSTRIES

525 MAIN ST., JANESVILLE, IA 50647

1-800-553-2404 In IOWA 319-987-2976

Inquiry 578.

#### HIGH PERFORMANCE RULES BASED EXPERT SYSTEM "SHELL" (H.E.S.)

Caters for thousands and thousands of rules, integrate with your existing database. Easy to use, no knowledge of programming required. Applications: medical diagnosis, fault diagnostics, business, admin, banking, finance, insurance, law, engineering, available on PC/XT/AT, MS-DOS, Xenix, Unix. Demo copy \$84 (with facility to create 300 rules). Full version \$21,000.

#### HORIZON SOFTWARE LTD.

27 East St., Leicester LE1 6NB, UK.

Tel (44) 533 556550

Inquiry 582.

### BAR CODE READERS

From the manufacturer for PC/XT/AT, & PS/2. Attaches as 2nd keyboard, reads as keyed data. External or bus install. With steel wand—\$399. Also Kimtron, Link, Wyse, & RS-232. Portables, Lasers, slot badge readers, and MagStripe too!

30 day \$ back.

#### Worthington Data Solutions

417-A Ingalls St., Santa Cruz, CA 95060  
(800) 345-4220 In CA: (408) 458-9938

#### SELF-INKING PRINTER RIBBON

Awarded United States Patent #4701062

Lasts 10-15 times longer than the conventional ribbon  
For printers using 1/4" width open spool ribbon:

Okidata-82A-83A-84-92-93 Dec LA 180/120  
Teletype-33, 35 Dec LA 301/EM 1443  
Star Gemini 10x Teletype-Model 40  
Extal TI 800/810, 820, 880

Contact us by mail, phone or telex and we will forward you a brochure.

#### CONTROLLED PRINTOUT DEVICES, INC.

POB 869, Baldwin Rd., Arden, NC 28704

(704) 684-9044 • TELEX: (FILMON-AREN) 577454

Inquiry 579.

#### Eliza in 'C'

Originally developed at MIT, Eliza is perhaps the first artificial intelligence Program. Now available with full 'C' source code. MS/DOS diskette \$79.95, or 9 track 1600 tape \$179.95. MC, Visa, or COD.

(206) 391-3725

#### LAN Comp Systems

14524 Issaquah-Hobart Rd., Issaquah, WA 98027

Inquiry 583.

#### PRINT BAR CODES/BIG TEXT FROM YOUR PROGRAM

Add bar codes and big graphics text to your program. Print from ANY MS-DOS language. Bar codes: UPC, EAN, 2 of 5, MSI, Code 39. Epson, OKI, IBM dot matrix text up to 1/2". LaserJet up to 2". Font cartridges not required. \$159—\$239. 30 day \$\$ back.

#### Worthington Data Solutions

417-A Ingalls St., Santa Cruz, CA 95060  
(800) 345-4220 In CA: (408) 458-9938

#### FREE SAMPLE LETTERHEAD

Now you can have personalized continuous-form letterheads in small quantities at low cost. Send us your name, address, phone number and printer make and model number and we'll send you your personalized samples.

#### FORMSMART, INC.

P.O. Box 592, E. Freetown, MA 02717

Inquiry 580.

#### NanoLISP \$99.99

An MS-DOS Common LISP interpreter that supports most Common LISP operations and strictly adheres to the standard. Numerous advanced and extra features, excellent debugging facilities, sample AI programs, fully-indexed manual, free technical support.

#### Microcomputer Systems Consultants

Box 6646, Santa Barbara, CA 93160

(805) 963-3412

Inquiry 584.

#### BAR CODE MADE EASY

PERCON® E.Z.READER™ keyboard interfaces and multiuser RS-232 models make it easy to add bar code to virtually any computer/terminal WITHOUT SOFTWARE MODIFICATION. Immediate shipping. Two year warranty. Bar code printing software available. Call for details on fast, accurate, easy data entry. Substantial reseller discounts.

#### PERCON®

2190 W. 11th St., Eugene, OR 97402

(503) 344-1189

Inquiry 586.

# THE BUYER'S MART

## BAR CODE

### READ & PRINT BAR CODES

Fast, reliable data entry into your programs as if from your keyboard. Internal unit for PC, XT, AT PS/2-M30, RS-232 unit for DOS & Non-DOS systems (incl. all PS/2). Stainless steel wand and LASER interfaces. Powerful Bar Code and Text printing software.

**Seagull Scientific Systems**  
601 University Ave., Suite 150, Sacramento, CA 95825  
(916) 386-1776

### BAR CODE READERS

Among the industries best and most widely used barcode reader, reads all major barcode formats (code 39, 2 of 5, UPC/EAN, codabar), connects between keyboard & system, advanced CMOS uses keyboard power supply, connects to all IBM compatibles and DIN terminals, completely OS independent, software independent. Same day ship, 1 year warranty, 30 day satisfaction guarantee. CALL for prices too low to advertise.

**Solutions Engineering Sales**  
8653 Georgia Ave., Silver Spring, MD 20910  
**800-635-6533**

Inquiry 587.

### DATA INPUT DEVICES

Bar Code & Magnetic Stripe Readers for microcomputers & terminals, including IBM PS/2 & others, DEC, AT&T, CT, Wyse, Wang. All readers connect on the keyboard cable & are transparent to all software. Low cost bar code print programs & magnetic encoders are also available. GSA contract #G500K87AGS5346.

**TPS Electronics**  
4047 Transport, Palo Alto, CA 94303  
**415-856-6833 Telex 371-9097 TPS PLA**

Inquiry 588.

### BAR CODE SCANNER/READER

For PC/XT/AT and compatibles, and APPLE II. Keyboard emulating model with wand for only \$249. Reads 2 of 5, UPC/EAN/JAN/UPC E, Code 39, CODABAR with 1 yr. warranty.

Also RS-232C and CENTRONICS models with choice of wands, hand-held, and auto scanners.  
Call or write for free catalog.

**TRADE MATRIX of Silicon Valley**  
3639 Sattinwood Dr., San Jose, CA 95148  
**(800) 222-4229 Ext. 39, (408) 238-1784**

Inquiry 589.

## CAD/CAM

### New! CADKEY3 Version 3.02

CADKEY CADExpert . . . . . On-line Tutorial  
New! CADKEY 1 . . . CADKEY 3 on a Budget  
New! CADKEY Solid Synthesis Real Power!

We also carry the new CADJET Master Templates and other fine support products for CADKEY.

**HLB Technology**  
PO Box 527, Blue Ridge, VA 24064  
**703-977-6520 MC/VISA**

Inquiry 590.

### ISN'T IT TIME THAT YOU DID SOMETHING NEW WITH YOUR CAD SOFTWARE?

Etch your CAD design in wood, plastic, glass, etc. Cut your CAD drawings out of wood, plastic, vinyl, rubber, etc. Introducing the Kern Electronics CAD/CAM controller. We specialize in making your idea become a reality.

**Kern Electronics**  
812 King Ave. SW., Wadena, MN 56482  
218-631-2641

Inquiry 591.

## CASE

### Affordable CASE

A new concept in Computer Aided Engineering for developing PC/DOS applications! C Dispatcher generates fast, efficient C code for command and menu driven applications. Develop, document, and change easily. Many features. For many compilers. \$295.00 MC/Visa

#### Amaryllis Inc.

563 Wataquodoc Rd., Bolton, MA 01740  
(617) 365-5456

Inquiry 592.

### FINITE STATE COMPILERS

A Case program that develops complex software programs in minutes instead of hours! The COMPEDITOR forms source Finite State programs in: ADA, BASIC, C, FORTRAN and PASCAL.

IBM PC, XT, AT, PS/2 175K RAM Dos 2.0+  
Price: \$175.00 per compiler (With Primer) Sampler \$30  
**AYECO** 5025 Nassau Circle, Orlando  
INCORPORATED FL 32808 1-800-537-4753

Inquiry 593.

## CD-ROM

### Public Data on CD-ROMs

- Econ/Stats I—Indices & other economic data
- Conso/Stats—BLS/Census consumer studies 1973 & 1984
- Agri/Stats—Agricultural series
- Makes tables, DIF, or ASCII
- \$49 each, req. MS-DOS
- CD-ROM publishing services available

**Hopkins Technology**  
421 Hazel La., Hopkins, MN 55343  
(612) 931-9376 Compuserve 74017,614

Inquiry 594.

## COMMUNICATIONS

### MULTI-LINE PC-DOS BBS

The Bread Board System (TBBS). Secure, reliable, full-feature commercial information system for IBM XT/AT/386/PS2 or compatible. Menu editor allows customization by non-programmers. Kermit, X & Y-Modem. High performance allows up to 32 simultaneous callers. User audit trail.  
300/1200/2400/9600 bps.

#### eSoft, Inc.

15200 E. Girard Ave. #2550, Aurora, CO 80014  
(303) 689-6565

Inquiry 595.

### FAX MACHINES \$395

MURATA FAX 1200/1600 . . . . . \$795/925  
SHARP FAX FO300/FO500 . . . . . \$1195/1495  
TOSHIBA FAX 30100/3300/3700 . . . . . \$1088/1240/CALL  
RICOH 1020 . . . . . \$1295/1595  
CANON FAX 20 . . . . . \$1279  
PC/XT SYS.Receiver/Transmit FAX+Scanner . . . . . \$1595  
PC/XT Telephone Answer & Voicemail . . . . . \$1195  
Prepay prices Visa/MC 2% cod 2% restock 20%

**TELEPHONE PRODUCTS CENTER**  
23591 #213 El Toro Rd., El Toro, CA 92630 714/739-9555

Inquiry 596.

### INSURES YOUR COMPUTER

SAFEWARE provides full replacement of hardware, media and purchased software. As little as \$39 a year provides comprehensive coverage. Blanket coverage; no list of equipment needed. One call does it all. Call 8 am-10 pm ET. (Sat. 9 to 5)

**TOLL FREE 1-800-848-3469**  
(Local 614-282-0559)

**SAFEWARE, The Insurance Agency Inc.**

Inquiry 597.

## COMPUTER RENTALS

### RENTALS

WEEKLY MONTHLY YEARLY

#### IBM - APPLE

**\$189** PER MO.  
Full Stock for Immediate Delivery  
Free Service & Maintenance

IBM PS/2 Model 50 800 PC-RENTL

Inquiry 598.

## CROSS ASSEMBLERS

### CROSS ASSEMBLERS

Universal Linker, Librarian  
Targets for 36 Microprocessors  
Hosts: PC/MS DOS, micro VAX, VAX 800  
Developed and supported at:

**ENERTEC, INC.**  
BOX 1312, Lansdale, PA 19446  
**215-362-0966 MC/VISA**

Inquiry 599.

### CROSS ASSEMBLERS

Macros, PC Compatible, Relocatable, Conditionals, Fast, Reliable . . . . . from \$150  
also: Disassemblers  
EPROM Programmer Board

**MICROCOMPUTER TOOLS CO.**  
Phone (800) 443-0779  
In CA (415) 825-4200  
912 Hastings Dr., Concord, CA 94518

Inquiry 600.

### Professional Series

PseudoCode releases its PseudoPam Professional Series of cross assemblers. All popular processors. Macros, Conditional Assembly, and Include Files. Virtually unlimited size. For IBM PC's, MS-DOS 2.0 or greater. With manual for \$35.00. Each additional \$20.00. (MI res. 4% tax). Visa/MC. (Dealer Inquiries Welcome.)  
Order from distributor:

**Micro Kit**  
6910 Patterson, Caledonia, MI 49316, 616-791-9333.

Inquiry 601.

### 680X0 Cross Assemblers

Now, inexpensive quality 680X0 Cross Assemblers that use your IBM PC or compatible. All versions include extensive listing facilities, up to 32 char labels, sorted symbol tables, INCLUDE files, PATH names, ORG, DC, DS, EQU, many other directives (except MACROS), printed manuals. Basic versions create S-records. Linking versions create either S-records or relocatable modules, and include a linker which creates S-records or binary output files. Not copy protected. Minimum requirements are 320K, DOS 2.0X, & 1-1/2" 5.25DD.  
Basic 68000/68010—\$49.95 Linking 68000/68010—\$89.95  
Basic 68020/68801—\$149.95

Checks, VISA, MC accepted. MN residents + 6% sales tax. No PO's or COD's, please.

**RAVEN Computer Systems**  
Box 12116, St. Paul, MN 55112 (612) 636-0365

Inquiry 602.

### ASSEMBLERS & TRANSLATORS

Over 20 high quality, full function, fast relocatable and absolute macro assemblers are available immediately. Source language translators help you change microcomputers. Hosts: MS/DOS, CP/M80, ISIS.

**RELMS™**  
PO. Box 6719, San Jose, CA 95150  
(408) 356-1210  
MC/VISA TWX 910-379-0014 AMEX

Inquiry 603.

# THE BUYER'S MART

## CROSS ASSEMBLERS

### Z80/HD64180

SLR Systems crossassemblers run on PC and are compatible with Microsoft M80/L80. \$195.00 for assembler and linker. We have CP/M emulator cards for PC. Up to 12.5 mhz Z80 clock speed, starting at \$249.95! Also Z80/HD64180 C compilers.

### Z-World

1772 Picasso Ave., Davis, CA 95616 (916) 753-3722  
Please see our ads on page 273.

Inquiry 604.

## DATA CONVERSION

### MEDIA CONVERSION/DATA TRANSLATION

More than just a straight dump or ASCII transfer!  
Word Processing, DBMS, and Spreadsheet data on Disks or Tapes transferred directly into applications running on Mainframes, Minis, Micros, Dedicated Word Processors, Typesetters, and Electronic Publishing systems.  
IBM PS/2 & Macintosh supported  
#1 in the translation industry!

### CompuData Translators, Inc.

3325 Wishore Blvd., Suite 1202, Los Angeles, CA 90010  
(213) 387-4477 1-800-825-8251

Inquiry 605.

## DATABASE MGMT. SYSTEMS

### SOFTWARE KIT PACKAGING

OEM supplier to one of the world's largest computer companies offers quality packaging and supplies for your software products. From diskettes to printed manuals. Quality products reflecting your company's image is our highest priority. Call or write.

### COMPUTER LOGICS LIMITED

4845 Transit Road Unit K-8, Depew, NY 14043  
(716) 633-2810 Fax (716) 633-2813

Inquiry 606.

### dBASE III WORKALIKE \$39

1 on 1 = 3!! "a programmable relational DBMS... the menu mode is a fancier and more complete version of dBASE's... faster operation in the interactive mode... dBASE III is a trademark of Ashton-Tate... at \$39, 1 on 1 = 3!! is a great deal for those who would be glad to have a dBASE III Plus clone" PC MAGAZINE 5/17/88. \$39 + \$4 s/h AMEX add \$2.00

### 1 on 1 Computer Solutions

26 Finchwood Dr., Trumbull, CT 06611  
203-375-0914

Inquiry 607.

### QUALITY CONVERSIONS

• Disk • Scanning • Tape

\*TYPEWRITTEN \$.33 per page to ASCII

\*TYPESET 6-24 point Low Rates

(\*WP Formats available)

IMAGES

Logos/Line Art/Glossies

### 1st Run Computer Services Inc.

1261 Broadway, Suite 508, New York, NY 10001

(212) 778-0800

Inquiry 608.

### Get the Expertise You Need!

Disk/Disk • Tape/Disk • OCR

Over 1,000 formats! 3 1/2", 5 1/4", or 8 inch disks; 9 track mag tape; 10 MB Bernoulli cartridge. Data base and word processor translation. Specialists in Government Security Data. Call for free consultation.

### Computer Conversions, Inc.

9580 Black Mtn. Rd., Ste J, San Diego, CA 92126

(619) 693-1697

Inquiry 609.

256 B Y T E • AUGUST 1988

## DATA/DISK CONVERSION

### DISK CONVERSIONS

Media transfer to or from: IBM, Xerox, DEC, Wang, Lanier, CPT, Micom, NBI, CT, also WP, WS, MS/WRD, DW3, MM, Sanna, DEC DX, MAS 11, Xerox-Writer, ASCII.

### FREE TEST CONVERSION

### CONVERSION SPECIALISTS

531 Main St., Ste. 835, El Segundo, CA 90245  
(213) 545-6551 (213) 322-6319

Inquiry 610

### DISK & TAPE CONVERSIONS

### AUTOMATICALLY

### SAVE TIME AND MONEY

Over 1000 formats from Mini, Micro Mainframe, Word Processors, & Typesetters.

TAPE Conversions as low as \$23.00 MB

DISK Conversions as low as \$15.00 per Disk

Call or write TODAY for a cost saving quotation.

### CREATIVE DATA SERVICES

1210 W. Latimer Ave., Campbell, CA 95008

(408) 866-6080

Inquiry 611.

### DISK INTERCHANGE

### SERVICE COMPANY

DISC specializes in transferring files between incompatible disk formats, and between disk and 9-track tape.

- Dedicated Word Processors
- Mini, Micro & Mainframe Computers
- 9-Track Tape (800, 1600 and 6250 BPI)
- MSDOS, CP/M, UNIX, DOS, PRODOS, TSX+, RT-11

2 Park Drive • Westford, MA 01886

(617) 692-0050

Inquiry 612.

### HEWLETT PACKARD

### TO MACINTOSH

Translate programs written in Hewlett Packard BASIC to run on the Macintosh. Copy files from HP Technical computers to Macintosh. Custom work quoted. Write:

### Indy Conversions

5525 N. Broadway St., Indianapolis, IN 46220

Inquiry 613.

### CONVERSION SERVICES

Convert any 9 track magnetic tape to or from over 1000 formats including 3 1/2", 5 1/4", 8" disk formats & word processors. Disk to disk conversions also available. Call for more info. Introducing OCR Scanning Services.

### Pivar Computing Services, Inc.

165 Arlington Hgts. Rd., Dept. #B

Buffalo Grove, IL 60089 (312) 459-6010

Inquiry 614.

### FREE dBASE III +

### COMPILER DEMO DISK

Don't buy Clipper™ until you see our FREE dBASE Compiler Evaluation Kit. Includes DEMO DISK with 8 PRG's and results of compiling with Clipper, Quicksilver & Fox-BASE+. Also 15 benchmark tests, complete magazine reviews, and detailed brochures about all 3 compilers. FREE. No obligation. Call 24 hours, 7 days.

dataBASE Specialties (415) 652-2790

P.O. Box 2975, Oakland, CA 94618

Inquiry 615.

## DEMOS/TUTORIALS

### INSTANT REPLAY III

Build Demos, Tutorials, Prototypes, Presentations. Music. Timed Keyboard Macros, and Menu Systems. Includes Screen Maker, Keystroke/Time Editor, Program Memorizer, and Animator. Rec'd *Great Reviews!* Simply the BEST. Not copy protected. No royalties. 60 day satisfaction money back guar. IBM and Compatib. \$149.95 U.S.Chk/Cr. Crd. Demo Diskette \$5.00

### NOSTRADAMUS, INC.

3191 South Valley Street (ste 252)  
Salt Lake City, Utah 84109 (801) 487-9662

Inquiry 615.

## DISK COMPATIBILITY

### IBM PC's USE Mac DISKS

MatchMaker lets you plug any Macintosh external floppy drive into an IBM PC. Half size card and software lets you copy to/from, view directory, initialize, or delete files on the Mac diskette. Works with PCs, XT's, AT's, and compatibles. *The easy way to move information!*

\$149.00 Visa/MC/COD/Chk.

### Micro Solutions Computer Products

132 W. Lincoln Hwy., DeKalb, IL 60115 815/756-3411

Inquiry 616.

## DISK DUPLICATION

DUPLICATION IS THE SINCEREST FORM OF FLATTERY

Let us Flatter you!!! See us for all disk duplication needs. 10 disks to 100,000 and more All formats—All systems. Best prices—Our own in-house printing of documentation—labels-sleeves.

### SYSTEMS SUPPORT DATA

223 North Royal Avenue, Front Royal, VA 22630  
1-800-231-4355

Inquiry 617.

## DISK DUPE EQUIPMENT

### DO YOUR OWN DUPLICATION

Copy 10,000 or only 10 . . . . . in as little as 15 seconds each with famous Mountain Duplication equipment at the very best prices!! See us for all of your duplication equipment needs from Disks to Drives to Duplicators.

### SYSTEMS SUPPORT DATA

223 North Royal Avenue, Front Royal, VA 22630  
1-800-231-4355

Inquiry 618.

### PS/2 DRIVES FOR PC's AT's

CompatKit/PC . . . . . \$329

CompatKit/AT . . . . . \$309

Built-in floppy controllers—no problem.

Supports multiple drives and formats. Lets your computer use IBM PS/2 1.4M diskettes *plus more!*

Call for further information or to place an order.

VISA/MC/COD/CHECK.

### Micro Solutions Computer Products

132 W. Lincoln Hwy., DeKalb, IL 60115 815/756-3411

Inquiry 619.

### CHEAP DISKS!!!

Although this headline may not convey quality. . . . . our 3 1/2" floppy disks do!

100% Certified

72pk only 98¢

1.44 MEG only \$2.60

### SYSTEMS SUPPORT DATA

223 North Royal Avenue, Front Royal, VA 22630

1-800-231-4355

Inquiry 620.

# THE BUYER'S MART

## DUPLICATION SERVICES

### SOFTWARE DUPLICATION

- One Stop Shopping • Technical Support
- Custom Packaging • Drop Shipping
- Copy Protection • Fast Turnaround
- Competitive Pricing

**SATISFACTION GUARANTEED**  
800-222-0490 NJ 201-462-7628

**MEGAsoft**

P.O. Box 710, Freshold, NJ 07726

See our ads on page 271.

Inquiry 621.

## SOFTWARE PRODUCTION

- Disk duplication
- All formats
- EVERLOCK copy protection
- Label/sleeve printing
- Full packaging services
- Warehousing
- Drop shipping
- Fulfillment
- 48-hour delivery
- Consultation & guidance

**Star-Byte, Inc.**

713 W. Main St., Lansdale, PA 19446

215-368-1200

800-243-1515

Inquiry 622.

## ELECTRONIC PROJECTS

### BUILD TALKING ROBOT!

- Build B.E.R.T.® the Basic Educational Robot Trainer
- Featured in BYTE April & May / 87
- Even a child can program this talking Robot, built from off-the-shelf components
- Minimum Kit \$43.00 U.S.
- Complete Kit \$165.00 U.S.
- For further information write to:

**GoCo Dist.**

Suite 806, 1146 Harwood St.  
Vancouver, B.C. Canada V6E 3V1

Inquiry 623.

### NEMESIS™ Go Master™

Go is a popular Oriental game of intellectual complexity and elegance. NEMESIS, recognized worldwide as the best Go program, is an ideal playmate and tutor. Pournelle's game of the month twice. "If you are interested in Go, buy this program." BYTE 7/87

**Toyogo, Inc.**

100 Fifth Ave., Dept. Y, Waltham, MA 02154  
(617) 890-4184

Inquiry 624.

### FLOW CHARTING II+ HELPS YOU!

Precise flowcharting is fast and simple with Flow Charting II+. Draw, edit and print perfect charts: bold and normal fonts, 26 shapes — 95 sizes; fast entry of arrows, bypasses & connectors; Fast Insert Line; shrink screen displays 200-column chart; 40 column edit screen for detail work, much more!

**PATTON & PATTON**

81 Great Oaks Blvd., San Jose, CA 95119

1-800-525-0082 (Outside CA)

408-629-5376 (CA/Int'l)

Inquiry 625.

### STRUCTURED FLOW CHART

NSChart creates Nassi-Shneiderman (structured) flowcharts from a simple PDL. Keywords define structures & text strings appear in the chart. Easy to create, even easier to revise! Automatic chart sizing, text centering. Translators from many languages available. For Mac and IBM PC.

**SILTRONIX, INC.**

P.O. Box 82544, San Diego, CA 92138

1-800-637-4888

Inquiry 626.

## HARDWARE

### IBM PS/2's Up to 41% off!

	Retail	Your Cost
MODEL 50-386	(New)	\$Call
MODEL 60-041	5,295	3,395
MODEL 60-071	6,295	3,850
MODEL 80-041	6,995	4,395
MODEL 80-071	8,495	4,995
MODEL 80-111	10,995	7,895
MODEL 80-311	13,995	9,995

American Micro Computer Center (305) 985-9406  
2890 Griffin Rd., Suite #4, Ft. Lauderdale, FL 33312

Inquiry 627.

### MYRIAD MODEM

**2400BPS ONLY \$119**

- Hayes compatible
- For IBM PC/XT/AT & compatibles
- Made in USA
- Free Bitcom software
- 4 Com ports selectable
- 2 years warranty

**DATA ERA STORE (408) 729-4589**

1556 Halford Ave., No. 168, Santa Clara, CA 95051

Inquiry 628.

### 8096 Microcontroller

Single Board 8096/77, Ser. Interface, 5V only; Assembler+Forth in EPROM+Manual/Software Guide \$400. Add-on EPROM Simulator incl. download S/W \$350. Hardware/Software evaluation package incl. cabling and tutorial books \$580. Cross Compiler (Assembler/Forth) available.

**DIGITAL MICRO CONTROL**

15617-25th Drive S.E., Mill Creek, WA 98012  
(206) 338-2406

Inquiry 629.

### CHIP CHECKER

- 74/54 TTL + CMOS
  - 14/4000 CMOS
  - 14-24 Pin Chips
  - 8000 Nat. + Signetics
  - 9000 TTL
  - .3" + .6" IC widths
- Tests/Identifies over 650 digital chips with ANY type of output in seconds. Also tests popular RAM chips. IBM compatible version \$259. C128 + C64 version \$159.

**DUNE SYSTEMS**

2603 Willa Dr., St. Joseph, MI 49085

(616) 983-2352

Inquiry 630.

### INDUSTRIAL STRENGTH SINGLE BOARD COMPUTER

Has optimum features for monitor + control applications: 16 Chan A/D • 4 RS232/422 Ports • 48 Prog I/O Lines • 8 Opto I/Os • 8 HiDrive O/U's • 4 Timers • Watchdog • 104K Memory • 5.25 x 8.0 Options: Resident FORTH OS with Target Compiler, Editor, Assembler, + Auto Load/Start; 5 MHz 8085 • 4 Chan D/A • Battery Backed Clock/DRAM • Networking • PC Support.  
E-PAC 1000 + \$249.00 E-PAC 2000 + \$449.00

**EMAC INC.**

P.O. Box 2042, Carbondale IL 62902 (618) 529-4525

Inquiry 631.

### 87C51 PROG. \$125.00

The UPA 87C51 Programming Adapter lets you use your general purpose programmer to program the 87C51, 8751H, AMD8753H, 87C252, and 8752BH. Also lets you program the 87C51/8751H security bits and the 87C51 encryption array. It's very simple and VERY cost effective.

**LOGICAL SYSTEMS CORPORATION**

6184 Teall Station, Syracuse NY 13217

(315) 478-0722

Telex 6715617 LOGS

Inquiry 632.

## HARDWARE

### SAFETY BUBBLE FOR YOUR PC

PCB-76/76C available from MemTech 512Kbyte or 1 megabyte of non-volatile Bubble Memory. IBM PC, XT, AT, or compatibles. Designed to operate in the harshest environments. Driver compatible with Version 2.0 through 3.3 of MS-DOS and PC DOS.

Priced from: 512K, 1 megabyte \$1245.

Contact: **MemTech**

101 Blue Ravine Rd., Folsom, CA 95630

(916) 351-3100

Inquiry 633.

### BUY ★ SELL ★ TRADE

- Apple • IBM • Compaq • Service Parts
- Accessories • Systems •

**PRE-OWNED Electronics, Inc.**

30 Clematis Avenue, Waltham, MA 02154

800-274-5343 FAX 617-891-3556

Service Centers and Dealers welcome

Inquiry 634.

## HARDWARE ADD-ONS

### PC CARDS/KITS

- 8 bit A/D card, 0-5V ..... \$79
- 8 bit D/A card, 0-2.5V ..... \$79
- Relay driver card, 8 outputs (3A) ..... \$149
- Digital I/O (8 TTL input/output) ..... \$79
- JB XT computer kit w/monitor ..... \$499
- FREE CATALOG—parts, kits, computers

**JB COMPU-TRONIX**

3816 N. Wadsworth Blvd., Wheat Ridge, CO 80033

(303) 425-9586

Inquiry 635.

## INFORMATION

### 100 TABLES

From the U.S. Statistical Abstract "The U.S. Statistical Abstract" has a wide variety of public information on (economics, health, education, crime, the world and more.) 100 selected tables of the 1988 Abstract are now available on disk in (CAL, WKS, CSV, or TXT) formats for (PC or MAC or most CP/M)—\$49.95

**FAIRFACTS**

Box 536, San Rafael, CA 94915

Tel. 415-485-1781

Inquiry 636.

## INVENTORY MANAGEMENT

### STOCK-MASTER 4.0

Commercial grade inventory management software at micro prices.

- Supports all 12 transaction types
- Trend Analysis
- Quality Control
- Multiple Locations
- Purchase Order Tracking
- Open Order Reporting
- Serial/Lot # Tracking
- Stock Status Reporting
- Activity History Analysis
- Bill of Materials
- Purchase Order Writing
- Order Entry
- Material Requirements
- On Line Inquiry

**Applied Micro Business Systems, Inc.**

177-F Riverside Ave., Newport Beach, CA 92663 714-758-0582

Inquiry 637.

## LANS

### LANLINE-1

with SAFFRON-1 NETWORK ..... 115.200 6AUD XFR RATE

Link Four PC Computers To Any PC Computer Via RS232 Ports, Link PC XT's, AT's, Desktops, or Laptops. MENU Driven: Read Directory, Remove Dir, Copy Files, Delete Files, and Print To Any Printer Connected. 3 1/2 and 5 1/4 disks.. You Will Love It

reg \$139.95SPECIAL INTRODUCTORY ..... \$79.95

DEALER INQUIRIES INVITED ..... 1-800-654-7222

**TAMPA BAY DIGITAL**

1750 DREW ST., CLEARWATER, FL 34615 813-443-7049

Inquiry 638.

# THE BUYER'S MART

## LAPTOP COMPUTERS

### LAPTOP SPECIALS

LAPTOPS: • Toshiba • Zenith • NEC • DATAVEE  
AFFORDABLE 5¼" or 3½" DRIVE UNITS for  
LAPTOPS & DESKTOPS including Tandy 1400  
LT. • DICOMIX PRINTERS • 768 card for T1000 •  
2400 BAUD MODEMS for Laptops • Laptop software  
• Hard drives • Fast reliable and friendly service.  
For Low Pricing call

**COMPUTER OPTIONS UNLIMITED**  
201-469-7678 (7 Days, 9 am-10 pm Eastern time)

Inquiry 639.

## LAP-LINK

The ultimate solution for linking laptop computer with any IBM compatible desktop PC. 115, 200 baud transfer rate—faster than any other product available. No installation necessary, easy to use split screen design. Includes incredible "universal cable" that connects any two computers. Transfer entire disks faster than a DOS copy command! Only \$129.95 including universal cable and both 3½" and 5¼" disks. "Bridge" owners can trade in for only \$89.95 w/o cable.

**Travelling Software, Inc.**  
19310 North Creek Parkway, Bothell WA 98011  
1-800-343-8080 (206) 483-8088

Inquiry 640.

## LEGAL

### LEGAL DOCUMENT MAKER

All pleadings and documents.  
Any word processor software.  
Free Brochure.  
New! Supra II™.

**TSC - The Software Company**

P.O. Box 872687, Wasilla, AK 99667  
(907) 373-6550

Inquiry 641.

## MAC

### DEVELOPMENT TOOLS

Professional Programmers Extender: Standard Mac interface, lists, printing, graphics, tiling. Extender GraphPac: Quality color graphs. Line, bar, semi-log, customizable symbols.

**INVENTION Software**  
(313) 996-8108

Inquiry 642.

## MEMORY CHIPS

### MEMORY CHIPS

41256-15-12-10	.....	Call	51000 (1 Meg)	.....	Call
4184-15	.....	Call	51258 for Compaq 386	.....	6.43
4184-12	.....	Call	8087-3-2	.....	96/143
41128 Piggy Back for AT	.....	2.83	90287-6-9-10	.....	155/233/293
41464-12 (64Kx4)	.....	3.27	80397	.....	Call
414258 (256Kx4)	.....	Call	NEC-V-20-8	.....	Call
2764.27128.27256.27512	.....	Call	Mouse	.....	\$49

Prices subject to change

**ESSKAY 718-353-3353**

Inquiry 643.

## MUSIC

### MIDI — PC/XT \$84.95

Your MIDI instruments can talk with your PC/XT via a MIDIAUTOR. Software INCLUDED! MT-8 Sequencer, Performance Splitter/Auto-Chord, & MIDI Monitor. Requires 256K, DOS 2.0+, Std. Serial Port (COM1 or COM2) & std. cables. Needs no modifications, exp. slot, or power sup. Introductory Price \$84.95+\$5.00 s/h, TX res. add 7.25% tax. MC, VISA, Check (allow 10 days).

**Key Electronic Enterprises**  
9112 Hwy. 80 W., Suite 221-B, Fort Worth, TX 76166  
(817) 560-1912

Inquiry 644.

## MUSIC

### PC/MIDI Hardware & Software—\$149.95

The new standard in the PC/MIDI world!  
• MIDI Interface Card • 64-track digital recording  
• Sequencer Software • 600 ticks per quarter note resolution  
• MIDI Cables (1 in/3 out) • 60,000 events

Developer's source code \$19.95. Best MIDI offer ever made!  
Make check payable to:

### MidIMusic

500 E. Arapaho, Suite 609, Richardson, TX 75081  
1-800-456-MIDI 214/238-5269

Inquiry 645.

## PROGRAMMER'S TOOLS

### Microsoft QuickBASIC does Database Management.

db/LIB Database Library is 100% dBASE file compat. Only \$139.00.

**AJS Publishing, Inc.**  
(800) 992-3383  
(818) 985-3383 In CA.

Inquiry 646.

### CLIPPER™ DEVELOPMENT TOOLBOX

Alternative Business Training, Inc. introduces BOATSWAIN'S MATE®, a set of over 200 functions, procedures, and DOS Utilities for dBase™ programmers who use clipper as a compiler. Thousands of development hours have gone into this software in order to save you hours of programming time. Whether you are a novice or a serious clipper developer, the BOATSWAIN'S MATE® is for you. Free list of library functions available. Source code available.

Call 1-800-328-7677 In N.H. 1-357-8865  
**ALTERNATIVE BUSINESS TRAINING, INC.**  
206 Washington St., Keene, NH 03431

Inquiry 646.

### TLIB™ 4.0 Version Control

The best gets better! They loved TLIB 3.0: "packed with features... [does deltas] amazingly fast... excellent!"—PC Tech Journal Sept 87. "has my highest recommendation!"—R. Richardson, Computer Shopper Aug 87. Now TLIB 4.0 has: branching, more keywords, wildcards & file lists, revision merge, LAN and WORM drive support, more. MS/PC-DOS 2.x & 3.x \$99.95 + \$3 s/h. Visa/MC.

**BURTON SYSTEMS SOFTWARE**  
P.O. Box 4156, Cary, NC 27519 (919) 858-0475

Inquiry 647.

### 8049/8051 Disassembler

Intelligent code tracking disassembler inputs data from Intel hex, Motorola hex, straight binary and Intel object file formats. Provides comment programs for target processor. Great for disassembling output from high level language compilers for hand optimization. Variety of options for customization. Disassembler \$149.95; Demo \$5.00, appl'd to purchase; S/H in U.S. incl. MC/VISA

### MONITRONICS, INC.

800 W. Rock Creek Rd., Norman, OK 73069  
405-364-0024

Inquiry 648.

### TURBO PLUS \$99.95

Programming tools for Turbo Pascal 4.0 Screen Painter, Code Generator, IO Fields, Dynamic Menus, Programming Unit Libraries, Sample Programs, 280 Page Illustrated Manual. 60 Day Satisfaction Guarantee! Brochures & Demo Diskettes avail. Highly Favorable Reviews! IBM & Compatibles.

### Nostradamus Inc.

3191 South Valley St. (Suite 252) Salt Lake City, UT 84109  
(801) 487-9662

Inquiry 649.

## PROGRAMMER'S TOOLS

### Modula-2

Novell's Btrieve is the industry standard file manager. PMI's new Repertoire/Btrieve Toolkit lets Modula-2 programmers write sophisticated Btrieve applications quickly and conveniently. Includes full copy of Repertoire. Only \$149. For JPI, Logitech, Stony Brook, FST, etc. From the creators of Repertoire, DynaMatrix, EmsStorage, Graphix, Macro2, and NetMod. MC/VISA/AMEX/PO/COD.

**PMI** 4536 SE 50th, Portland, OR 97206  
(503) 777-8844; TLX: 6502691013

Inquiry 650.

## FREE BUYER'S GUIDE

See Page 39

Programmer's Connection is an independent dealer representing more than 250 manufacturers with over 700 software products for IBM personal computers. Call to receive our FREE comprehensive Buyer's Guide or refer to page 39 of this issue to see a partial list of our software products.

**Programmer's Connection**  
800-336-1166  
216-494-3781

Inquiry 651.

### The SOURCE GENERATOR (c)

More than a "DISASSEMBLER". Takes executable machine code program (.EXE or .COM) and produces \*.ASM file. Generates: symbol, opcode, operand, and even a comment. Plus Table of all references. Generated files can be modified and reassembled. \$95.

Write to:

**SYLVERSOFT Inc.**  
5 Parc Samuel Holland, Suite 130  
Quebec, Canada G1S 4S2

Inquiry 652.

## PUBLIC DOMAIN

### OUTSTANDING IBM SOFTWARE ONLY \$2.75/DISK OR LESS

Our collection contains the latest versions of the Best Shareware and Public Domain Programs. Most are menu driven with full documentation. 350" format is also available. Orders shipped First Class Within 24 hours and Satisfaction is guaranteed.

Write or call for FREE CATALOG Today

**A.C.L. (916) 973-1850**  
1621 Fulton Ave., Suite #35-B, Sacramento, CA 95825

Inquiry 653.

### \$3.00 SOFTWARE FOR IBM PC

Hundreds to choose from, wordprocessors, databases, spreadsheets, games, lotto, communications, business, music, bible, art, education, language and useful utilities for making your computer easier to learn. Most programs have documentation on the disk.

WRITE FOR YOUR FREE CATALOG TODAY!

### BEST BITS & BYTES

P.O. Box 8245—Dept. B, Van Nuys, CA 91409  
In CA: (818) 781-9975 800-245-BYTE

Inquiry 654.

## FREE CATALOGUE PUBLIC DOMAIN/SHAREWARE

• 400 IBM PC & compatibles disks •  
200 Amiga disks • 125 Atari ST disks  
PC disks as low as \$1.25 each, Amiga & ST as low as \$1.60 each! Rent or buy. Free shipping! Call toll free, write or circle reader service for FREE BIG CATALOGUE with full descriptions. Please specify computer—48 hr. turnaround!

### Computer Solutions

P.O. Box 354—Dept. B, Mason, Michigan 48854  
1-800-874-9375 (M-F 10-8 EST) 1-517-828-2943

Inquiry 655.



# THE BUYER'S MART

## RENT SOFTWARE \$1/DISK

Rent Public Domain and User Supported Software for \$1 per diskfull or we'll copy. IBM (3 1/2" also), Apple, C-64, Sanyo 550 and Mac. Sampler \$3. VISA/MC. 24 hr. info/order line. (619) 941-3244 or send #10 SASE (specify computer) Money Back Guarantee!

### FutureSystems

Box 3040 (T), Vista, CA 92083  
office: 10-6 PST Mon-Sat. (619) 941-9761

Inquiry 656.

## QUALITY SOFTWARE IBM/COMPATIBLES

Get a Word Processor, Spreadsheet, Database, Money Manager and 5 arcade games plus our 10,000 program catalog for ONLY \$10.00 (+s/h)  
800-992-1992 (National)  
800-992-1993 (Ca only)

619-942-9998 (Foreign)  
VISA, MC, AMEX Accepted. (COD + 1.90)

### The International Software Library

511-104 Encinitas Blvd., Encinitas, CA 92024

Inquiry 657.

## FREE SOFTWARE

### Buy or Rent \$1/disk

World's largest Free Software Library of IBM PC & Compatibles and Macintosh. Over 3000 programs for Religion, Utilities, Business, Com., Word Processor, Education, and Games on 5.4" and 3.5" format. Best quality, Lowest rate, and Fastest service. For fast free catalogue write to:

### SOFTSHOPPE

P.O. Box 15022, Ann Arbor, MI 48105  
(313) 763-8721

Inquiry 658.

## \$4.00 SHAREWARE \$4.00

### IBM-PC Compatible Software

- Over 700 Disks to Choose From
- Not Half Full Like Some Distributors
- Dozens of Programs in All Categories

Call or Write for FREE Catalog on Disk  
— Please specify 5 1/4" or 3 1/2" Disk —

### The Software Kingdom

P.O. Box 358, Manchester, NH 03105-0358  
1-800-552-DISK (In N.H.) (603) 627-0444

Inquiry 659.

## SECURITY

### BIT-LOCK® SECURITY

Piracy SURVIVAL 5 YEARS proves effectiveness of powerful multilayered security. Rapid decryption algorithms. Reliable/small port transparent security device. PARALLEL or SERIAL port. Countdown and timeout options also available. KEY-LOK™ security at about 1/2 BIT-LOCK cost.

### MICROCOMPUTER APPLICATIONS

7805 S. Windemere Circle, Littleton, CO 80120  
(303) 922-6410 or 798-7883

Inquiry 660.

## COPY PROTECTION

The world's leading software manufacturers depend on Softguard copy protection systems. Your FREE DISKETTE introduces you to SuperLock™—invisibile copy protection for IBM-PC (and compatibles) and Macintosh.

- Hard disk support
- Customized versions
- No source code changes
- LAN support
- New upgrades available!

(408) 773-9680

### SOFTGUARD SYSTEMS, INC.

710 Lakeway, Suite 200, Sunnyvale, CA 94086  
FAX (408) 773-1405

Inquiry 661.

## SOFTWARE/ACCOUNTING

### ACCOUNTING TUTOR \$79.95

Peanuts and Caviar Accounting Software is designed to introduce the principles of accounting and bookkeeping to non-accountants through its software and textbook. It then may be used as your business' accounting software. Being used by educational institutions to teach accounting (e.g., Pepperdine, etc.) \$79.00

### COUNTERTRADE PRODUCTS, INC.

5145 Idylwild Tr., Boulder, CO 80301  
303-530-5433

Inquiry 662.

### dBASE BUSINESS TOOLS

- General Ledger
- Accounts Recvbl.
- Order Entry
- Sales Analysis
- Purch Ord/Inventory
- Accounts Payable
- Job Costing
- Job Estimating

\$99 EA. + s&h w/dBASE 2, 3 or 3+ SOURCE CODE

### DATAMAR SYSTEMS™ Cr. Crd/Chk/COD

4876-B Santa Monica Ave  
San Diego, CA 92107 (619) 223-3344

Inquiry 663.

### FINANCE MANAGER II

Easy to learn, fully integrated, menu-driven book-keeping system for small business and personal use. IBM PC, XT, AT, PS/2 or compatible. **Try before you buy!** General Ledger evaluation copy for only \$10!

CALL TODAY! (719) 528-8989

HOOPER INTERNATIONAL: PO Box 62219,  
Colorado Springs, Colorado 80962

Inquiry 664.

## SOFTWARE/BASIC

### XGRAF DRAWS IN BASIC!

FINALLY! XGRAF replaces QuickBASIC's poor drawing commands with assembly language calls that work on Hercules, EGA, VGA, CGA and EEGA screens. Only \$99.00 + \$4.00 S&H. Call us at 1-800-423-3400 (9:00 AM to 8:00 PM EST)

### KOMPUTERWERK, INC.

851 Parkview Blvd., Pittsburgh, PA 15215  
For info., call (412) 782-0384

Inquiry 665.

## SOFTWARE/BASIC TOOLS

### QuickWindows

As seen in the Microsoft Value-Pack Catalog! Create windows, pop-up and pull-down menus, data-entry screens, and multiple-input dialog boxes quickly and easily. Full support of Microsoft mouse. Join the many Fortune 500 companies using QuickWindows and order your copy today. QuickWindows \$79. Advanced \$139. For Microsoft QuickBASIC or BASCOM.

### Software Interphase, Inc.

5 Bradley St., Suite 106 • Providence, RI 02908  
(401) 274-5465

Inquiry 666.

## SOFTWARE/BUSINESS

### DATA ENTRY SYSTEM

Heads-down data entry with two-pass verification for the PC/XT/AT • PS/2 & compatibles. Loaded with features like: Auto dup & skip, verify bypass, range checks, & table lookups. Fully menu driven only \$395. Call for free 30 day trial period.

### COMPUTER KEYS

21929 Makah Rd., Woodway, WA 98020  
(206) 776-6443 1-800-356-0203

## SOFTWARE/BUSINESS

### TPRO88 - ROUTE FINDER

A powerful interactive system for finding routes on transportation networks w/up to 512 nodes and 16K links. TPRO88 can find the shortest path between two nodes, sequence up to 50 stops, compute minimum spanning trees and times/distances between all points. Req. IBM PC, 192K, graphics adapter. \$149 w/8067 support, user's guide, sample U.S. Highway network. VISA/MC.

### EASTERN SOFTWARE PRODUCTS, INC.

POB 15328, Alexandria, VA 22309  
(703) 360-7600

Inquiry 667.

### dFELLER Inventory

Business inventory programs written in modifiable dBASE source code.

dFELLER Inventory \$150.00

Requires dBASE II or III, PC-DOS/CPM

dFELLER Plus \$200.00

with History and Purchase Orders

Requires dBASE III or dBASE III Plus (For Stockrooms)

### Feller Associates

550 CR PPA, Route 3, Ishpeming, MI 49849  
(906) 486-6024

Inquiry 668.

### 1-2-3® + @RISK = Risk Analysis

Manage risk with @RISK 1-2-3 Add-In! An @RISK simulation automatically reflects thousands of "what-if" scenarios. View full range of possible outcomes ■ Monte Carlo simulation ■ Graphs in .PIC format ■ 30 new probability distribution @functions Now required for all Harvard MBAs

FREE DEMO

### Pallsade Corporation

2189 Elmira Road, Newfield, NY 14867  
(607) 564-9993

Inquiry 669.

## SOFTWARE/CHURCH

### PowerChurch Plus®

Fast, friendly, reliable church administration system. Full fund accounting, mailing lists, membership, contributions, attendance, word processing, accts. payable, payroll, multi-user support, and much more - all for \$695 complete. FREE demo version.

### F1 SOFTWARE

P.O. Box 3096, Beverly Hills, CA 90212  
(213) 854-0885

Inquiry 670.

### ROMAR CHURCH SYSTEMS™

Membership-61 fields plus alternate addresses, labels, letters, reports any field(s). Offering-256 funds; optional pledge; statements, post to 256/yr; Finance-gen. ledger w/budget; up to 500 subtotals & 99 desc's., month & YTD reports anytime for any month. Attendance-8 service times; 250 events per service; 60 consecutive weeks. Available for floppy, 3 1/2 & hard disk. Ad too short! Write for free 48-page guide.

### Romar Church Systems, Attn: BJB

P.O. Box 4211, Elkhart, IN 46514  
(219) 262-2188

Inquiry 671.

### STOREHOUSE

Treasurers, make your job easy and fun! You'll impress your church board with the professional look of your new reports. Members will be grateful for the handy title receipts. No more budget allocations to calculate. Spend more time doing what you want to do. Top quality—\$295.

### Scott D. Charlton

7509 Pear Tree Ln., Fort Worth, TX 76133  
(817) 370-1450

Inquiry 672.

## SOFTWARE/CULINARY

### Ethnic Recipes

IBM Compatible Floppy  
Greek, Arab, Slav, Ethiopian

Send \$9.11 inc. tax & shipping

#### Golden Cobra

P.O. Box 25, Palmer, TX 75152

Inquiry 673.

## SOFTWARE/ENGINEERING

### Affordable Engineering Software

FREE APPLICATION GUIDE & CATALOG

Circuit Analysis • Root Locus • Thermal Analysis • Plotter Drivers • Engineering Graphics • Signal Processing • Active/Passive Filter Design • Transfer Function/FFT Analysis • Logic Simulation • Microstrip Design • PC/MSDOS • Macintosh • VISA/MC

**BV Engineering • Professional Software**

2023 Chicago Ave., Suite B-13, Riverside, CA 92507  
(714) 781-0252

Inquiry 674.

### Engineer's Aide

Join the Desktop Engineering Revolution!

• Pipeline/Ductwork Sizing • Critical/Control Valve Sizing  
• Pump/Fan/Compr. Sizing • Project Financial Analysis  
• Heat Exchanger Sizing • Conversion Calculator  
• Fluid Properties Library • Specification Writer

Above programs in one stand alone integrated package for \$695. For IBM PC & Macintosh.

#### EPCON

1-800-367-3585 (24 hr) 1-805-484-5381 (Ca)

Inquiry 675.

### STRUCTURAL ANALYSIS

MICROSAFE: inexpensive, easy to learn and use Finite Element Analysis for IBM PCs and compatibles. Up to 400 nodes, 600 beams, 500 plates. Graphics. 2-D: \$75, 3-D: \$120, Both: \$160. Overseas add \$20. Evaluation copies. NOT COPY-PROTECTED. Ask for brochure.

**MICROSTRESS Corp.** (Dep. BM1)

10950 Forest Ave. S., Seattle, WA 98178-3205  
(206) 772-0508

Inquiry 676.

### SIMULATION WITH GPSS/PC™

GPSS/PC™ is an IBM personal computer implementation of the popular mainframe simulation language GPSS. Graphics, animation and an extremely interactive environment allow a totally new view of your simulations. Simulate complex real-world systems with the most interactive and visual yet economical simulation software.

#### MINUTEMAN Software

P.O. Box 1717V, Stow, Massachusetts, U.S.A.  
(617) (800)

Inquiry 677

### Circuit Analysis — SPICE

Non-linear DC & Transient; Linear AC.  
• Version 3B1 with BSIM, GaAs, JFET, MOSFET, BJT, diode, etc. models, screen graphics, improved speed and convergence.  
• PC Version 2G6 available at \$95.

Call, write, or check inquiry # for more info.

#### Northern Valley Software

28327 Rothrock Dr., Rancho Palos Verdes, CA 90274  
(213) 541-3677

Inquiry 678.

260 B Y T E • AUGUST 1988

## SOFTWARE/ENGINEERING

### FREE ENGINEERING MAGAZINE

*Personal Engineering* is a monthly magazine sent free of charge (USA only) to scientists/engineers who use PCs for technical applications. Topics each month include **Instrumentation • Data Acq/Control • Design Automation**. To receive a free sample issue and qualification form either circle below or send request on letterhead to:

**Personal Engineering Communications**

Box 1821, Brookline, MA 02146

Inquiry 679.

### EC-Ace ANALOG CIRCUIT ANALYSIS

You can afford to get started with EC-Ace, a subset of the powerful ECA-2 circuit simulator. Includes all the basics and built-in graphics.

• AC, DC, Temperature, Transient  
• A full 525 pg. ECA-2 manual.  
• Interactive, twice as fast as SPICE.

**EC-Ace 2.31 IBM PC or Mac \$145.**

Call 313-863-8810 for FREE DEMO

#### Tatum Labs, Inc.

1478 Mark Twain Ct., Ann Arbor, MI 48103

Inquiry 680.

## SOFTWARE/GENERAL

### US\$5... INCLUDING DISK

Over 2,000+ software titles for IBM-PC Apple I, +, e, c, GS, Macintosh, C64/128, Amiga. Latest titles and versions. Lots of hi-quality manuals. Best services.

1200 bps Pocket-size Modem ..... \$159  
256K Auto Hi-Res EGA card ..... \$179  
16 MHz AT/286 Motherboard/4 Mb ..... \$649

Lots of bargains, ram chips, etc. . . . Specify your computer type. FREE catalog sent to you by air-mail. Write:

**IBRAHIM BIN ABU BAKAR, Dept. BYTE**

Raffles City P.O. Box 1029, Singapore 9117

REPUBLIC OF SINGAPORE

Inquiry 681.

## SOFTWARE/GRAPHICS

### PC TECHNICAL GRAPHICS

TEKMAR is a graphics library for the EGA or Tecmar Graphics Master. Similar to PLOT-10, includes WINDOW, VIEWPORT, AXIS. Support for HP, HI plotters. Curve fitting, complete plotting program. Log, semi-log, multi-axis, 3-D, contours. Jerry Pournelle (Aug 86 Byte): "As good as any I have ever seen." Demo disks, literature available.

**Advanced Systems Consultants**

21115 Devonshire St. #329, Chatsworth, CA 91311

(818) 407-1059

Inquiry 682.

### TurboGeometry Library

(Source & Manual)

Turbo Pascal, C, Mac, & Microsoft C. Over 150 2 & 3 dimensional routines including: Intersections, Transformations, Equations, Hidden Lines, Perspective, Curves, Areas, Volumes, Clipping, Planes, Matrices, Vectors, Distance, PolyDecomp. IBM PC (Comp.), MAC.

VISA/MC \$99.95.

#### Disk Software, Inc.

2116 E. Arapaho #487, Richardson, TX 75081

(214) 423-7288

Inquiry 683.

Scientific Engineering ★ Numeric Spreadsheet  
Graphics ★ Lotus 1-2-3 Interface  
System ★ Log, Date & Linear Axes  
Curve Fitting & Smoothing

See "What's New" page 82, Byte June, 1988. Supports all video standards, PC printers & plotters. Ten curves with 5000+ points each. Plus many more advanced features. Call Today.

#### Edmond Software

3817 Window Drive  
Edmond, OK 73013

1-405-842-0568  
1-800-992-3425

Inquiry 684.

## SOFTWARE/GRAPHICS

### FPLOTT PEN PLOTTER EMULATOR

Use your dot matrix or laser printer as an HP pen plotter. Fast hi-res output. Vary line width. Includes VPLLOT virtual plotter utility to capture plotting commands. Supports NEC P5/P6, IBM Proprinter, Epson LQ/MX/FX, HP Laserjet. Uses Hercules, CGA, EGA or VGA for screen preview. \$64 check or m.o.

#### HORIZON SOFTWARE

Suite 605, 24-16 Steinway St., Astoria, NY 11103

212-418-8469

Inquiry 685.

### GRAPHICS PRINTER SUPPORT

AT LAST! Use the PrtSc key to make quality scaled B&W or color reproductions of your display on any dot matrix, inkjet, or laser printer. GRAFPLUS supports all versions of PC or MS-DOS with IBM (incl. EGA, VGA), Tecmar, and Hercules graphics boards. \$49.95.

#### Jewell Technologies, Inc.

4740 44th Ave. SW, Seattle, WA 98116

800-628-2828 x 527 (206) 937-1081

Inquiry 686.

### CGA → Hercules™ Graphics

**Mode-MGA™** allows you to use business graphics, games, BASIC graphics and other CGA specific software with your Hercules™ Monochrome Graphics adaptor and monochrome monitor. Works with all CGA programs. \$79.95 (+ \$5 s&h) for the 3k3Trt version. 30-day money back guarantee. Call or write:

#### T.B.S.P. Inc.

2265 Westwood Blvd., Suite 793, Los Angeles, CA 90064

(213) 312-0154

Inquiry 687.

## SOFTWARE/HEALTH

### FamilyCare™ Software

This comprehensive medical diagnostic program gives parents peace of mind when dealing with health problems of newborns through teenagers. It analyzes hundreds of possible symptoms, injuries, and diseases, offering specific instruction for medical care, home treatment, and medications. It provides answers quickly in life-threatening situations.

#### FamilyCare™ Software

Lundin Laboratories, Inc.

29451 Greenfield Rd., Suite #215, Southfield, MI 48076

800/426-8426 or 313/559-4561

Inquiry 688.

## SOFTWARE/INVESTMENT

The new Business Week TOP 1000 and Mutual Fund Scoreboard Diskette use the enormous power of your IBM or compatible PC to select, rate, and compare every equity and fixed income mutual fund on the market (Mutual Fund Scoreboard), and virtually every Business Week 1000 company (TOP 1000)—At the touch of a key.

**Mutual Fund Scoreboard Diskettes:**

\$49.95 each or \$239.90 for subscriptions to both.

**TOP 1000 & TOP 1000 ELITE Diskettes:**

\$199 for the TOP 1000 & \$299 for the ELITE version

which offers names & addresses of the top officers and

Order now or receive more information by calling 1-800-553-3575

(In Illinois, call 1-312-250-9292).

Or write to: **Business Week Diskettes**

P.O. Box 621, Elk Grove, IL 60009

Inquiry 689.

### FORTH-RIGHT & FORTH-WITH

#### DRUMA FORTH-83

Strict '83 STANDARD. Ideal for instructors/assignments. 1MB + memory, 84K speed & compactness to 320K. Comprehensive DOS interfaces. On-line doc/journalry. Keywordless code. ASCII/SCR files. Other supports. Powerful development environment.

• IBM PC/XT/AT & ALL compatibles  
• Standard package \$79, S&H \$2, VISA/MC  
• 15 day money back. CALL or WRITE

#### DRUMA INC.

6448 Hwy. 290 East E103, Austin, TX 78723

Orders: 512-323-0403 BBoard: 512-323-2402

Inquiry 690.

## SOFTWARE/LANGUAGES

### FORTRAN for Macintosh

Language Systems FORTRAN is a full-featured FORTRAN 77 compiler integrated w/MPW. Full ANSI FORTRAN 77 plus VAX-type extensions. SANE numerical calculations & data types incl. COMPLEX\*16, 68000, 68020 and 68881 object code. Arrays greater than 32K. Link with Pascal, C, MacApp. \$304 w/MPW via air. MC/VISA/Check. MAC+, SE, Mac II. HD req.

#### Language Systems Corp.

441 Carlisle Drive, Herndon, VA 22070  
(703) 478-0181

Inquiry 691.

### The SPINDRIFT Library

At last! Now there's a way for FORTRAN programmers to do the things they always wanted to do: Execute other programs via CALL EXEC; edit key control of CURSOR; WINDOWS; POP UP HELP; Wildcard file search; Save/restore screen images; COLOR. 150 subroutines and functions in all. Price: \$149. + S&H Write for DEMO DISK: \$5 credited to purchase. Specify your Compiler.

#### Spindrifft Laboratories, Ltd.

116 S. Harvard Ave., Arlington Hts., IL 60005  
(312) 255-6909

Inquiry 692.

### MULTI-USER DEVELOPMENT PLATFORM

Gain the 80386 edge for your applications with THEOS C, an advanced compiler for the new THEOS 386 multi-user, multitasking operating system. Meets ANSI C standard, plus offers the power of 250 additional functions for VDI graphics, real-time processing and file access. Provides UNIX and DOS source code compatibility. Breaks 84K limitation. Two-volume manual set. BASIC Language package also available. For complete multi-user solutions, call us today.

#### THEOS Software Corp.

1777 Boitelho Dr., Suite 360, Walnut Creek, CA 94596  
(415) 935-1118 FAX (415) 935-1177

Inquiry 693.

## SOFTWARE/LOTTERY

### WIN LOTTO

GAIL HOWARD'S systems have won \$27 million for 9 Lotto jackpot winners! Now available on IBM PC 5 1/4" diskettes the complete *authentic Gail Howard* Wheeling Systems (*Smart Luck Computer Wheel*) \$29.95 + \$2 s/h; also Gail Howard's *Smart Luck Computer Advantage* \$39.95 + \$2 s/h (specify Lotto game). VISA/MC welcome.

Smart Luck Computer Systems, Dept. B-1  
1271 West Dundee Rd., Suite 16-A, Buffalo Grove, IL 60089  
312-934-3300A list of Gail Howard's Lotto books is also available.

Inquiry 694.

## SOFTWARE/MATHEMATICS

### What? You've never seen a complex function?

Try *f(z)* - The Complex Variables Graphing Package for PC's with CGA/EGA

"Let our animated screens show you what the printed page cannot."

#### Lascaux Graphics

(212) 654-7429

Inquiry 695.

## SOFTWARE/PACKAGING

### HARD TO FIND COMPUTER SUPPLIES FOR SOFTWARE DEVELOPERS & POWER USERS

Cloth binders & slipcases like IBM's. Vinyl binders, boxes, and folders in many sizes. Disk pages, envelopes, & labels. Low quantity imprinting. Bulk disks. Everything you need to bring your software to market. Disk and binder mailers. Much more! Low Prices! Fast service. Call or write for a FREE CATALOG.

#### Anthropomorphic Systems, Limited

376 E. St. Charles Rd., Lombard, IL 60148

1-800-DEAL-NOW 312-629-5160

Inquiry 696.

## SOFTWARE/PACKAGING

### SAVE SAVE SAVE SAVE LET'S TALK LABELS

We do disk labels (5 1/4" & 3 1/2")  
• Better • Faster • Cheaper •  
Because we specialize in disk labels... Let's Talk

We also have Tyvek Sleeves  
Mailers • Binders • Vinyl Pages

We are a complete software packaging service.

#### Hice & Associates

9303 Cincinnati-Columbus Rd., West Chester, OH 45069  
513-777-0133

Inquiry 697.

## SOFTWARE/PRODUCTION

### Bullet Design Software

Five-disk pack designs projectiles from your description. No math, engineering skill. Used by military, commercial bullet-makers in nine countries. By world's leading authority in the field. \$72. (200-pg. book, \$5) VISA/MC

#### Corbin Software

600 Industrial Circle, White City, OR 97053  
503-826-6737

Inquiry 698.

## SOFTWARE/SCANNERS

### Optical Character Recognition

Stop retyping! PC-OCR™ software will convert typed or printed pages into editable text files for your word processor. Works with HP ScanJet, Canon and most other scanners. Supplied with 15 popular fonts. User trainable: you can teach PC-OCR™ to read virtually any typestyle, incl. foreign fonts. Proportional text, matrix printer output, Xerox copies OK. \$385. Check/VISA/MC/AmExp/COD

#### Essex Publishing Co.

P.O. Box 391, Cedar Grove, NJ 07009  
(201) 783-6940

Inquiry 699.

## SOFTWARE/SCIENTIFIC

### DATA ACQUISITION & ANALYSIS ON PC'S

\* Free application assistance. Tell us about your DSP, process control, A/D or D/A needs. Our expert engineering staff will provide you with a system solution to fit your needs and budget.  
\* A/D & IEEE 488 boards from Metrabyte, Scientific Solutions and Analog Devices.  
\* Analysis software including PRIME FACTOR FFT subroutine library, FOURIER PERSPECTIVE II advanced linear systems analysis.  
\* Menu driven software from Unitek, Laboratory Technologies, Quinn Curtis, and Golden. Scientific engineering 2 & 3D graphics.  
See "What's New" page 80, BYTE July, 1988

#### LOW PRICES—Satisfaction GUARANTEED ALLIGATOR TECHNOLOGIES

P.O. Box 9706, Fountain Valley, CA 92708

Tel. (714) 850-9984 FAX. (714) 850-9987 MCI. ALLIGATOR

Inquiry 700.

### Spectra Calc Data Processing

Acquire and analyze data from commercial or custom analytical instrumentation. Fast real-time display. WYSIWYG plotting. Extremely fast applications for curve fitting, deconvolution, PLS algorithms etc. Spectral search and archive. Array programming language includes matrix, FFT, graphic commands.

#### GIC

395 Main St., Salem, N.H. 03079  
800-862-6004 603-898-7600 FAX 603-898-6228

Inquiry 701.

### 100% GUARANTEED!

Top-Quality PC Software for Engineers & Scientists. All with complete money-back guarantee. See *MATHTOOL™ The Numerical Methods Toolbox* \$95 in BYTE's June '88 "What's New." Gulf's line includes: *MATHTOOL™*, *CHEMICALC™ PIPE-CALC™* & *PETROCALC™*.

FREE CATALOG! from

#### Gulf Publishing Company

Dept. LE • P.O. Box 2608 • Houston, Texas 77252  
(713) 520-4444 FAX: (713) 520-4433

Inquiry 702.

## SOFTWARE/SCIENTIFIC

### Scientific/Engineering/Graphics Libraries Turbo & Lightspeed Pascal, Modula-2, C

Send for FREE catalogue of software tools for Scientists and Engineers. Includes: Scientific subroutine libraries, device independent graphics libraries (including EGA, HP plotter and Laserjet support), scientific charting libraries, 3-D plotting library, data acquisition libraries, menu-driven process control software. Versions available for a variety of popular languages.

#### Quinn-Curtis

1191 Chestnut St., Unit 2-5, Newton, MA 02164

Inquiry 703.

## SOFTWARE/SORT

### OPT-TECH SORT/MERGE

Extremely fast Sort/Merge/Select utility. Run as an MS-DOS command or CALL as a subroutine. Supports most languages and filetypes including Btrieve and dBASE. Unlimited file sizes, multiple keys and much more! MS-DOS \$149. XENIX \$249.

(702) 588-3737

#### Opt-Tech Data Processing

P.O. Box 678 • Zephyr Cove, NV 89448

Inquiry 704.

## SOFTWARE/TAX PREP.

### W-2 (COPY A) ON FLOPPY

The W-2 MAG program makes an IRS/SSA FORMAT floppy from a data entry screen or imported ASCII file. Includes manual and application forms.

- Used nation wide
- Step-by-step data entry
- Free phone support
- Menus, user friendly
- Prints W-2 forms
- PC compatible

#### Illinois Business Machines Inc.

Department PC  
1403 Box 310 Troy Rd., Edwardsville, IL 62025  
PH # (618) 682-6060

Inquiry 705.

## SOFTWARE/TOOLS

### C or T Pascal Code Instantly

Complete database in just minutes. Draw & Paint your screen, show what fields to use for indexes—That's it—running source code in 6 seconds. Automatic context sensitive help, programmer docs on each program. \$389/TPascal ver. or \$499/TC or MS-C ver.

Call ASCII (800) 227-7681

Inquiry 706.

### NATURAL LANGUAGE SOFTWARE

Use JAKE to create a front end to your database, game, or graphics program! JAKE translates English queries and commands into C function calls and data structures. JAKE offers context-sensitive semantic processing; interfaces easily; <64K mem.

\$495. INTERACTIVE DEMO \$10

#### ENGLISH KNOWLEDGE SYSTEMS, INC.

5525 Scotts Valley Dr. #22, Scotts Valley, CA 95066  
(408) 438-6922

Inquiry 707.

## STATISTICS

### STATA

Statistics and graphics join to make STATA the most powerful package for the PC. No comparable program is as fast, friendly, and accurate. \$20 Demo. Quantity discount available. Call toll-free for more information. AX/VISA/MC.

#### 1-800-STATAPC Computing Resource Center

10801 National Boulevard, Los Angeles, CA 90064  
(213) 470-4341

Inquiry 708.

# THE BUYER'S MART

## STATISTICS

### THE SURVEY SYSTEM

An easy-to-use package designed specifically for **questionnaire data**. Produces banner format, cross tabs & related tables, statistics (incl. regression) & bar charts. Codes and reports answers to open-ended questions. All reports are camera-ready for professional presentations. CRT interviewing system.

#### CREATIVE RESEARCH SYSTEMS

15 Lone Oak Ctr., Dept. B, Petaluma, CA 94952  
707-765-1001

Inquiry 709.

### RESULTS NOT SIGNIFICANT?

Next time use EX-SAMPLE. Expert program estimates sample size using power analysis for comparisons of means, props, regression, ANOVA, chi-square, log-linear, LISREL, surveys, experiments, many more. Justify sample size to funding agencies, plan sampling budget. Can pay for itself in a single study. IBM/MS-DOS, \$195/s/h. (50% educ. disc.). VISA/MC/PQ. 30-day guarantee. Call now for FREE brochure.

#### The Idea Works, Inc.

100 West Briarwood, Columbia, MO 65203  
1-800-537-4886 314-445-4554

Inquiry 710.

### STATISTIX™ II

Comprehensive, powerful and incredibly easy-to-use. Full screen editor, transformations, linear models (ANCOVA, regression, logit, PCA, etc), ARIMA, most standard stat procedures. Clear, well organized documentation. Satisfaction guaranteed. \$169 PC DOS, \$99 Apple II.

#### NH ANALYTICAL SOFTWARE

P.O. Box 13204, Roseville, MN 55113  
(612) 631-2852

Inquiry 711.

### NCSS

Professional, easy to use, menu driven statistical system. Used by over 5,000 researchers.

- 5.0 Statistical System —\$99
- 5.1 Graphics (2D & 3D)—\$59
- 5.3 Power Pac Supplement—\$49
- 5.4 Exp. Design/CC—\$49
- 5.5 Survival Analysis—\$49

We accept checks, PC's, Visa, MC. Add \$3 s/h.

#### NCSS-B

865 East 400 North, Kaysville, UT 84037  
801-546-0445

Inquiry 712.

### StatPac Gold™

Voted World's Best Statistical & Forecasting Package in 1987 by PC World Magazine readers. Six times more votes than the next closest competitor. More comprehensive & easier to use than all others. Get the facts. Call now for your FREE brochure.

1-800-328-4907

#### Walonick Associates, Inc.

6500 Nicollet Ave. S., Minneapolis, MN 55423  
(612) 866-9022

Inquiry 713.

## TEXT RETRIEVAL

### TEXT RETRIEVAL

GOter, high speed text retrieval software for IBM PC compatible and Apple Macintosh computers. Highly acclaimed.

- No file conversion or indexing required.
- Searches for text in any file. (ASCII, EBCDIC, WordStar, etc.)
- RAM resident operation for immediate availability, also runs as a standard DOS application—Desk Accessory on the Macintosh.
- Moves text across different file formats (Display/Write to WordStar, MS Word to WordPerfect, etc.)

Call or write to order: (VISA, MC, COD, Check)

#### Microlytics

300 Main St., Suite 1591, East Rochester, NY 14445  
(800) 828-6293 (716) 377-0130 in NYS

Inquiry 714.

262 B Y T E • AUGUST 1988

## UTILITIES

### CleanUp

#### the File Management System

**FEATURES:** global file search, wild card & Attribute file marking, source & target space info, file copy to multiple disks when full, pop up windows, prompted file deleting and many more for MS/DOS.

Price: \$49.95

1-800-553-0846

#### Acme Software Works

1380 156th Ave. N.E. Suite 147, Bellevue, WA. 98007

Inquiry 715.

### Enhanced DOS Commands

Get directory listings of all files that don't match a template. Search all directories for files matching a template. New commands and new versions of existing commands, all with lots of variable options. Plus all commands accept special codes to reduce repetitive entries. Get the most from DOS with these time-saving routines. For MS-DOS/PCDOS 2.0 and higher. \$29.95

#### Driscoll Graphics

135 E. Church, P.O. Box 625  
Clinton, MI 49236

Inquiry 716.

### MATCH PRINTERS TO PC

Match-A-Printer adapts most printers to PC/PS2 and compatibles. With this resident driver, get the full extended IBM ASCII character set on most printers. French, Spanish, German, Italian, Swedish, Greek, etc., and logic symbols. Works great with Apple ImageWriter and D.M.P., Epson and most daisy-wheel printers. Solve character compatibility now, great for academic and engineering application. Introductory Price \$59.95 & \$2 S&H. California residents add 6 1/2% sales tax. MO/Checks.

#### MATCH SOFTWARE

6426 Coldwater Canyon, North Hollywood, CA 91606-1113  
Toll free # 1 (800) FLOPPYO

Inquiry 717.

### COPY AT TO PC

The 1.2MB drive has long been known to READ but NOT reliably WRITE on 360kB floppies. With "CPYAT2PC"™ 1.2MB drives CAN reliably WRITE 360kB floppies saving a slot for a second hard disk or backup tape. "CPYAT2PC" (Not Copy Protected) offers the preferable SOFTWARE SOLUTION! ONLY \$79+\$4 S/H VISA/MC/COD UPS B/F

#### MICROBRIDGE COMPUTERS

655 Skyway, San Carlos, CA 94070

Order toll free 1-800-523-8777

415-593-8777 (CA) 212-334-1858 (NY)  
TELEX EZLNK 62673089 FAX 415-593-7675

Inquiry 718.

### Recover deleted files fast!

Disk Explorer now includes automatic file recovery. You type in the deleted file's name. Disk Explorer finds and restores it. Disk Explorer also shows what's really on disk; view, change or create formats, change a file's status, change data in any sector. MS-DOS \$75 U.S. Check/Credit card welcome.

#### QUAID SOFTWARE LIMITED

45 Charles St. E. 3rd Fl.  
Toronto, Ontario, Canada M4Y 1S2  
(416) 961-8243

Inquiry 719.

### HANDS OFF THE PROGRAM®

- Locks Hard Disk. - Restricts Floppy Use.
- Protects Subdirectories.
- Normal Use of DOS Commands and Application Software.
- IBM PC, XT, AT and True Compatibles.
- DOS V2.0 and Higher. Hard Disk System.
- Keep Other People's HANDS OFF Your System.

\$89.95 VISA/MC

#### SYSTEM CONSULTING, INC.

314 Canterbury Dr., Pittsburgh, PA 15238  
(412) 963-1624

Inquiry 719.

## UTILITIES

### LOGGER®

Logger, for IBM-PC and compatibles, tracks and reports: User, Time on, Time off, Directories used, Programs used, Program start/end time, and calculates totals. Tracks directories/files: Opened, Created, Renamed, Deleted. Completely transparent. Retails for \$74.95 with quantity discounts available.

#### System Automation Software, Inc.

8555 16th St., Silver Spring, MD 20910

1-800-321-3267 or 1-301-565-8080

Inquiry 720.

### FastRetrieve®

FastRetrieve, for IBM-PC and compatibles, indexes your wordprocessing documents to instantly (< 1 sec.) retrieve text using your search expressions (boolean statements, phrases, spelling variations). Retrieved text can be edited, printed, and saved to disk. Retails for \$99. Discounts available.

#### System Automation Software, Inc.

8555 16th St., Silver Spring, MD 20910

1-800-321-3267 or 1-301-565-8080

Inquiry 721.

### \$79.95!!

Buy the RED Utilities now! Programs include: Disk cache to speed hard disk. Printer spooler. Batch file compiler. Path command for data files. Wild card exceptions. Protect hard disk from accidental formatting. Sort directories. Over 10 more programs. IBM PC. Visa/MC.

#### The Wenham Software Company

5 Burley St., Wenham, MA. 01984 (617) 774-7036

Inquiry 722.

## WORD PROCESSING

### FARSI / GREEK / ARABIC / RUSSIAN

Hebrew, all European, Scandinavian, plus either Hindi, Punjabi, Bengali, Gujarati, Tamil, Thai, Korean, Viet. or IPA. Full-featured multi-language word processor supports on-screen foreign characters and NLQ printing with no hardware modifications. Includes Font Editor. \$355 dot matrix; \$150 add'l for laser; \$19 demo. S/H in U.S. incl'd. Req. PC, 640K, graphics. 30 day Guarantee. MC/VISA/AMEX

#### GAMMA PRODUCTIONS, INC.

710 Wishire Blvd., Suite 809, Santa Monica, CA 90401  
213/394-8622 Tlx: 5106008273 Gamma Pro SNM

Inquiry 723.

### DuangJan

Bilingual word processor for English and: Armenian, Bengali Euro/Latin, Greek, Hindi, Khmer, Lao, Punjabi, Russian, Sinhalese, Tamil, Thai, Viet... \$109+\$5 s/h (foreign + \$12 s/h). Font editor included. For IBM with dot-matrix & LaserJet printer. Demo \$6 + \$1 s/h.

#### MegaChomp Company

3524 Cortman Ave., Philadelphia, PA 19149-1606  
(215) 331-2748

Inquiry 724.

### PC-Write™ Shareware Ver. 2.71

Fast, full featured word processor/text editor for IBM PC. With spell check, screen clip, mailmerge, split screen, ASCII files, macros. Easy to use. Supports 400 printers - LaserJet+ and PostScript. Software, User Guide, and Tutorial on 2 disks for \$16. Try it, then register with us for only \$89 and get User Manual, 1 year tele-support, newsletter and 2 upgrades. 90-day guarantee. VISA/MC.

#### Quicksoft 1-800-888-8088 CALL TODAY!

219 First N., #224-BYTC, Seattle, WA 98109

Inquiry 725.



**NEC V20 & V30 CHIPS**

Replace the 8086 or 8088 in Your IBM-PC and Increase Its Speed by up to 40%!

Part No.	1-9	10+	Price
UPD70108-5	(5MHz) V20 Chip		\$ 7.49
UPD70108-8	(8MHz) V20 Chip		\$ 8.95
UPD70108-10	(10MHz) V20 Chip		\$24.95 \$14.95
UPD70116-8	(8MHz) V30 Chip		\$ 11.95
UPD70116-10	(10MHz) V30 Chip		\$24.95 \$19.95

**7400**

Part No.	1-9	10+	Part No.	1-9	10+
7400	.29	.19	7485	.65	.55
7402	.29	.19	7486	.45	.35
7404	.29	.19	7489	2.05	1.95
7405	.35	.25	7490	.49	.39
7406	.39	.29	7493	.45	.35
7407	.39	.29	74121	.45	.35
7408	.39	.29	74123	.55	.45
7410	.29	.19	74125	.55	.45
7414	.49	.39	74126	.69	.59
7416	.39	.29	74143	3.95	3.85
7417	.39	.29	74150	1.35	1.25
7420	.35	.25	74154	1.35	1.25
7430	.35	.25	74158	1.99	.99
7432	.39	.29	74173	.65	.75
7438	.39	.29	74174	.59	.49
7442	.55	.45	74175	.59	.49
7445	.79	.69	74176	.99	.89
7446	.89	.79	74181	1.95	1.85
7447	.89	.79	74189	1.95	1.85
7448	2.05	1.95	74193	.79	.69
7472	.39	.29	74217	1.85	.79
7473	.39	.29	74221	.99	.89
7474	.39	.29	74273	1.95	1.85
7475	.49	.39	74365	.65	.55
7476	.45	.35	74367	.65	.55

**74LS**

Part No.	1-9	10+	Part No.	1-9	10+
74LS00	.29	.19	74LS165	.75	.65
74LS02	.29	.19	74LS166	.99	.89
74LS04	.35	.25	74LS173	.59	.49
74LS05	.35	.25	74LS174	.49	.39
74LS06	1.09	.99	74LS175	.49	.39
74LS07	1.09	.99	74LS189	4.59	4.49
74LS08	.29	.19	74LS191	.59	.49
74LS10	.29	.19	74LS193	.79	.69
74LS14	.49	.39	74LS221	.69	.59
74LS27	.35	.25	74LS240	.69	.59
74LS30	.35	.25	74LS243	.69	.59
74LS32	.39	.29	74LS244	.69	.59
74LS42	.49	.39	74LS245	.89	.79
74LS47	.99	.89	74LS259	.99	.89
74LS73	.39	.29	74LS273	.89	.79
74LS74	.35	.25	74LS279	.49	.39
74LS75	.39	.29	74LS322	4.05	3.95
74LS76	.55	.45	74LS365	.49	.39
74LS85	.35	.25	74LS367	.49	.39
74LS86	.35	.25	74LS368	.49	.39
74LS90	.49	.39	74LS369	.49	.39
74LS92	.49	.39	74LS373	.79	.69
74LS123	.59	.49	74LS374	.79	.69
74LS125	.49	.39	74LS393	.89	.79
74LS138	.49	.39	74LS590	6.05	5.95
74LS139	.49	.39	74LS624	2.65	1.49
74LS154	1.09	.99	74LS629	2.95	2.85
74LS157	.45	.35	74LS640	1.09	.99
74LS158	.45	.35	74LS645	1.09	.99
74LS163	.59	.49	74LS670	1.09	.99
74LS164	.59	.49	74LS688	2.39	2.29

**74S/PROMS\***

Part No.	Price	Part No.	Price
74S00	.29	74S188*	1.49
74S04	.29	74S189	1.69
74S08	.35	74S196*	6.49
74S10	.29	74S240	1.49
74S32	.35	74S244	1.49
74S74	.45	74S253	.79
74S85	1.79	74S287*	1.49
74S86	1.79	74S288*	1.49
74S124	2.75	74S373	1.49
74S174	.79	74S474*	2.95
74S175	.79		

**74F**

Part No.	Price	Part No.	Price
74F00	.29	74F139	.69
74F04	.29	74F157	.69
74F08	.29	74F193	2.95
74F10	.29	74F240	.99
74F32	.29	74F244	.99
74F74	.39	74F253	.69
74F86	.39	74F373	.99
74F138	.69	74F374	.99

**CD-CMOS**

Part No.	Price	Part No.	Price
CD4001	.19	CD4076	.59
CD4008	.69	CD4081	.25
CD4011	.19	CD4082	.25
CD4013	.29	CD4093	.89
CD4016	.29	CD4094	.89
CD4017	.49	CD4103	2.49
CD4018	.29	CD4107	.49
CD4020	.59	CD4109	.79
CD4024	.49	CD4510	.69
CD4027	.35	CD4511	.69
CD4030	.29	CD4520	.75
CD4040	.85	CD4522	.79
CD4049	.29	CD4538	.79
CD4050	.29	CD4541	.89
CD4051	.59	CD4543	.79
CD4052	.59	CD4553	4.95
CD4053	.59	CD4555	.79
CD4063	1.49	CD4559	7.95
CD4066	.29	CD4566	2.49
CD4067	1.95	CD4583	.69
CD4068	.25	CD4584	.69
CD4070	.25	CD4585	.69
CD4071	.25	MC14411P	8.95
CD4072	.25	MC14490P	4.49

**MICROPROCESSOR COMPONENTS**

MISCELLANEOUS CHIPS		6500/6800/68000 Cont.		6800 SERIES Cont.	
Part No.	Price	Part No.	Price	Part No.	Price
D765AC	4.95	6845	9.95	6228	2.95
WD9216	6.95	6850	1.95	6237-5	4.49
95H90	9.95	6854	1.49	6243	2.65
		6855	1.75	6250A	6.49
		6856	1.49	6250B (FO-IBML)	6.95
		6857	1.19	6251A	1.89
		6858	1.95	6253-5	1.95
		6859	1.95	6254	4.95
		6860	1.95	6255A-5	2.95
		6861	1.95	6259-5	2.25
		6862	1.95	6272	4.95
		6863	1.95	6273-5	2.95
		6864	1.95	6279-5	9.95
		6865	1.95	6280	9.95
		6866	1.95	6281	20.95
		6867	1.95	6282	19.95
		6868	1.95	6283	7.95
		6869	1.95	6284	9.95
		6870	1.95	6285	9.95
		6871	1.95	6286	9.95
		6872	1.95	6287	9.95
		6873	1.95	6288	9.95
		6874	1.95	6289	9.95
		6875	1.95	6290	9.95
		6876	1.95	6291	9.95
		6877	1.95	6292	9.95
		6878	1.95	6293	9.95
		6879	1.95	6294	9.95
		6880	1.95	6295	9.95
		6881	1.95	6296	9.95
		6882	1.95	6297	9.95
		6883	1.95	6298	9.95
		6884	1.95	6299	9.95
		6885	1.95	6300	9.95
		6886	1.95	6301	9.95
		6887	1.95	6302	9.95
		6888	1.95	6303	9.95
		6889	1.95	6304	9.95
		6890	1.95	6305	9.95
		6891	1.95	6306	9.95
		6892	1.95	6307	9.95
		6893	1.95	6308	9.95
		6894	1.95	6309	9.95
		6895	1.95	6310	9.95
		6896	1.95	6311	9.95
		6897	1.95	6312	9.95
		6898	1.95	6313	9.95
		6899	1.95	6314	9.95
		6900	1.95	6315	9.95
		6901	1.95	6316	9.95
		6902	1.95	6317	9.95
		6903	1.95	6318	9.95
		6904	1.95	6319	9.95
		6905	1.95	6320	9.95
		6906	1.95	6321	9.95
		6907	1.95	6322	9.95
		6908	1.95	6323	9.95
		6909	1.95	6324	9.95
		6910	1.95	6325	9.95
		6911	1.95	6326	9.95
		6912	1.95	6327	9.95
		6913	1.95	6328	9.95
		6914	1.95	6329	9.95
		6915	1.95	6330	9.95
		6916	1.95	6331	9.95
		6917	1.95	6332	9.95
		6918	1.95	6333	9.95
		6919	1.95	6334	9.95
		6920	1.95	6335	9.95
		6921	1.95	6336	9.95
		6922	1.95	6337	9.95
		6923	1.95	6338	9.95
		6924	1.95	6339	9.95
		6925	1.95	6340	9.95
		6926	1.95	6341	9.95
		6927	1.95	6342	9.95
		6928	1.95	6343	9.95
		6929	1.95	6344	9.95
		6930	1.95	6345	9.95
		6931	1.95	6346	9.95
		6932	1.95	6347	9.95
		6933	1.95	6348	9.95
		6934	1.95	6349	9.95
		6935	1.95	6350	9.95
		6936	1.95	6351	9.95
		6937	1.95	6352	9.95
		6938	1.95	6353	9.95
		6939	1.95	6354	9.95
		6940	1.95	6355	9.95
		6941	1.95	6356	9.95
		6942	1.95	6357	9.95
		6943	1.95	6358	9.95
		6944	1.95	6359	9.95
		6945	1.95	6360	9.95
		6946	1.95	6361	9.95
		6947	1.95	6362	9.95
		6948	1.95	6363	9.95
		6949	1.95	6364	9.95
		6950	1.95	6365	9.95
		6951	1.95	6366	9.95
		6952	1.95	6367	9.95
		6953	1.95	6368	9.95
		6954	1.95	6369	9.95
		6955	1.95	6370	9.95
		6956	1.95	6371	9.95
		6957	1.95	6372	9.95
		6958	1.95	6373	9.95
		6959	1.95	6374	9.95
		6960	1.95	6375	9.95
		6961	1.95	6376	9.95
		6962	1.95	6377	9.95
		6963	1.95	6378	9.95
		6964	1.95	6379	9.95
		6965	1.95	6380	9.95
		6966	1.95	6381	9.95
		6967	1.95	6382	9.95
		6968	1.95	6383	9.95
		6969	1.95	6384	9.95
		6970	1.95	6385	9.95
		6971	1.95	6386	9.95
		6972	1.95	6387	9.95
		6973	1.95	6388	9.95

# Now Available...Jameco's NEW Summer Flyer #137 with 48 pages of Computer Peripherals, Components & More!



## JAMECO SOLDERLESS BREADBOARD SOCKETS

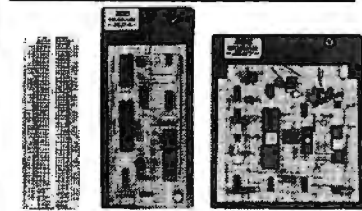

Part No.	Dim. L" x W"	Contact Points	Binding Posts	Price
JE23	6 1/2 x 3/4	200	0	\$ 2.29
JE21	3 1/4 x 2 1/2	400	0	\$ 4.49
JE22	6 1/2 x 1 1/2	630	0	\$ 5.95
JE23	6 1/2 x 2 1/2	830	0	\$ 7.49
JE24	6 1/2 x 3 1/2	1,360	2	\$14.95
JE25	6 1/2 x 4 1/4	1,660	3	\$22.95
JE26	6 1/2 x 5 1/4	2,390	4	\$27.95
JE27	7 1/4 x 7 1/2	3,220	4	\$37.95

## COMPUTER PERIPHERALS



- Award BIOS ROMs included
- JE1001
- JE1002 4.77/8MHz (PC/XT) ... \$ 99.95
- JE1002 4.77/10MHz (PC/XT) ... \$119.95
- JE1007 6/8/10/12MHz (AT) ... \$349.95

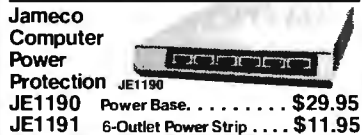

- JE1190 Power Base. .... \$29.95
- JE1191 6-Outlet Power Strip ... \$11.95



- JE1016 Pictured
- JE1015 Standard AT layout (XT/AT) .. \$59.95
- JE1016 Enhanced layout (XT/AT) ... \$79.95

## Jameco Extended 80-Column Card for Apple IIe



- 80 Col./64K RAM - Doubles amount of data your Apple IIe can display as well as its memory capacity - Ideal for word processing - Complete with instructions
- JE864 \$39.95

## ADD12 (Disk Drive II, II+, IIe) \$99.95

DATA BOOKS	
400041 NSC Linear Data Book-Vol. I (88).....	\$14.95
400042 NSC Linear Data Book-Vol. II (88).....	\$ 9.95
400043 NSC Linear Data Book-Vol. III (88).....	\$ 9.95
210830 Intel Memory Handbook (88).....	\$17.95
230843 Intel Microsystem Handbk. Set (88)....	\$24.95

U.S. Funds Only  
Shipping: Add 5% plus \$1.50 Insurance  
(May vary according to weight)

California Residents:  
Add 6%, 6 1/2% or 7%  
Sales Tax  
FAXES: 415-592-2503  
or 415-595-2664



Data Sheets - 50¢ each  
Prices Subject to Change

Send \$2.00 Postage for a FREE 1988 CATALOG

Telex: 176043

©1988 Jameco Electronics

8/88

1355 Shoreway Rd., Belmont, CA 94002 • 24 HR. ORDER HOTLINE 415-592-8097 • All Other Inquiries (7am-5pm PST) 415-592-8121

## IBM AT COMPATIBLE KIT Mini-286 6/8/10/12MHz Kit

- Baby AT Motherboard (Zero-K RAM - includes Award BIOS ROMs)..... \$349.95
- JE1015 XT/AT Style Keyboard..... \$ 59.95
- JE1017 Baby AT Flip-Top Case..... \$ 69.95
- JE1022 5 1/4" Hi-Density Disk Drive... \$109.95
- JE1032 200 Watt Power Supply..... \$ 89.95
- JE1043 360K/720K/1.2M Floppy Controller Card..... \$ 49.95
- JE1065 Input/Output Card..... \$59.95

Regular List \$789.55

SAVE \$99.70!  
JE1059 \$519.95 (EGA Monitor and Card not included)

JE2009\* IBM AT Compatible Kit..... \$689.95

JE286M JE2009 Technical Manual..... \$29.95  
\*RAM not included - Minimum RAM configuration 512K (18 Chips 41256-120, see left)

## IBM COMPATIBLE DISPLAY MONITORS

- 12" Amber Monochrome - TTL Input, High Resolution (PC/XT/AT) AMBER..... \$99.95
- 14" RGB Color - CGA Compatible Amber/Green/Color Switchable, 640 x 200 Resolution (PC/XT/AT) TTX1410..... \$279.95
- 14" EGA Color - EGA/CGA Compat., 720 x 350 Max. Resolution (PC/XT/AT) TE5154..... \$399.95
- 14" EGA Monitor and EGA Card - EGA compatible, 720 x 350 Max. Resolution - displays up to 16 colors (PC/XT/AT) JE1059..... \$519.95
- 14" Multiscan Color - VGA/PGC/EGA compatible, 800 x 600 Max. Resolution (PC/XT/AT) CTX1435..... \$549.95

## IBM PC/XT/AT COMPATIBLE CARDS

### Graphic Display Cards



- JE1050 Mono Graphics Card w/Printer Port (PC/XT/AT)..... \$59.95
- JE1052 Color Graphics Card w/Printer Port (PC/XT/AT)..... \$49.95
- JE1055 EGA Card with 256K Video RAM (PC/XT/AT)..... \$169.95
- JE1071 Multi I/O with Drive Controller and Mono Graphics (PC/XT)..... \$119.95

### Multifunction, I/O and Expansion Cards

- JE1060 I/O Card with Serial, Game, Parallel Printer Port and Real Time Clock (PC/XT)..... \$59.95
- JE1061 RS232 Serial Half Card (PC/XT/AT)..... \$29.95
- JE1065 I/O Card with Serial, Game and Parallel Printer Port (AT)..... \$59.95
- JE1078 Expand to 384K (zero-K on-board) Multifunc. w/Serial, Game, Parallel Printer Port & Real Time Clock (PC/XT) .. \$69.95
- JE1081 2MB of expanded or extended memory (zero-K on-board) (AT)..... \$119.95
- JE1082 3MB of expanded or extended memory, parallel printer port, serial port and game port (zero-K on-board) (AT)..... \$169.95

### Floppy and Hard Disk Controller Cards

- JE1040 360KB Floppy Disk Drive Controller Card (PC/XT)..... \$29.95
- JE1041 20/40MB Hard Disk Controller Card (PC/XT)..... \$79.95
- JE1043 360K/720K/1.2MB Floppy Disk Cont. Card (PC/XT/AT) \$49.95
- JE1045 360K/720K/1.2MB Floppy/Hard Disk Controller Card (AT)..... \$149.95



## COMPUTER PERIPHERALS

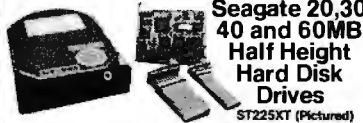

- ST225 20MB Drive only (PC/XT/AT)..... \$224.95
- ST225XT 20MB w/Controller (PC/XT)..... \$269.95
- ST225AT 20MB w/Controller (AT)..... \$339.95
- ST238 30MB Drive only (PC/XT/AT)..... \$249.95
- ST238XT 30MB w/Controller (PC/XT)..... \$299.95
- ST238AT 30MB w/Controller (AT)..... \$389.95
- ST251 40MB Drive only (PC/XT/AT)..... \$429.95
- ST251XT 40MB w/Cont. Card (PC/XT)..... \$469.95
- ST251AT 40MB w/Controller Card (AT)..... \$539.95
- ST277 60MB Drive only (PC/XT/AT)..... \$499.95
- ST277XT 60MB w/Controller (PC/XT)..... \$549.95
- ST277AT 60MB w/Controller Card (AT)..... \$639.95

### 40MB Tape Back-Up for IBM PC/XT/AT

- XR4 40MB Tape Back-Up... \$369.95
- TB40 40MB Tape Cartridge..... \$24.95



- JE1020 360K Black Bzl. (PC/XT/AT) ... \$ 89.95
- JE1021 360K Beige Bzl. (PC/XT/AT) ... \$ 89.95
- JE1022 1.2MB Beige Bzl. (PC/XT/AT) . \$109.95

### 3.5" PC/XT/AT Compatible Disk Drives

- 352KU 3.5" 720KB (Bezels and Installation Kit Incl.) (PC/XT/AT)..... \$129.95
- MF355B 3.5" 1.44MB (Bezels and Installation Kit Incl.) (PC/XT/AT)..... \$149.95

## 2400/1200/300 Modems

- Datronics**
  - Hayes command compatible
  - Bell 103/212A compatible
  - Auto-dial/auto-answer
  - FCC approved
  - 1-year warranty
  - Includes MaxiMite Communication Software
- 1200H 1200/300 Baud Internal Modem... \$ 69.95
- 2400S 2400/1200/300 Internal Modem... \$139.95
- 1200C 1200/300 Baud External Modem... \$119.95
- 2400E 2400/1200/300 External Modem... \$179.95

## TEST EQUIPMENT

### Digital Multimeters

- Kingdom KD302:**
  - Pocket Size in handy carry case
  - 3 1/2 Digit LCD
  - Auto or manual ranging
  - Audible continuity tester
  - Tests: AC/DC Voltage, Resistance and Continuity
  - One Year Warranty
  - Size: 4 1/4" x 2 1/8" x 1 1/8"
- KD302 .. \$27.95

- Metex M4650:**
  - Handheld, high accuracy
  - 4 1/2 Digit LCD
  - Manual ranging with Overload Protection
  - Audible continuity tester
  - Tests: AC/DC Voltage, Resistance, Continuity Capacitance, Frequency
  - One Year Warranty
  - Size: 7 1/4" x 3 1/2" x 1 1/8"
- M4650 .. \$89.95

# MONTGOMERY GRANT

BYTE  
8/88

Warehouse address: 33 34th Street, Brooklyn, N.Y. 11232

Circle 153 on Reader Service Card

**OUTSIDE USA---CALL  
(718)692-0071**

FOR CUSTOMER SERVICE  
Call Mon-Fri: 9:30am-5pm  
(718)692-1148

**FOR ORDERS & INFORMATION  
CALL TOLL FREE**

**1-800-759-6565**

CORPORATE LEASING AVAILABLE

OR WRITE TO:  
Montgomery Grant  
P.O. Box 58 Brooklyn, NY 11230  
FAX NO. 718-692-3372  
TELEX NO. 422132HMOLLER

OPEN 7 DAYS A WEEK FOR ORDERS: Monday - Friday 9:00 AM - 7:30 PM / Saturday & Sunday 9:30 - 6 PM (EDT)

### The LAPTOP BOX

**TOSHIBA 1000**  
-512K RAM-720K Floppy Drive  
4.77MHz - Super Twist LCD  
Screen

**\$699**

NEC MULTISPEED..... \$979  
NEC MULTISPEED EL.II \$1369  
NEC MULTISPEED HD. \$2149

TOSHIBA 1200.....\$2149  
TOSHIBA 3100/20.....\$2929  
TOSHIBA 3200.....\$3695  
TOSHIBA 5100.....\$4895  
TOSHIBA 1100+.....\$1369

ZENITH 181.....\$1349  
ZENITH 183/20.....\$1949  
SPARK by Datavue  
640K w/2 720K Drives.....\$989  
SPARK EL.....\$1149

MODEMS, EXTERNAL  
DRIVES and ACCESSORIES  
available for all Laptops!

### EPSON

**EPSON EQUITY 1+ Package**  
IBM PC/XT COMPATIBLE  
-640K RAM w/Clock Calendar  
360K Drive-Keyboard-Serial &  
Parallel Ports-12" High Resolu-  
tion Monitor-Box of 10 Diskettes

**\$769**

Same Pkg w/One Floppy & 20 MB Hard Drive **\$1029**  
Same Pkg. w/Two 360K Floppy Drives **\$849**

**EPSON EQUITY III+**  
40 MB Hard Drive Package  
IBM AT Compatible  
-Keyboard-80286 Processor  
640K RAM-6/8/10 Mhz -1.2 MB  
Floppy Drive-40MB Hard Drive  
12" Monitor-8 Expansion Slots  
Serial and Parallel Ports

**\$1899**

### IBM XT

**CLEARANCE**

**Hard Drive Package**  
- IBM XT Computer - IBM Keyboard 256K  
RAM Expandable to 640K - 360K Disk Drive  
- 20MB Hard Drive - Package of 10 Diskettes  
(Monitor Optional)

**\$1299**

IBM XT Package with  
2 360K Floppy Drives **\$1079**

### IBM PERSONAL SYSTEM 2

**MODEL 30 Package**  
- IBM Computer - Two 720K  
Drives - 640 K RAM - Built-in  
Graphics - Serial and Parallel  
Ports-Optional 12" Monitor

**\$1199**

PS/2 MODEL 30 with 720K  
Floppy Drive & 20MB IBM  
Hard Drive **\$1599**

**MODEL 50**  
640K RAM 720K Floppy Drive  
20 MB Hard Drive

**\$2599**

PS/II Model 25.....\$1049  
PS/II Model 25 w/Color Monitor.....\$1299  
PS/II Model 50 w/44 MB & 720K Floppy.....\$3299  
PS/II Model 60 w/70 MB & 720K Floppy.....\$3698  
PS/II Model 80 w/44 MB & 720K Floppy.....\$4295  
PS/II Model 80 w/70 MB & 720K Floppy.....\$4893

5.25 External Drive for PS/II.....\$229

IBM Personal System II Monitors  
8500 Monochrome Monitor.....\$209  
8512 Color Monitor.....\$459  
8513 Color Monitor.....\$519  
IBM Printer II.....\$369

### NEC PowerMate 1

IBM PC/XT/AT COMPATIBLE  
PACKAGE  
- 800286 10 Mhz Processor  
640K RAM-1.2 MB Floppy Drive  
12" Monitor **\$1299**

Same Package with NEC  
20 MB Hard Drive **\$1529**

Powermate II  
with Monitor **\$1799**

### COMPAQ

**DESKPRO 386 MODEL 40**  
Hard Drive Package  
- Keyboard - 80386 16 Mhz  
Microprocessor-1 MB RAM-40  
MB Hard Drive-1.2 MB Floppy  
Drive (monitor optional)

**\$4295**

### APPLE PACKAGES

- Apple IIC or IIE Keyboard -  
5.25" Disk Drive - 12" Monitor  
- All Hook-up Cables &  
Adaptors - Pkg. of 10 Diskettes

APPLE IIC **\$579**    APPLE IIE **\$779**

Apple IIGS Computer - 3.5" Disk  
Drive - Apple RGB Color Monitor  
Package of 10 Diskettes - All  
Cables & Adaptors - Package of  
10 Diskettes - Apple Software

MAC PLUS Computer Package.....\$1399  
IMAGEWRITER II Printer.....\$449  
MAC SE Computer w/Dual Drive.....\$1949  
MAC SE Computer w/20MB  
APPLE Hard Drive.....\$2599  
APPLE MAC II.....CALL

**\$1379**

### LEADING-EDGE™

**MODEL D Package**  
IBM PC/XT Compatible

512 K RAM Keyboard - 4.7-7.16 Mhz.  
360K Floppy Drive - 12" Monitor  
8088-2 Processor

**\$729**

Same Package with  
20 MB Hard Drive **\$989**

### AMSTRAD

IBM PC/XT Compatible  
PACKAGE  
512K - One 360K Drive-  
Clock Calendar - Mono-  
graphics Card - Serial &  
Parallel Ports - Mono  
Monitor - Mono Monitor  
Stand

Same Pkg. with  
20 MB Hard Drive **\$839**

**VENDEE HEADSTART** IBM PC/XT  
Compatible  
4.77-8 Mhz. Dual Floppy Drives - 7  
Expansion Slots - 512K Expandable  
to 768K - Parallel & Serial Ports  
Mouse - Available in Color or Mono  
System - Over 1000 Worth of  
Software - NO CHARGE!

Mono System **\$849**    Color System **\$999**

### HARD DRIVES

SEAGATE  
20MB 1/2 Ht. w/Controller.....\$289  
30MB 1/2 Ht. w/Controller.....\$319  
40MB 1/2 Ht. w/Controller.....\$439

MINISCRIBE  
40MB 1/2 Ht. w/Controller.....\$369  
CMS 20MB Card.....\$339  
CMS 30MB Card.....\$379

### PRINTERS

**EPSON**  
FX-86E.....\$289.95  
FX-286E.....\$419.95  
LQ-800.....\$315.95  
LQ-850.....\$329.95  
LQ-850.....\$509.95  
LQ-1050.....\$699.95  
EX-800.....\$419.95  
LX-800.....\$199.95

**PANASONIC**  
1080-II.....\$159.95  
1092I.....\$289.95  
1091-1I.....\$189.95  
KXP-1524.....\$499.95

**TOSHIBA**  
321-SL.....\$479.95  
341-SL.....\$649.95  
351-SL.....\$799.95

### PRINTERS

**OKIDATA**  
Oki-120.....\$189.95  
Okiwrite 180.....\$119.95  
Okiwrite 180.....\$219.95  
Okiwrite 183.....\$289.95  
Diconix Inkjet \$295.95

**STAR**  
NX-1000.....\$219.95  
RAINBOW.....\$219.95  
NX-1000.....\$169.95  
NX-15.....\$289.95  
NX-2400.....\$339.95  
NB-2410.....\$409.95  
NB-2415.....\$559.95

**NEC**  
P-2200.....\$339.95  
P-6.....\$419.95

### MONITORS

THOMSON 14" CGA Monitor.....\$289  
THOMSON TTL Amber 12".....\$69  
MAGNAVOX 13" RGB Color.....\$199  
MAGNAVOX EGA Monitor.....\$339  
with EGA Card.....\$459  
NEC Multisync II Monitor.....\$559

**HP Laserjet, Series II**  
1 MB Expander \$349  
HP DESKJET PRINTER-719 **\$1599**

### Commodore

**128 PACKAGE**  
Commodore 128 Computer - Commodore 1571 Disk  
Drive-Commodore 1902 Color RGB Monitor  
- Commodore 1515 Column Printer **\$699**

**64/c PACKAGE**  
Commodore 64/c Computer - Commodore 1541 Disk  
Drive-Computer Printer  
- 12" Computer Monitor **\$399**

### Commodore AMIGA

**AMIGA 500 Computer**  
w/1084 RGB Monitor **\$779**

**AMIGA 500 Computer**  
w/1084 Monitor & 1010  
3.5" Floppy Drive **\$979**

ALL PERIPHERALS IN STOCK  
A-501 512K EXPANSION - A-1010 3.5" FLOPPY  
DRIVE-A-1020T 5.25" DISK DRIVE WITH TRANS-  
FORMER - A-2068D BRIDGE CARD- A-1084 RGB,  
COLOR MONITOR - A-1680 MOEM - A-1060  
SIDE CAR - A-2090 HARD DRIVE CONTROLLER,  
FOR A-2000 - A-2010 3.5" INTERNAL DISK DRIVE,  
FOR A-2000-A-2062 2MB EXPANSION FOR A-2000

**AMIGA 2000 IN STOCK**

### BLUE CHIP

Monitor Package  
IBM PC/XT Compatible

512K Expandable to 640K - 360K Floppy  
Drive - 12" Monitor - Box of 10 Diskettes -  
Game Disk

**\$449**

Same Package with  
20 MB Hard Drive **\$699**

### Commodore

**PC10-1**  
IBM PC/XT Compatible  
PACKAGE

- PC10-1 Computer - 512K RAM Ex-  
pandable to 640K - 360K Disk Drive  
Enhanced Keyboard - Serial & Parallel  
Ports - 12" Monitor - AC Adaptors - All  
Hook-up Cables - Pkg of 10 Diskettes

**\$499**

Same Package with  
20 MB Hard Drive **\$749**



Certified Checks, Bank Checks, Money Orders, Mastercard, Visa, Amex, Diners Club, Cash, Discover Card, C.O.D. and approved P.O.s accepted. No additional surcharge for credit card orders. Non-cashier checks must wait 4 weeks for clearance. Please add 5% for shipping and handling. APO/FPO addresses: Add 10% for shipping and handling. All APO/FPO are shipped first class priority mail. NY residents add applicable sales tax. Prices subject to change without notice. Not responsible for typographical errors. Returns of defective merchandise must have prior return authorization number or rebate will not be accepted. IBM PC/XT/AT are registered trademarks of International Business Machines Corp. All orders can be shipped Air Express. Call for details. For your protection we check for credit card theft.

NO ADDITIONAL SURCHARGE FOR CREDIT CARD ORDERS WE WELCOME CORPORATE & EDUCATIONAL ACCOUNTS



# Compu\$ave

Call Toll Free: 1-800-624-8949

## BOARDS

Above Board 286	319	Orchid Tiny Turbo	259
Adv. Dig. Slave	SAVE	Orchid Designer	268
AST 4 Port	309	Paradise 480Auto	145
AST 5251-11E	595	Paradise VGA+	238
ATI VGA Wonder	SAVE	Paradise VGA Pro	352
ATI EGA Wonder	172	STB VGA EM	299
BOCA RAM AT	142	Sigma VGA H	252
Genoa EGA HiRes+	209	Vega Deluxe	179
Genoa VGA HiRes	435	Video 7 V RAM	489
Hercules VGA	242	Video 7 Vega VGA	252
Melhus 1104	1099	VMI IM 1024	2795
Artist/BNW/Everex/Number 9/Computone	CALL		
Talltree/Quadram/Vericom/Intel/West. Dig.	CALL		

## MONITORS

Amdek 310A	69	PGS Ultra Synch	498
Amdek 1280	645	PGS LM 300	539
Intercolor 19"VGA	1595	Tatung Multiscan	479
Mitsubishi 1371A	489	Taxan 770+	515
Mitsubishi 20" Auto	1845	Thomson 4160RGB	225
NEC Multisync II	569	Thomson EGA	299
NEC Multisync +	915	Sigma Laser 19"	1765
NEC Multisync XL	2095	Wyse 700	678
NEC Multisync GS	179	Verticom 2 Page	1765
Magnavox Multi	512	Zenith 1490	598
Seiko 1430: 14", Multiscan, 1024x768, 26mm	649		

## SCANNERS

PC Hand Scanner	158	Datacopy 730	1095
PGS LS-300 fw PC Paintbrush & OCR	965		
AST/Hewlett Packard/Taxan/Others	CALL		

## COMPUTERS

AST Model 286	CALL	Sharp PC-7100	1745
AST Model 386	CALL	Toshiba 1000	729
Mitsubishi 286/110	1039	Toshiba T1200F	1635
NEC Laptops	SAVE	Toshiba T1200H	2395
Intel 25 MHz	CALL	Toshiba 3100/20	2995
Samsung Laptops SAVE	Toshiba 3200	3685	
Sharp PC-7000A	1165	Toshiba 5100	4785
Sharp 4521	1975	Zenith Supersport	1625
Sharp PC-4502	1165	Zenith Supersport 286	3395
Acer 80386:16 MHz/0 Wait/1 Meg Ram	2745		
Acer 80386:20 MHz/0 Wait	CALL		
NEC Powermate Portable 286/640k/20M	2645		
NEC Powermate Portable 286/640k/40M	3095		
Sperry PC IT 512k/44M HD/Keyboard	2795		
Samsung S500 AT: 10MHz/40M Drive	1565		
Televideo 386: 16 MHz/2m/1.2M Drive	2595		
Wyse 2108: 8 MHz/512k/1.2M Drive	1199		
Wyse 2112: 12.5 MHz/1M/1.2M Drive	1699		
Wyse 2214: 12.5 MHz/0 Wait/1.2M Drive	1895		
Wyse 386: 16 MHz/1M/1.2M Drive/0 Wait	2795		
Unisys 386: 16 MHz/1M/1.2M Drive/0 Wait	2599		
ITT/Altos/Compaq/AT&T/Apple	CALL		

## TERMINALS

Altos V	485	Televideo 965	419
IBM 3151	385	Wyse 30	289
Kimtron KT-70 PC	359	Wyse 50	359
Link	CALL	Wyse 60	395
Televideo 905	315	Wyse 85G	399
Televideo 955	375	Wyse 99GT	469
Visual/Link/CIE/Addis/Quem/Falco	CALL		

## PLOTTERS

Calcomp 1023GT	3785	Houston 62	4495
Calcomp 5902	3395	HP 7475	1395
Calcomp 1043GT	6275	HP 7550 A	2895
Enter SP 1800	3095	HP 7595	7595
Houston DMP 52	2795	Ioline 3700	3045
Houston 41/42	2095	Ioline 4000	3995
Houston 61	3295	Roland 980	1195
Houston 56A	3795	Roland 880	929
Numerics/Taxan/Versatec/JDL/Other Models	CALL		

## DIGITIZERS

Calcomp 12 x12	365	Kurta IS 8.5 x 11	249
Calcomp 44 x 60	3745	Kurta IS 12 x 12	315
Calcomp 36 x 48	3195	Kurta IS 12 x 17	535
GTCO 24 x36	1945	Summa 12 x 12 +	348
GTCO 36 x 48	2395	Summa 12 x 18	598
Hitachi 11 x 11	439	Summa 24 x 36	3095
Kurta IS 3	CALL	Summa 42 x 60	4195

## MODEMS

ATI ETC.	159	Novation Parrot	85
Anchor 2400E	145	Practical 1200I	65
AST 9600	779	Prometheus 2400B/2	119
Avatec 1200 Ext.	9.5	Prometheus 2400G	149
Hayes 1200	279	Racal-Vadic 2400VP	399
Hayes 2400	412	USR Courier 2400	299
Incomm T2400 MNP	235	USR 2400E	345
Migent Pocket	109	USR HST 9600	649
Multitech 224 EH	388	Ven-Tel 18000	939
Multitech 224 EC	325	Zoom 2400 HC	139
Avatec/Case/Everex/UDS/Other Models	CALL		

## PRINTERS

Alps Allegro 24	365	NEC 5200	528
Canon BJ 130	795	NEC 5300	698
Citizen 120D	142	NEC P5XL	815
Citizen 180D	158	NEC P9XL	1018
Citizen MSP40	282	Panasonic 1080M2	158
Citizen MSP45	408	Panasonic 1091M2	198
Fujitsu DL3400	512	Panasonic 1524	549
Okidata 390	475	Panasonic 1595	439
Okidata 391	649	Star NX1000	169
NEC P2200	325	Toshiba P351SX	959
Canon 8II	1565	NEC LC 890	3185
HP Laser Jet II	SAVE	Quadram Postscript	2795
Brother/Citoh/Data Products/Data South	CALL		
Diconx/Epson/Genicom/QMS/OTC/TI	CALL		

## SOFTWARE

C Compiler 5.1	279	MS Word 4.0	212
Carbon Copy+ 5.0	108	PC EXCEL 2.01	299
DBase III Plus	374	Quattro	142
Fastback Plus	95	Ventura Publisher	499
Harvard Graph 2.1	275	WordPerfect 5.0	199

## DISK DRIVES

MAC Hard Drives	Call	Seagate 20M Kit	265
Miniscribe 40M	312	Seagate 30M Kit	282
Miniscribe 6053	509	Seagate 251	375
Miniscribe 6085	695	Seagate ST251-1	445
PlusCard 20M	522	Seagate 4096	695
PlusCard 40M	655	Toshiba 3.5" Kr	94
AST/Archive/Alloy/CDC/Genoa/Iomega	CALL		
Micropolis/Maynard/Maxtor/Talgrass/Tecmar	CALL		

HOURS: MON-FRI 7AM-6PM/SAT 9AM-2PM

ARIZONA SALES: (602)437-4855, CUSTOMER SERVICE (602)437-4856  
CompuSave: 4207 S. 37th St. Phoenix AZ 85040. Prices reflect cash discounts and are subject to change without notice. We do not guarantee compatibility. Major credit cards and selected PO's are accepted.

International orders are welcome.

### PACIFIC-286-12

- 80286-12
- 1 2MB Floppy Drive (Option \$120 3 1/2" Drive)
- 640K Ram (Option \$95 for 360K Drive)
- Serial/Parallel
- 101-Key Enhanced Key Board
- SI - 13.3 (1 Wait)
- SI - 15.2 (0 Wait \$150 Option)
- 6/12 MHz Key Board Switchable
- WA2 HD & FD Controller



- MONO SYSTEM**
- W/Mono Monitor
- 20 MB Hard Disk
- \$1195**
- CGA COLOR SYSTEM**
- W/CGA Monitor
- 20 MB Hard Disk
- \$1395**
- EGA COLOR SYSTEM**
- W/EGA Card
- W/EGA Monitor
- W/20 MB Hard Disk
- \$1580**

### LCD-286 PORTABLE

- 10 MHz 80286
- 640K Ram
- SI - 10.3
- Key Board
- LCD Screen
- Super Twist Back Lighting
- Serial/Parallel
- 1.2 MB Floppy Drive
- 80287 Socket
- 200 W Power Supply
- 20 MB Hard Disk
- 23 lbs.
- Size 15 1/2" x 9 1/4" x 8"

\$1595



### PACIFIC-386

- 80386-16 (20 MHz)
- SI - 23
- 1 MB Memory
- One 1.2 MB Floppy Drive
- 40 MB (Seagate ST-251)
- 101 Enhanced Key Board
- 200 W Power Supply
- I/O Card Serial/Parallel
- 80387 Socket

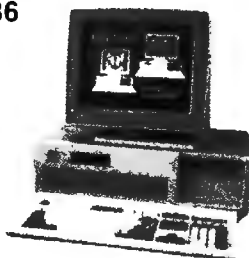

- MONO SYSTEM**
- W/Mono/P Card
- Mono Monitor
- \$2395**
- EGA COLOR SYSTEM**
- W/EGA Card (640x350)
- EGA Monitor
- \$2785**

### CRT-PORTABLE 8088

- Compaq Type
- 8088-110 MHz
- 2 Floppy Drive
- 150W Power Supply
- TTL Display 8" Amber
- Key Board

\$770



### CRT-PORTABLE-286

- Compaq Type
- 80286 (10 MHz or 12 MHz)
- One 1.2 MB Floppy Drive
- 200 W Power Supply
- TTL Display 8" Amber
- At Key Board
- I/O Card Serial/Parallel
- WA2 HD & FD Controller
- 20 MB Hard Disk

\$1389

PRICE SUBJECT TO CHANGE WITHOUT NOTICE

Dealers are welcome  
Call For Quantity Price

## PACIFIC COMPUTER (818) 571-5548

120 E. Valley Blvd., #H, San Gabriel, CA 91776  
FAX: 818-571-0905

(800) 346-7207 (California)  
(800) 421-1102 (Outside California)

ORDER ONLY



# RS-422/232

## CURRENT LOOP

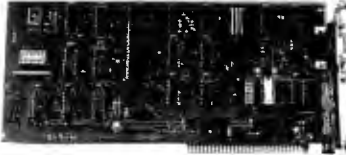

DS-225

- Single channel async communication board for IBM PC/XT/AT
- Software selectable to be RS/422/485, 232 or Current Loop
- Selectable Address & Interrupt

1-800-553-1170



478 E. Exchange St., Akron, OH 44304  
(216) 434-3154 TLX: 5101012726

Circle 186 on Reader Service Card

# SERIAL/PARALLEL

## Communications Board

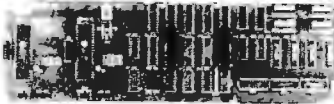

- Two Parallel Printer Ports
- Two 8-Bit Digital I/O Ports
- Two Serial Ports, RS-232, RS-422 or RS-485
- Address Selectable
- Selectable & Shareable Interrupts

1-800-553-1170



478 E. Exchange St., Akron, OH 44304  
TEL: (216) 434-3154 FAX: (216) 434-1409  
TLX: 5101012726

Circle 187 on Reader Service Card

# RS-422

## Communications Board

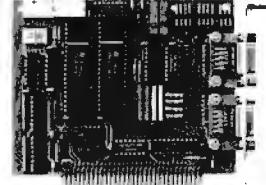

- For IBM PC/XT/AT/PS/2
- Dual channel RS-422/RS-485
- Selectable/shareable interrupts
- Differential drivers to 4000 ft.
- Immediate delivery

1-800-553-1170



Leaders in Communication Technology  
478 E. Exchange St., Akron, OH 44304  
(216) 434-3154 TLX: 5101012726

Circle 188 on Reader Service Card

# 72 Digital I/O



## PXB-721

### Parallel Expansion Board

- For IBM-PC & Compatibles
- 72 Digital I/O Lines
- Simple Programming
- Uses One Expansion Slot
- Fast Delivery

**\$195**

1-800-553-1170



478 E. Exchange St., Akron, OH 44304  
(216) 434-3154 TLX: 5101012726

Circle 189 on Reader Service Card

# MODULAR

## DATA ACQUISITION

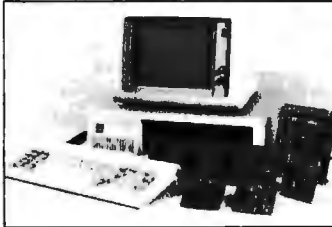

- FOR IBM & Compatibles
- Flexible and Inexpensive
- Money Back Guarantee
- Free Technical Support

Fast Delivery  
1-800-553-1170



Leaders in Communication Technology  
478 E. Exchange St., Akron, OH 44304  
(216) 434-3154 TLX: 5101012726

Circle 190 on Reader Service Card

# IEEE-488

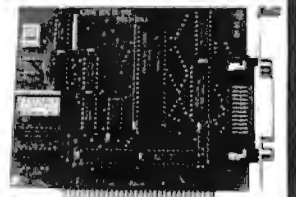

MXI-100

- GPIB controller board for IBM PC/XT/AT
- Control up to 14 Devices
- User friendly Software Commands
- DMA Transfer to 200k byte/sec.

\$345.00 including software



478 E. Exchange St., Akron, OH 44304  
(216) 434-3154 TLX: 5101012726  
800-553-1170

Circle 191 on Reader Service Card

# RS-232

## Communications Board

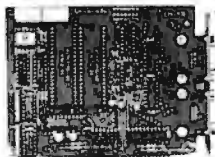

- For IBM-PC/XT/AT & comp.
- Dual RS-232C interface
- Optional software supports COM1, COM2, COM3, COM4
- Jumper selectable interrupts

Fast Delivery

1-800-553-1170



478 E. Exchange St., Akron, OH 44304  
(216) 434-3154 TLX: 5101012726

Circle 192 on Reader Service Card

# WAVEFORM

## SYNTHESIZER

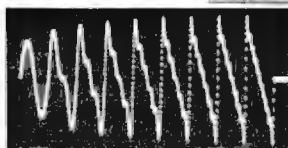
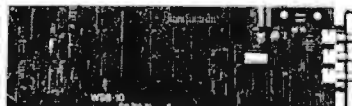

- For IBM PC/XT/AT and compatibles
- Generates user-definable signal
- Up to 2000 points per envelope

\$795.00

1-800-553-1170

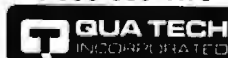

478 E. Exchange St., Akron, OH 44304  
(216) 434-3154 TLX: 5101012726

Circle 193 on Reader Service Card

# RS-422

## Communications Board

FOR

# PS/2

MODELS 50, 60, 80

- DUAL CHANNEL
- ADDRESS SELECTABLE
- BAUD RATE TO 256 K
- INTERRUPT SELECTABLE

1-800-553-1170



Leaders in Communication Technology  
478 E. EXCHANGE ST.  
AKRON, OH 44304  
(216) 434-3154 TLX: 5101012726  
FAX: (216) 434-1409

Circle 194 on Reader Service Card

**EXTERNAL  
2nd FLOPPY DRIVE  
FOR LAPTOPS**

Toshiba Tandy 1400 LT  
Datavue Zenith  
**\$219.95**

---

800K External Floppy  
for Mac **\$199.95**

---

2nd Floppy for  
IBM PC Jr **\$199.95**  
IBM PS 2 **\$199.95**

---

**True Data Products**  
115 So. Main Street  
Uxbridge, MA 01569  
1-800-635-0300  
1-617-278-6555

Circle 243 on Reader Service Card

**EPROM PROGRAMMER**  
\$349



THE EP-1'S A GREAT VALUE AND HERE'S WHY:

- READS, PROGRAMS, COPIES OVER 350 EPROM AND EEPROMS FROM 30 MFG'S INCLUDING 2716-27513, 2804-28256, 27011
- READS/WRITES INTEL, MOTOROLA, STRAIGHT HEX & BINARY
- OPTIONAL HEADS PROGRAM INTEL 874X, 8751, 87CS1, 8755
- MENU-DRIVEN CHIP SELECTION BY MFG & P/N; NO MODULES
- FAST, SLOW, QUICK PULSE PROGRAMMING ALGORITHMS
- SPUTS FILES BY BASE ADDRESS AND ODD/EVEN (16 & 32 BIT)
- ALL INTELLIGENCE IN UNIT: 280 MICROPROCESSOR BASED
- 5, 12.5, 21.25 V PROGRAMMING FOR CMOS & -A SUFFIX PARTS
- FREE PC-DOS SOFTWARE
- GOLD TEXT TOOL ZIF SOCKET
- MONEY BACK GUARANTEE
- 2 FREE FIRMWARE UPDATES
- CHECKSUMS SUPPORTED
- RS232 TO ANY COMPUTER
- 8 BAUD RATES TO 38,400
- ONE YEAR WARRANTY
- SAME DAY SHIPMENT
- UV ERASERS FROM \$34.95

**CALL TODAY FOR MORE INFORMATION**  
800/225-2102

**BP MICROSYSTEMS**  
10681 HADDINGTON #190, HOUSTON, TX 77043  
713/461-9430 TLX: 1561477 FAX: 713/461-7413

Circle 32 on Reader Service Card



**6805/6305 SINGLE CHIP  
MICROCOMPUTER  
DEVELOPMENT SYSTEMS**

Two systems allow the IBM PC/XT/AT to be used as a complete development system for the MOTOROLA 6805 series single chip microcomputers. Model MCPM-1 supports the MC68705P3, P5, U3, U5, R3, & R5 chips. Model MCPM-2 supports the MC1468705F2 & G2 cmos versions. Both systems are priced at \$495 and include a cross assembler program, a Simulator/Debugger program and a programming circuit board with driver software. A system is also avail. for the HITACHI 63705 ZTAT micro.

**THE ENGINEERS COLLABORATIVE**  
P.O. Box 53, West Glover, VT 05875  
**(802) 525-3458**

Circle 85 on Reader Service Card

**Motion Control &  
Data Acquisition**



A card in your PC creates the fast LAB 40 bus which supports up to 8 modules. User Friendly Packages for PC/XT/AT.

- **Intelligent DC Servo:** Joystick, numeric control, motion record/playback, C calls. Up to 16 axes. Two axis package w/motors \$1550 (USA).
- **4-Axis Stepper w/source code & motor \$316.**
- **Scope/FFT 650KHz A/D 4 ch. w/source \$525.**
- **Modules:** 8 & 12 bit A/D, Relay, Stepper, Clock, Servo & Amps, Prog Controller (Forth, A/D, EEPROM, 68HC11, RS-232/422/485, LAB 40).
- **Adapter for RS-232 for Mac and others.**
- **\*Free immediate technical support & literature. Call (415) 755-1978 or our BBS (415) 755-1524.**

75 Southgate,  
Daly City, CA 94015

**Computer Continuum**  
(415) 755-1978 Telex: 3727438

**UNIVERSAL LOGIC PROGRAMMER**



- PROGRAMS, READS, DUPLICATES, TESTS AND SECURES HUNDREDS OF 20- AND 24-PIN DEVICES
- 23 UNIVERSAL PIN DRIVERS WITH INDEPENDENT DAC, ADC & SLEW FUNCTIONS PROGRAM MOST ANY LOGIC DEVICE
- MENU DRIVEN OPERATION IS EASY TO LEARN AND QUICK TO OPERATE
- CONNECTS TO ANY IBM COMPATIBLE COMPUTER VIA PARALLEL PRINTER PORT
- EDITS FUSE DATA & TEST VECTORS WITH FULL SCREEN EDITOR
- TESTS WITH VECTORS & SECURES AFTER PROGRAMMING
- SUPPORTS ALL POPULAR PLD DEVELOPMENT SOFTWARE
- GOLD TEXT TOOL ZIF IC SOCKET • ONLINE HELP FUNCTION
- MONEY BACK GUARANTEE
- SELF CALIBRATING
- TOLL-FREE TECH SUPPORT
- JEDEC FILE IN/OUTPUT
- UPDATABLE VIA FLOPPY
- ONE YEAR WARRANTY
- EPROM PROGRAMMERS ALSO • SAME DAY SHIPMENT
- JUST \$798

**CALL FOR FREE DEMO DISK 800/225-2102**

**BP MICROSYSTEMS**  
10681 HADDINGTON #190 HOUSTON, TX 77043  
713/461-9430 TLX: 1561477 FAX: 713/461-7413

Circle 32 on Reader Service Card

**Fix common problems fast!**

You don't need to be an expert to diagnose and correct problems involving PC setup. All you need is **HELPME™** software! More than 300 tests. On-screen help for understanding and correcting identified problems. Quick identification of system configuration and compatibility. \$99 plus shipping and handling. MC and VISA accepted. California Software Products, Inc., 525 N. Cabrillo Park Drive, Santa Ana, CA 92701 (714) 973-0440.

Circle 37 on Reader Service Card (DEALERS: 38)

**\*FREE 3M  
Headcleaning Kit**

DS-DD	Quantity Discounts Available	DS-HD
.73*	5.25" .....	1.49
1.59	3.50" .....	4.75
DC-1000 .....	12.80	DC-300XLP .... 19.65
DC-2000 .....	17.40	DC-600A ..... 21.85

**WHOLLY KAO** World's Finest Professional Quality Color Diskettes

Media from the Surface Scientists. Unlike other "so-called manufacturers" (fabricators, in reality) these color diskettes are Wholly KAO!

- LIFETIME WARRANTY
- 75%+ CLIPPING LEVEL
- 100% Tested & Certified
- 110% of Industry Standards
- Rainbow Color Pack or Solid Pack for organizing your data files
- Sturdy re-usable plastic storage box, includes Tyvek sleeves, ID labels & W/P tabs

DS/DD Color ..... 5.25" ..... DS/HD Color  
.79 ..... in Plastic Storage Box .... **1.29**  
DS/DD Color ..... 3.50" ..... DS/DD Softbox  
**1.69** ..... in Plastic Storage Box .... **1.35**  
**3.50" High Density 2MB ..... 3.49**

**SUMMER SPECIALS**

- ★ Box of Ten 5.25" DS/DD-48 TPI Disks (min 10 boxes) ..... **350**
- ★ Plastic Storage Box of TEN 3.50" DS/DD Rainbow Color Disks (min 5 boxes) ..... **1290**
- ★ KAO High Density in Minidex/78 with 60 KAO 5.25" DS/HD "AT" ..... **5700**
- ★ KAO 3.50" DS/DD in Microdex/25 with 25 KAO 3.50" DS/DD ..... **3300**
- ★ 3M 3.50" DS/DD in Flip 'n File with 10 3M 3.50" DS/DD (min 5 boxes) .. **1750**
- ★ BASF in Minidex/60 with 30 BASF 5.25" DS/DD (min 2 boxes) .... **1995**

**Verbatim DataLifePlus**  
A Kodak Company

5.25" DS/DD	3.50" DS/DD	5.25" DS/HD
<b>.75</b>	<b>1.59</b>	<b>1.49</b>
(min. 5 boxes)		

**BASF \*FREE Plastic Library Case**

5.25" DS/DD	3.50" DS/DD	5.25" DS/HD
<b>.65*</b>	<b>1.35</b>	<b>.95</b>
(min. 10 boxes)		

**Nashua**

5.25" DS/DD	3.50" DS/DD	5.25" DS/HD
<b>.48</b>	<b>1.32</b>	<b>.89</b>
(min 10 boxes)		

**BULK**

BLACK DISKS	COLOR DISKS
.29 ..... 5.25" DS/DD 48TPI .....	.39
.75 ..... 5.25" DS/HD 96TPI .....	.82
1.05 ..... 3.50" DS/DD 135TPI .....	1.21

\*5.25" Bulk Disks with Tyvek, color-coded ID labels and w/p tabs, add 6¢

**YOUR NAME & LOGO** Disks/Envelopes

Put your name on the world's best diskettes! Choose from 3M, BASF, KAO Color or Sony Media. Call for information.

TERMS: VISA, Mastercard or AMEX. COD only add \$3.00. Prepaid orders deduct 2% cash discount. PO's accepted from recognized institutions and corporations on Net 30. Shipping: \$4/100 or fewer disks.

**WE BEAT ANY PRICE!**

Toll Free Order Line: **1-800-523-9681**  
Information Line: **1-801-255-0080**  
TLX-9102404712 FAX-801-572-3327

**DISK COTECH**  
DISKCO TECHNOLOGIES, INC.  
213 Cottage Avenue  
P.O. Box 1339 Sandy, Utah 84091

AUGUST 1988 • B Y T E 269

# 8051 FAMILY EMULATORS



For info call:

Austria	02 22 38 76 38-0
Australia	02 654 1873
Denmark	02 65 81 11
Finland	See Sweden
France	01 69 412 801
Great Britain	01 464 2586
Israel	03 499034
Korea	02 784 7841
New Zealand	04 886 375
Norway	See Sweden
Portugal	01 83 56 70
Spain	03 217 2340
Switzerland	01 740 41 05
West Germany	08 131 16 87
Sweden	040 92 24 25
U.S.A.	408 866 1820

**NOHAU**  
CORPORATION

51 E. Campbell Ave., #107E  
Campbell, CA 95008  
(408) 866-1820

# RAMCHECK®



STOP THROWING AWAY SUSPECTED MEMORY CHIPS. WITH TODAY'S HIGH MEMORY CHIP PRICES YOU CAN EASILY JUSTIFY RAMCHECK'S COST AFTER TESTING ONLY 20 MEMORY CHIPS. RAMCHECK BOASTS A BUILT-IN 8088 POWERFUL PROCESSOR FOR TESTING EVERY CELL OF A 64K/256K DRAM CHIP IN JUST 2.3 SECONDS. ONLY \$199 FOR DEALERS, PROFESSIONALS, CORPORATIONS, GOVERNMENT AND SCHOOLS (\$249 RETAIL). THOUSANDS SOLD WORLDWIDE.

"... an indispensable tool for anyone who services, sells or otherwise handles products that use memory chips."

Made in USA by: **INNOVENTIONS, Inc.**  
10804 FALLSTONE RD., SUITE 214  
(713) 879-6226 HOUSTON, TX 77099

# ANGEL II Universal Print Buffer

SIX MOST USEFUL INTERFACE DEVICES IN ONE BOX



By combining all the features of a megabyte buffer, an interface converter, a protocol converter, an automatic A/B switch, a code generator, and an interface tester in the most useful interface devices in one box, the ANGEL II is a buffer in its own class. It gives the maximum value at the lowest cost. It provides the completeness and convenience to the computer user that was never available before. It is the ideal buffer for your Laser printer, Plotter, CAM/CAD, and Desktop Publishing applications. ANGEL II DOES IT ALL FOR YOU!

THE ANGEL II GIVES YOU THE BEST VALUE IN THE MARKET TODAY!  
Angeli-64K \$325.00  
Angel II-256K \$325.00  
Angel II-1M \$645.00  
(We accept Visa, Mastercard, C.O.D. (cash).  
To order from the U.S. Call Toll-Free:  
1-800-263-7487

## ANGEL II'S OUTSTANDING FEATURES

- An universal buffer that provides automatic switch between two computers and two printers, serial and parallel interfaces.
- POWER UP AND GO feature eliminates cable, switch and manual adjustments.
- The first buffer that provides graphic compression, and store data theoretically up to 64K bytes.
- With standard RS-232 and Centronics connections, full range of protocols including hardware DIRECTOR handwriting, non-soft for serial and ASCII - ASCII control for parallel.
- Memory size is user expandable to 256K, 1M bytes. It is a Megabyte!
- The only buffer that can detect and report incoming broadcast, data bus, and parity on serial input. AutoLoad for automatic broadcast.
- Serial input/output hardware are independently selectable from 300 to 19.2K.
- Instructions at installation on the box. It's easy to install & designed to last.
- 15 Useful remote commands for buffer control from the computer.
- Copy, Continue Copy, Hold/Run, Stop/Reset, etc.

COMPUTER AGE LTD.  
P.O. BOX 730  
NOBLETON, ONT. L6C 1N0  
1-416-859-0370

Circle 159 on Reader Service Card

Circle 264 on Reader Service Card

Circle 53 on Reader Service Card

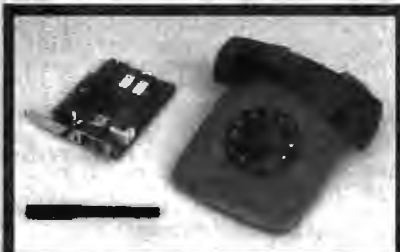

# 2400BAUD \$95 MODEM

30 DAY FREE TRIAL

WE AREN'T KIDDING...HIGH PERFORMANCE TEXAS INSTRUMENT CHIP SET, YET LOWEST COST 2400 BAUD AUTO SPEED SELECT ANYWHERE. FULL FEATURED, HAYES COMPATIBLE IBM INTERNAL HALF CARD. SOFTWARE INCLUDED.

CompuCom Corporation  
(800) ACT ON IT (408) 732-4500 (CA)

Circle 50 on Reader Service Card

## DYNAMIC RAMS

1MBIT	100ns	\$39.00
51258	100ns	\$12.00
41464	150ns	\$10.75
41256	100ns	\$13.15
41256	120ns	\$12.00
✓ 41256	150ns	← \$11.25
41264	150ns	← \$14.75
✓ 4164	150ns	← \$ 2.95

\* For high speed, Zip, Picc, Simm... Please Call!

PROCESSORS		E PROMS	
80287-18	18MHz \$475.00	27C101	250ns \$ 24.00
80287-10	10MHz \$285.00	27C512	250ns \$ 15.00
80287-8	8MHz \$235.00	27S12	250ns \$ 12.95
80287-6	6MHz \$158.00	27C256	250ns \$ 5.90
8087-1	10MHz \$189.00	27S56	250ns \$ 4.95
8087-2	8MHz \$145.00	27128A	250ns \$ 5.25
8087	5MHz \$102.00	27C264A	250ns \$ 4.95
V-30	8MHz \$ 12.75	2794	250ns \$ 3.50
V-40	10MHz \$ 17.00	43258	120ns \$ 18.95
V-20	8MHz \$ 8.50	4364	150ns \$ 14.50

## I.C. EXPRESS

15358 Valley Blvd. City of Industry, CA 91748 Tel: 818-369-2688  
ORDER TOLL FREE (95) PH & PST  
(800) 892-8889 - (800) 882-8181  
Outside California Inside California  
CALL FOR CURRENT PRICES & VOLUME DISCOUNTS  
Price Shown for cash. MasterCard/Visa and Tru. Prices are subject to change  
Minimum order \$10.00. Shipping & Handling: UPS Ground \$5.00, Air \$7.00 (1 lb.)  
ALL MERCHANDISE @ 10% GUARANTEED WITH PROMPT DELIVERY.

Circle 106 on Reader Service Card

## SMART SWITCHES

... at your command

Master Switch is sophisticated yet flexible. Several computers can access one another or share printers and modems. Use serial or parallel interfaces, up to nine ports. The buffer is expandable up to one megabyte. Access a job control menu from each computer to view the queue or cancel, hold, and release jobs. Many other features.

MasterNet software allows computer networking and electronic mail capabilities for PCs.

Other solutions from ROSE

- Printer Sharing
- Multiplexers
- Protocol Conversion
- Modems
- Buffering
- Manual Switches
- Micro to mainframe
- Cables

We design a variety of quality products for computer networking and data communication on solutions guaranteed to work.  
Dealer and OEM inquiries are welcome.

**ROSE ELECTRONICS** P.O. BOX 742571 HOUSTON, TX 77274  
CALL FOR CATALOG 713 933 7673

Circle 206 on Reader Service Card (DEALERS: 207)

# DATAFLEX™

- Multi-user Database!
- Powerful!
- Multiple Operating System Compatibility!
- Attractive Dealer Pricing!
- Full Dealer Support!

Datalflex is a trademark of Data Access  
Dealer Inquiries Invited

## COGITATE

24000 Telegraph Road  
Southfield, Michigan 48034 USA  
(313) 352-2345

Circle 47 on Reader Service Card

## 9-TRACK MAG. TAPE SUBSYSTEM\* FOR THE IBM PC/XT/AT AND...

For information interchange, backup and archival storage. AK Systems offers a 9-track, 5¼" format, compactible 1/2" magnetic tape subsystem for the IBM PC featuring:

- IBM format 1600/3200 and 800 cpi.
- Software for PC-DOS, MS-DOS, XENIX.
- Also for AT&T, DEC, VAX, VME, S-100, F5-232, IEEE 488.

AK Systems  
20741 Marilla Ct  
Chico, CA 95111  
(818) 709-8100  
TWX: 910-493-2071

\*formerly RBEZ Membrane  
Write, Disk or TWX for information.

Circle 10 on Reader Service Card

## ZSTEM

VT220 VT240 D400  
TERMINAL EMULATION

KEA SYSTEMS LTD.  
#412 - 2150 West Broadway  
Vancouver, B.C. CANADA, V6K 4L9  
Tel: 604-732-7411 Telex: 04-352848 VCR  
FAX: 604-732-0715  
Order Toll Free (800) 663-8702

**KEA SYSTEMS**

Circle 120 on Reader Service Card

# AMX 68000

KADAK's engineers bring years of practical real-time experience to over 600 installations world-wide

**This real time MULTITASKING KERNEL simplifies real life product development**

- No royalties
- Full source code included
- C interface
- Preemptive scheduler
- Inter-task messages
- Terminal Handler
- Dynamic memory allocation
- Event Manager
- Semaphore Manager
- Resource Manager
- Buffer Manager

AMX 68000 operates on any 68000/10/20 system

Manual only \$75 US  
AMX 68000 \$1600 US  
Options - ask for price list

(Shipping/handling extra)  
Also available for 68010, 286, 386, 486/286

**KADAK Products Ltd.**  
235 - 1847 W Broadway  
Vancouver, B.C. Canada V6J 1Y5  
Tel: 604-55670  
Fax: (604) 734-8114  
Telephone: (604) 734-2796

Circle 118 on Reader Service Card

## BUY QUALITY FOR LESS!

# DYSAN

**5 1/4" DS/DD 39¢**  
100% CERTIFIED LIFETIME WARRANTY  
Price based on quantity of 250 in bulk includes Tyvek sleeves and label kits.

**800-222-0490**  
In NJ 201-462-7628  
FAX 201-462-5658

• 24 HOUR SHIPMENT •

# MEGA Soft

P.O. Box 710, Freehold, NJ 07728  
Full service duplication facility

Circle 140 on Reader Service Card

# PDK51



**The \$595 Solution to 8051 Product Development**

The PDK51 is a powerful and economical choice for the development of 8051-based systems. The PDK51 is used with an IBM-PC or equivalent and includes:

- SIBEC-II 8052 Basic Microcontroller
- SKA51 Cross Assembler
- ROM-Based Monitor/Debugger
- PROM Programmer
- Power Supplies
- Documentation, Tutorial and More

**Call Now! (603) 469-3232**

**Binary Technology, Inc.**  
Main St., P.O. Box 67, Meriden, NH 03770



**UNIVERSAL E(E) PROM PROGRAMMER \$495 (Kits from \$165)**

- No personally modules; Menu driven device selection.
- Built-in Eraser/Timer option (\$50); Conductive foam pad.
- Direct technical support; Full 1 year warranty.
- Stand alone duplication & verify (27XX parts).
- Quick pulse algorithm (27256 under 60 sec).
- 27xxx to 1 Mbit; 25xx; 68xx; CMOS; EEPROMS.
- 8741, 2, 4, 8, 8H, 9, 9H, 51, C51, S2, 55, 9761 & more.
- IBM-PC, Apple, CPM or Unix driver; Autohazard RS232.
- Offset/split Hex, Binary, Intel & Motorola 8,16,32 bit.
- Manual with complete schematics.

VISA MC AMEX Call today for datasheets!!

**B&C MICROSYSTEMS**  
355 WEST OLIVE AVE. SUNNYVALE, CA 94086  
PH: (408) 730-5511 FAX: (408) 730-5521 TELEX: 984185

Circle 20 on Reader Service Card

# MAXELL

100% CERTIFIED  
**5 1/4" BULK DISKS**

**5 1/4" DS/DD 59¢**

**3 1/2" DS/DD 1.09**  
Price based on quantity of 300 includes sleeves, labels and tabs.

**800-222-0490**  
In NJ 201-462-7628  
FAX 201-462-5658

• 24 Hour Shipment •

# MEGA Soft

P.O. Box 710, Freehold, NJ 07728

Circle 141 on Reader Service Card

**IBM PC/VT220**

**EM220 \$169**

- VT220, VT102 emulation
- File Transfer
- 132 Column modes
- Color Support
- Hot Key

**TEK 4105**

**EM4105 \$349**

- Tektronix 4105 emulation
- Tektronix 4010 emulation
- VT220, VT102 emulation
- Picture files
- High resolution hardcopy
- VGA and EGA support

**Diversified Computer Systems, Inc.**  
3775 Iris Ave., Suite 1B  
Boulder, CO 80301  
(303) 447-9251

Trademarks: VT102, VT220 - DEC; IBM PC, XT - IBM Corp; Tektronix - Tektronics Inc.

Circle 75 on Reader Service Card

**FCC APPROVED!**



**Sub-Mini AT! The Space Saver 3-DR. Capability 8-Expansion Slots!**

**Basic System:**

- 8/10MHz Speed, 0 Wait
- 3-LEDs, Reset & Turbo Switch
- 0-1MB on Board With 0K
- 200-Watt Power Supply
- AT Style Keyboard
- 1ea 1.2M Floppy Disk Drive
- 1ea Floppy/H.D. Controller
- 1ea Mono Graphics Card W/Printer
- 1ea 12" TTL Amber Monitor W/Swivel Base
- Assembled & Tested

**\$963.00**

**10MHz XT Turbo Basic System:**

- Baby AT Case W/Keyboard
- 4.77/10MHz Hardware Selectable
- 8 Expansion Slots
- 0-640K on Board With 0K
- 150-Watt Power Supply
- XT Style Keyboard
- 1ea 360K Floppy Disk Drive
- 1ea Floppy Disk Controller
- 1ea Mono Graphics Card W/Printer
- 1ea 12" TTL Amber Monitor W/Swivel Base
- Assembled & Tested

**\$493.00**

**10MHz or 12MHz AT-286 Basic System:**

- 6/10 or 6/12 MHz Speed, 0 Wait
- 8 Expansion Slots
- 0-1MB on Board With 0K
- Regular AT Slide Case or Digital Display Case
- 200-Watt Power Supply
- AT Style Keyboard
- 1ea 1.2MB Floppy Disk Drive
- 1ea Floppy & H.D. Controller
- 1ea Mono Graphics Card W/Printer
- 1ea 12" TTL Amber Monitor W/Swivel Base
- Assembled & Tested

Regular Case	10MHz	12MHz
Digital Case	<b>938.00</b>	<b>1001.00</b>
	<b>959.00</b>	<b>1022.00</b>

**PERIPHERALS AT/XT For XT**

1. Floppy Disk Controller With Cable	\$22.50
2. Hard Disk Controller With Cable	\$72.20
3. 0-384K Multifunction Card, 0K	\$86.30
4. Monochrome Graphics Printer Card	\$43.80
5. Color Graphics Card	\$46.30
6. Color Graphics Printer Card	\$50.00
7. Enhanced Graphics Adaptor (EGA)	\$131.10
8. Color/Monochrome Display Card	\$61.30
9. Parallel Printer Card	\$18.80
10. Dual Game I/O Card	\$18.80
11. Serial I/O Card	\$25.00
12. Dual Serial I/O Card	\$43.80
13. Mouse For AT/XT W/Driver Software	\$61.30
14. Multi I/O W/Controller	\$68.80
15. Multi I/O	\$56.30
16. No-Slot-Clock	\$28.80
17. 576K RAM Card, 0K	\$35.00
18. 4.77/8MHz XT Turbo Motherboard	\$93.80
19. 4.77/10MHz XT Turbo Motherboard	\$100.00
20. XT Slide Case	\$35.30
21. XT Flip Top Case	\$32.90
22. Baby AT Case, XT	\$47.10
23. 150-Watt Power Supply	\$48.80
24. 150-Watt Power Supply (UL)	\$68.80

**For AT**

25. Floppy/H.D. Controller W/Cables	\$156.30
26. 128K RAM Card, 0K	\$68.80
27. 2MB EMS RAM Card, 0K	\$123.80
28. Serial/Parallel Card	\$46.30
29. 8/10MHz AT Motherboard, 0 Wait	\$331.30
30. 8/12MHz AT Motherboard, 0 Wait	\$393.80
31. 8/10MHz Mini AT Motherboard, 0 Wait	\$362.50
32. AT Slide Case	\$64.70
33. AT SLide Case W/Digital Display	85.90
34. Mini AT Slide Case	61.20
35. 200-Watt Power Supply	81.30
36. 200-Watt Power Supply (UL)	95.00
37. 200-Watt Power Supply For Mini AT	78.80

**ORDER HOT LINE 1-800-543-5107**  
Technical Information (714) 990-2097  
Hours: Mon. - Fri 9:00 am - 6:00 pm PST  
Please write for our complete price list.

**JAWIN COMPUTER PRODUCTS**  
565 W. Lambert Rd., #C  
Brea, CA 92621

**Terms:** Please add 5% (or \$2.00, whichever is higher) plus .25¢ for each \$100.00 CA residents please add 6% sales tax. We accept VISA/MC/Cash. Personal checks please allow 2 weeks to clear. All merchandise is warranted for 1 year unless otherwise stated.

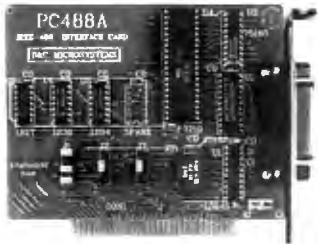

### PC488A \$145/195

LOW COST PC/XT/AT INTERFACE FOR IEEE-488 (GPIB/HPIB)

- Includes INSTALLABLE DOS DEVICE DRIVERS and software support for BASIC
- Optional language support for C, PASCAL, FORTRAN and ASSEMBLY - \$50
- Selectable base I/O address, IRQ and DMA
- CONTROLLER/TALKER/LISTENER capability
- Customer support via dedicated 24 hours B&C Microsystems BULLETIN BOARD
- Quantity discounts available

VISA MC AMEX Call today for datasheet!!

#### B&C MICROSYSTEMS

355 West Olive Ave, Sunnyvale, CA 94086  
PIE (408)730-5511 FAX: (408)730-5523 TELEX: 984185

Circle 21 on Reader Service Card

## VMEbus Multibus I & II S-100 bus

To achieve performance, you need a performance bus. To find out the latest information on any of the above buses, you need

### SUPERMICRO

the magazine for integrators and users of VME, Multibus, and S-100.

SUPERMICRO, PO Box 2089, Provo, UT 84603

To find out how you can receive a trial issue, circle the number below.

Circle 227 on Reader Service Card

### 2400 Baud Performance Incredible \$149 Price!!



- 2400, 1200, 300 Baud Async Modem
- Hayes "AT" Command Set
- CCITV.22bis, V.22 & Bell212A/103 Compatible
- Auto Answer/Auto Dial
- Compact Size
- Programmable non-volatile phone number memory, user configuration & speaker volume
- One year warranty

Order Now  
Toll Free



330 Central Avenue  
Fillmore, CA 93015

USA:800-533-8049  
CA:800-624-5628

MCM/ISA/AMEX Accepted  
(905) 524-4189

Serving Computer Users Since 1982

Circle 42 on Reader Service Card

### Dealers!

**Network-OS LAN Systems** - Includes Boards, Cabling, Terminators and Software. Two-user hardware and software for under \$1,000 list!

**Close-Up Remote Communications** - Support your customer without leaving your office. Authored by Cogitate for Norton-Lambert!

**Context Sensitive Help for DataFlex, RM/COBOL, Clipper and dBase III** - Puts your application's documentation "on line."

**DataFlex Database Management** - True Multi-User database for MS/PC-DOS, Unix and Xenix. Site licensing available.

**Dump/Restore-XT** - Seven utilities for the MS/PC-DOS user.

Call or write today for our catalog and pricing!

#### COGITATE, INCORPORATED

"A Higher Form of Software"

24000 Telegraph Road  
Southfield, MI 48034  
(313) 352-2345/Telex: 386581

Visa/MasterCard Accepted

Circle 48 on Reader Service Card



### 9 TRACK TAPE SYSTEM

FOR IBM PC/XT/AT



- Mainframe to PC Data Transfer
- High Speed Backup
- All Software, Complete System
- Service and Support, easy Installation

call (818) 343-6505 or write to:  
Contech Computer Corp.  
P.O. Box 153 Tarzana, Calif. 91356



Circle 62 on Reader Service Card

NEW!

## INSTANT TERMINAL

"EXACT TERMINAL EMULATION AND COMMUNICATIONS SOFTWARE"

- PRECISE EMULATION OF THE DEC VT52, VT100, VT102, VT220
- EXPANSION MODULES FOR OVER 40 EXACT EMULATIONS
- 9 FILE TRANSFER PROTOCOLS.
- EASY TO USE, QUICK TO INSTALL, AND MUCH MORE
- IBM PC, XT, AT, PS/2

FOR INFORMATION  
800/548-9777

ONLY

\$97.50

SOFTRONICS  
303/593-9540  
TELEX 450236

Circle 220 on Reader Service Card

## IMAGING CARD



### DV-01 GRAY SCALE FRAME GRABBER

Composite video in/out

256 x 240 resolution

Digitize/display at frame speed

256 gray levels in

16 Meg. color palette out

PC/XT/AT compatible

\$849.00 Complete with software

VISA/MC Demo Disk available

**Control Vision**

P.O. Box 596, Pittsburg, KS 66762  
(316)231-6647

Circle 63 on Reader Service Card

## OPTICAL DISKS



- as featured in PC WEEK 4/26/88
- 800MB storage on single disk
  - connecting to any host via SCSI interface
  - Plug'n Play to any operating system
- only \$4995 Limited time only

### PANASONIC LS5000

\$2495 - 200 MB

### OPTICAL MEDIA

For IBM & Panasonic Optical Drives - \$52

We carry a full line of  
5 1/4" & 12" Optical Drives

SKAN TEKNOLOGIES, INC.  
optical storage systems  
(212) 809-5570 (516) 295-2237

Circle 217 on Reader Service Card

## new! SPEECH THING™

For all PCs, compatibles, laptops



\$69.95

CLEAR, CLEAN,  
DIGITIZED SPEECH &  
MUSIC, UNLIMITED  
TEXT-TO-SPEECH  
Attaches outside  
the computer.

Now get popular speech technologies in ONE product! Speech Thing is a full-featured 8 bit D/A sound converter. Easily attaches outside the computer - no slots required. Software includes prerecorded speech vocabularies, synthetic text to speech (speaks any ASCII text), demo programs, and complete editing features. Price only \$69.95. Also available: Voice Master PC plug in board for digital recording, editing, and VOICE RECOGNITION. (Requires Speech Thing for sound output.) Only \$79.95. Patented price/performance breakthrough!

TO ORDER BY MAIL include \$4 shipping & handling (\$6 Canada, \$12 overseas) per order. Visa, MasterCard phone orders accepted. 30 day money back guarantee, one year warranty. Other voice I/O systems available for Apple, Commodore, and Atari computers.



Call or write today for FREE Product Catalog

COVOX INC. (503) 342-1271  
675 Conger St. Eugene, Oregon 97402

Circle 64 on Reader Service Card

**NEW!** **VERS. 2.0**

# BIG MOUTH™

REAL VOICE Digital Recording  
for your PC, XT, AT or Compatible

- ◆ VOICE MAIL SYSTEM
- ◆ TELEMARKETING  
- Inbound & Outbound
- ◆ SMARTEST ANSWERING MACHINE
- ◆ AUTODIALER—DATABASE
- ◆ VOICEPAD™  
- Voice for your Programs
- ◆ PROGRAMMER'S TOOLKIT  
- (optional \$79.95)

1/2 card, software, cables, and speaker

**\$239<sup>00</sup> + 5 s/h**

**(415) 652-9600**  
Talking Technology, Inc.  
4383 Piedmont Ave. Suite B  
Oakland, CA 94611

Circle 233 on Reader Service Card

# RS-422

- RS-422/485
- Selectable Address/IRQ
- Two/Four Wire Operation
- One/Two/Four Port Versions
- Delivery From Stock



SEALEVEL SYSTEMS INC  
PO BOX 1808  
EASLEY, SC 29641  
**(803) 855-1581**

Circle 215 on Reader Service Card

## HD64180 Single Board Prototyping / Control Computer

Get your 64180 project going quickly!



The SBC100 is a complete computer powered by a wall transformer. Available C compiler, assembler, linker and debugger run on a PC. Has battery-backed RAM, battery-backed clock, power fail interrupt, SBX bus connectors, serial and parallel I/O, prototype area for up to 20 IC's. Only \$295 including serial cable, power supply, 32k of battery backed RAM and schematics.

**Z-World**  
1772A Picasso Avenue  
Davis, CA 95616  
**(916) 753-3722** "Z80 Family Specialists"  
In Germany: iSystem 08131/1687

Circle 259 on Reader Service Card

# C

See how well you can program for

## Z80 or HD64180

This professional, IBM-PC based, compiler is a complete implementation of the "C" language for the Z80 or HD64180 microprocessor. Includes features such as: function prototyping, 31-character names, single precision floating point, full library source, M80-L80 and SLR Systems compatibility, etc. Hi-Tech™ "C" has been established for years in Australia. Pricing from \$295.00. We also have Z80/HD64180 co-processor cards for IBM-PC and PC/AT. Call for a full catalog of Microprocessor development tools.

**Z-World**  
1772A Picasso Ave.  
Davis, CA 95616  
**(916) 753-3722** "Z80 Specialists"  
In Germany: iSystem Tel: 08131/1687

Circle 260 on Reader Service Card

## Sure it's insured?

SAFWARE® Insurance provides full replacement of hardware, media and purchased software. As little as \$39/yr. covers:

- Fire • Theft • Power Surges
- Earthquake • Water Damage • Auto Accident

For information or immediate coverage call:  
**1-800-848-3469**  
In Ohio call 1-614-262-0559

**SAFWARE**  
SAFWARE, The Insurance Agency Inc.

Circle 210 on Reader Service Card

## REAL WORLD I/O

For PC/XT/ATs



DG24 • 24-line digital I/O, 10 MHz 8255. \$95  
AD500 • 8 channel 12-bit (plus sign) integrating A/D; programmable gains of 1, 10, & 100. Hi-Z input and 7 digital lines. \$239  
AD100 • Single channel version of AD500 with 10 digital lines. \$149  
AD200 • 4 channel, 125 uS, 12-bit A/D board. \$239  
ADA300 • 8 channel, 25 uS, 8-bit A/D; single D/A; 24 TTL I/O lines (10 MHz 8255). \$239  
DA600 • Fast settling dual 12-bit D/A. \$169  
PD200 • Prototype/development board with address decoder, buffer, 100+ page application/project manual. \$99  
XB40 • External connection/prototype board with cable. \$49

All boards include BASIC, Pascal, C, and Fortb Drivers.  
30 day return: 1 year warranty. Call for "Real World Interfacing" application notes.

**Real Time Devices, Inc.**  
P.O. Box 906 State College, PA 16804  
**(814) 234-8087**

Circle 205 on Reader Service Card

"WITH TYVEK SLEEVES" **29¢** ea.

1000+

# BULK 5 1/4" DISKS

Double Side-Double Den.

100% Tested & Certified Error Free, at "Minimum 55% Clipping Level or Higher." "Lifetime Warranty" With Tyvek Sleeves & Write on Labels

100	200	600
.38¢ each	.35¢ each	.32¢ each

DEALERS WELCOME

Telex #4933362 • Fax #405-495-4598  
Shipping Charges Vary With Quantity Call

Delaware 1-800-451-1849  
PO BOX 10247 WILMINGTON, DE 19850

Oklahoma 1-800-654-4058  
PO BOX 18184 OKLAHOMA CITY, OK 73158

Nevada 1-800-621-6221  
PO BOX 12390 LAS VEGAS, NV 89112

Minimum Order \$25.00 - Visa, MasterCard accepted. COD add 30% UPS delivery. US Mail for APO, FPO, AK, HI, or PR add 5% additional for PAL.

# 3M



	5 Box	10 Box
D-Side D-Den.	950	850
HIGH Den.	1750	1650
	1600	1600

"Worldwide" Orders Accepted

3.5 S-Side 1195	DATA CARTRIDGES DC 1000 12.95	8" S-Side S-Den. 1540
3.5 D-Side 1650	DC 2000 17.50	8" S-Side D-Den. 1895
3.5 H-Den. 4795	DC 300XLP 19.75	8" D-Side D-Den. 2095
	DC 600A 21.95	

Authorized Distributor  
Magnetic Media Division

Delaware 1-800-451-1849  
PO BOX 10247 WILMINGTON, DE 19850

Oklahoma 1-800-654-4058  
PO BOX 18184 OKLAHOMA CITY, OK 73158

Nevada 1-800-621-6221  
PO BOX 12390 LAS VEGAS, NV 89112

Minimum Order \$25.00. Visa, MasterCard accepted. COD orders add 3.0% Surface Shipping on 3.5 or 5.25 and \$3.00 per 100 disks. \$ add \$1.00 per 100 disks. UPS delivery only \$5.00 for 3.5 or 5.25. AK, HI or PR add an additional 5% for PAL. Prices subject to change without notice.

Telex #4933362 • Fax #405-495-4598

# BASF QUALIMETRIC



5 1/4" D-Side 750	5 1/4" High Den. 995
Min 5 Box	Min 5 Box

ALLSOP  
DISK FILE 60 (5.95 EA.) With Each Purchase of 5 Boxes

"INTERNATIONAL ORDERS ACCEPTED"

Delaware 1-800-451-1849  
PO BOX 10247 WILMINGTON, DE 19850

Oklahoma 1-800-654-4058  
PO BOX 18184 OKLAHOMA CITY, OK 73158

Nevada 1-800-621-6221  
PO BOX 12390 LAS VEGAS, NV 89112

Minimum Order \$25.00. Visa, MasterCard accepted. COD orders add 3.0% Surface Shipping on 3.5 or 5.25 and \$3.00 per 100 disks. \$ add \$1.00 per 100 disks. UPS delivery only \$5.00 for 3.5 or 5.25. AK, HI or PR add an additional 5% for PAL. Prices subject to change without notice.

TELEX #4933362 - FAX #405-495-4598

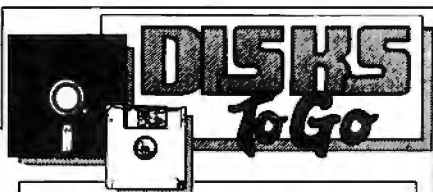

**WE OFFER:**

1. Same Day Service - All orders shipped, insured, within 24 hrs
2. Guaranteed Satisfaction - Lifetime warranty, 30-day return guarantee
3. In-stock Inventory - No delays, no disappointments
4. No Minimum Order - Quantity discounts also available
5. Pre-Approved Purchase Orders and Visa & MasterCard Accepted

**AND GREAT PRICES!**

- 5.25 Black Disks, DS/DD . . . . .36 ea.
- 5.25 Color Disks, 8 Colors Available, DS/DD . . . . .46 ea.
- 5.25 Black Disks, DS/HD . . . . .82 ea.
- 5.25 Color Disks, 8 Colors Available, DS/HD . . . . .94 ea.
- 3.5 Blue or Gray Disks, DS/DD . . . . .1.12 ea.
- 3.5 Color Disks, 5 Colors Available, DS/DD . . . . .1.28 ea.
- 3.5 High Density, Black only . . . . .3.80 ea.

100% certified and tested. Error free lifetime warranty. All disks include generic white box, Tyvek sleeves, labels, write protect tabs, shrink wrapped.



**CONTINUOUS FORM LABELS**

Size	Across	Box Qty.	Price/1,000
2 3/4 x 7/16	1 across	10,000	\$1.95
2 3/4 x 7/16	4 across	20,000	\$1.95
2 1/2 x 1 5/16	1 across	5,000	\$2.18
2 1/2 x 1 5/16	3 across	15,000	\$1.98
2 3/4 x 2 3/4*	1 across	2,500	\$12.00
2 3/4 x 1-7/16	1 across	5,000	\$3.00
3 x 1 5/16	4 across	20,000	\$2.00
3.3 x 1 5/16	4 across	20,000	\$2.05
3 1/2 x 1 5/16	1 across	5,000	\$1.90
3 1/2 x 1 5/16	2 across	10,000	\$1.90
3 1/2 x 1 5/16	3 across	15,000	\$1.90
3 1/2 x 1 5/16	4 across	20,000	\$1.90
4 x 1 5/16	1 across	5,000	\$3.21
4 x 1 5/16	3 across	15,000	\$3.21
4 x 1-7/16	1 across	5,000	\$3.25
4 x 1-7/16	3 across	15,000	\$3.25

Prices quoted for full boxes only.  
\* Designed for the 3 1/2" disk.

"The Quality Disk & Label Specialist Since 1982"

1040 Broadway  
Westville, NJ 08093  
**609-456-6996**  
**FAX# 609-456-7172**

All products assembled in the U.S.A.  
All orders F.O.B. Westville, NJ  
C.O.D. orders add \$2.20

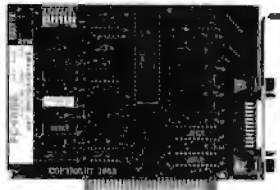

**PC488B \$445**  
**IEEE-488 INTERFACE CARD WITH BUILT-IN BUS ANALYZER**

- CPBASIC package complements IBM/Microsoft BASIC interpreter and compiler to create a programming environment similar to HP desktop computers.
- Additional libraries of over 20 high level 488 dedicated functions for C, Pascal or Fortran available (\$50).
- Powerful menu-driven bus analyzer, which can run in the foreground or in the background while 488 programs or commands are executed, features program stepping, break points and real time bus data capture (4k circular buffer).
- Instant toggling between foreground and Analyzer screen.
- Complete Talker/Listener/Controller capability.
- Dipswitch selectable Base Address, I/O, DMA

VISA MC AMEX Call today for datasheet!!  
**B&C MICROSYSTEMS**  
355 Wes PH: (408)7 94086 3X: 984185

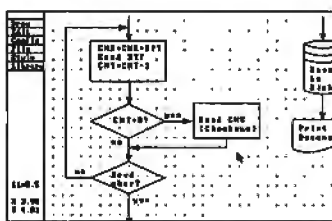

**Curves, ellipses**      **Any size symbols**  
**User defined library**      **Paper size to 34" x 44"**  
**Pop-up menus**      **WYSIWYG**  
**Automatic PANning to scan drawing quickly**  
**Hercules monochrome, CGA, EGA**  
**IBM/EPSON, NEC, OKIDATA, HP LaserJet**  
**HP-GL, DM/PL, SweetP plotters**

Dayton Electronics  
610 S. Sherman, #104  
Richardson, TX 75081  
Texas residents add 8% sales tax  
**CALL 1-214-669-2137**

**PAL/EPROM PROGRAMMER CARD**  
For PC/XT/AT Systems  
NEW - VERSION 2 OF SOFTWARE AND HARDWARE

Pin MMI, NS, TI, AMD, ALTERA, CYPRESS, RICOH, and PANATEC PALS. Supports EPID polarity, RA, and shared product term types.  
-Functions include: Read, Write, Verify, Protect, Edit, Print, and File load and save of program.  
-JEDEC supported.  
-Software Included

**\$1199**  
24 Channels at 20MHz-20MHz  
6 Channels at 100 Mhz  
Internal Clock up to 100 Mhz  
External Clock up to 25 Mhz  
Threshold Voltage TTL, ECL or variable from -10 to +10V  
CASH CHECK MULTIPLE QUANT. All Software Included

**CALL NOW FOR ORDERS AND TECHNICAL INFO (201) 994-6669**  
Link Computer Graphics, Inc. 4 Sparrow Dr., Livingston, NJ 07039. FLX: 9102409305 LINK COMPUTER

**"INDISPENSABLE"**  
Jerry Pournelle, Byte, 8/87

Vopt is the fast, safe disk organizer. It will quickly eliminate the file fragmentation that slows your disk operations.

Vopt includes Vmap for viewing the organization of your disks plus numerous other utilities that test and report on the efficiency of your system.

Call for a free demo disk!  
**\$59.95** \$3 shipping/handling  
CA add 6.5% sales tax.

**GOLDEN BOW SYSTEMS**  
2870 Fifth Ave., Suite 201  
San Diego, CA 92103  
**800/284-3269**



**Presto!**  
**A Link to Mainframe Graphics**

Find out how our whole family of EMU-TEK graphics terminal emulation software makes good sense for the work you do. Call today for more information.

(714) 995-3900  
(800) 962-3900 (800) 972-3900 (Calif.)  
10801 Dale St., Suite M-2  
Stanton, CA 90680

**ICs PROMPT DELIVERY!!!**  
SAME DAY SHIPPING (USUALLY)  
QUANTITY ONE PRICES SHOWN FOR JUNE 14, 1988

OUTSIDE OKLAHOMA NO SALES TAX

SIMM	DYNAMIC RAM	EPROM	STATIC RAM
1Mbit	1048Kx9 100 ns \$600.00	27C1000 128Kx8 200 ns \$37.50	132561-12 32Kx8 120 ns \$16.50
41256 256Kx1 60 ns 16.00	27C512 64Kx8 200 ns 14.95	6264P-12 8Kx8 120 ns 13.75	
41256 256Kx1 80 ns 15.30	27256 32Kx8 250 ns 7.50		
41256 256Kx1 100 ns 14.50	27128 16Kx8 250 ns 6.95		
51258 * 256Kx1 100 ns 15.50			
41256 256Kx1 120 ns 13.25			
41256 256Kx1 150 ns 11.75			
41264 + 64Kx4 120 ns 16.95			

640K MOTHERBOARD UPGRADE: Zenith 150, IBM PC XT, Compaq Portable & Plus, hp Vectra

OPEN 6 1/2 DAYS, 7:30 AM-10 PM SHIP VIA FED-EX ON SAT.  
WE EXPORT ONLY TO CANADA, GUAM, PUERTO RICO & VIRGIN ISLANDS  
SAT DELIVERY INCLUDED ON FED-EX ORDERS RECEIVED BY: 11:00 AM EST  
TEL: 800 255 3131 FAX: 910 252 1181

Factory New, Prime Parts **µP**  
MICROPROCESSORS UNLIMITED, INC.  
24 000 S. Pecos Ave. • (918) 267-9961  
BEGGS, OK 74429  
No minimum order. Please note that prices are subject to change. Shipping & insurance extra. & up to \$1 for packing materials. Orders received by 8 PM CST can usually be delivered the next morning, via Federal Express Standard Air is \$5.00, or guaranteed next day Priority One is \$10.25!



# The Amazing A-BUS

**NEW**

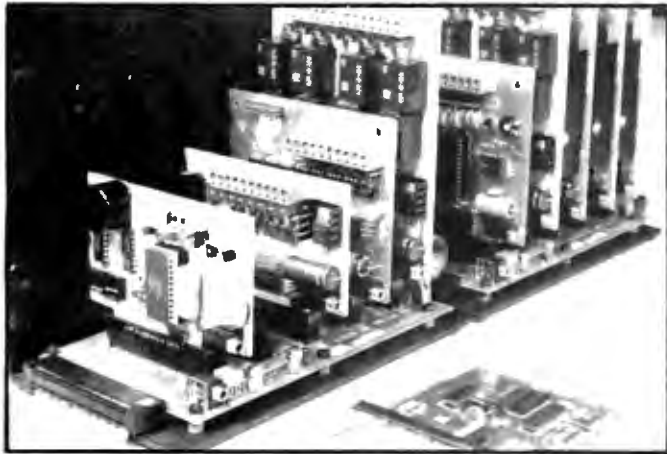

An A-BUS system with two Motherboards  
A-BUS adapter (IBM) in foreground

## Plug into the future

With the A-BUS you can plug your PC (IBM, Apple, TRS-80) into a future of exciting new applications in the fields of control, monitoring, automation, sensing, robotics, etc.

Alpha's modular A-BUS offers a proven method to build your "custom" system today. Tomorrow, when you are ready to take another step, you will be able to add more functions. This is ideal for first time experimenting and teaching.

A-BUS control can be entirely done in simple BASIC or Pascal, and no knowledge of electronics is required!

An A-BUS system consists of the A-BUS adapter plugged into your computer and a cable to connect the Adapter to 1 or 2 A-BUS cards. The same cable will also fit an A-BUS Motherboard for expansion up to 25 cards in any combination.

The A-BUS is backed by Alpha's continuing support (our 11th year, 50000 customers in over 60 countries).

The complete set of A-BUS User's Manuals is available for \$10.

### About the A-BUS:

- All the A-BUS cards are very easy to use with any language that can read or write to a Port or Memory. In BASIC, use INP and OUT (or PEEK and POKE with Apples and Tandy Color Computers)
- They are all compatible with each other. You can mix and match up to 25 cards to fit your application. Card addresses are easily set with jumpers.
- A-BUS cards are shipped with power supplies (except PD-123) and detailed manuals (including schematics and programming examples).

#### Relay Card

RE-140: \$129

Includes eight industrial relays. (3 amp contacts. SPST) individually controlled and latched. 8 LED's show status. Easy to use (OUT or POKE in BASIC). Card address is jumper selectable.

#### Reed Relay Card

RE-156: \$99

Same features as above, but uses 8 Reed Relays to switch low level signals (20mA max). Use as a channel selector, solid state relay driver, etc.

#### Analog Input Card

AD-142: \$129

Eight analog inputs. 0 to +5V range can be expanded to 100V by adding a resistor. 8 bit resolution (20mV). Conversion time 120us. Perfect to measure voltage, temperature, light levels, pressure, etc. Very easy to use.

#### 12 Bit A/D Converter

AN-146: \$139

This analog to digital converter is accurate to .025%. Input range is -4V to +4V. Resolution: 1 millivolt. The on board amplifier boosts signals up to 50 times to read microvolts. Conversion time is 130ms. Ideal for thermocouple, strain gauge, etc. 1 channel. (Expand to 8 channels using the RE-156 card).

#### Digital Input Card

IN-141: \$59

The eight inputs are optically isolated, so it's safe and easy to connect any "on/off" devices, such as switches, thermostats, alarm loops, etc. to your computer. To read the eight inputs, simply use BASIC INP (or PEEK).

#### 24 Line TTL I/O

DG-148: \$65

Connect 24 input or output signals (switches or any TTL device) to your computer. The card can be set for: input, latched output, strobed output, strobed input, and/or bidirectional strobed I/O. Uses the 8255A chip.

#### Clock with Alarm

CL-144: \$89

Powerful clock/calendar with: battery backup for Time, Date and Alarm setting (time and date); built in alarm relay, led and buzzer; timing to 1/100 second. Easy to use decimal format. Lithium battery included.

#### Touch Tone® Decoder

PH-145: \$79

Each tone is converted into a number which is stored on the board. Simply read the number with INP or POKE. Use for remote control projects, etc.

#### A-BUS Prototyping Card

PR-152: \$15

3 1/2 by 4 1/2 in. with power and ground bus. Fits up to 10 I.C.s

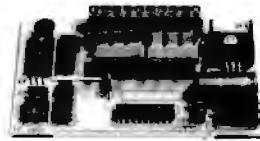

ST-143

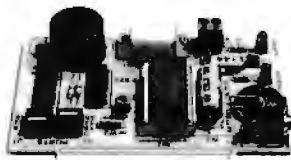

CL-144



RE-140



IN-141



AD-142



AD-142

### Smart Stepper Controller SC-149: \$299

World's finest stepper controller. On board microprocessor controls 4 motors simultaneously. Incredibly, it accepts plain English commands like "Move arm 10.2 inches left". Many complex sequences can be defined as "macros" and stored in the on board memory. For each axis, you can control: coordinate (relative or absolute), ramping, speed, step type (half, full, wave), scale factor, units, holding power, etc. Many inputs: 8 limit & "wait until" switches, panic button, etc. On the fly reporting of position, speed, etc. On board drivers (350mA) for small steppers (MO-103). Send for SC-149 flyer.

### Remote Control Keypad Option RC-121: \$49

To control the 4 motors directly, and "teach" sequences of motions.

### Power Driver Board Option PD-123: \$89

Boost controller drive to 5 amps per phase. For two motors (eight drivers).

### Breakout Board Option BB-122: \$19

For easy connection of 2 motors. 3 ft. cable ends with screw terminal board.

### Stepper Motor Driver ST-143: \$79

Stepper motors are the ultimate in motion control. The special package (below) includes everything you need to get familiar with them. Each card drives two stepper motors (12V, bidirectional, 4 phase, 350mA per phase).

### Special Package: 2 motors (MO-103) + ST-143: PA-181: \$99

Pancake type, 2 1/4" dia. 1/4" shaft, 7.5"/step, 4 phase bidirectional, 300 step/sec, 12V, 36 ohm, bipolar. 5 oz-in torque. same as Airpax K82701-P2.

### Stepper Motors MO-103: \$15 or 4 for \$39

Intelligent Voice Synthesizer, 14 Bit Analog to Digital converter, 4 Channel Digital to Analog converter, Counter Timer, Voice Recognition.

### Current Developments

Intelligent Voice Synthesizer, 14 Bit Analog to Digital converter, 4 Channel Digital to Analog converter, Counter Timer, Voice Recognition.

### A-BUS Adapters for:

IBM PC, XT, AT and compatibles. Uses one short slot	AR-133...\$69
Tandy 1000, 1000 EX & SX, 1200, 3000. Uses one short slot	AR-133...\$69
Apple II, II+, IIe. Uses any slot	AR-134...\$49
TRS-80 Model 102, 200. Plugs into 40 pin "system bus"	AR-136...\$69
Model 100. Uses 40 pin socket. (Socket is duplicated on adapter).	AR-135...\$69
TRS-80 Mod 3.4.4.D. Fits 50 pin bus. (With hard disk, use Y-cable)	AR-132...\$49
TRS-80 Model 4P. Includes extra cable. (50 pin bus is recessed).	AR-137...\$62
TRS-80 Model I. Plugs into 40 pin I/O bus on KB or E/I.	AR-131...\$39
Color Computers (Tandy). Fits ROM slot. Multipak or Y-cable	AR-138...\$49

### A-BUS Cable (3 ft, 50 cond.) CA-163: \$24

Connects the A-BUS adapter to one A-BUS card or to first Motherboard.

### Special cable for two A-BUS cards: CA-162: \$34

### A-BUS Motherboard MB-120: \$99

Each Motherboard holds five A-BUS cards. A sixth connector allows a second Motherboard to be added to the first (with connecting cable CA-161: \$12). Up to five Motherboards can be joined this way to a single A-BUS adapter. Sturdy aluminum frame and card guides included.

Add \$3.00 per order for shipping.  
Visa, MC, checks, M.O. welcome.  
CT & NY residents add sales tax.  
C.O.D. add \$3.00 extra.  
Canada: shipping is \$5  
Overseas add 10%



**ALPHA Products**

242-B West Avenue, Darien, CT 06820

Technical info: (203) 656-1806

Orders only 800 221-0916

Except in CT

Connecticut orders: (203) 348-9436

All lines open weekdays 9 to 5 Eastern time

**DiskMASTER®**  
The Ultimate Diskette Value ...



**Discover the Difference ...**  
2 FOR 1 LIFETIME WARRANTY

- ✓ Pkg'd in 6 different colors, bulk or boxed
- ✓ 100% tested and certified
- ✓ Guaranteed clipping level of 65% or above
- ✓ Includes tyvek envelopes (not paper), write protect tabs and user labels
- ✓ Quality at affordable prices

5-1/4" - 48 TPI DS-DD	DS-HD 96 TPI IBM-AT Compatible	
<b>.49</b>	BULK COLOR OR GRAY	<b>.90</b>
<b>.59</b>	BOXED COLOR	<b>.99</b>

**ICENTECH®** America's Premium Quality Color Diskettes

- ✓ TIMELESS WARRANTY
- ✓ 75%+ clipping level guaranteed
- ✓ Each disk 100% tested and certified
- ✓ 18 COLORS for data organization
- ✓ Pkgs. include sleeves, w/p tabs, & ID labels

5-1/4" - 48 TPI DS-DD	DS-HD 96 TPI IBM-AT Compatible	
<b>.84</b>	PLASTIC STORAGE BOX COLOR	<b>1.39</b>
<b>.63</b>	BULK COLOR	<b>1.15</b>
3-1/2" - 135 TPI DS-DD COLOR	3-1/2" - 135 TPI BLACK DS-HD	
<b>1.75</b>	PLASTIC STORAGE BOX	<b>4.50</b>

**BASF**

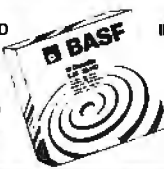
5-1/4" 48 TPI DS-DD	DS-HD 96 TPI IBM-AT Compatible	
<b>.67</b>		<b>.98</b>
3-1/2" DS-HD	3-1/2" DS-DD	
<b>4.50</b>	<b>1.39</b>	

Call for best prices on Data Cartridges & Pelikan Ribbons

5-1/4" - 48 TPI DS-DD	DS-HD 96 TPI IBM-AT Compatible	
<b>.79</b>		<b>1.50</b>

**Nashua**

5-1/4" - 48 TPI DS-DD	DS-HD 96 TPI IBM-AT Compatible	
<b>.50</b>	BOXED	<b>*.84*</b>

**BULK**

**32¢** 5-1/4" DS/DD 48 TPI Exceeds ANSI specifications + 6¢ FORTYVEK

**ORDERING INFORMATION**

TERMS: P.O. orders accepted, government and schools on net30. SHIPPING: U.S. orders add \$3.00 per 100 diskettes or fraction thereof, add \$3.00 for COD orders. PRICE PROMISE: We will better any lower delivered price on the same products and quantities advertised nationally.

Toll Free Order Line: **1-800-233-2477** Information Line: **1-801-561-0092**



**DISC INTERNATIONAL**  
SUPPLY COMPANY  
1376 W. 8040 S. / WEST JORDAN, UT 84088  
HRS: 8 AM TO 5 PM (MTN. TIME)

**8051 SIMULATOR**  
for the IBM-PC/XT or 280 CP/M microcomputer **\$ 99**

The 8051SIM software package assists in the debug of 8051 microcomputer programs. 8051SIM is a screen oriented, menu and command driven program that simulates the Intel 8051 family of single chip microcomputers. It accepts Intel HEX files (produced by most cross assemblers) and features Memory display/modify, Trace, and Single Step commands.

By providing the programmer with an interactive method of developing 8051 programs, 8051SIM speeds up the development process without the expense and physical limitations of an in-circuit emulator.

8051SIM can prove invaluable when learning the instructions, since instructions can be executed interactively, and the effects are immediately apparent on the display.

 CALL TODAY FOR COMPLETE INFORMATION   
HiTech Equipment Corporation  
9560 Black Mountain Road, San Diego, CA 92126  
For Immediate Action Call: **619-566-1892**

Circle 104 on Reader Service Card

**Get the whole story on graphics terminal emulation.**



To find out more about software that lets your PC emulate TEKTRONIX™ 4105/6/7/9 and DEC VT100™ terminals, call or write:

**GRAFFPOINT**  
4340 Stevens Creeks Blvd., Suite 280, San Jose, CA 95129 (408) 249-7951

Circle 96 on Reader Service Card

Dear Advertiser,

**Great News!!!**

Now you can advertise your clients products to over 20 million potential customers Nationwide on our Electronic Home — shopping service. Also thru our Customer Access Machines. 24 hrs a day, seven days a week. No cost for use by user. Just buy, buy, Nationwide!!!

Space is short  
Cost is \$149.95 per Screen  
Regularly \$395.95 per screen.  
Send Ad Copy and Check to:  
WorldWide Services  
6925 Union Park Suite 300  
Salt Lake City, Utah 84047  
**or Call 1-800-228-0640**

Circle 251 on Reader Service Card



**GANG/SET (E)EPROM MULTIPROGRAMMERS™**  
Model 135-E: **\$995.00\***  
Others from **\$345\***

- Model 135 is a SET Programmer, GANG Duplicator, & UNIVERSAL Device Programmer.
- Programs virtually all 24, 28, & 32-pin (E)EPROMs.
- RAM expandable to 2 MegaByte.
- Optional support for 40-pin EPROMs, Bipolar PROMs, 40-pin Micros, & (E)PLD/GAL/FPLA Devices.
- 18-Month WARRANTY & 12-Month FREE Device Updates.

**1-800-523-1565**  
In Florida: 1-407-994-3520

**BYTEK** BYTEK Corporation  
1021 S. Rogers Cr., Boca Raton, FL 33487  
FAX: (407) 994-3615 Telex: 4998369 BYTEK  
\*U.S. Prices only

Circle 34 on Reader Service Card

**ATTENTION p-cad USERS**

Now you can increase the productivity of your software by using the new...

**RAPICAD buffer/decoder.**  
Two buffers in one unit with parallel and serial in/out. Up to 1 Meg total memory.

**NO EXTERNAL DECODER** needed any more... because RAPICAD is fully p-cad box compatible and software transparent, allowing the use of p-cad and any other software with any printer, plotter, laser, etc.  
Prices as low as **\$995.00**

 **INTECTRA Inc.**  
2629 Terminal Blvd.  
Mtn. View, CA 94043  
(415) 964-5018

Dear Retailer,

**Great News!!!**

Now you can sell your products to over 20 million potential home personal computer users using our **Electronic Home Shopping Network...**

**Nationwide!!!**  
Personal Computer Owners beginning in June will be able to access our Network Free!!! to purchase products of all types, No \$5.00 per hour charge, plus registration fees. Just buy, buy, and buy. 24 hrs a day, 7 days a week, all from the comfort of their home.

**Act Now!!!**  
**Space is Short. \*No upfront costs!**  
\*A 5% fee is added to each item ordered.

**Call Now!!!**  
**1-800-228-0640**  
WorldWide Services  
6925 Union Park Suite 300  
Salt Lake City, Utah 84047

Circle 252 on Reader Service Card

OPTION A  
12" Mono Amber Monitor  
Graphics Card w/par port  
\$519<sup>00</sup>

OPTION B  
640 x 200 Color Monitor  
Graphics Card w/par port  
\$759<sup>00</sup>

OPTION C  
12" Mono Amber Monitor  
Graphics Card w/par port  
20 Meg Hard Drive  
\$819<sup>00</sup>

OPTION A AT  
12" Mono Amber Monitor  
Graphics Card w/par port

640 x 200 Color Monitor  
Graphics Card w/par port

12" Mono Amber Monitor  
Graphics Card w/par port  
20 Meg Hard Drive  
\$1399<sup>00</sup>

6FT PARALLEL  
CABLE  
14<sup>00</sup>

## PRINTERS

PANASONIC		CITIZEN	
KXP1080I 144CPS	199	180D 180CPS 9 Pin 10"	199
KXP1091I 192CPS	229	MSP15E 160CPS 9 Pin 15"	369
KXP1092I 240CPS	379	MSP40 250CPS 9 Pin 10"	369

Tractors — Sheet Feeders — Cables — Ribbons Available

## EPSON 3½ DISK DRIVE

• In 5¼ Mounting • 720K  
\$99<sup>00</sup> 10 for \$92<sup>00</sup>

## 150 WATT POWER SUPPLY

• Direct PC Replacement  
\$59<sup>00</sup>

## HARD DRIVES

 **Seagate**  
COMPLETE KITS

ST225 20Meg w/cont. & Cables	279 <sup>00</sup>
ST238 30Meg w/cont. & Cables	299 <sup>00</sup>
ST251 40Meg ½ HT 40 Mil w/software	379 <sup>00</sup>
ST251-1 40Meg, 2.8 Mil Sec	479 <sup>00</sup>
ST4026 20Meg Full HT 40 Mil	279 <sup>00</sup>
ST4096 80Meg Full HT w/software	699 <sup>00</sup>

## EVEREX MEMORY & IO CARDS

EV138 0-576K For XT	89 <sup>00</sup>
EV173 Par/Ser/Clock 0-1 Meg XT	109 <sup>00</sup>
EV173A Par/Ser 0-1 Meg AT	79 <sup>00</sup>
EV159 RAM 3000 Lotus/Intel 0-3 Meg	119 <sup>00</sup>
EV170 I.O. Par/Ser/Clock	69 <sup>00</sup>
EV659 EGA 640 x 350 Auto Switching	149 <sup>00</sup>

## EVEREX TAPE BACKUPS

40MB Mini Cartridge, 1.8MB/min, XT	359 <sup>00</sup>
40MB Mini Cartridge, 3.6MB/min, AT	359 <sup>00</sup>
40MB Streaming Cassette, 5MB/min w/cont.	539 <sup>00</sup>
60MB Streaming Cassette, 5MB/min w/cont.	619 <sup>00</sup>
60MB Streaming Cartridge, 5MB/min w/Full cont.	779 <sup>00</sup>
125MB Streaming Cartridge, 5MB/min w/Full cont.	989 <sup>00</sup>

External Add 195<sup>00</sup>

## MODEMS

~~EVEREX~~

EV-920 EverCom 12 300/1200 bps	74 <sup>00</sup>
EV-940 Internal 300/1200/2400	159 <sup>00</sup>
EV-945 External 300/1200/2400	239 <sup>00</sup>

Mead / Hayes Compatible

1200 Baud w/Bitcom 5 yr. Warranty	69 <sup>00</sup>
1200 Baud External, 5 yr. Warranty	99 <sup>00</sup>
2400 Baud Internal, 5 yr. Warranty	129 <sup>00</sup>

## MONITORS

GOLDSTAR	
EGA 640 x 350	
SAMSUNG	
12" Monochrome Amber	79 <sup>00</sup>
14" RGB Color 640 x 200	249 <sup>00</sup>
14" EGA Multisync	449 <sup>00</sup>

## RAM UPGRADES

4164 150 NS, 64 x 1	3 <sup>00</sup>
4164 120 NS, 64 x 1	3 <sup>25</sup>
4164 100 NS, 100 NS, 64K x 1	4 <sup>45</sup>
41256 150 NS, 256K x 1	12 <sup>95</sup>
41256 120 NS, 256K x 1	13 <sup>45</sup>
41256 100 NS, 256K x 1	13 <sup>95</sup>
4464 150 NS, 64K x 4	12 <sup>95</sup>
1Meg 100 NS, 1048 x 1	39 <sup>00</sup>

## INTEL COPROCESSORS

Intel 8087 5Mhz	99 <sup>00</sup>
Intel 8087 8Mhz	149 <sup>00</sup>
Intel 80287 6Mhz	179 <sup>00</sup>
Intel 80287 8Mhz	239 <sup>00</sup>
Intel 80287 10Mhz	289 <sup>00</sup>
Intel 80387 16Mhz	478 <sup>00</sup>
Intel 80387 20Mhz	779 <sup>00</sup>

LARGE QUANTITIES AVAILABLE

## SIMM RAM UPGRADES

# LETTER QUALITY PRINTER

Why pay \$1149 for a C. Itch  
**STARWRITER™ F-10**

When our 40 cps letter quality daisywheel printer from the same manufacturer is only

**100 for \$249**

These printers were originally priced to sell at over \$1100. Through a special arrangement MEAD has purchased these units from a major computer manufacturer and is offering these printers at a fraction of their original cost.

• 6 ft. Serial Cable	199 <sup>00</sup>
• AT or XT RS232/Serial Interface	399 <sup>00</sup>
• Bidirectional Tractor	149 <sup>00</sup>
• Cut Sheet Feeder	199 <sup>00</sup>

- 40 CPS • Accepts Paper to 15 inches
- Form Length and Pitch Set from Control Panel
- Industry compatible ribbon, printwheels and control commands
- RS232 Serial Interface

## TANDON

160K FLOPPY DRIVE  
• TM 100-1A • 160K  
• IBM Pkg & Instructions

List 249<sup>00</sup> Mead 89<sup>00</sup> List 199<sup>00</sup> Mead 39<sup>00</sup>

## 10 MEG HARD DRIVE

COGITO  
• 1/2 Height  
• 65 Mil Sec.

List 299<sup>00</sup> Mead 109<sup>00</sup> Add 70<sup>00</sup> w/controller

## EPSON OR IBM PRINTER STANDS

List 39<sup>00</sup> Mead 19<sup>00</sup>

## OKI DISK DRIVE

• 360K IBM Compatible  
• 5¼", 1/3 Height • 90 Day Warranty  
List 199<sup>00</sup> Mead 49<sup>00</sup>

## MITSUBISHI FLOPPY DRIVE

12 MEG  
• Black Face • 1 Year Warranty  
List 99<sup>00</sup> Mead 79<sup>00</sup>

## DATA CARTRIDGE

3M COMPATIBLE  
• DC 300 XLP • 45 Meg or Less • Indiv. Wrapped  
List 39<sup>00</sup> Mead 14<sup>00</sup>

DC1000  
• 3M  
\$9 ea

**800-654-7762**

SALES: 7 a.m.-6 p.m. PST

**702-294-0204**

CUSTOMER SERVICE / ORDER STATUS:  
9 a.m.-4 p.m. PST

**FAX 702-294-1168**

NO SURCHARGE FOR MC/VISA

TERMS:

MC • VISA • COD • CASH  
Purchase Orders from Qualified Firms  
Personal Checks • AE add 4%

## PROGRAMMERS FOR IBM PC/XT/AT



- Select Device with vender name & type number directly
  - Enable user to set up Program Pulse Width, Vpp, Vcc
  - Over-program Pulse Width & Iteration Counts.
  - Capable of set & B/16/32-bits wide—word programming.
- |          |   |       |
|----------|---|-------|
| XP6000A  | Adapter & cable installs in PC for connecting programmer externally | \$55  |
| XP6001   | 1-socket 1M-bits EPROMs programmer                                  | \$160 |
| XP6002   | 8-socket 1M-bits EPROMs programmer                                  | \$375 |
| XP6003   | 1-socket MCS-48 micros programmer                                   | \$215 |
| XP6004   | 1-socket MCS-51 micros programmer                                   | \$270 |
| XP6014   | 4-sockets 1M-bits EPROM programmer                                  | \$260 |
| AT-101/A | EPROM Eraser erases 30 24-pin ICs with timer                        | \$195 |

2 YEARS WARRANTY + 30 DAYS MONEY BACK WARRANTY



### Xender Corporation

2824 KENNEDY BLVD., FL. JERSEY CITY, NJ 07310  
TEL: 201-659-8291 TX: 910 240 4444 CHAMPION  
Fax: 201-864-9737

Xender

Circle 254 on Reader Service Card

## The BEST for LESS 29<sup>¢</sup> EA

Quality 5 1/4" DS/DD Diskettes Min. 100

Guaranteed Two-for-One Replacement  
if found initially defective within six months  
FREE sleeves, tabs, labels

- |                                  |        |
|----------------------------------|--------|
| 5 1/4" COLOR (Min. 100)          | 39¢    |
| 5 1/4" HIGH DENSITY (Min. 50)    | 69¢    |
| Brand Box 5 1/4" (Min. 10)       | \$3.99 |
| Brand Box COLOR 5 1/4"           |        |
| with FREE Plastic Case (Min. 10) | \$4.99 |
| 3 1/2" DS/DD (Min. 50)           | \$1.09 |

100% Lifetime Warranty

Shipping: \$4.50 per min. order \$2.00 each addtl. lot  
MCMSA Only

1-800-537-1600

Operator No. 227

**MEP**

Dept. No. 1523 P.O. Box 61000  
San Francisco, CA 94161

Circle 143 on Reader Service Card

## "D" SIZE PLOTTER

\$2295<sup>00</sup>  
RETAIL



\$1695<sup>00</sup>  
INTRODUCTORY  
OFFER

- Model PC 3600
- Repeatability .001"
- Speed at 7" Per Second
- Vacuum Paper Hold Down
- High Resolution Circles: Suitable for PCB Artwork

(415) 490-8380 **ZERICON**  
STEVENS BUSINESS PARK  
BOX 1669, FREMONT, CA 94538

Circle 257 on Reader Service Card

## ON TARGET ASSOCIATES

Products and Services  
for Design and Manufacturing Engineers.

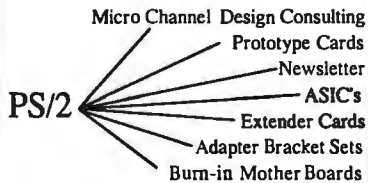

We will move your PC/XT/AT products to the  
Micro Channel, or create your new design.

CALL: (408) 980-7118  
for our Free catalog

ON TARGET  
TARGET  
TARGET

...the PS/2 leaders.

PS/2 and Micro Channel are trademarks of IBM Corp.

Circle 161 on Reader Service Card

## DATA ACQUISITION TO GO INTERFACE FOR ANY COMPUTER

FREE IBM SOFTWARE



Connects via RS-232. Fully IBM compatible. Built-in BASIC. Stand alone capability. Expandable. Battery Option. Basic system: 16 ch. 12 bit A/D, 2 ch. D/A, 32 bit Digital I/O. Expansion boards available. Direct Bus units for many computers.

(201) 299-1615

P.O. Box 246, Morris Plains, NJ 07950

**ELEXOR**

Circle 84 on Reader Service Card

Okidata ML 82A and ML 83A Printers:

## IBM EMULATION "PLUS"

Epson Compatibility/Letter Quality

### PC-WRITER

ONLY  
\$99.00

plus shipping & sales  
tax (Calif. addresses)  
Money back guarantee



- FULL EMULATION OF THE IBM PC GRAPHICS PRINTER
- LETTER QUALITY PRINTING
- ELITE CHARACTER PITCH
- SUBSCRIPTS/SUPERSUBSCRIPTS
- DDT ADDRESSABLE GRAPHICS
- FRONT PANEL FEATURE SELECTION

To Order: (714) 261-0228

Dealer Information Available



**RAINBOW TECHNOLOGIES, INC.**

18011-A Mitchell So., Irvine, CA 92714  
(714) 261-0228 Telex: 386078

Circle 202 on Reader Service Card

## 9-Track Tape Subsystem for the IBM PC/XT/AT



Now you can exchange data files between your IBM PC and any mainframe or mini-computer using IBM compatible 1600 BPI 9-Track tape. Unit can also be used for disk backup. Transfer rate is up to 4 megabytes per minute on PCs and compatibles. Subsystems include 7" or 10 1/2" streaming tape drive, tape coupler card and DOS or XENIX compatible software.

Prices start at \$2,995.

**QUALSTAR**

9621 Irontdale Ave., Chatsworth, CA 91311  
Telephone: (818) 882-5822

Circle 195 on Reader Service Card

## ANALOG I/O and DSP

ideal for PC based  
Measurement/Test, Control,  
Acoustics, and Signal Processing

- |               |   |
|---------------|---|
| PC-12         | • 16 SE or 8 DF inputs, programmable gain amplifier, precision S/H, 12-bit A/D, dual 12-bit D/A, I/O Filters, 8-bit digital I/O, memory mapped I/O assisted by timer. \$650.  |
| PC-125C       | • 12-bit A/D & D/A with I/O Filters and timer, for voice I/O, IEEE Speech Course, etc. \$450.   |
| PC-DMA 12     | • 12-bit A/D and D/A to 100 KHz, dual-channel DMA controller for concurrent I/O capability, programmable H/W timer for zero timing jitter, I/O filters, programmable gain and offset amplifier, 16-channel auto-scan multiplexer, 8-bit digital I/O, etc. \$1250. |
| PC-DMA 16     | • Features compatible to PC-DMA, but with 16-bit A/D and dual 16-bit D/A. \$1595.   |
| PC-DSP 22     | • 22-bit floating point DSP board for PC, compatible to the above PC-DMA boards for R/T DSP, 1 K complex FFT in 10msec.   |
| SAMPLE EDITOR | • S/W for PC-DMA performs continuous hard disk transfer, search, audio edit, etc.   |
- Other new products include 1 MHz 12-bit A/D and D/A, servo motor controller, etc. All products supported by S/W driver and application packages.

CANETICS, Inc.

PO Box 70549, Pasadena, CA 91107  
(818) 584-0436

Circle 39 on Reader Service Card

## Satellite Communication

### MICROSAT II Expansion Board

\$700

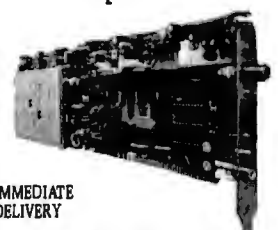

IMMEDIATE  
DELIVERY

- For IBM PC/XT/AT and compatible.
- Satellite data receiver - 9600 baud.
- Satellite bulletin board.
- Satellite video and audio option - Add \$200

PERSONAL SPACE COMMUNICATIONS

707 Johnson Road, Blaine WA 98230  
(604) 597-6298 TLX 04-508306 FAX (604) 597-6214

Circle 174 on Reader Service Card

# TIMELINE INC.

COOL  
SUMMER  
DEALS!

Continental U.S.A.  
**(800) 872-8878**

ORDER DESK ONLY

Inside California  
**(800) 223-9977**

L.A. & Technical Info  
**(213) 217-8912**

OEM INQUIRIES  
WELCOME

## VGA COLOR GRAPHICS PACKAGE

### POSSIBLE DISPLAY MODES VGA GRAPHICS:

800 x 560 x 16 colors  
320 x 200 x 256 colors

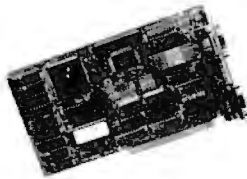

**\$649**

#### ALSO:

640 x 480 x 16 colors  
640 x 350 x 16 colors  
640 x 200 x 16 colors  
640 x 200 black & white  
320 x 200 x 4 colors  
Hercules Graphics  
40 and 80 column character mode

### INCREDIBLE!

The manufacturer of this monitor SET THE STANDARD FOR COLOR GRAPHICS. The card is an ATI improved VIP CARD. The package comes with user friendly manual and step-by-step instructions. One year warranty on the monitor, two year warranty on the card.

CALL FOR QUANTITY DISCOUNTS.

- 13" color screen
- Max resolution (800x560)
- Bandwidth: 17 Mhz
- Software selectable to VGA, EGA, CGA, MDA, HGA
- Anti-reflective, coated non-interlaced flicker free screen
- .31 dot pitch

### REMEX RFD480

FLOPPY DISK DRIVE  
2/3 HT • 360K • DS/DD

**\$29**

### ADAPTEC 4000A CONTROLLER

I/O for the ST412-506 Interface  
Using MFM Encoding

**\$79**

### ZENITH

7" DIAGONAL SCREEN

### HIGH RESOLUTION AMBER MONITOR

**\$29.95**

MODEL DJ7NKG

22 MHZ  
TYPICAL  
BANDWIDTH

NEW!  
IN BOX

\* **AST ADVANTAGE** **\$79**  
For AT. 1-Serial, 1-Parallel Port.  
Has extended memory (no EMS or EEMS). (10-K memory)

\* **DC 600 STYLE TAPES** **\$15 ea.**  
10,000 fpi 10+  
ea. 19.95 3-9 17.95 ea. (minimum order 2)

\* **1.2 MB-OKIDATA** **\$79**  
Half Height Floppy for AT.  
1.2 MB • DS/DD • 96 tpi

\* **FULCRUM TRACKBALL** **\$89**  
Stationary Mouse. PC Magazine Editor's  
first choice for CAD use.

- Flat faceplate
- 900 lines at center  
650 lines at  
corners
- Operates from  
12VDC at 1.4 amp
- Vertical input is 47  
to 63 Hz
- Horizontal  
frequency: 15 KHz  
(adjustable)



4 for  
**\$99.00**

For split video (TTL inputs) operation.  
Not composite video.

1490 W. ARTESIA BLVD, GARDENA, CA 90247



Continental U.S.A.  
**(800) 872-8878**  
Inside California  
**(800) 223-9977**

**(800) 872-8878**



L.A. Area & Technical Info.  
**(213) 217-8912**

15% Restocking fee for returned orders.

#### NO SURCHARGE FOR CREDIT CARD ORDERS!

Minimum Order: \$25.00. Shipping & handling charges via UPS Ground: \$50/lb. UPS Air: \$100/lb. Minimum Charge: \$4.00. We accept cashiers checks, MC or VISA. No personal check COD's. California residents add 6 1/2% sales tax. We are not responsible for typographical errors. All merchandise subject to prior sale. Phone orders welcome. Foreign Orders require special handling. Prices subject to change without notice.

**MICRO CHANNEL  
ENGINEERING DEVELOPMENT  
SUPPLIES**

**INTRODUCING: The PS/2 Burn-In Board!**

For Design and Manufacturing Engineers

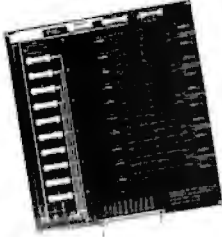

1. First Passive Backplane for PS/2 Micro Channel
2. Test adapters without power cycling computers
3. Test adapters without damaging computer
4. Optional module and software provides single step bus emulation

CALL now for your FREE Catalog. Quality PS/2 compatible products available.

**ON TARGET  
TARGET  
TARGET**

ON TARGET Associates  
1034 W. Maude Ave., # 602  
Sunnyvale, CA 94086  
(408) 980-7118

PS/2 and Micro Channel are trademarks of IBM Corp.

**FRUSTRATED?**

**Soft-X-plore™ v2.2** is a disassembler and patcher you can use to explore and customize your IBM PC XT AT or clone.

- \* uses four algorithms to separate code from data at 10,000 lines per minute.
- \* any file up to 500kb in size or RAM and ROM memory
- \* 8086 up to 80386/387
- \* MASM ready output
- \* unique labels for Branch, Jump, Calls, and Data
- \* comments MSDOS and BIOS services, and IN/OUT ports
- \* saves result of first pass to expedite future listings

Order now: \$99.95 plus \$4 s&h and use MC, VISA or COD. (CT 7.5% sales tax)



**RJ Swantek & Associates**  
178 Brookside Road  
Newington, CT 06111

(800) 446-4656 ..... (203) 560-0236

**The Original™  
PC Pillow**



**THE KEYBOARD LAPTOP TABLE  
DESIGNED TO ADD COMFORT WHILE  
WORKING AT YOUR COMPUTER.  
A Unique Gift or Promotional Item!**

**REGULAR PRICE \$19.95  
ORDER YOURS TODAY AT OUR  
SPECIAL BYTE PRICE**

**\$14.95** MASTERCARD VISA  
Plus S & H AMERICAN EXPRESS

**Universal Data Inc.**  
120 INTERSTATE N. PKWY., E.  
SUITE 420 ATLANTA, GA 30339  
1-800 535-3282  
DEALER INQUIRY WELCOME

Circle 162 on Reader Service Card

Circle 208 on Reader Service Card

Circle 246 on Reader Service Card  
(DEALERS: 247)

**6800  
Family Development  
Software**



Combine our software and your editor for a powerful development system. Our C-Compilers feature a complete implementation (excluding bit fields) of the language as described by Kernigan & Ritchie and yields 30-70% shorter code than other compilers. Our Motorola-compatible Assemblers feature macros and conditional assembly. Linker and Terminal Emulator are included.



Wintek Corporation  
1801 South Street  
Lafayette, IN 47904-2993  
(317) 742-8428 or (800) 742-6809

Circle 250 on Reader Service Card

**PAL®/PLA DESIGN  
APPLICATION  
HANDBOOK \$24.95**

A Comprehensive Textbook on Theory and Hands-on Design Implementing Programmable Logic.

PAL is a registered trademark of MMI.



**From A Name You Can Trust**

**LOGICAL DEVICES INC.**

1201 N.W. 65th Place  
Ft. Lauderdale, FL 33309

1-800-331-7766 (305) 974-0967  
Telex 383142 Fax (305) 974-8531

Circle 127 on Reader Service Card

**the HUSKY™**

EPROM  
PLD  
MICRO  
GANG  
SET

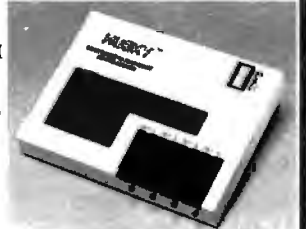

PC based PROGRAMMER  
\$599.00\*

\*modules not included.

**From A Name You Can Trust**

**LOGICAL DEVICES, INC.**

1201 N.W. 65th Place, Ft. Lauderdale, FL 33309

1-800-331-7766 (305) 974-0967  
Telex 383142 Fax (305) 974-8531

Circle 128 on Reader Service Card

**CHIP SHOP**

**CALL FOR THE  
LOWEST PRICES**

**SAME DAY SHIPMENT**

**4164 8087  
4128 80287  
41256 80387  
1 meg chips  
V20, V30 and more**

**SABINA INTERNATIONAL, INC.**  
Phone 1-800-2SABINA  
Phone 1-714-594-6336  
FAX 714-595-4008

Circle 209 on Reader Service Card

**RS-232C/422A USERS:  
BI-DIRECTIONAL CONVERTER  
for EXTENDED USE**

Convert RS-232C to  
RS-422A and/or  
RS-422A to RS-232C  
only **\$49.95**



*Guaranteed satisfaction.* Bi-directional, first-quality, versatile converter. Extends cable lengths up to 4,000 feet! Bit rates up to 90K Baud. (Two B & B RS-422CON Converters can extend your RS-232C capability up to 4,000 ft.)

Includes male DB25P connector for RS-232C and includes female DB25S connector for RS-422A, no hand shake lines connected.  
Requires 12V DC at 100 ma. Optional power supply available for only \$14.95.

Order Direct from Manufacturer **TODAY** and **SAVE!** **SAME-DAY SHIPMENT! MONEY-BACK GUARANTEE!**

Request our **FREE** catalog listing **B & B ELECTRONICS'** comprehensive line of RS-232C interface and measuring equipment.

\*Terms: Visa, MC, cash on order only. P.O.'s honored if pre-authorized. Illinois residents add 6 1/4% sales tax.

**B & B electronics**  
MANUFACTURING COMPANY

1502H Boyce Memorial Drive • P.O. Box 1040 • Ottawa, IL 61350  
Phone: 815-434-0846

Circle 19 on Reader Service Card

Advertise your  
computer products  
through  
**BYTE BITS**  
(2" x 3" ads)

For more information  
call Dan Harper at  
**603-924-6830**

**BYTE**  
70 Main St.  
Peterborough, NH 03458

Circle 269 on Reader Service Card

# Low Prices, Fast Service.

**Satisfaction  
Guaranteed!  
Since 1975**

## Turbo-XT \$398



- 4.77 & 8 MHz
- 640K Motherboard with 256K
- 8 slots • 8087 socket
- 150W power supply

### Option A

- High resolution amber monitor
- Hi-res graphics card add
- Parallel printer port ..... **\$148**

### Option B

- Hi-res RGB color monitor
- Hi-res graphics card add
- Parallel printer port ..... **\$298**

### Option C

- Hard disk drive
- Dual hard disk controller
- 30 MB for XT    40 MB For PC/XT/AT
- add **\$298**                      add **\$498**

## Amdek 310A \$98

Best selling hi-resolution non-glare amber monitor

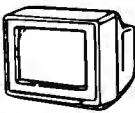

## No Slot Clock \$48

## MICROSOFT MS-DOS 3.21..... \$98

### intel Math Coprocessors

- |                |                |
|----------------|----------------|
| 8087 \$98      | 8087-2 \$138   |
| 8087-1 \$198   | 80287-6 \$178  |
| 80287-8 \$228  | 80287-10 \$268 |
| 80387-16 \$468 | 80387-20 \$728 |

### PC Mouse

- |                           |       |
|---------------------------|-------|
| LogiTech mouse .....      | \$78  |
| Mouse systems mouse ..... | \$98  |
| Microsoft mouse .....     | \$108 |
| Genius mouse .....        | \$58  |
| Fastrap trackball .....   | \$98  |
| Deluxe joystick .....     | \$24  |

## 1200 Baud Deluxe Modem \$58



- |                                 |       |
|---------------------------------|-------|
| 2400 baud 1/2 card internal ... | \$128 |
| 1200 baud external.....         | \$88  |
| 2400 baud external.....         | \$168 |

## 30 MB Hard Disk

Complete kit with controller



## CMS \$298

- |                           |       |
|---------------------------|-------|
| 10 MB PC/XT Kit.....      | \$198 |
| 20 MB PC/XT Kit.....      | \$248 |
| 20 MB Card.....           | \$398 |
| 40 MB for AT .....        | \$338 |
| 40 MB PC/XT Kit.....      | \$468 |
| Mountain 40 MB Tape ..... | \$398 |

## 360K Disk Drive

Half height, IBM compatible Direct Drive



**\$68**

- |   |       |
|---|-------|
| Tandon TM100-2 full height for IBM PC or XT ..... | \$118 |
| 1.2 MB for AT.....                                | \$98  |
| 5 1/4" drive for PS/2.....                        | \$268 |

## 3 1/2" Disk Drive

- |          |      |             |       |
|----------|------|-------------|-------|
| 720K.... | \$98 | 1.44 MB.... | \$128 |
|----------|------|-------------|-------|

## VGA Package

Monitor & Card **\$648**

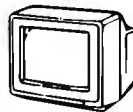

- 800 x 560
- Up to 256K brilliant colors
- Hi-res EGA card 640x480 .... \$128
- EGA monitor 640x350 ..... \$378
- VGA AutoSync monitor
- 800 x 560..... \$498
- NEC MultiSync II 640x560 ... \$598
- RGB color monitor 640x240 \$258
- Vega VGA card ..... \$278
- Paradise VGA card ..... \$278

## EPSON 9 Pin \$198 LX-800



EPSON Near Letter Quality Near Letter Quality Printer FX-850, FX-1050, EX-800 .... Call

## EPSON 24 Pin \$369 LQ-500



List Price \$529

EPSON Letter Quality Printers LQ-850, LQ-1050, LQ-2500 .. Call

## hp HEWLETT PACKARD LaserJet II

**\$1698**



List Price \$2595

Extra Toner Cartridge ..... \$98  
PDP 4 MB RAM card w/OK .. \$198

- |       |       |        |
|-------|-------|--------|
| 1 MB  | 2 MB  | 4 MB   |
| \$348 | \$648 | \$1148 |

## HP DeskJet \$698

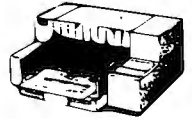

List Price \$995

300 x 300 DPI with full with full page graphics  
PDP 128K RAM ..... \$98  
Extra ink cartridge ..... \$18

## Laser Printer \$1198

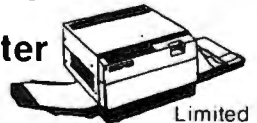

Limited Quantity!

1.5 MB RAM card ..... \$198  
Toner cartridge ..... \$58

## OKIDATA

- |                  |       |
|------------------|-------|
| Okidata 320..... | \$358 |
| Okidata 321..... | \$498 |
| Okidata 390..... | \$498 |
| Okidata 391..... | \$688 |



Place orders toll free!  
Continental U.S.A. 1-800-421-5500  
Inside California 1-800-262-1710  
All others 1-213-973-7707  
Fax machine 1-213-675-2522

# JADE COMPUTER

Prices at our eight store locations will be higher on some items.

### California

Torrance, Santa Ana, Woodland Hills  
Kearny Mesa, Sunnyvale

### Texas

Addison, Houston

### Georgia

Smyrna



We accept checks, credit cards or purchase orders from qualified firms and institutions. No surcharge on credit card orders. CA., TX. & GA. residents add sales tax. Prices & availability subject to change without notice. Shipping & handling charges via UPS ground 50¢/lb. UPS air \$1.00/lb. Minimum charge \$3.00.

4901 W. Rosecrans Ave. Box 5046  
Hawthorne, California 90251-5046



# C's IC's, Parts, Components... Shipped Fast!

## West Coast's Largest Selection... Call for More

### RAM Upgrades!

...priced in sets of 9

- 64K/120ns ..... CALL
- 64K/150ns ..... CALL
- 256K/100ns ..... CALL
- 256K/120ns ..... CALL
- 256K/150ns ..... CALL

### DYNAMIC RAMS

4116/200ns	Call	4464/150ns	Call
MK4332/200ns	Call	41256/100ns	Call
4164/200ns	Call	41256/120ns	Call
4164/150ns	Call	41256/150ns	Call
4164/120ns	Call	41264/150ns	Call
4164/PIN ONE	Call	4128/150ns	Call
4416/200ns	Call	8118/4517	Call
4416/150ns	Call	1 MEG/100ns	Call
4464/120ns	Call	TMS4161/150ns	Call

### STATIC RAMS

2102LP/450ns	\$ .99	6116/120ns	\$2.95
2101/450ns	1.79	6166LP/150ns	2.45
2112/450ns	2.69	6286LP/120ns	4.95
2114/450ns	.89	6286LP/150ns	4.45
21142	1.19	6264/150ns	4.25
2114L/2	1.99	62256/120ns	12.85
6116/150ns	2.45	62256/100ns	19.95

### 74 HCT SERIES

74HC100	\$25	74HC161	\$65	74HC154	\$1.99
74HC102	25	74HC163	65	74HC154	1.99
74HC104	25	74HC164	65	74HC156	2.99
74HC108	25	74HC175	65	74HC156	2.99
74HC100	25	74HC1240	1.29	74HC157	1.99
74HC127	30	74HC1241	1.29	74HC157	1.99
74HC174	49	74HC1244	1.29	74HC160	1.99
74HC138	50	74HC1245	1.29	74HC164	2.99
74HC157	65	74HC1257	65	74HC156	2.99
74HC160	65	74HC1259	1.10	74HC156	2.99

### LINEAR

CA3086	\$1.19	LM566	\$1.10	LM3900	45
CA3089	1.19	LM567	75	LM3909	1.25
CA3403	1.19	LM723	30	LM3911	1.95
LF347N	1.49	LM733	30	LM3914	2.75
LF348N	1.49	LM741	30	LM3915	2.75
LF356H	1.99	LM747	60	LM3916	2.75
LF441	1.69	LM748	65	LM4024	3.95
LM301	30	LM1414	1.49	LM4044	3.95
LM309K	1.00	LM1886	3.29	LM4136	1.50
LM317K	2.95	LM1330	1.95	LM4558	75
LM317T	1.75	LM1350	1.25	LM7555	2.50
LM318	1.15	LM1358	1.95	LM7556	2.50
LM319	95	LM1372	2.25	LM7660	2.95
LM320T-XX	60	LM1408L8	2.50	LM7663	2.95
LM320K-XX1	35	LM1458	40	LM78H05	6.95
LM323K	4.25	LM1468	60	LM78H12	6.95
LM324	35	LM1489	60	LM8038	3.75
LM33502	1.19	LM1889	2.50	MC3423	1.49
LM33602	1.19	LM2003	3.75	MC3459	2.69
LM3373H	2.49	LM2206	3.75	MC3270	2.99
LM337K	4.95	LM2211	1.19	MC3480	6.99
LM338K	6.95	LM2211	2.75	MC3486	1.69
LM340T-XX	60	LM2240	1.75	MC3487	1.69
LM340K-XX1	1.35	LM2900	1.19	MC3524	1.99
LM358	45	LM2901	1.19	TDAl170	5.49
LM376	1.69	LM2917	1.28	TDAl180	5.99
LM380	95	LM3405	1.19	TL074	1.65
LM386	95	LM3054	1.99	TL081	75
LM393	65	LM3079	1.49	TL082	85
LM497	2.50	LM3130	95	TL084	1.25
LM565	30	LM3140	95	ULN2003	1.19
LM566	45	LM3160	1.95	ULN2064	1.79
LM568	85	LM3161	1.95	ULN2074	1.99
LM564	2.75	LM3162	1.95	ULN2081	1.49
LM565	1.50	LM3852	1.49	ULN2981	1.99

### 74HC SERIES

74HC00	\$25	74HC125	\$50	74HC174	\$65
74HC02	25	74HC132	50	74HC175	65
74HC04	25	74HC133	50	74HC240	1.29
74HC08	25	74HC138	55	74HC244	1.29
74HC09	25	74HC139	55	74HC245	1.29
74HC10	25	74HC148	75	74HC268	65
74HC11	25	74HC151	65	74HC373	1.29
74HC14	25	74HC153	65	74HC374	1.29
74HC20	25	74HC154	3.75	74HC4020	99
74HC32	25	74HC157	65	74HC4060	99
74HC74	35	74HC161	65	74HC4066	99
74HC85	65	74HC166	1.15	74HC4075	89
74HC112	65	74HC173	65	74HC4078	1.49

### 7400 SERIES

7400	\$.18	7474	\$.35	74157	\$.65
7402	.18	7475	.35	74158	.65
7404	.18	7476	.35	74173	.65
7405	.18	7485	.35	74174	.65
7406	.35	7486	.35	74175	.65
7407	.35	7490	.35	74176	.65
7408	.25	7493	.35	74181	1.75
7410	.25	7495	.35	74189	2.95
7414	.35	74121	.35	74193	.65
7420	.25	74123	.45	74195	.65
7426	.25	74125	.45	74198	1.65
7427	.25	74126	.45	74221	.75
7430	.25	74148	.65	74273	.75
7432	.25	74150	1.20	74365	.50
7438	.25	74151	.65	74366	.50
7442	.30	74153	.65	74367	.50
7446	.85	74154	1.20	74368	.50
7447	.95				

### 74C CHIPS

74C00	\$ .25	74C154	\$2.85	74C374	\$1.69
74C02	.25	74C173	.99	74C903	1.19
74C04	.25	74C174	.99	74C906	1.19
74C08	.35	74C175	.99	74C912	6.95
74C10	.35	74C221	1.25	74C923	3.95
74C14	.49	74C240	1.69	74C923	3.95
74C32	.35	74C244	1.69	74C929	4.89
74C90	1.19	74C373	1.69	74C932	14.89

**Partial Listing Only!!!**  
Call us for components...

### 74LS SERIES

74LS00	\$.19	74LS125	\$.45	74LS241	\$.99
74LS02	.19	74LS126	.49	74LS242	.99
74LS03	.19	74LS138	.45	74LS243	.99
74LS04	.19	74LS139	.45	74LS244	.99
74LS05	.19	74LS153	.59	74LS245	.99
74LS08	.19	74LS154	1.29	74LS257	.69
74LS09	.19	74LS157	.40	74LS258	.69
74LS10	.19	74LS158	.40	74LS259	.99
74LS14	.35	74LS161	.49	74LS323	.99
74LS27	.28	74LS163	.49	74LS322	1.79
74LS30	.25	74LS164	.49	74LS323	1.79
74LS32	.28	74LS165	.49	74LS365	.59
74LS47	.99	74LS166	.99	74LS366	.59
74LS73	.35	74LS173	.49	74LS367	.59
74LS74	.35	74LS174	.49	74LS368	.99
74LS75	.35	74LS175	.49	74LS373	.99
74LS76	.35	74LS189	3.95	74LS374	.99
74LS85	.49	74LS190	.49	74LS393	.99
74LS86	.28	74LS191	.49	74LS624	1.89
74LS90	.45	74LS192	.49	74LS629	1.89
74LS93	.45	74LS193	.49	74LS640	1.89
74LS107	.45	74LS195	.49	74LS641	1.89
74LS109	.45	74LS221	.65	74LS670	.99
74LS123	.49	74LS240	.99	74LS688	1.89

### 74F SERIES

74F00	\$.35	74F153	\$.59	74F243	\$1.29
74F02	.35	74F157	.59	74F244	1.29
74F04	.35	74F158	.59	74F245	1.29
74F08	.35	74F160	.59	74F251	.79
74F10	.35	74F161	.59	74F258	.79
74F11	.35	74F163	.59	74F280	2.89
74F20	.35	74F174	.69	74F373	1.49
74F32	.35	74F175	.69	74F374	1.49
74F46	.49	74F181	.99	74F379	1.99
74F74	.49	74F189	.99	74F399	2.99
74F86	.49	74F219	.49	74F521	2.99
74F109	.49	74F240	1.29	74F533	2.99
74F139	.49	74F241	1.29	74F534	2.99
74F151	.59				

### IC SOCKETS

SOLDERTAIL	HR16S/T	.59	22PIN/W/1.29
8PIN/P	HR18S/T	.69	24PIN/W/1.29
14PIN/P	HR20S/T	.79	28PIN/W/1.59
16PIN/P	HR22S/T	.89	40PIN/W/1.99
16PIN/P	HR24S/T	.99	HI RES W/W
20PIN/P	HR28S/T	1.19	HR8W/W \$79
22PIN/P	HR40S/T	1.49	HR14W/W 1.19
24PIN/P	HR45S/T	1.49	HR16W/W 1.29
28PIN/P	HR45S/T	1.49	HR18W/W 1.39
40PIN/P	HR45S/T	1.49	HR20W/W 1.69
48PIN/P	HR45S/T	1.49	HR22W/W 1.79
64PIN/P	HR45S/T	1.49	HR24W/W 1.99
HI RES	18PIN/W/99		HR28W/W 2.29
HR8S/T	\$.39	20PIN/W/1.19	HR40W/W 3.49
HR14S/T	.49		

### SPECIAL FUNCTION

VOICE RECOGNITION	16450 - 16 BIT
CHIP SET	USART
YAMAHA DXY	8250 - 8 BIT
CHIP SET	USART
TMS 6100	5832 - CLOCK
SPEECH CHIP	95 18167 - CLOCK
TMS 5200 SPEECH CHIP	7.95

### CMOS

CD4001	\$.18	CD4017	\$.59	CD4047	\$.65	CD4069	\$.29	CD4510	\$.69	CD4543	\$.89
CD4002	.18	CD4018	.59	CD4048	.75	CD4070	.29	CD4511	.69	CD4555	.99
CD4007	.59	CD4020	.59	CD4049	.29	CD4071	.29	CD4512	.69	CD4566	.99
CD4008	.59	CD4024	.49	CD4050	.39	CD4072	.29	CD4518	.79	CD4584	.69
CD4009	.59	CD4025	.59	CD4051	.39	CD4073	.79	CD4519	.79	CD14409	6.95
CD4010	.29	CD4027	.35	CD4052	.59	CD4076	.65	CD4520	.79	CD14410	7.95
CD4011	.29	CD4030	.29	CD4053	.59	CD4081	.29	CD4522	.79	CD14411	8.95
CD4012	.29	CD4040	.65	CD4060	1.49	CD4082	.29	CD4538	.79	CD14412	8.95
CD4013	.29	CD4042	.65	CD4063	1.49	CD4083	.35				
CD4016	.59	CD4046	.65	CD4066	.29	CD40103	1.90				

Call Us For More!!

### CO-PROCESSORS V20/30

8087 (5 MHz)	\$105.	80287 (0 10 MHz)	365.
8087-2 (8 MHz)	160.	V20-5 (5 MHz)	\$9.95
80287 (5 MHz)	185.	V20-8 (8 MHz)	12.95
80287-8 (8 MHz)			



# ACP's Break thru Prices!!

## Since 1976...The Nation's TOP Computer Supplier

**Quantum Theory!**  
We made a truckload purchase from the factory and while the supply lasts we are offering them at this unbelievable price...

**sale**

**389.**

**Quantum Q540 42.6Mb**

Unformatted, 40ms, perfect for 286 & 386 AT's

**ACP...famous since 1976 for delivering the Best Deals!!**

**TRUE BLUE!!!**  
**REAL IBM® Internal 1200 Baud Modem**

with diagnostic disc.

**89.**

Factory Direct! Amdek®

**TTL Amber Monitor 88.**  
12", Model 310A, List \$240.

**While Supply Lasts!**

**New! RAY-O-VAC® 995**  
Introductory Price.....

**AT Replacement Battery**

Direct replacement for real-time clocks, AT/286/386

**MEMORY LOSS?**

Don't feel like the Lone Ranger... we are also suffering from loss of memory. ACP sells more Memory Upgrade IC's than any other mail order supplier...But...the present shortage is driving us up a wall. We can't get them at the right price, but we are getting them.

**PLEASE BEAR WITH US...as the market price comes down our price will come down.**

**SELLING Chips? Call us, we're buying.**

**Special Purchase CLOSEOUTS!**

**AMDEK EPSON QUADRAM**

- Bulk DS/DD 5 1/4" Diskettes each 32¢
- Box of 100 Quadram Diskettes sale 98.
- upgrade PCXT to 10 MHz sale 98.
- Sixpack Compatible Quadram Silver Board, OK sale 98.
- Liberty Card, EMS, OK sale 98.
- EPSON Equity II sale 699.
- 1200 Baud Internal Modem with software sale 79.
- Sharp PC5000 Portable sale 149.
- Omnitel 1200 Baud Modem 2 serial ports (game/software) sale 129.
- Diablo 620 Printer sale 249.
- Mindset Personal Computer 360K/100ppm/mouse/joy/MS-DOS 2.0 299.

**PC COMPATIBLE CARDS**

**ACP Advanced Cards/IBM**

Monographics/EGA/w/printer port 55.  
Colorgraphics/w/printer port 55.  
SuperEGA Genoa compatible 169.  
SuperVGA 1024x768 339.  
Diamond Multi I/O 2s.p.p.c/XT 139.  
XT Six-Pak compatible/OK 89.  
XT 286 Accelerator card 269.  
XT Multi I/O w/floppy cont. 59.  
XT dual floppy controller 29.  
XT Serial I/O card 29.  
XT AT Parallel I/O card 29.  
XT AT Serial I/O card 39.  
XT/AT Game adapter port 29.  
XT/AT EPROM programmer 149.  
AT 3.5Mb w/Multi I/O, OK 119.  
AT SuperMULTI I/O w/floppy 119.  
PS/2 Multi I/O 99.  
PS/2 Floppy controller 1.4Mb 89.  
HP LaserJet 1Mb Ram card 349.

**COMPUTERS**

**Advanced 386 Clones**

Advanced386/16Base system 1795.  
Advanced386/16 w/40Mb 2195.  
Advanced386/16w/80Mb 2495.

**Advanced 286 Clones**

Advanced286/10Base system 849.  
Advanced286/10 w/20Mb 1099.  
Advanced286/10 w/40Mb 1299.

**Advanced XT Clones**

AdvancedXT base system 489.  
Advanced4XT w/floppy/20Mb 999.  
call for options & details.

**AST Research**

Premium286Model40,40Mb 2995.  
Premium Workstation 2195.  
Premium386Model340,40Mb 4699.  
call for all AST models.

**COMPAG**

Portable II Model20 call.  
Desktop286 Model20 call.  
Desktop386 Model40 call.  
Portable386 Model40 call.

**EPSON**

Equity II call.  
Equity III call.  
Equity IV call.

**HYUNDAI**

Hyundai286 call.  
HyundaiXT call.  
Hyundai PC/LAN Terminal call.

**NEC**

MultiSpeed EL backlit LCD call.  
MultiSpeed HD, 20Mb call.

**SHARP**

4500 Laptop single floppy 699.  
4500 dual floppy, 640K 1295.  
4520 Laptop 20Mb 2195.  
PC7100 Portable, 20Mb 2195.  
PC7221 Portable/286, 20Mb 2895.

**TOSHIBA**

T1000 Laptop single floppy 749.  
T1100 dual floppy 1420.  
T1200 Laptop, 20Mb 2395.  
T3100 Laptop/286, 20Mb 2995.  
T3200 286 full keyboard, 40Mb 3995.  
T5100 386, EGA, 40Mb 4995.

**5813 12" EGA(640x480) 595.**  
**8514 16" Hi-res(1024x768) 1395.**

**MAGNAVOX**

Multiscan 14" multicolor 599.  
EGA 14" w/gm&amberswitch 399.  
CGA 13" color 288.  
Tri Mono 12" gm/amber 89.

**NEC**

Multisync II 13" TTL/Analog 595.  
Multisync Plus 15" VGA/EGA 945.  
Multisync XL 20"(1024x768) 2275.  
Monographics 12"(1024x768) 1555.

**SAMSUNG/LTI**

Flatscreen 12" amber/TTL 99.  
Mono 12" amber/TTL 88.  
CGA 14" RGB Color 288.  
EGA 14" EGA/CGA Color 395.

**SONY**

CPD1302 13" Multiscan color 699.  
CPD1303 13" EGA 569.

**WYSE**

WY30 14" terminal 349.  
WY50 14" terminal 419.  
WY60 14" terminal ASCII 519.

**System Saver II 69.**  
**System Saver IIgs 119.**  
**Printer Microlite, 80column 39.**  
**Printer MICROFIL ACCESSORIES**

514" Rolloff Diskette File 29.  
301" Rolloff Diskette File 22.  
PC Vacuum Cleaner 39.  
CSP Value II (12"x12") 119.  
Underdeck 8000 Drawer 49.

**FLIP n' FILE**

Flip MiniXT, 100 5 1/4" smoke 10.  
FNF MicroXT, 100 3 1/2" smoke 11.  
FNF Maxi 50 8" smoke 15.  
FNF Micro, 25 3 1/2" smoke 8.  
Universal Printer Stand 9.

**DISKETTES- lifetime warranty**

5 1/4" DS/DD Disks PCKT360K Maxell MD2-D 11.  
Verbatim Datafile DS/DD 12.  
Fuji MD20 11.  
PC/MS 80 w/ plastic box 8.  
5 1/4" DS+HD High Density AT 1.2Mb Maxell MD2-DD 23.  
Verbatim DatafileHD 23.  
Fuji MD2HD 22.  
3 1/2" High Density Disks (1.44Mb) Maxell 49.  
Verbatim Datafile 49.  
Fuji 49.  
300P w/wide cartidge(par) 539.

**MOTHERBOARDS**

XT Turbo w/BIOS, 8MHz 89.  
XT Turbo w/BIOS, 10MHz 99.  
AT 286 w/BIOS, 10MHz 289.  
AT 386 w/BIOS, 12MHz 299.  
AT 386 w/BIOS, 16MHz 1499.

**FLOPPY DISK DRIVES**

**SONY**

3 1/2" Micro Floppy 1.44Mb 149.

**TEAC**

559F 360K Floppy/PC/XT/AT 89.

**TOSHIBA AMERICA**

FDD403 3 1/2" Micro 760K 129.  
3 1/2" Micro 1.44Mb w/kit 139.  
DD404 360K Floppy/PC/XT 84.  
DD404E 360K Floppy AT gray 84.  
DD80DE-G 1.2Mb AT gray 110.

**PRINTERS**

**DICONSIX/KODAK**

ISO Portable printer(par) 339.  
300P w/wide cartidge(par) 539.

**EPSON**

LX80080column, 80cps 199.  
EX800 FX286a/FX86a/L0850, L01050, L01000 call.  
ACP is full line Epson dealer

**HEWLETT PACKARD**

LaserJet Series II 1699.  
Deskjet/w/label quality 895.  
Scanjet/w/label scanner 1549.

**IBM PRINTERS**

Proprietary II, 24cps 435.  
Proprietary X24, 240cps 24pin 635.  
Proprietary XL24, 240cps 24pin 635.

**NEC**

P2200, 24pin(360/300) 399.  
P565YL Color, 100cps 1095.  
P650 Pinwriter, 65cps/MLO 599.  
LC890 Silentwriter LSR 3649.

**PRINTER BUFFERS**

Advanced 64K buffer 129.  
Advanced 64K AB buffer 169.

**SWITCH BOXES**

Advanced 2-position AB, 2625 29.  
Advanced 2-position AB, 3535 29.  
Advanced parallel converter 69.  
Advanced parallel/parallel converter 69.  
Buffalo SX PC share (upto 7) 498.  
Logical Connection 256K 499.

**INTELLICOM**

Linklink-Parallel 199.  
Linklink-Serial 199.  
Quicklink-Par to Ser-64K 149.  
Quicklink-Par to Par-64K 149.  
Metaklink-40 Par-Bus & Ser. 299.

**TRIPLITE**

Isobar4 surge supp w/4 outlets 59.  
Isobar6 surge supp w/6 outlets 69.  
LineConditioner w/4 outlets 149.  
Backup Power Supply, 450w 399.  
Backup Power Supply, 675w 578.  
Advanced Power Supply, 1000w 999.  
Backup Power Supply, 2000w 1299.

**HARDWARE**

**AST Research**

Xtormer/286, 512K, 10MHz 699.  
Advantage 2/386, mod 80, 1Mb 725.  
Advantage 2/286/PS/2, OK 349.  
Advantage Premium 286, 512K 388.  
Rampage 2/286/PS/2, 512K 499.  
Rampage 286, 512K 489.  
AST SixpakPlus, OK 119.

**ATI Technologies**

EGA Wonder 800 199.  
VGA/VIP 319.  
240dot/in. Modem w/MNP-5 189.

**GENOA**

Super EGA call.  
Super VGA call.

**GULFSTREAM**

EZ-FAX Board w/software 1188.

**MERCURIES**

Color Card CGA 149.  
Graphics Card Plus 174.

**HARD DISK DRIVES**

**MICROPLUS**

1333A 95Mb Full ht, 30ms 649.  
1335 95Mb Full ht, 65ms 849.

**MINISCRIBE**

3650 43Mb Half ht, 6.1ms 389.  
6053 53Mb Full ht, 28ms 649.  
6085 85Mb Full ht, 28ms 849.  
8439 38Mb Half ht, 65ms-RL 299.

**PLUS Development**

Plus2D Hardcard, 20Mb, 49ms 549.  
Plus4D Hardcard, 40Mb, 39ms 719.

**SEAGATE**

ST225 25Mb, 65ms, w/WD cont. 299.  
ST138 38Mb, New! 31/2" 399.  
ST138 38Mb, 65ms, w/WD RLL 398.  
ST251 51Mb, 40ms 449.  
ST251-1 51Mb, 28ms 499.  
ST4038 38Mb, 40ms, REDUCED 469.  
ST4936 96Mb, 28ms, REDUCED 799.

**WESTERN DIGITAL**

FilecadP530 PS/2/mod.25/30 389.  
Filecad30 449.  
1008RAH Contr. 1, Interleave 199.  
1003RAH Contr. RLL/AT 187.  
1003WAZ Floppy/Hard/AT 149.  
1002-27X Controller RLL/XT 98.  
1002-WX1 Controller AT 89.

**NETWORKS**

**3COM**

Ethernet card 399.  
Ethernet II card 399.

**WESTERN DIGITAL**

StarLAN/Novell starter kit 1077.  
(network for less than \$400/node)

Ethernet Plus adapter board 239.  
VialNet LAN software 120.  
Starhub 329.

**SOFTWARE**

**ncp -not copy protected**

cp-copy protected

**ALDUS-ncp**

PageMaker/IBM 499.  
PageMaker/MAC 379.  
Freehand/MAC call.

**ALPHA SOFTWARE-ncp**

Advanced Keyworks I.0 175.  
Alpha/tree I.0 232.  
Grand View 175.

**AMER. SMALL BUSINESS-ncp**

Design CAD 30 3.0. 168.

**ANSA**

Paradox v.1.1 329.  
Paradox v.1.0 w/EMS&EMS 424.  
ASHTON T.1-ncp 422.  
Basilett plus I.1 275.  
Rapidfite 1.2 219.  
Multimate Advantangel I.0 275.  
Appliance Presentation pkg call.

**BORLAND-ncp**

Sidekick/ps 139.  
Sidekick 1.0 199.  
Turbo BASIC 1.0 69.  
Turbo PASCAL 4.0 69.

**QUADRAM**

Quad386XT 747.  
Prosync(640x480,752x410) 269.  
Microcenter buffer/5.64 199.  
Quadpsprint XT accelerator 98.  
Liberty EMS XT card, OK 98.  
Video Quadboard, Sixpak comp. 98.

**VIDEO 7**

VEGA Deluxe 199.  
VEGA VGA 299.

**MODEMS**

**Advanced MODEMS**

1200baud w/software(int) 79.  
1200baud External 89.  
1200baud Pocket MODEM 99.  
2400baud w/software(int) 149.  
2400baud External 159.

**HAYES**

Smartmodem 1200B wsw(int) 299.  
Smartmodem 1200 External 299.  
Smartmodem2400B wsw(int) 447.  
Smartmodem 2400 External 447.

**MIGENT**

Pocket MODEM 1200 129.  
PROMETHEUS

2400G External 199.  
2400B/2 w/software (int) 149.  
2400PS/2 w/software (int) 299.  
1200B/2 w/software(int) sale 79.

**MONITORS**

**AMDEK**

VIDEO 310A 12" amber TTL 99.  
410A 12" amber/green or white 153.  
1280 13" graphics(1280x800) 799.  
LaserDrive CD ROM w/MS/soft 899.

**IBM MONITORS**

8503 12" Monoc(640x480) 228.  
8512 14" Color analog 527.

**SOFTWARE**

**ncp -not copy protected**

cp-copy protected

**ALDUS-ncp**

PageMaker/IBM 499.  
PageMaker/MAC 379.  
Freehand/MAC call.

**ALPHA SOFTWARE-ncp**

Advanced Keyworks I.0 175.  
Alpha/tree I.0 232.  
Grand View 175.

**AMER. SMALL BUSINESS-ncp**

Design CAD 30 3.0. 168.

**ANSA**

Paradox v.1.1 329.  
Paradox v.1.0 w/EMS&EMS 424.  
ASHTON T.1-ncp 422.  
Basilett plus I.1 275.  
Rapidfite 1.2 219.  
Multimate Advantangel I.0 275.  
Appliance Presentation pkg call.

**BORLAND-ncp**

Sidekick/ps 139.  
Sidekick 1.0 199.  
Turbo BASIC 1.0 69.  
Turbo PASCAL 4.0 69.

**INPUT DEVICES**

**Advanced PC Keyboards**

5160 84key XT/AT switchable 59.  
5161 101key XT/AT switchable 79.

**CH Products**

Match I Joystick-IBM 39.  
Match II Joystick-Apple 39.

**BACKUP DEVICES**

**ALPHAMICRO**

VCR Video tape backup card 349.

**OMEGB**

Bernoulli 20Mb 5 1/4" internal 945.  
Bernoulli dual20Mb 5 1/4" ext 1699.  
Bernoulli dual20Mb 8" ext 1895.  
Tri-pak 20Mb cartridge, 8" 2 5/8 189.  
Tri-pak 20Mb cartridge, 8" 2 5/8 189.  
PC38 Adapter card, PC/XT/AT 189.  
PS4 Adapter-PS/2/mod.50,60,80 299.

**IRWIN**

1100 XT/AT 10Mb backup(int) 199.  
1200 XT 20Mb backup(int) 369.  
145C AT 40Mb backup(int) 499.  
245P PS/2 40Mb backup 479.

**TALLGRASS Technologies**

1020 AT 20Mb backup(int) 338.  
1020 XT 20Mb backup(int) 338.  
1040 AT 40Mb backup(int) 599.  
1040 XT 40Mb backup(int) 599.  
8503 12" Monoc(640x480) 228.  
8512 14" Color analog 527.

**HOUSTON INSTRUMENTS**

DMP41 or 42 2399.  
DMP51 or 52 3099.  
SCANCAD 2499.  
DMP65A 4599.

**ROLAND**

DXY880, 8 pen AB size 1088.  
DXY980 1488.

**SOFTWARE**

**ncp -not copy protected**

cp-copy protected

**ALDUS-ncp**

PageMaker/IBM 499.  
PageMaker/MAC 379.  
Freehand/MAC call.

**ALPHA SOFTWARE-ncp**

Advanced Keyworks I.0 175.  
Alpha/tree I.0 232.  
Grand View 175.

**AMER. SMALL BUSINESS-ncp**

Design CAD 30 3.0. 168.

**ANSA**

Paradox v.1.1 329.  
Paradox v.1.0 w/EMS&EMS 424.  
ASHTON T.1-ncp 422.  
Basilett plus I.1 275.  
Rapidfite 1.2 219.  
Multimate Advantangel I.0 275.  
Appliance Presentation pkg call.

**BORLAND-ncp**

Sidekick/ps 139.  
Sidekick 1.0 199.  
Turbo BASIC 1.0 69.  
Turbo PASCAL 4.0 69.

**Advanced Computer Products, Inc.**

Mail Order: P.O. Box 17329 Irvine, CA 92713

Retail: 131D-B E. Edinger, Santa Ana, CA 92705

**for Fast Service Order by Phone!**

**NEW PHONE FOR ALL USA 800-FONE ACP**

800-366-3227 • 714-558-8813

**OUR POLICY**

- \$25.00 Minimum MAIL ORDER
- No S charge for USA or International
- Product subject to change without notice
- ACP Retail store pricing may vary. Not responsible for typos.
- Limited warranties and other conditions may apply

**Call for our NEW 1988 Catalog...**



# JDR Microdevices®

Complete customer satisfaction... superior service... friendly, knowledgeable personnel  
quality merchandise... providing the best values in leading edge technology.

## STATIC RAMS

2112	256x4	(450ns)	2.99
2114	1024x4	(450ns)	.99
TMM2016-100	2048x8	(200ns)(LOW POWER)	1.49
HM6116-1	2048x8	(100ns)	1.95
HM6116-3	2048x8	(200ns)(CMOS)	3.29
HM6116-P	2048x8	(150ns)(CMOS)	3.95
HM6116LP-4	2048x8	(200ns)(CMOS)(LP)	4.29
HM6116LP-3	2048x8	(150ns)(CMOS)(LP)	4.95
HM6116LP-2	2048x8	(120ns)(CMOS)(LP)	5.49
HM6264LP-15	8192x8	(150ns)(CMOS)(LP)	6.49
HM6264LP-12	8192x8	(120ns)(CMOS)(LP)	6.99
HM43256LP-15	32768x8	(150ns)(CMOS)(LP)	12.95
HM43256LP-12	32768x8	(120ns)(CMOS)(LP)	14.95
HM43256LP-10	32768x8	(100ns)(CMOS)(LP)	19.95

## DYNAMIC RAMS

4116-250	16384x1	(250ns)	.49
4116-200	16384x1	(200ns)	.89
4116-150	16384x1	(150ns)	.99
4116-120	16384x1	(120ns)	1.49
MK4332	32768x1	(200ns)	6.95
4164-150	65536x1	(150ns)	2.89
4164-120	65536x1	(120ns)	3.19
MCM6665	65536x1	(200ns)	1.95
TMS4166	65536x1	(150ns)	1.95
4164-REFRESH	65536x1	(150ns)(PIN 1 REFRESH)	2.95
TMS4416	16384x4	(150ns)	3.75
41128-150	131072x1	(150ns)	5.95
TMS4464-15	65536x4	(150ns)	7.95
41256-150	262144x1	(150ns)	12.45
41256-120	262144x1	(120ns)	12.95
41256-100	262144x1	(100ns)	14.45
HM51258-100	262144x1	(100ns)(CMOS)	6.95
1 MB-120	1048576x1	(120ns)	34.95
1 MB-100	1048576x1	(100ns)	37.95

## EPROMS

2708	1024x8	(450ns)(25V)	4.95
2716	2048x8	(450ns)(25V)	3.49
2716-1	2048x8	(350ns)(25V)	3.95
TMS2532	4096x8	(450ns)(25V)	2.95
2732	4096x8	(450ns)(25V)	2.95
2732A	4096x8	(250ns)(21V)	3.95
2732A-2	4096x8	(200ns)(21V)	4.25
27C64	8192x8	(250ns)(12.5V CMOS)	4.95
2764	8192x8	(450ns)(12.5V)	3.49
2764-250	8192x8	(250ns)(12.5V)	3.69
2764-200	8192x8	(200ns)(12.5V)	4.25
MCM68766	8192x8	(350ns)(21V)(24 PIN)	16.95
27128	16384x8	(250ns)(12.5V)	4.25
27C256	32768x8	(250ns)(12.5V CMOS)	7.95
27256	32768x8	(250ns)(12.5V)	5.95
27512	65536x8	(250ns)(12.5V)	11.95
27C512	65536x8	(250ns)(12.5V CMOS)	12.95

MEMORY PRICES SUBJECT TO CHANGE DUE TO MARKET CONDITIONS. PLEASE CALL TO CONFIRM PRICES.

## HIGH-TECH SPOTLIGHT 1 MB EPROMS

■ 128K x 8 ORGANIZATION ■ 200 NS  
■ CMOS DESIGN FOR LOW POWER

PIN ARRANGEMENT

**\$34.95**

## 8000

8031	3.95
8035	1.49
8039	1.95
8052AH BASIC	3.95
8080	2.49
8085	1.95
8086	6.49
8088	7.95
8088-2	7.95
8155	2.49
8155-2	3.95
8741	9.95
8748	7.95
8749	9.95
8755	14.95

## 8200

8203	14.95	8255-5	1.59
8205	3.29	8259	1.95
8212	1.49	8259-5	2.29
8216	1.49	825	2.25
8224	2.25	8272	4.39
8228	2.25	8274	4.95
8237	3.95	8275	16.95
8237-5	4.75	8279	2.49
8243	1.95	8279-5	2.95
8250	6.95	8282	3.95
8251	1.29	8283	3.95
8251A	1.69	8284	2.25
8253	1.59	8286	3.95
8253-5	1.95	8287	3.95
8255	1.49	8288	4.95

## MATH COPROCESSORS

8087	5 MHz	\$99.95
8087-2	8 MHz	\$159.95
8087-1	10 MHz	\$229.95
80287	6 MHz	\$179.95
80287-8	8 MHz	\$249.95
80287-10	10 MHz	\$309.95
80387-16	16 MHz	\$499.95
80387-20	20 MHz	\$799.95

## 74LS00

74LS00	.16	74LS112	.29	74LS241	.69
74LS01	.18	74LS122	.45	74LS242	.69
74LS02	.17	74LS127	.49	74LS243	.69
74LS03	.18	74LS124	2.75	74LS244	.69
74LS04	.16	74LS125	.39	74LS245	.79
74LS05	.18	74LS126	.39	74LS251	.49
74LS08	.18	74LS132	.39	74LS253	.49
74LS09	.18	74LS133	.49	74LS257	.39
74LS10	.16	74LS136	.39	74LS258	.45
74LS12	.22	74LS139	.39	74LS259	1.29
74LS13	.22	74LS139	.39	74LS260	.49
74LS13	.26	74LS145	.99	74LS266	.39
74LS14	.39	74LS147	.99	74LS273	.79
74LS15	.26	74LS148	.99	74LS279	.39
74LS20	.17	74LS151	.39	74LS280	1.98
74LS21	.22	74LS153	.39	74LS283	.59
74LS22	.22	74LS156	1.49	74LS290	.89
74LS27	.23	74LS155	.59	74LS293	.89
74LS28	.26	74LS156	.49	74LS299	1.49
74LS30	.17	74LS157	.35	74LS322	3.95
74LS32	.18	74LS158	.29	74LS323	2.49
74LS33	.28	74LS160	.29	74LS365	.39
74LS37	.26	74LS161	.39	74LS367	.39
74LS38	.26	74LS162	.49	74LS368	.39
74LS42	.29	74LS165	.39	74LS373	.39
74LS47	.75	74LS164	.49	74LS374	.79
74LS48	.85	74LS165	.65	74LS375	.95
74LS51	.17	74LS166	.95	74LS377	.79
74LS73	.29	74LS169	.95	74LS390	1.19
74LS74	.24	74LS173	.49	74LS393	.79
74LS75	.29	74LS174	.39	74LS541	1.49
74LS83	.49	74LS175	.39	74LS542	1.95
74LS85	.49	74LS191	.49	74LS560	.95
74LS86	.49	74LS192	.69	74LS565	.99
74LS88	.22	74LS193	.69	74LS570	.89
74LS90	.39	74LS194	.69	74LS582	3.20
74LS92	.49	74LS195	.69	74LS588	2.40
74LS93	.39	74LS196	.59	74LS583	22.95
74LS95	.49	74LS221	.59	74LS592	1.95
74LS107	.34	74LS222	.59	74LS593	1.95
74LS109	.36	74LS240	.69	74LS594	1.95

## 7400

7400	.19
7402	.19
7404	.19
7406	.29
7407	.29
7408	.24
7410	.19
7411	.25
7414	.49
7416	.25
7417	.25
7420	.19
7430	.19
7432	.29
7433	.29
7438	.49
7442	.49
7445	.69
7447	.89
7473	.34
7474	.33
7475	.45
7476	.35
7483	.50
7485	.59
7486	.35
7489	2.15
7490	.39
7493	.29
74121	.49
74123	.49
74125	.45
74150	1.35
74151	.55
74152	.75
74154	1.49
74157	.55
74159	1.65
74161	.69
74164	.85
74166	1.00
74175	.89
74367	.65

## LINEAR

LM071	.69	LM567	.79
LM072	1.09	NE570	2.95
LM074	1.95	NE592	.98
LM082	.99	LM723	.49
LM084	1.49	LM733	.98
LM301	.44	LM741	.29
LM309K	1.25	LM747	.69
LM311	.59	MC1330	1.69
LM311H	.89	MC1350	1.19
LM317K	3.49	LM1468	.35
LM317	.69	LM1488	.49
LM318	1.49	LM1489	.49
LM319	1.25	LM1496	.85
LM320 see 7900		ULN2003	.79
LM323K	3.49	XR220	2.95
LM324	.34	XR221	2.95
LM331	3.95	LM2917	1.95
LM334	1.19	CA3046	.89
LM335	1.79	CA3146	1.29
LM338	1.49	LMC173	1.29
LM338K	4.49	MC3470	1.95
LM339	.59	MC3480	8.95
LM340 see 7800		MC3487	2.95
LF353	.59	LM3900	.49
LF356	.99	LM3901	2.25
LF357	.99	LM3909	.98
LM358	.59	LM3914	1.89
LM380	.89	MC4024	3.49
LM393	3.95	MC4044	3.99
LM394K	.89	RC4136	1.25
LM394	.89	RC4558	.69
LM394H	5.95	LM13600	1.49
TL494	4.20	75107	1.49
TL497	3.25	75110	1.95
NE555	.49	75150	1.95
NE556	.49	75154	1.95
NE558	.79	75188	1.25
NE564	1.95	75189	1.25
LM565	.65	75191	.39
LM566	1.49	75452	.39
NE590	2.50	75477	1.29

H-T-O-5 CAN, K-T-O-3, T-T-O-220

## 6500

6502	1.0 MHz	2.25
65020 (CMOS)	1.0 MHz	7.95
6502	1.65	
6522	2.95	
6526	13.95	
6532	5.95	
6545	2.95	
6551	2.95	
6551A	6.95	
6502B	4.25	

## Z-80

Z80-CPU	1.29	
Z80A-CTC	1.69	
Z80A-DART	5.95	
Z80A-DMA	5.95	
Z80A-PIO	1.89	
Z80A-SIO 0	5.95	
Z80A-SIO 1	5.95	
Z80A-SIO 2	5.95	
Z80B-CPU	2.75	
Z80B-CTC	4.25	
Z80B-PIO	4.25	
Z80B-DART	6.95	
Z80B-SIO 0	12.95	
Z80B-SIO 2	12.95	
Z8671 ZILOG	9.98	

## DISK CONTROLLERS

1771	4.95
1791	9.95
1795	12.95
1797	12.95
2791	19.95
2793	19.95
2797	29.95
8273	4.39
UMPD765	4.95
MB8876	12.95
MB8877	12.95
1691	6.95
2143	6.95
9216	6.29

## V 20 SERIES

V20* 5 MHz	8.95
V20* 8 MHz	10.95
V20* 10 MHz	12.95
V20 8 MHz	13.95

\*Replaces 8088 to speed up PC 10-40%\*

## PALS

16L8	\$2.95
16R8	\$2.95
16R6	\$2.95
16R4	\$2.95

## CRYSTALS

32.768 KHz	.95
1.0 MHz	2.95
1.8432	2.95
2.0	1.95
2.4576	1.95
3.579545	1.95
4.0	1.95
5.0	1.95
5.0688	1.95
6.0	1.95
6.144	1.95
8.0	1.95
10.0	1.95
10.738635	1.95
12.0	1.95
14.31818	1.95
16.0	1.95
18.0	1.95
18.432	1.95
20.0	1.95
22.1184	1.95
24.0	1.95
32.0	1.95

## 74F1745

74F00	.35
74F02	.35
74F04	.35
74F08	.35

### CAPACITORS TANTALUM

1.0µ	15V	.12	1.0µ	35V	.45
6.8	15V	42	2.2	35V	.19
10	15V	45	4.7	35V	.39
22	15V	99	10	35V	.69

### DISC

10µ	50V	.05	.001µ	50V	.05
22	50V	.05	.005	50V	.05
33	50V	.05	.01	50V	.07
47	50V	.05	.05	50V	.07
100	50V	.05	.1	50V	.10
220	50V	.05	.1	50V	.12

### MONOLITHIC

.01µ	50V	.14	.1µ	50V	.18
.047µ	50V	.15	.47µ	50V	.25

### ELECTROLYTIC

RADIAL		AXIAL			
1µ	25V	.14	1/2	50V	14
4.7	50V	.11	10	50V	16
10	50V	.11	22	16V	14
47	35V	.13	47	50V	.19
100	16V	.15	100	35V	.19
220	35V	.20	470	50V	.29
470	25V	.30	1000	16V	.29
2200	16V	.70	2200	16V	.70
4700	25V	1.45	4700	16V	1.25

### VOLTAGE REGULATORS

7805T	.49	7812K	1.39
7808T	.49	7905K	1.69
7812T	.49	7912K	1.49
7815T	.49	78L05	.49
7905T	.59	78L12	.49
7908T	.59	79L05	.69
7912T	.59	79L12	1.49
7915T	.59	LM323K	4.79
7805K	1.59	LM338K	6.95

### DISCRETE

1N751	.15	4N28	.69
1N4148Z5	1.00	4N33	.89
1N400410	1.19	4N37	1.19
1N5402	.25	MCT-2	.59
KBP02	.55	MCT-6	1.29
2N2222	.25	TIL-111	.99
PR222	.10	2N3906	1.10
2N2907	.25	2N4401	.25
2N3055	.79	2N4402	.25
2N3904	1.0	2N4403	.25
4N26	.69	2N6045	1.75
4N27	.69	TIP31	.49

### SOLDER STATION

UL APPROVED

- ADJUSTABLE HEAT SETTING WITH TIP TEMPERATURE READOUT
- REPLACEMENT TIPS AVAILABLE \$2.95

**\$49.95**



### WIREWRAP PROTOTYPE CARDS

FR-4 EPOXY GLASS LAMINATE WITH GOLD PLATED EDGE-CARD FINGERS SILK SCREENED LEGENDS, MOUNTING BRACKETS INCLUDED

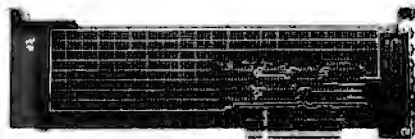

### FOR PS/2

JDR-PR32	32 BIT PROTOTYPE CARD	69.95
JDR-PR16	16 BIT CARD WITH I/O DECODING LAYOUT	49.95
JDR-PR16PK	PARTS KIT FOR JDR-PR16 ABOVE	15.95
JDR-PR16V	16 BIT CARD FOR VIDEO APPLICATIONS	39.95

### FOR AT

JDR-PR10	16 BIT CARD WITH I/O DECODING LAYOUT	34.95
JDR-PR10PK	PARTS KIT FOR JDR-PR10 ABOVE	12.95

### FOR XT

IBM-PR1	WITH +5V AND GROUND PLANE	27.95
IBM-PR2	AS ABOVE WITH I/O DECODING LAYOUT	29.95

### BYPASS CAPACITORS

.01 µF CERAMIC DISC	100	\$5.00
.01 µF MONOLITHIC	100	\$10.00
.1 µF CERAMIC DISC	100	\$6.50
.1 µF MONOLITHIC	100	\$12.50

### RESISTOR NETWORKS

SIP 10 PIN	9 RESISTOR	.69
SIP 8 PIN	7 RESISTOR	.59
OIP 16 PIN	8 RESISTOR	1.09
DIP 16 PIN	16 RESISTOR	1.09
DIP 14 PIN	7 RESISTOR	.99
DIP 14 PIN	13 RESISTOR	.99

### SHORTING BLOCKS

\$101.00

### EXTENDER CARDS

FOR PROTOTYPE DEBUGGING AND TROUBLESHOOTING

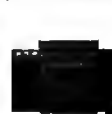

EXT-8088	FOR XT SYSTEM	29.95
EXT-80286	FOR AT SYSTEM	39.95
EXT-16	MICROCHANNEL 16-BIT	69.95
EXT-32	MICROCHANNEL 32-BIT	99.95

### "SNAPABLE" HEADERS

CAN BE SNAPPED APART TO MAKE ANY SIZE HEADER. ALL WITH .1" CENTERS

1x40	STRAIGHT LEAD	.99
1x40	RIGHT ANGLE LEAD	.49
2x40	2 STRAIGHT LEADS	2.49
2x40	2 RIGHT ANGLE LEADS	2.99



## WHY THOUSANDS CHOOSE JDR

- QUALITY MERCHANDISE
  - COMPETITIVE PRICES
  - MOST ORDERS SHIPPED IN 24 HOURS
  - FRIENDLY, KNOWLEDGEABLE STAFF
  - 30-DAY MONEY BACK GUARANTEE
  - TOLL FREE TECHNICAL SUPPORT
  - EXCELLENT CUSTOMER SERVICE
- CALL FOR VOLUME QUOTES

### SOLDERLESS BREADBOARDS

WBU-D	100 TIE PTS.	2.95	WBU-204	1660 TIE PTS.	24.95
WBU-T	630 TIE PTS.	6.95	WBU-206	2390 TIE PTS.	29.95
WBU-204-3	1360 TIE PTS.	17.95	WBU-208	3220 TIE PTS.	39.95



### IDC CONNECTORS/RIBBON CABLE

DESCRIPTION	ORDER BY	CONTACTS					
		10	20	26	34	40	50
SOLDER HEADER	IDHxxS	.82	1.29	1.68	2.20	2.58	3.24
RIGHT ANGLE SOLDER HEADER	IDHxxSR	.85	1.35	1.76	2.31	2.72	3.39
WIREWRAP HEADER	IDHxxW	1.86	2.98	3.84	4.50	5.28	6.63
RIGHT ANGLE WIREWRAP HEADER	IDHxxWR	2.05	3.28	4.22	4.45	4.80	7.30
RIBBON HEADER SOCKET	IDSxx	.63	.89	.95	1.29	1.49	1.69
RIBBON HEADER	IDMxx	---	5.50	6.25	7.00	7.50	8.50
RIBBON EDGE CARD	IDExx	.85	1.25	1.35	1.75	2.05	2.45
10' GREY RIBBON CABLE	RCxx	1.60	3.20	4.10	5.40	6.40	7.50

FOR ORDERING INSTRUCTIONS, SEE D-SUBMINIATURE CONNECTORS, BELOW

### 3 VOLT LITHIUM BATTERY

\$1.95

HOLDER \$1.49



### SPECTRONICS CORPORATION EPROM ERASERS

Model	Timer	Chip Capacity	Intensity (uW/Cm <sup>2</sup> )	Unit Cost
PE-140	NO	9	8,000	\$89
PE-140T	YES	9	8,000	\$139
PE-240T	YES	12	9,600	\$189



### D-SUBMINIATURE CONNECTORS

DESCRIPTION	ORDER BY	CONTACTS						
		9	15	19	25	37	50	
SOLDER CUP	MALE	DBxxP	.45	.59	.69	.89	1.35	1.85
	FEMALE	DBxxS	.49	.69	.75	.75	1.39	2.29
RIGHT ANGLE PC SOLDER	MALE	DBxxPR	.49	.69	---	.79	2.27	---
	FEMALE	DBxxSR	.55	.75	---	.85	2.49	---
WIREWRAP	MALE	DBxxPWW	1.69	2.56	---	3.89	5.60	---
	FEMALE	DBxxSWW	2.76	4.27	---	6.84	9.95	---
IDC RIBBON CABLE	MALE	IDBxxP	1.39	1.99	---	2.25	4.25	---
	FEMALE	IDBxxS	1.45	2.05	---	2.35	4.49	---
HOOKS	METAL	MHOODxx	1.05	1.15	1.25	1.25	---	---
	GREY	HOODxx	.39	.39	---	.39	.69	.75

ORDERING INSTRUCTIONS: INSERT THE NUMBER OF CONTACTS IN THE POSITION MARKED 'xx' OF THE ORDER BY PART NUMBER LISTED. EXAMPLE: A 15 PIN RIGHT ANGLE MALE PC SOLDER WOULD BE DB15PR

MOUNTING HARDWARE 59¢

### RS-232 BREAKOUT BOX

- OPEN/CLOSE INDIVIDUAL CIRCUITS
- 20 JUMPERS CROSS-CONNECT ANY TWO CIRCUITS
- 10 LEDS SHOW CIRCUIT ACTIVITY



### GENDER CHANGERS

- FOR 25 PIN D-SUBMINIATURE CONNECTORS
- GENDER-FF FEMALE-MALE 7.95
- GENDER-MM MALE-MALE 7.95
- GENDER-MF MALE-FEMALE 7.95
- GENDER-MH HULL MODEM 8.95
- GENDER-JB JUMPER BOX 8.95
- GENDER-MT MINITESTER 14.95

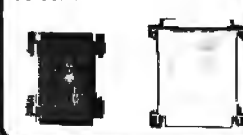

### DATABASE

- ERASES 2 EPROMS IN 10 MINUTES
- VERY COMPACT, NO DRAWER
- THIN METAL SHUTTER PREVENTS UV LIGHT FROM ESCAPING

**\$34.95**



### IC SOCKETS/DIP CONNECTORS

DESCRIPTION	ORDER BY	CONTACTS								
		8	14	16	18	20	22	24	28	40
SOLDERTAIL SOCKETS	xxST	.11	.11	.12	.15	.18	.15	.20	.22	.30
WIREWRAP SOCKETS	xxWW	.59	.69	.69	.99	1.09	1.39	1.49	1.69	1.99
ZIF SOCKETS	ZIFxx	---	4.95	4.95	---	5.95	---	5.95	6.95	9.95
TOOLED SOCKETS	AUGATxxST	.62	.79	.89	1.09	1.29	1.39	1.49	1.69	2.49
TOOLED WW SOCKETS	AUGATxxWW	1.30	1.80	2.10	2.40	2.50	2.90	3.15	3.70	5.40
COMPONENT CARRIERS	ICCxx	.49	.59	.69	.99	.99	.99	.99	1.09	1.49
DIP PLUGS (IDC)	IDPxx	.95	.49	.59	1.29	1.49	---	.85	1.49	1.59

FOR ORDERING INSTRUCTIONS, SEE D-SUBMINIATURE CONNECTORS ABOVE



JDR MICRODEVICES, 110 KNOWLES DRIVE, LOS GATOS, CA 95030  
LOCAL (408) 866-6200 FAX (408) 378-8927 TELEX 171-110



RETAIL STORE: 1256 SOUTH BASCOM AVE., SAN JOSE, CA (408) 947-8881  
HOURS: M-F 10-7 SAT. 9-5 SUN. 12-4



**ORDER TOLL FREE 800-538-5000**

COPYRIGHT 1988 JDR MICRODEVICES

CONTINENTAL U.S. AND CANADA

Terms: Minimum order \$10.00. For shipping and handling include \$2.00 for UPS ground and \$3.50 UPS air. Orders over 1 lb. and foreign orders may require additional shipping charges - please contact the sales department for the amount. CA residents must include applicable sales tax. Prices are subject to change without notice. We are not responsible for typographical errors. We reserve the right to limit quantities and to substitute manufacturer. All merchandise subject to prior sale. A full copy of our terms is available upon request. Items pictured may only be representative.

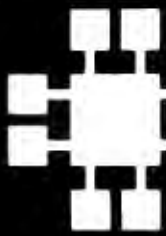

# JDR Microdevices®

Complete customer satisfaction... superior service... friendly, knowledgeable personnel  
quality merchandise... providing the best values in leading edge technology.



**PROMETHEUS**  
**2400 BAUD**  
**MODEM**  
**\$129.95**  
**NEW LOW PRICE!**

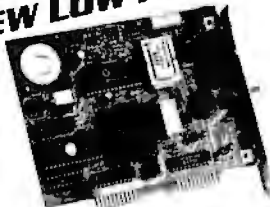

IT'S TIME TO TRADE UP NOW THAT JDR BREAKS THE PRICE BARRIER ON 2400 BAUD MODEMS

- AUTO DIAL ANSWER
- SELF TEST ON POWER-UP
- TOUCHTONE OR PULSE DIALING
- HAYES & BELL SYSTEMS COMPATIBLE
- FULL OR HALF DUPLEX
- MIRROR II COMMUNICATIONS SOFTWARE INCLUDED

MCT-241

MCT-121 1200 BAUD 1/2 CARD \$ 69.95

### EXTERNAL MODEMS

MCT-12E 1200 BAUD \$ 99.95  
MCT-24E 2400 BAUD \$169.95

## COMPUTER CASES

ATTRACTIVE, STURDY STEEL CASES FIT THE POPULAR SIZED MOTHERBOARDS AND INCLUDE SPEAKERS, FACEPLATES, EXPANSION SLOTS, FRONT PANEL KEYLOCKS, LED INDICATORS AND ALL NECESSARY HARDWARE.



XT STYLE FLIP-TOP \$34.95  
 XT STYLE SLIDE-TOP \$39.95  
 AT STYLE SLIDE-TOP \$89.95  
 JR. AT STYLE FLIP-TOP \$149.95  
 ■ INCLUDES 150 WATT POWER SUPPLY

## POWER SUPPLIES

FOR IBM XT COMPATIBLE \$59.95

- UL APP., 135 WATTS
- +5V.15A, +12V.4.2A
- 5V.5A, -12V.5A

PS-135

PS-150 150W MODEL \$69.95



FOR IBM AT COMPATIBLE \$89.95

- 200 WATTS
- +5V.22A, +12V.8A
- -5V.5A, -12V.5A

PS-200



**DIABLO**  
**PRINTER**  
**\$279.95**

- LETTER QUALITY AT 20 CPS, 132 COLS
- 10, 12, 15 PITCH & PROPORTIONAL SPACING
- SERIAL & PARALLEL INTERFACE
- AUTO PAPER LOAD, FRICTION FEED
- FULL XEROX WARRANTY



**CENTRONICS**  
**LASER \$1195**  
**PRINTER**

NEAR TYPESET QUALITY  
AFFORDABLE AT LAST

- 8 PAGES PER MINUTE ■ 300 DPI RESOLUTION
- 1 YEAR WARRANTY ■ CHOICE OF EMULATION BOARDS

MULTI-PRINTER EMULATION BOARD:  
EPSON FX-80 EMULATION—NOTHING ELSE REQUIRED

IBM PC GRAPHICS, PROPRINTER & DIABLO 630  
EMULATION REQUIRES ADDITIONAL FONT CARD

HP LJ+ EMULATION BOARD:

HP LASERJET EMULATION—3 RESIDENT FONTS &  
2 PITCHES ADDITIONAL FONT CARD AVAILABLE

1.5MB RAM CARD \$139.95  
 EXTRA FONT CARDS \$199.95  
 TONER CARTRIDGES \$59.95  
 PFS FIRST PUBLISHER \$99.95

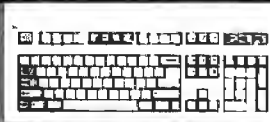

**IBM**  
**COMPATIBLE**  
**KEYBOARDS**  
**FULL ONE YEAR WARRANTY**

IBM ENHANCED STYLE LAYOUT \$79.95

- AUTOSENSE FOR XT OR AT COMPATIBLES
- LED INDICATORS ■ AUTO REPEAT FEATURE
- SEPARATE CURSOR PAD

MCT-5339

IBM AT STYLE LAYOUT \$59.95

- SOFTWARE AUTOSENSE FOR XT OR AT COMPATIBLES
- LED INDICATORS ■ AUTO REPEAT FEATURE

MCT-5060

MAXI-SWITCH KEYBOARDS \$84.95

- STANDARD ENHANCED KEYBOARD LAYOUT
- TACTILE FEEDBACK
- LIGHTED NUM, CAPS, AND SCROLL LOCK
- NUMERIC & CURSOR KEYPADS, 12 "F" KEYS

MAX-5339

MAX-5060 MAXI-SWITCH, AT STYLE \$64.95

## VGA COMPATIBLE PACKAGE

**\$649.00**

**MONITOR  
& CARD  
TOGETHER**

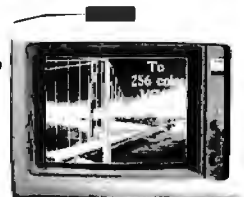

- 800 X 560 MAXIMUM RESOLUTION
- 640 X 480 IN 16 COLORS
- 320 X 200 IN 256 COLORS
- IBM STYLE, ANALOG MONITOR
- FULLY VGA, EGA, CGA, HERCULES & MONOCHROME COMPATIBLE



**NEC MULTISYNC \$599.95**

- ORIGINAL CGA, EGA, VGA COMPATIBLE MONITOR
- AUTO FREQUENCY ADJUSTMENT
- RESOLUTION AS HIGH AS 800 X 560

**CASPER EGA \$399.95**

- 15.75 21 85 KHz SCANNING FREQUENCIES
- 640 X 200 350 RESOLUTION ■ .31 MM DOT PITCH
- 14" BLACKMATRIX SCREEN ■ 16 COLORS

**CASPER RGB \$279.95**

- COLOR GREEN AMBER SWITCH ■ 39MM DOT PITCH
- 640 X 240 RESOLUTION ■ 14" NON-GLARE SCREEN
- RGB/IBM COMPATIBLE ■ CABLE INCLUDED

**SAKATA MONOCHROME \$69.95**

- IBM COMPATIBLE TTL INPUT
- 12" NON-GLARE SCREEN
- CABLE FOR IBM PC INCLUDED

**SAMSUNG MONOCHROME MONITOR \$129.95**

### MONITOR STANDS

**MODEL MS-100 \$12.95**

- TILTS AND SWIVELS
- STURDY PLASTIC CONSTRUCTION

**MODEL MS-200 \$39.95**

- TILTS AND SWIVELS ■ BUILT-IN SURGE SUPPRESSOR
- INDEPENDENTLY CONTROLS UP TO 5 AC OUTLETS

## LOGITECH MOUSE

**\$79.95**



PC MAGAZINE'S EDITORS CHOICE  
ALL MODELS HAVE SERIAL SLIP/PORT (COM1 COM2), 200  
DPI RESOLUTION, LOTUS 1-2-3 SHELL, SELF-INSTALLING  
SOFTWARE AND "POINT EDITOR"

SERIAL MOUSE W/PC PAINTBRUSH \$99.95  
 BUS MOUSE W/PC PAINTBRUSH \$99.95  
 BUS MOUSE W/PC PAINTBRUSH/CAD \$149.95

## 3.5" FLOPPY DISK DRIVE

**\$149.95**



**1.44 MB 3 1/2" DRIVE**

- ULTRA HIGH DENSITY
- ALSO WORKS WITH 720K DISKS
- FDD-1.44 x BLACK FACEPLATE \$149.95
- FDD-1.44 x BEIGE FACEPLATE \$149.95

**720K 3 1/2" FLOPPY DRIVE \$129.95**

- FDD-3.5 x (FORXT) \$149.95
- FDD-3.5 x (FORAT) \$129.95

**Seagate**

**NEW!**  
**FAST 40MB DRIVE**  
**\$529.00**

THE NEW ST-251-1 DRIVE IS 30% FASTER WITH AN AVERAGE ACCESS TIME OF 28 MS. EASY TO INSTALL HALF-HEIGHT DRIVE.

ST-251-1  
WITH MCT-HDC CONTROLLER \$569.00  
WITH MCT-ATFH CONTROLLER \$639.00

**1/2 HEIGHT DRIVES**

**20 MB, 65 MS, ST-225 \$225.00**  
WITH MCT-HDC CONTROLLER \$269.00  
WITH MCT-ATFH CONTROLLER \$339.00

**30 MB RLL, 65 MS, ST-238 \$249.00**  
WITH MCT-RLL CONTROLLER \$299.00  
WITH MCT-ATFH-RLL CONTROLLER \$389.00

**40 MB, 40 MS, ST-251 \$429.00**  
WITH MCT-HDC CONTROLLER \$469.00  
WITH MCT-ATFH CONTROLLER \$539.00

**60 MB RLL, 40 MS, ST-277 \$499.00**  
WITH MCT-RLL CONTROLLER \$549.00  
WITH MCT-ATFH CONTROLLER \$639.00

**FULL HEIGHT DRIVES**

30 MB, 40 MS, ST-4038 \$559.00  
80 MB, 28 MS, ST-4096 \$895.00

**INTERFACE CARDS FROM MODULAR CIRCUIT TECHNOLOGY DISPLAY ADAPTORS**

**MONOCHROME GRAPHICS CARD \$59.95**  
TRUE HERCULES COMPATIBILITY SUPPORTS LOTUS 123  
■ PARALLEL PRINTER PORT CONFIGURES AS CPT1 OR LPT2 ■ USES VLSI CHIPS TO ENSURE RELIABILITY  
MCT-MGP

**ENHANCED GRAPHICS ADAPTOR \$149.95**  
100% IBM COMPATIBLE, PASSES IBM EGA DIAGNOSTICS  
■ 256K OF VIDEO RAM ALLOWS 640 X 350 IN 16 OF 64 COLORS ■ COMPATIBLE WITH COLOR AND MONOCHROME ADAPTORS  
MCT-EGA

**COLOR GRAPHICS ADAPTOR \$49.95**  
COMPATIBLE WITH IBM GRAPHICS STANDARDS  
■ SUPPORTS RGB, COLOR & COMPOSITE MONOCHROME  
■ 640 320 X 200 RESOLUTION, LIGHT PEN INTERFACE  
MCT-CG

**MULTIFUNCTION CARDS**

**MONOGRAPHICS MULTI I/O \$119.75**  
TOTAL SYSTEM CONTROL FROM A SINGLE SLOT!  
■ CTRL 2 FLOPPY'S, SERIAL, PARALLEL, GAME PORT, CLOCK CAL ■ RUN COLOR GRAPHICS SOFTWARE ON A MONOCHROME MONITOR  
MCT-MGM10

**MULTI I/O FLOPPY CONTROLLER \$79.95**  
A PERFECT COMPANION FOR OUR MOTHERBOARDS  
■ SUPPORTS UP TO 2 360K FLOPPIES, 720K WITH DOS 3.2  
■ SERIAL, PARALLEL, GAME PORT, CLOCK CALENDAR  
MCT-MIO  
MIO-SERIAL—2ND SERIAL PORT \$15.95

**MULTI I/O CARD \$59.95**  
USE WITH MCT-FH FOR A MINIMUM OF SLOTS USED  
■ SERIAL PORT, CLOCK CALENDAR WITH BATTERY BACK-UP ■ PARALLEL PRINTER PORT ADDRESSABLE AS LPT1 OR LPT2  
MCT-IO

**AT MULTIFUNCTION CARD \$139.95**  
ADDS UP TO 3 MB OF RAM TO YOUR AT  
■ USER EXPANDABLE TO 1.5 MB, OR 3 MB WITH OPTIONAL PIGGYBACK BOARD (0 K INSTALLED) ■ INCLUDES SERIAL AND PARALLEL PORT  
MCT-ATMF-MC PIGGYBACK BOARD \$29.95  
ATMF SERIAL-2ND SERIAL PORT \$24.95

**AT MULTI I/O CARD \$59.95**  
USE WITH MCT-ATFH FOR MINIMUM OF SLOTS USED  
■ SERIAL, PARALLEL AND GAME PORTS ■ USES 16450 SERIAL SUPPORT CHIPS FOR HIGH SPEED OPS  
MCT-ATIO  
ATIO-SERIAL—2ND SERIAL PORT \$24.95

**MEMORY CARDS**

**576K RAM CARD \$59.95**  
A CONTIGUOUS MEMORY SOLUTION IN A SHORT SLOT  
■ USER SELECTABLE CONFIGURATION UP TO 576K  
■ USES 64K & 256K RAM CHIPS (ZERO K INSTALLED)  
MCT-RAM

**EXPANDED MEMORY CARD \$129.95**  
2 MB OF LOTUS INTEL MICROSOFT COMPATIBLE MEMORY FOR AN XT ■ CONFORMS TO LOTUS INTEL EMS ■ USER EXPANDABLE TO 2 MB ■ CAN BE USED AS EXPANDED OR CONVENTIONAL MEMORY, RAMDISK AND SPOOLER  
MCT-EMS  
MCT-ATEMS AT COMPATIBLE VERSION \$139.95

**DRIVE CONTROLLERS**

**FLOPPY DISK CONTROLLER \$29.95**  
QUALITY DESIGN FOR SINGLE SLOT CONTROL OF 4 FLOPPY'S ■ INTERFACES UP TO 4 FDD'S TO AN IBM PC OR COMPATIBLE ■ SUPPORTS BOTH DS DD AND DS OD WITH DOS 3.2  
MCT-FDC

**1.2 MB FLOPPY CONTROLLER \$69.95**  
ADD VERSATILITY AND CAPACITY TO YOUR XT  
■ SUPPORTS 2 DRIVES, BOTH MAY BE 360K OR 1.2 MB  
■ ALLOWS DATA TO FLOW FREELY FROM XTS TO AT'S  
MCT-FDC-1.2

**FLOPPY/HARD CONTROLLER \$139.95**  
XT SYSTEM STARVED FOR SLOTS? THIS CARD FREES ONE UP ■ INTERFACES UP TO 2 FDD'S & 2 HDD'S, CABLING FOR 2 FDD/1 HDD ■ SUPPORTS BOTH DS/DD & DS/OD WITH DOS 3.2  
MCT-FH

**ATIFH CONTROLLER \$149.95**  
FLOPPY/HARD DISK CONTROL IN A TRUE AT DESIGN  
■ SUPPORTS UP TO 2 360K/720K 1.2MB FDD'S AS WELL AS 2 HDD'S USING STANDARD CONTROL TABLES  
MCT-ATFH

**RLL DISK CONTROLLER \$199.95**  
IMPROVE SPEED AND STORAGE OF YOUR AT COMPATIBLE ■ SUPPORTS UP TO 2 RLL HARD DISCS AND 2 FLOPPY DRIVES ■ SUPPORTS 360/720-1.2 MB FLOPPIES IN 5.25" & 3.5"  
MCT-ATFH-RLL

**intel**



**INBOARD 386/PC \$895.00**

UPGRADE YOUR XT TO A 386 FOR LESS THAN \$1000  
■ 16 MHZ PROCESSOR REPLACES 8088 ■ 1 MB INSTALLED ■ EXPAND TO 3MB WITH PIGGYBACK CARD  
■ 5 YR WARRANTY

INBOARD 386/AT \$1199.95  
ABOVE BOARD PS 286 \$399.95  
ABOVE BOARD 286 \$369.95

**TEAC DISK DRIVE**



**360K 5 1/4" DRIVE**  
■ RELIABLE DIRECT DRIVE MOTOR  
■ DOUBLE-SIDED/DOUBLE-DENSITY FD-558

**\$99.95**

**1/2 HEIGHT FLOPPY DISK DRIVES**

5 1/4" TEAC FD-55G DS/HD 1.2M \$129.95  
5 1/4" FUJITSU M2551A DS/DD 360K \$89.95  
5 1/4" FUJITSU M2553K DS/HD 1.2M \$119.95  
5 1/4" DS/DD 360K \$89.95  
5 1/4" DS/HD 1.2M \$109.95  
3 1/2" MITSUBISHI DS/DD (AT OR XT) \$129.95

**ARCHIVE XL TAPE BACK-UP \$369.95**



BACK UP 40 MB IN 40 MINUTES!  
■ EASY-TO-USE MENU DRIVEN SOFTWARE  
■ USES STANDARD OIC DATA FORMAT  
■ FULL & INCREMENTAL BACK-UP  
■ PARTIAL & FULL RESTORE  
AR 5240 XT —FOR XTS & AT'S  
AR 5540 AT —AT'S ONLY, 2X FASTER  
TAPE NOT INCLUDED  
TAPE CARTRIDGE—40 MB \$24.95

**20MB HARD DISK ON A CARD \$349**

■ SAVES SPACE AND REDUCES POWER CONSUMPTION  
■ IDEAL FOR PC'S WITH FULL HEIGHT FLOPPIES  
■ LEAVES ROOM FOR A HALF LENGTH CARD IN ADJACENT SLOT



JUST A NOTE TO LET YOU KNOW THAT MY SALESPERSON, HELEN MORSE, AT YOUR COMPANY HAS BEEN VERY HELPFUL AND COURTEOUS. THIS IS A PLEASANT CHANGE FROM MOST TELEPHONE SALESPERSONS I DEAL WITH. PLEASE PASS MY THANKS TO HELEN. I PLAN ON DOING FREQUENT BUSINESS WITH JDR AS MY NEW COMPANY, ODEM INC, GETS GOING, AND HELEN'S ATTITUDE AND HELPFULNESS ARE A MAJOR REASON WHY I LIKE DOING BUSINESS WITH YOU.

R.C.K. BENSEALEN, PA

**BARGAIN HUNTER'S CORNER**  
**720K FLOPPY DISK DRIVE BY MITSUBISHI**  
■ 5 1/4" HALF-HEIGHT  
■ 96 T.P.I.  
■ 100% IBM COMPATIBLE  
■ DOUBLE-SIDED/QUAD DENSITY  
**ONLY \$69.95**  
SPECIAL ENDS 8/31/88



JDR MICRODEVICES, 110 KNOWLES DRIVE, LOS GATOS, CA 95030  
LOCAL (408) 866-6200 FAX (408) 378-8927 TELEX 171-110

**ORDER TOLL FREE 800-538-5000**

COPYRIGHT 1988 JDR MICRODEVICES

CONTINENTAL U.S. AND CANADA

# BUILD YOUR OWN SYSTEM

OVER 20,000 JDR SYSTEMS HAVE ALREADY BEEN BUILT. EASY TO ASSEMBLE IN JUST 2 HOURS WITH A SCREWDRIVER. SAVE MONEY AND LEARN ABOUT YOUR COMPUTER AT THE SAME TIME.

**10 MHZ XT COMPATIBLE**  
**\$656<sup>50</sup>**

- INCLUDES SERIAL PORT, 2 PARALLEL PORTS, CLOCK CALENDAR AND GAME ADAPTOR. RUNS COLOR GRAPHICS ON A MONOCHROME MONITOR
- MOTHERBOARD
- 256K RAM MEMORY
- 135 WATT POWER SUPPLY
- FLIP-TOP CASE
- AT STYLE KEYBOARD
- 360K FLOPPY DRIVE
- MONOGRAPHS I/O CARD
- MONOCHROME MONITOR

**12 MHZ AT COMPATIBLE**  
**\$1101<sup>70</sup>**

- 12 MHZ BABY AT MOTHERBOARD
- 256K RAM MEMORY
- MINI-AT CASE W/POWER SUPPLY
- AT STYLE KEYBOARD
- 1.2 MB FLOPPY DRIVE
- FLOPPY/HARD DRIVE CONTROLLER
- MONOCHROME MONITOR
- GRAPHICS ADAPTOR

**16 MHZ 1 MB 386**  
**\$2298<sup>65</sup>**

- MYLEX 386 MOTHERBOARD
- 1 MB RAM ON BOARD
- 200 WATT POWER SUPPLY
- AT STYLE CASE
- ENHANCED AT STYLE KEYBOARD
- 1.2 MB FLOPPY DRIVE
- AT FLOPPY HARD CONTROLLER
- MONOCHROME MONITOR
- MONOGRAPHS CARD

**VIDEO INSTRUCTIONS \$4<sup>95</sup>**  
**WITH KIT PURCHASE**  
**IT'S A JDR EXCLUSIVE!**  
**EASY TO FOLLOW 20 MINUTE VHS TAPE SHOWS YOU STEP-BY-STEP HOW TO BUILD AN XT COMPATIBLE SYSTEM.**  
**WITHOUT KIT \$19.95**



## MOTHERBOARDS

**TURBO 4.77/8 MHZ \$99.95**    **12 MHZ MINI 80286 \$399.95**

- 4.77 OR 8 MHZ OPERATION WITH 8088-2 & OPTIONAL 8087-2 CO-PROCESSOR
- FRONT PANEL LED SPEED INDICATOR AND RESET SWITCH SET SUPPORTED
- CHOICE OF NORMAL TURBO MODE OR SOFTWARE SELECT PROCESSOR SPEED

**MCT-TURBO**  
**MCT-XTMB STANDARD MOTHERBOARD \$87.95**

- 6 MHZ, 10 MHZ (0/1 WAIT STATE), 12 MHZ (1 WAIT STATE)
- USES ZYMOS ASIC'S FOR LESS CHIPS. GREATER RELIABILITY
- SUPPORTS 256K-1024K MEMORY
- RE-CHARGEABLE HIGH CAPACITY NI-CAD BATTERY
- 6 16-BIT SLOTS, 2 8-BIT SLOTS
- MOUNTS IN STANDARD XT CASE

**MCT-BATMB-12**  
**MCT-BATMB 6/10 MHZ MINI 80286 BOARD \$389.95**

**80286 6/8 MHZ \$379.95**    **16 MHZ MYLEX 386 \$1649.00**

- 8 SLOT (2 EIGHT BIT, 6 SIXTEEN BIT) AT MOTHERBOARD
- HARDWARE SELECTION OF 6 OR 8 MHZ
- 1 WAIT STATE
- KEYLOCK SUPPORTED. RESET SWITCH, FRONT PANEL LED INDICATOR
- SOCKETS FOR 1 MB OF RAM AND 80287
- BATTERY BACKED CLOCK

**MCT-ATMB**

- 1 MB RAM ON BOARD
- 8 SLOTS, 2 8-BIT, 6 16-BIT
- SUPPORTS 80287 MATH CO-PROCESSOR
- SUPPORTS 80387 W/ADAPTOR
- 64 KB CACHE FOR NEAR 0 WAIT STATE
- USES AMI BIOS

**MCT-386 MB**  
**MCT-386 MB-4 4 MB MEMORY INSTALLED \$2649.00**  
**MCT-386 MB-MCB MATH CO-PROCESSOR ADAPTOR BOARD \$149.00**

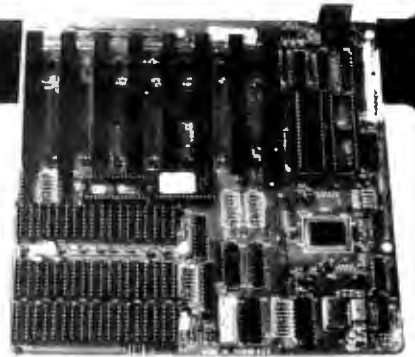

**10 MHZ SINGLE CHIP XT**  
**\$129<sup>95</sup>**

- SINGLE CHIP USES LESS POWER, IMPROVES RELIABILITY
- KEY SELECTABLE SPEED, 4.77 MHZ OR 10 MHZ
- 2.3 TIMES FASTER THAN A STANDARD
- RESET SWITCH, KEYLOCK AND SPEED POWER INDICATORS SUPPORTED

**MCT-TURBO-10**

## DEVELOPMENT TOOLS

**EPROM PROGRAMMER**  
**\$129<sup>95</sup>**

- PROGRAMS 27XX & 27XXX EPROMS UP TO 27512
- SUPPORTS VARIOUS PROGRAMMING FORMATS AND VOLTAGES
- SPLIT OR COMBINE CONTENTS OF SEVERAL EPROMS OF DIFFERENT SIZES
- READ, WRITE, COPY, ERASE CHECK AND VERIFY
- SOFTWARE FOR HEX AND INTEL HEX FORMATS

**MCT-EPROM**  
**MCT-EPROM-4 4 GANG PROGRAMMER \$189.00**  
**MCT-EPROM-10 10 GANG PROGRAMMER \$299.95**  
**MCT-PAL PAL PROGRAMMER \$269.95**  
**MCT-MP PROCESSOR PROG. \$199.95**



- **1 YEAR WARRANTY ON MCT PRODUCTS**
- **30 DAY MONEY BACK GUARANTEE**
- **TOLL-FREE TECHNICAL SUPPORT**
- **NEXT DAY AIR SHIP AVAILABLE**

**JDR Microdevices®**  
JDR MICRODEVICES, 110 KNOWLES DRIVE, LOS GATOS, CA 95030  
LOCAL (408) 866-6200 FAX (408) 378-8927 TELEX 171-110



**ORDER TOLL FREE 800-538-5000**

COPYRIGHT 1988 JDR MICRODEVICES

CONTINENTAL U.S. AND CANADA

# Protect Your Copies of BYTE

**NOW AVAILABLE:**

Custom-designed library *files* or *binders* in elegant blue simulated leather stamped in gold leaf.

**Binders—Holds 6 issues, opens flat for easy reading.**  
\$9.95 each, two for \$18.95, or four for \$35.95.

**Files—Holds 6 issues.**  
\$7.95 each, two for \$14.95, or four for \$27.95.

## Order Now!

Mail to: Jesse Jones Industries, Dept. BY,  
499 East Erie Ave.,  
Philadelphia, PA 19134

Please send \_\_\_\_\_ files;  
\_\_\_\_\_ binders for BYTE magazine.

Enclosed is \$ \_\_\_\_\_. Add \$1 per file/binder for postage and handling. Outside U.S.A. add \$2.50 per file/binder (U.S. funds only please).

Charge my: (minimum \$15)

\_\_\_\_\_ American Express \_\_\_\_\_ Visa  
\_\_\_\_\_ MasterCard \_\_\_\_\_ Diners Club

Card # \_\_\_\_\_ Exp. Date \_\_\_\_\_

Signature \_\_\_\_\_

CALL TOLL FREE (24 hours):  
1-800-972-5858

Name \_\_\_\_\_

Address \_\_\_\_\_ (No P.O. Box)

City \_\_\_\_\_

State \_\_\_\_\_ Zip \_\_\_\_\_

Satisfaction guaranteed.

Pennsylvania residents add 6% sales tax.

Allow 5-6 weeks delivery in the U.S.

## FRAME GRABBERS

RESOLUTION	PRICE with frame grab	frame grab
256 x 256 x 4	495	NA
256 x 256 x 8	795	NA
512 x 512 x 8	995	NA
HRT 512-24 512 x 512 x 24	1495	1095

- IBM PC/XT/AT COMPATIBLE
- DIGITALIZE IN REAL TIME
- COMPOSITE VIDEO IN
- 24 BIT RGB OUT except model HRT 256-4  
16 level gray scale out
- SOFTWARE LIBRARY OF IMAGE ANALYSIS ROUTINES
- FREE SOFTWARE UPGRADES TO REGISTERED OWNERS
- FULL CREDIT ON UPGRADE PURCHASE IN FIRST YEAR RETURN OLD BOARD AND JUST PAY DIFFERENCE

INPUT DEVICES (optional)  
..... \$99  
..... \$359

HIGH RES TECHNOLOGIES  
P.O. BOX 76  
LEWISTON, N.Y. 14092

**Tango-Schematic** With Library Manager.  
**Tango-PCB** 1 mil Grid, 9 Layers, Gerber Output.  
**Tango-Route** Autoroutes 90+% Fast!  
**Tango-Tools** 8 Money-Saving Utilities.

Let's discuss *your* design needs Toll-Free, or order a full function Evaluation Pkg. just \$10. VISA/MC.

**800 433-7801** Satisfaction guaranteed.

ACCEL Technologies, 7358 Trade St., San Diego, CA 92121

### ADAPTEC

PC/XT Controller ST506/412	..... \$45
2071 PC/XT to ST506 RLL (1 drive)	..... \$79
2072 PC/XT RLL	..... \$98
2370 PC/AT to ST506 RLL	..... \$149
3530 SCSI to Tape QIC 36	..... \$78
4000 SCSI to ST506/412	..... \$89
4520 SCSI to ESDI	..... \$98
5500 SCSI to ST506/412	..... \$125
5580 SCSI to SMD	..... \$175

### XEBEC

S1410 SASI Controller	.....
S1420 SASI to 5 1/4" Floppy & Hard Disk Controller.	.....
Apple II, II+, IIE Host Adapter	.....

### OTHERS

OMT1 20C, L SASI Controller	.....
DTC 510A SASI Controller	.....
WD 1002-SHD Xebec Compatible SASI Controller	..... \$109
Konan DJ-210 35" SASI to ST506/412 (Xebec 1410 clone)	..... \$89

\* Call for cable prices.  
\* Controller manuals \$8 each.

Upgrade Options: (Call for Everset products and prices)  
A. Sample 720K/484/724 Harddisk \$259/445/472 B. 3 1/2" ds 720K/1.44K \$125/145  
C. Everset EMS 3M12 \$ 26 D. Everset PDD/PT 1200 B Modern \$120  
E. Everset Super EGA (800 x 600) \$ 199 F. Mega VGA card \$289  
G. Genoa Super EGA (800 x 600) \$219 H. Panasonic 1000 printer \$199

**Schwab Computer Center**  
"The Everset Store" - Authorized Everset Dealer  
3282 El Camino Real, Santa Clara, CA 95051  
408-241-1210  
M-F 10-7, SAT 11-4 VISA/MC/AMEX  
Prices change without notice

 **Computer Surplus Store** "WE BUY AND SELL"  
Phone 408-434-1060  
FAX 408-434-0931  
Telex 1561447  
MC/VISA/Discover/COD's

E(E)PROM (16K-1MB)  
PAL (20 & 24 pins)  
BIFOLAR  
8741/42/48/49/50 CPU  
87(C)51/44 CPU  
DYNAMIC/STATIC RAM &  
TTL TESTER  
Option: 4 Socket adaptor  
only \$585 complete

Other products available. Individual programmers for E(E)PROM (up to 1MB), PAL, BIPOLAR, 8748 series, 8751 series, Memory/TTL Tester, and gang programmers with 4, 8, & 16 sockets. Also industrial quality EPROM Eraser with timer and safety switch is available (erases 30 of 28 pin eproms at a time).

OEM & Distributor welcome.  
10 % educational discount

473 Sapena Ct #24  
Santa Clara, CA 95054 **XELTEK** VISA  
Tel (408) 727-6995 M/C  
FAX (408) 727-6996 AMEX

# EDITORIAL INDEX BY COMPANY

Index of companies covered in articles, columns, or news stories in this issue  
Each reference is to the first page of the article or section in which the company name appears

INQUIRY #	COMPANY	PAGE	INQUIRY #	COMPANY	PAGE	INQUIRY #	COMPANY	PAGE
	ADAPTEC.....	11		FEDERAL COMMUNICATIONS		979	RATIONAL SYSTEMS.....	226
	ADDISON-WESLEY .....	51		COMMISSION .....	135	970	REAL-TIME COMPUTER	
751	ADVANCED LOGIC RESEARCH ...	67	944	FLAGSTAFF ENGINEERING.....	101		SCIENCE .....	226
	ADVANCED MICRO DEVICES.....	11	785	FLAMINGO GRAPHICS.....	67	854	REFERENCE SOFTWARE .....	89, 101
967	ALCYON .....	226	908	FOX SOFTWARE .....	125	902	RELAY COMMUNICATIONS.....	148
904	APPLE COMPUTER .....	11, 125, 185	891	FULCRUM COMPUTER		779	RESOURCE ANALYSIS	
905				PRODUCTS .....	173		INTERNATIONAL.....	67
906				GEOCOMP .....	67	942	SCANDINAVIAN PC SYSTEMS ...	101
989	APPLE PROGRAMMERS & DEVELOPERS ASSOCIATION ..	226	786	GIGABIT LOGIC.....	11		SEMATECH .....	11
968	ARCHIMEDES SOFTWARE .....	226	788	GIGATAPE .....	67		SIERRA SYSTEMS .....	226
920	ASHTON-TATE .....	125	965	GIMPEL SOFTWARE.....	226	972	SILICON COMPOSERS .....	226
	AT&T .....	11	976	GRAEME PUBLISHING .....	11		SIMPLENET .....	140
759	ATI TECHNOLOGIES .....	67		GUIDELINES SOFTWARE.....	226	898	SOFTKLONE .....	148
776	AUTODECK.....	67	780	HANDICORP .....	67	946	SOFTLOGIC SOLUTIONS .....	131
	AVOCET SYSTEMS .....	239	903	HAYES MICROCOMPUTER		896	SOFTRONICS .....	148
				PRODUCTS .....	148	769	SOFTWARE BLACKSMITHS .....	67
	BASIC BOOKS .....	51	766	HEWLETT-PACKARD .....	67	963	SOFTWARE DEVELOPMENT	
772	BLACK AND WHITE		895	HILGRAEVE .....	148		SYSTEMS.....	226
	INTERNATIONAL.....	67					SOFTWARE PUBLISHERS	
774	BMDP STATISTICAL SOFTWARE..	67	959	IBM .....	226		ASSOCIATION .....	11
856	BORLAND		787	IMAGE COMPUTER SYSTEMS.....	67	936	SOFTWARE PUBLISHING .....	115
	INTERNATIONAL.. 11, 89, 101, 226			INTEL.....	140, 239	978	SPECTRA MICRO	
943			790	IOTECH.....	67		DEVELOPMENT.....	226
940	BRODERBUND SOFTWARE .....	101		JAMECO.....	239	853	SSI COMPUTER SYSTEM .....	89
974	C WARE .....	226		JDR MICRODEVICES .....	239		STANFORD MEDICAL CENTER ...	11
784	CE SOFTWARE .....	67		KRUEGER TECHNOLOGY .....	239		STANFORD RESEARCH	
939	CHEETAH INTERNATIONAL.....	101					INSTITUTE .....	135
764	CHRONOS COMPUTERS.....	67	984	LANGUAGE PROCESSORS .....	226	960	STANFORD UNIVERSITY .....	11
964	CNS .....	226	980	LATTICE .....	226		SUPERSOFT .....	226
	COMMODORE		955	LIFEBOAT ASSOCIATES .....	226	934	SYMANTEC .....	115
	INTERNATIONAL.....	11	892	LIGHTGATE .....	173	767	TANGENT TECHNOLOGIES .....	67
900	COMMUNICATIONS RESEARCH		983	LIVING SOFTWARE .....	226	883	TATUNG COMPANY OF	
	GROUP .....	148	761	LOGITECH .....	67		AMERICA .....	162
	COMPAQ COMPUTER .....	140				782	10COMMUNICATIONS .....	67
	COMPUTER & BUSINESS		956	MANX SOFTWARE .....	226	765	IONET COMMUNICATIONS .....	67
	EQUIPMENT MANUFACTURERS		981	MARK WILLIAMS .....	226	957	THE AUSTIN CODE WORKS .....	226
	ASSOCIATION .....	11	937	MAXIMUM STORAGE.....	101	775	THE GREAT SOUTHWESTERN	
969	COMPUTER INNOVATIONS.....	226	897	MAXON SYSTEMS .....	148		COMPANY .....	67
	CONOGRAPHIC .....	11, 67		MCGRAW-HILL BOOKS.....	239		THE SOFTWARE TOOLWORKS ..	226
985	CONSULAIR .....	226	754	MECHANICAL ENTERPRISES.....	67		THE STEPSTONE .....	226
	CSS LABS .....	11	986	MEGAMAX .....	226	971	THEOS SOFTWARE .....	226
753	CUBIX .....	67	893	MERIDIAN TECHNOLOGY .....	148	982	THINK TECHNOLOGIES .....	226
			977	METAWARE .....	226	938	TRAVELING SOFTWARE .....	101
758	DATA TRANSLATION.....	67	777	MICROSOFT .....	67, 131, 226	852	TURBOPOWER SOFTWARE .....	89
757	DATADESK INTERNATIONAL .....	67	760	MICROSPEED .....	67, 173			
783	DATAEASE INTERNATIONAL.....	67	768	MICROWAY .....	67, 226	907	VERSACAD .....	195
958	DATALIGHT .....	226		MIT MEDIA LABORATORY .....	219		W. F. FREEMAN .....	51
935	DATASTORM		752	MITSUBISHI ELECTRONICS		855	WATCOM .....	89, 226
	TECHNOLOGIES .....	115, 148		AMERICA .....	67	781	WESTFORD HARBOR.....	67
770	DELL COMPUTER.....	67, 89	988	MIX SOFTWARE .....	226	962	WHITESMITHS .....	226
	DIGIKEY .....	239				961	WINTEK .....	226
894	DIGITAL COMMUNICATIONS		763	NETWORK TECHNOLOGIES .....	67	899	WOOLF SOFTWARE SYSTEMS....	148
	ASSOCIATES .....	148	755	NUTMEG SYSTEMS.....	67	966	WORDCRAFT .....	226
	DISCOVERY SYSTEMS .....	11	973	OASYS .....	226			
773	DSP DEVELOPMENT .....	67		OFFICE OF TECHNOLOGY		846	XDB SYSTEMS.....	121
				ASSESSMENT .....	135		YARC SYSTEMS .....	11
975	ECOSOFT .....	226	762	PACIFIC DATA PRODUCTS .....	67		ZORTECH.....	226
778	ELECTRONIC ARTS.....	67		PARCPLACE SYSTEMS .....	11			
771	EUGENE NELSON.....	67	756	PLUSDEVELOPMENT.....	67			
885	EVEREX COMPUTER SYSTEMS		884	PROTEUS TECHNOLOGY .....	162			
	DIVISION.....	140, 162		PSEUDOCODE.....	239			



## COMING UP IN BYTE

---

### PRODUCTS IN PERSPECTIVE:

The **Product Focus** for September will zero in on 600-dot-per-inch PostScript-compatible laser printers. Testing of 13 such machines by our laboratory staff has brought out some interesting and surprising features.

**System reviews** include 80386-based laptop machines from both GRiD and Toshiba and a desktop 80386 from AST Research.

A **hardware review** will look at 10 facsimile transmit/receive boards for the IBM PC and compatibles.

In **software reviews**, first on the list will be a look at Ada—as implemented on the Macintosh. Next comes a look at two **application reviews**. One is Dataplex, a new data-entry and format-conversion program from Tools and Technologies; the other is Total Word from Lifetree Software, a product that straddles the line between word processing and desktop publishing.

### IN DEPTH:

The most obvious component of most computers, regardless of how they're used, is the screen. Now that we've looked at monitors in a previous Product Focus, we're going to take a look at the **technology that underlies the display interface**. In September, we'll have an overview of the current state of the art, followed by a detailed discussion describing how some of the most striking displays in the industry are developed and created.

Possible **Short Takes** for September include two 25-MHz accelerator boards for the Macintosh—from Radius and Novy Systems, respectively. Also in for scrutiny will be a new product from Borland International: Turbo Prolog 2.0. Konan has a new disk drive controller with built-in memory. Proximity Software has released Choice Words, a Merriam-Webster dictionary on a disk. An extended Short Take will look at a card-size motherboard replacement from Sota.

Our expanded **columns** section has contributions from Jerry Pournelle, Ezra Shapiro, Wayne Rash Jr., Don Crabb, Mark Minasi, and Brock N. Meeks. In their own ways—and from their own perspectives—each presents a thoughtful look at the products and technologies that make up the whole world of microcomputing.

### FEATURES:

In our new Hands On section, Steve Ciarcia presents the second part of his microcontroller project, and Rick Grehan presents the next installment of Some Assembly Required—floating-point without a coprocessor. We also have articles available on power protection for microcomputers, new user interfaces, parallel Prologs, and an OS/2 communications program.

## Subscription Problems?



### We want to help!

*If you have a problem with your BYTE subscription, write us with the details. We'll do our best to set it right. But we must have the name, address, and zip of the subscription (new and old address, if it's a change of address). If the problem involves a payment, be sure to include copies of the credit card statement, or front and back of cancelled checks. Include a "business hours" phone number if possible.*

**BYTE**

Subscriber Service  
P.O. Box 7643  
Teaneck, NJ 07666-9866



# READER SERVICE

To get further information on the products advertised in BYTE, fill out the reader service card by circling the numbers on the card that correspond to the inquiry number listed with the advertiser. This index is provided as an additional service by the publisher, who assumes no liability for errors or omissions.

\* Correspond directly with company

## Alphabetical Index to Advertisers

Inquiry No.	Page No.	Inquiry No.	Page No.	Inquiry No.	Page No.	Inquiry No.	Page No.
3 A + L MEIER VOGT	169	66 CUESTA SYSTEMS	106	136 MANNESMANN TALLY	81	206 ROSE ELECTRONICS	270
4 A+ L MEIER VOGT	171	67 CUESTA SYSTEMS	106	137 MARK WILLIAMS	30	207 ROSE ELECTRONICS	270
263 ACCEL TECH.	289	68 DATA ACCESS	251	138 MATHSOFT	69	208 R.J. SWANTEK	280
5 ADVANCED COMP. PROD.	282,283	273 DATACODE, INC.	210	* MAXELL DATA PRODUCTS	7	209 SABINA INT'L.	280
6 ADVANCED LOGIC RESEARCH	8,9	69 DATAPATH TECH.	94	* MCGRAW-HILL NRI	216E-F	210 SAFEWARE	273
7 ADVANCED LOGIC RESEARCH	8,9	* DATRANCORP.	223	139 MEAD COMPUTER	277	211 SANTA CRUZ OPERATIONS	53
8 ADVANCED MATRIX TECH.	246,247	70 DAYBREAK TECH.	197	140 MEGASOFT	271	212 SANTA RITA SOFTWARE	104
267 AETECH	98	71 DAYBREAK TECH.	197	141 MEGASOFT	271	213 SCHWAB	289
268 AETECH	98	72 DAYBREAK TECH.	199	142 MENDELSON ELECTRONICS	130	214 SCIENCE & ENGIN. S/W	123
10 AK SYSTEMS	270	73 DAYBREAK TECH.	199	143 MEP (MICRO ELEC. PROD.)	278	215 SEA LEVEL	273
11 ALOIS SCHONBACHLER	96	74 DAYTRON ELECTRONICS	274	144 MERIDIAN TECHNOLOGY	64	216 SHAMROCK COMPUTER	99
12 ALPHA PRODUCTS	275	75 DCS (DIVERSIFIED COMP.)	271	145 MERRITT COMPUTER PROD.	58	57 SILICON SPECIALTIES	42,43
13 AMER. SMALL BUS. COMP.	93	261 DELLCOMP. (N. AMERICA)	144-147	* MICRO LOGIC CORP.	95	58 SILICON SPECIALTIES	42,43
* AMPRO	114	262 DELL COMP. (INT'L)	144-147	274 MICRO 1	211	17 SIMPLE NET SYSTEM	134
14 ATI TECHNOLOGIES	31	272 DESTINY TECHNOLOGY	225	146 MICRO 1	216A	18 SIMPLE NET SYSTEM	134
15 ATRON	66	77 DIGITALK INC.	190,191	147 MICROCOM SYSTEMS	26	217 SKAN TECH	272
16 AVOCET SYSTEMS	61	78 DIGITALK INC.	190,191	* MICROCOMP. MKTG. CNCIL.	217	218 SN'W ELECTRONICS	34
19 B&B ELECTRONICS	280	79 DISC INTERNATIONAL	276	* MICROLYTICS	218	219 SOFTKLONE DISTRIBUTING	184
20 B&C MICRO	271	80 DISKCOTECH	269	* MICROMINT	235	220 SOFTRONICS	272
21 B&C MICRO	272	81 DISKETTE CONNECTION	273	148 MICROPROCESSORS UNLTD.	274	221 SOFTWARE DEVELOP. SYS.	124
22 B&C MICRO	274	82 DISKS TO GO	274	149 MICROSIM CORP.	194	222 SOFTWARE LINK, THE	28,29
23 BAY TECHNICAL ASSOC.	117	83 ECOSOFT	113	150 MICROSIM CORP.	194	223 SOFTWARE LINK, THE	28,29
24 BEDE TECH.	46	84 ELEXOR	278	* MICROSOFT	212,213	224 SOLUTION SYSTEMS	103
* BINARY TECH.	271	85 ENGINEERS COLLABORATIVE	269	151 MICROWAY	111	225 SPECTRUM SOFTWARE	13
450 BIX	182,183	86 EVEREX	25	152 MIX SOFTWARE	209	226 STSC	91
25 BLAISE	33	87 EVEREX	25	153 MONTGOMERY GRANT	266	227 SUPERMICRO	272
26 BORLAND	CII	88 FLAGSTAFF	100	154 M.H.I.	112	228 SUPERSOFT	92
27 BORLAND	CII	89 FLAGSTAFF	100	155 NANTUCKET	137	229 SYSGEN	15
28 BORLAND	1	90 FORTRON INC.	32	156 NATURAL MICROSYSTEMS	201	230 SYSTAT	189
29 BORLAND	1	91 FOX SOFTWARE	23	157 NEC HOME ELEC. DIV.	62,63	231 SYSTAT	189
30 BORLAND	7	92 FTG	274	* NEC INFO. SYS.	CIII	232 S.C. SYSTEMS	59
31 BORLAND	71	93 GATEWAY 2000	175	159 NOHAU CORP.	270	233 TALKING TECHNOLOGY	273
32 BP MICROSYSTEMS	269	94 GENOA	79	160 OKIDATA	109	234 TALLGRASS TECH	45
32 BP MICROSYSTEMS	269	95 GOLDEN BOW	274	161 ON TARGET	278	235 TALLGRASS TECH	45
33 BUS COMPUTER SYSTEMS	263	96 GRAFPOINT	276	162 ON TARGET	280	236 TANDON	58,57
* BUYERS MART	254-262	97 GTEK INC.	52	* ORACLE	77	237 TANDON	56,57
* BYTE BACK ISSUES	296	98 GTEK INC.	52	163 ORION	96	238 TELEBYTE TECH. INC.	181
269 BYTE BITS	280	99 GUIDELINES SOFTWARE	24	164 OSBORNE/MCGRAW-HILL	58	57 TELEBART	42,43
* BYTE CIRCULATION	248	101 HAMMERLY COMP. SERVICES	97	165 OSBORNE/MCGRAW-HILL	170	58 TELEMAT	42,43
* BYTE MARKETING	253	102 HEWLETT-PACKARD	157	166 OSBORNE/MCGRAW-HILL	231	270 TELEVIDEO	238
* BYTE SUB. MESSAGE	160	103 HEWLETT-PACKARD	159	167 PACIFIC COMPUTER	267	239 TIMELINE	279
* BYTE SUB. SERVICE	291	104 HI TECH. EQUIP.	278	168 PACIFIC COMPUTER	267	240 TOSHIBA	48,49
34 BYTEK	276	265 HIGH RES. TECHNOLOGIES	289	169 PARSONS TECHNOLOGY	177	241 TOSHIBA	48,49
35 CADAM	73	105 HIWARE	60	170 PATTON & PATTON	1	242 TOUCHBASE SYSTEMS INC.	136
36 CADAM	73	106 IC EXPRESS	270	171 P C DESIGN	127	243 TRUE DATA PROD.	269
37 CALIFORNIA SOFTWARE	269	264 INNOVATIONS	270	172 PC PLUS	116	244 TRUEVISION	187
38 CALIFORNIA SOFTWARE	269	* INTECTRA	276	173 PERSOFT	85	245 TURNPOINT SYSTEMS	168
39 CANETICS	278	107 INTEGRAND	40	174 PERSONAL SPACE COMM.	278	246 UNIVERSAL DATA	280
40 CAPITAL EQUIPMENT	119	108 INTELLIGENCEWARE	17	175 PERSONAL TEX	126	247 UNIVERSAL DATA	280
41 CAPITAL EQUIPMENT	24	109 IO TECH.	289	176 PETER NORTON	133	* VERMONT CREATIVE	19
42 CENTRAL COMP. PROD.	272	110 ITRON	151	177 PETER NORTON	133	248 WAREHOUSE DATA PROD.	55
271 CHANCELOGIC INC.	237	111 JADE COMPUTER PROD.	281	178 PRINCETON GRAPHIC SYS.	167	249 WINTEK CORP.	5
266 CITIZEN AMERICA	82,83	112 JAMECO ELECTRONICS	284,285	181 PROGRAMMERS SHOP	103	250 WINTEK CORP.	280
* CLEO SOFTWARE	204	113 JAWIN COMPUTER PROD.	271	182 PROGRAMMER'S CONNECTION	39	251 WORLDWIDE SERVICES	276
43 CNS INC.	60	114 JAWIN COMPUTER PROD.	271	183 PROGRAMMER'S PARADISE	107	252 WORLDWIDE SERVICES	276
44 CNS INC.	60	115 JENSEN & PARTNERS INT'L.	87	185 PROTEUS TECH. CORP.	41	253 XELTEK	289
45 COEFFICIENT SYS. CO.	160	118 J.D.R. MICRODEVICES	284,285	186 QUA TECH	268	254 XENDER	278
46 COEFFICIENT SYS. CO.	161	117 J.D.R. MICRODEVICES	286,287	187 QUA TECH	268	255 ZENITH DATA SYSTEMS	181
47 COGITATE	270	117 J.D.R. MICRODEVICES	288	188 QUA TECH	268	258 ZEOS INT'L	47
48 COGITATE	272	118 KADAK	271	189 QUA TECH	268	257 ZERICON	278
49 COMPACT DISK PRODUCTS	94	119 KEA SYSTEMS	128	190 QUA TECH	268	258 ZORTECH	27
* COMPAQ COMP. CORP.	32A-D	120 KEA SYSTEMS	270	191 QUA TECH	268	259 Z-WORLD	273
50 COMPUCOM GROUP	270	121 KNOWLEDGE GARDEN	233	192 QUA TECH	268	260 Z-WORLD	273
51 COMPUHAVE	280	122 KONAN	172	193 QUA TECH	268		
52 COMPUSERVE	216C	123 KONAN	172	194 QUA TECH	268		
53 COMPUTER AGE LTD.	270	125 LAHEY COMPUTER SYSTEMS	128	* QUAID SOFTWARE LTD.	54		
* COMPUTER CONTINUUM	269	126 LINK COMP. GRAPHICS	274	195 QUALSTAR	278		
54 COMPUTER EXPO	50	127 LOGICAL DEVICES	280	196 QUANTUM	10		
55 COMPUTER MAIL ORDER	36,37	128 LOGICAL DEVICES	280	197 QUARTERDECK OFFICE SYS.	120		
56 COMP. SUPPORT GROUP	192,193	129 LOGITECH	74,75	198 QUARTERDECK OFFICE SYS.	120		
57 COMPUTER WAREHOUSE	42,43	130 LOGITECH	74,75	199 QUARTERDECK OFFICE SYS.	214		
58 COMPUTER WAREHOUSE	42,43	131 LOGITECH	154	200 QUARTERDECK OFFICE SYS.	214		
60 COMP. DISCOUNT WAREHOUSE	105	132 LOGITECH	154	201 RADIO SHACK	CIV		
61 COMP. SURPLUS STORE	289	133 LOGITECH	155	* RAIMA	35		
62 CONTECH	272	134 LOGITECH	155	202 RAINBOW TECHNOLOGIES	278		
63 CONTROL VISION	272	* LOTUS DEVELOPMENT	20,21	203 RAINBOW TECHNOLOGIES	179		
64 COVOX	272	* MAC SUPPLEMENT	M1-M98	204 RAINBOW TECHNOLOGIES	179		
65 CROSSTALK COMM.	139	135 MANNESMANN TALLY	81	205 REAL TIME DEVICES	273		

INTERNATIONAL SECTION 88IS-1-32  
No North American inquiries please.

476 ABC COMPUTER	88IS-23
477 ANALYTICAL ENGINES	88IS-22
478 BCL	88IS-26
479 BIX	88IS-31
* BYTE BACK ISSUES	88IS-20
* BYTE CIRCULATION	88IS-30
* BYTE SUB. MESSAGE	88IS-18
* CALEND	88IS-13
480 COMPUADD	88IS-11



# READER SERVICE

To get further information on the products advertised in BYTE, fill out the reader service card by circling the numbers on the card that correspond to the inquiry number listed with the advertiser. This index is provided as an additional service by the publisher, who assumes no liability for errors or omissions.

\* Correspond directly with company

## Index to Advertisers by Product Category

Inquiry No.	Page No.	Inquiry No.	Page No.	Inquiry No.	Page No.	Inquiry No.	Page No.
<b>HARDWARE</b>		<b>283 INSTRUMENTATION</b>		<b>53 COMPUTER AGE LTD. .... 270</b>		<b>201 RADIO SHACK ..... CIV</b>	
<b>280 ADDINS</b>		<b>84 ELEXOR ..... 278</b>		<b>102 HEWLETT-PACKARD ..... 159</b>		<b>213 SCHWAB ..... 289</b>	
<b>12 ALPHA PRODUCTS ..... 275</b>		<b>162 ON TARGET ..... 280</b>		<b>103 HEWLETT-PACKARD ..... 157</b>		<b>* SEMITECH MICRO ELEC. 88IS-15</b>	
<b>21 B&amp;C MICRO ..... 272</b>		<b>284 MASS STORAGE</b>		<b>489 LASER TEAM ..... 88IS-24</b>		<b>498 STONE COMPUTECH CO. 88IS-28</b>	
<b>22 B&amp;C MICRO ..... 274</b>		<b>10 AK SYSTEMS ..... 270</b>		<b>136 MANNESMANN TALLY ..... 81</b>		<b>497 STONE COMPUTECH CO. 88IS-28</b>	
<b>* BINARY TECH ..... 271</b>		<b>86 EVEREX ..... 25</b>		<b>135 MANNESMANN TALLY ..... 81</b>		<b>498 STONE COMPUTECH CO. 88IS-28</b>	
<b>40 CAPITAL EQUIPMENT ..... 119</b>		<b>87 EVEREX ..... 25</b>		<b>* NEC INFO. SYS. .... CIII</b>		<b>240 TOSHIBA ..... 48,49</b>	
<b>41 CAPITAL EQUIPMENT ..... 24</b>		<b>* MAXELL DATA PRODUCTS ..... 7</b>		<b>160 OKIDATA ..... 109</b>		<b>241 TOSHIBA ..... 48,49</b>	
<b>* COMPUTER CONTINUUM ..... 269</b>		<b>492 MITSUBISHI KASEI ..... 88IS-32</b>		<b>178 PRINCETON GRAPHIC SYS. ... 167</b>		<b>245 TURNPOINT SYSTEMS ..... 168</b>	
<b>63 CONTROL VISION ..... 272</b>		<b>493 NIPPON COLUMBIA ..... 88IS-19</b>		<b>202 RAINBOW TECH. .... 278</b>		<b>441 UNIQTECH ..... 88NE-9</b>	
<b>* DATRAN CORP. .... 223</b>		<b>195 QUALSTAR ..... 278</b>		<b>206 ROSE ELECTRONICS ..... 270</b>		<b>258 ZEOS INT'L ..... 47</b>	
<b>94 GENOA ..... 79</b>		<b>217 SKAN TECH ..... 272</b>		<b>255 ZENITH DATA SYSTEMS ..... 181</b>		<b>259 Z-WORLD ..... 273</b>	
<b>487 INES ..... 88IS-26</b>		<b>234 TALLGRASS TECH ..... 45</b>		<b>257 ZERICON ..... 278</b>		<b>287 TERMINALS</b>	
<b>109 IO TECH ..... 289</b>		<b>235 TALLGRASS TECH ..... 45</b>		<b>289 SCANNERS/DIGITIZERS</b>		<b>270 TELEVIDEO ..... 238</b>	
<b>122 KONAN ..... 172</b>		<b>236 TANDON ..... 56,57</b>		<b>88 FLAGSTAFF ..... 100</b>		<b>SOFTWARE</b>	
<b>123 KONAN ..... 172</b>		<b>237 TANDON ..... 56,57</b>		<b>89 FLAGSTAFF ..... 100</b>		<b>293 IBM/MSDOS APPLICATIONS</b>	
<b>142 MENDELSON ELECTRONICS ... 130</b>		<b>* MISCELLANEOUS</b>		<b>433 F&amp;W COMMUNICATIONS 88NE-17</b>		<b>Business/Office</b>	
<b>151 MICROWAY ..... 111</b>		<b>19 B&amp;B ELECTRONICS ..... 280</b>		<b>265 HIGH RES. TECHNOLOGIES ... 289</b>		<b>30 BORLAND ..... 71</b>	
<b>159 NOHAU CORP. .... 270</b>		<b>24 BEDE TECH ..... 46</b>		<b>129 LOGITECH ..... 74,75</b>		<b>31 BORLAND ..... 71</b>	
<b>162 ON TARGET ..... 280</b>		<b>66 CUESTA SYSTEMS ..... 106</b>		<b>130 LOGITECH ..... 74,75</b>		<b>47 COGITATE ..... 270</b>	
<b>164 OSBORNE/MCGRAW-HILL ..... 58</b>		<b>67 CUESTA SYSTEMS ..... 106</b>		<b>424 VUTEK SYSTEMS ..... 88PC-6</b>		<b>68 DATA ACCESS ..... 251</b>	
<b>174 PERSONAL SPACE COMM. .... 278</b>		<b>69 DATAPATH TECH ..... 94</b>		<b>425 VUTEK SYSTEMS ..... 88PC-6</b>		<b>72 DAYBREAK TECH. .... 199</b>	
<b>186 QUA TECH ..... 268</b>		<b>503 GLOBE MFG. SALES ..... 88IS-18</b>		<b>290 SOFTWARE SECURITY</b>		<b>73 DAYBREAK TECH. .... 199</b>	
<b>187 QUA TECH ..... 268</b>		<b>* INTECTRA ..... 276</b>		<b>64 COVOX ..... 272</b>		<b>91 FOX SOFTWARE ..... 23</b>	
<b>188 QUA TECH ..... 268</b>		<b>107 INTEGRAND ..... 40</b>		<b>189 QUA TECH ..... 268</b>		<b>92 FTG ..... 274</b>	
<b>189 QUA TECH ..... 268</b>		<b>488 INVERDATA ..... 88IS-22</b>		<b>190 QUA TECH ..... 268</b>		<b>95 GOLDEN BOW ..... 274</b>	
<b>190 QUA TECH ..... 268</b>		<b>118 KADAK ..... 271</b>		<b>191 QUATECH ..... 268</b>		<b>* LOTUS DEVELOPMENT ..... 20,21</b>	
<b>191 QUA TECH ..... 268</b>		<b>145 MERRITT COMPUTER PROD. ... 58</b>		<b>193 QUA TECH ..... 268</b>		<b>* MICRO LOGIC CORP. .... 95</b>	
<b>192 QUATECH ..... 268</b>		<b>163 ORION ..... 96</b>		<b>203 RAINBOW TECHNOLOGIES .. 179</b>		<b>* MICROLYTICS ..... 218</b>	
<b>193 QUATECH ..... 268</b>		<b>246 UNIVERSAL DATA ..... 280</b>		<b>204 RAINBOW TECHNOLOGIES .. 179</b>		<b>155 NANTUCKET ..... 137</b>	
<b>194 QUATECH ..... 268</b>		<b>247 UNIVERSAL DATA ..... 280</b>		<b>414 VILLARREAL CONSULTING 88PC-8</b>		<b>494 NOVELL DEVELOPMENT 88IS-29</b>	
<b>205 REAL TIME DEVICES ..... 273</b>		<b>285 MODEMS/MULTIPLEXORS</b>		<b>291 SYSTEMS</b>		<b>* ORACLE ..... 77</b>	
<b>207 ROSE ELECTRONICS ..... 270</b>		<b>14 ATI TECHNOLOGIES ..... 31</b>		<b>476 ABC COMPUTER ..... 88IS-23</b>		<b>169 PARSONS TECHNOLOGY .... 177</b>	
<b>381 SCIENTIFIC SOLUTIONS. 88MW-1</b>		<b>42 CENTRAL COMP. PROD. .... 272</b>		<b>6 ADVANCED LOGIC RESEARCH 8,9</b>		<b>199 QUARTERDECK OFFICE SYS. 214</b>	
<b>382 SCIENTIFIC SOLUTIONS. 88MW-1</b>		<b>50 COMPU COM GROUP ..... 270</b>		<b>7 ADVANCED LOGIC RESEARCH 8,9</b>		<b>200 QUARTERDECK OFFICE SYS. 214</b>	
<b>215 SEA LEVEL ..... 273</b>		<b>417 MICROCOMPUTER SQUARE .. 88PC-2</b>		<b>* AMPRO ..... 114</b>		<b>* RAIMA ..... 35</b>	
<b>227 SUPERMICRO ..... 272</b>		<b>238 TELEBYTE TECH INC. .... 161</b>		<b>33 BUS COMPUTER SYSTEMS .. 263</b>		<b>294 IBM/MSDOS APPLICATIONS</b>	
<b>233 TALKING TECHNOLOGY ..... 273</b>		<b>242 TOUCHBASE SYSTEMS INC. ... 136</b>		<b>393 CORTEX ..... 88M/AT-3</b>		<b>Scientific/Technical</b>	
<b>244 TRUEVISION ..... 187</b>		<b>286 MONITORS</b>		<b>377 CORTEX ..... 88MW-6</b>		<b>39 CANETICS ..... 278</b>	
<b>260 Z-WORLD ..... 273</b>		<b>157 NEC HOME ELEC. DIV. .... 62,63</b>		<b>481 CUBIX ..... 88IS-7</b>		<b>74 DAYTRON ELECTRONICS .... 274</b>	
<b>281 DRIVES</b>		<b>423 TATUNG SCIENCE &amp; TECH. 88PC-7</b>		<b>261 DELL COMP. (N. AMER.) . 144-147</b>		<b>83 ECOSOFT ..... 113</b>	
<b>434 MANZANA ..... 88NE-1</b>		<b>292 NETWORK HARDWARE</b>		<b>262 DELL COMP. (INT'L) .... 144-147</b>		<b>138 MATHSOFT ..... 69</b>	
<b>229 SYSGEN ..... 15</b>		<b>23 BAY TECHNICAL ASSOC. .... 117</b>		<b>483 ELONEX ..... 88IS 25</b>		<b>149 MICROSIM CORP. .... 194</b>	
<b>282 HARDWARE PROGRAMMERS</b>		<b>48 COGITATE ..... 272</b>		<b>85 ENGINEERS COLLABORATIVE 269</b>		<b>150 MICROSIM CORP. .... 194</b>	
<b>20 B&amp;C MICRO ..... 271</b>		<b>110 ITRON ..... 151</b>		<b>90 FORTRON INC. .... 32</b>		<b>435 NEURALWARE ..... 88NE-11</b>	
<b>32 BP MICROSYSTEMS ..... 269</b>		<b>156 NATURAL MICROSYSTEMS .. 201</b>		<b>433 F&amp;W COMMUNICATIONS 88NE-17</b>		<b>170 PATTON &amp; PATTON ..... 16</b>	
<b>32 BP MICROSYSTEMS ..... 269</b>		<b>174 PERSONAL SPACE COMM. .... 278</b>		<b>93 GATEWAY 2000 ..... 175</b>		<b>175 PERSONAL TEX ..... 126</b>	
<b>34 BYTEK ..... 276</b>		<b>206 ROSE ELECTRONICS ..... 270</b>		<b>113 JAWIN COMPUTER PROD. .... 271</b>		<b>225 SPECTRUM SOFTWARE ..... 13</b>	
<b>97 GTEK INC. .... 52</b>		<b>207 ROSE ELECTRONICS ..... 270</b>		<b>114 JAWIN COMPUTER PROD. .... 271</b>		<b>226 STSC ..... 91</b>	
<b>98 GTEK INC. .... 52</b>		<b>288 PRINTERS/PLOTTERS</b>		<b>274 MICRO 1 ..... 211</b>		<b>230 SYSTAT ..... 189</b>	
<b>264 INNOVATIONS ..... 270</b>		<b>23 BAY TECHNICAL ASSOC. .... 117</b>		<b>146 MICRO 1 ..... 218A</b>		<b>231 SYSTAT ..... 189</b>	
<b>380 KORE, INC. .... 88MW 2</b>		<b>48 COGITATE ..... 272</b>		<b>* MICROSMART ..... 88NE-14,15</b>		<b>295 IBM/MSDOS—CAD</b>	
<b>126 LINK COMP GRAPHICS ..... 274</b>		<b>110 ITRON ..... 151</b>		<b>402 OMEGA MICRO SYSTEMS 88SE-4</b>		<b>263 ACCEL TECH ..... 289</b>	
<b>128 LOGICAL DEVICES ..... 280</b>		<b>156 NATURAL MICROSYSTEMS .. 201</b>		<b>394 OWL COMP. SERVICES. 88M/AT-7</b>			
<b>253 XELTEK ..... 289</b>		<b>174 PERSONAL SPACE COMM. .... 278</b>		<b>167 PACIFIC COMPUTER ..... 267</b>			
<b>254 XENDER ..... 278</b>		<b>206 ROSE ELECTRONICS ..... 270</b>		<b>168 PACIFIC COMPUTER ..... 267</b>			
		<b>207 ROSE ELECTRONICS ..... 270</b>		<b>171 PC DESIGN ..... 127</b>			
		<b>288 PRINTERS/PLOTTERS</b>		<b>437 PIONEER SYSTEMS ..... 88NE-3</b>			
		<b>8 ADV. MATRIX TECH. .... 246,247</b>		<b>185 PROTEUS TECH. CORP. .... 41</b>			
		<b>266 CITIZEN AMERICA ..... 82,83</b>					

# READER SERVICE

Mac Supplement follows page 200.  
See Reader Service Index and card on page M96.

Advertising Supplement included with this issue:  
Priority One Electronics (U.S. Subscribers)

Inquiry No.	Page No.
13	AMER. SMALL BUS. COMPUTERS... 93
35	CADAM... 73
36	CADAM... 73
249	WINTEK CORP. .... 5
296 IBM/MSDOS—LAN	
206	ROSE ELECTRONICS ..... 270
207	ROSE ELECTRONICS ..... 270
211	SANTA CRUZ OPERATIONS ... 53
17	SIMPLE NET SYSTEM ..... 134
18	SIMPLENET SYSTEM ..... 134
297 IBM/MSDOS—GRAPHICS	
58	COMP. SUPPORT GRP. ... 192,193
272	DESTINY TECHNOLOGY... 225
486	IES ..... 88IS-12
439	RIX SOFTWARES ..... 88NE-20
440	RIX SOFTWARES ..... 88NE-20
420	RIX SOFTWARES ..... 88PC-1
421	RIX SOFTWARES ..... 88PC-1
298 IBM/MSDOS—LANGUAGES	
3	A + L MEIER VOGT ..... 189
11	ALOIS SCHONBACHLER ..... 96
16	AVOCET SYSTEMS ..... 61
26	BORLAND ..... CII
27	BORLAND ..... CII
28	BORLAND ..... 1
29	BORLAND ..... 1
*	CALEND ..... 88IS-13
43	CNS INC. .... 60
44	CNS INC. .... 60
77	DIGITAL KINC. .... 190,191
78	DIGITAL INC. .... 190,191
99	GUIDELINES SOFTWARE ..... 24
485	IAR ..... 88IS-27
108	INTELLIGENCEWARE ..... 17
115	JENSEN & PARTNERS INT'L ... 87
125	LAHEY COMPUTER SYSTEMS 128
131	LOGITECH ..... 154
132	LOGITECH ..... 155
133	LOGITECH ..... 155
134	LOGITECH ..... 154
137	MARK WILLIAMS ..... 30
*	MICROSOFT ..... 212,213
152	MIX SOFTWARE ..... 209
502	WARREN POINT LTD. .... 88IS-24
250	WINTEK CORP. .... 280
258	ZORTECH ..... 27
299 UTILITIES	
4	A + L MEIER \ ..... 171
287	AETECH ..... 98
268	AETECH ..... 98
15	ATRON ..... 66
25	BLAISE ..... 33
37	CALIFORNIA SOFTWARE ..... 269
36	CALIFORNIA SOFTWARE ..... 269
271	CHANCELOGIC INC. .... 237
273	DATA CODE, INC. .... 210
70	DAYBREAK TECH. .... 197
71	DAYBREAK TECH. .... 197
101	HAMMERLY COMP. SERVICES 97
104	HI TECH EQUIP. .... 276

Inquiry No.	Page No.
105	HIWARE ..... 60
137	MARK WILLIAMS ..... 30
152	MIX SOFTWARE ..... 209
418	NU-MEGA ..... 88PC-9
176	PETER NORTON ..... 133
177	PETER NORTON ..... 133
*	QUAID SOFTWARE LTD. .... 54
197	QUARTERDECK OFFICE SYS. 120
198	QUARTERDECK OFFICE SYS. 120
208	R.J. SWANTEK ..... 280
212	SANTA RITA SOFTWARE ..... 104
228	SUPERSOFT ..... 92
*	VERMONT CREATIVE ..... 19
300 IBM/MSDO —COMMUNICATIONS	
*	CLEO SOFTWARE ..... 204
45	COEFFICIENT SYS. CO. .... 160
46	COEFFICIENT SYS. CO. .... 161
391	COMM. RESEARCH ..... 88M/AT-6
430	COMM. RESEARCH ..... 88NE-19
85	CROSSTALK COMM. .... 139
75	DCS (DIVERSIFIED COMP.) ... 271
96	GRAFFPOINT ..... 276
119	KEA SYSTEMS ..... 128
120	KEA SYSTEMS ..... 270
144	MERIDIAN TECHNOLOGY .... 64
173	PERSOFT ..... 85
219	SOFTKLONEDISTRIBUTING ... 184
220	SOFTRONICS ..... 272
301 OTHER—CROSS DEVELOPMENT	
221	SOFTWARE DEV. SYS. .... 124
* <b>MAC SUPPLEMENT M1-M96</b>	
302 MAIL ORDER/RETAIL	
409	3-F ..... 88PC-18
5	ADV. COMP. PRODS. .... 282,283
*10	ALTEC TECHNOLOGY ..... 88PC-8
376	ALTEX ELECTRONICS ..... 88MW-8
387	ALTEX ELECTRONICS ..... 88SW-1
477	ANALYTICAL ENGINES ... 88IS-22
429	APPLIED PROG. ELEC. .... 88NE-8,7
478	BCL ..... 88IS-26
*	BUYERS MART. .... 254-262
49	COMPACT DISK PRODUCTS ... 94
*	COMPARE COMPUTERS. 88MW-5
*	COMPARE COMPUTERS. 88NE-5
480	COMPUADD ..... 88IS-11
51	COMPUSAVE ..... 267
431	COMPUTER AGE ..... 88NE-10
54	COMPUTER EXPO ..... 50
389	COMPUTER LANE ..... 88SW-8
392	COMPUTER LANE ..... 88M/AT-5
411	COMPUTER LANE ..... 88PC-5
55	COMPUTER MAIL ORDER ... 36,37
57	COMPUTER WAREHOUSE ... 42,43
58	COMPUTER WAREHOUSE ... 42,43
412	COMPUTOWN ..... 88PC-13

Inquiry No.	Page No.
60	COMP. DISCOUNT WAREHOUSE ... 101
61	COMP. SURPLUS STORE ..... 281
62	CONTECH. .... 271
432	C.H.A.S. MICRO ..... 88NE-1
79	DISC INTERNATIONAL ..... 271
80	DISK COTECH ..... 261
81	DISKETTE CONNECTION ... 273
82	DISKS TO GO ..... 274
413	D-DATA ..... 88PC-14
388	D-DATA ..... 88SW-3
482	ECOSOFT AG ..... 88IS-26
484	GREY MATTER ..... 88IS-21
378	HARD DRIVES INT'L ..... 88MW-7
379	HARD DRIVES INT'L ..... 88MW-7
399	HARD DRIVES INT'L ..... 88SE-1
400	HARD DRIVES INT'L ..... 88SE-1
106	IC EXPRESS ..... 270
111	JADE COMPUTER PROD. .... 281
112	JAMECO ELECTRONICS ... 264,265
116	J.D.R. MICRODEVICES ... 284,285
117	J.D.R. MICRODEVICES ... 286,287
117	J.D.R. MICRODEVICES ... 288
415	KNAPCO ..... 88PC-15
401	KNAPCO ..... 88SE-3
*	MCGRAW-HILL BOOKS ... 88NE-11
*	MCGRAW-HILL BOOKS ... 88SE-7
*	MCGRAW-HILL BOOKS ... 88SW-7
139	MEAD COMPUTER ..... 277
140	MEGASOFT ..... 271
141	MEGASOFT ..... 271
143	MEP (MICRO ELEC. PROD) ... 278
147	MICROCOM SYSTEMS ..... 28
*	MICROCOMP. MKTG. COUNCIL 88M/AT-8
*	MICROCOMP. MKTG. COUNCIL 88MW-3
*	MICROCOMP. MKTG. COUNCIL 88NE-12
*	MICROCOMP. MKTG. COUNCIL 88PC-10
*	MICROCOMP. MKTG. COUNCIL 88SE-5
*	MICROCOMP. MKTG. COUNCIL 88SW-5
*	MICROCOMP. MKTG. COUNCIL ... 217
*	MICROMINT ..... 235
*	MICROMINT ..... 88SE-8
148	MICROPROCESSORS UNLTD. 274
153	MONTGOMERY GRANT ..... 286
154	M.H.I. .... 112
394	OWL COMP. SERVICES. 88M/AT-7
436	PC LINK ..... 88NE-11
172	PC PLUS ..... 116
438	POWER COMPUTER ..... 88NE-11
181	PROGRAMMERS SHOP ..... 103
182	PROGRAMMER'S CONNECTION ... 39
183	PROGRAMMER'S PARADISE ... 107
209	SABINA INT'L ..... 280
213	SCHWAB ..... 289
214	SCIENCE & ENG. S/W ..... 123
216	SHAMROCK COMPUTER ..... 99
57	SILICON SPECIALTIES ... 42,43
58	SILICON SPECIALTIES ... 42,43
218	SN'W ELECTRONICS ..... 34
*	SOFTLINE CORP. .... 88IS-17
224	SOLUTION SYSTEMS ..... 103
499	S-100 ..... 88IS-9
500	S-100 ..... 88IS-9
232	S.C. SYSTEMS ..... 59
395	S.F. MICRO ..... 88M/AT-1
422	S.F. MICRO ..... 88PC-11
57	TELEMART ..... 42,43
58	TELEMART ..... 42,43
239	TIMELINE ..... 279

Inquiry No.	Page No.
243	TRUE DATA PROD. .... 269
501	USA SOFTWARE ..... 88IS-5
248	WAREHOUSE DATA PROD. ... 55
403	WJL ..... 88SE-2
383	Y.E.S. MULTINATIONAL ... 88MW-4

## 303 EDUCATIONAL/INSTRUCTIONAL

*	BYTE BACK ISSUES ..... 296
*	BYTE BACK ISSUES ..... 88IS-20
289	BYTE BITS ..... 280
*	BYTE CIRCULATION ..... 248
*	BYTE CIRCULATION ..... 88IS-30
*	BYTE MARKETING ..... 253
*	BYTE SUB. MESSAGE ..... 160
*	BYTE SUB. MESSAGE ... 88IS-18
*	BYTE SUB. SERVICE ..... 291
*	BYTE TIPS ..... 88M/AT-2
*	BYTE TIPS ..... 88NE-4
*	BYTE TIPS ..... 88PC-6
*	BYTE TIPS ..... 88SW-2
*	COMPUTERS FOR THE BLIND 88M/AT-4
*	COMPUTERS FOR THE BLIND 88SW-4
*	EXPOCONSULINT'L ..... 88PC-12
121	KNOWLEDGE GARDEN ..... 233
127	LOGICAL DEVICES ..... 280
490	MICROPROCESS. ENGIN. 88IS-24
185	OSBORNE/MCGRAW-HILL ... 170
186	OSBORNE/MCGRAW-HILL ... 231
419	PC SIG. .... 88PC-3

## 304 DESKTOP PUBLISHING

416	MERLIN PUBLISHING ..... 88PC-4
-----	--------------------------------

## \* MISCELLANEOUS

UN TARGET ..... 270	
* ROBT. TINNEY GRAPHICS 88NE-16	
* ROBT. TINNEY GRAPHICS 88SE-8	
* ROBT. TINNEY GRAPHICS 88SW-6	
210	SAFEWARE ..... 273

## 305 OPERATING SYSTEMS

180	QUANTUM ..... 110
222	SOFTWARE LINK, THE ..... 28,29
223	SOFTWARE LINK, THE ..... 28,29

## 306 ON-LINE SERVICES

479	BIX ..... 88IS-31
450	BIX ..... 182,183
52	COMPUSERVE ..... 216C
251	WORLDWIDE SERVICES ..... 276
252	WORLDWIDE SERVICES ..... 276
491	MICRO TECHNOLOGY. .... 88IS-2



# FREE Information Retrieval Service

To assist you in making your evaluations, purchasing decisions, or recommendations, you can request further information directly from the manufacturer or service company on products and services advertised in this issue. There is no charge, no obligation. Just complete and mail the attached post-paid, self-addressed reply card, and we'll do the rest.

- 1** Circle numbers on reply card which correspond to numbers assigned to items of interest to you.
- 2** Check all the appropriate answers to questions "A" through "F".
- 3** Print your name and address and mail.

Fill out this coupon carefully. PLEASE PRINT. Requests cannot be honored unless the zip code is included. This card is valid for 6 months from cover date.

**A. What is your primary job function? (Check one only)**

- 1 Business Owner, General Management, Administrative
- 2 MIS/DP, Programming
- 3 Engineering/Scientific, R&D
- 4 Professional (law, medicine, accounting)
- 5 Other

**B. How many people does your company employ?**

- 1 25 or fewer
- 2 26-99
- 3 100-499
- 4 500-999
- 5 1000 or more

**C. Reason for request: (Check all that apply).**

- 1 Business use for yourself
- 2 Business use for your company
- 3 Personal use

**D. Your next step after information is received:**

- 1 Purchase order
- 2 Evaluation
- 3 Specification/Recommendation

**E. Please indicate the product categories for which you influence the selection or purchase at your (or your client's) company or organization. (Check all that apply).**

- 1 Microcomputers
- 2 Peripherals
- 3 Software
- 4 Accessories and supplies

**F. For how many microcomputers do you influence the purchase of products at your (or your client's) company or organization?**

- 1 1
- 2 2-4
- 3 5-9
- 4 10 or more

AUGUST  
48BRNU-9

**Circle your first information**

1	2	3	4	5	6	7	8	9	10	11	12	13	14	15	16	17	18	19	20	21	22	23	24	25	26	27
28	29	30	31	32	33	34	35	36	37	38	39	40	41	42	43	44	45	46	47	48	49	50	51	52	53	54
55	56	57	58	59	60	61	62	63	64	65	66	67	68	69	70	71	72	73	74	75	76	77	78	79	80	81
82	83	84	85	86	87	88	89	90	91	92	93	94	95	96	97	98	99	100	101	102	103	104	105	106	107	108
109	110	111	112	113	114	115	116	117	118	119	120	121	122	123	124	125	126	127	128	129	130	131	132	133	134	135
136	137	138	139	140	141	142	143	144	145	146	147	148	149	150	151	152	153	154	155	156	157	158	159	160	161	162
163	164	165	166	167	168	169	170	171	172	173	174	175	176	177	178	179	180	181	182	183	184	185	186	187	188	189
190	191	192	193	194	195	196	197	198	199	200	201	202	203	204	205	206	207	208	209	210	211	212	213	214	215	216
217	218	219	220	221	222	223	224	225	226	227	228	229	230	231	232	233	234	235	236	237	238	239	240	241	242	243
244	245	246	247	248	249	250	251	252	253	254	255	256	257	258	259	260	261	262	263	264	265	266	267	268	269	270
271	272	273	274	275	276	277	278	279	280	281	282	283	284	285	286	287	288	289	290	291	292	293	294	295	296	297
298	299	300	301	302	303	304	305	306	307	308	309	310	311	312	313	314	315	316	317	318	319	320	321	322	323	324
325	326	327	328	329	330	331	332	333	334	335	336	337	338	339	340	341	342	343	344	345	346	347	348	349	350	351
352	353	354	355	356	357	358	359	360	361	362	363	364	365	366	367	368	369	370	371	372	373	374	375	376	377	378
379	380	381	382	383	384	385	386	387	388	389	390	391	392	393	394	395	396	397	398	399	400	401	402	403	404	405
406	407	408	409	410	411	412	413	414	415	416	417	418	419	420	421	422	423	424	425	426	427	428	429	430	431	432
433	434	435	436	437	438	439	440	441	442	443	444	445	446	447	448	449	450	451	452	453	454	455	456	457	458	459
460	461	462	463	464	465	466	467	468	469	470	471	472	473	474	475	476	477	478	479	480	481	482	483	484	485	486
487	488	489	490	491	492	493	494	495	496	497	498	499	500	501	502	503	504	505	506	507	508	509	510	511	512	513
514	515	516	517	518	519	520	521	522	523	524	525	526	527	528	529	530	531	532	533	534	535	536	537	538	539	540
541	542	543	544	545	546	547	548	549	550	551	552	553	554	555	556	557	558	559	560	561	562	563	564	565	566	567
568	569	570	571	572	573	574	575	576	577	578	579	580	581	582	583	584	585	586	587	588	589	590	591	592	593	594
595	596	597	598	599	600	601	602	603	604	605	606	607	608	609	610	611	612	613	614	615	616	617	618	619	620	621
622	623	624	625	626	627	628	629	630	631	632	633	634	635	636	637	638	639	640	641	642	643	644	645	646	647	648
649	650	651	652	653	654	655	656	657	658	659	660	661	662	663	664	665	666	667	668	669	670	671	672	673	674	675
676	677	678	679	680	681	682	683	684	685	686	687	688	689	690	691	692	693	694	695	696	697	698	699	700	701	702
703	704	705	706	707	708	709	710	711	712	713	714	715	716	717	718	719	720	721	722	723	724	725	726	727	728	729
730	731	732	733	734	735	736	737	738	739	740	741	742	743	744	745	746	747	748	749	750	751	752	753	754	755	756
757	758	759	760	761	762	763	764	765	766	767	768	769	770	771	772	773	774	775	776	777	778	779	780	781	782	783
784	785	786	787	788	789	790	791	792	793	794	795	796	797	798	799	800	801	802	803	804	805	806	807	808	809	810
811	812	813	814	815	816	817	818	819	820	821	822	823	824	825	826	827	828	829	830	831	832	833	834	835	836	837
838	839	840	841	842	843	844	845	846	847	848	849	850	851	852	853	854	855	856	857	858	859	860	861	862	863	864
865	866	867	868	869	870	871	872	873	874	875	876	877	878	879	880	881	882	883	884	885	886	887	888	889	890	891
892	893	894	895	896	897	898	899	900	901	902	903	904	905	906	907	908	909	910	911	912	913	914	915	916	917	918
919	920	921	922	923	924	925	926	927	928	929	930	931	932	933	934	935	936	937	938	939	940	941	942	943	944	945
946	947	948	949	950	951	952	953	954	955	956	957	958	959	960	961	962	963	964	965	966	967	968	969	970	971	972
973	974	975	976	977	978	979	980	981	982	983	984	985	986	987	988	989	990	991	992	993	994	995	996	997	998	999

Name \_\_\_\_\_  
 Title \_\_\_\_\_  
 Company \_\_\_\_\_  
 Address \_\_\_\_\_  
 City \_\_\_\_\_ State \_\_\_\_\_  
 Zip \_\_\_\_\_ Telephone \_\_\_\_\_



NO POSTAGE  
NECESSARY  
IF MAILED  
IN THE  
UNITED STATES

**BUSINESS REPLY MAIL**  
 FIRST CLASS MAIL PERMIT NO. 176 DALTON, MA

POSTAGE WILL BE PAID BY ADDRESSEE

**BYTE**  
 READER SERVICE  
 PO Box 298  
 Dalton, MA 01227-0298  
 USA



# FREE Information Retrieval Service

To assist you in making your evaluations, purchasing decisions, or recommendations, you can request further information directly from the manufacturer or service company on products and services advertised in this issue. There is no charge, no obligation. Just complete and mail the attached post-paid, self-addressed reply card, and we'll do the rest.

- 1** Circle numbers on reply card which correspond to numbers assigned to items of interest to you.
- 2** Check all the appropriate answers to questions "A" through "F".
- 3** Print your name and address and mail.



NO POSTAGE  
NECESSARY  
IF MAILED  
IN THE  
UNITED STATES

**BUSINESS REPLY MAIL**  
FIRST CLASS MAIL PERMIT NO. 176 DALTON, MA

POSTAGE WILL BE PAID BY ADDRESSEE

**BYTE**

READER SERVICE  
PO Box 298  
Dalton, MA 01227-0298  
USA

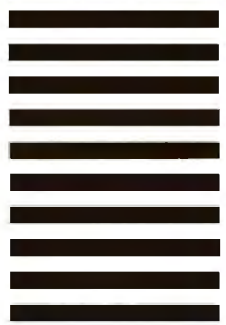

Fill out this coupon carefully. PLEASE PRINT. Requests cannot be honored unless the zip code is included. This card is valid for 6 months from cover date.

AUGUST  
48BRNU-9

**A. What is your primary job function? (Check one only)**

- 1  Business Owner, General Management, Administrative
- 2  MIS/DP, Programming
- 3  Engineering/Scientific, R&D
- 4  Professional (law, medicine, accounting)
- 5  Other

**B. How many people does your company employ?**

- 1  25 or fewer
- 2  26-99
- 3  100-499
- 4  500-999
- 5  1000 or more

**C. Reason for request: (Check all that apply).**

- 1  Business use for yourself
- 2  Business use for your company
- 3  Personal use

**D. Your next step after information is received:**

- 1  Purchase order
- 2  Evaluation
- 3  Specification/Recommendation

**E. Please indicate the product categories for which you influence the selection or purchase at your (or your client's) company or organization. (Check all that apply).**

- 1  Microcomputers
- 2  Peripherals
- 3  Software
- 4  Accessories and supplies

**F. For how many microcomputers do you influence the purchase of products at your (or your client's) company or organization?**

- 1  1
- 2  2-4
- 3  5-9
- 4  10 or more

Name \_\_\_\_\_  
 Title \_\_\_\_\_  
 Company \_\_\_\_\_  
 Address \_\_\_\_\_  
 City \_\_\_\_\_ State \_\_\_\_\_  
 Zip \_\_\_\_\_ Telephone \_\_\_\_\_

1	2	3	4	5	6	7	8	9	10	11	12	13	14	15	16	17	18	19	20	21	22	23	24	25	26	27
28	29	30	31	32	33	34	35	36	37	38	39	40	41	42	43	44	45	46	47	48	49	50	51	52	53	54
55	56	57	58	59	60	61	62	63	64	65	66	67	68	69	70	71	72	73	74	75	76	77	78	79	80	81
82	83	84	85	86	87	88	89	90	91	92	93	94	95	96	97	98	99	100	101	102	103	104	105	106	107	108
109	110	111	112	113	114	115	116	117	118	119	120	121	122	123	124	125	126	127	128	129	130	131	132	133	134	135
136	137	138	139	140	141	142	143	144	145	146	147	148	149	150	151	152	153	154	155	156	157	158	159	160	161	162
163	164	165	166	167	168	169	170	171	172	173	174	175	176	177	178	179	180	181	182	183	184	185	186	187	188	189
190	191	192	193	194	195	196	197	198	199	200	201	202	203	204	205	206	207	208	209	210	211	212	213	214	215	216
217	218	219	220	221	222	223	224	225	226	227	228	229	230	231	232	233	234	235	236	237	238	239	240	241	242	243
244	245	246	247	248	249	250	251	252	253	254	255	256	257	258	259	260	261	262	263	264	265	266	267	268	269	270
271	272	273	274	275	276	277	278	279	280	281	282	283	284	285	286	287	288	289	290	291	292	293	294	295	296	297
298	299	300	301	302	303	304	305	306	307	308	309	310	311	312	313	314	315	316	317	318	319	320	321	322	323	324
325	326	327	328	329	330	331	332	333	334	335	336	337	338	339	340	341	342	343	344	345	346	347	348	349	350	351
352	353	354	355	356	357	358	359	360	361	362	363	364	365	366	367	368	369	370	371	372	373	374	375	376	377	378
379	380	381	382	383	384	385	386	387	388	389	390	391	392	393	394	395	396	397	398	399	400	401	402	403	404	405
406	407	408	409	410	411	412	413	414	415	416	417	418	419	420	421	422	423	424	425	426	427	428	429	430	431	432
433	434	435	436	437	438	439	440	441	442	443	444	445	446	447	448	449	450	451	452	453	454	455	456	457	458	459
460	461	462	463	464	465	466	467	468	469	470	471	472	473	474	475	476	477	478	479	480	481	482	483	484	485	486
487	488	489	490	491	492	493	494	495	496	497	498	499	500	501	502	503	504	505	506	507	508	509	510	511	512	513
514	515	516	517	518	519	520	521	522	523	524	525	526	527	528	529	530	531	532	533	534	535	536	537	538	539	540
541	542	543	544	545	546	547	548	549	550	551	552	553	554	555	556	557	558	559	560	561	562	563	564	565	566	567
568	569	570	571	572	573	574	575	576	577	578	579	580	581	582	583	584	585	586	587	588	589	590	591	592	593	594
595	596	597	598	599	600	601	602	603	604	605	606	607	608	609	610	611	612	613	614	615	616	617	618	619	620	621
622	623	624	625	626	627	628	629	630	631	632	633	634	635	636	637	638	639	640	641	642	643	644	645	646	647	648
649	650	651	652	653	654	655	656	657	658	659	660	661	662	663	664	665	666	667	668	669	670	671	672	673	674	675
676	677	678	679	680	681	682	683	684	685	686	687	688	689	690	691	692	693	694	695	696	697	698	699	700	701	702
703	704	705	706	707	708	709	710	711	712	713	714	715	716	717	718	719	720	721	722	723	724	725	726	727	728	729
730	731	732	733	734	735	736	737	738	739	740	741	742	743	744	745	746	747	748	749	750	751	752	753	754	755	756
757	758	759	760	761	762	763	764	765	766	767	768	769	770	771	772	773	774	775	776	777	778	779	780	781	782	783
784	785	786	787	788	789	790	791	792	793	794	795	796	797	798	799	800	801	802	803	804	805	806	807	808	809	810
811	812	813	814	815	816	817	818	819	820	821	822	823	824	825	826	827	828	829	830	831	832	833	834	835	836	837
838	839	840	841	842	843	844	845	846	847	848	849	850	851	852	853	854	855	856	857	858	859	860	861	862	863	864
865	866	867	868	869	870	871	872	873	874	875	876	877	878	879	880	881	882	883	884	885	886	887	888	889	890	891
892	893	894	895	896	897	898	899	900	901	902	903	904	905	906	907	908	909	910	911	912	913	914	915	916	917	918
919	920	921	922	923	924	925	926	927	928	929	930	931	932	933	934	935	936	937	938	939	940	941	942	943	944	945
946	947	948	949	950	951	952	953	954	955	956	957	958	959	960	961	962	963	964	965	966	967	968	969	970	971	972
973	974	975	976	977	978	979	980	981	982	983	984	985	986	987	988	989	990	991	992	993	994	995	996	997	998	999



Make a  
career  
move!

Get your  
own copy  
of **BYTE!**

There's no better way to plug into happenings in the personal computer field. Each monthly issue of **BYTE** brings the latest information on buying and using personal computer systems. News of new technology... new hardware... new software... and more. You'll get the whole range from music to memory, word processors to artificial intelligence. And the articles and features now on our editor's desk promise to be among the most exciting we've ever published. So have **BYTE** delivered to *your* door in *your* name. Use one of the adjacent cards and get your own copy of **BYTE**.



For direct ordering call toll free weekdays 9:00am-5:00pm EST: 1 800 423-8272 (in New Jersey: 1 800 367-0218).

For your own subscription to **BYTE**,  
complete this card and mail.



Name \_\_\_\_\_  
 Company \_\_\_\_\_  
 Address \_\_\_\_\_  
 City \_\_\_\_\_  
 State \_\_\_\_\_ Zip \_\_\_\_\_ Country \_\_\_\_\_  
 Bill me (U.S.A., Canada, Mexico only)  
 Check enclosed (All checks must be payable in U.S. funds drawn on a U.S. bank.)  
 Charge to my  MasterCard  VISA 488RNU-9  
 Card # \_\_\_\_\_ Expiration Date \_\_\_\_\_  
 Signature \_\_\_\_\_

**Subscription Rates**

	USA	Canada/ Mexico
ONE YEAR:	<input type="checkbox"/> \$22.95	<input type="checkbox"/> \$25.95
TWO YEARS:	<input type="checkbox"/> \$39.95	<input type="checkbox"/> \$45.95
THREE YEARS:	<input type="checkbox"/> \$55.95	<input type="checkbox"/> \$64.95
<input type="checkbox"/> \$75 Europe (air delivery)		
<input type="checkbox"/> \$40 Europe (surface mail)		
<input type="checkbox"/> \$45 Worldwide (surface mail)		
Air mail rates outside Europe available upon request.		

Please allow 6-8 weeks for processing. Thank you.



**BUSINESS REPLY MAIL**  
 FIRST CLASS MAIL PERMIT NO. 684 TEANECK, NJ

POSTAGE WILL BE PAID BY ADDRESSEE:

**BYTE**  
 Subscription Dept.  
 P. O. Box 7640  
 Teaneck, NJ 07666-9866

NO POSTAGE  
 NECESSARY  
 IF MAILED  
 IN THE  
 UNITED STATES

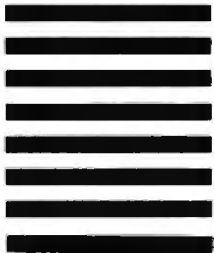

For your own subscription to **BYTE**,  
complete this card and mail.



Name \_\_\_\_\_  
 Company \_\_\_\_\_  
 Address \_\_\_\_\_  
 City \_\_\_\_\_  
 State \_\_\_\_\_ Zip \_\_\_\_\_ Country \_\_\_\_\_  
 Bill me (U.S.A., Canada, Mexico only)  
 Check enclosed (All checks must be payable in U.S. funds drawn on a U.S. bank.)  
 Charge to my  MasterCard  VISA 488RNU-9  
 \_\_\_\_\_ Expiration Date \_\_\_\_\_  
 Signature \_\_\_\_\_

**Subscription Rates**

	USA	Canada/ Mexico
ONE YEAR:	<input type="checkbox"/> \$22.95	<input type="checkbox"/> \$25.95
TWO YEARS:	<input type="checkbox"/> \$39.95	<input type="checkbox"/> \$45.95
THREE YEARS:	<input type="checkbox"/> \$55.95	<input type="checkbox"/> \$64.95
<input type="checkbox"/> \$75 Europe (air delivery)		
<input type="checkbox"/> \$40 Europe (surface mail)		
<input type="checkbox"/> \$45 Worldwide (surface mail)		
Air mail rates outside Europe available upon request.		

Please allow 6-8 weeks for processing. Thank you.



**BUSINESS REPLY MAIL**  
FIRST CLASS MAIL PERMIT NO. 684 TEANECK, NJ

POSTAGE WILL BE PAID BY ADDRESSEE:

**BYTE**

Subscription Dept.  
P. O. Box 7640  
Teaneck, NJ 07666-9866

NO POSTAGE  
NECESSARY  
IF MAILED  
IN THE  
UNITED STATES

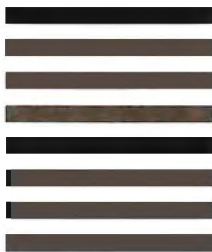

**Make a  
career  
move!**

**Get your  
own copy  
of BYTE!**

There's no better way to plug into happenings in the personal computer field. Each monthly issue of BYTE brings the latest information on buying and using personal computer systems. News of new technology... new hardware... new software... and more. You'll get the whole range from music to memory, word processors to artificial intelligence. And the articles and features now on our editor's desk promise to be among the most exciting we've ever published. So have BYTE delivered to *your* door in *your* name. Use one of the adjacent cards and get your own copy of BYTE.



For direct ordering  
call toll free weekdays  
9:00am-5:00pm EST:  
1 800 423-8272 (in New  
Jersey: 1 800 367-0218).

**For your own subscription to **BYTE**,  
complete this card and mail.**



Name \_\_\_\_\_

Company \_\_\_\_\_

Address \_\_\_\_\_

City \_\_\_\_\_

State \_\_\_\_\_ Zip \_\_\_\_\_ Country \_\_\_\_\_

- Bill me (U.S.A., Canada, Mexico only)
- Check enclosed (All checks must be payable in U.S. funds drawn on a U.S. bank.)

Charge to my  MasterCard  VISA 488RNU-9

Card # \_\_\_\_\_ Expiration Date \_\_\_\_\_

Signature \_\_\_\_\_

**Subscription Rates**

	USA	Canada/ Mexico
ONE YEAR:	<input type="checkbox"/> \$22.95	<input type="checkbox"/> \$25.95
TWO YEARS:	<input type="checkbox"/> \$39.95	<input type="checkbox"/> \$45.95
THREE YEARS:	<input type="checkbox"/> \$55.95	<input type="checkbox"/> \$64.95

- \$75 Europe (air delivery)
  - \$40 Europe (surface mail)
  - \$45 Worldwide (surface mail)
- Air mail rates outside Europe available upon request.

Please allow 6-8 weeks for processing. Thank you.



**BUSINESS REPLY MAIL**  
FIRST CLASS MAIL PERMIT NO. 684 TEANECK, NJ

POSTAGE WILL BE PAID BY ADDRESSEE:

**BYTE**

Subscription Dept.  
P. O. Box 7640  
Teaneck, NJ 07666-9866

NO POSTAGE  
NECESSARY  
IF MAILED  
IN THE  
UNITED STATES

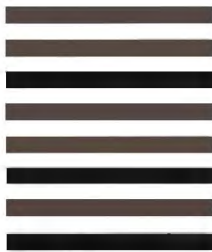

# OUR NEW PRINTERS MAKE EVEN BAD WRITING LOOK GOOD.

CHAPTER ONE  
THE BLACKEST HOUR IS MIDNIGHT

It was not a night fit for man or beast what with the sky being as black as ink and it starting to rain like cats and dogs. As if things weren't bad enough Jeffrey Whipple had to climb all the way up to the top of Bald Eagle hill in his snakeskin boots so new their smell reminded him of a car he once leased in Flagstaff, Arizona just to check things out because earlier in the day a message had gotten through that there was going to be trouble this night so he was feeling ominous as the dry wind whipped up the dust around his feet and wondering if he should go on or go back to camp when suddenly, he heard a twig crack behind him or thought he did but as he turned he couldn't see anything except the black bleakness of the

We're sorry that our new 24-wire Pinwriter® P5200 and P5300 printers can't do much for the quality of your writing. But they can certainly do wonders for the way it looks. The secret is the ribbon. Other dot matrix printers only use a fabric ribbon. Our Pinwriters print with both a fabric and a letter-quality, multi-strike film ribbon—the same kind used on executive typewriters.

The NEC Pinwriters can also enhance your writing in other ways. They have seven resident type styles. Plus four more are available on plug-in font cards. Which means you can express your thoughts with just the right typeface. You can also get an inexpensive, user-installed color option. And if graphics are part of your story, these Pinwriters produce the highest resolution of any printer you can buy.

Call NEC Information Systems at 1-800-343-4418 to see how much better our new Pinwriter P5200 and the wider P5300 can make your writing look.

Whether you're a budding Hemingway, or a Hemingway & Company.

**NEC PRINTERS. THEY ONLY STOP  
WHEN YOU WANT THEM TO.**

# NEC



NEC Information Systems, Dept. 1610, 1414 Massachusetts Ave., Boxborough, MA 01719.

**Tandy Computers:  
Because there is  
no better value.<sup>TM</sup>**

# The Tandy<sup>®</sup> 1000 TX



**Buy a Tandy 1000 TX  
and receive a \$299<sup>95</sup>  
Color Monitor...  
at no extra charge.**

## **Power you need at a great price**

Now, for a limited time, buy a Tandy 1000 TX computer for only \$1199 and we'll include our CM-5 Color Monitor. The PC-compatible Tandy 1000 TX features a high-speed Intel<sup>®</sup> 80286 microprocessor for far greater processing power than ordinary PCs.

## **Comes with its own software**

With the included Personal DeskMate<sup>™</sup> 2 software, you get seven popular applications: Text—an easy-to-use word-processing program; Worksheet—a spreadsheet-analysis application; File—an efficient electronic-filing system; Paint—a colorful graphics program; Music—for playing and composing songs; Calendar—to keep those important dates; and Telecom—to communicate with other computers and information services.

## **Start computing immediately**

This system is ready to run from day one because the TX comes with 640K RAM, a 720K 3 1/2" disk drive, all the necessary adapters, as well as MS-DOS<sup>®</sup> 3.2 and GW-BASIC.

## **Choose from a variety of computers**

Tandy offers a complete line of PC-compatible computers for every need. Visit a nearby Radio Shack today and take advantage of this special offer featuring the remarkable Tandy 1000 TX with Personal DeskMate 2 and the CM-5 Color Monitor.

**Radio Shack<sup>®</sup>**  
**COMPUTER CENTERS**

A DIVISION OF TANDY CORPORATION

Offer includes Tandy 1000 TX (25-1600) and CM-5 Color Monitor (25-1043). Monitor appearance may vary. Personal DeskMate 2 communications require modem. Intel/Reg. TM Intel Corp. IBM/Reg. TM IBM Corp. MS-DOS/Reg. TM Microsoft Corp. Sale begins 6/21/88, ends 8/23/88.