



Liebert® EXL S1

Operation and Maintenance Guide

250kVA – 1200kVA, 60Hz, Three-Phase UPS, Single-Module and Multi-Module
(Distributed Bypass)

The information contained in this document is subject to change without notice and may not be suitable for all applications. While every precaution has been taken to ensure the accuracy and completeness of this document, Vertiv assumes no responsibility and disclaims all liability for damages resulting from use of this information or for any errors or omissions. Refer to other local practices or building codes as applicable for the correct methods, tools, and materials to be used in performing procedures not specifically described in this document.

The products covered by this instruction manual are manufactured and/or sold by Vertiv. This document is the property of Vertiv and contains confidential and proprietary information owned by Vertiv. Any copying, use or disclosure of it without the written permission of Vertiv is strictly prohibited.

Names of companies and products are trademarks or registered trademarks of the respective companies. Any questions regarding usage of trademark names should be directed to the original manufacturer.

Technical Support Site

If you encounter any installation or operational issues with your product, check the pertinent section of this manual to see if the issue can be resolved by following outlined procedures. Visit <https://www.Vertiv.com/en-us/support/> for additional assistance.

TABLE OF CONTENTS

Important Safety Instructions	1
Battery Cabinet Precautions	3
1 Introduction	5
1.1 General Description	5
1.2 Modes of Operation	8
1.2.1 Normal Mode	8
1.2.2 Bypass Mode	8
1.2.3 Battery Mode	8
1.2.4 ECO Mode	8
1.2.5 Intelligent Paralleling	9
1.2.6 Dynamic Online Mode	9
1.2.7 Maintenance Bypass	9
1.3 Options	9
1.3.1 Setpoints (User Adjustable)	11
2 Operation	13
2.1 Touchscreen Navigation	13
2.2 Manual Operations—All Systems	13
2.2.1 Startup—Single Module System	18
2.2.2 Load Transfer and Re-Transfer—Single-Module System	20
2.2.3 Maintenance Bypass Load Transfers—Single Module System	20
2.2.4 UPS Shutdown—Single-Module System	22
2.3 Manual Operations—1+N Systems	22
2.3.1 Startup—1+N Module System	22
2.3.2 Load Transfer-1+N System: Transfer System Inverter to Bypass	25
2.3.3 Load Transfer-1+N System: Transfer System from Bypass to Inverter	25
2.3.4 Load Transfer-1+N System: Remove a UPS from System (Collective)	25
2.3.5 Load Transfer-1+N System: Add a UPS to the System (Collective)	26
2.3.6 Maintenance Bypass Load Transfers—1+N Module System	26
2.3.7 Shutdown-1+N System Shutdown	28
2.4 Energy Saving Mode Activation and Deactivation	29
2.5 Test Operation Mode	30
2.5.1 Enabling Test Operation Mode	30
2.5.2 Disabling Test Operation Mode	30
2.6 System Load Bank Testing	31
2.7 Module Load Bank Testing with the Critical Bus on Inverter	31
2.8 Transformer Energization	32
3 Options	33
3.1 Remote Alarm Status Panel	33
3.1.1 Lamp Test/Reset Push Button	33
3.1.2 Audio Reset Push Button	33

3.2 Vertiv™ Liebert® MBSM	33
3.3 DC Ground Fault	34
4 Maintenance	35
4.1 Safety Precautions	35
4.2 Routine Maintenance	36
4.2.1 Record Log	36
4.2.2 Air Filters	37
4.2.3 Limited Life Components	37
4.3 Battery Maintenance	38
4.3.1 Battery Safety Precautions	38
4.3.2 Torque Requirements	40
4.4 Detecting Trouble	41
4.5 Reporting a Problem	41
4.6 Upstream Feeder Circuit Breaker Setting Inspections	41
5 Specifications	43
Appendices	49
Appendix A: UPS Messages—Status, Alarms, and Faults	49
Appendix B: Performance Data	71
Appendix C: Liebert® EXL S1 Efficiency Curves	72

IMPORTANT SAFETY INSTRUCTIONS

Save These Instructions

This manual contains important instructions that should be followed during operation and maintenance of the Liebert® Liebert EXL S1 uninterruptible power system and DC source.



WARNING! Risk of electric shock. Can cause equipment damage, injury or death.

Exercise extreme care when handling UPS cabinets to avoid equipment damage or injury to personnel. Refer to separate installation manual for equipment handling information and installation procedures.

Follow all DC source safety precautions when installing, charging or servicing DC sources. In addition to the hazard of electric shock, gas produced by batteries can be explosive and sulfuric acid can cause severe burns.

In case of fire involving electrical equipment, use only carbon dioxide fire extinguishers or others approved for use in electrical fire fighting.

Extreme caution is required when performing maintenance. Service and maintenance work must be performed only by properly trained and qualified personnel and in accordance with applicable regulations as well as with manufacturers' specifications.

Be constantly aware that the UPS contains high DC as well as AC voltages. With input power Off and the DC source disconnected, high voltage at filter capacitors and power circuits should be discharged within 5 minutes. However, if a power circuit failure has occurred, assume that high voltage still exists after shutdown. Check with a voltmeter before making contact.

AC voltage will remain on the system bypass, the UPS output terminals and the static bypass switch, unless associated external circuit breakers are opened.

Check for voltage with both AC and DC voltmeters prior to making contact.

When the UPS is under power, both the operator and any test equipment must be isolated from direct contact with earth ground and the UPS chassis frame by using rubber mats.

Some components within the cabinets are not connected to the chassis ground. Any contact between floating circuits and the chassis is a lethal shock hazard. Exercise caution that the test instrument exterior does not make contact, either physically or electrically, with earth ground.

AVERTISSEMENT : Risque de décharge électrique pouvant entraîner des dommages matériels, des blessures et même la mort.

Faites preuve d'une extrême prudence lors de la manutention des armoires ASC afin d'éviter de les endommager ou de blesser le personnel. Reportez-vous au manuel d'installation approprié pour connaître les consignes de manutention et les procédures d'installation de l'équipement. Observez toutes les mesures de sécurité relatives à la source d'alimentation c.c. décrites dans la section 4.0 - Entretien lors de l'installation, de la charge ou de l'entretien des sources c.c. Outre les risques de décharge électrique associés aux batteries, les gaz qu'elles produisent peuvent être explosifs et l'acide sulfurique qu'elles contiennent peut provoquer des brûlures graves.

En cas d'incendie associé à du matériel électrique, n'utilisez que des extincteurs à dioxyde de carbone ou homologués pour la lutte contre les incendies d'origine électrique.

Les opérations d'entretien requièrent une extrême prudence. Les opérations d'entretien ne doivent être confiées qu'à du personnel qualifié et dûment formé. Toutes les interventions doivent être effectuées conformément aux règlements applicables et aux spécifications du fabricant. Soyez toujours conscient du fait que le système ASC contient des tensions c.c. et c.a. élevées.



Une fois l'alimentation d'entrée coupée et la source d'alimentation c.c. débranchée, la haute tension aux condensateurs de filtrage et aux circuits d'alimentation devrait se dissiper en moins de 5 minutes. En cas de défaillance d'un circuit d'alimentation, toutefois, il importe de présumer qu'une tension élevée est présente même après l'arrêt. Vérifiez toujours les tensions avec un voltmètre avant d'établir des contacts.

Le circuit de dérivation, les bornes de sortie ASC et le commutateur statique de dérivation continueront d'afficher une tension c.a. à moins que les disjoncteurs externes associés ne soient ouverts.

Vérifiez les tensions avec des voltmètres c.a. et c.c. avant d'établir tout contact.

Lorsque le système ASC est sous tension, les responsables de l'entretien et l'équipement d'essai doivent reposer sur des tapis de caoutchouc pour prévenir tout contact direct avec le sol et avec le châssis du système lors des interventions.

Certains composants à l'intérieur des armoires ne sont pas connectés à la masse du châssis. Tout contact entre les circuits flottants et le châssis présente un risque de décharge mortelle. Il importe de veiller à ce que l'extérieur des équipements d'essai n'entre pas en contact physique ou électrique avec le sol.

This equipment contains circuitry that is energized with high voltage. Only test equipment designated for troubleshooting should be used. This is particularly true for oscilloscopes. Always check with an AC and DC voltmeter to ensure safety before making contact or using tools. Even when the power is turned Off, dangerously high voltage may exist at the capacitor banks.

Observe all DC source precautions when near the DC source for any reason.

ONLY properly trained and qualified service personnel should perform maintenance on the UPS system. When performing maintenance on any part of the equipment under power, service personnel and test equipment should be standing on rubber mats. The service personnel should wear insulating shoes for isolation from direct contact with the floor (earth ground).

One person should never work alone. A second person should be standing nearby to assist and summon help in case an accident should occur. This is particularly true when work is performed on the DC source.

BATTERY CABINET PRECAUTIONS

The following warning applies to all battery cabinets supplied with UPS systems. Additional warnings and cautions applicable to battery cabinets may be found in [Important Safety Instructions](#) on page 1 and [Battery Maintenance](#) on page 38.



WARNING! Internal battery strapping must be verified by manufacturer prior to moving a battery cabinet (after initial installation).

- Battery cabinets contain non-spillable batteries.
- Keep units upright.
- Do not stack.
- Do not tilt.

Failure to heed this warning could result in smoke, fire or electric hazard.

Contact Vertiv™ Technical Support before moving battery cabinets (after initial installation).

For systems using DC sources other than batteries, refer to the manufacturer's recommendations for handling and care.

ADVERTISSEMENT : L'arrimage des batteries internes doit être vérifié par le fabricant avant de déplacer une armoire de batteries (après l'installation initiale).

- Les armoires de batteries contiennent des batteries étanches.
- Maintenir les systèmes à la verticale.



- Ne pas empiler.
- Ne pas incliner.

Le non-respect de ces consignes comporte des risques liés à la fumée, au feu ou à l'électricité. Composez le Vertiv™ avant de déplacer des armoires de batteries (après l'installation initiale).

Reportez-vous aux recommandations du fabricant relatives à la manipulation et à l'entretien pour les systèmes qui utilisent d'autres sources d'alimentation c.c. que les batteries.

This page intentionally left blank

1 INTRODUCTION

1.1 General Description

The Vertiv™ Liebert® EXL S1 provides continuous, high-quality AC power to business-critical equipment, such as telecommunications and data processing equipment. The Liebert EXL S1 supplies power that is free of the disturbances and variations in voltage and frequency common to utility power, which is subject to brownouts, blackouts, surges and sags.

The Liebert EXL S1 utilizes the latest in high-frequency, double-conversion, pulse-width modulation technology and fully digital controls to enhance its reliability and increase the ease of use.

As shown in **Figure 1.1** below, the AC utility source is input at the rectifier and the rectifier converts the AC utility into DC power. The inverter converts that DC power from the rectifier or DC power from the DC source into AC power for the load. The DC source will power the load through the inverter in the event of a power failure. The utility source can also power the load through the static bypass.

If maintenance or repair of the UPS is necessary, the load can be switched without interruption in service to the optional maintenance bypass.

Figure 1.1 Typical single-module UPS one-line diagram, single input with static bypass and back-feed disconnect

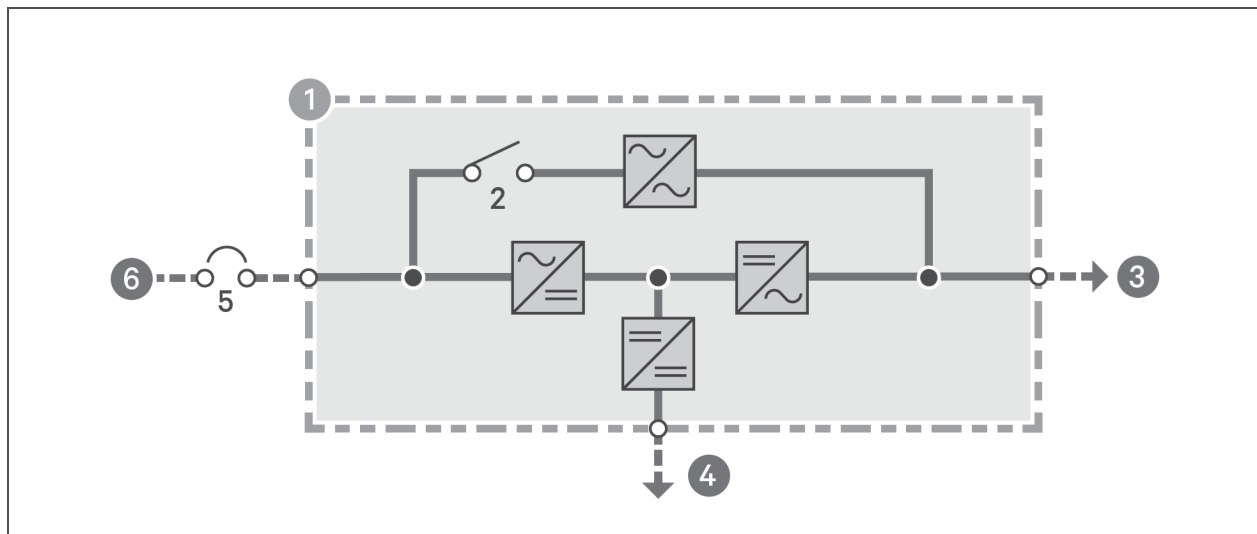

Item	Description
1	UPS cabinet
2	Back-feed disconnect
3	AC output
4	To DC supply
5	Breaker
6	Module AC input

Figure 1.2 Typical single-module UPS one-line diagram, dual input with static bypass and back-feed disconnect

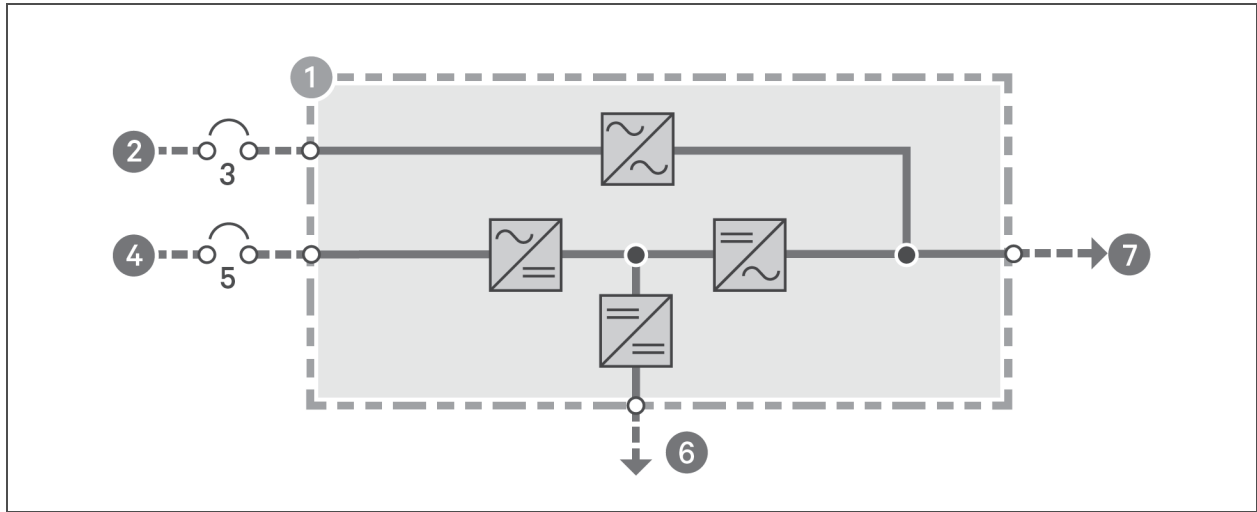

Item	Description
1	UPS cabinet
2	Bypass AC Input
3	RBB
4	Rectifier AC Input
5	RFB
6	To DC supply
7	AC output

Figure 1.3 Customer-connection locations in all models

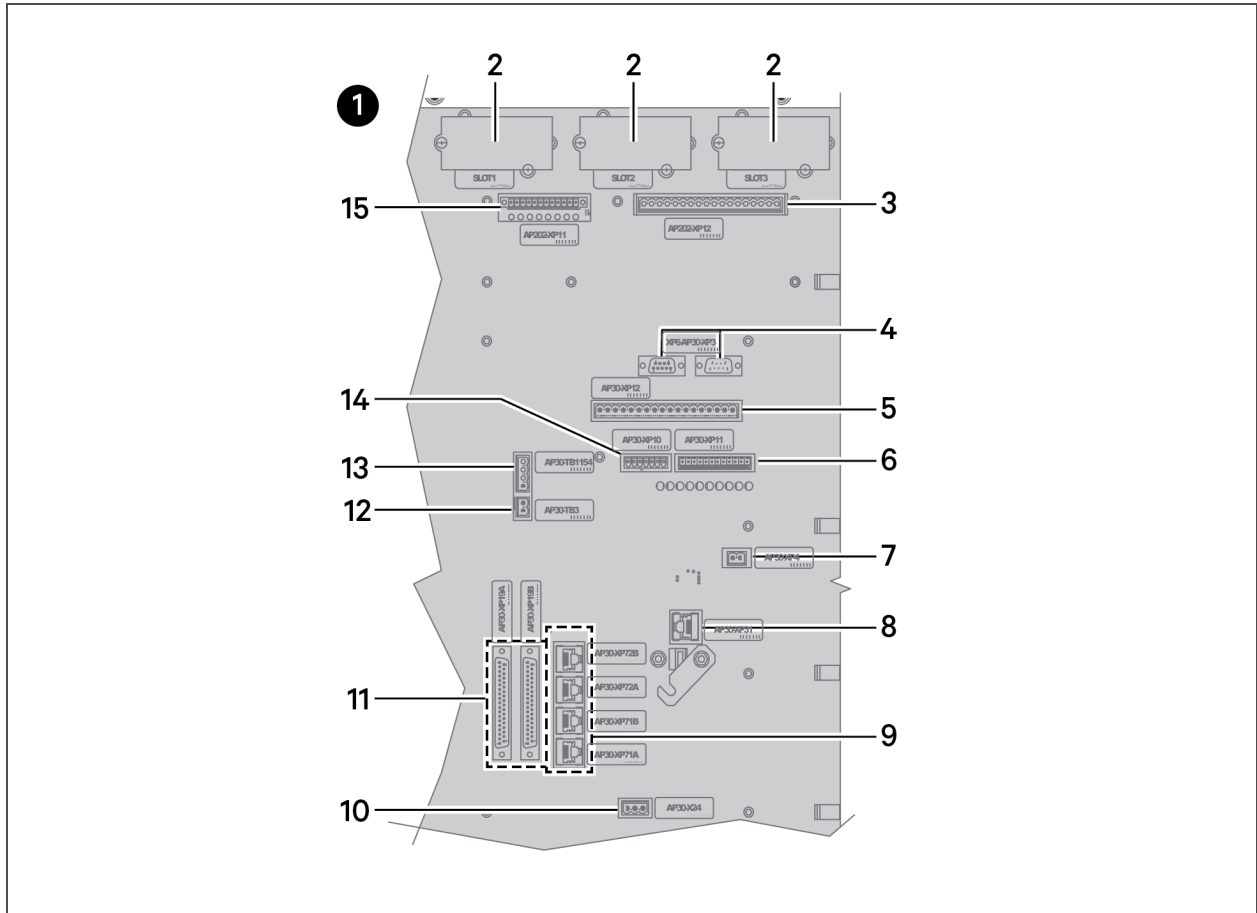

Table 1.1 Connection interfaces

Item	Description
1	Bottom
2	Slots 1, 2, 3 for Vertiv™ Liebert® IntelliSlot Communication Cards. NOTE: The center bay is serial interface for Vertiv LIFE™ Services.
3	AP202-XP12 - Selectable Output Dry Contacts, 6 Form C Contacts
4	XP6-AP30-XP3 - DP-9 connectors; Serial Interface For Service
5	AP30-XP12 - Selectable Output Dry Contacts, 6 Form C Contacts
6	AP30-XP11 - Selectable Input Dry Contacts; 8 Form A/B or 4 Form C Contacts)
7	Not Used. AP30-XP4
8	AP30-XP31 - Load Bus Sync port,
9	AP30-XP71A, 71B; AP30-XP72A, 72B - Parallel UPS Communication Connections
10	AP30-XP24 - Back-Feed CB Output Dry Contacts

Table 1.1 Connection interfaces (continued)

Item	Description
11	Not Used. AP30-XP19A/19B
12	AP30-TB3 - 24VDC Option Power
13	AP30-TB1154 - BIB Interface
14	AP202-XP11 - Selectable Input Dry Contacts; 8 Form A/B or 4 Form C Contacts
15	AP30-XP10 - REPO Status

1.2 Modes of Operation

1.2.1 Normal Mode

Operating in Normal Mode, the rectifier derives power from a utility AC source and supplies regulated DC power to the inverter, which regenerates precise AC power to supply the connected equipment. The rectifier also uses the utility source power to charge the DC sources.

1.2.2 Bypass Mode

In Bypass Mode, the load is directly supported by utility power and is without DC source backup protection.

The inverter and bypass static switch will shift the load from the inverter to bypass mode without an interruption in AC power if the inverter is synchronous with the bypass and any of the following occurs:

- Inverter fails
- Inverter overload capacity is exceeded
- Inverter is manually turned Off

NOTE: If the inverter is asynchronous with the bypass, the static switch will transfer the load from the inverter to the bypass WITH interruption in AC power to the critical load. This interruption is 16 ms.

1.2.3 Battery Mode

When utility AC power fails, the Liebert® EXL S1 instantaneously channels DC source power to the inverter, which continues supporting the critical load without interruption.

When utility power returns and is within acceptable limits, the UPS automatically shifts back to Normal Mode, with the rectifier powering the critical load.

1.2.4 ECO Mode

ECO Mode powers the critical load from the bypass source when that source is within acceptable operating limits. If the bypass source voltage or frequency goes outside the acceptable operation band, the critical load is automatically transferred to the UPS inverter without interruption. The load can be transferred from the bypass source to the inverter in a make-before-break operation. ECO Mode may be activated or deactivated through the OPERATE menu screen of the Touchscreen Control Panel. Energy saving must be enabled through the SETUP Context Menu.

1.2.5 Intelligent Paralleling

Intelligent Paralleling increases overall efficiency of multi-module systems by automatically placing individual modules in Standby Mode so that only the modules required to provide the output power required by the connected load are operating. The system adjusts the number of modules in Standby Mode according to load conditions so that the system operates at maximum efficiency. Modules will switch between Standby Mode and Normal Mode automatically so that each module operates an equal amount of time, prolonging service life for each module. Intelligent Paralleling may be activated or deactivated through the OPERATE menu screen of the Touchscreen Control Panel. Energy saving must be enabled through the SETUP Context Menu.

1.2.6 Dynamic Online Mode

Dynamic Online is a high efficiency mode of operation to allow an increase in efficiency without compromising reliability. Dynamic Online mode offers up to 99% efficiency without decreasing reliability. While operating in Dynamic Online the UPS is able to maintain the output voltage within the IEC 62040-3 Class 1 specification in all operating conditions. When the quality of the supply network is within tolerances, the UPS activates Dynamic Online mode. In this mode, the energy is supplied by the network to the load through the static bypass switch, and the UPS inverter will function as an active filter, providing the reactive power necessary to compensate load THDi and load Power Factor. In case of network parameters outside tolerances, the UPS will instantly activate double-conversion mode (VFI) with a Class 1 transfer. Dynamic Online Mode (if available) may be activated or deactivated through the OPERATE menu screen of the Touchscreen Control Panel. Energy saving must be enabled through the SETUP Context Menu.

1.2.7 Maintenance Bypass

Vertiv™ recommends installing a Maintenance Bypass Cabinet or Assembly to allow isolating the UPS from all power sources while continuing to supply power to the critical load. Maintenance Bypass use is described in [Operation](#) on page 13.

1.3 Options

NOTE: Although solenoid key release units (SKRU) are not required, Vertiv recommend that all UPS installations incorporate a solenoid key release unit as part of the maintenance bypass cabinet or switch board. Improper load transfers between the UPS Inverter and Maintenance Bypass may result in equipment damage and loss of load.

A number of options are available from Vertiv for the Liebert® EXL S1 (some options are not available for all ratings). Below are the most frequently provided options. Others are available. Contact your Vertiv representative for more information.

- **DC (Battery) Ground Fault**—Enables the detection and annunciation of battery DC ground faults to facilitate proactive resolution of such ground faults for 2014 NEC compliance. The UPS can be configured to allow the circuit breaker to Open or remain Closed upon detection of a ground fault.
- **Liebert IntelliSlot Cards (3 Ports)**—Provides Web, embedded Vertiv LIFE™ Technology, Vertiv Protocol, SNMP, BACnet IP/MSTP, Modbus TCP/RTU, SMTP, SMS, and telnet communication and control capabilities in one unified communication platform.
- **Load Bus Synchronization (LBS)**—Allows synchronizing the outputs of two or more modules when the source for one of more modules is supplied by a separate, non-synchronized source.
- **Local EPO Button**—A local EPO button with protective cover is available. This option is typically installed at the factory but may be field-installed by a Vertiv technician.
- **Maintenance Bypass**—This switchboard provides make-before-break maintenance bypass. It includes: Maintenance Bypass Breaker (MBB) and Maintenance Isolation Breaker (MIB). The Maintenance Bypass is a buyout item and not available from Vertiv.
- **Remote Alarm Status Panel**—Provides alarm lamps for up to eight UPS alarms. Power provided via AP30-TB3.
- **Seismic Bracing**—A separate kit for tying down the UPS module allows the unit to meet provisions of the International Building Code (IBC).

- **Temperature Sensor**—Allows the UPS module to compensate battery charging voltage, depending on temperature, to prolong battery life. The Temperature Sensor is required for battery solutions utilizing a non-matching Module Battery Disconnect or Battery Isolation Switch. Liebert® battery packs have built-in temperature sensors. The Temperature Sensor option includes a remote sensor that must be field-installed.
- **Battery and Racks**—The batteries provide power in the event of utility power loss. The Liebert EXL S1 can use a variety of battery types, provided the battery plant is designed for the UPS DC voltage range and the load requirements of the application.
- **Battery Cabinets**—Available battery types are flooded-cell; valve-regulated, lead-acid; and lithium-ion. The battery cabinets are designed to be either attached to the UPS or separate from the UPS.
- **Battery Interface Box**—A Battery Interface Box (BIB) is available to support the UPS and third-party battery cabinets or rack-mounted batteries. A BIB is required for each MBD (stand-alone or inside the third-party battery cabinet). A BIB is optional with each Battery Isolation Switch. A BIB is required for each temperature sensor.
- **Flywheel Energy Storage System**—An optional Vycon Flywheel Energy Storage System is available, consisting of the number of Vycon flywheel units in separate cabinets necessary to provide the specified operating time. Each flywheel unit has an internal circuit breaker for isolating the flywheel from the UPS and a control interface to the UPS module. Installer provides interconnect cabling.
- **Battery Isolation Switch**—A Battery Isolation Switch (BIS) is used to isolate individual battery strings when a system MBD is used. When the optional Battery Interface Box is used, the status of the Battery Isolation Switch is displayed on the UPS HMI. A temperature sensor is recommended to allow proper battery charging and overtemperature protection.
- **Module Battery Disconnect**—The UPS system utilizes a separate Module Battery Disconnect (MBD) for remotely located batteries. A sensing circuit in the UPS module, set at the battery low voltage limit, trips the Module Battery Disconnect to safeguard the battery from excessive discharge. The Module Battery Disconnect has an undervoltage release mechanism designed to ensure that during any shutdown or failure mode all battery potential is removed from the UPS system.
- **Alber™ Monitoring System**—The matching Liebert® Battery Cabinet allows installing an optional Alber battery monitoring system in the cabinet. The Alber battery monitoring continuously checks all critical battery parameters, such as cell voltage, overall string voltage, current and temperature.

1.3.1 Setpoints (User Adjustable)

The following will change the settings of the modules:

- Screen Saver - Enable/Disable
- Display Options
 - Customize Layout
 - Display Properties (Language, Theme, Back-Light Off Timer, Alarm Window Timeout, Auto-Logout Timer, Display Brightness, Status Indicator Brightness, Calibrate Touchscreen)
 - Date & Time (Time Zone, Date, Local Time)
 - Format (Date, Time, Measurement System)
 - Custom Labels (Settings, Network Interfaces)
- Audible Alarm - Silence, Enable, Disable
- Automatic Battery Test - Enable/Disable, Test Duration (hh:mm:ss), Test Cycle (1-45 days), Test Inhibit Time (1 - 1092 hr), Minimum Cell Voltage (1.65 - 2.9 V/cell)
- Manual Battery Test - Start, Duration, Minimum Cell Voltage (1.65 - 2.9 V/cell)
- Battery Equalize - Start, Charge Duration (1 - 72hr), Charge Voltage (2.3 - 2.9V/cell)
- Manage Permissions - Operator and Admin PIN
- Dial Control Setup - Center, Upper and Lower Meter
- UPS Setting - Enable/Disable ECO Mode, Enable/Disable Audible Alarm, Enable/Disable Intelligent Parallel Mode, Enable/Disable Dynamic Online Mode

This page intentionally left blank

2 OPERATION

2.1 Touchscreen Navigation

Several menu items can be accessed from the main display screen (refer to the Touchscreen Control Panel user manual, SL-26094, available at www.Vertiv.com).

2.2 Manual Operations—All Systems

The Liebert® EXL S1 functions unattended by an operator. The system control logic automatically handles many important functions. Other procedures must be performed manually.

Manual procedures available to the operator include startup, load transfers and shutdowns. These are performed with the touchscreen and some manually operated circuit breakers and switches.

This section lists typical step-by-step instructions.

NOTE: The following step-by-step instructions apply to DSP firmware version V1.40 and higher. For all other firmware versions, use the instructions detailed in the Operation and Maintenance Guide, SL-26090 that applies to your UPS. Contact the factory to obtain the relevant document. Firmware versions for each UPS module can be identified via the Touchscreen Control Panel.

- **Startup**—Including initial startup, recovering from input power failure, recovering from DC source shutdown and recovering from shutdowns for emergencies or maintenance.
- **Load Transfers**—Including transfers from UPS to bypass and retransfers from bypass to the UPS system.
- **Maintenance Bypass Load Transfers**—Including transfers from internal bypass to maintenance bypass and transfers from maintenance bypass to internal bypass.
- **Shutdowns**—Including module shutdowns for maintenance and emergency shutdowns.

Figure 21 on the next page to **Figure 24** on page 17, illustrate several of the possible maintenance bypass configurations for Liebert EXL S1 systems.

Figure 2.1 Maintenance bypass configurations—Two breakers and back-feed disconnect

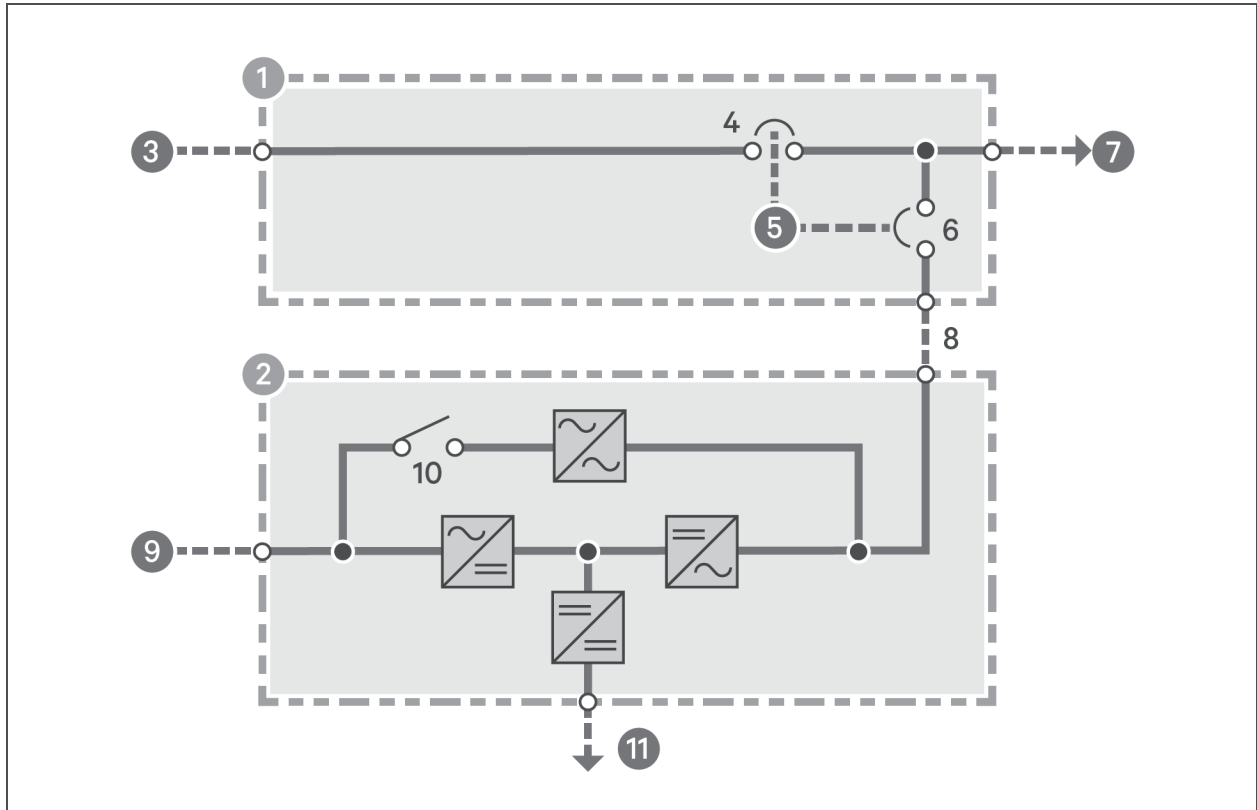

Item	Description
1	Maintenance-bypass panelboard/switchboard
2	UPS cabinet
3	Bypass AC input
4	MBB
5	Optional interlock
6	MIB
7	AC output
8	Module AC output
9	Module AC input
10	BFD
11	To DC supply

Figure 2.2 Maintenance bypass configurations—Three breakers and back-feed disconnect for single-input UPS

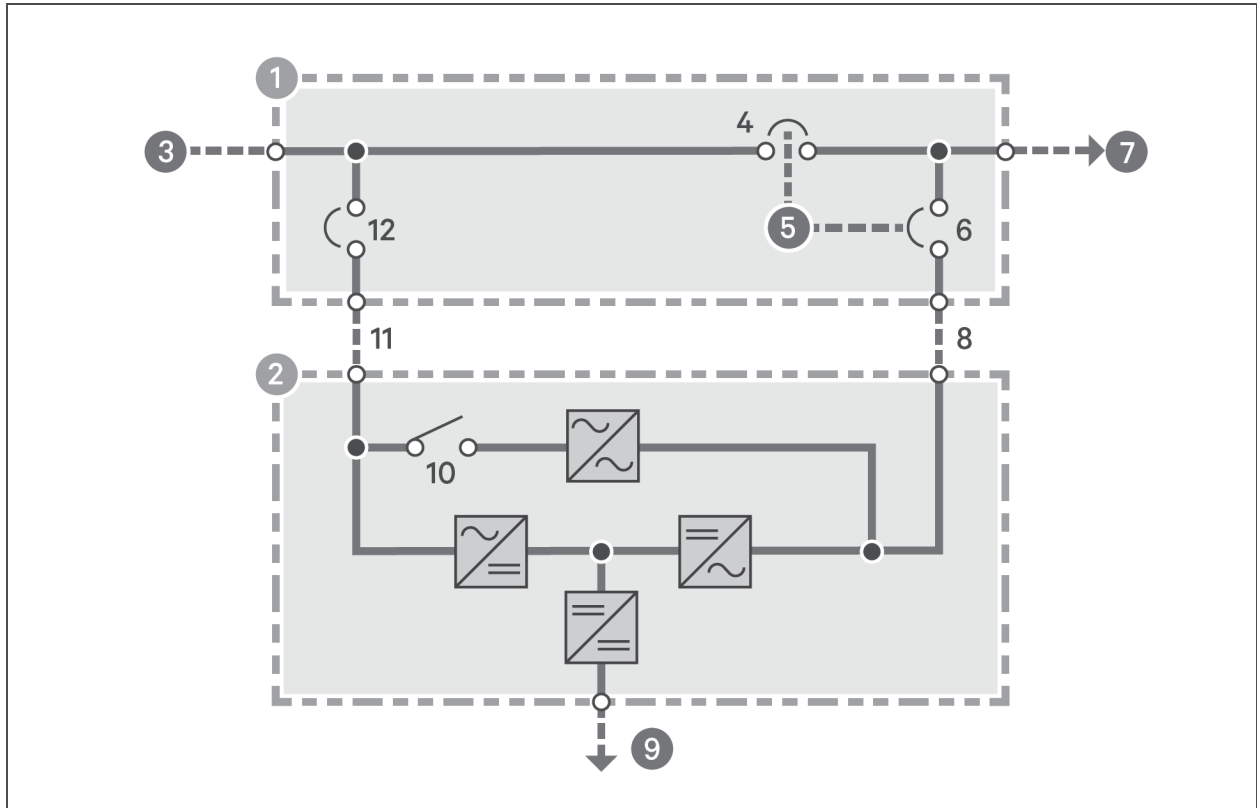

Item	Description
1	Maintenance-bypass panelboard/switchboard
2	UPS cabinet
3	Bypass AC input
4	MBB
5	Optional interlock
6	MIB
7	AC output
8	Module AC output
9	To DC supply
10	BFD
11	Module AC output

Figure 2.3 Maintenance bypass configurations—Three breakers for dual-input UPS

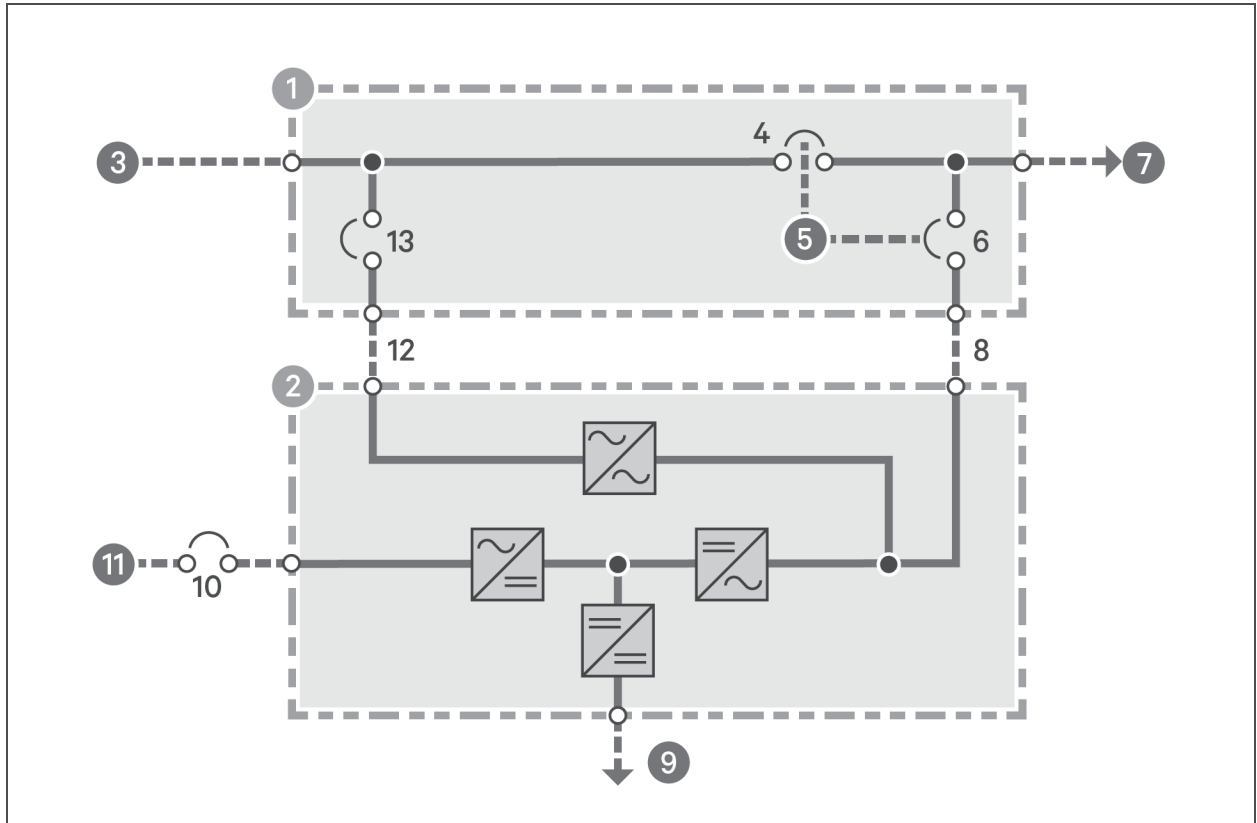

Item	Description
1	Maintenance-bypass panelboard/switchboard
2	UPS cabinet
3	Bypass AC input
4	MBB
5	Optional interlock
6	MIB
7	AC output
8	Module AC output
9	To DC supply
10	RFB
11	Module rectifier AC input
12	Module AC input
13	RBB

Figure 2.4 Maintenance bypass configurations—Four breakers for dual-input UPS

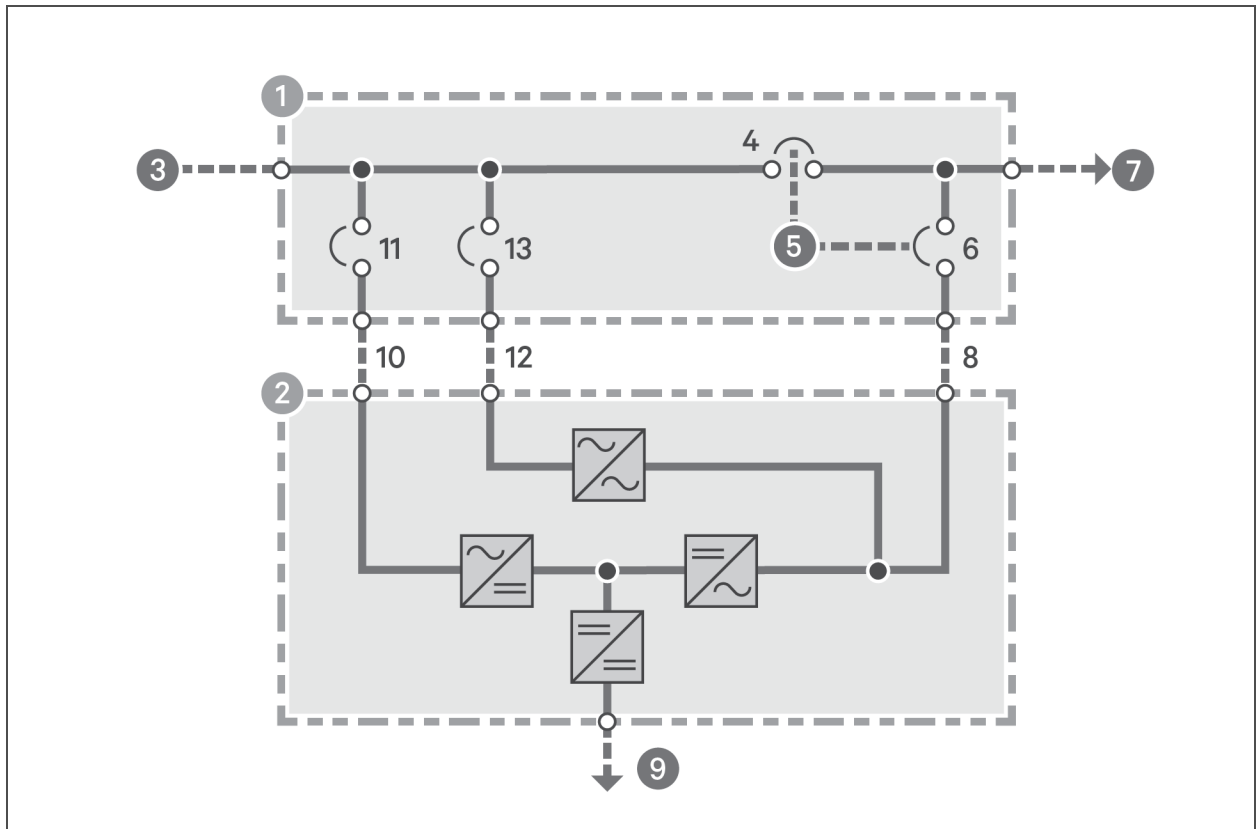

Item	Description
1	Maintenance-bypass panelboard/switchboard
2	UPS cabinet
3	Bypass AC input
4	MBB
5	Optional interlock
6	MIB
7	AC output
8	Module AC output
9	To DC supply
10	Module Rectifier AC input
11	RFB
12	Module Bypass AC input
13	RBB

2.2.1 Startup—Single Module System

NOTE: The following procedure assumes that the UPS installation inspection and initial startup have been performed by Vertiv™-authorized technician. A Vertiv-authorized representative must perform the initial system startup to ensure proper system operation.

This section lists step-by-step instructions for UPS's with maintenance bypass configurations as shown in this manual. If the system has a different maintenance bypass operation, consult the provider of that system for operating procedures.



WARNING! Risk of electric shock. Can cause equipment damage, personal injury and death. The following procedure provides power to the critical load distribution system. Verify that the critical load distribution is ready to accept power. Make sure that personnel and equipment are ready for the critical load distribution system to be energized.



AVERTISSEMENT : Risque de décharge électrique pouvant entraîner des dommages matériels, des blessures et même la mort. La procédure suivante fournit de l'énergie au système de distribution de la charge critique. Vérifiez que ce système est prêt à être alimenté. Assurez-vous que le personnel et les équipements sont préparés pour la mise sous tension du système de distribution de la charge critique.

NOTE: The following step-by-step instructions apply to DSP firmware version V1.40 and higher. For all other firmware versions, use the instructions detailed in the Operation and Maintenance Guide, SL-26090 that applies to your UPS. Contact the factory to obtain the relevant document. Firmware versions for each UPS module can be identified via the Touchscreen Control Panel.

Starting the Unit Without Power Supplied to the Connected Load

If the installation includes a Maintenance Bypass, power may already be supplied to the critical load equipment through the Maintenance Bypass. If there is no power to the critical load, apply power through the UPS bypass line per the following procedure.

During startup, power is supplied to the load through the UPS (internal) bypass line while the UPS system is being energized. Depending on the reason for the UPS shutdown, power may be present in the bypass line. To determine this, check the Touchscreen Control Panel after control power is available.

NOTE: If the system was shut down because of an Emergency Off, there may be alarm messages on the touchscreen that describe system conditions before (or at the time of) the shutdown. Some or all of the alarm conditions may have been resolved. Contact Vertiv technical support for assistance in clearing any remaining alarm messages. If the system is a multi-module system, verify that the UPS is in Maintenance Bypass Mode, then open the Module Output Breakers (in the distribution switchboard) because the output bus provides an additional source of control power. Wait at least 10 minutes for the control power circuitry to completely de-energize. After 10 minutes, turn control power back On.



WARNING! Risk of electric shock and high short circuit current. Can cause equipment damage, injury and death. If the UPS has been shut down for maintenance, verify that all of the UPS system doors are closed and latched. All test equipment must be removed from the system. All electrical connections must be secure.



AVERTISSEMENT : Risque de décharge électrique et de présence de courant de court-circuit élevé pouvant entraîner des dommages matériels, des blessures et même la mort. Si l'alimentation sans coupure a été interrompue à des fins d'entretien, assurez-vous que toutes les portes du système ASC sont fermées et verrouillées. Tous les appareils de test doivent être retirés du système. Tous les branchements électriques doivent être serrés.

This section lists typical step-by-step instructions.

1. Before applying power to the UPS module, determine the location and position of the following circuit breakers and switches. External/remote breakers will be located in the appropriate switchgear.
 - **Input Circuit Breaker** - Verify that this breaker is in the Open position.
 - External Remote Back-feed Breaker (RBB) for single input/feed applications
 - External Rectifier Feed Breaker (RFB) for dual input/feed applications
 - **Module Battery Disconnect (MBD)** - Verify that this external breaker is Open or tripped. If DC source cabinets are used, verify that breakers on all the cabinets are Open.
 - **Bypass Circuit Breaker** - Verify that this breaker is in the Open position.
 - External Remote Back-feed Breaker (RBB) for single input/feed applications
 - (Optional) Internal Back-Feed Disconnect (BFD)
 - **Maintenance Isolation Breaker (MIB)** - Verify that this breaker, if installed, is in the Open position.
2. Close the external rectifier feeder breaker.
 - External Remote Back-feed Breaker (RBB) for single input/feed applications
 - External Rectifier Feed Breaker (RFB) for dual input/feed applications

NOTE: The rectifier will start at this time. Do not proceed until the Touchscreen Control Panel is fully operational.

3. Verify that the rectifier has started. The rectifier icon on the Touchscreen Control Panel should be green. If not, the issue must be corrected before proceeding.
4. Close the external Remote Back-Feed Breaker (RBB), if installed.
5. If installed, close the optional internal Back-Feed Disconnect (BFD). The Bypass Static Switch (BPSS) will activate.
6. Verify that the Bypass Static Switch (BPSS) has started. The BPSS icon on the Touchscreen Control Panel should be green. If it is not, the issue must be corrected before proceeding.
7. Close the external Module Battery Disconnect(s) (MBD).
8. Verify that the MBD contact icon on the Touchscreen Control Panel is Closed and that the battery icon is green. If it is not, the issue must be corrected before proceeding.
9. Close the external MIB, if used. The load should be on the UPS bypass.
10. From the Touchscreen Control Panel, touch *OPERATE* > *UNIT OPERATIONS* > *Inverter On* > *Single*.
11. Verify that the UPS inverter is connected to the collective bus.

NOTICE

Risk of equipment damage. If an abnormal situation occurs during startup, open the circuit breakers and investigate the problem. Call Vertiv™ Technical Support if help is required.



WARNING! Risk of electric shock, explosive reaction, hazardous chemicals and fire. Can cause equipment damage, personal injury and death. Do not use equalize charging with valve-regulated, lead-acid batteries. Refer to the battery manufacturer's manual, available on the manufacturer's Web site, for specific information about equalize charging.



AVERTISSEMENT : Risque de décharge électrique, de réaction explosive, d'incendie et d'exposition à des produits chimiques dangereux pouvant entraîner des dommages matériels, des blessures et même la mort. N'utilisez pas de charge d'égalisation avec les batteries au plomb-acide à régulation par soupape. Reportez-vous au manuel du fabricant des batteries, disponible sur le site Web du fabricant, pour obtenir des renseignements précis sur la charge d'égalisation.

2.2.2 Load Transfer and Re-Transfer—Single-Module System

Changing the load from the UPS system to the UPS bypass is called a *transfer*. Changing the load from UPS bypass to the UPS system is called a *re-transfer*. Note that the UPS system control logic can initiate automatic load transfers and re-transfers.

Transfer Procedure

1. From the Touchscreen Control Panel, touch *OPERATE > UNIT OPERATIONS > Inverter Off > Single*.
2. Verify that the critical load transfers from the UPS inverter to the UPS bypass.

Re-Transfer Procedure

1. From the Touchscreen Control Panel, touch *OPERATE > UNIT OPERATIONS > Inverter On > Single*.
2. Verify that the critical load transfers from the UPS bypass to the UPS inverter.

2.2.3 Maintenance Bypass Load Transfers—Single Module System

Follow these instructions to manually transfer the load between the Maintenance Bypass and the UPS bypass line. Do not transfer the load between the Maintenance Bypass and the UPS module (Inverter) output. Use the Touchscreen Control Panel to verify that the UPS bypass line is available.

NOTICE

Risk of equipment damage. Failing to follow the proper sequence when operating any circuit breaker may cause damage to the connected equipment. Operating a Maintenance Bypass circuit breaker out of sequence could cut off power to the critical load.

NOTICE

Risk of equipment damage. The UPS must be on internal bypass before performing the following procedures and operating the MIB or the MBB, or damage to the UPS may occur and the critical load may be lost.

Maintenance Bypass Load Transfers—Single Module System: If Load is on UPS Bypass

After the UPS been transferred to bypass (see [Load Transfer and Re-Transfer—Single-Module System](#) on page 20), the OK to transfer lamp on the key-release unit will light.

NOTE: If the maintenance bypass cabinet or switchboard has any other type of custom interlock, follow the specific instructions for that interlock system to remove the key.

1. If using a key interlock system, depress the key-release unit push button, turn the key and remove it from key-release unit.

NOTE: The UPS is now locked in bypass and cannot be re-transferred to the inverter until the key is reinserted.

2. If using a key interlock system, insert the key into the lock for the Maintenance Bypass Breaker (MBB); retract the bolt.
3. Close the Maintenance Bypass Breaker (MBB).

NOTICE

Risk of improper operation sequence. May cause equipment damage.

Failure to close the Maintenance Bypass Breaker (MBB) will interrupt power to the load.

4. Open the Maintenance Isolation Breaker (MIB). The UPS is now isolated from the critical load and the load is now on Maintenance Bypass.
5. If using a key interlock system, remove the key from the lock for the Maintenance Isolation Breaker (MIB).
6. If the maintenance bypass cabinet or switchboard has an optional two-key interlock system, replace the key into the solenoid.
7. If UPS bypass shutdown is required, following instructions in [UPS Shutdown—Single-Module System](#) on page 22.

Maintenance Bypass Load Transfers—Single Module System: If Load is on Maintenance Bypass

1. Verify that power is available to the module's bypass and rectifier inputs.
2. Verify that the UPS is started and in Bypass Mode.
3. If using a key interlock system:
 - a. Depress the key-release unit push button.
 - b. Turn the key and remove it from the key-release unit.

NOTE: The UPS is now locked in bypass and cannot be re-transferred to the Inverter until the key is returned.

4. If using a key interlock system:
 - a. Insert the key into the lock for the Maintenance Isolation Breaker (MIB)
 - b. Retract the bolt.
5. Close the Maintenance Isolation Breaker (MIB).

NOTICE

Risk of improper operation sequence. May cause equipment damage.

Failure to close the Maintenance Isolation Breaker (MIB) will interrupt power to the load.

6. Open the Maintenance Bypass Breaker (MBB). Load is now on UPS Internal Bypass.
7. If using a key interlock system, remove the key from the lock for the Maintenance Bypass Breaker (MBB) to lock it open.
8. If the maintenance bypass cabinet or switchboard has an optional two-key interlock system, insert the key into the solenoid.

The UPS system may now be transferred from bypass to UPS (see [Load Transfer and Re-Transfer—Single-Module System](#) on page 20).

2.2.4 UPS Shutdown—Single-Module System

Follow these instruction to completely shut down and de-energize the UPS module.

NOTE: This shutdown turns Off the inverter, rectifier and bypass static switch. This will shut down the UPS completely.

1. From the Touchscreen Control Panel, touch *OPERATE > UNIT OPERATIONS > Inverter Off > Single*.
2. Verify that the critical load transfers from the UPS inverter to UPS bypass.
3. Open the external Module Battery Disconnect(s) (MBD).
4. Open the external MIB, if used.

NOTE: This will remove the UPS output completely.

5. Open the external Remote Back-feed Breaker (RBB) and optional internal Back-Feed Disconnect (BFD) if installed. The Bypass Static Switch (BPSS) will turn Off.
6. Open the external rectifier feeder breaker.
 - External Remote Back-Feed Breaker (RBB) for single input/feed applications
 - External Rectifier Feed Breaker (RFB) for dual input/feed applications
7. Once shutdown is complete, the Touchscreen Control Panel will turn Off.

2.3 Manual Operations—1+N Systems

2.3.1 Startup—1+N Module System



WARNING! Risk of electrical shock. Can cause equipment damage, personal injury and death. The following procedure provides power to the critical load distribution system. Verify that the critical load distribution is ready to accept power. Make sure that personnel and equipment are ready for the critical load distribution system to be energized.



AVERTISSEMENT : Risque de décharge électrique pouvant entraîner des dommages matériels, des blessures et même la mort. La procédure suivante fournit de l'énergie au système de distribution de la charge critique. Vérifiez que ce système est prêt à être alimenté. Assurez-vous que le personnel et les équipements sont préparés pour la mise sous tension du système de distribution de la charge critique.

If the installation includes a Maintenance Bypass, power may already be supplied to the critical load equipment through the Maintenance Bypass. If there is no power to the critical load, apply power through the UPS bypass line per the following procedure.

During startup, power is supplied to the critical load through the UPS (internal) bypass line while the UPS system is being energized. Depending on the reason for the UPS system shutdown, power may be present in the bypass line. To determine this, check the Touchscreen Control Panel screen after control power is available.

NOTE: If the system was shut down in response to an Emergency Off, there may be alarm messages on the touchscreen that describe system conditions before (or at the time of) the shutdown. Some or all of the alarm conditions may have been resolved. Contact Vertiv™ Technical Support for assistance in clearing any remaining alarm messages.



WARNING! Risk of electrical shock and high short circuit current. Can cause equipment damage, personal injury and death. If the UPS has been shut down for maintenance, verify that all of the UPS doors are closed and latched. All test equipment must be removed from the system. All electrical connections must be secure.



ADVERTISSEMENT : Risque de décharge électrique et de présence de courant de court-circuit élevé pouvant entraîner des dommages matériels, des blessures et même la mort. Si l'alimentation sans coupure a été interrompue à des fins d'entretien, assurez-vous que toutes les portes du système ASC sont fermées et verrouillées. Tous les appareils de test doivent être retirés du système. Tous les branchements électriques doivent être serrés.



WARNING! The following procedure must be performed exactly as described. Deviating from the procedure can result in electric shock hazard to personnel and the risk of fire.



ADVERTISSEMENT : La procédure suivante doit être suivie à la lettre. Dévier de cette procédure peut entraîner des risques d'électrocution à la personne ainsi que des risques d'incendie.

This section lists typical step-by-step instructions to start a 1+N Module System with and without remote breakers. The Touchscreen Control Panel will list all steps required for the process, based on the unit's operational status and other factors.

- **Startup**—Including initial startup, recovering from input power failure, recovering from DC source shutdown and recovering from shutdowns for emergencies or maintenance.
- **Load Transfers**—Including transfers from UPS to bypass and re-transfers from bypass to the UPS system.
- **Maintenance Bypass Load Transfers**—Including transfers from internal bypass to maintenance bypass and transfers from maintenance bypass to internal bypass.
- **Shutdowns**—Including module shutdown for maintenance and emergency shutdown.

NOTE: The following step-by-step instructions apply to DSP firmware version V1.40 and higher. For all other firmware versions, use the instructions detailed in the Operation and Maintenance Guide, SL-26090 that applies to your UPS. Contact the factory to obtain the relevant document. Firmware versions for each UPS module can be identified via the Touchscreen Control Panel.

NOTE: The following procedure assumes that the UPS installation inspection and initial startup have been performed by Vertiv™-authorized technician. A Vertiv-authorized representative must perform the initial system startup to ensure proper system operation.

1. Verify that all parallel cables are properly connected to the UPS modules of the system.
2. Before applying power to the UPS modules, determine the location and position of the following circuit breakers and switches. External/Remote breakers will be located in the appropriate switch gear.
 - Input Circuit Breaker—Verify that these breakers are in the open position.
 - External Remote Back-feed Breaker (RBB) for single input/feed applications
 - External Rectifier Feed Breaker (RFB) for dual input/feed applications
 - Module Battery Disconnect (MBD)—Verify that this external breaker is open or tripped. If DC source cabinets are used, verify that breakers on all the cabinets are open.
 - Bypass Circuit Breaker—Verify that these breakers are in the open position.
 - External Remote Back-Feed Breaker (RBB) for single input/feed applications
 - (Optional) Internal Back-Feed Disconnect (BFD)
 - Maintenance Isolation Breaker (MIB)—Verify that this breaker is in the open position, if installed.
 - Module Output Breakers (MOB)—Verify that these breakers are in the open position.
3. Close the external rectifier feeder breaker for each UPS module in the system that will be added to the collective bus.

NOTE: Any UPS module that will not be added to the collective bus must remain de-energized or be in Test Operation Mode (see [Test Operation Mode](#) on page 30).

- External Remote Back-Feed Breaker (RBB) for single input/feed applications
- External Rectifier Feed Breaker (RFB) for dual input/feed applications

NOTE: The rectifier on each UPS will start at this time. Do not proceed until the Touchscreen Control Panel is fully operational on each UPS.

4. Verify that the rectifier has started on each UPS that will be added to the collective bus. The rectifier icon on the Touchscreen Control Panel should be green. If it is not, the issue must be corrected before proceeding.
5. Close the external Remote Back-Feed Breaker (RBB) and optional internal Back-Feed Disconnect (BFD) on each UPS that will be added to the collective bus, if installed.
6. Verify that the Bypass Static Switch (BPSS) has started on each UPS that will be added to the collective bus. The BPSS icon on the Touchscreen Control Panel should be green. The UPS module output should be on Bypass. If it is not, the issue must be corrected before proceeding.
7. Close the external Module Battery Disconnect(s) (MBD) for each UPS that will be added to the collective bus.
8. Verify that the MBD contact icon on the Touchscreen Control Panel is closed and that the Battery icon is green on each UPS that will be added to the collective bus. If it is not, the issue must be corrected before proceeding.
9. Close the external Module Output Breaker (MOB) on each UPS.
10. Close the external MIB if used. If a maintenance bypass interlocking scheme is available, then proceed with the operation of the interlock until the MIB is closed and the MBB is opened.
11. The critical load should be on the UPS bypass.
12. From the Touchscreen Control Panel of one of the energized UPS modules, touch *OPERATE > UNIT OPERATIONS > Inverter On > System*.
13. Verify that each energized UPS module automatically transfers to Inverter. The critical load should be on the UPS Inverter.

2.3.2 Load Transfer-1+N System: Transfer System Inverter to Bypass

This section lists typical step-by-step instructions to transfer the UPS system from Inverter Mode to Bypass Mode.

The critical load should be on the UPS Inverter.

1. From the Touchscreen Control Panel of any UPS module in the system, touch *OPERATE > UNIT OPERATIONS > Inverter Off > System*.
2. Verify that each UPS automatically transferred to Bypass.

NOTE: The load will now be on static bypass in each UPS.

2.3.3 Load Transfer-1+N System: Transfer System from Bypass to Inverter

This section lists typical step-by-step instructions to transfer the UPS system from Bypass to Inverter mode of operation.

The critical load should be on the UPS Bypass.

1. From the Touchscreen Control Panel of any UPS module in the system, touch *OPERATE > UNIT OPERATIONS > Inverter On > System*.
2. Verify that each UPS automatically transferred to Inverter.

2.3.4 Load Transfer-1+N System: Remove a UPS from System (Collective)

NOTE: UPS modules must be de-energized with MOB open or be in Test Operation Mode once removed from the collective bus.

1. Verify that enough UPS modules will remain present to support the load if one module is removed from the collector bus.
2. From the Touchscreen Control Panel of the UPS module that will be removed from the collective, select *OPERATE > UNIT OPERATIONS > Inverter Off > Single*. Confirm the operation when prompted.
3. Open the Module Output Breaker (MOB) of the UPS module to be removed from the collective bus.
4. Verify that the Inverter for the module to be removed from the collective turns Off. The other UPS modules in the system should be supporting the load.
5. Open the Module Battery Disconnect(s) (MBD) of the module that was removed from service.
6. Open the optional internal Back-Feed Disconnect (BFD), if installed, of the module that was removed from service.
7. Open the upstream feed breakers (RBB, RFB) to the UPS rectifier and bypass buses. The UPS module rectifier will shut Off.

2.3.5 Load Transfer-1+N System: Add a UPS to the System (Collective)

Adds one UPS module to the collective bus with the critical load supplied by the UPS inverter.

NOTE: UPS modules must be de-energized with the MOB Open or be in Test Operation Mode once removed from the collective bus.

1. Verify that all parallel cables are properly connected to the UPS modules in the system.
2. Close the external rectifier feeder breaker on the UPS module to be added to the collective bus.
 - External Remote Back-Feed Breaker (RBB) for single-input/feed applications
 - External Rectifier Feed Breaker (RFB) for dual-input/feed applications

NOTE: The Rectifier will start the UPS module at this time. Do not proceed until the Touchscreen Control Panel on the UPS module is fully operational.

3. Verify that the Rectifier on the UPS module being added to the collective bus has started. The rectifier icon on the Touchscreen Control Panel should be green. If it is not, the issue must be corrected before proceeding.
4. Close the external Remote Back-Feed Breaker (RBB) and optional internal Back-Feed Disconnect (BFD) on the UPS module, if installed.

NOTE: The Bypass Static Switch (BPSS) of the UPS module being added to the collective will remain Off if the collective bus is on Inverter but will turn On if the collective bus is on BYPASS.

5. Close the external Module Battery Disconnect(s) (MBD) on the UPS module.
6. Close the external Module Output Breaker (MOB) on the UPS module.
7. From the Touchscreen Control Panel on the UPS module being added to the collective bus, select *OPERATE > UNIT OPERATIONS > Inverter On > Single*.
8. Verify that all UPS modules are connected to the collective bus.

2.3.6 Maintenance Bypass Load Transfers—1+N Module System

Follow these instructions to manually transfer the load between Maintenance Bypass and the UPS bypass line. Do not transfer the load between Maintenance Bypass and the UPS module inverter output. Use the Touchscreen Control Panel screen to verify that the UPS bypass line is available.

NOTICE

Risk of improper operating sequence. Can cause equipment damage.

Failing to follow the proper sequence when operating any circuit breaker may cause damage to the connected equipment.

Operating a Maintenance Bypass circuit breaker out of sequence could cut off power to the critical load.

NOTICE

Risk of improper load transfer. Can cause equipment damage.

The UPS must be on internal bypass before performing the following procedures and operating the MIB or the MBB, or damage to the UPS may occur and the critical load may be lost.

Maintenance Bypass Load Transfers-1+N Module System: If Load is on UPS Bypass

This section lists typical step-by-step instructions to transfer the UPS system from Bypass to Maintenance Bypass.

1. Transfer the UPS system to bypass (see [Load Transfer-1+N System: Transfer System Inverter to Bypass](#) on page 25). The OK to transfer lamp on the key-release unit will light.

NOTE: If the maintenance bypass cabinet or switchboard has any other type of custom interlock, follow the instructions for that interlock systems to remove the key.

2. If using a key interlock system:
 - a. Press the key-release unit push button.
 - b. Turn the key and remove it from key-release unit.

NOTE: The UPS is now locked in bypass and cannot be re-transferred to the inverter until the key is reinserted.

3. If using a key interlock system, insert the key into the lock for the Maintenance Bypass Breaker (MBB); retract the bolt.
4. Close the MBB.

NOTICE

Risk of improper operation sequence. May cause equipment damage.

Failure to close the MBB will interrupt power to the load.

5. Open the Maintenance Isolation Breaker (MIB). The UPS system is now isolated from the critical load and the load is now on Maintenance Bypass.
6. If using a key interlock system, remove the key from the lock for the MIB.
7. If the maintenance bypass cabinet or switchboard has an optional, two-key interlock system, insert the key into the solenoid.
8. If UPS bypass shutdown is required, follow the instruction in [Shutdown-1+N System Shutdown](#) on page 28 or [Load Transfer-1+N System: Remove a UPS from System \(Collective\)](#) on page 25

Maintenance Bypass Load Transfers—1+N Module System: If Load is on Maintenance Bypass

This section lists typical step-by-step instructions to transfer the UPS system from Maintenance Bypass to Bypass.

1. If the UPS modules are Off, start the system. Refer to [Startup—1+N Module System](#) on page 22.
2. Place all the UPS units in the system in Bypass Mode. Refer to [Load Transfer-1+N System: Transfer System Inverter to Bypass](#) on page 25.
3. If using a key interlock system:
 - a. Press the key-release unit push button.
 - b. Turn the key and remove it from the key-release unit.

NOTE: The UPS is now locked in bypass and cannot be re-transferred to the inverter until the key is reinserted.

4. If using a key interlock system, insert the key into the lock for the Maintenance Isolation Breaker (MIB); retract the bolt.
5. Close the MIB.

NOTICE

Risk of improper operation sequence. May cause equipment damage.

Failure to close the MIB will interrupt power to the load.

6. Open the Maintenance Bypass Breaker (MBB). The load is now on UPS internal bypass.
7. If using a key interlock system, remove the key from the lock for the MBB to lock it open.
8. If the maintenance bypass cabinet or switchboard has an optional two-key interlock system, insert the key into the solenoid.

The UPS system can now be transferred from bypass to UPS (see [Load Transfer-1+N System: Transfer System from Bypass to Inverter](#) on page 25).

2.3.7 Shutdown-1+N System Shutdown

Perform a system shutdown procedure to remove power from the entire UPS system.

NOTE: Service and maintenance must be performed only by properly trained and qualified personnel and in accordance with applicable regulations as well as with manufacturer's specifications.

1. If the UPS system is operating in Inverter Mode, transfer the UPS system to bypass (see [Load Transfer-1+N System: Transfer System Inverter to Bypass](#) on page 25). The OK to Transfer lamp on the key-release unit will light.

2. If an external, wraparound bypass is installed, perform the following steps; otherwise skip to step 3.
If using a key interlock system:
 - a. Press the key-release unit push button.
 - b. Turn the key and remove it from the key-release unit.

NOTE: The UPS system is now locked in bypass and cannot be transferred until the key is returned.

- c. If using a key interlock system, insert the key into the lock for the MBB; retract the bolt.
- d. Close the MBB.

NOTE: Failure to close the Maintenance Bypass Breaker (MBB) will interrupt power to the load.

- e. Open the MIB. The UPS system is now isolated from the critical load, and the load is now on Maintenance Bypass.
 - f. If using a key interlock system, remove the key from the lock for the MIB.
 - g. If the maintenance bypass cabinet or switchboard has an optional, two-key interlock system, insert the key into the solenoid.
3. Open the external Module Output Breaker (MOB) on each UPS.
 4. Open the external Module Battery Disconnect(s) (MBD) for each UPS module.
 5. Open the external Remote Back-Feed Breaker (RBB) and optional internal Back-Feed Disconnect (BFD) on each UPS, if installed.
 6. Open the external Rectifier Feeder Breaker for each UPS in the system.
 - External Remote Back-Feed Breaker (RBB) for single-input/feed applications
 - External Rectifier Feed Breaker (RFB) for dual-input/feed applications

NOTE: The Rectifier will shut down on each UPS at this time. Once shutdown is complete, the Touchscreen Control Panel will turn Off.

2.4 Energy Saving Mode Activation and Deactivation

Available energy saving modes are Intelligent Parallel, ECO Mode and Dynamic Online.

1. Touch the SETUP Function Menu.
2. Touch the Context Menu and select *UPS Settings*.
3. Choose the desired mode from the drop-down menu:
 - Intelligent Parallel
 - ECO Mode
 - Dynamic Online (an optional, dedicated operating mode)
 - Disabled (Choosing *Disabled* will remove the choices from the OPERATE menu.)
4. Touch Save. The Save button is inactive until the activation state is changed.
5. Set up the energy saving mode chosen by touching the OPERATE Function Menu, then touching *Setup*.
6. In the drop-down menu, choose from the drop-down menu to enable, disable or force start the selected energy saving mode. (Choosing *Disabled* will deactivate Energy Saving Mode.)
7. Touch Save.

NOTE: If Intelligent Parallel, ECO Mode or Dynamic Online mode have not been enabled or disabled in *all* of the UPS modules in a multi-module system, the system will not switch to or from the configured Energy Saving mode. On the System status, the LCD on the UPS with the mode enabled will show *Pending request: Intelligent Parallel, ECO Mode, or Dynamic Online* depending on which energy saving mode is selected. The LCD of the UPS where the mode has not been enabled will not show the pending request.

2.5 Test Operation Mode

The Test Operation Mode feature (if available) tests a UPS module following service or maintenance with the remaining modules of the system available to support the critical load.

NOTE: Test Operation Mode requires V1.40 DSP (or higher) with Parallel Interface Board 419561G1_rev8 (or higher).

NOTE: The Module Output Breaker (MOB) must remain open while the UPS module is operating in Test Operation Mode.

NOTE: Any UPS module that will not be added to the collective bus must remain de-energized or be in Test Operation Mode.

2.5.1 Enabling Test Operation Mode

This procedure assumes the module has been removed from the collective bus and has been de-energized.

1. Close the external rectifier feeder breaker.
 - External Remote Back-Feed Breaker (RBB) for single-input/feed applications
 - External Rectifier Feed Breaker (RFB) for dual-input/feed applications

NOTE: The rectifier will start at this time. Do not proceed until the Touchscreen Control Panel is fully operational.

2. Verify that the rectifier has started.
The rectifier icon on the Touchscreen Control Panel should be green. If it is not, the issue must be corrected before proceeding.
3. Close the external Remote Back-Feed Breaker (RBB), if installed.
4. If installed, close the optional internal Back-Feed Disconnect (BFD).
The Bypass Static Switch (BPSS) activates.
5. Close the external Module Battery Disconnect(s) (MBD).
6. Verify that the MBD contact icon on the Touchscreen Control Panel is Closed and that the battery icon is green. If it is not, the issue must be corrected before proceeding.
7. Enable Test Operation Mode from the Touchscreen Control Panel of the isolated UPS module, touch *OPERATE > UNIT OPERATIONS > Test Operation Mode Activation Setup > Enable*.
8. On the Touchscreen Control Panel of the isolated UPS module, touch *OPERATE > UNIT OPERATIONS > Inverter On -> Single*.
9. Verify that the inverter for the isolated UPS module turns On.
The isolated module can now be tested with the remaining modules of the system supporting the critical bus.

2.5.2 Disabling Test Operation Mode

This procedure assumes the module is isolated from the system and operating in Test Operation Mode with the Inverter On.

1. Turn Off the inverter from the Touchscreen Control Panel of the isolated UPS module, touch *OPERATE > UNIT OPERATIONS > Inverter Off -> Single*.
2. Verify that the inverter of the isolated module turns Off and the Bypass Static Switch (BPSS) of that module turns On.

3. Disable Test Operation Mode from the Touchscreen Control Panel of the isolated UPS module, touch *OPERATE* > *UNIT OPERATIONS* > *Test Operation Mode Activation Setup* > *Disable*.
4. Open the external Module Battery Disconnect(s) (MBD) of the isolated module.
5. Open the external Remote Back-feed Breaker (RBB) and optional internal Back-Feed Disconnect (BFD) if installed of the isolated module.
The Bypass Static Switch (BPSS) turns Off for the isolated module.
6. Open the external rectifier feeder breaker of the isolated module.
 - External Remote Back-Feed Breaker (RBB) for single-input/feed applications
 - External Rectifier Feed Breaker (RFB) for dual-input/feed applications

Once shutdown is complete, the Touchscreen Control Panel of the isolated module will turn Off.

2.6 System Load Bank Testing

Tests the system load bank, if equipped.

1. Transfer the UPS system to Bypass (see [Load Transfer-1+N System: Transfer System Inverter to Bypass](#) on page 25).
2. Transfer the critical load to Maintenance Bypass (see [Maintenance Bypass Load Transfers-1+N Module System: If Load is on UPS Bypass](#) on page 27).
3. Verify the Maintenance Isolation Breaker (MIB) is Open, the Maintenance Bypass Breaker (MBB) is Closed, and the critical bus is supported by maintenance bypass.
4. Close the Load Bank Breaker (LBB) for the UPS system.
5. Transfer the UPS system to Inverter (see [Load Transfer-1+N System: Transfer System from Bypass to Inverter](#) on page 25).
The UPS system can now be load bank tested.
6. Once load bank testing is complete, open Load Bank Breaker for the system.
7. Transfer the UPS system to Bypass (see [Load Transfer-1+N System: Transfer System Inverter to Bypass](#) on page 25).
8. Verify that the UPS system is on Bypass.
9. Transfer the critical load to the UPS Bypass (see [Maintenance Bypass Load Transfers—1+N Module System: If Load is on Maintenance Bypass](#) on page 28).
10. Verify the Maintenance Isolation Breaker (MIB) is Closed, the Maintenance Bypass Breaker (MBB) is Open, and the critical bus is supported by the UPS Bypass.
11. Transfer the critical load to UPS Inverter (see [Load Transfer-1+N System: Transfer System from Bypass to Inverter](#) on page 25).
12. Verify the critical load is on UPS Inverter.

2.7 Module Load Bank Testing with the Critical Bus on Inverter

Tests the module load bank, if equipped, while the critical bus is on Inverter.

1. Verify that enough UPS modules will remain present to support the critical load if one module is removed from the collective bus.
2. Turn Off the Inverter from the Touchscreen Control Panel of the UPS module to be tested: touch *OPERATE* > *UNIT OPERATIONS* > *Inverter Off* > *Single*.
3. Open the external Module Output Breaker (MOB) on the UPS module to be load bank tested.
4. Close the Load Bank Breaker for the isolated module.

5. Enable Test Operation Mode from the Touchscreen Control Panel of the isolated UPS module: touch *OPERATE* > *UNIT OPERATIONS* > *Test Operation Mode Activation Setup* > *Enable*.
6. On the Touchscreen Control Panel of the isolated UPS module, touch *OPERATE* > *UNIT OPERATIONS* > *Inverter On* > *Single*.
The UPS module can now be load bank tested.
7. Once load bank testing is complete, open the Load BankBreaker for the module.
8. On the Touchscreen Control Panel of the isolated UPS module, touch *OPERATE* > *UNIT OPERATIONS* > *Inverter Off* > *Single*.
9. Disable Test Operation Mode from the Touchscreen Control Panel of the isolated UPS module, touch *OPERATE* > *UNIT OPERATIONS* > *Test Operation Mode Activation Setup* > *Disable*.
10. Close the external Module Output Breaker (MOB) on the isolated UPS module.
11. Turn On the Inverter from the Touchscreen Control Panel of the isolated UPS module: touch *OPERATE* > *UNIT OPERATIONS* > *Inverter On* > *Single*.
12. Verify that all UPS modules are connected to the collective bus.

2.8 Transformer Energization

The Liebert® EXL S1 features a rugged inverter design such that a like-size transformer can be energized while the UPS is operating on inverter. When the bypass source is available, the UPS will perform Dynamic Line Support for up to 500% of nominal input current for up to 800 milliseconds where the bypass is used in parallel with the inverter to help source the transformer inrush current. When the bypass source is unavailable, the inverter will source up to 210% of nominal current for up to 200 milliseconds.

The UPS shall support multiple downstream transformers being energized one at a time with a recommended 5-second break between transformer startups. If your connected PDU load exceeds 2X system load Vertiv™ recommends to go to maintenance bypass. When energizing multiple downstream transformers, Vertiv recommends that these transformers be designed for low inrush. Contact your Vertiv representative for more information or for application-specific questions.

3 OPTIONS

NOTE: These items must be enabled by Vertiv™ Services before they become functional. If a feature is disabled, the feature will not be available and the menu item will not be displayed.

3.1 Remote Alarm Status Panel

The Remote Alarm Status Panel (RAS) uses LED status indicators that allow the operator to monitor the UPS.

The main purpose of the Remote Alarm Status Panel option is to report the status of the load and the UPS. To interpret the LED indicators, see **Table 3.1** below.

Table 3.1 RAS Indicators

LED Name	LED Color	Meaning
Load on UPS	Green	The load is fully protected and no alarm conditions are present. The UPS is supplying uninterrupted power to the load.
Load on Bypass Alarm	Red	Power to the load is bypassing the UPS. The UPS is no longer supplying power to the load.
Battery Discharge Alarm	Red	The DC source is providing power to the UPS.
Low Battery Warning	Red	DC source capacity is low and has reached the low-battery alarm setting.
Overload	Red	System load has exceeded the system rating.
System Summary Alarm	Red	An alarm has occurred at the UPS.

The RAS also includes:

- An audible alarm
- Lamp Test/Reset push button to test the LED indicators
- Audio Reset push button to silence an audible alarm

3.1.1 Lamp Test/Reset Push Button

The Lamp Test/Reset push button is used to verify that each LED indicator is in working condition and to reset an LED indicator that has been triggered by a condition at the load or UPS.

To test the LED's, press the *Lamp Test/Reset* push button. This lights all of the LED indicators for visual inspection.

If an LED indicator does not respond to the lamp test, contact your local Vertiv™ representative for assistance.

To reset an activated LED, press the *Lamp Test/Reset* push button.

3.1.2 Audio Reset Push Button

The *Audio Reset* push button is used to silence an audible alarm that has been triggered and reset the alarm to activate on the next alarm condition. After correcting the alarm condition, press the push button to reset the audible alarm.

3.2 Vertiv™ Liebert® MBSM

The Liebert MBSM provides a frequency reference signal to each connected UPS. Each UPS uses the frequency reference signal, when appropriate, to automatically phase lock the inverter.

Each UPS in the system is supplied by a common electrical bus; the UPS synchronization source (reference) is per default the power source connected on its reserve input and, because it is the power source common to all the UPS's, the inverters' outputs will be in synchronization.

If the main power (reserve inputs) fail, each UPS will synchronize its inverter to the signal coming from the Liebert MBSM and, as a result, the inverters will remain synchronized.

3.3 DC Ground Fault

Some regulatory agencies require a system to detect battery DC ground faults in ungrounded DC systems. Generally, this applies to DC systems, both battery and flywheel systems, field-wired to the UPS. The National Electrical Code does not require this for DC systems directly attached to the UPS and which have no field wiring.

Vertiv™ recommends that you understand the applicable requirements in your area because local codes may have different interpretations and there may be internal requirements that systems have DC ground fault detection systems. For details, contact your local Vertiv representative.

4 MAINTENANCE

4.1 Safety Precautions

Observe the safety precautions in the [Important Safety Instructions](#) on page 1.

Observe all of the warnings and cautions in this document before performing any maintenance on the UPS and associated equipment. Also observe the manufacturer's safety precautions pertaining to the battery system, along with the battery safety precautions in this section.



WARNING! Risk of electric shock. Can cause injury and death. Only Vertiv™ or Vertiv-trained service personnel should work on this equipment. Both AC and DC high voltages are present in lethal amounts within this equipment. Extreme care should be taken when working around UPS equipment. Always identify the source of connecting wiring before disconnecting it. Mark any disconnected wires so they can be properly reconnected. Do not substitute parts except as authorized by Vertiv. Keep the UPS cabinets free of foreign materials such as solder, wire cuttings, etc.



ADVERTISSEMENT : Risque de décharge électrique et de présence de courant de court-circuit élevé pouvant entraîner des dommages matériels, des blessures et même la mort. L'entretien et la réparation de cet équipement doivent être confiés exclusivement à un personnel qualifié du Vertiv ou formé par Vertiv. Des hautes tensions c.a. et c.c. mortelles sont présentes dans cet équipement. Faites preuve d'une grande prudence lorsque vous travaillez à proximité d'un système ASC. Identifiez tous les circuits de connexion avec de débrancher des câbles. Ne remplacez aucun composant sans l'autorisation expresse du Vertiv. Assurez-vous que les armoires d'ASC sont exemptes de matériaux étrangers tels que des résidus de soudure, des bouts de câble, etc.



WARNING! Extreme caution is required when performing maintenance. Be constantly aware that the UPS system contains high DC as well as AC voltages. With input power off and the battery disconnected, high voltage at filter capacitors and power circuits should be discharged within 30 seconds. However, if a power circuit failure has occurred, assume that high voltage still exists after shutdown. Check with a voltmeter before making contact.

AC voltage will remain on the bypass and output contactors and the static bypass switch unless associated external circuit breakers are opened. Check for voltage with both AC and DC voltmeters before making contact.

When the UPS system is under power, both the operator and any test equipment must be isolated from direct contact with earth ground and the UPS chassis frame by using rubber mats.

Some components within the cabinets are not connected to chassis ground.

Any contact between floating circuits and the chassis is a lethal shock hazard. Use differential oscilloscopes when measuring a floating circuit. The differential input should have at least 800 vrms common mode input rating and a common mode rejection ratio of at least 80 db.

Exercise caution that the test instrument exterior does not make contact either physically or electrically with earth ground.

In case of fire involving electrical equipment, use only carbon dioxide fire extinguishers or others approved for use in fighting electrical fires.

AVERTISSEMENT : Faire preuve d'une extrême prudence lors de travaux d'entretien. Soyez conscient en tout temps que le système d'alimentation sans coupure contient des tensions élevées c.c. et c.a. Lorsque la tension d'entrée est coupée et que les batteries sont déconnectées, les tensions élevées aux condensateurs de filtrage et aux circuits de puissance devraient être dissipées en moins de 30 secondes. Toutefois, si une panne est survenue dans un circuit de puissance, il est présumé qu'une tension élevée est toujours présente après l'arrêt du système. Vérifiez à l'aide d'un voltmètre avant d'établir le contact. Une tension c.a. reste présente sur les contacteurs de dérivation et de sortie et sur le sectionneur de dérivation statique, à moins que les disjoncteurs externes associés ne soient ouverts (position Off). Vérifiez si une tension est présente à l'aide de voltmètres c.c. et c.a. avant d'établir le contact. Lorsqu'un système d'alimentation sans coupure est sous tension, l'exploitant et l'équipement de test doivent être isolés de tout contact direct avec la terre et le cadre de châssis du système d'alimentation sans coupure en utilisant des tapis de caoutchouc.



Certains composants à l'intérieur des armoires ne sont pas raccordés à la masse du châssis. Tout contact entre des circuits isolés et le châssis représente un danger de secousse électrique fatale. Utiliser des oscilloscopes différentiels lors de mesures sur un circuit isolé. L'entrée différentielle doit avoir une tension d'entrée nominale en mode commun d'au moins 800 V efficace et un rapport de réjection en mode commun d'au moins 80 décibels.

Prendre les précautions nécessaires pour empêcher l'extérieur de l'instrument de test d'entrer en contact physique ou électrique avec la terre.

En cas d'incendie impliquant de l'équipement électrique, n'utiliser que des extincteurs au dioxyde de carbone ou autres extincteurs approuvés pour combattre des incendies d'origine électrique.

4.2 Routine Maintenance

Become thoroughly familiar with the equipment, but never go beyond the specific procedures in this manual while performing maintenance or correcting a malfunction. If there is any doubt as to what must be done, contact Vertiv™ Technical Support.

The UPS is designed for unattended operation, but does require some common sense maintenance.

- **Keep good records**—Troubleshooting is easier if there are good service records.
- **Keep it clean**—Keep the UPS free of dust and moisture.
- **Keep it cool**—Battery systems must be kept in the range of 72-77°F (22-25°C) to meet design specifications for capacity and longevity. The UPS will reliably meet all performance specifications at temperatures up to 104°F (40°C) and can be slightly derated for operation at even higher temperatures. However, performance and longevity will be optimized when the UPS is operated at the same temperature as the batteries.
- **Keep connections tight**—Tighten all connections at installation and at least annually thereafter.

4.2.1 Record Log

Set up a maintenance log to record scheduled checks and any abnormal conditions.

The log should have space for all metered data, including phase readings, alarm messages, UPS mode of operation, air filter replacement date and observations. Maintain a second log for the battery module as directed by the battery manufacturer.

Vertiv recommends periodic walk-through inspections of the UPS and battery rooms to check for visible and audible indications of problems. Log the inspection, metered parameter indications and any discrepancies.

4.2.2 Air Filters

The air filters must be inspected and serviced regularly. The frequency of inspections will depend on environmental conditions. Under normal conditions, the air filters will require cleaning or replacement approximately every 2 months. Abnormal or dusty conditions will require more frequent cleaning and replacement of air filters.

Inspect installations in new buildings more often, then alter the inspection period as experience dictates.

All Liebert® EXL S1 models have a replaceable air filter inside the front doors. These filters can be changed while the UPS is in operation.

NOTE: Service and maintenance must be performed only by properly trained and qualified personnel and in accordance with applicable regulations as well as with manufacturer's specifications.

4.2.3 Limited Life Components

The Liebert EXL S1 has a design life well in excess of 10 years. Well-maintained units can continue to provide economic benefits for 20 years or more. Long-life components are used in the UPS wherever practical and cost-effective. However, due to the currently available component material, manufacturing technology limitations and the general function and use of the component, a few components in the UPS will have a shorter life cycle and require replacement in less than 10 years.

The following components utilized in the UPS have a limited life cycle. To prevent a wear-out failure of one of these components affecting the critical load operations, we recommend that these components be periodically inspected and replaced before the expected expiration of their life cycle. The expected life of each component listed below is simply an estimate and is not a guarantee. Individual users may have site-specific requirements, maintenance and other environmental conditions that affect the length of the component's useful life cycle.

In most cases, replacement components must exactly match the original component specifications.

These replacement components are not readily available from third-party component distributors.

For assistance with specific component specifications, replacement component selection and sourcing, contact Vertiv™ Technical Support. Visit the product page at www.Vertiv.com for the support available in your area.

Table 4.1 UPS Component Service Life

Component	Expected Life	Replace in
Power AC Filter Capacitors	15 Years	12 to 15 Years
Power DC Filter Capacitors	15 Years	12 to 15 Years
Low-Profile Fans	> 8 Years	6 to 7 Years
Air Filters	1 to 3 Years	Check Four Times per Year
Battery, Lithium Logic Memory Backup	10 Years	8 to 9 Years
Battery, Storage		
Lead-Acid Wet-Cell (User Selection)	15 to 20 Years	12 to 15 Years
Valve-Regulated, Lead-Acid (VRLA)	5 Years	2 to 3 Years
	10 Years	3 to 4 Years
	20 Years	8 to 12 Years
Lithium-Ion	15 Years	10 Years
<i>Expected Life is sometimes referred to as Design Life.</i>		

4.3 Battery Maintenance



WARNING! Risk of electrical shock and high short circuit current. Can cause equipment damage, personal injury and death. These maintenance procedures will expose hazardous live parts. Refer servicing to qualified personnel. DC fuses operate at the rated battery voltage at all times. A blown DC bus fuse indicates a serious problem. Serious injury or damage to the equipment can result if the fuse is replaced without knowing why it failed. Contact Vertiv Technical Support for assistance.



AVERTISSEMENT : Risque de secousse électrique et de courant élevé de court-circuit. Peuvent causer des dommages aux équipements, des blessures corporelles et la mort. Des composants affichant des tensions dangereuses seront accessibles durant ces procédures d'entretien. Faire exécuter l'entretien par du personnel qualifié. Les fusibles c.c. fonctionnent en tout temps à la tension nominale des batteries. Un fusible c.c. grillé indique un problème majeur. De graves blessures ou des dommages importants aux équipements peuvent survenir si le fusible est remplacé sans avoir identifié la cause de la panne. Communiquer avec le centre de service de Vertiv™ pour de l'assistance.

4.3.1 Battery Safety Precautions

Servicing of batteries must be performed or supervised by personnel experienced with batteries and the required precautions. Keep unauthorized personnel away from batteries.

When replacing batteries, use the same number and type of batteries.

Regular maintenance of the battery module is an absolute necessity. Periodic inspections of battery and terminal voltages, specific gravity, and connection resistance should be made. Strictly follow the procedures in the battery manufacturer's manual. (See battery manufacturer's Web site.)

Valve-regulated, lead-acid batteries require periodic visual inspections and checks of battery voltage and connection resistance.

Since individual battery characteristics are not identical and may change over time, the UPS module is equipped with circuitry to equalize battery cell voltages. This circuit temporarily increases charging voltage to maintain flooded type battery cells at full capacity.



WARNING! Risk of electrical shock. Can cause personal injury and death. Special care must be taken when working with the batteries associated with this equipment. Be constantly aware that the battery system contains high AC as well as DC voltages. Check for voltage with AC and DC voltmeters before making contact. Observe all DC safety precautions before working on or near the DC system.

Follow all battery safety precautions when installing, charging or servicing batteries. In addition to the hazard of electric shock, gas produced by batteries can be explosive and sulfuric acid can cause severe burns.

Lead-acid batteries contain hazardous materials. Batteries must be handled, transported, and recycled or discarded in accordance with federal, state and local regulations. Because lead is a toxic substance, lead-acid batteries should be recycled rather than discarded.

- Do not dispose of a battery in a fire. The battery may explode.
- Do not open or mutilate a battery. Released electrolyte is harmful to the skin and eyes. It is toxic.

A battery can present a risk of electrical shock and high short circuit current. The following precautions should be observed when working on batteries:

- Remove watches, rings and other metal objects.
- Use tools with insulated handles.
- Wear rubber gloves and boots.
- Do not lay tools or metal parts on top of batteries.
- Disconnect charging source prior to connecting or disconnecting battery terminals.
- Determine if any battery is inadvertently grounded. If any inadvertently grounded batteries are found, remove the source of the ground. Contact with any part of a grounded battery can result in electrical shock. The likelihood of such shock will be reduced if such grounds are removed during installation and maintenance.
- Lead-acid batteries can present a risk of fire because they generate hydrogen gas. In addition, electrical connections must be protected against accidental short circuits, which can cause sparks.

The following procedures should be followed:

- Do not smoke near batteries.
- Do not cause flame or spark in battery area.
- Discharge static electricity from body before touching batteries by first touching a grounded metal surface.
- After replacing battery jars in a battery cabinet, replace the retaining straps that hold the jars in place on the shelves. This will limit accidental movement of the jars and connectors should the cabinet ever need to be repositioned or relocated.



AVERTISSEMENT : Risque de secousse électrique. Peut causer des blessures corporelles et la mort. Il faut prendre des précautions particulières lors de tout travail exécuté sur les batteries associées à cet équipement. Soyez conscient en tout temps que le système de batteries contient des tensions élevées c.c. et c.a. Vérifiez si une tension est présente à l'aide de voltmètres c.c. et c.a. avant d'établir le contact.

Observer toutes les mesures de sécurité relatives aux tensions c.c. avant de travailler sur le système c.c. ou près de celui-ci.

Observer toutes les mesures de sécurité relatives aux batteries avant d'installer ou de charger des batteries ou d'en faire l'entretien. En plus du danger de secousse électrique, les gaz produits par les batteries peuvent causer des explosions et l'acide sulfurique peut causer de graves brûlures.

Les batteries au plomb-acide contiennent des matières dangereuses. Les batteries doivent être manipulées, transportées et recyclées selon les stipulations de la réglementation fédérale, provinciale et locale. Puisque le plomb est une substance toxique, les batteries au plomb-acide doivent être recyclées plutôt que d'être mises aux rebuts.

- Ne pas jeter une ou plusieurs batteries dans un feu. Elle(s) pourrai(en)t exploser.
- Ne pas ouvrir ou abîmer la ou les batteries. Les projections d'électrolyte sont dangereuses pour la peau et les yeux. L'électrolyte est également toxique.

Une batterie peut présenter un risque de secousse électrique et un courant élevé de court-circuit. Il faut observer les mesures de sécurité suivantes lors de travaux exécutés sur les batteries:

- Retirer les montres, les bijoux et tout autre objet métallique.
- Utiliser des outils dont les manches sont isolés. Porter des gants et des bottes de caoutchouc.
- Ne pas déposer d'outils ou de pièces métalliques sur le dessus des batteries.
- Débrancher l'équipement de charge avant de connecter ou de déconnecter les bornes de batteries.

- Vérifier si les batteries sont accidentellement mises à la terre. Si elles sont accidentellement mises à la terre, enlever la source de mise à la terre. Tout contact avec une partie quelconque d'une batterie mise à la terre peut causer une secousse électrique. Le danger d'une telle secousse sera réduit si de telles mises à la terre sont enlevées durant l'installation et l'entretien.
- Les batteries au plomb-acide peuvent présenter un risque d'incendie, car elles génèrent de l'hydrogène sous forme de gaz. De plus, les connexions électriques doivent être protégées contre les courts-circuits accidentels, lesquels peuvent produire des étincelles. Suivre les procédures suivantes :
- Ne pas fumer près des batteries.
- Ne pas produire de flamme ou d'étincelles dans l'environnement immédiat des batteries.
- Décharger l'électricité statique de votre corps avant de toucher aux batteries en touchant d'abord une surface de métal mise à la terre.
- Après avoir remplacé des bacs de batteries dans une armoire de batteries, remettre en place les sangles de rétention maintenant les bacs en place sur les étagères. Ceci limitera tout mouvement accidentel des bacs et connecteurs si l'armoire doit éventuellement être repositionnée ou déplacée.

NOTE: Do not use cleaners on the batteries. Solvents can make the battery cases brittle. Use only a dry cloth or a cloth moistened in water.

NOTE: Do not use equalize charging with valve-regulated, lead-acid batteries, such as those used in some Liebert® battery cabinets. Consult the battery manufacturer's manual for specific information about equalize charging.

The equalizing charge time is adjustable from zero to 200 hours and can be initiated automatically or manually.

4.3.2 Torque Requirements

All electrical connections must be tight. Refer to the torque values for the connections in the UPS below. Use these values unless the equipment is labeled otherwise.

Table 4.2 Recommended Torque Values

Grade 5 Steel: Unified Thread System Torque, lbf.*in.				Class 8.8 Steel: Metric Thread System Torque, N*m			
Fastener Finish		Plain Steel	Zinc Plating	Fastener Finish		Plain Steel	Zinc Plating
Size	Threads/ Inch, Tpi	No Washer/ Flat Washer	No Washer/ Flat Washer	Size	Thread Pitch, Tp	No Washer/ Flat Washer	No Washer/ Flat Washer
1/4	20	101	91	M5	0.8	6.1	5.5
	28	116	104		0.5	6.9	6.2
5/16	18	209	188	M6	1	10	9
	24	231	208		0.75	11	10
3/8	16	370	333	M8	1.25	25	23
	24	420	378		1	27	24
7/16	14	593	534	M10	1.5	50	45
	20	662	596		1.25	53	47

Table 4.2 Recommended Torque Values (continued)

Grade 5 Steel: Unified Thread System Torque, lbf.·in.				Class 8.8 Steel: Metric Thread System Torque, N·m			
Fastener Finish		Plain Steel	Zinc Plating	Fastener Finish		Plain Steel	Zinc Plating
Size	Threads/ Inch, Tpi	No Washer/ Flat Washer	No Washer/ Flat Washer	Size	Thread Pitch, Tp	No Washer/ Flat Washer	No Washer/ Flat Washer
1/2	13	904	814	M12	1.75	87	78
	20	1020	918		1.25	95	86
9/16	12	1305	1175	M14	2	139	125
	18	1456	1310		1.5	151	136

4.4 Detecting Trouble

The operator must check the instrument readings if abnormal equipment performance is suspected. Any metered value that differs appreciably from normal could mean an impending malfunction and should be investigated.

Items to check on the various UPS display screens include:

- **Output Voltage Levels:** Output voltages of all phases should be within 1% of normal voltage. Output currents on each phase should not normally differ by more than 20%. If the difference is greater, the load is unbalanced and must be corrected.
- **Battery Charge Current Levels:** If the UPS has not operated on battery power during the last 10 hours, the batteries should require little charging current. The battery mimic should indicate normal DC voltage with relatively little battery charge current.
- **Input Current:** Input current on each phase should be within 10% of the average input current. Alarm messages indicate malfunction or impending malfunction. A daily check of the control panel will help provide an early detection of problems. Refer to the Liebert® EXL S1 Touchscreen Control Panel, SL-26094 to interpret alarm messages.
- **Event Log:** Alarm messages and the metered parameter indications help in tracing a problem to a particular section. These are stored in the UPS Event Log and can be displayed at the touchscreen or downloaded by Vertiv™ Services.

4.5 Reporting a Problem

If a problem occurs, review all alarm messages along with other pertinent data, and contact Vertiv Technical Support. Visit the product page at www.Vertiv.com for the technical support contact for your area.

4.6 Upstream Feeder Circuit Breaker Setting Inspections

During normal UPS operations, short-term overload current demand from the bypass source may reach 10 times the UPS output current rating. This overload current demand may be caused by the magnetizing inrush current of one or more downstream transformers (e.g., power distribution units) or faults on downstream branch circuits. The instantaneous trip point(s) of the upstream bypass feeder breaker(s) must be set to support these temporary overloads. The magnitude of short-term overload bypass current demand is typically six to eight times the UPS current rating, but must be determined by analysis on a per-site basis. This analysis, generally known as an End-to-End Fault Coordination Study, must be done by a registered professional engineer experienced in this activity and familiar with local codes and related requirements.

Vertiv™ highly recommends periodic inspections of the bypass feeder breaker instantaneous trip settings, as well as the module input (rectifier) feeder breaker trip settings, to ensure that they are correct. For a variety of reasons, although typically during circuit breaker maintenance procedures by others, trip settings have been inadvertently left improperly set. Correct trip setting of these circuit breakers is most important to achieving high-availability from the UPS.

For further information regarding proper trip settings for the feeder breakers, contact Vertiv Technical Support.

NOTE: The instantaneous trip setting of the breaker feeding the UPS bypass input should be high enough to accommodate short-duration overloads. The bypass static switch power path inside the UPS can draw up to 10 times the system's rated current for up to three cycles.

NOTE: While Vertiv can provide typical guidelines, the responsibility for the proper breaker trip settings outside the Liebert® UPS equipment resides with the owner.

5 SPECIFICATIONS

Table 5.1 Specifications and Standards

UPS Rating, kVA	400/500	250/300/400	500/600	625/750/800	1000/1100/1200
Output Active Power at 104°F (40°C), kW	400/500	250/300/400	500/600	625/750/800	1000/1100/1200
Input AC Parameters					
Input Voltage to Rectifier, VAC	415, 3-Phase, 4-Wire	480, 3-Phase, 3-Wire			
Input Voltage to Bypass, VAC	415, 3-Phase, 4-Wire	480, 3-Phase, 3-Wire			
Permissible Input Voltage Range	+10%, -15%				
Input Frequency, Hz	60				
Permissible Input Frequency Range, Hz	55 to 65				
Input Power Factor	≥ 0.99				
Input Current Distortion (THDi) at Nominal Voltage at Full Load, %	≤ 3.0 with Input Voltage Distortion (THDv) <1%				
Power Walk-In (seconds)	1 to 300 (Selectable in 1 Second Increments)				
Input/Bypass Withstand Rating	100 kA				
Battery and DC Parameters					
Battery Type	Lithium-Ion; VRLA (Valve-Regulated, Lead Acid); VLA (Vented Lead Acid)				
Nominal Battery Bus, VDC	480				
Battery Float Voltage, VDC	540				
DC Ripple at Float Voltage	< 1.0% (RMS value) < 3.4% Vpp				
Temperature Compensated Battery Charging	Standard with Vertiv™ Battery Cabinets				
Output Parameters					
Load Power Factor Supported (Without Derating)	0.7 Leading to 0.4 Lagging				
Output Voltage, VAC	480, 3-Phase, 3-Wire				
Output Voltage Regulation, %	< 1.0 (3-Phase RMS Average)				
Output Voltage Regulation (50% Unbalanced Load), %	< 2.0 (3-Phase RMS Average)				
Output Frequency, Hz	60				
Output Frequency Regulation, %	± 0.1				
Output THD at Nominal Voltage (Linear Load), %	≤ 1.5 (RMS Value)				
Output THD at Nominal Voltage Including a 100kVA Non-Linear Load per IEC 62040-3, %	≤ 5.0 (RMS Value)				
Efficiency AC-AC Double Conversion with DC Source Disconnected	Up to 97% maximum efficiency				

Table 5.1 Specifications and Standards (continued)

UPS Rating, kVA	400/500	250/300/400	500/600	625/750/800	1000/1100/1200
Efficiency AC-AC Eco Mode and Dynamic Online Mode with DC Source Disconnected	Up to 99% maximum efficiency				
Transient Recovery	IEC 62040-3, section 5.3.1 Figure 1				
Voltage Displacement (Balanced Loads)	120 degrees ± 1 degree				
Voltage Displacement (50% Unbalanced Loads)	120 degrees ± 2 degrees				
Overload at Nominal Voltage and 77°F (25°C)	110% continuously; 125% for 10 minutes; 150% for 60 seconds; 200% for 200 milliseconds				
Physical Characteristics					
Dimensions, WxDxH, in. (mm)	See Table 5.2 on the facing page.				
Color	Black (RAL 7021)				
Protection Class, UPS Enclosure	NEMA 1, IP 20 (with and without front door open)				
Environmental					
Operating Temperature	32°F to 104°F (0°C to 40°C)				
Relative Humidity	0% to 95%, maximum non-condensing for operation and storage				
Operating Altitude, ft. (m)	Up to 3300 (1000) without derating				
Acoustical Noise, dBA	78 (72 at partial load)				
General and System Data					
Inverter Type	High-Efficiency, Transformer-Free IGBT, Three-Level PWM Inverter				
Rectifier Type	High-Efficiency, Transformer-Free IGBT, Three-Level PWM Inverter				
Parallel Configuration	Up to 8 units in parallel				
Access	Front and Top (no rear access required)				
Communication					
Options	2 Liebert® IntelliSlot™ Bays				
Card Compatibility	Liebert® IS-UNITY-DP, Liebert® IS-485EXI				
Protocols Available	Modbus-IP, Modbus-485, BACnet-IP, BACnet-MSTP, SNMP, HTTP, LIFE™ Services				
Standards					
Transportation	ISTA Procedure 3B				
Safety	UL 1778 5th Edition; CSA 22.2 NO 107.3				
EMI	IEC 62040-2; FCC Part 15, Class A				
Surge	ANSI C62.41, Category B3				
Electrostatic Discharge (ESD) Immunity	IEC 61000-4-2 Level 2 (4kV) contact; Level 3 (8kV) air				
Seismic	IBC 2015, CBC 2016, ASCE, OSHPD Consult the factory for further details.				

Table 5.2 Dimensions and Weights—With and Without Options

UPS Rating		Voltage	Installed Options			Dimensions WxDxH, in. (mm)	Approximate Weight Unpackaged, lb (kg)
kVA	kW		Back-Feed Disconnect (BFD)	Bypass (Sharing) Inductors	Common Mode Choke		
400/500	400/500	415	—	—	—	63.0 x 36.0 x 79.1 (1600 x 914 x 2009)	2450 (1111)
400/500	400/500	415	x	—	—	74.8 x 36.0 x 79.1 (1900 x 914 x 2009)	2749 (1247)
400/500	400/500	415	—	x	—	2749 (1247)	
400/500	400/500	415	x	x	—	2850 (1293)	
250/300/400	250/300/400	480	—	—	—	51.2 x 36 x 79.1 (1300 x 914 x 2009)	1,869 (848)
250/300/400	250/300/400	480	x	—	—	63 x 36 x 79.1 (1600 x 914 x 2009)	2168 (984)
250/300/400	250/300/400	480	—	x	—	63 x 36 x 79.1 (1600 x 914 x 2009)	2168 (984)
250/300/400	250/300/400	480	x	x	—	63 x 36 x 79.1 (1600 x 914 x 2009)	2269 (1030)
500/600	500/600	480	—	—	—	63 x 36 x 79.1 (1600 x 914 x 2009)	2450 (1111)
500/600	500/600	480	x	—	—	74.8 x 36 x 79.1 (1900 x 914 x 2009)	2749 (1247)
500/600	500/600	480	—	x	—	2749 (1247)	
500/600	500/600	480	x	x	—	2850 (1293)	
625/750/800	625/750/800	480	—	—	—	78.8 x 36 x 79.1 (2002 x 914 x 2009)	3508 (1591)
625/750/800	625/750/800	480	x	—	—	109.3 x 36 x 79.1 (2777 x 914 x 2009)	4258 (1931)
625/750/800	625/750/800	480	—	x	—	4428 (2009)	
625/750/800	625/750/800	480	—	—	x	4787 (2171)	
625/750/800	625/750/800	480	x	x	—	4558 (2067)	
625/750/800	625/750/800	480	x	—	x	5096 (2312)	
625/750/800	625/750/800	480	—	x	x	5457 (2475)	
625/750/800	625/750/800	480	x	x	x	5665 (2570)	
1000/1100/1200	1000/1100/1200	480	—	—	—	104.5 x 36 x 79.1 (2654 x 914 x 2009)	4546 (2062)
1000/1100/1200	1000/1100/1200	480	x	—	—	128.1 x 36 x 79.1 (3254 x 914 x 2009)	5116 (2321)

Table 5.2 Dimensions and Weights—With and Without Options (continued)

UPS Rating		Voltage	Installed Options			Dimensions WxDxH, in. (mm)	Approximate Weight Unpackaged, lb (kg)
kVA	kW		Back-Feed Disconnect (BFD)	Bypass (Sharing) Inductors	Common Mode Choke		
1000/1100/1200	1000/1100/1200	480	—	x	—	5286 (2398)	
1000/1100/1200	1000/1100/1200	480	—	—	x	5645 (2561)	
1000/1100/1200	1000/1100/1200	480	x	x		5416 (2457)	
1000/1100/1200	1000/1100/1200	480	x	—	x	5954 (2701)	
1000/1100/1200	1000/1100/1200	480	—	x	x	6315 (2864)	
1000/1100/1200	1000/1100/1200	480	x	x	x	6523 (2959)	

Minimum clearance above the UPS is 2 ft. (0.6m).

Top or bottom cable entry are available through removable access plates. Cut plate to suit conduit size. If aluminum cable is to be used, top and bottom cable entry may be required. Contact Applications Engineering for assistance.

Control wiring and power cables must be run in separate conduits. Control wiring must be stranded tinned conductors.

Table 5.3 Environmental Specifications

Parameter	Specification
Enclosure	The UPS is housed in a NEMA-1 enclosure. The enclosure is designed for indoor use only and is not to be subjected to falling objects or precipitation.
Recommended Operating Temperature, °F (°C)	77 (25) ambient
Maximum Operating Temperature, °F (°C)	104 (40) ambient (design temperature) without derating
Minimum Operating Temperature, °F (°C)	32 (0)
Storage Temperature, °F (°C)	-4 to 104 (-20 to 40) Contact factory for information about storage above 104°F (40°C)
Typical Battery Temperature Requirements	Average annual temperature must not exceed 80°F (27°C). Peak temperature must not exceed 109°F (43°C). See battery manufacturer's recommendations.
Relative Humidity	0% to 95%, maximum non-condensing for operation and storage
Operating Elevation	Sea level to 3300 ft (1000 m) without derating
Storage Elevation	Sea level to 50,000 ft (15,240 m)
Acoustical Noise at 39 inches (990 mm), dBA	78 (72 at partial load)

Table 5.4 Current-versus-time curves of inverter overload capacity

Ambient Temperature							
Time, sec.	77°F (25°C)	Time, sec.	86°F (30°C)	Time, sec.	95°F (35°C)	Time, sec.	104°F (40°C)
	Load %		Load %		Load %		Load %
0.2	200%	0.2	200%	0.2	200%	0.2	200%
1	158%	1	158%	1	158%	1	158%
28	155%	30	155%	15	155%	19	155%
50	152%	47	152%	30	152%	28	152%
330	130%	155	130%	90	130%	40	130%
600	125%	210	125%	115	125%	47	125%
—	110%	—	110%	207	110%	77	102%

Based on nominal input voltage and no battery charging.

Table 5.5 Current-versus-time curves of bypass overload capacity, 104° (40°C)

% Load	Overload Time, sec.
110	750
125	300
130	210
152	19
155	5.45
158	5.17
165	0.61

Based on nominal input voltage

This page intentionally left blank

APPENDICES

Appendix A: UPS Messages—Status, Alarms, and Faults

Table A.1 Status Messages

Component	Type	Text Display	ID	Description
Battery	Status	Battery warning	04-000	A warning is pending.
Battery	Status	Battery fault	04-001	A fault is pending.
Battery	Status	Battery idle	04-002	The battery is idle; energy is flowing neither in nor out.
Battery	Status	Battery is discharging	04-004	The battery is discharging.
Battery	Status	Automatic Battery Test Started	04-032	An automatic battery test has been started.
Battery	Status	Battery Test Requested	04-033	(Not supported) see BAW1 bit 4
Battery	Status	Battery Test Failed	04-035	A battery test has failed. Permanent state: a manual reset is required.
Battery	Status	Battery Test Idle	04-048	The battery test function is not being performed.
Battery	Status	Battery Test Start Pending	04-052	In a parallel system with a common battery, the <i>Start</i> command is present on some but not all the units.
Battery	Status	Battery Test Stop Pending	04-053	In a parallel system with a common battery, the <i>Stop</i> command is present on some but not all the units.
Battery	Status	Battery Non-Blocking Fault	04-054	Set when a non-blocking fault is active in the stage.
Battery	Status	Battery Not Connected	04-065	Set when V_BATT1 < 100V (fix threshold). Control always active independently to battery breaker status.
Battery	Status	Battery is charging	14-003	The battery is being charged.
Battery	Status	Battery Test Running	14-034	Battery test is running.
Battery	Status	Battery Test Not Allowed	14-036	Conditions preclude performing a battery test.
Battery	Status	Battery Test Finished OK	14-037	Battery test finished; active for 5 seconds, then switches to Battery Test Idle.
Battery	Status	Battery Test Canceled	14-038	(Not supported)
Battery	Status	Battery Test Interrupted	14-050	(Not supported)
Battery	Status	Battery Test Stopped by User	14-051	User has stopped the battery test; active for 5 seconds, then switches to Battery Test Idle. Valid only for a manual battery test.
Bypass	Status	Bypass is not present	01-000	—
Bypass	Status	Bypass Is On	01-001	—
Bypass	Status	Bypass Is Off	01-002	—
Bypass	Status	Bypass is stopped due to a fault	01-003	—

Table A.1 Status Messages (continued)

Component	Type	Text Display	ID	Description
Bypass	Status	Bypass not prepared	01-004	Static switch board is not installed or the bypass voltage is over the threshold (P 106.i04).
Bypass	Status	Bypass fault	01-005	Set when a blocking fault is active in the stage.
Bypass	Status	Bypass warning	01-007	Set when at least one warning is active.
Bypass	Status	Bypass available with delay	01-008	Set when the bypass and inverter are not synchronized.
Bypass	Status	Parallel bypass OK	01-029	All bypass inputs are OK.
Bypass	Status	Parallel bypass one fault	01-030	One bypass input fault exists.
Bypass	Status	Parallel bypass at least one OK	01-031	At least one bypass input is OK.
Bypass	Status	Parallel bypass fault	01-032	All bypass inputs are in fault.
Bypass	Status	Undelayed Bypass Ref. Failure	01-040	Bypass reference failure notification without any delay.
Bypass	Status	Bypass is Centralized	01-041	The internal bypass is disabled; the UPS is using the centralized / common (MSS) bypass.
Bypass	Status	Bypass Non-Blocking Fault	01-042	Set when a non-blocking fault is active in the stage.
Bypass	Status	Bypass Global On Request	01-078	Bypass Static Switch On command request on the shared bus
Bypass	Status	Bypass Global On	01-079	Bypass Static Switch on global status read from the shared bus.
Bypass	Status	Bypass Global Off	01-080	Bypass Static Switch Off Global status read from the shared bus.
Bypass	Status	Bypass mains is out of tolerance	11-006	Bypass failure notification without any delay.
Bypass	Alarm	Bypass Input Switch Open	21-012	Bypass input switch is open.
Charger/Booster	Status	Charger in Standby - (not charging)	03-000	—
Charger/Booster	Status	Charger is on	03-001	—
Charger/Booster	Status	Charger is off	03-002	—
Charger/Booster	Status	Charger Forced On	03-003	—
Charger/Booster	Status	Charger Stopped due to a Fault	03-038	—
Charger/Booster	Status	Charger in Current Limitation	03-039	Displayed as long as the voltage reference is lower than the nominal.
Charger/Booster	Status	Charging Status OFF	03-040	—
Charger/Booster	Status	Charging Status INIT	03-041	—

Table A.1 Status Messages (continued)

Component	Type	Text Display	ID	Description
Charger/Booster	Status	Charging Status FLOAT 1	03-042	—
Charger/Booster	Status	Charging Status FLOAT 2	03-043	—
Charger/Booster	Status	Charging Status POST	03-044	—
Charger/Booster	Status	Charging Status PAUSE	03-045	—
Charger/Booster	Status	Charging Status MANUAL	03-046	—
Charger/Booster	Status	Charging Status FAULT	03-047	—
Charger/Booster	Status	Buck-Booster Fault	03-048	At least one fault is active.
Charger/Booster	Status	Buck-Booster Warning	03-049	Set when at least one warning is active.
Charger/Booster	Status	Booster Off	03-050	—
Charger/Booster	Status	Booster Turning On	03-051	—
Charger/Booster	Status	Booster On	03-052	—
Charger/Booster	Status	Booster Stopped Due To Fault	03-053	—
Charger/Booster	Status	Booster Runs From Battery	03-054	Status set after a fixed delay equivalent to P1110.
Charger/Booster	Status	Buck-Booster Non-Blocking Fault	03-055	At least one non-blocking fault is active.
Charger/Booster	Status	DC Bus Too Low To Charge	03-061	—
General	Status	Warning pending	00-000	Set when at least one stage in the core is in warning.
General	Status	Fault pending	00-001	Set when at least one stage in the core is in fault.
General	Status	General Fault	00-002	Set when a fault is active in general stage.
General	Status	Parallel Unit	00-003	Set when P129 = 1.
General	Status	External Synch enabled	00-005	Set when P700 = 1.
General	Status	Inverter/Rectifier OFF Command Issued	00-006	Set when command <i>UPS Off</i> is received; resets when command is not present.
General	Status	Inverter on rectifier	00-009	Inverter is supplied by the rectifier.
General	Status	Inverter on battery	00-010	Inverter is supplied by the battery.
General	Status	Parameter reset active	00-011	Set after a parameter reset. Resets as soon as the parameter is written.
General	Status	Intelligent Parallel Not Allowed	00-014	Inverter status is not compatible with circular redundancy.
General	Status	Core Running	00-016	Core running.

Table A.1 Status Messages (continued)

Component	Type	Text Display	ID	Description
General	Status	Operating Request for VFI	00-102	—
General	Status	SKRU: Inverter start inhibited	00-131	On B001 Liebert® EXL S1, the DIC1 inverter board will check the status of the input/output contact Function #16 to inhibit the inverter start.
General	Status	General Warning	00-146	Set when a warning is active in the general stage.
General	Status	General Non-Blocking Fault	00-147	Set when a non-blocking fault is active in general stage.
General	Status	Non-Blocking Fault pending	00-148	Set when at least one stage in the CORE is in a non-blocking fault.
General	Status	General Fault	00-171	Set when a fault is active in general stage.
General	Status	General Warning	00-172	Set when a warning is active in general stage.
General	Status	General Non-Blocking Fault	00-173	Set when a non-blocking fault is active in general stage.
General	Status	General Core Summary Warning	00-174	Set when a customer blocking fault flag is present (not yet defined).
General	Status	General Core Summary Fault	00-175	Set when at least one customer warning is active. (Not yet defined)
General	Status	General Core Non-Blocking Fault	00-176	Set when a customer non-blocking fault in stage is set (not yet defined).
General	Status	Manual Mode Command Pending	00-200	Set when manual command is pending but global status not confirmed.
General	Status	Synchronize Rectifier Mains Failure	00-219	Request to synchronize the rectifier in case mains failure affects only one core or unit.
General	Status	One or More Fans Not Working	00-221	Set when one fan out of the entire set of monitored fans is not working.
General	Status	BCB: Trip command issued	00-226	Enabled by Output Function 47 BCB trip. Battery Circuit Breaker (BCB) opening command has been issued.
General	Status	Operating Request for Intelligent ECO	00-273	—
General	Status	Core Sleeping	10-015	Core is sleeping.
General	Status	Intelligent ECO Enabled	10-204	—
General	Status	Intelligent Parallel Enabled	10-205	—
General	Status	Fan Test in Progress	10-220	Set when fan test is in progress. Valid for either Automatic or Manual.
Inverter	Status	Inverter is off	06-000	—
Inverter	Status	Inverter is turning on	06-001	—
Inverter	Status	Inverter is on	06-002	—
Inverter	Status	Inverter is stopped due to a fault	06-003	—

Table A.1 Status Messages (continued)

Component	Type	Text Display	ID	Description
Inverter	Status	Inverter fault	06-004	Set when a blocking fault is present on the inverter stage.
Inverter	Status	Synchronization Source: Bypass	06-005	—
Inverter	Status	Synchronization Source: Output	06-006	—
Inverter	Status	Synchronization Source: Self Clock	06-007	—
Inverter	Status	Synchronization Source: External	06-008	—
Inverter	Status	Inverter warning	06-010	Set when at least one warning is active
Inverter	Status	Inverter out of Synchronization	06-011	Set when the inverter is not synchronized with local bypass
Inverter	Status	Inverter out of Synchronization	06-016	Set when the inverter is not synchronized with external synchronization signal.
Inverter	Status	Online operation / VFI	06-018	—
Inverter	Status	VI	06-019	—
Inverter	Status	Intelligent ECO / VFD	06-020	—
Inverter	Status	Intelligent Parallel / CR	06-079	—
Inverter	Status	Intelligent Parallel / CR	06-079	—
Inverter	Status	Intelligent Parallel / CR	06-079	—
Inverter	Status	Operation: ECO mode	06-086	Active if inverter is turning On, the load is on Bypass and P580=1 (DIM enabled).
Inverter	Status	Inverter in Standby	06-087	—
Inverter	Status	Inverter Ready and Sync	06-088	—
Inverter	Status	Inverter Not Ready	06-089	—
Inverter	Status	Current Limit Last more than 3ms	06-090	Current limit lasts > 3 ms.
Inverter	Status	Inverter Non-Blocking Fault	06-091	Set when a non-blocking fault is active in the stage.
Inverter	Status	Inverter Fault	06-110	Set when customer blocking fault flag is present.
Inverter	Status	Inverter warning	06-111	Set when at least one customer warning is active.
Inverter	Status	Inverter Non-Blocking Fault	06-112	Set when a customer non-blocking fault in stage is set.
Inverter	Status	Inverter pending on command	16-029	—
Load	Status	Load supplied by bypass	07-001	Set when load is supplied by Automatic Bypass and Inverter is Off.

Table A.1 Status Messages (continued)

Component	Type	Text Display	ID	Description
Load	Status	Load Supplied By Maint. Bypass	07-002	Set when load is supplied by Manual Bypass.
Load	Status	Load is currently not supplied	07-003	Set when module is not supplying load.
Load	Status	Load on low priority line	07-004	Set when the load is supplied by the inverter and P568=1 or when the load is supplied by the bypass and P580=0.
Load	Status	Load on phase U-A > 85%	07-005	—
Load	Status	Load on phase V-B > 85%	07-006	—
Load	Status	Load on phase W-C > 85%	07-007	—
Load	Status	Load warning	07-008	Set when at least one warning is active.
Load	Status	Load supplied by battery	07-026	Set when the load is secured by the inverter and energy is provided by the battery.
Load	Status	Load Secured by Inverter	07-027	Set when the load is secured by the inverter. This includes the inverter in VFI or DIM (Eco) Mode.
Load	Status	Load Fault	07-028	Set when a blocking fault is present in the actual stage (not yet implemented).
Load	Status	Load Non-Blocking Fault	07-029	Set when a non-blocking fault is present in the actual stage (not yet implemented).
MUN	Status	MUN has a warning	08-000	Set when at least one MUN stage is in warning.
MUN	Status	MUN has a fault	08-001	Set when at least one non-blocking fault is present on MUN.
MUN	Status	UPS Model detection in progress	08-003	MUN is searching for Model Information.
MUN	Status	MUN initialization done	08-004	MUN is setup with auto detection.
MUN	Status	MUN reboot required	08-005	MUN detects difference in environment variable.
MUN	Status	System Started	08-011	Set at application startup; never reset.
MUN	Status	Acknowledge Button Pressed	08-025	Acknowledge button has been pressed.
MUN	Status	UPS Time not valid	08-026	Set when date is < 1 Jan 2009.
MUN	Status	Life call in progress	08-033	Call in progress.
MUN	Status	Life call rescheduled	08-034	Call rescheduled.
MUN	Status	Life modem not detected	08-035	Set when MUN does not receive replies from modem.
MUN	Status	Parameter read failed	08-054	Parameter can not be read from DSP. Set when Parameter Reading returns with an exception Reset when Parameter Reading returns with an OK.

Table A.1 Status Messages (continued)

Component	Type	Text Display	ID	Description
MUN	Status	Parameter set failed	08-055	Parameter can not be written to DSP. Set when Parameter Writing returns with an exception. Reset when Parameter Writing returns with an OK.
MUN	Status	Life Service Mode	08-060	Life is in Service mode, so emergency calls are not sent to station (used when an SE is operating on the device in field).
MUN	Status	Ntp is Disconnected from Touchscreen	08-061	—
MUN	Status	Life interface Init in Progress	08-079	Set at application start up; reset after one second
MUN	Status	Life Events Sampling started	08-095	Ignore events history and restart sampling from current time.
MUN	Status	MUN/DSP are not Sync with SYNW	08-097	—
MUN	Status	Life Measures Sampling Started	08-098	Ignore measures history and restart sampling from current time.
MUN	Status	System Time Moved Ahead	08-110	Set when device time is moved ahead after time adjustment from Life Station.
MUN	Status	System Time Moved Back	08-111	Set when device time is moved back after time adjustment from Life Station.
Rectifier	Status	Rectifier is off	02-000	—
Rectifier	Status	Rectifier is turning on	02-001	—
Rectifier	Status	Rectifier is on	02-002	—
Rectifier	Status	Rectifier fault	02-004	Set either blocking or non-blocking.
Rectifier	Status	Rectifier Warning	02-009	Set when at least one warning is active.
Rectifier	Status	No pre-charge in progress	02-010	No pre-charge active. Active while mains is out of tolerance.
Rectifier	Status	Charger in progress	02-011	Hold off delay and resistor pre-charge.
Rectifier	Status	Walk-in in progress	02-012	Rectifier current limit ramp.
Rectifier	Status	pre-charge finished	02-013	Pre-charge finished. Active while mains is OK.
Rectifier	Status	Rectifier Power Limitation Active	02-048	Set when the input current is limited by standard or customer limit. (See .)
Rectifier	Status	Rectifier Current Limit	02-049	Set when input current reaches the limit defined by P 1740.11 and lasts more 3 ms but less 10 ms.
Rectifier	Status	Rectifier Non-Blocking Fault	02-050	Set when a non-blocking fault in rectifier stage is set.
Rectifier	Status	Rectifier fault	02-070	Set when customer blocking fault flag is present (not yet defined).
Rectifier	Status	Rectifier Warning	02-071	Set when at least one customer warning is active (not yet defined).

Table A.1 Status Messages (continued)

Component	Type	Text Display	ID	Description
Rectifier	Status	Rectifier Non-Blocking Fault	02-072	Set when a customer non-blocking fault in stage is set (not yet defined).
Rectifier	Status	Rectifier Stopped - Fault	02-092	Set when a customer blocking fault in stage is set.
Rectifier	Status	Rectifier Inhibited	02-093	Set when the rectifier pulse is inhibited due to DC overvoltage.
Rectifier	Status	Rectifier mains is out of tolerance	12-005	Mains failure notification without any delay.

Table A.2 Alarm Messages

Component	Type	Text Display	ID	Description
Battery	Alarm	Battery under voltage	24-012	The battery voltage is under the shutdown voltage defined by 5 points of P1513 <i>Shutdown Voltage Table</i> . This warning causes the inverter to stop. This warning will be kept as long as the battery voltage is lower than the Inverter Restart Threshold.
Battery	Alarm	High battery temperature	24-015	RBM battery temperature user alarm (Temp. P1533.1 [0°C] < T < P1533.2 [38°C].)
Battery	Alarm	Battery temperature out of range	24-016	RBM battery temperature is out of range -10°C < T < P 1533.1 or 1533.2 < T < 40°.
Battery	Alarm	Temperature Probe Broken	24-017	RBM temperature probe is not responding (Temp. T < 10°C or T > 50°C or RBM Sensor Status [bit 3-2] = 11).
Battery	Alarm	Battery Switch Wiring Fault	24-056	Core only: Set when the RBM option is installed with Form C wiring and related cubicle breaker wiring fails.
Battery	Alarm	Cubicle Battery Switch Open	24-063	Core and Monolithic. CORE: set when an RBM option is installed. Monolithic: set when IO Function 18 is enabled.
Battery	Alarm	Battery Is Not Connected	24-064	Battery is not connected - warning.
Battery	Alarm	Imminent End Of Autonomy - Volt	24-066	Set if P1590 = 2 or 3. The battery voltage is lower than the threshold defined by 5 points of P1513 <i>Shutdown Voltage Table</i> + P 1591 <i>Delta shutdown imminent</i> .
Battery	Alarm	Imminent End Of Autonomy - Time	24-067	Set if P1590 = 1 or 3. The autonomy is below the defined threshold P1117 <i>Battery stored energy time limit</i> .
Battery	Alarm	BCB Breaker Open	24-068	Enabled by Input Function 21 BCB. Battery Circuit Breaker (BCB) is open.
Battery	Alarm	Battery Breaker Open	24-072	One or more BIB reports an open breaker.
Bypass	Alarm	Bypass Input Switch Open	21-012	Bypass input switch is open.
Bypass	Alarm	Bypass mains failure	21-013	Warning set after delay defined by P 110.
Bypass	Alarm	Bypass in Overload Condition	21-014	—

Table A.2 Alarm Messages (continued)

Component	Type	Text Display	ID	Description
Bypass	Alarm	Bypass disabled	21-016	<i>Bypass ON</i> command disabled (SW bypass inhibition to avoid DC capacitor overcurrent. Detected on DIC Inv. when DC link higher than $(\sqrt{2} * \text{Phase voltage RMS}) - 30V$, delay 0.4 seconds).
Bypass	Alarm	Bypass overtemperature	21-017	Set when inverter temp. $P 151.01 < T < P 151.02$.
Bypass	Alarm	Bypass mode not auto	21-018	Set when the Bypass Control CAN ID 04002300h is not AUTO. Normally set in <i>Power Circuit Test</i> page.
Bypass	Alarm	Parallel Bypass Failure	21-038	Set when the input <i>Bypass OK</i> is set.
Bypass	Alarm	Bypass Wrong Phase Rotation	21-083	Bypass input wrong phase rotation.
Charger/Booster	Alarm	Battery Not Connected	23-012	Set when $-100V < V_BATT1 < 100V$ (fix threshold). Control always active independently to battery breaker status.
Charger/Booster	Alarm	Reversed polarity	23-014	Set when $V_BATT1 < -100V$ (fix threshold). Control always active independently to Battery breaker status. Inhibits starting the battery charger.
Charger/Booster	Alarm	Buck-Booster DC Voltage Low	23-056	Booster inhibit when DC voltage $< P1135.i03$ (to be verified).
Charger/Booster	Alarm	Buck-Booster Overtemperature	23-057	Set when the temperature is greater than the P 1151 value.
Charger/Booster	Alarm	Buck-Booster B Overtemperature	23-067	Set when the temperature is greater than the P 1151 value).
Charger/Booster	Alarm	DC Overvoltage	23-080	Set when the DC bus voltage crosses the maximum threshold of P1753.30 for P1753.31 time.
General	Alarm	System Power UP	00-023	—
General	Alarm	Commissioning / Test Mode	20-018	—
General	Alarm	System Maint. Bypass Switch Closed	20-019	—
General	Alarm	Synchronization system fault	20-022	—
General	Alarm	System shutdown	20-024	—
General	Alarm	The ID Card is missing	20-025	—
General	Alarm	Calibration is started	20-026	—
General	Alarm	Input Air High Temperature	20-027	—
General	Alarm	System Output Switch Open	20-031	—

Table A.2 Alarm Messages (continued)

Component	Type	Text Display	ID	Description
General	Alarm	System Bypass Switch Closed	20-032	—
General	Alarm	Detected Cores Mismatch	20-127	—
General	Alarm	Communication Loss BIB	20-132	—
General	Alarm	AC Ground Fault	20-133	—
General	Alarm	Communication Loss MI Ph. U-A	20-153	—
General	Alarm	Communication Loss MI Ph. V-B	20-154	—
General	Alarm	Communication Loss MI Ph. W-C	20-155	—
General	Alarm	Communication Loss MI BB	20-156	—
General	Alarm	Motherboard Overtemperature	20-165	—
General	Alarm	PIB Overtemperature	20-166	—
General	Alarm	Cable Conduit Overtemperature	20-167	—
General	Alarm	MIB Overtemperature	20-168	—
General	Alarm	Duplicated Parallel Unit Id	20-169	—
General	Alarm	Parallel Unit Number Mismatch	20-170	—
General	Alarm	Communication Loss MI-B Ph. U-A	20-206	—
General	Alarm	Communication Loss MI-B Ph. V-B	20-207	—
General	Alarm	Communication Loss MI-B Ph. W-C	20-208	—
General	Alarm	Communication Loss MI-B BB	20-209	—
General	Alarm	Fan Failure Phase U	20-210	—
General	Alarm	Fan Failure Phase V	20-211	—
General	Alarm	Fan Failure Phase W	20-212	—

Table A.2 Alarm Messages (continued)

Component	Type	Text Display	ID	Description
General	Alarm	Fan Failure Buck-Booster	20-213	—
General	Alarm	Battery Switch Open - Do Not Close	20-214	—
General	Alarm	CPU Time Slice	20-215	—
General	Alarm	Fan Failure Static Switch	20-222	—
General	Alarm	Fan Failure Board Slot	20-223	—
General	Alarm	I/O Transformer Overtemperature	20-224	—
General	Alarm	DC Overvoltage	20-227	—
General	Alarm	Communication Loss PIB-S1	20-243	—
General	Alarm	Communication Loss PIB-S1	20-244	—
General	Alarm	Communication Loss PIB-S1- I2C	20-245	—
Inverter	Alarm	Inverter DC Undervoltage	26-025	—
Inverter	Alarm	Inverter overload	26-026	RMS overload condition.
Inverter	Alarm	The inverter is off	26-027	—
Inverter	Alarm	Inverter pending off command	26-028	—
Inverter	Alarm	Inverter overload	26-031	Set when the overload timeout has reached 100%. This triggers the request to transfer to bypass with default configuration.
Inverter	Alarm	Overtemperature Phase U-A	26-101	Set when Phase U temperature is greater than the value specified by P 151.
Inverter	Alarm	Overtemperature Phase V-B	26-102	Set when Phase V temperature is greater than the value specified by P 151.
Inverter	Alarm	Overtemperature Phase W-C	26-103	Set when Phase W temperature is greater than the value specified by P 151.
Inverter	Alarm	Overtemperature B Phase U-A	26-119	Set when Phase U temperature is greater than the value specified by P 151.
Inverter	Alarm	Overtemperature B Phase V-B	26-120	Set when Phase V temperature is greater than the value specified by P 151.
Inverter	Alarm	Overtemperature B Phase W-C	26-121	Set when Phase W temperature is greater than the value specified by P 151.
Inverter	Alarm	DC Overvoltage	26-137	Set when DC bus voltage crosses the maximum threshold P753.40 for P753.41 time.

Table A.2 Alarm Messages (continued)

Component	Type	Text Display	ID	Description
Load	Alarm	Output Switch Open	27-009	The output breaker MOB is open.
Load	Alarm	Load is currently not supplied	27-010	Monolithic only: UPS is not supplying the load
Load	Alarm	Re-transfer is inhibited	27-011	Load transfer to inverter inhibited due to overload (to be verified with overload specification (see).
MUN	Status	MUN has a warning	08-000	Set when at least one MUN stage is in warning.
MUN	Status	MUN has a fault	08-001	Set when at least one non-blocking fault is present on MUN.
MUN	Status	UPS Model detection in progress	08-003	MUN is searching for model information.
MUN	Status	MUN initialization done	08-004	MUN is setup with auto detection.
MUN	Status	MUN reboot required	08-005	MUN detects difference in environmental variables.
MUN	Status	System Started	08-011	Set at application standup; never reset.
MUN	Status	Acknowledge Button Pressed	08-025	Acknowledge button has been pressed.
MUN	Status	UPS Time not valid	08-026	Set when date is < 1 Jan 2009.
MUN	Status	Life call in progress	08-033	Call in progress.
MUN	Status	Life call rescheduled	08-034	Call rescheduled.
MUN	Status	Life modem not detected	08-035	Set when MUN does not receive replies from modem.
MUN	Status	Parameter read failed	08-054	Parameter can not be read from DSP. Set when Parameter Reading returns with an exception. Reset when Parameter Reading returns with OK.
MUN	Status	Parameter set failed	08-055	Parameter cannot be written to DSP. Set when Parameter Writing returns with an exception. Reset when Parameter Writing returns with OK.
MUN	Status	Life Service Mode	08-060	Vertiv™ LIFE™ is in Service Mode, so emergency calls are not sent to station (used when a service engineer is operating on the device).
MUN	Status	Ntp is Disconnected from Touchscreen	08-061	—
MUN	Status	Life interface Init in Progress	08-079	Set at application startup; reset after one second.
MUN	Status	Life Events Sampling started	08-095	Ignore events history and restart sampling from current time.

Table A.2 Alarm Messages (continued)

Component	Type	Text Display	ID	Description
MUN	Status	MUN/DSP are not Sync with SYNW	08-097	—
MUN	Status	Life Measures Sampling Started	08-098	Ignore measures history and restart sampling from current time.
MUN	Status	System Time Moved Ahead	08-110	Set when device time is moved ahead after time adjustment from Life Station.
MUN	Status	System Time Moved Back	08-111	Set when device time is moved back after time adjustment from Life Station.
MUN	Alarm	CAN Communication Loss	28-008	Set when CAN telegram are not received for 10 seconds. Reset when a general stage telegram is received.
MUN	Alarm	UPS Model cannot be identified	28-056	UPS model not detected.
Rectifier	Status	Rectifier is off	02-000	—
Rectifier	Status	Rectifier is turning on	02-001	—
Rectifier	Status	Rectifier is on	02-002	—
Rectifier	Status	Rectifier fault	02-004	Set as either <i>blocking</i> or <i>non-blocking</i> .
Rectifier	Status	Rectifier Warning	02-009	Set when at least one warning is active.
Rectifier	Status	No pre-charge in progress	02-010	No pre-charge active. Active while mains is out of limits.
Rectifier	Status	pre-charge in progress	02-011	Hold off delay and resistor pre-charge.
Rectifier	Status	Walk-in in progress	02-012	Rectifier current limit ramp.
Rectifier	Status	pre-charge finished	02-013	Pre-charge finished. Active while mains is OK.
Rectifier	Status	Rectifier Power Limitation Active	02-048	Set when the input current is limited by standard or customer limit. (See Overload specification.)
Rectifier	Status	Rectifier Current Limit	02-049	Set when input current reaches the limit defined by P 1740.11 and lasts more than 3 ms but less than 10 ms.
Rectifier	Status	Rectifier Non-Blocking Fault	02-050	Set when a non-blocking fault in rectifier stage is set.
Rectifier	Status	Rectifier fault	02-070	Set when a customer blocking fault flag is present (not yet defined).
Rectifier	Status	Rectifier Warning	02-071	Set when at least one customer warning is active (not yet defined).
Rectifier	Status	Rectifier Non-Blocking Fault	02-072	Set when a customer non-blocking fault in stage is set. (not yet defined).
Rectifier	Status	Rectifier Stopped - Fault	02-092	—
Rectifier	Status	Rectifier Inhibited	02-093	Set when the rectifier pulse is inhibited due to DC overvoltage.

Table A.2 Alarm Messages (continued)

Component	Type	Text Display	ID	Description
Rectifier	Status	Rectifier mains is out of tolerance	12-005	Mains failure notification without any delay.
Rectifier	Alarm	Rectifier Input Switch Open	22-014	—
Rectifier	Alarm	Rectifier mains failure	22-015	Warning set after the delay defined by P1110.
Rectifier	Alarm	Wrong phase rotation	22-017	Input line phase rotation is incorrect.
Rectifier	Alarm	DC voltage low	22-018	DC link voltage under the threshold defined by P1135.2, causing PWM inhibition.
Rectifier	Alarm	Out of synchronization	22-020	During the rectifier running it causes the rectifier to stop temporarily.
Rectifier	Alarm	Peak Input Voltage	22-021	Mains voltage high peak detector trips when instantaneous voltage exceeded the limit defined by P 1140.i05.
Rectifier	Alarm	Overtemperature Phase U-A	22-061	Set when Phase U temperature is greater then P 1151 setting (Def = 80°C)
Rectifier	Alarm	Overtemperature Phase V-B	22-062	Set when Phase V temperature is greater then P 1151 setting (Def = 80°C).
Rectifier	Alarm	Overtemperature Phase W-C	22-063	Set when Phase W temperature is greater then P 1151 setting (Def = 80°C).
Rectifier	Alarm	Overtemperature B Phase U-A	22-073	Set when Phase U temperature is greater then P 1151 setting (Def = 80°C).
Rectifier	Alarm	Overtemperature B Phase V-B	22-074	Set when Phase V temperature is greater then P 1151 setting (Def = 80°C).
Rectifier	Alarm	Overtemperature B Phase W-C	22-075	Set when Phase W temperature is greater then P 1151 setting (Def = 80°C).
Rectifier	Alarm	DC Overvoltage	22-102	Set when the rectifier detects DC bus voltage above threshold P1753.29.

Table A.3 Fault Messages

Component	Type	Text Display	ID	Description
Battery	Fault	Battery Test Failure	34-023	—
Battery	Fault	Battery Overcurrent Fault	34-070	BCB Control algorithm has detected an overcurrent condition. BCB Open command issued.
Battery	Fault	Battery Ground Fault	34-071	Enabled by Input Function 22 BCB GND Fault. Battery ground fault detector is tripped.
Bypass	Fault	E.P.O.	31-020	—
Bypass	Fault	Bypass hardware failure	31-021	Output voltage is out of tolerance and the bypass input is within tolerance (SW detected fault monitoring output signals).

Table A.3 Fault Messages (continued)

Component	Type	Text Display	ID	Description
Bypass	Fault	Bypass hardware failure	31-022	Set when the bypass static switch board is not installed (i.e., bypass voltage < 170 V).
Bypass	Fault	Back-feed protection	31-023	Back-feed fault has been detected. Enabled by P142.
Bypass	Fault	Overload	31-026	—
Bypass	Fault	Bypass Failure During Line Support	31-027	—
Bypass	Fault	Parallel Failure During Support	31-028	—
Bypass	Fault	Overtemperature	31-036	Bypass heat sink overtemperature.
Charger/Booster	Fault	Charger Temperature high	33-018	Set when temperature is greater than P 1152 value.
Charger/Booster	Fault	Temperature Probe Broken	33-019	Buck booster temperature sensor fault SW detected; based on M.I. value outside sensor limit interval -15°C < T < +150°C for 60 seconds (P 1780.6).
Charger/Booster	Fault	Charger Temperature high	33-020	Booster/Charger filter overtemperature (M.I. XP31 pin 1-6).
Charger/Booster	Fault	Charger De-saturation	33-021	Charger desaturation.
Charger/Booster	Fault	Charger Redundant Voltage error	33-022	If the absolute value of the difference between primary and secondary battery voltage acquisition is greater than a predefined threshold, a fault is issued and the booster/charger is turned Off because the voltage measurement is corrupted.
Charger/Booster	Fault	Charger DC Bus	33-023	Set when DC voltage +/- is greater than the P753.i15 threshold.
Charger/Booster	Fault	E.P.O.	33-035	—
Charger/Booster	Fault	Charger Voltage Out of Limit	33-025	The charger is switched Off due to an overvoltage on the battery. The time until switch Off depends on the overvoltage value.
Charger/Booster	Fault	Buck-Booster Overcurrent	33-058	The current limitation control has tripped the booster.
Charger/Booster	Fault	Booster Defenestration	33-059	Booster desaturation.
Charger/Booster	Fault	Booster and Charger De-saturation	33-060	Charger and booster desaturation.
Charger/Booster	Fault	Charger Temperature High	33-070	—
Charger/Booster	Fault	Charger Temperature High	33-071	—
Charger/Booster	Fault	Temp Probe Module B Broken	33-072	—
Charger/Booster	Fault	Charger De-saturation	33-073	—

Table A.3 Fault Messages (continued)

Component	Type	Text Display	ID	Description
Charger/Booster	Fault	Booster B De-saturation	33-074	—
Charger/Booster	Fault	Booster and Charger B De-saturation	33-075	—
Charger/Booster	Fault	Fuse Blown Pos Pole	33-076	Positive line buck booster fuse is blown.
Charger/Booster	Fault	Fuse Blown Neg Pole	33-077	Negative line buck booster fuse is blown.
Charger/Booster	Fault	Fuse Blown Module B Pos Pole	33-078	Positive B line buck booster fuse blown.
Charger/Booster	Fault	Fuse Blown Module B Neg Pole	33-079	Negative B line buck booster fuse is blown.
General	Fault	Incorrect power class	30-036	—
General	Fault	DSP Signal Hardware Failure	30-049	—
General	Fault	DSP Signal Hardware Failure	30-049	—
General	Fault	DSP Signal Hardware Failure	30-049	—
General	Fault	DSAVE active	30-053	—
General	Fault	Ambient Sensor Broken	30-059	—
General	Fault	Parallel cable missing	30-071	—
General	Fault	Parallel timeout	30-078	—
General	Fault	Parallel Identification Error	30-079	—
General	Fault	Parallel impossible	30-080	—
General	Fault	E.P.O.	30-145	—
General	Fault	DSP ADC Serial Comm Failure	30-163	—
General	Fault	DSP Signal Software Failure	30-164	—
General	Fault	Fast De-saturation	30-178	—
General	Fault	High Ambient Temperature	30-202	—

Table A.3 Fault Messages (continued)

Component	Type	Text Display	ID	Description
General	Fault	Input Contact Wiring Error	30-203	—
General	Fault	SMPS DC Supply Failure	30-216	—
General	Fault	SMPS Single AC Supply Failure	30-217	—
General	Fault	SMPS Double AC Supply Failure	30-218	—
Inverter	Fault	E.P.O.	36-034	—
Inverter	Fault	Overtemperature	36-035	Set when the Phase U temperature is greater than the value specified by P 152.
Inverter	Fault	Overtemperature	36-036	Set when the Phase V temperature is greater than the value specified by P 152.
Inverter	Fault	Overtemperature	36-038	Set when the Phase W temperature is greater than the value specified by P 152 (see)
Inverter	Fault	Overload	36-044	Set if the inverter stops for DC bus undervoltage four times in 5 minutes.
Inverter	Fault	Overload	36-045	Set when: Current limit condition occurs at inverter start while the output voltage is ramping up. Current limit condition lasts more then 200 ms Current limit condition set again after 2nd Dynamic line Support
Inverter	Fault	Overload	36-046	Set when the RMS overload counter reaches the end.
Inverter	Fault	DC Overvoltage	36-047	Set when DC voltage +/- is greater than P753.i15 threshold
Inverter	Fault	Output out of tolerance	36-048	Set when Output voltage filtered is above V Nominal + (P106.1 + P107.1 + P118.0 + P105.0) OR Output voltage fast is above V Nominal + (P106.2 + P118.8 + P105.0)
Inverter	Fault	Output out of tolerance	36-049	Set when Output voltage filtered is below V Nominal - (P106.1 + P107.1) OR Output voltage fast is below V Nominal - (P106.2)
Inverter	Fault	Output out of tolerance	36-050	—
Inverter	Fault	Output out of tolerance	36-051	—
Inverter	Fault	Output out of tolerance	36-052	—
Inverter	Fault	Output out of tolerance	36-053	—

Table A.3 Fault Messages (continued)

Component	Type	Text Display	ID	Description
Inverter	Fault	Output out of tolerance	36-054	—
Inverter	Fault	Inverter DC/AC de-saturation	36-055	Desaturation Phase U (Group A)
Inverter	Fault	Inverter DC/AC de-saturation	36-056	Desaturation Phase V (Group A)
Inverter	Fault	Inverter DC/AC de-saturation	36-057	Desaturation Phase W (Group A)
Inverter	Fault	DC Bus undervoltage	36-059	If (Udc < P135.i04) and (rectifier mains within tolerance) AND (rectifier input breaker closed) AND (NO Test Mode) AND (NO HW-Init) AND (60-second delay expired)
Inverter	Fault	Fuse Blown Phase U-A	36-080	Set by M.I. Phase U XP21 pin 7 -8. Indicates output fuse Phase U open.
Inverter	Fault	Fuse Blown Phase V-B	36-081	Set by M.I. Phase V XP21 pin 7 -8. Indicates output fuse Phase V open.
Inverter	Fault	Fuse Blown Phase W-C	36-082	Set by M.I. Phase W XP21 pin 7 -8. Indicates output fuse Phase W open.
Inverter	Fault	Temp Probe Broken Phase U-A	36-104	Inverter temperature sensor fault SW detected; based on M.I. value outside sensor limit interval -15°C < T < +150°C for 60 seconds (P 780.23).
Inverter	Fault	Temp Probe Broken Phase V-B	36-105	Inverter temperature sensor fault SW detected; based on M.I. value outside sensor limit interval -15°C < T < +150°C for 60 seconds (P 780.23).
Inverter	Fault	Temp Probe Broken Phase W-C	36-106	Inverter temperature sensor fault SW detected; based on M.I. value outside sensor limit interval -15°C < T < +150°C for 60 seconds (P 780.23).
Inverter	Fault	Overtemperature Choke Ph. U-A	36-107	Inverter filter overtemperature. Any of Thermal Switch "ALA" (M.I. XP31 Pin 4-9) active.
Inverter	Fault	Overtemperature Choke Ph. V-B	36-108	Inverter filter overtemperature. Any of Thermal Switch "ALA" (M.I. XP31 Pin 4-9) active
Inverter	Fault	Overtemperature Choke Ph. W-C	36-109	Inverter filter over-temperature. Any of Thermal Switch "ALA" (M.I. XP31 Pin 4-9) active
Inverter	Fault	Fuse Blown B Phase U-A	36-122	Set by M.I. Phase U-B XP21 Pin 7 -8. Indicates output fuse Phase U is open.
Inverter	Fault	Fuse Blown B Phase V-B	36-123	Set by M.I. Phase V-B XP21 Pin 7 -8. Indicates output fuse Phase V is open.
Inverter	Fault	Fuse Blown B Phase W-C	36-124	Set by M.I. Phase W-B XP21 Pin 7 -8. Indicates output fuse Phase W is open.
Inverter	Fault	Overtemperature	36-125	Inverter B overtemperature fault Phase U-A
Inverter	Fault	Overtemperature	36-126	Inverter B overtemperature fault Phase V-B

Table A.3 Fault Messages (continued)

Component	Type	Text Display	ID	Description
Inverter	Fault	Overtemperature	36-127	Inverter B overtemperature fault Phase W-C
Inverter	Fault	Inverter DC/AC de-saturation	36-128	De-saturation Phase U group B
Inverter	Fault	Inverter DC/AC de-saturation	36-129	De-saturation Phase V group B
Inverter	Fault	Inverter DC/AC de-saturation	36-130	De-saturation Phase W group B
Inverter	Fault	Temp Probe B Broken Phase U-A	36-131	Inverter temperature sensor fault SW detected; based on M.I. value outside sensor limit interval $-15^{\circ}\text{C} < T < +150^{\circ}\text{C}$ for 60 seconds (P 780.23).
Inverter	Fault	Temp Probe B Broken Phase V-B	36-132	Inverter temperature sensor fault SW detected; based on M.I. value outside sensor limit interval $-15^{\circ}\text{C} < T < +150^{\circ}\text{C}$ for 60 seconds (P 780.23).
Inverter	Fault	Temp Probe B Broken Phase W-C	36-133	Inverter temperature sensor fault SW detected; based on M.I. value outside sensor limit interval $-15^{\circ}\text{C} < T < +150^{\circ}\text{C}$ for 60 seconds (P 780.23).
Inverter	Fault	Overtemperature Choke B Ph. U-A	36-134	Inverter filter overtemperature. Any of Thermal Switch "ALA" (M.I. XP31 Pin 4-9) active.
Inverter	Fault	Overtemperature Choke B Ph. V-B	36-135	Inverter filter overtemperature. Any of Thermal Switch "ALA" (M.I. XP31 Pin 4-9) active.
Inverter	Fault	Overtemperature Choke B Ph. W-C	36-136	Inverter filter overtemperature. Any of Thermal Switch "ALA" (M.I. XP31 Pin 4-9) active.
Rectifier	Fault	E.P.O.	32-024	Depending on application: A02 stops rectifier.
Rectifier	Fault	Rectifier pre-charge failure	32-025	DC bus under threshold P135.101.
Rectifier	Fault	Rectifier pre-charge failure	32-026	DC bus under threshold P135.102.
Rectifier	Fault	Rectifier pre-charge failure	32-027	KM1 feedback not OK.
Rectifier	Fault	Rectifier Temperature fault	32-028	Rectifier Phase U temperature is greater then P 1152 setting (def = 95°C).
Rectifier	Fault	Rectifier Temperature fault	32-029	Rectifier Phase V temperature is greater then P 1152 setting (def = 95°C).
Rectifier	Fault	Rectifier Temperature fault	32-030	Rectifier Phase W temperature is greater then P 1152 setting (def = 95°C).
Rectifier	Fault	Rectifier DC Overvoltage	32-031	DC overvoltage.
Rectifier	Fault	Rectifier de-saturation failure	32-032	De-saturation Phase U (group A)
Rectifier	Fault	Rectifier de-saturation failure	32-033	De-saturation Phase V (group A)
Rectifier	Fault	Rectifier de-saturation failure	32-034	De-saturation Phase W (group A)

Table A.3 Fault Messages (continued)

Component	Type	Text Display	ID	Description
Rectifier	Fault	Rectifier synchronization failure	32-035	During standup, synchronization with the mains is not achieved in XXX sec.
Rectifier	Fault	Rectifier Overcurrent failure	32-036	Set when input current reaches the limit defined by P 1740.11 and last more 30 ms.
Rectifier	Fault	Fuse Blown Phase U-A	32-055	Set by M.I. Phase U XP21 pin 1 -2. Indicates input fuse Phase U open.
Rectifier	Fault	Fuse Blown Phase V-B	32-056	Set by M.I. Phase V XP21 pin 1 -2. Indicates input fuse Phase V open.
Rectifier	Fault	Fuse Blown Phase W-C	32-057	Set by M.I. Phase W XP21 pin 1 -2. Indicates input fuse Phase W open.
Rectifier	Fault	Temp Probe Broken Phase U-A	32-064	Rectifier temperature sensor fault SW detected; based on M.I. value outside sensor limit interval -15°C < T < +150°C for 60 seconds (P 1780.6).
Rectifier	Fault	Temp Probe Broken Phase V-B	32-065	Rectifier temperature sensor fault SW detected; based on M.I. value outside sensor limit interval -15°C < T < +150°C for 60 seconds (P 1780.6).
Rectifier	Fault	Temp Probe Broken Phase W-C	32-066	Rectifier temperature sensor fault SW detected; based on M.I. value outside sensor limit interval -15°C < T < +150°C for 60 seconds (P 1780.6).
Rectifier	Fault	Overtemperature Choke Ph. U-A	32-067	Rectifier filter overtemperature. Any of Thermal Switch "ALA" (M.I. XP31 Pin 1-6) active
Rectifier	Fault	Overtemperature Choke Ph. V-B	32-068	Inverter filter overtemperature. Any of Thermal Switch "ALA" (M.I. XP31 Pin 1-6) active
Rectifier	Fault	Overtemperature Choke Ph. W-C	32-069	Inverter filter overtemperature. Any of Thermal Switch "ALA" (M.I. XP31 Pin 1-6) is active.
Rectifier	Fault	Fuse Blown B Phase U-A	32-076	Set by M.I. Phase U-B XP21 Pin 1 -2. Indicates input fuse Phase U is open.
Rectifier	Fault	Fuse Blown B Phase V-B	32-077	Set by M.I. Phase V-B XP21 Pin 1 -2. Indicates input fuse Phase V is open.
Rectifier	Fault	Fuse Blown B Phase W-C	32-078	Set by M.I. Phase W-B XP21 Pin 1 -2. Indicates input fuse Phase W is open.
Rectifier	Fault	Rectifier Temperature fault	32-079	Rectifier Phase U temperature is greater than P 1152 setting (def = 95°C).
Rectifier	Fault	Rectifier Temperature fault	32-080	Rectifier Phase V temperature is greater than P 1152 setting (def = 95°C).
Rectifier	Fault	Rectifier Temperature fault	32-081	Rectifier Phase W temperature is greater than P 1152 setting (def = 95°C).
Rectifier	Fault	Rectifier De-saturation Failure	32-082	Desaturation Phase U Group B.
Rectifier	Fault	Rectifier De-saturation Failure	32-083	Desaturation Phase V Group B.
Rectifier	Fault	Rectifier De-saturation Failure	32-084	Desaturation Phase W Group B.

Table A.3 Fault Messages (continued)

Component	Type	Text Display	ID	Description
Rectifier	Fault	Temp Probe B Broken Phase U-A	32-085	Rectifier temperature sensor fault SW has been detected; based on M.I. value outside sensor limit interval $-15^{\circ}\text{C} < T < +150^{\circ}\text{C}$ for 60 seconds (P 1780.6).
Rectifier	Fault	Temp Probe B Broken Phase V-B	32-086	Rectifier temperature sensor fault SW detected; based on M.I. value outside sensor limit interval $-15^{\circ}\text{C} < T < +150^{\circ}\text{C}$ foal seconds (P 1780.6).
Rectifier	Fault	Temp Probe B Broken Phase W-C	32-087	Rectifier temperature sensor fault SW detected; based on M.I. value outside sensor limit interval $-15^{\circ}\text{C} < T < +150^{\circ}\text{C}$ for 60 seconds (P 1780.6).
Rectifier	Fault	Overtemperature Choke B Ph. U-A	32-088	Rectifier filter overtemperature. Any of the Thermal Switch "ALA" (M.I. XP31 pin 1-6) active.
Rectifier	Fault	Overtemperature Choke B Ph. V-B	32-089	Inverter filter overtemperature. Any of the Thermal Switch "ALA" (M.I. XP31 pin 1-6) is active.
Rectifier	Fault	Overtemperature Choke B Ph. W-C	32-090	Inverter filter overtemperature. Any of the Thermal Switch "ALA" (M.I. XP31 pin 1-6) is active.

This page intentionally left blank

Appendix B: Performance Data

The technical illustrations are in the order of the drawing part number. **Table B.1** below, groups the drawings by topic/application.

Table B.1 Performance Data Graph

Drawing Number	Model Size
Inverter AC-AC Efficiency	
ES1-18-S062	250kVA/kW
ES1-18-S019	300kVA/kW
ES1-18-S025	400kVA/kW, 415V
ES1-18-S020	400kVA/kW, 480V
ES1-18-S026	500kVA/kW, 415V
ES1-18-S021	500kVA/kW, 480V
ES1-18-S022	600kVA/kW
ES1-18-S007	625kVA/kW
ES1-18-S008	750kVA/kW
ES1-18-S009	800kVA/kW
ES1-18-S001	1000kVA/kW
ES1-18-S002	1100kVA/kW
ES1-18-S003	1200kVA/kW
Inverter DC-AC Efficiency	
ES1-18-S063	250kVA/kW
ES1-18-S027	300kVA/kW
ES1-18-S033	400kVA/kW, 415V
ES1-18-S028	400kVA/kW, 480V
ES1-18-S034	500kVA/kW, 415V
ES1-18-S029	500kVA/kW, 480V
ES1-18-S030	600kVA/kW
ES1-18-S010	625kVA/kW
ES1-18-S011	750kVA/kW
ES1-18-S012	800kVA/kW
ES1-18-S004	1000kVA/kW
ES1-18-S005	1100kVA/kW
ES1-18-S006	1200kVA/kW
ECO Mode AC-AC Efficiencies	

Table B.1 Performance Data Graph (continued)

Drawing Number	Model Size
ES1-18-S064	250kVA/kW
ES1-18-S035	300kVA/kW
ES1-18-S041	400kVA/kW, 415V
ES1-18-0036	400kVA/KW, 480V
ES1-18-0042	500kVA/KW, 415V
ES1-18-0037	500kVA/KW, 480V
ES1-18-0038	600kVA/KW
ES1-18-0014	750kVA/KW
ES1-18-0015	800kVA/KW
ES1-18-0016	1000kVA/KW
ES1-18-0017	1100kVA/KW
ES1-18-0018	1200kVA/KW
Dynamic Online Mode AC-AC Efficiencies	
ES1-18-S051	250kVA/kW
ES1-18-S052	300kVA/kW
ES1-18-S049	400kVA/kW, 415V
ES1-18-S053	400kVA/KW, 480V
ES1-18-S050	500kVA/KW, 415V
ES1-18-S054	500kVA/KW, 480V
ES1-18-S055	600kVA/KW
ES1-18-S056	625kVA/KW
ES1-18-S057	750kVA/KW
ES1-18-S058	800kVA/KW
ES1-18-0059	1000kVA/KW
ES1-18-0060	1100kVA/KW
ES1-18-0061	1200kVA/KW
Inverter Overload Curves	
ES1-18-S045	Inverter Overload Curves, Temperature v. Time
Bypass Overload Curves	
ES1-18-S0046	Bypass Overload Curves, Temperature v. Time

Appendix C: Liebert® EXL S1 Efficiency Curves

- NOTES
 1. NO LOAD POWER LOSS: 2.8kW
 2. MEASUREMENTS TAKEN WITH DC/DC CONVERTER OPERATING, NO DC SOURCE CONNECTED.

EXL S1 250kVA AC/AC EFFICIENCIES

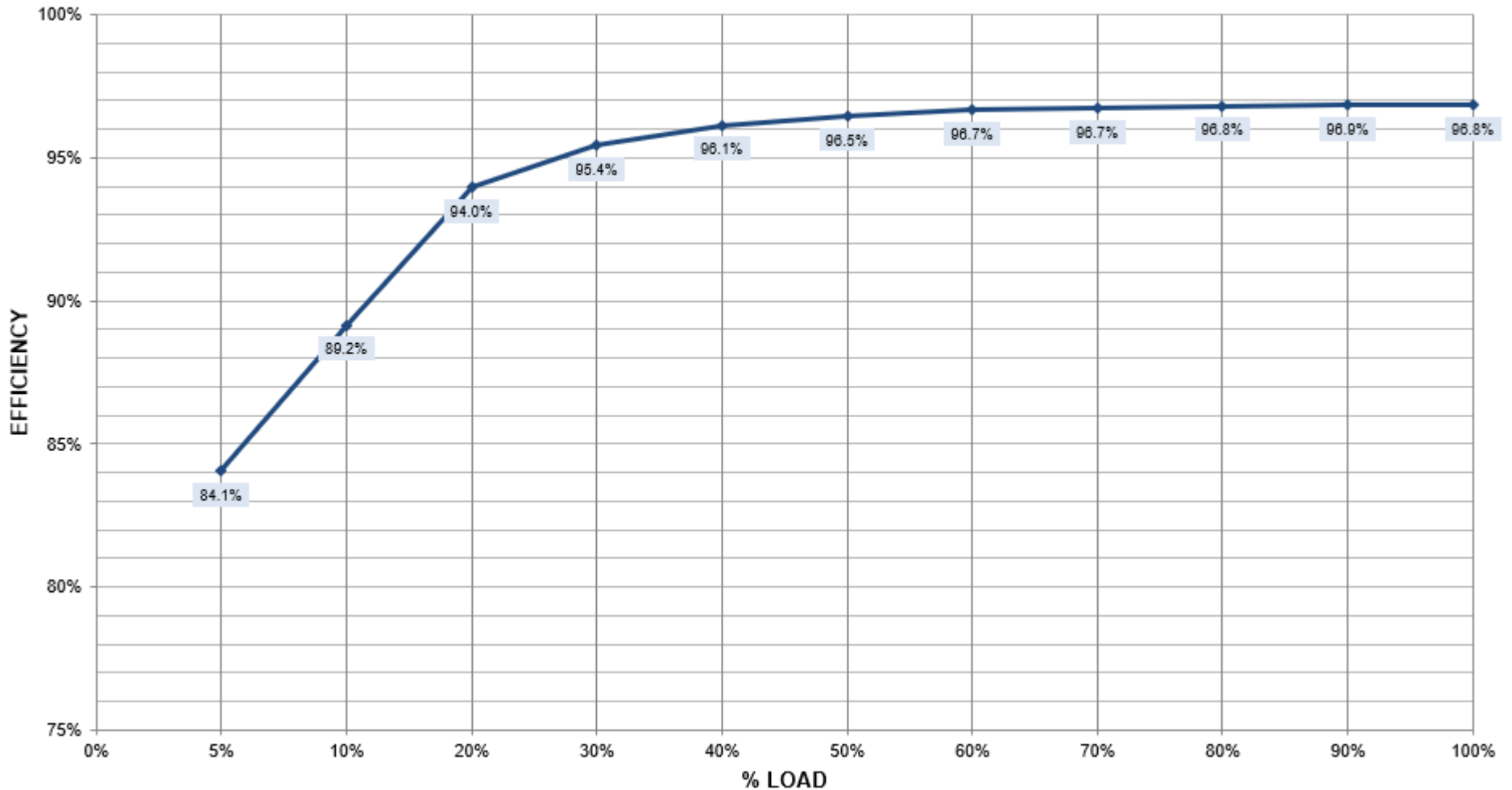

SHEET NO. 1 OF 1	DRAWN BY: JASON ZHANG
ECN NO. ECN NO	DESIGNED BY: JASON ZHANG
REF DWG. REF DWG	APPROVED BY: S. MAJOR

TITLE MODULE AC/AC EFFICIENCY TYPICAL, SMS AND 1+N 250kVA/250kW 480V 60Hz LIEBERT EXL S1	
--	--

DWG. NO. ES1-18-S062
DATE (LATEST REV.) 1/16/2020
REVISION 0
1050 DEARBORN DR P.O. BOX 29186 COLUMBUS, OH 43229



NOTES

1. NO LOAD POWER LOSS: 2.8kW
2. MEASUREMENTS TAKEN WITH DC/DC CONVERTER OPERATING, NO DC SOURCE CONNECTED.

EXL S1 300kVA AC/AC EFFICIENCIES

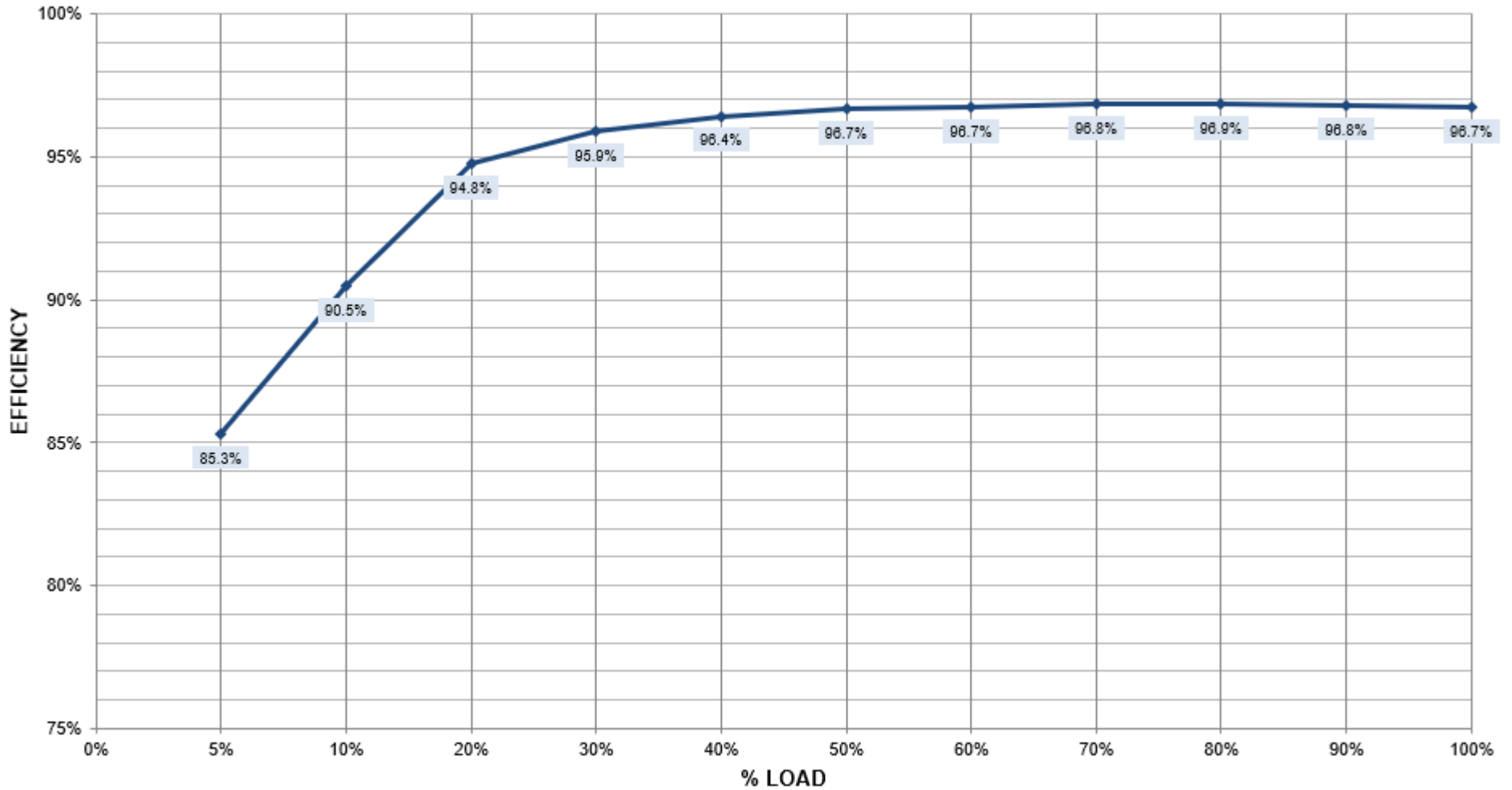

SHEET NO. 1 OF 1	DRAWN BY: JASON ZHANG
ECN NO. ECN NO	DESIGNED BY: JASON ZHANG
REF DWG. REF DWG	APPROVED BY: S. MAJOR

<p>MODULE AC/AC EFFICIENCY TYPICAL, SMS AND 1+N 300kVA/300kW 480V 60Hz LIEBERT EXL S1</p>	
--	--

DWG. NO. ES1-18-S019
DATE (LATEST REV.) 1/16/2020
REVISION 0
1050 DEARBORN DR P.O. BOX 29186 COLUMBUS, OH 43229



NOTES

1. NO LOAD POWER LOSS: 4.2 kW
2. MEASUREMENTS TAKEN WITH DC/DC CONVERTER OPERATING, NO DC SOURCE CONNECTED.

EXL S1 400kVA AC/AC EFFICIENCIES

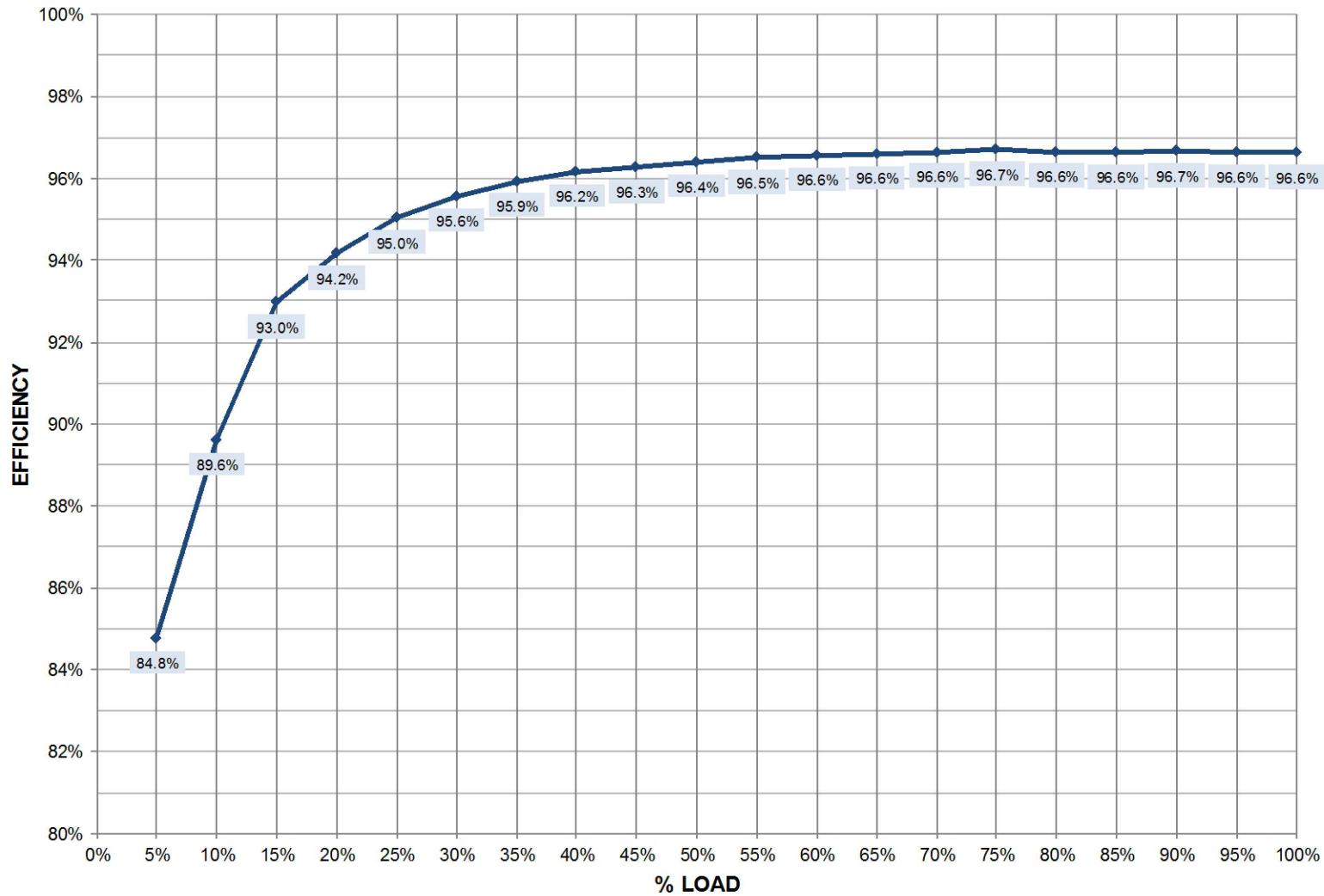

SHEET NO. 1 OF 1	DRAWN BY: J. SHIPMAN
ECN NO.	DESIGNED BY: S. MAJOR
REF DWG.	APPROVED BY: S. MAJOR

TITLE

**MODULE AC/AC EFFICIENCY
TYPICAL, SMS AND 1+N 400kVA/400kW
415V 60Hz
LIEBERT EXL S1**

DWG. NO. ES1-18-S025
DATE (LATEST REV.) 11/16/2018
REVISION 0



1050 DEARBORN DR
P.O. BOX 29186
COLUMBUS, OH 43229

NOTES

1. NO LOAD POWER LOSS: 2.8kW
2. MEASUREMENTS TAKEN WITH DC/DC CONVERTER OPERATING, NO DC SOURCE CONNECTED.

EXL S1 400kVA AC/AC EFFICIENCIES

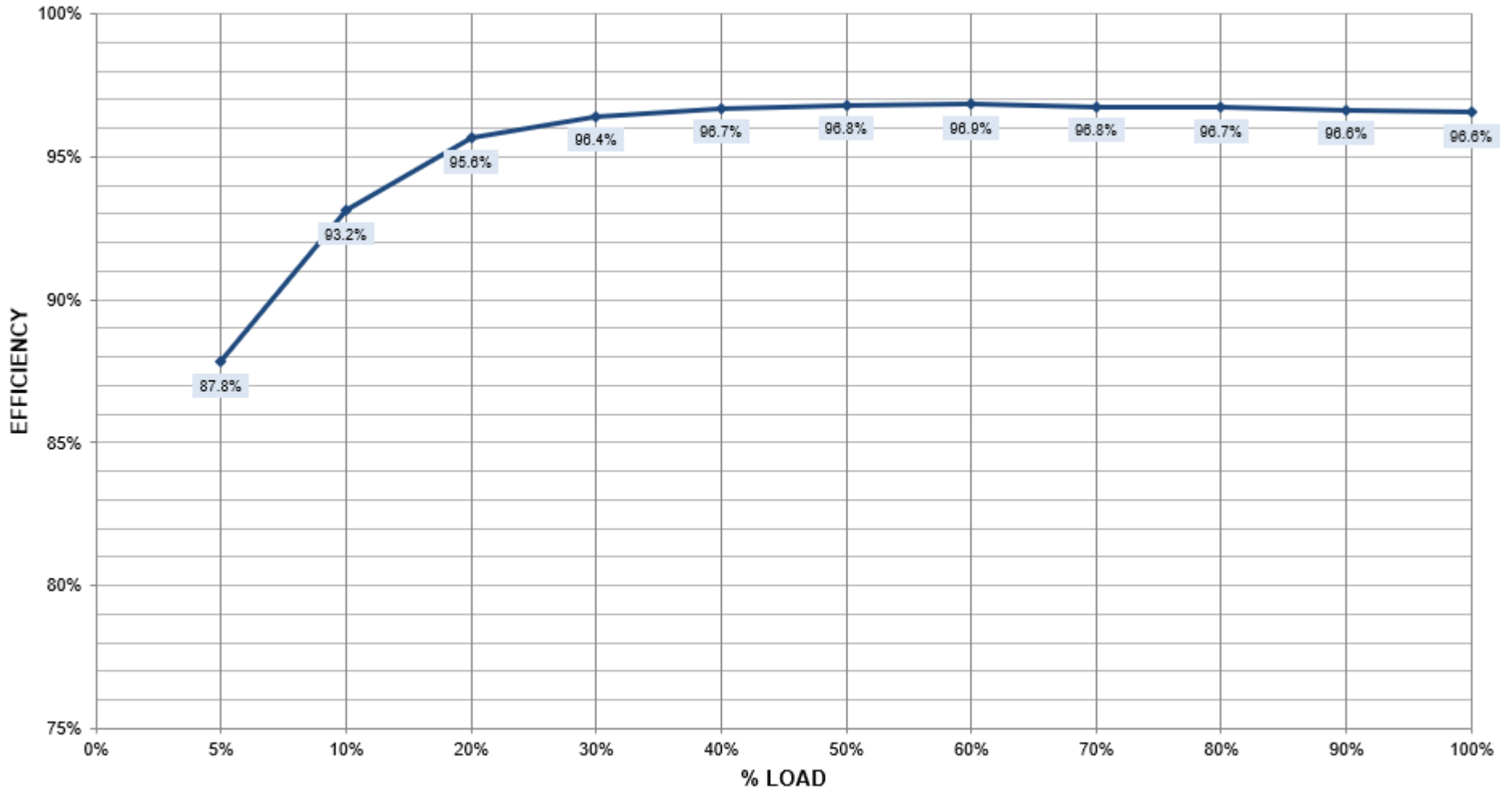

SHEET NO. 1 OF 1	DRAWN BY: JASON ZHANG
ECN NO. ECN NO	DESIGNED BY: JASON ZHANG
REF DWG. REF DWG	APPROVED BY: S. MAJOR

TITLE MODULE AC/AC EFFICIENCY TYPICAL, SMS AND 1+N 400kVA/400kW 480V 60Hz LIEBERT EXL S1
--

DWG. NO. ES1-18-S020
DATE (LATEST REV.) 1/16/2020
REVISION 0
1050 DEARBORN DR P.O. BOX 29186 COLUMBUS, OH 43229



NOTES

1. NO LOAD POWER LOSS: 4.2 kW
2. MEASUREMENTS TAKEN WITH DC/DC CONVERTER OPERATING, NO DC SOURCE CONNECTED.

EXL S1 500kVA AC/AC EFFICIENCIES

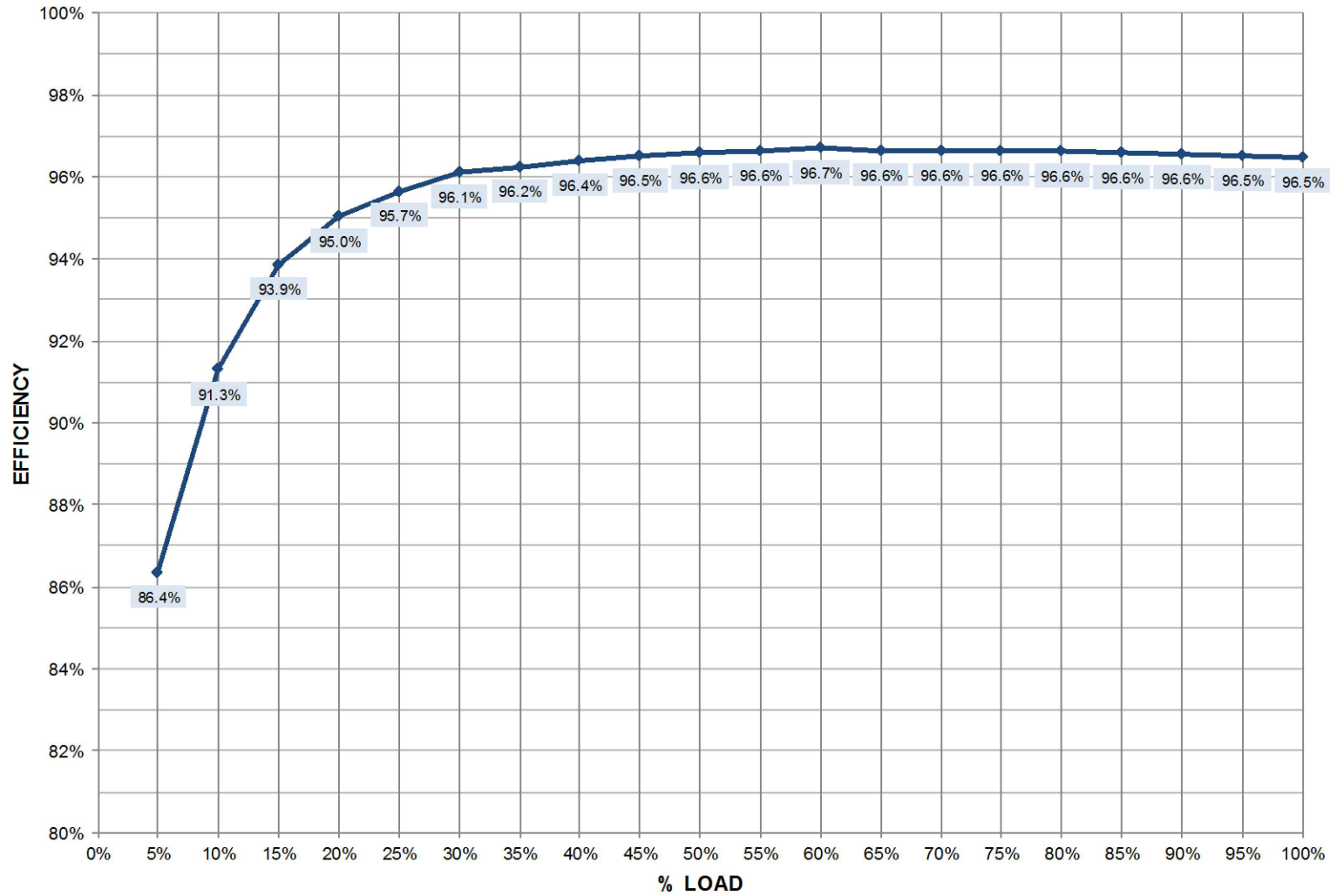

SHEET NO. 1 OF 1	DRAWN BY: J. SHIPMAN
ECN NO.	DESIGNED BY: S. MAJOR
REF DWG.	APPROVED BY: S. MAJOR

TITLE MODULE AC/AC EFFICIENCY TYPICAL, SMS AND 1+N 500kVA/500kW 415V 60Hz LIEBERT EXL S1
--

DWG. NO. ES1-18-S026
DATE (LATEST REV.) 11/16/2018
REVISION 0

	VERTIV™
1050 DEARBORN DR P.O. BOX 29186 COLUMBUS, OH 43229	

NOTES

1. NO LOAD POWER LOSS: 4.2 kW
2. MEASUREMENTS TAKEN WITH DC/DC CONVERTER OPERATING, NO DC SOURCE CONNECTED.

EXL S1 500kVA AC/AC EFFICIENCIES

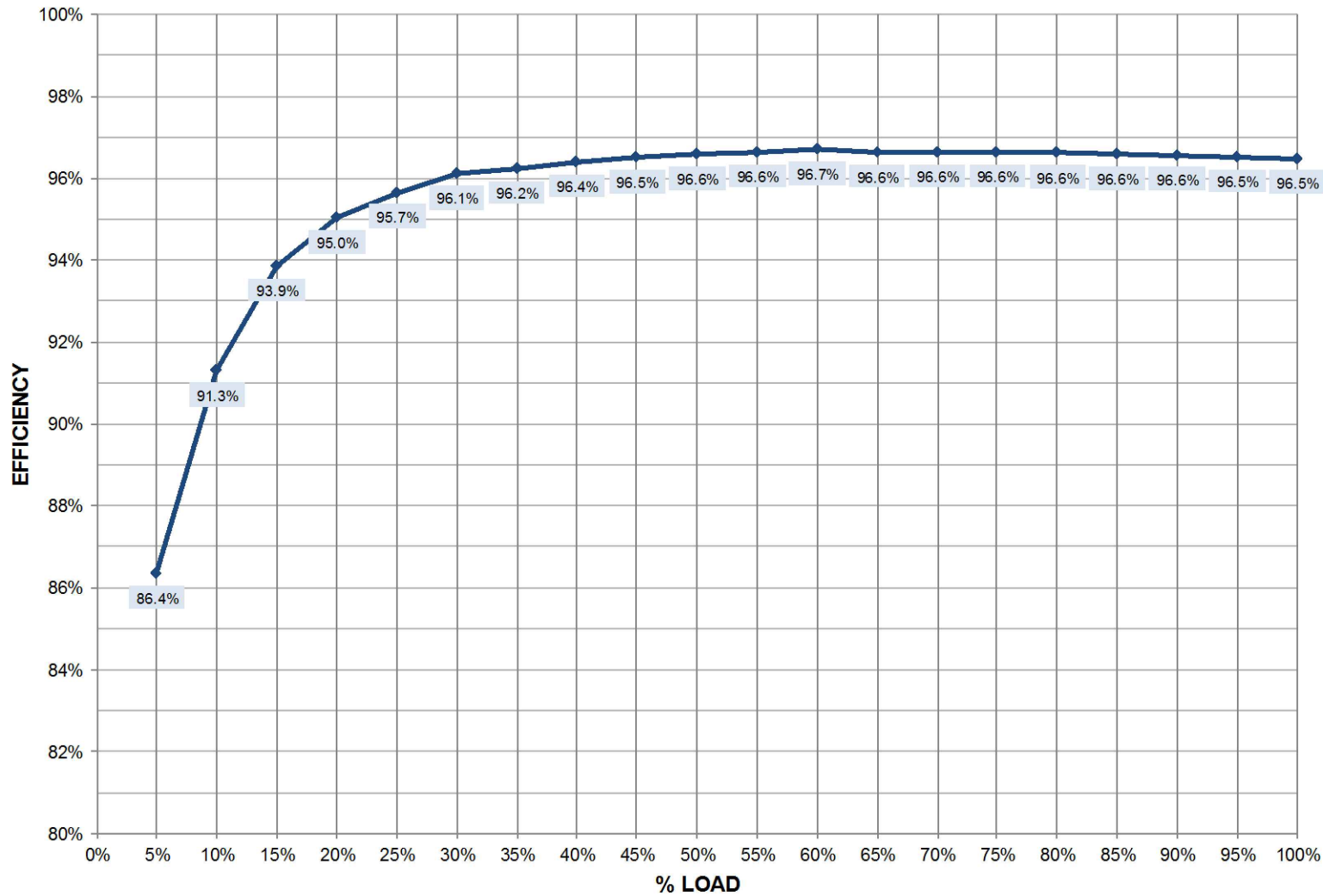

SHEET NO. 1 OF 1	DRAWN BY: J. SHIPMAN
ECN NO.	DESIGNED BY: S. MAJOR
REF DWG.	APPROVED BY: S. MAJOR

MODULE AC/AC EFFICIENCY
TYPICAL, SMS AND 1+N 500kVA/500kW
480V 60Hz
LIEBERT EXL S1

DWG. NO. ES1-18-S021
DATE (LATEST REV.) 11/16/2018
REVISION 0

1050 DEARBORN DR
P.O. BOX 29186
COLUMBUS, OH 43229



NOTES

1. NO LOAD POWER LOSS: 4.2 kW
2. MEASUREMENTS TAKEN WITH DC/DC CONVERTER OPERATING, NO DC SOURCE CONNECTED.

EXL S1 600kVA AC/AC EFFICIENCIES

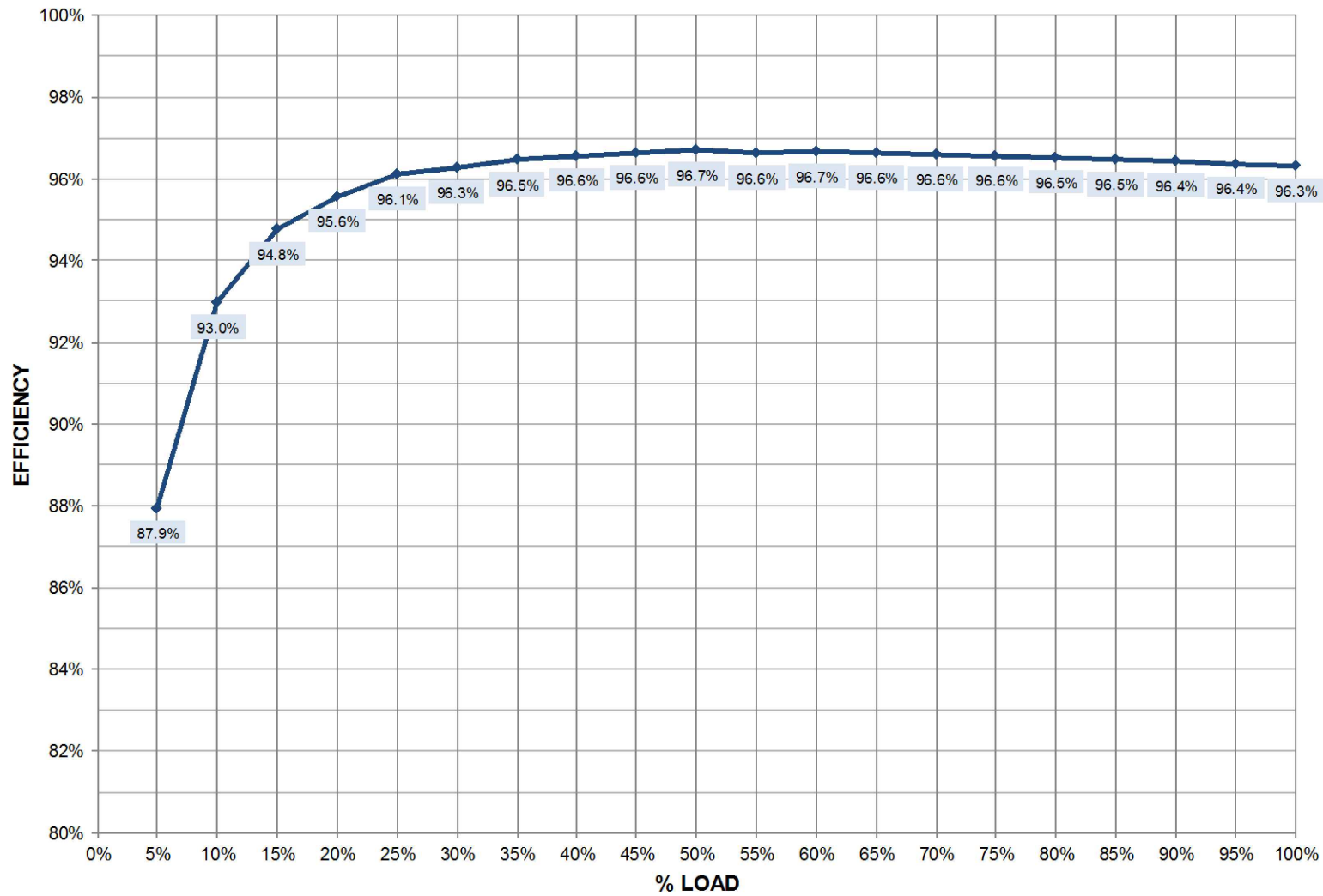

SHEET NO. 1 OF 1	DRAWN BY: J. SHIPMAN
ECN NO.	DESIGNED BY: S. MAJOR
REF DWG.	APPROVED BY: S. MAJOR

TITLE MODULE AC/AC EFFICIENCY TYPICAL, SMS AND 1+N 600kVA/600kW 480V 60Hz LIEBERT EXL S1
--

DWG. NO. ES1-18-S022
DATE (LATEST REV.) 11/16/2018
REVISION 0

1050 DEARBORN DR
P.O. BOX 29186
COLUMBUS, OH 43229



NOTES

1. NO LOAD POWER LOSS: 5.4 kW
2. MEASUREMENTS TAKEN WITH DC/DC CONVERTER OPERATING, NO DC SOURCE CONNECTED.

EXL S1 625kVA AC/AC EFFICIENCIES

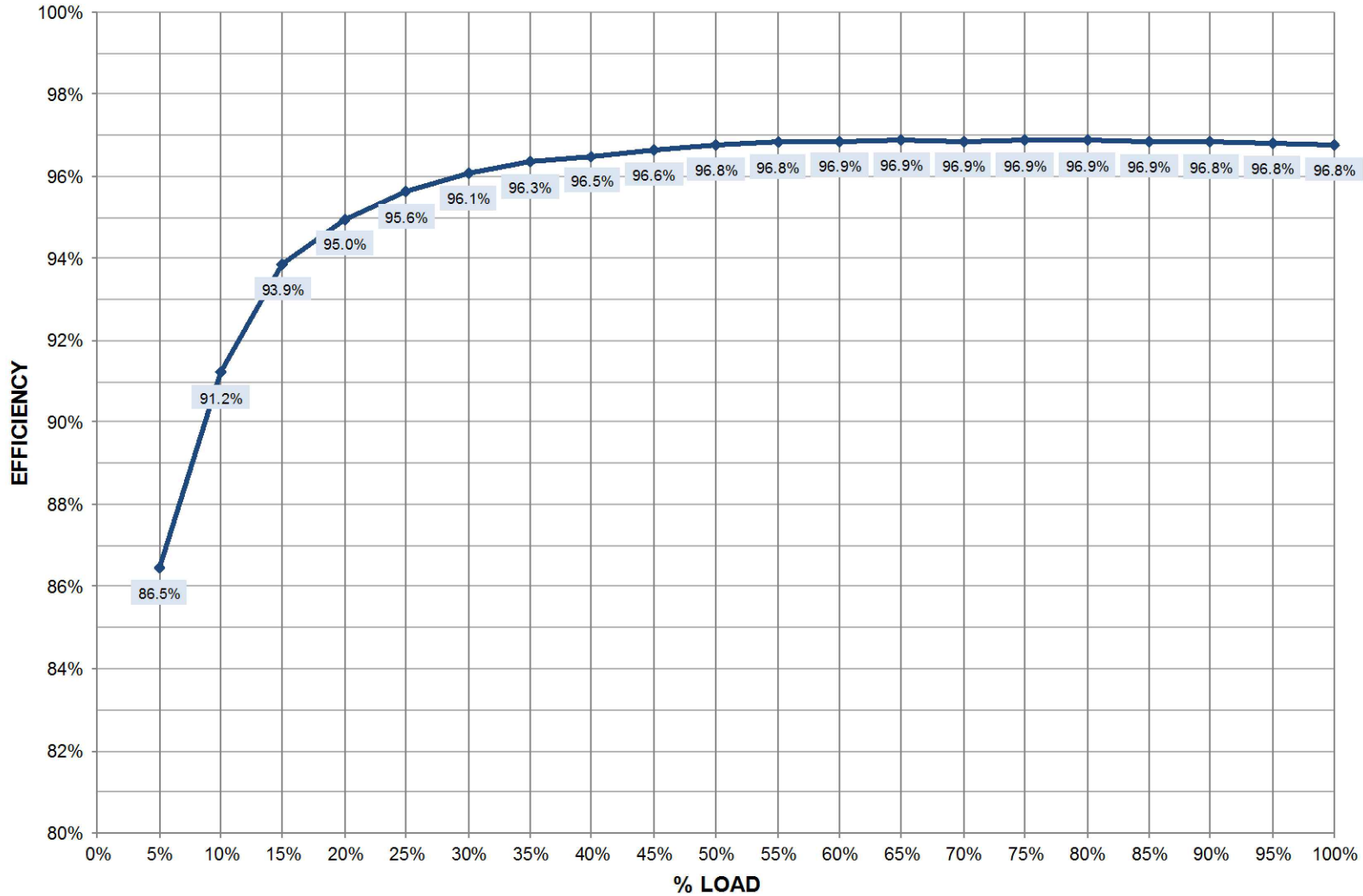

SHEET NO. 1 OF 1	DRAWN BY: J. SHIPMAN
ECN NO.	DESIGNED BY: S. MAJOR
REF DWG.	APPROVED BY: S. MAJOR

TITLE MODULE AC/AC EFFICIENCY SMS 625kVA/625kW, TYPICAL 480V 60Hz LIEBERT EXL S1
--

DWG. NO. ES1-18-S007
DATE (LATEST REV.) 10/10/2017
REVISION 0

1050 DEARBORN DR
P.O. BOX 29186
COLUMBUS, OH 43229



NOTES

1. NO LOAD POWER LOSS: 5.4 kW
2. MEASUREMENTS TAKEN WITH DC/DC CONVERTER OPERATING, NO DC SOURCE CONNECTED.

EXL S1 750kVA AC/AC EFFICIENCIES

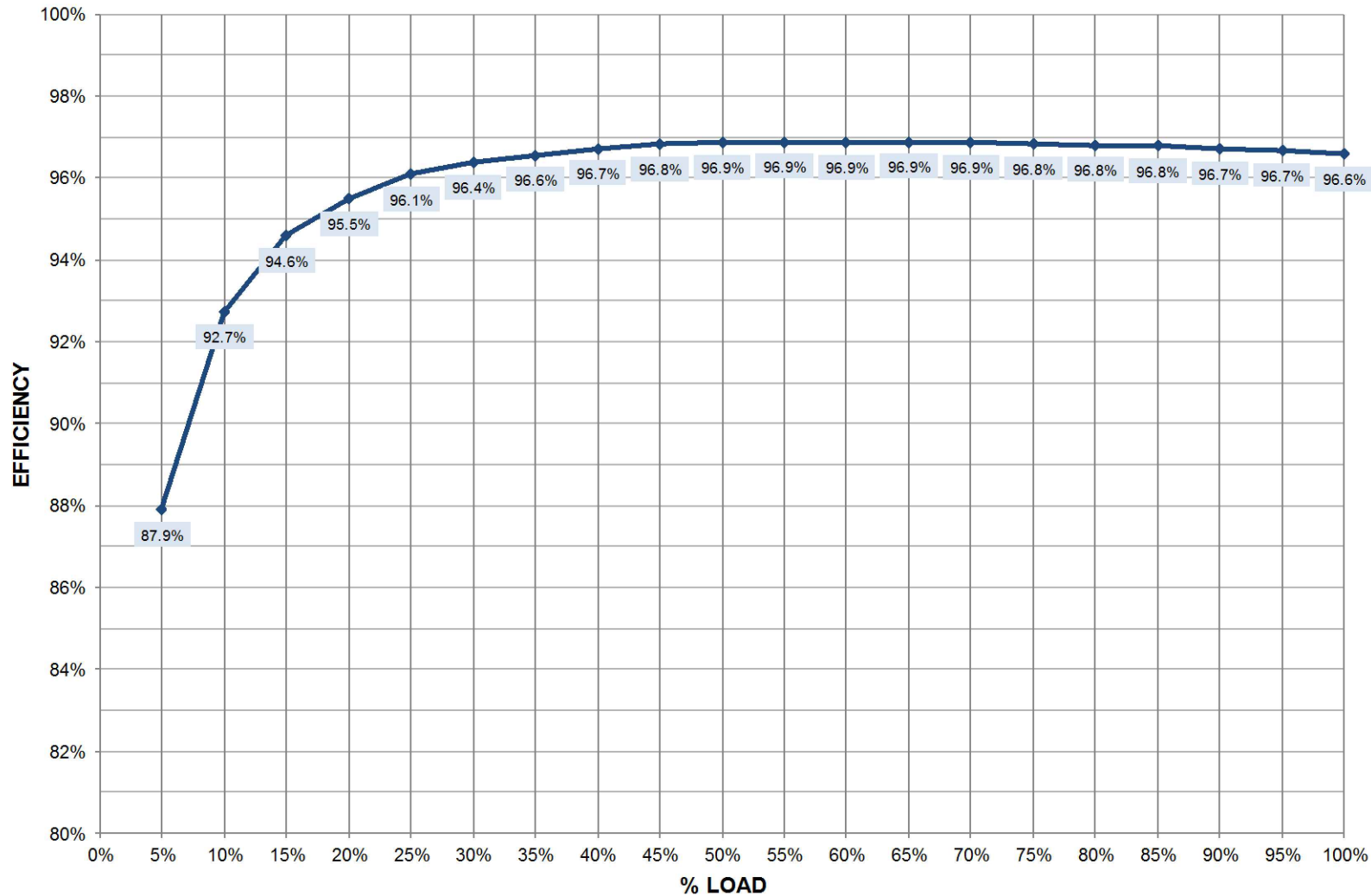

SHEET NO. 1 OF 1	DRAWN BY: J. SHIPMAN
ECN NO.	DESIGNED BY: S. MAJOR
REF DWG.	APPROVED BY: S. MAJOR

TITLE MODULE AC/AC EFFICIENCY SMS 750kVA/750kW, TYPICAL 480V 60Hz LIEBERT EXL S1
--

DWG. NO. ES1-18-S008
DATE (LATEST REV.) 10/10/2017
REVISION 0

1050 DEARBORN DR
P.O. BOX 29186
COLUMBUS, OH 43229



NOTES

1. NO LOAD POWER LOSS: 5.4 kW
2. MEASUREMENTS TAKEN WITH DC/DC CONVERTER OPERATING, NO DC SOURCE CONNECTED.

EXL S1 800kVA AC/AC EFFICIENCIES

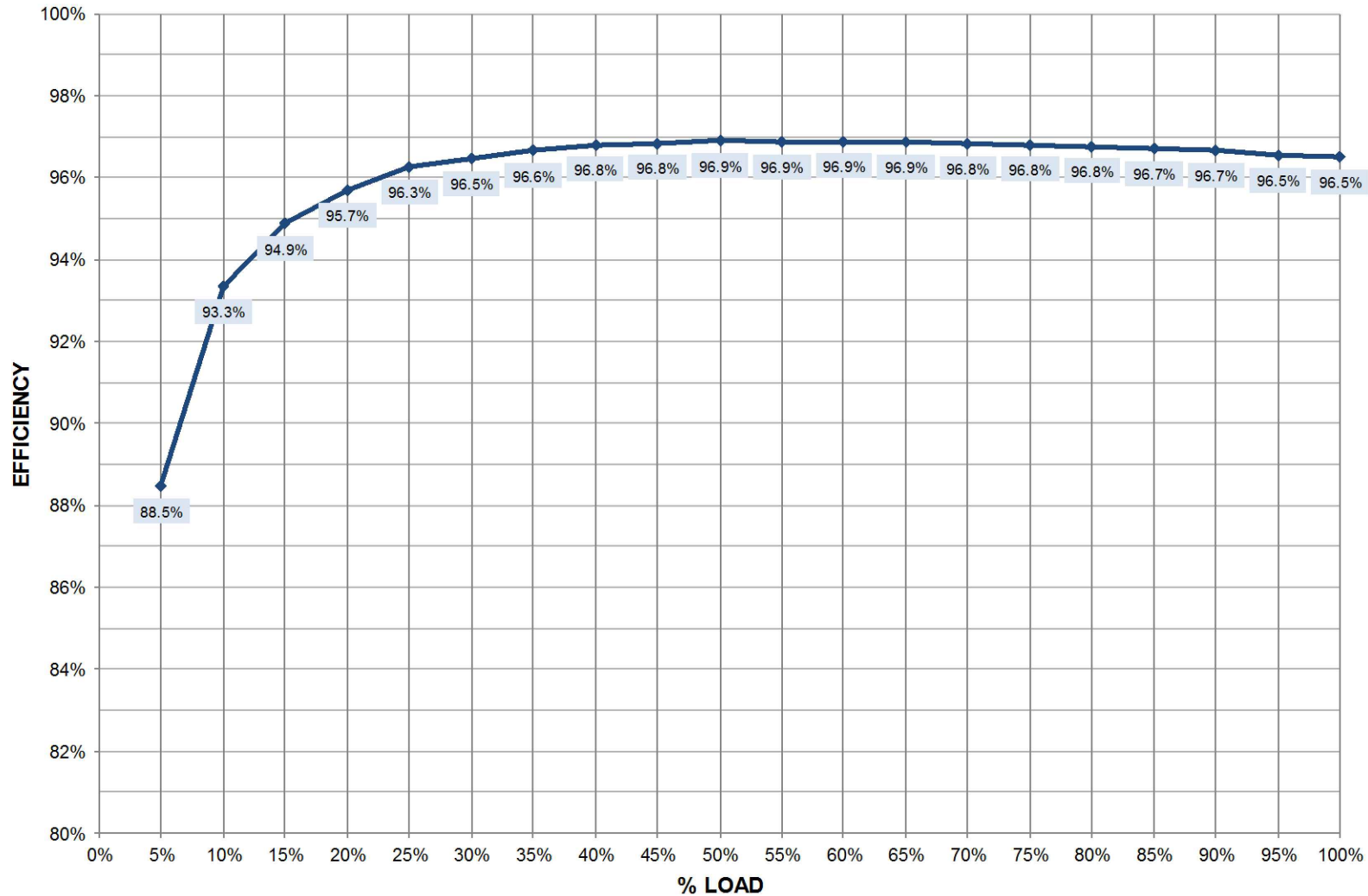

SHEET NO. 1 OF 1	DRAWN BY: J. SHIPMAN
ECN NO.	DESIGNED BY: S. MAJOR
REF DWG.	APPROVED BY: S. MAJOR

TITLE MODULE AC/AC EFFICIENCY SMS 800kVA/800kW, TYPICAL 480V 60Hz LIEBERT EXL S1
--

DWG. NO. ES1-18-S009
DATE (LATEST REV.) 10/10/2017
REVISION 0



1050 DEARBORN DR
P.O. BOX 29186
COLUMBUS, OH 43229

NOTES

1. NO LOAD POWER LOSS: 7.9 kW
2. MEASUREMENTS TAKEN WITH DC/DC CONVERTER OPERATING, NO DC SOURCE CONNECTED.

EXL S1 1000kVA AC/AC EFFICIENCIES

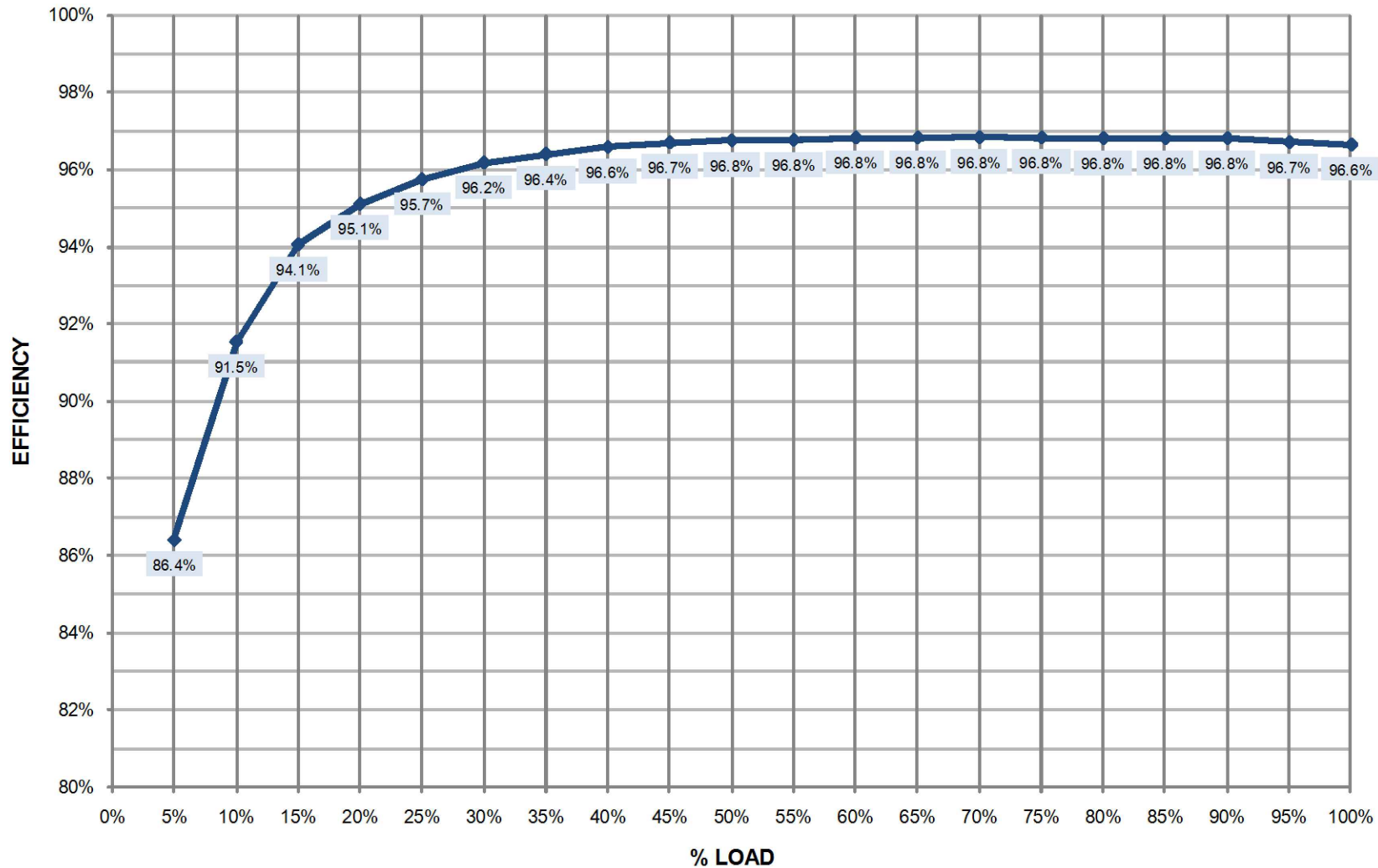

SHEET NO. 1 OF 1	DRAWN BY: J. SHIPMAN
ECN NO.	DESIGNED BY: S. MAJOR
REF DWG.	APPROVED BY: S. MAJOR

TITLE
**MODULE AC/AC EFFICIENCY
 SMS 1000kVA/1000kW, TYPICAL
 480V 60Hz
 LIEBERT EXL S1**

DWG. NO. ES1-18-S001
DATE (LATEST REV.) 06/162017
REVISION 1

1050 DEARBORN DR
 P.O. BOX 29186
 COLUMBUS, OH 43229



NOTES

1. NO LOAD POWER LOSS: 7.9 kW
2. MEASUREMENTS TAKEN WITH DC/DC CONVERTER OPERATING, NO DC SOURCE CONNECTED.

EXL S1 1100kVA AC/AC EFFICIENCIES

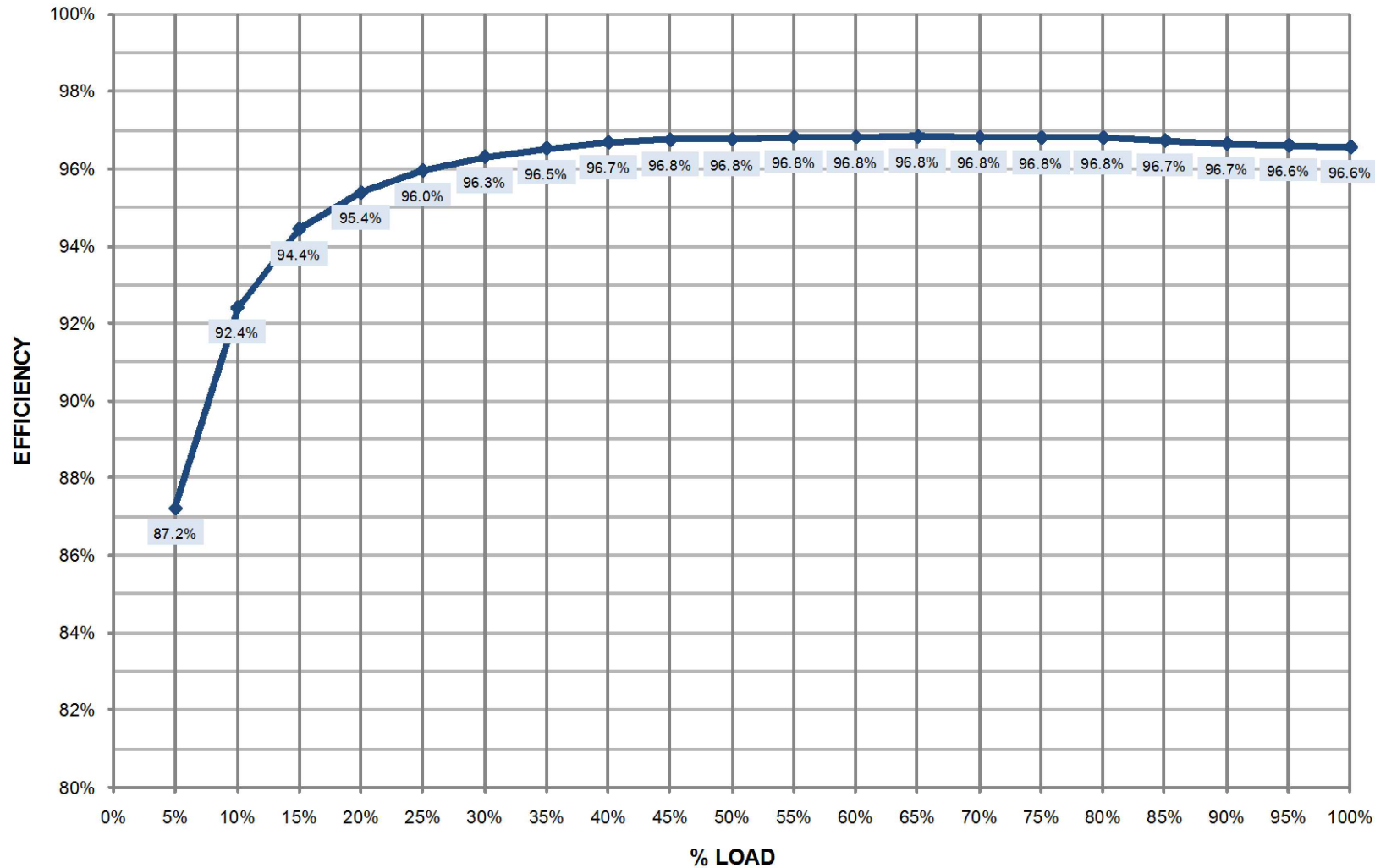

SHEET NO. 1 OF 1	DRAWN BY: J. SHIPMAN
ECN NO.	DESIGNED BY: S. MAJOR
REF DWG.	APPROVED BY: S. MAJOR

TITLE MODULE AC/AC EFFICIENCY SMS 1100kVA/1100kW, TYPICAL 480V 60Hz LIEBERT EXL S1
--

DWG. NO. ES1-18-S002
DATE (LATEST REV.) 06/16/2017
REVISION 1



1050 DEARBORN DR
P.O. BOX 29186
COLUMBUS, OH 43229

NOTES

1. NO LOAD POWER LOSS: 7.9 kW
2. MEASUREMENTS TAKEN WITH DC/DC CONVERTER OPERATING, NO DC SOURCE CONNECTED.

EXL S1 1200kVA AC/AC EFFICIENCIES

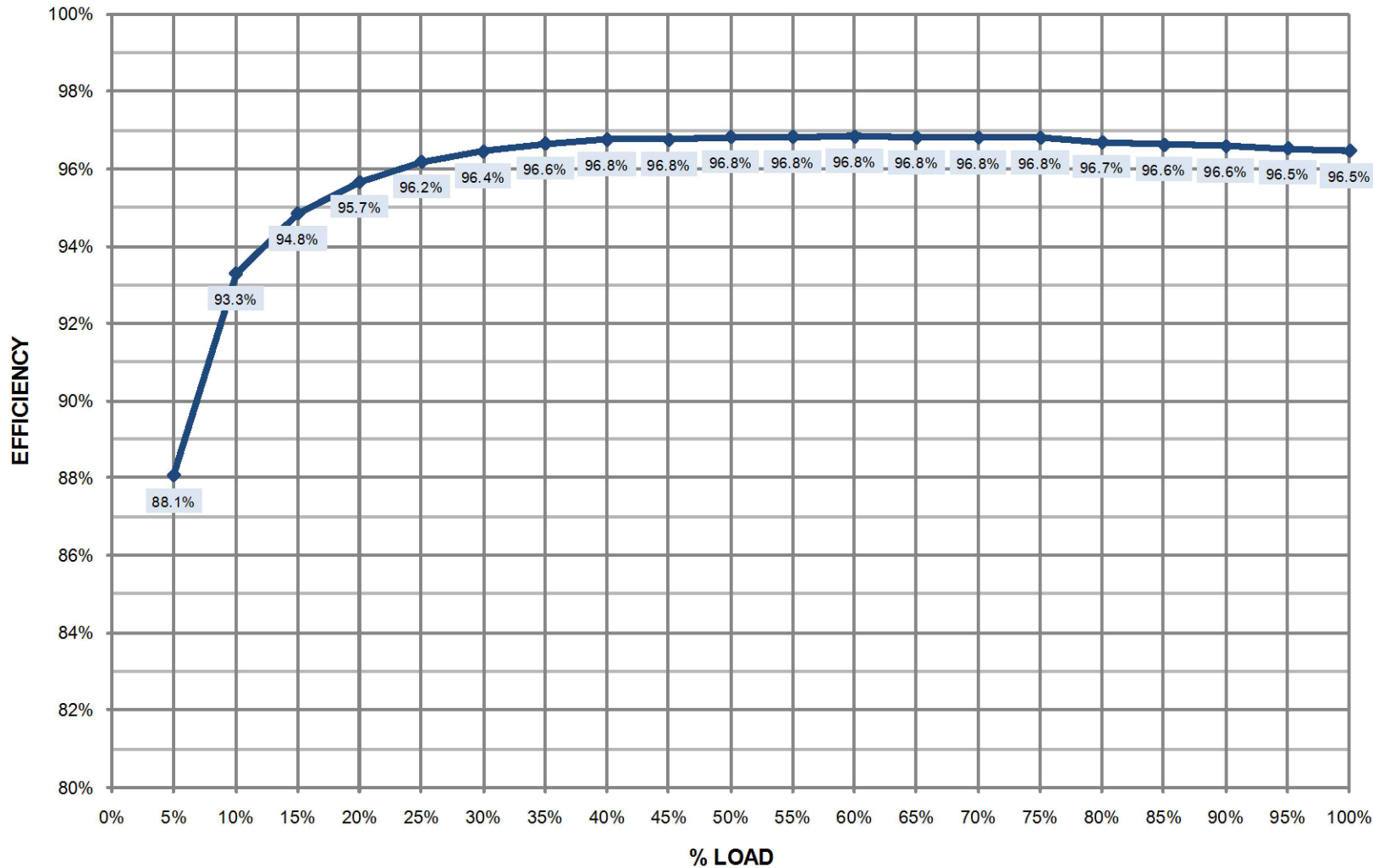

SHEET NO. 1 OF 1	DRAWN BY: J. SHIPMAN
ECN NO.	DESIGNED BY: S. MAJOR
REF DWG.	APPROVED BY: S. MAJOR

TITLE
**MODULE AC/AC EFFICIENCY
 SMS 1200kVA/1200kW, TYPICAL
 480V 60Hz
 LIEBERT EXL S1**

DWG. NO. ES1-18-S003
DATE (LATEST REV.) 06/16/2017
REVISION 1

1050 DEARBORN DR
 P.O. BOX 29186
 COLUMBUS, OH 43229



- NOTES
1. NO LOAD POWER LOSS: 2.8kW
 2. MEASUREMENTS TAKEN WITH DC/DC CONVERTER OPERATING, NO DC SOURCE CONNECTED.

EXL S1 250kVA DC/AC EFFICIENCIES

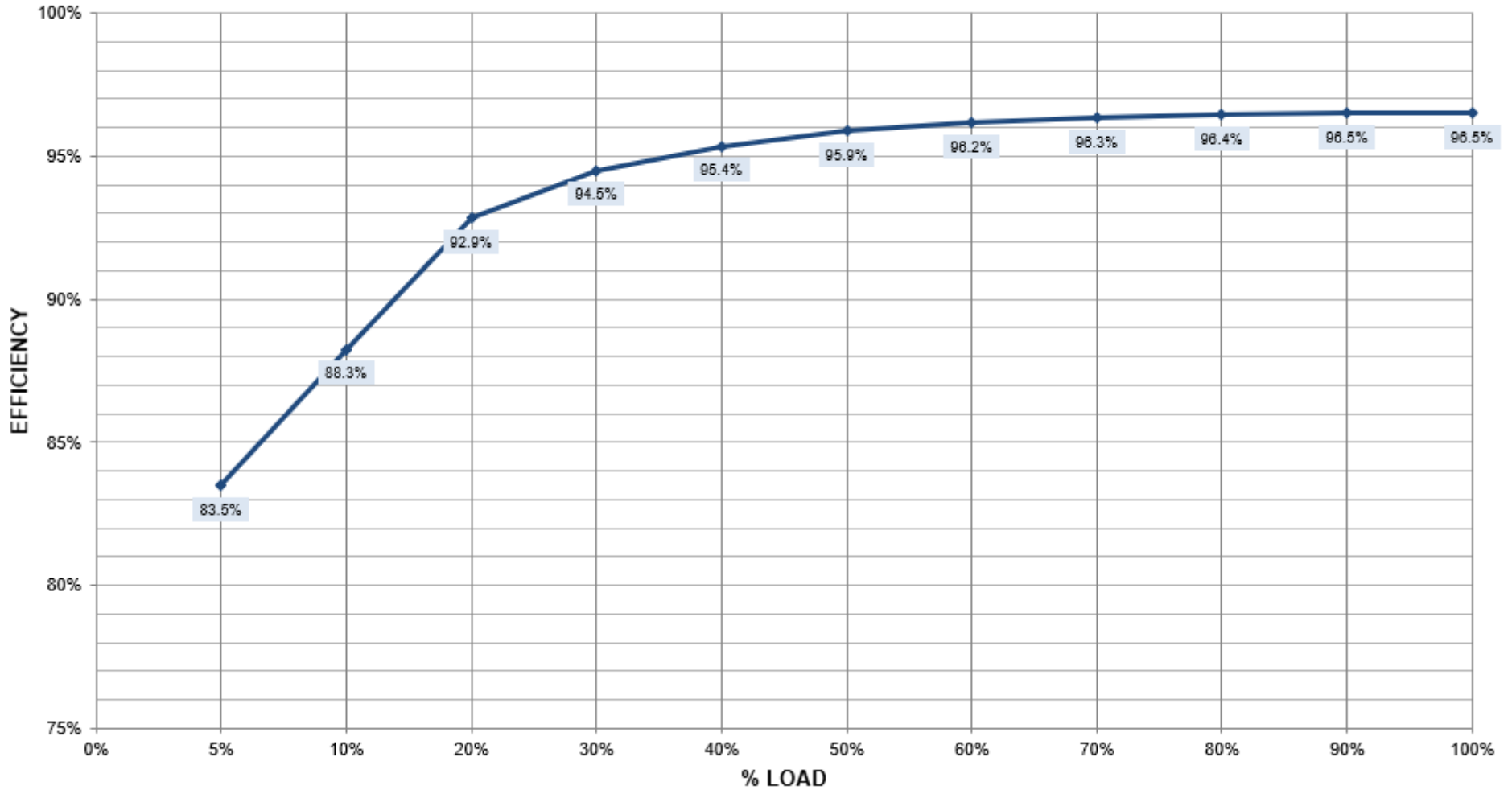

SHEET NO. 1 OF 1	DRAWN BY: JASON ZHANG
ECN NO. ECN NO	DESIGNED BY: JASON ZHANG
REF DWG. REF DWG	APPROVED BY: S. MAJOR

TITLE MODULE DC/AC EFFICIENCY TYPICAL, SMS AND 1+N 250kVA/250kW 480V 60Hz LIEBERT EXL S1
--

DWG. NO. ES1-18-S063
DATE (LATEST REV.) 1/16/2020
REVISION 0
1050 DEARBORN DR P.O. BOX 29186 COLUMBUS, OH 43229



- NOTES
 1. NO LOAD POWER LOSS: 2.8kW
 2. MEASUREMENTS TAKEN WITH DC/DC CONVERTER OPERATING, NO DC SOURCE CONNECTED.

EXL S1 300kVA DC/AC EFFICIENCIES

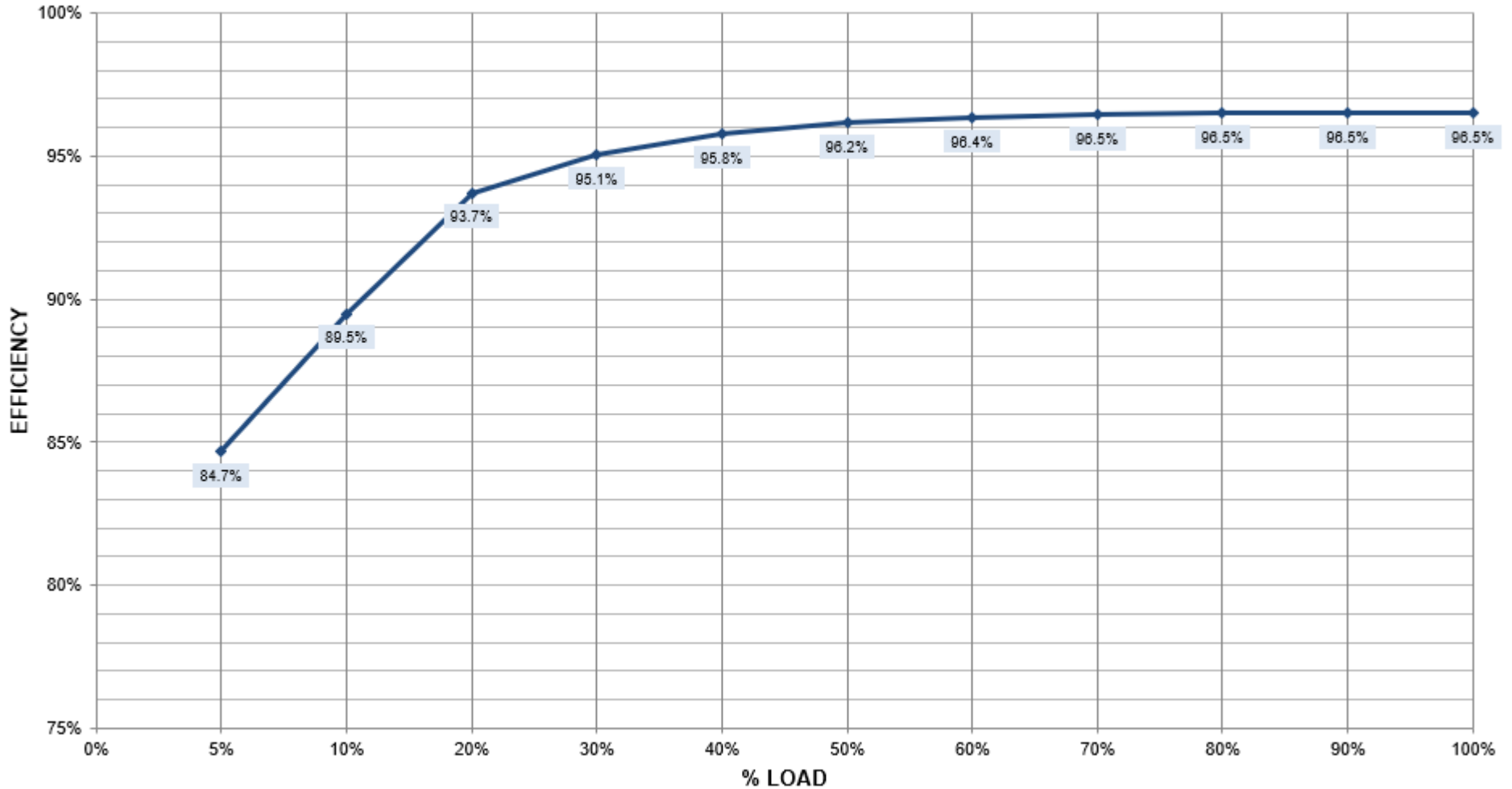

SHEET NO. 1 OF 1	DRAWN BY: JASON ZHANG
ECN NO. ECN NO	DESIGNED BY: JASON ZHANG
REF DWG. REF DWG	APPROVED BY: S. MAJOR

TITLE MODULE DC/AC EFFICIENCY TYPICAL, SMS AND 1+N 300kVA/300kW 480V 60Hz LIEBERT EXL S1

DWG. NO. ES1-18-S027
DATE (LATEST REV.) 1/16/2020
REVISION 0
1050 DEARBORN DR P.O. BOX 29186 COLUMBUS, OH 43229



NOTES

- 1. NO LOAD POWER LOSS: 4.2 kW

EXL S1 400kVA DC/AC EFFICIENCIES

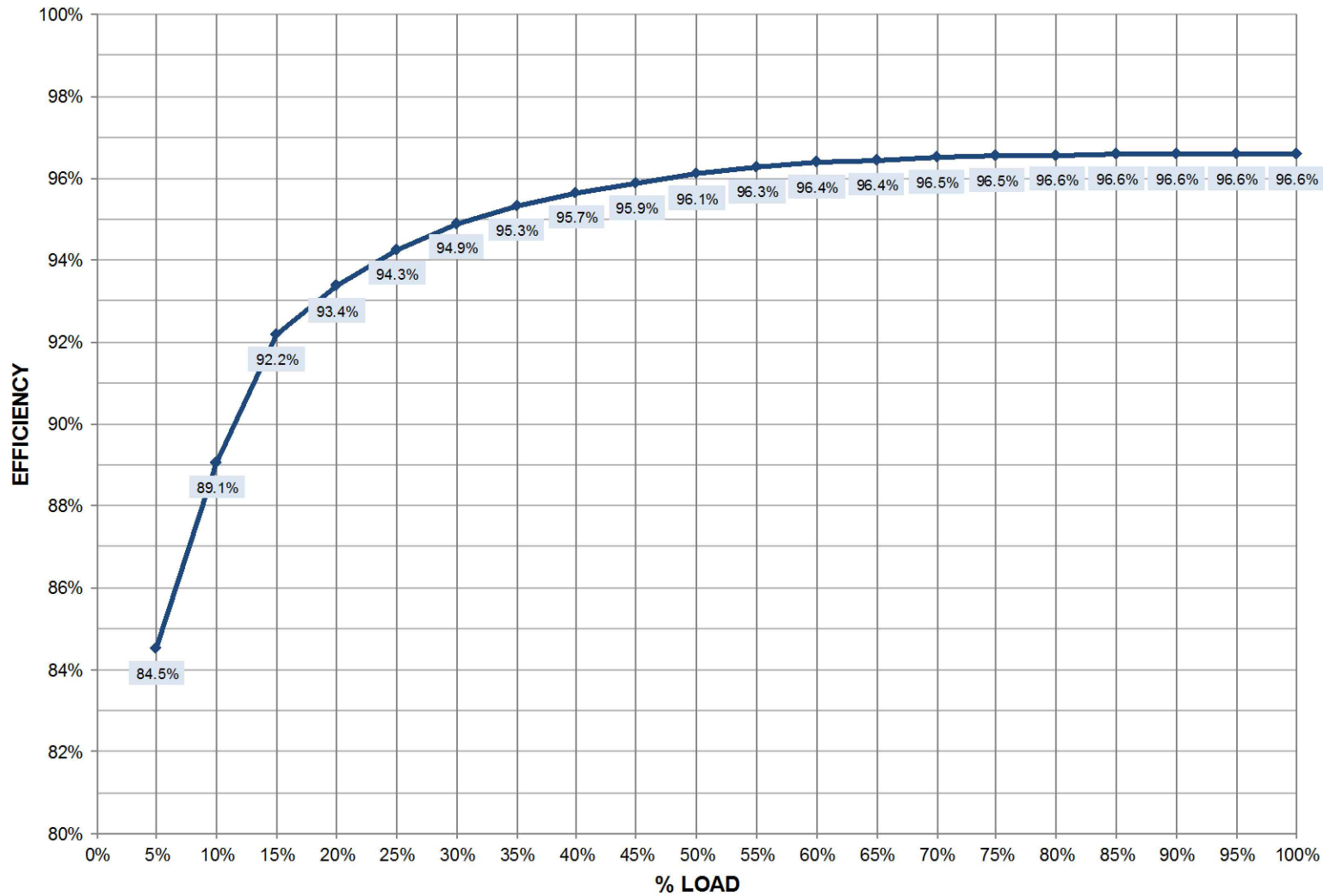

SHEET NO. 1 OF 1	DRAWN BY: J. SHIPMAN
ECN NO.	DESIGNED BY: S. MAJOR
REF DWG.	APPROVED BY: S. MAJOR

TITLE MODULE DC/AC EFFICIENCY TYPICAL, SMS AND 1+N 400kVA/400kW 415V 60Hz LIEBERT EXL S1
--

DWG. NO. ES1-18-S033
DATE (LATEST REV.) 11/16/2018
REVISION 0



1050 DEARBORN DR
P.O. BOX 29186
COLUMBUS, OH 43229

- NOTES
 1. NO LOAD POWER LOSS: 2.8kW
 2. MEASUREMENTS TAKEN WITH DC/DC CONVERTER OPERATING, NO DC SOURCE CONNECTED.

EXL S1 400kVA DC/AC EFFICIENCIES

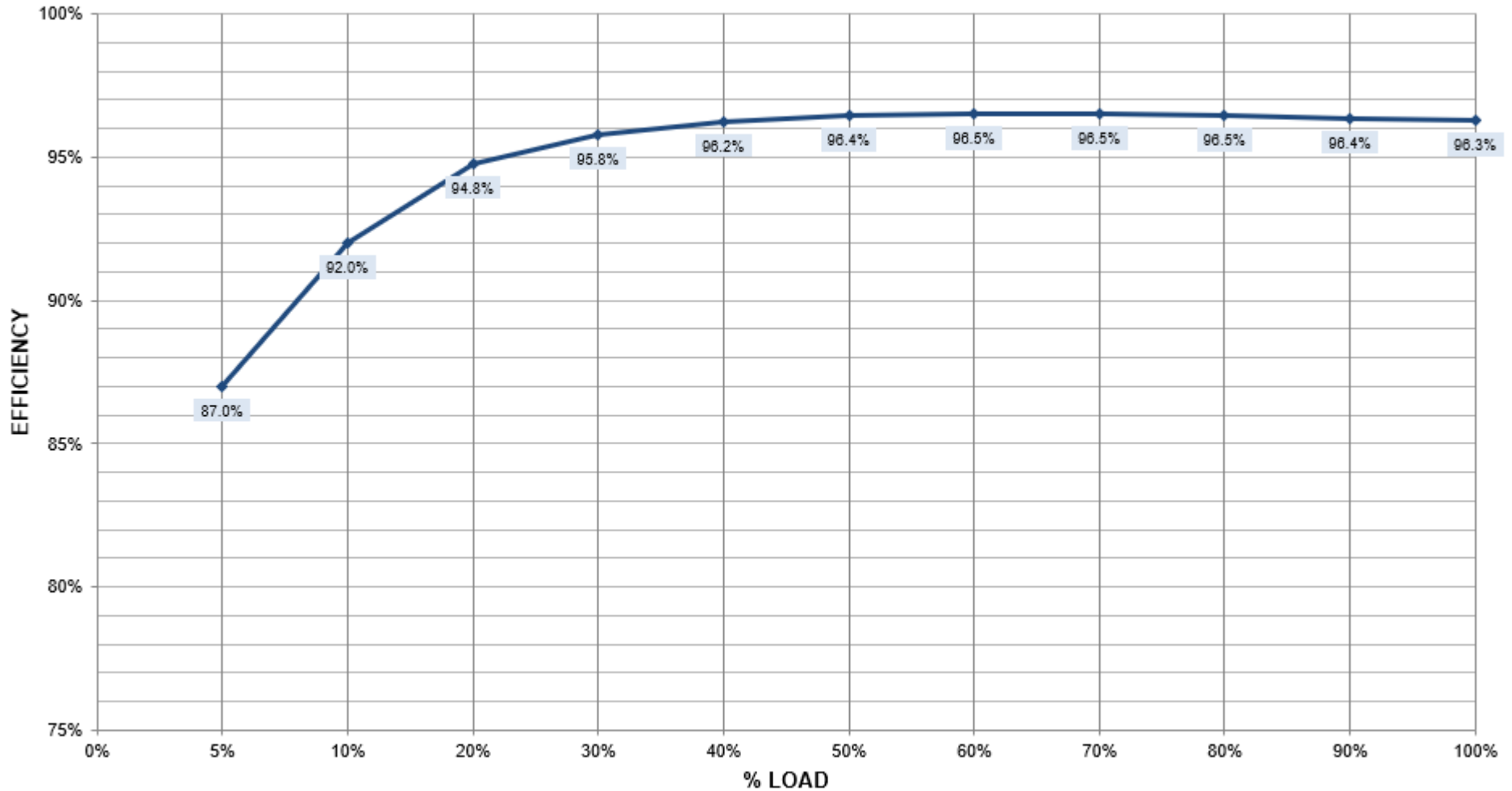

SHEET NO. 1 OF 1	DRAWN BY: JASON ZHANG
ECN NO. ECN NO	DESIGNED BY: JASON ZHANG
REF DWG. REF DWG	APPROVED BY: S. MAJOR

TITLE MODULE DC/AC EFFICIENCY TYPICAL, SMS AND 1+N 400kVA/400kW 480V 60Hz LIEBERT EXL S1
--

DWG. NO. ES1-18-S028
DATE (LATEST REV.) 1/16/2020
REVISION 0
1050 DEARBORN DR P.O. BOX 29186 COLUMBUS, OH 43229



NOTES

- 1. NO LOAD POWER LOSS: 4.2 kW

EXL S1 500kVA DC/AC EFFICIENCIES

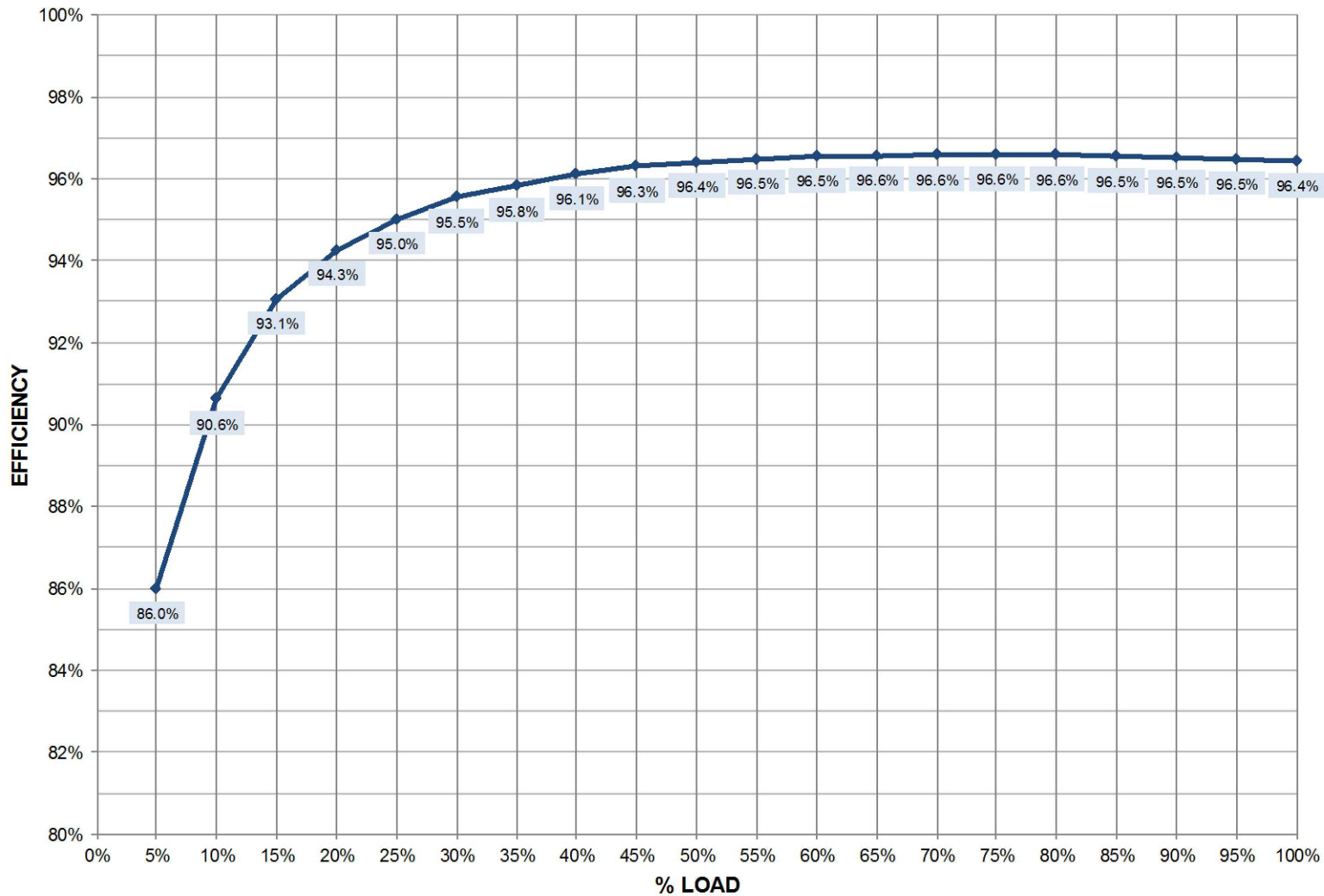

SHEET NO. 1 OF 1	DRAWN BY: J. SHIPMAN
ECN NO.	DESIGNED BY: S. MAJOR
REF DWG.	APPROVED BY: S. MAJOR

TITLE

MODULE DC/AC EFFICIENCY
TYPICAL, SMS AND 1+N 500kVA/500kW
415V 60Hz
LIEBERT EXL S1

DWG. NO. ES1-18-S034
DATE (LATEST REV.) 11/16/2018
REVISION 0



VERTIV™

1050 DEARBORN DR
P.O. BOX 29186
COLUMBUS, OH 43229

NOTES

- 1. NO LOAD POWER LOSS: 4.2 kW

EXL S1 500kVA DC/AC EFFICIENCIES

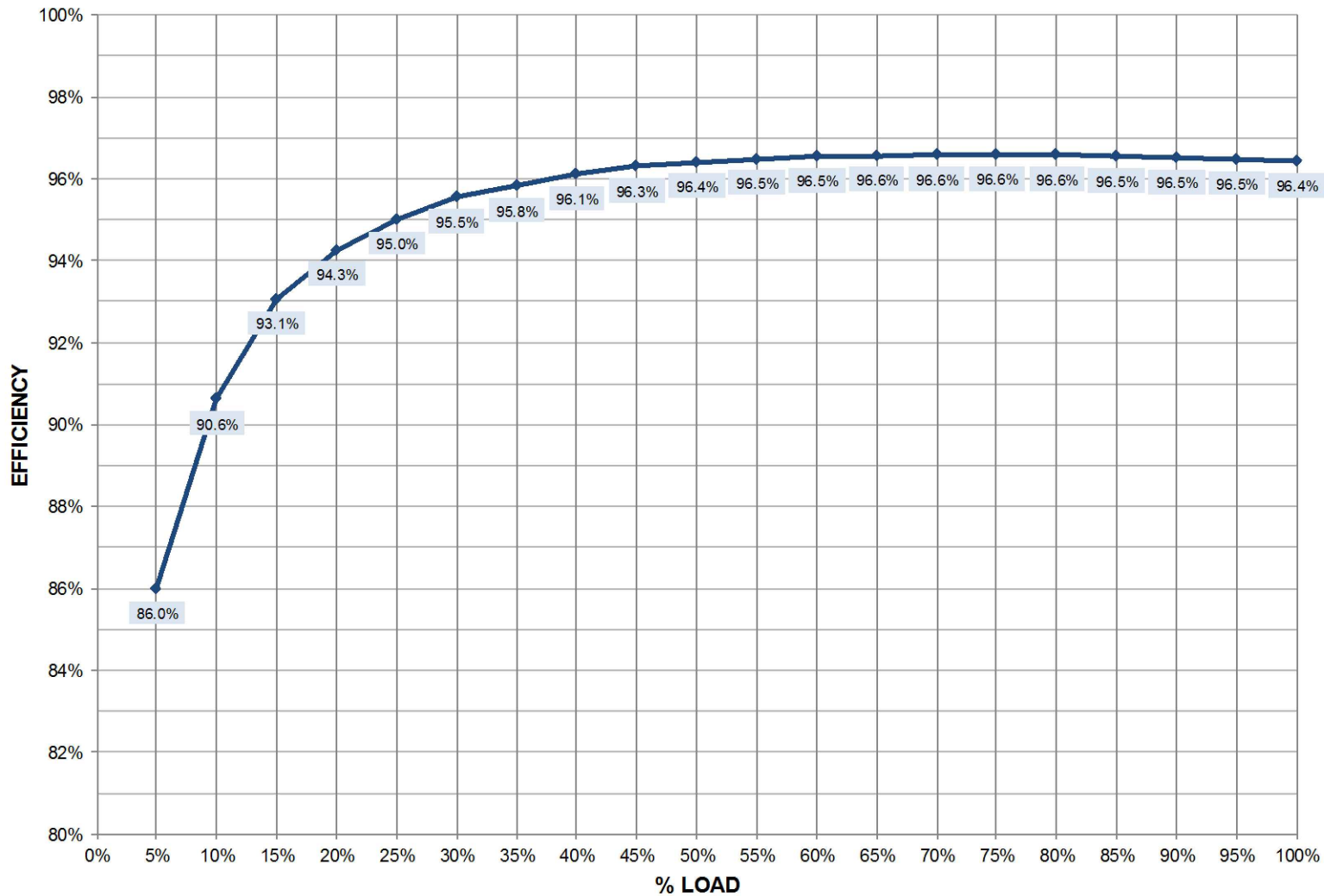

SHEET NO. 1 OF 1	DRAWN BY: J. SHIPMAN
ECN NO.	DESIGNED BY: S. MAJOR
REF DWG.	APPROVED BY: S. MAJOR

TITLE MODULE DC/AC EFFICIENCY TYPICAL, SMS AND 1+N 500kVA/500kW 480V 60Hz LIEBERT EXL S1
--

DWG. NO. ES1-18-S029
DATE (LATEST REV.) 11/16/2018
REVISION 0

1050 DEARBORN DR
P.O. BOX 29186
COLUMBUS, OH 43229

NOTES

- 1. NO LOAD POWER LOSS: 4.2 kW

EXL S1 600kVA DC/AC EFFICIENCIES

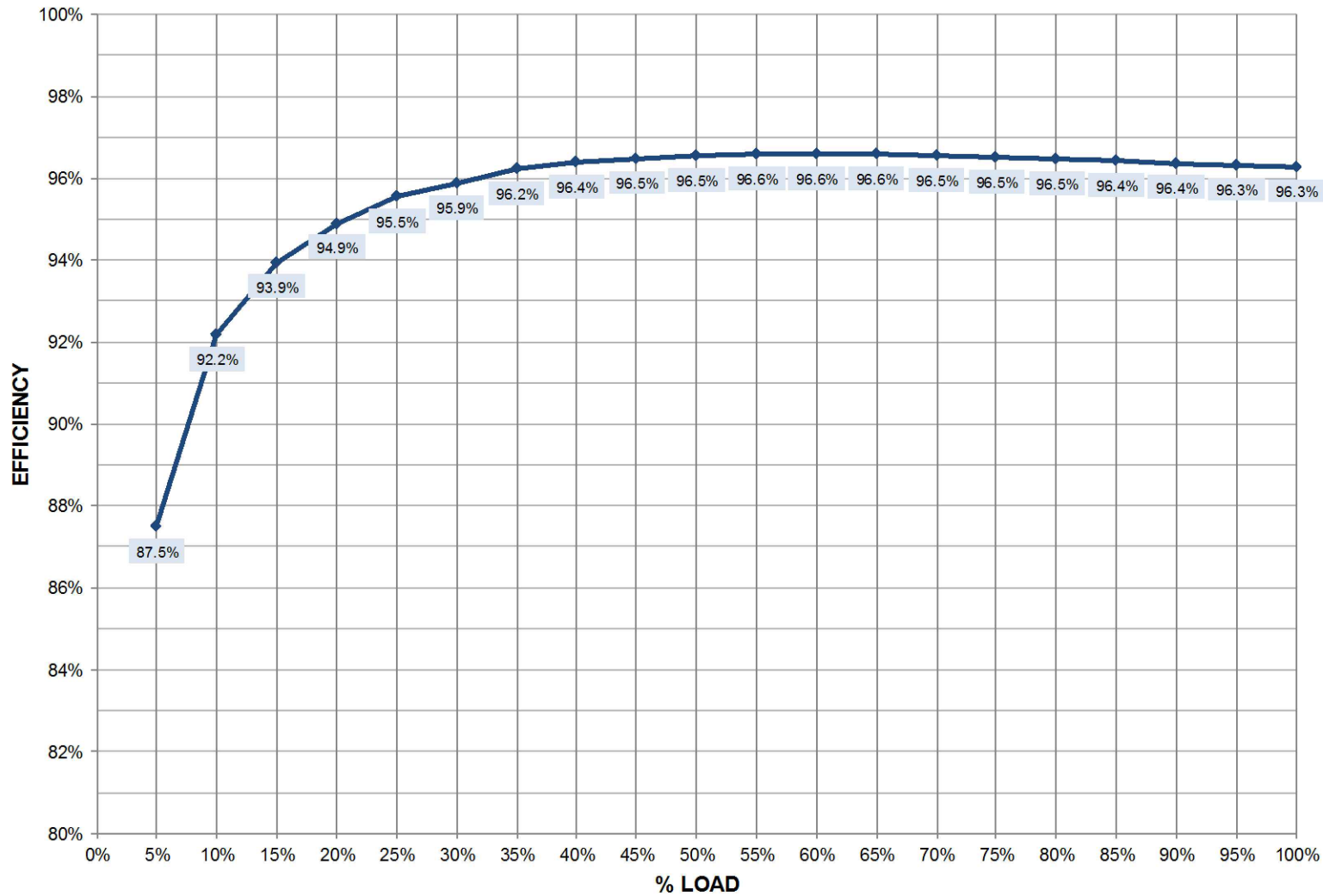

SHEET NO. 1 OF 1	DRAWN BY: J. SHIPMAN
ECN NO.	DESIGNED BY: S. MAJOR
REF DWG.	APPROVED BY: S. MAJOR

TITLE

MODULE DC/AC EFFICIENCY
TYPICAL, SMS AND 1+N 600kVA/600kW
480V 60Hz
LIEBERT EXL S1

DWG. NO. ES1-18-S030
DATE (LATEST REV.) 11/16/2018
REVISION 0

1050 DEARBORN DR
P.O. BOX 29186
COLUMBUS, OH 43229



NOTES

- 1. NO LOAD POWER LOSS: 5.4kW

EXL S1 625kVA DC/AC EFFICIENCIES

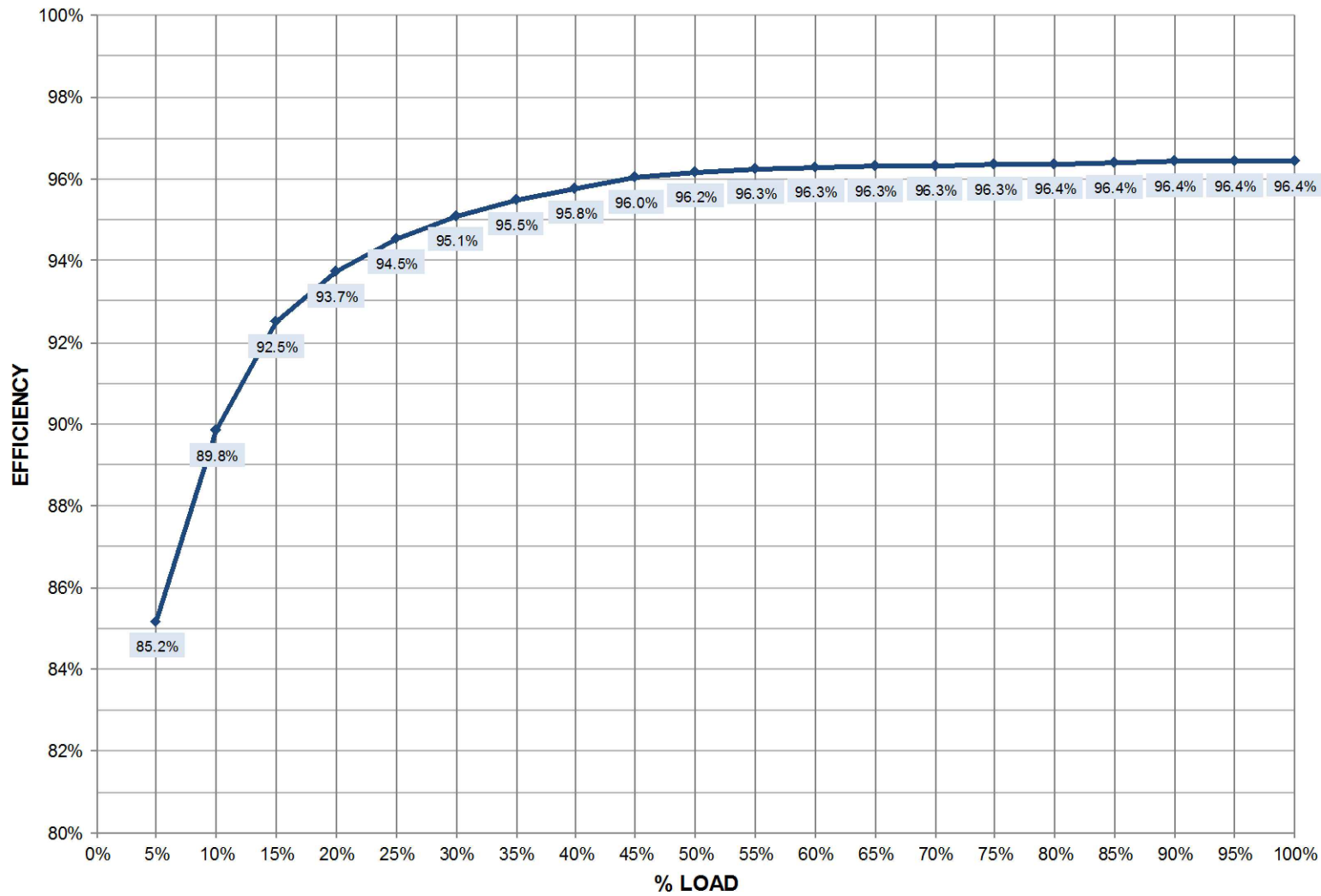

SHEET NO. 1 OF 1	DRAWN BY: J. SHIPMAN
ECN NO.	DESIGNED BY: S. MAJOR
REF DWG.	APPROVED BY: S. MAJOR

TITLE

MODULE DC/AC EFFICIENCY
TYPICAL, SMS AND 1+N 625kVA/625kW
480V 60Hz
LIEBERT EXL S1

DWG. NO. ES1-18-S010
DATE (LATEST REV.) 02/09/2018
REVISION 0



1050 DEARBORN DR
P.O. BOX 29186
COLUMBUS, OH 43229

NOTES

- 1. NO LOAD POWER LOSS: 5.4kW

EXL S1 750kVA DC/AC EFFICIENCIES

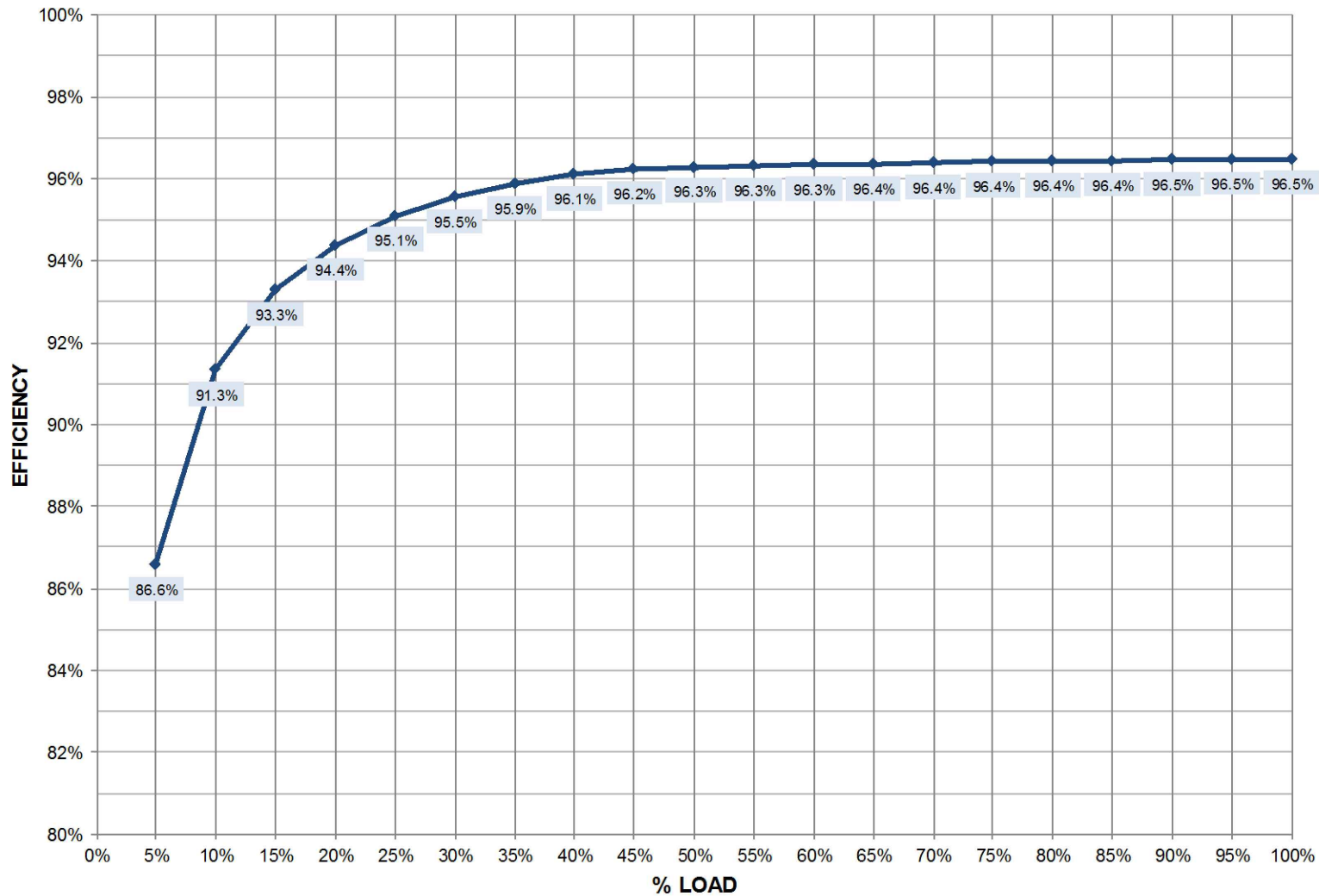

SHEET NO. 1 OF 1	DRAWN BY: J. SHIPMAN
ECN NO.	DESIGNED BY: S. MAJOR
REF DWG.	APPROVED BY: S. MAJOR

TITLE
MODULE DC/AC EFFICIENCY
TYPICAL, SMS AND 1+N 750kVA/750kW
480V 60Hz
LIEBERT EXL S1

DWG. NO. ES1-18-S011
DATE (LATEST REV.) 02/09/2018
REVISION 0



NOTES

- 1. NO LOAD POWER LOSS: 5.4kW

EXL S1 800kVA DC/AC EFFICIENCIES

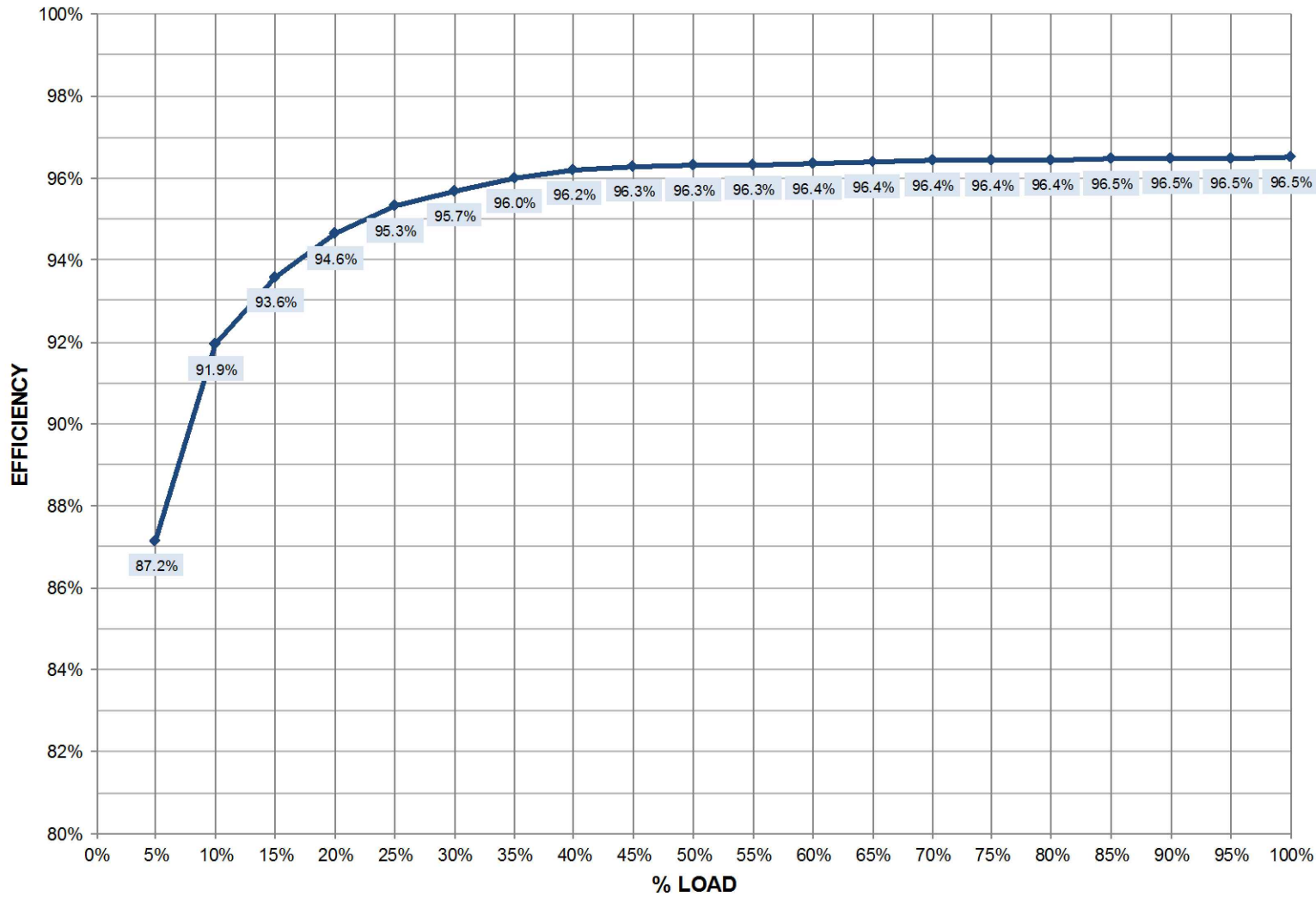

SHEET NO. 1 OF 1	DRAWN BY: J. SHIPMAN
ECN NO.	DESIGNED BY: S. MAJOR
REF DWG.	APPROVED BY: S. MAJOR

TITLE MODULE DC/AC EFFICIENCY TYPICAL, SMS AND 1+N 800kVA/800kW 480V 60Hz LIEBERT EXL S1
--

DWG. NO. ES1-18-S012
DATE (LATEST REV.) 02/09/2018
REVISION 0

1050 DEARBORN DR
P.O. BOX 29186
COLUMBUS, OH 43229



NOTES

- 1. NO LOAD POWER LOSS: 7.1 kW

EXL S1 1000kVA DC/AC EFFICIENCIES

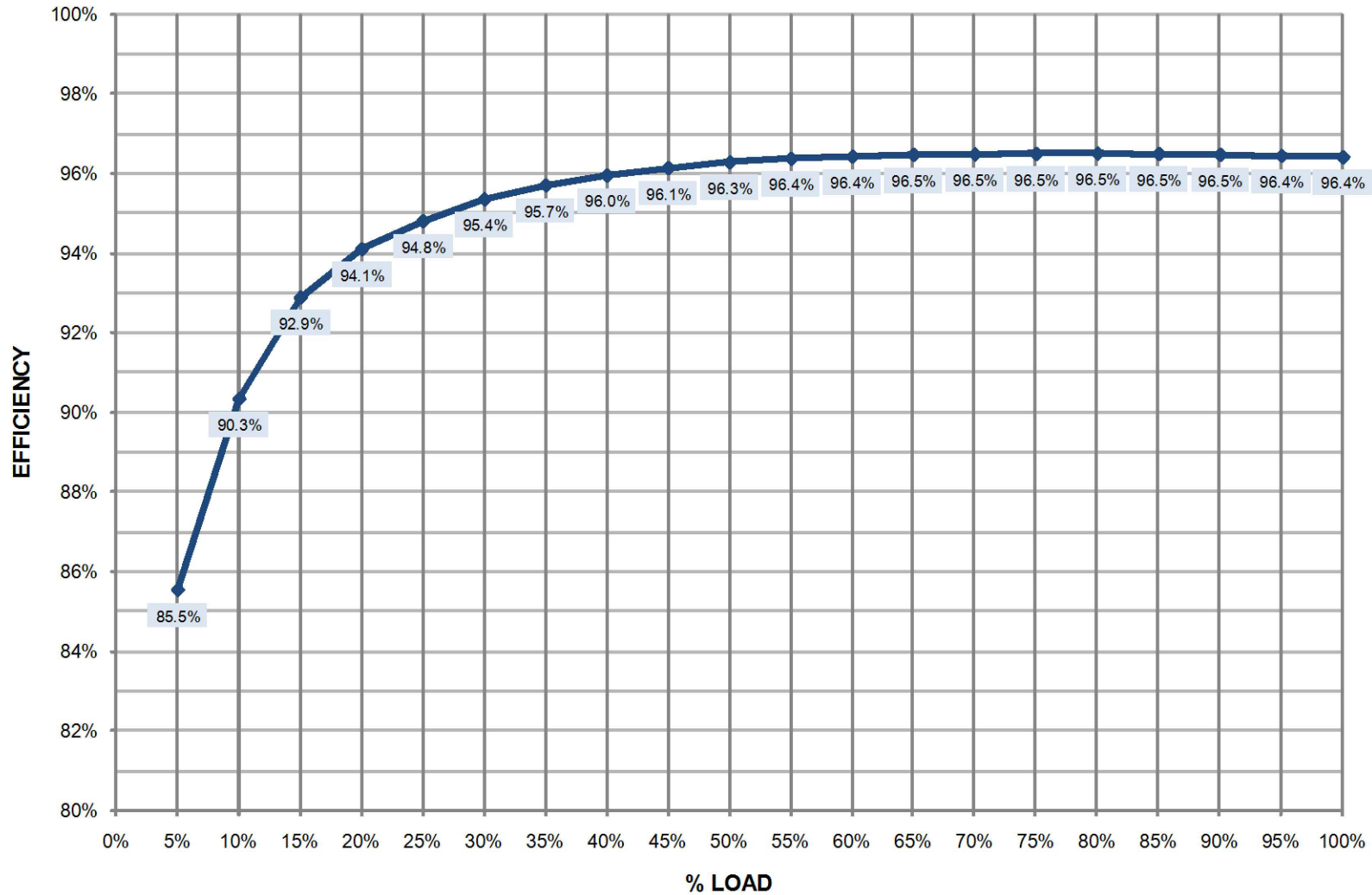

SHEET NO. 1 OF 1	DRAWN BY: J. SHIPMAN
ECN NO.	DESIGNED BY: S. MAJOR
REF DWG.	APPROVED BY: S. MAJOR

TITLE
**MODULE DC/AC EFFICIENCY
SMS 1000kVA/1000kW, TYPICAL
480V 60Hz
LIEBERT EXL S1**

DWG. NO. ES1-18-S004
DATE (LATEST REV.) 06/26/2017
REVISION 1

1050 DEARBORN DR
P.O. BOX 29186
COLUMBUS, OH 43229



NOTES

1. NO LOAD POWER LOSS: 7.1 kW

EXL S1 1100kVA DC/AC EFFICIENCIES

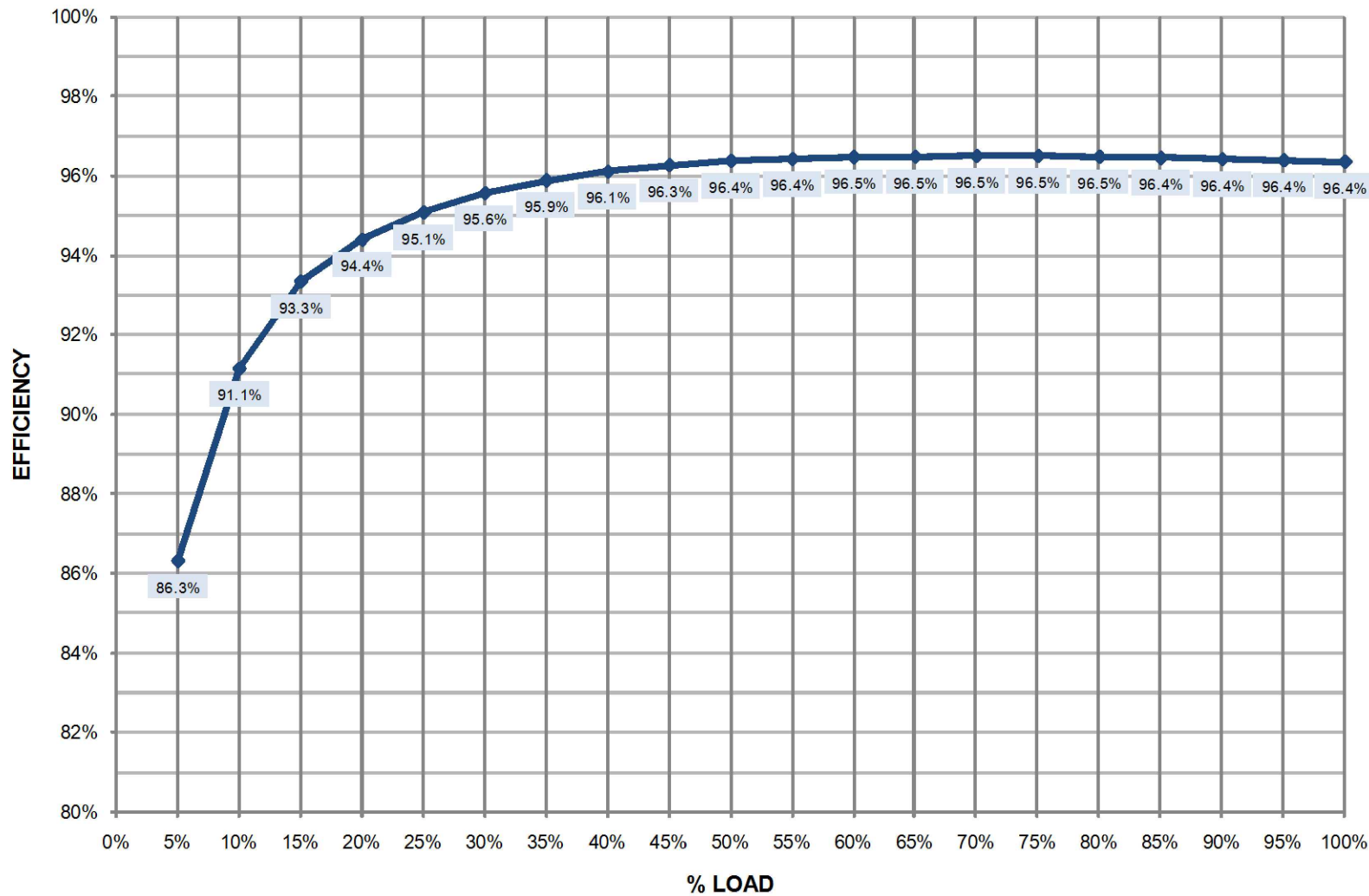

SHEET NO. 1 OF 1	DRAWN BY: J. SHIPMAN
ECN NO.	DESIGNED BY: S. MAJOR
REF DWG.	APPROVED BY: S. MAJOR

TITLE
**MODULE DC/AC EFFICIENCY
 SMS 1100kVA/1100kW, TYPICAL
 480V 60Hz
 LIEBERT EXL S1**

DWG. NO. ES1-18-S005
DATE (LATEST REV.) 06/26/2017
REVISION 1

1050 DEARBORN DR
 P.O. BOX 29186
 COLUMBUS, OH 43229



NOTES

- 1. NO LOAD POWER LOSS: 7.1 kW

EXL S1 1200kVA DC/AC EFFICIENCIES

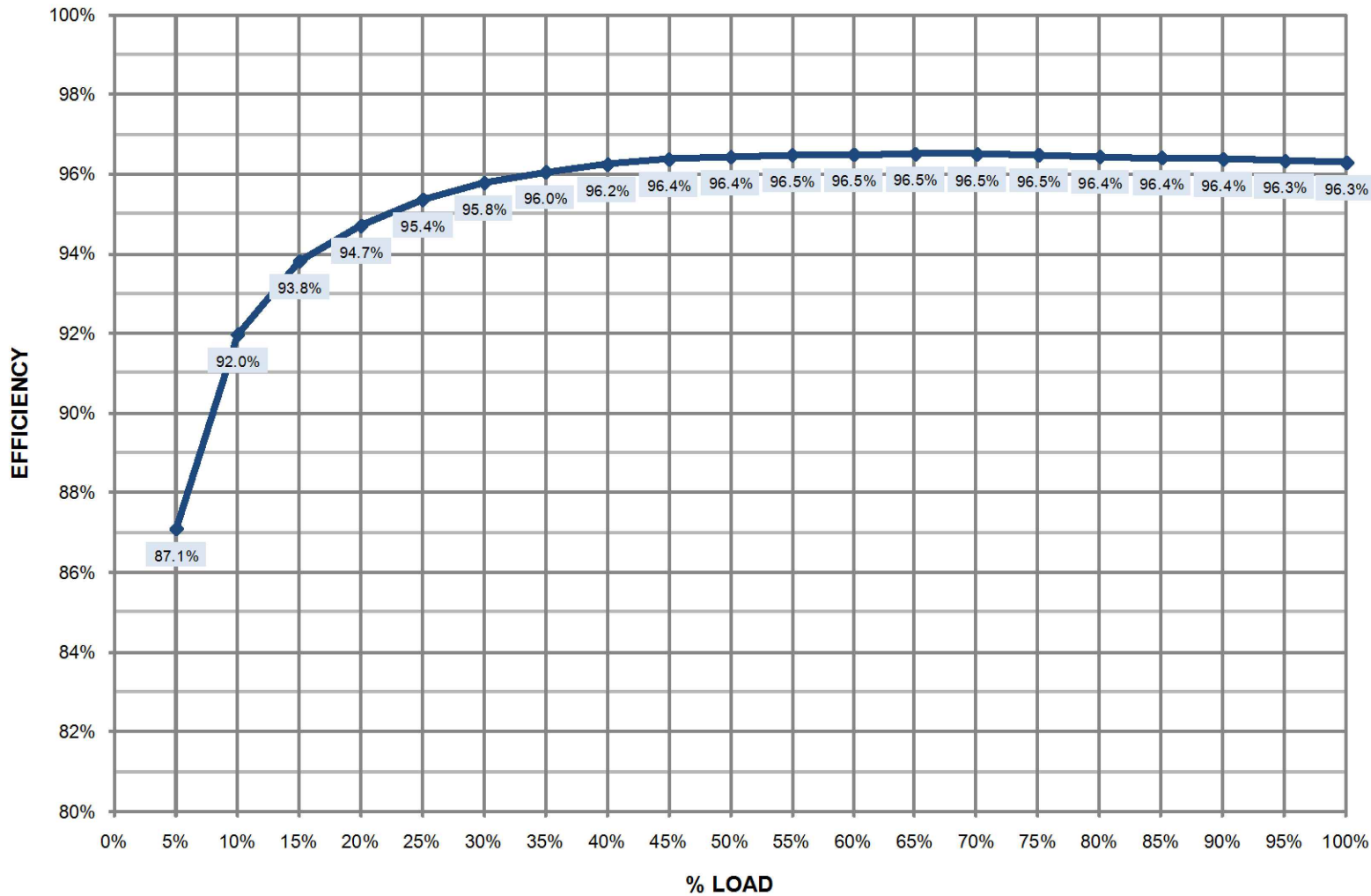

SHEET NO. 1 OF 1	DRAWN BY: J. SHIPMAN
ECN NO.	DESIGNED BY: S. MAJOR
REF DWG.	APPROVED BY: S. MAJOR

TITLE
**MODULE DC/AC EFFICIENCY
 SMS 1200kVA/1200kW, TYPICAL
 480V 60Hz
 LIEBERT EXL S1**

DWG. NO. ES1-18-S006
DATE (LATEST REV.) 06/26/2017
REVISION 1

1050 DEARBORN DR
 P.O. BOX 29186
 COLUMBUS, OH 43229



- NOTES
 1. NO LOAD POWER LOSS: 2.8kW
 2. MEASUREMENTS TAKEN WITH DC/DC CONVERTER OPERATING, NO DC SOURCE CONNECTED.

EXL S1 250kVA ECO MODE AC/AC EFFICIENCIES

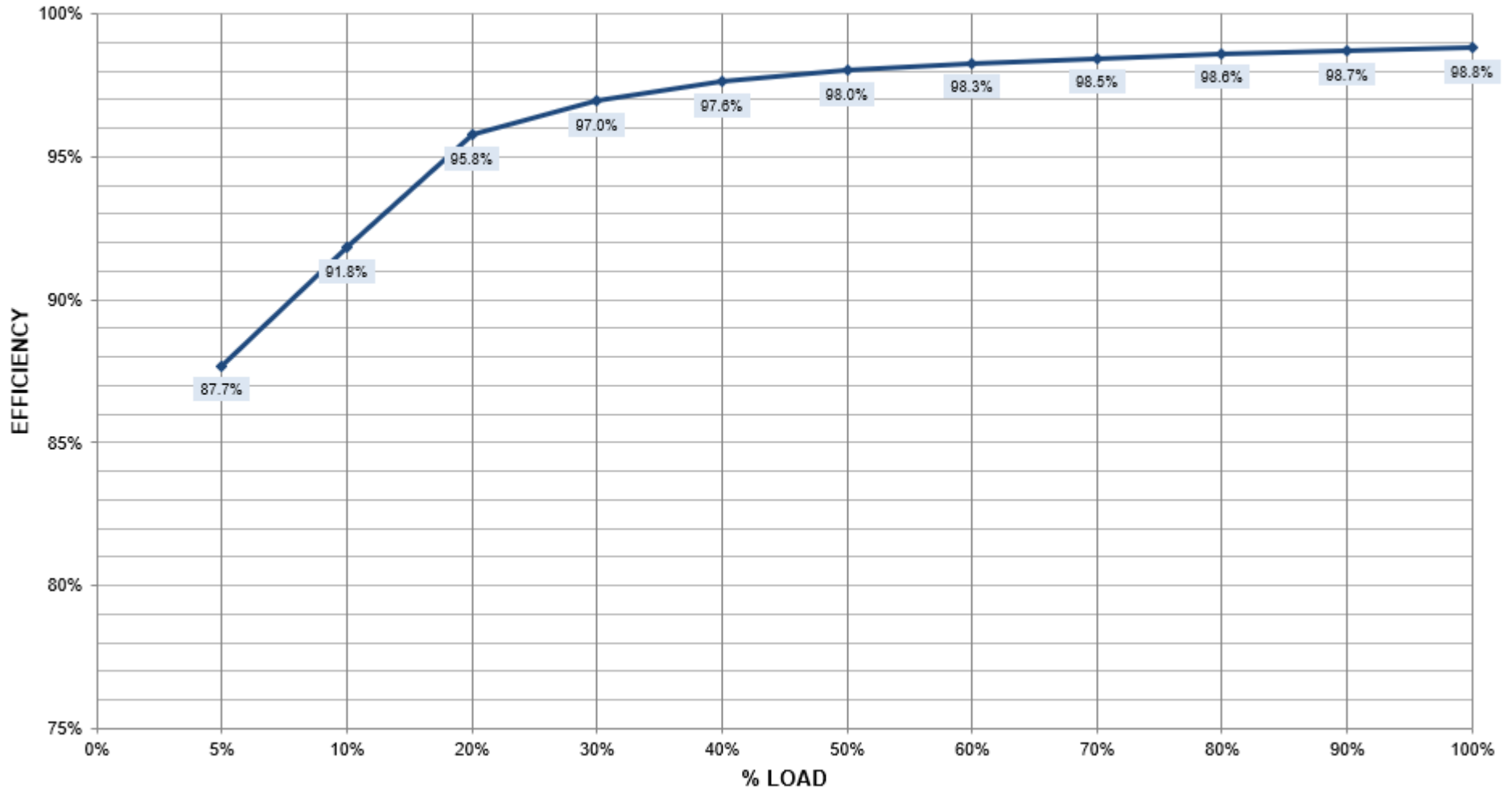

SHEET NO. 1 OF 1	DRAWN BY: JASON ZHANG
ECN NO. ECN NO	DESIGNED BY: JASON ZHANG
REF DWG. REF DWG	APPROVED BY: S. MAJOR

TITLE MODULE ECO MODE AC/AC EFFICIENCY TYPICAL, SMS AND 1+N 250kVA/250kW 480V 60Hz LIEBERT EXL S1

DWG. NO. ES1-18-S064
DATE (LATEST REV.) 1/16/2020
REVISION 0
1050 DEARBORN DR P.O. BOX 29186 COLUMBUS, OH 43229



- NOTES
 1. NO LOAD POWER LOSS: 2.8kW
 2. MEASUREMENTS TAKEN WITH DC/DC CONVERTER OPERATING, NO DC SOURCE CONNECTED.

EXL S1 300kVA ECO MODE AC/AC EFFICIENCIES

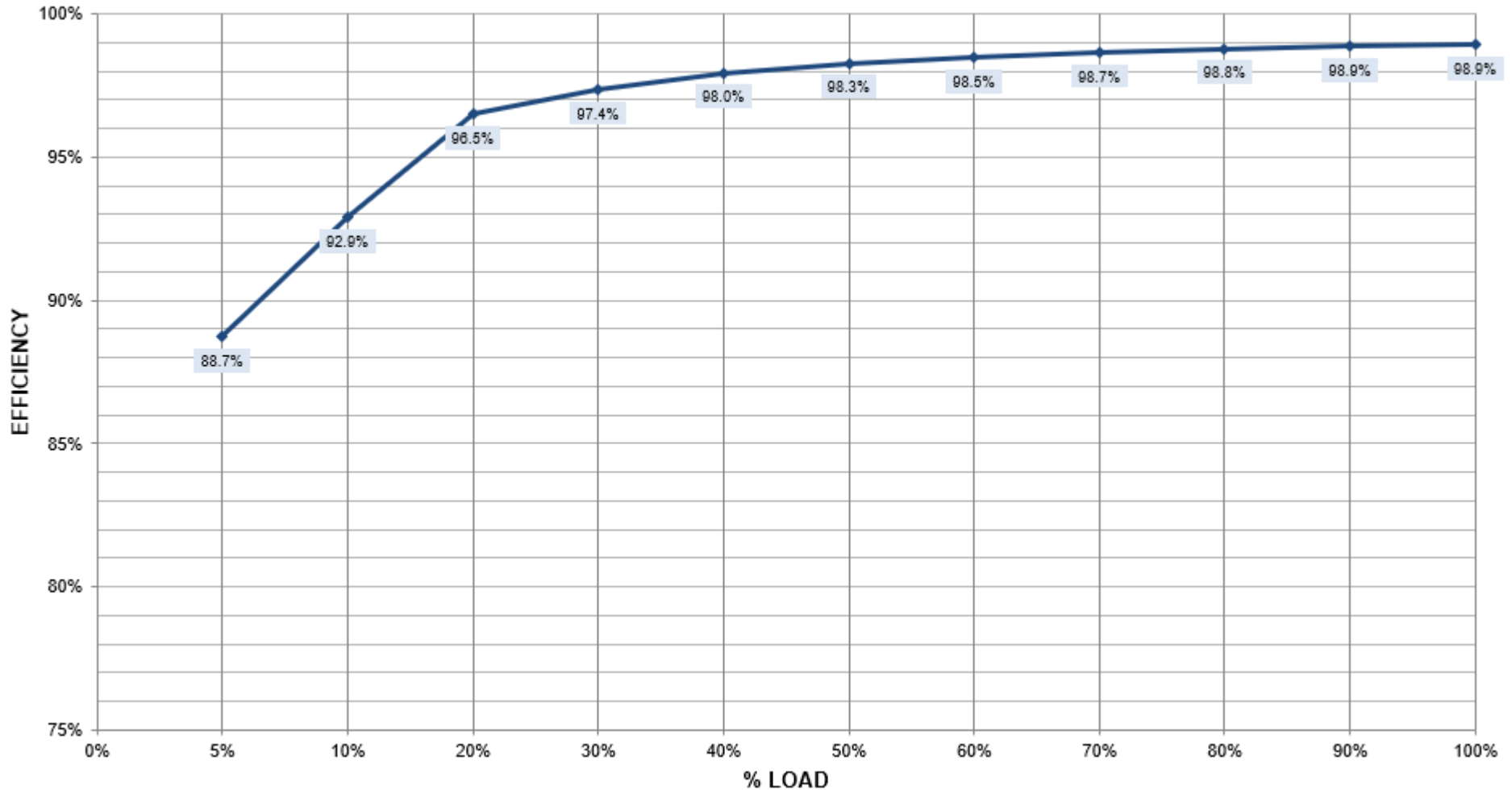

SHEET NO. 1 OF 1	DRAWN BY: JASON ZHANG
ECN NO. ECN NO	DESIGNED BY: JASON ZHANG
REF DWG. REF DWG	APPROVED BY: S. MAJOR

TITLE
**MODULE ECO MODE AC/AC EFFICIENCY
 TYPICAL, SMS AND 1+N 300kVA/300kW
 480V 60Hz
 LIEBERT EXL S1**

DWG. NO. ES1-18-S035
DATE (LATEST REV.) 1/16/2020
REVISION 0
1050 DEARBORN DR P.O. BOX 29186 COLUMBUS, OH 43229



NOTES

1. NO LOAD POWER LOSS: 4.2 kW
2. MEASUREMENTS TAKEN WITH DC/DC CONVERTER OPERATING, NO DC SOURCE CONNECTED.

EXL S1 400kVA ECO MODE AC/AC EFFICIENCIES

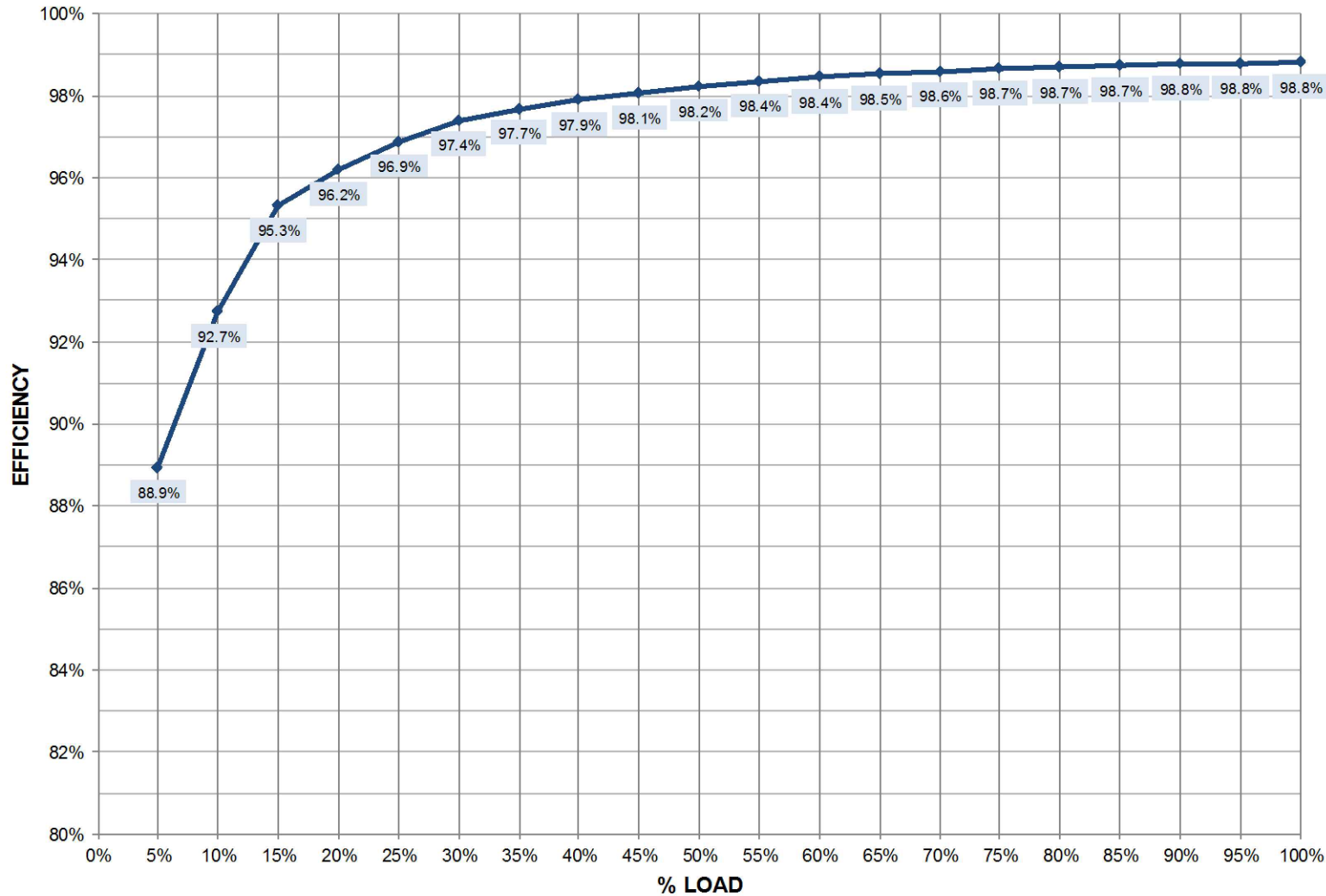

SHEET NO. 1 OF 1	DRAWN BY: J. SHIPMAN
ECN NO.	DESIGNED BY: S. MAJOR
REF DWG.	APPROVED BY: S. MAJOR

TITLE
**MODULE ECO MODE AC/AC EFFICIENCY
 TYPICAL, SMS AND 1+N 400kVA/400kW
 415V 60Hz
 LIEBERT EXL S1**

DWG. NO. ES1-18-S041
DATE (LATEST REV.) 11/16/2018
REVISION 0

1050 DEARBORN DR
 P.O. BOX 29186
 COLUMBUS, OH 43229



- NOTES
1. NO LOAD POWER LOSS: 2.8kW
 2. MEASUREMENTS TAKEN WITH DC/DC CONVERTER OPERATING, NO DC SOURCE CONNECTED.

EXL S1 400kVA ECO MODE AC/AC EFFICIENCIES

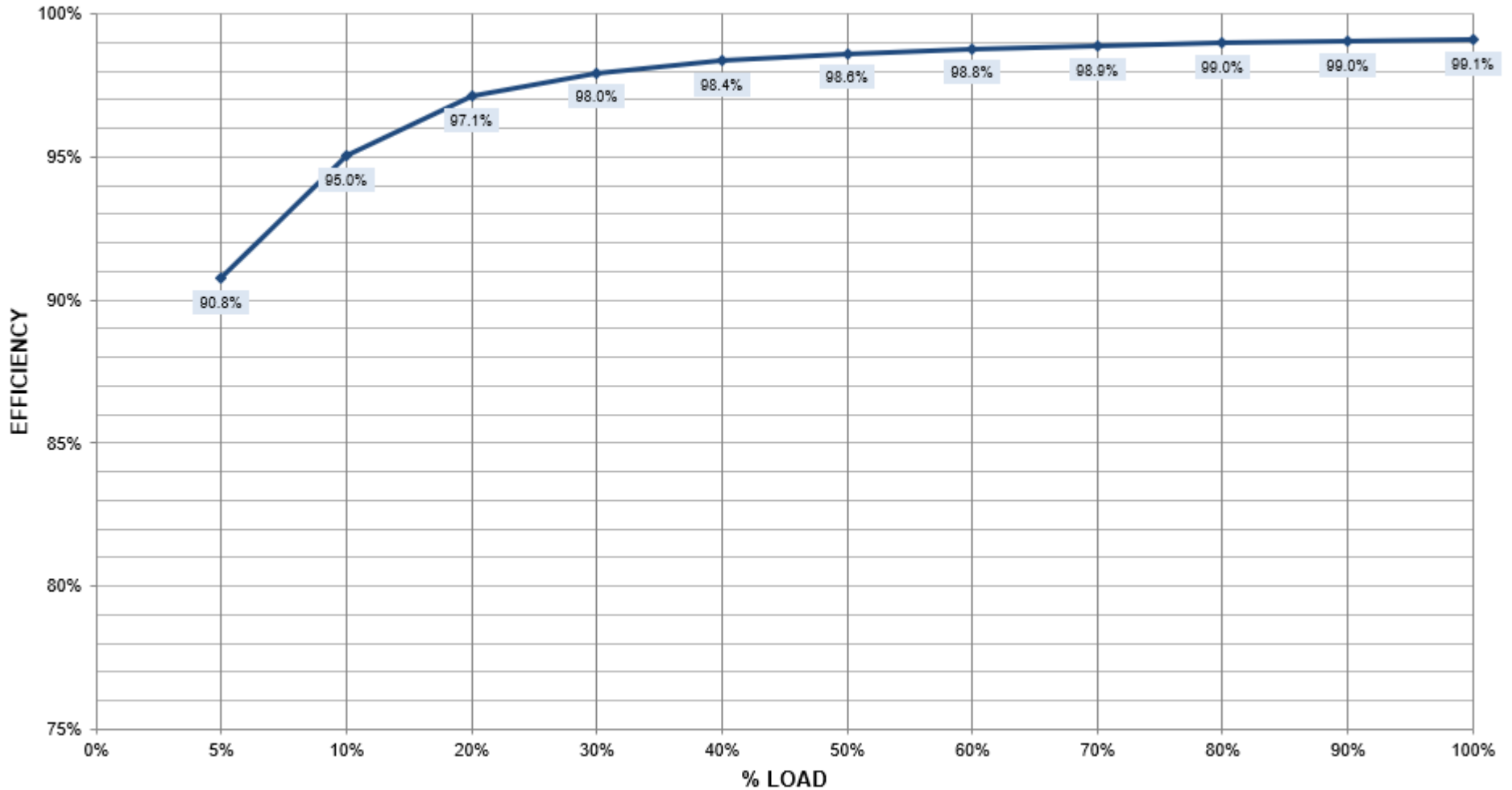

SHEET NO. 1 OF 1	DRAWN BY: JASON ZHANG
ECN NO. ECN NO	DESIGNED BY: JASON ZHANG
REF DWG. REF DWG	APPROVED BY: S. MAJOR

TITLE MODULE ECO MODE AC/AC EFFICIENCY TYPICAL, SMS AND 1+N 400kVA/400kW 480V 60Hz LIEBERT EXL S1

DWG. NO. ES1-18-S036
DATE (LATEST REV.) 1/16/2020
REVISION 0
1050 DEARBORN DR P.O. BOX 29186 COLUMBUS, OH 43229



NOTES

1. NO LOAD POWER LOSS: 4.2 kW
2. MEASUREMENTS TAKEN WITH DC/DC CONVERTER OPERATING, NO DC SOURCE CONNECTED.

EXL S1 500kVA ECO MODE AC/AC EFFICIENCIES

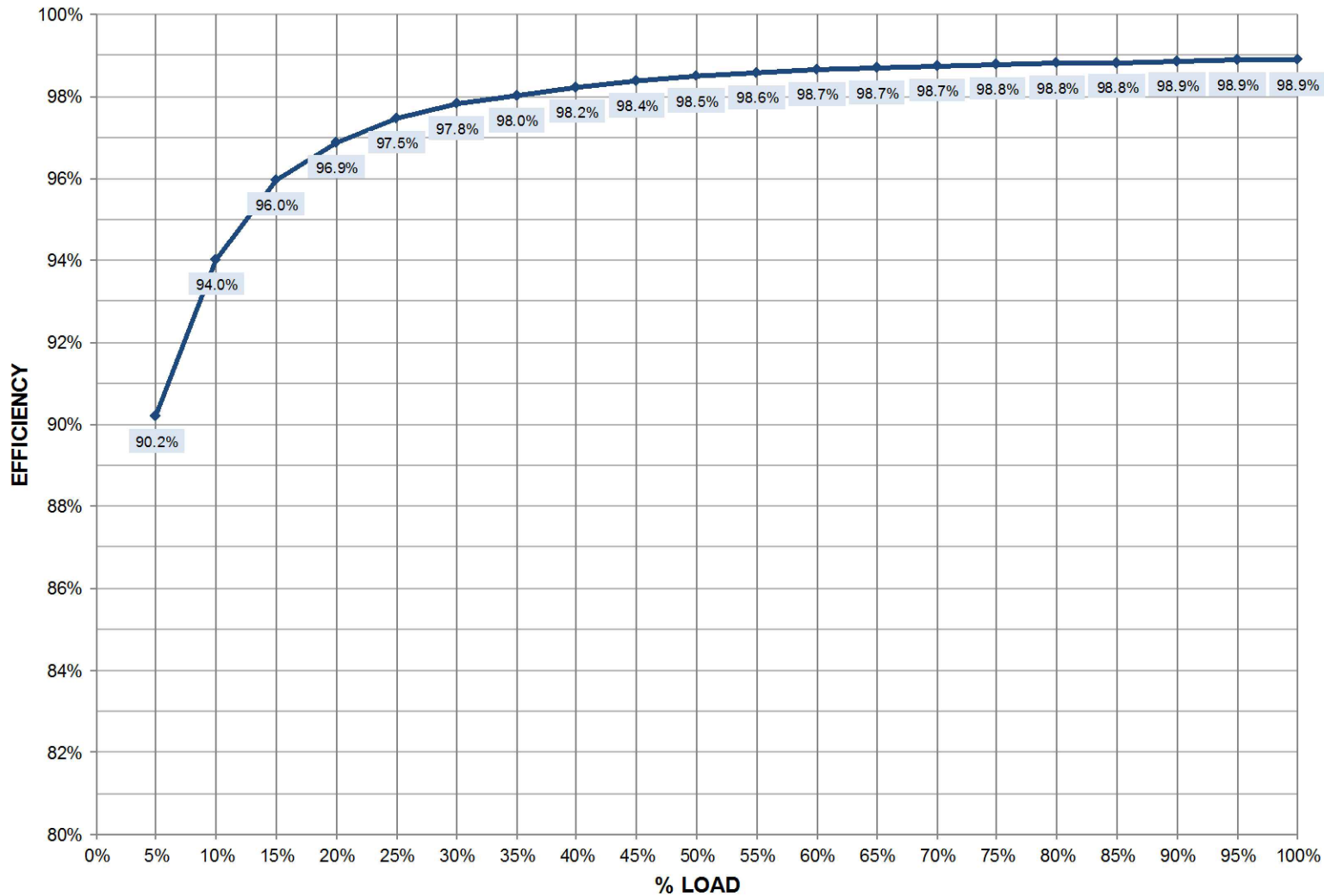

SHEET NO. 1 OF 1	DRAWN BY: J. SHIPMAN
ECN NO.	DESIGNED BY: S. MAJOR
REF DWG.	APPROVED BY: S. MAJOR

TITLE
**MODULE ECO MODE AC/AC EFFICIENCY
 TYPICAL, SMS AND 1+N 500kVA/500kW
 415V 60Hz
 LIEBERT EXL S1**

DWG. NO. ES1-18-S042
DATE (LATEST REV.) 11/16/2018
REVISION 0

1050 DEARBORN DR
 P.O. BOX 29186
 COLUMBUS, OH 43229



NOTES

1. NO LOAD POWER LOSS: 4.2 kW
2. MEASUREMENTS TAKEN WITH DC/DC CONVERTER OPERATING, NO DC SOURCE CONNECTED.

EXL S1 500kVA ECO MODE AC/AC EFFICIENCIES

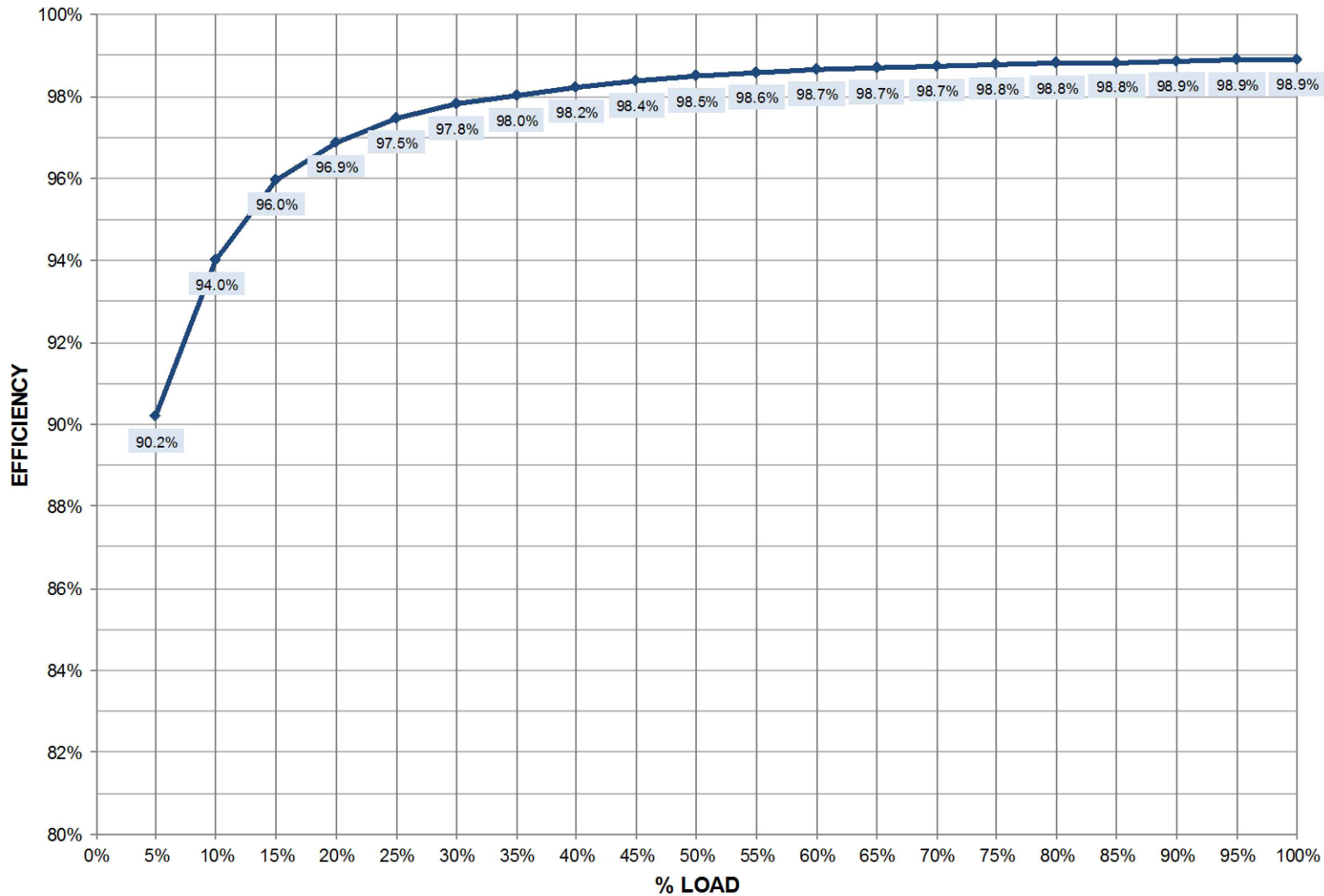

SHEET NO. 1 OF 1	DRAWN BY: J. SHIPMAN
ECN NO.	DESIGNED BY: S. MAJOR
REF DWG.	APPROVED BY: S. MAJOR

TITLE
**MODULE ECO MODE AC/AC EFFICIENCY
 TYPICAL, SMS AND 1+N 500kVA/500kW
 480V 60Hz
 LIEBERT EXL S1**

DWG. NO. ES1-18-S037
DATE (LATEST REV.) 11/16/2018
REVISION 0

1050 DEARBORN DR
 P.O. BOX 29186
 COLUMBUS, OH 43229



NOTES

- 1. NO LOAD POWER LOSS: 4.2 kW
- 2. MEASUREMENTS TAKEN WITH DC/DC CONVERTER OPERATING, NO DC SOURCE CONNECTED.

EXL S1 600kVA ECO MODE AC/AC EFFICIENCIES

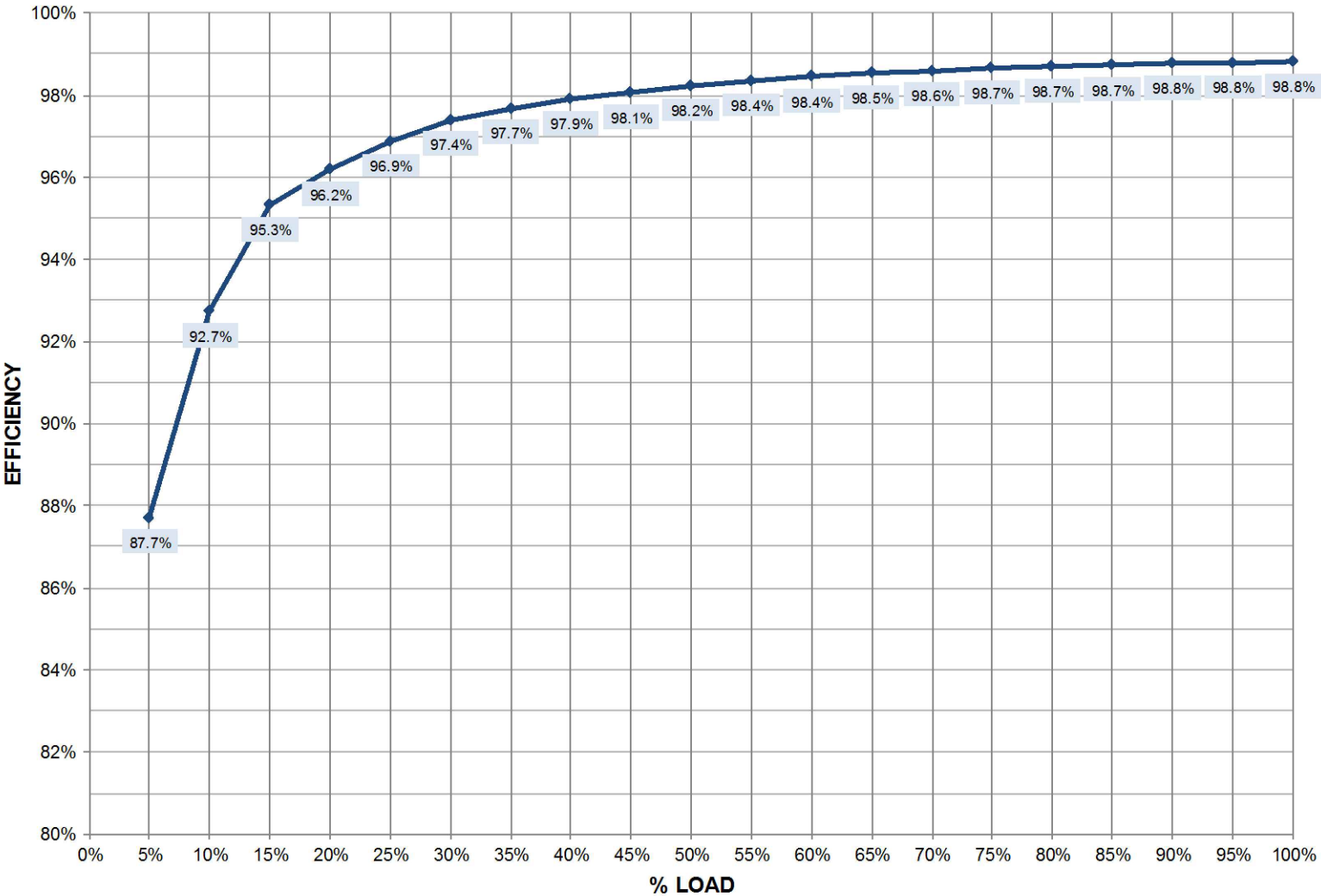

SHEET NO. 1 OF 1	DRAWN BY: J. SHIPMAN
ECN NO.	DESIGNED BY: S. MAJOR
REF DWG.	APPROVED BY: S. MAJOR

TITLE
**MODULE ECO MODE AC/AC EFFICIENCY
 TYPICAL, SMS AND 1+N 600kVA/600kW
 480V 60Hz
 LIEBERT EXL S1**

DWG. NO. ES1-18-S038
DATE (LATEST REV.) 11/16/2018
REVISION 0

1050 DEARBORN DR
 P.O. BOX 29186
 COLUMBUS, OH 43229



NOTES

1. NO LOAD POWER LOSS: 5.4kW
2. MEASUREMENTS TAKEN WITH DC/DC CONVERTER OPERATING, NO DC SOURCE CONNECTED.

EXL S1 750kVA ECO MODE AC/AC EFFICIENCIES

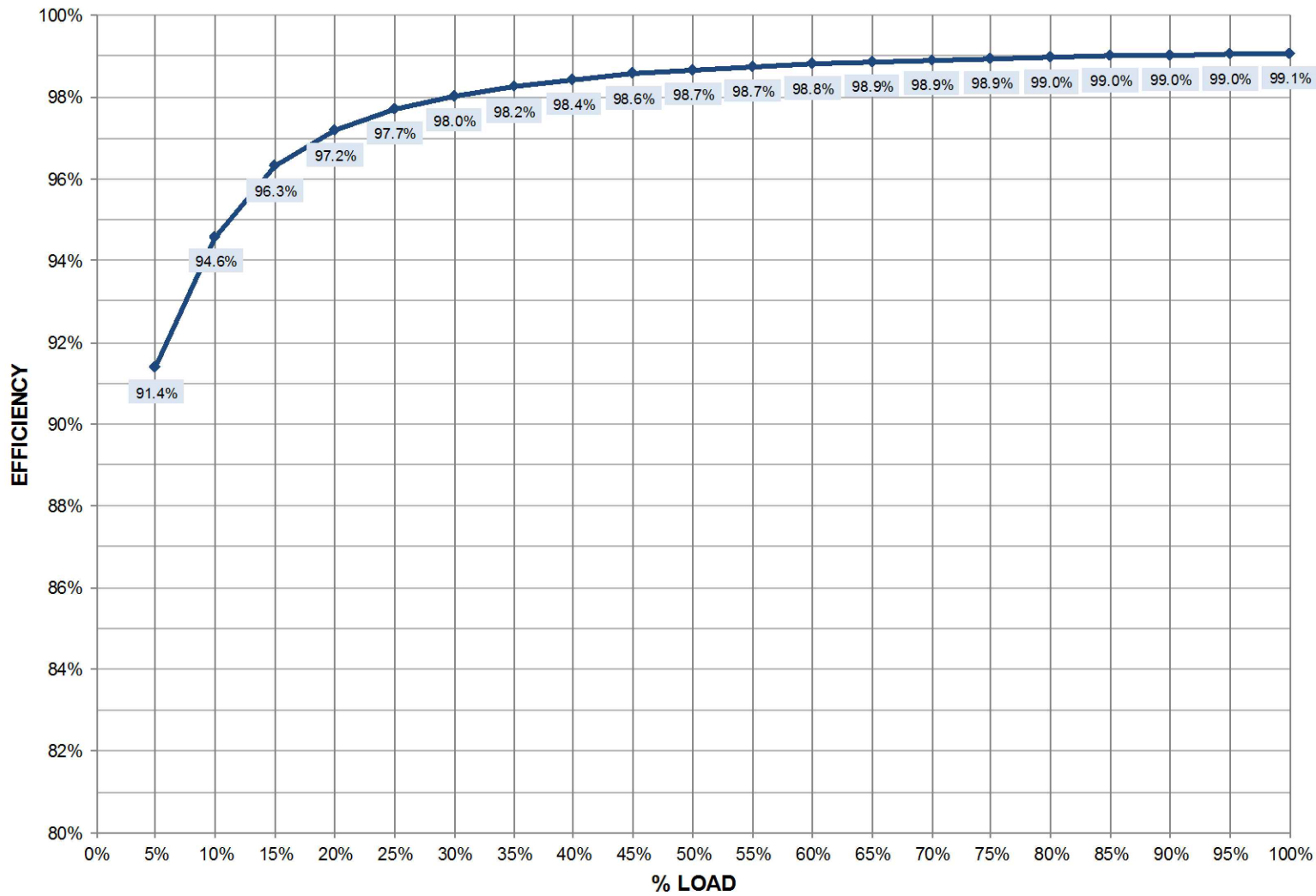

SHEET NO. 1 OF 1	DRAWN BY: J. SHIPMAN
ECN NO.	DESIGNED BY: S. MAJOR
REF DWG.	APPROVED BY: S. MAJOR

TITLE
**MODULE ECO MODE AC/AC EFFICIENCY
 TYPICAL, SMS AND 1+N 750kVA/750kW
 480V 60Hz
 LIEBERT EXL S1**

DWG. NO. ES1-18-S014
DATE (LATEST REV.) 02/09/2018
REVISION 0

1050 DEARBORN DR
 P.O. BOX 29186
 COLUMBUS, OH 43229



NOTES

1. NO LOAD POWER LOSS: 5.4kW
2. MEASUREMENTS TAKEN WITH DC/DC CONVERTER OPERATING, NO DC SOURCE CONNECTED.

EXL S1 800kVA ECO MODE AC/AC EFFICIENCIES

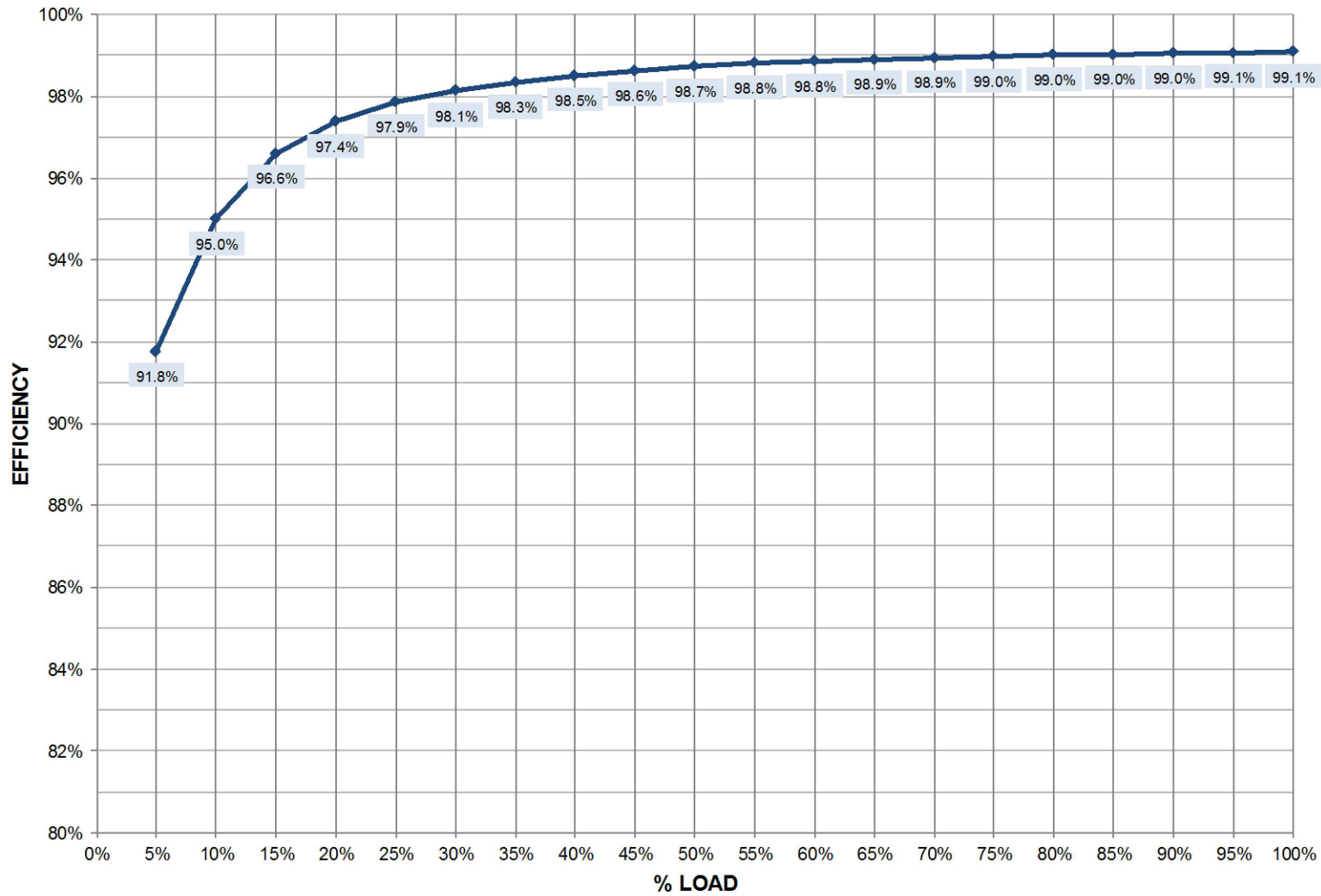

SHEET NO. 1 OF 1	DRAWN BY: J. SHIPMAN
ECN NO.	DESIGNED BY: S. MAJOR
REF DWG.	APPROVED BY: S. MAJOR

TITLE
**MODULE ECO MODE AC/AC EFFICIENCY
 TYPICAL, SMS AND 1+N 800kVA/800kW
 480V 60Hz
 LIEBERT EXL S1**

DWG. NO. ES1-18-S015
DATE (LATEST REV.) 02/09/2018
REVISION 0
1050 DEARBORN DR P.O. BOX 29186 COLUMBUS, OH 43229



NOTES

- 1. NO LOAD POWER LOSS: 7.9kW
- 2. MEASUREMENTS TAKEN WITH DC/DC CONVERTER OPERATING, NO DC SOURCE CONNECTED.

EXL S1 1000kVA ECO MODE AC/AC EFFICIENCIES

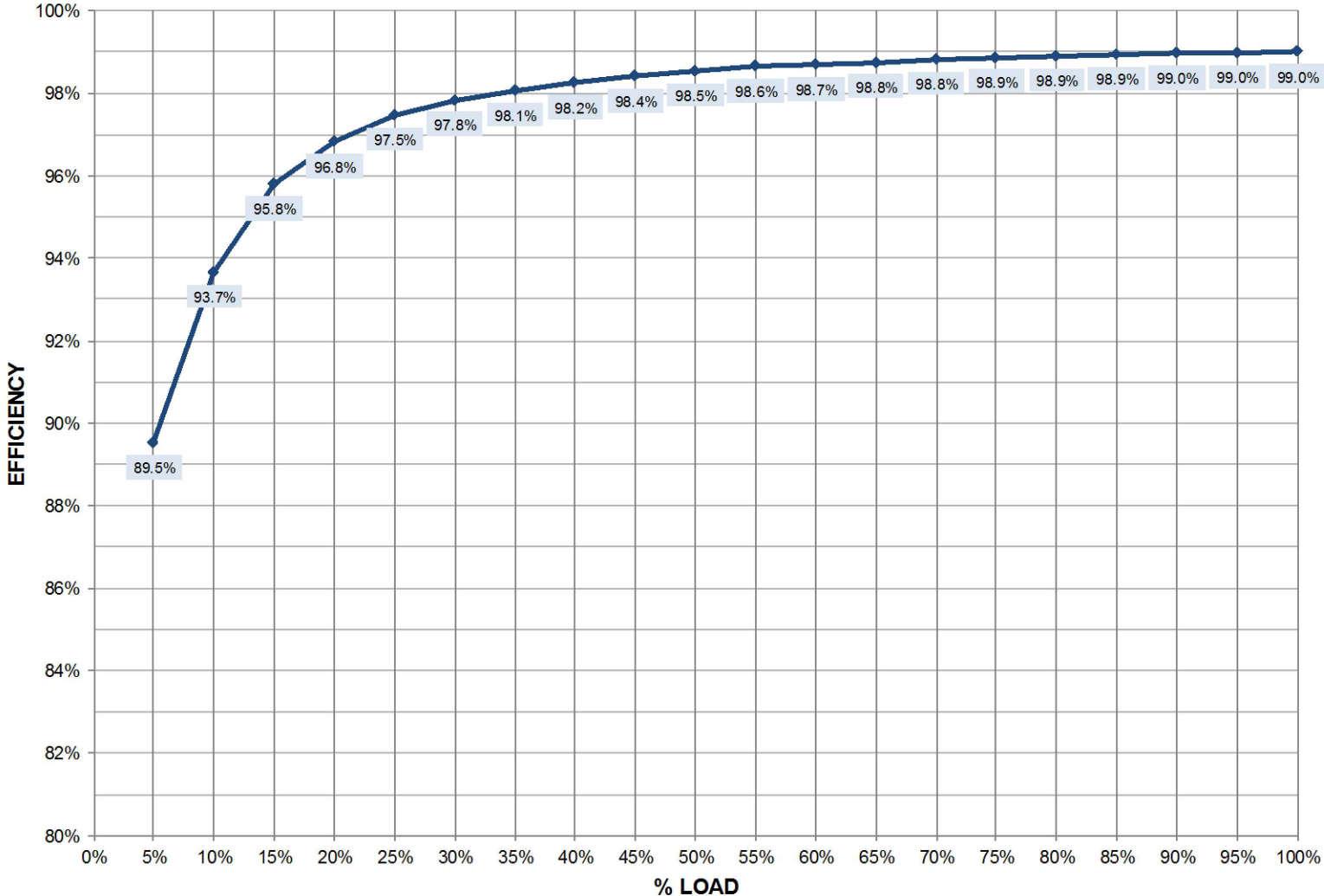

SHEET NO. 1 OF 1	DRAWN BY: J. SHIPMAN
ECN NO.	DESIGNED BY: S. MAJOR
REF DWG.	APPROVED BY: S. MAJOR

TITLE
**MODULE ECO MODE AC/AC EFFICIENCY
 TYPICAL, SMS AND 1+N 1000kVA/1000kW
 480V 60Hz
 LIEBERT EXL S1**

DWG. NO. ES1-18-S016
DATE (LATEST REV.) 02/09/2018
REVISION 0

1050 DEARBORN DR
 P.O. BOX 29186
 COLUMBUS, OH 43229



NOTES

- 1. NO LOAD POWER LOSS: 7.9kW
- 2. MEASUREMENTS TAKEN WITH DC/DC CONVERTER OPERATING, NO DC SOURCE CONNECTED.

EXL S1 1100kVA ECO MODE AC/AC EFFICIENCIES

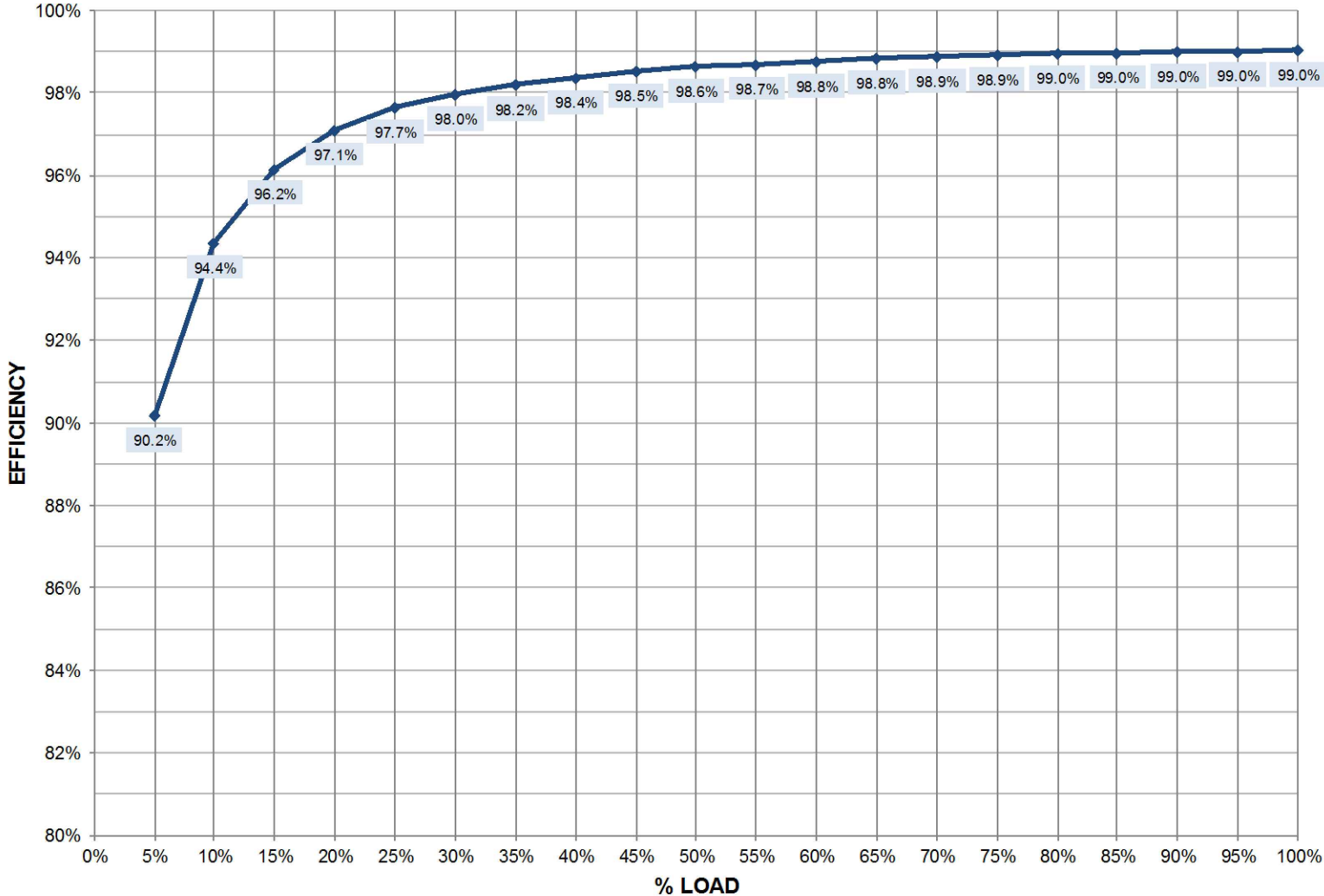

SHEET NO. 1 OF 1	DRAWN BY: J. SHIPMAN
ECN NO.	DESIGNED BY: S. MAJOR
REF DWG.	APPROVED BY: S. MAJOR

TITLE
**MODULE ECO MODE AC/AC EFFICIENCY
 TYPICAL, SMS AND 1+N 1100kVA/1100kW
 480V 60Hz
 LIEBERT EXL S1**

DWG. NO. ES1-18-S017
DATE (LATEST REV.) 02/09/2018
REVISION 0

1050 DEARBORN DR
 P.O. BOX 29186
 COLUMBUS, OH 43229



NOTES

1. NO LOAD POWER LOSS: 7.9kW
2. MEASUREMENTS TAKEN WITH DC/DC CONVERTER OPERATING, NO DC SOURCE CONNECTED.

EXL S1 1200kVA ECO MODE AC/AC EFFICIENCIES

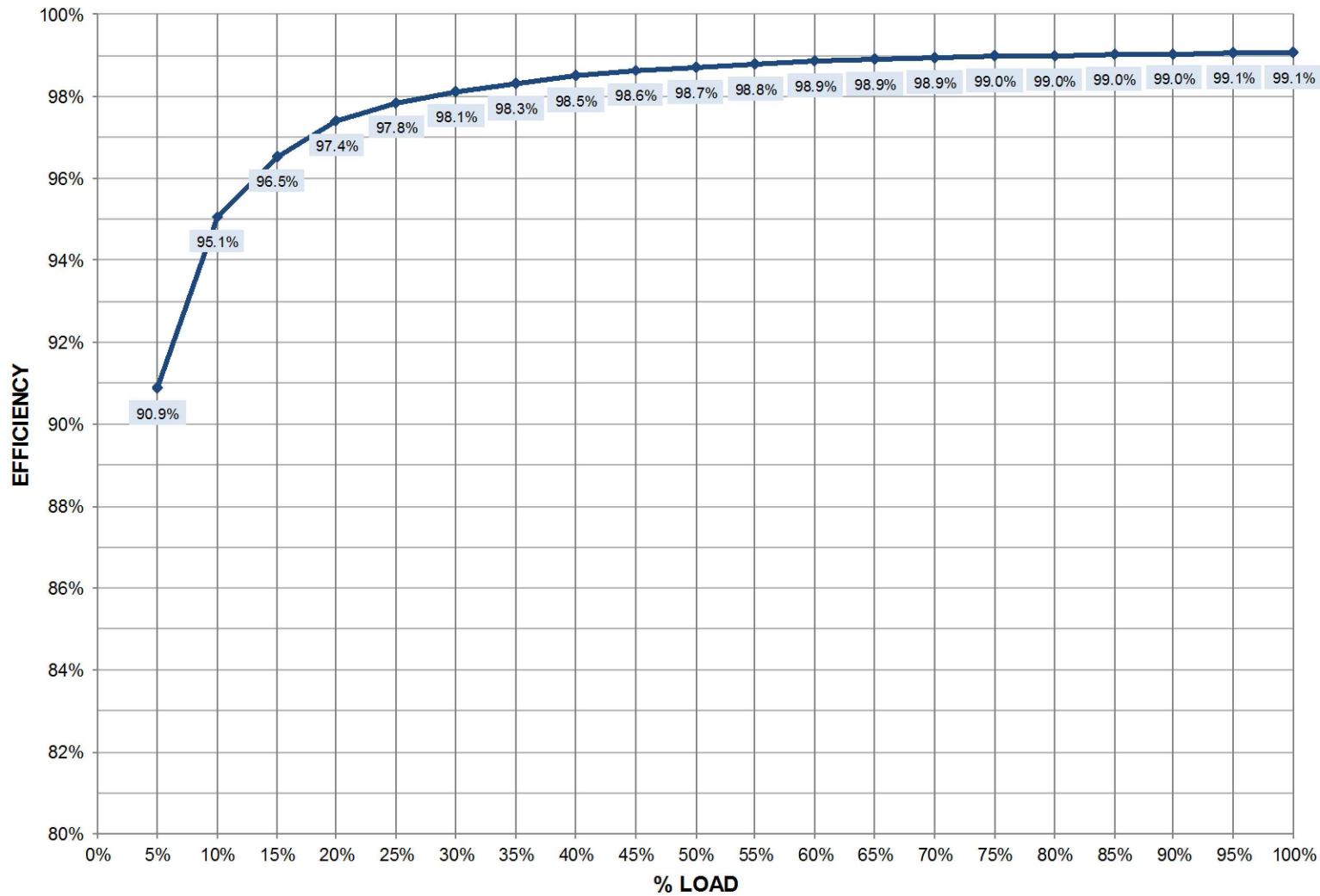

SHEET NO. 1 OF 1	DRAWN BY: J. SHIPMAN
ECN NO.	DESIGNED BY: S. MAJOR
REF DWG.	APPROVED BY: S. MAJOR

TITLE MODULE ECO MODE AC/AC EFFICIENCY TYPICAL, SMS AND 1+N 1200kVA/1200kW 480V 60Hz LIEBERT EXL S1

DWG. NO. ES1-18-S018
DATE (LATEST REV.) 02/09/2018
REVISION 0



1050 DEARBORN DR
P.O. BOX 29186
COLUMBUS, OH 43229

NOTES

1. NO LOAD POWER LOSS: 2.8kW
2. MEASUREMENTS TAKEN WITH DC/DC CONVERTER OPERATING, NO DC SOURCE CONNECTED.
3. MEASUREMENTS TAKEN WITH RESISTIVE LOAD.
MEASUREMENTS MAY VARY FOR CAPACITIVE (LEADING) LOADS AND INDUCTIVE (LAGGING) LOADS.

EXL S1 250kVA DYNAMIC ONLINE (VI) MODE AC/AC EFFICIENCIES

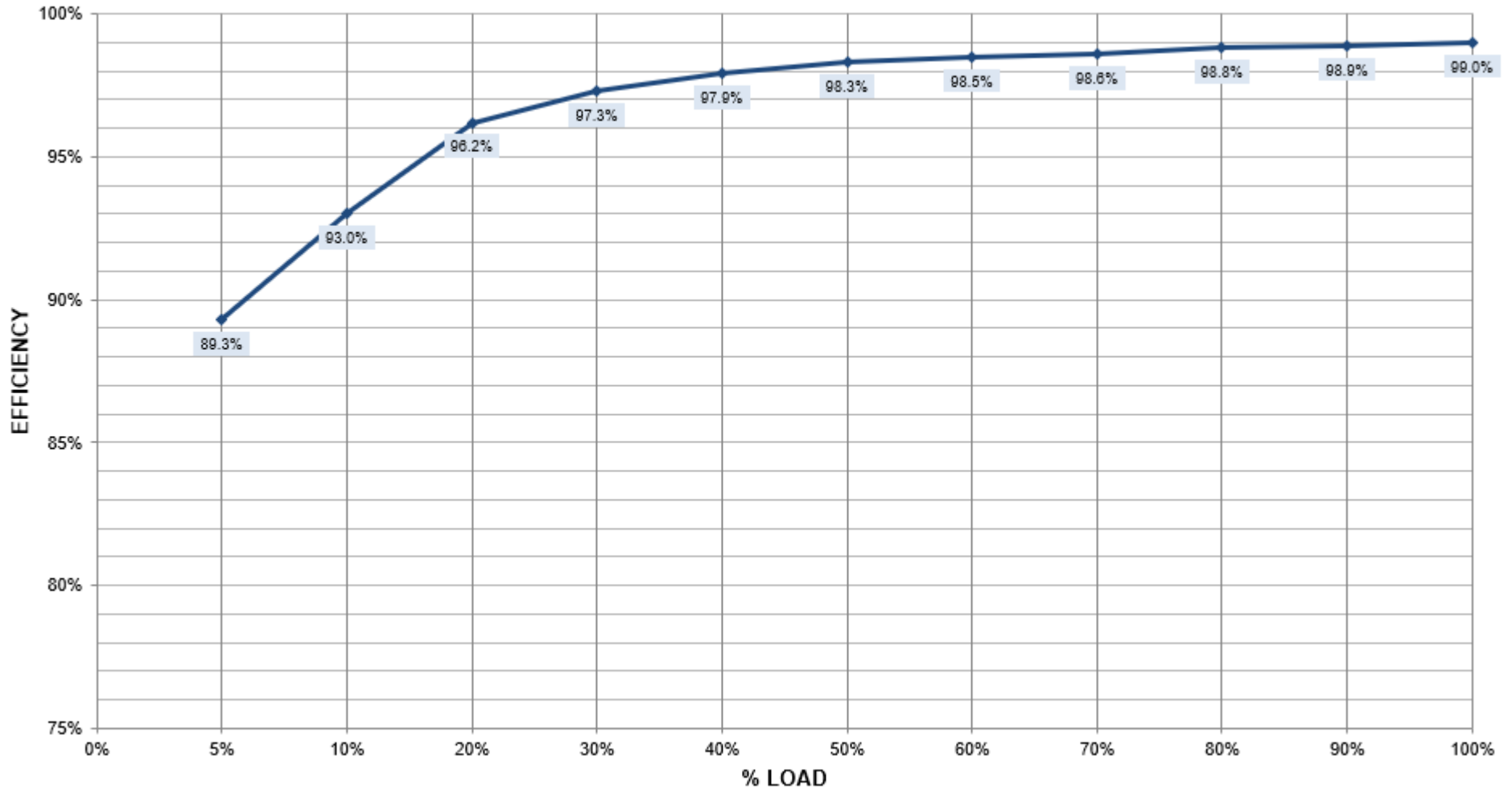

SHEET NO. 1 OF 1	DRAWN BY: JASON ZHANG
ECN NO.	DESIGNED BY: JASON ZHANG
REF DWG.	APPROVED BY: S. MAJOR
REF DWG	

TITLE MODULE DYNAMIC ONLINE(VI) MODE AC/AC EFFICIENCY TYPICAL, SMS AND 1+N 250kVA/250kW 480V 60Hz LIEBERT EXL S1
--

DWG. NO. ES1-18-S051
DATE (LATEST REV.) 1/16/2020
REVISION 0
1050 DEARBORN DR P.O. BOX 29186 COLUMBUS, OH 43229



NOTES

1. NO LOAD POWER LOSS: 2.8kW
2. MEASUREMENTS TAKEN WITH DC/DC CONVERTER OPERATING, NO DC SOURCE CONNECTED.
3. MEASUREMENTS TAKEN WITH RESISTIVE LOAD.
MEASUREMENTS MAY VARY FOR CAPACITIVE (LEADING) LOADS AND INDUCTIVE (LAGGING) LOADS.

EXL S1 300kVA DYNAMIC ONLINE (VI) MODE AC/AC EFFICIENCIES

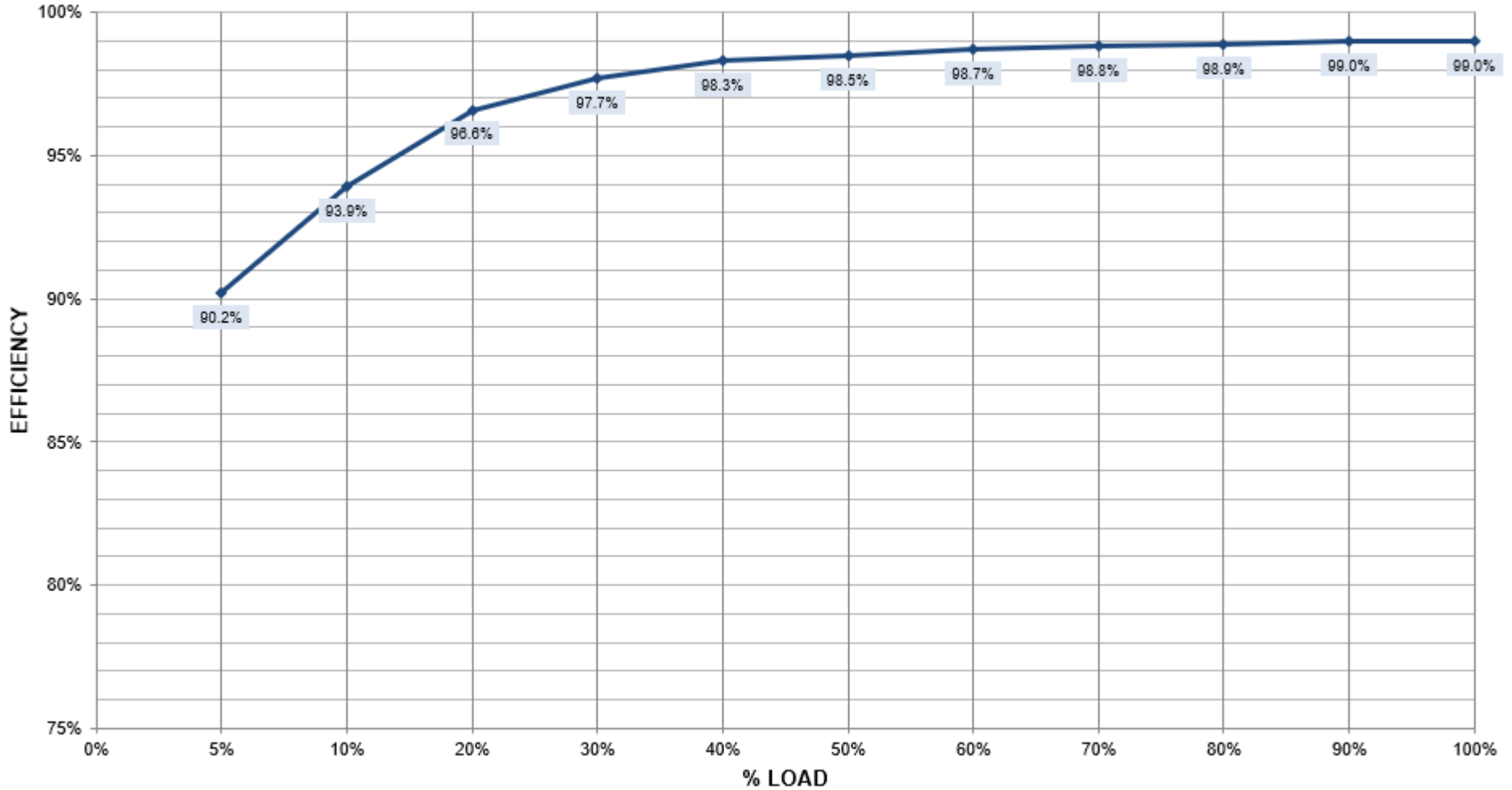

SHEET NO. 1 OF 1	DRAWN BY: JASON ZHANG
ECN NO.	DESIGNED BY: JASON ZHANG
REF DWG.	APPROVED BY: S. MAJOR
REF DWG	

TITLE MODULE DYNAMIC ONLINE(VI) MODE AC/AC EFFICIENCY TYPICAL, SMS AND 1+N 300kVA/300kW 480V 60Hz LIEBERT EXL S1
--

DWG. NO. ES1-18-S052
DATE (LATEST REV.) 1/16/2020
REVISION 0
1050 DEARBORN DR P.O. BOX 29186 COLUMBUS, OH 43229



NOTES

1. NO LOAD POWER LOSS: 4.2 kW
2. MEASUREMENTS TAKEN WITH DC/DC CONVERTER OPERATING, NO DC SOURCE CONNECTED.

EXL S1 400kVA DYNAMIC ONLINE (VI) MODE AC/AC EFFICIENCIES

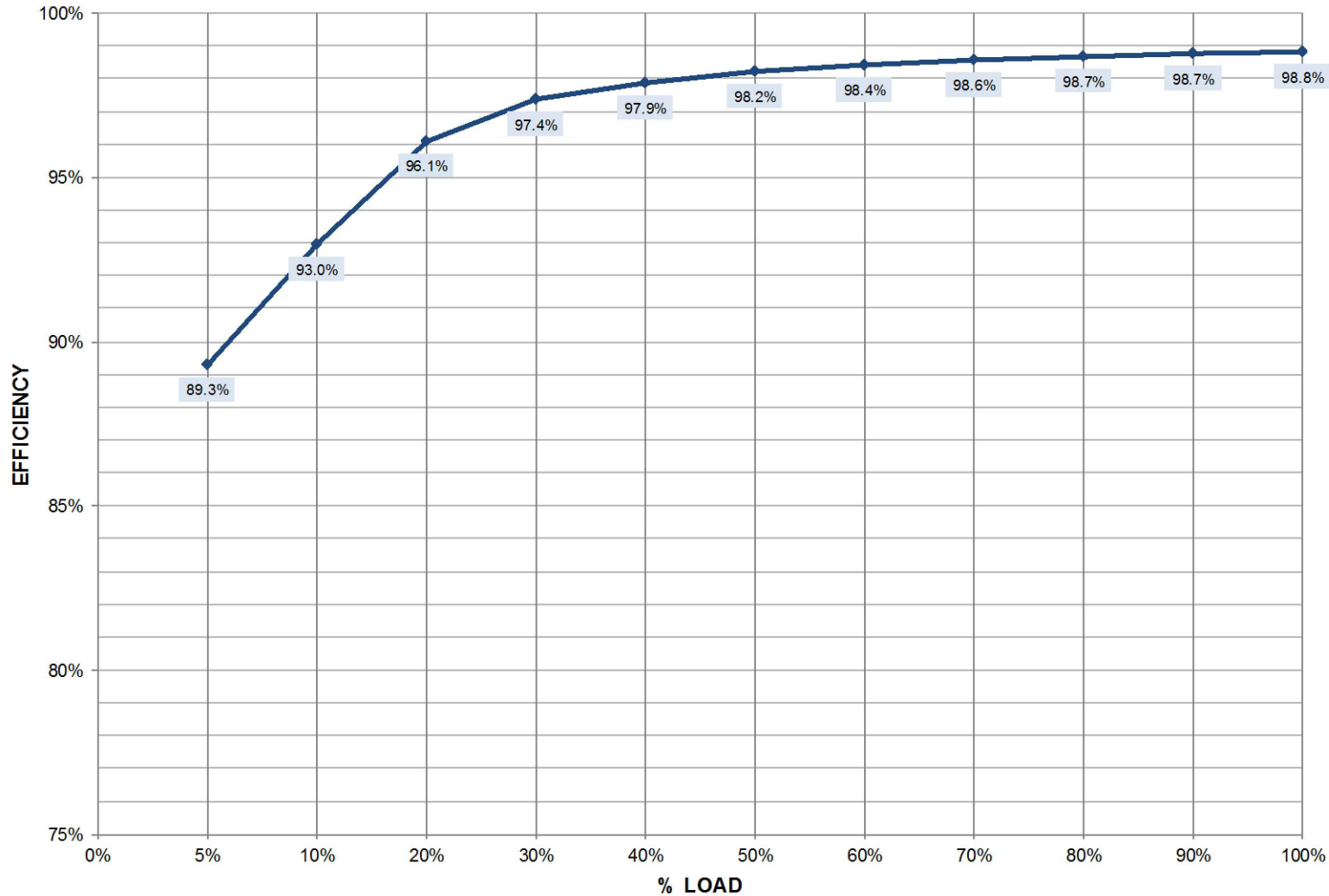

SHEET NO. 1 OF 1	DRAWN BY: J. SHIPMAN
ECN NO.	DESIGNED BY: S. MAJOR
REF DWG.	APPROVED BY: S. MAJOR

TITLE
MODULE DYNAMIC ONLINE (VI) MODE AC/AC EFFICIENCY
TYPICAL, SMS AND 1+N 400kVA/400kW
415V 60Hz
LIEBERT EXL S1

DWG. NO. ES1-18-S049
DATE (LATEST REV.) 01/07/2018
REVISION 0



VERTIV™

1050 DEARBORN DR
P.O. BOX 29186
COLUMBUS, OH 43229

NOTES

1. NO LOAD POWER LOSS: 2.8kW
 2. MEASUREMENTS TAKEN WITH DC/DC CONVERTER OPERATING, NO DC SOURCE CONNECTED.
 3. MEASUREMENTS TAKEN WITH RESISTIVE LOAD.
- MEASUREMENTS MAY VARY FOR CAPACITIVE (LEADING) LOADS AND INDUCTIVE (LAGGING) LOADS.

EXL S1 400kVA DYNAMIC ONLINE (VI) MODE AC/AC EFFICIENCIES

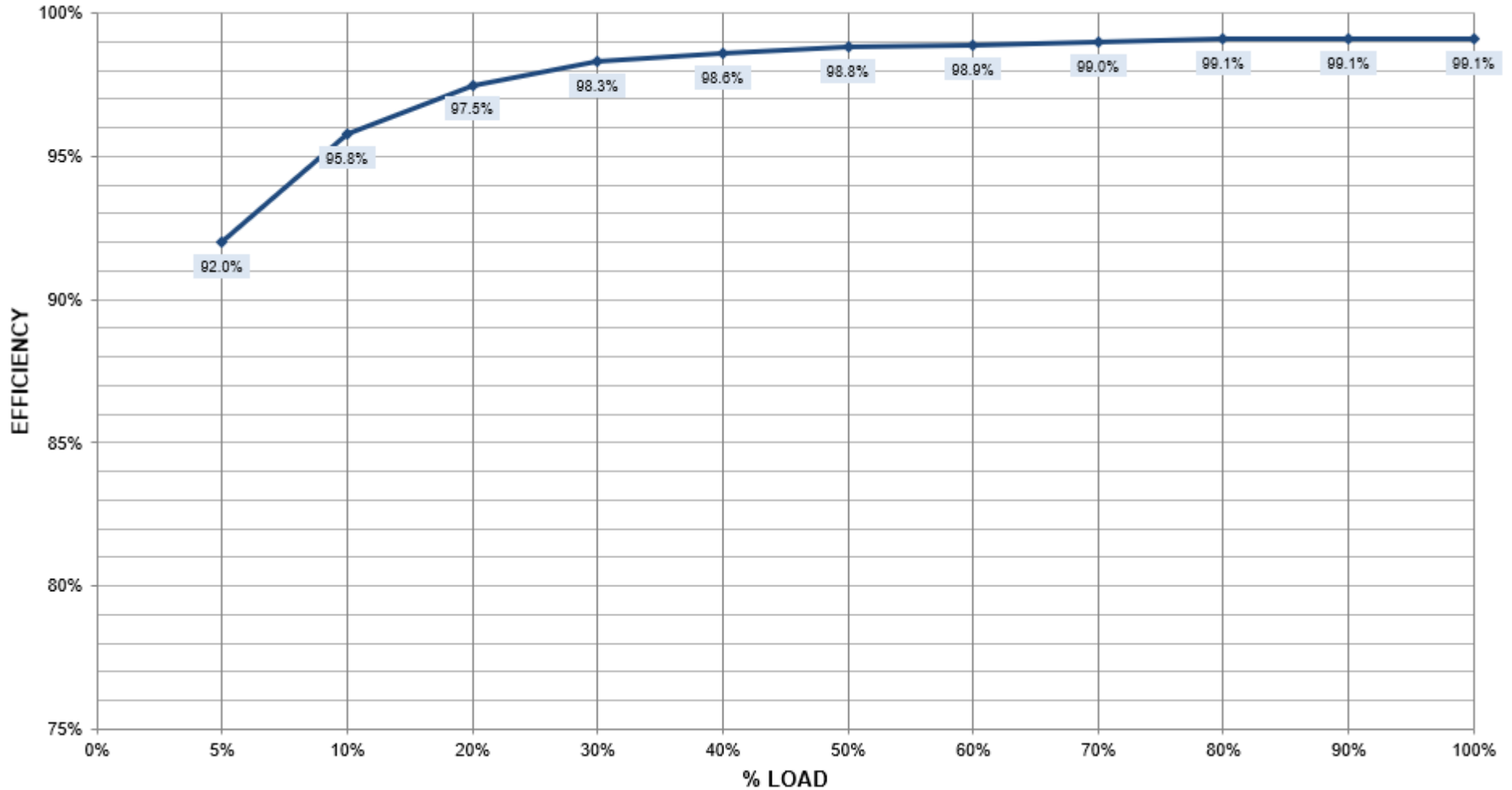

SHEET NO. 1 OF 1	DRAWN BY: JASON ZHANG
ECN NO.	DESIGNED BY: JASON ZHANG
REF DWG.	APPROVED BY: S. MAJOR
REF DWG	

TITLE MODULE DYNAMIC ONLINE(VI) MODE AC/AC EFFICIENCY TYPICAL, SMS AND 1+N 400kVA/400kW 480V 60Hz LIEBERT EXL S1
--

DWG. NO. ES1-18-S053
DATE (LATEST REV.) 1/16/2020
REVISION 0
1050 DEARBORN DR P.O. BOX 29186 COLUMBUS, OH 43229



NOTES

1. NO LOAD POWER LOSS: 4.2 kW
2. MEASUREMENTS TAKEN WITH DC/DC CONVERTER OPERATING, NO DC SOURCE CONNECTED.

EXL S1 500kVA DYNAMIC ONLINE (VI) MODE AC/AC EFFICIENCIES

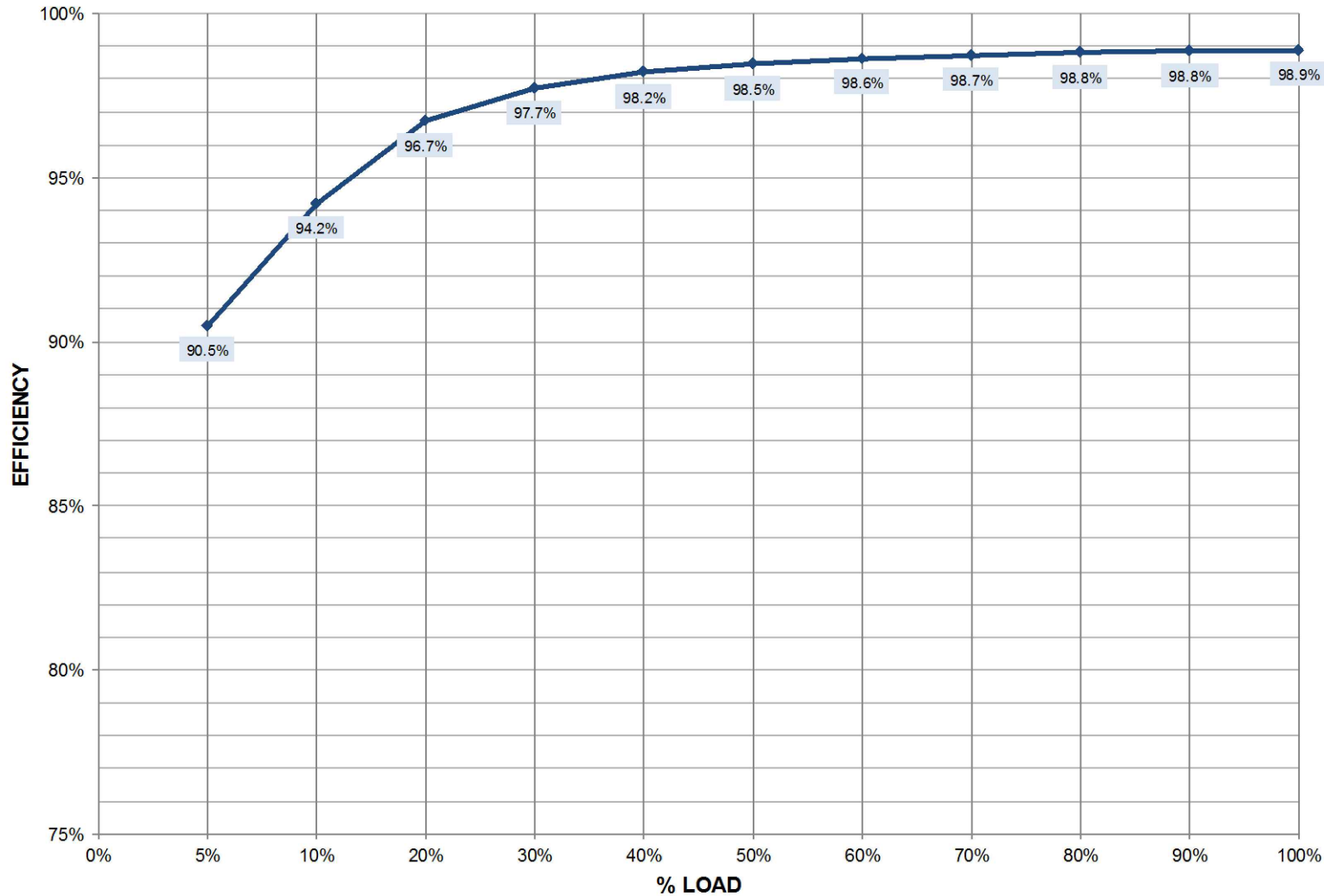

SHEET NO. 1 OF 1	DRAWN BY: J. SHIPMAN
ECN NO.	DESIGNED BY: S. MAJOR
REF DWG.	APPROVED BY: S. MAJOR

TITLE MODULE DYNAMIC ONLINE (VI) MODE AC/AC EFFICIENCY TYPICAL, SMS AND 1+N 500kVA/500kW 415V 60Hz LIEBERT EXL S1

DWG. NO. ES1-18-S050
DATE (LATEST REV.) 01/07/2018
REVISION 0

 VERTIV™	1050 DEARBORN DR P.O. BOX 29186 COLUMBUS, OH 43229
--	--

NOTES

1. NO LOAD POWER LOSS: 4.2 kW
2. MEASUREMENTS TAKEN WITH DC/DC CONVERTER OPERATING, NO DC SOURCE CONNECTED.

EXL S1 500kVA DYNAMIC ONLINE (VI) MODE AC/AC EFFICIENCIES

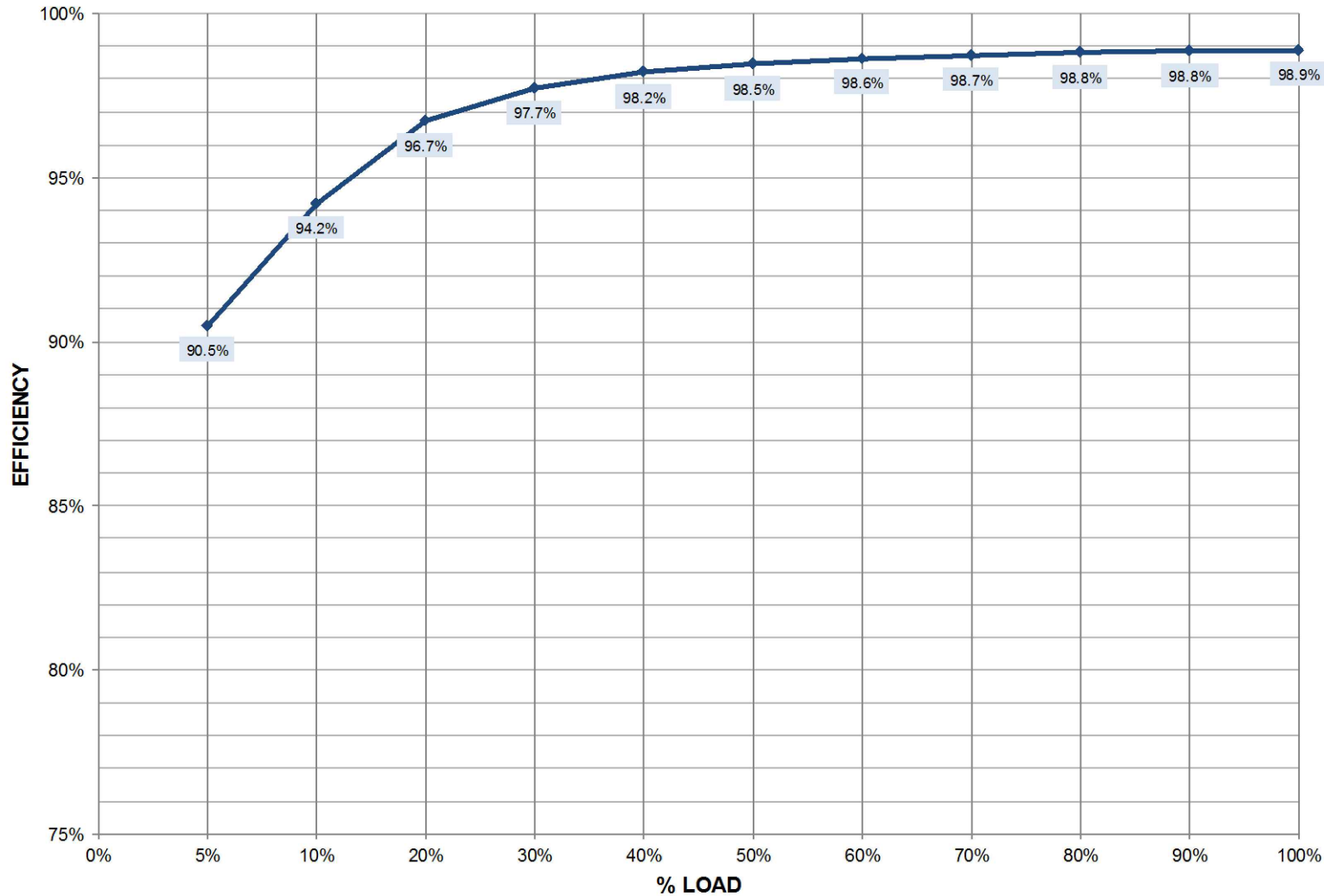

SHEET NO. 1 OF 1	DRAWN BY: J. SHIPMAN
ECN NO.	DESIGNED BY: S. MAJOR
REF DWG.	APPROVED BY: S. MAJOR

TITLE MODULE DYNAMIC ONLINE (VI) MODE AC/AC EFFICIENCY TYPICAL, SMS AND 1+N 500kVA/500kW 480V 60Hz LIEBERT EXL S1

DWG. NO. ES1-18-S054
DATE (LATEST REV.) 01/07/2018
REVISION 0



VERTIV™

1050 DEARBORN DR
P.O. BOX 29186
COLUMBUS, OH 43229

NOTES

1. NO LOAD POWER LOSS: 4.2 kW
2. MEASUREMENTS TAKEN WITH DC/DC CONVERTER OPERATING, NO DC SOURCE CONNECTED.

EXL S1 600kVA DYNAMIC ONLINE (VI) MODE AC/AC EFFICIENCIES

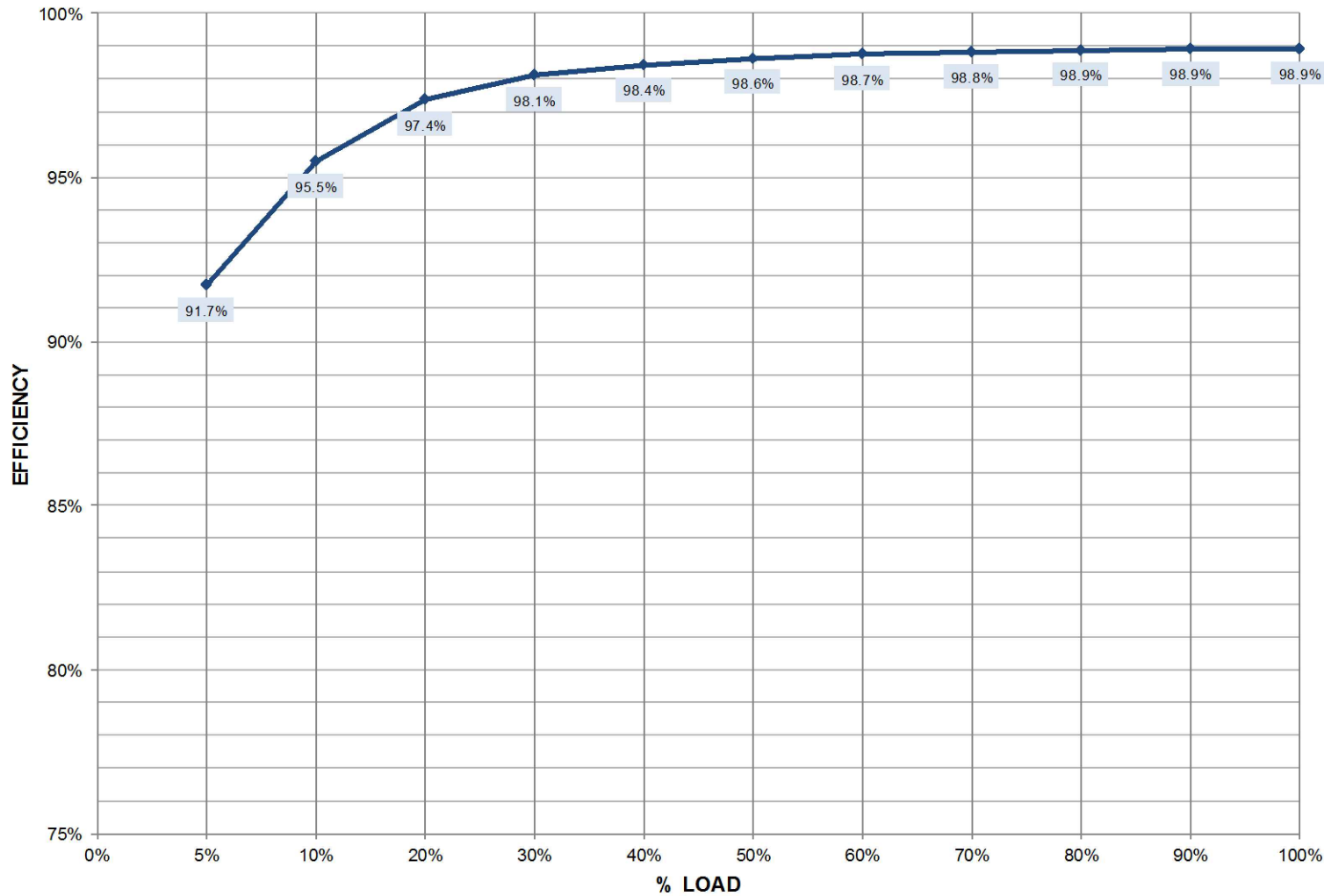

SHEET NO. 1 OF 1	DRAWN BY: J. SHIPMAN
ECN NO.	DESIGNED BY: S. MAJOR
REF DWG.	APPROVED BY: S. MAJOR

TITLE MODULE DYNAMIC ONLINE (VI) MODE AC/AC EFFICIENCY TYPICAL, SMS AND 1+N 600kVA/600kW 480V 60Hz LIEBERT EXL S1

DWG. NO. ES1-18-S055
DATE (LATEST REV.) 01/07/2018
REVISION 0

 VERTIV™
<small>1050 DEARBORN DR P.O. BOX 29186 COLUMBUS, OH 43229</small>

NOTES

1. NO LOAD POWER LOSS: 5.4 kW
2. MEASUREMENTS TAKEN WITH DC/DC CONVERTER OPERATING, NO DC SOURCE CONNECTED.

EXL S1 625kVA DYNAMIC ONLINE (VI) MODE AC/AC EFFICIENCIES

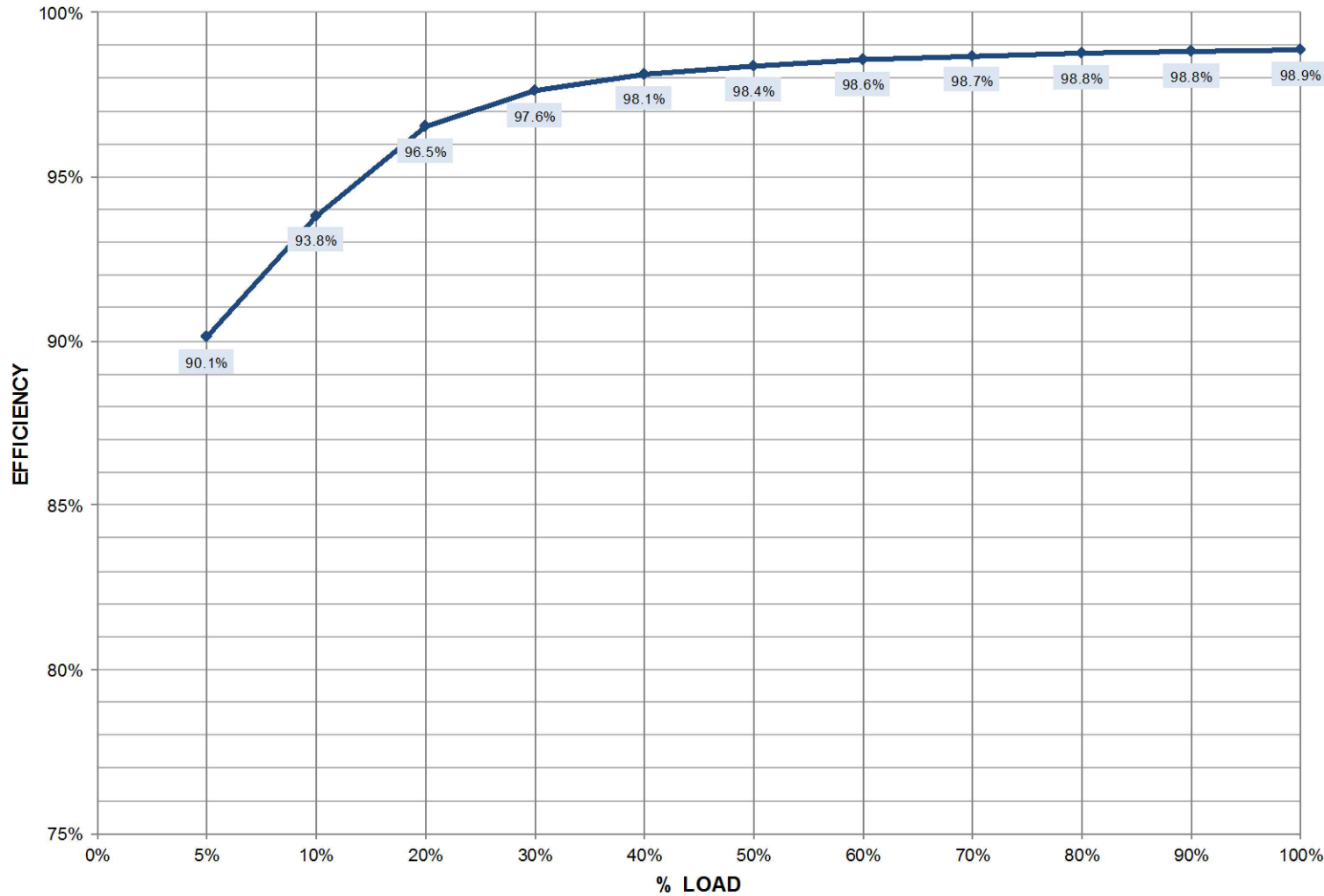

SHEET NO. 1 OF 1	DRAWN BY: J. SHIPMAN
ECN NO.	DESIGNED BY: S. MAJOR
REF DWG.	APPROVED BY: S. MAJOR

TITLE MODULE DYNAMIC ONLINE (VI) MODE AC/AC EFFICIENCY TYPICAL, SMS AND 1+N 625kVA/625kW 480V 60Hz LIEBERT EXL S1

DWG. NO. ES1-18-S056
DATE (LATEST REV.) 01/07/2018
REVISION 0

 VERTIV™
<small>1050 DEARBORN DR P.O. BOX 29186 COLUMBUS, OH 43229</small>

NOTES

1. NO LOAD POWER LOSS: 5.4 kW
2. MEASUREMENTS TAKEN WITH DC/DC CONVERTER OPERATING, NO DC SOURCE CONNECTED.

EXL S1 750kVA DYNAMIC ONLINE (VI) MODE AC/AC EFFICIENCIES

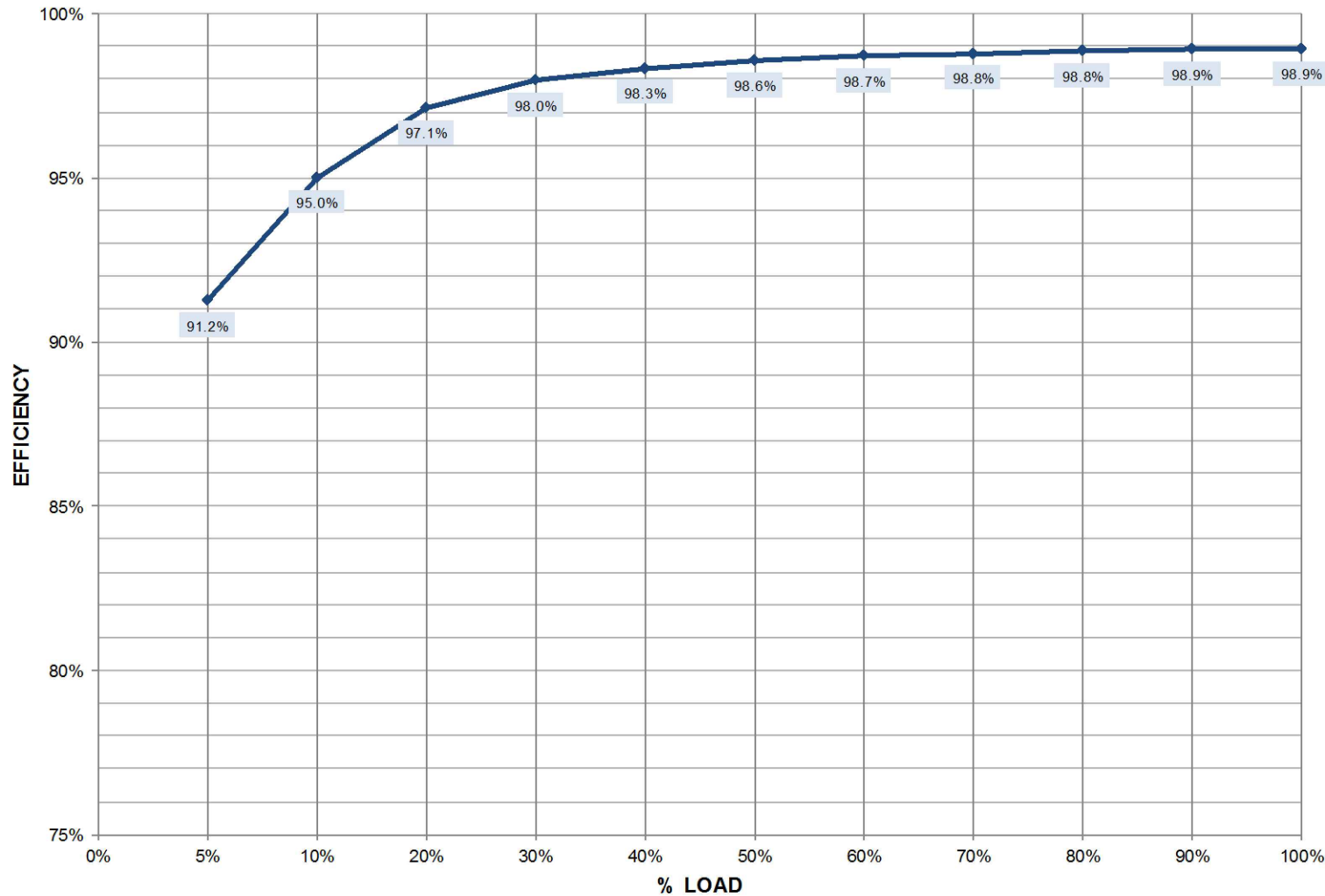

SHEET NO. 1 OF 1	DRAWN BY: J. SHIPMAN
ECN NO.	DESIGNED BY: S. MAJOR
REF DWG.	APPROVED BY: S. MAJOR

TITLE
MODULE DYNAMIC ONLINE (VI) MODE AC/AC EFFICIENCY
TYPICAL, SMS AND 1+N 750kVA/750kW
480V 60Hz
LIEBERT EXL S1

DWG. NO. ES1-18-S057
DATE (LATEST REV.) 01/07/2018
REVISION 0

1050 DEARBORN DR
P.O. BOX 29186
COLUMBUS, OH 43229



VERTIV™

NOTES

1. NO LOAD POWER LOSS: 5.4 kW
2. MEASUREMENTS TAKEN WITH DC/DC CONVERTER OPERATING, NO DC SOURCE CONNECTED.

EXL S1 800kVA DYNAMIC ONLINE (VI) MODE AC/AC EFFICIENCIES

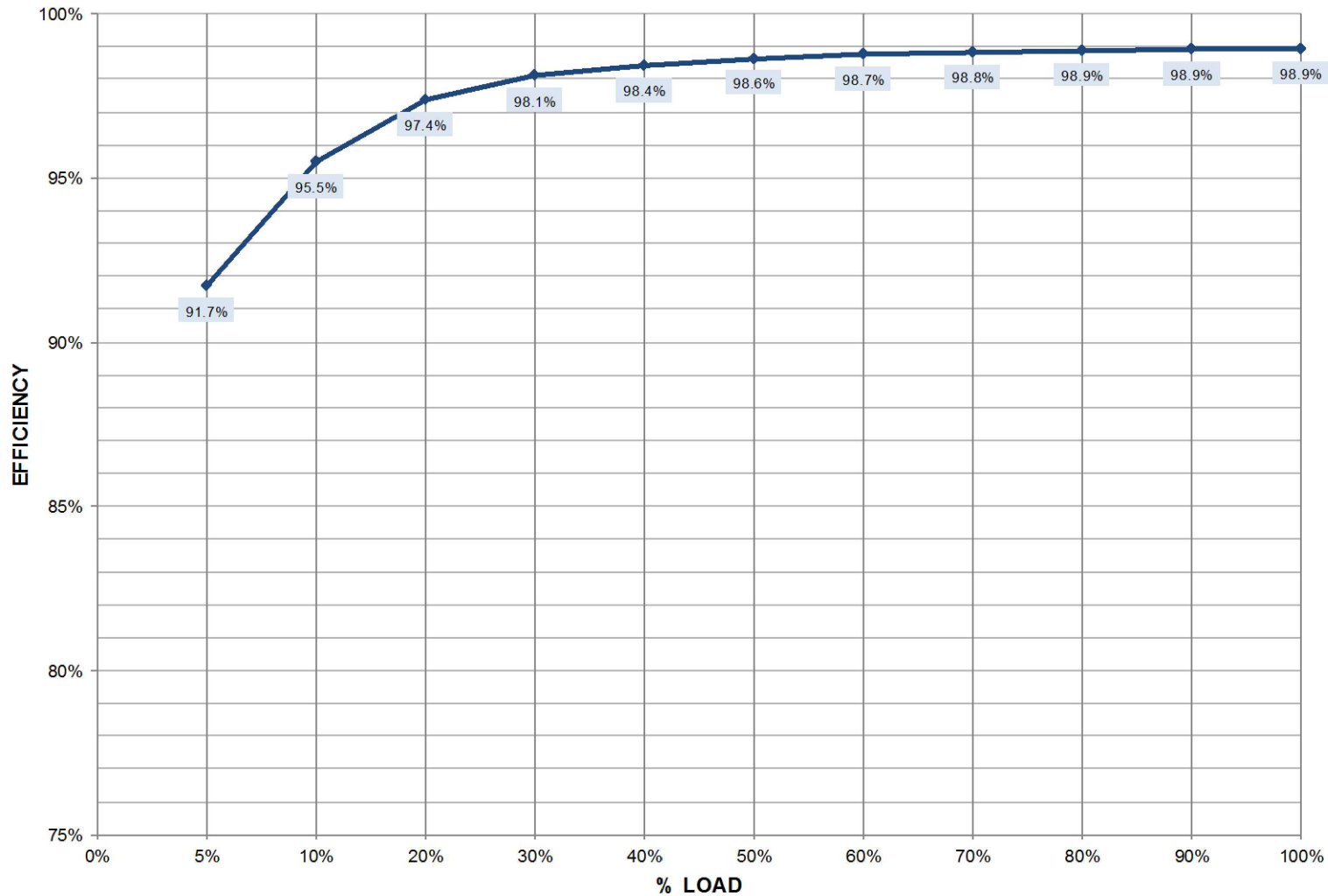

SHEET NO. 1 OF 1	DRAWN BY: J. SHIPMAN
ECN NO.	DESIGNED BY: S. MAJOR
REF DWG.	APPROVED BY: S. MAJOR

TITLE
MODULE DYNAMIC ONLINE (VI) MODE AC/AC EFFICIENCY
TYPICAL, SMS AND 1+N 800kVA/800kW
480V 60Hz
LIEBERT EXL S1

DWG. NO. ES1-18-S058
DATE (LATEST REV.) 01/07/2018
REVISION 0

1050 DEARBORN DR
P.O. BOX 29186
COLUMBUS, OH 43229

NOTES

1. NO LOAD POWER LOSS: 7.9 kW
2. MEASUREMENTS TAKEN WITH DC/DC CONVERTER OPERATING, NO DC SOURCE CONNECTED.

EXL S1 1000kVA DYNAMIC ONLINE (VI) MODE AC/AC EFFICIENCIES

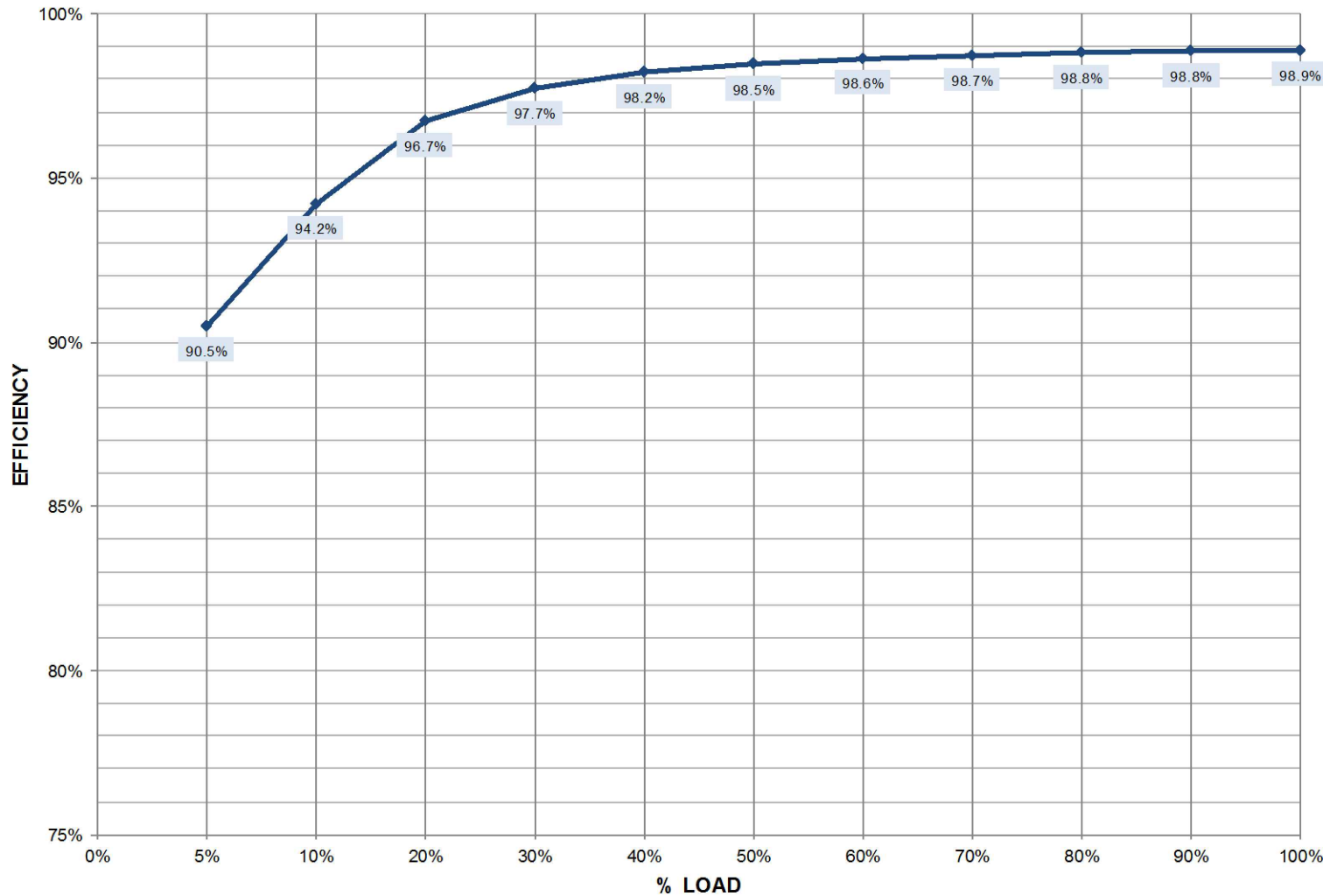

SHEET NO. 1 OF 1	DRAWN BY: J. SHIPMAN
ECN NO.	DESIGNED BY: S. MAJOR
REF DWG.	APPROVED BY: S. MAJOR

TITLE
MODULE DYNAMIC ONLINE (VI) MODE AC/AC EFFICIENCY
TYPICAL, SMS AND 1+N 1000kVA/1000kW
480V 60Hz
LIEBERT EXL S1

DWG. NO. ES1-18-S059
DATE (LATEST REV.) 01/07/2018
REVISION 0

 VERTIV™	1050 DEARBORN DR P.O. BOX 29186 COLUMBUS, OH 43229
--	--

NOTES

1. NO LOAD POWER LOSS: 7.9 kW
2. MEASUREMENTS TAKEN WITH DC/DC CONVERTER OPERATING, NO DC SOURCE CONNECTED.

EXL S1 1100kVA DYNAMIC ONLINE (VI) MODE AC/AC EFFICIENCIES

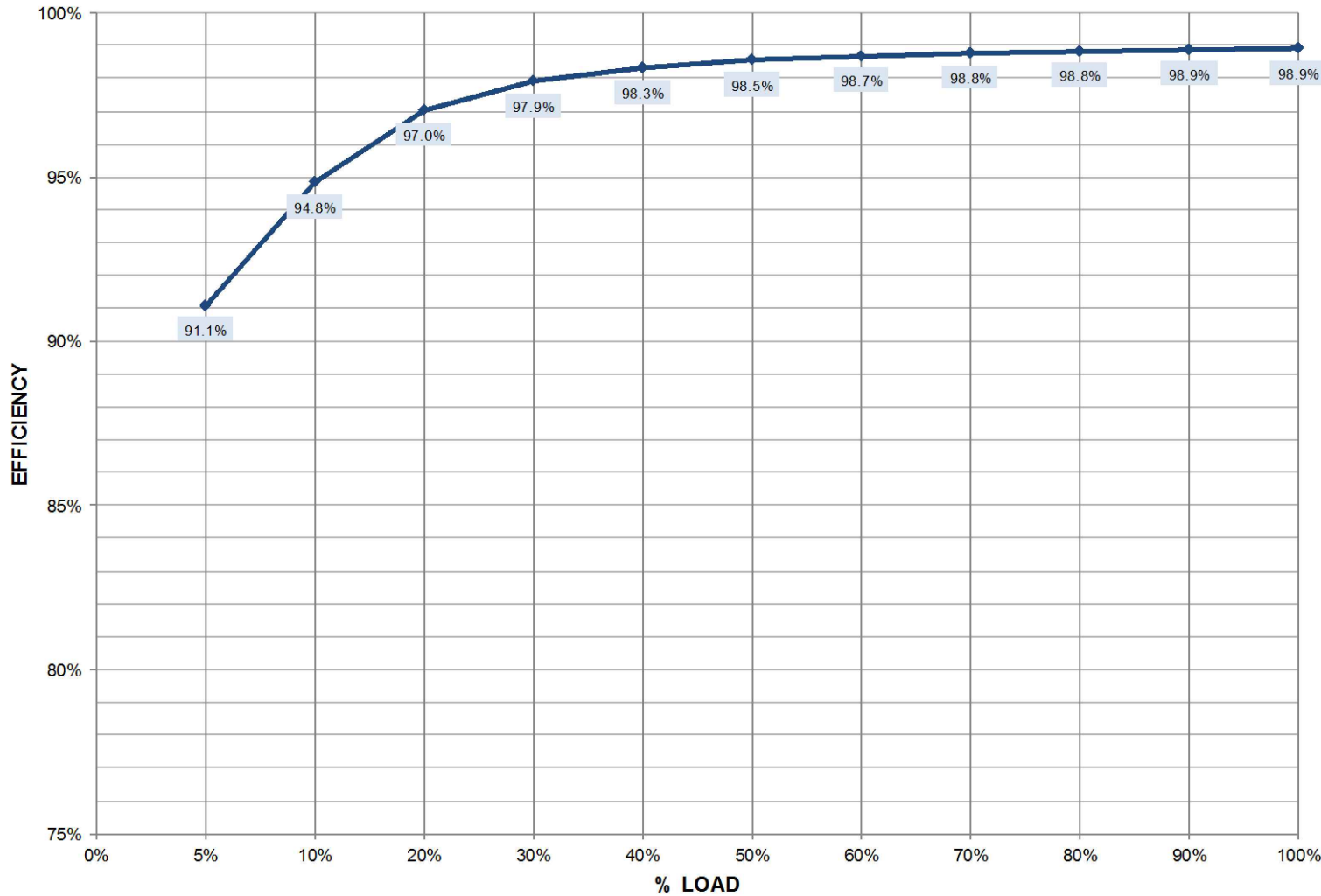

SHEET NO. 1 OF 1	DRAWN BY: J. SHIPMAN
ECN NO.	DESIGNED BY: S. MAJOR
REF DWG.	APPROVED BY: S. MAJOR

TITLE
MODULE DYNAMIC ONLINE (VI) MODE AC/AC EFFICIENCY
TYPICAL, SMS AND 1+N 1100kVA/1100kW
480V 60Hz
LIEBERT EXL S1

DWG. NO. ES1-18-S060
DATE (LATEST REV.) 01/07/2018
REVISION 0

1050 DEARBORN DR
P.O. BOX 29186
COLUMBUS, OH 43229

NOTES

1. NO LOAD POWER LOSS: 7.9 kW
2. MEASUREMENTS TAKEN WITH DC/DC CONVERTER OPERATING, NO DC SOURCE CONNECTED.

EXL S1 1200kVA DYNAMIC ONLINE (VI) MODE AC/AC EFFICIENCIES

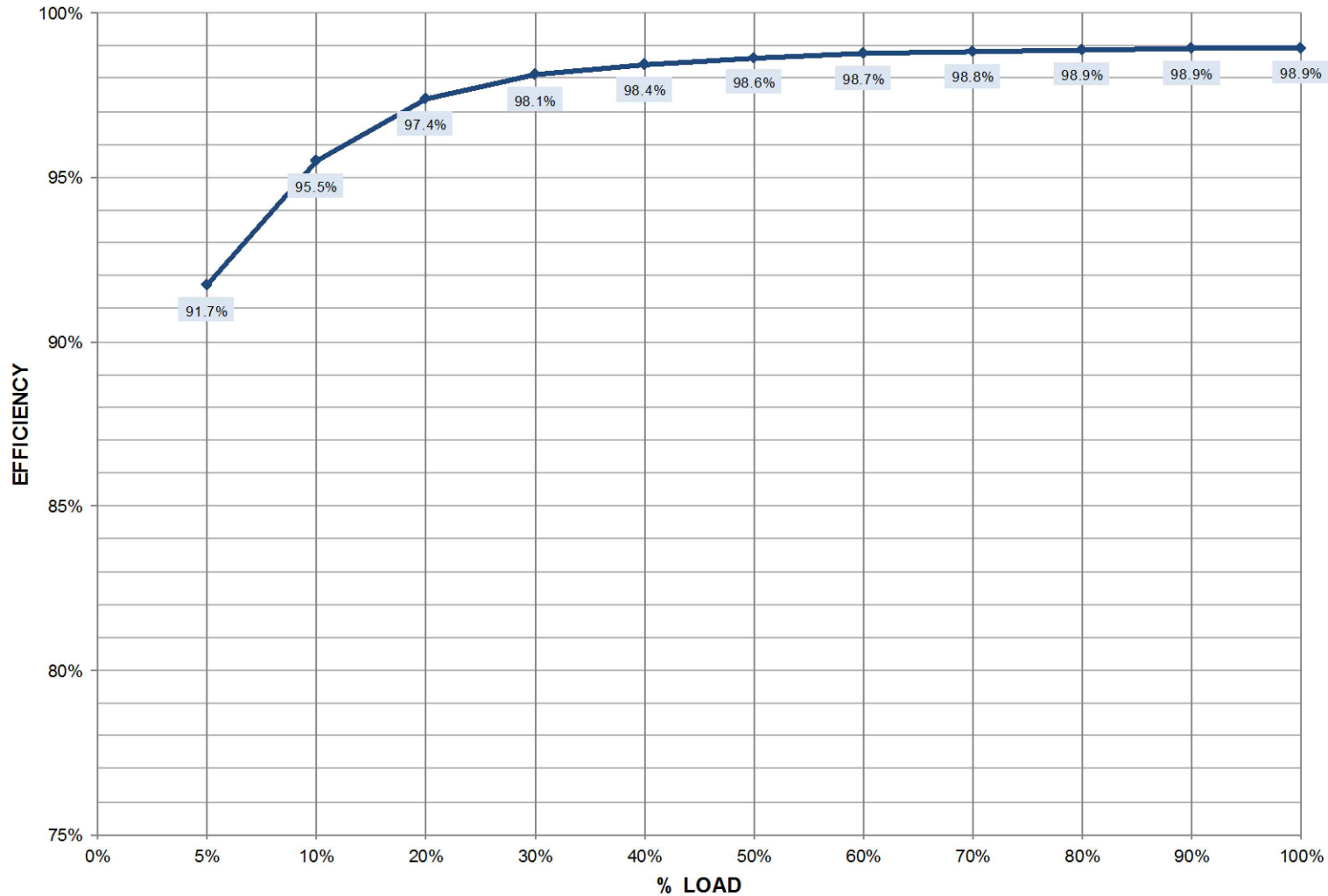

SHEET NO. 1 OF 1	DRAWN BY: J. SHIPMAN
ECN NO.	DESIGNED BY: S. MAJOR
REF DWG.	APPROVED BY: S. MAJOR

TITLE
MODULE DYNAMIC ONLINE (VI) MODE AC/AC EFFICIENCY
TYPICAL, SMS AND 1+N 1200kVA/1200kW
480V 60Hz
LIEBERT EXL S1

DWG. NO. ES1-18-S061
DATE (LATEST REV.) 01/07/2018
REVISION 0

1050 DEARBORN DR
P.O. BOX 29186
COLUMBUS, OH 43229



VERTIV™

NOTES

- OVERLOAD AT 480V NOMINAL INPUT VOLTAGE AND NO BATTERY CHARGING CURRENT.

EXL S1 INVERTER OVERLOAD CHART

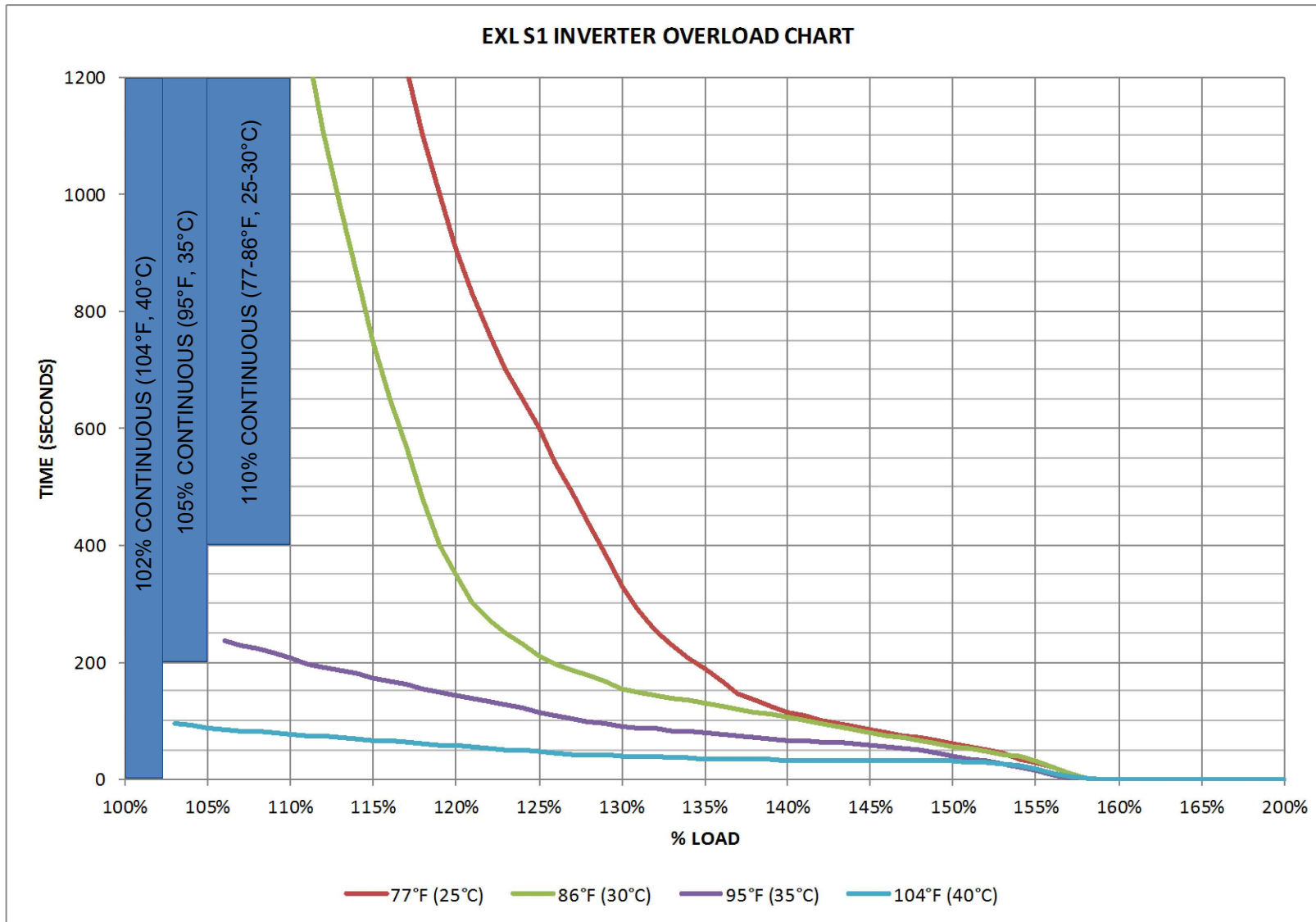

SHEET NO. 1 OF 1	DRAWN BY: J. SHIPMAN
ECN NO.	DESIGNED BY: S. MAJOR
REF DWG.	APPROVED BY: S. MAJOR

TITLE
**INVERTER OVERLOAD CHART
 FOR ALL KVA
 LIEBERT EXL S1**

DWG. NO. ES1-18-S045
DATE (LATEST REV.) 06/01/2018
REVISION 0
1050 DEARBORN DR P.O. BOX 29186 COLUMBUS, OH 43229



EXL S1 BYPASS OVERLOAD CHART

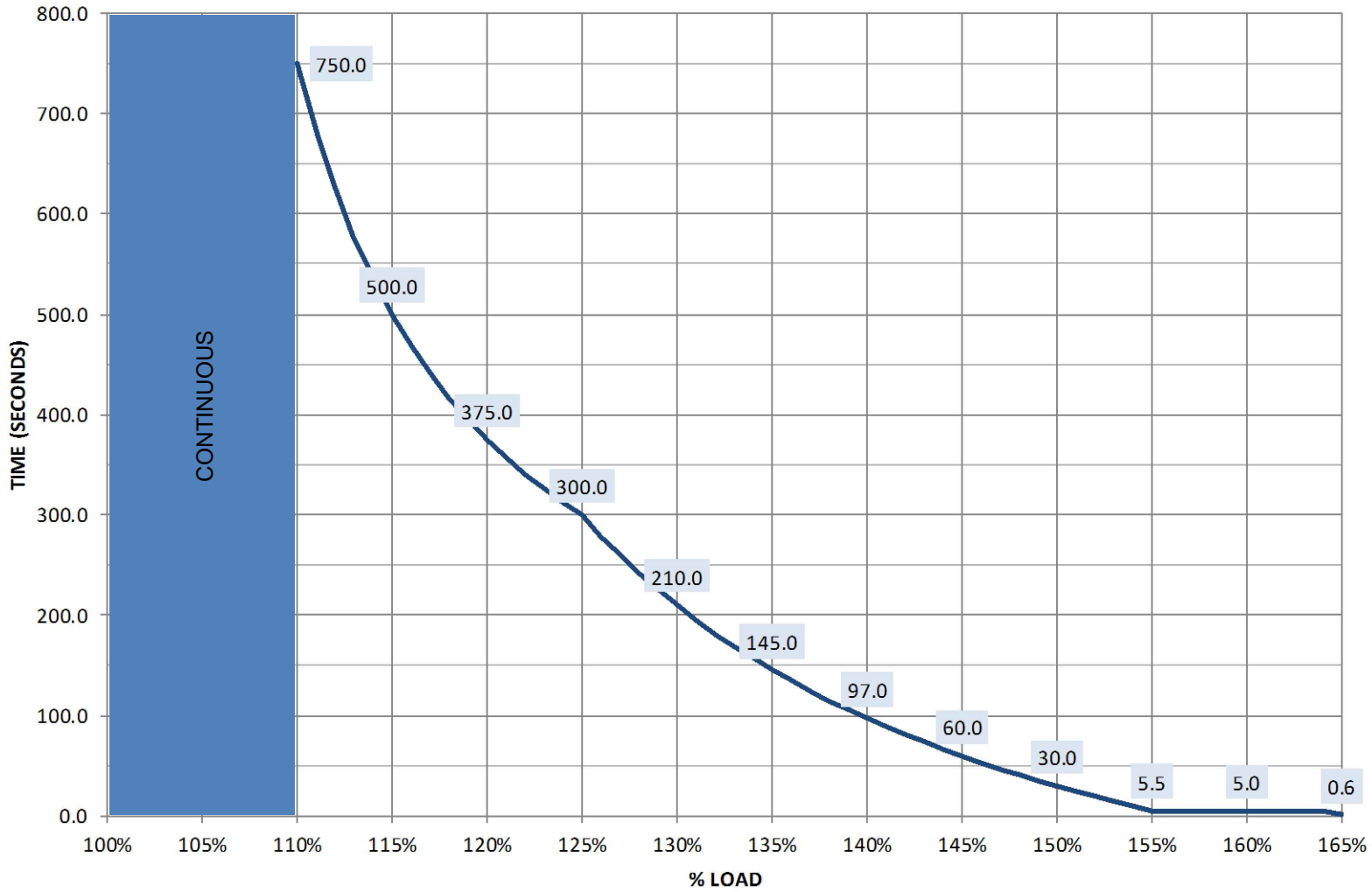

SHEET NO. 1 OF 1	DRAWN BY: J. SHIPMAN
ECN NO.	DESIGNED BY: S. MAJOR
REF DWG.	APPROVED BY: S. MAJOR

TITLE BYPASS OVERLOAD CHART FOR ALL KVA LIEBERT EXL S1
--

DWG. NO. ES1-18-S046
DATE (LATEST REV.) 06/01/2018
REVISION 0
1050 DEARBORN DR P.O. BOX 29186 COLUMBUS, OH 43229







Vertiv.com | Vertiv Headquarters, 1050 Dearborn Drive, Columbus, OH, 43085, USA

© 2015-2020 Vertiv Group Corp. All rights reserved. Vertiv™ and the Vertiv logo are trademarks or registered trademarks of Vertiv Group Corp. All other names and logos referred to are trade names, trademarks or registered trademarks of their respective owners. While every precaution has been taken to ensure accuracy and completeness herein, Vertiv Group Corp. assumes no responsibility, and disclaims all liability, for damages resulting from use of this information or for any errors or omissions. Specifications are subject to change without notice.

SL-26090_REV5_05-20