



RX-V365

AV Receiver

OWNER'S MANUAL

Caution: Read this before operating your unit.

- 1 To assure the finest performance, please read this manual carefully. Keep it in a safe place for future reference.
- 2 Install this sound system in a well ventilated, cool, dry, clean place – away from direct sunlight, heat sources, vibration, dust, moisture, and/or cold. Allow ventilation space of at least 30 cm on the top, 20 cm on the left and right, and 20 cm on the back of this unit.
- 3 Locate this unit away from other electrical appliances, motors, or transformers to avoid humming sounds.
- 4 Do not expose this unit to sudden temperature changes from cold to hot, and do not locate this unit in an environment with high humidity (i.e. a room with a humidifier) to prevent condensation inside this unit, which may cause an electrical shock, fire, damage to this unit, and/or personal injury.
- 5 Avoid installing this unit where foreign objects may fall onto this unit and/or this unit may be exposed to liquid dripping or splashing. On the top of this unit, do not place:
 - Other components, as they may cause damage and/or discoloration on the surface of this unit.
 - Burning objects (i.e. candles), as they may cause fire, damage to this unit, and/or personal injury.
 - Containers with liquid in them, as they may fall and liquid may cause electrical shock to the user and/or damage to this unit.
- 6 Do not cover this unit with a newspaper, tablecloth, curtain, etc. in order not to obstruct heat radiation. If the temperature inside this unit rises, it may cause fire, damage to this unit, and/or personal injury.
- 7 Do not plug in this unit to a wall outlet until all connections are complete.
- 8 Do not operate this unit upside-down. It may overheat, possibly causing damage.
- 9 Do not use force on switches, knobs and/or cords.
- 10 When disconnecting the power cable from the wall outlet, grasp the plug; do not pull the cable.
- 11 Do not clean this unit with chemical solvents; this might damage the finish. Use a clean, dry cloth.
- 12 Only voltage specified on this unit must be used. Using this unit with a higher voltage than specified is dangerous and may cause fire, damage to this unit, and/or personal injury. Yamaha will not be held responsible for any damage resulting from use of this unit with a voltage other than specified.
- 13 To prevent damage by lightning, keep the power cord and outdoor antennas disconnected from a wall outlet or the unit during a lightning storm.
- 14 Do not attempt to modify or fix this unit. Contact qualified Yamaha service personnel when any service is needed. The cabinet should never be opened for any reasons.
- 15 When not planning to use this unit for long periods of time (i.e. vacation), disconnect the AC power plug from the wall outlet.
- 16 Install this unit near the AC outlet and where the AC power plug can be reached easily.
- 17 Be sure to read the “Troubleshooting” section on common operating errors before concluding that this unit is faulty.
- 18 Before moving this unit, press **(A) STANDBY/ON** to set this unit in the standby mode, and disconnect the AC power plug from the wall outlet.
- 19 **VOLTAGE SELECTOR** (Asia and General models only)
The **VOLTAGE SELECTOR** on the rear panel of this unit must be set for your local main voltage **BEFORE** plugging into the AC wall outlet. Voltages are:
..... AC 110–120/220–240 V, 50/60 Hz
- 20 The batteries shall not be exposed to excessive heat such as sunshine, fire or like.
- 21 Excessive sound pressure from earphones and headphones can cause hearing loss.
- 22 When replacing the batteries, be sure to use batteries of the same type. Danger of explosion may happen if batteries are incorrectly replaced.

WARNING
TO REDUCE THE RISK OF FIRE OR ELECTRIC SHOCK, DO NOT EXPOSE THIS UNIT TO RAIN OR MOISTURE.

As long as this unit is connected to the AC wall outlet, it is not disconnected from the AC power source even if you turn off this unit by **(A) STANDBY/ON**. In this state, this unit is designed to consume a very small quantity of power.

Contents

INTRODUCTION

Features	2
Supplied accessories	2
Functional overview	3
Front panel	3
Front panel display.....	4
Remote control.....	5
Rear panel	6
Quick start guide	7

PREPARATION

Preparation of remote control	8
Connections	9
Placing speakers.....	9
Connecting speakers	9
Connecting video components.....	11
Connecting other components	13
Using the VIDEO AUX jacks on the front panel	14
Connecting the FM and AM antennas	15
Connecting the power cable.....	15
Turning on and off the power	15
Optimizing the speaker setting for your listening room (YPAO)	16
Using AUTO SETUP.....	16

BASIC OPERATION

Playback	18
Basic procedure.....	18
Additional operations.....	19
Selecting the SCENE templates	22
Selecting the desired SCENE template.....	22
Creating your original SCENE templates	24
Using remote control on the SCENE feature	25
Sound field programs	26
Selecting sound field programs.....	26
FM/AM tuning	28
Overview.....	28
FM/AM tuning operations	28
Preset FM/AM stations	28

ADVANCED OPERATION

Set menu	30
Using set menu.....	31
1 SOUND MENU	31
2 INPUT MENU	33
3 OPTION MENU	34
Remote control features	36
Controlling this unit, a TV, or other components	36
Setting remote control codes.....	38
Advanced setup	39

ADDITIONAL INFORMATION

Troubleshooting	40
Glossary	45
Specifications	46
Index	47

APPENDIX

(at the end of this manual)

List of remote control codes	i
---	---

About this manual

- * indicates a tip for your operation.
- Some operations can be performed by using either the buttons on the front panel or the ones on the remote control. In case the button names differ between the front panel and the remote control, the button name on the remote control is given in parentheses.
- This manual is printed prior to production. Design and specifications are subject to change in part as a result of improvements, etc. In case of differences between the manual and product, the product has priority.
- “**(A)STANDBY/ON**” or “**(6)DVD**” (example) indicates the name of the parts on the front panel or the remote control. Refer to the “Functional overview” on page 3.

INTRODUCTION

PREPARATION

OPERATION

ADVANCED OPERATION

ADDITIONAL INFORMATION

APPENDIX

English

INTRODUCTION

Features

Built-in 5-channel power amplifier

(1 kHz, 0.9% THD, 6 Ω)

Front: 100 W/ch

Center: 100 W

Surround: 100 W/ch

Various input/output connectors

- ◆ HDMI (IN x 2, OUT x 1), Component video (IN x 3, OUT x 1), Composite video (IN x 3, OUT x 2), Coaxial digital audio (IN x 1), Optical digital audio (IN x 2), Analog audio (IN x 9, OUT x 2)
- ◆ Speaker out (5-channel), Subwoofer out
- ◆ Discrete multi-channel input (6-channel)

SCENE select function

- ◆ Preset SCENE templates for various situations
- ◆ SCENE template customizing capability

Sound field programs

- ◆ Proprietary Yamaha technology for the creation of surround field
- ◆ Compressed Music Enhancer mode
- ◆ SILENT CINEMA™

Decoders and DSP circuits

- ◆ Dolby Digital decoder
- ◆ Dolby Pro Logic/Dolby Pro Logic II decoder
- ◆ DTS decoder
- ◆ Virtual CINEMA DSP
- ◆ SILENT CINEMA™

Sophisticated FM/AM tuner

- ◆ 40-station random and direct preset tuning
- ◆ Automatic preset tuning

HDMI™ (High-Definition Multimedia Interface)

- ◆ HDMI interface for standard, enhanced or high-definition video (includes 1080p video signal transmission)

Other features

- ◆ 192-kHz/24-bit D/A converter
- ◆ Sleep timer
- ◆ Cinema and music night listening modes
- ◆ Remote control with preset remote control codes



Manufactured under license from Dolby Laboratories. "Dolby," "Pro Logic," and the double-D symbol are trademarks of Dolby Laboratories.



Manufactured under license under U.S. Patent No's: 5,451,942;5,956,674;5,974,380;5,978,762;6,487,535 and other U.S. and worldwide patents issued and pending. DTS is a registered trademark and the DTS logos and symbol are trademarks of DTS, Inc. © 1996-2007 DTS, Inc. All Rights Reserved.

HDMI

"HDMI," the "HDMI" logo and "High-Definition Multimedia Interface" are trademarks, or registered trademarks of HDMI Licensing LLC.

SILENT™
CINEMA

"SILENT CINEMA" is a trademark of Yamaha Corporation.

Supplied accessories

Check that you received all of the following parts.

- Remote control
- Batteries (2) (AAA, R03, UM-4)
- AM loop antenna
- Indoor FM antenna
- Optimizer microphone

Functional overview

Front panel

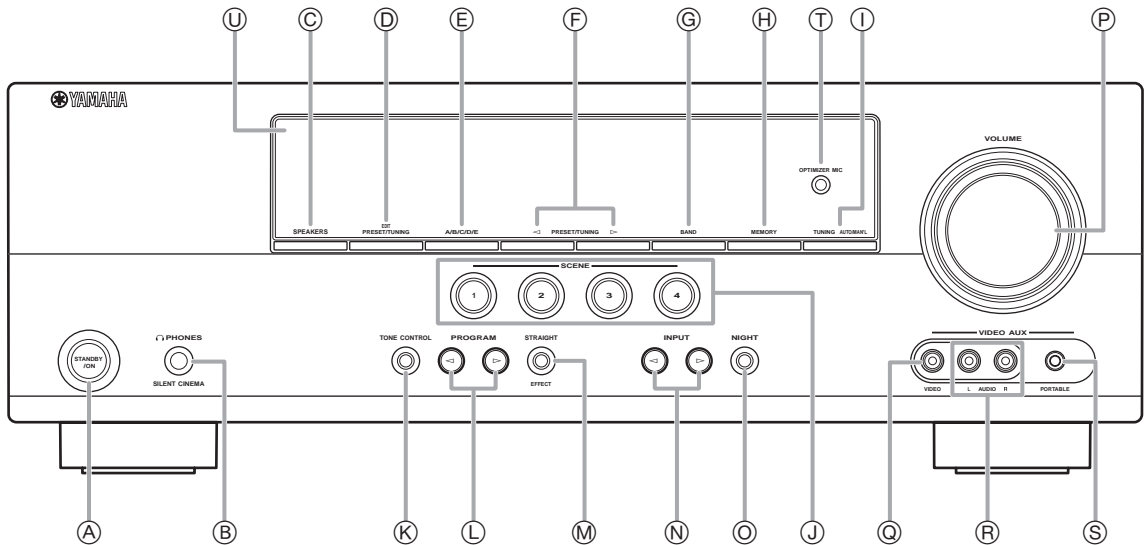

- (A) STANDBY/ON**
Turns on this unit, or sets it to standby mode (see page 15).
- (B) PHONES jack**
Connect to a pair of headphones (see page 20).
- (C) SPEAKERS**
Turns on or off the set of front speakers connected to the FRONT A or FRONT B speaker terminals (see page 19).
- (D) EDIT PRESET/TUNING**
Switches the tuning mode (see page 28).
- (E) A/B/C/D/E**
Selects the preset station group (A to E) (see page 29).
- (F) PRESET/TUNING </>**
Tunes into radio stations manually or automatically and selects a preset station group (see page 28).
- (G) BAND**
Selects the reception band from FM and AM (see page 28).
- (H) MEMORY**
Stores a station that you tuned into as a preset station (see page 28).
- (I) TUNING AUTO/MAN'L**
Selects a tuning method from automatic or manual tuning (see page 28).
- (J) SCENE 1/2/3/4**
Recalls an input source and a sound field program assigned to each SCENE button (see page 22).
- (K) TONE CONTROL**
Selects "BASS" and "TREBLE" to adjust frequency response (see page 20).
- (L) PROGRAM </>**
Selects a sound field program (see page 26).
- (M) STRAIGHT**
Activates the "STRAIGHT" mode (see page 27).
- (N) INPUT </>**
Selects an input source (see page 18).
- (O) NIGHT**
Selects a night listening mode (see page 20).
- (P) VOLUME control**
Adjusts the volume level of this unit (see page 18).
- (Q) VIDEO (VIDEO AUX) jack**
Connects to a game console or a video camera using a composite video cable (see page 14).
- (R) AUDIO L/R (VIDEO AUX) jacks**
Connects to a game console or a video camera using analog audio cables (see page 14).
- (S) PORTABLE (VIDEO AUX) jack**
Connects to an audio component (such as iPod) (see page 14).
- (T) OPTIMIZER MIC jack**
Connect to the supplied optimizer microphone (see page 16).
- (U) Front panel display**
Shows information about the operational status of this unit (see page 18).

Front panel display

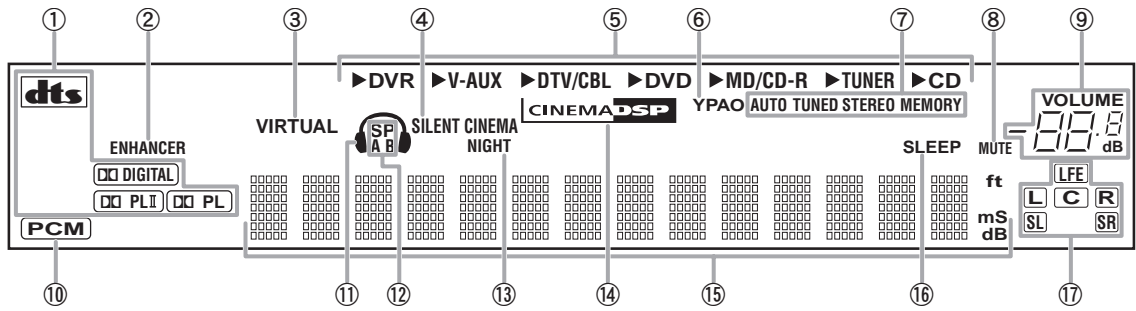

① Decoder indicator

Lights up when any of the decoders of this unit functions.

② ENHANCER indicator

Lights up when the Compressed Music Enhancer mode is selected (see page 26).

③ VIRTUAL indicator

Lights up when Virtual CINEMA DSP is active (see page 27).

④ SILENT CINEMA indicator

Lights up when headphones are connected and a sound field program is selected (see page 27).

⑤ Input source indicators

The corresponding cursor lights up to show the currently selected input source.

⑥ YPAO indicator

Lights up when you run "AUTO SETUP" and when the speaker settings set in "AUTO SETUP" are used without any modifications (see page 16).

⑦ Tuner indicators

Lights up when this unit is in the FM or AM tuning mode (see page 28).

⑧ MUTE indicator

Flashes while the MUTE function is on (see page 20).

⑨ VOLUME level indicator

Indicates the current volume level.

⑩ PCM indicator

Lights up when this unit is reproducing PCM (Pulse Code Modulation) digital audio signals.

⑪ Headphones indicator

Lights up when headphones are connected (see page 20).

⑫ SP A B indicators

Lights up according to the set of front speakers selected (see page 18).

⑬ NIGHT indicator

Lights up when you select a night listening mode (see page 20).

⑭ CINEMA DSP indicator

Lights up when you select a sound filed program (see page 27).

⑮ Multi-information display

Shows the name of the current sound field program and other information when adjusting or changing settings.

⑯ SLEEP indicator

Lights up while the sleep timer is on (see page 21).

⑰ Input channel and speaker indicators

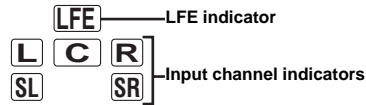

- **LFE indicator**
Lights up when the input signal contains the LFE signal.
- **Input channel indicators**
Indicates the channel components of the current digital input signal.

Remote control

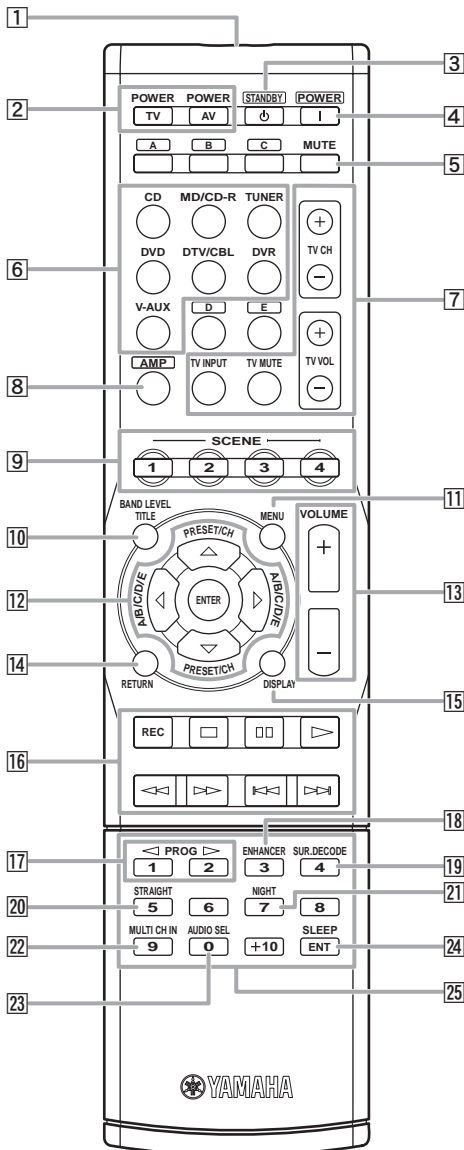

- 1 Infrared window**
Outputs infrared control signals (see page 8).
- 2 TV/AV POWER**
Turns your TV or other components on or off (see page 37).
- 3 STANDBY (ϕ)**
Sets this unit to the standby mode (see page 15).
- 4 POWER (I)**
Turns this unit on (see page 15).
- 5 MUTE**
Mutes audio output (see page 20).
- 6 Input selector buttons**
Switches the input source to each source (see page 18).
- 7 TV control buttons**
Controls your TV (see page 36).

- 8 AMP**
Press this button before you control this unit (see page 18).
- 9 SCENE 1/2/3/4**
Recalls an input source and a sound field program assigned to each SCENE button (see page 22).
- 10 BAND LEVEL TITLE**
Selects the speaker that you want to adjust (see page 20).
- 11 MENU**
Displays the set menu on the front panel display (see page 31).
- 12 Cursors (</>/∇/Δ) / ENTER**
 - Press cursors to navigate the set menu (see page 31).
 - Press ENTER to confirm a selection in the set menu (see page 31).
- 13 VOLUME +/-**
Adjusts the volume level of this unit (see page 18).
- 14 RETURN**
Returns the previous menu level when the set menu is displayed (see page 31).
- 15 DISPLAY**
Displays the information of external components (such as a DVD player) (see page 37).
- 16 Control buttons**
Control external components (such as a DVD player) connected to this unit (see page 37).
- 17 PROG </>**
Selects the sound field program (see page 26).
- 18 ENHANCER**
Sets the sound field program to the “Music Enh. 2ch” or “Music Enh. 5ch” (see page 26).
- 19 SUR.DECODE**
Selects a decoder from four decoders (see page 27).
- 20 STRAIGHT**
Activates the “STRAIGHT” mode (see page 27).
- 21 NIGHT**
Selects a night listening mode (see page 20).
- 22 MULTI CH IN**
Sets the input source to MULTI CH IN (see page 19).
- 23 AUDIO SEL**
Selects an audio input select setting for each input source (see page 19).
- 24 SLEEP**
Sets the sleep timer (see page 21).
- 25 Numeric buttons**
Enter remote control codes or preset station number (see page 38).

Rear panel

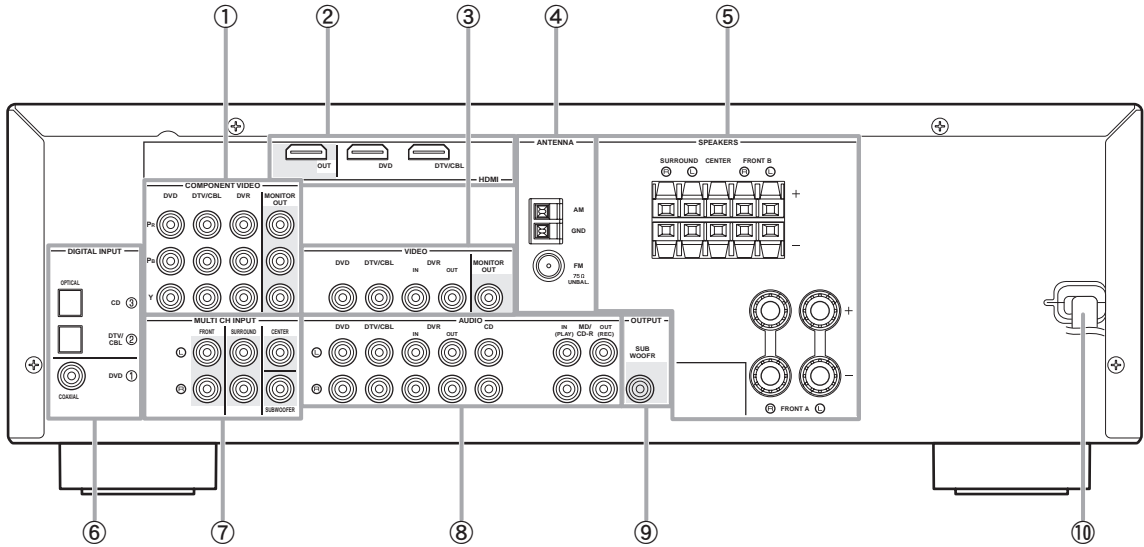

① COMPONENT VIDEO jacks

Connect to Y, Pb/CB and Pr/CR jacks on your video components with component video cables (see page 11).

- DVD input jacks
- DTV/CBL input jacks
- DVR input jacks
- MONITOR OUT output jacks

② HDMI terminals

Connect to HDMI output/input terminals on your external components with HDMI cables (see page 11).

- HDMI DVD terminal
- HDMI DTV/CBL terminal
- HDMI OUT output terminal

③ VIDEO jacks

Connect to video jacks on your video components with composite video cables (see page 11).

- DVD input jack
- DTV/CBL input jack
- DVR IN jack
- DVR OUT jack
- MONITOR OUT jack

④ ANTENNA terminals

Connect to the supplied FM and AM antennas (see page 15).

⑤ SPEAKERS terminals

Connect to each speakers (see page 9).

- FRONT A L/R
- FRONT B L/R
- SURROUND L/R
- CENTER

⑥ DIGITAL INPUT jacks

Connect to the DIGITAL output jacks on your digital audio components with Coaxial/Optical digital audio cables. This input jacks support PCM, Dolby Digital and DTS bitstream (see page 11).

- COAXIAL (DVD)
- OPTICAL (DTV/CBL)
- OPTICAL (CD)

⑦ MULTI CH INPUT jacks

Connect to the output jacks on your multi-format player or external decoder with analog audio cables (see page 14).

- FRONT L/R jack
- SURROUND L/R jack
- CENTER jack
- SUBWOOFER jack

⑧ AUDIO jacks

Connect to the audio output/input jacks on your components with analog audio cables (see page 11).

- DVD L/R jack
- DTV/CBL L/R jack
- DVR IN L/R jack
- DVR OUT L/R jack
- CD L/R jack
- IN (PLAY) L/R jack
- OUT (REC) L/R jack

⑨ SUBWOOFER OUTPUT jack

Connect to a Subwoofer with an analog audio cable (see page 9).

⑩ Power cable

Connect to a standard AC outlet (see page 15).

Quick start guide

The following steps describe the easiest way to operate this unit. See the related pages for details on the operation and settings.

Step 1: Check the items

In these steps, you need the following items which are not included in the package of this unit.

❑ Speakers

We recommend magnetically shielded speakers.

- ❑ **Front speaker** x 2
At least two front speakers are required to start playback.
- ❑ **Center speaker** x 1
- ❑ **Surround speaker** x 2
- ❑ **Active subwoofer** x 1
Select an active subwoofer equipped with an RCA input jack.
- ❑ **Speaker cable** x 5
- ❑ **Subwoofer cable** x 1
Select a monaural RCA cable.
- ❑ **DVD player** x 1
Select DVD player equipped with coaxial digital audio output jack and composite video output jack.
- ❑ **Video monitor** x 1
Select a TV monitor, video monitor or projector equipped with a composite video input jack.
- ❑ **Video cable** x 2
Select an RCA composite video cable.
- ❑ **Digital coaxial audio cable** x 1

Step 2: Set up your speakers

Place your speakers in the room and connect them to this unit.

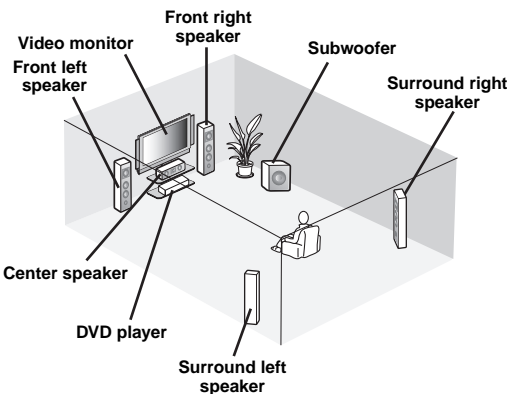

- Placing speakers P. 9
- Connecting speakers P. 9

Step 3: Connect your components

Connect your TV, DVD player or other components.

- Connecting a TV monitor or projector P. 12
- Connecting audio and video components P. 13
- Connecting a multi-format player or an external decoder P. 14
- Using the VIDEO AUX jacks on the front panel P. 14
- Connecting the FM and AM antennas P. 15

Step 4: Turn on the power

Connect the power cable and turn on this unit.

- Connecting the power cable P. 15
- Turning on and off the power P. 15

Step 5: Select the input source and start playback

Select the component connected in the step 3 as an input source and start playback.

- Basic procedure P. 18
- Selecting the SCENE templates P. 22
- Adjusting the sound field programs P. 26

PREPARATION

Preparation of remote control

Installing batteries in the remote control

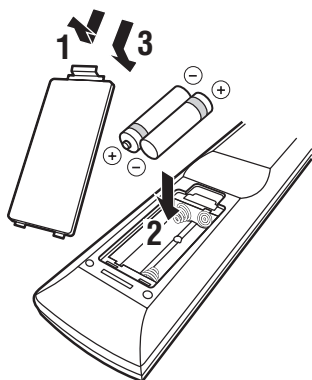

- 1 Take off the battery compartment cover.
- 2 Insert the four supplied batteries (AAA, R03, UM-4) according to the polarity markings (+ and -) on the inside of the battery compartment.
- 3 Snap the battery compartment cover back into place.

Notes

- Change all of the batteries if you notice the following conditions:
 - the operation range of the remote control decreases.
- Do not use old batteries together with new ones.
- Do not use different types of batteries (such as alkaline and manganese batteries) together. Read the packaging carefully as these different types of batteries may have the same shape and color.
- If the batteries have leaked, dispose of them immediately. Avoid touching the leaked material or letting it come into contact with clothing, etc. Clean the battery compartment thoroughly before installing new batteries.
- Do not throw away batteries with general house waste; dispose of them correctly in accordance with your local regulations.
- If the remote control is without batteries for more than 2 minutes, or if exhausted batteries remain in the remote control, the contents of the memory may be cleared. When the memory is cleared, insert new batteries and set up the remote control code.

Using the remote control

The remote control transmits a directional infrared ray. Be sure to aim the remote control directly at the remote control sensor on this unit during operation.

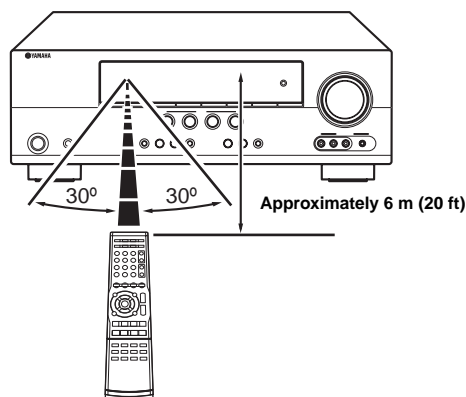

1 Infrared window

Outputs infrared control signals. Aim this window at the component you want to operate.



- To set the remote control codes for other components, see page 38.

Notes

- Do not spill water or other liquids on the remote control.
- Do not drop the remote control.
- Do not leave or store the remote control in the following types of conditions:
 - places of high humidity, such as near a bath
 - places of high temperature, such as near a heater or stove
 - places of extremely low temperatures
 - dusty places
- To set the remote control codes for other components, see page 38.

Connections

Placing speakers

The speaker layout below shows the speaker setting we recommend. You can use it to enjoy CINEMA DSP and multi-channel audio sources.

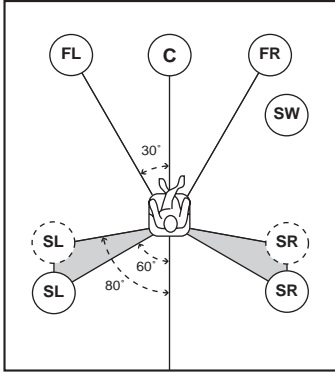

Front left and right speakers (FL and FR)

The front speakers are used for the main source sound plus effect sounds. Place these speakers at an equal distance from the ideal listening position. The distance of each speaker from each side of the video monitor should be the same.

Center speaker (C)

The center speaker is for the center channel sounds (dialog, vocals, etc.). If for some reason it is not practical to use a center speaker, you can do without it. Best results, however, are obtained with the full system.

Surround left and right speakers (SL and SR)

The surround speakers are used for effect and surround sounds.

Subwoofer (SW)

The use of a subwoofer with a built-in amplifier, such as the Yamaha Active Servo Processing Subwoofer System, is effective not only for reinforcing bass frequencies from any or all channels, but also for high fidelity sound reproduction of the LFE (low-frequency effect) channel included in Dolby Digital and DTS sources. The position of the subwoofer is not so critical, because low bass sounds are not highly directional. But it is better to place the subwoofer near the front speakers. Turn it slightly toward the center of the room to reduce wall reflections.

Connecting speakers

Be sure to connect the left channel (L), right channel (R), “+” (red) and “-” (black) properly. If the connections are faulty, this unit cannot reproduce the input sources accurately.

Caution

- Use speakers with the specified impedance shown on the rear panel of this unit.
- Before connecting the speakers, make sure that this the AC power plug is disconnected from the AC wall outlet.
- Do not let the bare speakers wires touch each other or do not let them touch any metal part of this unit. This could damage this unit and/or speakers.
- Use magnetically shielded speakers. If this type of speaker still creates interference with the monitor, place the speakers away from the monitor.

■ 5.1-channel speaker connection

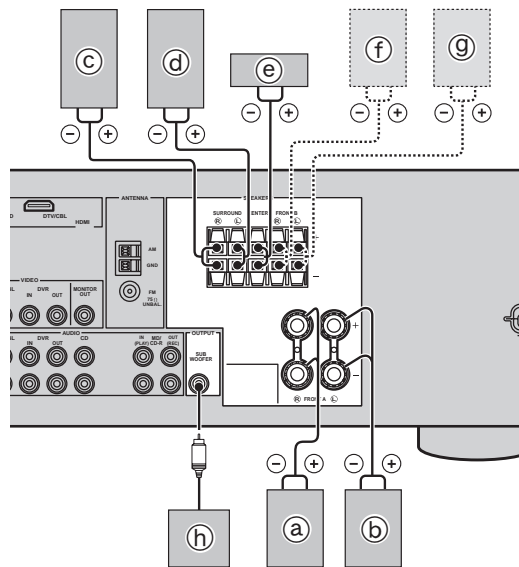

Speakers	Jacks on this unit
Ⓐ Front speaker (A) Right*	FRONT A (R)
Ⓑ Front speaker (A) Left*	FRONT A (L)
Ⓒ Surround speaker Right	SURROUND (R)
Ⓓ Surround speaker Left	SURROUND (L)
Ⓔ Center speaker	CENTER
Ⓕ Front speaker (B) Right*	FRONT B (R)
Ⓖ Front speaker (B) Left*	FRONT B (L)
Ⓗ Subwoofer	SUBWOOFER

* You can select the front speaker set from Front speakers (A) and Front speakers (B) by pressing **Ⓒ SPEAKERS** repeatedly. See page 19 for details.

■ **Connect speaker cables to each speaker**

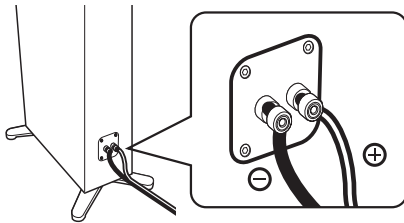

Cables are colored or shaped differently, perhaps with a stripe, groove or ridge. Connect the striped (grooved, etc.) cable to the “+” (red) terminals of your speaker. Connect the plain cable to the “-” (black) terminals.

■ **Before connecting to the SPEAKERS terminal**

A speaker cord is actually a pair of insulated cables running side by side. Cables are colored or shaped differently, perhaps with a stripe, groove or ridges. Connect the striped (grooved, etc.) cable to the “+” (red) terminals of this unit and your speaker. Connect the plain cable to the “-” (black) terminals.

Remove approximately 10 mm (3/8”) of insulation from the end of each speaker cable and then twist the bare wires of the cable together to prevent short circuits.

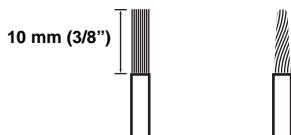

■ **Connecting to the FRONT A terminals**

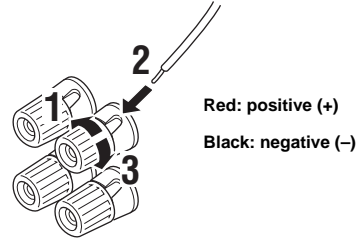

- 1 Loosen the knob.
- 2 Insert the bare end of the speaker wire into the slit on the terminal.
- 3 Tighten the knob to secure the wire.

■ **Connecting to the FRONT B, CENTER, and SURROUND terminals**

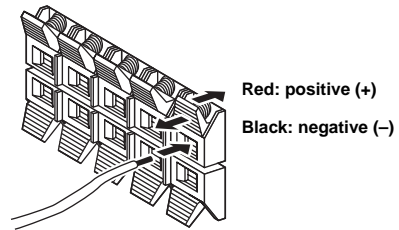

- 1 Press down the tab.
- 2 Insert the bare end of the speaker wire into the hole on the terminal.
- 3 Release the tab to secure the wire.

Connecting video components

Information on jacks and cable plugs

Audio jacks and cable plugs

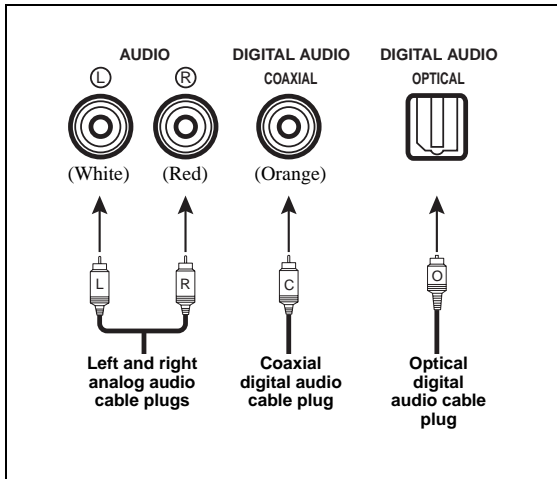

AUDIO jacks

For conventional analog audio signals transmitted via left and right analog audio cables. Connect red plugs to the right jacks and white plugs to the left jacks.

COAXIAL jack

For digital audio signals transmitted via coaxial digital audio cable.

OPTICAL jacks

For digital audio signals transmitted via optical digital audio cables.

Notes

- You can use the digital jacks to input PCM, Dolby Digital, and DTS bitstreams. All digital input jacks are compatible with digital signals with up to 96 kHz of sampling frequency.
- This unit handles digital and analog signals independently. Thus audio signals input at the digital jacks are not output at the analog AUDIO OUT (REC) jack.

Video jacks and cable plugs

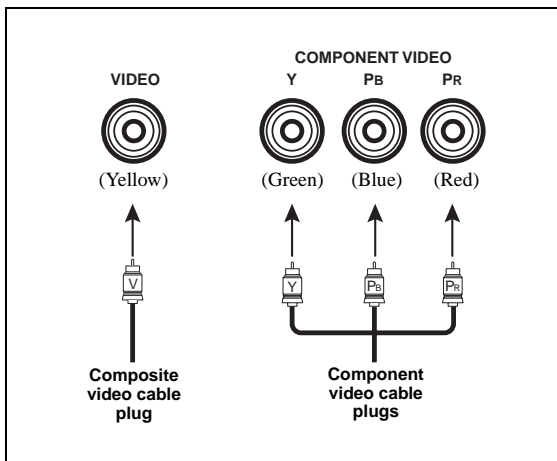

VIDEO jacks

For conventional composite video signals transmitted via composite video cables.

COMPONENT VIDEO jacks

For component signals, separated into the luminance (Y) and chrominance (PB, PR) video signals transmitted on separate wires of component video cables.

Video signal flow for MONITOR OUT

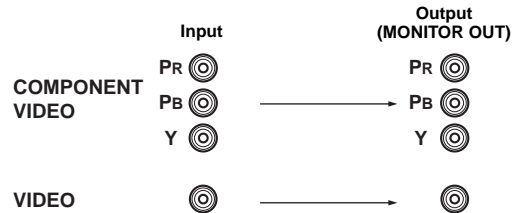

Information on HDMI™

Audio signals input at the HDMI jack are not output from any speaker terminals but output from the connected video monitor. To enjoy the sound from speakers connected to this unit,

- make an analog or digital connection besides the HDMI connection (see page 13).
- mute the volume of the connected video monitor.

You can play back pictures by connecting your video monitor and video source component to this unit using HDMI connections.

At that time, audio/video signals output from the connected component (such as DVD player etc.) are output to the connected video monitor only when this unit is turned on and set to the input source (DVD or DTV/CBL).

Furthermore, available audio/video signals depend on the specification of the connected video monitor. Refer to the instruction manual of each connected component.

HDMI jack and cable plug

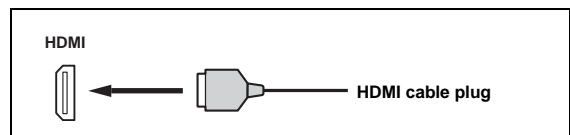

- We recommend using an HDMI cable shorter than 5 meters (16 feet) with the HDMI logo printed on it.
- Use a conversion cable (HDMI jack ↔ DVI-D jack) to connect this unit to other DVI components.

Using the AUDIO OUT REC jack

You can record the audio signal output at the AUDIO OUT (REC) jack by using the recording components.

Note

- Check the copyright laws in your country to record from CDs, radio, etc. Recording of copyrighted material may infringe copyright laws.

Connecting a TV monitor or projector



Make sure that this unit and other components are unplugged from the AC wall outlets.

Note

- If you turn off the video monitor connected to the HDMI OUT jack via a DVI connection, the connection may fail. In this case, the HDMI indicator flashes irregularly.

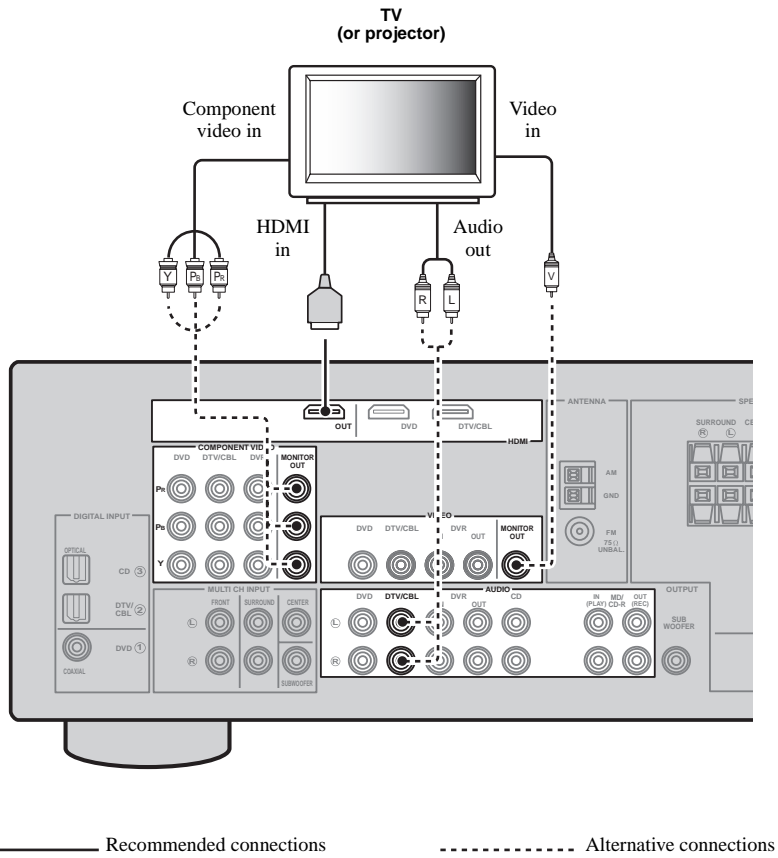

Connecting other components

Connecting audio and video components

This unit has three types of audio jacks, two types of video jacks and HDMI jacks. You can choose the connection method depending on the component to be connected.

■ Connecting example (connecting a DVD player)

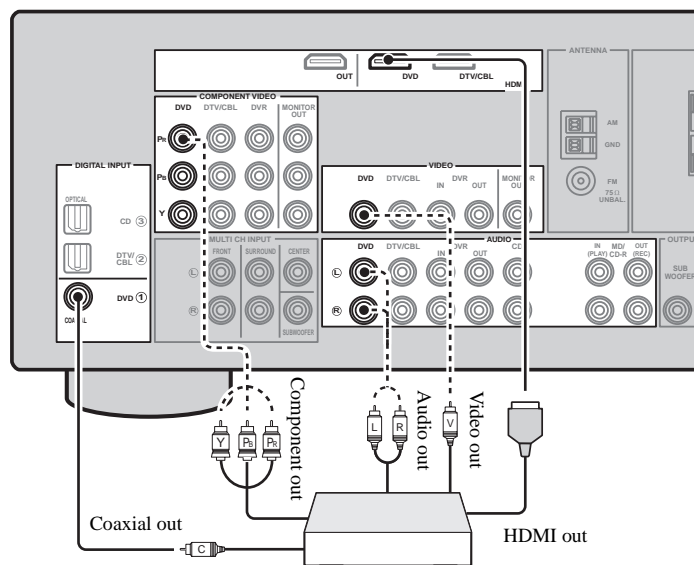

————— Recommended connections

----- Alternative connections

■ Jacks used for audio and video connections

Recommended connections are indicated by (*). When connecting a recording component, you need to make additional connections for recording (signal transmission from this unit to the recording component).



Make sure that this unit and other components are unplugged from the AC wall outlets.



- You can also use the VIDEO AUX jacks (see page 14) on the front panel to connect an additional component.
- To confirm the positions of “jacks on this unit” in the following table, refer to “Rear panel” in “Functional overview” on page 6.

Component	Signal type	Jacks on component	Jacks on this unit
DVD player or Blu-ray Disc player	Video	HDMI out*	HDMI (DVD)*
		Component out	COMPONENT VIDEO (DVD)
		Video out (composite)	VIDEO (DVD)
	Audio	Optical out*	COAXIAL (DVD)*
Audio out (analog)		AUDIO (DVD)	
Set-top box	Video	HDMI out*	HDMI (DTV/CBL)*
		Component out	COMPONENT VIDEO (DTV/CBL)
		Video out (composite)	VIDEO (DTV/CBL)
	Audio	Optical out*	OPTICAL (DTV/CBL)*
		Analog out (analog)	AUDIO (DTV/CBL)

Component	Signal type	Jacks on component	Jacks on this unit
DVD recorder	Video	HDMI out*	HDMI (DVR)*
		Video out (composite)	VIDEO (DVR IN)
	Audio	Audio out (analog)*	AUDIO (IN (PLAY))*
	Audio recording	Audio in (analog)*	AUDIO (OUT (REC))*
	Video recording	Video in (composite)*	VIDEO (DVR OUT)*
	Audio	Coaxial out*	OPTICAL (CD)*
CD player		Audio out (analog)	AUDIO (CD)
	MD or CD recorder	Audio out (analog)*	AUDIO (IN (PLAY))*
	Audio recording	Audio in (analog)*	AUDIO (OUT (REC))*

Notes

- Be sure to make the same type of video connections as those made for your TV if the video conversion is disabled. For example, if you connected your TV to the VIDEO MONITOR OUT jack of this unit, connect other components to the VIDEO jacks.
- Check the copyright laws in your country to record from CDs, radio, etc. Recording of copyrighted material may infringe copyright laws.
- To make a digital connection to a component other than the default one assigned to each DIGITAL INPUT or DIGITAL OUTPUT jack, configure the "INPUT ASSIGN" setting (see page 33).
- Only analog audio signals output at AUDIO OUT (REC) jack can be recorded using the recording components. Therefore Digital signals input at the DIGITAL INPUT jacks or analog signals input at MULTI CH IN jacks can be output at the analog AUDIO OUT (REC) jack for recording.

Connecting a multi-format player or an external decoder

This unit is equipped with 6 additional input jacks (FRONT L/R, SURROUND L/R, CENTER and SUBWOOFER) for discrete multi-channel input from a multi-format player, external decoder or sound processor. Connect the output jacks on your multi-format player or external decoder to the MULTI CH INPUT jacks. Be sure to match the left and right output jacks to the left and right input jacks for the front and surround channels.

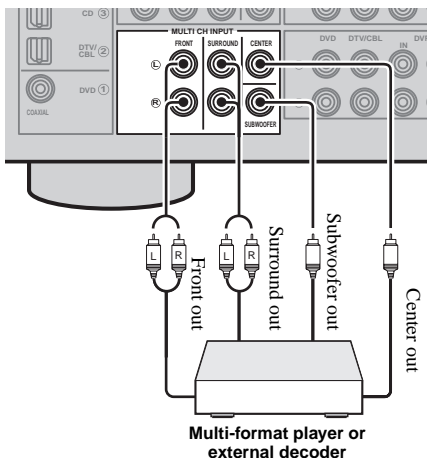

Notes

- When you select the component connected to the MULTI CH INPUT jacks as the input source (see page 19), this unit automatically turns off the digital sound field processor, and you cannot select sound field programs.
- This unit does not redirect signals input at the MULTI CH INPUT jacks to accommodate for missing speakers. We recommend that you connect a 5.1-channel speaker system before using this feature.
- The source connected to the MULTI CH INPUT jacks on this unit cannot be recorded.

Using the VIDEO AUX jacks on the front panel

Use the VIDEO AUX jacks on the front panel to connect a game console or a video camera to this unit. To reproduce the source signals input at these jacks, select "V-AUX" as the input source.

Caution

Be sure to turn down the volume of this unit and other components before making connections.

Note

- The audio signals input at the PORTABLE mini jack take priority over the ones input at the AUDIO L/R jacks.

Connecting the FM and AM antennas

Both FM and AM indoor antennas are supplied with this unit. In general, these antennas should provide sufficient signal strength. Connect each antenna correctly to the designated terminals.

Notes

- The AM loop antenna should be placed away from this unit.
- A properly installed outdoor antenna provides clearer reception than an indoor one. If you experience poor reception quality, install an outdoor antenna. Consult the nearest authorized Yamaha dealer or service center about outdoor antennas.
- The AM loop antenna should always be connected, even if an outdoor AM antenna is connected to this unit.

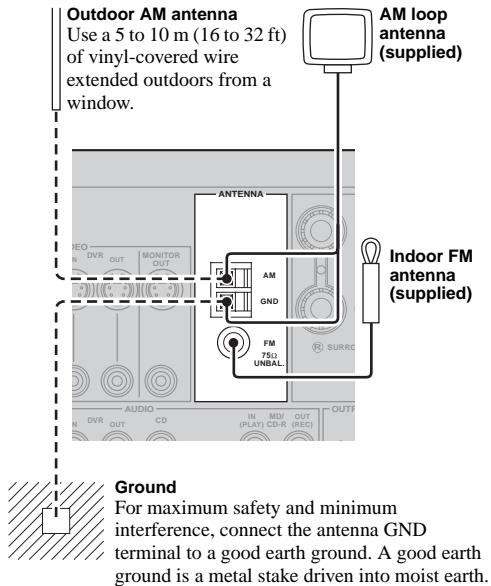

Connecting the wire of the AM loop antenna

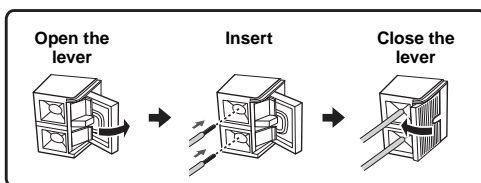

Assembling the supplied AM loop antenna

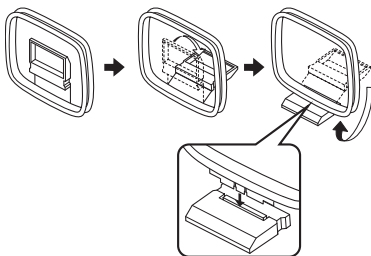

Note

- The types of the supplied AM loop antenna is different depending on the models.

Connecting the power cable

Once all connections are complete, plug the power cable into the AC wall outlet.

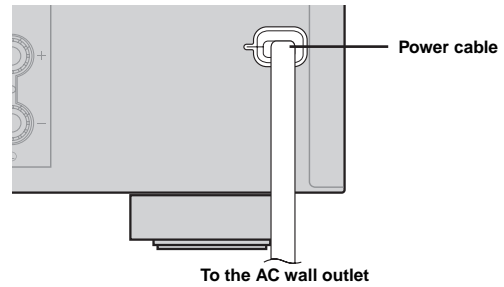

Turning on and off the power

Turning on this unit

Press **A** **STANDBY/ON** (or **4** **POWER**) to turn on this unit.



- When you turn on this unit, there will be a 4 to 5-second delay before this unit can reproduce sound.

Set this unit to the standby mode

Press **A** **STANDBY/ON** (or **3** **STANDBY**) to turn off this unit.

Note

- In the standby mode, this unit consumes a small amount of power in order to receive infrared signals from the remote control.

Optimizing the speaker setting for your listening room (YPAO)

This unit has the Yamaha Parametric Acoustic Optimizer (YPAO). With the YPAO, this unit automatically adjusts output characteristics of your speakers based on speaker positions, speaker performances, and acoustic characteristics of the room. We recommend that you first adjust the output characteristics with the YPAO when you use this unit.

Caution

- Be advised that it is normal for loud test tones to be output during the “AUTO SETUP” procedure. Do not allow small children to enter the room during the procedure.
- To achieve the best results, make sure that the room is as quiet as possible while the “AUTO SETUP” procedure is in progress. If there is too much ambient noise, the results may not be satisfactory.

Using AUTO SETUP



- Initial settings are indicated by (*) in the following each parameter.

1 Make sure of the following check points.

Before starting the automatic setup, check the following check points.

- All speakers and subwoofer are connected appropriately.
- Headphones are disconnected from this unit.
- This unit is turned on.
- The connected subwoofer is tuned on and the volume level is set to about half way (or slightly less).
- FRONT A speakers are selected as the front speaker system (see page 19).
- The room is sufficiently quiet.
- The crossover frequency control of the connected subwoofer is set to the maximum.

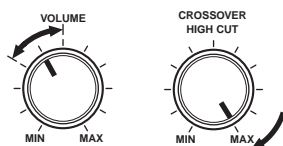

Controls of a subwoofer (example)

2 Connect the supplied optimizer microphone to the OPTIMIZER MIC jack on the front panel.

“SETUP•••••AUTO” appears on the front panel display.

3 Place the optimizer microphone at your normal listening position on a flat level surface with the omni-directional microphone heading upward.

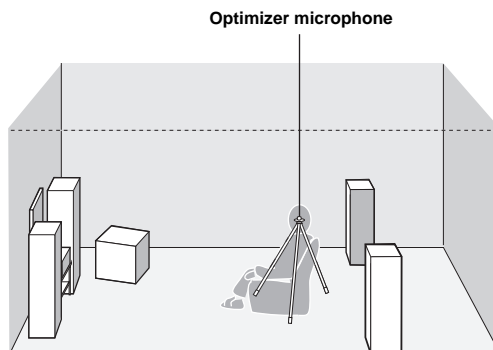

- We recommend that you use a tripod (etc.) to affix the optimizer microphone at the same height as your ears would be when you are seated in your listening position. You can use the attached screw of a tripod (etc.) to fix the optimizer microphone to the tripod (etc.).

4 Press [F2] < / > to select “AUTO.”

Choice	Function
AUTO*	Automatically runs the entire “AUTO SETUP” procedure.
RELOAD	Reloads the last “AUTO SETUP” settings and overrides the previous settings.
UNDO	Undoes the last “AUTO SETUP” settings and restores the previous settings.
DEFAULT	Resets the “AUTO SETUP” parameters to the initial factory settings.

Note

- “RELOAD” or “UNDO” is available only when you have previously run “AUTO SETUP” and confirmed the results.

5 Press [F2] ENTER to start the setup procedure.

This unit starts the automatic setup procedure. Loud test tones are output from each speaker during the audio setup procedure. After all settings (“INITIALIZING,” “WIRING/LEVEL,” “DISTANCE,” “SIZE”) are sequentially completed, “FINISH” appears on the front panel display.



- To cancel the automatic setup, press [F2] Δ.

Notes

- During the automatic setup procedure, do not perform any operation on this unit.
- We recommend that you get out of the room while this unit is in the auto setup procedure. It takes approximately 3 minutes for this unit to complete the auto setup procedure.

6 When all measurements are completed successfully, “FINISH” appears on the front panel display.

The result of the automatic setup for each speaker appears in order on the front panel display.

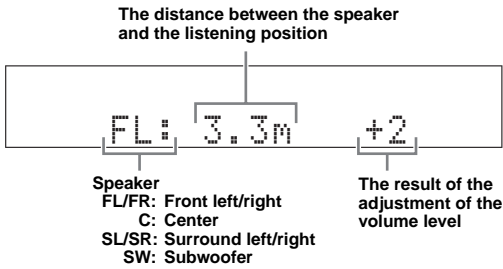

- To display the result of the automatic setup again, press [12]△ / ▽ repeatedly.

Notes

- If you select “RELOAD” in step 4, no test tones are output.
- If an error occurs during the “AUTO:CHECK” procedure, the setup procedure is canceled and an error screen appears. For details, see “If an error screen appears” on page 17.
- When this unit detects potential problems during the “AUTO SETUP” procedure, “WARNING” and the warning messages appear after this unit displays the result of the automatic setup. For details, refer to the “AUTO SETUP” section in “Troubleshooting” on page 43.
- The distance measurement result may be longer than the actual distance depending on the characteristics of your subwoofer.

7 Press [12]◀ / ▶ to select “SET” or “CANCEL.”

Choice	Function
SET*	Confirms the “AUTO SETUP” results.
CANCEL	Cancels the “AUTO SETUP” results.

8 Press [12]ENTER to confirm your selection.
“AUTO SETUP” appears on the front panel display.

9 Press [11]MENU to exit from “SET MENU.”

10 Disconnect the optimizer microphone from this unit.

The optimizer microphone is sensitive to heat. Keep it away from direct sunlight and do not place it on top of this unit.



- If you change speakers, speaker positions, or the layout of your listening environment, run “AUTO SETUP” again to recalibrate your system.
- When you want to check the result of the automatic setup in detail or manually adjust the parameters, use “MANUAL SETUP” (see page 31).

■ If an error screen appears

If this unit detects the potential problems, an error message appears on the front panel display during the automatic setup.

For details about each error message, see the “AUTO SETUP” section in “Troubleshooting” on page 43.

After a few seconds later, the following choices appear. Press [12]◀ / ▶ to select “RETRY” or “EXIT” and then press [12]ENTER.

Choice	Function
RETRY*	Starts the “AUTO SETUP” again.
EXIT	Exits from the “AUTO SETUP” procedure.

■ If “WARNING” appears

When this unit detects potential problems during the automatic setup procedure, “WARNING” appears on the front panel display after result of each speaker. Check the warning messages to correct your speaker settings.

Note

- Warnings differ from errors in that warnings do not cancel the automatic setup procedure.

Press [12]▽ to display the detailed information about the warning.

The detailed information about the warning is displayed and the indicators of inapplicable speakers blink on the front panel display.

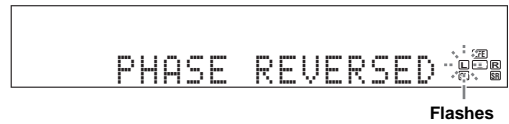

- For details about each warning message, see the “AUTO SETUP” section in “Troubleshooting” on page 43.

BASIC OPERATION

Playback

Caution

Extreme caution should be exercised when you play back CDs encoded in DTS. If you play back a CD encoded in DTS on a DTS-incompatible CD player, you will only hear some unwanted noise that may damage your speakers. Check whether your CD player supports CDs encoded in DTS. Also, check the sound output level of your CD player before you play back a CD encoded in DTS.

Basic procedure

- 1 Turn on external components (TV, DVD player, etc.) connected to this unit.
- 2 Press **ⓈPEAKERS** repeatedly to select the front speakers you want to use.
The respective speaker indicators lights up on the front panel display.
- 3 Press **ⓂINPUT** $\triangleleft/\triangleright$ repeatedly (or press one of the input selector buttons (**Ⓜ**)) to select the desired input source.
The name of the currently selected input source appears on the front panel display for a few seconds.

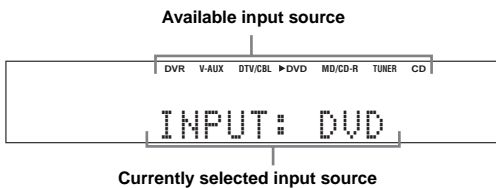

- 4 Start playback on the selected component or select a broadcast station.

Notes

- Refer to the operating instructions for the source component.
- See page 28 for details about FM or AM tuning instructions.



- To adjust the level of each speaker, see page 20.

- 5 Rotate **ⓈVOLUME** (or press **ⓈVOLUME +/-**) to adjust the volume to the desired output level.

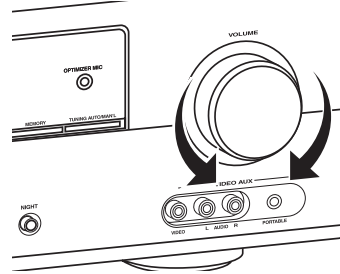

- See page 20 to adjust the level of each speaker.
- This does not affect the AUDIO OUT (REC) level.
- You can set the initial volume level and maximum volume level (see page 33).

- 6 Press **ⓂPROGRAM** $\triangleleft/\triangleright$ (or press **ⓂAMP** and then **ⓂPROG** $\triangleleft/\triangleright$) repeatedly to select the desired sound field program.

The name of the selected sound field program appears on the front panel display.

See page 22 for details about sound field programs.

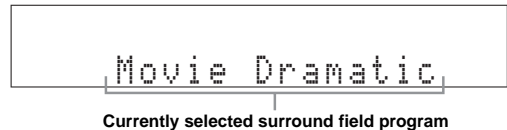

Notes

- Choose a sound field program based on your listening preference, not merely on the name of the program.
- When you select an input source, this unit automatically selects the last sound field program used with the corresponding input source.
- Sound field programs cannot be selected when the component connected to the MULTI CH INPUT jacks is selected as the input source (see page 19).
- When PCM signals with a sampling frequency higher than 48 kHz are input, this unit is automatically set to the "STRAIGHT" mode (see page 27).
- To display information about the currently selected input source on the front panel display, see page 21 for details.

Guide to contents

When you want...	See page
Adjust the tonal quality of the front speakers	20
Edit parameters of sound field programs	27
Enjoy the sources which have wide dynamic range at night	20
Use headphones	20
Select a decoder to play back sources with	27
Set this unit to the standby mode automatically	21

Additional operations

Using input setting features

Use the following features to select input jack or input source.

■ Selecting the front speaker set

Press **Ⓢ****SPEAKERS** repeatedly change the active front speaker set that is connected to the **FRONT A** or **FRONT B** speaker terminals or turn off the front speakers.

The active front speaker set changes as follows:

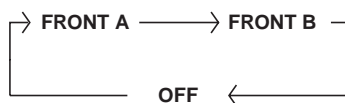

Note

- Turn off the volume level of this unit before you switch the front speaker setting.

■ Using the Zone B feature

When you set “FRONT B” to “ZONE B” (see page 31), you can use the speakers connected to **FRONT B** speaker terminals in another room (Zone B).

Press **Ⓢ****SPEAKERS** on the front panel repeatedly to turn on or off the Zone B speakers.

When you activate the Zone B speakers, all the speakers in the main room are muted.

Notes

- You cannot activate both the main room and Zone B speakers simultaneously.
- If you select CINEMA DSP sound field program and activate the Zone B speakers, Virtual CINEMA DSP is activated automatically (see page 27).

■ Selecting the component connected to the MULTI CH INPUT jacks as the input source

Use this feature to select the component connected to the MULTI CH INPUT jacks (see page 14) as the input source.

Press **Ⓢ****INPUT** **◀/▶** repeatedly (or press **Ⓢ****AMP** and then press **Ⓢ****MULTI CH IN**) to select “MULTI CH.”

“MULTI CH” appears on the front panel display.



- You can configure the multi channel input settings in “MULTI CH” (see page 34).

Notes

- Sound field programs, or the night listening mode, etc. cannot be selected when “MULTI CH” is selected as the input source.
- When headphones are used, signals are output only from the front left and right channels.

■ Selecting audio input jacks (AUDIO SELECT)

Use this feature (audio input jack select) to switch the input jack assigned to an input source when two or more jacks are assigned to an input source.



- We recommend that you set the audio input jack select to “AUTO” in most cases.
- You can adjust the default audio input jack select of this unit by using “AUDIO SELECT” in “OPTION MENU” (see page 35).

1 Press **Ⓢ****INPUT** **◀/▶** repeatedly (or press one of the input selector buttons (**Ⓢ**)) to select the desired input source.

2 Press **Ⓢ****AMP** and then **Ⓢ****AUDIO SEL** repeatedly to select the desired Audio input jack select setting.



Audio input jack select setting

Choice	Function
AUTO	Automatically selects input signals in the following order: (1) Digital signals (2) Analog signals
ANALOG	Selects only analog signals. If no analog signals are input, no sound is output.



- You can configure the audio input jack select setting in “AUDIO SELECT.”

Note

- This feature is not available if no digital input jack is assigned to the selected input source in “INPUT ASSIGN” (see page 33).

Using audio features

Use the following features to adjust the audio output or speaker level.

■ Muting the audio output

Press **[5] MUTE** on the remote control to mute the audio output. Press **[5] MUTE** again to resume the audio output.



- You can also rotate **[P] VOLUME** (or press **[13] VOLUME +/-**) to resume the audio output.
- You can configure the muting level by using “MUTE TYP.” in “SOUND MENU” (see page 33).
- The MUTE indicator flashes on the front panel display when the audio output is muted and disappears from the front panel display when the audio output is resumed.

■ Adjusting the tonal quality

Use this feature to adjust the balance of bass and treble for the front left and right speaker channels.

Press **[K] TONE CONTROL** repeatedly to select “BASS” or “TREBLE” and then press **[L] PROGRAM </>** to adjust the corresponding frequency response level.

Control range: -10 dB to +10 dB

Each choice is defined as follows.

Choice	Function
BASS	Adjusts the low-frequency response.
TREBLE	Adjusts the high-frequency response.

Notes

- Speaker and headphone adjustments are stored independently.
- If you increase or decrease the high-frequency or low-frequency sound to an extreme level, the tonal quality of the surround speakers may not match that of the front left and right speakers.
- This does not affect recorded material.

■ Adjusting the speaker level

You can adjust the output level of each speaker while listening to a music source. This is also possible when playing sources input at the MULTI CH INPUT jacks.

Note

- This operation will override the level adjustment made in “SP LEVEL” (see page 32).

1 Press **[8] AMP** and then press **[10] BAND LEVEL TITLE** repeatedly to select the speaker you want to adjust.

Choice	Description
FRONT L	Front left speaker
FRONT R	Front right speaker
CENTER	Center speaker
SWFR	Subwoofer
SUR. L	Surround left speaker
SUR. R	Surround right speaker



- Once you press **[10] BAND LEVEL TITLE** on the remote control, you can also select the speaker by pressing **[12] Δ / ∇**.
- The available speaker channels differ depending on the speaker settings.

2 Press **[12] </>** on the remote control (or press **[F] PRESET/TUNING </>**) to adjust the speaker output level.

Control range: -10.0 dB to +10.0 dB

Using optional features

Use the following features to utilize various useful functions equipped on this unit.



- Initial settings are indicated by (*) in this following each parameter.

■ Using your headphones

Connect a pair of headphones with a stereo analog audio cable plug to the PHONES jack on the front panel.



- When you select a sound field program, SILENT CINEMA mode is automatically activated (see page 27).

Notes

- When you connect headphones, no signals are output at the speaker terminals.
- All Dolby Digital and DTS audio signals are mixed down to the left and right headphone channels.

■ Selecting the night listening mode

The night listening modes are designed to improve listenability at lower volumes or at night.

1 Press **[O] NIGHT** (or press **[8] AMP** and then **[21] NIGHT**) repeatedly to select “NIGHT:CINEMA” or “NIGHT:MUSIC.”

Each choice is defined as follows.

Choice	Function
NIGHT:CINEMA	Narrows the dynamic range of film soundtracks and makes dialog easier to hear at lower volumes.
NIGHT:MUSIC	Preserves ease-of-listening for all sounds.
NIGHT OFF	Disables this feature.



- When a night listening mode is selected, the NIGHT indicator lights up on the front panel display.

2 Press **[12]** </> to adjust the effect level while “NIGHT:CINEMA” or “NIGHT:MUSIC” is displayed on the front panel display.

Each choice is defined as follows.

Choice	Function
MIN	Slightly lowers the effect level.
MID*	Moderately lowers the effect level.
MAX	Considerably lowers the effect level.



- “NIGHT:CINEMA” and “NIGHT:MUSIC” adjustments are stored independently.

Notes

- You cannot use the night listening modes in the following cases:
 - when the component connected to the MULTI CH INPUT jacks is selected as the input source.
 - when headphones are connected to the PHONES jack.
 - when the sampling frequency of the input sources are higher than 48 kHz.
- The effect of night listening modes may vary depending on the input source and surround sound settings you use.

■ Displaying the input source information (SIGNAL INFO)

You can display the format, sampling frequency, channel, bit rate and flag data of the current input signal.

1 Press **[8]** AMP and then press **[11]** MENU on the remote control.

“AUTO SETUP” appears on the front panel display.

• AUTO SETUP

2 Press **[12]** Δ / ▽ repeatedly to select “SIGNAL INFO” and then press **[12]** ENTER.

3 Press **[12]** Δ / ▽ to switch the displayed information.

The following information about the input source appears on the front panel display.

Choice	Description
FORMAT	Signal format.
SAMPLING	The number of samples per second taken from a continuous signal to make discrete signals.
CHANNEL	The number of source channels in the input signal (front/surround/LFE).
BITRATE	The number of bits passing a given point per second.
FLAG	Flag data encoded in DTS, Dolby Digital, or PCM signals that cue this unit to automatically switch decoders.

4 Press **[11]** MENU on the remote control again to exit from “SET MENU.”

■ Using the sleep timer

Use this feature to automatically set this unit to the standby mode after a certain amount of time. The sleep timer is useful when you are going to sleep while this unit is playing or recording from a source.

Press **[8]** AMP and then press **[24]** SLEEP repeatedly to set the amount of time.

The sleep timer setting changes as follows.

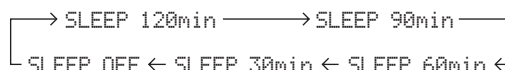

Once the sleep timer is set, the SLEEP indicator lights up on the front panel display, and the display returns to the selected sound field program.

To cancel the sleep timer

Press **[24]** SLEEP on the remote control repeatedly to select “SLEEP OFF.”



- If you set the main zone to the standby mode, the sleep timer is automatically canceled.

■ Playing video sources in the background

You can combine a video image from a video source with sound from an audio source. For example, you can enjoy listening to classical music while viewing beautiful scenery from the video source on the video monitor.

Press the input selector buttons (**[6]**) on the remote control to select a video source and then an audio source.

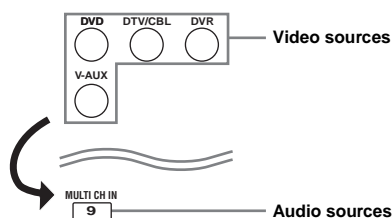
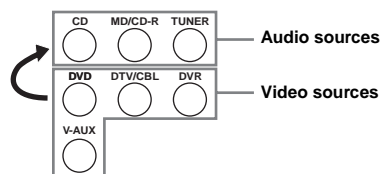

Selecting the SCENE templates

Just by pressing one SCENE button, you can recall your favorite input source and sound field program according to the SCENE template that has been assigned to the SCENE button. The SCENE templates are built combinations of input sources and sound field programs.

This unit is equipped with 12 preset SCENE templates for various situations. The following SCENE templates are assigned to respective SCENE buttons in the default settings.

Default SCENE button	The name of the SCENE template and its description
SCENE 1	DVD Movie Viewing – input source: DVD – sound field program: STRAIGHT For when you want to enjoy a DVD playback.
SCENE 2	Music Disc Listening – input source: DVD – sound field program: 2ch Stereo For when you want to listen to a music disc from the connected DVD player.
SCENE 3	TV Viewing *1 – input source: DTV/CBL – sound field program: STRAIGHT For when you want to watch a TV program.
SCENE 4	Radio Listening *2, *3, *4 – input source: TUNER – sound field program: Music Enh. 5ch For when you want to listen to a music program from the FM radio station.

Notes

- *1 You must connect a cable TV or a satellite tuner to this unit in advance. See page 13 for details.
- *2 You need to connect the supplied FM and AM antennas to this unit in advance. See page 15 for details.
- *3 You have to tune into the desired radio station. See pages 28 to 29 for the tuning information.
- *4 To achieve the best possible reception, orient the connected AM loop antenna, or adjust the position of the end of the indoor FM antenna.

If you want to use other SCENE templates, you can select the desired SCENE templates from the SCENE template library and assign the templates to the selected SCENE buttons on the front panel and the remote control.

Select the desired SCENE template

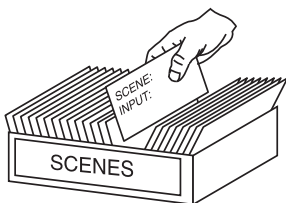

SCENE template library (Image)



Assign the SCENE template to the SCENE button

Selecting the desired SCENE template

- 1 Press and hold the desired **SCENE** (or **SCENE**) button for 3 seconds.

The MEMORY indicator on the front panel starts to flash, and the name of currently assigned SCENE template appears on the front panel display.

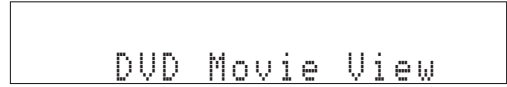

- 2 Press **INPUT** </> (or press **AMP** and then **</>**) to select the desired template.



- 3 Press the **SCENE** (or **SCENE**) button again to confirm the selection.

The MEMORY indicator stops flashing and the select SCENE template is assigned to the button.



- To cancel the procedure, press **AMP** and then **RETURN**.

Note

- Once the desired SCENE templates are assigned to the corresponding SCENE buttons, you may need to set the input source of the SCENE template on the remote control. See page 25 for details.

Which SCENE template would you like to select?

The following tables indicate preset SCENE template descriptions. Select the corresponding SCENE templates for the desired source. The illustrations of the SCENE button in the following table indicate that the SCENE templates in those cells are assigned to the SCENE buttons, respectively.

You can also create your original SCENE templates by editing the preset SCENE templates. See page 24 for details.

■ Video sources (DVD video, Recorded video)

SCENE template	Input source	Playback mode	Features
DVD Viewing	DVD	STRAIGHT	Select this SCENE template when you play back general contents on your DVD player.
 DVD Movie Viewing	DVD	Movie Dramatic	Select this SCENE template when you play back movies on your DVD player.
DVD Live Viewing	DVD	Pop/Rock	Select this SCENE template when you enjoy music live video on your DVD player.
DVR Viewing	DVR	Movie Dramatic	Select this SCENE template when you play back movies on your digital video recorder.

■ Music discs (CD, SA-CD or DVD-Audio)

SCENE template	Input source	Playback mode	Features
 Music Disc Listening	DVD	2ch Stereo	Select this SCENE template when you play back music discs on your DVD player.
Disc Listening	DVD	5ch Stereo	Select this SCENE template when you play back music sources as the back ground music on your DVD player.
CD Listening	CD	5ch Stereo	Select this SCENE template when you play back music source as the back ground music on your CD player.
CD Music Listening	CD	2ch Stereo	Select this SCENE template when you play back music discs on your CD player.

■ Radio programs

SCENE template	Input source	Playback mode	Features
 Radio Listening	TUNER	Music Enh. 5ch	Select this SCENE template when you enjoy FM or AM radio programs.

■ TV programs

SCENE template	Input source	Playback mode	Features
 TV Viewing	DTV/CBL	STRAIGHT	Select this SCENE template when you enjoy TV programs.
TV Sports Viewing	DTV/CBL	TV Sports	Select this SCENE template when you enjoy sports programs on TV.

■ Video games

SCENE template	Input source	Playback mode	Features
Game Playing	V-AUX	Game	Select this SCENE template when you play video games.

Creating your original SCENE templates

You can create your original SCENE templates for each SCENE button. Refer to the preset 12 SCENE templates to create the original SCENE templates.

Customizing the preset SCENE templates

Use this feature to customize the preset SCENE templates.

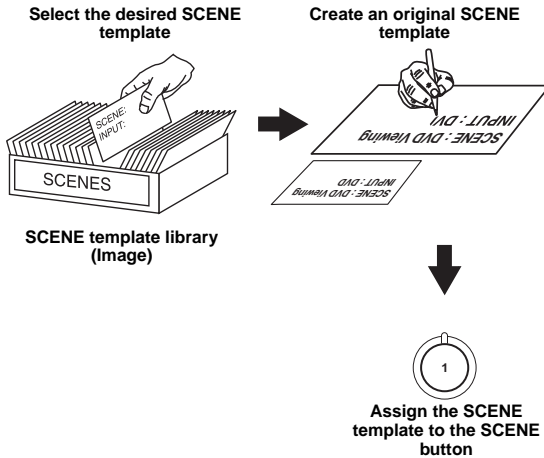

1 Press and hold the desired **[9] SCENE** button for 3 seconds and then press **[8] AMP**.

The MEMORY indicator on the front panel starts to flash.



Note

- When the SCENE template you want to customize is not assigned to any of the **[9] SCENE** button, press **[12] </>** repeatedly to recall the desired SCENE template (see page 22).

2 Press **[12] Δ / ▽** to select the desired parameter of the SCENE template and then **[12] </>** to select the desired value of the selected parameter.

You can adjust the following parameters for a SCENE template:

- The input source component
- The active sound field programs or STRAIGHT mode
- The night listening mode setting (see page 20)
 - SYSTEM: Keeps the current night listening mode.
 - CINEMA: Sets the night listening mode to the CINEMA mode.
 - MUSIC: Sets the night listening mode to the MUSIC mode.

3 Press the **[9] SCENE** button again to confirm the edit.



- An asterisk mark (*) appears by the name of the original SCENE template.
- To cancel the procedure, press **[8] AMP** and then **[14] RETURN**.

Notes

- After changing the assignment of the SCENE template to the **[9] SCENE** buttons, you may need to set the input source of the SCENE template on the remote control. See page 25 for details.
- You can create a customized SCENE template for each **[9] SCENE** button, and if you create another customized SCENE template, this unit overwrites the old customized SCENE template with the new one.
- The customized SCENE template is only available for the assigned **[9] SCENE** button.

Using remote control on the SCENE feature

Controlling the input source components in the SCENE mode

You can operate both this unit and the input source component by using the remote control. You must set the appropriate remote control code for each input source in advance (see page 38).

- 1 Press the desired **[9] SCENE** button on the remote control.
- 2 Press the desired buttons in the * area below to control the input source component of the selected SCENE template.

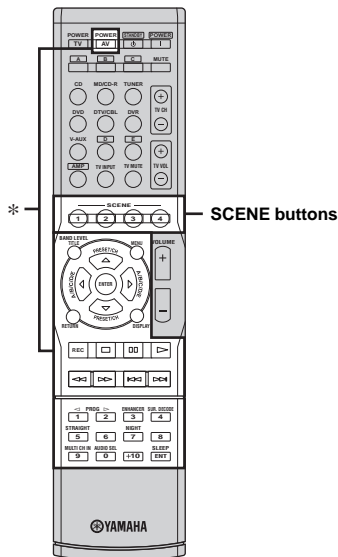

Note

- These buttons control the input source component. See page 36 for details of the function of each button.

Setting input source of the customized SCENE template on the remote control

If you customize the input source of the selected SCENE template, you must set the input source of the SCENE template on the remote control to operate the input source component correctly.

Press and hold the **[9] SCENE** button and the desired input selector button (**[6]**) for 3 seconds.



- Press the **[9] SCENE** button again to operate the input source component.

Sound field programs

This unit is equipped with a variety of precise digital decoders that allow you to enjoy multi-channel playback from almost any stereo or multi-channel sound source. This unit is also equipped with a Yamaha digital sound field processing (DSP) chip containing several sound field programs which you can use to enhance your playback experience.

Selecting sound field programs

Press **PROGRAM** $\triangleleft/\triangleright$ (or press **AMP** and then press **PROG** $\triangleleft/\triangleright$ repeatedly).

The name of the selected sound field program appears on the front panel display and on the OSD.

Sound field program descriptions



- Select a sound field program based on your listening preference, not merely on the name of the program, etc.
- The available sound field parameters differ depending on the settings of the speakers.

Notes

- When you select an input source, this unit automatically selects the last sound field program used with corresponding input source.
- Sound field programs cannot be selected when the component connected to the MULTI CH INPUT jacks is selected as the input source (see page 19).
- When PCM signals with a sampling frequency higher than 48 kHz are input, this unit is automatically set to the "STRAIGHT" mode (see page 27).



- Choose a sound field program based on your listening preference, not merely on the name of the program itself.
- You can select "Music Enh. 2ch" and "Music Enh. 5ch" by pressing **ENHANCER** repeatedly.

Category	Program	Features
MUSIC	Pop/Rock	CINEMA DSP processing. This program presents an image of pop, rock, or jazz live concert. The sound field reproduces the spaciousness of a massive pavilion with an emphasis on the vividness of vocals on the stage and solo instruments and the beats of rhythm instruments.
	Hall	CINEMA DSP processing. This sound field is suitable for classic and orchestral music. The program uses data collected in a large concert hall in Munich. You can enjoy delicate and beautiful reverberation and a majestic atmosphere.
	Jazz	CINEMA DSP processing. The sound field is suitable for jazz and fusion music. It uses data collected in a famous jazz club in New York. You can enjoy clear reverberation.
ENTERTAIN	Game	CINEMA DSP processing. You can enjoy dynamic and thrilling sound effects as you play games. The program lets you feel the depth and three-dimensional surrounding sounds of the field where you are playing, and offers cinema-like surrounding sound effects for the scenes of movies.
	TV Sports	CINEMA DSP processing. You can enjoy sports relays broadcast in stereo and variety shows with a live sound environment. For sports relays, the voices of commentators and announcers come clearly from the center; the cheers and atmosphere in the stadium spread around within a comfortable range, and you can feel like as if you are in the stadium.
MOVIE	Movie Spacious	CINEMA DSP processing. The sound field is suitable for movies with an emphasis on spectacular sound effects, and is a perfect fit with a wide screen. The program reproduces a wide dynamic range from minimum sound effects to powerful sounds.
	Movie Dramatic	CINEMA DSP processing. This sound field is also suitable for movies with an emphasis on three-dimensional sound effects. It restrains reverberation to an moderate extent, but reproduces sound effects and background music in a soft, three-dimensional manner with clarity and center orientation of voices as pivots.
STEREO	2ch Stereo	Downmixes multi-channel sources to 2 channel or plays back 2-channel sources as they are.
	5ch Stereo	CINEMA DSP processing. Using this program increases the listening position range. This is a sound field suitable for background music at parties.
ENHANCER	Music Enh. 2ch Music Enh. 5ch	Select these programs to play back compression artifacts (such as the MP3 format) in 2-channel or 5-channel stereo. This program enhances your listening experience by regenerating the missing harmonics in a compression artifact.

■ Selecting decoders for 2-channel sources (surround decode mode)

Signals input from 2-channel sources can also be played back on multi-channels.

Press **[8]AMP** and then press **[19]SUR. DECODE** repeatedly to select a decoder.

You can select from the following decoders depending on the type of source you are playing and your personal preference.

STANDARD	Function
PRO LOGIC	Dolby Pro Logic processing for any sources
PLII Movie	Dolby Pro Logic II processing for movie sources
PLII Music	Dolby Pro Logic II processing for music sources
PLII Game	Dolby Pro Logic II processing for game sources

■ Editing sound field parameters

Although you can enjoy good quality sound with the factory default parameters, you can change some of the parameters to better suit the input source or your listening room.

1 While listening to a source, press **[8]AMP** and then press **[12]▲ / ▼** to select desired parameter.

2 Press **[12]◀ / ▶** to change the parameter value.

Note

- You cannot change parameter values when "MEM.GUARD" in "OPTION MENU" is set to "ON" (see page 34).



- Initial settings are indicated by (*) in the following each parameter.

For Pop/Rock, Hall, Jazz, Game, TV Sports, Movie Spacious and Movie Dramatic:

DSP level DSP LEVEL

Function:	Adjusts the effect level.
Choices:	MIN, MID*, MAX

For PRO LOGIC II Music:

Panorama PANORAMA

Function:	Sends stereo signals to the surround speakers as well as the front speakers for a wraparound effect.
Choices:	OFF*, ON

Dimension DIMENSION

Function:	Gradually adjusts the sound field either towards the front or towards the rear.
Control range:	-3 (towards the rear) to +3 (towards the front), initial setting is STD (standard).

Center width CT WIDTH

Function:	Adjusts the center image from all three front speakers to varying degrees. A larger value adjusts the center image towards the front left and right speakers.
Control range:	0 (center channel sound is output only from center speaker) to 7 (center channel sound is output only from front left and right speakers), initial setting is 3.

For Music Enh. 2ch and Music Enh. 5ch

Effect level

Function:	Adjusts the effect level.
Choices:	LOW, HIGH*

■ Using sound field programs without surround speakers (Virtual CINEMA DSP)

Virtual CINEMA DSP allows you to enjoy the CINEMA DSP sound field programs without surround speakers.

When you set "SUR. L/R" to "NONE" (see page 32), Virtual CINEMA DSP is activated automatically whenever you select a CINEMA DSP sound field program (see page 26).

■ Enjoying multi-channel sources and sound field programs with headphones (SILENT CINEMA)

SILENT CINEMA allows you to enjoy multi-channel music or movie sound through ordinary headphones. SILENT CINEMA is activated automatically whenever you connect headphones to the PHONES jack while listening to CINEMA DSP sound field programs (see page 26).



- When it is activated, the SILENT CINEMA indicator lights up on the front panel display.

■ Enjoying unprocessed input sources (Straight decoding mode)

When this unit is in the "STRAIGHT" mode, 2-channel stereo sources are output from only the front left and right speakers. Multi-channel sources are decoded straight into the appropriate channels without any additional effect processing.

Press **[M]STRAIGHT** (or press **[8]AMP** and then **[20]STRAIGHT**) to select "STRAIGHT."

"STRAIGHT" appears on the front panel display.

To deactivate the "STRAIGHT" mode

Press **[M]STRAIGHT** (or **[20]STRAIGHT**) again so that "STRAIGHT" disappears from the front panel display.

FM/AM tuning

Overview

You can use two tuning modes to tune into a desired FM/AM station:

■ Frequency tuning mode

You can search or specify the frequency of the desired FM/AM station automatically or manually (see “FM/AM tuning operations” on this page).

■ Preset tuning mode

You can preset the desired FM/AM station in advance, and then recall the station by specifying the preset group and number (see “Selecting preset stations” on page 29).

Note

- Orient the connected AM loop antenna, or adjust the position of the end of the indoor FM antenna for the best reception.

FM/AM tuning operations

- 1 Press **INPUT** $\triangleleft/\triangleright$ repeatedly so that “TUNER” is displayed on the front panel display.
- 2 Press **BAND** to select the reception band (FM or AM).
- 3 To search the station automatically, press **TUNING AUTO/MAN'L** so that the **AUTO** indicator lights up on the front panel display. To search the station manually, press **TUNING AUTO/MAN'L** again so that the **AUTO** indicator disappears from the front panel display.

Lights up during automatic tuning

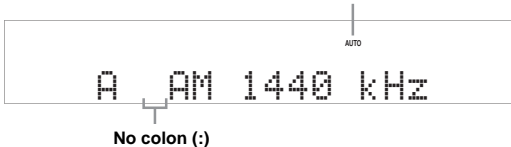

If a colon (:) appears on the front panel display, automatic/manual tuning is not possible. Press **EDIT PRESET/TUNING** to turn the colon (:) off.

- 4 To begin automatic tuning, press **PRESET/TUNING** $\triangleleft/\triangleright$ once. To tune into the desired station manually, press **PRESET/TUNING** $\triangleleft/\triangleright$ repeatedly. When this unit is tuned into a station, the **TUNED** indicator lights up and the frequency of the received station is shown on the front panel display.

Lights up



- To tune into a higher frequency, press **PRESET/TUNING** \triangleright .
- To tune into a lower frequency, press **PRESET/TUNING** \triangleleft .

Note

- If the signal from the station you want to select is weak, tune into it manually.

Preset FM/AM stations

Use this feature to store up to 40 stations (A1 to E8: 8 preset station numbers in each of 5 preset station groups). Preset the desired stations to this unit by using the automatic or manual station preset.

Automatic station preset

You can use the automatic preset tuning feature to store up to 40 FM stations with strong signals in order.

- 1 Press **INPUT** $\triangleleft/\triangleright$ repeatedly so that “TUNER” is displayed on the front panel display.
- 2 Press **BAND** to select “FM” as the reception band.
- 3 Press and hold **MEMORY** for more than 3 seconds. The preset station number as well as the **MEMORY** and **AUTO** indicators flashes. After approximately 5 seconds, automatic presetting status from the current frequency and proceeds toward the higher frequencies.

Flashes

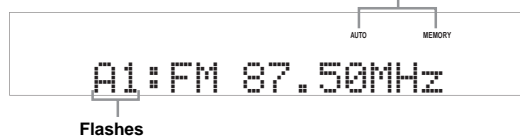

When automatic preset tuning is completed, the front panel display shows the frequency of the last preset station.



- You can select the preset station group and the preset station number where the first received station will be stored by pressing **A/B/C/D/E** and then **PRESET/TUNING** $\triangleleft/\triangleright$.

Notes

- Any stored station data existing under a preset station number is cleared when you store a new station under the same preset station number.
- Only FM stations with sufficient signal strength are stored automatically by automatic preset tuning. If the station you want to store is weak in signal strength, tune it manually and store it as described in “Manual station preset” on this page.

Manual station preset

Use this feature to store the FM or AM stations manually.

1 Tune into a station.

See page 28 for using instructions.

2 Press **MEMORY**.

The MEMORY indicator flashes on the front panel display for approximately 30 seconds.

3 Press **A/B/C/D/E** and **PRESET/TUNING** $\triangleleft/\triangleright$ repeatedly to select a preset station group and number (A1 to E8) while the MEMORY indicator is flashing.

Check that the colon (:) appears on the front panel display.

- To select a higher preset station group and number, press **PRESET/TUNING** \triangleright .
- To select a lower preset station group and number, press **PRESET/TUNING** \triangleleft .

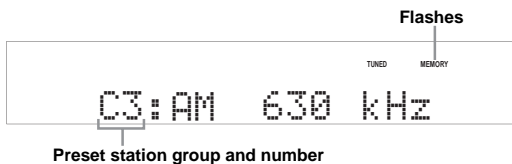

4 Press **MEMORY** while the MEMORY indicator is flashing.

The station band and frequency appear on the front panel display with the preset station group and number you have selected.



Selecting preset stations

You can tune into any desired station simply by selecting the preset station group and number under which it is stored.

When performing this operation with the remote control, press **6 TUNER** to select “TUNER” as the input source.

1 Press **A/B/C/D/E** (or **12** $\triangleleft/\triangleright$) repeatedly to select the desired preset station group (A to E).

The preset station group letter appears on the front panel display and changes each time you press the button.

2 Press **PRESET/TUNING** $\triangleleft/\triangleright$ (or **12** $\triangleleft/\triangleright$) to select the desired preset station number (1 to 8).

The preset station group and number, along with station band and frequency, appear on the front panel display.



- You can select the desired preset station number (1 to 8) directly by pressing the numeric buttons (25).

Exchanging preset stations

You can exchange the assignments of two preset stations between the two. The example below describes the procedure to exchange preset station “E1” and “A5.”

1 Select preset station “E1” using **A/B/C/D/E** and **PRESET/TUNING** $\triangleleft/\triangleright$.

See “Selecting preset stations” on this page.

2 Press and hold **EDIT PRESET/TUNING** for more than 3 seconds.

“E1” and the MEMORY indicator flash on the front panel display.

3 Select preset station “A5” using **A/B/C/D/E** and **PRESET/TUNING** $\triangleleft/\triangleright$.

“A5” and the MEMORY indicator flash on the front panel display.

See “Selecting preset stations” on this page.

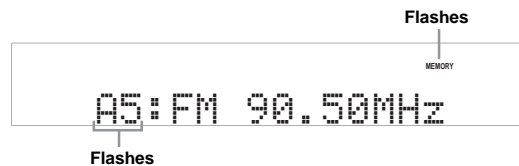

4 Press **EDIT PRESET/TUNING** again.

“EXCHANGE E1-A5” appears on the front panel display and the assignments of the two preset stations are exchanged.

ADVANCED OPERATION

Set menu

You can use the following parameters in the set menu to adjust a variety of system settings and customize the way this unit operates. Change the initial settings to reflect the needs of your listening environment.

Auto setup AUTO SETUP

Use this feature to automatically adjust speaker and system parameters (see page 16).

Manual setup MANUAL SETUP

Use this feature to manually adjust speaker and system parameters.

■ Sound menu 1 SOUND MENU

Use this menu to manually adjust any speaker settings, alter the quality and tone of the sound output by the system or compensate for video signal processing delays when using LCD monitors or projectors.

Parameter	Features	Page
A)SPEAKER SET	Selects the size of each speaker, the speakers for low-frequency signal output, the crossover frequency, and the location of the front speakers connected to the FRONT B terminals.	31
B)SP LEVEL	Adjusts the output level of each speaker.	32
C)SP DISTANCE	Adjusts the distance of each speaker.	32
D)CENTER GEQ	Adjusts the tonal quality of the center speaker.	32
E)LFE LEVEL	Adjusts the output level of the LFE channel for Dolby Digital or DTS signals.	33
F)D.RANGE	Adjusts the dynamic range of Dolby Digital or DTS signals.	33
G)AUDIO SET	Adjusts the muting level, audio delay settings, maximum volume level and initial volume level.	33

■ Input menu 2 INPUT MENU

Use this menu to manually reassign the input jacks, select the input mode or rename the input source.

Parameter	Features	Page
A)INPUT ASSIGN	Assigns the input jacks on this unit according to the component to be used.	33
B)INPUT RENAME	Changes the name of the input source.	34
C)VOLUME TRIM	Adjusts the output volume of each jack.	34
D)DECODER MODE	Selects the decoder mode for the sources connected to the DIGITAL INPUT jacks on the rear panel of this unit.	34
E)MULTI CH SET	Select the video source played in the background of the sources input from the MULTI CH INPUT jacks.	34

■ Option menu 3 OPTION MENU

Use this menu to manually adjust the optional system parameters.

Parameter	Features	Page
A)DISPLAY SET	Adjusts the brightness of the front panel display.	34
B)MEMORY GUARD	Locks sound field program parameters and other set menu settings.	34
C)AUDIO SELECT	Designates the default audio input jack select setting mode for the input sources connected to the DIGITAL INPUT jacks when you turn on the power of this unit.	35
D)PARAM. INI	Sets all the parameters of the sound field programs to the initial factory settings.	35

Signal information SIGNAL INFO

Use this feature to check audio signal information (see page 21).

Using set menu

Use the remote control to access and adjust each parameter.



- You can change the set menu parameters while this unit is reproducing sound.

1 Press **[8]AMP** and then press **[11]MENU** on the remote control.
“AUTO SETUP” appears on the front panel display.

2 Press **[12]Δ / ▽** to select “MANUAL SETUP.”

▪ MANUAL SETUP

3 Press **[12]ENTER** to enter “MANUAL SETUP.”
“1 SOUND MENU” appears on the front panel display.

1 SOUND MENU

4 Press **[12]Δ / ▽** repeatedly and then press **[12]ENTER** to select and enter the desired menu.

The following menus appear on the front panel display as you press **[12]Δ / ▽** repeatedly.

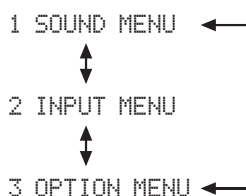

5 Press **[12]Δ / ▽** repeatedly and then press **[12]ENTER** to select and enter the desired submenu.

- Repeat this step to navigate to and enter the items you want to adjust.
- To return to the previous menu level, press **[14]RETURN**.

6 Press **[12]Δ / ▽** to select the desired parameter and then **[12]< / >** to change the parameter value.

- Press **[12]>** to increase the value.
- Press **[12]<** to decrease the value.

7 Press **[11]MENU** to exit from set menu.

1 SOUND MENU

Use this menu to manually adjust any speaker settings or compensate for video signal processing delays when using LCD monitors or projectors.



- Initial settings are indicated by (*) in this following each parameter.

Speaker settings A)SPEAKER SET

Use this feature to manually adjust any speaker settings.

■ FRONT B speaker setting FRONT B

Use this feature to select the location of the front speakers connected to the FRONT B terminals.

Choice	Condition
FRONT*	When FRONT B speakers are set in the main zone.
ZONE B	When FRONT B speakers are set in another zone. This setting mutes all the speakers in the main room when FRONT B is selected by [C]SPEAKERS .

Notes

- If you connect headphones to the PHONES jack on this unit, the sound is output from both headphones and the FRONT B terminals while “FRONT B” is set to “ZONE B.”
- If a DSP program is selected when “FRONT B” is set to “ZONE B,” this unit automatically enters the Virtual CINEMA DSP mode (see page 27).

■ Front speakers, Center speaker, Surround left/right speakers

FRONT, CENTER, SUR. LR

Select “LARGE (LRG)” or “SMALL (SML)” depending on the size of your each speaker. When Center speaker or Surround speakers is not connected, select “NONE.”

Initial setting:

FRONT: “LARGE”

CENTER: “SML”

SUR. LR: “SML”

Woofers diameter of a speaker is 16 cm (6.5 in) or larger: LARGE (LRG)
Woofers diameter of a speaker is smaller than 16 cm (6.5 in): SMALL (SML)

Notes

- When “BASS OUT” is set to “FRONT” on this page, you can select only “LARGE” in “FRONT.” If “FRONT” is set to a setting other than “LARGE” in advance, this unit automatically changes the value to “LARGE.”
- When you select “NONE” in “CENTER,” the center channel signals are directed to the front left and right speakers.
- When you select “NONE” in “SUR. LR,” this unit is automatically enters the Virtual CINEMA DSP mode (see page 27).

■ LFE/Bass out BASS OUT

Use this feature to select the speakers that output the LFE (low-frequency effect) and the low-frequency signals.



- If you are not satisfied with the bass sounds from your speakers, you can change these settings according to your preference.

LFE signals output

Choice	Subwoofer	Front speakers	Other speakers
BOTH*	Output	No output	No output
SWFR	Output	No output	No output
FRONT	No output	Output	No output

Low-frequency signals output

Choice	Subwoofer	Front speakers	Other speakers
BOTH*	*1	*2	*3
SWFR	*4	*3	*3
FRONT	No output	*1	*3

Notes

- *1 Outputs the low-frequency signals of the front channels and other speakers to "SML" or "NONE."
- *2 Always output the low-frequency signals of the front channels.
- *3 Output the low-frequency signals if the sizes of speakers are set to "LARGE" (or "LRG").
- *4 Output the low-frequency signals of the speakers set to "SML."

■ Crossover CROSSOVER

Use this feature to select a crossover frequency of all the speakers set to "SML" (or "SMALL") or to "NONE" in "SPEAKER SET" (see pages 30 and 31).

Choices: 40Hz, 60Hz, 80Hz*, 90Hz, 100Hz, 110Hz, 120Hz, 160Hz, 200Hz

Note

- All frequencies below the selected frequency will be sent to the subwoofer or to the speakers set to "LRG" (or "LARGE") in "SPEAKER SET" (see pages 30 and 31).

■ Subwoofer phase SWFR PHASE

Use this feature to switch the phase of your subwoofer if bass sounds are lacking or unclear.

Choice	Function
NRM*	Does not reverse the phase of your subwoofer.
REV	Sets the phase of your subwoofer to reverse.

Speaker level B)SP LEVEL

Use this feature to manually adjust the output level of each speaker.

Control range: -10 dB to 0 dB* to +10 dB

Control step: 1 dB

SP LEVEL	Adjusted speaker
FL	Front left speaker
FR	Front right speaker
C	Center speaker
SL	Surround left speaker
SR	Surround right speaker
SWFR	Subwoofer

Notes

- The available speaker channels differ depending on the setting of the speakers.
- This does not affect recorded material.

Speaker distance C)SP DISTANCE

Use this feature to manually adjust the distance of each speaker and the delay applied to the respective channel. All sounds would be adjusted to arrive at the listening position at the same time regardless of distance from each speaker.

■ Unit UNIT

Choice	Condition
meters*	When you adjust speaker distances in meters.
feet	When you adjust speaker distances in feet.

■ Speaker distances

Control range: 0.30 to 24.00 m (1.0 to 80.0 ft)

Control step: 0.10 m (0.5 ft)

Initial setting:

FRONT L/FRONT R/SWFR: 3.00 m (10.0 ft)

CENTER: 2.60 m (8.5 ft)

SUR. L/SUR. R: 2.40 m (8.0 ft)

SP DISTANCE	Adjusted speaker
FRONT L	Front left speaker
FRONT R	Front right speaker
CENTER	Center speaker
SUR. L	Surround left speaker
SUR. R	Surround right speaker
SWFR	Subwoofer

Note

- The available speaker channels differ depending on the setting of the speakers.

Center graphic equalizer D)CENTER GEO

Use this feature to adjust the built-in 5-frequency band (100Hz, 300Hz, 1kHz, 3kHz and 10kHz) graphic equalizer for the center channel so that the tonal quality of the center speaker matches that of the front speakers.

Control range: -6.0 dB to 0 dB* to +6.0 dB

Control step: 0.5 dB



- Press \square / ∇ to select a frequency band and \square < / > to adjust the selected frequency band.
- You can make adjustment while listening to the currently source or a test tone.

Following is an example where "100Hz" is selected as the frequency band.

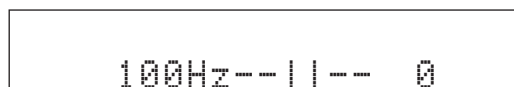

■ Test tone TEST

Use this feature to make adjustments for “CENTER GEQ” while listening to a test tone.

Choice	Function
OFF*	Stops test tones and output the currently.
ON	Outputs test tones from the center and from left speakers.

Low-frequency effect level E\LFE LEVEL

Use this feature to adjust the output level of the LFE (low-frequency effect) channel according to the capacity of your subwoofer or headphones.

Control range: -20 dB to 0 dB*

Control step: 1 dB

■ Speaker LFE SP LFE

Adjusts the speaker LFE level.

■ Headphone LFE HP LFE

Adjusts the headphone LFE level.

Notes

- Depending on the settings of “BASS OUT” (see page 31), some signals may not be output at the SUBWOOFER OUTPUT jack.
- The LFE channel carries low-frequency special effects which are only added to certain scenes.
- This setting is effective when the input signal contains the LFE channel.

Dynamic range F\D.RANGE

Use this feature to select the amount of dynamic range compression to be applied to your speakers or headphones. This setting is effective only when this unit is decoding Dolby Digital and DTS signals.

Choice	Function
MIN	Adjusts the dynamic range to narrow.
STD	Adjusts the dynamic range to medium.
MAX*	Preserves the greatest amount of dynamic range.

■ Speaker dynamic range SP D.R

Adjusts the speaker compression.

■ Headphone dynamic range HP D.R

Adjusts the headphone compression.

Audio settings G\AUDIO SET

Use this feature to adjust the overall audio settings of this unit.

■ Mute type MUTE TYP.

Use this feature to adjust how much the mute function reduces the output volume (see page 20).

Choice	Function
FULL*	Completely mutes all the audio output.
-20dB	Reduces the current volume by 20 dB.

■ Audio delay A.DELAY

Use this feature to delay the sound output and synchronize it with the video image. This may be necessary for certain LCD monitors or projectors.

Control range: 0 ms* to 160 ms

Control step: 1 ms

■ Maximum volume MAX VOL.

Use this feature to set the maximum volume level regardless of the original volume range. This feature is useful to avoid the unexpected loud sound.

Control range: +16 dB*, +10 dB to -30 dB

Control step: 5 dB

Note

- The “MAX VOL.” setting takes priority over the “INI.VOL.” setting. For example, if “INI.VOL.” is set to -20 dB and “MAX VOL.” is set to -30 dB, the volume level is automatically set to -30 dB when you turn on the power of this unit next time.

■ Initial volume INI.VOL.

Use this feature to set the volume level when the power of this unit is turned on.

Choices: Off*, -80 dB to +16 dB

Control step: 1 dB

Note

- The “MAX VOL.” setting takes priority over the “INI.VOL.” setting.

2 INPUT MENU

Use this menu to reassign the input jacks, select the input mode or rename the input source.



- Initial settings are indicated by (*) in this following each parameter.

Input assignment A\INPUT ASSIGN

Use this feature to assign the input jacks according to the component to be used if the initial settings of this unit do not correspond to your needs.

Choices: CD, MD/CD-R, DVD, DTV/CBL, V-AUX, DVR

Initial setting:

IN (1) (COAXIAL jack): DVD

IN (2) (OPTICAL (DTV/CBL) jack): DTV/CBL

IN (3) (OPTICAL (CD) jack): CD

Notes

- You cannot select a specific item more than once.
- You cannot assign the same input source to both “IN (2)” and “IN (3).” For example, you assign “CD” to “IN (2),” “----” appears in “IN (3).”
- Once the input jacks are reassigned, you can select the corresponding component by using **INPUT** <|/> (or the input selector buttons (6)) on the remote control).

Input rename B)INPUT RENAME

Use this feature to change the name of the input source that appears on the front panel display.

The following is an example where “DVD” is renamed “My DVD.”

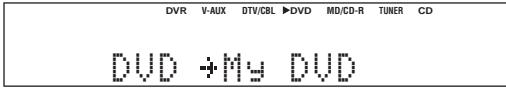

- 1 Press one of the input selector buttons (6) or [22] **MULTI CH IN** to select the input source you want to change the name of.
- 2 Press [8] **AMP** and then press [12] </> on the remote control to place the “_” (underscore) under the space or the character you want to edit.
- 3 Press [12] Δ / ∇ to select the character you want to use and then press [12] </> to move to the next space.

Notes

 - You can use up to 8 characters for each input.
 - Press [12] ∇ to change the character in the following order, or press [12] Δ to go in the reverse order:
A to Z, a space, 0 to 9, a space, a to z, a space, symbols (#, *, -, +, etc.)
- 4 Repeat steps 1 through 3 to rename each input source.
- 5 Press [11] **MENU** to exit from “INPUT RENAME.”

Volume trim C)VOLUME TRIM

Use this feature to adjust the level of the signal input at each jack. This is useful if you want to balance the level of each input source to avoid sudden changes in volume when switching between input sources.

Press one of the input selector buttons (6) or [22] **MULTI CH IN** to select the input source you want to adjust the level.

Choices: CD, TUNER, MD/CD-R, DVD, DTV/CBL, V-AUX, DVR, MULTI CH IN

Control range: -6.0 dB to 0.0 dB* to +6.0 dB

Control step: 1.0 dB

Decoder mode D)DECODER MODE

Decoder select mode

Use this feature to designate the default decoder mode for the input sources connected to the DIGITAL INPUT jacks.

Choice	Function
AUTO*	Automatically detect the type of input signals and selects the appropriate decoder mode.
LAST	Automatically select the last decoder mode used the connected input source.

DTS decoder prioritize setting

Choice	Function
AUTO*	Automatically detect the type of input signals and selects the appropriate input mode.
DTS	Enables to playback a DTS-CD.

Multi channel input setup**E)MULTI CH SET**

BGV BGV

Use this feature to select the video source played in the background of the sources input from the MULTI CH INPUT jacks.

Choices: LAST*, DVR, V-AUX, DTV/CBL, DVD



- Select “LAST” to set this unit to automatically select the last selected video source as the background video source.

3 OPTION MENU

Use this menu to adjust the optional system parameters.



- Initial settings are indicated by (*) in this following each parameter.

Display settings A)DISPLAY SET

Dimmer DIMMER

Use this feature to adjust the brightness of the front panel display.

Control range: -4 to 0*

Control step: 1

- Press [12] < to make the front panel display dimmer.
- Press [12] > to make the front panel display brighter.

Memory guard B)MEMORY GUARD

Memory guard MEM.GUARD

Use this feature to prevent accidental changes to DSP program parameter values and other system settings.

Choice	Function
OFF*	Turns off the “MEM.GUARD” feature.
ON	Protects: <ul style="list-style-type: none"> - sound field program parameters - all set menu items - SCENE template parameters

Note

- When “MEM.GUARD” is set to “ON,” you cannot select and adjust any other set menu items.

Audio select C)AUDIO SELECT

Use this feature to designate the default audio input jack select setting for the input sources.

Choice	Function
AUTO*	Automatically detect the type of input signals and select the appropriate input mode.
LAST	Automatically select the last input mode used for the connected input source (see page 19).

Parameter initialization D)PARAM. INI

Use this feature to set all the parameters of the sound field programs to the initial factory settings.

Choice	Function
NO*	Cancels the parameter initialization and returns to the previous menu level.
YES	Sets all the sound field parameters to the initial factory settings.

Notes

- You cannot automatically revert to the previous parameter settings once you initialize the sound field program parameters.
- You cannot separately initialize individual sound field programs.

Remote control features

In addition to controlling this unit, the remote control can also operate other audiovisual components made by Yamaha and other manufacturers. To control your TV or other components, you must set up the appropriate remote control code for each input source (see page 38).

Controlling this unit, a TV, or other components

■ Controlling this unit

Press **[8]AMP** to control this unit.

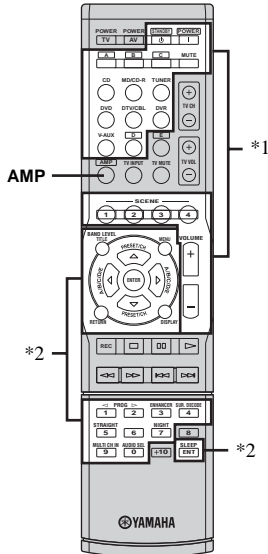

■ Controlling a TV

Press **[6]DTV/CBL** to control your TV. To control your TV, set the appropriate remote control code for **[6]DTV/CBL** (see page 38).

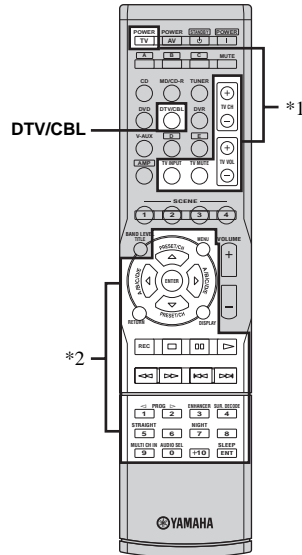

Notes

- *1 These buttons always control this unit.
- *2 These buttons control this unit only when **[8]AMP** is pressed.

Notes

- *1 These buttons always control your TV regardless of whether you press **[6]DTV/CBL** or not.

Remote control	Digital TV/Cable TV
TV POWER	Turns on or off the power.
TV CH +/-	Changes the channel number.
TV VOL +/-	Increases or decreases the volume level.
TV INPUT	Changes the input source.
TV MUTE	Mutes the audio output.

- *2 These buttons control your TV only when **[6]DTV/CBL** is pressed. For details, see the “Digital TV/Cable TV” column on page 37.



- You can control more than one TV by setting the appropriate remote control code for any input source selector buttons other than **[6]DTV/CBL**. In such a case, you can control the buttons highlighted above (*1 and *2) when you press the input source selector button.

■ Controlling other components

Press one of the input selector buttons (6) or A to E buttons to control other components. You must set the appropriate remote control code for each input source in advance (see page 38). The following table shows the function of each control button used to control other components assigned to each input selector button. Be advised that some buttons may not correctly operate the selected component.



- The remote control has 13 modes (input areas) to control components so that the remote control can operate up to 13 different components.
- When you press one of the optional component control area buttons (A to E), you can control the desired component without changing the input source of this unit.

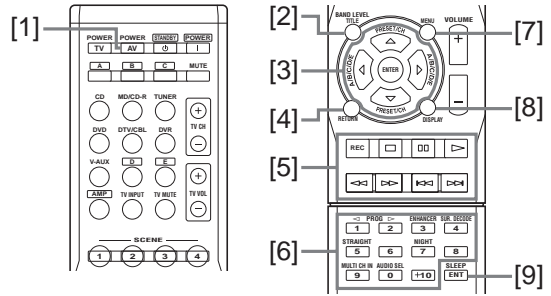

Remote control	DVD player/ recorder	VCR	Digital TV/ Cable TV	LD player	CD player	MD/CD recorder	Tuner
[1] AV POWER	Power *1	Power *1	Power *2	Power *1	Power *1	Power *1	
[2] TITLE	Title						Band
[3] PRESET/CH Δ	Up	VCR channel up	Up				Preset up (1-8)
PRESET/CH ∇	Down	VCR channel down	Down				Preset down (1-8)
A/B/C/D/E ◀	Left		Left				Preset down (A-E)
A/B/C/D/E ▶	Right		Right				Preset up (A-E)
ENTER	Enter		Enter				
[4] RETURN	Return		Return				
[5] REC	Disc skip (player) Rec (recorder)	Rec	Rec *2		Disc skip	Rec	
▷	Play	Play	Play *2	Play	Play	Play	
◀◀	Search backward	Search backward	Search backward *2	Search backward	Search backward	Search backward	
▶▶	Search forward	Search forward	Search forward *2	Search forward	Search forward	Search forward	
⏸	Pause	Pause	Pause *2	Pause	Pause	Pause	
◀◀◀	Skip backward	Skip backward	Skip backward *2	Skip backward	Skip backward	Skip backward	
▶▶▶	Skip forward	Skip forward	Skip forward *2	Skip forward	Skip forward	Skip forward	
◻	Stop	Stop	Stop *2	Stop	Stop	Stop	
[6] 1-9, 0, +10	Numeric buttons	Numeric buttons	Numeric buttons	Numeric buttons	Numeric buttons	Numeric buttons	Preset stations (1-8)
[7] MENU	Menu		Menu				
[8] DISPLAY	Display	Display	Display	Display	Display	Display	
[9] ENT	Title/Index	Enter	Enter	Chapter/Time	Index	Index	

Notes

- *1 This button is operational only when the original remote control supplied with the component has a POWER button.
*2 These buttons operate your DVD recorder only when you set the appropriate remote control code for DVR (see page 38).

Setting remote control codes

You can control other components by setting the appropriate remote control codes. For a complete list of available remote control codes, refer to “List of remote control codes” at the end of this manual.

Remote control code default settings

Input source	Component category	Manufacturer	Default code
CD	CD	Yamaha	5013
MD/CD-R	CD-R	Yamaha	5001
TUNER	TUNER	Yamaha	5007
DVD	DVD	Yamaha	2000
DTV/CBL	—	—	—
V-AUX	TUNER	Yamaha	5011
DVR	DVR	Yamaha	2011
A	TUNER	Yamaha	5012
B	TUNER	Yamaha	5009
C	TUNER	Yamaha	5017
D	—	—	—
E	—	—	—

Note

- You may not be able to operate your Yamaha component even if a Yamaha remote control code is preset as listed above. In this case, try setting another Yamaha remote control code.

- While pressing and holding one of the input selector buttons (A-E) on the remote control to select the input area you want to set up, press **AV POWER** for more than 3 seconds.

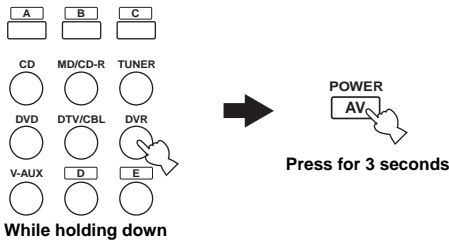

- Press the numeric buttons (0 to 9) (25) to enter the four-digit remote control code for the component to be used.

When the setting succeeds, “RemoteSetup OK” appears; however, when it does not, “RemoteSetup NG” appears on the front panel display.

Notes

- If the manufacturer of your component has more than one code, try each of them until you find the correct one.
- If you do not press any buttons within 30 seconds in step 2, the setup process is canceled. If this happens, repeat the setup procedure.

Resetting all remote control codes

Use this feature to clear all the remote control codes previously set and reset all of them to the initial factory settings.

- While pressing and holding **AMP**, press **AV POWER** for more than 3 seconds.



- Press the numeric buttons (25) to enter the code number “9981.”

“RemoteSetup OK” appears on the front panel display, and the remote control codes previously set are cleared and reset to the initial factory settings.



- If you do not press any buttons within 30 seconds after step 1, the clearing process is canceled. In this case, repeat the clearing procedure.

Advanced setup

This unit has additional menus that are displayed on the front panel display. The advanced setup menu offers additional operations to adjust and customize the way this unit operates. Change the initial settings (indicated by (*) in this following parameter) to reflect the needs of your listening environment.

Notes

- Only **STANDBY/ON**, **PROGRAM** $\triangleleft/\triangleright$ and **STRAIGHT** are effective while you are using the advanced setup menu.
- No other operations can be made while you are using the advanced setup menu.
- The advanced setup menu is only available on the front panel display.

1 Press **STANDBY/ON** on the front panel to set this unit to the standby mode.

2 Press and hold **TONE CONTROL** and then press **STANDBY/ON** to turn on this unit.

This unit turns on, and the advanced setup menu appears on the front panel display.

3 Press **PROGRAM** $\triangleleft/\triangleright$ to select the parameter you want to adjust.

The name of the selected parameter appears on the front panel display.

4 Press **STRAIGHT** repeatedly to change the selected parameter setting.

5 Press **STANDBY/ON** to confirm your selection and set this unit to the standby mode.



- The settings you made are reflected next time you turn on this unit.

■ Initializing PRESET

Use this feature to reset all the parameters of this unit to the initial factory settings.

Choices: CANCEL*, RESET

- Select “CANCEL” not to reset any parameters of this unit.
- Select “RESET” to reset the parameters of this unit.

Note

- The initial factory settings are activated next time you turn on this unit.

ADDITIONAL INFORMATION

Troubleshooting

Refer to the table below when this unit does not function properly. If the problem you are experiencing is not listed below or if the instruction below does not help, turn off this unit, disconnect the power cable, and contact the nearest authorized Yamaha dealer or service center.

■ General

Problem	Cause	Remedy	See page
This unit fails to turn on or enters the standby mode soon after the power is turned on.	The power cable is not connected or the plug is not completely inserted.	Connect the power cable firmly.	—
	The protection circuitry has been activated.	Make sure that all speaker wire connections on this unit and on all speakers are secure and that the wire for each connection does not touch anything other than its respective connection.	9
	This unit has been exposed to a strong external electric shock (such as lightning or strong static electricity).	Set this unit to the standby mode, disconnect the power cable, plug it back in after 30 seconds and then use it normally.	—
No sound	Incorrect input or output cable connections.	Connect the cables properly. If the problem persists, the cables may be defective.	11-13
	No appropriate Audio input jack select has been set.	Set an appropriate Audio input jack select.	35
	No appropriate input source has been selected.	Select an appropriate input source with ⓂINPUT <◁/▷> on the front panel (or the input selector buttons (Ⓜ) on the remote control).	18, 19
	Speaker connections are not secure.	Secure the connections.	9
	The front speakers to be used have not been selected properly.	Select the front speakers with ⓄSPEAKERS .	19
	The volume is turned down.	Turn up the volume.	—
	The sound is muted.	Press ⓂMUTE or ⓂVOLUME +/- on the remote control to resume audio output and then adjust the volume.	20
	Signals this unit cannot reproduce are being input from a source component, such as a CD-ROM.	Play a source whose signals can be reproduced by this unit.	—
	Audio signals input at the HDMI jack are not output from any speaker terminals.	Make an analog or digital connection beside the HDMI connection.	—
	The setting of the connected component is improper.	Make an appropriate setting following the instruction manual of the connected component.	—
The sound suddenly goes off.	The protection circuitry has been activated because of a short circuit, etc.	Check that the speaker wires are not touching each other and then turn this unit back on.	—
	The sleep timer has turned off this unit.	Turn on this unit, and play the source again.	—
	The sound is muted.	Press ⓂMUTE or ⓂVOLUME +/- on the remote control to resume audio output.	20
Sound is heard from the speaker on one side only.	Incorrect cable connections.	Connect the cables properly. If the problem persists, the cables may be defective.	11-14
	Incorrect settings in “SP LEVEL.”	Adjust the “SP LEVEL” settings.	32

Problem	Cause	Remedy	See page
Only the center speaker outputs substantial sound.	When playing a monaural source with a CINEMA DSP program, the source signal is directed to the center channel, and the front and surround speakers output effect sounds.		
No sound is heard from the center speaker.	“CENTER” in “SPEAKER SET” is set to “NONE.”	Set “CENTER” to “SML” or “LRG.”	31
	Some sound field programs do not output sounds from the center speaker.	Try another sound field program.	26
No sound is heard from the surround speakers.	“SUR. LR” in “SPEAKER SET” is set to “NONE.”	Set “SUR. LR” to “SML” or “LRG.”	31
	This unit is in the “STRAIGHT” mode and a monaural source is being played back.	Press STRAIGHT on the front panel so that “STRAIGHT” disappears from the front panel display.	27
No sound is heard from the subwoofer.	“BASS OUT” in “SPEAKER SET” is set to “FRONT” when a Dolby Digital or DTS signal is being played.	Set “BASS OUT” to “SWFR” or “BOTH.”	31
	“BASS OUT” in “SPEAKER SET” is set to “SWFR” or “FRONT” when a 2-channel source is being played.	Set “BASS OUT” to “BOTH.”	31
	The source does not contain low-frequency bass signals.		
Dolby Digital or DTS sources cannot be played. (Dolby Digital or DTS indicator on the front panel display does not light up.)	The connected component is not set to output Dolby Digital or DTS digital signals.	Make an appropriate setting following the operating instructions for your component.	—
	Audio input jack select is set to “ANALOG.”	Set Audio input jack select to “AUTO.”	19
A humming sound is heard.	Incorrect cable connections.	Connect the audio cables firmly. If the problem persists, the cables may be defective.	—
The volume level cannot be increased, or the sound is distorted.	You are attempting to set the volume level higher than the maximum volume level.	Adjust “MAX VOL.” setting.	33
	The component connected to the AUDIO OUT (REC) jack on this unit is turned off.	Turn on the power of the component.	—
The sound effect cannot be recorded.	It is not possible to record the sound effect with a recording component.		
A source cannot be recorded by an analog component connected to the AUDIO OUT (REC) jack.	The source component is not connected to the analog AUDIO IN jacks on this unit.	Connect the source component to the analog AUDIO IN jacks.	13
The sound field parameters and some other settings of this unit cannot be changed.	“MEM.GUARD” in “OPTION MENU” is set to “ON.”	Set “MEM.GUARD” to “OFF.”	34

Problem	Cause	Remedy	See page
This unit does not operate properly.	The internal microcomputer has been frozen by an external electric shock (such as lightning or excessive static electricity) or by a power supply with low voltage.	Disconnect the power cable from the AC wall outlet and then plug it in again after about 30 seconds.	—
“CHECK SP WIRES” appears on the front panel display.	Speaker cables are short-circuited.	Make sure all speaker cables are connected correctly.	9
There is noise interference from digital or radio frequency equipment.	This unit is too close to the digital or high-frequency equipment.	Move this unit further away from such equipment.	—
The picture is disturbed.	The video source uses scrambled or encoded signals to prevent dubbing.		
This unit suddenly enters the standby mode.	The internal temperature is too high and the overheat protection circuitry has been activated.	Wait about 1 hour for this unit to cool down and then turn it back on.	—
Virtual CINEMA DSP is not activated.	“MULTI CH” is selected as the input source.	Select an input source other than “MULTI CH.”	18
	Headphones are connected to the PHONES jack.	Disconnect the headphone plug from the PHONES jack.	—
	This unit is in the “5ch Stereo” mode.	Exit from the “5ch Stereo” mode.	26
SILENT CINEMA is not activated.	“MULTI CH” is selected as the input source.	Select an input source other than “MULTI CH.”	18
	The unit is in the “2ch Stereo,” “STRAIGHT” or “Music Enh.2ch” mode.	Exit from the “2ch Stereo,” “STRAIGHT” or “Music Enh2ch” mode.	26

■ Tuner

Problem	Cause	Remedy	See page
FM stereo reception is noisy.	The characteristics of FM stereo broadcasts may cause this problem when the transmitter is too far away or the antenna input is poor.	Check the antenna connections.	15
		Try using a high-quality directional FM antenna.	—
		Use the manual tuning method.	28
FM There is distortion, and clear reception cannot be obtained even with a good FM antenna.	There is multi-path interference.	Adjust the antenna position to eliminate multi-path interference.	—
		The desired station cannot be tuned into with the automatic tuning method.	The signal is too weak.
		Use the manual tuning method.	28
Previously preset stations can no longer be tuned into.	This unit has been disconnected for a long period.	Set preset stations.	28

Problem	Cause	Remedy	See page
The desired station cannot be tuned into with the automatic tuning method.	The signal is weak or the antenna connections are loose.	Tighten the AM loop antenna connections and orient it for the best reception.	—
		Use the manual tuning method.	28
AM There are continuous crackling and hissing noises.	Noises result from lightning, fluorescent lamps, motors, thermostats and other electrical equipment.	Use an outdoor antenna and a ground wire. This will help somewhat, but it is difficult to eliminate all noise.	—
There are buzzing and whining noises.	A TV set is being used nearby.	Move this unit away from the TV set.	—

■ **AUTO SETUP**

Before AUTO SETUP

Error message	Cause	Remedy	See page
Connect MIC!	Optimizer microphone is not connected.	Connect the supplied optimizer microphone to the OPTIMIZER MIC jack on the front panel.	16
Unplug HP!	Headphones are connected.	Unplug the headphones.	—

During AUTO SETUP

Error message	Cause	Remedy	See page
NO FRONT L SP NO FRONT R SP	Front L/R channel signals are not detected.	Check the front L/R speaker connections.	9
NO SUR. L SP NO SUR. R SP	A surround channel signal is not detected.	Check the surround speaker connections.	9
NOISY	Background noise is too loud.	Try running "AUTO SETUP" in a quiet environment.	—
		Turn off noisy electric equipment like air conditioners or move them away from the optimizer microphone.	—
NO MIC	The optimizer microphone was unplugged during the "AUTO SETUP" procedure.	Connect the supplied optimizer microphone to OPTIMIZER MIC jack on the front panel.	16
USER CANCEL	The "AUTO SETUP" procedure was cancelled due to user activity.	Run "AUTO SETUP" again.	16

After AUTO SETUP

Warning message	Cause	Remedy	See page
PHASE REVERSED	Speaker polarity is not correct. This message may appear depending on the speakers even when the speakers are connected correctly.	Check the speaker connections for proper polarity (+ or -).	9
DISTANCE ERROR	The distance between the nearest speaker and the furthest speaker is out of adjustable range.	Bring the speaker closer to the listening position.	—
LEVEL ERROR	The difference of volume level among speakers is excessive. (No level correction is made.)	If “SWFR:TOO LOUD” or “SWFR:TOO LOW” appears, adjust the output volume of the subwoofer.	16
		Readjust the speaker installation so that all speakers are set in locations with similar conditions.	—
		Check the speaker connections.	9
		Use speakers of similar quality.	—

Notes

- If the “ERROR” or “WARNING” screens appears, check the cause of the problem, then run “AUTO SETUP” again.
- If a warning message “PHASE REVERSED” appears, corrections are made, but they may not be optimal.
- If a warning message “DISTANCE ERROR” or “LEVEL ERROR” appears, no corrections are made.

■ Remote control

Problem	Cause	Remedy	See page
The remote control does not work nor function properly.	Wrong distance or angle.	The remote control functions within a maximum range of 6 m (20 ft) and no more than 30 degrees off-axis from the front panel.	8
	Direct sunlight or lighting (from an inverter type of fluorescent lamp, etc.) is striking the remote control sensor of this unit.	Reposition this unit.	—
	The batteries are weak.	Replace all batteries.	8
	The remote control code is not correctly set.	Set the remote control code correctly using “List of remote control codes” at the end of this manual.	38
		Try setting another code for the same manufacturer using “List of remote control codes” at the end of this manual.	38
Even if the remote control code is correctly set, there are some models that do not respond to the remote control.			

■ Resetting the system

Use this feature to reset all the parameters of this unit to the initial factory settings. For details about the procedure of resetting the system, see “Initializing” in “Advanced setup” on page 39.

■ Audio information

Dolby Digital

Dolby Digital is a digital surround sound system that gives you completely independent multi-channel audio. With 3 front channels (front L/R and center), and 2 surround stereo channels, Dolby Digital provides 5 full-range audio channels. With an additional channel especially for bass effects, called LFE (Low Frequency Effect), the system has a total of 5.1-channels (LFE is counted as 0.1 channel). By using 2-channel stereo for the surround speakers, more accurate moving sound effects and surround sound environment are possible than with Dolby Surround. The wide dynamic range from maximum to minimum volume reproduced by the 5 full-range channels and the precise sound orientation generated using digital sound processing provide listeners with unprecedented excitement and realism. With this unit, any sound environment from monaural up to a 5.1-channel configuration can be freely selected for your enjoyment.

Dolby Pro Logic II

Dolby Pro Logic II is an improved technique used to decode vast numbers of existing Dolby Surround sources. This new technology enables a discrete 5-channel playback with 2 front left and right channels, 1 center channel, and 2 surround left and right channels instead of only 1 surround channel for conventional Pro Logic technology. There are three modes available: "Music mode" for music sources, "Movie mode" for movie sources and "Game mode" for game sources.

Dolby Surround

Dolby Surround uses a 4-channel analog recording system to reproduce realistic and dynamic sound effects: 2 front left and right channels (stereo), a center channel for dialog (monaural), and a surround channel for special sound effects (monaural). The surround channel reproduces sound within a narrow frequency range. Dolby Surround is widely used with nearly all video tapes and laser discs, and in many TV and cable broadcasts as well. The Dolby Pro Logic decoder built into this unit employs a digital signal processing system that automatically stabilizes the volume on each channel to enhance moving sound effects and directionality.

DTS Digital Surround

DTS digital surround was developed to replace the analog soundtracks of movies with a 5.1-channel digital sound track, and is now rapidly gaining popularity in movie theaters around the world. DTS, Inc. has developed a home theater system so that you can enjoy the depth of sound and natural spatial representation of DTS digital surround in your home. This system produces practically distortion-free 5.1-channel sound (technically, left, right and center channels, 2 surround channels, plus an LFE 0.1 channel as a subwoofer, for a total of 5.1-channels).

LFE 0.1 channel

This channel reproduces low-frequency bass signals. The frequency range of this channel is from 20 Hz to 120 Hz. This channel is counted as 0.1 because it only enforces a low-frequency range compared to the full-range reproduced by the other 5 channels in Dolby Digital or DTS 5.1-channel systems.

PCM (Linear PCM)

Linear PCM is a signal format under which an analog audio signal is digitized, recorded and transmitted without using any compression. This is used as a method of recording CDs and DVD audio. The PCM system uses a technique for sampling the size of the analog signal per very small unit of time. Standing for "Pulse Code Modulation," the analog signal is encoded as pulses and then modulated for recording.

■ Sampling frequency and number of quantized bits

When digitizing an analog audio signal, the number of times the signal is sampled per second is called the sampling frequency, while the degree of fineness when converting the sound level into a numeric value is called the number of quantized bits. The range of rates that can be played back is determined based on the sampling rate, while the dynamic range representing the sound level difference is determined by the number of quantized bits. In principle, the higher the sampling frequency, the wider the range of frequencies that can be played back, and the higher the number of quantized bits, the more finely the sound level can be reproduced.

■ Sound field program information

CINEMA DSP

Since the Dolby Surround and DTS systems were originally designed for use in movie theaters, their effect is best felt in a theater having many speakers designed for acoustic effects. Since home conditions, such as room size, wall material, number of speakers, and so on, can differ so widely, it is inevitable that there are differences in the sound heard. Based on a wealth of actually measured data, Yamaha CINEMA DSP uses Yamaha original DSP technology to combine Dolby Pro Logic, Dolby Digital and DTS systems to provide the audiovisual experience of movie theater in the listening room of your own home.

SILENT CINEMA

Yamaha has developed a natural, realistic sound effect DSP algorithm for headphones. Parameters for headphones have been set for each sound field program so that accurate representations of all the sound field programs can be enjoyed on headphones.

Virtual CINEMA DSP

Yamaha has developed a Virtual CINEMA DSP algorithm that allows you to enjoy DSP surround effects even without any surround speakers by using virtual surround speakers. It is even possible to enjoy Virtual CINEMA DSP using a minimal two-speaker system that does not include a center speaker.

■ Video information

Component video signal

With the component video signal system, the video signal is separated into the Y signal for the luminance and the PB and PR signals for the chrominance. Color can be reproduced more faithfully with this system because each of these signals is independent. The component signal is also called the "color difference signal" because the luminance signal is subtracted from the color signal. A monitor with component input jacks is required in order to output component signals.

Composite video signal

With the composite video signal system, the video signal is composed of three basic elements of a video picture: color, brightness and synchronization data. A composite video jack on a video component transmits these three elements combined.

Specifications

AUDIO SECTION

- Minimum RMS Output Power for Front, Center, Surround
 - [U.S.A. and Canada models]
 - 1 kHz, 0.9% THD, 8 Ω 100 W/ch
 - [Other models]
 - 1 kHz, 0.9% THD, 6 Ω 100 W/ch
- Maximum Power (JEITA)
 - [U.S.A. and Canada models]
 - 1 kHz, 10% THD, 8 Ω 135 W/ch
 - [Asia, China, Korea and General models]
 - 1 kHz, 10% THD, 6 Ω 135 W/ch
- MAX Power Per Channel
 - [U.K., Russia, and Europe models]
 - 1 kHz, 0.7% THD, 4 Ω 105 W or more
- IEC Power
 - [U.K., Russia, and Europe models]
 - 1 kHz, 0.1% THD, 6 Ω 90 W or more
- Dynamic Power
 - [U.S.A. and Canada models] (Impedance Selector: 8 Ω)
 - (IHF, 8/6/4/2 Ω) 110/130/160/180 W
 - [Other models]
 - (IHF, 6/4/2 Ω) 105/130/150 W
- Dynamic Headroom [U.S.A. and Canada models]
 - 8 Ω 0.41 dB
- Frequency Response
 - CD, etc. to Front 10 Hz to 100 kHz, 0/-3 dB
 - V-AUX to Front 10 Hz to 20 kHz, 0/-3 dB
- Total Harmonic Distortion
 - CD, etc. (2ch stereo) to Front SP OUT,
 - [U.S.A. and Canada models]
 - 1 kHz, 50 W/8 Ω 0.06% or less
 - [Other models]
 - 1 kHz, 50 W/6 Ω 0.06% or less
- Signal to Noise Ratio (IHF-A Network)
 - CD, etc. (STEREO) Input shorted
 - 250 mV 100 dB or more
 - 200 mV 98 dB or more
- Residual Noise (IHF-A Network)
 - Front L/R 170 μV or less
- Channel Separation
 - CD, etc. Input 5.1 kΩ shorted (1 kHz/10 kHz)
 - 60 dB/45 dB or more
- Tone Control
 - BASS Boost/Cut ±10 dB/100 Hz
 - TREBLE Boost/Cut ±10 dB/20 kHz
- Headphone Jack Rated Output/Impedance
 - CD, etc. (1 kHz, 200 mV, 8 Ω) 0.4 V/470 Ω
- Input Sensitivity/Input Impedance
 - CD, etc. 200 mV/47 kΩ
 - MULTI CH INPUT 200 mV/47 kΩ
- Maximum Input Signal
 - CD, etc. 1 kHz, 0.5% THD (EFFECT ON) 2.0 V or more
- Output Level/Output Impedance
 - AUDIO OUT (REC) 200 mV/1.2 kΩ
 - SUBWOOFER OUTPUT
 - (2ch Stereo and FRONT SP: SMALL) 4 V/1.2 kΩ
- Filter Characteristics (fc=40/60/80/90/100/110/120/160/200 Hz)
 - H.P.F. (Front, Center, Surround) 12 dB/oct.
 - L.P.F. (Subwoofer) 24 dB/oct.

VIDEO SECTION

- Signal Level
 - Composite 1 V_{p-p}/75 Ω
 - Component 1 V_{p-p}/75 Ω (Y), 0.7 V_{p-p}/75 Ω (PB/PR)
- Video Maximum Input Level 1.5 V_{p-p} or more
- Signal to Noise Ratio 50 dB or more
- Frequency Response (MONITOR OUT)
 - Component Signal 5 Hz to 60 MHz, -3 dB

FM SECTION

- Tuning Range
 - [U.S.A. and Canada models] 87.5 to 107.9 MHz
 - [Asia and General models] 87.5/87.50 to 108.0/108.00 MHz
 - [Other models] 87.50 to 108.00 MHz
- 50 dB Quieting Sensitivity (IHF, 100% mod.)
 - Mono 2.8 μV (20.2 dBf)
- Signal to Noise Ratio (IHF)
 - Mono/Stereo 73 dB/70 dB
- Harmonic Distortion (1 kHz)
 - Mono/Stereo 0.5%/0.5%

AM SECTION

- Tuning Range
 - [U.S.A. and Canada models] 530 to 1710 kHz
 - [Asia and General models] 530/531 to 1710/1611 kHz
 - [Other models] 531 to 1611 kHz

GENERAL

- Power Supply
 - [U.S.A. and Canada models] 120 V AC, 60 Hz
 - [Australia model] 240 V AC, 50 Hz
 - [Korea model] 220 V AC, 60 Hz
 - [China model] 220 V AC, 50 Hz
 - [U.K., Russia, and Europe models] 230 V AC, 50 Hz
 - [Asia and General models]
 - 110-120/220-240 V AC, 50/60 Hz
- Power Consumption
 - [U.S.A. and Canada models] 240 W/320 VA
 - [Other models] 240 W
- Standby Power Consumption
 - [Except Asia and General models] 0.8 W
- Maximum Power Consumption
 - [Asia and General models]
 - 5ch, 10%/THD 530 W
- Dimensions (W x H x D) 435 x 151 x 318 mm
(17-1/8" x 5-15/16" x 12-1/2")
- Weight 8.0 kg (17 lbs 10 oz)

* Specifications are subject to change without notice.

Index

■ Numerics

1 SOUND MENU	30, 31
2 INPUT MENU	30, 33
2ch Stereo	26
3 OPTION MENU	30, 34
5ch Stereo	26

■ A

A)DISPLAY SET	34
A)INPUT ASSIGN	33
A)SPEAKER SET	31
A.DELAY	33
A/B/C/D/E, front panel	3
Adjusting the speaker level	20
Adjusting the tonal quality	20
AM tuning	28
AMP, remote control	5
ANTENNA terminals	6
Audio cable plugs	11
Audio delay	33
AUDIO jacks	6, 11
Audio jacks	11
AUDIO L/R (VIDEO AUX) jacks, front panel	3
AUDIO SEL, remote control	5
AUDIO SELECT	19
Audio select	35
Audio settings	33
AUTO SETUP	16, 30
Auto setup	30
AUTO SETUP, Error message	43
Automatic preset tuning	28
Automatic tuning	28

■ B

B)INPUT RENAME	34
B)MEMORY GUARD	34
B)SP LEVEL	32
BAND LEVEL TITLE, remote control	5
BAND, front panel	3
BASS OUT	31
BGV	34

■ C

C)AUDIO SELECT	35
C)SP DISTANCE	32
C)VOLUME TRIM	34
CD Listening	23
CD Music Listening	23
CENTER	31
Center graphic equalizer	32
Center speaker	31
Center width	27
CINEMA DSP indicator	4
COMPONENT VIDEO jacks	6, 11
Connect MIC!, Auto setup error message	43
Connecting a DVD player	13
Connecting a TV	12
Connecting audio components	13
Connecting speakers	9
Connecting the AM antennas	15
Connecting the FM antennas	15
Connecting the power cable	15
Connecting to CD player	13
Connecting to DVD recorder	13
Connecting to MD recorder/CD recorder	13
Connecting to the CENTER terminals	10
Connecting to the COMPONENT VIDEO jacks	11
Connecting to the FRONT A terminals	10
Connecting to the FRONT B terminals	10
Connecting to the HDMI jacks	11
Connecting to the MULTI CH INPUT jacks	14
Connecting to the SURROUND terminals	10
Connecting video components	13

Control buttons, remote control	5
Creating original SCENE templates	24
CROSSOVER	32
Crossover	32
CT WIDTH	27
Cursors/ENTER, remote control	5

■ D

D)CENTER GEO	32
D)DECODER MODE	34
D)PARAM. INI	35
Decoder indicator	4
Decoder mode	34
Decoder select mode	34
DIGITAL AUDIO COAXIAL jack	11
DIGITAL AUDIO OPTICAL jacks	11
DIGITAL INPUT COAXIAL assignment	33
DIGITAL INPUT jacks	6
DIMENSION	27
Dimension	27
DIMMER	34
Dimmer	34
Disc Listening	23
Display settings	34
DISPLAY, remote control	5
DISTANCE ERROR, Auto setup error message	44
DSP LEVEL	27
DSP level	27
DTS decoder prioritize setting	34
DVD Live Viewing	23
DVD Movie Viewing	23
DVD Viewing	23
DVR Viewing	23
Dynamic range	33

■ E

E)LFE LEVEL	33
E)MULTI CH SET	34
EDIT PRESET/TUNING, front panel	3
Editing sound field parameters	27
ENHANCER indicator	4
ENHANCER, remote control	5
Enjoying 2-channel sources using the standard decoders	27
Exchanging preset stations	29

■ F

F)D.RANGE	33
FM tuning	28
FRONT	31
FRONT B	31
FRONT B speaker setting	31
Front panel	3
Front panel display	3, 4
Front speakers	31

■ G

G)AUDIO SET	33
Game Playing	23

■ H

Hall	26
HDMI	11
HDMI jack, HDMI cable plug	11
HDMI terminals	6
Headphone dynamic range	33
Headphone LFE	33
Headphones indicator	4
HP D.R	33
HP LFE	33

■ I

Infrared window	8
Infrared window, remote control	5
INI.VOL.	33

Initial volume	33
Initializing	39
Input assignment	33
Input channel and speaker indicators	4
Input channel indicators	4
Input menu	30
Input rename	34
Input selector buttons, remote control	5
Input source indicators	4
Input source information	21
INPUT, front panel	3
Installing batteries in the remote control	8

■ J

Jazz	26
------------	----

■ L

LEVEL ERROR, Auto setup error message	44
LFE indicator	4
LFE/Bass out	31
Listening to unprocessed input signals	27
Low-frequency effect level	33

■ M

Manual preset tuning	29
MANUAL SETUP	30
Manual setup	30
Manual tuning	28
MAX VOL.	33
Maximum volume	33
MEM.GUARD	34
Memory guard	34
MEMORY, front panel	3
MENU, remote control	5
Movie Dramatic	26
Movie Spacious	26
MULTI CH IN, remote control	5
MULTI CH INPUT jacks	6
Multi channel input setup	34
Multi-channel sources and sound field programs with headphones	27
Multi-information display	4
Music Disc Listening	23
Music Enh. 2ch	26
Music Enh. 5ch	26
MUTE indicator	4
MUTE TYP.	33
Mute type	33
MUTE, remote control	5
Muting the audio output	20

■ N

NIGHT indicator	4
Night listening mode	20
NIGHT, front panel	3
NIGHT, remote control	5
NO FRONT L SP, Auto setup error message	43
NO FRONT R SP, Auto setup error message	43
NO MIC, Auto setup error message	43
NO SUR.L SP, Auto setup error message	43
NO SUR.R SP, Auto setup error message	43
NOISY, Auto setup error message	43
Numeric buttons, remote control	5

■ O

OPTIMIZER MIC jack, Auto setup	16
OPTIMIZER MIC jack, front panel	3
Optimizer microphone	16
Optimizer microphone, Auto setup	16
Optimizing speaker setting	16
Option menu	30

■ P

PANORAMA	27
Panorama	27
Parameter initialization	35
PCM indicator	4
PHASE REVERSED, Auto setup error message	44
PHONES jack, front panel	3
Placing speakers	9
Playing video sources in the background	21
Pop/Rock	26
PORTABLE (VIDEO AUX) jack, front panel	3
Power cable	6
POWER, remote control	5
PRESET	39
Preset SCENE templates	23
PRESET/TUNING, front panel	3
PROG, remote control	5
PROGRAM, front panel	3

■ R

Radio Listening	23
Rear panel	6
Remote control	5
Resetting the system	39
RETURN, remote control	5

■ S

SCENE	22
SCENE 1/2/3/4, front panel	3
SCENE 1/2/3/4, remote control	5
Selecting audio input jacks	19
Selecting preset stations	29
Selecting the MULTI CH INPUT component as the input source	19
Selecting the night listening mode	20
Selecting the SCENE templates	22
Set menu	30
Set this unit to the standby mode	15
Setting input source of the customized SCENE template on the remote control	25
Setting remote control codes	38
SIGNAL INFO	21
Signal information	30
SILENT CINEMA	27
SILENT CINEMA indicator	4
SLEEP indicator	4
Sleep timer	21
SLEEP, remote control	5
Sound field programs	26
Sound menu	30
SP A B indicators	4
SP D.R	33
SP LFE	33
Speaker distance	32
Speaker distances	32
Speaker dynamic range	33
Speaker level	32
Speaker LFE	33
Speaker settings	31
SPEAKERS terminals	6
SPEAKERS, front panel	3
Specifications	46
STANDBY, remote control	5
STANDBY/ON, front panel	3
Straight decoding mode	27
STRAIGHT, front panel	3
STRAIGHT, remote control	5
SUBWOOFER OUTPUT jack	6
Subwoofer phase	32
Supplied accessories	2
SUR. LR	31
SUR.DECODE, remote control	5
Surround left/right speakers	31
SWFR PHASE	32

■ T

TEST	33
Test tone	33
TONE CONTROL, front panel	3
Troubleshooting	40
Tuner indicators	4
TUNING AUTO/MAN'L, front panel	3
Turning off the power	15
Turning on the power	15
TV control buttons, remote control	5
TV Sports	26
TV Sports Viewing	23
TV Viewing	23
TV/AV POWER, remote control	5

■ U

UNIT	32
Unit	32
Unplug HP!, Auto setup error message	43
USER CANCEL, Auto setup error message	43
Using the remote control	8
Using the VIDEO AUX jacks	14
Using your headphones	20

■ V

VIDEO (VIDEO AUX) jack, front panel	3
Video cable plugs	11
VIDEO jacks	6, 11
Video jacks	11
Virtual CINEMA DSP	27
VIRTUAL indicator	4
VOLUME +/-, remote control	5
VOLUME control, front panel	3
VOLUME level indicator	4
Volume Trim	34

■ Y

Yamaha Parametric Room Acoustic Optimizer	16
YPAO	16
YPAO (Yamaha Parametric Room Acoustic Optimizer)	16
YPAO indicator	4

■ Z

Zone B	19
--------------	----

“(A)STANDBY/ON” or
“(6)DVD” (example) indicates the
name of the parts on the front panel
or the remote control. Refer to
“Functional overview” on page 3.

List of remote control codes

Blu-ray Player

Samsung 2137

CD Player

Yamaha 5000, 5013

CD Recorder

Yamaha 5001

DVD

Acoustic Solutions

2078
 Aiwa 2055, 2100
 Akai 2096
 Akura 2076
 Alba 2078, 2086
 Apex 2027, 2049
 Awa 2078
 Axion 2078
 Brainwave 2096
 Brandt 2073, 2085
 Broksonic 2060
 Bush 2075, 2078, 2112
 Centrex 2077
 Classic 2078
 Clatronic 2075
 Coby 2078
 C-Tech 2074
 CyberHome 2025, 2079, 2091
 Daewoo 2092, 2098
 Dansai 2096
 Daytek 2080, 2089
 DEC 2075
 Denon 2030, 2102, 2103
 Denver 2075, 2076
 Diamond 2074
 DK Digital 2094
 Dual 2078
 D-Vision 2096
 DVX 2074
 Elta 2096
 Euroline 2096
 Funai 2052, 2058
 Global Solutions 2074
 Global Sphere 2074
 Goodmans 2075, 2077, 2078
 Grundig 2077, 2098
 H&B 2075
 Haaz 2074
 HE 2078
 Hitachi 2032, 2072
 Home Electronics 2078
 Innovation 2072
 Irradio 2134
 JDB 2078
 JVC 2033, 2045, 2053, 2073, 2099
 Kenwood 2030, 2097
 Kingavon 2075
 Koda 2075
 Lawson 2074
 Lenco 2075
 LG 2084, 2087
 Lifetec 2072
 Limit 2074
 LogicLab 2074
 Luxor 2077
 Magnavox 2037, 2073, 2075
 Magnum 2072

MBO 2078
 Medion 2072
 Micromaxx 2072
 Micromedia 2073
 Microstar 2072
 Mitsubishi 2035
 Mizuda 2075
 Mustek 2078
 Naiko 2077
 Onkyo 2073, 2135
 Orava 2075
 P&B 2075
 Pacific 2074
 Panasonic 2030, 2040, 2054, 2057, 2105, 2110
 Philips 2019, 2026, 2046, 2073, 2081, 2090
 Pioneer 2036, 2082
 Proline 2077
 Provision 2075
 RCA 2031, 2042, 2050, 2051
 Red Star 2076
 Reoc 2074
 Roadstar 2075, 2078, 2086
 Rowa 2077
 Saba 2085
 Sabaki 2074
 Samsung 2032, 2041, 2104, 2113
 Sansui 2074
 Sanyo 2095
 ScanMagic 2078
 Scientific Labs 2074
 Scott 2088
 SEG 2074, 2086
 Sharp 2034, 2043, 2059, 2093, 2106
 Silva 2076
 Singer 2074
 Skymaster 2074, 2078
 Skyworth 2076
 SM Electronic 2074, 2078
 Sony 2028, 2029, 2039, 2083, 2107
 Soundmaster 2074
 Soundmax 2074
 Standard 2074
 Star Cluster 2074
 Starmedia 2075
 Supervision 2074, 2078
 Sylvania 2052, 2058
 Synn 2074
 TCM 2072
 Teac 2074
 Tec 2076
 Technics 2030
 Technika 2096
 Technosonic 2096
 Tevion 2072, 2074
 Thomson 2085, 2109
 Tokai 2076
 Toshiba 2026, 2044, 2048, 2056, 2073, 2108, 2111
 United 2078
 Voxson 2078
 Wharfedale 2074
 Xlogic 2074
 Yakumo 2077
 Yamada 2077

Yamaha 2000, 2001, 2003, 2030, 2101
 Yukai 2078
 Zenith 2038, 2047, 2073

DVD Recorder

Apex 2024
 JVC 2070
 LG 2071
 Panasonic 2020, 2065, 2066, 2067
 Philips 2019, 2061, 2062, 2063
 Pioneer 2021
 RCA 2018
 Sony 2022, 2064
 Toshiba 2068
 Yamaha 2023
 Yukai 2069

DVD/LD

Pioneer 2036

DVD/VCR

JVC 1017, 2045
 LG 1071, 2087
 Panasonic 1020, 1072, 2040, 2105
 Philips 1025
 RCA 1022, 2042
 Samsung 1021, 2041, 2104
 Sharp 1023, 1073, 2043, 2106
 Sony 1019, 1074, 2039, 2107
 Toshiba 1024, 1075, 2044, 2108
 Zenith 1026, 2047

DVD/DVR

Panasonic 2067
 Pioneer 2114
 Samsung 2115
 Toshiba 2068

DVR

ABS 2132
 Alienware 2132
 CyberPower 2132
 Dell 2132
 DIRECTV 2123, 2128, 2129, 2133
 DISH Network 2126, 2127
 Dishpro 2126
 Echostar 2126, 2127
 Expressvu 2126
 Gateway 2132
 GOI 2126
 Hewlett Packard 2132
 Hitachi 2008
 Howard Computers 2132
 HTS 2126
 Hughes 2123, 2128
 Humax 2123
 Hush 2132
 iBUYPOWER 2132
 JVC 2126, 2127
 Linksys 2132
 Media Center PC 2132

Microsoft 2132
 Mind 2132
 Niveus Media 2132
 Northgate 2132
 Panasonic 2015, 2016, 2017, 2120
 Philips 2117, 2121, 2123, 2128
 Pioneer 2012, 2013, 2014
 Proscan 2129
 RCA 2116, 2124, 2129, 2133
 ReplayTV 2118, 2119, 2120
 Sharp 2009, 2010
 Sonic Blue 2119, 2120
 Sony 2005, 2006, 2007, 2122, 2130, 2131, 2132
 Stack 10 2132
 Stack 9 2132
 Systemax 2132
 Tagar Systems 2132
 Tivo 2116, 2121, 2122, 2123, 2130, 2131
 Toshiba 2004, 2125, 2132
 Touch 2132
 UltimateTV 2133
 Viewsonic 2132
 Voodoo 2132
 Yamaha 2011
 ZT Group 2132

HD DVD

Toshiba 2136

iPod

Yamaha 5011

LD Player

Yamaha 2002

MD

Yamaha 5002, 5003, 5004

Tape Deck

Yamaha 5005, 5006

Tuner

Yamaha 5007, 5008, 5009, 5010, 5012, 5014, 5015, 5016, 5017, 5018

TV

Acer 0093
 Acme 0207
 Acura 0208
 ADA 0255
 ADC 0206
 Admiral 0058, 0205, 0206, 0210, 0211
 Adyson 0200, 0207
 Agashi 0200
 Agazi 0206
 AGB 0204
 Aiko 0127, 0200, 0207, 0208
 Aiwa 0028, 0139, 0229, 0237

Akai	0059, 0065, 0127, 0129, 0130, 0200, 0204, 0208, 0209, 0213, 0217, 0218, 0255	Cascade	0208	Envision	0060, 0061	Hisawa	0209, 0218
		Cathay	0213, 0217	Erres	0213, 0217	Hitachi	0006, 0014, 0015, 0016, 0042, 0060, 0061, 0095, 0105, 0127, 0156, 0179, 0180, 0204, 0207, 0210, 0211, 0215, 0216, 0251
Akiba	0209, 0218	CCE	0127	ESA	0080		
Akura	0206, 0209, 0218	Celebrity	0059	Etron	0208		
Alaron	0200	Centurion	0213, 0217	Euro-Feel	0206		
Alba	0200, 0207, 0208, 0209, 0217, 0218	Century	0205	Euroline	0217		
ALBIRAL	0212	CGE	0214, 0215	Euroman	0200		
Allstar	0213	Cimline	0208, 0218	Euromann	0206, 0207, 0213		
Amplivision	0207	Citizen	0060, 0061, 0062, 0064	Europhon	0200, 0204, 0207, 0213, 0215	Hornophon	0213
Amstrad	0204, 0206, 0208, 0209, 0218	City	0208	Fenner	0208	Hoshai	0209, 0218
Amtron	0062	Clarivox	0212, 0217	Ferguson	0212, 0217, 0226	Huanyu	0200, 0207
Anam	0208	Clatronic	0206, 0207, 0208, 0209, 0213, 0214, 0218	Fidelity	0200, 0207, 0210	Hygashi	0200, 0207
Anam National	0062	CMS	0200	Finlandia	0210	Hyper	0200, 0207, 0208, 0214, 0215
Anglo	0208	Colorlyme	0060, 0061	Finlux	0204, 0205, 0207, 0213, 0215, 0217	Hypson	0206, 0207, 0213, 0217
Anitech	0206, 0208	Concerto	0060, 0061	Firstline	0200, 0207, 0208, 0213, 0214	ICE	0127, 0200, 0206, 0207, 0208, 0209, 0213, 0218
Ansonic	0203, 0208	Concorde	0208	Fisher	0064, 0127, 0128, 0205, 0207, 0215	ICeS	0200, 0218
AOC	0060, 0061	Condor	0200, 0207, 0213	Flint	0213, 0218	IMA	0062
Apex	0118, 0122, 0132	Contec	0200, 0207, 0208	Formenti	0200, 0205, 0207, 0215, 0217	Imperial	0211, 0213, 0214, 0215
Arc en Ciel	0216	Contec/Cony	0062	Formenti-Phoenix		Indiana	0213, 0217
Arcam	0200	Continental Edison	0216			Infinity	0063
Arcam Delta	0207	Cosmel	0208			Ingelen	0211
Aristona	0213, 0217	Craig	0062	Fortress	0205	Ingersol	0208
ASA	0205, 0211	Crosley	0205, 0214, 0215	Frontech	0206, 0208, 0210, 0211, 0214	Inno Hit	0201, 0204, 0207, 0208, 0209, 0213, 0217, 0218
Asberg	0213	Crown	0062, 0063, 0128, 0208, 0213, 0217	Fujitsu	0023, 0024, 0025, 0088, 0127		
Astra	0208	CS Electronics	0200, 0207, 0209, 0214, 0218	Funai	0033, 0034, 0035, 0036, 0037, 0062, 0206	Innovation	0206, 0208
Asuka	0200, 0206, 0207, 0209, 0218	CTC	0214			Interbuy	0208, 0214
Atlantic	0200, 0207, 0213, 0217	Curtis Mathes	0057, 0060, 0061, 0064, 0065	Futurtech	0062	Interfunk	0205, 0211, 0213, 0214, 0216, 0217
Atori	0208	CXC	0062	Gateway	0094	International	0200
Audiosonic	0207, 0208, 0209, 0213, 0216, 0217, 0218	Cybertron	0209, 0218	GBC	0208, 0215, 0218	Intervision	0206, 0207, 0218
AudioTon	0207	Daewoo	0060, 0061, 0120, 0127, 0155, 0193, 0200, 0207, 0208, 0213, 0218, 0238	GE	0057, 0060, 0061, 0122, 0147	Irradio	0201, 0208, 0209, 0213, 0217, 0218
Audiovox	0062			GEC	0204, 0207, 0211, 0213, 0217	Isukai	0209, 0218
Autovox	0205, 0206, 0207	Dainichi	0200, 0209, 0218	Geloso	0208, 0210, 0215	ITC	0207, 0215
Awa	0200	Dansai	0200, 0206, 0213, 0217	General Technic	0208	ITS	0200, 0209, 0213, 0218
Baird	0216			Genexxa	0209, 0211, 0213, 0218	ITT	0129, 0208, 0211
Bang & Olufsen	0205	Dantax	0217			ITV	0208, 0217
Basic Line	0208, 0209, 0213, 0218	Daytron	0060, 0061, 0208	Gibraltar	0060	JBL	0063
Bastide	0207	De Graaf	0210	GoldHand	0200	JC Penney	0057, 0060, 0061
Baur	0217	Decca	0204, 0207, 0213, 0217	GoldStar	0060, 0061, 0127, 0128, 0200, 0201, 0207, 0208, 0210, 0213, 0214, 0215, 0217	JCB	0059
Beko	0228	Desmet	0213, 0217			Jensen	0060, 0061
Belcor	0060	Diamond	0200	Goodmans	0171, 0201, 0204, 0206, 0208, 0213, 0217, 0240	JVC	0017, 0018, 0019, 0108, 0136, 0153, 0178, 0190, 0213, 0218
Bell & Howell	0058, 0064	Dimensia	0057			Kaisui	0200, 0207, 0208, 0209, 0218
Benq	0081	Dixi	0208, 0213, 0217			Kamosonic	0207
Beon	0213, 0217	DTS	0208	GPM	0209, 0218	Kamp	0200, 0207
Bestar	0213	Dual	0207, 0215, 0216	Graetz	0211	Kapsch	0211
Binatone	0207	Dual-Tec	0207, 0208, 0215	Granada	0204, 0207, 0210, 0213, 0217	Karcher	0207, 0208, 0212, 0217
Black Star	0214	Dumont	0060, 0127, 0205, 0207			Kawasho	0059, 0060, 0061, 0200
Blaupunkt	0255			Grandin	0208, 0209, 0217		
Blue Sky	0209, 0218	Durabrand	0126	Grundig	0128, 0130, 0222, 0236, 0255	Kendo	0128, 0210
Bondstec	0214	Dux	0217			Kennedy	0215
Boots	0207	Dynatron	0213, 0217	Grunpy	0062	Kenwood	0060, 0061
Bradford	0062	Elbe	0203, 0204, 0212, 0218	Halifax	0200, 0206, 0207	Kingsley	0200, 0207
Brandt	0216, 0226	Elcit	0204, 0205	Hallmark	0060, 0061	Kloss Novabeam	0062
Brionvega	0205, 0213, 0217	ELECTRO TECH		Hampton	0200, 0207	Kneissel	0203
Broksonic	0138			Hanseatic	0203, 0207, 0208, 0213, 0215, 0217	Kolster	0213
Bruns	0205	Electroband	0059	Hantarex	0204, 0208	Konka	0209, 0218
BSR	0215	Electrohome	0059, 0060, 0061	Harvard	0062	Korpel	0213, 0217
BTC	0209, 0218	Elin	0200, 0207, 0213, 0217	HCM	0206, 0207, 0208, 0218	Korting	0205
Bush	0177, 0208, 0209, 0210, 0213, 0215, 0216, 0217, 0218, 0230, 0237	Elite	0209, 0213, 0218	Higashi	0200	Koyoda	0208
Candle	0060, 0061	Elman	0215	Hinari	0208, 0209, 0213, 0217, 0218	KTV	0062, 0127, 0207
Capsonic	0206	Elta	0200, 0208			Kyoto	0200, 0212
		Emerson	0060, 0061, 0062, 0064, 0128, 0205				

Lenco	0208	NEC	0026, 0053, 0060,	0182, 0194, 0195,	Sanyo	0020, 0021, 0022,	
Lenoir	0207, 0208		0061, 0096, 0127	0211, 0213, 0216,		0049, 0060, 0064,	
Lesa	0214	Neckermann	0205, 0207, 0210,	0217, 0250		0127, 0128, 0200,	
Leyco	0206, 0213, 0217		0213, 0217, 0255	0206, 0213		0203, 0207, 0215	
LG	0016, 0038, 0039,	NEI	0213, 0217	Plantron			
	0127, 0128, 0157,	Nesco	0214	Polaroid	0075	SBR	0217
	0158, 0163, 0164,	NET-TV	0082, 0101	Poppy	0208	SCHAUB LORENTZ	0211
	0166, 0188, 0189,	New Tech	0208, 0213	Portland	0060, 0061		
	0200, 0201, 0207,	New World	0209, 0218	Prandoni-Prince	0204, 0210	Schneider	0207, 0209, 0213,
	0208, 0210, 0213,	Nicamagic	0200, 0207	Precision	0207		0215, 0216, 0217,
	0214, 0215, 0217	Nikkai	0200, 0206, 0207,	Prima	0208, 0211		0218
Liesenk	0217		0209, 0213, 0217,	Profex	0208	Scotch	0061
Life	0206, 0208		0218	Profi-Tronic	0213	Scott	0060, 0061, 0062
Lifetec	0206, 0208, 0218	Nikko	0061	Proline	0213	Sears	0057, 0060, 0061,
Loewe	0063, 0128, 0203,	Nobliko	0200, 0207	Proscan	0057		0064
	0204, 0223, 0227	Nogamatic	0216	Prosonic	0200, 0207, 0217	SEG	0200, 0206, 0207,
Loewe Opta	0205, 0213, 0217	Nokia	0129, 0211	Protech	0206, 0207, 0208,		0214, 0215, 0217
Logik	0058	Nordmende	0205, 0211, 0213,		0213, 0214, 0215,	SEI	0204
Luma	0210, 0217		0216	Proton	0060, 0061	SEI-Sinudyne	0204, 0205, 0211
Lumatron	0210, 0213, 0217	Nordvision	0217	Provision	0217	Seleco	0210, 0211, 0215
Lux May	0213	Oceanic	0211	Pulsar	0060	Sencora	0208
Luxman	0060, 0061	Olevia	0084	Pye	0213, 0217	Sentra	0218
Luxor	0201, 0207, 0210	ONCEAS	0207	Pymi	0208	Serino	0200
LXI	0057, 0061, 0063,	Onwa	0062, 0218	Quasar	0152, 0214	Sharp	0009, 0010, 0011,
	0064	Orbit	0213	Quelle	0201, 0206, 0207,		0060, 0061, 0066,
Magnadyne	0204, 0205, 0214,	Orion	0126, 0204, 0208,		0213, 0214, 0215,		0070, 0087, 0111,
	0215, 0217		0213, 0217, 0235		0217		0143, 0145, 0167,
Magnafon	0200, 0204, 0207	Orline	0218	Radialva	0218		0168, 0169, 0198,
Magnavox	0060, 0061, 0063,	Orsowe	0204	Radio Shack	0064		0204, 0224, 0247,
	0102, 0103, 0150	Osaki	0127, 0206, 0207,	Radio Shack/Realistic		Shogun	0248, 0249
	0206, 0208		0209, 0218		0057, 0060, 0061,		0060
Magnum	0058	Osio	0201		0062, 0064	Siarem	0204, 0205, 0215
Majestic	0206	Oso	0209, 0218	Radiola	0213, 0217	Sicatel	0212
Mandor	0206	Osune	0218	Radiomarelli	0204, 0205, 0214	Siemens	0255
Manesth	0206, 0207, 0213,	Otto Versand	0204, 0207, 0213,	Radiotone	0213	Sierra	0213
	0217		0215, 0216, 0217,	RCA	0057, 0060, 0061,	Signature	0058
Marantz	0060, 0061, 0063,		0255		0091, 0133, 0135,	Silva	0200
	0090, 0213, 0217	Pael	0200, 0207		0147, 0149	Singer	0205, 0214, 0215
Marelli	0205	Palladium	0207	Realistic	0064	Sinudyne	0204, 0205, 0215,
Mark	0200, 0213, 0217	Panama	0200, 0206, 0207,		0213, 0217		0217
Matsui	0204, 0207, 0208,		0208	Revox	0213, 0217	Skantic	0211
	0210, 0213, 0217	Panasonic	0006, 0007, 0063,	Rex	0206, 0210, 0211	Solavox	0211
Mediator	0213, 0217		0073, 0074, 0097,	RFT	0203, 0205	Sonoko	0206, 0207, 0208,
Medion	0206, 0208		0110, 0114, 0137,	Rhapsody	0200		0213, 0217
Megatron	0061		0141, 0151, 0162,	R-Line	0213, 0217	Sonolor	0211
Melectronic	0200, 0207, 0208,		0165, 0186, 0204,	Roadstar	0206, 0208, 0209,	Sontec	0213, 0217
	0211, 0213, 0216,		0211, 0244, 0245,		0218, 0237	Sony	0041, 0059, 0067,
	0217		0246, 0254	Robotron	0205		0085, 0086, 0174,
Memorex	0058, 0061, 0064,	Pathe Cinema	0200, 0203, 0207,	Rowa	0200		0196, 0199, 0208,
	0208		0212, 0215	RTF	0205		0219, 0234
Memphis	0208		0212, 0216	Saba	0204, 0205, 0211,	Sound & Vision	0209, 0218
Metz	0205	Pathe Marconi	0208		0216	Soundesign	0060, 0061, 0062
MGA	0060, 0061	Pausa	0200	saccs	0212	Soundwave	0213, 0217
Micromaxx	0206, 0208	Perdio	0200	Saisho	0204, 0206, 0207,	SSS	0060, 0062
Microstar	0206, 0208	Philco	0060, 0061, 0063,		0208	Standard	0207, 0208, 0209,
Minerva	0204		0128, 0205, 0214,	Salora	0201, 0204, 0210,		0213, 0218
Minoka	0213		0215		0211, 0215	Starlight	0217
Mitsubishi	0006, 0015, 0016,	Philharmonic	0207	Sambers	0204	Starlite	0062
	0048, 0060, 0061,	Philips	0040, 0060, 0063,	Sampo	0060, 0061, 0083,	Stenway	0218
	0104, 0112, 0113,		0072, 0115, 0116,		0101	Stern	0210, 0211
	0125, 0205, 0213,		0124, 0130, 0150,	Samsung	0029, 0030, 0031,	Sunkai	0208, 0218
Mivar	0200, 0201, 0202,		0175, 0184, 0187,		0032, 0044, 0045,	Sunwood	0208, 0213
	0203, 0204, 0207		0205, 0207, 0213,		0046, 0047, 0060,	Superla	0200, 0204, 0207
Montgomery Ward			0215, 0217, 0220,		0061, 0065, 0068,	SuperTech	0200
	0058		0221, 0232, 0233,		0069, 0071, 0079,	Supra	0208
MTC	0060, 0061, 0128,	Philips Magnavox	0252, 0253		0087, 0127, 0128,	Supreme	0059
	0200				0130, 0144, 0160,	Susumu	0209
Multi System	0217		0124		0161, 0170, 0176,	Sutron	0208
Multitech	0062, 0127, 0128,	Phoenix	0200, 0205, 0213,		0183, 0185, 0200,	Sydney	0200, 0207
	0200, 0207, 0208,		0217		0201, 0206, 0207,	Sylvania	0060, 0061, 0063,
	0210, 0214, 0215,	Phonola	0200, 0205, 0213,		0208, 0213, 0217,		0080, 0134, 0142,
	0217		0217		0239, 0241, 0242,		0148
Murphy	0200, 0207	Pilot	0060		0243	Symphonic	0062, 0080
NAD	0061	Pioneer	0012, 0013, 0060,	Sandra	0200, 0207	Sysline	0217
Naonis	0210		0061, 0098, 0109,	Sansui	0123, 0126, 0213	Sytong	0200
			0117, 0128, 0181,				

Tandy	0127, 0207, 0209, 0211, 0218	Weltblick	0213, 0217	Alba	1044, 1050	GoldHand	1050
Tashiko	0200, 0207, 0210	Weston	0215	American High	1004	Goldstar	1000, 1003, 1042, 1045
Tatung	0127, 0204, 0207, 0213, 0217, 0237	White Westinghouse		Amstrad	1042	Goodmans	1042, 1045, 1050, 1069
TCM	0206, 0208	Yamaha	0000, 0001, 0002, 0003, 0004, 0005, 0060, 0061	Anitech	1050	Gradiente	1005
Teac	0127	Yamishi	0218	ASA	1045, 1046	Graetz	1043, 1047
Tec	0207, 0208, 0214, 0215	Yoko	0200, 0206, 0207, 0208, 0209, 0213, 0217, 0218	Asha	1002, 1014	Granada	1046, 1047, 1049
Techwood	0060, 0061	Yorx	0209, 0218	Asuka	1042, 1045, 1046, 1050	Grandin	1042, 1045, 1050
Teknika	0058, 0060, 0061, 0062	Zanussi	0210	Audio Dynamics	1000	Grundig	1046, 1050, 1062
Teleavia	0216	Zenith	0058, 0060, 0100, 0105, 0119, 0121, 0154	Baird	1042, 1043, 1047	Hanseatic	1045, 1046
Telecor	0218			Basic Line	1044, 1050	Harley Davidson	1005
Telefunken	0065, 0213, 0216			Baur	1046	Harman/Kardon	1000
Telegazi	0218			Beaumarck	1002, 1014	Harwood	1006
Teletech	0208, 0214, 0217			Bell & Howell	1001	HCM	1050
Teleton	0207			Blaupunkt	1046, 1048	Headquarter	1001
Televideon	0200			Broksonic	1012, 1013	Hinari	1044, 1050
Tensai	0208, 0209, 0213, 0218			Bush	1044, 1050, 1066	Hisawa	1044
Tesmet	0213			Calix	1003	Hitachi	1007, 1010, 1039, 1042, 1043, 1046, 1049
Tevion	0206, 0208			Candle	1002, 1003	Hughes Network Systems	1010
Texet	0200, 0207			Canon	1004	Hypson	1044, 1050
Thomson	0191, 0192, 0207, 0213, 0216, 0226			CCE	1006	Imperial	1042
Thorn	0212, 0217			CGE	1042, 1043	Inno Hit	1046, 1050
TMK	0060, 0061			Cimline	1044, 1050	Innovation	1044, 1048
Tokai	0213			Citizen	1002, 1003	Instant Replay	1004
Tokyo	0200, 0207			Colortyme	1000	Interbuy	1045
Toshiba	0027, 0043, 0053, 0054, 0064, 0078, 0089, 0090, 0106, 0107, 0127, 0131, 0140, 0146, 0159, 0197, 0225, 0231, 0237			Colt	1006	Interfunk	1046, 1047
Towada	0211, 0215			Craig	1002, 1003, 1006, 1014	Intervision	1042
Transtec	0200			Crown	1050	Irradio	1045, 1050
Trident	0204			Curtis Mathes	1000, 1002, 1004, 1009	ITT	1043, 1047
Tristar	0218			Cybernex	1002, 1014	ITV	1045
Triumph	0204			Daewoo	1005, 1038, 1061, 1067	JC Penney	1000, 1001, 1002, 1003, 1004, 1006
Uher	0211, 0213			Dansai	1050	JCL	1004
Ultravox	0200, 0205, 0207, 0214, 0215			Dantax	1044	Jensen	1007
United	0217			DBX	1000	JVC	1000, 1001, 1007, 1011, 1017, 1036, 1043
Universum	0127, 0128, 0129, 0201, 0206, 0213, 0214, 0215, 0217			De Graaf	1046, 1049	Kaisui	1050
Univox	0212			Decca	1042, 1043, 1046	Karcher	1046
Vestel	0210, 0211, 0213, 0214, 0215, 0217			Denon	1010	Kendo	1044
Vexa	0208, 0217			Dimensia	1009	Kenwood	1000, 1001, 1007, 1011, 1043
Victor	0213			Dual	1043, 1046	KLH	1006
VIDEOLOGIC	0200			Dumont	1042, 1046, 1047, 1049	Kodak	1003, 1004
Videologique	0200, 0207, 0209, 0218			Dynatech	1005	Korpel	1050
Videosat	0214			Electrohome	1003	Leyco	1050
VideoSystem	0213			Electrohome	1003	LG	1003, 1042, 1045, 1071
Videotechnic	0200			Elta	1050	Lifetec	1044, 1048
Vidtech	0060, 0061			Emerson	1003, 1004, 1005, 1012, 1013	Lloyd's	1005
Viewsonic	0076, 0077, 0092, 0099, 0172, 0173			Etzuko	1050	Loewe	1048
Visiola	0200, 0207			Ferguson	1043	Loewe Opta	1045, 1046
Vision	0213			Fidelity	1042	Logik	1006, 1050
Vortec	0213, 0217			Finlandia	1046, 1047, 1049	Luxor	1047
Voxson	0205, 0210, 0211, 0213			Finlux	1042, 1043, 1046, 1047, 1049	LXI	1003
Waltham	0207, 0212			FIRST LINE	1044, 1045, 1049, 1050	M Electronic	1042
Wards	0057, 0058, 0060, 0061, 0063			Fisher	1001, 1047	Magnasonic	1047
Watson	0213, 0217, 0218			Flint	1044	Magnavox	1004, 1018, 1033
Watt Radio	0200, 0207, 0212, 0215			Formenti/Phoenix	1046	Magnin	1003, 1014
Wega	0205			Fuji	1004	Manesth	1050
				Fujitsu	1042	Marantz	1000, 1001, 1004, 1046, 1051
				Funai	1005, 1042	Marta	1003
				Galaxy	1042	Matsui	1044, 1045
				Garrard	1005	Matsushita	1004
				GBC	1050	Mediator	1046
				GE	1002, 1004, 1009, 1014, 1030	Medion	1044, 1048
				GEC	1046	MEI	1004
				Geloso	1050		
				General Technic	1044, 1048		
				Go Video	1014		

TV/DVD

Aiwa	0139, 2055
Apex	0132, 2049
Broksonic	0138, 2060
Bush	0230, 2112
JVC	0136, 2053
Panasonic	0137, 0254, 2054, 2110
RCA	0133, 0135, 2050, 2051
Sylvania	0134, 2052
Thomson	0226, 2109
Toshiba	0131, 0231, 2048, 2111

TV/DVD/VCR

Panasonic	0141, 1040, 2057
Samsung	0241, 1070, 2113
Sharp	0143, 1028, 2059
Sylvania	0142, 1041, 2058
Toshiba	0140, 1029, 2056

TV/VCR

Aiwa	0237, 1066
Bush	0237, 1066
Daewoo	0155, 0238, 1038, 1067
GE	0147, 1030
Goodmans	0240, 1069
Grundig	0236, 1062
Hitachi	0156, 1039
JVC	0153, 1036
Magnavox	0150, 1033
Orion	0235, 1065
Panasonic	0151, 1034
Philips	0150, 0232, 0233, 1033, 1062, 1063
Quasar	0152, 1035
RCA	0149, 1032
Roadstar	0237, 1066
Samsung	0144, 0239, 1027, 1068
Sharp	0145, 1028
Sony	0234, 1064
Sylvania	0148, 1031
Tatung	0237, 1066
Toshiba	0146, 0237, 1029, 1066
Zenith	0154, 1037

VCR

Admiral	1008, 1013
Adventura	1005
Aiwa	1005, 1042, 1043, 1044, 1066
Akai	1007, 1043
Akiba	1050
Akura	1043, 1050

List of remote control codes

The following remote control codes are available in addition to “List of remote control codes” at the end of the owner’s manual.

VCR

Memorex	1001, 1002, 1003, 1004, 1005, 1008, 1013, 1014, 1042, 1045, 1047	Panasonic	1004, 1020, 1034, 1040, 1048, 1054, 1072	Saisho	1044, 1050	Tashiko	1003, 1042
Memphis	1050	Pathe Marconi	1043	Salora	1047	Tatung	1007, 1042, 1043, 1046, 1066
Metz	1048	Penney	1010, 1014	Samsung	1002, 1014, 1021, 1027, 1052, 1068, 1070	TCM	1044, 1048
MGA	1014	Pentax	1010, 1049	Sanky	1008	Teac	1005, 1007
MGN Technology		Perdio	1042	Sansui	1007, 1011, 1013, 1043	Technics	1004, 1048
	1002, 1014	Philco	1004, 1051	Sanyo	1001, 1002, 1014, 1047	Teknika	1003, 1004, 1005
Micromaxx	1044, 1048	Philips	1004, 1025, 1033, 1046, 1056, 1057, 1059, 1062, 1063	SBR	1046	Teleavia	1043
Microstar	1044, 1048	Philips Magnavox		Schaub Lorenz	1042, 1043, 1047	Telefunken	1043
Migros	1042		1018	Schneider	1042, 1044, 1045, 1046, 1050	Tenosal	1050
Minolta	1010	Phonola	1046	Scott	1012	Tensai	1042, 1045, 1050
Mitsubishi	1011, 1042, 1046	Pilot	1003	Sears	1001, 1003, 1004, 1010	Tevion	1044, 1048
Montgomery Ward		Pioneer	1011, 1046	SEG	1050	Thomson	1043, 1058
	1008	Prinz	1042	SEI-Sinudyne	1046	Thorn	1043, 1047
Motorola	1004, 1008	Profex	1050	Seleco	1043	TMK	1002, 1014
MTC	1002, 1014	Profitronic	1014	Sharp	1008, 1023, 1028, 1053, 1073	Tokai	1045, 1050
Multitech	1002, 1005, 1006, 1042, 1046, 1050	Proline	1042	Shintom	1006, 1047, 1050	Tonsai	1050
Murphy	1042	Proscan	1009	Shivaki	1045	Toshiba	1013, 1024, 1029, 1043, 1046, 1066, 1075
National	1048	Prosonic	1044	Shogun	1002, 1014	Totevision	1002, 1003, 1014
NEC	1000, 1001, 1007, 1011, 1043, 1051	Protoc	1006	Siemens	1045, 1047	Towada	1050
Neckermann	1043, 1046	Pye	1046, 1056	Signature 2000	1008	Towika	1050
NEI	1046	Quarter	1001	Silva	1045	Uher	1045
Nesco	1050	Quartz	1001, 1047	Singer	1004, 1006	Unitech	1002, 1014
Nikko	1003	Quasar	1004, 1035	Sinudyne	1046	Universum	1042, 1045, 1046
Noblex	1002, 1014	Quelle	1042, 1046, 1047	Sontec	1045	Vector Research	1000
Nokia	1043, 1047	Radio Shack	1003	Sony	1016, 1019, 1055, 1060, 1064, 1074	Video Concepts	1000
Nordmende	1043	Radio Shack/Realistic	1001, 1002, 1003, 1004, 1005, 1008	STS	1004, 1010	Videoon	1044, 1048
Oceanic	1042, 1043	Radiola	1046	Sunkai	1044	Videosonic	1002, 1014
Okano	1044	Radix	1003	Sunstar	1042	Wards	1002, 1003, 1004, 1005, 1006, 1008, 1010, 1014
Olympus	1004	Randex	1003	Suntronic	1042	Weltblick	1045
Optimus	1003, 1008	RCA	1002, 1004, 1009, 1010, 1014, 1015, 1022, 1032	Sunwood	1050	White Westinghouse	1013
Orion	1012, 1013, 1044, 1065	Realistic	1001, 1002, 1003, 1004, 1005, 1008	Sylvania	1004, 1005, 1031, 1041	XR-1000	1004, 1005, 1006
Orson	1042	Rex	1043	Symphonic	1005	Yamaha	1000, 1001, 1007
Osaki	1042, 1045, 1050	RFT	1046	Taisho	1044	Yamishi	1050
Otto Versand	1046	Roadstar	1045, 1050, 1066	Tandy	1001	Yokan	1050
Palladium	1043, 1045, 1050	Saba	1043			Yoko	1045, 1050
						Zenith	1013, 1026, 1037



© 2009 Yamaha Corporation All rights reserved.

YAMAHA CORPORATION
Printed in China © WQ95900

NS-50F

SPEAKER SYSTEM

Thank you for choosing a Yamaha speaker system.

Caution

■ Read the following before using the speaker:

- To assure the finest performance, please read this manual carefully. Keep it in a safe place for future reference.
- Install the speakers in a cool, dry, clean place away from windows, heat sources, sources of excessive vibration, dust, moisture and cold. Avoid sources of humming (transformers, motors). To prevent fire or electric shock, do not expose the speakers to dripping or splashing.
- To prevent the enclosure from warping or discoloring, do not place the speakers where they will be exposed to direct sunlight or excessive humidity.
- Do not place the following objects on top of the speakers:
 1. Glass, china, etc.
If glass etc. falls by vibrations and breaks, it may cause personal injury.
 2. A burning candle etc.
If the candle falls by vibrations, it may cause fire and personal injury.
 3. A vessel with water in it
If the vessel falls by vibrations and water spills, it may cause damage to the unit, and/or you may get an electric shock.
- Do not place the speakers where foreign objects such as water drips might fall. It might cause a fire, damage to this unit, and/or personal injury.
- Do not place the speakers where they are liable to be knocked over or struck by falling objects. Stable placement will also ensure better sound performance.
- Secure placement or installation is the owner's responsibility. Yamaha shall not be liable for any accident caused by improper placement or installation of speakers.
- Any time you note distortion, reduce the volume of your amplifier immediately. Make sure the input power does not exceed the specified maximum input power, otherwise the speakers will be damaged.
- Do not attempt to clean the speakers with chemical solvents as this might damage the finish. Use a clean, dry cloth.
- Do not attempt to modify or fix the speakers. Contact qualified Yamaha service personnel when any service is needed. The cabinet should never be opened for any reasons.

Note:

This speaker is magnetically shielded, but placing them too close to a TV may impair the TV picture. If this happens, move the speaker away from the TV.

Precautions When Positioning the Speakers

The speaker is constructed with the majority of the weight located in its upper portion, and is thus susceptible to falling over if proper care is not taken to insure its stability. If the speaker falls over, it may damage the speaker or be the cause of injury (or even death) to persons and/or damage to personal property.



■ For safe and proper use of the speaker:

- Position the speaker in a location that is solid, level, smooth, and low (with respect to the floor).
- Do not push or apply pressure to the side of the speaker when moving, or lean objects against the side of the speaker.
- Do not sit on or set objects on top of the speaker.

Vibrations or jolts associated with earthquakes and other phenomena or activities may cause the speaker to fall over. For safety reasons, using commercially available products that increase stability in the speaker is recommended (metal fittings or chains, etc.).

■ Use the stands included with the speaker to increase stability:

Be sure to use the stands regardless of where the speaker is positioned. Attaching the stands included with the speaker reinforces the base of the speaker not to fall over.

Please be cautioned that even though the stands are connected, this does not guarantee that the speaker will not fall over.

Supplied Accessories

- Speaker cable (4 m)



× 1

- Stand

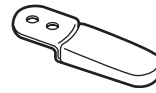

× 4

- Screw



× 8

- Pad



× 4

Placing the Speakers

Place the speakers on a sturdy, vibration-free surface.

■ Using as Normal Stereo Speakers

To get the best stereo performance, angle the speakers inward so as to create a triangle, with the listener at the apex.

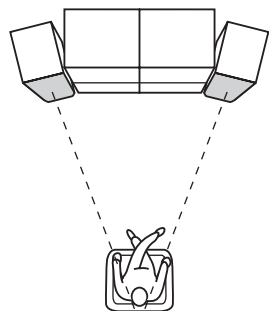

■ Using as Front Speakers in a Surround Sound System

Position the speakers both side of your TV. The positioning of these speakers is important because they provide a solid anchor for the sound image. They should be positioned facing the listener at about ear level, and equidistant from the TV.

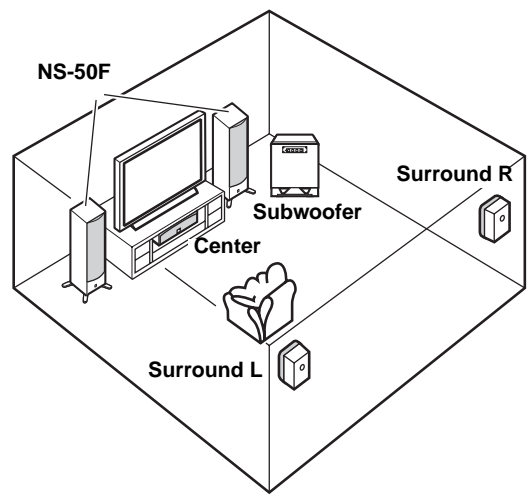

Attaching the Stands

When placing the speakers, be sure to use the stands to increase stability.

Use the 8 specified holes located on the base of the speaker.

■ Procedure:

1. Put the screw through the inner hole of the stand, and screw it into the outside hole of the speaker. Do not tighten too much at this point.

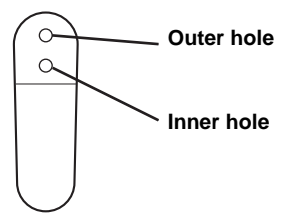

2. Put a screw through the outer hole on the stand, and screw it into the other hole on the base of the speaker.
3. Tighten both of the screws firmly.
4. Attach a pad to the bottom of the end portion of the stand.
5. Attach the other stands to the other corners of the base of the speaker in the same way and confirm that all 4 stands have been firmly attached.

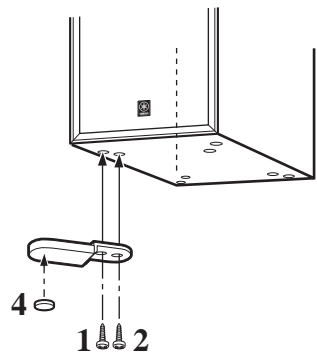

Note:
Be careful not to apply force to the side of the speaker, otherwise the speaker may fall causing damage to the speaker or personal injury.

Connecting Your Speakers

Always turn off your amplifier or receiver before making any connections.

■ Preparing Your Speaker Cables

Carefully remove 10 mm (3/8 ") of insulation from both ends of your speaker cables and twist the bare wires tightly, as shown.

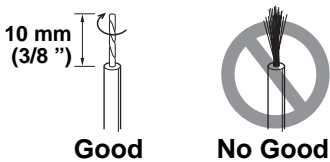

■ Hookup

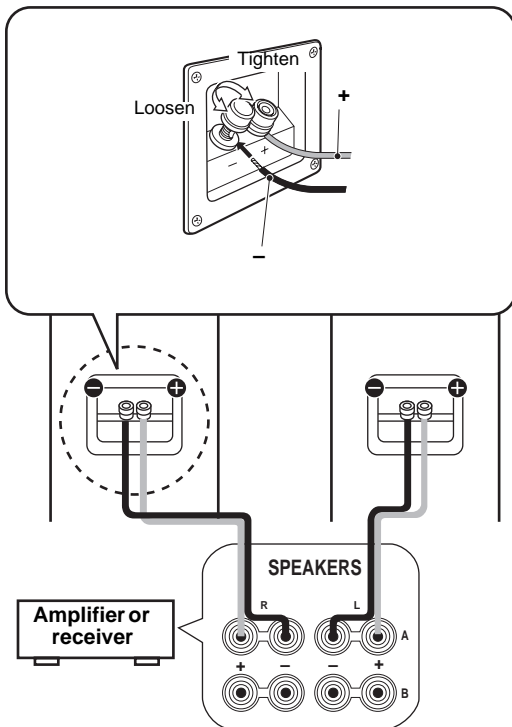

Notes:

- Make sure that the bare wires are not touching each other as this could damage the speaker and amplifier.
- Connect one speaker to the left terminals of your amplifier, and another speaker to the right terminals, making sure not to reverse the polarity (+, -). If one speaker is connected with reversed polarity, the sound will be unnatural and lack bass.

■ Using a Banana Plug

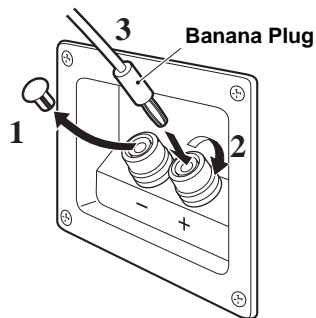

1. Remove the speaker terminal cover by gently pulling it toward you.
2. Tighten the terminal knob.
3. Simply insert the banana plug into the terminal.

Removing the front cover

The front cover, which is attached to the speaker at six points, can be removed if desired. To remove a cover, using both hands, gently pull the top of the cover away from the speaker. When the cover comes away, gently pull the bottom of the cover away from the speaker. To reattach the cover, line up the six pegs on the cover with the six holes on the speaker, and gently push the cover onto the speaker.

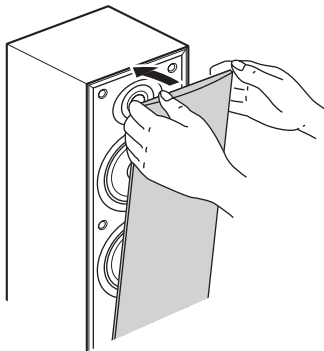

Note:

When removing the cover, be careful that you don't touch the drive units, and don't exert excessive force with any tools.

Specifications

Type	2-way bass-reflex speaker system magnetic shielding type
Drivers	3 cm (1 ") dome tweeter 16 cm (6.5 ") cone woofer x2
Impedance	6 Ω
Frequency response	35 Hz–35 kHz
Nominal Input power.....	80 W
Maximum input power	240 W
Sensitivity	90 dB/2.83 V/m
Crossover frequency	2 kHz
Dimensions (with the stand) (W \times H \times D)	233 (9.2 ") \times 880 (34.6 ") \times 271 (10.6 ") mm
Weight	12.5 kg (27.6 lbs)

* Specifications are subject to change without notice due to product improvements.



This product mainly uses lead-free solder.
Cet appareil utilise principalement de la soudure sans plomb.
Dieses Produkt verwendet hauptsächlich bleifreies Lot.
Este producto utiliza principalmente soldadura sin plomo.

©2004 YAMAHA CORPORATION All rights reserved.

YAMAHA ELECTRONICS CORPORATION, USA 6660 ORANGETHORPE AVE., BUENA PARK, CALIF. 90620, U.S.A.
YAMAHA CANADA MUSIC LTD. 135 MILNER AVE., SCARBOROUGH, ONTARIO M1S 3R1, CANADA
YAMAHA ELECTRONIK EUROPA G.m.b.H. SIEMENSSTR. 22-34, 25462 RELLINGEN BEI HAMBURG, F.R. OF GERMANY
YAMAHA ELECTRONIQUE FRANCE S.A. RUE AMBROISE CROIZAT BP70 CROISSY-BEAUBOURG 77312 MARNE-LA-VALLÉE CEDEX02, FRANCE
YAMAHA ELECTRONICS (UK) LTD. YAMAHA HOUSE, 200 RICKMANSWORTH ROAD WATFORD, HERTS WD18 7GQ, ENGLAND
YAMAHA SCANDINAVIA A.B. J A WETTERGRENS GATA 1, BOX 30053, 400 43 VÄSTRA FRÖLUNDA, SWEDEN
YAMAHA MUSIC AUSTRALIA PTY, LTD. 17-33 MARKET ST., SOUTH MELBOURNE, 3205 VIC., AUSTRALIA

YAMAHA CORPORATION
Printed in Indonesia  WD68450-1



YAMAHA NS-P60

**HOME CINEMA CENTER
& EFFECT SPEAKERS**

“NS-P60” is the package number which includes the YAMAHA speaker system NS-C55 and NS-E55.

Thank you for selecting this Yamaha NS-P60 speaker system.

NS-C55 Natural Sound Center Speaker System

PRECAUTIONS

This model is designed to be used as a center speaker system.

Read these precautions carefully before using your speaker.

- Any time you note distortion, reduce the volume control on your amplifier to a lower setting. Never allow your amplifier to be driven into “clipping”. Otherwise the speaker may be damaged.
- When using an amplifier with a rated output power higher than the nominal input power of the speaker, care should be taken never to exceed the speaker’s maximum input.
- Do not attempt to clean the speaker with chemical solvents as this might damage the finish. To clean, wipe with a dry, soft cloth.
- To prevent the enclosure from warping or discoloring, do not place the speaker where it will be exposed to direct sunlight or excessive humidity.
- Do not place the speaker where it is liable to be knocked over or struck by falling objects. Stable placement will also ensure better sound performance.
- Placing the speaker on the same shelf or rack as the turntable can result in feedback.
- **Secure placement or installation is the owner’s responsibility.**

YAMAHA shall not be liable for any accident caused by improper placement or installation of the speaker.

PLACING THE SPEAKER

Place the speaker on top of the TV or on the floor under the TV or inside the TV rack so that it is stabilized. When placing the speaker on top of the TV, to prevent the speaker from falling down, put the provided velcro strips at two points on both bottom of the speaker and top of the TV.

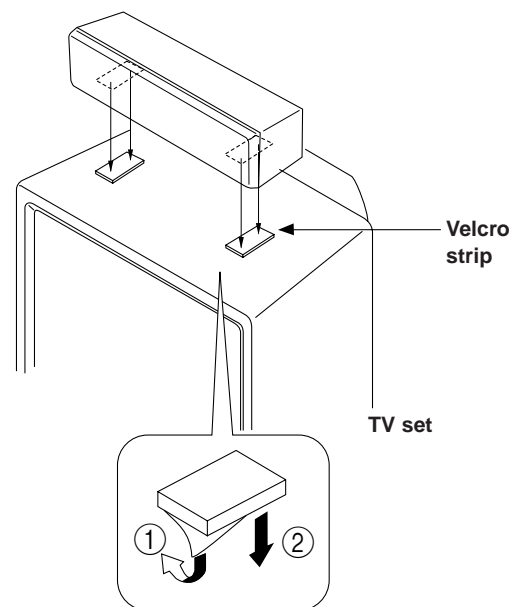

Notes

- Do not place the speaker on top of the TV whose area is smaller than the bottom area of the speaker. If placed, the speaker may drop out causing an injury to you.
- Though this speaker is a magnetic shielding type, there may be some influence on a TV picture depending on the type of TV or the placement of the speaker. In such a case, place the speaker apart from the TV so that there is no influence on TV picture.

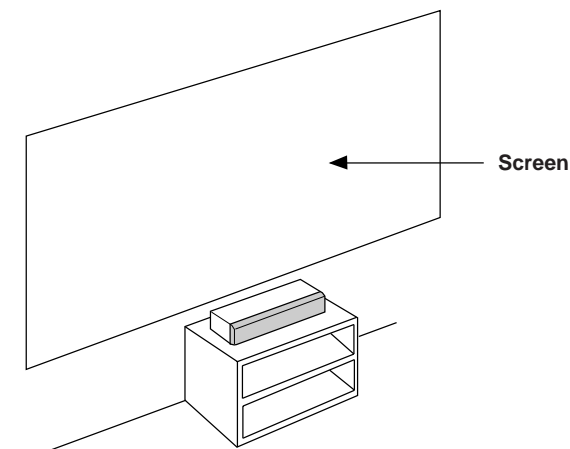

CONNECTION TO YOUR AMPLIFIER

BEFORE MAKING CONNECTIONS, MAKE SURE THAT THE AMPLIFIER IS SWITCHED OFF.

■ CONNECTIONS

- Connect the screw-type input terminals at the rear of the speaker to the speaker output terminals of your amplifier with the provided speaker cords.
- One side of the speaker cord is red and the other side is black. Connect the (+) terminals on both the amplifier and the speaker using this red side. Connect the (-) terminals on both components using the black side of the cord.
- Be careful not to reverse the polarity (+, -). If connected with reversed polarity, the sound will be unnatural and lack bass.

Procedures:

- ① Loosen the terminal knob.
- ② Insert the bare speaker wire end properly into the terminal hole. [Remove approx. 10 mm (3/8") insulation from the speaker cord.]
- ③ Tighten the knob.
- ④ Test the security of the connection by pulling lightly the cord at the terminal.

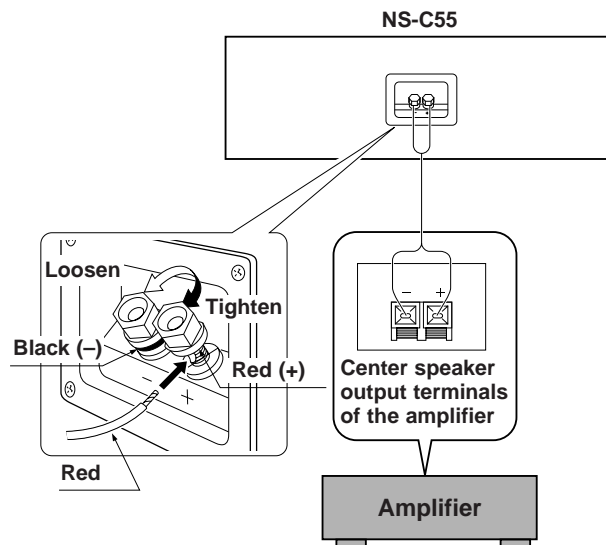

Note

Do not let the bare speaker wires touch each other as this could damage the speaker or the amplifier, or both of them.

SPECIFICATIONS

Type.....	2-way 3-speaker acoustic-suspension speaker system
	Magnetic-shielding type
Speaker Unit.....	10 cm cone woofer x 2
	2.2 cm dome tweeter
Input Terminal.....	Screw-type
Impedance.....	6 ohm
Frequency Response.....	70 Hz – 30 kHz
Nominal Input Power.....	60W
Maximum Input Power.....	180W
Sensitivity (2.83V, 1m).....	91 dB
Crossover Frequency.....	5 kHz
Dimensions (WxHxD).....	465 x 135 x 173.5 mm
	(18-5/16" x 5-5/16" x 6-7/8")
Weight.....	3.5 kg (7 lbs. 12 oz.)
Accessories.....	Speaker cord (4m) x 1
	Velcro strip x 2

* Specifications subject to change without notice due to product improvements.

* Care should be taken not to exceed the input power values noted above.



YAMAHA CORPORATION
V415010

NS-E55 Natural Sound Effect Speaker System

PRECAUTIONS

This model is designed to be used as an effect speaker system.

Read these precautions carefully before using your speakers.

- Any time you note distortion, reduce the volume control on your amplifier to a lower setting. Never allow your amplifier to be driven into "clipping". Otherwise the speakers may be damaged.
- When using an amplifier with a rated output power higher than the nominal input power of the speakers, care should be taken never to exceed the speakers' maximum input.
- Do not attempt to clean the speakers with chemical solvents as this might damage the finish. To clean, wipe with a dry, soft cloth.
- To prevent the enclosure from warping or discoloring, do not place the speakers where they will be exposed to direct sunlight or excessive humidity.
- Do not place the speakers where they are liable to be knocked over or struck by falling objects. Stable placement will also ensure better sound performance.
- Placing the speakers on the same shelf or rack as the turntable can result in feedback.
- As these speakers contain strong magnets, avoid placing watches, magnetic tapes, etc. near them. Also, placing the speakers near a TV set may impair picture color. If this happens, move the TV set away from the speakers.
- **Secure placement or installation is the owner's responsibility.**

YAMAHA shall not be liable for any accident caused by improper placement or installation of the speakers.

SETTING UP THE SPEAKERS

■ Mounting the speakers on a wall

The speakers can be mounted on a wall by using the holes provided on the speakers' back panels.

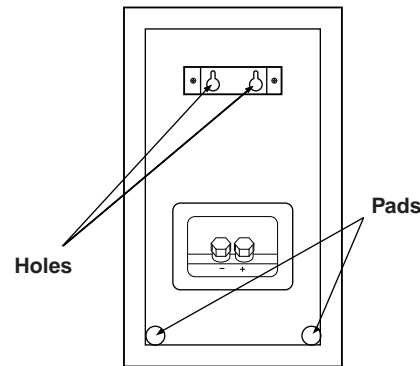

Make sure that the screws are caught by a narrow part of the holes securely. Put the screws into a wall according to the figure shown below.

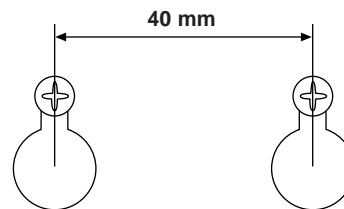

Fasten screws into a firm wall or wall support as shown in the figure below, and hang the holes on the protruding screws.

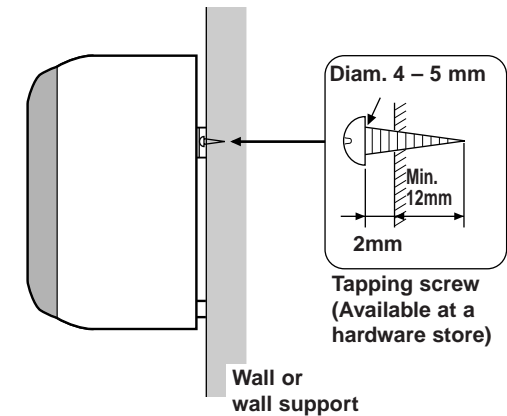

WARNING

- Each speaker weighs 2.2 kg (4 lbs. 13 oz.). Do not mount them on thin plywood or soft wall surface material, as the screws may come out of the flimsy surface, causing the speakers to fall down and be damaged, or result in personal injury.
- Do not fasten the speakers to wall with nails, adhesives, or other unsound hardware. Long term use and vibrations may cause them to fall down.
- To avoid accidents resulting from tripping over loose speaker cords, fix them to the wall.

CONNECTION TO YOUR AMPLIFIER

BEFORE MAKING CONNECTIONS, MAKE SURE THAT THE AMPLIFIER IS SWITCHED OFF.

■ CONNECTIONS

- Connect the screw-type input terminals at the rear of the speakers to the speaker output terminals of your amplifier with the provided speaker cords.
- One side of the speaker cord has a gray line. Connect the (+) terminals on both the amplifier and the speakers using the side of the cord with the gray line. Connect the (-) terminals on both components using the side without a gray line.
- Connect one speaker to the left (marked L) terminals of your amplifier, and another speaker to the right (marked R) terminals, making sure not to reverse the polarity (+, -). If one speaker is connected with reversed polarity, the sound will be unnatural and lack bass.

Procedures:

- ① Loosen the terminal knob.
- ② Insert the bare speaker wire end properly into the terminal hole. [Remove approx. 10 mm (3/8") insulation from the speaker cord.]
- ③ Tighten the knob.
- ④ Test the security of the connection by pulling lightly the cord at the terminal.

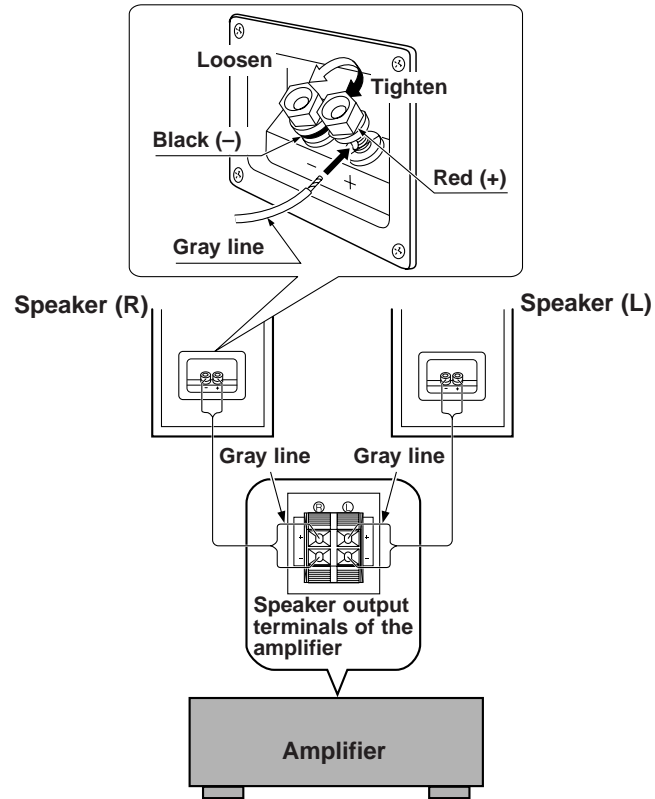

Note

Do not let the bare speaker wires touch each other as this could damage the speaker or the amplifier, or both of them.

SPECIFICATIONS

Type.....	2-way 2-speaker acoustic-suspension speaker system
Speaker Unit.....	10 cm cone woofer 2.2 cm dome tweeter
Input Terminal.....	Screw-type
Impedance.....	6 ohm
Frequency Response.....	80 Hz – 30 kHz
Nominal Input Power.....	50W
Maximum Input Power.....	150W
Sensitivity (2.83V, 1m).....	90 dB
Crossover Frequency.....	5 kHz
Dimensions (WxHxD).....	150 x 265 x 156.3 mm (5-7/8" x 10-7/16" x 6-3/16")
Weight.....	2.2 kg (4 lbs. 13 oz.)
Accessories.....	Speaker cords (10m) x 2

* Specifications subject to change without notice due to product improvements.

* Care should be taken not to exceed the input power values noted above.



UB



YST-SW216

Subwoofer System

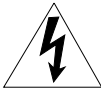

OWNER'S MANUAL

IMPORTANT SAFETY INSTRUCTIONS

	CAUTION RISK OF ELECTRIC SHOCK DO NOT OPEN	
CAUTION: TO REDUCE THE RISK OF ELECTRIC SHOCK, DO NOT REMOVE COVER (OR BACK). NO USER-SERVICEABLE PARTS INSIDE. REFER SERVICING TO QUALIFIED SERVICE PERSONNEL.		

• Explanation of Graphical Symbols

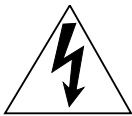

The lightning flash with arrowhead symbol, within an equilateral triangle, is intended to alert you to the presence of uninsulated "dangerous voltage" within the product's enclosure that may be of sufficient magnitude to constitute a risk of electric shock to persons.



The exclamation point within an equilateral triangle is intended to alert you to the presence of important operating and maintenance (servicing) instructions in the literature accompanying the appliance.

WARNING TO REDUCE THE RISK OF FIRE OR ELECTRIC SHOCK, DO NOT EXPOSE THIS APPLIANCE TO RAIN OR MOISTURE.

IMPORTANT Please record the serial number of this system in the space below. Model: Serial No.: The serial number is located on the rear of the main unit. Retain this Owner's Manual in a safe place for future reference.

For Canadian Customers To prevent electric shock, match wide blade of plug to wide slot and fully insert. This Class B digital apparatus complies with Canadian ICES-003.
--

- 1 Read these instructions.
- 2 Keep these instructions.
- 3 Heed all warnings.
- 4 Follow all instructions.
- 5 Do not use this apparatus near water.
- 6 Clean only with dry cloth.
- 7 Do not block any ventilation openings. Install in accordance with the manufacturer's instructions.
- 8 Do not install near any heat sources such as radiators, heat registers, stoves, or other apparatus (including amplifiers) that produce heat.
- 9 Do not defeat the safety purpose of the polarized or grounding-type plug. A polarized plug has two blades with one wider than the other. A grounding type plug has two blades and a third grounding prong. The wide blade or the third prong are provided for your safety. If the provided plug does not fit into your outlet, consult an electrician for replacement of the obsolete outlet.
- 10 Protect the power cord from being walked on or pinched particularly at plugs, convenience receptacles, and the point where they exit from the apparatus.
- 11 Only use attachments/accessories specified by the manufacturer.



12 Use only with the cart, stand, tripod, bracket, or table specified by the manufacturer, or sold with the apparatus. When a cart is used, use caution when moving the cart/apparatus combination to avoid injury from tip-over.

- 13 Unplug this apparatus during lightning storms or when unused for long periods of time.
- 14 Refer all servicing to qualified service personnel. Servicing is required when the apparatus has been damaged in any way, such as power-supply cord or plug is damaged, liquid has been spilled or objects have fallen into the apparatus, the apparatus has been exposed to rain or moisture, does not operate normally, or has been dropped.

- | |
|--|
| <ul style="list-style-type: none">• Be sure to allow spaces of at least 20 cm above, behind and on both sides of the unit.• Do not place the following objects on the unit:
A vessel with water in it.
If the vessel falls by vibrations and water spills, it may cause damage to the unit, and/or you may get an electric shock. |
|--|

FCC INFORMATION (for US customers)

1 IMPORTANT NOTICE: DO NOT MODIFY THIS UNIT!

This product, when installed as indicated in the instructions contained in this manual, meets FCC requirements. Modifications not expressly approved by Yamaha may void your authority, granted by the FCC, to use the product.

2 IMPORTANT: When connecting this product to accessories and/or another product use only high quality shielded cables. Cable/s supplied with this product **MUST** be used. Follow all installation instructions. Failure to follow instructions could void your FCC authorization to use this product in the USA.

3 NOTE: This product has been tested and found to comply with the requirements listed in FCC Regulations, Part 15 for Class "B" digital devices. Compliance with these requirements provides a reasonable level of assurance that your use of this product in a residential environment will not result in harmful interference with other electronic devices.

This equipment generates/uses radio frequencies and, if not installed and used according to the instructions found in the users manual, may cause interference harmful to the operation of other electronic devices.

Compliance with FCC regulations does not guarantee that interference will not occur in all installations. If this product is found to be the source of interference, which can be determined by turning the unit "OFF" and "ON", please try to eliminate the problem by using one of the following measures:

Relocate either this product or the device that is being affected by the interference.

Utilize power outlets that are on different branch (circuit breaker or fuse) circuits or install AC line filter/s.

In the case of radio or TV interference, relocate/reorient the antenna. If the antenna lead-in is 300 ohm ribbon lead, change the lead-in to coaxial type cable.

If these corrective measures do not produce satisfactory results, please contact the local retailer authorized to distribute this type of product. If you can not locate the appropriate retailer, please contact Yamaha Electronics Corp., U.S.A. 6660 Orangethorpe Ave, Buena Park, CA 90620.

The above statements apply **ONLY** to those products distributed by Yamaha Corporation of America or its subsidiaries.

We Want You Listening For A Lifetime

YAMAHA and the Electronic Industries Association's Consumer Electronics Group want you to get the most out of your equipment by playing it at a safe level. One that lets the sound come through loud and clear without annoying blaring or distortion – and, most importantly, without affecting your sensitive hearing.

Since hearing damage from loud sounds is often undetectable until it is too late, YAMAHA and the Electronic Industries Association's Consumer Electronics Group recommend you to avoid prolonged exposure from excessive volume levels.



CAUTION: Read this before operating your unit

Please read the following operating precautions before use. YAMAHA will not be held responsible for any damage and/or injury caused by not following the cautions below.

- To assure the finest performance, please read this manual carefully. Keep it in a safe place for future reference.
- Install this unit in a cool, dry, clean place - away from windows, heat sources, sources of excessive vibration, dust, moisture and cold. Avoid sources of humming (transformers, motors). To prevent fire or electrical shock, do not expose this unit to rain or water.
- Never open the cabinet. If something drops into the set, contact your dealer.
- The voltage to be used must be the same as that specified on the rear panel. Using this unit with a higher voltage than specified is dangerous and may cause a fire and/or electric shock.
- To reduce the risk of fire or electric shock, do not expose this unit to rain or moisture.
- Do not use force on switches, controls or connection wires. When moving the unit, first disconnect the power plug and the wires connected to other equipments. Never pull the wires themselves.
- When not planning to use this unit for a long period (i.e., vacation, etc.), disconnect the AC power plug from the wall outlet.
- Since this unit has a built-in power amplifier, heat will radiate from the rear panel. Place the unit apart from the walls, allowing at least 20 cm of space above, behind and on both sides of the unit to prevent fire or damage. Furthermore, do not position with the rear panel facing down on the floor or other surfaces.
- Do not cover the rear panel of this unit with a newspaper, a tablecloth, a curtain, etc. in order not to obstruct heat radiation. If the temperature inside the unit rises, it may cause fire, damage to the unit and/or personal injury.
- Do not place the following objects on this unit:
 - Glass, china, small metallic etc.
If glass etc. falls by vibrations and breaks, it may cause bodily injury.
 - A burning candle etc.
If the candle falls by vibrations, it may cause fire and bodily injury.
 - A vessel with water in it
If the vessel falls by vibrations and water spills, it may cause damage to the speaker, and/or you may get an electric shock.
- Do not place this unit where foreign objects such as water drips might fall. It might cause a fire, damage to this unit, and/or personal injury.
- Never put a hand or a foreign object into the YST port located on the right side of this unit. When moving this unit, do not hold the port as it might cause personal injury and/or damage to this unit.
- Never place a fragile object near the YST port of this unit. If the object falls or drops by the air pressure, it may cause damage to the unit and/or personal injury.
- Never open the cabinet. It might cause an electric shock since this unit uses a high voltage. It might also cause personal injury and/or damage to this unit.
- When using a humidifier, be sure to avoid condensation inside this unit by allowing enough spaces around this unit or avoiding excess humidification. Condensation might cause a fire, damage to this unit, and/or electric shock.
- Super-bass frequencies reproduced by this unit may cause a turntable to generate a howling sound. In such a case, move this unit away from the turntable.
- This unit may be damaged if certain sounds are continuously outputted at high volume level. For example, if 20 Hz-50 Hz sine waves from a test disc, bass sounds from electronic instruments, etc. are continuously outputted, or when the stylus of a turntable touches the surface of a disc, reduce the volume level to prevent this unit from being damaged.
- If you hear distorted noise (i.e., unnatural, intermittent “rapping” or “hammering” sounds) coming from this unit, reduce the volume level. Extremely loud playing of a movie soundtrack’s low frequency, bass-heavy sounds or similarly loud popular music passages can damage this speaker system.
- Vibration generated by super-bass frequencies may distort images on a TV. In such a case, move this unit away from the TV set.
- Do not attempt to clean this unit with chemical solvents as this might damage the finish. Use a clean, dry cloth.
- Be sure to read the “TROUBLESHOOTING” section regarding common operating errors before concluding that the unit is faulty.
- Install this unit near the wall outlet and where the AC power plug can be reached easily.
- **Secure placement or installation is the owner’s responsibility. YAMAHA shall not be liable for any accident caused by improper placement or installation of speakers.**

This unit features a magnetically shielded design, but there is still a chance that placing it too close to a TV set might impair picture color. Should this happen, move this unit away from the TV set..

As long as this unit is connected to the AC wall outlet, it is not disconnected from the AC power source even if you turn off this unit by POWER.

SPECIAL INSTRUCTIONS FOR U.K. MODEL

IMPORTANT:

THE WIRES IN MAINS LEAD ARE COLOURED IN ACCORDANCE WITH THE FOLLOWING CODE:

Blue: NEUTRAL

Brown: LIVE

As the colours of the wires in the mains lead of this apparatus may not correspond with the coloured markings identifying the terminals in your plug, proceed as follows: The wire which is coloured BLUE must be connected to the terminal which is marked with the letter N or coloured BLACK. The wire which is coloured BROWN must be connected to the terminal which is marked with the letter L or coloured RED. Making sure that neither core is connected to the earth terminal of the three pin plug.

For U.K. customers

If the socket outlets in the home are not suitable for the plug supplied with this appliance, it should be cut off and an appropriate 3 pin plug fitted. For details, refer to the instructions described below.

Note: The plug severed from the mains lead must be destroyed, as a plug with bared flexible cord is hazardous if engaged in a live socket outlet.

VOLTAGE SELECTOR

(For Asia and General models only)

The voltage selector switch on the rear panel of this unit must be set for your local main voltage BEFORE plugging this unit into the AC main supply. Voltages are 110-120/220-240 V AC, 50/60 Hz.

CONTENTS

CAUTION	iii
FEATURES	1
SUPPLIED ACCESSORIES	1
PLACEMENT	2
CONNECTIONS	3
① Connecting to line output (pin jack) terminals of the amplifier	3
② Connecting to speaker output terminals of the amplifier	5
Connecting to the INPUT 1/ OUTPUT terminals of the subwoofer	7
Plug in the subwoofer to the AC outlet	7
CONTROLS AND THEIR FUNCTIONS	8
ADJUSTING THE SUBWOOFER BEFORE USE	9
Frequency characteristics	10
ADVANCED YAMAHA ACTIVE SERVO TECHNOLOGY II	11
TROUBLESHOOTING	12
SPECIFICATIONS	13

FEATURES

- This subwoofer system employs Advanced Yamaha Active Servo Technology II which Yamaha has developed for reproducing higher quality super-bass sound. (Refer to page 11 for details on Advanced Yamaha Active Servo Technology II.) This super-bass sound adds a more realistic, theater-in-the-home effect to your stereo system.
- This subwoofer can be easily added to your existing audio system by connecting to either the speaker terminals or the line output (pin jack) terminals of the amplifier.
- The HIGH CUT switch provides you with two positions (HIGH and LOW) to adjust the tone balance between the subwoofer and the front speakers.

SUPPLIED ACCESSORIES

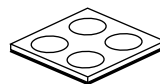

After unpacking, check that the following parts are contained.





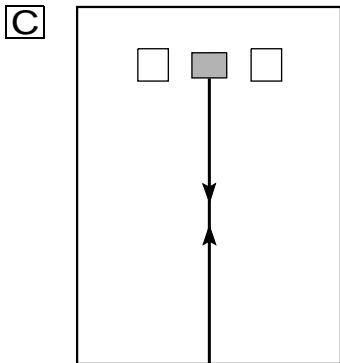
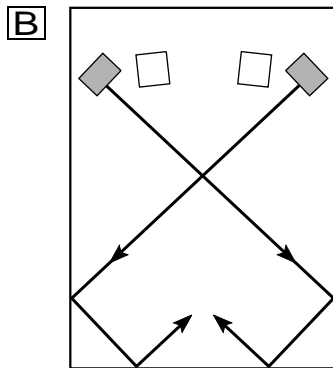
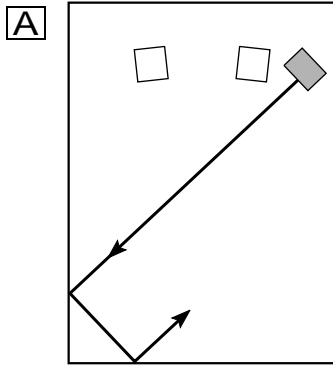

Non-skid pads (1 set, 4 pieces)

PLACEMENT



( : subwoofer,  : front speaker)

One subwoofer will have a good effect on your audio system, however, the use of two subwoofers is recommended to obtain more effect.

If using one subwoofer, it is recommended to place it on the outside of either the right or the left front speaker. (See fig. .) If using two subwoofers, it is recommended to place them on the outside of each front speaker. (See fig. .) The placement shown in fig.  is also possible, however, if the subwoofer system is placed directly facing the wall, the bass effect may lessen because the sound from it and the sound reflected by the wall may cancel out each other. To prevent this from happening, face the subwoofer system at an angle as in fig.  or .

Note

There may be a case that you cannot obtain enough super-bass sounds from the subwoofer when listening in the center of the room. This is because "standing waves" have been developed between two parallel walls and they cancel the bass sounds.

In such a case, face the subwoofer obliquely to the wall. It also may be necessary to break up the parallel surfaces by placing bookshelves etc. along the walls.

Use the non-skid pads

Put the provided non-skid pads at the four corners on the bottom of the subwoofer to prevent the subwoofer from moving by vibrations etc.

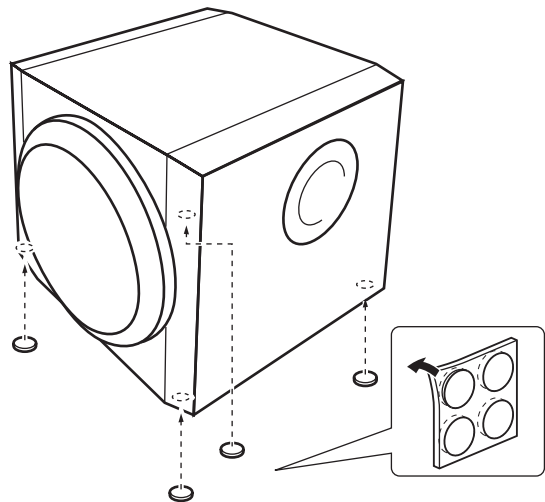

CONNECTIONS

Choose one of the following two connecting methods that is more suitable for your audio system.

■ Choose ① (pages 3-4) when you want to enjoy 5.1 surround system

■ Choose ② (pages 5-6) when you want to output the low frequency signals

Caution

Unplug the subwoofer and other audio/video components before making connections.

Notes

- All connections must be correct, that is to say L (left) to L, R (right) to R, “+” to “+” and “-” to “-”. Also, refer to the owner’s manual of your component to be connected to the subwoofer.
- After all connections are completed, plug in the subwoofer and other audio/video components.

① Connecting to line output (pin jack) terminals of the amplifier

- To connect with a YAMAHA DSP amplifier (or AV receiver), connect the SUBWOOFER (or LOW PASS etc.) terminal on the rear of the DSP amplifier (or AV receiver) to the ①/MONO INPUT 2 terminal of the subwoofer.
- When connecting the subwoofer to the SPLIT SUBWOOFER terminals on the rear of the DSP amplifier, be sure to connect the ①/MONO INPUT2 terminal to the “L” side and the ② INPUT 2 terminal to the “R” side of the SPLIT SUBWOOFER terminals.

Notes

- Some amplifiers have line output terminals labeled PRE OUT. When you connect the subwoofer to the PRE OUT terminals of the amplifier, make sure that the amplifier has at least two sets of PRE OUT terminals. If the amplifier has only one set of PRE OUT terminals, do not connect the subwoofer to the PRE OUT terminals. Instead, connect the subwoofer to the speaker output terminals of the amplifier. (Refer to pages 5-6.)
- When connecting to a monaural line output terminal of the amplifier, connect the ①/MONO INPUT2 terminal.
- When connecting to line output terminals of the amplifier, other speakers should not be connected to the OUTPUT terminals on the rear panel of the subwoofer. If connected, they will not produce sound.

■ Using one subwoofer

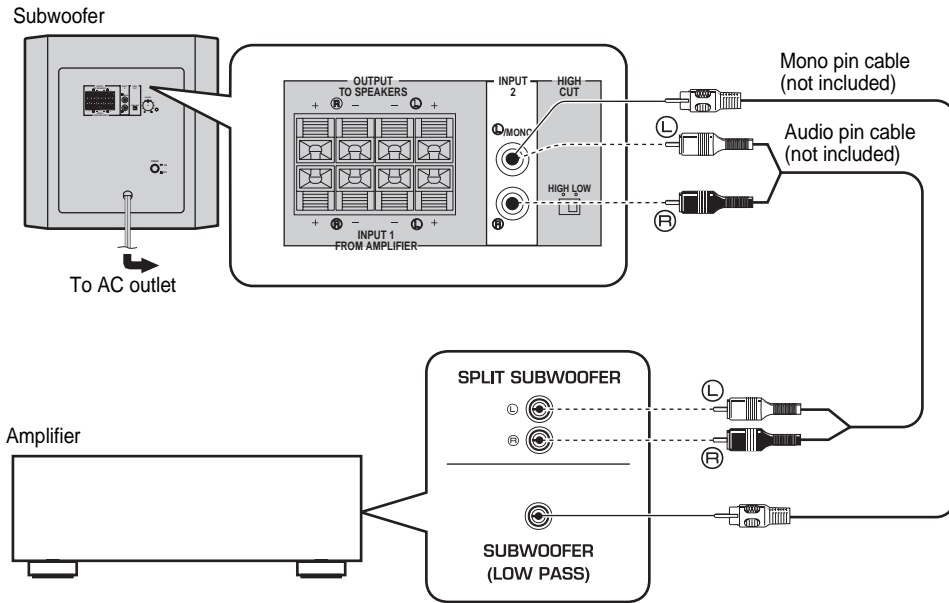

■ Using two subwoofers

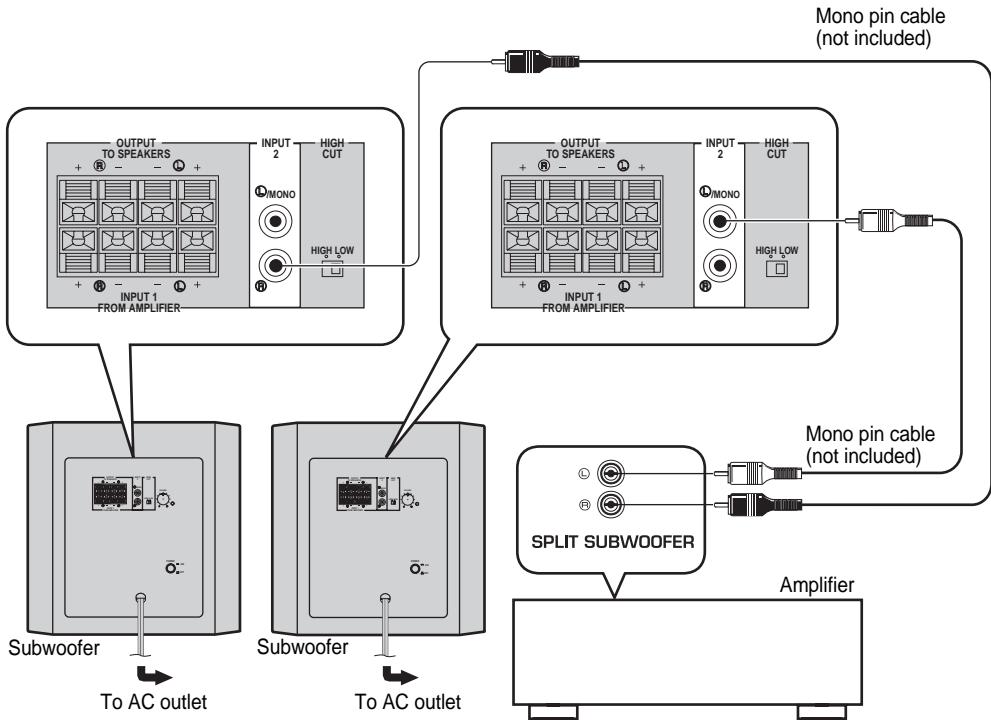

2 Connecting to speaker output terminals of the amplifier

Select this method if your amplifier has no line output (pin jack) terminal.

If your amplifier has two sets of front speaker output terminals and both terminals can output sound signals simultaneously.

- Connect one set of front speaker output terminals of the amplifier to the INPUT 1 terminals of the subwoofer, and connect the other set of front speaker output terminals of the amplifier to the front speakers.
- Set the amplifier so that both sets of front speaker output terminals output sound signals simultaneously.

Note

- If your amplifier has only one set of front speaker output terminals, see page 6.

■ Using one subwoofer (with speaker cables)

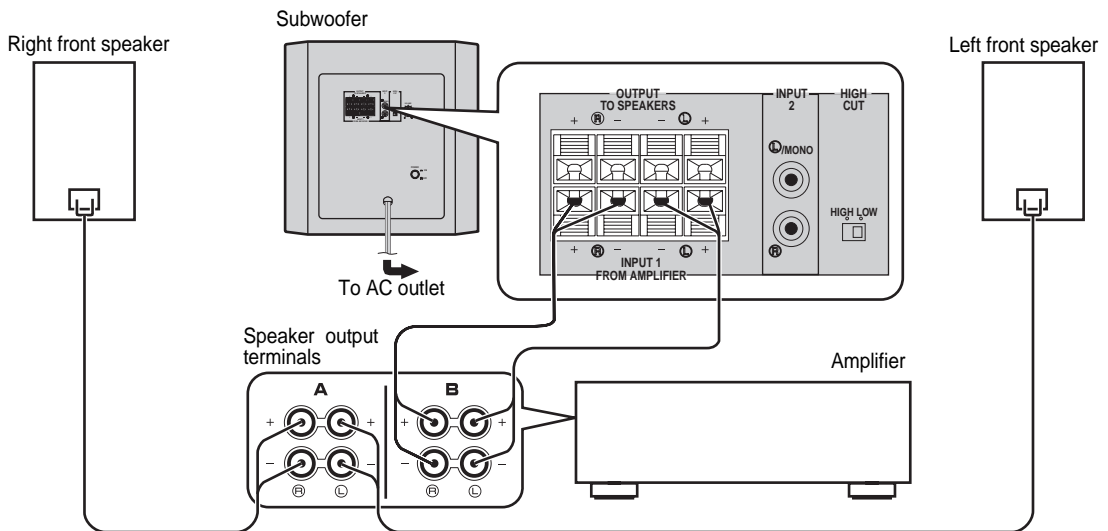

■ Using two subwoofers (with speaker cables)

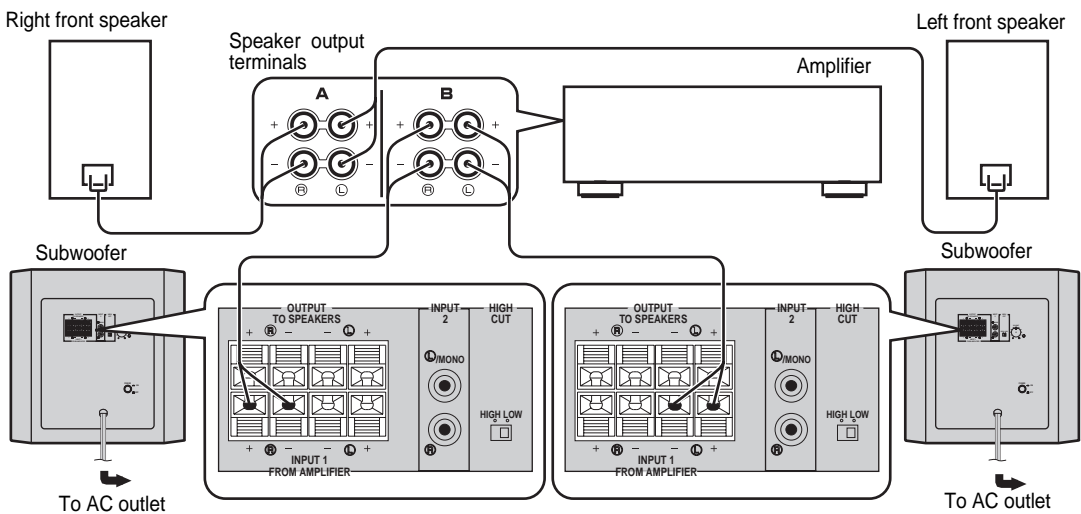

If your amplifier has only one set of front speaker output terminals.

Connect the speaker output terminals of the amplifier to the INPUT 1 terminals of the subwoofer, and connect the OUTPUT terminals of the subwoofer to the front speakers.

■ Using one subwoofer (with speaker cables)

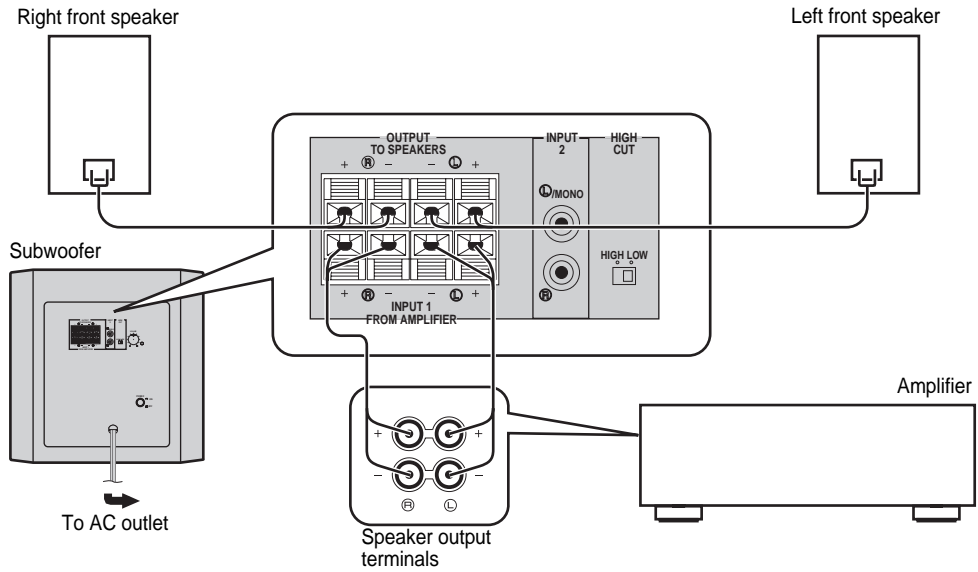

■ Using two subwoofers (with speaker cables)

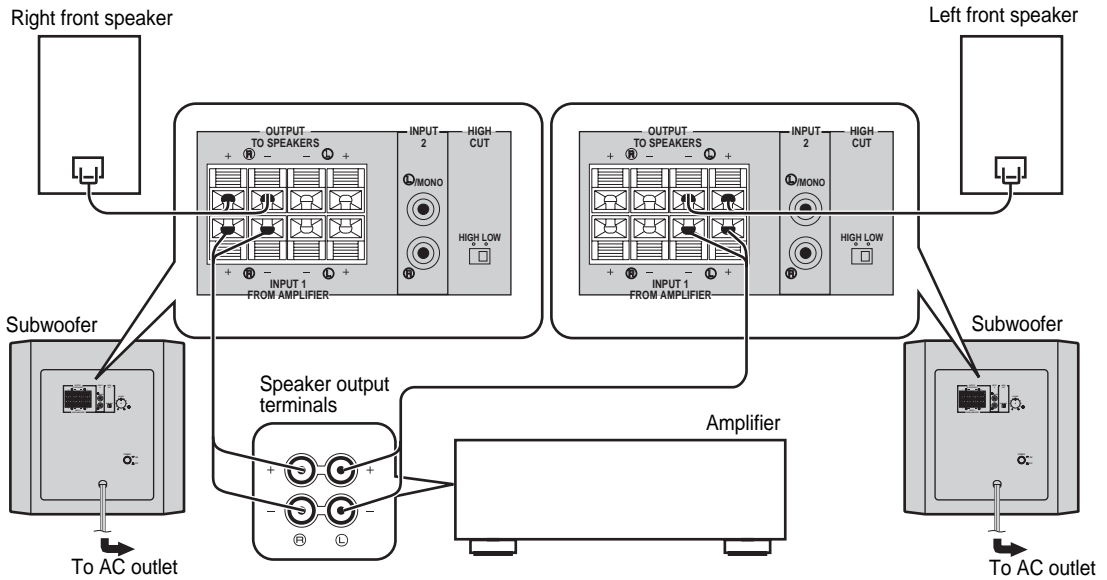

Connecting to the INPUT 1/OUTPUT terminals of the subwoofer

For connection, keep the speaker cables as short as possible. Do not bundle or roll up the excess part of the cables. If the connections are faulty, no sound will be heard from the subwoofer or the speakers, or both of them. Make sure that the + and – polarity markings of the speaker cables are observed and set correctly. If these cables are reversed, the sound will be unnatural and lack bass.

Caution

Do not let the bare speaker wires touch each other, because this could damage the subwoofer or the amplifier, or both of them.

■ Before connecting

Remove the insulation coating at the extremity of each speaker cable by twisting the coating off.

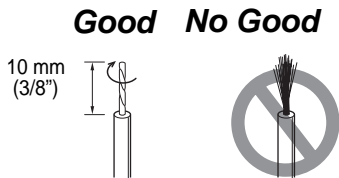

■ How to connect:

- ① Press and hold the terminal's tab, as shown in the figure.
- ② Insert the bare wire.
- ③ Release your finger from the tab to allow it to lock securely on the cable's wire end.
- ④ Test the firmness of the connection by pulling lightly on the cable at the terminal.

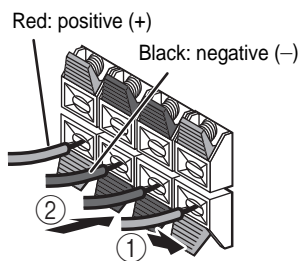

Note: Do not insert the insulation coating into the hole. The sound may not be produced.

Plug in the subwoofer to the AC outlet

After all connections are completed, plug in the subwoofer and other audio/video components to the AC outlet.

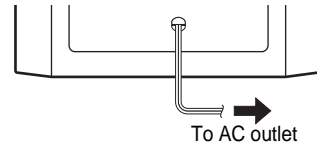

CONTROLS AND THEIR FUNCTIONS

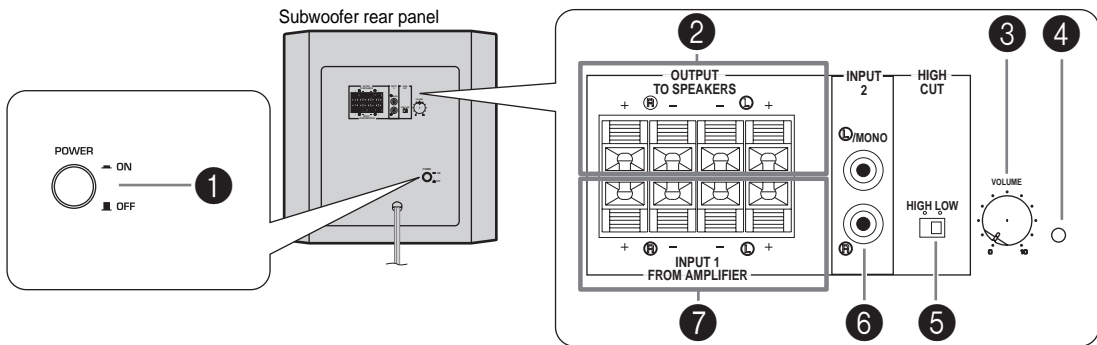

1 POWER switch

Press this switch to the **ON** position to turn on the power to the subwoofer. When the power of the subwoofer is on, the power indicator (4) on the rear panel light up in green. Press this switch again to set it to **OFF** position to turn off the power of the subwoofer.

2 OUTPUT (TO SPEAKERS) terminals

Can be used for connecting to the front speakers. Signals from the **INPUT 1** terminals are sent to these terminals. (Refer to “**CONNECTIONS**” for details.)

3 VOLUME control

Adjusts the volume level. Turn the control clockwise to increase the volume, and counterclockwise to decrease the volume.

4 Power indicator

Light up in green when the power switch (1) is turned on; turns off when the power switch is turned off.

5 HIGH CUT switch

Selects the high frequency cut off point. Normally, it is set to **LOW**, however, you may set to **HIGH** if necessary. (Refer to page 9)

6 INPUT 2 terminals

Used to input line level signals from the amplifier. (Refer to “**CONNECTIONS**” for details.)

7 INPUT 1 (FROM AMPLIFIER) terminals

Used to connect the subwoofer with the speaker terminals of the amplifier. (Refer to “**CONNECTIONS**” for details.)

ADJUSTING THE SUBWOOFER BEFORE USE

Before using the subwoofer, adjust the subwoofer to obtain the optimum volume and tone balance between the subwoofer and the front speakers by following the procedures described below.

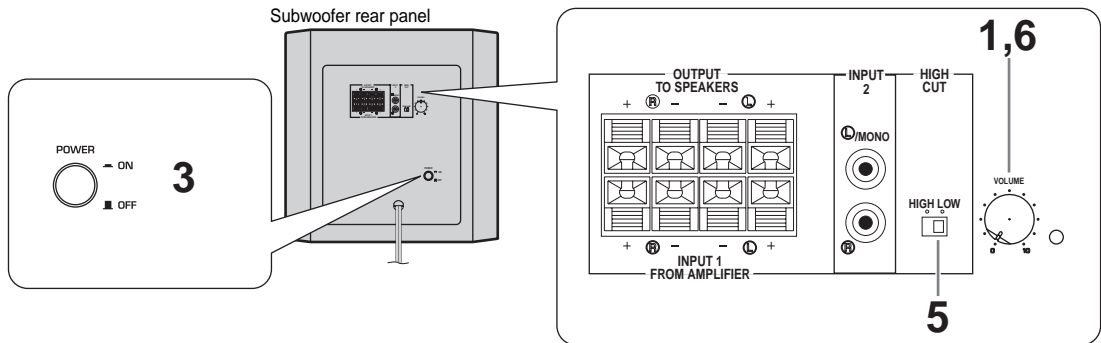

- 1 Set the **VOLUME** control to minimum (0).
- 2 Turn on the power of all the other components.
- 3 Press the **POWER** switch to the **ON** position.
* The Power indicator lights up in green.
- 4 Play a source containing bass signal and adjust the amplifier's volume control to the desired listening level.
- 5 Set the **HIGH CUT** switch to the **LOW** or **HIGH** position.
This subwoofer is designed so that the optimum tone balance between the subwoofer and the front speakers is obtained when this switch is set to the **LOW** position. The tone balance may change, however, depending on the room size, the distance from the subwoofer to the front speakers, and so on. If necessary, switch it to the **HIGH** position.
- 6 Rotate the **VOLUME** control gradually to adjust the volume balance between the subwoofer and the other speakers.
* Normally, set the control to the level where you can obtain a little more bass effect than when the subwoofer is not used. If the desired response cannot be obtained, adjust the **HIGH CUT** switch and the **VOLUME** control again.

Notes

- Once the volume balance between the subwoofer and the front speakers is adjusted, you can adjust the volume of your whole sound system by using the amplifier's volume control. However, if you change the front speakers to others, you must make this adjustment again.
- For adjusting the **VOLUME** control, the **HIGH CUT** switch, refer to "Frequency characteristics" on page 10.

Frequency response

The frequency response of this subwoofer

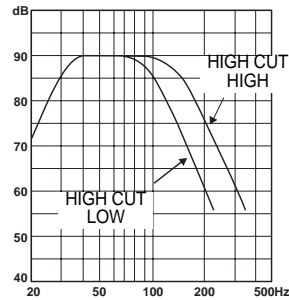

The figures below show the optimum adjustment of each control and the frequency characteristics when this subwoofer is combined with a typical front speaker system.

■ **EX.1 When combined with a 4" or 6.5" (10 cm or 16 cm) acoustic suspension, 2 way system front speakers**

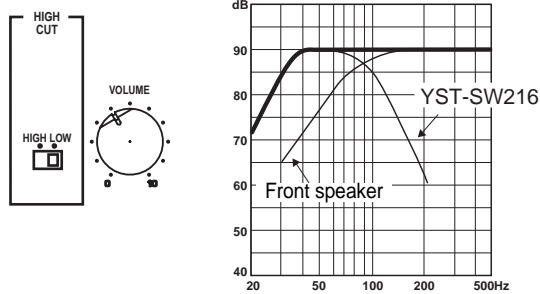

*This diagram does not depict actual frequency response characteristics accurately.

ADVANCED YAMAHA ACTIVE SERVO TECHNOLOGY II

In 1988, Yamaha brought to the marketplace speaker systems utilizing YST (Yamaha Active Servo Technology) to give powerful, high quality bass reproduction. This technique uses a direct connection between the amplifier and speaker, allowing accurate signal transmission and precise speaker control.

As this technology uses speaker units controlled by the negative impedance drive of the amplifier and resonance generated between the speaker cabinet volume and port, it creates more resonant energy (the "air woofer" concept) than the standard bass reflex method. This allows for bass

reproduction from much smaller cabinets than was previously possible.

Yamaha's newly developed Advanced YST II adds many refinements to Yamaha Active Servo Technology, allowing better control of the forces driving the amplifier and speaker. From the amplifier's point of view, the speaker impedance changes depending on the sound frequency. Yamaha developed a new circuit design combining negative-impedance and constant-current drives, which provides a more stable performance and clear bass reproduction without any murkiness.

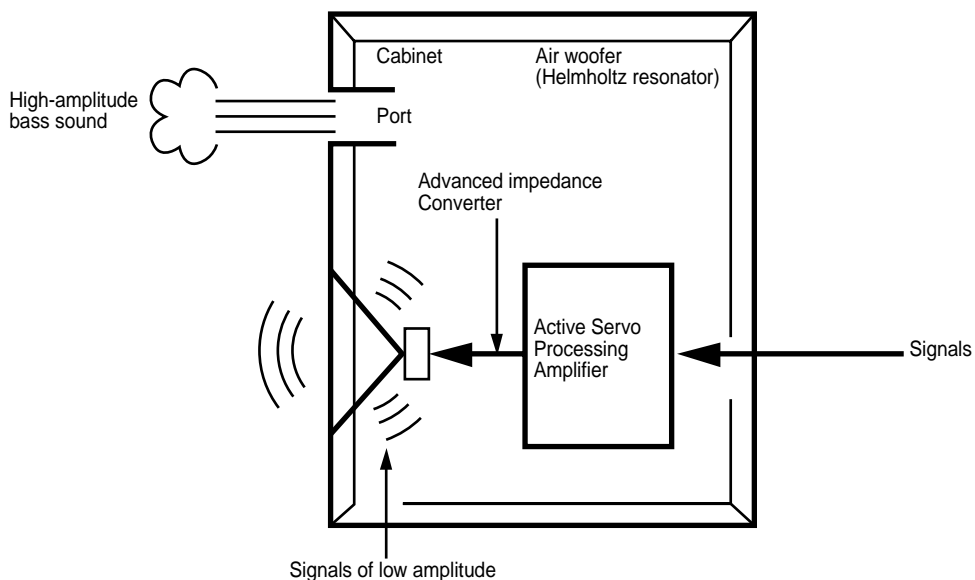

TROUBLESHOOTING

Refer to the chart below when this unit does not function properly. If the problem you are experiencing is not listed below or if the instructions given below do not help, disconnect the power cord and contact your authorized YAMAHA dealer or service center.

Problem	Cause	What to Do
Power is not supplied even though the POWER switch is set to the ON position.	The power plug is not securely connected.	Connect it securely.
No sound.	The volume is set to minimum.	Raise the volume up.
	Speaker cables are not connected securely.	Connect them securely.
Sound level is too low.	Speaker cables are not connected correctly.	Connect them correctly, that is L (left) to L, R (right) to R, “+” to “+” and “-” to “-”.
	A source sound with few bass frequencies is played.	Play a source sound with bass frequencies. Set the HIGH CUT switch to the HIGH position.
	It is influenced by standing waves.	Reposition the subwoofer or break up the parallel surface by placing bookshelves etc. along the walls.

SPECIFICATIONS

TypeAdvanced Yamaha Active Servo Technology II	Power Consumption45 W
Driver25 cm (10") cone woofer Magnetic shielding type	Dimensions (W x H x D) 340 mm x 340 mm x 385 mm (13-3/8" x 13-3/8" x 15-5/32")
Output Power 50 W (100 Hz, 5 Ω 10 %T.H.D)	Weight 11.2 kg (24.7 lbs.)
Dynamic Power 100 W, 5 Ω	Please note that all specifications are subject to change without notice.
Input Impedance 12 K Ω	
Frequency Response 25 Hz - 180 Hz (-10 dB)	
Input Sensitivity50 mV (100 Hz, 50 W/5 Ω)	
Power Supply U.S.A. and Canada models AC 120V, 60 Hz U.K. and Europe models AC 230V, 50 Hz Australia model AC 240V, 50 Hz Asia and General models AC 110-120/220-240 V, 50/60 Hz	



© 2006 YAMAHA CORPORATION All rights reserved.

YAMAHA ELECTRONICS CORPORATION, USA 6660 ORANGETHORPE AVE., BUENA PARK, CALIF. 90620, U.S.A.
YAMAHA CANADA MUSIC LTD. 135 MILNER AVE., SCARBOROUGH, ONTARIO M1S 3R1, CANADA
YAMAHA ELECTRONIK EUROPA G.m.b.H. SIEMENSSTR. 22-34, 25462 RELLINGEN BEI HAMBURG, GERMANY
YAMAHA ELECTRONIQUE FRANCE S.A. RUE AMBROISE CROIZAT BP70 CROISSY-BEAUBOURG 77312 MARNE-LA-VALLEE CEDEX02, FRANCE
YAMAHA ELECTRONICS (UK) LTD. YAMAHA HOUSE, 200 RICKMANSWORTH ROAD WATFORD, HERTS WD18 7GQ, ENGLAND
YAMAHA SCANDINAVIA A.B. J A WETTERGRENS GATA 1, BOX 30053, 400 43 VÄSTRA FRÖLUNDA, SWEDEN
YAMAHA MUSIC AUSTRALIA PTY, LTD. 17-33 MARKET ST., SOUTH MELBOURNE, 3205 VIC., AUSTRALIA

YAMAHA CORPORATION
Printed in Indonesia © WG59120