

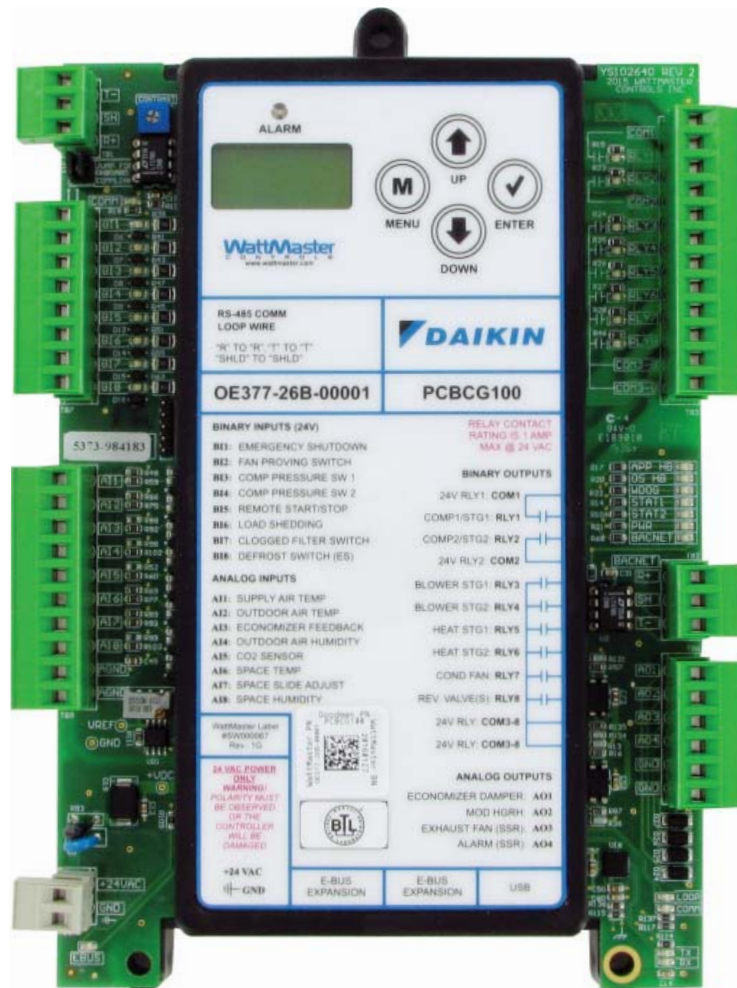

DDC Controller Technical Guide

DDC Controller Code: SS9001 Version 1.0 and up
Requires PrismD Code: SS9002 Version 1.0 and up
Requires System Manager TS II-G Code: SS9003 Version 1.0 and up





WattMaster Controls Inc.
8500 NW River Park Drive · Parkville, MO 64152
All rights reserved.
© June 2016 WattMaster Controls, Inc.
DAIKIN® is a registered trademark of Daikin Industries,
LTD

WattMaster Form: DK-DDC-TGD, Revision 01B
Daikin Part No: DK-DDC-TGD-01B
BACnet® is a registered trademark of ASHRAE Inc., Atlanta, GA.
LON® and LONWorks® are registered trademarks of Eschelon
Corporation.
Neither WattMaster Controls, Inc. nor Daikin Industries, Ltd.
assumes any responsibility for errors or omissions in this
document and are separate companies. This document is
subject to change without notice.

OVERVIEW 5

- Overview and Features 5
- Applications 6
- Parts List..... 7
- Parts Descriptions 8
- DDC Controller Dimensions 12
- DDC Controller Components..... 13

INSTALLATION & WIRING..... 14

- Important Wiring Considerations 14
- Binary Inputs..... 15
- Analog Inputs..... 16
- Analog Outputs..... 17
- E-BUS Digital Room Sensor..... 18
- E-BUS CO₂ Wall Mounted Sensor 19
- Duct Mounted E-BUS CO₂ Sensor 20
- Space Temperature Sensor & Slide Adjust..... 21
- Space Humidity Sensor 22
- Space or Return Air CO₂ Sensor..... 23
- Supply Air Temperature Sensor..... 24
- Outdoor Air Temperature Sensor 25
- E-BUS Outdoor Air Temperature and Humidity Sensor 26
- Outdoor Air Humidity Sensor 27
- Economizer Feedback Signal..... 28
- Economizer Damper Actuator..... 29
- Exhaust Fan Signal 30
- Alarm Signal 31

START-UP & COMMISSIONING 32

- CommLink Settings 32
- Programming the Controller 33

INPUTS & OUTPUTS 34

SEQUENCE OF OPERATIONS..... 36

- Operation Modes 36
- HVAC Modes of Operation 36
 - Cooling 36
 - Heating 36
 - Ventilation 36
 - Off Mode 36
- Blower Control..... 37
- Cooling Enable 37
- Heat Enable..... 37
- Economizer Enable 37

TABLE OF CONTENTS

| | |
|--|----|
| ALARMS & TREND LOGGING | 38 |
| Alarm Detection and Reporting | 38 |
| Sensor Failure Alarms | 38 |
| Mechanical Failure Alarms | 38 |
| Failure Mode Alarms..... | 39 |
| Title 24 Economizer Alarms | 39 |
| Trend Logging..... | 40 |
| | |
| TROUBLESHOOTING..... | 41 |
| LED Diagnostics | 41 |
| | |
| APPENDIX A | 42 |
| System Configurations | 42 |
| Space and Outdoor Air Temperature Sensor Testing | 46 |
| | |
| APPENDIX B - LCD Display Screens (Controller Interface & BACnet® Configuration) | 47 |
| | |
| APPENDIX C - DDC BACnet® Connection to MS/TP Network, BACnet® Parameters & PICS Statement | 61 |
| | |
| INDEX..... | 68 |

Overview

The DDC Controller (WattMaster Part No. OE337-26B-00001; Daikin Part No. PCBCG100) is designed with 8 analog inputs, 4 analog outputs, 8 binary inputs, and 8 relay outputs.

The DDC Controller has an on-board BACnet® port for connection to a BACnet® MS/TP network.

The DDC Controller contains a 2 x 8 LCD character display and 4 buttons that allow for status and alarm display, setpoint configuration, and BACnet® configuration.

There are also 2 E-BUS Expansion Ports which allow the connection of communicating sensors and future E-BUS Modules via modular cable assemblies. In addition, there is a USB port which is used for connection to a computer running PrismD software.

The DDC Controller has an on-board CommLink that provides for stand-alone programming and monitoring via a direct USB connection to a computer running PrismD software. If used on a networked system that has an external CommLink, this on-board CommLink would not be used. Alternatively, the System Manager Touch Screen II for DDC (OE392-10-G) can be used to view status, perform force modes, and set schedules.

There are presently 6 communicating sensors available. Two of these sensors have LCD displays: E-BUS Digital Space Temperature Only Sensor or E-BUS Digital Space Temperature and Humidity Sensor. There is a communicating E-BUS Space Temperature and Humidity Sensor and E-BUS Outdoor Air Temperature and Humidity Sensor with no LCD display as well as an E-BUS Space CO₂ Sensor, and E-BUS Duct CO₂ Sensor with no LCD display.

The DDC Controller provides for constant volume applications.

NOTE: The internal USB communication port of the DDC Controller uses specialized USB drivers that must be installed on your Windows® PC before communication to the device using PrismD can be established. To install the USB Drivers, follow the instructions in the *PrismD Technical Guide*.

Features

The DDC Controller provides the following:

- Controls up to 2 Heat Stages
- Controls up to 2 Compressors
- Fan Proving Interlock
- Dirty Filter Alarm
- Emergency Shutdown Input (Smoke Detector/Phase Monitor/Firestat or other Shutdown Conditions)
- Remote Start/Stop Control
- Title 24 Economizer Certified
- 7 day, 2 events per day schedule
- 14 Holiday Event Scheduling
- Optimal Start
- Daylight Savings Time Adjustment
- Trend Logging Capability
- Set up using a computer with PrismD software installed or with the System Manager Touch Screen II-G (sold separately)
- Can be operated Stand-Alone or connected to a networked system
- On-board CommLink for Stand-Alone programming using a USB connection to a computer running PrismD software
- On-board BACnet® port for connection to an MS/TP network (See Appendix C)



Applications

Constant Air Volume Unit

The DDC Controller can handle the main lines of the following type of Constant Volume (CV) units from 3 to 25 tons:

- AC unit with or without electric heat
- Heat Pump unit with or without electric heat
- Gas Heat unit that contains a furnace board





The DDC Controller can perform the following functions:

- Cooling Mode Control
 - One or two stages of cooling.
 - Compressor(s) operation monitor.
- Economizer Control
 - California Title 24 economizer control
 - Demand control ventilation based on CO₂
 - Exhaust Fan control
- Heating Mode Control
 - One or Two stages of heating (Electric or Gas Heat)
 - Heat Pump heating with Defrost control
- Blower - Configurable for 1 or 2 speed operation
- On board BACnet® MS/TP
- Load shedding
- Controller LCD display and keypad/overlay capabilities
- USB connector for PC running PRISMD computer software

| PART DESCRIPTION | WATTMASTER / DAIKIN PART NUMBER |
|--|--|
| DDC Controller | OE377-26B-00001 / PCBCG100 |
| CO ₂ Sensor - Duct Mounted | OE255-G / 0130L00110 |
| CO ₂ Sensor - Space | OE256-G / 0130L00111 |
| CommLink 5 Communications Interface | OE361-13-G / 0130L00126 |
| EBC E-BUS Cable Assembly E-BUS Power & Comm 3 Ft, 10 Ft, 50 Ft,150 Ft | EBC-3-F-G / 0130L00114 EBC-10-F-G / 0130L00115 EBC-50-F-G / 0130L00116 EBC-150-F-G / 0130L00117 |
| E-BUS Adapter Hub | MS000248-G |
| E-BUS Adapter Hub with 1.5 Ft. EBC Cable | HZ-EBC-248-G |
| E-BUS Adapter Board | OE365-15-EBA-G |
| E-BUS CO ₂ Sensor with Remote Pickup - Duct Mounted | OE256-07-G / 0130L00131 |
| E-BUS CO ₂ Sensor - Space | OE256-05-G / 0130L00128 |
| E-BUS Digital Room Sensor - LCD Display - Temp. Only | OE217-02-G / 0130L00118 |
| E-BUS Digital Room Sensor - LCD Display - Temp & RH | OE217-03-G / 0130L00119 |
| E-BUS Digital Room Sensor - No LCD Display - Temp & RH | OE217-04-G / 0130L00127 |
| E-BUS Horizontal Outside Air Temperature & RH Sensor | OE265-15-G / 0130L00132 |
| E-BUS Vertical Outside Air Temperature & RH Sensor | OE265-16-G / 0130L00133 |
| IP Module Kit | OE415-02-G / 0130L00122 |
| MiniLink PD 5 | OE364-23-G / 0130L00125 |
| Outdoor Air Humidity Sensor | OE265-13-G / 0130L00106 |
| Outdoor Air Temperature Sensor | OE250-G / 0130L00108 |
| PT-Link II LON-3-G | OE368-23-LON-3-G / 0130L00124 |
| Space Humidity Sensor | OE265-11-G / 0130L00129 |
| Standard Room Sensor - W/ Override & Slide Adjust | OE213-G / 0130L00107 |
| Supply Air Temperature Sensor | OE230-G / 0130L00112 OE231-G / 0130L00113 |
| Surge Protector | OE437-03-G / 0130L00130 |
| System Manager Touch Screen II-G | OE392-10-G / 0130L00121 |

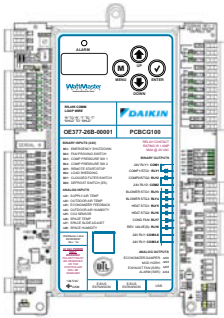
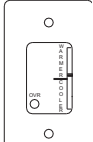
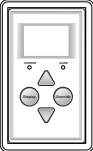
OVERVIEW

Parts and Descriptions

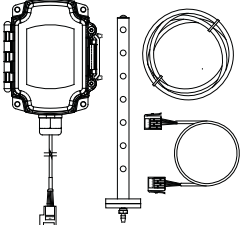
| PART NO. | PART DESCRIPTION | ILLUSTRATION | PAGE NO. |
|----------------------------|---|---|-------------|
| OE377-26B-00001 / PCBCG100 | <p>DDC Controller</p> <p>Setpoints and monitoring of the DDC Controller requires one of the following communication interfaces—PrismD computer software, System Manager Touch Screen II-G, DDC LCD interface, BACnet® connection, or LON® connection with PT-Link II LON-3-G Controller.</p> |  | Pages 12-15 |
| OE213-G / 0130L00107 | <p>Standard Room Sensor-w/Override & Slide Adjust</p> <p>Includes: Standard Room Sensor - with Override and Slide Adjust.</p> <p>For wall mounting. Use with DDC Controller only. Connects to controller via field wiring.</p> |  | Page 21 |
| OE217-02-G / 0130L00118 | <p>E-BUS Digital Room Sensor - Temp. Only</p> <p>LCD Display and keypad allow for setpoint adjustment, override, and display of certain status and setpoints. The OE217-02-G is used with the DDC Controller for room air temperature sensing applications. Uses EBC E-BUS cable.</p> |  | Page 18 |
| OE217-03-G / 0130L00119 | <p>E-BUS Digital Room Sensor - Temp and Humidity</p> <p>LCD Display and keypad allow for setpoint adjustment, override, and display of certain status and setpoints. The OE217-03-G is used with the DDC Controller for room air temperature and humidity sensing applications. Uses EBC E-BUS cable.</p> |  | Page 18 |
| OE217-04-G / 0130L00127 | <p>E-BUS Digital Room Sensor - Temp and Humidity</p> <p>The OE217-04-G is used with the DDC Controller for room air temperature and humidity sensing applications. Contains no LCD Display or keypad. Uses EBC E-BUS cable.</p> |  | Page 18 |
| OE256-05-G / 0130L00128 | <p>E-BUS CO₂ Wall-Mounted Sensor</p> <p>Used with the DDC for CO₂ sensing applications where wall mounting in the space is desired. Connects to the DDC Controller with an EBC E-BUS cable of required length. Cable sold separately.</p> |  | Page 19 |
| OE256-07-G / 0130L00131 | <p>E-BUS CO₂ Duct Sensor with Remote Pickup Tube</p> <p>Used with the DDC Controller for duct mounted CO₂ sensing applications. Connects to the DDC Controller with an EBC E-BUS cable of required length. Includes: Duct Mounted CO₂ Sensor, Integral Aspiration Box, Airflow Pickup Tube and 10 ft. EBC Cable.</p> |  | Page 20 |

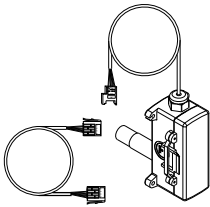
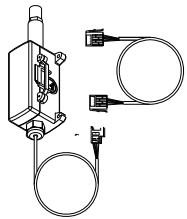
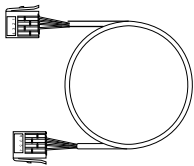
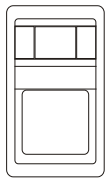
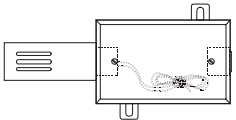
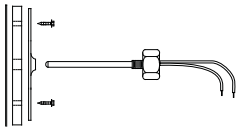
| PART NO. | PART DESCRIPTION | ILLUSTRATION | PAGE NO. |
|---|---|---|----------|
| OE265-15-G / 0130L00132 | <p>E-BUS Horizontal Outdoor Air Temperature & Humidity Sensor</p> <p>Used for outdoor temperature and humidity sensing applications. Connects to DDC Controller or E-BUS Adapter Hub using EBC E-BUS cable. Includes: 10k Ohm E-BUS Horizontal Outside Air Temperature & Humidity Sensor, mounted in a weatherproof handy box with attached 3 foot EBC E-BUS Cable with jack. A 10 foot EBC cable is included to connect to the DDC Controller. If a longer EBC cable is required, it must be ordered separately.</p> |  | Page 26 |
| OE265-16-G / 0130L00133 | <p>E-BUS Vertical Outdoor Air Temperature & Humidity Sensor</p> <p>Used for outdoor temperature and humidity sensing applications. Connects to DDC Controller or E-BUS Adapter Hub using EBC E-BUS cable. Includes: 10k Ohm E-BUS Vertical Outside Air Temperature & Humidity Sensor, mounted in a weatherproof handy box with attached 3 foot EBC E-BUS Cable with jack. A 10 foot EBC cable is included to connect to the DDC Controller. If a longer EBC cable is required, it must be ordered separately.</p> |  | Page 26 |
| <p>EBC-3-G / 0130L00114</p> <p>EBC-10-F-G/ 0130L00115</p> <p>EBC-50-F-G / 0130L00116</p> <p>EBC-150-F-G /0130L00117</p> | <p>EBC E-BUS Cables</p> <p>The EBC E-BUS Expansion Cables attach to the DDC Controller, DDC Expansion Modules, and E-BUS Sensors. The EBC E-BUS cables can be crimped and clamped to the E-BUS connector. Different lengths can be joined together using an E-BUS extension adapter. The EBC E-BUS Cables are available in 3, 10, 50, 150 feet lengths. Includes: EBC E-BUS Cable Assembly.</p> |  | N/A |
| OE265-11-G / 0130L00129 | <p>3% Room Mounted Relative Humidity Sensor 0-5 VDC Output</p> <p>Includes: 0-5 VDC, Room Mounted Relative Humidity Transmitter only. Used for room air humidity sensing applications.</p> |  | Page 22 |
| OE250-G / 0130L00108 | <p>Outdoor Air Temperature Sensor</p> <p>Used for temperature sensing applications. Includes: 10k Ohm Outside Air Temperature Sensor, 2 wire, mounted in a weatherproof handy box only.</p> |  | Page 25 |
| <p>OE230-G / 0130L00112</p> <p>OE231-G / 0130L00113</p> | <p>Duct Temperature Sensor - 6" Probe</p> <p>Duct Temperature Sensor - 12" Probe</p> <p>OE230 = 6" probe length. OE231 = 12" probe length. Used for return or supply air temperature sensing applications. Includes: 10k Ohm Duct Temperature Sensor, 2 wire only.</p> |  | Page 24 |

OVERVIEW

Parts and Descriptions

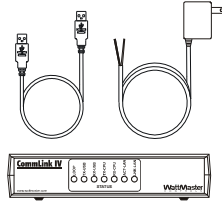
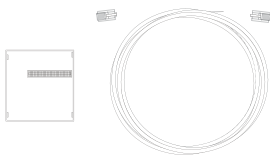
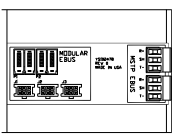
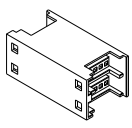
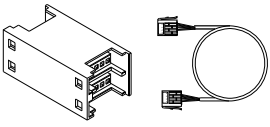
| PART NO. | PART DESCRIPTION | ILLUSTRATION | PAGE NO. |
|-------------------------|---|---|---|
| OE392-10-G / 0130L00121 | <p>System Manager TS II-G Operator Interface</p> <p>The System Manager TS II-G provides a direct, graphic-enhanced, menu-driven link to enable the system operator to view the status and adjust the setpoints of any controller on the DDC control system. The System Manager TS is equipped with a 4.3" 480 x 272 WQVGA RGB TFT LCD Touch Screen Display. The System Manager TS is furnished with hardware for flush mounting into hollow drywall or surface mounting on concrete brick or plaster surfaces. Includes: System Manager TS with 12 ft. long pigtail cable assembly.</p> |  | <p>See <i>Daikin System Manager Touch Screen II-G Technical Guide</i></p> |
| OE361-13-G / 0130L00126 | <p>CommLink 5 Communications Interface</p> <p>The CommLink 5 connects to your control system using a USB computer connection to provide direct on-site communications with the control system from a computer with the PrismD software installed. For remote communications, see OE415-02-G IP Module Kit.</p> <p>Includes: CommLink 5, 6 ft. long USB cable, and 120/24 VAC power supply. Required on all networked systems or if direct computer or remote computer connection is required. Connects to your computer's USB 1.1 or 2.1 port. PrismD computer software must be installed on the direct connected or remote connected computer in order to communicate with your system.</p> |  | <p>See <i>CommLink 5 Technical Guide</i></p> |
| OE415-02-G / 0130L00122 | <p>IP Module Kit - Internet/LAN Connection</p> <p>Used for Internet or Local Area Network communications with the control system. Field installs by plugging into the CommLink 5 circuit board and provides an addressable Ethernet connection to the controls system from any computer connected to your building's LAN. It can also be configured to allow access to the control system from the Internet through your LAN if your Ethernet firewall is configured for this option.</p> <p>Includes: IP Link module, 10 ft. long Ethernet cable, and installation instructions. PrismD computer software must be installed on the remote computer in order to communicate with the controls system.</p> |  | <p>See <i>IP Module Technical Guide</i></p> |
| OE365-15-EBA-G | <p>E-BUS Adapter Board</p> <p>The E-BUS Adapter Board is used connecting E-BUS devices and Controllers together with EBC E-BUS cables of varying lengths. The E-BUS Adapter Board connects to the DDC Controller with an EBC E-BUS cable. Cable supplied separately.</p> |  | <p>Page 26</p> |
| MS000248-G | <p>E-BUS Adapter Hub</p> <p>The E-BUS Adapter Hub is used for connecting E-BUS devices and Controllers together with EBC E-BUS cables of varying lengths. Includes: E-BUS Adapter Hub.</p> |  | <p>Page 26</p> |
| HZ-EBC-248-G | <p>E-BUS Adapter Hub with 1.5 Foot EBC E-BUS Cable</p> <p>The E-BUS Adapter Hub is used for connecting E-BUS devices and Controllers together with EBC E-BUS cables of varying lengths. Includes: E-BUS Adapter Hub and 1.5 foot EBC E-BUS cable.</p> |  | <p>Page 26</p> |

Parts and Descriptions

| PART NO. | PART DESCRIPTION | ILLUSTRATION | PAGE NO. |
|-------------------------------|--|--------------|---|
| OE368-23-LON-3-G / 0130L00124 | <p>PT-Link II LON-3-G WattMaster's PT-Link II LON-3-G (Protocol Translator) is used to provide bi-directional translation of data and information between the communication protocol and the DDC controller. Protocol specific plug in modules will allow the PT-Link to communicate with LON-3® control protocols. New plug in modules for future communication protocols give the PT-Link II extended flexibility. LON-3-G can accommodate 1 DDC Controller.</p> <p>Includes: PT-Link II LON-3-G board complete with one communication protocol module and a 10 foot crossover cable. Supplied mounted in plastic enclosure.</p> | | See Daikin PT-Link II LON-3 Technical Guide |
| OE437-03-G / 0130L00130 | <p>Communication Surge Protector Kit Used to isolate power surges to the communications wiring caused by lightning strikes for communications wiring loops that are routed outdoors or between buildings. One kit is required at each point where the communications wiring leaves or enters a building.</p> <p>Includes: Communication Bus Surge Protector, Base Module, and Mounting/Wiring Instructions.</p> | | N/A |

Software can be downloaded from the Daikin Technical Support Website at www.daikin.wattmaster.com

SOFTWARE

PrismD Front-End Computer Software
PrismD provides standard, easy to understand status screens for each type of DDC equipment installed. All controlling setpoints and trend logs are accessed with PrismD. PrismD can be configured for direct on-site installation or TCP/IP Internet connection.

USB Driver Software
The USB Driver software must be downloaded and installed in your computer in order to use PrismD computer software.

DOCUMENTATION

MANUAL PART NO:

DDC Controller Technical Guide

DK-DDC-TGD

PrismD Technical Guide

DK-PRISMD-TGD

System Manager Touch Screen II-G Technical Guide

DK-SMTSII-TGD

CommLink 5 Technical Guide

DK-CL5-TGD

IP Module Technical Guide

DK-IPM-TGD

PT-Link II LON-3-G Technical Guide

DK-PTLNK3LON-TGD

OVERVIEW

DDC Controller Dimensions

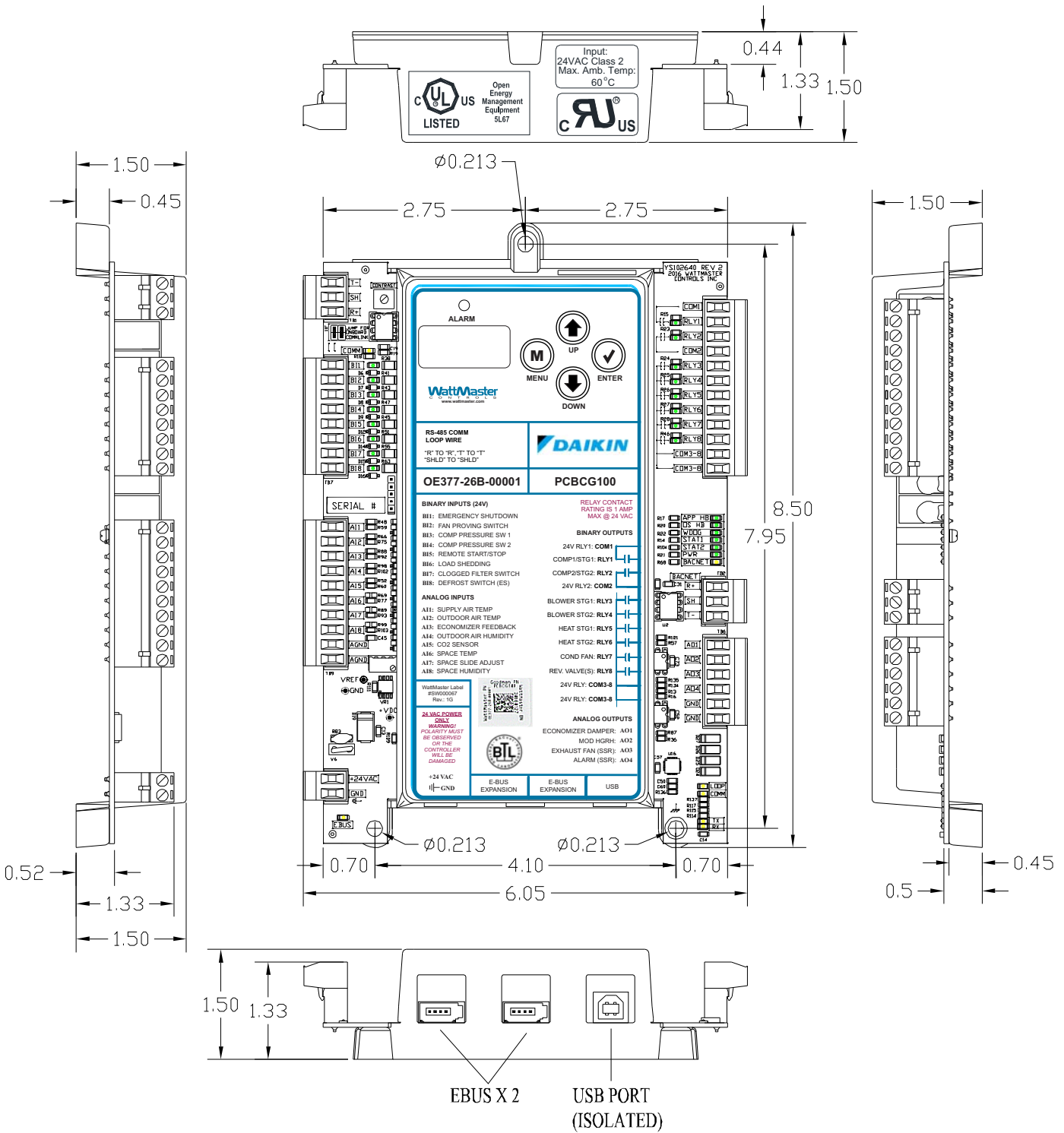

Figure 1: DAIKIN DDC Controller Dimensions

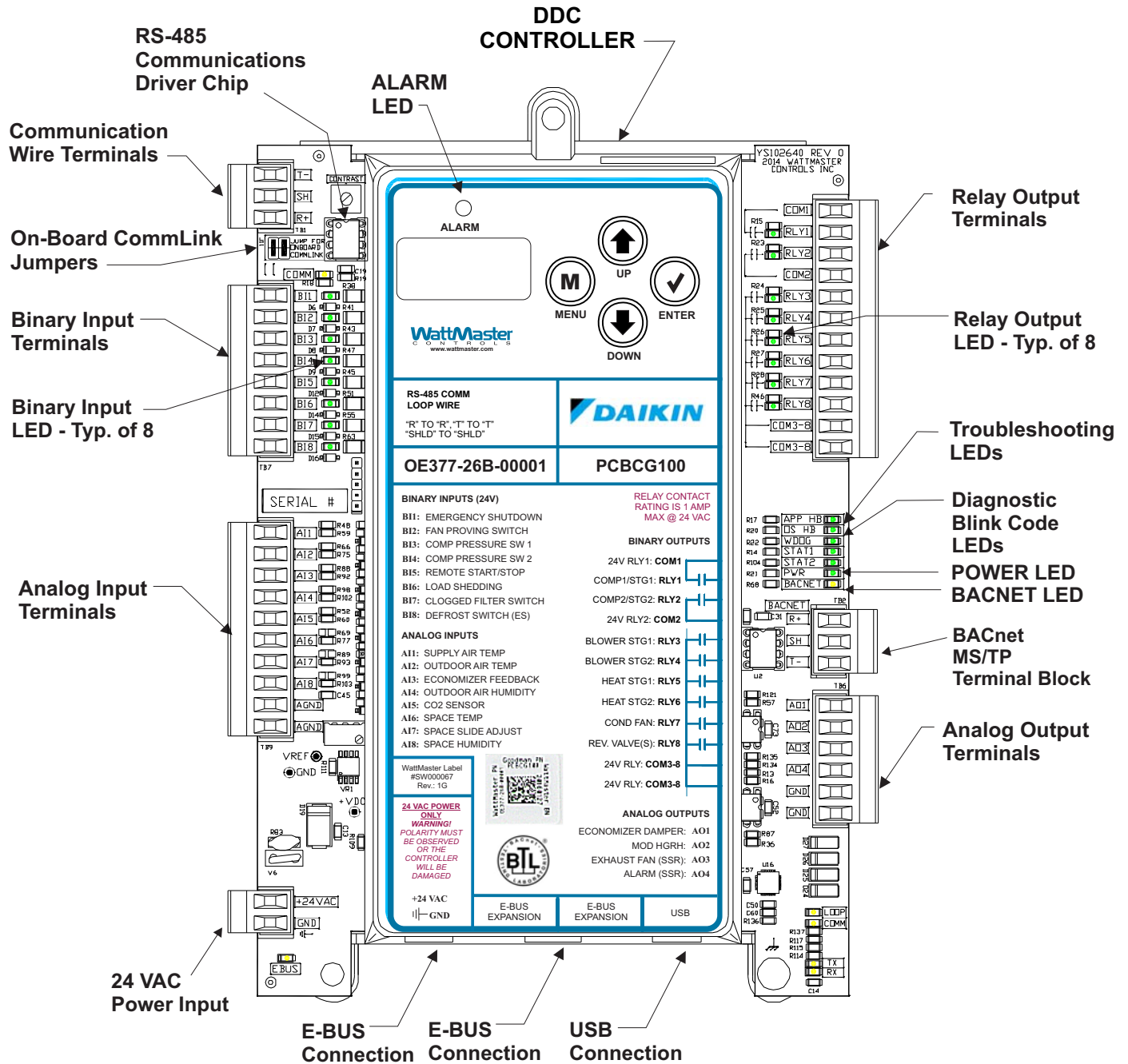

Figure 2: DDC Controller Components

Important Wiring Considerations

General

Correct wiring of the DDC Controller is the most important factor in the overall success of the controller installation process. In general, most DDC Controllers are factory installed and wired at the DAIKIN factory. Some of the following information pertains to field wiring and may not apply to your installation if it was pre-wired at the factory. However, if troubleshooting of the controller is required, it is a good idea to be familiar with the system wiring, no matter if it was factory or field wired.

Controller Mounting

See **Table 1** for a list of the required operating conditions for the DDC Controller.

The DDC Controller is housed in a plastic enclosure. It is designed to be mounted by using the 3 mounting holes in the enclosure base. The DDC Controller needs to be installed in an environment which can maintain a temperature range between -30°F and 150°F not to exceed 90% RH levels (non-condensing). Be careful not to damage the electronic components when mounting the controller.

Considerations

The DDC Controller must be connected to a 24 VAC power source of the proper size for the calculated VA load requirements. All transformer sizing should be based on the VA rating listed in **Table 1**.

| Control Device | Voltage | VA Load | Temperature | Humidity (Non-Condensing) |
|-----------------------------------|---------|---------|-------------------|---------------------------|
| OE377-26B-00001 DDC Controller | 24VAC | 15 | -30°F to 150°F | 90% RH |

Table 1: Voltage and Environment Requirements

WARNING: When using a single transformer to power more than one controller or expansion module, the correct polarity must always be maintained between the boards. Failure to observe correct polarity will result in damage to the DDC Controller.

Please carefully read and apply the following information when wiring the DDC Controller.

1. All wiring is to be in accordance with local and national electrical codes and specifications.
2. All 24 VAC wiring must be connected so that all ground wires remain common. Failure to follow this procedure can result in damage to the controller and connected devices.
3. Minimum wire size for 24 VAC wiring should be 18-gauge.
4. Minimum wire size for all sensors should be 24-gauge. Some sensors require 2-conductor wire and some require 3-or 4-conductor wire.
5. Minimum wire size for 24 VAC thermostat wiring should be 22 gauge.
6. Be sure that all wiring connections are properly inserted and tightened into the terminal blocks. Do not allow wire strands to stick out and touch adjoining terminals which could potentially cause a short circuit.
7. When communication wiring is to be used to interconnect DDC Controllers together or to connect to other communication devices, all wiring must be plenum-rated, minimum 18-gauge, 2-conductor, twisted pair with shield.
8. Before applying power to the DDC Controller, be sure to recheck all wiring connections and terminations thoroughly.

POWER LED Operation

When the DDC Controller is first powered up, the POWER LED should light up and stay on continuously. If it does not light up, check to be sure that you have 24 VAC connected to the controller, that the wiring connections are tight, and that they are wired for the correct polarity. The 24 VAC power must be connected so that all ground wires remain common. If after making all these checks, the POWER LED does not light up, please contact WattMaster Controls Technical Support for assistance.

DDC Controller Binary Input Wiring

DDC Controller Binary Inputs

The DDC Controller has 8 Binary Inputs. See **Figure 3**, below for Binary Input wiring.

The DDC Controller must be connected to 24 VAC as shown in the wiring diagram below. Also please note that when wiring the DDC Controller, its contacts must be wired as wet contacts (connected to 24 VAC).

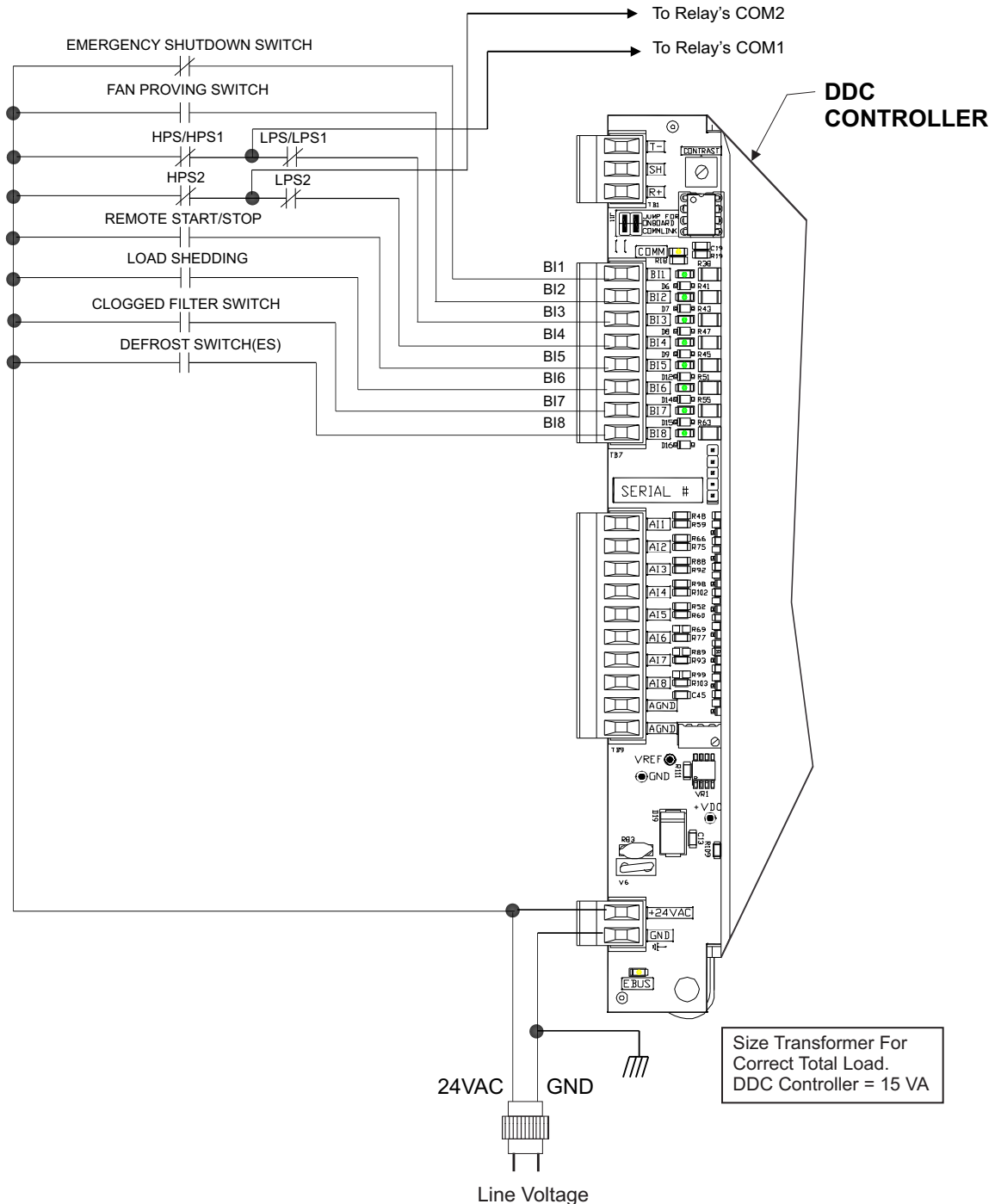

Figure 3: DDC Controller Binary Input Wiring

INSTALLATION & WIRING

DDC Controller Analog Inputs Wiring

DDC Controller Analog Inputs

The DDC Controller is designed with 8 analog inputs. See **Figure 4**, below for wiring details.

There are also 2 E-BUS Expansion Ports which allow the use of E-BUS communicating sensors and a USB port to connect a computer or a CommLink 5.

The DDC Controller must be connected to 24 VAC as shown in the wiring diagram below.

Detailed wiring for all analog inputs is shown later in this manual.

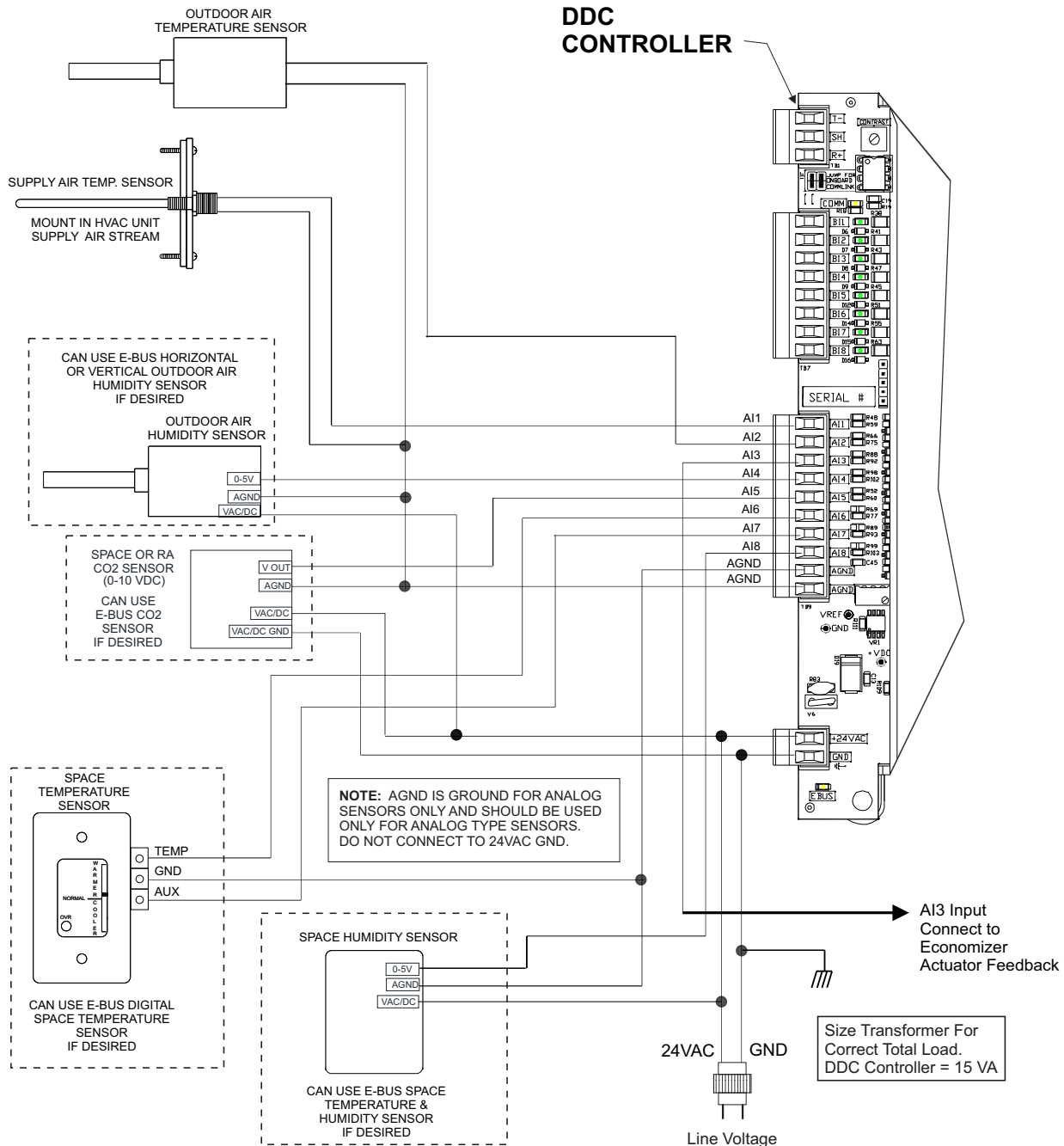

Figure 4: DDC Controller Analog Input Wiring

DDC Controller Output Wiring

DDC Controller Outputs

The DDC Controller must be connected to 24 VAC.

The DDC Controller has 8 Relays and 4 Analog Outputs. See **Figure 5**, below for wiring.

Detailed wiring for all analog outputs is shown later in this manual.

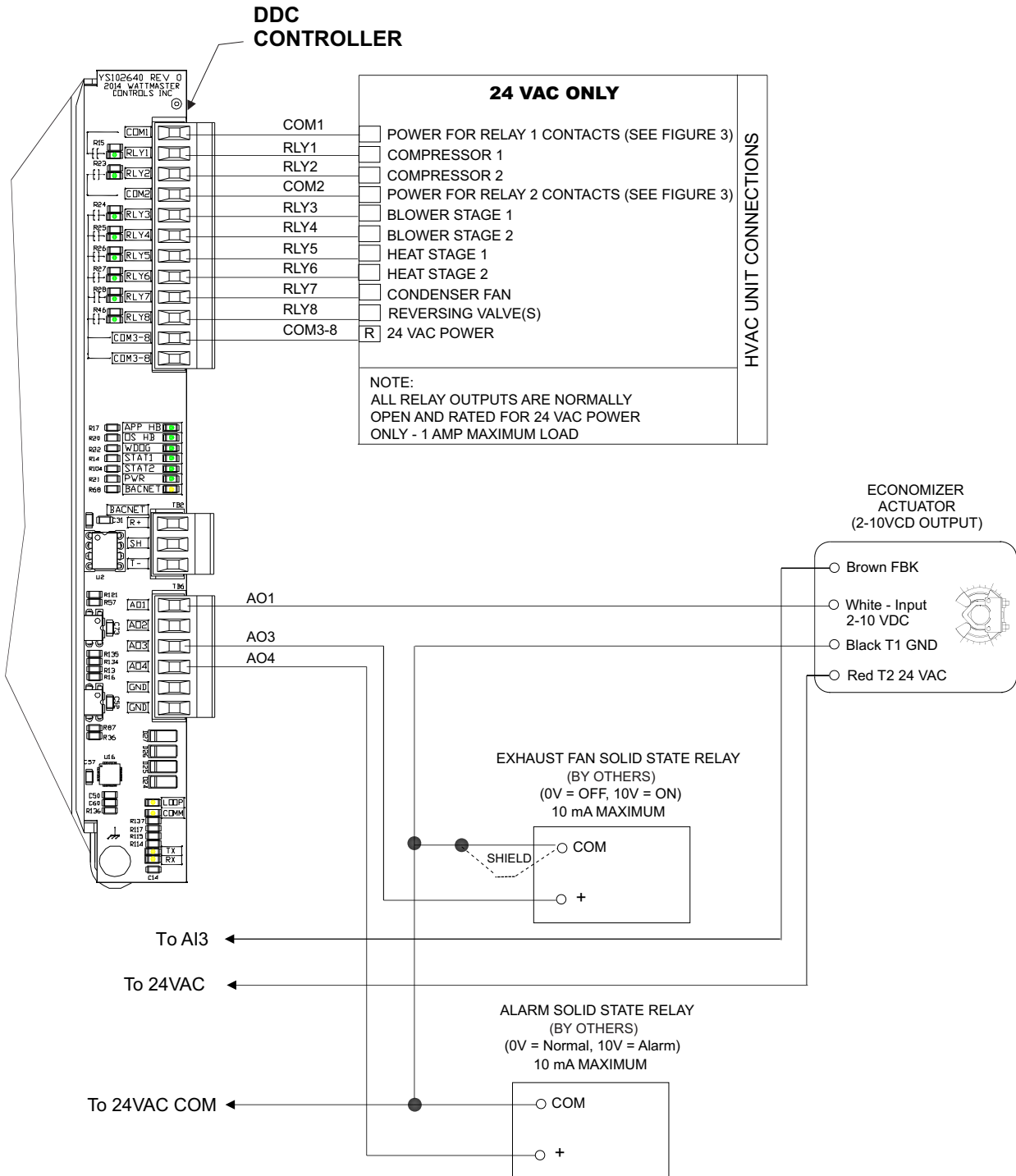

Figure 5: DDC Controller Output Wiring

E-BUS Digital Room Sensor Wiring

E-BUS Digital Room Sensor

The OE217-02-G E-BUS Digital Room Temperature Sensor can be used to sense Space Temperature. The OE217-03-G or OE217-04-G E-BUS Digital Room Temperature and Humidity Sensor can be used to sense Space Temperature and Humidity. The OE217-G has no LCD display or keypad. The Sensor connects to the DDC Controller with the EBC E-BUS expansion cable. It can also be daisy-chained with a CO₂ Sensor for applications requiring both a wall mounted CO₂ sensor and space temperature sensor.

The E-BUS Digital Room Sensor should be mounted at approximately 5 Ft. above the floor on the wall in an area that does not have drafts or is exposed to direct sunlight. See **Figure 6**, below for wiring details

NOTE: The E-BUS Digital Room Sensor must be configured using the DDC Controller's LCD Configuration Setpoint Screens and/or Prism D software. Select "Digital" for the configuration.

NOTE: If using multiple E-BUS Sensors or Modules, the E-BUS Hub or Adapter Board may be required.

Alternatively, instead of using the OE217-02-G E-BUS Digital Room Temperature Sensor, the OE213-G Space Sensor can be wired to the controller at the AI6 input. See **Figure 9** for details.

In addition, instead of using the OE217-03-G or OE217-04-G E-BUS Digital Room Sensor, the OE265-11-G Space Humidity Sensor can be wired to the controller at the AI8 input. See **Figure 10** for details.

The BK00081 Sensor Mounting Plate can be used, if necessary, to cover the Sensor sheet rock opening. It is provided with each E-BUS Digital Room Temperature Sensor.

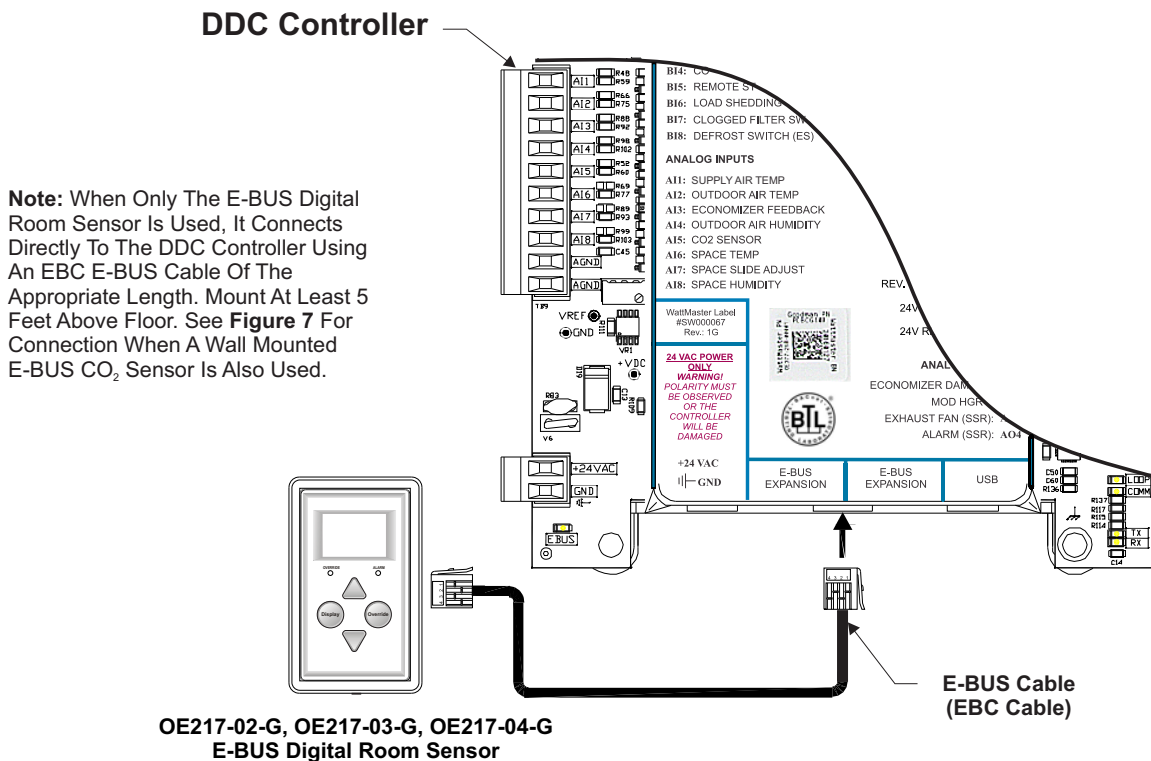

Figure 6: OE217-02-G, OE217-03-G, OE217-04-G – E-BUS Digital Room Sensor Wiring

Wall-Mounted E-BUS CO₂ Sensor Wiring

E-BUS CO₂ Wall-Mounted Sensor

The OE256-05-G Wall Mounted E-BUS CO₂ Sensor is used to monitor CO₂ levels in the space served by the HVAC unit. The E-BUS CO₂ Sensor connects to the DDC Controller with an EBC E-BUS cable. It can be daisy-chained with the E-BUS Digital Room Sensor (OE217-02-G, OE217-03-G, OE217-04-G) for applications requiring both a room CO₂ sensor and room temperature sensor. The BK00081 Sensor Mounting Plate can be used, if necessary, to cover the Sensor sheet rock opening. It is provided with the sensor.

It should be mounted at approximately 5 Ft. above the floor on the wall in an area that does not have drafts or is exposed to direct sunlight. See **Figure 7**, below for wiring details and installation notes. A Duct Mounted E-BUS CO₂ Sensor can be used if desired instead of the Wall Mounted E-BUS CO₂ Sensor. See **Figure 8** for Duct Mounted E-BUS CO₂ Sensor wiring details.

NOTE: The E-BUS CO₂ Wall-Mounted Sensor must be configured using the DDC Controller's LCD Configuration Setpoint Screens and/or Prism D software. Select "Digital" for the configuration.

Alternatively, a Space CO₂ Sensor (by others) can be wired to the controller. See **Figure 11** for details.

NOTE: If using multiple E-BUS Sensors or Modules, the E-BUS Hub or Adapter Board may be required.

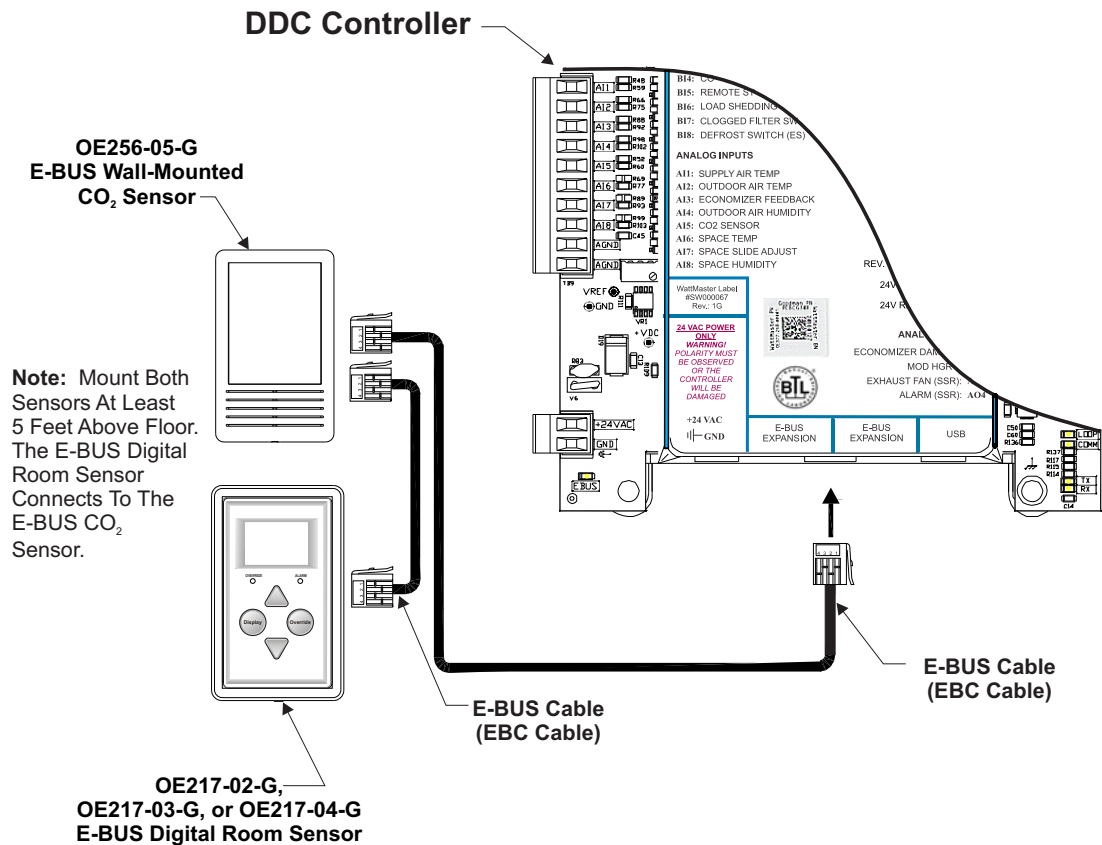

Figure 7: OE256-05-G – Wall Mounted E-BUS CO₂ Sensor Wiring

INSTALLATION & WIRING

Duct Mounted E-BUS CO₂ Sensor

Duct Mounted E-BUS CO₂ Sensor

The OE256-07-G Duct Mounted E-BUS CO₂ Sensor with Remote Pickup Tube is used for sensing the current CO₂ level in the HVAC unit's return air stream. This is useful when you want an average CO₂ reading in the area served by the HVAC unit or when you don't want a wall mounted E-BUS CO₂ Sensor due to sensor tampering concerns in the space.

The OE256-07-G Duct Mounted Return Air CO₂ Sensor is comprised of the CO₂ Sensor, the WattMaster Aspiration Box Assembly, and a Remote Pickup Tube.

The Duct Mounted Return Air E-BUS CO₂ Sensor with Remote Pickup Tube is designed to be mounted in the return air duct of the HVAC unit and uses its integral aspiration box to sample the CO₂ level in the duct. See **Figure 8**, below for wiring and installation details.

NOTE: The E-BUS CO₂ Duct-Mounted Sensor must be configured using the DDC Controller's LCD *Configuration Setpoint Screens* and/or Prism D software. Select "Digital" for the configuration.

Alternatively, a Return CO₂ Sensor (by others) can be wired to the controller. See **Figure 11** for details.

NOTE: If using multiple E-BUS Sensors or Modules, the E-BUS Hub or Adapter Board may be required.

Note:
1.) The Duct Mounted E-BUS CO₂ Sensor Connects To The DDC Controller Using An EBC E-BUS Cable Of The Required Length Or The Provided 10 Foot EBC Cable.

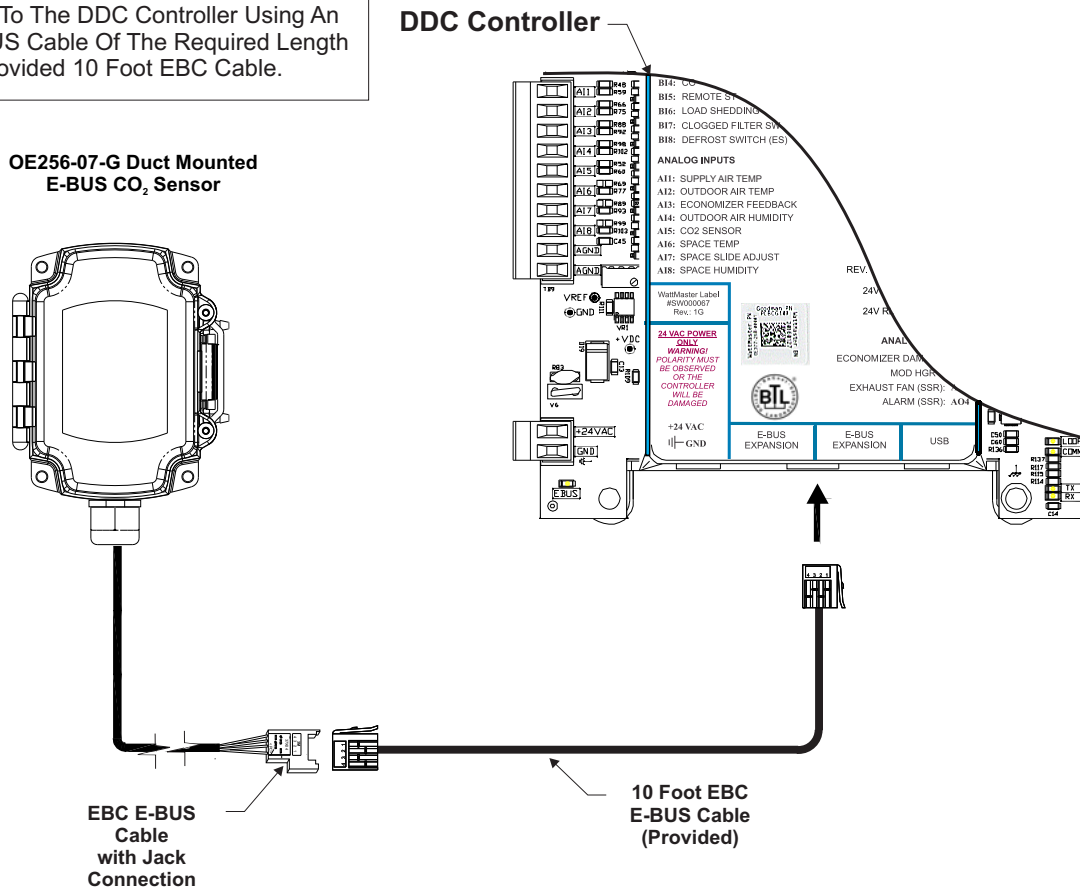

Figure 8: OE256-07-G - Duct Mounted E-BUS CO₂ Sensor Wiring

Space Temperature Sensor Wiring

Space Temperature Sensor

The OE213-G Space Temperature Sensor is typically used for constant volume HVAC unit applications controlling one zone. The Space Temperature Sensor is a 10K Type III thermistor sensor and should be mounted approximately 5 feet above the floor in the space that is to be controlled.

The Space Temperature Sensor provides override and slide adjust capabilities.

See **Figure 9**, below for complete Space Temperature Sensor wiring details.

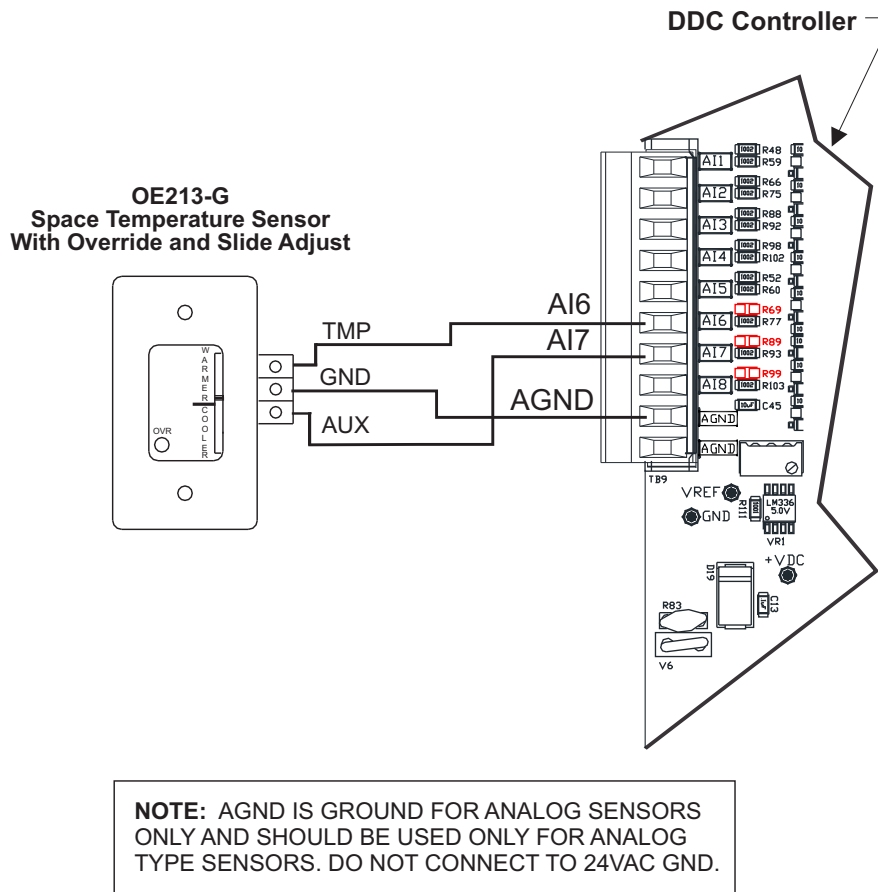

Figure 9: OE213-G – Space Temperature Sensor Wiring and Slide Adjust

INSTALLATION & WIRING

Space Humidity Sensor Wiring

Indoor Wall-Mounted Humidity Sensor

When used, the OE265-11-G Indoor Wall-Mounted Humidity Sensor is connected to the system by wiring it to the AI8 input on the DDC Controller. It must be wired as shown in **Figure 10**, below for proper controller operation.

Alternatively, the OE217-03-G or OE217-04-G E-BUS Digital Room Temperature and Humidity Sensor can be used. See **Figure 6** for details.

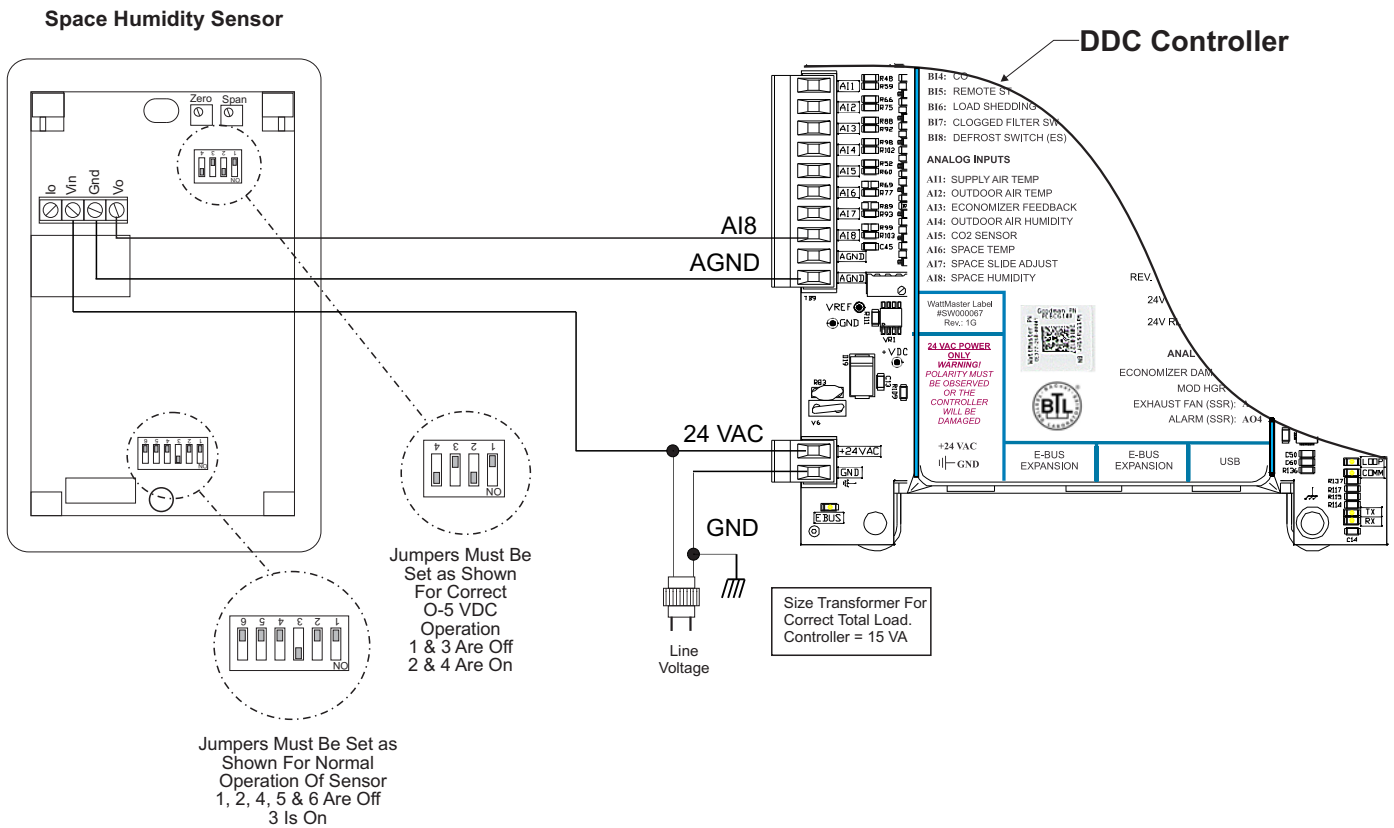

Figure 10: OE265-11-G – Indoor Wall-Mounted Humidity Sensor Wiring

Space or Return Air CO₂ Sensor Wiring

Space or Return Air CO₂ Sensor

The OE256-G Space CO₂ Sensor is used to monitor CO₂ levels in the space served by the HVAC unit. It should be mounted at approximately 5 Ft. above the floor on the wall in an area that does not have drafts or is exposed to direct sunlight. See **Figure 11**, below for wiring details and installation notes.

The OE255-G Return Air CO₂ Sensor is used for sensing the current CO₂ level in the HVAC unit's return air stream. This is useful when you want an average CO₂ reading in the area served by the HVAC unit or when you don't want a wall mounted CO₂ Sensor due to sensor tampering concerns in the space.

Alternatively, the OE256-05-G or OE256-07-G E-BUS CO₂ Sensor can be used. See **Figures 7 and 8** for details.

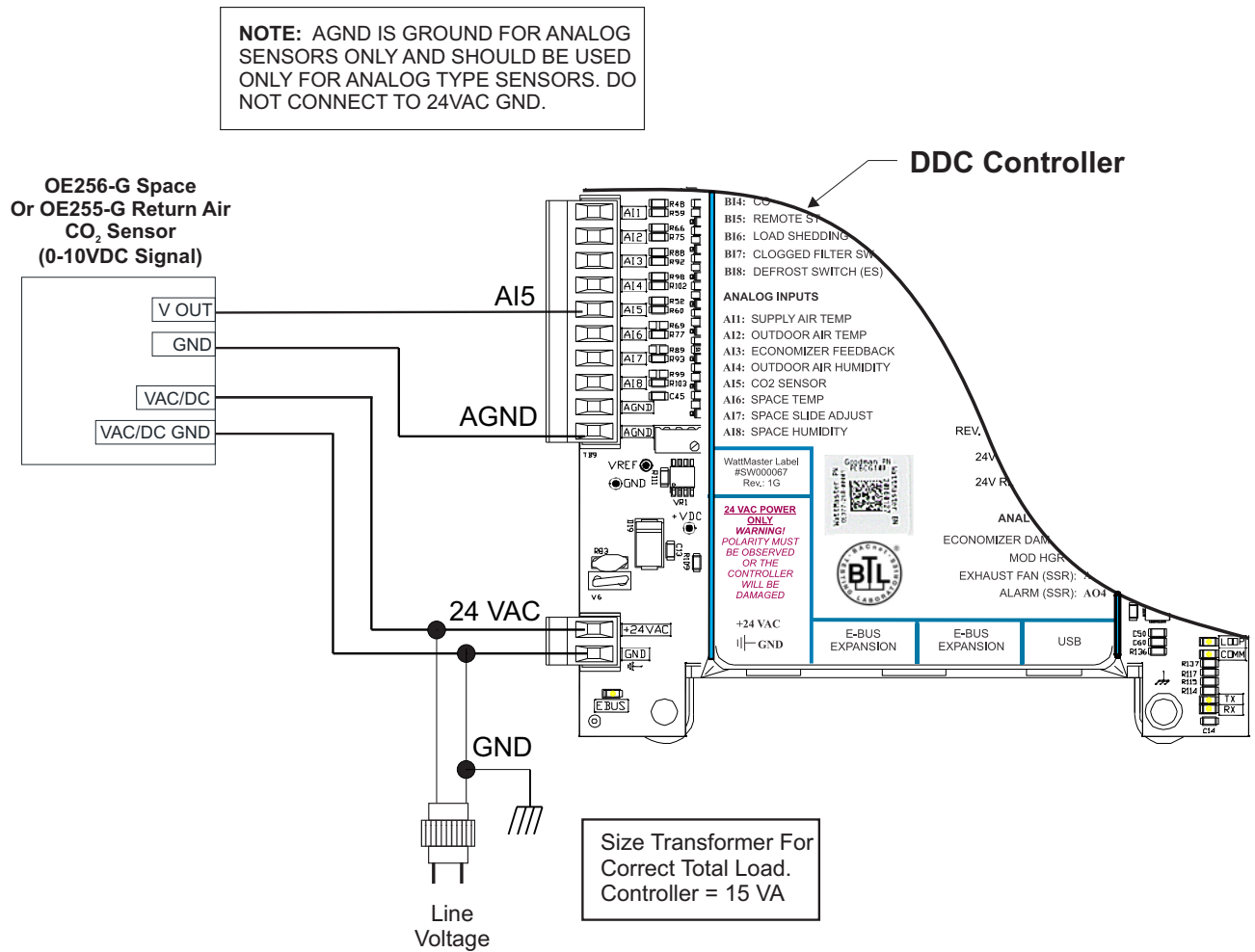

Figure 11: OE256-G Space or OE255-G Return Air CO₂ Sensor Wiring

Supply Air Temperature Sensor Wiring

Supply Air Temperature Sensor

The OE230-G or OE231-G Supply Air Temperature Sensor must be wired as shown for proper operation. The OE230 Temperature Sensor is 6" in length and the OE231-G Temperature Sensor is 12" in length. The Supply Air Temperature Sensor is a 10K Type III thermistor sensor. The Supply Air Temperature Sensor should be mounted in the unit discharge plenum or in the supply air duct. See **Figure 12**, below for details.

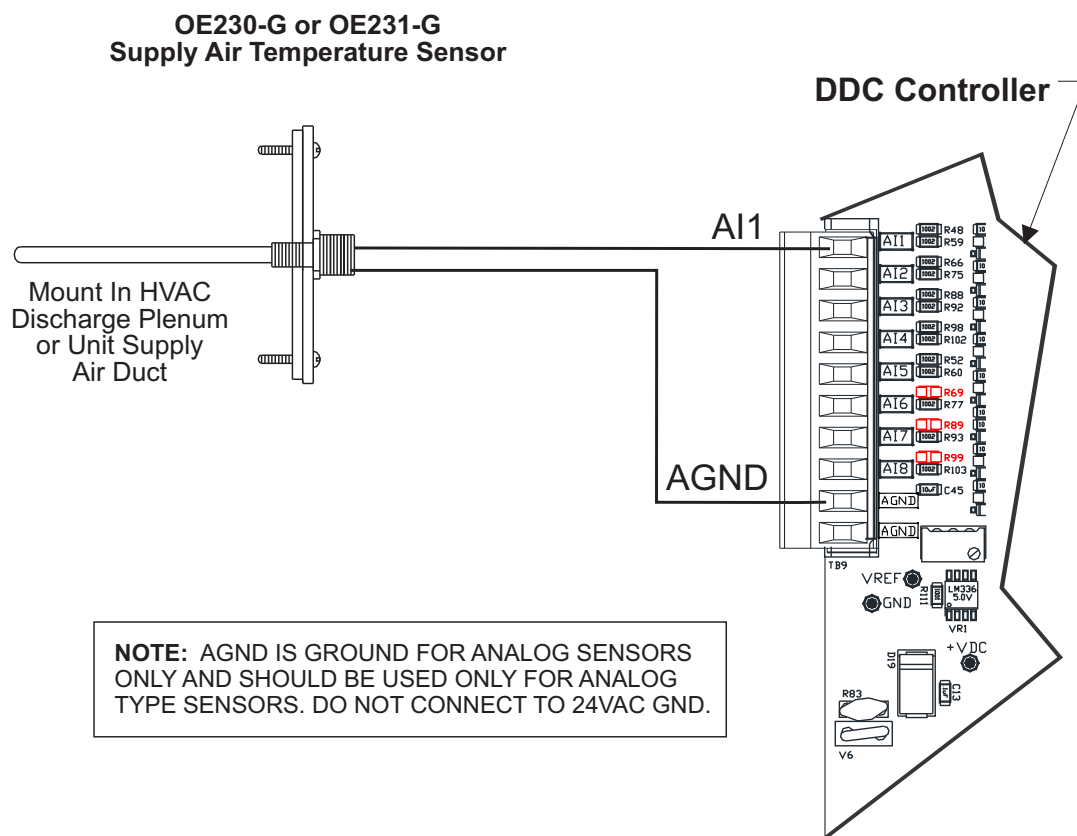

Figure 12: OE230-G or OE231-G – Supply Air Temperature Sensor Wiring

Outdoor Air Temperature Sensor Wiring

Outdoor Air Temperature Sensor

The OE250-G Outdoor Air Temperature Sensor must be wired as shown for proper operation of the DDC Controller. The Outdoor Air Temperature Sensor is a 10K Type III thermistor sensor. The sensor should be mounted in the upright position as shown in an area that is protected from the elements and direct sunlight. Be sure to make the wiring splices inside of the Outdoor Air Temperature Sensor weather-tight enclosure. See **Figure 13**, below for details.

For applications involving Outdoor Air Humidity, the OE265-13-G Outside Air & Humidity Sensor must be used instead. See **Figure 15** for details.

CAUTION: Be sure to mount the Outdoor Air Temperature Sensor in an area that is not exposed to direct sunlight. The shaded area under the HVAC unit rain hood is normally a good location. Unused conduit opening(s) must have closure plugs installed and must be coated with sealing compound to provide a rain-tight seal. Water can damage the sensor.

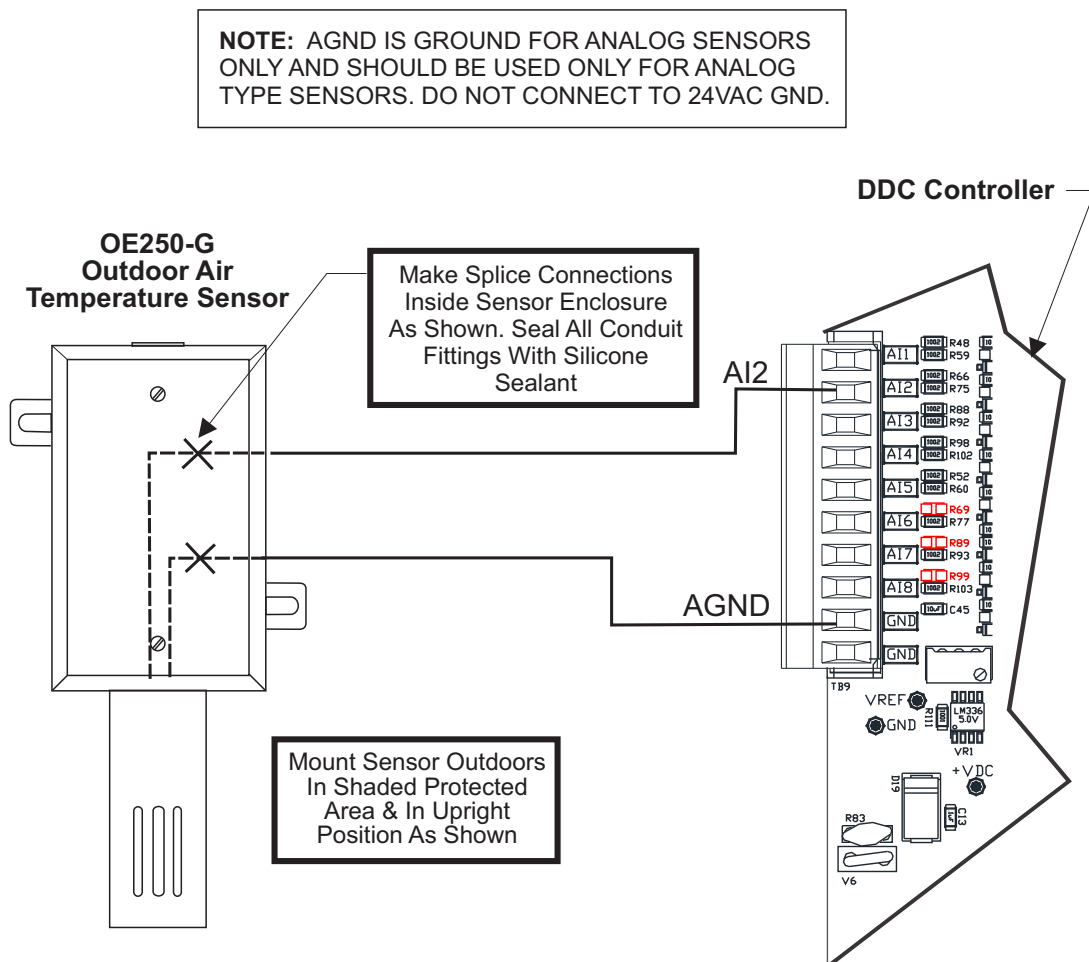

Figure 13: OE250-G – Outdoor Air Temperature Sensor Wiring

INSTALLATION & WIRING

E-BUS Outdoor Air Temperature & Humidity Sensor Wiring

E-BUS Horizontal or Vertical Outdoor Air Temperature & Humidity Sensor

The OE265-15-G (Horizontal) or OE265-16-G (Vertical) E-BUS Outdoor Air Temperature & Humidity Sensor connects to the DDC Controller. A 10 foot EBC E-BUS cable (provided) plugs into the Sensor's attached 3 foot cable and then plugs into the E-BUS port of the DDC Controller or other E-BUS Expansion Board. The sensor should be mounted in the upright position as shown in an area that is protected from the elements and direct sunlight. See **Figure 14**, below for details.

CAUTION: Be sure to mount the Outdoor Air Temperature & Humidity Sensor in an area that is not exposed to direct sunlight. The shaded area under the HVAC unit rain hood is normally a good location. Unused conduit opening(s) must have closure plugs installed and must be coated with sealing compound to provide a rain-tight seal. Water can damage the sensor.

NOTE: The E-BUS Outdoor Air Humidity Sensor must be configured using the DDC Controller's LCD *Configuration Setpoint Screens* and/or Prism D software. Select "Digital" for the configuration.

NOTE: If using multiple E-BUS Sensors or Modules, the E-BUS Hub (HZ-EBC-248-G or MS000248-G) or E-BUS Adapter Board (OE365-15-EBA-G) may be required.

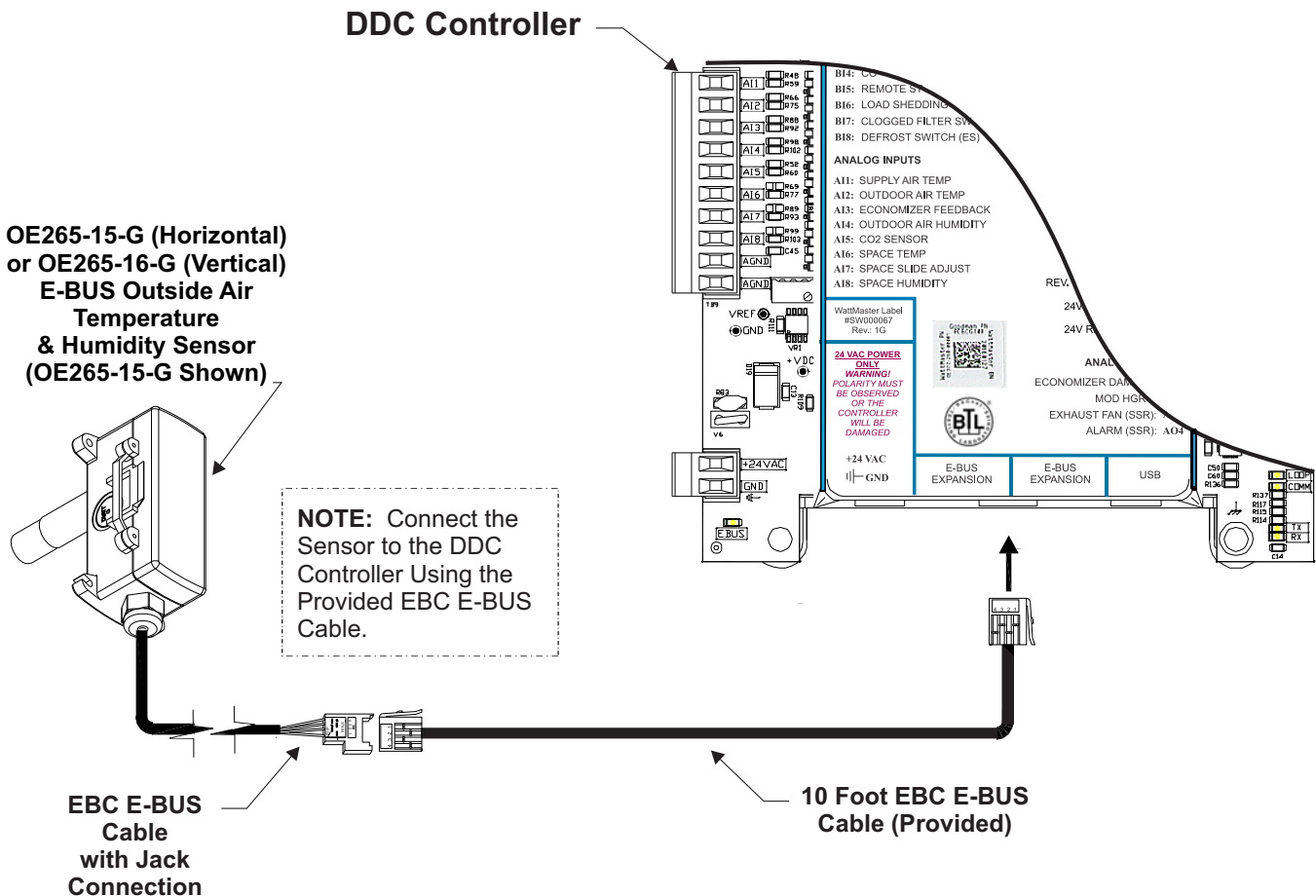

Figure 14: OE265-15-G or OE265-16-G – E-BUS Outdoor Air Temperature & Humidity Sensor Wiring

Outdoor Air Humidity Sensor Wiring

Outdoor Air Humidity Sensor

The OE265-13-G Outdoor Air Humidity Sensor is connected to the system by wiring it to the AI4 input on the DDC Controller. It must be wired as shown in **Figure 15**, below for proper controller operation.

WARNING: It is very important to be certain that all wiring is correct as shown in the wiring diagram below. Failure to observe the correct polarity will result in damage to the OA Humidity Sensor or DDC Controller.

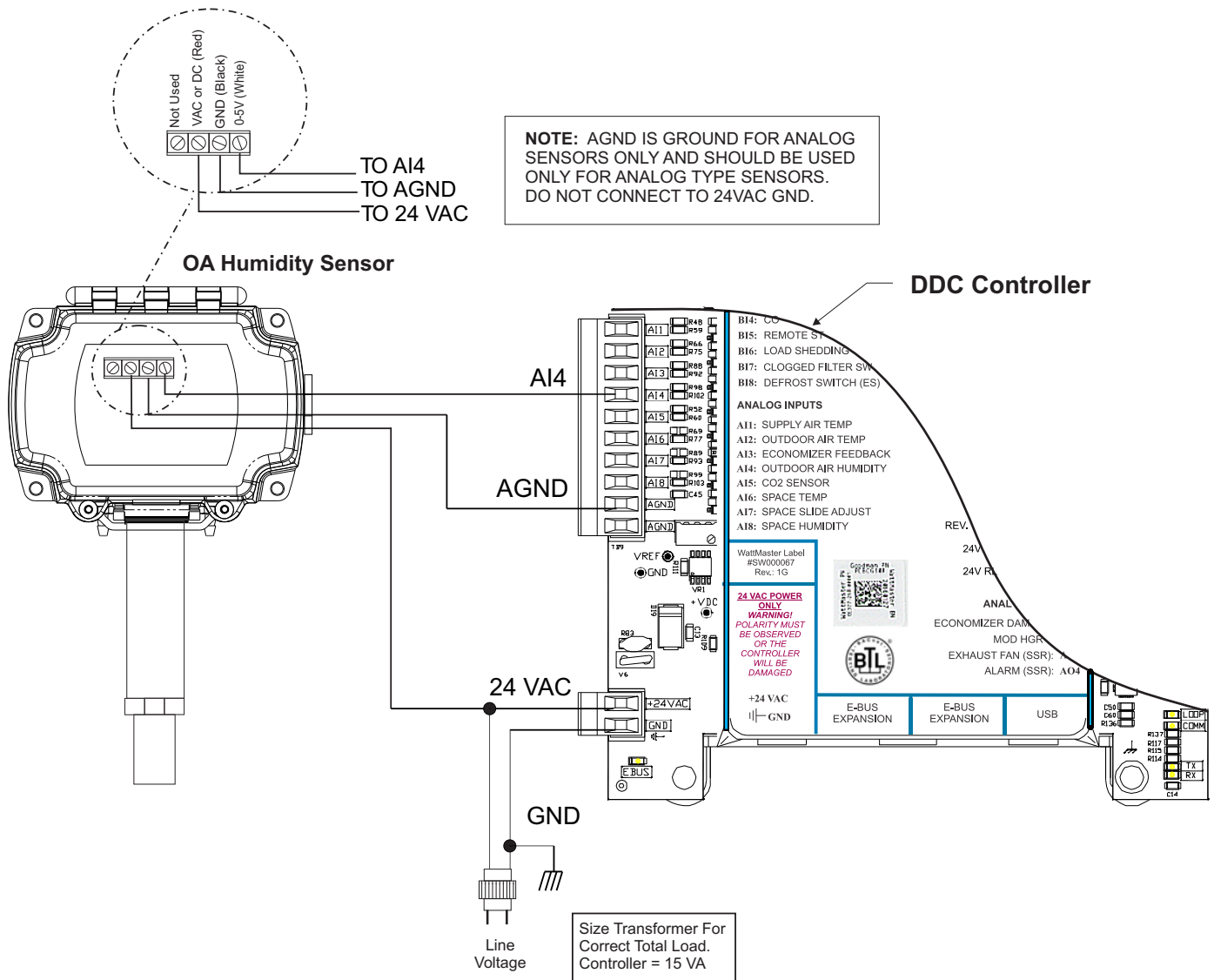

Figure 15: OE265-13-G – Outdoor Air Humidity Sensor Wiring

Economizer Actuator Feedback Signal Wiring

Economizer Actuator Feedback Signal

The Economizer Actuator Feedback signal is wired to the AI3 input.

See **Figure 16**, below for wiring. See **Figure 17** for Economizer Damper Actuator wiring.

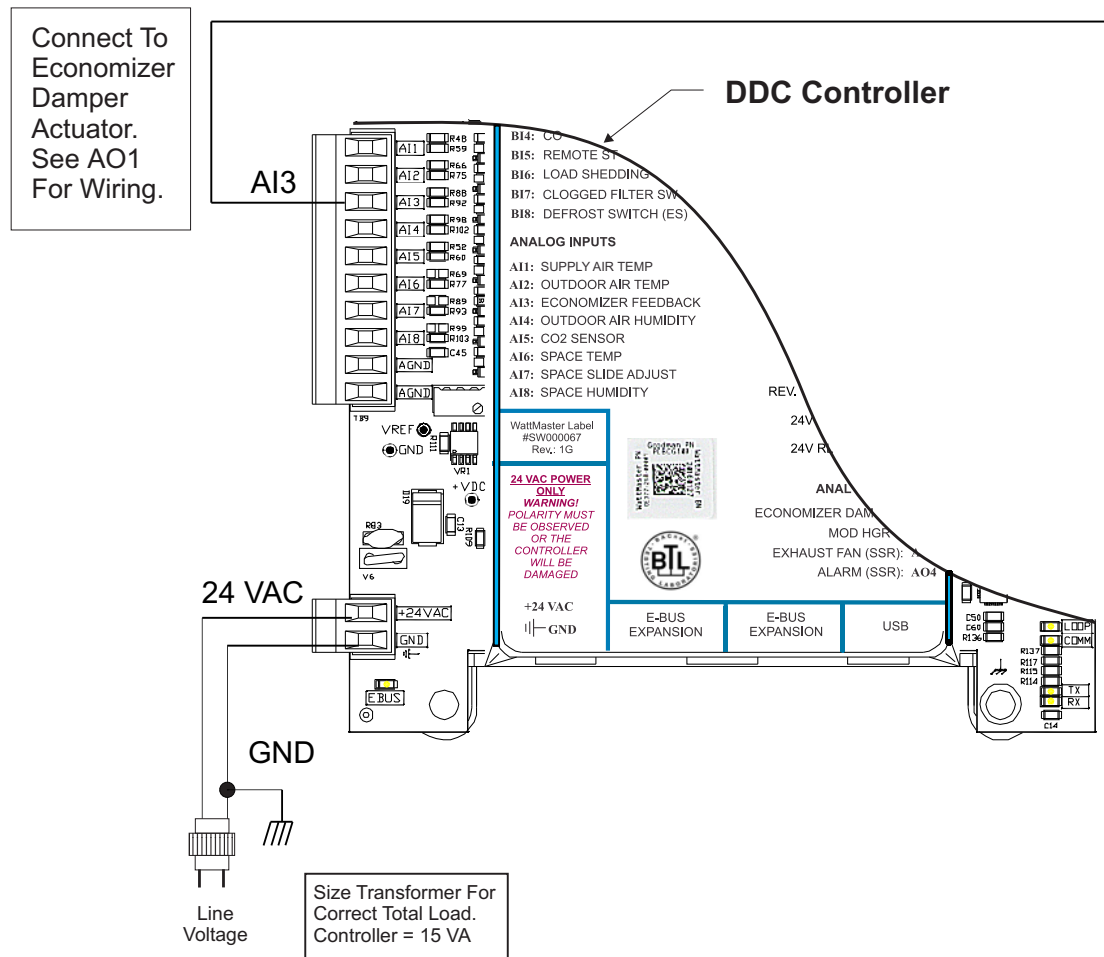

Figure 16: Economizer Actuator Feedback Signal Wiring

INSTALLATION & WIRING

Exhaust Fan Signal Wiring

Exhaust Fan Signal

The Exhaust Fan Signal (by others) uses a 0-10 VDC analog output (AO3) on the DDC Controller. However, it is not modulating. 0V = Off and 10V = On.

See **Figure 18**, below for detailed wiring.

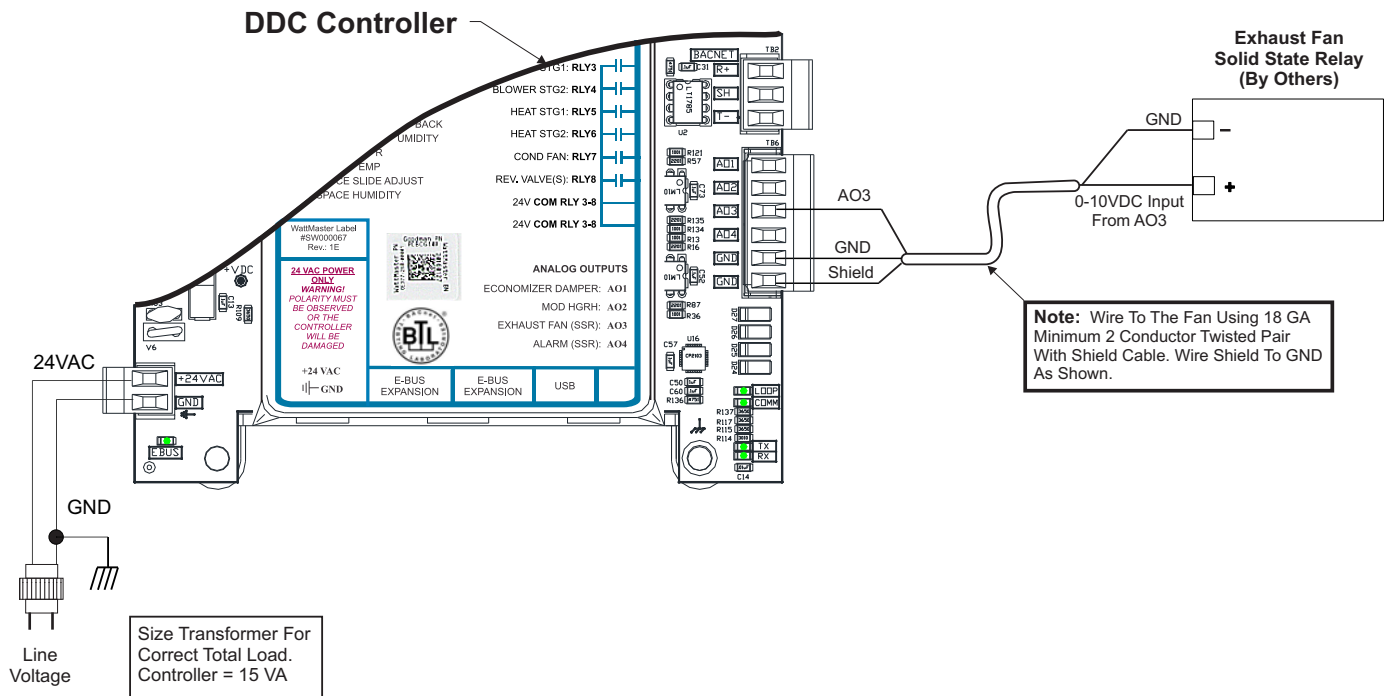

Figure 18: Exhaust Fan Wiring

Alarm Signal

The Alarm Signal (by others) uses a 0-10 VDC analog output (AO4) on the DDC Controller. However, it is not modulating. 0V = Normal and 10V = Alarm.

See **Figure 19**, below for detailed wiring.

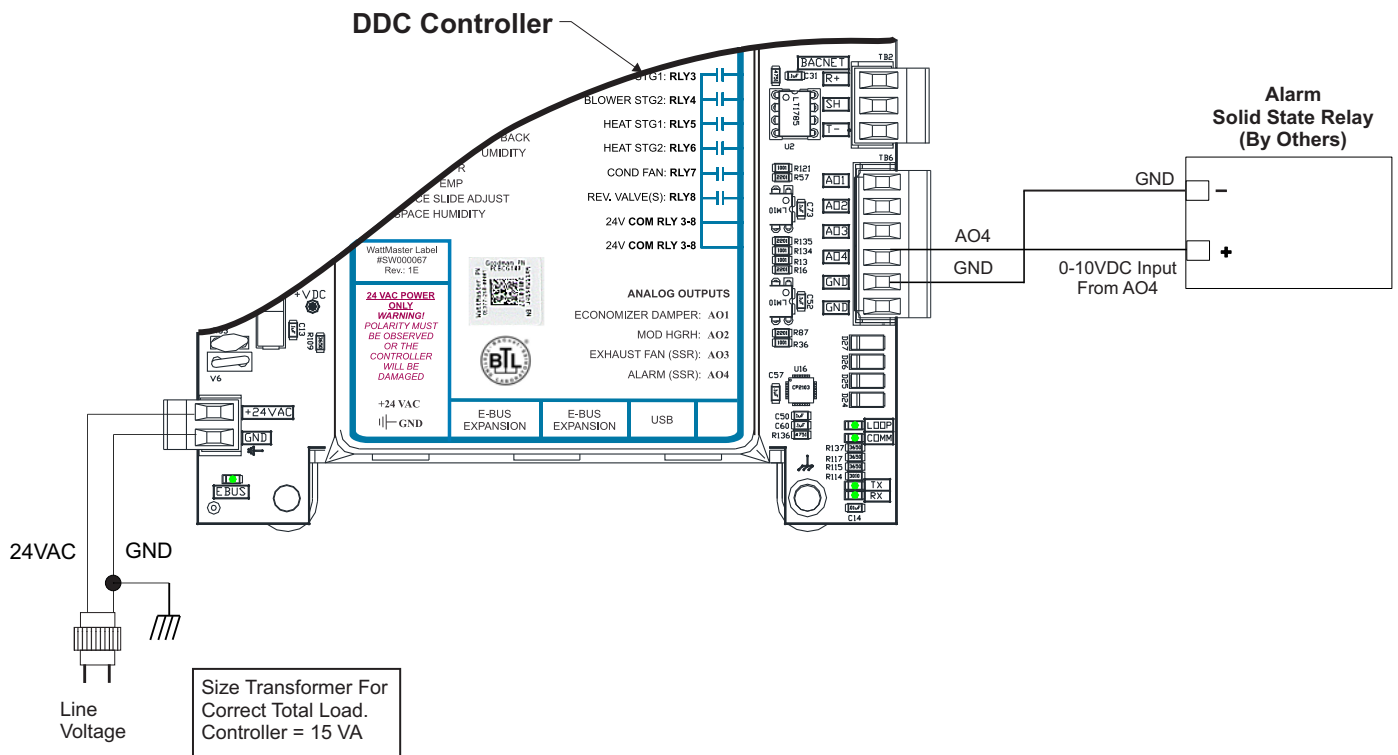

Figure 19: Alarm Solid State Wiring

Communication Settings

Communication Settings

Stand Alone Operation

The DDC Controller has an on-board CommLink that is used during Stand-Along operation when using PrismD. When configured for Stand-Along operation, a computer running PrismD software can be connected directly to the USB port located at the bottom of the DDC Controller for programming and monitoring.

Stand Alone Mode also applies if you are using a System Manager Touch Screen II-G and you are not using an external CommLink or MiniLink anywhere on the loop.

In order to operate in Stand-Along Mode when using either operator interface - PrismD or the System Manager Touch Screen II-G, both CommLink Jumpers found on the upper left-hand side of the board need to be set to ON and the communication loop wiring needs to be disconnected, if applicable. See **Figure 20**, below for details.

Interconnected or Network Operation

The DDC Controller can be configured for connection to an interconnected or networked system that has an external CommLink. In this case, the on-board CommLink would not be used. For this configuration, both CommLink Jumpers found on the upper left-hand side of the board need to be set to OFF. See **Figure 20**, below for details. Set the CommLink 5 to single if controllers are on a Single loop and to Multi if controllers are on a network.

NOTE: For all applications using PrismD - stand-alone, interconnected, or network -, you must install the USB drivers. See the *PrismD Technical Guide* for details.

NOTE: For Stand-Along Programming, You Must Disconnect The Controller From The Communications Loop.

ON-BOARD COMMLINK SETTING

| Jumper 1 | Jumper 2 | Setting |
|----------|----------|-----------------------|
| ON | ON | Use On-Board CommLink |
| OFF | OFF | Use External CommLink |

Both Jumpers ON (Default)



USE ON-BOARD COMMLINK

Both Jumpers OFF



USE EXTERNAL COMMLINK

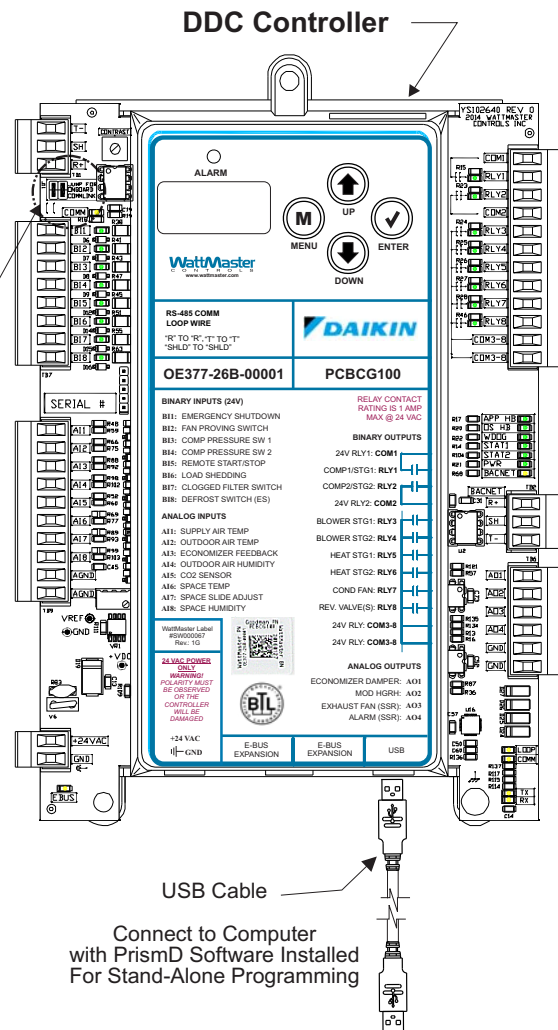

Figure 20: DDC Controller On-Board CommLink Setting

Before Applying Power

In order to have a trouble free start-up, it is important to follow a few simple procedures. Before applying power for the first time, it is very important to run through a few simple checks.

One of the most important checks to make before powering up the system for the first time is to confirm proper voltage and transformer sizing for each controller. Each DDC Controller requires 15 VA of power delivered to it at 24 VAC. You may use separate transformers for each device (preferred) or power several devices from a common transformer. If several devices are to be powered from a single transformer, correct polarity must be followed.

WARNING: Observe Polarity! All boards must be wired with GND-to-GND and 24 VAC-to-24 VAC. Failure to observe polarity will result in damage to one or more of the boards.

Check all wiring leads at the terminal block for tightness. Be sure that wire strands do not stick out and touch adjacent terminals. Confirm that all sensors required for your system are mounted in the appropriate location and wired into the correct terminals on the DDC Controller.

After all the above wiring checks are complete, apply power to the DDC Controller.

Before Removing Power

CAUTION: Disconnect all communication loop wiring from the controller before removing power from the controller. Reconnect power and then reconnect the communication loop wiring.

Programming the Controller

The next step is programming the controller for your specific requirements. In order to configure and program the DDC Controller, you must use an operator interface. Two different operator interfaces are available for programming and monitoring of the DDC Controller. See **Figure 21**, below. They are as follows:

- System Manager Touch Screen II-G
- Computer with PrismD Computer Software & USB Drivers Installed and the CommLink 5 Communications Interface (CommLink 5 is only needed for interconnected, network, or remote operations)

Any of these devices or a combination of them can be used to access the status, configuration, and setpoints of any controller on your communications loop.

If using a computer and the PrismD Computer Software, refer to the *PrismD Technical Guide*. If using the System Manager Touch Screen with your system, refer to the *System Manager Touch Screen II-G Technical Guide* for complete DDC Controller programming instructions.

No matter which operator interface you use, we recommend that you proceed with the programming and setup of the DDC Controller in the order that follows:

1. Configure Economizer and Electric Heat (if applicable).
2. Calibrate the Economizer.
3. Program the Controller setpoints.
4. Program the Controller operation schedules.
5. Set the Controller current time and date.
6. Review Controller status screens to verify system operation and correct Controller configuration.

NOTE: For BACnet® Configuration, see **Appendix C**.



Figure 21: PrismD Computer Software and System Manager TS II-G Operator Interfaces

DDC Controller Inputs

Analog Inputs (See Figure 4, page 16)

AI1 - Supply Air Temperature Sensor Input

Once the unit is in the Heating or Cooling Mode (based on the temperature from the mode enable sensor), the unit will control the staging of the heating or cooling sources to maintain a Heating or Cooling Supply Air Setpoint. The HVAC unit must always have a Supply Air Temperature Sensor installed. Thermistor Duct Mounted Sensor is required for operation. Factory provided for field installation.

AI2 - Outdoor Air Temperature Sensor Input

The Outdoor Air Temperature is used to lock out Heating or the Compressors to conserve energy and to prevent damage to the unit at whatever temperature you deem appropriate for each Mode of Operation. The Outdoor Air Temperature Sensor is also required for Economizer operation. The HVAC unit must always have an Outdoor Air Temperature Sensor installed. Thermistor Outdoor Air Mounted Sensor is required for operation. Factory installed.

AI3 - Economizer Feedback Signal

If Economizer operation has been configured, this input is required and will be used for the 2-10 VDC converted to 0-100% Feedback Signal from the Economizer actuator. Feedback signal follows the physical position of the Economizer Damper.

AI4 - Outdoor Air Humidity Sensor Input

This input is used to connect an Outdoor Air Humidity Sensor that when combined with the Outdoor Air Temperature Sensor reading is used to calculate Dewpoint, Wetbulb, and Enthalpy readings. The Outdoor Air Humidity is required for Wetbulb, Dewpoint and Enthalpy configuration of Economizer. 0-5VDC Outdoor Humidity Sensor. 0-5V converted to 0 to 100%.

AI5 - CO₂ Sensor Input

This Sensor is required if you need to monitor Indoor Air Quality and modify the Economizer operation based on levels of CO₂ in the space or building you are monitoring. The CO₂ Sensor can be either a Wall Mounted CO₂ Sensor or and Return Air Mounted CO₂ Sensor as required by the specific application. CO₂ Sensor is a field installed option. 0-10VDC CO₂ Sensor with a range of 0-2000 ppm.

AI6 - Space Temperature Sensor Input

The Space Temperature Sensor will initiate Occupied Heating and Cooling modes if the unit is configured for Space Temperature control. If the Space Temperature Sensor used is equipped with the optional Push-Button Override feature, this input will detect user overrides and switch the unit from the Unoccupied Mode back to the Occupied Mode operation for a user-adjustable amount of time. Space Temperature - Required for operation. Factory provided for field installation. Thermistor Analog Type III Space Sensor.

AI7 - Space Temperature Sensor Slide Adjust

If the Space Temperature Sensor being used has the optional Slide Adjust feature, its AUX output is connected to this input. The Slide Adjust control is used to vary the HVAC Mode Heating and Cooling Setpoints by a user-configured maximum amount. Space Slide Adjust - +/-3°F. If Thermistor Type Space Sensor, Resistive Slide Adjust included on sensor.

AI8 - Space Humidity Sensor Input

The Indoor Air Humidity Sensor is used for Monitoring Only at this time. The Sensor is a Wall-Mounted Space Humidity Sensor or Duct-Mounted Return Air Humidity Sensor. 0-5VDC Space Mounted Humidity Sensor. 0-5V converted to 0 to 100%

NOTE: All Temperature Sensors must be Thermistor Type III which provide 77.0°F @ 10K Ohms Resistance.

Binary Inputs (See Figure 3, page 15)

BI1 - Emergency Shutdown Input

The Emergency Shutdown input is used to tell the Controller that a manual safety has tripped and disabled the unit. Once the 24VAC on this input is removed, the Controller shuts off all outputs so that when the manual safety is reset and 24VAC is restored to the binary input, the Controller can energize the outputs following the programmed Minimum Off Times.

BI2 - Fan Proving Input

A Fan Proving Switch that provides a wet contact closure whenever the HVAC unit Supply Fan is operating can be connected to this input. If the Fan Proving contact opens while the Supply Fan is operating, all Heating and Cooling is suspended or disabled.

BI3 - Pressure Switch 1

Typically, the source for this is the low pressure and high pressure switches for Compressor 1. If the signal for this input opens, Compressor 1 Enable Relay will de-energize and the appropriate alarm will be generated.

NOTE: If you have a Compressor with 2 Stages, the safeties will be wired to both BI3 & BI4

BI4 - Pressure Switch 2

Typically, the source for this is the low pressure and high pressure switches for Compressor 2. If the signal for this input opens, Compressor 2 Enable Relay will de-energize and the appropriate alarm will be generated.

NOTE: If you have a Compressor with 2 Stages, the safeties will be wired to both BI3 & BI4

BI5 - Remote Start/Stop Input

When this wet contact input closes, it will force the DDC Controller into the Occupied Mode. When the Remote Forced Occupied Signal is removed, the controller will revert back to the Internal Schedule.

BI6 - Load Shedding

When this wet contact input closes, the control will offset the Space Setpoint to an adjustable amount up to 4°F up from the Active Cooling Setpoint and down from the Active Heating Setpoint. If this input is open, the offset is 0°F.

BI7 - Clogged Filter Contact Closure Input

This wet contact input is required for Filter Status Indication and requires a Differential Pressure Switch to initiate a Clogged Filter alarm.

BI8 - Defrost Coil Temperature Switch Input

This input is required for heat pump applications. This wet contact input monitors a Defrost Coil Temperature Switch on air to air heat pump units. If the compressors are operating in the Heating Mode and this switch closes, it will initiate the Defrost Timer, which when met, will then initiate a Defrost Mode.

NOTE: The Binary Inputs require wet contacts (24 VAC only) to recognize an active input. If you provide dry contacts, the contact closure will not be recognized.

Analog Outputs (See Figure 5, page 17)

AO1 - Economizer (Outdoor Air Damper) Control Signal

This 2-10 VDC - 0-100% voltage signal is used to control the Outdoor Air Damper during Economizer operation. It is also used to maintain the Outdoor Air Damper at its Minimum Position during the Occupied Mode when the Outdoor Air Temperature is not suitable for Economizer Cooling purposes. This minimum position can be reset based on CO₂ override conditions.

AO2 - (Not Used)

AO3 - Exhaust Fan Signal (SSR)

If the Economizer is open past the minimum position, this output will activate a Solid State Relay (SSR) using a 10VDC signal from AO3. (0V = Off, 10V = On).

AO4 - Alarm Control Signal (SSR)

This voltage signal is used to provide alarm annunciation using an Alarm Solid State Relay (SSR). Uses Analog Output to control Solid State Relay Only (0V = Normal, 10V = Alarm).

Binary Outputs (See Figure 5, page 17)

RLY1 - Compressor 1 Output

This relay turns on the 1st Compressor.

RLY2 - Compressor 2 / Stage 2 Output

If the unit has two compressors, this relay turns on the 2nd compressor. If the unit has a 2 stage, single compressor, this relay energizes the 2nd stage of the compressor.

RLY3 - Low Speed Blower Output

If configured for single-speed, this relay controls the single-speed Blower. If configured for two-speed, this relay controls the Low Speed Blower operation.

RLY4 - High Speed Blower Output

If configured for two-speed, this relay turns on the High Speed Blower operation or it remains off.

RLY5 - Heat Stage 1 Output

This relay turns on the 1st stage of heat or 1st stage of Aux Heat.

RLY6 - Heat Stage 2 Output

This relay turn on the 2nd stage of heat or 2nd stage of Aux Heat.

RLY7 - Condenser Fan Output

This relay turns on the Condenser Fan.

RLY8 - Reversing Valve(s) Output (Heat Pump Applications Only)

This relay turns on the Reversing Valve(s) for Cooling and turns them off for Heating. If the unit is configured for anything other application than Heat Pump, this output remains de-energized.

SEQUENCE OF OPERATIONS

Scheduling, Occupancy, HVAC Modes & Blower Control

Scheduling / Occupancy

- 2 event per day Weekly Schedule
- 14 Holidays per year
- Remote Occupied Binary Input
- Remote Occupied via BACnet® or LONworks®
- Remote Force Schedule Mode via PrismD computer software.
- Optimal Start - The goal of the optimal start feature is to make sure the Space Temperature reaches the Space Temperature Setpoint at the start of the programmed schedule. To achieve this goal, the DDC Controller will activate the system before the start of the programmed schedule to provide Heating or Cooling as needed to bring the Space Temperature to setpoint.

HVAC Modes of Operation

There are 4 possible HVAC Modes of Operation. They are as follows:

- Cooling Mode
- Heating Mode
- Vent Mode
- Off Mode

Cooling Mode

- If the Space Temperature rises above the Space Cooling Setpoint plus 75% of the Deadband, and the Vent Mode Timer is met, the controller will enter the Cooling Mode.
- If the Space Temperature drops 75% of the Deadband below the Space Cooling Setpoint, the controller will enter the Vent Mode.

Heating Mode

- If the Space Temperature drops below the Space Heating Setpoint minus 75% of the Deadband, and the Vent Mode Timer is met, the controller will enter the Heating Mode.
- If the Space Temperature rises 75% of the Deadband above the Space Heating Setpoint, the controller will enter the Vent Mode.

Vent Mode

- When the unit goes from Unoccupied to Occupied, the controller first goes into a Vent Mode to bring fresh air into the facility. It will stay in this mode for a minimum time set by the Vent Mode Minimum Timer.
- Vent Mode is also active when the controller is in Occupied Mode, the Blower is set for continuous operation, and there is no call for Heating or Cooling.
- During Vent Mode, the Low Speed/Single Speed Blower will be active. There is no call for Heating or Cooling because the Space Sensor Temperature (Controlling Sensor) is between the Space Cooling and Space Heating setpoints. Any time the controller switches from one mode to another; it must always go through the Vent Mode. For example, if the Unit is in the Cooling Mode and a call for Heat is generated, the controller will switch to Vent Mode and remain there until the Vent Mode Minimum Time is met. It can then switch to Heat Mode. However, if the previous call was the same as the new call, the Vent Mode Timer is ignored and the controller can re-enter that mode without delay (assuming the appropriate Minimum Off timers have been met).

Off Mode

- Off Mode occurs in the Unoccupied Mode if there is no call for Heating or Cooling. The blower will not be running.
- Off Mode occurs in the Occupied Mode if the blower is set to Fan Cycle operation and there is no call for Heating or Cooling. The blower will not be running.

Blower Control

The blower can be configured as Single or Two Speed. (NOTE: The motor has to match the configuration).

- Single speed blower - If the blower is set for Continuous operation, the blower runs continuously during Occupied Mode if there is no shutdown alarm. If the blower is set for Fan Cycle operation, the blower only runs when there is a call for Cooling (including Economizer Cooling), Heating, or high CO₂ (if selected). The blower remains off if the demands are removed. (NOTE: For Gas applications, the controller doesn't control the blower during Heating Mode.)
- Two speed blower – Speeds are controlled by the Low Speed and High Speed Blower Relay Outputs. Any time the blower switches between speeds, the current blower speed relay will turn off and there will be a 2 second delay before the other blower speed relay turns on.

Cool, Heat, Heat Pump Enabled & Economizer Enable

Cool Enable

If all of the following conditions are met, the compressors will be enabled.

- 24VAC is applied to the Shutdown Input.
- The blower is on and Fan Proof of Flow is met.
- The Outdoor Air Temperature is above the Cooling Compressor Outdoor Air Lockout Setpoint to enable the compressors in Cooling Mode or is above the Heat Pump Outdoor Air Lockout Setpoint to enable the compressors in Heat Pump Heating Mode.
- The unit is in the Cooling Mode or Heating Mode and the Supply Air Low Temperature Cutoff has not been activated.
- When 24 VAC is applied to Pressure Switch Input 1, Compressor 1 will be enabled.
- When 24 VAC is applied to Pressure Switch Input 2, Compressor 2 will be enabled.

Heat Enable

If all of the following conditions are met, Heat will be enabled.

- 24VAC is applied to the Emergency Shutdown Input.
- The blower is on and Fan Proof of Flow is met.
- The Outdoor Air Temperature is below the Heat Outdoor Air Temperature Lockout Setpoint.
- The Supply Air High Temperature Cutoff has not been activated.

Heat Pump Enable

If all of the following conditions are met, the Heat Pump Heat will be enabled.

- The 24VAC is applied to the Emergency Shutdown Input.
- The blower is on and Fan Proof of Flow is met.
- The Outdoor Air Temperature is below the Heat Outdoor Air Temperature Lockout Setpoint.
- The Outdoor Air Temperature is above the Heat Pump Heat Outdoor Air Temperature Lockout Setpoint.

Economizer Enable

If all of the following conditions are met, the Economizer will be enabled and will be used as the 1st Stage of Cooling.

- The Economizer configuration is set to something other than “No Economizer Control”; otherwise, it will remain at 0%.
- The Unit is in Occupied Mode.
- The Outdoor Air Temperature must be below the Economizer Outdoor Air Drybulb Enable Setpoint in all economizer configurations.
- If configured for Wetbulb, Dewpoint, or Enthalpy control, the Outdoor Wetbulb, Dewpoint or Enthalpy Temperature must also be below the Enthalpy/Wetbulb/Dewpoint Outdoor Air Enable Setpoint in addition to the outdoor conditions above. All options have a 2°F/BTU deadband or differential.

NOTE: During Occupied Mode, if the Economizer is configured to be used and is locked out due to outdoor conditions, the Economizer will remain at the Minimum Position.

Exhaust Fan Enable

An exhaust fan can be wired to the DDC Controller and will enable anytime the unit is operating in Economizer mode.

CO₂ Economizer Override

The Economizer Minimum Position can be reset higher based on indoor CO₂ levels.

- Low and High CO₂ Level Setpoints can be configured
- A Minimum Economizer Position and a High CO₂ Economizer Minimum Position can be configured
- As the CO₂ level rises from the Low to High CO₂ Level Setpoints, the Economizer Minimum Position will be proportionally reset higher from the configured Minimum Economizer Position to the High CO₂ Economizer Minimum Position
- The Economizer can still open further based on Economizer Cooling requirements

Alarms

Alarm Detection and Reporting

The DDC Controller continuously performs self diagnostics during normal operation to determine if any operating failures have occurred.

These failures (alarms) can be reported to the Touch Screen System Manager II-G, to a computer running PrismD software, or through BACnet® or LONWorks®.

The following are the available alarm designations for the DDC Controller:

- Supply Air Temperature Sensor Missing
- Space Temperature Sensor Missing Alarm
- Outdoor Air Temperature Sensor Missing Alarm
- Mechanical Cooling Failure Alarm
- Mechanical Heating Failure Alarm
- Fan Proof of Flow Alarm
- Dirty Filter Switch Alarm
- Emergency Shutdown Alarm
- Low Pressure Switch 1 Alarm
- Low Pressure Switch 2 Alarm
- High / Low Space Temperature Alarm
- High Supply Air Temperature Alarm
- Low Supply Air Temperature Alarm
- Economizer Not Economizing Alarm
- Economizer Economizing When it Should Not Alarm
- Economizer Not Modulating Alarm
- Economizer Excess Outdoor Air Alarm
- BACnet® Space Sensor Alarm
- BACnet® Outdoor Air Sensor Missing Alarm
- BACnet® Outdoor Air Humidity Sensor Missing Alarm
- BACnet® Indoor Air Humidity Sensor Missing Alarm
- BACnet® CO₂ Sensor Missing Alarm
- BACnet® Load Shedding Sensor Missing Alarm (For future use)
- BACnet® Schedule Alarm
- BACnet® Economizer Signal Missing Alarm (For future use)

Sensor Failure Alarms

Supply Air Temperature Sensor Failure Alarm

The Supply Air Temperature Sensor Failure Alarm is generated when the controller detects an open or short circuit on the Supply Air Temperature Sensor input. Once the alarm is generated, the unit will be completely shut down. If a sensor is properly detected after the unit has alarmed, the alarm will be cleared and the unit will restart operations.

Space Temperature Sensor Failure Alarm

The Space Temperature Sensor Failure Alarm is generated when the controller detects an open or short circuit on the Space Temperature Sensor input. Once the alarm is generated, the unit will be completely shut down. If a sensor is properly detected after the unit has alarmed, the alarm will be cleared and the unit will restart operations.

Outdoor Air Temperature Sensor Failure Alarm

The Outdoor Air Temperature Sensor Failure Alarm is generated when the controller detects an open or short circuit on the Outdoor Air Temperature Sensor input. When this occurs, the Outdoor Air reading will be artificially set to -255 and an alarm will be generated. The unit will still continue to operate in the Cooling and Heating modes without looking at the Outdoor Air Lockouts; however, the Economizer will go to 0% and be disabled.

CO₂ Sensor Failure Alarm

This alarm is generated if the controller is configured to have a CO₂ sensor, but does not detect it. IAQ Mode is disabled when this occurs. If a sensor is properly detected after the unit has alarmed, the alarm will be cleared and the unit will be return to CO₂ control.

Outdoor Air Humidity Sensor Failure Alarm

The Outdoor Air Humidity Sensor Failure Alarm is generated when the controller detects an open or short circuit on the Outdoor Air Humidity Sensor input. If a sensor is properly detected after the unit has alarmed, the alarm will be cleared and the unit will restart operations.

Space Humidity Sensor Failure Alarm

The Space Air Humidity Sensor Failure Alarm is generated when the controller detects an open or short circuit on the Space Humidity Sensor input. If a sensor is properly detected after the unit has alarmed, the alarm will be cleared and the unit will restart operations.

Mechanical Failure Alarms

Mechanical Cooling Failure

The Mechanical Cooling Failure Alarm is generated if the Supply Air Temperature fails to drop a user-adjustable amount within a user-adjustable time period from the temperature the supply air was at when the cooling was activated. The alarm will be cleared when the Supply Air Temperature drops by the user-adjustable amount. The failure timer is also set back to zero.

Mechanical Heating Failure

The Mechanical Heating Failure Alarm is generated if the Supply Air Temperature fails to rise a user-adjustable amount within a user-adjustable time period from the temperature the supply air was at when the heating was activated. The alarm will be cleared when the Supply Air Temperature rises by the user-adjustable amount. The failure timer is also set back to zero.

Fan Proving Alarm

A Fan Proving switch provides a 24 VAC wet contact closure when the Supply Fan is operating. If this contact opens while the fan is being called to run, all heating and cooling is disabled, and a Fan Proving Alarm is generated.

Clogged Filter Switch Alarm

A differential pressure switch is used to provide a 24 VAC wet contact closure to indicate a clogged filter status. A Clogged Filter Alarm is then generated. A Clogged Filter alarm is also generated when the Accumulated Fan Run Time exceeds the Clogged Filter Fan Run Time Setpoint.

Emergency Shutdown Alarm

This alarm will occur when a manual safety has tripped and disabled the unit. Once the 24VAC on this input is removed, the Controller shuts off all outputs so that when the manual safety is reset and 24VAC is restored to the binary input, the Controller can energize the outputs following the programmed Minimum Off Times.

Low Pressure Switch 1 Alarm

When the compressor energizes, the Low Pressure Switch is ignored for the first 2 minutes to allow the refrigerant circuit to equalize without generating false trips. However, if the controller attempts to energize the compressor output and the Low Pressure Switch is already open, the compressor will not be allowed to energize and an alarm is generated.

If the Compressor energizes properly and the first 2 minute ignore timer is met, if the Low Pressure Switch opens, the compressor will immediately de-energize and an alarm will be generated.

If the Controller counts 5 Low Pressure Switch trips within a 4 hour period, the controller will completely lock out the compressor and a Manual Reset of the Pressure Switch Alarm is required.

Low Pressure Switch 2 Alarm

When the compressor energizes, the Low Pressure Switch is ignored for the first 2 minutes to allow the refrigerant circuit to equalize without generating false trips. However, if the controller attempts to energize the compressor output and the Low Pressure Switch is already open, the compressor will not be allowed to energize and an alarm is generated.

If the Compressor energizes properly and the first 2 minute ignore timer is met, if the Low Pressure Switch opens, the compressor will immediately de-energize and an alarm will be generated.

If the Controller counts 5 Low Pressure Switch trips within a 4 hour period, the controller will completely lock out the compressor and a Manual Reset of the Pressure Switch Alarm is required.

Failure Mode Alarms

High / Low Space Temp Alarm

This alarm is activated when the Space Temperature rises above the Cooling Temperature Setpoint or drops below the Heating Temperature Setpoint for a user-adjustable alarm offset value and time period.

High and Low Supply Temp Alarm

These alarms are activated when the Supply Air Temperature (SAT) rises above the High Cutoff Temperature Setpoint (immediate) or drops below the Low Cutoff Temperature Setpoint (for 10 minutes). Both cutoff setpoints are user-adjustable.

If the SAT rises above the High Cutoff Temperature Setpoint, the controller will shut off all outputs except the Fan.

If the SAT drops below the Low Cutoff Temperature Setpoint, the controller will shut off all outputs including the Fan.

The unit will automatically try running again if the SAT comes back into range after 10 minutes.

Title 24 Economizer Alarms

Economizer Temperature Sensor Failure

Outside Air or Supply Air Temperature Sensor is shorted or missing.

Economizer Not Economizing When It Should
Economizer is enabled but not following the desired Economizer position commanded.

Economizer Is Economizing When It Should Not
Economizer is not enabled but the feedback signal indicates a position open more than the minimum.

Economizer Damper Not Modulating

Economizer is enabled but not within 10% of desired position within 150 seconds.

Economizer Excess Outdoor Air Filter

Economizer feedback is lost or Economizer is not following commanded position.

Trend Logging

Trend Logging

The DDC Controller continuously maintains an Internal Trend Log in memory which records a fixed set of values at a user-defined interval.

120 log positions (timed retrievals) are available on the controller. Once these positions are full, the controller begins overwriting the oldest data.

Values can be retrieved using the PrismD software program.

With PrismD running continuously, values can be saved to the computer hard drive at regular intervals to keep from losing data.

The following are the fixed items that can be logged:

- Date
- Time
- Mode of Op (Occupied / Override / Unoccupied)
- HVAC Mode
- Space Temperature
- Active Cooling Mode Setpoint
- Active Heating Mode Setpoint
- Slide Adjust
- Supply Air Temperature
- Outdoor Air Temperature
- Outdoor Air Temperature & Humidity
- Indoor Humidity
- Outdoor Air Dewpoint
- Outdoor Air Wetbulb
- Outdoor Air Enthalpy
- CO2
- Economizer Position
- Economizer Feedback
- Economizer Enabled
- Compressor Enabled
- Heat Enabled
- Defrost Switch
- Defrost Mode
- Shed Status
- Low Speed Blower Relay
- High Speed Blower Relay

- Compressor Fan 1 Relay
- Compressor Fan 2 Relay
- Heat 1 Relay
- Heat 2 Relay
- Reversing Valve Relay
- Condenser Fan Relay
- High Speed Blower Proof of Alarm
- Dirty Filter Switch Alarm
- Emergency Shutdown Alarm
- Pressure Switch Alarm 1
- Pressure Switch Alarm 2
- High Supply Air Temperature Alarm
- Low Supply Air Temperature Alarm
- Mechanical Cooling Alarm
- Mechanical Heating Alarm
- Space Temperature Alarm
- Space Sensor Missing Alarm
- Outdoor Air Temperature Sensor Missing Alarm
- Economizer Not Economizing Alarm
- Economizer Economizing When it Should Not Alarm
- Economizer Not Modulating Alarm
- Economizer Excess Outdoor Air Alarm
- BACnet® Space Sensor Alarm
- BACnet® Outdoor Air Sensor Missing Alarm
- BACnet® Outdoor Air Humidity Sensor Missing Alarm
- BACnet® Indoor Air Humidity Sensor Missing Alarm
- BACnet® CO2 Sensor Missing Alarm
- BACnet® Load Shedding Sensor Missing Alarm
- BACnet® Schedule Alarm

DDC Controller LEDs

The DDC Controller is equipped with LEDs that can be used to verify operation and perform troubleshooting. There are LEDs for communication, operation modes, and diagnostic codes. The LEDs associated with these inputs and outputs allow you to see what is active without using a voltmeter. See **Figure 2, page 15** for LED locations. The LEDs and their uses are as follows:

Operation LEDs - Factory Troubleshooting

PWR - This green LED will light up to indicate that 24 VAC power has been applied to the controller.

APP HB - This green LED will light up and blink continuously to indicate the application software is working properly.

OS HB - This green LED will light up and blink continuously to indicate the operating system is working properly.

WDOG - This green LED will light up and stay lit to indicate the operating system is working properly.

Diagnostic LEDs

ALARM - This red LED is a diagnostic blink code LED. It will light up and stay lit when there is an alarm present. The type of alarm will display on the LCD display.

Communication LEDs

COMM - This yellow LED will light up and blink continuously to indicate the DDC Controller is communicating.

BACNET - This yellow LED will light up and blink continuously to indicate BACnet® communications.

Relay LEDs

RLY1 - RLY8 - These green LEDs will light up when the relays are enabled and will stay lit as long as they are active.

Binary Input LEDs

B11 - This green LED will light up when the Emergency Shutdown contact is closed.

B12 - This green LED will light up when the Fan Proving switch is closed.

B13 - This green LED will light up when the Compressor 1 switch is closed.

B14 - This green LED will light up when the Compressor 2 switch is closed.

B15 - This green LED will light up when the Remote Start/Stop switch is closed.

B16 - This green LED will light up when the Load Shedding switch is closed.

B17 - This green LED will light up when the Clogged Filter switch is closed.

B18 - This green LED will light up when the Defrost Switch contact is closed.

System Configurations

System Configuration Options

The DDC Controller can be used as a Stand-Alone System (one DDC Controller only), connected together on an Interconnected System (multiple DDC Controllers only) or connected together on a Network System (multiple DDC Controllers with a CommLink or MiniLink) to form a complete Controls System that can be programmed and monitored with one or more of the available Operator Interfaces.

Operator Interfaces

The Operator Interfaces are designed to provide for programming and monitoring of DDC Controller(s) connected to your System. See **Figure 23**. The available Operator Interfaces are as follows:

- System Manager Touch Screen II-G (OE392-10-G)
- Computer with PrismD Computer Software Installed and On-Board CommLink or CommLink 5

You can use either one of these interfaces or both of them on the same DDC Control System.

Stand-Alone System

The Stand-Alone System is used when you have a single DDC Controller only. Programming and status monitoring are accomplished by selecting and installing one or more of the Operator Interfaces.

See **Figure 24** for a Typical Stand-Alone System Layout diagram.

Interconnected System

The Interconnected System is used when you have multiple DDC Controllers on your job. With this system, you simply connect the controllers together using WattMaster communications wire or 18-gauge, 2-conductor twisted pair with shield wire (Belden #82760 or equivalent). This allows for all controllers that are connected on the communications loop to be programmed and monitored from one or both of the available Operator Interfaces connected on the communications loop.

See **Figure 25** for a Typical Interconnected System Layout diagram.

Networked System

If you have 1 to 59 DDC Controllers that require information sharing, simply connect the controllers together using WattMaster communications wire or 18-gauge, 2-conductor twisted pair with shield wire (Belden #82760 or equivalent). The Networked Single Loop System requires that either a MiniLink communication interface and/or CommLink communication interface are purchased and wired into the communications loop in a similar manner to the DDC Controllers.

The Networked Multiple Loop system is used when you have more than 59 DDC Controllers. These groups of controllers are broken up into multiple “Local Loops” that connect to each other via the “Network Loop.” Each individual MiniLink handles its specific local loop’s communications requirements. The CommLink communications interface handles all the communications between the individual MiniLinks to form the network loop. Up to 60 local loops can be connected together with this configuration. This provides the capability for over 3500 controllers to be networked together.

See **Figure 26** for a Typical Networked System Layout diagram.

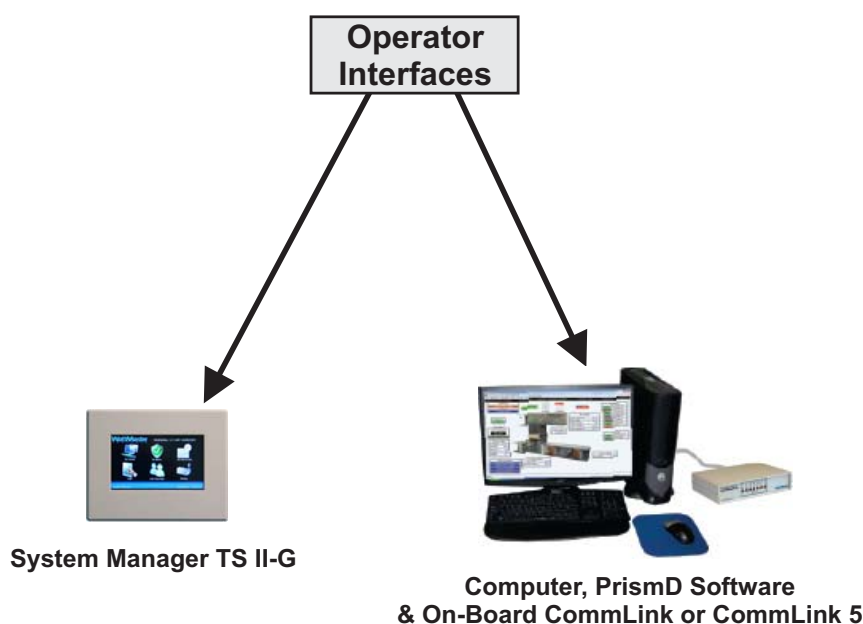

Figure 23: Available Operator Interfaces

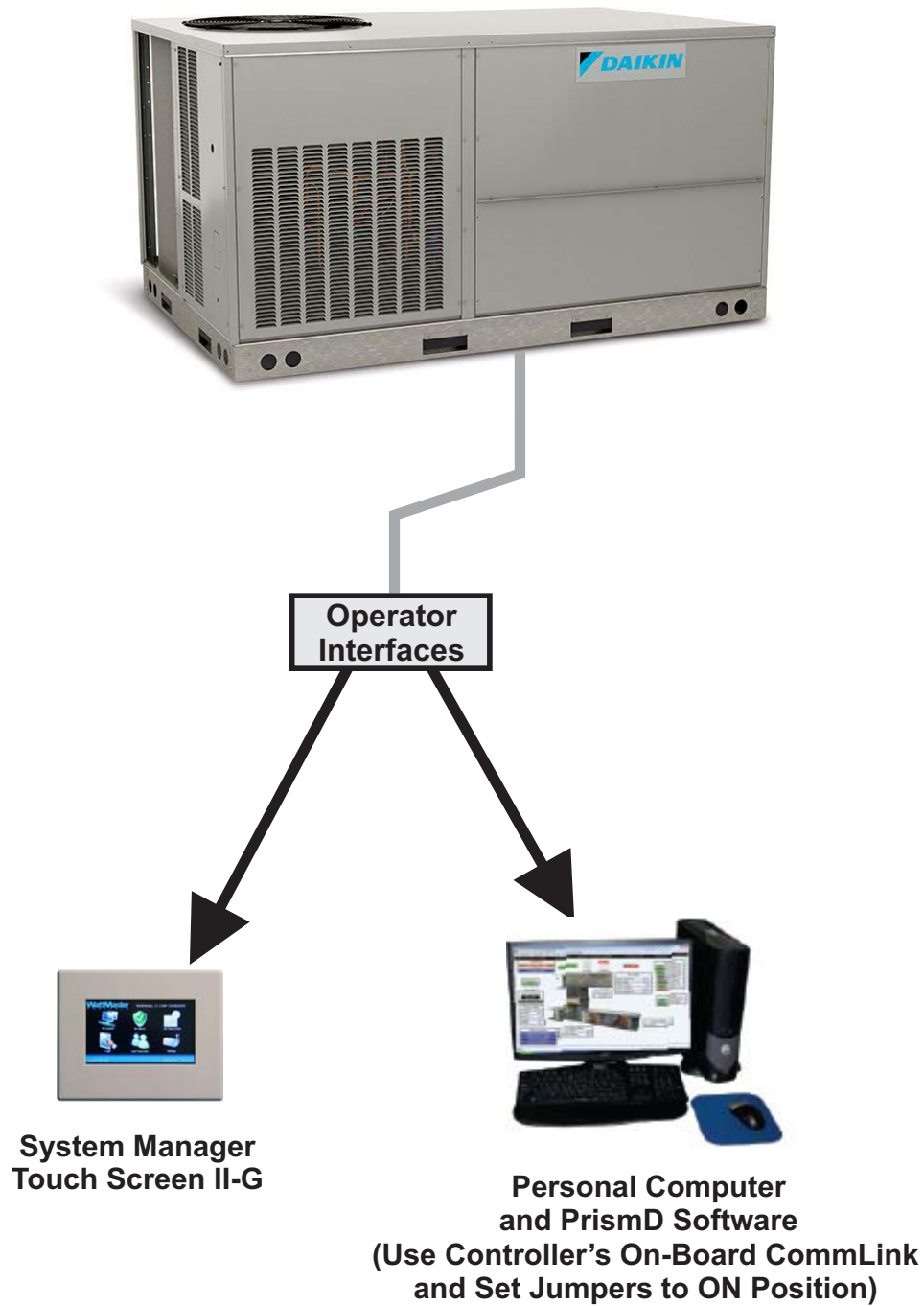

Figure 24: Typical Stand-Alone System Layout

Interconnected System Layout

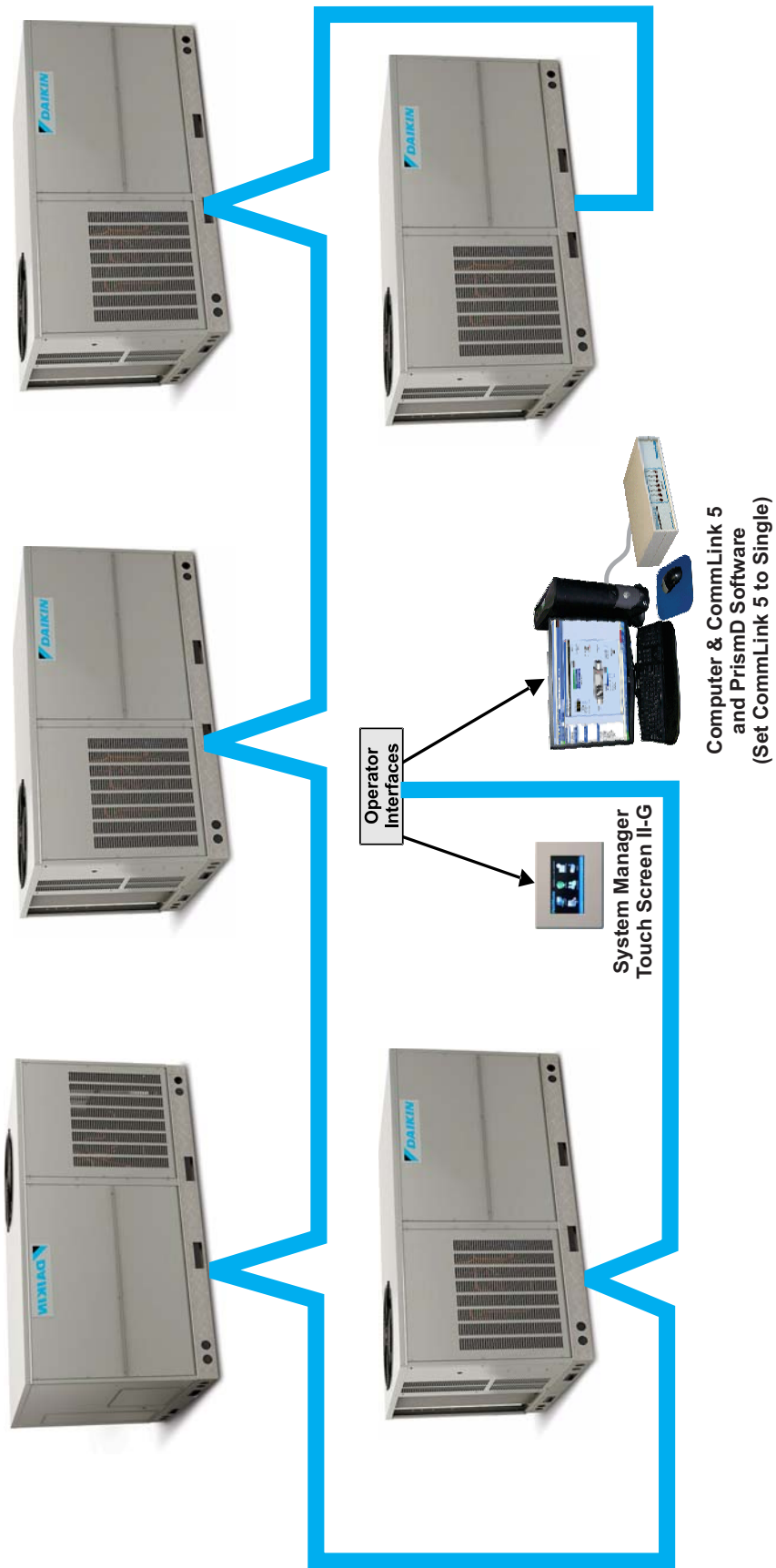

Figure 25: Typical Interconnected System Layout

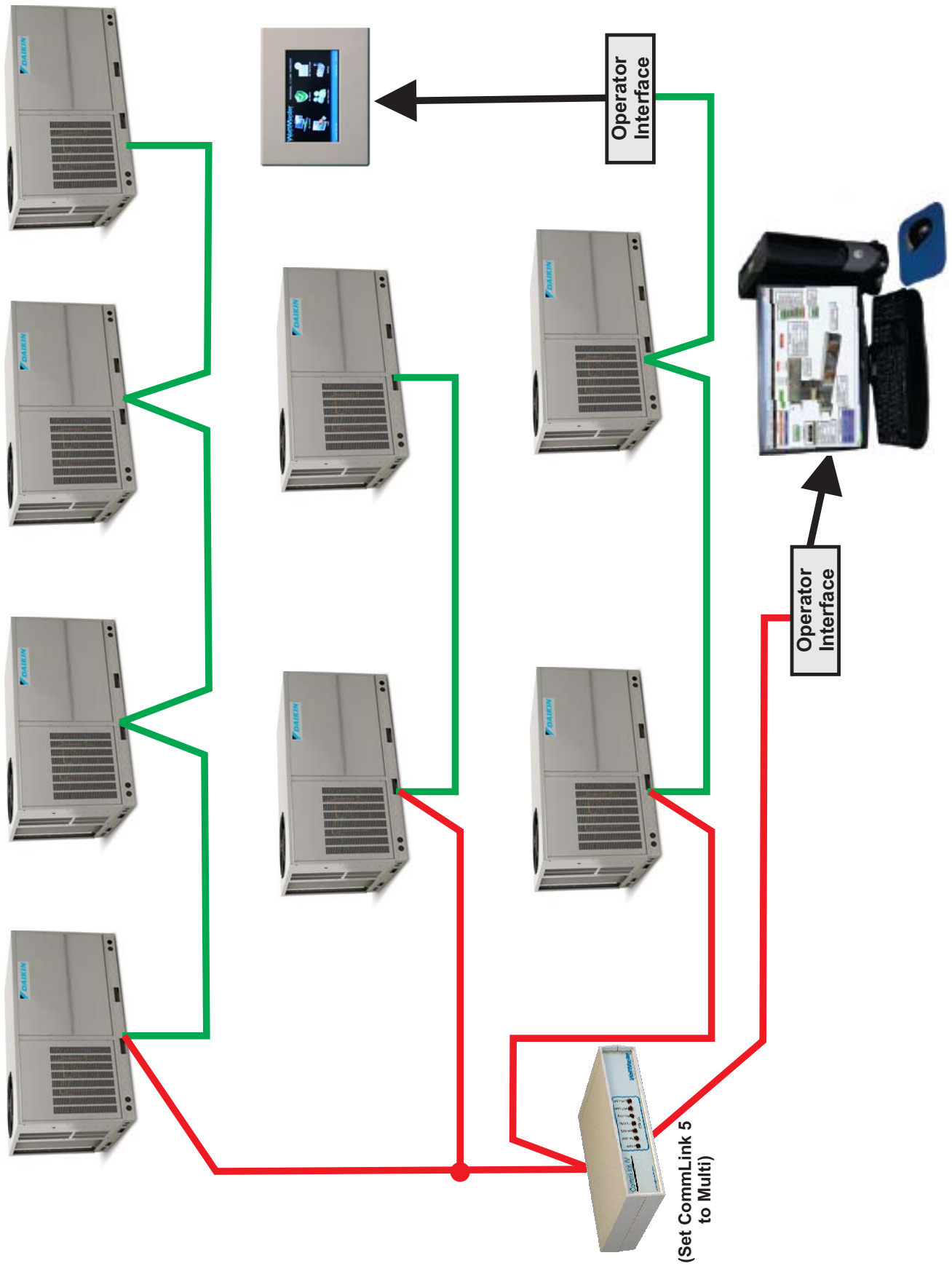

Figure 26: Typical Networked System Layout

Temperature Sensor Testing

Space & Outdoor Air Temperature Sensor Testing

The following sensor voltage and resistance table is provided to aid in checking sensors that appear to be operating incorrectly. Many system operating problems can be traced to incorrect sensor wiring. Be sure all sensors are wired per the wiring diagrams in this manual.

If the sensors still do not appear to be operating or reading correctly, check voltage and/or resistance to confirm that the sensor is operating correctly per the tables. Please follow the notes and instructions that appear after the chart when checking sensors.

| Temperature - Resistance - Voltage for Type III 10 K Ohm Thermistor Sensors | | | |
|---|-----------|-------------------|-----------------------|
| Temp (°F) | Temp (°C) | Resistance (Ohms) | Voltage @ Input (VDC) |
| -10 | -23.33 | 93333 | 4.51 |
| -5 | -20.55 | 80531 | 4.45 |
| 0 | -17.77 | 69822 | 4.37 |
| 5 | -15 | 60552 | 4.29 |
| 10 | -12.22 | 52500 | 4.2 |
| 15 | -9.44 | 45902 | 4.1 |
| 20 | -6.66 | 40147 | 4.002 |
| 25 | -3.88 | 35165 | 3.891 |
| 30 | -1.11 | 30805 | 3.773 |
| 35 | 1.66 | 27140 | 3.651 |
| 40 | 4.44 | 23874 | 3.522 |
| 45 | 7.22 | 21094 | 3.39 |
| 50 | 10 | 18655 | 3.252 |
| 52 | 11.11 | 17799 | 3.199 |
| 54 | 12.22 | 16956 | 3.143 |
| 56 | 13.33 | 16164 | 3.087 |
| 58 | 14.44 | 15385 | 3.029 |
| 60 | 15.55 | 14681 | 2.972 |
| 62 | 16.66 | 14014 | 2.916 |
| 64 | 17.77 | 13382 | 2.861 |
| 66 | 18.88 | 12758 | 2.802 |
| 68 | 20 | 12191 | 2.746 |
| 69 | 20.55 | 11906 | 2.717 |
| 70 | 21.11 | 11652 | 2.691 |
| 71 | 21.66 | 11379 | 2.661 |
| 72 | 22.22 | 11136 | 2.635 |
| 73 | 22.77 | 10878 | 2.605 |

Table 2: Temperature/Resistance for Type III 10K Ohm Thermistor Sensors

| Temperature - Resistance - Voltage for Type III 10 K Ohm Thermistor Sensors | | | |
|---|-----------|-------------------|-----------------------|
| Temp (°F) | Temp (°C) | Resistance (Ohms) | Voltage @ Input (VDC) |
| 74 | 23.33 | 10625 | 2.576 |
| 75 | 23.88 | 10398 | 2.549 |
| 76 | 24.44 | 10158 | 2.52 |
| 77 | 25 | 10000 | 2.5 |
| 78 | 25.55 | 9711 | 2.464 |
| 80 | 26.66 | 9302 | 2.41 |
| 82 | 27.77 | 8893 | 2.354 |
| 84 | 28.88 | 8514 | 2.3 |
| 86 | 30 | 8153 | 2.246 |
| 88 | 31.11 | 7805 | 2.192 |
| 90 | 32.22 | 7472 | 2.139 |
| 95 | 35 | 6716 | 2.009 |
| 100 | 37.77 | 6047 | 1.884 |
| 105 | 40.55 | 5453 | 1.765 |
| 110 | 43.33 | 4923 | 1.65 |
| 115 | 46.11 | 4449 | 1.54 |
| 120 | 48.88 | 4030 | 1.436 |
| 125 | 51.66 | 3656 | 1.339 |
| 130 | 54.44 | 3317 | 1.246 |
| 135 | 57.22 | 3015 | 1.159 |
| 140 | 60 | 2743 | 1.077 |
| 145 | 62.77 | 2502 | 1.001 |
| 150 | 65.55 | 2288 | 0.931 |

Table 2, cont.: Temperature/Resistance for Type III 10K Ohm Thermistor Sensors

Thermistor Sensor Testing Instructions

Use the resistance column to check the thermistor sensor while disconnected from the controllers (not powered).

Use the voltage column to check sensors while connected to powered controllers. Read voltage with meter set on DC volts. Place the “-” (minus) lead on GND terminal and the “+” (plus) lead on the sensor input terminal being investigated.

If the voltage is above 4.88 VDC, then the sensor or wiring is “open.” If the voltage is less than 0.05 VDC, then the sensor or wiring is shorted.

LCD Display Screen & Navigation Keys

The LCD display screens and buttons allow you to view status and alarms, enable force modes, and make BACnet® configuration changes. See **Figure 27** and refer to **Table 3** for descriptions.

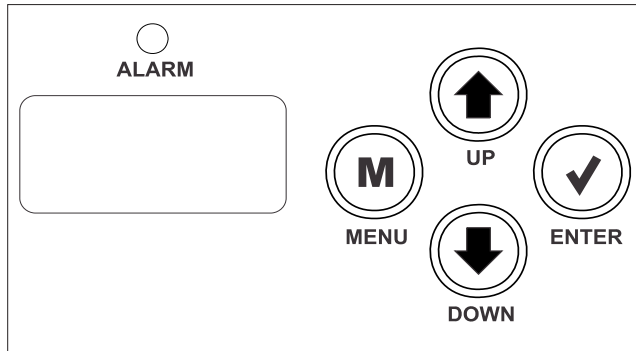

Figure 27: LCD Display and Navigation Keys





| NAVIGATION KEY | KEY FUNCTION |
|---|--|
| MENU  | Use the MENU key to move through screens within Main Menu categories and return to the Main Menu while at other screens. |
| UP  | Use this key to adjust setpoints and change configurations. |
| DOWN  | Use this key to adjust setpoints and change configurations. |
| ENTER  | Use the ENTER key to navigate through the Main Menu Screen categories. |

Table 3: Navigation Key Functions

Main Screens Map

Main Screens Map

Refer to the following map when navigating through the LCD Main Screens. The first screen is an initialization screen. To scroll through the rest of the screens, press the <MENU> button.



Press to scroll through the GENERAL INFO Screens.

Press to go to STATUS Screens.

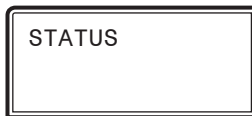

Press to scroll through the STATUS Screens.

Press to go to the ALARM STATUS Screens.

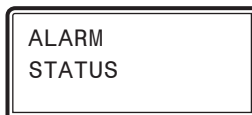

Press to scroll through the ALARM STATUS Screens.

Press to go to the TEMPERATURE SETPOINT Screens.



Press to scroll through the TEMPERATURE SETPOINT Screens.

Press to go to the ECONOMIZER SETPOINT Screens.



Press to scroll through the ECONOMIZER SETPOINT Screens.

Press to go to the TIMER / DELAYS Screens.



Press to scroll through the TIMER / DELAYS Screens.

Press to go to the CONFIGURATION SETPOINT Screens.

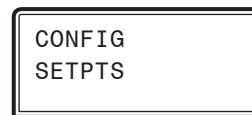

Press to scroll through the CONFIGURATION SETPOINT Screens.

Press to go to the SENSOR CALIBRATION Screens.

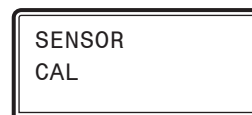

Press to scroll through the SENSOR CALIBRATION Screens.

General Information Screens

From the GENERAL INFO Screen, press <ENTER> to scroll through the screens.

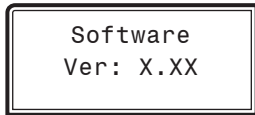

CURRENT SOFTWARE VERSION

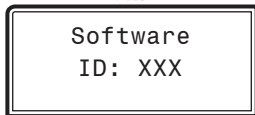

CURRENT SOFTWARE ID NUMBER



CURRENT BOARD ADDRESS

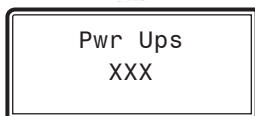

POWER LOSS COUNT

Displays the number of times the board has been reset due to power loss.



BLOWER CONFIGURATION

Displays Blower Configuration:
One Spd, Two Spd

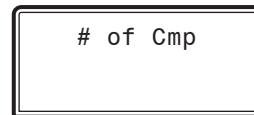

COMPRESSOR CONFIGURATION

Displays Number of Configured Compressors:
(1 - 2)

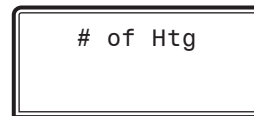

HEAT CONFIGURATION

Displays Number of Configured Heat / Aux Heat Stages:
(0 - 2)

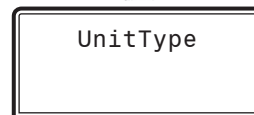

UNIT TYPE CONFIGURATION

Displays What the Unit is Configured As:
Electric, Gas Heat, Heat Pump

Status Screens

Status Screens

From the STATUS Screen, press <ENTER> to scroll through the screens.

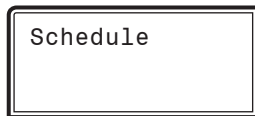
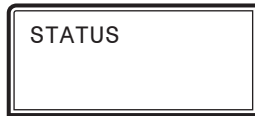

SCHEDULE

This screen displays the schedule mode of the DDC Controller. The mode options are:

- Unoc.
- Occupied
- Pb.Ovr.
- Hol Unoc
- Hol Occ.
- Frc Occ.
- Frc Unoc
- Rem Occ.

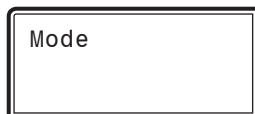

MODE

This screen displays the mode of operation of the DDC Controller. The mode options are:

- Off Mode
- Venting
- Cooling
- Heating

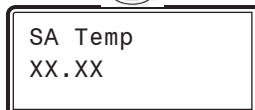

SUPPLY AIR TEMPERATURE

This is the current Supply Air Temperature.

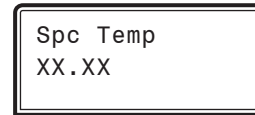

SPACE TEMPERATURE

This is the current Space Temperature.



SLIDE ADJUST

This is the current Slide Adjust Offset.

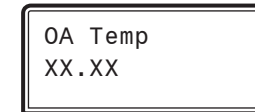

OUTDOOR AIR TEMPERATURE

This is the current Outdoor Air Temperature.

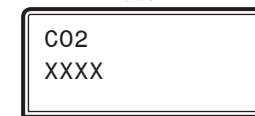

CURRENT CO2 READING

This is the current CO2 reading.

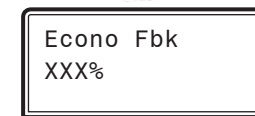

TITLE 24 ECONOMIZER FEEDBACK POSITION

This is the current Title 24 Economizer Actuator position.

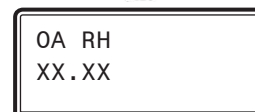

OUTDOOR AIR HUMIDITY

This is the current Outdoor Air Humidity.



Spc RH
XX.X

SPACE HUMIDITY
This is the current Space Humidity.



Dewpoint
XX.X

OUTDOOR DEWPOINT TEMPERATURE
This is the current Outdoor Dewpoint.



Wetbulb
XX.X

OUTDOOR WETBULB TEMPERATURE
This is the current Wetbulb temperature.



Enthalpy
XX.X

CURRENT CALCULATED ENTHALPY
This is the current Enthalpy value.



Load Shd

LOAD SHEDDING
Active or Inactive



Econo Pos
XXX%

CURRENT ECONOMIZER POSITION
This is the current Economizer position.



Defrost

DEFROST STATUS
Active or Inactive



Cool Sp
XX.XX

COOLING TEMPERATURE SETPOINT STATUS
This is the current Cooling Temperature Setpoint which includes any Offsets.



Heat Sp
XX.XX

HEATING TEMPERATURE SETPOINT STATUS
This is the current Heating Temperature Setpoint which includes any Offsets.



Cool En

COOL ENABLED
Enabled or Disabled



Heat En

HEAT ENABLED
Enabled or Disabled



Econ En

ECONOMIZER ENABLED
Enabled or Disabled

Status Screens

If NOT configured for Heat Pump, the next two screens will read Heat 1 and Heat 2:



0aHP En

HEAT PUMP HEATING ENABLED
Enabled or Disabled



Comp 1
On/Off

COMPRESSOR RELAY 1
On / Off



Comp 2
On/Off

COMPRESSOR RELAY 2
On / Off



Low Fan
On/Off

LOW FAN RELAY
On / Off



High Fan
On/Off

HIGH FAN RELAY
On / Off



Aux Ht 1
On/Off

AUXILIARY HEAT RELAY 1
On / Off



Aux Ht 2
On/Off

AUXILIARY HEAT RELAY 2
On / Off



Rev Valv
On/Off

REVERSING VALVE RELAY
On / Off



Cond Fan
On/Off

CONDENSER FAN RELAY
On / Off



Exh. Fan
On/Off

EXHAUST FAN RELAY
On / Off



Alarm
On/Off

ALARM RELAY
On / Off

Alarm Status Screens

From the ALARM STATUS Screen, press <ENTER> to scroll through the screens. Each Alarm Screen will display OK or Active. See Alarm descriptions on pages 38 & 39.

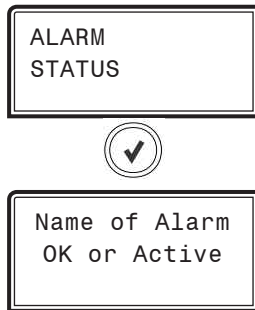

- Fan Pof Fan Proof of Flow
- Clg Fltr Clogged Filter
- Em. Shdn Emergency Shutdown
- Pres Sw1 Pressure Switch 1
- Pres Sw2 Pressure Switch 2
- High SaT High Supply Air Temperature
- Low SaT Low Supply Air Temperature
- Cool Fail Cooling Failure
- Heat Fail Heating Failure
- HiLo Spc High/Low Space
- Spc Sens Space Temperature Sensor
- Sat Sens Supply Air Temperature Sensor
- Oat Sens Outdoor Air Temperature Sensor

- Econ Er1 Economizer Not Economizing Economizer
- Econ Er2 Economizing When It's Not Supposed To
- Econ Er3 Economizer Not Modulating
- Econ Er4 Economizer Excess Outdoor Air
- BN Spc BACnet Space Sensor Missing
- BN Oat BACnet Outdoor Air Temperature Sensor Missing
- BN OaRh BACnet Outdoor Humidity Sensor Missing
- BN IaRh BACnet Indoor Humidity Sensor Missing (Not used at this time)
- BN Co2 BACnet Co2 Sensor Missing
- BN Shed BACnet Load Shed Input Missing
- BN Sched BACnet Schedule Input Missing
- BN Econo BACnet Economizer Signal Missing
- Rst All Manual Reset - Press UP to reset. Press Up Will display Done when completed.

Temperature Setpoint Screens

Temperature Setpoint Screens

From the TEMPERATURE SETPOINTS Screen, press <ENTER> to scroll through the screens.

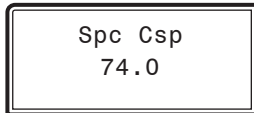

SPACE COOLING SETPOINT

This is the Space Temperature maintained in the Cooling Mode. Valid range is 40 to 90 degrees. Default is 74 degrees.

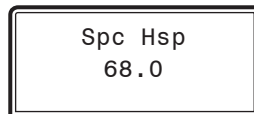

SPACE HEATING SETPOINT

This is the Space Temperature maintained in the Heating Mode. Valid range is 40 to 90 degrees. Default is 68 degrees.

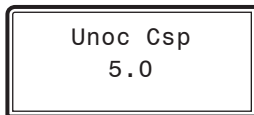

UNOCCUPIED COOLING SETPOINT

This amount is added to the Cooling Setpoint during Unoccupied operation. Valid range is 0 to 30 degrees. Default is 5 degrees.

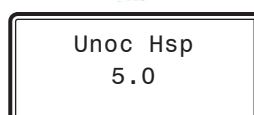

UNOCCUPIED HEATING SETPOINT

This amount is subtracted from the Heating Setpoint during Unoccupied operation. Valid range is 0 to 30 degrees. Default is 5 degrees.

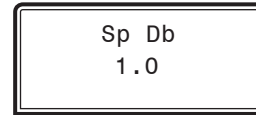

SPACE DEADBAND SETPOINT

This setpoint prevents cycling between Cooling/Vent/Heating modes. Valid range is 0.5 to 5.0 degrees. Default is 1 degree.

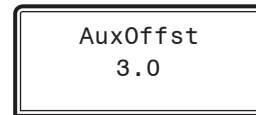

AUXILIARY HEAT OFFSET SETPOINT

The Aux Heat Stages if the Space Temperature is below the Heating Setpoint of this offset amount. Valid range is 0.0 to 30.0 degrees. Default is 3 degrees.

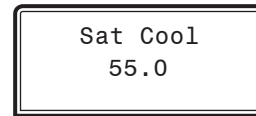

SUPPLY AIR TEMPERATURE COOLING SETPOINT

During Cooling Mode, this is the Supply Air Temperature Setpoint. Valid range is 35 to 90 degrees. Default is 55 degrees.

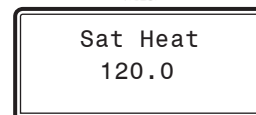

SUPPLY AIR TEMPERATURE HEATING SETPOINT

During Heating Mode, this is the Supply Air Temperature Setpoint. Valid range is 35 to 160 degrees. Default is 120 degrees.

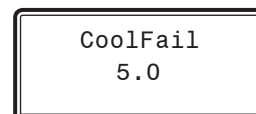

COOLING TEMPERATURE FAILURE SETPOINT

If the Supply Temperature remains below the SAT Cooling Setpoint by this amount for the Delay period, an alarm will be generated. Valid range is -1.0 to 30.0 degrees. Default is 5 degrees.



Temperature & Economizer Setpoint Screens

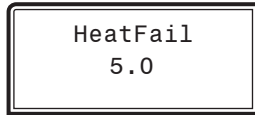

HEATING TEMPERATURE FAILURE SETPOINT

If the Supply Temperature remains above the SAT Heating Setpoint by this amount for the Delay period, an alarm will be generated. Valid range is -1.0 to 30.0 degrees. Default is 5 degrees.

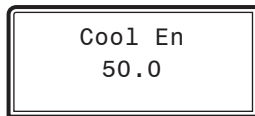

COOL ENABLE SETPOINT

Cooling will be enabled if the outdoor air temperature is above this setpoint. Valid range is 0 to 90 degrees. Default is 50 degrees.

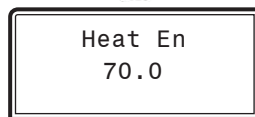

HEAT ENABLE SETPOINT

Heating will be enabled if the outdoor air temperature is below this setpoint. Valid range is 35 to 90 degrees. Default is 70 degrees.

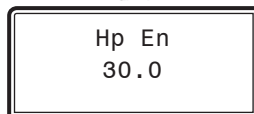

HEAT PUMP ENABLE SETPOINT

Heat Pump Compressor(s) will be enabled if the outdoor air temperature is above this setpoint. Valid range is 0 to 90 degrees. Default is 30 degrees.

Economizer Setpoints Screens

From the ECONOMIZER SETPOINTS Screen, press <ENTER> to scroll through the screens.



ECONOMIZER CALIBRATION

Press <UP> to start the calibration. While the unit is calibrating, the screen will display "Running". Don't press any buttons during this time. When done calibrating, the screen will display "Finished". This must be done any time an Economizer is installed or replaced.

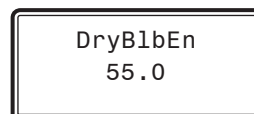

DRYBULB ENABLE SETPOINT

If the Economizer Drybulb Enable Source is below this value, the Economizer is enabled for Cooling operation. Valid range is 35 to 90 degrees. Default is 55 degrees.

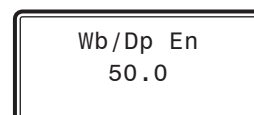

WETBULB / DEWPOINT ENABLE SETPOINT

If the Economizer Wetbulb / Dewpoint Enable Source is below this value, the Economizer is enabled for Cooling operation. Valid range is 30.0 to 80.0 degrees. Default is 50 degrees.



Economizer & Timer / Delays Setpoint Screens

Enthalpy
23.0

ENTHALPY ENABLE SETPOINT

If the Economizer Enthalpy Enable Source is below this value, the Economizer is enabled for Cooling operation. Valid range is 0.0 to 40.0 degrees. Default is 23 degrees.



Min Pos
10

ECONOMIZER MINIMUM POSITION

This is the minimum position maintained by the Economizer with no call for Cooling. Valid range is 0 to 100%. Default is 10%.



CO2 Min
50

HIGH CO₂ ECONOMIZER MINIMUM POSITION

This is the maximum value the Economizer Minimum can be reset to during CO₂ override. Valid range is 0 to 100%. Default is 50%.



Hi CO2
1000

HIGH CO₂ LEVEL

At this CO₂ level, the Minimum Economizer Setpoint will be reset to the High CO₂ Economizer Position set on the previous screen. Valid range is 0 to 2000. Default is 1000.



Lo CO2
900

LOW CO₂ LEVEL

At this CO₂ level, the Minimum Economizer Setpoint will be at to the configured Economizer Minimum Position. Valid range is 0 to 2000. Default is 900.

Timer / Delays Setpoints Screens

From the TIMER / DELAYS SETPOINTS Screen, press <ENTER> to scroll through the screens.

TIMER /
DELAYS



Month
#

MONTH

Value between January & December.



Date
#

DATE

Value between 1 and 31.



Year
#

YEAR

Value between 0 and 9999.



Hour
#

HOUR

Value between 0 and 23.



Minutes
#

MINUTES

Value between 0 and 59.

Timer Setpoint Screens

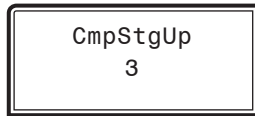

COMPRESSOR STAGE UP DELAY TIME

If the Compressor is energized, the controller will have to wait this long before another stage is brought on. Valid range is 1 to 60 minutes. Default is 3 minutes.

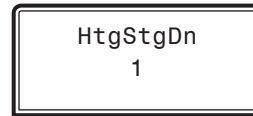

HEAT STAGE DOWN DELAY TIME

If a stage of Heat is energized and needs to be turned off, the controller will have to wait this long before it is de-energized. Valid range is 1 to 60 minutes. Default is 1 minute.

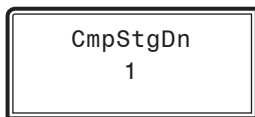

COMPRESSOR STAGE DOWN DELAY TIME

If the Compressor is energized and needs to be turned off, the controller will have to wait this long before it is de-energized. Valid range is 1 to 60 minutes. Default is 1 minute.

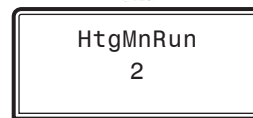

HEAT MINIMUM RUN TIME

If a stage of Heat is on, it must remain on for this long before it can turn off. Valid range is 1 to 60 minutes. Default is 2 minutes.

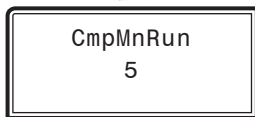

COMPRESSOR MINIMUM RUN TIME

If the Compressor is on, it must remain on for this long before it can turn off. Valid range is 1 to 60 minutes. Default is 5 minutes.

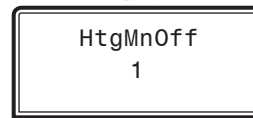

HEAT MINIMUM OFF TIME

If a stage of Heat is off, it must remain off for this long before it can turn on. Valid range is 1 to 60 minutes. Default is 1 minute.

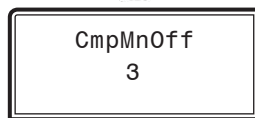

COMPRESSOR MINIMUM OFF TIME

If the Compressor is off, it must remain off for this long before it can turn on. Valid range is 1 to 60 minutes. Default is 3 minutes.

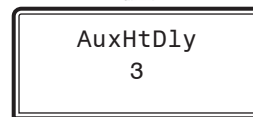

AUXILIARY HEAT DELAY TIME

If the Compressors are being used for Heat, and the Space is not reaching the Setpoint, the Aux Heat can be used. However, this additional amount of time will be added to the Stage Up Timer to give the Compressors ample time to raise the temperature. Valid range is 1 to 60 minutes. Default is 3 minutes.

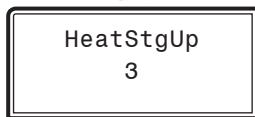

HEAT STAGE UP DELAY TIME

If a stage of Heat is energized, the controller will have to wait this long before another stage is brought on. Valid range is 1 to 60 minutes. Default is 3 minutes.

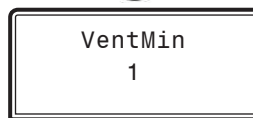

VENT MODE MINIMUM TIME PERIOD

Once Vent Mode has been entered, it must remain in this mode for this amount of time. Valid range is 1 to 60 degrees. Default is 1 degree.

Timer & Configuration Setpoint Screens



MechFail
20

MECHANICAL FAILURE ALARM

This setpoint is to adjust how long a heat or cool activation has to change the temperature 5 degrees. If this is not achieved, an alarm is generated. No operation is affected. It is a notification only. Valid range is 0 to 120 minutes. Default is 20 minutes.



SatAlrm
10

SUPPLY AIR ALARM TIMER

Enter the amount of time the Supply Temperature must remain outside the alarm limits before a supply temperature alarm will be generated. Valid range is 0 to 120 minutes. Default is 10 minutes.



DfrstInt
90

DEFROST TIMER

The Defrost Timer is the amount of time between Defrost Cycles. Valid range is 30, 60, 90 minutes. Default is 90 minutes.



OvrTime
2.0

PUSH-BUTTON OVERTIME TIMER

The Push-Button Override Duration Setpoint allows you to adjust the amount of time the Override will remain in effect when the Override Button is pressed. Valid range is 0.0 to 8.0 hours. Default is 2 minutes.



DFS Timer
1000

DIRTY FILTER TIMER

A Clogged Filter Alarm is generated when the accumulated Fan Run Time exceeds this Dirty Filter Timer Setpoint. Valid range is 8 to 2000 minutes. Default is 1000 minutes.

Configuration Setpoints Screens

From the CONFIGURATION SETPOINTS Screen, press <ENTER> to scroll through the screens.

CONFIG
SETPTS



Scaling
Deg F
Deg C

TEMPERATURE SCALING

Fahrenheit or Celsius. Default is Fahrenheit.



UnitType
Electric, Gas
HeatPump

UNIT TYPE

Electric, Gas, or Heat Pump. Default is Electric.



Spc Sens
Analog
Digital

TYPE OF SPACE SENSOR INSTALLED

Analog or Digital. Default is Analog.



Spc Rh
Inst
Not Inst

SPACE HUMIDITY SENSOR INSTALLED

Installed or Not Installed. Default is Installed.



Spc Rh
Analog
Digital

TYPE OF SPACE HUMIDITY SENSOR INSTALLED

Analog or Digital. Default is Analog.

APPENDIX B - LCD SCREENS

Configuration Setpoints Screens



Oa Sensr
Analog
Digital

TYPE OF OUTDOOR SENSOR INSTALLED
Analog or Digital. Default is Analog.



OA Rh
Inst
Not Inst

OUTDOOR HUMIDITY SENSOR INSTALLED
Installed or Not Installed. Default is Installed.



Econ Typ
Econ Only,
Econ/CO2, None

TYPE OF ECONOMIZER
Economizer Only, CO₂, or None. Default is Economizer Only.



Enb Src

ENABLE SOURCE
Drybulb, Wetbulb, Dewpoint, Enthalpy. Default is Drybulb.



CO2
Inst
Not Inst

CO2 SENSOR INSTALLED
Installed or Not Installed. Default is Installed.



CO2 Type
Analog

CO2 SENSOR TYPE
Analog or Digital. Default is Analog.



Fan Mode
Auto or On

FAN MODE
Auto = Fan Cycle or On = Continuous Fan. Default is On.



Fan Type
One Spd
Two Spd

FAN TYPE
One Speed or Two Speed. Default is One Speed.



CompStgs
1 or 2

NUMBER OF COMPRESSOR STAGES
Valid range is 1-2. Default is 1.



HEATSTGS
0

HEAT STAGES
Valid range is 0-2. Default is 0.



Address
1

UNIT ADDRESS
You must cycle power to the controller if you change the unit address. You must also perform a new Search for Units if using PrismD once the controller has finished restarting. Valid range is 1-59. Default is 1.



Configuration Screens & Sensor Calibration Screens

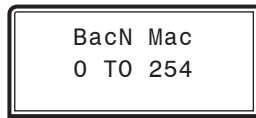

BACnet® - CURRENT MAC ADDRESS
Valid range is 0 to 254. Default is 1.

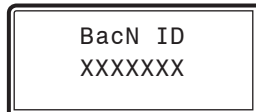

BACnet® - CURRENT DEVICE ID
Valid range is 0 to 32,000.

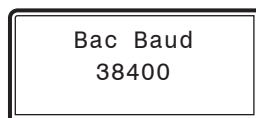

BACnet® - CURRENT BAUD RATE
9600, 19200, 38400, 57600, 76800. Default is 38400.

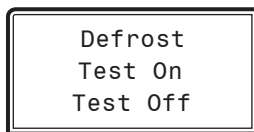

DEFROST TEST
Press <UP> to run the test.

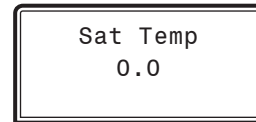

SUPPLY AIR TEMPERATURE SENSOR CALIBRATION
Allows you to adjust the temperature for testing or slight irregularities.
Valid range is -20.0 to 20.0. Default is 0.0.

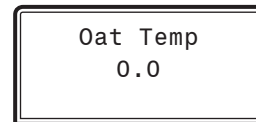

OUTDOOR AIR TEMPERATURE SENSOR CALIBRATION
Allows you to adjust the temperature for testing or slight irregularities.
Valid range is -20.0 to 20.0. Default is 0.0.

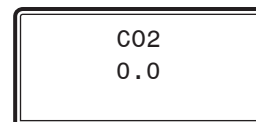

CO2 SENSOR CALIBRATION
Allows you to adjust the temperature for testing or slight irregularities.
Valid range is -20.0 to 20.0. Default is 0.0.

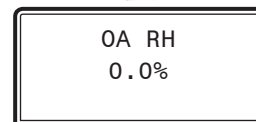

OUTDOOR AIR HUMIDITY SENSOR CALIBRATION
Allows you to adjust the temperature for testing or slight irregularities.
Valid range is -20.0 to 20.0. Default is 0.0%.

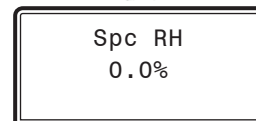

SPACE HUMIDITY SENSOR CALIBRATION
Allows you to adjust the temperature for testing or slight irregularities.
Valid range is -20.0 to 20.0. Default is 0.0%

Sensor Calibration Screens

From the SENSOR CALIBRATION Screen, press <ENTER> to scroll through the screens.

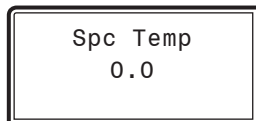
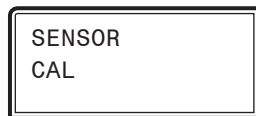

SPACE SENSOR CALIBRATION
Allows you to adjust the temperature for testing or slight irregularities.
Valid range is -20.0 to 20.0. Default is 0.0.

DDC BACnet® Connection To MS/TP Network

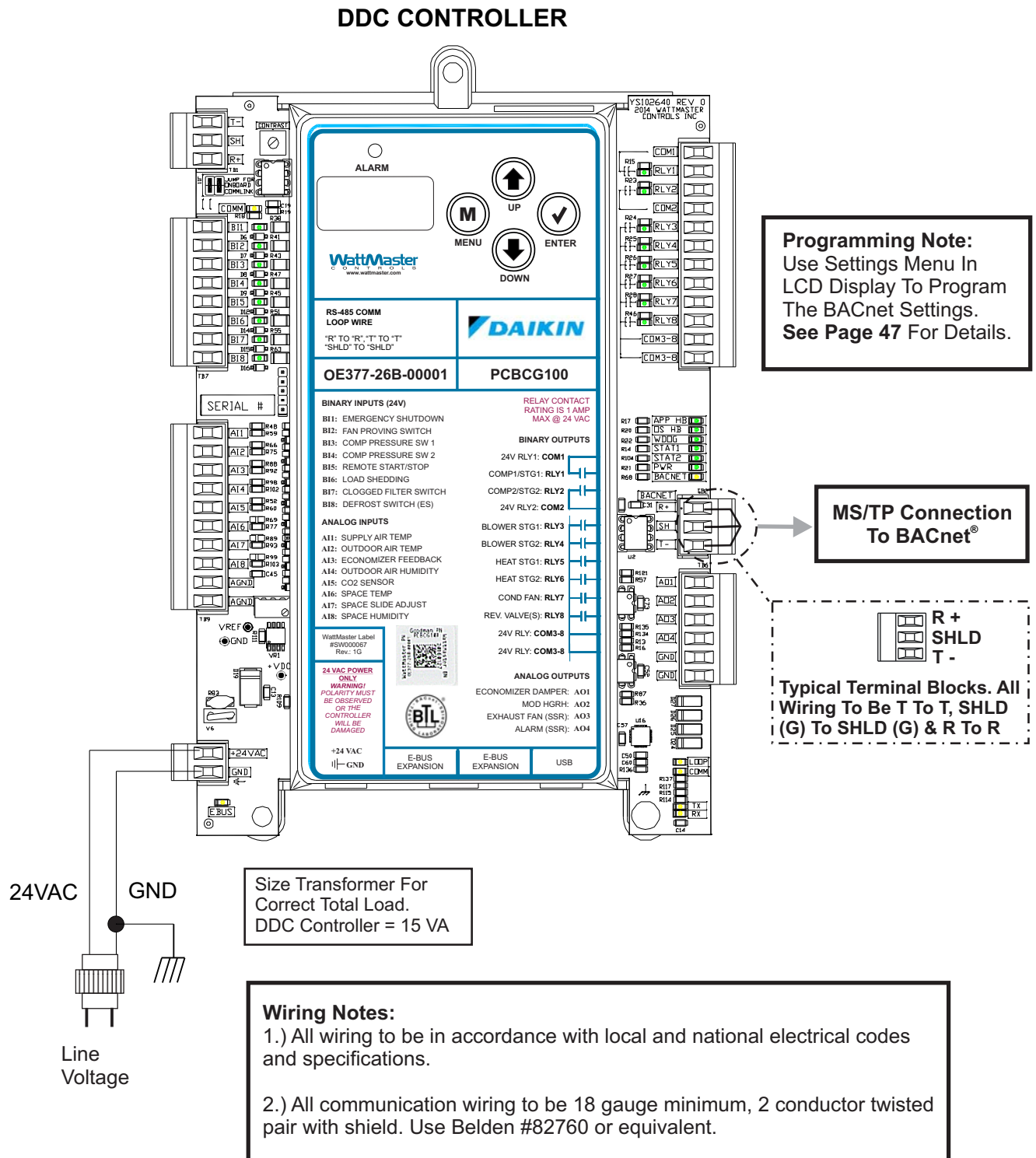

Figure 28: DDC BACnet® Connection to MS/TP Network

DDC BACnet® Parameters

NOTE: DDC LON parameters are located in the *Daikin PT-Link II LON-3 Technical Guide*.

NOTE: Objects labeled AI and BI are read-only. Objects labeled AV are read/writeable. You cannot write directly to Sensor Inputs.

NOTE: When using Celsius scaling, all temperature values will need to be divided by 10 by the BMS to properly read the status and setpoint values, e.g., a value of 200° C needs to be divided by 10 for an actual value of 20° C.

NOTE: When a new setpoint is received from BACnet, it is maintained and used in temporary memory until the unit goes unoccupied. It is then stored in permanent memory and will become the new default setpoint even if power is cycled. Therefore, if power is cycled prior to the unit going unoccupied, the setpoint will not have been stored in permanent memory.

BACnet® Properties for the DDC Controller

| Parameter | Object | Description | Limits |
|-----------------------------------|--------|---|-------------------|
| Outside Air Dewpoint Temperature | AI: 11 | Current Calculated Outdoor Air Dewpoint Temperature. | |
| Outside Air Wetbulb Temperature | AI: 12 | Current calculated Outdoor Wetbulb Temperature. | |
| Title 24 Economizer Feedback | AI: 13 | Current Feedback position from Economizer actuator. | |
| Economizer Position | AI: 14 | Current position signal to the Economizer actuator. | |
| Calculated Space Cooling Setpoint | AI: 15 | Current Space Cooling Setpoint calculated from the Cooling Setpoint, Slide Adjust Value, Unoccupied Setbacks, and Load Shed Status. | |
| Calculated Space Heating Setpoint | AI: 16 | Current Space Heating Setpoint calculated from the Heating Setpoint, Slide Adjust Value, Unoccupied Setbacks, and Load Shed Status. | |
| Outdoor Enthalpy | AI: 17 | Current calculated Outdoor Air Enthalpy. | |
| Indoor CO ₂ | AI: 18 | Current Indoor CO ₂ Level. | |
| Low Speed Blower Relay | BI: 0 | Current status of the Low Speed Blower Relay. | 0 = Off 1 = On |
| High Speed Blower Relay | BI: 1 | Current status of the High Speed Blower Relay. | 0 = Off 1 = On |
| Compressor 1 Relay | BI: 2 | Current status of Compressor 1 Relay on the DDC Main Board. | 0 = Off 1 = On |
| Compressor 2 Relay | BI: 3 | Current status of Compressor 2 Relay on the DDC Main Board. | 0 = Off 1 = On |
| Heat 1 Relay | BI: 4 | Current status of Heat 1 Relay on the DDC Main Board. | 0 = Off 1 = On |
| Heat 2 Relay | BI: 5 | Current status of Heat 2 Relay on the DDC Main Board. | 0 = Off 1 = On |
| Reversing Valve Relay | BI: 6 | Current status of Reversing Valve Relay on the DDC Main Board. | 0 = Off 1 = On |
| Condenser Fan Relay | BI: 7 | Current status of Condenser Fan Relay on the DDC Main Board. | 0 = Off 1 = On |
| Exhaust Fan Enable Output | BI: 8 | Current status of Exhaust Fan Enable output voltage on the DDC Main Board. | 0 = Off 1 = On |

BACnet® Properties for the DDC Controller

| Parameter | Object | Description | Limits |
|------------------------------|--------|---|------------------------------------|
| Application Software Version | AI: 0 | Current version of the software in the unit. | |
| Controller ID# | AI: 1 | Controller Identification Number. | |
| Power Up Counts | AI: 2 | Number of times the board has been reset due to power loss. | |
| Schedule Mode | AI: 3 | Current Occupied/Unoccupied Status | See Schedule Mode Bits on page 66. |
| HVAC Mode | AI: 4 | Current operational status. | See HVAC Mode Bits on page 66. |
| Space Temperature | AI: 5 | Current value of the Space Temperature Sensor. | |
| Slide Adjust | AI: 6 | Amount of Current Sensor Slide Offset | |
| Indoor Air Humidity | AI: 7 | Current value of the Indoor Humidity Sensor. | |
| Supply Air Temperature | AI: 8 | Current value of the Supply Air Temperature Sensor. | |
| Outside Air Temperature | AI: 9 | Current value of the Outdoor Temperature Sensor. | |
| Outside Air Humidity | AI: 10 | Current value of the Outdoor Humidity Sensor. | |

DDC BACnet® Parameters

| BACnet® Properties for the DDC Controller | | | |
|---|--------|---|-------------------|
| Parameter | Object | Description | Limits |
| Alarm Output | BI: 9 | Current status of Alarm output voltage on the DDC Main Board. | 0 = Off 1 = On |
| Load Shed Status | BI: 10 | Status that indicates Load Shedding is active. | 0 = Off 1 = On |
| Defrost Mode Status | BI: 11 | Status that indicates Defrost Mode is enabled. | 0 = Off 1 = On |
| Cooling Enable Status | BI: 12 | Status that indicates Cooling is enabled based on the Outdoor Temperature. | 0 = Off 1 = On |
| Heating Enable Status | BI: 13 | Status that indicates Heating is enabled based on the Outdoor Temperature. | 0 = Off 1 = On |
| Heat Pump Heat Enable Status | BI: 14 | Status that indicates Heat Pump Heat is enabled based on the Outdoor Temperature. | 0 = Off 1 = On |
| Economizer Enable Status | BI: 15 | Status that indicates Economizer is enabled based on the Economizer Enable Setpoint. | 0 = Off 1 = On |
| Fan Proof of Flow Alarm | BI: 16 | Alarm that indicates an Airflow failure. | 0 = Off 1 = On |
| Dirty Filter Alarm | BI: 17 | Alarm that indicates a dirty filter condition. | 0 = Off 1 = On |
| Emergency Shutdown Alarm | BI: 18 | Alarm that indicates that Emergency Shutdown has been activated. Will shut the unit down. | 0 = Off 1 = On |
| Pressure Switch 1 Alarm | BI: 19 | Alarm that indicates Pressure Switch 1 is open. Compressor 1 will shut down. | 0 = Off 1 = On |
| Pressure Switch 2 Alarm | BI: 20 | Alarm that indicates Pressure Switch 2 is open. Compressor 2 will shut down. | 0 = Off 1 = On |
| High Supply Air Temp Alarm | BI: 21 | The Supply Air has risen above the Hi SAT Cutoff Setpoint. Heating stages begin to deactivate and the fan continues to run. | 0 = Off 1 = On |
| Low Supply Air Temp Alarm | BI: 22 | The Supply Air has fallen below the Low SAT Cutoff Setpoint. The unit will shut off including the Fan. | 0 = Off 1 = On |
| Mechanical Cooling Alarm | BI: 23 | Cooling Outputs are energized but the Supply Air Temperature has not changed a user-adjustable amount in a user-adjustable time period. | 0 = Off 1 = On |

| BACnet® Properties for the DDC Controller | | | |
|---|--------|---|-------------------|
| Parameter | Object | Description | Limits |
| Mechanical Heating Alarm | BI: 24 | Heating Outputs are energized but the Supply Air Temperature has not changed a user-adjustable amount in a user-adjustable time period. | 0 = Off 1 = On |
| Space Temperature Alarm | BI: 25 | The Space Temperature has gone outside of the user-adjustable range for a user-adjustable amount of time. | 0 = Off 1 = On |
| Space Sensor Missing Alarm | BI: 26 | A Space Sensor is not detected. | 0 = Off 1 = On |
| Supply Air Sensor Missing Alarm | BI: 27 | A Supply Air Sensor is not detected. | 0 = Off 1 = On |
| Outdoor Air Sensor Missing Alarm | BI: 28 | An Outdoor Air Sensor is not detected. | 0 = Off 1 = On |
| Econo Not Economizing Alarm | BI: 29 | Economizer is enabled but not following the desired Economizer position commanded. | 0 = Off 1 = On |
| Econo Economizing Alarm | BI: 30 | Economizer is not be using for free cooling, but the feedback signal indicates a position more open than the minimum. | 0 = Off 1 = On |
| Econo Not Modulating Alarm | BI: 31 | Economizer is being used for free cooling, but not within 10% of the desired position within 150 seconds. | 0 = Off 1 = On |
| Econo Excess Outdoor Air Alarm | BI: 32 | Economizer feedback is lost or Economizer is not following commanded position. | 0 = Off 1 = On |
| Temp Scaled in Celsius | AV: 0 | Temperature Scale is in Celsius | 0 1 |
| Number of Heat Stages | AV: 1 | Number of Heat Stages that are configured | 0 2 |
| Economizer Enable Source | AV: 2 | The economizer enable source: 0 = None, 1 = Drybulb, 2 = Dewpoint, 3 = Wetbulb | 0 3 |
| Economizer Configuration | AV: 3 | The economizer configuration: 0 = None, 1 = Standard, 2 = IAQ | 0 2 |
| Digital Space Sensor Installed | AV: 4 | An E-BUS Digital Room Sensor is configured and installed | 0 1 |
| Fan Auto Mode Configuration | AV: 5 | Fan configuration 0 = Continuous Fan, 1 = Fan Cycles | 0 1 |

DDC BACnet® Parameters

| BACnet® Properties for the DDC Controller | | | | |
|---|--------|---|--------|----|
| Parameter | Object | Description | Limits | |
| Defrost Interval | AV: 6 | This is the amount of time between Defrost Cycles if the Defrost Switch is closed in the Heat Pump Heating Mode. | 1 | 3 |
| Compressor Stage Up Delay | AV: 7 | This is the amount of time between compressors when the demand is high enough to run more than one stage of Cooling. It is also the time between the Economizer and the first compressor. | 1 | 10 |
| Compressor Stage Down Delay | AV: 8 | This is the amount of time between compressors when the unit is staging down due to the Supply Air Temperature being met. | 1 | 10 |
| Compressor Minimum Run Time | AV: 9 | Minimum time a Compressor must run before it can stage off. | 1 | 10 |
| Compressor Minimum Off Time | AV: 10 | The minimum time a Compressor must be off before it can stage back on. | 1 | 10 |
| Heat Stage Up Delay | AV: 11 | This is the amount of time between Gas and Electric Heat stages when the demand is high enough to run more than one stage of Heating. | 1 | 10 |
| Heat Stage Down Delay | AV: 12 | This is the amount of time between Gas and Electric Heat stages when the unit is staging down due to the Supply Air Temperature being met. | 1 | 10 |
| Heat Minimum Run Time | AV: 13 | The minimum time a Heat stage must run before it can stage off. | 1 | 10 |
| Heat Minimum Off Time | AV: 14 | The minimum time a Heat stage must be off before it can stage back on. | 1 | 10 |
| Aux Heat Delay | AV: 15 | The delay period before Auxiliary Heating Stages can be activated once Compressor Heating Stages have been activated. | 1 | 60 |
| Vent Mode Minimum Time | AV: 16 | If the controller switches between Heat and Cool mode, this is minimum amount of time the controller must remain in Vent mode before switching. | 1 | 60 |

| BACnet® Properties for the DDC Controller | | | | |
|---|--------|--|--------|-----|
| Parameter | Object | Description | Limits | |
| Fan Starting Delay | AV: 17 | To prevent multiple units operating on the same schedule from starting their fans at the same time, enter a different starting delay (in seconds) for each unit to stagger the load effects on building power consumption. -1 = 5 seconds multiplied by controller address. | -1 | 600 |
| Occupied Cooling Setpoint | AV: 18 | This is the customer's desired Cooling Setpoint for the space. The controller will create a "Calculated Space Cooling Setpoint" from this "Base" Cooling Setpoint as described for that status point. | 40 | 90 |
| Occupied Heating Setpoint | AV: 19 | This is the customer's desired Heating Setpoint for the Space. The controller will create a "Calculated Space Heating Setpoint" from this "Base" Heating Setpoint as described for that status point. | 40 | 90 |
| Space Setpoint Deadband | AV: 20 | This value is added to and subtracted from the space setpoints to determine when the unit will enter and leave the Cooling and Heating modes. | 0 | 5 |
| Unoccupied Cooling Offset | AV: 21 | During the Unoccupied Mode of Operation, this Setpoint offsets the Occupied Cooling Setpoint up by this user-adjustable amount. | 0 | 30 |
| Unoccupied Heating Offset | AV: 22 | During the Unoccupied Mode of Operation, this Setpoint offsets the Occupied Heating Setpoint down by this user-adjustable amount. | 0 | 30 |
| Space Slide Adjust Offset | AV: 23 | Enter an offset to adjust the Space Cooling and Heating Setpoints. | 0 | 3 |
| Aux Heat Offset | AV: 24 | The Aux Heat stages on if the Space Temperature is below the setpoint by this offset amount. | 0 | 30 |
| Load Shed Offset | AV: 25 | If the Load Shedding contact activates, the Heat/Cool Setpoints are separated or offset by this amount. | 0 | 10 |
| Push Button Override Duration | AV: 26 | The Push-Button Override Duration Setpoint allows you to adjust the amount of time the Override will remain in effect when the Override Button is pressed. | 0 | 8 |

| BACnet® Properties for the DDC Controller | | | | |
|---|--------|--|--------|-----|
| Parameter | Object | Description | Limits | |
| Space Temp Alarm Offset | AV: 27 | If the Space Temperature is this value above the Cooling Setpoint or below the Heating Setpoint for the Alarm Delay period, this Space Temperature Alarm will occur. | 1 | 30 |
| Space Temp Alarm Time Delay | AV: 28 | This is the amount of time the Space Temperature must remain outside the alarm limits before a space temperature alarm will be generated. | 1 | 300 |
| Supply Air Cooling Setpoint | AV: 29 | Supply Air Cooling Setpoint. | 35 | 90 |
| Supply Air Heating Setpoint | AV: 30 | Supply Air Heating Setpoint. | 35 | 150 |
| Supply Air Cool Stage Off Deadband | AV: 31 | In Cooling Mode, if the Supply Air Temperature drops below the Supply Air Cooling Setpoint minus the deadband, a Cooling Stage will be deactivated after its Minimum Run Time. | 1 | 30 |
| Supply Air Heat Stage Off Deadband | AV: 32 | In Heating Mode, if the Supply Air Temperature rises above the Supply Air Heating Setpoint plus the deadband, a Heating Stage will be deactivated after its Minimum Run Time. | 1 | 30 |
| High Supply Air Alarm Setpoint | AV: 33 | Heating will be disabled if the Supply Air Temperature rises above this value. See sequence for more details. | 35 | 170 |
| Low Supply Air Alarm Setpoint | AV: 34 | Cooling will be disabled if the Supply Air Temperature falls below this value. See sequence for more details. | 32 | 90 |
| Supply Air Hi/Low Alarm Time Delay | AV: 35 | This is the amount of time the Supply Air Temperature must remain outside the alarm limits before a space temperature alarm will be generated. | 0 | 120 |
| Mechanical Cool Alarm Offset | AV: 36 | If the Supply Air Temperature remains this far from setpoint for the Mechanical Alarm Time Delay, this alarm will occur. | 0 | 30 |
| Mechanical Heat Alarm Offset | AV: 37 | If the Supply Air Temperature remains this far from setpoint for the Mechanical Alarm Time Delay, this alarm will occur. | 0 | 30 |

| BACnet® Properties for the DDC Controller | | | | |
|---|--------|--|--------|------|
| Parameter | Object | Description | Limits | |
| Mechanical Alarm Time Delay | AV: 38 | This setpoint adjusts the amount of time the unit has to change the Supply Air Temperature a user-adjustable amount after a stage of Heating or Cooling is energized. | 0 | 120 |
| OA Compressor Enable Setpoint | AV: 39 | Cooling will be enabled if the outdoor air temperature is above this setpoint. | 0 | 90 |
| OA Heat Enable Setpoint | AV: 40 | Heating will be enabled if the outdoor air temperature is below this setpoint. | 35 | 90 |
| OA Heat Pump Enable Setpoint | AV: 41 | Heat Pump Compressor(s) will be enabled if the outdoor air temperature is above this setpoint. | 0 | 90 |
| OA Economizer Enable Setpoint | AV: 42 | If the Economizer Drybulb Enable Source is below this value, the Economizer is enabled for Cooling operation. | 35 | 90 |
| OA WB/DP Enable Setpoint | AV: 43 | The economizer is enabled if the outdoor dewpoint or wetbulb temperature falls below this setpoint. | 0 | 90 |
| OA Enthalpy Enable Setpoint | AV: 44 | If the Outdoor Air Enthalpy is below this value, the Economizer is enabled for Cooling operation. | 12 | 90 |
| Economizer Minimum Position | AV: 45 | The minimum position of the Outdoor Air damper in the Occupied Mode. This can be reset upwards based on indoor CO ₂ levels. | 0 | 100 |
| Economizer Min at High CO ₂ | AV: 46 | This is the minimum carbon dioxide level that resets the Economizer Minimum Position to the High CO ₂ Minimum setting. | 0 | 100 |
| High CO ₂ Level Setpoint | AV: 47 | This is the CO ₂ level at which the Economizer Min Damper Position will be reset to the Economizer Max Position in High CO ₂ . In between the Min and Max CO ₂ levels the Economizer Min Damper Position will be proportionally reset between the configured Min Damper Position and the Max Position in High CO ₂ . | 0 | 2000 |
| Low CO ₂ Level Setpoint | AV: 48 | This is the threshold CO ₂ level at which the Economizer Min Damper Position Setpoint will begin to be reset higher. | 0 | 2000 |

DDC BACnet® Parameters

| BACnet® Properties for the DDC Controller | | | | |
|---|--------|--|--------|------|
| Parameter | Object | Description | Limits | |
| Write Space Temperature Value | AV: 49 | If the controller is configured for this operation, the user can write a Space Sensor value. | -40 | 100 |
| Write Outdoor Air Temperature Value | AV: 50 | If the controller is configured for this operation, the user can write an Outdoor Sensor value. | -40 | 120 |
| Write Outdoor Humidity Value | AV: 51 | If the controller is configured for this operation, the user can write an Outdoor Humidity Sensor value. | 0 | 100 |
| Write Indoor Humidity Value | AV: 52 | Reserved for future use. Not available at this time. | | |
| Write Carbon Dioxide Value | AV: 53 | If the controller is configured for this operation, the user can write a CO ₂ Sensor value. | 0 | 2000 |
| Write Force Occupy Command | AV: 54 | 0 = Auto, 1 = Occupied | 0 | 1 |
| Write Load Shed Enable Command | AV: 55 | 0 = No Load Shedding, 1 = Load Shedding | 0 | 1 |
| Write Econo Position | AV: 56 | User-writeable Economizer Position. | 0 | 100 |

DDC BACnet® Property Identifier:

BACNETPropertyIdentifier :

DDCScheduleModeStatusBits ::= ENUMERATED {

- Unoccupied (0)
 - Occupied (1),
 - Push-Button Override (2),
 - Holiday Unoccupied (3),
 - Holiday Occupied (4),
 - Forced Occupied (5),
 - Forced Unoccupied (6),
 - Remote Occupied (7),
- }**

DDCHVACModeStatusBits ::= ENUMERATED {

- Off (0),
- Vent Mode (1),
- Cooling Mode (2),
- Heating Mode (3),



BACnet® Protocol Implementation Conformance Statement

| | | |
|---|---------------------------|----------------|
| Vendor | | Listing Status |
| WattMaster Controls, Inc. 8500 NW River Park Drive, Suite 108A Parkville, MO 64152 USA | | Listed Product |
| Test Requirements | BACnet® Protocol Revision | Date Tested |
| Requirements as of December 2011 | Revision 12 (135-2010) | April 2013 |

| | | |
|----------------|-----------------|------------------|
| Product Name | Model Number | Software Version |
| DDC Controller | OE377-26B-00001 | 1.00 |

| |
|--|
| BACnet® Standardized Device Profile (Annex L) |
| BACnet Application Specific Controller (B-ASC) |

| | | |
|-----------------|------------------------|----------|
| BIBBs Supported | | |
| Data Sharing | ReadProperty-B | DS-RP-B |
| | ReadPropertyMultiple-B | DS-RPM-B |
| | WriteProperty-B | DS-WP-B |

| | | |
|-------------------------------|-------------------------------|----------|
| Device and Network Management | Dynamic Device Binding-B | DM-DDB-B |
| | Dynamic Object Binding-B | DM-DOB-B |
| | DeviceCommunication Control-B | DM-DCC-B |

| | | |
|--|--------------|--------------|
| Object Type Support | | |
| Device | Analog Input | Analog Value |
| Binary Input | Binary Value | |
| Device does not support CreateObject, DeleteObject, and there are no Proprietary Properties. | | |

| | |
|-------------------------|---------------------------------|
| Data Link Layer Options | |
| Media | Options |
| MS/TP Master | 9600,19200, 38400, 57600, 76800 |

| |
|-----------------------|
| Character Set Support |
| ANSI X3.4 |

A-C

2-Conductor Wire.....14
 3- or 4-Conductor Wire.....14
 24 VAC-to-24 VAC.....33

A

Actuator Feedback Signal.....28
 Actuators, Economizer Damper.....29
 Address Screen.....59
 AI1- AI8.....34
 Alarm Control Signal.....35
 Alarm Definitions.....38
 Alarm Detection.....38
 Alarm Relay Screen.....52
 Alarms.....38
 Clogged Filter Alarm.....39
 CO₂ Sensor Failure Alarm.....38
 Economizer Damper Not Modulating.....39
 Economizer Excess Outdoor Air Filter.....39
 Economizer Is Economizing When It Should Not.....39
 Economizer Not Economizing When It Should.....39
 Economizer Temperature Sensor Failure.....39
 Emergency Shutdown Alarm.....39
 Failure Mode Alarms.....39
 Fan Proving Alarm.....38
 High Supply Temp Alarm.....39
 Low Pressure Switch 1 Alarm.....39
 Low Pressure Switch 2 Alarm.....39
 Low Supply Temp Alarm.....39
 Mechanical Cooling Failure.....38
 Mechanical Heating Failure.....38
 Outdoor Air Humidity Sensor Failure Alarm.....38
 Outdoor Air Temperature Sensor Failure Alarm.....38
 Sensor Failure Alarms.....38
 Space Humidity Sensor Failure Alarm.....38
 Space Temperature Sensor Failure Alarm.....38
 Title 24 Economizer Alarms.....39
 Alarm Signal.....31
 Alarm Signal Wiring.....31
 Alarm Solid State Wiring.....31
 Alarm Status Screens.....53
 Analog Inputs.....34
 Analog Input Wiring, DDC Controller.....16
 Analog Outputs, Described.....35
 AOUT1.....31
 APP HB LED.....41
 Applications Overview.....6
 Auxiliary Heat 2 Relay Screen.....52
 Auxiliary Heat Delay Time Screen.....57
 Auxiliary Heat Offset Setpoint Screen.....54
 Auxiliary Heat Relay 1 Screen.....52

B

BACnet® Baud Rate Screen.....60
 BACnet® Connection.....61
 BACnet® ID Screen.....59
 BACnet® MAC Address Screen.....59
 BACnet® Parameters.....62
 BACnet® PICS Statement.....67

BI 1-8.....34
 Binary Input LEDs.....41
 Binary Inputs
 Described.....34
 Binary Input Wiring.....15
 Binary Outputs
 Described.....35
 Blower Configuration Screen.....49
 Blower Control.....37
 Board Address Screen.....49

C

Calibrate Economizer.....33
 Calibration Screens.....60
 Clogged Filter Contact Closure Input.....35
 Clogged Filter Switch Alarm.....39
 CO₂ Duct-Mounted Sensor.....8,20
 CO₂ High Level Setpoint Screen.....56
 CO₂ Low Level Setpoint Screen.....56
 CO₂ Minimum Position Screen.....56
 CO₂ Reading Screen.....50
 CO₂ Sensor Calibration Screen.....60
 CO₂ Sensor Failure Alarm.....38
 CO₂ Sensor Input
 Description.....34
 CO₂ Sensor Type Screen.....59
 CO₂ Sensor Wiring.....19,20,23
 CO₂ Wall-Mounted Sensor.....8, 20
 Coil Temperature Switch LED.....41
 CommLink 5.....10,33,42
 CommLink 5 Technical Guide.....11
 CommLink Jumpers.....32
 Communication Settings.....32
 Communication Surge Protector Kit.....11
 Components
 DDC Controller.....13
 Compressor 1 Enable Relay.....35
 Compressor 1 Relay Screen.....52
 Compressor 2 Enable Relay.....35
 Compressor 2 Relay Screen.....52
 Compressor Configuration Screen.....49
 Compressor Enable.....37
 Compressor Minimum Off Time Screen.....57
 Compressor Minimum Run Time Screen.....57
 Compressor Stage Down Delay Time Screen.....57
 Compressor Stage Up Delay Time Screen.....57
 Condenser Fan Enable Relay.....35
 Condenser Fan Relay Screen.....52
 Configurations
 Interconnected System.....42
 Interconnected System Layout.....44
 Networked System Layout.....45
 Networked System.....42
 Stand-Alone System.....42
 Stand-Alone System Layout.....43
 Configuration Setpoints Screens.....59
 Configuring
 DDC Controller.....42,47
 Economizer.....33

Constant Air Volume Unit, Overview.....6
 Controller
 Mounting Requirements.....14
 Programming.....33
 Voltage and Environment Requirements.....14
 Cool Enable Setpoint Screen.....55
 Cool Enabled Screen.....51
 Cooling Mode Operation.....36
 Cooling Setpoint Screen.....51
 Cooling Temperature Failure Setpoint Screen.....55

D

Data Entry Keys, Described.....47
 DDC Controller
 Alarms.....38
 Analog Inputs.....34
 Analog Input Wiring.....16
 BACnet® Connection.....61
 Coil Temperature Switch Input.....35
 CommLink Settings.....32
 Components.....13
 Description.....8
 Dimensions.....12
 Dirty Filter Contact Closure Input.....35
 E-BUS Digital Room Sensor Wiring.....18
 Economizer Control Signal.....35
 Economizer Damper Actuator Wiring.....29
 Emergency Shutdown Input.....34
 Fan Proving Input.....34
 Inputs.....34
 Input Wiring.....15
 Outdoor Air Damper Control Signal.....35
 Outdoor Air Temperature Sensor Input.....34
 Outputs.....35
 Output Wiring.....17
 Overview.....5
 Programming.....33
 RA CO₂ Sensor Wiring.....20
 RH Level.....14
 Space Temperature Sensor Slide Adjust.....34
 Temperature Range.....14
 DDC Controller Binary Input Wiring.....15
 DDC Controller Inputs.....34
 Defrost Coil Temperature Switch Input.....35
 Defrost Screen.....51
 Defrost Test Screen.....60
 Defrost Timer Screen.....58
 Delay Setpoints Screen.....57
 Dewpoint Enable Setpoint Screen.....56
 Dewpoint Screen.....51
 Diagnostics
 LED.....41
 Digital Room Sensor Wiring.....18
 Dimensions
 DDC Controller.....12
 Dirty Filter Alarm.....5
 Dirty Filter Contact Closure Input Description.....35
 Dirty Filter Switch LED.....41

DOWN Key, Defined.....47
 Drybulb Enable Setpoint Screen.....56
 Duct Mounted E-BUS CO₂ Sensor.....20
 Duct Temperature Sensor, Described.....9
 Duct Temperature Sensor - 6" Probe.....9
 Duct Temperature Sensor - 12" Probe.....9

E

EBC E-BUS Cables.....9
 E-BUS Adapter Board.....10
 E-BUS Adapter Hub.....10
 E-BUS Cables.....9
 E-BUS CO₂ Duct Sensor.....8
 E-BUS CO₂ Wall-Mounted Sensor.....8
 Described.....8
 Wiring.....19
 E-BUS CO₂ Sensor Wiring.....19,20
 E-BUS Digital Room Sensor.....8,19
 Wiring.....18
 E-BUS Digital Room Sensor - Temp and RH.....8
 E-BUS Digital Room Sensor - Temp Only.....8
 E-BUS LED.....41
 E-BUS Outdoor Air Temperature & Humidity Sensor.....9
 E-BUS Outdoor Air Temperature & Humidity Sensor
 Wiring.....26
 E-BUS Outside Air Temp & RH Sensor Wiring.....26
 Economizer Actuator Feedback Signal Wiring.....28
 Economizer Calibration Screen.....56
 Economizer Configuration.....33
 Economizer Control Signal.....35
 Economizer Damper Actuator Wiring.....29
 Economizer Damper Not Modulating.....39
 Economizer Enable.....37
 Economizer Enabled Screen.....51
 Economizer Enable Source Screen.....59
 Economizer Excess Outdoor Air Filter.....39
 Economizer Feedback Position Screen.....50
 Economizer Feedback Signal Input Description.....34
 Economizer Is Economizing When It Should Not.....39
 Economizer Minimum Position Screen.....56
 Economizer Not Economizing When It Should.....39
 Economizer Position Screen.....51
 Economizer Setpoints Screens.....56
 Economizer Temperature Sensor Failure.....39
 Economizer Type Screen.....59
 Emergency Shutdown Alarm.....39
 Emergency Shutdown Input.....5
 Description.....34
 Emergency Shutdown LED.....41
 ENTER Key, Defined.....47
 Enthalpy Enable Setpoint Screen.....56
 Enthalpy Screen.....51
 Exhaust Fan Relay Screen.....52
 Exhaust Fan Signal.....30,35

F-M

- F**
- Factory Troubleshooting.....41
 - Factory Wired.....14
 - Failure Mode Alarms.....39
 - Fan Mode Screen.....59
 - Fan Proving Alarm.....38
 - Fan Proving Input Description.....34
 - Fan Proving Interlock.....5
 - Features and Applications
 - DDC Controller.....6
 - Field Wired.....14
- G**
- General Information Screens.....49
 - GENERAL INFO Screen.....49
 - GND-to-GND.....33
- H**
- Heat Configuration Screen.....49
 - Heat Enable.....37
 - Heat Enabled Screen.....51
 - Heat Enable Setpoint Screen.....55
 - Heating Mode.....36
 - Heating Setpoint Screen.....51
 - Heating Temperature Failure Setpoint Screen.....55
 - Heat Minimum Off Time Screen.....57
 - Heat Minimum Run Time Screen.....57
 - Heat Pump Enabled Screen.....52
 - Heat Pump Enable Setpoint Screen.....55
 - Heat Stage 1 Enable Relay.....35
 - Heat Stage 2 Enable Relay.....35
 - Heat Stage Down Delay Time Screen.....57
 - Heat Stages Screen.....59
 - Heat Stage Up Delay Time Screen.....57
 - High CO₂ Level Setpoint Screen.....56
 - High Fan Relay Screen.....52
 - High Speed Blower Enable Relay.....35
 - High Supply Temp Alarm.....39
 - Holidays.....36
 - Holiday Scheduling.....5
 - Humidity Sensor 0-5 VDC.....9
 - HVAC Modes.....36
 - HZ-EBC-248.....10
- I**
- Indoor Air Humidity Sensor Input
 - Description.....34
 - Indoor Wall-Mounted Humidity Sensor.....22
 - Inputs
 - DDC Controller.....34
 - Input Wiring
 - DDC Controller.....15
 - Interconnected Operation.....32
 - Interconnected System.....42
 - Defined.....42
 - Interconnected System Layout.....44
 - Internet/LAN Connection.....10
 - IP Module Kit
 - Described.....10
 - IP Module Technical Guide.....11
- K**
- Keys
 - Described.....47
 - Function.....47
- L**
- LCD Display Screen.....47
 - LEDs
 - APP HB.....41
 - Binary Input.....41
 - Coil Temperature Switch.....41
 - Diagnostics.....41
 - Dirty Filter Switch.....41
 - EBUS.....41
 - Emergency Shutdown.....41
 - Locations.....13
 - LOOP COMM.....41
 - Operation.....41
 - OS HB.....41
 - POWER.....14,41
 - Proof of Flow Switch.....41
 - STATUS 1.....41
 - WDOG.....41
 - Load Shedding Input.....35
 - Load Shedding Screen.....51
 - LOOP COMM LED.....41
 - Low CO₂ Level Setpoint Screen.....56
 - Low Fan Relay Screen.....52
 - Low Pressure Switch 1 Alarm.....39
 - Low Pressure Switch 2 Alarm.....39
 - Low Speed Blower Enable Relay.....35
 - Low Supply Temp Alarm.....39
- M**
- Main Screens Map.....48
 - Mechanical Cooling Failure.....38
 - Mechanical Failure Alarms.....38
 - Mechanical Failure Alarm Screen.....58
 - Mechanical Heating Failure.....38
 - MENU Key, Defined.....47
 - Minimum Economizer Position Screen.....56
 - Minimum Wire Size
 - For 24 VAC.....14
 - For Sensors.....14
 - Mode Screen.....50
 - MS000248.....10

N

Networked System, Defined.....42
 Networked System Layout.....45
 Network Operation.....32
 Network System.....42

O

Occupancy.....36
 OE213 Space Temperature Sensor.....21
 OE217-02 E-BUS Digital Room Sensor.....8,18
 OE217-03 E-BUS Digital Room Sensor.....8,18,19
 OE217-04 E-BUS Digital Room Sensor.....8,18,19
 OE230 Supply Air & Return Air Temperature Sensor.....9,24
 OE231 Supply Air & Return Air Temperature Sensor.....9,24
 OE250 Outdoor Air Temperature Sensor.....9,25
 OE256-05 Wall Mounted E-BUS CO₂ Sensor.....8,19
 OE256-07 Duct-Mounted E-BUS CO₂ Sensor.....8,20
 OE265-11 Indoor Wall-Mounted Humidity Sensor.....9,22
 OE265-13 Outdoor Air Humidity Sensor.....27
 OE265-15 E-BUS Horizontal Outside Air Temp & RH
 Sensor.....9,26
 OE265-16 E-BUS Vertical Outside Air Temp & RH
 Sensor.....9,26
 OE361-13 CommLink 5.....10
 OE365-15-EBA E-BUS Adapter Board.....10
 OE368-23-LON3-G.....11
 OE377-26B-00001 DDC Controller.....8, 14
 OE392-10-G System Manager Touch Screen II-G.....10
 OE415-02 IP Module Kit.....10
 OE437-03 Communication Surge Protector Kit.....11
 Off Mode.....36
 On-Board BACnet® Port.....5
 On-Board CommLink Setting.....32
 Operator Interfaces.....33,42
 Optimal Start.....5,36
 Optimal Start Scheduling.....5
 OS HB LED.....41
 Outdoor Air Damper Control Signal.....35
 Outdoor Air Heat Pump Enabled Screen.....52
 Outdoor Air Humidity Screen.....50
 Outdoor Air Humidity Sensor.....27
 Input Description.....34
 Wiring.....27
 Outdoor Air Humidity Sensor Calibration Screen.....60
 Outdoor Air Humidity Sensor Failure Alarm.....38
 Outdoor Air Humidity Sensor Input
 Description.....34
 Outdoor Air Humidity Sensor Wiring.....27
 Outdoor Air Temperature & Humidity Sensor.....9
 Outdoor Air Temperature & Humidity Sensor Wiring.....26
 Outdoor Air Temperature Screen.....50
 Outdoor Air Temperature Sensor.....9
 Outdoor Air Temperature Sensor Calibration Screen.....60
 Outdoor Air Temperature Sensor Failure Alarm.....38
 Outdoor Air Temperature Sensor Testing.....46
 Outdoor Air Temperature Sensor Wiring.....25

Output Wiring

 DDC Controller.....17
 Outside Air Temperature Sensor.....25
 Described.....9
 Input Description.....34
 Wiring.....25
 Outside Air Temp & RH Sensor.....26
 Overtime Screen.....58

P

Part Number Cross Reference.....7
 Part Number List.....7
 Part Numbers
 Daikin.....7
 Polarity
 Correct.....14,33
 Observing.....33
 Warning.....33
 POWER LED.....14,41
 Power Requirements
 Before Applying Power.....33
 Power Ups Screen.....49
 Power Wiring.....33
 Pressure Switch 1 Input.....34
 Pressure Switch 2 Input.....34
 Primary/Secondary Heating Control.....5
 PrismD Front-End Computer Software.....11,33,42
 PrismD Technical Guide.....11
 Programming Controllers.....33
 Proof of Flow Switch LED.....41
 PT-Link II LON-3-G.....11
 PT-Link II LON-3-G Technical Guide.....11
 Push-Button Overtime Screen.....58

R

Relays, Described.....35
 Remote Force Schedule Mode.....36
 Remote Occupied Binary Input.....36
 Remote Forced Occupied Mode Input.....34
 Remote Occupied via BACnet® or LONworks®.....36
 Remote Start/Stop Control.....5
 Remote Start/Stop Input.....34
 Return Air CO₂ Sensor Wiring.....23
 Return Air Sensor Input.....34
 Reversing Valve Relay Screen.....52
 Reversing Valve(s) Enable Relay.....35
 RH Level
 DDC Controller.....14
 RLY1 - RLY8.....35
 Room Sensor.....8

S-U

S

Scaling Screen.....59
 Schedule Screen.....50
 Scheduling.....36
 Screens
 LCD Display Screens.....48
 Sensor Calibration Screens.....60
 Sensors
 Duct Mounted E-BUS CO₂.....20
 E-BUS Outdoor Air & RH.....26
 Indoor Wall-Mounted Humidity.....22
 Outdoor Air Humidity.....27
 Outdoor Air Temperature.....25
 Space Temperature.....21
 Supply Air Temperature.....24
 Temperature Sensor Testing.....46
 Thermistor Sensor Testing Instructions.....46
 Type III 10K Ohm Thermistor Sensors.....46
 Wall-Mounted E-BUS CO₂.....19
 Sequence of Operations.....36
 Single Speed Blower.....37
 Sizing
 Transformer.....33
 Slide Adjust.....21,34
 Slide Adjust Screen.....50
 Software ID Screen.....49
 Software Version Screen.....49
 Space CO₂ Sensor Wiring.....23
 Space Cooling Setpoint Screen.....54
 Space Deadband Setpoint Screen.....54
 Space Heating Setpoint Screen.....54
 Space Humidity Screen.....51
 Space Humidity Sensor Calibration Screen.....60
 Space Humidity Sensor Failure Alarm.....38
 Space Humidity Sensor Input.....34
 Space Humidity Sensor Installed Screen.....59
 Space Sensor Installed Screen.....59
 Space Temperature Calibration Screen.....60
 Space Temperature Screen.....50
 Space Temperature Sensor
 Diagram.....21
 Input Description.....34
 Overview.....21
 Slide Adjust.....34
 Wiring.....21
 Space Temperature Sensor Failure Alarm.....38
 Space Temperature Sensor Input
 Description.....34
 Space Temperature Sensor Slide Adjust
 Input Description.....34
 Space Temperature Sensor Testing.....46
 Space Temperature Slide Adjust.....21
 Stand Alone Operation.....32
 Stand-Alone System.....42
 Defined.....42
 Layout.....43
 Stand-Alone System Layout.....43

Standard Room Sensor, Described.....8
 STATUS1 LED.....41
 Status Screens.....50
 Supply Air Alarm Timer Screen.....58
 Supply Air Temperature Calibration Screen.....60
 Supply Air Temperature Cooling Setpoint Screen.....55
 Supply Air Temperature Heating Setpoint Screen.....55
 Supply Air Temperature Screen.....50
 Supply Air Temperature Sensor.....24
 Diagram.....24
 Input Description.....34
 Wiring.....24
 Supply Air Temperature Sensor Failure Alarm.....38
 System
 Applications.....6
 Configuration.....42
 Powering-Up.....33
 System Manager Touch Screen II-G Technical Guide.....11
 System Manager Touch Screen II-G.....10, 33, 42

T

Temperature Range
 For DDC Controller.....14
 Temperature/Resistance
 Chart.....46
 Temperature/Resistance for Type III 10K Ohm Thermistor
 Sensors.....46
 Temperature Scaling Screen.....59
 Temperature Sensor Testing.....46
 Temperature Setpoints Screens.....54
 Thermistor Sensor Testing Instructions.....46
 Timer Setpoints Screen.....57
 Title 24 Economizer Alarms.....39
 Title 24 Economizer Certified.....5
 Touch Screen System Manager.....33
 Transformer Sizing.....14,33
 Trend Logging.....40
 Capability.....5
 Trendlogs.....40
 Troubleshooting
 LED Diagnostics.....41
 Two Speed Blower.....37
 Type III 10K Ohm Thermistor Sensors.....46

U

Unit Selection Screen.....50
 Unit Type Screen.....49
 Unoccupied Heating Offset Screen.....54
 Unoccupied Heating Setpoint Screen.....54
 UP Key.....47
 USB Driver Software.....11

V

- VA Load Requirements.....14
- VA Rating.....14
- Vent Mode Minimum Time Period Screen.....58
- Vent Mode Operation.....36
- VFD.....31
- Voltage
 - Proper.....33
- Voltage and Environment Requirements.....14

W

- Wall Mounted E-BUS CO₂ Sensor.....19
 - Wiring.....19
- WattMaster Aspiration Box Assembly.....20
- WDOG LED.....41
- Weekly Schedule.....36
- Wetbulb Enable Setpoint Screen.....56
- Wetbulb Screen.....51
- Wire Size
 - 18-gauge.....14
 - Minimum for 24 VAC.....14
- Wiring
 - 18-gauge.....14
 - 24-gauge.....14
 - 24 VAC-to-24 VAC.....33
 - Alarm Solid State Wiring.....31
 - Duct-Mounted CO₂ Sensor.....20
 - E-BUS CO₂ Wall-Mounted Sensor.....19
 - E-BUS Digital Room Sensor.....18
 - E-BUS Outdoor Air Temperature & Humidity Sensor.....26
 - Economizer Actuator Feedback Signal.....28
 - Economizer Damper Actuator.....29
 - Exhaust Fan Signal.....30
 - GND-to-GND.....33
 - Important Considerations.....14
 - Indoor Wall-Mounted Humidity Sensor.....22
 - Outdoor Air Humidity Sensor.....27
 - Outdoor Air Temperature & Humidity Sensor.....26
 - Outdoor Air Temperature Sensor.....25,26
 - Overview.....14
 - RA CO₂ Sensor.....20
 - Space Temperature Sensor.....21
 - Space Temperature Sensor Slide Adjust.....21
 - Supply Air Temperature Sensor.....24
 - Wall-Mounted CO₂ Sensor.....19



WattMaster Form: DK-DDC-TGD, Revision 01B

June 2016

Daikin Part No.: DK-DDC-TGD-01B

All rights reserved.

Printed in the USA

© 2016

WattMaster Controls Inc. • 8500 NW River Park Drive • Parkville, MO • 64152



Our continuing commitment to quality products may mean a change in specifications without notice.
© 2016 **DAIKIN NORTH AMERICA LLC** · Houston, Texas · USA · www.northamerica-daikin.com