



Maintenance and Service Guide

SUMMARY

This guide provides information about spare parts, removal and replacement of parts, security, backing up, and more.

© Copyright 2020 HP Development Company, L.P.

AMD, Athlon, Ryzen, Radeon, and Radeon Vega are trademarks of Advanced Micro Devices, Inc. Bluetooth is a trademark owned by its proprietor and used by HP Inc. under license. Intel is a trademark of Intel Corporation or its subsidiaries in the U.S. and/or other countries. SDHC, SDXC, and microSD are trademarks or registered trademarks of SD-3C LLC. Microsoft and Windows are either registered trademarks or trademarks of Microsoft Corporation in the United States and/or other countries. Miracast is a registered trademark of Wi-Fi Alliance.

The information contained herein is subject to change without notice. The only warranties for HP products and services are set forth in the express warranty statements accompanying such products and services. Nothing herein should be construed as constituting an additional warranty. HP shall not be liable for technical or editorial errors or omissions contained herein.

First Edition: May 2020

Document Part Number: L97707-001

Product notice

This guide describes features that are common to most models. Some features may not be available on your computer.

Not all features are available in all editions or versions of Windows. Systems may require upgraded and/or separately purchased hardware, drivers, software or BIOS update to take full advantage of Windows functionality. Windows 10 is automatically updated, which is always enabled. ISP fees may apply and additional requirements may apply over time for updates. Go to <http://www.microsoft.com> for details.

To access the latest user guides, go to <http://www.hp.com/support>, and follow the instructions to find your product. Then select **User Guides**.

Software terms

By installing, copying, downloading, or otherwise using any software product preinstalled on this computer, you agree to be bound by the terms of the HP End User License Agreement (EULA). If you do not accept these license terms, your sole remedy is to return the entire unused product (hardware and software) within 14 days for a full refund subject to the refund policy of your seller.

For any further information or to request a full refund of the price of the computer, please contact your seller.

Safety warning notice

Reduce the possibility of heat-related injuries or of overheating the computer by following the practices described.

 **WARNING!** To reduce the possibility of heat-related injuries or of overheating the computer, do not place the computer directly on your lap or obstruct the computer air vents. Use the computer only on a hard, flat surface. Do not allow another hard surface, such as an adjoining optional printer, or a soft surface, such as pillows or rugs or clothing, to block airflow. Also, do not allow the AC adapter to come into contact with the skin or a soft surface, such as pillows or rugs or clothing, during operation. The computer and the AC adapter comply with the user-accessible surface temperature limits defined by applicable safety standards.

Table of contents

1 Product description	1
2 Components	5
Right side	5
Left side	6
Display	7
Low blue light mode (select products only)	7
Keyboard area	8
Touchpad components	8
Lights	9
Button, vent, speakers, and fingerprint reader	10
Special keys	12
Bottom	13
Labels	13
3 Illustrated parts catalog	15
Computer major components	15
Display assembly subcomponents	18
Cables	19
Miscellaneous parts	20
4 Removal and replacement procedures preliminary requirements	23
Tools required	23
Service considerations	23
Plastic parts	23
Cables and connectors	23
Drive handling	23
Workstation guidelines	24
Electrostatic discharge information	24
Generating static electricity	25
Preventing electrostatic damage to equipment	25
Personal grounding methods and equipment	26
Grounding the work area	26
Recommended materials and equipment	26
Packaging and transporting guidelines	27

5 Removal and replacement procedures for authorized service provider parts	29
Component replacement procedures	29
Preparation for disassembly	29
Bottom cover	29
Battery	31
Memory modules	33
WLAN module	34
Solid-state drive	36
Power button/card reader board	37
Touchpad	37
Fingerprint reader board (select products only)	38
Fan	39
Heat sink	40
System board	42
Speakers	44
Display assembly	46
Power connector cable	55
Keyboard with top cover	56
6 Using Setup Utility (BIOS)	59
Starting Setup Utility (BIOS)	59
Updating Setup Utility (BIOS)	59
Determining the BIOS version	59
Preparing for a BIOS update	60
Downloading a BIOS update	60
Installing a BIOS update	60
7 Backing up, restoring, and recovering	63
Backing up information and creating recovery media	63
Using Windows tools	63
Using the HP Cloud Recovery Download Tool to create recovery media (select products only)	63
Restoring and recovery	64
Restoring, resetting, and refreshing using Windows tools	64
Recovering using HP Recovery media	64
Changing the computer boot order	64
Using HP Sure Recover (select products only)	65
8 Using HP PC Hardware Diagnostics	67
Using HP PC Hardware Diagnostics Windows (select products only)	67
Using an HP PC Hardware Diagnostics Windows hardware failure ID code	67

Accessing HP PC Hardware Diagnostics Windows	67
Accessing HP PC Hardware Diagnostics Windows from HP Help and Support	67
Accessing HP PC Hardware Diagnostics Windows from Support Assistant	68
Downloading HP PC Hardware Diagnostics Windows	68
Downloading the latest HP PC Hardware Diagnostics Windows version from HP	68
Downloading the HP PC Hardware Diagnostics Windows from the Microsoft Store	68
Downloading HP Hardware Diagnostics Windows by product name or number (select products only)	68
Installing HP PC Hardware Diagnostics Windows	69
Using HP PC Hardware Diagnostics UEFI	69
Using an HP PC Hardware Diagnostics UEFI hardware failure ID code	69
Starting HP PC Hardware Diagnostics UEFI	69
Downloading HP PC Hardware Diagnostics UEFI to a USB flash drive	70
Downloading the latest HP PC Hardware Diagnostics UEFI version	70
Downloading HP PC Hardware Diagnostics UEFI by product name or number (select products only)	70
Using Remote HP PC Hardware Diagnostics UEFI settings (select products only)	70
Downloading Remote HP PC Hardware Diagnostics UEFI	71
Downloading the latest Remote HP PC Hardware Diagnostics UEFI version	71
Downloading Remote HP PC Hardware Diagnostics UEFI by product name or number	71
Customizing Remote HP PC Hardware Diagnostics UEFI settings	71
9 Specifications	73
Computer specifications	73
35.6 cm (14.0 in) display specifications	74
Solid-state drive specifications	74
Solid-state drive specifications (SATA-3)	75
10 Power cord set requirements	77
Requirements for all countries	77
Requirements for specific countries and regions	77
11 Recycling	79
Index	81

1 Product description

This table provides detailed product information.

Table 1-1 Product components and their descriptions

Category	Description
Product Name	HP 14 Laptop PC
	HP 14s Laptop PC
	Model number: 14-fq0xxx, 14s-fq0xxx, 14s-fr0xxx, 14s-fy0xxx
	CTO model number: 14z-fq0000
Processors	AMD® processors
	AMD Ryzen™ 7-4700U (2.0 GHz [turbo up to 4.2 GHz], 8 cores, 3200 MHz/8 MB L2 cache, 25 W)
	AMD Ryzen 5-4500U (2.3 GHz [turbo up to 4.0 GHz], 6 cores, 3200 MHz/8 MB L3 cache, 25 W)
	AMD Ryzen 5-3500U (2.1 GHz [turbo up to 3.7 GHz], 4 cores, 2400 MHz/6 MB L2+L3 cache, 15 W)
	AMD Ryzen 3-3250U (2.6 GHz [turbo up to 3.5 GHz], 2 cores, 2400 MHz/1 MB L2 cache, 15 W)
	AMD Athlon™ Gold3150U (2.4 GHz [turbo up to 3.3 GHz], 2 cores, 2400 MHz/1 MB L2 cache, 15 W)
	AMD Athlon Silver3050U (2.3 GHz [turbo up to 3.2 GHz], 2400 MHz/1 MB L2 cache, 15 W)
Graphics	AMD 3020e (1.2 GHz [turbo up to 2.6 GHz], 2 cores, 2400 MHz/1 MB L2 cache, 6 W)
	Internal graphics
	AMD Radeon™ Vega™ 8 Graphics (Ryzen 5 processors)
	AMD Radeon Graphics
	Supports HD Decode, DX12, and HDMI
Display	35.6 cm (14.0 in), WLED, slim-flat (3.0 mm), narrow bezel, 45% NTSC
	High-definition (HD) (1366 × 768), antiglare, SVA, 220 nits
	HD, BrightView, SVA, 220 nits
	HD, BrightView, SVA, 220 nits, Touch-on Panel (TOP)
	Full high-definition (FHD) (1920 × 1080), antiglare, UWVA, 250 nits, eDP
	FHD, BrightView, UWVA, 250 nits
	FHD, antiglare, SVA, 220 nits
Memory	Two SODIMM slots, not customer accessible or upgradeable supporting up to 16 GB of RAM
	DDR4-2666 dual-channel support (DDR4-3200 bridge to DDR4-2666)
	DDR4-2400 dual-channel support (DDR4-3200 bridge to DDR4-2666 and DDR-2400)
	Supports the following configurations:
	<ul style="list-style-type: none">• 16 GB (8 × 2)

Table 1-1 Product components and their descriptions (continued)

Category	Description
	<ul style="list-style-type: none"> • 12 GB (8 + 4) • 8 GB (8 × 1) or (4 × 2) • 4 GB (4 × 1)
Primary storage	NVMe, M.2, solid-state drives <ul style="list-style-type: none"> • 1 TB, PCIe • 512 GB, PCIe • 256 GB, PCIe • 128 GB, SATA-3, TLC
eMMC	On-board embedded MultiMedia Controller (eMMC v5.0) configuration 64 GB
Audio and video	Audio control panel: HP Audio Control Support for Cortana far field (for dual mic) Dual speakers HP TrueVision HD Camera: indicator LED, USB 2.0, HD, f2.0 720p by 30 frames per second Dual-array digital microphone with appropriate software: beam forming, echo cancellation, noise suppression HP Webcam: indicator LED, USB 2.0, f2.4 640 × 480 by 30 frames per second Single digital microphone
Wireless	Wireless Local Area Network (WLAN) Intel Wi-Fi 6 AX200 + Bluetooth 5 (non-vPro) (802.11ax 2 × 2, MU-MIMO, supporting gigabit file transfer speeds) Realtek RTL8822CE 802.11ac 2 × 2 Wi-Fi + Bluetooth 5 (MU-MIMO supported) Realtek RTL8821CE 802.11ac 1 × 1 Wi-Fi + Bluetooth 4.2 (MU-MIMO supported) Compatible with Miracast® devices Support for Modern Standby (Connected) Support for Turbo Lite WLAN SVTP
Media card reader	Supports microSD™, SDHC™, SDXC™ Push-pull insertion/removal
Ports	Hot plug/unplug and autodetect for correct output to wide-aspect vs. standard aspect video HDMI v1.4b supporting: up to 1920 × 1080 @ 60 Hz Audio-out (headphone)/audio-in (microphone) combo jack USB 3.2 Gen 1 Type C (supports data transfer)

Table 1-1 Product components and their descriptions (continued)

Category	Description
	USB 3.2 Gen 1 Type A (supports HP Sleep & Charge; right side)
	AC Smart Pin adapter plug
Keyboard/pointing devices	Keyboard
	Island style, backlit
	Full-size
	Full-sized, textured
	Touchpad
	Clickpad with image sensor
	Multitouch gestures enabled
	Precision touchpad support
	Support for Modern Trackpad Gestures
	Taps enabled as default
Power requirements	Battery
	3 cell, 41 Wh, polymer, HP Long Life
	Supports battery fast charge (45 minutes, 50% charged)
	Smart AC adapters (nPFC, 4.5 mm)
	65 W, right angle
	45 W
	Power cord
C5, 1 m	
Security	Supports Trusted Platform Module (TPM) 2.0, firmware based
	Integrated fingerprint reader
Operating system	Windows® 10 Home 64
	Windows 10 Home S 64 Entry Season Compact
	Windows 10 Home 64 Chinese Market CPPP
	Windows 10 Home 64 High-end Chinese Market CPPP
	Windows 10 Home 64 Plus
	Windows 10 Home 64 Plus Single Language
	Windows 10 Home 64 Plus Single Language Africa Market
	Windows 10 Home 64 Plus Single Language APAC EM PPP
	Windows 10 Home 64 Plus Single Language India Market
	Windows 10 Home 64 Plus Single Language Indonesia Market
	Windows 10 Home 64 Single Language

Table 1-1 Product components and their descriptions (continued)

Category	Description
	Windows 10 Home 64 Single Language Africa Market
	Windows 10 Home 64 Single Language APAC EM PPP
	Windows 10 Home 64 Single Language India Market
	Windows 10 Home 64 Single Language Indonesia Market
	Windows 10 Home 64 Single Language Value Africa Market
	Windows 10 Home 64 Single Language value APAC EM PPP
	Windows 10 Home 64 Single Language Value India Market
	Windows 10 Home 64 Single Language Value Indonesia Market
	Windows 10 Home 64 Value Single Language
	Windows 10 Home S 64
	Windows 10 Home S 64 Entry
	Windows 10 Home S 64 Plus Single Language
	Windows 10 Home S 64 Single Language
	Windows 10 Home S 64 Value
	Windows 10 Home S 64 Value Single Language
	Windows 10 Pro 64
	FreeDOS 3.0
Serviceability	End user replaceable parts
	AC adapter

2 Components

Your computer features top-rated components. This chapter provides details about your components, where they are located, and how they work.

Right side

Use the illustration and table to identify the components on the right side of the computer.

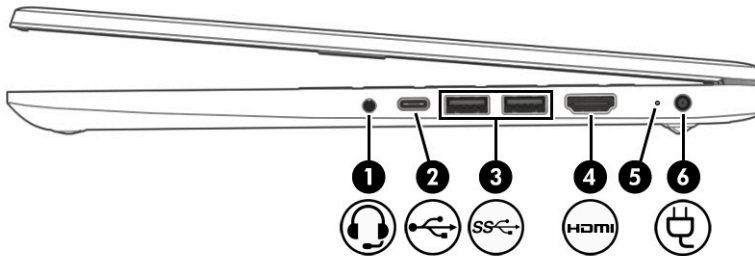

Table 2-1 Right-side components and their descriptions





Component	Description
<p>(1)  Audio-out (headphone)/Audio-in (microphone) combo jack</p>	<p>Connects optional powered stereo speakers, headphones, earbuds, a headset, or a television audio cable. Also connects an optional headset microphone. This jack does not support optional standalone microphones.</p> <p>WARNING! To reduce the risk of personal injury, adjust the volume before putting on headphones, earbuds, or a headset. For additional safety information, see the <i>Regulatory, Safety, and Environmental Notices</i>.</p> <p>To access this guide:</p> <ul style="list-style-type: none"> ▲ Type HP Documentation in the taskbar search box, and then select HP Documentation. <p>NOTE: When a device is connected to the jack, the computer speakers are disabled.</p>
<p>(2)  USB Type-C port</p>	<p>Connects a USB device, provides data transfer, and (for select products) charges small devices when the computer is on or in Sleep mode.</p> <p>NOTE: Cables, adapters, or both (purchased separately) may be required.</p>
<p>(3)  USB SuperSpeed ports (2)</p>	<p>Connects a USB device, provides high-speed data transfer, and (for select products) charges small devices when the computer is on or in Sleep mode.</p>
<p>(4)  HDMI port</p>	<p>Connects an optional video or audio device, such as a high-definition television, any compatible digital or audio component, or a high-speed High-Definition Multimedia Interface (HDMI) device.</p>
<p>(5) AC adapter and battery light</p>	<ul style="list-style-type: none"> • White: The AC adapter is connected and the battery is fully charged.

Table 2-1 Right-side components and their descriptions (continued)

Component	Description
	<ul style="list-style-type: none"> Blinking white: The AC adapter is disconnected and the battery has reached a low battery level. Amber: The AC adapter is connected and the battery is charging. Off: The battery is not charging.
(6)  Power connector	Connects an AC adapter.

Left side

Use the illustration and table to identify the components on the left side of the computer.

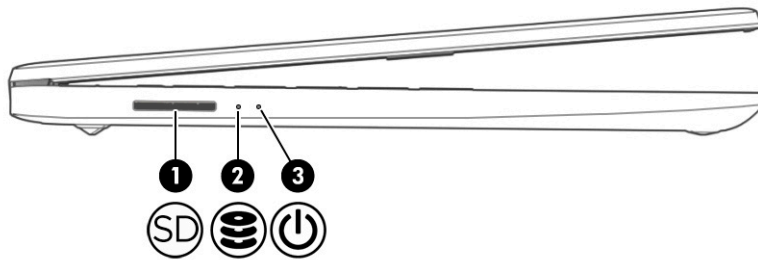





Table 2-2 Left-side components and their descriptions

Component	Description
(1)  Memory card reader	<p>Reads optional memory cards that enable you to store, manage, share, or access information.</p> <p>To insert a card:</p> <ol style="list-style-type: none"> Hold the card label-side up, with connectors facing the computer. Insert the card into the memory card reader, and then press in on the card until it is firmly seated. <p>To remove a card:</p> <ul style="list-style-type: none"> ▲ Press in on the card, and then remove it from the memory card reader.
(2)  Drive light (select products only)	Blinking white: The solid-state drive is being accessed.
(3)  Power light	<ul style="list-style-type: none"> On: The computer is on. Blinking white (select products only): The computer is in the Sleep state, a power-saving state. The computer shuts off power to the display and other unneeded components. Off: The computer is off or in Hibernation. Hibernation is a power-saving state that uses the least amount of power.

Display

The computer display can include essential components such as speakers, antennas, cameras, and microphones.

Low blue light mode (select products only)

Your computer display is shipped from the factory in low blue light mode for improved eye comfort and safety. Also, blue light mode automatically adjusts blue light emissions when you are using the computer at night or for reading.

⚠ WARNING! To reduce the risk of serious injury, read the *Safety & Comfort Guide*. It describes proper workstation setup and proper posture, health, and work habits for computer users. The *Safety & Comfort Guide* also provides important electrical and mechanical safety information. The *Safety & Comfort Guide* is available on the web at <http://www.hp.com/ergo>.

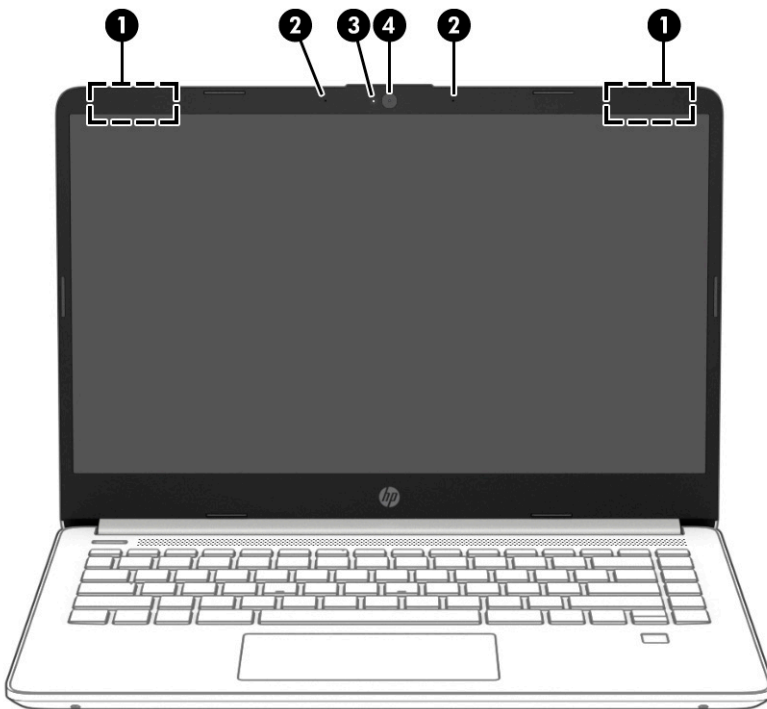

Table 2-3 Display components and their descriptions

Component	Description
(1) WLAN antennas*	Send and receive wireless signals to communicate with wireless local area networks (WLANs).
(2) Internal microphones	Record sound.
(3) Camera light	On: The camera is in use.
(4) Camera	Allows you to video chat, record video, and record still images. Some cameras also allow a facial recognition logon to Windows, instead of a password logon.

Table 2-3 Display components and their descriptions (continued)

Component	Description
	<p>NOTE: Camera functions vary depending on the camera hardware and software installed on your product.</p> <p>*The antennas are not visible from the outside of the computer. For optimal transmission, keep the areas immediately around the antennas free from obstructions.</p> <p>For wireless regulatory notices, see the section of the <i>Regulatory, Safety, and Environmental Notices</i> that applies to your country or region.</p> <p>To access this guide:</p> <ul style="list-style-type: none">▲ Type <code>HP Documentation</code> in the taskbar search box, and then select HP Documentation.

Keyboard area

Keyboards can vary by language.

Touchpad components

Identify the touchpad components.

To adjust touchpad settings and gestures, or to turn off the touchpad:

1. Type **touchpad settings** in the taskbar search box, and then press `enter`.
2. Choose a setting.

To turn on the touchpad:

1. Type **touchpad settings** in the taskbar search box, and then press `enter`.
2. Using an external mouse, click the **touchpad** button.

- or -

- ▲ Press the `Tab` key repeatedly until the pointer rests on the **touchpad** button. Then press the spacebar to select the button.

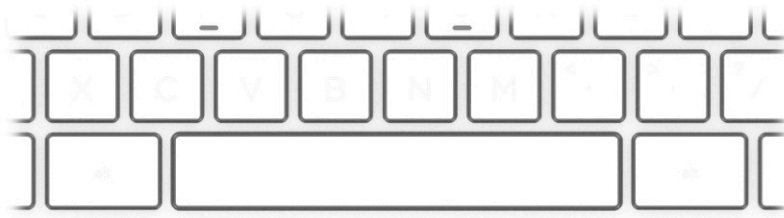

Table 2-4 Touchpad components and their descriptions

Component	Description
(1) Touchpad zone	Reads your finger gestures to move the pointer or activate items on the screen.
(2) Left control zone	Textured area that allows you to perform additional gestures.
(3) Right control zone	Textured area that allows you to perform additional gestures.

Lights

Identify the lights on the computer.

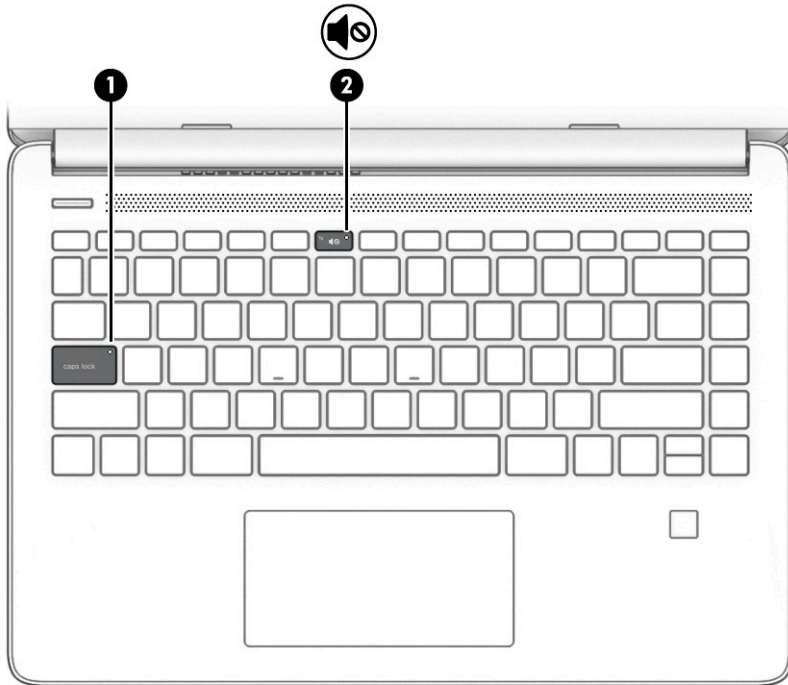



Table 2-5 Lights and their descriptions

Component	Description
(1) Caps lock light	On: Caps lock is on, which switches the key input to all capital letters.
(2)  Mute light	<ul style="list-style-type: none"> • On: Computer sound is off. • Off: Computer sound is on.

Button, vent, speakers, and fingerprint reader

Identify the computer button, vent, speakers, and fingerprint reader.

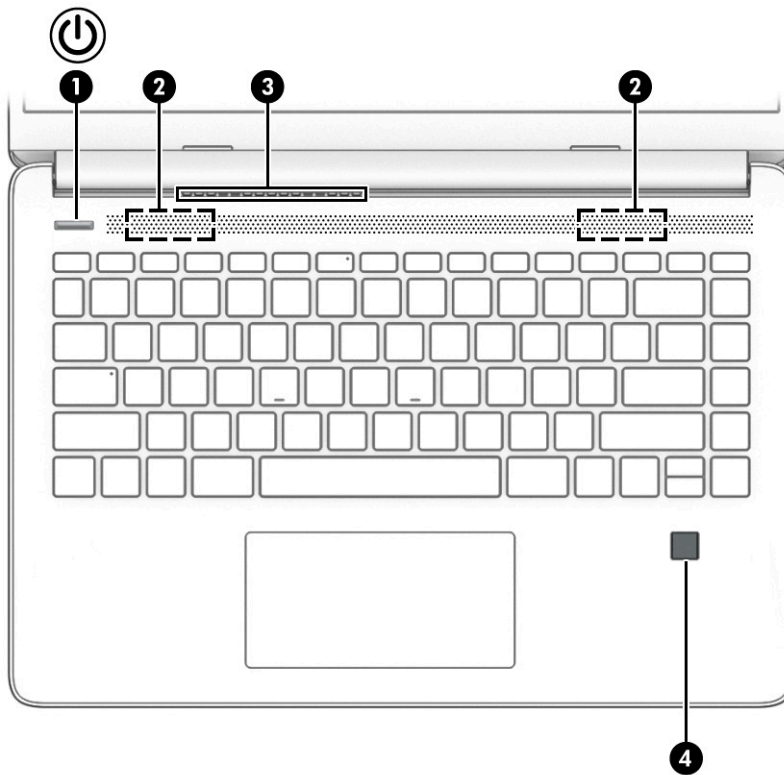

Table 2-6 Button, vent, speakers, and fingerprint reader and their descriptions

Component	Description
(1)  Power button	<ul style="list-style-type: none"> • When the computer is off, press the button briefly to turn on the computer. • When the computer is on, press the button briefly to initiate Sleep. • When the computer is in the Sleep state, press the button briefly to exit Sleep (select products only). • When the computer is in Hibernation, press the button briefly to exit Hibernation. <p>IMPORTANT: Pressing and holding down the power button results in the loss of unsaved information.</p> <p>If the computer has stopped responding and shutdown procedures are ineffective, press and hold the power button down for at least 10 seconds to turn off the computer.</p> <p>To learn more about your power settings, see your power options:</p> <ul style="list-style-type: none"> ▲ Right-click the Power icon, and then select Power Options.
(2) Speakers (2)	Produce sound
(3) Vent	Enables airflow to cool internal components.

Table 2-6 Button, vent, speakers, and fingerprint reader and their descriptions (continued)

Component	Description
	NOTE: The computer fan starts up automatically to cool internal components and prevent overheating. It is normal for the internal fan to cycle on and off during routine operation.
(4) Fingerprint reader (select products only)	Allows a fingerprint logon to Windows, instead of a password logon. ▲ Swipe down across the fingerprint reader. IMPORTANT: To prevent fingerprint logon issues, make sure when you register your fingerprint that all sides of your finger are registered by the fingerprint reader.

Special keys

Identify the special keys.

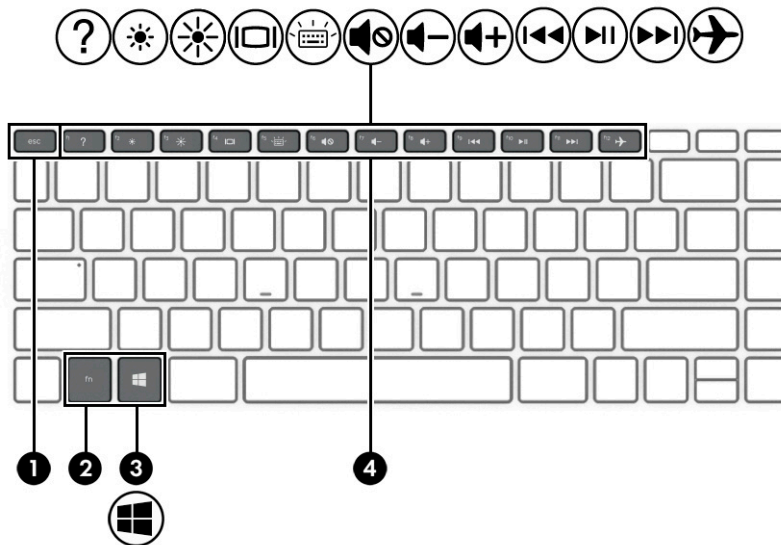



Table 2-7 Special keys and their descriptions

Component	Description
(1) <code>esc</code> key	Displays system information when pressed in combination with the <code>fn</code> key.
(2) <code>fn</code> key	Executes specific functions when pressed in combination with another key.
(3)  Windows key	Opens the Start menu. NOTE: Pressing the Windows key again will close the Start menu.
(4) Action keys	Execute frequently used system functions.

Bottom

Identify the bottom component.

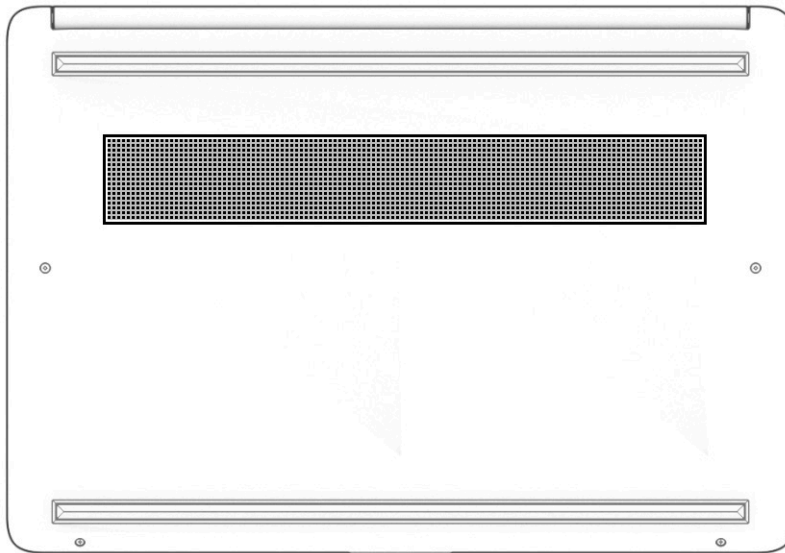



Table 2-8 Bottom component and its description

Component	Description
Vent	Enables airflow to cool internal components. NOTE: The computer fan starts up automatically to cool internal components and prevent overheating. It is normal for the internal fan to cycle on and off during routine operation.

Labels

The labels affixed to the computer provide information that you might need when you troubleshoot system problems or travel internationally with the computer. Labels can be in paper form or imprinted on the product.

 **IMPORTANT:** Check the following locations for the labels described in this section: the bottom of the computer, inside the battery bay, under the service door, on the back of the display, or on the bottom of a tablet kickstand.

- Service label—Provides important information to identify your computer. When contacting support, you might be asked for the serial number, the product number, or the model number. Locate this information before you contact support.

Your service label information order might vary by country and might not include the wording "Model" due to the country regulation.

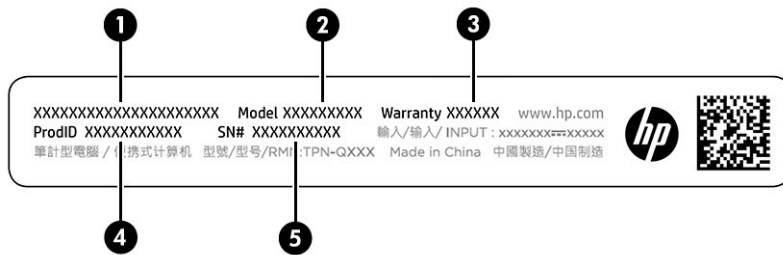

Table 2-9 Service label components

Component	
(1)	HP product name
(2)	Model number
(3)	Warranty period
(4)	Product ID
(5)	Serial number

- Regulatory label(s)—Provide(s) regulatory information about the computer.
- Wireless certification label(s)—Provide(s) information about optional wireless devices and the approval markings for the countries or regions in which the devices have been approved for use.

3 Illustrated parts catalog

Use this table to determine the spare parts that are available for the computer.

Computer major components

To identify the computer major components, use this illustration and table.

NOTE: HP continually improves and changes product parts. For complete and current information about supported parts for your computer, go to <http://partsurfer.hp.com>, select your country or region, and then follow the on-screen instructions.

NOTE: Details about your computer, including model, serial number, product key, and length of warranty, are on the service tag at the bottom of your computer.

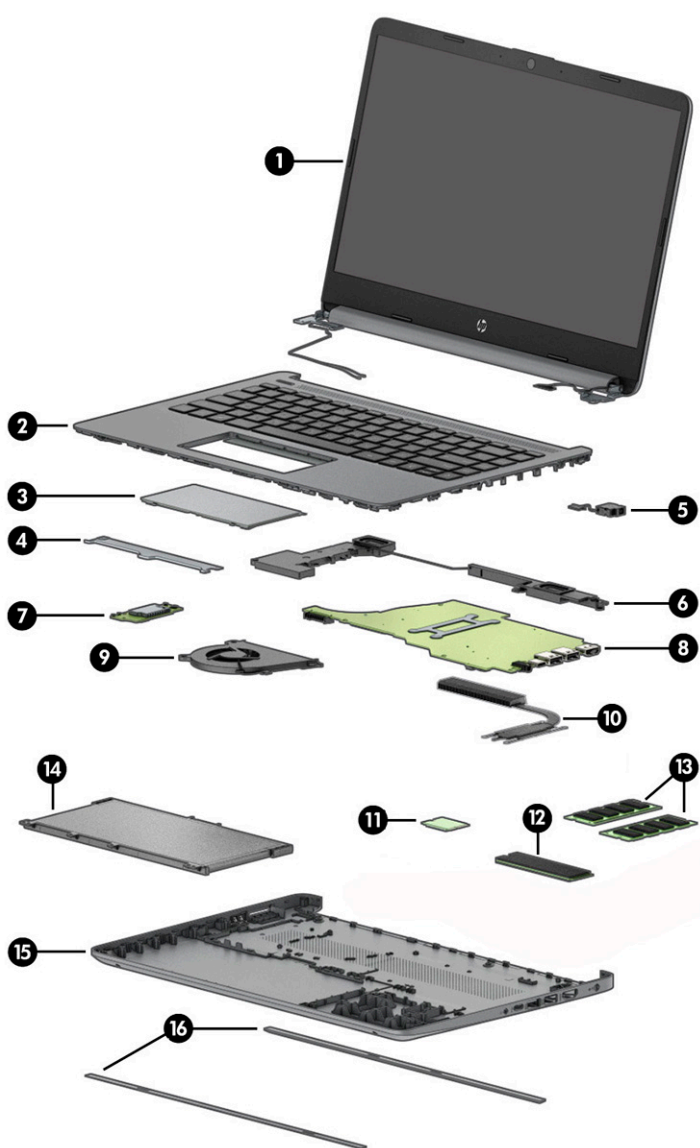

Table 3-1 Computer major component descriptions and part numbers

Item	Component	Spare part number
(1)	Display assembly	
	NOTE: Display assemblies are offered as spare parts only at a subcomponent level.	
(2)	Keyboard/top cover	
	For a detailed list of country codes, see Keyboard with top cover on page 56 .	
	Silver, with fingerprint reader, not backlit	L61506-xx1
	Silver, with fingerprint reader, backlit	L61507-xx1
	Silver, without fingerprint reader, not backlit	L88200-xx1
	Silver, without fingerprint reader, backlit	L88206-xx1
	White, not backlit	L61508-xx1
	White, backlit	L61509-xx1
	Black	M03796-xx1
	Blue	M03797-xx1
(3)	Touchpad	
	Silver	L64897-001
	White	L64899-001
	Black	M03782-001
	Blue	M03783-001
(4)	Touchpad bracket	not available as spare part
(5)	Power connector cable	808155-010
(6)	Speaker assembly	M13562-001
(7)	Power button/card reader board	M13557-001
	NOTE: The power button/card reader board cable is available as spare part number L64887-001.	
(8)	System board (includes processor):	
	All system boards use the following part numbers:	
	xxxxxx-001: Non-Windows operating system	
	xxxxxx-601: Windows 10 operating system	
	AMD Ryzen 7 4700U processor	M03776-xx1
	AMD Ryzen 5 4500U processor	M03775-xx1
	AMD Ryzen 5 3500U processor	M03774-xx1
	AMD Ryzen 3 3250U processor	M03773-xx1
	AMD Athlon 3150U processor	M03772-xx1
	AMD Athlon 3050U processor	M03771-xx1
	AMD 3020e processor	M04583-xx1

Table 3-1 Computer major component descriptions and part numbers (continued)

Item	Component	Spare part number
	AMD 3020e processor and 64 GB of eMMC	M10792-xx1
(9)	Fan	
	For use in models with a backlit keyboard	L63587-001
	For use in models without a backlit keyboard	L63588-001
(10)	Heat sink	
	For use in models with a 15 W processor	L64890-001
	For use in models with a 6 W processor	M13558-001
(11)	WLAN module	
	Realtek RTL8821CE 802.11ac 1 × 1 Wi-Fi + Bluetooth 4.2	L17365-005
	Intel Wi-Fi 6 AX200 802.11ax 2 × 2 Wi-Fi + Bluetooth 5 (non-vPro)	L35282-005
	Realtek RTL8822CE 802.11ac 2 × 2 Wi-Fi + Bluetooth 5	L44796-005
(12)	Solid-state drive (M.2)	
	1 TB, PCIe	L85370-005
	512 GB, PCIe	L85364-005
	256 GB, PCIe	L85354-005
	128 GB, SATA-3, TLC	L85346-005
(13)	Memory modules (DDR4-2666)	
	8 GB	937236-855
	4 GB	L10598-855
(14)	Battery (3 cell, 41 Wh)	L11119-855
(15)	Bottom cover	
	Silver	L64894-001
	Gold	L64895-001
	White	L64896-001
	Black	M03777-001
	Blue	M03778-001
(16)	Rubber feet	
	Silver	L65866-001
	Gold	L66226-001
	Black	M03779-001
	Blue	M03780-001
	Fingerprint reader board (not illustrated)	M13559-001
	NOTE: The fingerprint reader board cable is available as spare part number M13560-001.	

Display assembly subcomponents

To identify the display assembly subcomponents, use this illustration and table.

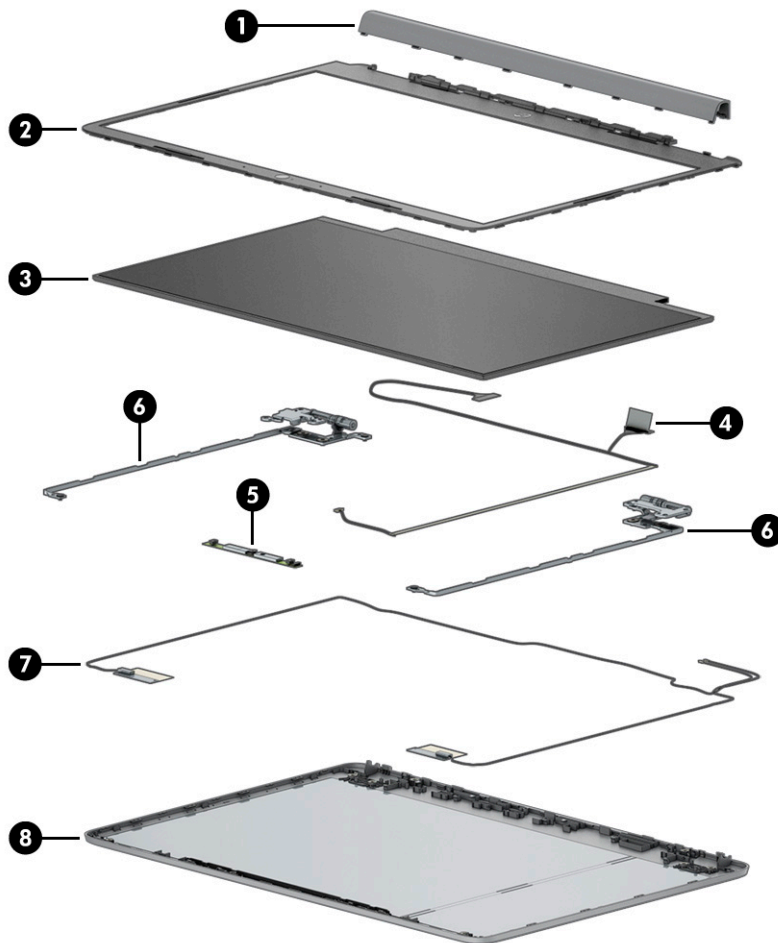

Table 3-2 Display component descriptions and part numbers

Item	Component	Spare part number
(1)	Hinge cover	
	Silver	L64911-001
	Gold	L64912-001
	White	L64913-001
	Black	M03788-001
	Blue	M03789-001
(2)	Display bezel	
	For use in models with dual antennas	L64905-001
	For use in models a single antenna	L64906-001
(3)	Display panel	
	FHD, antiglare, SVA, 220 nits	M03765-001

Table 3-2 Display component descriptions and part numbers (continued)

Item	Component	Spare part number
	FHD, antiglare, UWVA, 250 nits	M03766-001
	FHD, BrightView, UWVA, 250 nits	M03767-001
	HD, antiglare, SVA, 220 nits	M03768-001
	HD, BrightView, SVA, 220 nits	M03769-001
	HD, BrightView, SVA, 220 nits, Touch-on Panel (TOP)	M03770-001
(4)	Display panel cable	
	For use in touch screen models	L64908-001
	For use in nontouch screen models	L64909-001
(5)	Camera module	
	HD, dual microphone	L64914-001
	VGA, single microphone	M04368-001
(6)	Display hinges (left and right; includes bezel and display cover adhesive)	L64910-001
(7)	Wireless antennas (includes bezel adhesive tape and display cover tape)	
	Dual	L64905-001
	Single	L64906-001
(8)	Display back cover (includes bezel adhesive tape)	
	Silver	L66227-001
	Gold	L66228-001
	White	L66229-001
	Black	M03785-001
	Blue	M03786-001
	Miscellaneous Kit (includes display panel conductive tape, display back cover tape, and bezel tape)	L64916-001

Cables

To identify the cables, use this illustration and table.

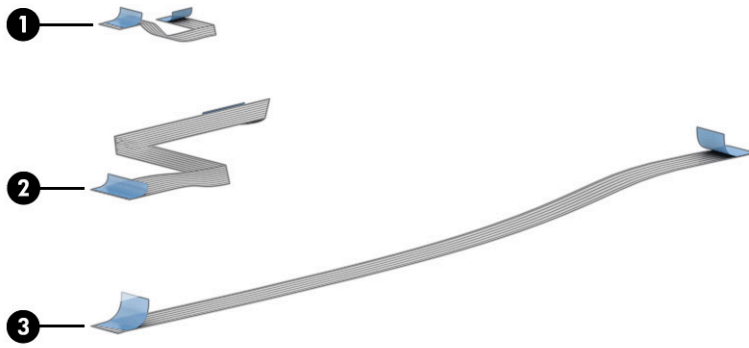

Table 3-3 Cable descriptions and part numbers

Item	Component	Spare part number
(1)	Fingerprint reader board cable	M13560-001
(2)	Touchpad cable	M13561-001
(3)	Power button/card reader board cable	L64887-001

Miscellaneous parts

To identify the miscellaneous parts, use this table.

Table 3-4 Miscellaneous part descriptions and part numbers

Component	Spare part number
AC adapters	
65 W	913691-850
45 W	741727-001
Screw Kit	M03790-001
HP HDMI-to-VGA adapter	701943-001
HP USB-to-Gigabit RJ-45 adapter	829941-001
HP USB External DVD±RW drive	747080-001
Power cords (C5, 1.0 m)	
Australia	L19358-001
Denmark	L19360-001
Europe (Austria, Belgium, Finland, France, Germany, the Netherlands, Norway, and Sweden)	L19361-001
India	L19363-001
Israel	L19362-001
North America	L19367-001
People's Republic of China	L19368-001
South Africa	L19369-001

Table 3-4 Miscellaneous part descriptions and part numbers (continued)

Component	Spare part number
South Korea	L19366-001
Switzerland	L19370-001
Taiwan	L19372-001
Thailand	L19371-001
United Kingdom	L19373-001

4 Removal and replacement procedures preliminary requirements

Use this information to properly prepare to disassemble and reassemble the computer.

Tools required

You need the following tools to complete the removal and replacement procedures:

- Tweezers
- Nonconductive, nonmarking pry tool
- Magnetic Phillips P1 screwdriver

Service considerations

The following sections include some of the considerations that you must keep in mind during disassembly and assembly procedures.

 **NOTE:** As you remove each subassembly from the computer, place the subassembly (and all accompanying screws) away from the work area to prevent damage.

Plastic parts

Using excessive force during disassembly and reassembly can damage plastic parts.

Cables and connectors

Handle cables with extreme care to avoid damage.

 **IMPORTANT:** When servicing the computer, be sure that cables are placed in their proper locations during the reassembly process. Improper cable placement can damage the computer.

Apply only the tension required to unseat or seat the cables during removal and insertion. Handle cables by the connector whenever possible. In all cases, avoid bending, twisting, or tearing cables. Be sure that cables are routed so that they cannot be caught or snagged as you remove or replace parts. Handle flex cables with extreme care; these cables tear easily.

Drive handling

Note the following guidelines when handling drives.



IMPORTANT: Drives are fragile components. Handle them with care. To prevent damage to the computer, damage to a drive, or loss of information, observe these precautions:

Before removing or inserting a hard drive, shut down the computer. If you are unsure whether the computer is off or in Hibernation, turn the computer on, and then shut it down through the operating system.

Before handling a drive, be sure that you are discharged of static electricity. While handling a drive, avoid touching the connector.

Before removing an optical drive, be sure that a disc is not in the drive, and be sure that the optical drive tray is closed.

Handle drives on surfaces covered with at least 2.54 cm (1 inch) of shock-proof foam.

Avoid dropping drives from any height onto any surface.

After removing a hard drive or an optical drive, place it in a static-proof bag.

Avoid exposing an internal hard drive to products that have magnetic fields, such as monitors or speakers.

Avoid exposing a drive to temperature extremes or liquids.

If a drive must be mailed, place the drive in a bubble pack mailer or other suitable form of protective packaging, and label the package “FRAGILE.”

Workstation guidelines

Follow these grounding workstation guidelines:

- Cover the workstation with approved static-shielding material.
- Use a wrist strap connected to a properly grounded work surface and use properly grounded tools and equipment.
- Use conductive field service tools, such as cutters, screw drivers, and vacuums.
- When fixtures must directly contact dissipative surfaces, use fixtures made only of static-safe materials.
- Keep the work area free of nonconductive materials, such as ordinary plastic assembly aids and polystyrene foam.
- Handle ESD-sensitive components, parts, and assemblies by the case or PCM laminate. Handle these items only at static-free workstations.
- Avoid contact with pins, leads, or circuitry.
- Turn off power and input signals before inserting or removing connectors or test equipment.

Electrostatic discharge information

A sudden discharge of static electricity from your finger or other conductor can destroy static-sensitive devices or microcircuitry. Often the spark is neither felt nor heard, but damage occurs. An electronic device exposed to electrostatic discharge (ESD) might not appear to be affected at all and can work perfectly throughout a normal cycle. The device might function normally for a while, but it has been degraded in the internal layers, reducing its life expectancy.

Networks built into many integrated circuits provide some protection, but in many cases, the discharge contains enough power to alter device parameters or melt silicon junctions.



IMPORTANT: To prevent damage to the device when you remove or install internal components, observe these precautions:

Keep components in their electrostatic-safe containers until you are ready to install them.

Before touching an electronic component, discharge static electricity by using the guidelines described [Personal grounding methods and equipment on page 26](#).

Avoid touching pins, leads, and circuitry. Handle electronic components as little as possible.

If you remove a component, place it in an electrostatic-safe container.

Generating static electricity

Follow these static electricity guidelines.

- Different activities generate different amounts of static electricity.
- Static electricity increases as humidity decreases.

Table 4-1 Static electricity occurrence based on activity and humidity

Event	Relative humidity		
	55%	40%	10%
Walking across carpet	7,500 V	15,000 V	35,000 V
Walking across vinyl floor	3,000 V	5,000 V	12,000 V
Motions of bench worker	400 V	800 V	6,000 V
Removing DIPs (dual in-line packages) from plastic tube	400 V	700 V	2,000 V
Removing DIPs from vinyl tray	2,000 V	4,000 V	11,500 V
Removing DIPs from polystyrene foam	3,500 V	5,000 V	14,500 V
Removing bubble pack from PCB (printed circuit board)	7,000 V	20,000 V	26,500 V
Packing PCBs in foam-lined box	5,000 V	11,000 V	21,000 V

Multiple electric components can be packaged together in plastic tubes, trays, or polystyrene foam.



NOTE: As little as 700 V can degrade a product.

Preventing electrostatic damage to equipment

Many electronic components are sensitive to ESD. Circuitry design and structure determine the degree of sensitivity. The following packaging and grounding precautions are necessary to prevent static electricity damage to electronic components.

- To avoid hand contact, transport products in static-safe containers such as tubes, bags, or boxes.
- Protect all electrostatic parts and assemblies with conductive or approved containers or packaging.
- Keep electrostatic-sensitive parts in their containers until they arrive at static-free stations.
- Place items on a grounded surface before removing them from their container.
- Always be properly grounded when touching a sensitive component or assembly.

- Avoid contact with pins, leads, or circuitry.
- Place reusable electrostatic-sensitive parts from assemblies in protective packaging or conductive foam.

Personal grounding methods and equipment

Using certain equipment can prevent static electricity damage to electronic components.

- **Wrist straps** are flexible straps with a maximum of $1\text{ M}\Omega \pm 10\%$ resistance in the ground cords. To provide proper ground, a strap must be worn snug against bare skin. The ground cord must be connected and fit snugly into the banana plug connector on the grounding mat or workstation.
- **Heel straps/Toe straps/Boot straps** can be used at standing workstations and are compatible with most types of shoes or boots. On conductive floors or dissipative floor mats, use them on both feet with a maximum of $1\text{ M}\Omega \pm 10\%$ resistance between the operator and ground.

Table 4-2 Static shielding protection levels

Static shielding protection levels	
Method	Voltage
Antistatic plastic	1,500
Carbon-loaded plastic	7,500
Metallized laminate	15,000

Grounding the work area

To prevent static damage at the work area, follow these precautions.

- Cover the work surface with approved static-dissipative material. Provide a wrist strap connected to the work surface and properly grounded tools and equipment.
- Use static-dissipative mats, foot straps, or air ionizers to give added protection.
- Handle electrostatic sensitive components, parts, and assemblies by the case or PCB laminate. Handle them only at static-free work areas.
- Turn off power and input signals before inserting and removing connectors or test equipment.
- Use fixtures made of static-safe materials when fixtures must directly contact dissipative surfaces.
- Keep work area free of nonconductive materials such as ordinary plastic assembly aids and polystyrene foam.
- Use field service tools, such as cutters, screwdrivers, and vacuums, that are conductive.

Recommended materials and equipment

HP recommends certain materials and equipment to prevent static electricity.

- Antistatic tape
- Antistatic smocks, aprons, or sleeve protectors
- Conductive bins and other assembly or soldering aids
- Conductive foam
- Conductive tabletop workstations with ground cord of $1\text{ M}\Omega \pm 10\%$ resistance

- Static-dissipative table or floor mats with hard tie to ground
- Field service kits
- Static awareness labels
- Wrist straps and footwear straps providing $1\text{ M}\Omega \pm 10\%$ resistance
- Material handling packages
- Conductive plastic bags
- Conductive plastic tubes
- Conductive tote boxes
- Opaque shielding bags
- Transparent metallized shielding bags
- Transparent shielding tubes

Packaging and transporting guidelines

Follow these grounding guidelines when packaging and transporting equipment.

- To avoid hand contact, transport products in static-safe tubes, bags, or boxes.
- Protect ESD-sensitive parts and assemblies with conductive or approved containers or packaging.
- Keep ESD-sensitive parts in their containers until the parts arrive at static-free workstations.
- Place items on a grounded surface before removing items from their containers.
- Always be properly grounded when touching a component or assembly.
- Store reusable ESD-sensitive parts from assemblies in protective packaging or nonconductive foam.
- Use transporters and conveyors made of antistatic belts and roller bushings. Be sure that mechanized equipment used for moving materials is wired to ground and that proper materials are selected to avoid static charging. When grounding is not possible, use an ionizer to dissipate electric charges.

5 Removal and replacement procedures for authorized service provider parts

This chapter provides removal and replacement procedures for authorized service provider parts.

 **IMPORTANT:** Components described in this chapter should be accessed only by an authorized service provider. Accessing these parts can damage the computer or void the warranty.

 **NOTE:** Details about your computer, including model, serial number, product key, and length of warranty, are on the service tag at the bottom of your computer.

Component replacement procedures

To remove and replace computer components, use these procedures.

 **NOTE:** HP continually improves and changes product parts. For complete and current information about supported parts for your computer, go to <http://partsurfer.hp.com>, select your country or region, and then follow the on-screen instructions.

You must remove, replace, or loosen as many as 52 screws when you service the parts described in this chapter. Make special note of each screw size and location during removal and replacement.

Preparation for disassembly

To remove and replace computer components, use these procedures.

See [Removal and replacement procedures preliminary requirements on page 23](#) for initial safety procedures.

1. Turn off the computer. If you are unsure whether the computer is off or in Hibernation, turn the computer on, and then shut it down through the operating system.
2. Disconnect the power from the computer by unplugging the power cord from the computer.
3. Disconnect all external devices from the computer.

Bottom cover

To remove the bottom cover, use this procedure and illustration.

Table 5-1 Bottom cover and rubber feet descriptions and part numbers

Description	Spare part number
Bottom cover for use in silver models	L64894-001
Bottom cover for use in gold models	L64895-001
Bottom cover for use in white models	L64896-001
Bottom cover for use in black models	M03777-001
Bottom cover for use in blue models	M03778-001
Rubber feet, silver	L65866-001

Table 5-1 Bottom cover and rubber feet descriptions and part numbers (continued)

Description	Spare part number
Rubber feet, gold	L66226-001
Rubber feet, black	M03779-001
Rubber feet, blue	M03780-001

Before removing the bottom cover, prepare the computer for disassembly ([Preparation for disassembly on page 29](#)).

Remove the bottom cover:

1. Peel the two rubber feet off the bottom cover.

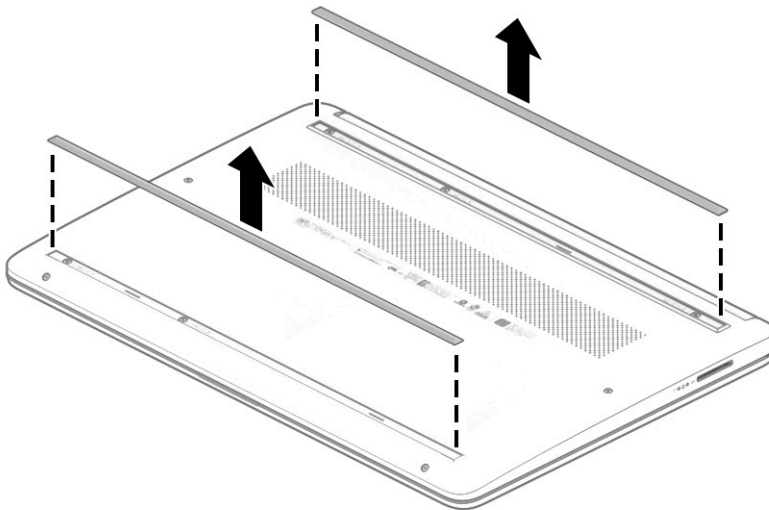

2. Remove the four Phillips M2.0 × 6.5 screws **(1)** from the bottom cover.
3. Remove the three Phillips M2.5 × 6.0 screws **(2)** from the bottom cover.

4. Remove the two Phillips M2.0 × 4.0 screws (3) from the bottom edge of the bottom cover.

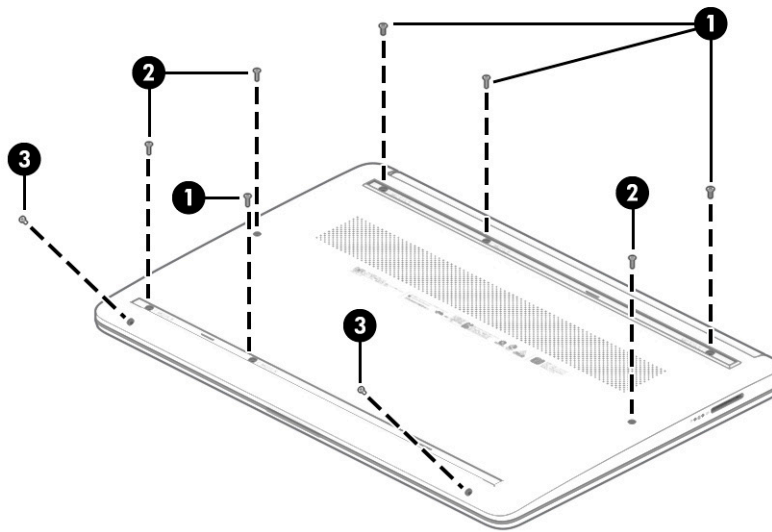

5. Insert a plastic tool between the bottom cover and the computer chassis (1), and then flex and lift the sides (2) and the top edge (3) of the bottom cover enough to separate it from the computer.
6. Remove the bottom cover from the computer (4).

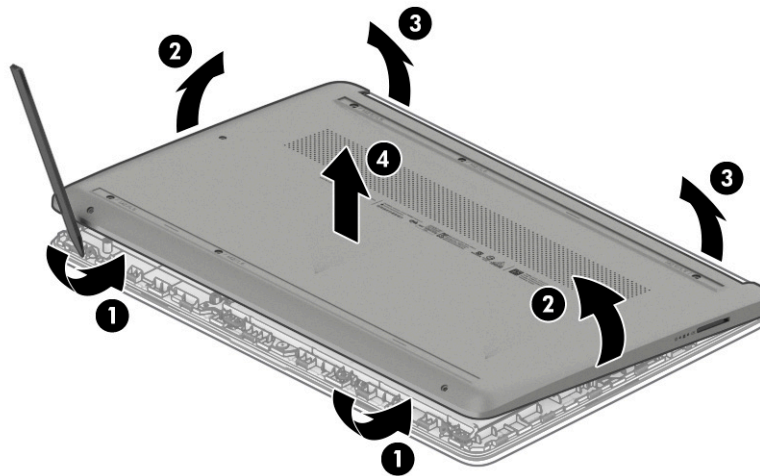

To replace the bottom cover, reverse the removal procedures.

Battery

To remove the battery, use this procedure and illustration.

Table 5-2 Battery description and part number

Description	Spare part number
Battery, 3 cell, 41 Wh	L11119-855

⚠ WARNING! To avoid personal injury and damage to the product:

- Do *not* puncture, twist, or crack the battery.
 - Do *not* cause an external puncture or rupture to the battery. They can cause a short inside the battery, which can result in battery thermal runaway.
 - Do *not* handle or touch the battery enclosure with sharp objects such as tweezers or pliers, which might puncture the battery.
 - Do *not* compress or squeeze the battery case with tools or heavy objects stacked on top of the case. These actions can apply undue force on the battery.
 - Do *not* touch the connectors with any metallic surface or object, such as metal tools, screws, or coins, which can cause shorting across the connectors.
-

Before removing the battery, follow these steps:

1. Prepare the computer for disassembly ([Preparation for disassembly on page 29](#)).
 2. Remove the bottom cover ([Bottom cover on page 29](#)).
-

⚠ WARNING! To reduce potential safety issues, use only the user-replaceable battery provided with the computer, a replacement battery provided by HP, or a compatible battery purchased from HP.

📝 IMPORTANT: Removing a battery that is the sole power source for the computer can cause loss of information. To prevent loss of information, save your work or shut down the computer through Windows before you remove the battery.

Remove the battery:

1. Remove the four Phillips M2.0 × 3.0 screws **(1)** that secure the battery to the computer.
2. Remove the battery from the computer **(2)**.

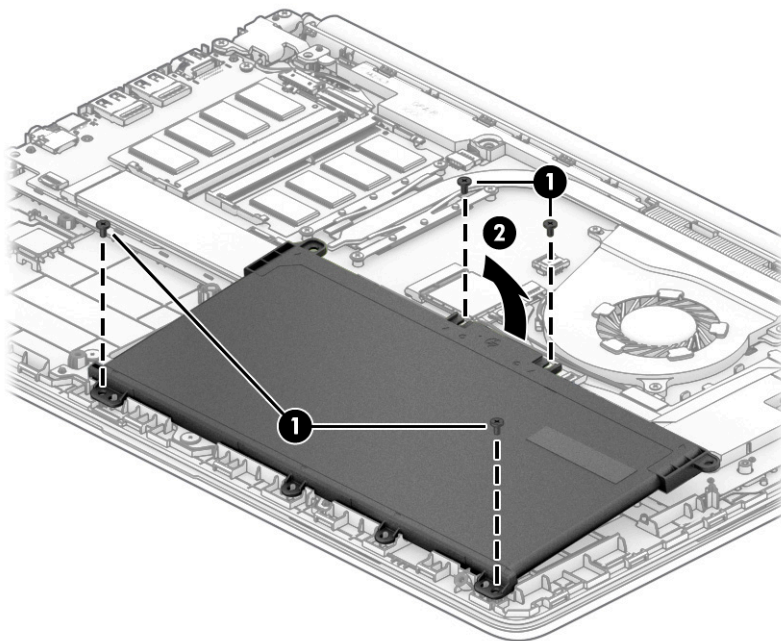

To insert the battery, reverse the removal procedures.

Memory modules

To remove the memory modules, use this procedure and illustration.

Table 5-3 Memory module descriptions and part numbers

Description	Spare part number
8 GB, DDR4-3200	937236-855
4 GB, DDR4-3200	L10598-855

Before removing the memory, follow these steps:

1. Prepare the computer for disassembly ([Preparation for disassembly on page 29](#)).
2. Remove the bottom cover ([Bottom cover on page 29](#)).
3. Remove the battery (see [Battery on page 31](#)).

If you are replacing a memory module, remove the existing memory module:

- ▲ Spread the two retention clips outward **(1)** until the memory module tilts up at a 45° angle, and then remove the module **(2)**. Use the same procedure to remove all memory modules.

 **IMPORTANT:** To prevent damage to the memory module, hold the memory module by the edges only. Do not touch the components on the memory module.

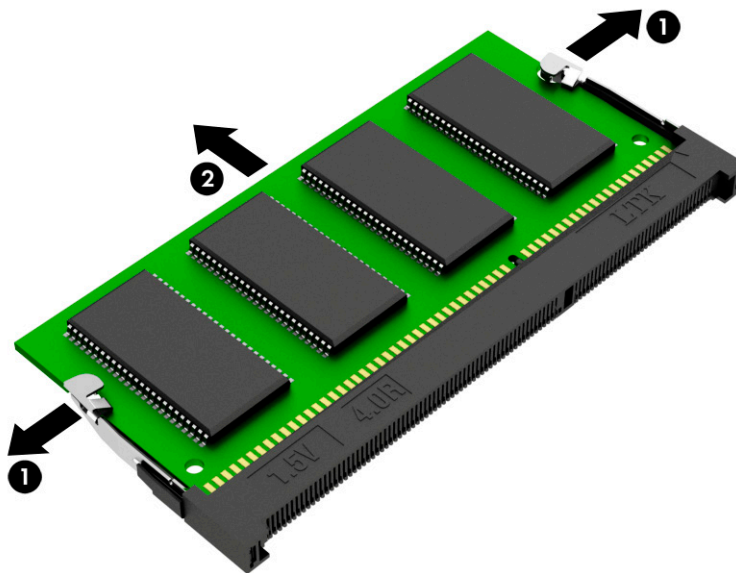

To protect a memory module after removal, place it in an electrostatic-safe container.

To install a memory module:

1. Align the notched edge of the module with the tab in the slot **(1)**, and then press the module into the slot at an angle until it is seated **(2)**.

2. Press down on the module until the side retention clips snap into place **(3)**.

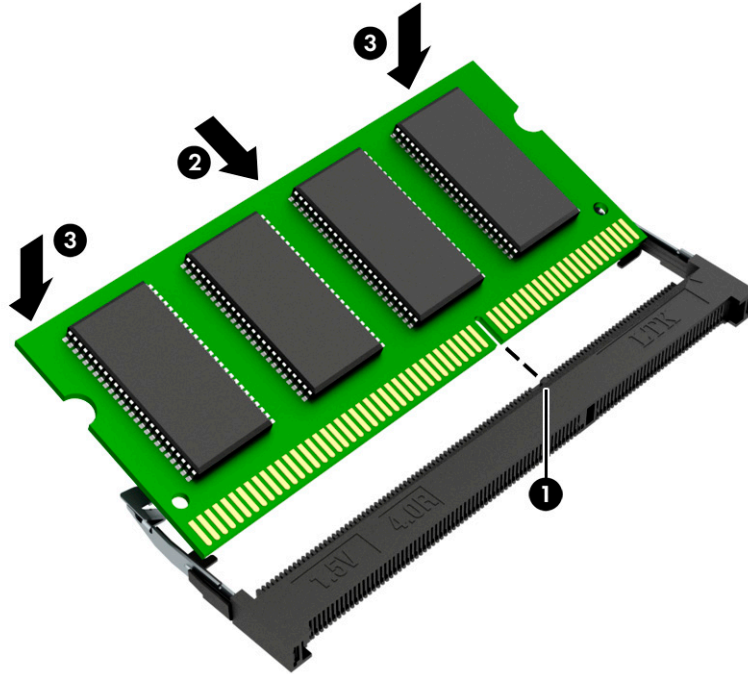

WLAN module

To remove the WLAN module, use this procedure and illustration.

Table 5-4 WLAN module descriptions and part numbers

Description	Spare part number
Realtek RTL8821CE 802.11ac 1 × 1 Wi-Fi + Bluetooth 4.2	L17365-005
Intel Wi-Fi 6 AX200 802.11ax 2 × 2 Wi-Fi + Bluetooth 5 (non-vPro)	L35282-005
Realtek RTL8822CE 802.11ac 2 × 2 Wi-Fi + Bluetooth 5	L44796-005

 **IMPORTANT:** To prevent an unresponsive system, replace the wireless module only with a wireless module authorized for use in the computer by the governmental agency that regulates wireless devices in your country or region. If you replace the module and then receive a warning message, remove the module to restore device functionality, and then contact technical support.

Before removing the WLAN module, follow these steps:

1. Prepare the computer for disassembly ([Preparation for disassembly on page 29](#)).
2. Remove the bottom cover ([Bottom cover on page 29](#)).
3. Remove the battery (see [Battery on page 31](#)).

Remove the WLAN module:

1. Carefully disconnect the two antenna cables from the module **(1)**.

2. Remove the Phillips M2.0 × 2.5 screw (2), and then remove the WLAN module (3).

 **NOTE:** Models have either one or two WLAN antennas. On models with two antennas, the #1 white WLAN antenna cable connects to the WLAN module #1 Main terminal. The #2 black WLAN antenna cable connects to the WLAN module #1 Aux terminal.

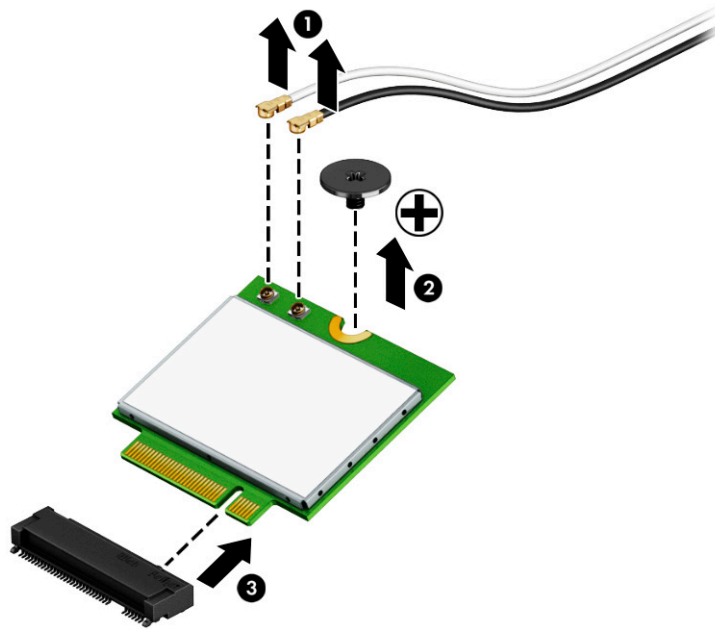

3. If the WLAN antenna is not connected to the terminal on the WLAN module, a protective sleeve must be installed on the antenna connector, as shown in the following illustration.

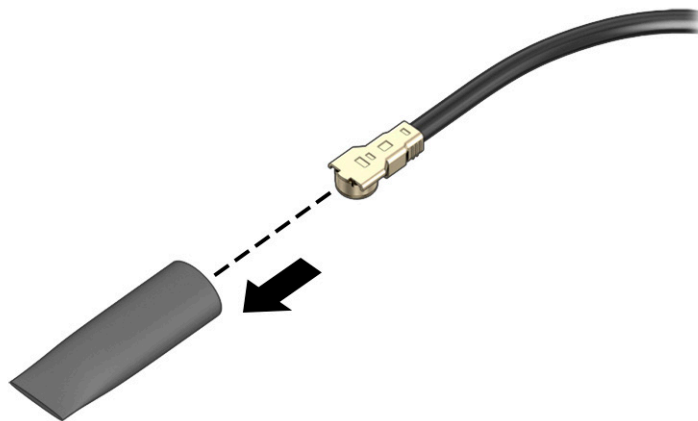

Reverse this procedure to install the WLAN module.

Solid-state drive

To remove the M.2 solid-state drive, use this procedure and illustration.

Table 5-5 Solid-state drive descriptions and part numbers

Description	Spare part number
1 TB, PCIe	L85370-005
512 GB, PCIe	L85364-005
256 GB, PCIe	L85354-005
128 GB, SATA-3, TLC	L85346-005

Before removing the solid-state drive, follow these steps:

1. Prepare the computer for disassembly ([Preparation for disassembly on page 29](#)).
2. Remove the bottom cover ([Bottom cover on page 29](#)).
3. Remove the battery (see [Battery on page 31](#)).

Remove the solid-state drive:

1. Remove the Phillips M2.0 × 2.5 screw **(1)** that secures the drive to the computer.
2. Pull the drive away from the socket to remove it **(2)**.

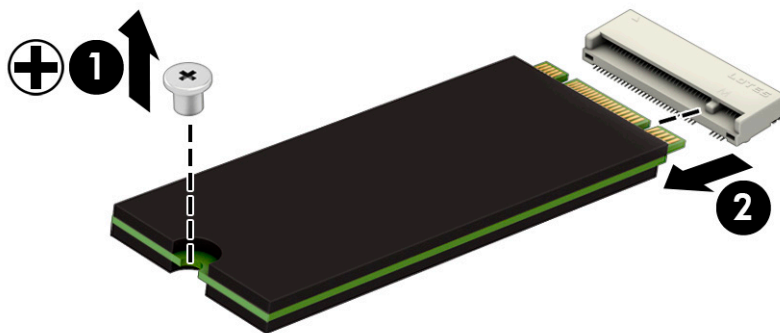

To install the solid-state drive, reverse the removal procedures.



NOTE: Solid-state drives are designed with a notch to prevent incorrect insertion.

Power button/card reader board

To remove the power button/card reader board, use this procedure and illustration.

Table 5-6 Power button/card reader board description and part number

Description	Spare part number
Power button/card reader board	M13557-001
Power button/card reader board	L64887-001

Before removing the power button/card reader board, follow these steps:

1. Prepare the computer for disassembly ([Preparation for disassembly on page 29](#)).
2. Remove the bottom cover ([Bottom cover on page 29](#)).
3. Remove the battery (see [Battery on page 31](#)).

Remove the power button/card reader board:

1. Disconnect the cable from the ZIF connector on the power button/card reader board **(1)**.
2. Remove the two Phillips M2.0 × 3.0 screws **(2)** that secure the board to the computer.
3. Remove the board from the computer **(3)**.

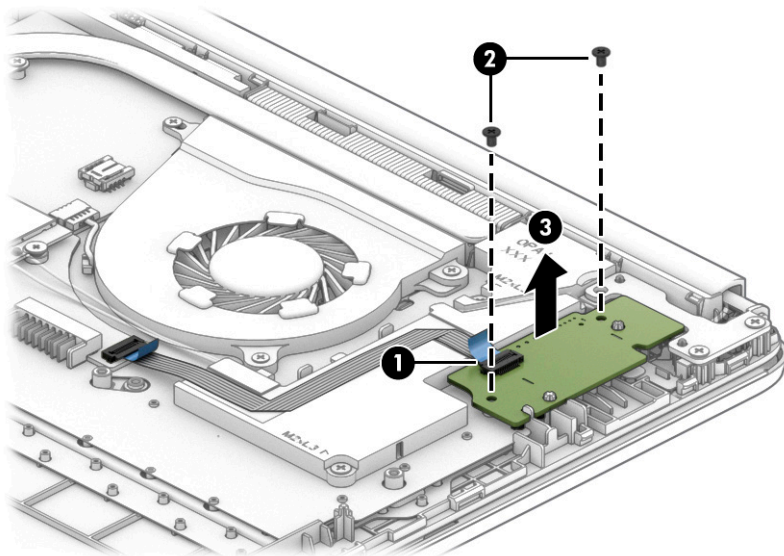

Reverse this procedure to install the power button/card reader board.

Touchpad

To remove the touchpad, use this procedure and illustration.

Table 5-7 Touchpad description and part number

Description	Spare part number
Touchpad, silver	L64897-001
Touchpad, white	L64899-001

Table 5-7 Touchpad description and part number (continued)

Description	Spare part number
Touchpad, black	M03782-001
Touchpad, blue	M03783-001
Touchpad cable	M13561-001

Before removing the touchpad, follow these steps:

1. Prepare the computer for disassembly ([Preparation for disassembly on page 29](#)).
2. Remove the bottom cover ([Bottom cover on page 29](#)).
3. Remove the battery (see [Battery on page 31](#)).

Remove the touchpad:

1. Disconnect the cable from the ZIF connector on the touchpad **(1)**.
2. Remove the three Phillips M2.0 × 2.0 screws **(2)** that secure the touchpad bracket to the computer, lift the tape off the bracket **(3)**, and then remove the bracket **(4)**.
3. Lift the tape that covers the screws on the top of the touchpad **(5)**.
4. Remove the three Phillips M2.0 × 2.0 screws **(6)** that secure the touchpad to the computer, and then remove the touchpad **(7)**.

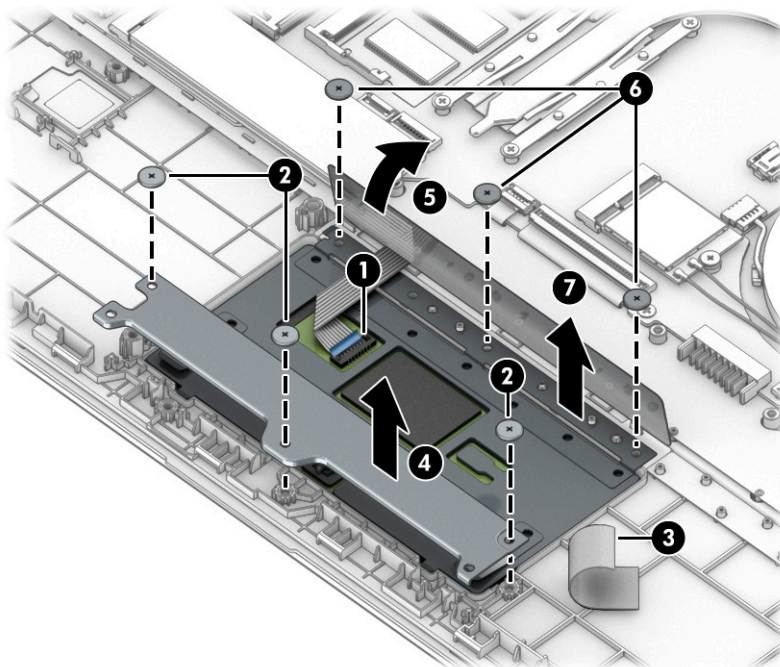

Reverse this procedure to install the touchpad.

Fingerprint reader board (select products only)

To remove the fingerprint reader board, use this procedure and illustration.

Table 5-8 Fingerprint reader board description and part number

Description	Spare part number
Fingerprint reader board	M13559-001
Fingerprint reader board cable	M13560-001

Before removing the fingerprint reader board, follow these steps:

1. Prepare the computer for disassembly ([Preparation for disassembly on page 29](#)).
2. Remove the bottom cover ([Bottom cover on page 29](#)).
3. Remove the battery (see [Battery on page 31](#)).

Remove the fingerprint reader board:

1. Remove the Phillips M2.0 × 2.0 screw **(2)** that secures the fingerprint reader bracket, and then remove the bracket **(2)**.
2. Disconnect the cable from the ZIF connector on the fingerprint reader board **(3)**.
3. Remove the fingerprint reader board from the computer **(4)**.

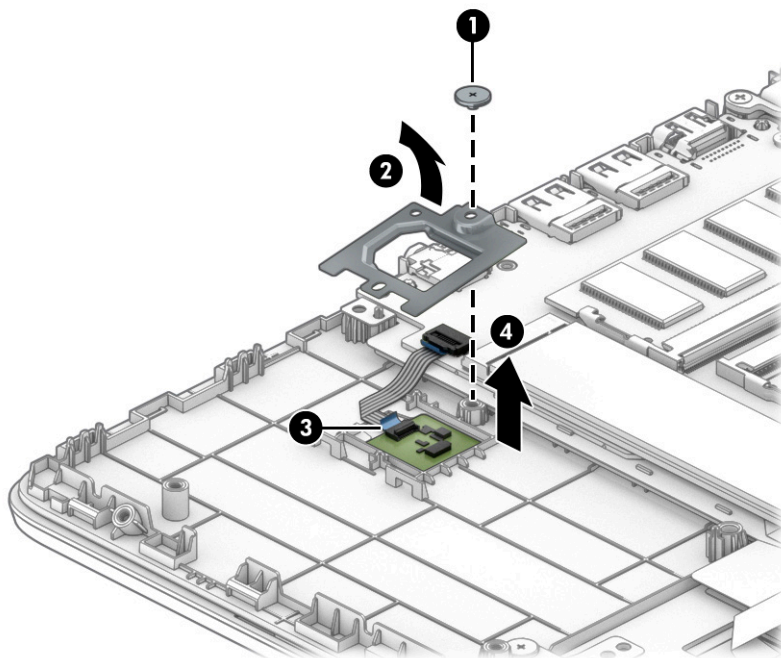

Reverse this procedure to install the fingerprint reader board.

Fan

To remove the fan, use this procedure and illustration.

Table 5-9 Fan description and part number

Description	Spare part number
Fan for use in models with a backlit keyboard	L63587-001
Fan for use in models without a backlit keyboard	L63588-001

Before removing the fan, follow these steps:

1. Prepare the computer for disassembly ([Preparation for disassembly on page 29](#)).
2. Remove the bottom cover ([Bottom cover on page 29](#)).
3. Remove the battery (see [Battery on page 31](#)).

Remove the fan:

1. Disconnect the fan cable from the system board (1).
2. Remove the three Phillips M2.0 × 3.0 screws (2) that secure the fan to the computer.
3. Remove the fan from the computer (3).

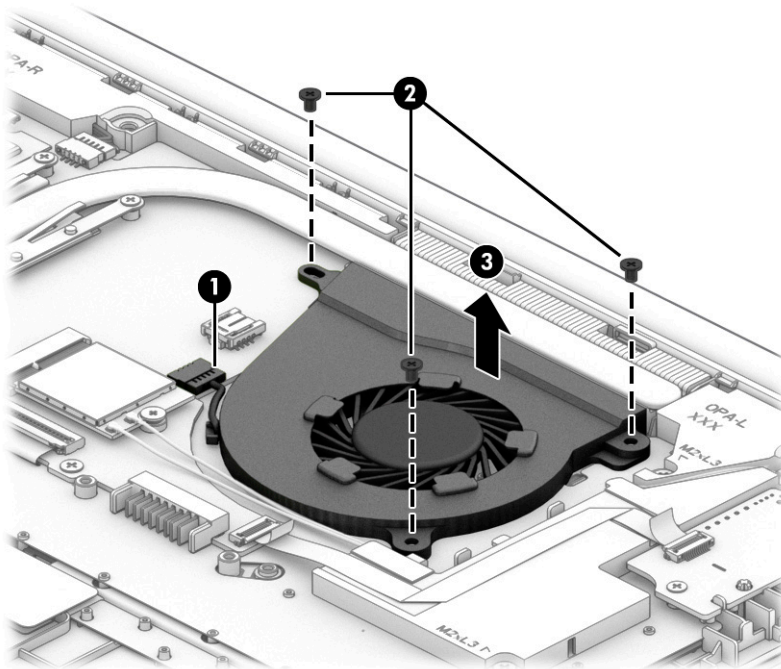

Reverse this procedure to install the fan.

Heat sink

To remove the heat sink, use these procedures and illustrations.

Table 5-10 Heat sink descriptions and part numbers

Description	Spare part number
Heat sink for use in models with discrete graphics	L52032-001
Heat sink for use in models with UMA graphics	L52033-001

Before removing the heat sink, follow these steps:

1. Prepare the computer for disassembly ([Preparation for disassembly on page 29](#)).
2. Remove the bottom cover ([Bottom cover on page 29](#)).
3. Remove the battery (see [Battery on page 31](#)).

Remove the heat sink:

1. Remove the four Phillips M2.0 × 2.5 screws **(1)** in the order indicated on the heat sink.
2. Remove the heat sink **(2)**.

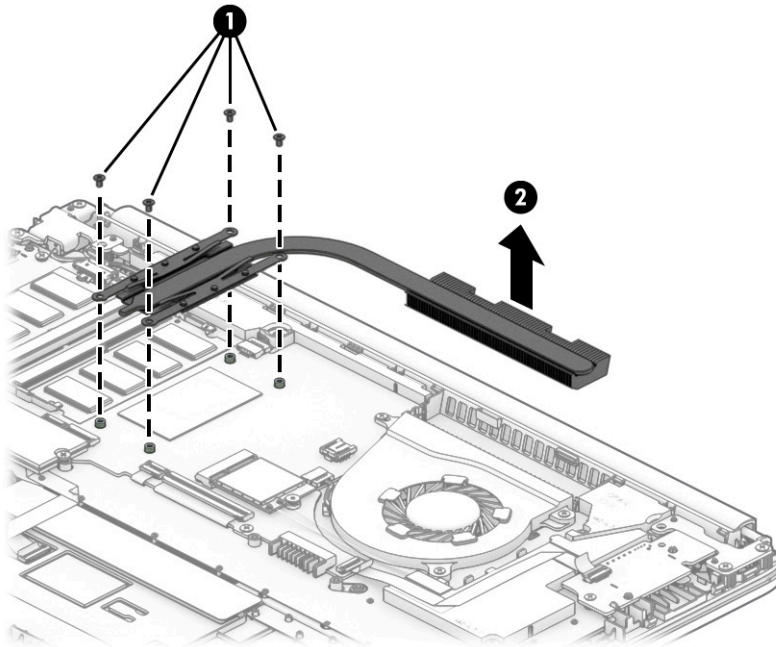

3. Apply thermal grease to the integrated processor on the system board (1) and associated location on the heat sink (2).

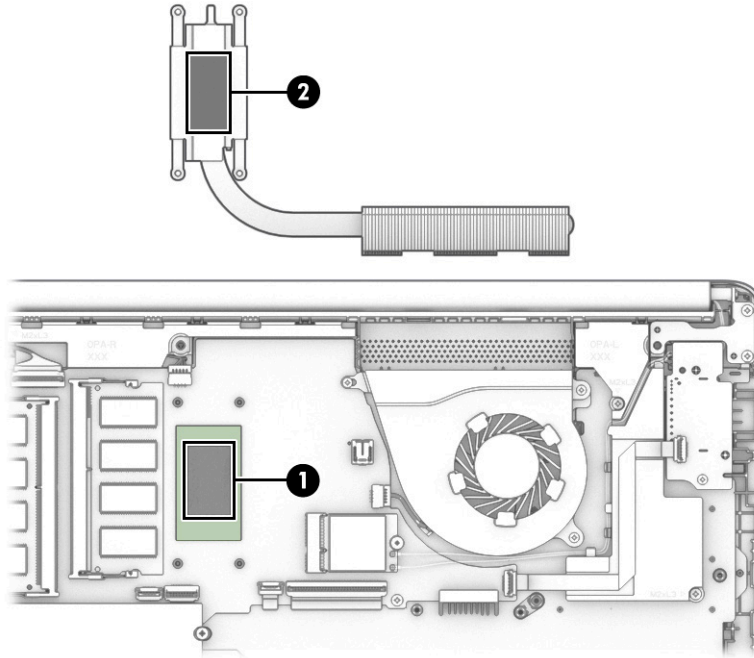

Reverse this procedure to install the heat sink.

System board

To remove the system board, use these procedures and illustrations.

Table 5-11 System board descriptions and part numbers

Description	Spare part number
System board (includes processor):	
All system boards use the following part numbers:	
xxxxxx-001: Non-Windows operating system	
xxxxxx-601: Windows 10 operating system	
System board with integrated AMD Ryzen 7 4700U processor	M03776-xx1
System board with integrated AMD Ryzen 5 4500U processor	M03775-xx1
System board with integrated AMD Ryzen 5 3500U processor	M03774-xx1
System board with integrated AMD Ryzen 3 3250U processor	M03773-xx1
System board with integrated AMD Athlon 3150U processor	M03772-xx1
System board with integrated AMD Athlon 3050U processor	M03771-xx1

Table 5-11 System board descriptions and part numbers (continued)

Description	Spare part number
System board with integrated AMD 3020e processor	M04583-xx1
System board with integrated AMD 3020e processor and 64 GB of eMMC	M10792-xx1

Before removing the system board, follow these steps:

1. Prepare the computer for disassembly ([Preparation for disassembly on page 29](#)).
2. Remove the bottom cover ([Bottom cover on page 29](#)).
3. Remove the battery (see [Battery on page 31](#)).
4. Remove the heat sink (see [Heat sink on page 40](#)).

Remove the system board:

1. Disconnect the following cables from the system board:
 - Power connector cable **(1)**
 - Display cable **(2)**
 - Speaker cable **(3)**
 - WLAN module antennas **(4)**
 - Power button/card reader board cable (ZIF) **(5)**
 - Keyboard cable **(6)**
 - Keyboard backlight cable (ZIF) **(7)**
 - Touchpad cable (ZIF) **(8)**
 - Fingerprint reader cable (ZIF) **(9)**

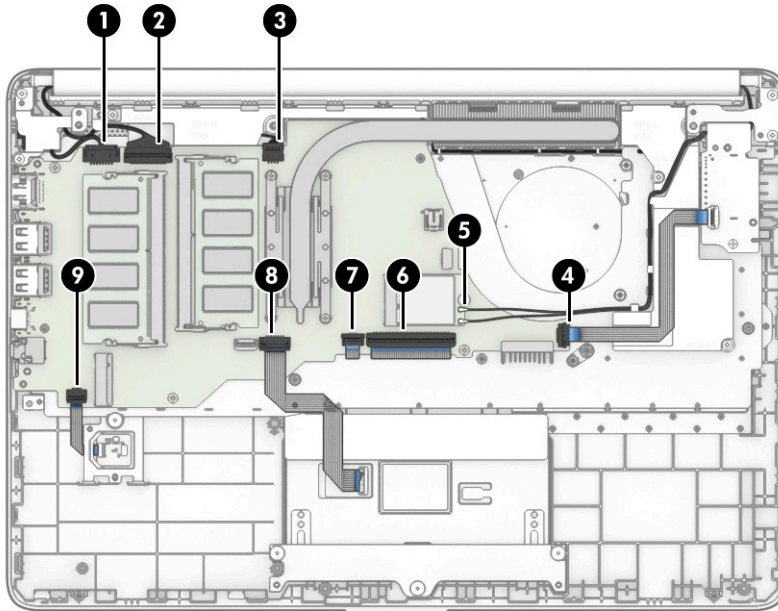

2. Remove the four Phillips M2.0 × 2.0 screws **(1)** that secure the system board to the computer.
3. Remove the system board from the computer **(2)**.

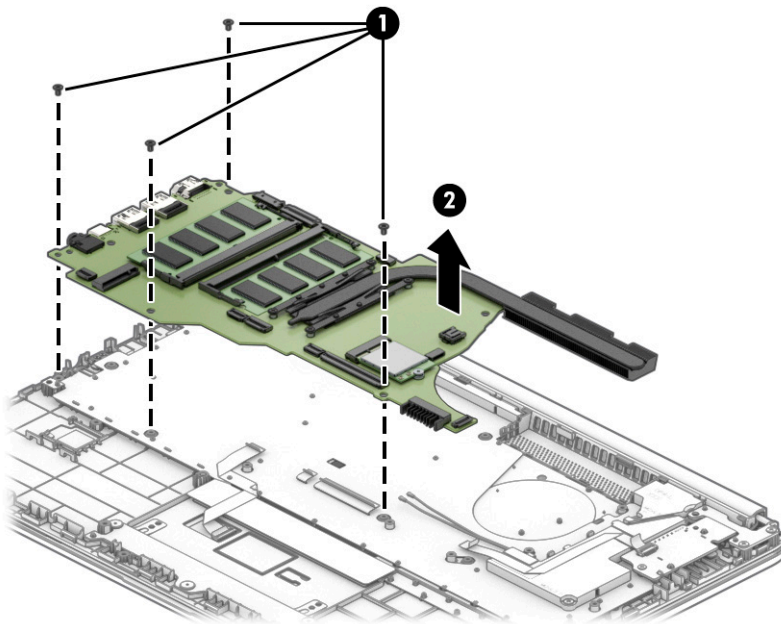

Reverse this procedure to install the system board.

Speakers

To remove the speakers, use this procedure and illustration.

Table 5-12 Speaker description and part number

Description	Spare part number
Speaker Kit	M13562-001

Before removing the speakers, follow these steps:

1. Prepare the computer for disassembly ([Preparation for disassembly on page 29](#)).
2. Remove the bottom cover ([Bottom cover on page 29](#)).
3. Remove the battery (see [Battery on page 31](#)).
4. Remove the fan (see [Fan on page 39](#)).
5. Remove the heat sink (see [Heat sink on page 40](#)).

Remove the speakers:

1. Disconnect the antennas from the WLAN module **(1)**, and then remove the antenna cables from the channel in the left speaker **(2)**.

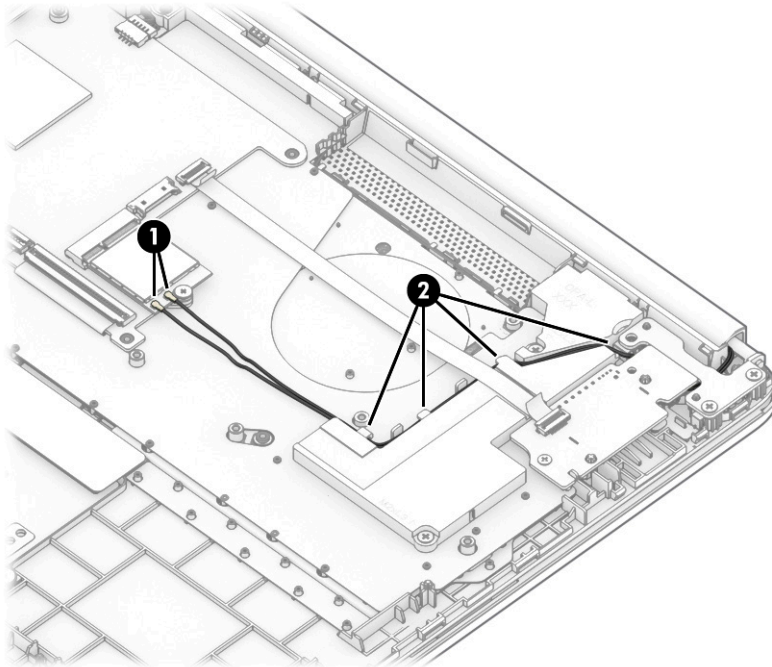

2. Disconnect the speaker cable from the system board **(1)**.
3. Remove the two Phillips M2.0 × 3.0 screws **(2)** that secure the speakers to the computer.
4. Lift the left speaker up from the computer **(3)**, remove the speaker cable from the clips in the computer chassis **(4)**.
5. Disconnect the cable from the ZIF connector on the power button/card reader board **(5)**.

6. Remove the right speaker from the computer **(6)**.

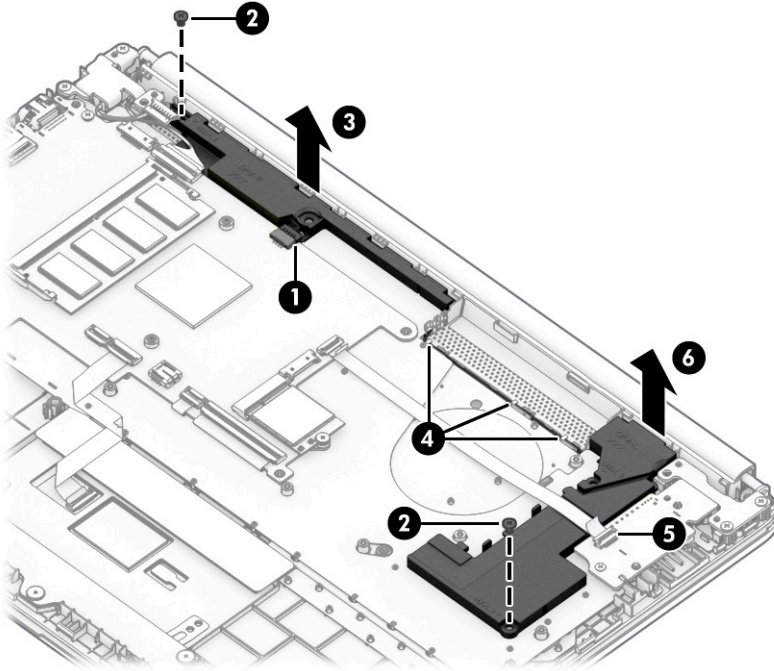

Reverse this procedure to install the speakers.

Display assembly

To remove and disassemble the display assembly, use these procedures and illustrations.



NOTE: Display assemblies are offered as spare parts only at a subcomponent level.

Before removing the display panel, follow these steps:

1. Prepare the computer for disassembly ([Preparation for disassembly on page 29](#)).
2. Remove the bottom cover ([Bottom cover on page 29](#)).
3. Remove the battery (see [Battery on page 31](#)).
4. Remove the power button/card reader board (see [Power button/card reader board on page 37](#)).

Remove the display assembly:

1. Disconnect the display cable from the system board **(1)**, and then remove the cable from the clips in the left hinge **(2)**.

2. Disconnect the wireless antenna cables from the WLAN module (3), and then remove the cables from the channel and clips in the right speaker (4).

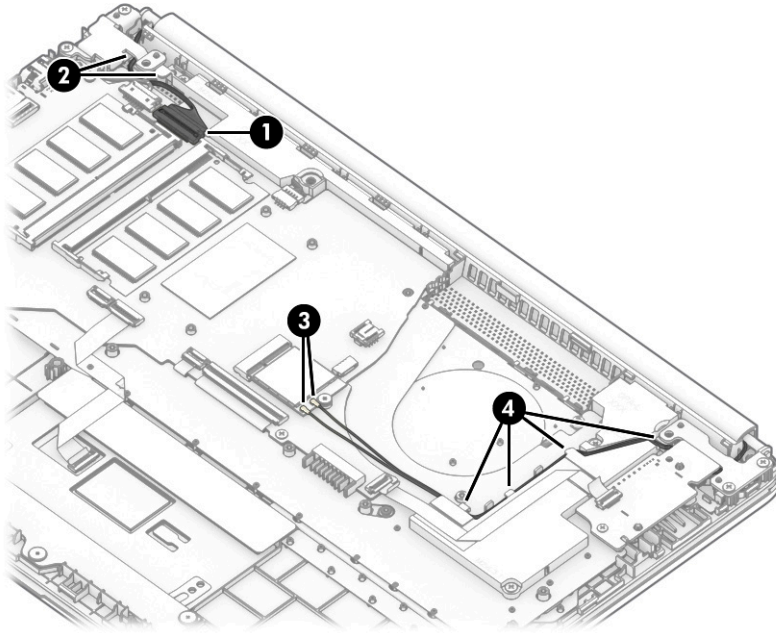

3. Remove the two Phillips M2.5 × 5.0 screws (1) from each hinge.
4. Open the display (2).
5. Separate the display from the computer (3).

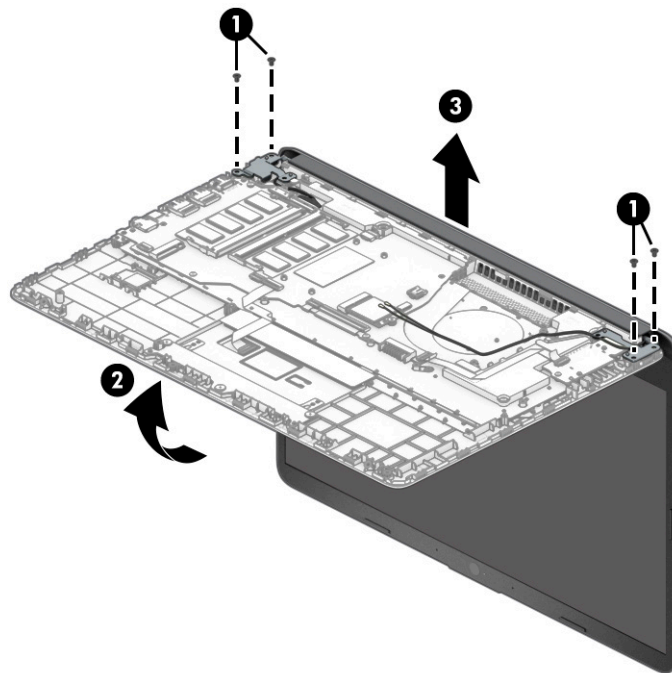

6. If you need to replace display assembly subcomponents:

- a. Remove the hinge cover by squeezing both ends of the cover **(1)**, and then pulling the cover off the display **(2)**.

The hinge cover is available as the following spare part numbers:

L64911-001: Silver

L64912-001: Gold

L64913-001: White

M03788-001: Black

M03789-001: Blue

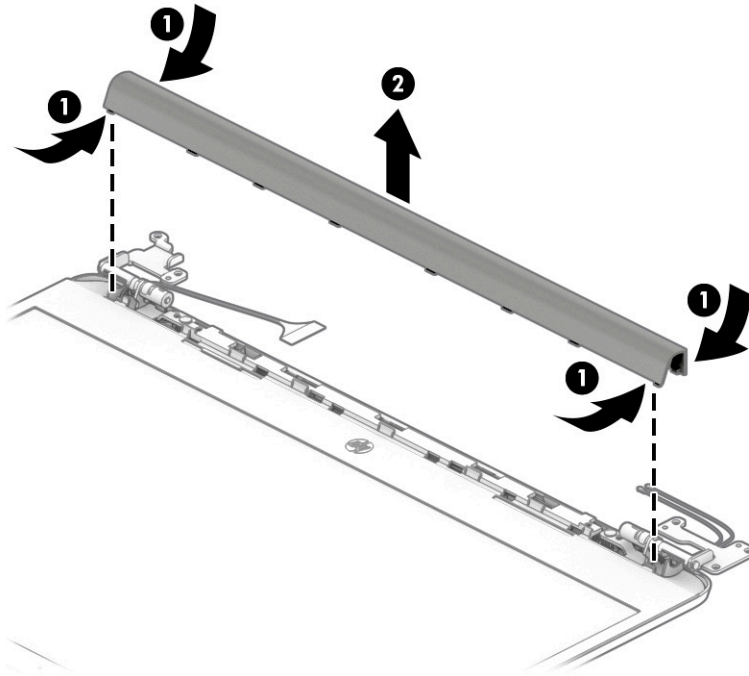

- b. Use a tool to release the bottom edge of the display bezel **(1)** from the display assembly.

 **IMPORTANT:** Be careful not to bend or break the narrow sections of the bezel when removing.

- c. Release the left and right edges of the display bezel **(2)** from the display assembly.
- d. Release the top of the display bezel **(3)** from the display assembly.

- e. Remove the display bezel **(4)**.

The display bezel is available as spare part number L64907-001 on models with dual microphones and M03787-001 on models with a single microphone.

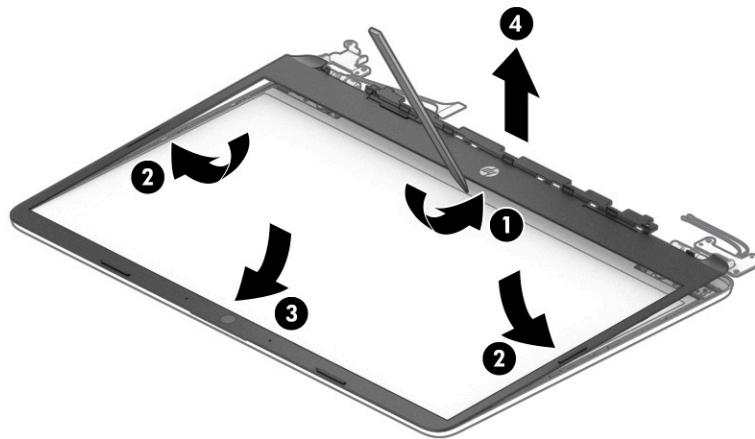

- 7. If you need to remove the camera module:

- a. Starting from the side, use a tool to lift and release **(1)** the camera module from the metal tape behind it **(2)**.
- b. Remove the module from the display back cover **(3)**, and then disconnect the cable **(4)**. The camera module is available as spare part number L64914-001 for the HD camera and M04368-001 for the VGA camera.

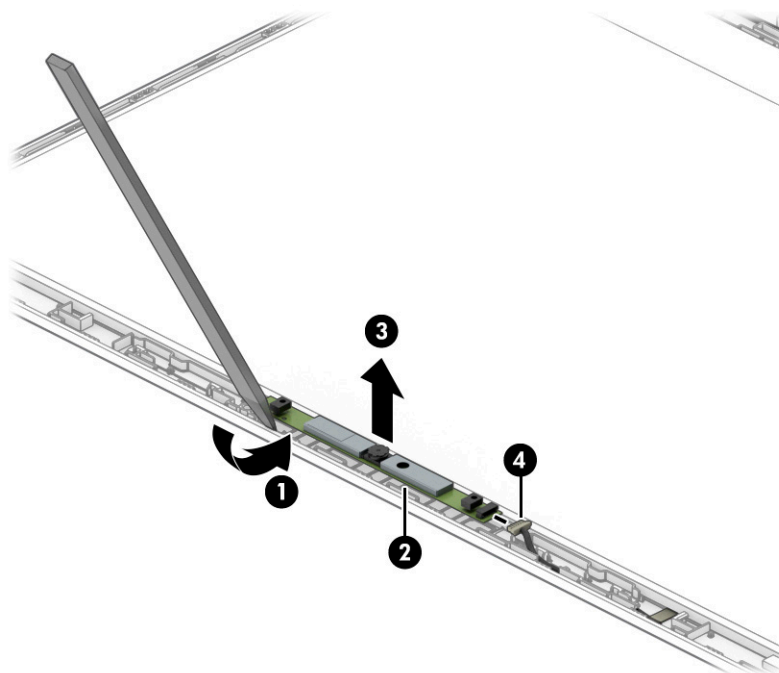

- 8. If you need to remove the display panel:

- a. Use tweezers to grasp the tape that routes behind both the left and right sides of the display panel **(1)**.

- b. Pull the tape from behind the left and right sides of the panel **(2)**.

 **IMPORTANT:** You have to pull on the tape multiple times before it is completely removed. To avoid tearing the tape, pull the tape evenly and carefully. Rolling the tape around the tweezer or the shaft of a screwdriver as you pull it can help to avoid pulling too hard and breaking the tape. Be sure to pull the tape straight out – do not pull it out along the sides of the panel.

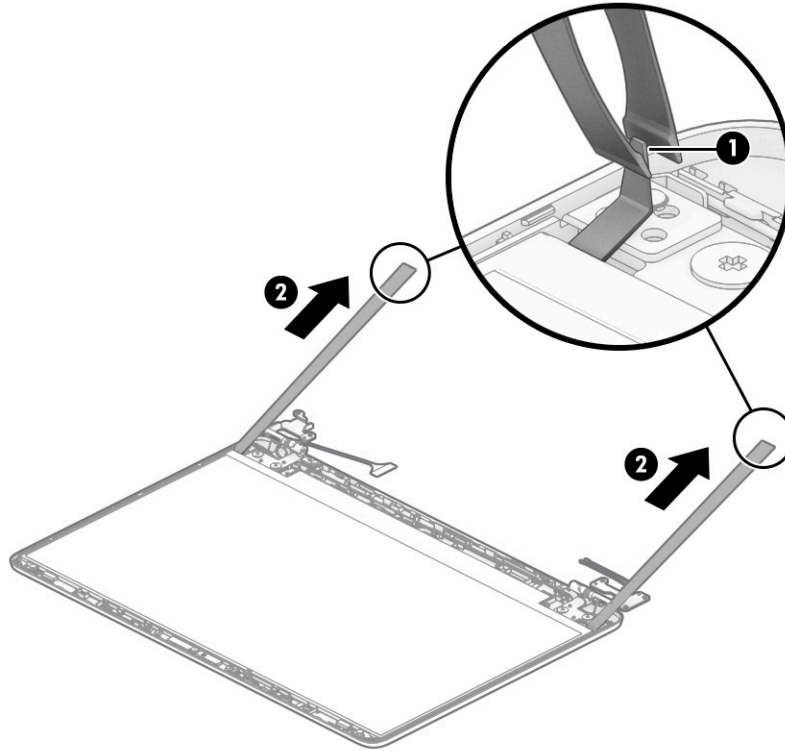

- c. Rotate the display panel over and place next to the display back cover **(1)**.

- d. Lift the tape from the connector on the rear of the panel **(2)**, and then disconnect the cable from the panel **(3)**.

Display panels are available as the following spare part numbers:

M03765-001: FHD, antiglare, SVA, 220 nits

M03766-001: FHD, antiglare, UWVA, 250 nits

M03767-001: FHD, BrightView, UWVA, 250 nits

M03768-001: HD, antiglare, SVA, 220 nits

M03769-001: HD, BrightView, SVA, 220 nits

M03770-001: HD, BrightView, SVA, 220 nits Touch-on Panel (TOP)

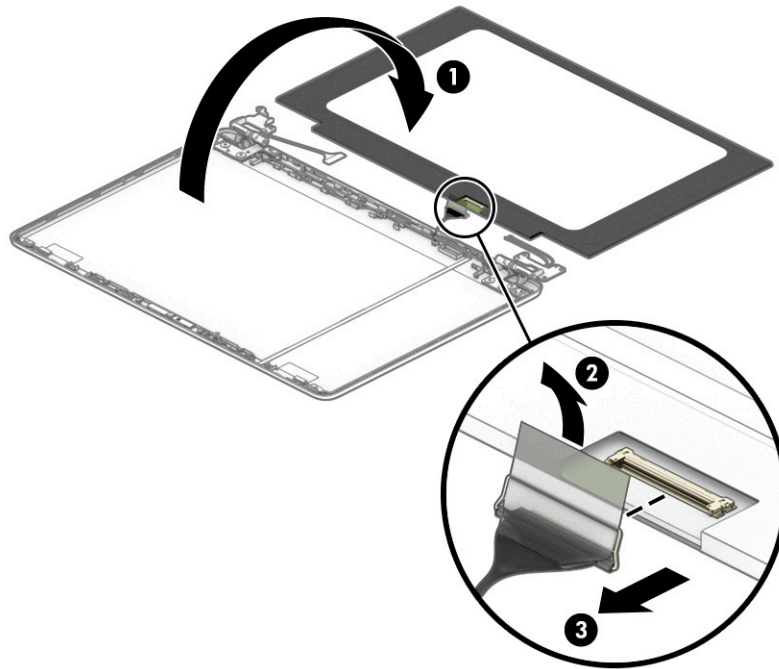

- e. When installing the display panel, apply the adhesive in the location as shown in the following illustration.

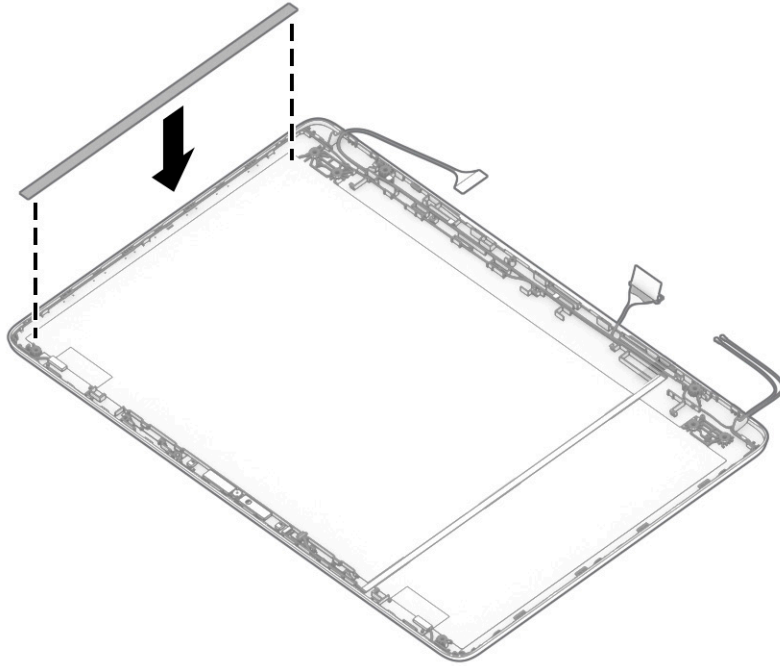

9. If you need to remove the hinges:
- a. Remove the Phillips M2.0 × 2.5 screw **(1)** from the bottom of each hinge.
 - b. Remove the two Phillips M2.5 × 2.5 screws **(2)** from the bottom of each hinge.
 - c. Remove the Phillips M2.5 × 3.0 screw **(3)** from the top of each hinge.
 - d. Remove the display hinges from the display back cover **(4)**.

The display hinges are available as spare part number L64910-001.

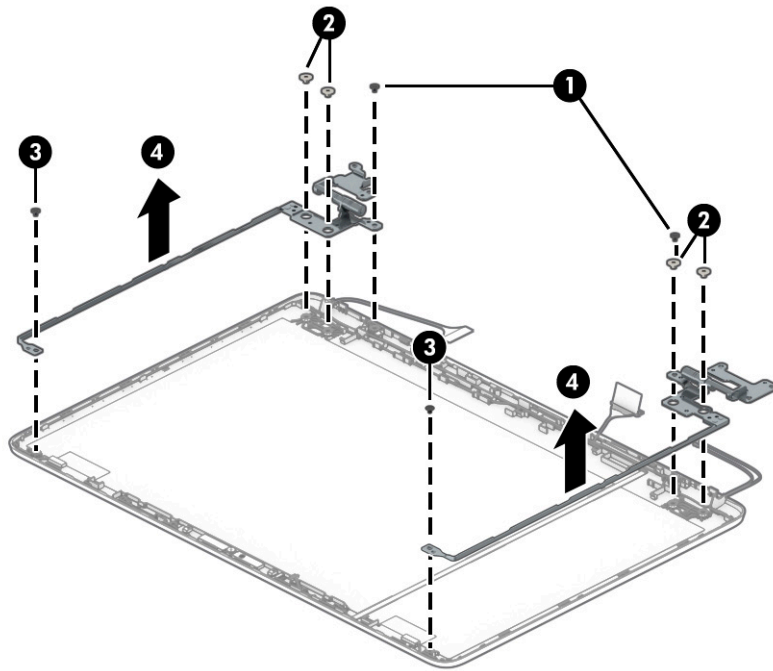

- 10.** If you need to remove the display panel cable:
- a.** Remove the cable from the channel at the bottom of the display back cover **(1)**.
 - b.** Remove the cable from the bottom **(2)** and top **(3)** of the display back cover.

- c. Disconnect the cable from the camera module (4), and then remove the cable from the display back cover (5).

Display panel cables are available as the following spare part numbers:

L64908-001: Touch displays

L64909-001: Nontouch displays

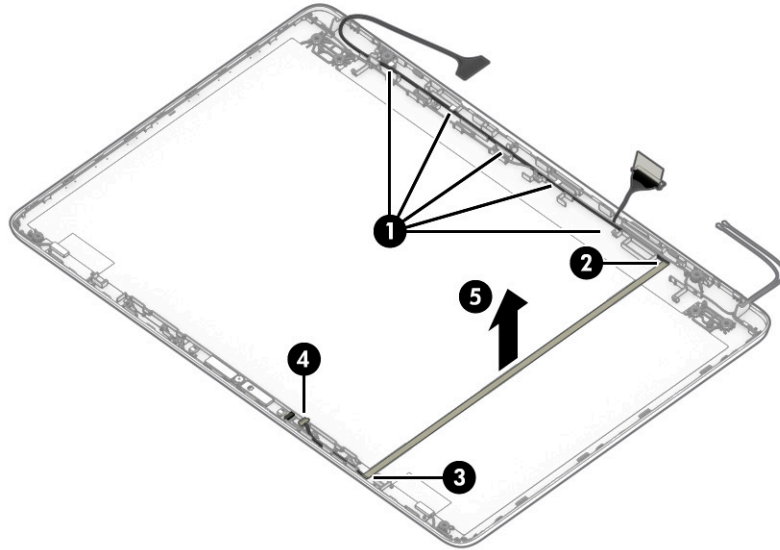

- d. When installing the display cable, position the cable in the middle of the alignment notch as marked on the inside of the display back cover.

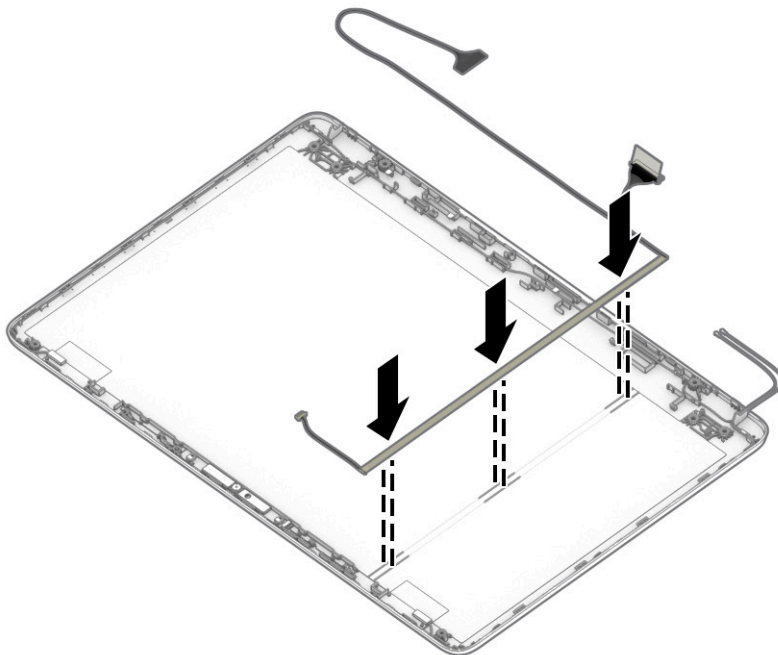

- 11. If you need to remove the antenna cables:
 - a. Peel the antennas off the top of the display back cover (1).

- b. Remove the antenna cables from the display back cover (2).

The wireless antennas are available as spare part number L64905-001 for dual antennas and L64906-001 for single antenna.

The display back cover is available as the following spare part numbers:

L66227-001: Silver

L66228-001: Gold

L66229-001: White

M03785-001: Black

M03786-001: Blue

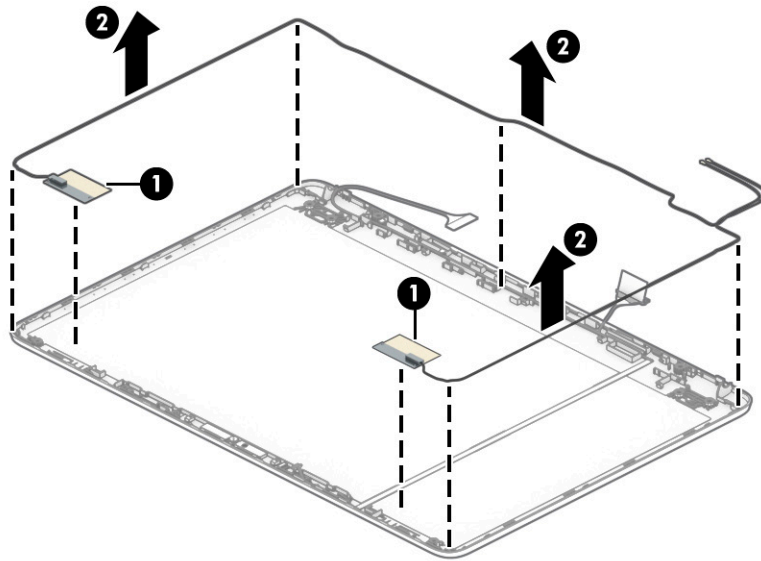

Reverse this procedure to reassemble and replace the display assembly.

Power connector cable

To remove the power connector cable, use this procedure and illustration.

Table 5-13 Power connector cable description and part number

Description	Spare part number
Power connector cable	808155-010

Before removing the power connector cable, follow these steps:

1. Prepare the computer for disassembly ([Preparation for disassembly on page 29](#)).
2. Remove the bottom cover ([Bottom cover on page 29](#)).
3. Remove the battery (see [Battery on page 31](#)).
4. Remove the display assembly (see [Display assembly on page 46](#)).

Remove the power connector cable:

1. Disconnect the cable from the system board (1).
2. Remove the power connector and cable from the computer (2).

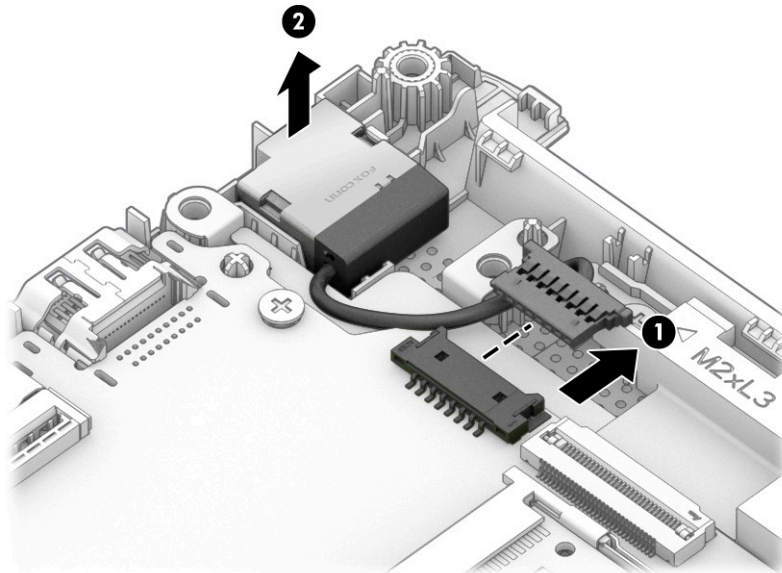

Reverse this procedure to install the power connector cable.

Keyboard with top cover

The top cover with keyboard remains after removing all other spare parts from the computer. In this section, the first table provides the main spare part number for the top cover/keyboards. The second table provides the country codes.

Table 5-14 Keyboard with top cover descriptions and part numbers

Description	Spare part number
Keyboard with top cover, silver, with fingerprint reader, not backlit	L61506-xx1
Keyboard with top cover, silver, with fingerprint reader, backlit	L61507-xx1
Keyboard with top cover, silver, without fingerprint reader, not backlit	L88200-xx1
Keyboard with top cover, silver, without fingerprint reader, backlit	L88206-xx1
Keyboard with top cover, white, not backlit	L61508-xx1
Keyboard with top cover, white, backlit	L61509-xx1
Keyboard with top cover, black	M03796-xx1
Keyboard with top cover, blue	M03797-xx1

Table 5-15 Spare part country codes

For use in country or region	Spare part number	For use in country or region	Spare part number	For use in country or region	Spare part number
Belgium	-A41	Iceland	-DD1	Slovenia	-BA1
Brazil	-201	India	-D61	South Korea	-AD1

Table 5-15 Spare part country codes (continued)

For use in country or region	Spare part number	For use in country or region	Spare part number	For use in country or region	Spare part number
Bulgaria	-261	Israel	-BB1	Spain	-071
Chile	-161	Italy	-061	Switzerland	-BG1
Czech Republic/Slovakia	-FL1	Japan	-291	Taiwan	-AB1
Denmark, Finland, and Norway	-DH1	The Netherlands	-B31	Thailand	-281
French Canada	-DB1	Northern Africa	-FP1	Turkey	-141
France	-051	Portugal	-131	Ukraine	-BD1
Germany	-041	Romania	-271	United Kingdom	-031
Greece	-151	Russia	-251	United States	-001
Hungary	-211	Saudi Arabia	-171		

6 Using Setup Utility (BIOS)

Setup Utility, or Basic Input/Output System (BIOS), controls communication between all the input and output devices on the system (such as disk drives, display, keyboard, mouse, and printer). Setup Utility (BIOS) includes settings for the types of devices installed, the startup sequence of the computer, and the amount of system and extended memory.

 **NOTE:** To start Setup Utility on convertible computers, your computer must be in notebook mode and you must use the keyboard attached to your notebook.

Starting Setup Utility (BIOS)

You have several ways to access the Setup Utility (BIOS).

 **IMPORTANT:** Use extreme care when making changes in Setup Utility (BIOS). Errors can prevent the computer from operating properly.

▲ Turn on or restart the computer and quickly press **f10**.

– or –

Turn on or restart the computer, quickly press **esc**, and then press **f10** when the Start menu is displayed.

Updating Setup Utility (BIOS)

Updated versions of Setup Utility (BIOS) might be available on the HP website. Most BIOS updates on the HP website are packaged in compressed files called *SoftPaqs*. Some download packages contain a file named *Readme.txt*, which contains information regarding installing and troubleshooting the file.

Determining the BIOS version

To decide whether you need to update Setup Utility (BIOS), first determine the BIOS version on your computer.

To reveal the BIOS version information (also known as *ROM date* and *System BIOS*), use one of these options.

- HP Support Assistant
 1. Type `support` in the taskbar search box, and then select the **HP Support Assistant** app.
 - or –
 - Select the question mark icon in the taskbar.
 2. Select **My notebook**, and then select **Specifications**.
- Setup Utility (BIOS)
 1. Start Setup Utility (BIOS) (see [Starting Setup Utility \(BIOS\) on page 59](#)).
 2. Select **Main**, and then make note of the BIOS version.
 3. Select **Exit**, select one of the options, and then follow the on-screen instructions.
- In Windows, press `ctrl+alt+s`.

To check for later BIOS versions, see [Preparing for a BIOS update on page 60](#).

Preparing for a BIOS update

Be sure to follow all prerequisites before downloading and installing a BIOS update.

 **IMPORTANT:** To reduce the risk of damage to the computer or an unsuccessful installation, download and install a BIOS update only when the computer is connected to reliable external power using the AC adapter. Do not download or install a BIOS update while the computer is running on battery power, docked in an optional docking device, or connected to an optional power source. During the download and installation, follow these instructions:

- Do not disconnect power from the computer by unplugging the power cord from the AC outlet.
- Do not shut down the computer or initiate Sleep.
- Do not insert, remove, connect, or disconnect any device, cable, or cord.

 **NOTE:** If your computer is connected to a network, consult the network administrator before installing any software updates, especially system BIOS updates.

Downloading a BIOS update

After you review the prerequisites, you can check for and download BIOS updates.

1. Type `support` in the taskbar search box, and then select the **HP Support Assistant** app.
– or –
Select the question mark icon in the taskbar.
2. Select **Updates**, and then select **Check for updates and messages**.
3. Follow the on-screen instructions.
4. At the download area, follow these steps:
 - a. Identify the most recent BIOS update and compare it to the BIOS version currently installed on your computer. If the update is more recent than your BIOS version, make a note of the date, name, or other identifier. You might need this information to locate the update later, after it has been downloaded to your hard drive.
 - b. Follow the on-screen instructions to download your selection to the hard drive.
Make a note of the path to the location on your hard drive where the BIOS update is downloaded. You will need to access this path when you are ready to install the update.

Installing a BIOS update

BIOS installation procedures vary. Follow any instructions that appear on the screen after the download is complete. If no instructions appear, follow these steps.

1. Type `file` in the taskbar search box, and then select **File Explorer**.
2. Select your hard drive designation. The hard drive designation is typically Local Disk (C:).
3. Using the hard drive path you recorded earlier, open the folder that contains the update.
4. Double-click the file that has an `.exe` extension (for example, `filename.exe`).
The BIOS installation begins.
5. Complete the installation by following the on-screen instructions.



NOTE: After a message on the screen reports a successful installation, you can delete the downloaded file from your hard drive.

7 Backing up, restoring, and recovering

This chapter provides information about processes that are standard procedure for most products.

- **Backing up your personal information**—You can use Windows tools to back up your personal information (see [Using Windows tools on page 63](#)).
- **Creating a restore point**—You can use Windows tools to create a restore point (see [Using Windows tools on page 63](#)).
- **Creating recovery media** (select products only)—You can use the HP Cloud Recovery Download Tool (select products only) to create recovery media (see [Using the HP Cloud Recovery Download Tool to create recovery media \(select products only\) on page 63](#)).
- **Restoring and recovery**—Windows offers several options for restoring from backup, refreshing the computer, and resetting the computer to its original state (see [Using Windows tools on page 63](#)).

 **IMPORTANT:** If you will be performing recovery procedures on a tablet, the tablet battery must be at least 70% charged before you start the recovery process.

IMPORTANT: For a tablet with a detachable keyboard, connect the tablet to the keyboard base before beginning any recovery process.

Backing up information and creating recovery media

These methods of creating recovery media and backups are available on select products only. Choose the appropriate method for your computer model.

Using Windows tools

You can use Windows tools to back up personal information and create system restore points and recovery media.

 **IMPORTANT:** Windows is the only option that allows you to back up your personal information. Schedule regular backups to avoid information loss.

 **NOTE:** If computer storage is 32 GB or less, Microsoft System Restore is disabled by default.

For more information and steps, see the Get Help app.

 **NOTE:** You must be connected to the Internet to access the Get Help app.

1. Select the **Start** button, and then select the **Get Help** app.
2. Enter the task you want to perform.

Using the HP Cloud Recovery Download Tool to create recovery media (select products only)

You can use the HP Cloud Recovery Download Tool to create HP Recovery media on a bootable USB flash drive.

For details:

- ▲ Go to <http://www.hp.com/support>, search for HP Cloud Recovery, and then select the result that matches the type of computer that you have.



NOTE: If you cannot create recovery media yourself, contact support to obtain recovery discs. Go to <http://www.hp.com/support>, select your country or region, and then follow the on-screen instructions.

Restoring and recovery

You have several options for recovering your system. Choose the method that best matches your situation and level of expertise.



NOTE: Not all methods are available on all products.

Restoring, resetting, and refreshing using Windows tools

Windows offers several options for restoring, resetting, and refreshing the computer.

For details, see [Using Windows tools on page 63](#).

Recovering using HP Recovery media

You can use HP Recovery media to recover the original operating system and software programs that were installed at the factory. On select products, it can be created on a bootable USB flash drive using the HP Cloud Recovery Download Tool.

For details, see [Using the HP Cloud Recovery Download Tool to create recovery media \(select products only\) on page 63](#).



NOTE: If you cannot create recovery media yourself, contact support to obtain recovery discs. Go to <http://www.hp.com/support>, select your country or region, and then follow the on-screen instructions.

To recover your system:

- ▲ Insert the HP Recovery media, and then restart the computer.

Changing the computer boot order

If your computer does not restart using the HP Recovery media, you can change the computer boot order. This is the order of devices listed in BIOS where the computer looks for startup information. You can change the selection to an optical drive or a USB flash drive, depending on the location of your HP Recovery media.

To change the boot order:



IMPORTANT: For a tablet with a detachable keyboard, connect the tablet to the keyboard base before beginning these steps.

1. Insert the HP Recovery media.
2. Access the system **Startup** menu.
 - For computers or tablets with keyboards attached, turn on or restart the computer or tablet, quickly press **esc**, and then press **f9** for boot options.
 - For tablets without keyboards, turn on or restart the tablet, quickly hold down the volume up button, and then select **f9**.

– or –

Turn on or restart the tablet, quickly hold down the volume down button, and then select **f9**.
3. Select the optical drive or USB flash drive from which you want to boot, and then follow the on-screen instructions.

Using HP Sure Recover (select products only)

Select computer models are configured with HP Sure Recover, a PC OS recovery solution built into the hardware and firmware. HP Sure Recover can fully restore the HP OS image without installed recovery software.

Using HP Sure Recover, an administrator or user can restore the system and install:

- Latest version of the operating system
- Platform-specific device drivers
- Software applications, in the case of a custom image

To access the latest documentation for HP Sure Recover, go to <http://www.hp.com/support>. Select **Find your product**, and then follow the on-screen instructions.

8 Using HP PC Hardware Diagnostics

The HP PC Hardware Diagnostics utility allows you to run diagnostics tests to determine whether your computer hardware is running properly. The three versions are HP PC Hardware Diagnostics Windows, HP PC Hardware Diagnostics UEFI (Unified Extensible Firmware Interface), and (for select products only) a firmware feature called Remote HP PC Hardware Diagnostics UEFI.

Using HP PC Hardware Diagnostics Windows (select products only)

HP PC Hardware Diagnostics Windows is a Windows-based utility that allows you to run diagnostic tests to determine whether the computer hardware is functioning properly. The tool runs within the Windows operating system to diagnose hardware failures.

If HP PC Hardware Diagnostics Windows is not installed on your computer, first you must download and install it. To download HP PC Hardware Diagnostics Windows, see [Downloading HP PC Hardware Diagnostics Windows on page 68](#).

Using an HP PC Hardware Diagnostics Windows hardware failure ID code

When HP PC Hardware Diagnostics Windows detects a failure that requires hardware replacement, a 24-digit Failure ID code is generated.

- ▲ Depending on the instructions on the screen, choose one of these options:
 - If failure ID link is displayed, select the link and follow the on-screen instructions.
 - If instructions for calling support are displayed. Follow those instructions.

Accessing HP PC Hardware Diagnostics Windows

After HP PC Hardware Diagnostics Windows is installed, you can access it from HP Help and Support or HP Support Assistant.

Accessing HP PC Hardware Diagnostics Windows from HP Help and Support

After HP PC Hardware Diagnostics Windows is installed, follow these steps to access it from HP Help and Support.

To access HP PC Hardware Diagnostics Windows from HP Help and Support:

1. Select the **Start** button, and then select **HP Help and Support**.
2. Select **HP PC Hardware Diagnostics Windows**.
3. When the tool opens, select the type of diagnostic test that you want to run, and then follow the on-screen instructions.



NOTE: To stop a diagnostic test, select **Cancel**.

Accessing HP PC Hardware Diagnostics Windows from Support Assistant

After HP PC Hardware Diagnostics Windows is installed, follow these steps to access it from HP Support Assistant.

To access HP PC Hardware Diagnostics Windows from HP Support Assistant:

1. Type `support` in the taskbar search box, and then select the **HP Support Assistant** app.
– or –
Select the question mark icon in the taskbar.
2. Select **Troubleshooting and fixes**.
3. Select **Diagnostics**, and then select **HP PC Hardware Diagnostics Windows**.
4. When the tool opens, select the type of diagnostic test that you want to run, and then follow the on-screen instructions.



NOTE: To stop a diagnostic test, select **Cancel**.

Downloading HP PC Hardware Diagnostics Windows

The HP PC Hardware Diagnostics Windows downloading instructions are provided in English only. You must use a Windows computer to download this tool because only .exe files are provided.

Downloading the latest HP PC Hardware Diagnostics Windows version from HP

To download HP PC Hardware Diagnostics Windows from HP, follow these steps.

1. Go to <http://www.hp.com/go/techcenter/pcdiags>. The HP PC Diagnostics home page is displayed.
2. Select **Download HP Diagnostics Windows**, and then select a location on your computer or a USB flash drive.

The tool downloads to the selected location.

Downloading the HP PC Hardware Diagnostics Windows from the Microsoft Store

You can download the HP PC Hardware Diagnostics Windows from the Microsoft Store.

1. Select the Microsoft app on your desktop or enter `Microsoft Store` in the taskbar search box.
2. Enter `HP PC Hardware Diagnostics Windows` in the **Microsoft Store** search box.
3. Follow the on-screen directions.

The tool downloads to the selected location.

Downloading HP Hardware Diagnostics Windows by product name or number (select products only)

You can download HP PC Hardware Diagnostics Windows by product name or number.



NOTE: For some products, you might have to download the software to a USB flash drive by using the product name or number.

1. Go to <http://www.hp.com/support>.
2. Select **Software and Drivers**, select your type of product, and then enter the product name or number in the search box that is displayed.
3. In the **Diagnostics** section, select **Download**, and then follow the on-screen instructions to select the specific Windows diagnostics version to be downloaded to your computer or USB flash drive.

The tool downloads to the selected location.

Installing HP PC Hardware Diagnostics Windows

To install HP PC Hardware Diagnostics Windows, navigate to the folder on your computer or the USB flash drive where the .exe file downloaded, double-click the .exe file, and then follow the on-screen instructions.

Using HP PC Hardware Diagnostics UEFI

HP PC Hardware Diagnostics UEFI (Unified Extensible Firmware Interface) allows you to run diagnostic tests to determine whether the computer hardware is functioning properly. The tool runs outside the operating system so that it can isolate hardware failures from issues that are caused by the operating system or other software components.

 **NOTE:** For Windows 10 S computers, you must use a Windows computer and a USB flash drive to download and create the HP UEFI support environment because only .exe files are provided. For more information, see [Downloading HP PC Hardware Diagnostics UEFI to a USB flash drive on page 70](#).

If your PC does not start in Windows, you can use HP PC Hardware Diagnostics UEFI to diagnose hardware issues.

Using an HP PC Hardware Diagnostics UEFI hardware failure ID code

When HP PC Hardware Diagnostics UEFI detects a failure that requires hardware replacement, a 24-digit Failure ID code is generated.

For assistance in solving the problem:

- ▲ Select **Contact HP**, accept the HP privacy disclaimer, and then use a mobile device to scan the Failure ID code that appears on the next screen. The HP Customer Support - Service Center page appears with your Failure ID and product number automatically filled in. Follow the on-screen instructions.

– or –

Contact support, and provide the Failure ID code.

 **NOTE:** To start diagnostics on a convertible computer, your computer must be in notebook mode, and you must use the attached keyboard.

 **NOTE:** If you need to stop a diagnostic test, press [esc](#).

Starting HP PC Hardware Diagnostics UEFI

To start HP PC Hardware Diagnostics UEFI, follow this procedure.

1. Turn on or restart the computer, and quickly press [esc](#).
2. Press [f2](#).

The BIOS searches three places for the diagnostic tools, in the following order:

- a. Connected USB flash drive

 **NOTE:** To download the HP PC Hardware Diagnostics UEFI tool to a USB flash drive, see [Downloading the latest HP PC Hardware Diagnostics UEFI version on page 70](#).

- b. Hard drive
- c. BIOS

3. When the diagnostic tool opens, select a language, select the type of diagnostic test you want to run, and then follow the on-screen instructions.

Downloading HP PC Hardware Diagnostics UEFI to a USB flash drive

Downloading HP PC Hardware Diagnostics UEFI to a USB flash drive can be useful in some situations.

- HP PC Hardware Diagnostics UEFI is not included in the preinstallation image.
- HP PC Hardware Diagnostics UEFI is not included in the HP Tool partition.
- The hard drive is damaged.

 **NOTE:** The HP PC Hardware Diagnostics UEFI downloading instructions are provided in English only, and you must use a Windows computer to download and create the HP UEFI support environment because only .exe files are provided.

Downloading the latest HP PC Hardware Diagnostics UEFI version

To download the latest HP PC Hardware Diagnostics UEFI version to a USB flash drive, follow this procedure.

1. Go to <http://www.hp.com/go/techcenter/pcdiags>. The HP PC Diagnostics home page is displayed.
2. Select **Download HP Diagnostics UEFI**, and then select **Run**.

Downloading HP PC Hardware Diagnostics UEFI by product name or number (select products only)

You can download HP PC Hardware Diagnostics UEFI by product name or number (select products only) to a USB flash drive.

 **NOTE:** For some products, you might have to download the software to a USB flash drive by using the product name or number.

1. Go to <http://www.hp.com/support>.
2. Enter the product name or number, select your computer, and then select your operating system.
3. In the **Diagnostics** section, follow the on-screen instructions to select and download the specific UEFI Diagnostics version for your computer.

Using Remote HP PC Hardware Diagnostics UEFI settings (select products only)

Remote HP PC Hardware Diagnostics UEFI is a firmware (BIOS) feature that downloads HP PC Hardware Diagnostics UEFI to your computer. It can then execute the diagnostics on your computer, and it might upload results to a preconfigured server.

For more information about Remote HP PC Hardware Diagnostics UEFI, go to <http://www.hp.com/go/techcenter/pcdiags>, and then select **Find out more**.

Downloading Remote HP PC Hardware Diagnostics UEFI

HP Remote PC Hardware Diagnostics UEFI is also available as a SoftPaq that you can download to a server.

Downloading the latest Remote HP PC Hardware Diagnostics UEFI version

You can download the latest HP PC Hardware Diagnostics UEFI version to a USB flash drive.

1. Go to <http://www.hp.com/go/techcenter/pcdiags>. The HP PC Diagnostics home page is displayed.
2. Select **Download Remote Diagnostics**, and then select **Run**.

Downloading Remote HP PC Hardware Diagnostics UEFI by product name or number

You can download HP Remote PC Hardware Diagnostics UEFI by product name or number.



NOTE: For some products, you might have to download the software by using the product name or number.

1. Go to <http://www.hp.com/support>.
2. Select **Software and Drivers**, select your type of product, enter the product name or number in the search box that is displayed, select your computer, and then select your operating system.
3. In the **Diagnostics** section, follow the on-screen instructions to select and download the **Remote UEFI** version for the product.

Customizing Remote HP PC Hardware Diagnostics UEFI settings

Using the Remote HP PC Hardware Diagnostics setting in Computer Setup (BIOS), you can perform the following customizations:

- Set a schedule for running diagnostics unattended. You can also start diagnostics immediately in interactive mode by selecting **Execute Remote HP PC Hardware Diagnostics**.
- Set the location for downloading the diagnostic tools. This feature provides access to the tools from the HP website or from a server that has been preconfigured for use. Your computer does not require the traditional local storage (such as a hard drive or USB flash drive) to run remote diagnostics.
- Set a location for storing the test results. You can also set the user name and password that you use for uploads.
- Display status information about the diagnostics run previously.

To customize Remote HP PC Hardware Diagnostics UEFI settings, follow these steps:

1. Turn on or restart the computer, and when the HP logo appears, press **F10** to enter Computer Setup.
2. Select **Advanced**, and then select **Settings**.
3. Make your customization selections.
4. Select **Main**, and then **Save Changes and Exit** to save your settings.

Your changes take effect when the computer restarts.

9 Specifications

This chapter provides specifications for your computer.

Computer specifications

This section provides specifications for your computer. When traveling with your computer, the computer dimensions and weights, as well as input power ratings and operating specifications, provide helpful information.

Table 9-1 Computer specifications

	Metric	U.S.
Dimensions		
Width	324.0 mm	12.8 in
Depth	225.0 mm	8.9 in
Height (front to back)	18.0 mm	0.7 in
Weight		
	1468.0 g	3.24 lb
Input power		
Operating voltage and current	19.5 V dc @ 3.33 A – 65 W	
	19.5 V dc @ 2.31 A – 45 W	
Temperature		
Operating	5°C to 35°C	41°F to 95°F
Nonoperating	–20°C to 60°C	–4°F to 140°F
Relative humidity (noncondensing)		
Operating	10% to 90%	
Nonoperating	5% to 95%	
Maximum altitude (unpressurized)		
Operating	–15 m to 3,048 m	–50 ft to 10,000 ft
Nonoperating	–15 m to 12,192 m	–50 ft to 40,000 ft

NOTE: Applicable product safety standards specify thermal limits for plastic surfaces. The device operates well within this range of temperatures.

35.6 cm (14.0 in) display specifications

This section provides specifications for your display.

Table 9-2 Display specifications

	Metric	U.S.
Active diagonal size	35.6 cm	14.0 in
Resolution	1920 × 1080 (FHD) 1366 × 768 (HD)	
Surface treatment	Antiglare or BrightView	
Brightness	HD: 220 nits FHD: 220 nits or 250 nits	
Viewing angle	SVA or UWVA	
Backlight	WLED	
Display panel interface	eDP	

Solid-state drive specifications

This section provides specifications for your solid-state drives.

Table 9-3 Solid-state drive specifications

	256 GB*	512 GB*	1 TB*
Dimensions			
Height	1.0 mm	1.0 mm	1.0 mm
Length	50.8 mm	50.8 mm	50.8 mm
Width	28.9 mm	28.9 mm	28.9 mm
Weight	< 10 g	< 10 g	< 10 g
Interface type			
Ready time, maximum (to not busy)	1.0 ms	< 1.0 ms	1.0 ms
Access times, logical	0.1 ms	0.1 ms	0.1 ms
Transfer rate			
Sequential read	up to 2150 MB/s	up to 2150 MB/s	up to 2150 MB/s
Random read	Up to 300,000 IOPs	Up to 300,000 IOPs	Up to 300,000 IOPs
Sequential write	up to 1550 MB/s	up to 1550 MB/s	up to 1550 MB/s
Random write	Up to 100,000 IOPs	Up to 100,000 IOPs	Up to 100,000 IOPs
Total logical sectors	468,883,296	1,000,215,216	1,500,336,388
Operating temperature	0°C to 70°C (32°F to 158°F)		

Table 9-3 Solid-state drive specifications (continued)

	256 GB*	512 GB*	1 TB*
*1 GB = 1 billion bytes when referring to hard drive storage capacity. Actual accessible capacity is less. Actual drive specifications may differ slightly.			
NOTE: Certain restrictions and exclusions apply. Contact support for details.			

Solid-state drive specifications (SATA-3)

This section provides specifications for your solid-state drive.

Table 9-4 Solid-state drive specifications

	128 GB*
Dimensions	
Height	1.35 mm
Weight	< 10 g
Interface type	
Ready time, maximum (to not busy)	1.0 ms
Access times, logical	0.1 ms
Transfer rate	up to 540 MB/s
Total logical sectors	234,441,648
Operating temperature	0°C to 70°C (32°F to 158°F)
*1 GB = 1 billion bytes when referring to hard drive storage capacity. Actual accessible capacity is less. Actual drive specifications may differ slightly.	
NOTE: Certain restrictions and exclusions apply. Contact support for details.	

10 Power cord set requirements

This chapter provides power cord requirements for countries and regions.

The wide-range input feature of the computer permits it to operate from any line voltage from 100 V ac to 120 V ac, or from 220 V ac to 240 V ac.

The 3-conductor power cord set included with the computer meets the requirements for use in the country or region where the equipment is purchased.

Power cord sets for use in other countries or regions must meet the requirements of the country and region where the computer is used.

Requirements for all countries

These power cord requirements are applicable to all countries and regions.

- The length of the power cord set must be at least **1.0 m** (3.3 ft) and no more than **2.0 m** (6.5 ft).
- All power cord sets must be approved by an acceptable accredited agency responsible for evaluation in the country or region where the power cord set will be used.
- The power cord sets must have a minimum current capacity of 10 A and a nominal voltage rating of 125 V ac or 250 V ac, as required by the power system of each country or region.
- The appliance coupler must meet the mechanical configuration of an EN 60 320/IEC 320 Standard Sheet C13 connector for mating with the appliance inlet on the back of the computer.

Requirements for specific countries and regions

To determine power cord requirements for specific countries and regions, use this table.

Table 10-1 Power cord requirements for specific countries and regions

Country/region	Accredited agency	Applicable note number
Argentina	IRAM	1
Australia	SAA	1
Austria	OVE	1
Belgium	CEBEC	1
Brazil	ABNT	1
Canada	CSA	2
Chile	IMQ	1
Denmark	DEMKO	1
Finland	FIMKO	1
France	UTE	1
Germany	VDE	1

Table 10-1 Power cord requirements for specific countries and regions (continued)

Country/region	Accredited agency	Applicable note number
India	BIS	1
Israel	SII	1
Italy	IMQ	1
Japan	JIS	3
The Netherlands	KEMA	1
New Zealand	SANZ	1
Norway	NEMKO	1
The People's Republic of China	CCC	4
Saudi Arabia	SASO	7
Singapore	PSB	1
South Africa	SABS	1
South Korea	KTL	5
Sweden	SEMKO	1
Switzerland	SEV	1
Taiwan	BSMI	6
Thailand	TISI	1
The United Kingdom	ASTA	1
The United States	UL	2

1. The flexible cord must be Type H05VV-F, 3-conductor, 0.75 mm² conductor size. Power cord set fittings (appliance coupler and wall plug) must bear the certification mark of the agency responsible for evaluation in the country or region where it will be used.
2. The flexible cord must be Type SVT/SJT or equivalent, No. 18 AWG, 3-conductor. The wall plug must be a two-pole grounding type with a NEMA 5-15P (15 A, 125 V ac) or NEMA 6-15P (15 A, 250 V ac) configuration. CSA or C-UL mark. UL file number must be on each element.
3. The appliance coupler, flexible cord, and wall plug must bear a T mark and registration number in accordance with the Japanese Dentori Law. The flexible cord must be Type VCTF, 3-conductor, 0.75 mm² or 1.25 mm² conductor size. The wall plug must be a two-pole grounding type with a Japanese Industrial Standard C8303 (7 A, 125 V ac) configuration.
4. The flexible cord must be Type RVV, 3-conductor, 0.75 mm² conductor size. Power cord set fittings (appliance coupler and wall plug) must bear the CCC certification mark.
5. The flexible cord must be Type H05VV-F 3-conductor, 0.75 mm² conductor size. KTL logo and individual approval number must be on each element. Approval number and logo must be printed on a flag label.
6. The flexible cord must be Type HVCTF 3-conductor, 1.25 mm² conductor size. Power cord set fittings (appliance coupler, cable, and wall plug) must bear the BSMI certification mark.
7. For 127 V ac, the flexible cord must be Type SVT or SJT 3-conductor, 18 AWG, with plug NEMA 5-15P (15 A, 125 V ac), with UL and CSA or C-UL marks. For 240 V ac, the flexible cord must be Type H05VV-F 3-conductor, 0.75 mm² or 1.00 mm² conductor size, with plug BS 1363/A with BSI or ASTA marks.

11 Recycling

When a nonrechargeable or rechargeable battery has reached the end of its useful life, do not dispose of the battery in general household waste. Follow the local laws and regulations in your area for battery disposal.

HP encourages customers to recycle used electronic hardware, HP original print cartridges, and rechargeable batteries. For more information about recycling programs, see the HP website at <http://www.hp.com/recycle>.

Index

A

- AC adapter and battery light, identifying lights
 - AC adapter and battery 5
- AC adapters, spare part numbers 20
- Audio-out (headphone)/Audio-in (microphone) combo jack 5

B

- backup, creating 63
- backups 63
- battery
 - illustrated 15
 - spare part number 15
- BIOS
 - determining version 59
 - downloading an update 60
 - starting the Setup Utility 59
 - updating 59
- Bluetooth label 13
- boot order, changing 64
- bottom components 13
- bottom cover
 - illustrated 15
 - removal 29
 - spare part number 15, 29
- buttons
 - power 11

C

- cables
 - spare part numbers 19
- camera
 - identifying 7
- camera light, identifying 7
- caps lock light 10
- cautions
 - electrostatic discharge 23, 24
- components
 - bottom 13
 - display 7
 - keyboard area 8
 - left side 6
 - right side 5

- computer major components 15
- computer specifications 73

D

- display
 - specifications 73, 74
- display assembly
 - subcomponents 18
- display back cover
 - illustrated 18
 - spare part number 18
- display bezel
 - illustrated 18
 - spare part number 18
- display cable
 - illustrated 18
 - spare part number 18
- display components 7
- display panel
 - illustrated 18
 - spare part number 18

E

- electrostatic discharge (ESD) 23, 24
 - preventing damage 23, 24, 25
- esc key, identifying keys
 - esc 12

F

- fan
 - illustrated 15
 - removal 39
 - spare part number 15, 39
- feet
 - removal 29
 - spare part number 29
- fingerprint reader board
 - removal 38
 - spare part numbers 38
- fingerprint reader board cable
 - spare part number 19
- fingerprint reader, identifying 12
- fn key, identifying 12

G

- grounding methods 23, 24, 26
- guidelines
 - packaging 23, 27
 - transporting 23, 27
 - workstation 23, 24

H

- hard drive
 - specifications 73
- heat sink
 - illustrated 15
 - removal 40
 - spare part number 15
 - spare part numbers 40
- hinge
 - illustrated 18
 - spare part number 18
- hinge cover
 - illustrated 18
 - spare part number 18
- HP PC Hardware Diagnostics UEFI
 - downloading 70
 - starting 69
 - using 69
- HP PC Hardware Diagnostics Windows
 - accessing 67, 68
 - downloading 68
 - installing 69
 - using 67
- HP Recovery media
 - recovery 64
- HP Sure Recover 65

I

- illustrated parts catalog 15
- internal microphones, identifying 7

J

- jacks
 - audio-out (headphone)/audio-in (microphone) combo, identifying 5

- K**
- keyboard
 - product description 3
- keyboard with top cover
 - spare part numbers 56
- keys
 - action 12
 - fn 12
 - Windows 12
- L**
- labels
 - Bluetooth 13
 - regulatory 13
 - serial number 13
 - service 13
 - wireless certification 13
 - WLAN 13
- left side components 6
- lights
 - camera 7
 - caps lock 10
 - mute 10
 - mute light, identifying 10
- M**
- memory card reader 6
- memory modules
 - removal 33
 - spare part numbers 33
- P**
- packaging guidelines 23, 27
- pointing device, product description 3
- ports
 - product description 2
 - USB SuperSpeed 5
- power button, identifying 11
- power button/card reader board
 - illustrated 15
 - spare part number 15
- power button/card reader board cable
 - spare part number 19
- power connector
 - identifying 6
- power connector cable
 - illustrated 15
 - removal 55
 - spare part number 15
 - spare part numbers 55
- power cord
 - requirements for all countries 77
 - requirements for specific countries and regions 77
 - set requirements 77
- power cords, spare part numbers 20
- product description
 - keyboard 3
 - pointing device 3
 - ports 2
- product name and number, computer 13
- R**
- recovery 63, 64
 - discs 64
 - media 64
 - USB flash drive 64
- recovery media 63
 - creating using HP Cloud Recovery Download Tool 63
 - creating using Windows tools 63
- regulatory information
 - regulatory label 13
 - wireless certification labels 13
- Remote HP PC Hardware Diagnostics
 - UEFI settings
 - customizing 71
 - using 70
- removal and replacement procedures 29
 - solid-state drive 36
- restoring 63
- right side components 5
- S**
- Screw Kit, spare part number 20
- serial number, computer 13
- service labels, locating 13
- slots
 - memory card reader 6
- solid-state drive
 - illustrated 15
 - removal and replacement 36
 - spare part number 15
 - specifications 74, 75
 - spare part country codes 56
- speaker
 - illustrated 15
 - removal 44
 - spare part number 15
 - spare part numbers 44
- speakers, identifying 11
- special keys, using 12
- specifications
 - computer 73
 - display 73, 74
 - hard drive 73
 - solid-state drive 74, 75
- static electricity 23, 24, 25
- system board
 - illustrated 15
 - removal 42
 - spare part number 15
 - spare part numbers 42
- system restore point, creating 63
- T**
- top cover/keyboard
 - illustrated 15
 - spare part number 15
- touchpad
 - illustrated 15
 - removal 37
 - spare part number 15
 - spare part numbers 37
- touchpad cable
 - spare part number 19
- touchpad zone, identifying 9
- transporting guidelines 23, 27
- traveling with the computer 13
- U**
- USB board
 - removal 37
 - spare part numbers 37
- USB SuperSpeed ports
 - identifying 5
- V**
- vent, identifying 11
- W**
- Windows
 - backup 63
 - recovery media 63
 - system restore point 63
 - Windows key, identifying 12

- Windows tools, using 63
- wireless antennas
 - illustrated 18
 - spare part number 18
- wireless antennas, identifying 7
- wireless certification label 13
- WLAN antennas, identifying 7
- WLAN device 13
- WLAN label 13
- WLAN module
 - illustrated 15
 - removal 34
 - spare part number 15
 - spare part numbers 34
- workstation guidelines 23, 24

Z

- zone
 - left touchpad 9
 - right touchpad 9

