



VIZIO

V-Series® User Manual



Scan to
learn more.

Models:

V435-J01, V505-J01, V505-J09,
V505C-J09, V555-J01, V585-J01,
V655-J04, V655-J09, V705-J01,
V705-J03, V705x-J03 & V755-J04

Table of Contents

Getting to Know Your TV	1	Changing the TV Name	23	Playing USB Media	31
Front Panel	1	Renaming Devices on the Input Menu	23	Preparing Your USB Drive to Play USB Media	31
Rear Panel	2	Adjusting the Power Mode	23	Displaying USB Media	31
Wall-mounting the TV	4	Using the USB Power Feature	24	Removing the USB Drive from the TV	31
Using the Remote	5	Turning the Power Indicator On or Off	24	Product Registration and Technical Support	35
Using Voice Control	6	Setting Timers	24	Help Topics	36
Completing the First-Time Setup	7	Setting a System PIN Code	25	Specifications	38
Using the On-Screen Menu	8	Adjusting the CEC Settings	25	Regulatory Information	39
Navigating the On-Screen Menu	8	Managing Mobile Devices	25	Limited Warranty	40
Changing the Input Source	8	Voice Remote	25	Legal Information	42
Adjusting the Picture Settings	9	Using the Admin & Privacy Menu	26		
Adjusting the Color Temperature	9	Performing a Reboot	26		
Changing the Picture Aspect Ratio	10	Viewing System Information	26		
Adjusting Advanced Picture Settings	10	Accessing the Support Code	26		
Adjusting Picture Input Settings	13	Checking for System Updates	26		
Adjusting the Picture Mode Edit Settings	13	Restoring the TV to Factory Default Settings	26		
Adjusting the Audio Settings	15	Viewing Data	27		
Sound Bar settings	15	Managing Advertising Settings	27		
Adjusting the Network Settings	16	View VIZIO Privacy Policy	27		
Setting Up TV Channels	17	Store Demo	27		
Scanning for TV Channels	17	Using the Info Window	28		
Skipping Channels	17	SmartCast Home™	29		
Changing the Analog Audio Language	18	What is SmartCast Home?	29		
Using Parental Controls	19	How to Launch SmartCast Home	29		
Accessibility Settings	20	What you can do with SmartCast Home	29		
Setting Up Closed Captioning	20	Control your TV with the SmartCast Mobile™ App	29		
Changing the Appearance of Digital Closed Captions	20	WatchFree+™	30		
Changing the System Settings	22	What is WatchFree+?	30		
Changing the On-Screen Menu Language	22	What you can do with WatchFree+	30		
Setting the Time	22	How to Launch WatchFree+	30		

Safety & Certification

THANK YOU FOR CHOOSING VIZIO

And congratulations on your new VIZIO TV!

To get the most out of your new VIZIO product, read these instructions before using your product and retain them for future reference. Be sure to inspect the package contents to ensure there are no missing or damaged parts.

PRODUCT REGISTRATION

To purchase or inquire about accessories and installation services for your VIZIO product, visit our website at vizio.com.

We recommend that you register your VIZIO product at vizio.com/product-registration.

WHEN READING THIS MANUAL



TIP: When you see this symbol, please read the accompanying helpful tip.



WARNING: When you see this symbol, please read the accompanying important warning or notice. It is intended to alert you to the presence of important operating instructions.

Color Text — This is the TV menu feature you should be selecting.

Grey Text — This is an action for you to complete, such as entering in a name.

> — The arrow sign shows the flow of the steps you should take.

1. Lists additional steps you can take for each setting.

- Bullets give more detailed information about each feature.

IMPORTANT SAFETY INSTRUCTIONS

Your TV is designed and manufactured to operate within defined design limits. Misuse may result in electric shock or fire. To prevent your TV from being damaged, the following instructions should be observed for the installation, use, and maintenance of your TV. Read the following safety instructions before operating your TV. Keep these instructions in a safe place for future reference.

- To reduce the risk of electric shock or component damage, switch off the power before connecting other components to your TV.
- Read these instructions.
- Keep these instructions.
- Heed all warnings.
- Follow all instructions.
- Do not use this apparatus near water.
- Clean only with dry cloth.
- Do not block any ventilation openings. Install in accordance with the manufacturer's instructions.
- Do not install near any heat sources such as radiators, heat registers, stoves, or other apparatus (including amplifiers) that produce heat.
- Do not defeat the safety purpose of the polarized or grounding-type plug. A polarized plug has two blades with one wider than the other.
 - A grounding type plug has two blades and a third grounding prong. The wide blade or the third prong are provided for your safety.
 - If the provided plug does not fit into your outlet, consult an electrician for replacement of the obsolete outlet.
- Protect the power cord from being walked on or pinched particularly at plugs, convenience receptacles, and the point where they exit from the apparatus.
- Only use attachments/accessories specified by the manufacturer.
- Use only with the cart, stand, tripod, bracket, or table specified by the manufacturer, or sold with the apparatus. When a cart is used, use caution when moving the cart/apparatus combination to avoid injury from tip-over.
- Unplug this apparatus during lightning storms or when unused for long periods of time.
- Refer all servicing to qualified service personnel. Servicing is required when the apparatus has been damaged in any way, such as power-supply cord or plug is damaged, liquid has been spilled or objects have fallen into the apparatus, the



apparatus has been exposed to rain or moisture, does not operate normally, or has been dropped.

- **CAUTION:** Always use a power outlet that is properly grounded.
- Unplug this TV during lightning storms or when unused for long periods of time.
- When moving your TV from an area of low temperature to an area of high temperature, condensation may form in the housing. Wait before turning on your TV to avoid causing fire, electric shock, or component damage.
- A distance of at least three feet should be maintained between your TV and any heat source, such as a radiator, heater, oven, amplifier, etc. Do not install your TV close to smoke. Operating your TV close to smoke or moisture may cause fire or electric shock.
- Slots and openings in the back and bottom of the TV are provided for ventilation. To ensure reliable operation of your TV and to protect it from overheating, be sure these openings are not blocked or covered. Do not place your TV in a bookcase or cabinet unless proper ventilation is provided.
- Never push any object into the slots and openings on your TV. Do not place any objects on the top of your TV. Doing so could short circuit parts causing a fire or electric shock. Never spill liquids on your TV.
- Your TV should be operated only from the type of power source indicated on the label. If you are not sure of the type of power supplied to your home, consult your dealer or local power company.
- Do not apply pressure or throw objects at your TV. This may compromise the integrity of the TV. The manufacturer's warranty does not cover user abuse or improper installations.
- The power cord must be replaced when using different voltage than the voltage specified. For more information, contact your dealer.
- When connected to a power outlet, power is always flowing into your TV. To totally disconnect power, unplug the power cord.
- The lightning flash with arrowhead symbol within an equilateral triangle is intended to alert the user to the presence of un-isolated, dangerous voltage within the inside of your TV that may be of sufficient magnitude to constitute a risk of electric shock to persons.
- Do not overload power strips and extension cords. Overloading can result in fire or electric shock.
- The wall socket should be installed near your TV and easily accessible.
- Only power of the marked voltage can be used for your TV. Any other voltage than the specified voltage may cause fire or electric shock.



- Do not touch the power cord during lightning. To avoid electric shock, avoid handling the power cord during electrical storms.
- Unplug your TV during a lightning storm or when it will not be used for long period of time. This will protect your TV from damage due to power surges.
- Do not attempt to repair or service your TV yourself. Opening or removing the back cover may expose you to high voltages, electric shock, and other hazards. If repair is required, contact your dealer and refer all servicing to qualified service personnel.
- **WARNING:** Keep your TV away from moisture. Do not expose your TV to rain or moisture. If water penetrates into your TV, unplug the power cord and contact your dealer. Continuous use in this case may result in fire or electric shock.
- Do not use your TV if any abnormality occurs. If any smoke or odor becomes apparent, unplug the power cord and contact your dealer immediately. Do not try to repair your TV yourself.
- Avoid using dropped or damaged appliances. If your TV is dropped and the housing is damaged, the internal components may function abnormally. Unplug the power cord immediately and contact your dealer for repair. Continued use of your TV may cause fire or electric shock.
- Do not install your TV in an area with heavy dust or high humidity. Operating your TV in environments with heavy dust or high humidity may cause fire or electric shock.
- Follow instructions for moving your TV. Ensure that the power cord and any other cables are unplugged before moving your TV.
- To prevent injury, this apparatus must be securely attached to the furniture/wall in accordance with the installation instructions.
- Insert batteries in accordance with instructions. Incorrect polarities may cause the batteries to leak which can damage the remote control or injure the operator. Do not expose batteries to excessive heat such as sunlight, fire, etc.
- When unplugging your TV, grab the head of the power plug, not the cord. Pulling on the power cord may damage the wires inside the cord and cause fire or electric shock. When your TV will not be used for an extended period of time, unplug the power cord.
- To reduce risk of electric shock, do not touch the connector with wet hands.
- Do not expose TV to liquids, including dripping or splashing.
- Do not place objects filled with liquid, such as vases, on the TV.
- **If the main wall plug or the appliance coupler is disconnected, the disconnected device will remain readily operable upon reconnection to**

an appropriate power source. If any of the following occurs, contact the dealer:

- The power cord fails or frays.
- Liquid sprays or any object drops into your TV.
- Your TV is exposed to rain or other moisture.
- Your TV is dropped or damaged in any way.
- The performance of your TV changes substantially.

- **CAUTION:** These servicing instructions are for use by qualified service personnel only. To reduce the risk of electric shock, do not perform any servicing other than that contained in the operating instructions unless you are qualified to do so.



- The lightning flash with arrowhead symbol within an equilateral triangle is intended to alert the user to the presence of uninsulated DANGEROUS VOLTAGE within the product's enclosure that may be of sufficient magnitude to constitute a risk of electrical shock to persons.
- **WARNING:** Exposure to loud sounds can damage your hearing causing hearing loss and tinnitus (ringing or buzzing in the ears). With continued exposure to loud noises, ears may become accustomed to the sound level, which may result in permanent damage to hearing without any noticeable discomfort.
- Install the TV where it cannot be pulled, pushed or knocked over.
- Do not allow children to hang onto the product.
- Store the accessories (remote, batteries, etc.) in a location safely out of the reach of children.
- The American Academy of Pediatrics discourages television viewing for children younger than two years of age.
- **WARNING — Stability Hazard:** A television set may fall, causing serious personal injury or death. Many injuries, particularly to children, can be avoided by taking simple precautions such as:
 - ALWAYS use cabinets or stands or mounting methods recommended by the manufacturer of the television set.
 - ALWAYS use furniture that can safely support the television set.

- ALWAYS ensure the television set is not overhanging the edge of the supporting furniture.
- ALWAYS educate children about the dangers of climbing on furniture to reach the television set or its controls.
- ALWAYS route cords and cables connected to your television so they cannot be tripped over, pulled or grabbed.
- NEVER place a television set in an unstable location.
- NEVER place the television set on tall furniture (for example, cupboards or bookcases) without anchoring both the furniture and the television set to a suitable support.
- NEVER place the television set on cloth or other materials that may be located between the television set and supporting furniture.
- NEVER place items that might tempt children to climb, such as toys and remote controls, on the top of the television or furniture on which the television is placed.
- If the existing television set is going to be retained and relocated, the same considerations as above should be applied.
- Disposal of a battery into fire or a hot oven, or mechanically crushing or cutting of a battery can result in an explosion.
- Leaving a battery in an extremely high temperature can result in an explosion or the leakage of flammable liquid or gas.
- A battery subjected to extremely low air pressure may result in an explosion or the leakage of flammable liquid or gas.
- **WARNING:** To prevent injury, this apparatus must be securely attached to the furniture/wall in accordance with the installation instructions.

TELEVISION ANTENNA CONNECTION PROTECTION

The TV shall be installed in accordance with the applicable provisions of Article 810 and Article 820.

If an outside antenna/satellite dish or cable system is to be connected to the TV, make sure that the antenna or cable system is electrically grounded to provide some protection against voltage surges and static charges.

Article 810 of the National Electrical Code, ANSI/NFPA 70, provides information with regard to proper grounding of the mast and supporting structure, grounding of the lead-in wire to an antenna discharge unit, size of the grounding conductors, location of antenna discharge unit, connection to grounding electrodes, and requirements of the grounding electrode.

Lightning Protection

For added protection of the TV during a lightning storm or when it is left unattended or unused for long periods of time, unplug the TV from the wall outlet and disconnect the antenna or cable system.

Power Lines

Do not locate the antenna near overhead light or power circuits, or where it could fall into such power lines or circuits. Remember, the screen of the coaxial cable is intended to be connected to earth in the building installation.

Installation of CATV

The installation instructions states the cable distribution system should be grounded (earthed) in accordance with ANSI/NFPA 70, the National Electrical Code (NEC), in particular Section 820.93, Grounding of Outer Conductive Shield of a Coaxial Cable.

Installation of Antenna

The installation instructions states the cable distribution system used for connection to antennas and dishes should be grounded (earthed) in accordance with ANSI/NFPA 70, the National Electrical Code (NEC), in particular Section 810.21, Bonding Conductors and Grounding Electrode Conductors — Receiving Stations.

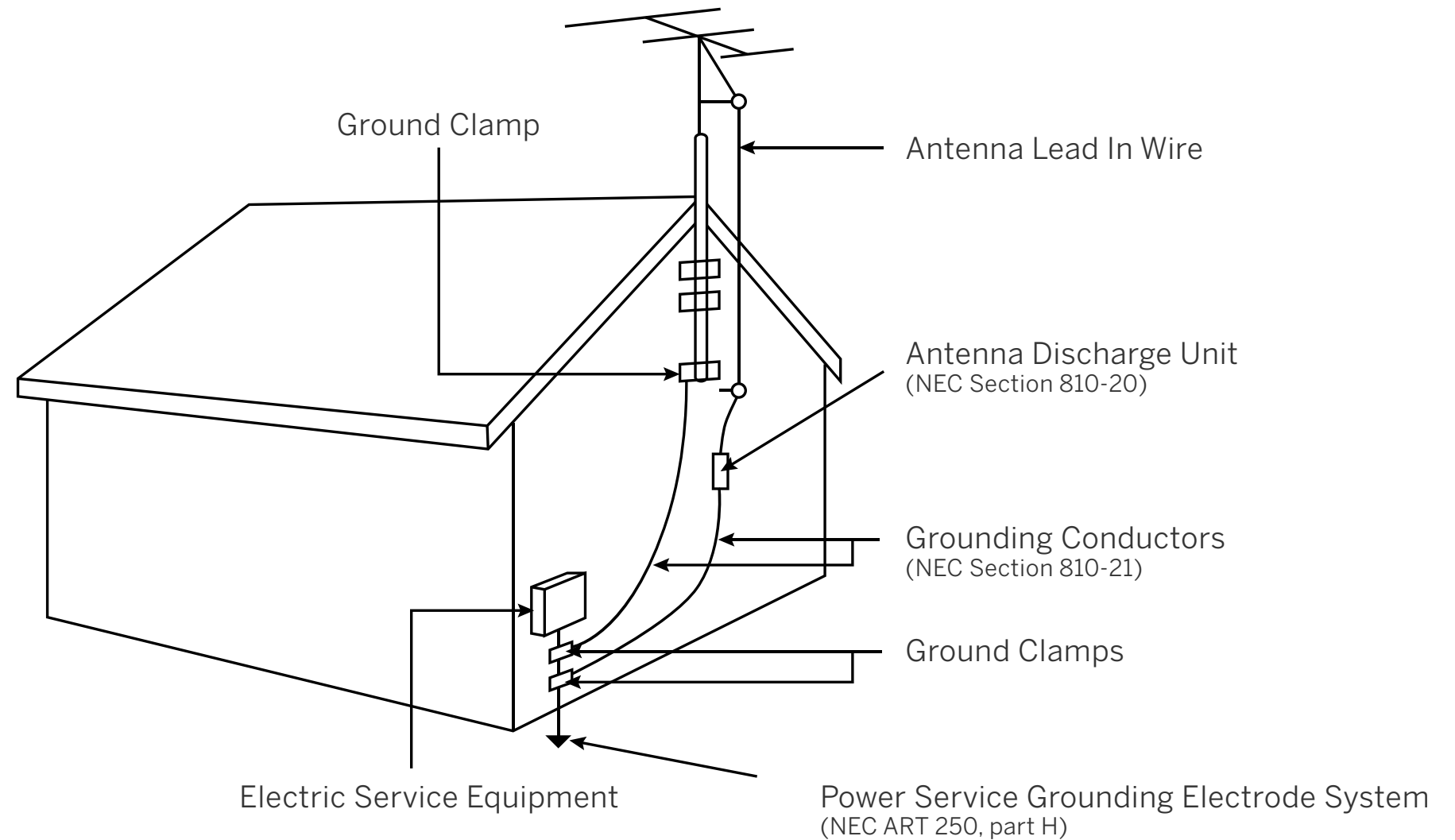

 **Dolby** Vision

 **Dolby** Audio

Dolby, Dolby Vision, Dolby Audio, and the double-D symbol are trademarks of Dolby Laboratories Licensing Corporation. Manufactured under license from Dolby Laboratories. Confidential unpublished works. Copyright © 1992-2021 Dolby Laboratories. All rights reserved.

 **HDMI**[®]
HIGH-DEFINITION MULTIMEDIA INTERFACE

The terms HDMI, HDMI High-Definition Multimedia Interface, and the HDMI Logo are trademarks or registered trademarks of HDMI Licensing Administrator, Inc.

 **dts x**[™]
DTS:X[®] Cinema Quality
Immersive Audio

 **dts**[®]
DTS[®] Virtual:X[™]
Virtualized 3D Sound

For DTS patents, see <http://patents.dts.com>.

Manufactured under license from DTS, Inc. DTS, DTS:X, Virtual:X, the DTS:X logo are registered trademarks or trademarks of DTS, Inc. in the United States and other countries. © 2020 DTS, Inc. ALL RIGHTS RESERVED.

FRONT PANEL

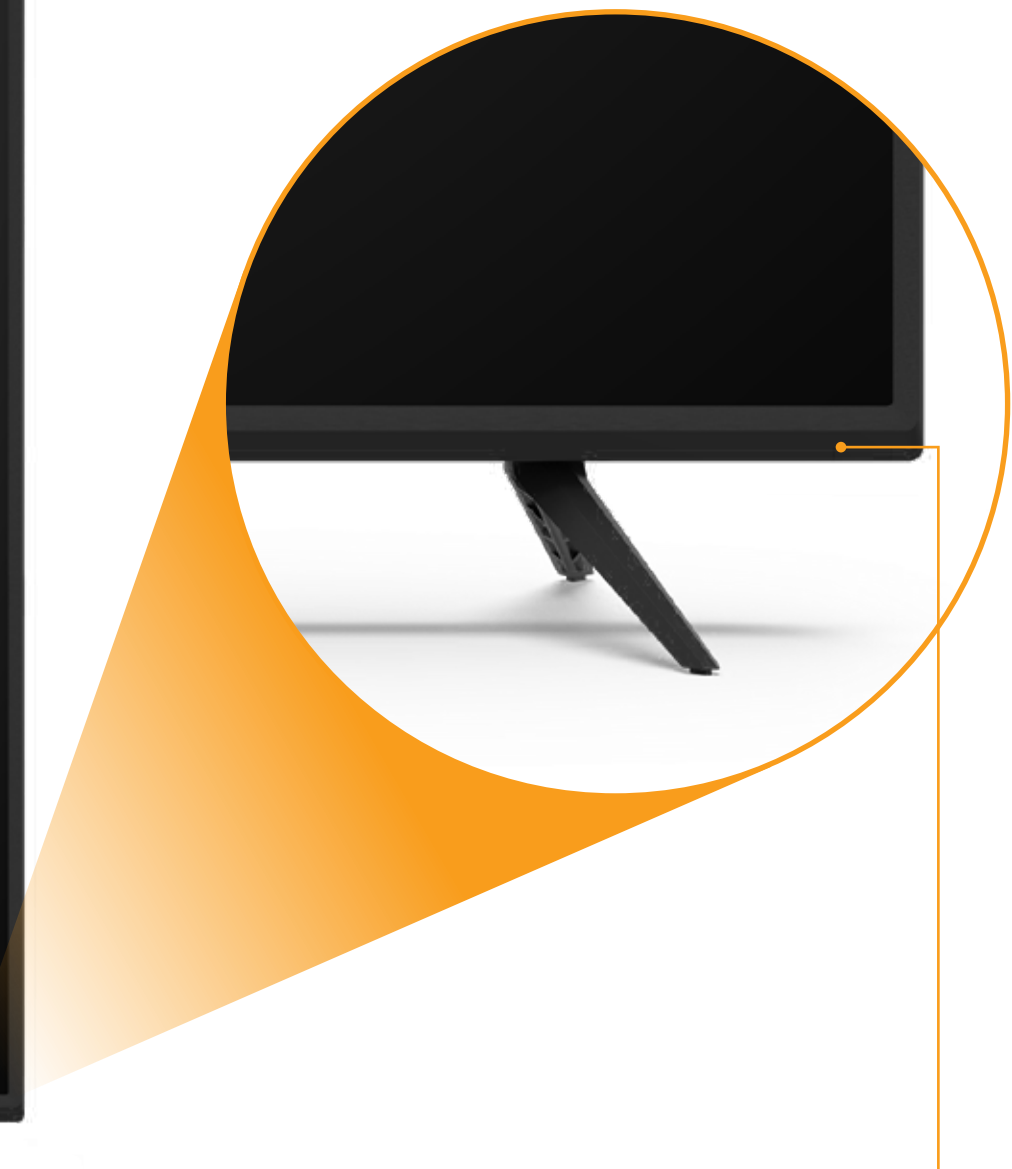

Remote Sensor and Power Indicator

When using the remote, aim it directly at this sensor. The power indicator flashes on when the TV turns on, then goes out after several seconds. To keep the power indicator on, see **Turning the Power Indicator On or Off on page 24.**

REAR PANEL

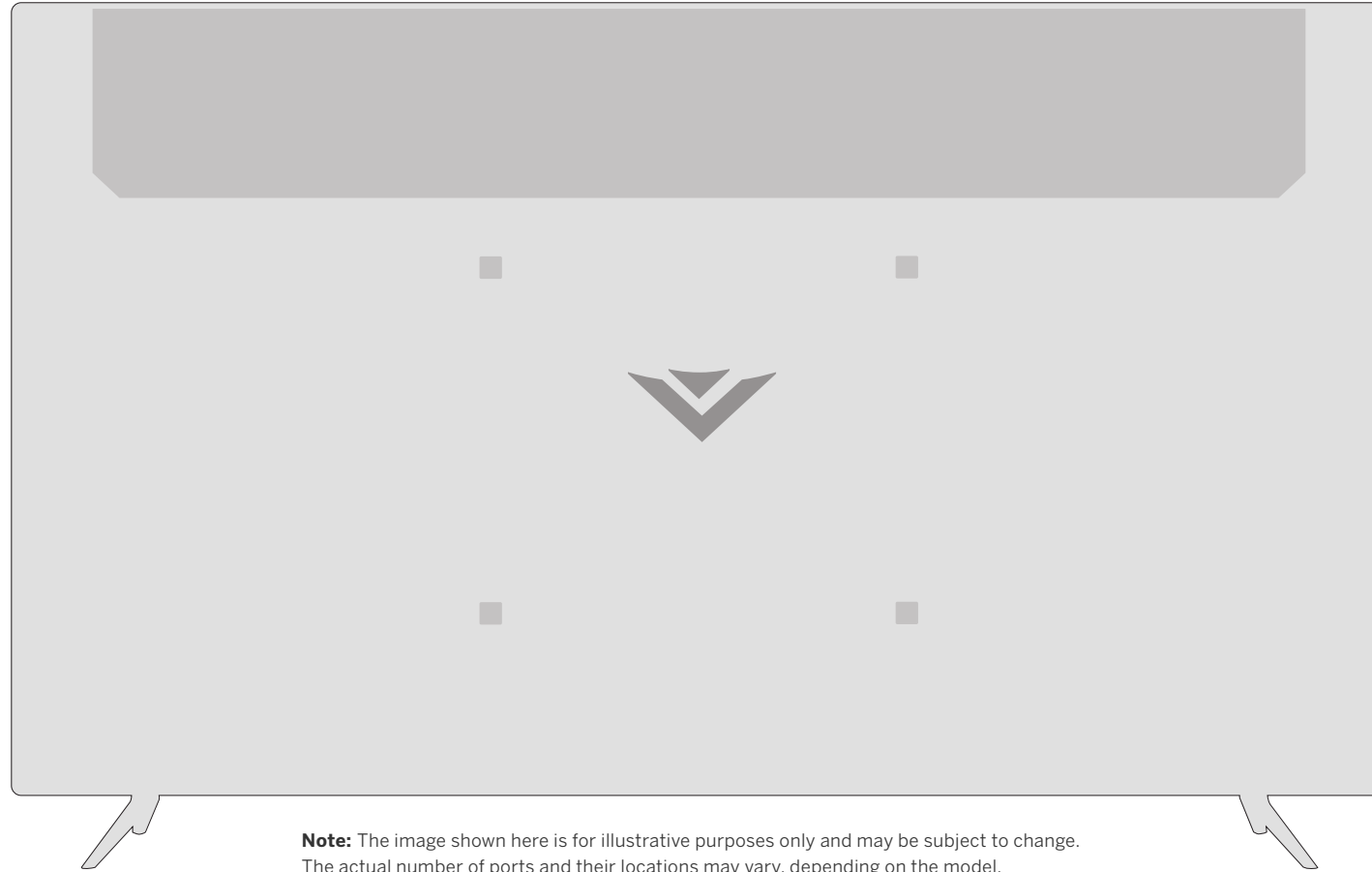

Note: The image shown here is for illustrative purposes only and may be subject to change. The actual number of ports and their locations may vary, depending on the model.

- Power**
Press to turn on the TV.
Press and hold to turn the TV off.
- Volume**
Press to increase or decrease the TV volume level.
- Input**
Press to access the input menu.



HDMI
Connect an HDMI device



Composite
Connect a composite



Audio Out
Connect to an RCA device,
such as sound bar



Coaxial
Connect to a coaxial
cable from cable,
satellite, or antenna



USB
Connect a USB thumb drive to
play photo, music, or video



Optical Audio Out
Connect to an optical/SPDIF
audio device, such as home
audio receiver



Ethernet
Connect an Ethernet cable
to modem/router

Connecting a device — AUDIO & VIDEO CABLE TYPES

Your TV can be used to display output from most devices.

1. Verify that your device has a video port that matches an available port on the TV (HDMI, Composite, etc.).
2. Connect the appropriate cable (not included) to the TV and the device.
3. Turn the TV and your device on.
4. Set the TV's input to match the connection you used (HDMI-1, HDMI-2, etc.).

HDMI CABLE

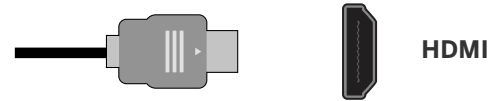

COAXIAL CABLE



COMPOSITE (AV) CABLE

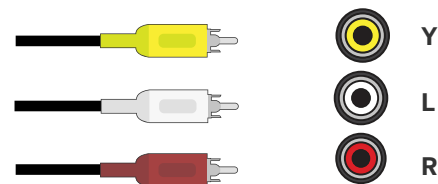

Connecting a device — AUDIO CABLE TYPES

Your TV can be output sound to an audio device, such as a receiver or sound bar.

1. Verify that your device has an audio port that matches an available port on the TV (optical, RCA, etc).
2. Connect the appropriate cable (not included) to the TV and the device.
3. Turn the TV and your device on.

HDMI CABLE

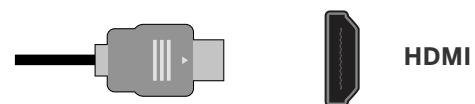

COMPONENT AND/OR COMPOSITE CABLE

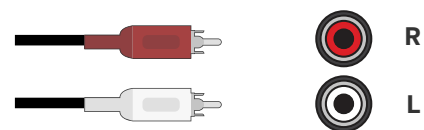

OPTICAL/SPDIF CABLE

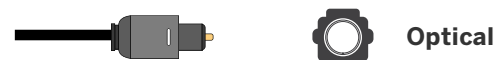

Note: The actual ports and their locations may vary, depending on the TV model.

WALL-MOUNTING THE TV

First you will need a wall mount. Consult the provided table below to find the appropriate mount for your TV.

Be sure the mount you choose is capable of supporting the weight of the TV.

To install your TV on a wall:

1. Disconnect any cables connected to your TV.
2. Place the TV face-down on a clean, flat, stable surface. Be sure the surface is clear of debris that can scratch or damage the TV.
3. If attached, remove the stands by loosening and removing the screws.
4. Attach your TV and wall mount to the wall by carefully following the instructions that came with your mount. Use only with a UL-listed wall mount bracket rated for the weight/load of your TV.

 **TIP:** Installing a TV on a wall requires lifting. To prevent injury or damage to the TV, ask someone to help you.

 **WARNING:** Do not use the screws that are included inside the wall mount holes to mount TV.

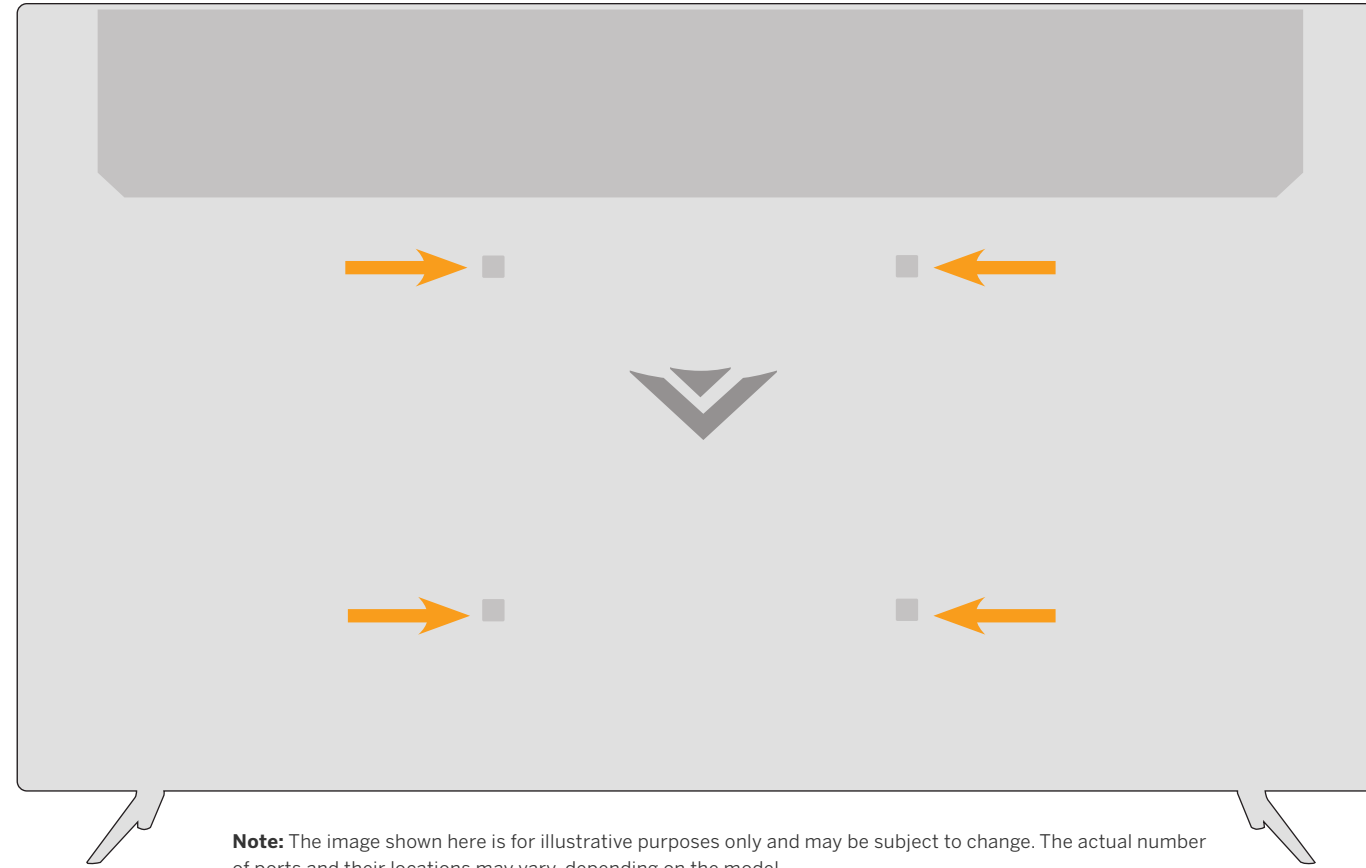

Note: The image shown here is for illustrative purposes only and may be subject to change. The actual number of ports and their locations may vary, depending on the model.

	V435-J01	V505-J01	V505-J09	V555-J01	V585-J01	V655-J04	V655-J09	V705-J01	V705-J03	V705x-J03	V755-J04
Screw Size	M6	M6	M6	M6	M6	M6	M6	M8	M6	M6	M8
# of Screws (not included)	4	4	4	4	4	4	4	4	4	4	4
Hole Depth	14 mm	14 mm	10.2 mm	14 mm	14 mm	10 mm	9 mm	12 mm	12 mm	12 mm	12 mm
Hole Pattern	200 x 200 mm	200 x 200 mm	200 x 200 mm	300 x 200 mm	300 x 200 mm	400 x 200 mm	400 x 200 mm	400 x 200 mm	400 x 200 mm	400 x 200 mm	400 x 400 mm
Weight w/o Stand	15.65 lb (7.1 kg)	21.38 lb (9.7 kg)	18.87 lb (8.56 kg)	30.14 lb (13.67 kg)	31.53 lb (14.3 kg)	42.6 lb (19.32 kg)	39.24 lb (17.8 kg)	49.30 lb (22.36 kg)	52.70 lb (23.9 kg)	52.7 lb (23.9 kg)	59.97 lb (27.2 kg)

USING THE REMOTE

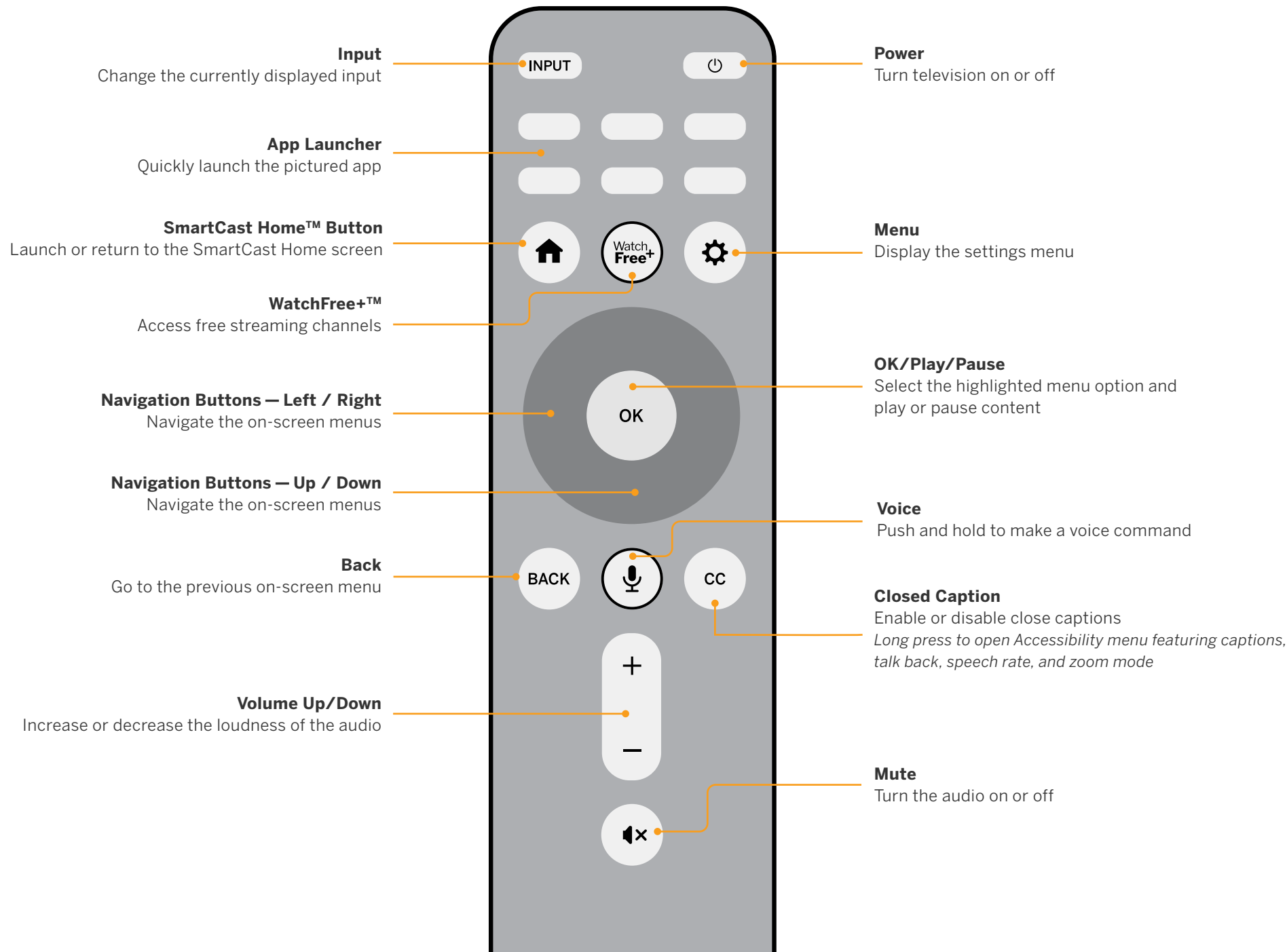

Replacing the Batteries

1. Push and slide the cover down. Then lift the cover to access the battery compartment.
2. Insert two batteries into the remote control. Make sure that the (+) and (-) symbols on the batteries match the (+) and (-) symbols inside the battery compartment.
3. Replace the battery cover and slide to close.

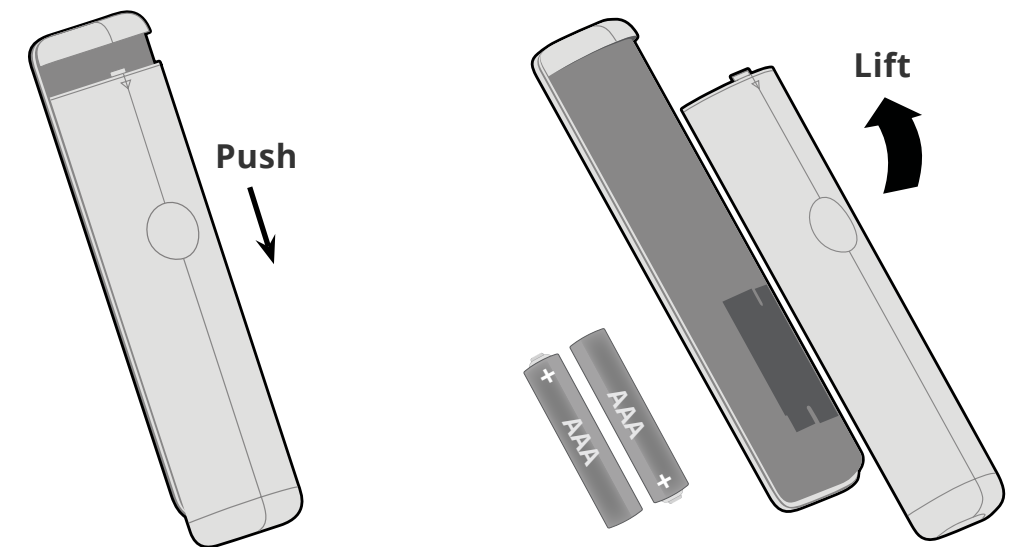

In many places batteries cannot be thrown away or discarded with household waste. Please ensure you properly dispose of your batteries consistent with the laws and/or regulations where you live. For more information please visit: www.vizio.com/environment

WARNING: Keep the remote control batteries away from children. It may cause choking and/or lead to a fire or chemical burn if mishandled. Do not dispose of batteries in fire. Replace only with batteries of the correct type. Risk of fire or explosion if the battery is replaced by an incorrect type.

TIP: When needed, VIZIO recommends replacing the batteries that came with this remote with two, new Duracell 'AAA' alkaline batteries.

POWER UP WITH DURACELL

USING VOICE CONTROL

You can easily control your TV with the included Voice Remote.

To pair your remote to the TV:

During first-time setup, your remote should automatically pair to your TV with Bluetooth.

To manually pair:

Press the **MIC**  button to launch pairing mode.



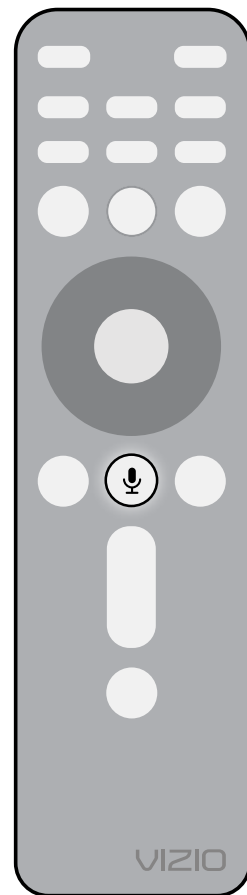

 **TIP:** The voice remote must be within close enough range of the TV to pair properly.

How to use the voice control:

1. Push and hold the  **MIC** button while speaking a command.



Here are some phrases you can say:

-  "Find free comedy movies."
-  "Switch input to HDMI-2."
-  "Launch WatchFree+."
-  "Turn on captions."
-  "Lower volume to 10."



vizio.com/qr/XRT260

Scan to learn more.

Scan with your phone camera or QR reader.

Using the SmartCast Mobile™ app for voice control:

You can also use the free VIZIO SmartCast Mobile app as a voice control remote. Refer to the *SmartCast Mobile section on page 29* for more information.

Connect to other popular voice assistant devices:

VIZIO TVs also work with Google Assistant, Siri, and Alexa-enabled devices for hands-free voice control.

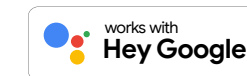

 **TIP:** If you want to use a voice assistant to turn your TV on, make sure Quick Start Mode is enabled. Refer to *Adjusting the Power Mode on page 23*.

This device is equipped with the VIZIO Voice feature. By activating the VIZIO Voice feature (either through the mobile application or Bluetooth remote), you can control your Smart TV, and use many of its features, with voice commands. In order to provide you the VIZIO Voice feature, some voice commands may be transmitted to a third-party service provider that will translate your voice command into text and provide VIZIO Voice features. We may also capture and collect voice commands and associated text(s) in order to provide the VIZIO Voice feature and evaluate and improve the features. VIZIO will only capture voice commands when you press the microphone button on your remote or mobile app and speak into the microphone on the remote control or mobile phone. You may disable the VIZIO Voice feature for your remote at any time by unpairing your Bluetooth remote.

Before you begin the first-time setup:

- Your TV should be installed and the power cord should be connected to an electrical outlet.
- If you have a wireless network, have the network password ready.
- If you are connecting to your network with an Ethernet cable, connect it to the Ethernet port on the TV.

The first time you turn on the TV, the on-screen instructions will guide you through each of the steps necessary to get your TV ready for use:

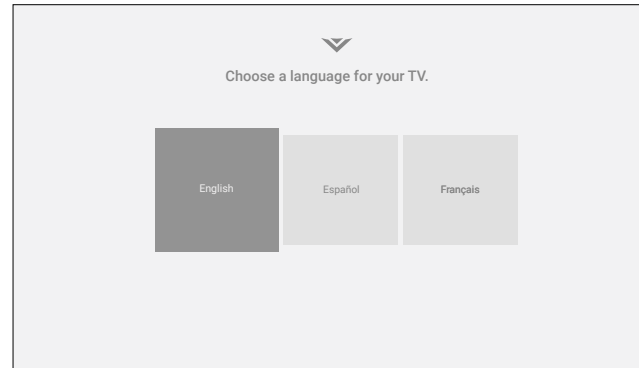

1. Choose your language. Pressing the CC button will enable TTS (text-to-speech) functionality.

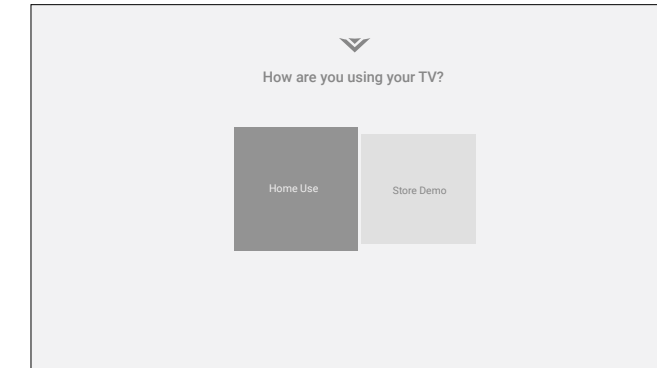

2. Choose home use.

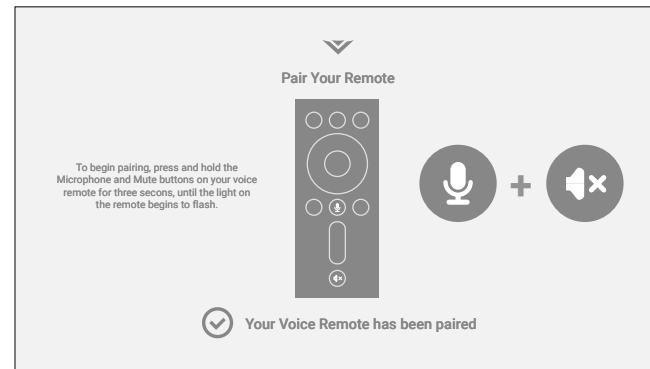

3. Pair your voice remote.

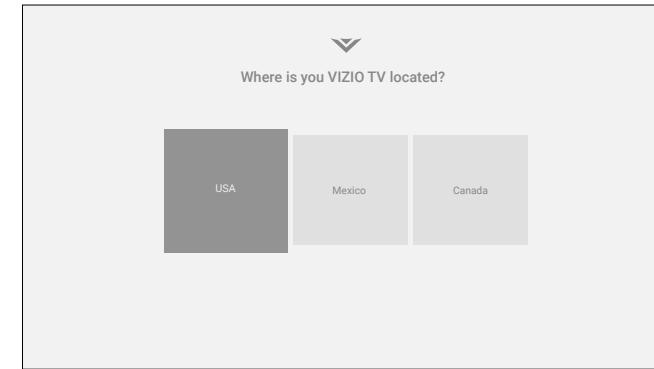

4. Choose your country (if applicable).

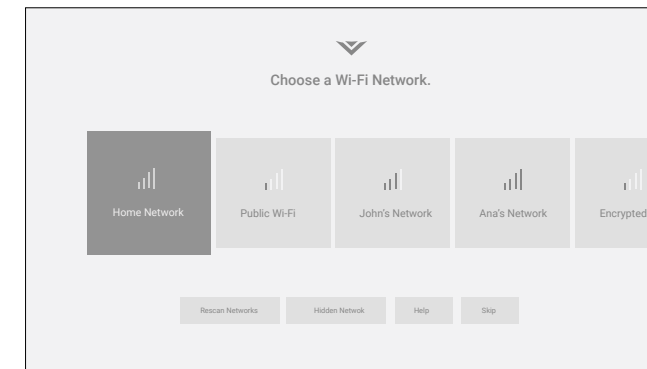

5. Choose your Wi-Fi network and enter the password.

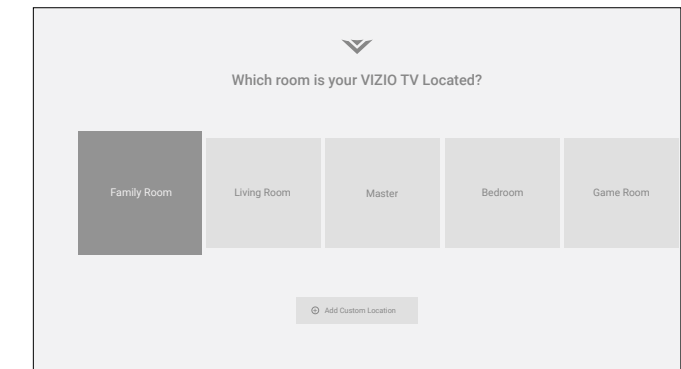

6. Name your TV.

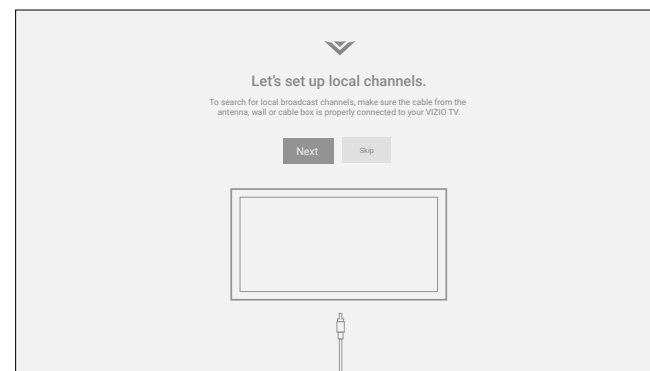

7. Scan for channels.

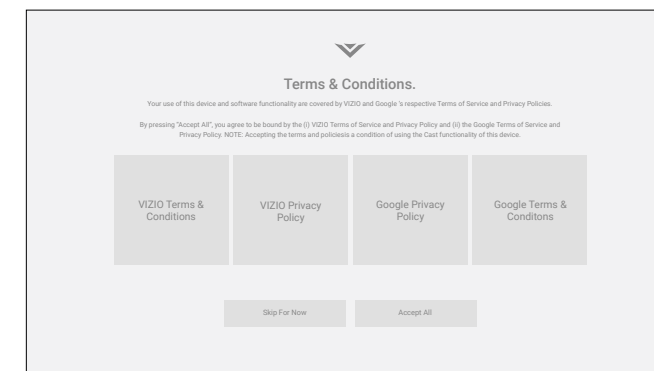

8. Accept the Terms & Conditions.

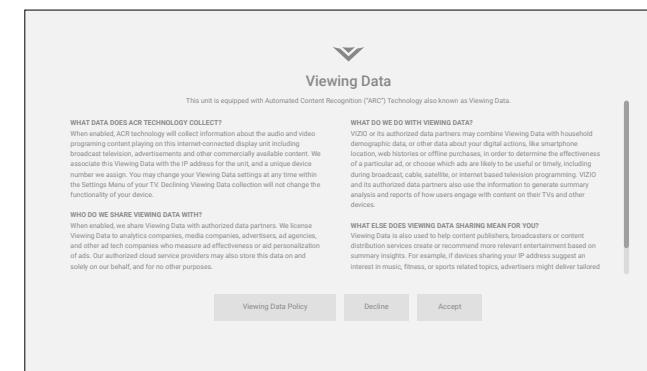

9. View and accept VIZIO Viewing Data Policy.



Your TV features an easy-to-use on-screen menu.

To open the on-screen menu, press the **MENU** button on the remote.

From this menu, you can:

- Adjust the picture settings
- Adjust the audio settings
- Adjust the network settings
- Adjust the TV channel settings
- Adjust accessibility settings
- Adjust TV system settings
- Access admin and privacy settings
- View the user manual

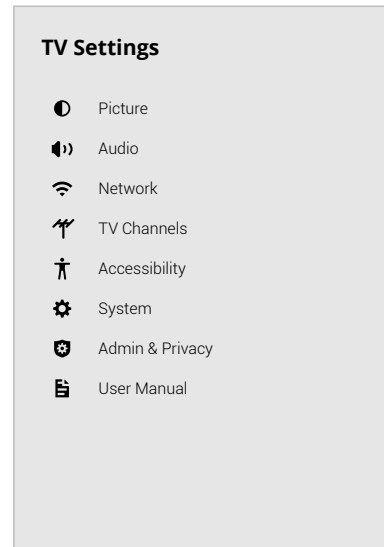

NAVIGATING THE ON-SCREEN MENU

To open the on-screen menu:

1. Press the **MENU** button on the remote.
2. Use the **Navigation** buttons to highlight a menu option, and press the **OK** button to select that option.

 **TIP:** While navigating the on-screen menu, you can press the **BACK** button at any time to return to the previous menu screen.

CHANGING THE INPUT SOURCE

External devices, such as DVD players, Blu-ray players, and video game consoles, can be connected to your TV. To use one of these devices with your TV, you must first change the input source using the input menu.

To change the input sources:

1. Press the **INPUT** button on the remote. The input menu is displayed.
2. Use the **Navigation** buttons or the **INPUT** button on the remote to highlight the input you wish to view. The corresponding inputs are named on the back of your TV.
3. Press **OK** or release the **INPUT** button. The selected input is displayed.

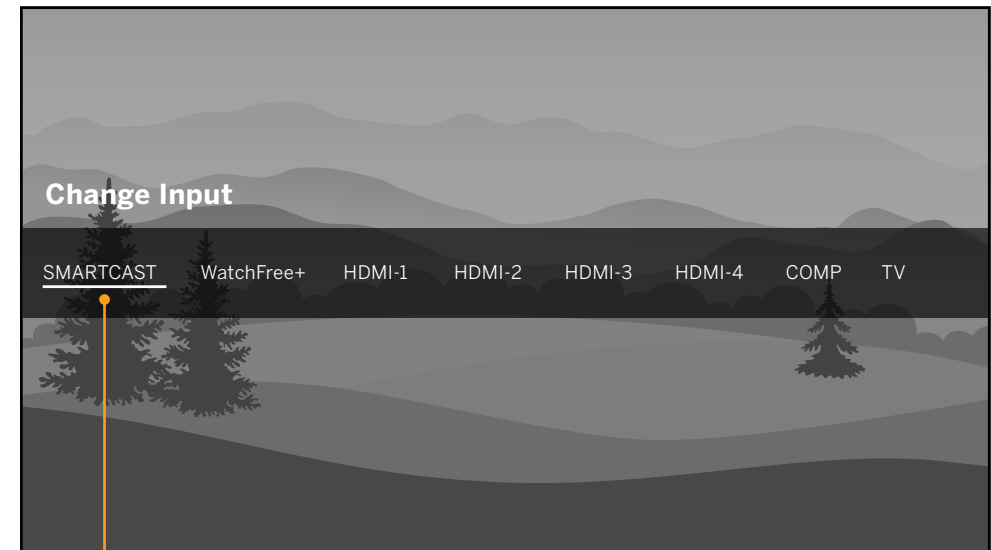

Input Name

The underlined input on the left is the current input selected. Inputs may vary by TV.

 **TIP:** You can change the input names that appear on the Input menu to make your devices easy to recognize. See **Renaming Devices on the Input Menu on page 23**.

ADJUSTING THE PICTURE SETTINGS

Your TV can be adjusted to suit your preferences and viewing conditions.

To adjust the picture mode settings:

Menu > Picture > Picture Mode

- Use the **Navigation** buttons on the remote to highlight **Picture Mode**, then use the **Left/Right Navigation** buttons to change the picture mode:
 - Vivid** — Sets the picture settings to values that produce a brighter, more vivid picture.
 - Bright** — Great for viewing everyday TV, such as news and TV shows, that requires a brighter image with motion enhancements.
 - Calibrated** — Accurate colors intended for cinema content viewing in a bright room.
 - Calibrated Dark** — Accurate colors intended for cinema content viewing in a dark room or at nighttime.
 - Game** — Reduces throughput delays and optimizes the picture settings for displaying game console output. Also the preferred picture mode for computer mode.
 - Sports** — Sets the picture settings to values ideal for watching sport events with motion control setting.



TIP: If you save changes to the setting for a picture mode, an asterick will appear after its name. See *Saving a Custom Picture Mode* on page 13.

- To manually change each of the picture settings, use the **Up/Down Navigation** buttons on the remote to highlight that picture setting, then use the **Left/Right Navigation** buttons to adjust the setting:
 - Backlight (SDR content) or Tone Mapping (HDR content)** — Adjusts the LED brightness to affect the overall brilliance of the picture.
 - Brightness** — Adjusts the black level of the picture. When this setting is too low, the picture may be too dark to distinguish details. When this setting is too high, the picture may appear faded or washed out.
 - Contrast** — Adjusts the white level of the picture. When this setting is too low, the picture may appear dark. When this setting is too high, the picture may appear faded or washed out. If the setting is too high or too low, detail may be difficult to distinguish in dark or bright areas of the picture.
 - Color** — Adjusts the intensity of the picture colors.
 - Tint** — Adjusts the hue of the picture. This setting is useful in adjusting the flesh tones in the picture. If flesh appears too orange, reduce the level of color before adjusting tint.
 - Sharpness** — Adjusts the edge sharpness of picture elements. It can be used to sharpen non-HD (high definition) content; however, it will not produce detail that does not otherwise exist.

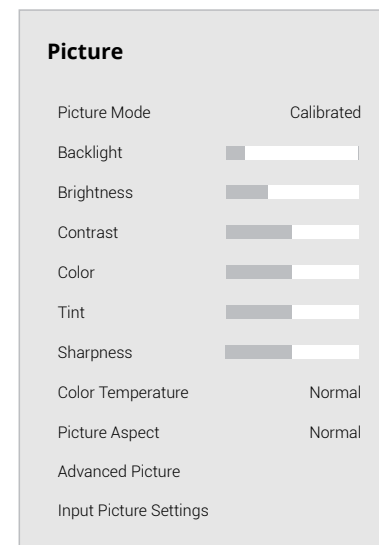

Adjusting the Color Temperature

Adjusting the color temperature changes the white balance of the picture.

To adjust the color temperature:

Menu > Picture > Color Temperature

Use the **Navigation** buttons on the remote to highlight a color temperature preset and then press **OK**.

- Warm** — Produces an orange-hued picture.
- Cool** — Produces a blue-hued picture.
- Normal** — Optimized for television viewing.

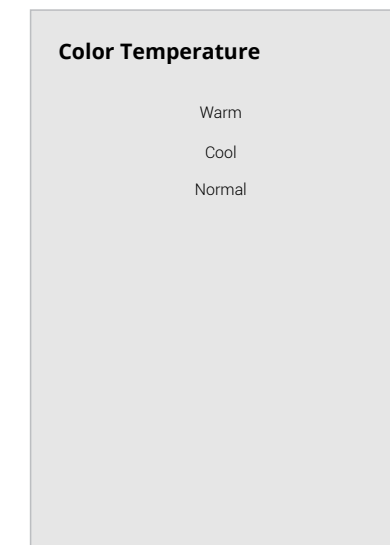

Changing the Picture Aspect Ratio

To change the screen aspect ratio:

Menu > Picture > Aspect Ratio

Use the **Navigation** buttons to highlight the aspect ratio you wish to view.

Your TV can display images in different modes:

- **Normal (default)** — No change to aspect ratio.
- **Panoramic*** — Stretches a 4:3 image to fill 16:9 screen with an algorithm so the center doesn't look stretched.
- **Wide** — Stretches a 4:3 aspect ratio to fill 16:9 screen. If a 16:9 image, adds black bars to top and bottom.
- **Zoom** — Expands image both horizontally and vertically by 14%.
- **Stretch*** — When the 16:9 signal is a 4:3 image with black bars left and right, stretches to fill the screen.

Some programs have black bars on the top or sides of the screen so that the picture keeps its original shape. Examples include widescreen movies and older TV programs.



TIP: The aspect ratio cannot be changed for Ultra HD content or HDR content.

Adjusting Advanced Picture Settings

To adjust advanced picture settings:

Menu > Picture > Advanced Picture

Use the **Navigation** buttons to highlight the setting you wish to adjust, then press the **Left/Right Navigation** buttons to change the setting:

- **Black Detail** — Adjusts the average brightness of the picture to compensate for large areas of brightness.
- **Super Resolution** — Configures the resolution to enhance dim and blurred pictures resulting in a sharper image.
- **Edge Enhancement** — Increases the smoothness of edges.
- **Local Contrast** — Adjust the contrast of the picture locally.
- **Backlight Control** — Dynamically improves the contrast ratio of the picture by adjusting the backlight.

Advanced Picture	
Black Detail	Off
Super Resolution	Medium
Edge Enhancement	Low
Local Contrast	Low
Backlight Control	On
Reduce Noise	
Gaming Engine	
Film Mode	On
Gamma	2.1 - Normal
Enhanced Viewing Angle	Off
Color Calibration	

- **Reduce Noise:**
 - **Signal Noise:** Reduces background picture noise when viewing analog sources. This function helps to correct "speckle" noise with a slight reduction in sharpness.
 - **Block Noise:** Reduces the side effects of digital compression such as "blocking" and noise on sharp edges. The High setting will cause a slight reduction in sharpness.
 - **Contour Smoothing:** Removes visible contour noise without loss of the complex detail.

- **Gaming Engine:**

- **Game Low Latency:** Reduces video delay (lag) when gaming. When set to Auto and Automatic Low Latency Mode (ALLM) is detected, ALLM will apply for the duration of the game.

- **Game HDR:** Optimizes picture quality for HDR game.

- **Film Mode** — Optimizes the picture for watching films. Select **On** or **Off**.

- **Gamma** — Set the shape of the Gamma curve. Use lower Gamma values for bright room conditions, and higher values when it's dark.

- **Enhanced Viewing Angle**** — Increases the viewing angle with richer colors and a higher contrast image. This mode reduces horizontal resolution.

- **Color Calibration** — Calibrate colors using HSB, gain, offset and 20 point white balance and test or reset colors to defaults.

**Only available on V505-J09

*Available aspect ratio settings may vary by input source. Panoramic mode is only available for standard definition TV (480i/480p) and Stretch mode is only available for high definition TV (720p/1080i/1080p).

Adjusting the Color Tuner Settings

The Color Tuner settings allow you to adjust the color management system, 20 point white balance, turn color channels off for testing, and display SMPTE, flat, ramp, and uniformity analyzer test patterns.

To access the color tuner table:

Menu > Picture > Advanced Picture > Color Calibration > Color Tuner



WARNING: The Color Tuner, White Balance, and test patterns allow technicians to manually calibrate the TV. Calibration requires specialized training, an input with precisely set colors, and a specialized light meter.

To turn color channels off and on:

1. Use the **Navigation** buttons on the remote to highlight **Red, Green, or Blue**.
2. Press the **OK** button to turn the color channel off or on. An **X** appears over a color channel that has been turned off.
3. Only two color channels can be turned off at the same time.



TIP: Any changes made affect the color temperature setting. Select the preferred color temperature setting first. See *Adjusting the Color Temperature* on page 9.

To adjust the color management system settings:

1. Use the **Navigation** buttons on the remote to highlight the Hue, Saturation, Brightness, Offset, or Gain of the color you wish to adjust. Press the **OK** button.
2. Use the **Left/Right Navigation** buttons to adjust the value. When you are finished press the **OK** button to save the setting.

Color Tuner						
	Red	Green	Blue	Cyan	Magenta	Yellow
Hue	0	0	0	0	25	-14
Saturation	-1	5	-4	0	-2	0
Brightness	-24	0	-22	0	0	0

To show or hide the SMPTE Test Pattern:

Menu > Picture > Advanced Picture > Color Calibration > Color Tuner > SMPTE Test Pattern

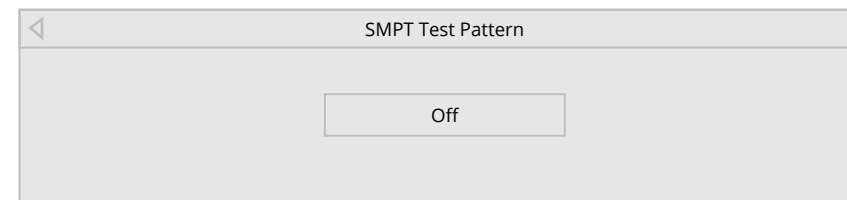

1. Use the **Navigation** buttons on the remote to highlight Off. Use the **Left/Right Navigation** buttons to select On to show the SMPTE Pattern.

—or—

2. To hide the SMPTE Test Pattern, use the **Left/Right Navigation** buttons to select Off.

To show or hide the Flat Test Pattern:

Menu > Picture > Advanced Picture > Color Calibration > Color Tuner > Flat Test Pattern

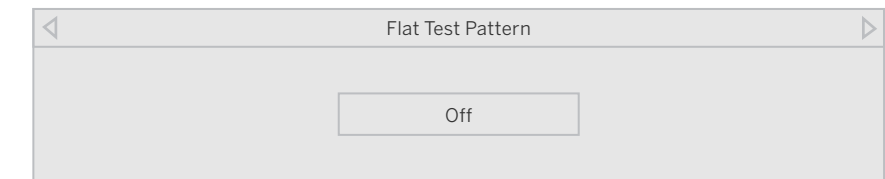

1. Use the **Navigation** buttons on the remote to highlight Off. Use the **Left/Right Navigation** buttons to select the percentage brightness for the flat test pattern. Selecting a percentage immediately shows the flat pattern at that brightness.

—or—

2. To disable the Flat Test Pattern, use the **Left/Right Navigation** buttons to select Off.

To show or hide the Ramp Test Pattern:

Menu > Picture > Advanced Picture > Color Calibration > Color Tuner > Ramp Test Pattern

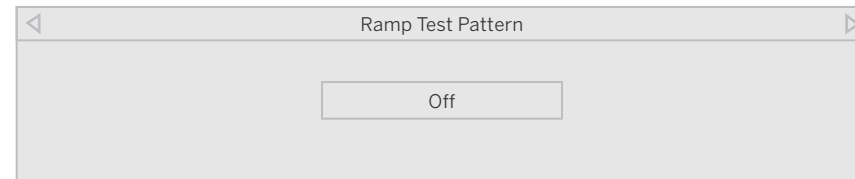

1. Use the **Navigation** buttons on the remote to highlight Off. Use the **Left/Right Navigation** buttons to select the color for the ramp test pattern. Selecting a color immediately shows that color ramp.

—or—

2. To hide the Ramp Test Pattern, use the **Left/Right Navigation** buttons to select Off.

To show or hide the Uniformity Analyzer Test Pattern:

Menu > Picture > Advanced Picture > Color Calibration > Color Tuner > Uniformity Analyzer Test Pattern

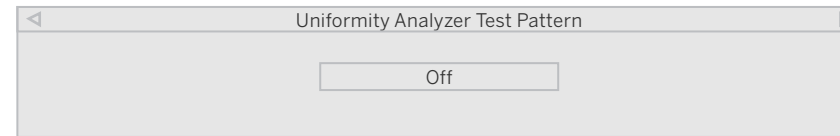

1. Use the **Navigation** buttons on the remote to highlight Off. Use the **Left/Right Navigation** buttons to select On to show the Uniformity Analyzer Test Pattern.

—or—

2. To hide the Uniformity Analyzer Test Pattern, use the **Left/Right Navigation** buttons to select Off.

To adjust the White Balance Tuner settings:

Menu > Picture > Advanced Picture > Color Calibration > White Balance Tuner

1. Use the **Navigation** buttons on the remote to highlight the Gain and Color values you wish to adjust. Press the **OK** button and use the **Left/Right Navigation** buttons to adjust the value. When you are finished, press the **OK** button to save the setting.

White Balance Tuner				
	Red	Green	Blue	
IRE% 5	0	0	0	
Offset	0	0	0	
Gain	0	0	0	

Adjusting Picture Input Settings

Enable HDMI Mode, Full Color 4:4:4, and adjust picture size and position.

To adjust the Input settings:

Menu > Picture > Input Picture Settings

Use the **Navigation** buttons to highlight the setting you wish to adjust.

- **Picture Size and Position*** — configure the display size and position of the picture to the screen.
- **HDMI Mode*** — Expanded color display. Only available for an HDMI input.
- **Full Color 4:4:4*** — Maintains full color data with 4:4:4 content. Some picture settings will not be available when this setting is On. Only available for an HDMI input.
- **Color Space Range** — Select Color Space for the source. Video sources uses YCbCr, but PC uses RGB.

Adjusting the Picture Mode Edit Settings

Manage custom picture modes and reset preset picture modes.

To adjust the Picture Mode Edit settings:

Menu > Picture > Picture Mode Edit

Use the **Navigation** buttons to highlight the setting you wish to adjust, then press **OK** to change the setting:

- **Save Picture Mode** — Save a custom picture mode.
- **Copy Picture Mode** — Copy the settings for a custom picture mode.
- **Lock Picture Mode** — Prevent changes to custom picture modes.
- **Reset Picture Mode** — Reset the picture mode settings to factory default values. Only available on customized preset modes.
- **Delete Picture Mode** — Delete a custom picture mode. Inputs assigned to the custom picture mode will use the Calibrated picture mode.

Saving a Custom Picture Mode

Custom picture modes allow you to save a group of custom settings for various viewing conditions and video sources.

To save a custom picture mode:

Menu > Picture > Picture Mode Edit > Save Picture Mode > Enter a Name > Save

Custom picture modes allow you to save a group of custom settings for various viewing conditions and video sources.

- Changes made while on any preset picture mode will add an asterisk on the top right corner of the preset mode.
- The custom picture mode is not automatically saved.

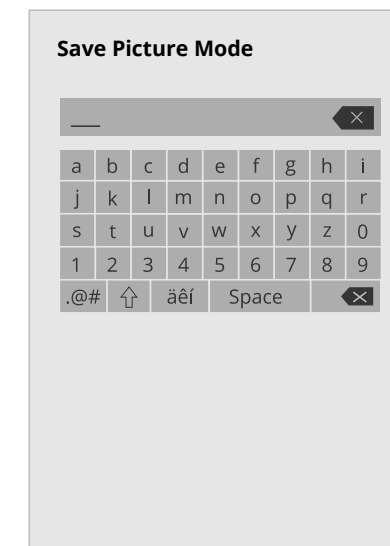
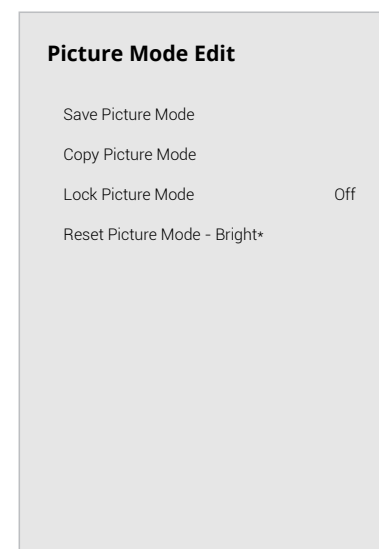

*Only available if there is an input source. Not available for WatchFree. Menu items will be grayed out if not available.

Copy a Picture Mode

Custom picture mode settings can be copied to be applied to other inputs.

- Complete the desired changes for the selected picture mode.
 - Select **Save Picture Mode** to save picture mode for all inputs.
- Select the input you want to copy your saved picture mode edits to.
- Change the picture mode to your custom saved mode: **Menu > Picture > Picture Mode > select saved custom picture mode**
- Copy your custom picture mode: **Menu > Picture > Picture Mode Edit > Copy Picture Mode**
- Select what picture mode you would like to copy over.
- A notification displays after the copy to your selected picture mode is completed. Now this picture mode will have your custom settings saved over it for the selected input.
- Repeat as needed to customize additional inputs.

Lock a Picture Mode

Custom picture modes can be locked/unlocked with a unique PIN to prevent accidental changes to their settings. If not previously set, you can set up your system PIN code here.

To lock all custom picture modes:

Menu > Picture > Picture Mode Edit > Lock Picture Mode > On > Enter Your PIN > Save

To unlock all custom picture modes:

Menu > Picture > Picture Mode Edit > Lock Picture Mode > Off > Enter Your PIN

Lock Picture Mode

Create a picture control PIN to prevent changes to all custom picture modes.

New PIN

Confirm PIN

1

2

3

4

5

6

7

8

9

0

←

Cancel

Save



TIP: To set a custom PIN code, see *Setting a System PIN Code on page 24*.

Deleting a Picture Mode

Custom picture modes that are no longer needed can be deleted.



TIP: Inputs assigned to deleted custom picture modes become assigned to the *Calibration* picture mode.

To delete a custom picture mode:

Menu > Picture > Picture Mode Edit > Delete Picture Mode > Delete

To delete the user created Custom 1 picture mode, select the Delete button.

Delete

Cancel

Resetting a Picture Mode

A preset picture mode that has been edited can be restored to the factory default settings.

To reset a customized preset picture mode:

Menu > Picture > Picture Mode Edit > Reset Picture Mode > Reset

ADJUSTING THE AUDIO SETTINGS

To adjust the audio settings:

Menu > Audio

Use the Navigation buttons to highlight the setting you wish to adjust, then press **Left/Right Navigation** buttons to change the setting:

- **TV Speakers** — Built-in speakers automatically turn off if a sound bar is discovered. Turn the built-in speakers On or Off.
- **Surround Sound** — When set to On, enables surround sound suitable for sports and TV shows. Virtual:X™ adds virtualized height best for movies.
- **Volume Leveling** — When set On, DTS TruVolume™ audio solution levels the speaker volume.
- **Balance** — Balance the audio loudness between the left and right speakers.
- **Bass** — Increase or decrease the bass level.
- **Treble** — Increase or decrease the treble level.
- **Lip Sync** — Synchronize the display image with the audio track.

Audio	
TV Speakers	Auto
Surround Sound	On
Volume Leveling	On
Balance	
Bass	
Treble	
Lip Sync	
Digital Audio Out	Auto
Analog Audio Out	Fixed
Dialogue Enhancer	Off
eARC	On

- **Digital Audio Out** — Select the digital audio output format for both the optical and HDMI ARC audio devices.
- To hear talk back when Talk Back function is enabled, digital audio out must be set to PCM.



TIP: You must select **Digital** for audio with more than two channels (e.g., 3.0, 5.0, or 5.1).

- **Analog Audio Out** — Select Variable if you are controlling the volume with the remote. Select Fixed if an external audio device (sound bar or AV receiver) will control the volume.
- **Dialogue Enhancer** — If enabled and the signal source includes Dolby 5.1 AC-4 audio then clarity of dialogue is enhanced.
- **eARC** — Toggle between ARC (Off) and eARC (On) for audio output using HDMI 1. If On, audio is sent using eARC and is uncompressed. If Off, audio is sent using ARC and some audio formats may play in standard Dolby Audio, DTS Digital Surround, or PCM.



TIP: Your connected sound bar or audio receiver must support eARC in order to receive uncompressed audio. Check your device's user manual for more information.

- **Equalizer** — Only available when Surround Sound is set to **OFF**. Boosts or attenuates loudness at different frequencies.

SOUND BAR SETTINGS

If a VIZIO sound bar is detected and connected via CEC (HDMI ARC/eARC), sound bar settings will appear.

To adjust the sound bar settings:

Menu > Audio > Sound Bar Settings

Use the Navigation buttons to highlight the setting you wish to adjust, then press **Left/Right Navigation** buttons to change the setting.



TIP: Available sound bar menu settings will be specific to the type of VIZIO sound bar connected. See *Adjusting the CEC Settings on page 25* to enable CEC under the SYSTEM settings.

ADJUSTING THE NETWORK SETTINGS

Your TV is Internet-ready, featuring both an Ethernet port and built-in high-speed wireless internet.



TIP: If your TV is connected to a network with an Ethernet cable, you will not see the wireless network connection menu. You must unplug the Ethernet cable to set a wireless network connection.

Connecting to a Wireless Network

To connect to a wireless network whose network name (SSID) is being broadcast:

Menu > Network > Choose your network > Enter in the password > Connect

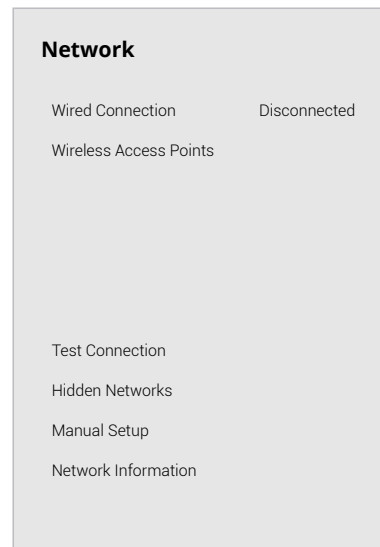

To forget a saved network:

Highlight a saved wireless access point > OK > Forget

If you do not see your wireless network displayed, click on:

More Access Points > Highlight your wireless network > Enter in the password > Connect

Testing Your Network Connection

To test your network connection:

Menu > Network > Test Connection

Connecting to a Hidden Network

To connect to a wireless network whose network name (SSID) is not being broadcast:

Menu > Network > Hidden Network > Enter the Access Point Name > Connect > Enter in the password

Changing the Manual Setup Settings

Advanced users can fine-tune the network settings using the Manual Setup feature. The security settings on your router may require you to enter the TV's MAC address.

To change advanced network settings:

Menu > Network > Manual Setup > DHCP > Off

1. Use the **Navigation** and **OK** buttons to adjust each setting:

- **IP Address** — The IP address assigned to the TV.
- **Subnet Mask** — The subnet Exit 2D.
- **Default Gateway** — Your network's default gateway address.
- **Pref. DNS Server** — Your preferred domain name server address.
- **Alt. DNS Server** — Your alternate domain name server address.

2. Use the **Navigation** buttons on the remote to highlight **Save** and press **OK**.

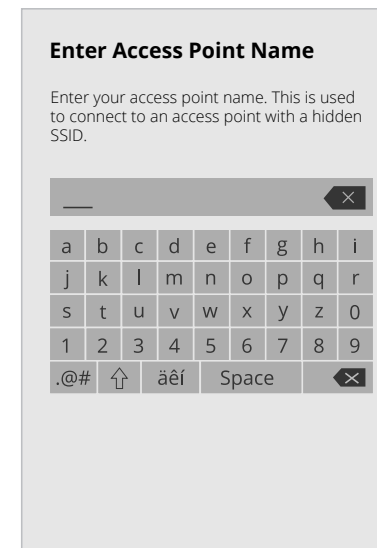

To find the TV's MAC address:

Menu > Network > Manual Setup

You can find your TV's MAC address at the bottom of the list. The MAC addresses for the connections in use are displayed:

- **RJ45 MAC** — The Ethernet or RJ45 MAC address may be needed to set up your network when you have connected the TV to your network when you have connected the TV to your network with an Ethernet (Cat 5) cable.
- **Wireless MAC** — The Wireless (Wi-Fi) MAC address may be needed to connect your TV to your network with Wi-Fi.

Manual Setup

DHCP	Off
IP Address	— — — —
Subnet Mask	— — — —
Default Gateway	— — — —
Pref. DNS Server	— — — —
Alt DNS Server	— — — —
RJ45 Mac	0:0:0:0:0
Wireless Mac	0:0:0:0:0

To view network information

Menu > Network > Network Information

SETTING UP TV CHANNELS

You can use the TV's Channels menu to:

- Find channels
- Find new channels
- Select channels to skip
- Select analog audio mode
- Select the language for digital audio
- Set parental controls

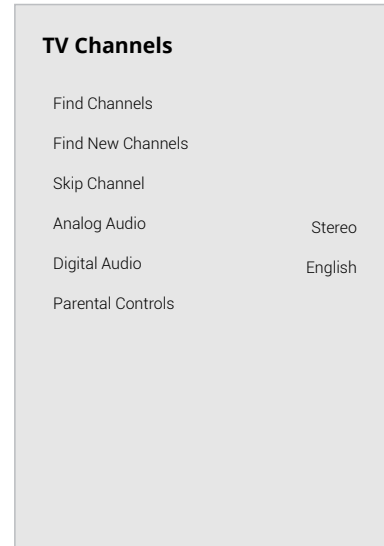

Scanning for TV Channels

The TV may need to scan for channels before it can display programs and their associated information. A channel scan is required for free over-the-air channels (using an antenna) and cable channels from an out-of-the-wall connection (without a cable box). Moving the TV to an area with different channels requires the TV to scan for channels again.

To perform an Auto Channel Scan:

Menu > TV Channels > Find Channels

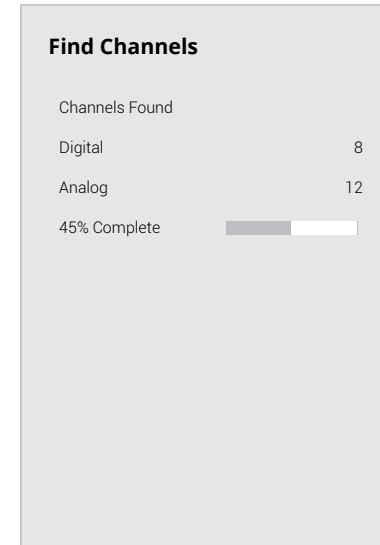

Wait until the channel scan is 100% complete. Highlight **Done** and press **OK**.

- If the channel scan is canceled, the channels that were already discovered are retained.

To perform a New Channel Scan:

Menu > TV Channels > Find New Channels

A New Channel Scan saves the current channel map and scans for additional channels.

Skipping Channels

After a channel scan is completed, you may find that some channels are too weak to watch comfortably. There may also be some channels you do not want to view. You can remove these channels from the TV's memory with the Skip Channel feature.



WARNING: Channels that have been removed with the *Skip Channel* feature can still be viewed if the channel is entered using the number pad.

If you wish to completely block a channel from being viewed, use *Locking and Unlocking Channels* on page 19.

To remove a channel:

1. From the TV CHANNELS menu, highlight **Skip Channel**, and press **OK**. The SKIP CHANNEL menu is displayed.
2. For each channel you wish to remove, use the **Up/Down Navigation** buttons on the remote to highlight the channel and press **OK**. A ✓ appears to the right of each channel you select.

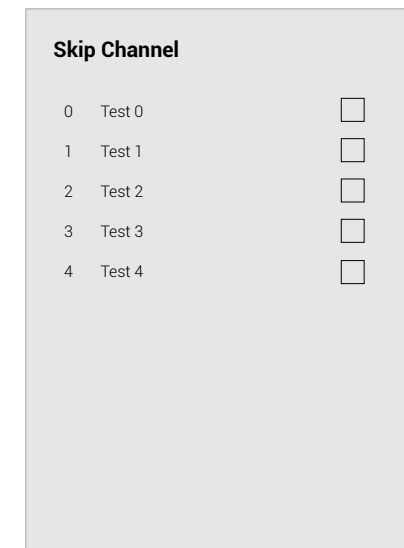

Changing the Analog Audio Language

Some analog over-the-air (free) and cable channels broadcast programs in more than one language. The TV's Analog Audio feature allows you to listen to audio in an alternate language using Secondary Audio Programming (SAP).

To use the Analog Audio feature:

Menu > TV Channels > Analog Audio



WARNING: Not all programs are broadcast in SAP. The Analog Audio Language feature only works when the program being viewed is being broadcast with Secondary Audio Programming.

- **Stereo** — More than one speaker channel is being used. Sounds may be dispersed through different speakers depending on how the audio is programmed.
- **SAP (Secondary Audio Program)** — Typically used for audio in a different language other than the native one used in the program.
- **Mono** — All speakers are producing the same sound; there is no distinction between left or right sounds.

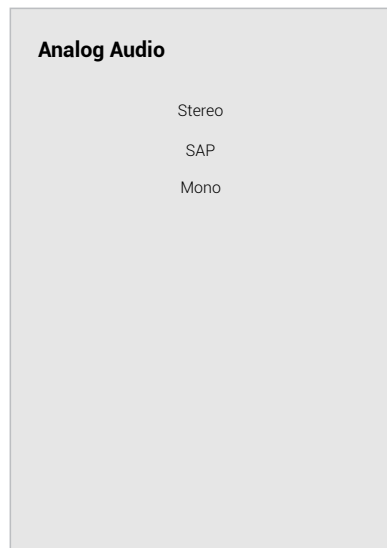

To use the Digital Language feature:

Menu > TV Channels > Digital Audio

Select the preferred audio language. Available languages or video description depend on the broadcast content.

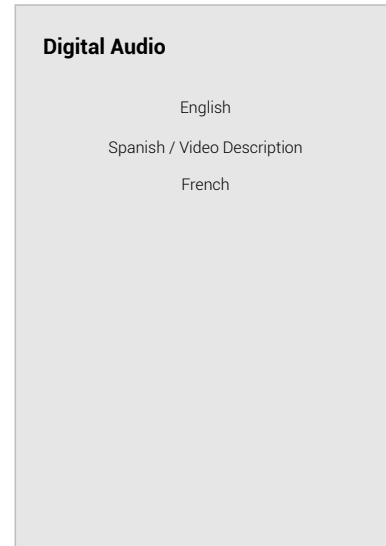

Using Parental Controls

The TV's parental controls allow you to prevent the TV from displaying certain channels or programs unless a PIN is used.

Accessing the Parental Controls Menu

To access the Parental Controls menu you must first set up a system PIN:

Menu > TV Channels > Parental Controls > Enter in PIN



TIP: to set a custom PIN code, see *Setting a System PIN Code* on page 25.

The **Parental Controls** menu only appears when:

- You are using the tuner to receive your TV signals, such as when you are using an antenna for Over-the-Air signals or when connected to cable TV directly from the wall (no cable box).
- You have a device connected using a composite video cable or a coaxial cable, such as a VCR, satellite or cable box, or DVR.



TIP: Other devices have their own parental control settings.

Enabling or Disabling Program Ratings

To manage program content according to its rating, you must first enable the Program Rating feature.

To enable or disable the Program Rating feature:

Menu > TV Channels > Parental Controls > Locks > Off/On



Locking and Unlocking Channels

When a channel is locked, it cannot be accessed. Locking a channel is a good way to prevent children from viewing inappropriate material.

To lock or unlock a channel:

Menu > TV Channels > Parental Controls > Channel Locks

Highlight the channel you want to lock or unlock and press **OK**.

- When a channel is locked, the Lock icon appears  locked. The channel is not accessible unless the system PIN is entered.
- When a channel is unlocked, the Lock icon appears  unlocked.

Blocking and Unblocking Content by Rating

A channel may sometimes broadcast programs that are meant for a variety of audiences (some for children and some for adults). You might not want to block the channel completely using a channel lock, but you can block certain programs from being viewed.

You can use the TV's Rating Block feature to block content based on its rating.



To block or unblock content by its rating:

1. From the Parental Controls menu, highlight the content type you want to adjust and press **OK**:
 - **USA TV** — USA television program broadcasts.
 - **USA Movie** — USA movie broadcasts.
 - **Canadian English** — Canadian English television program broadcasts.
 - **Canadian French** — Canadian French television program broadcasts.



TIP: For a list of content ratings and their definitions, please visit: www.tvguidelines.org.

2. For each rating type you want to block or unblock, use the **Navigation** buttons to highlight the rating type and press **OK**.

- When the rating type is **blocked**, the Lock icon appears  locked. Content with this rating and all higher ratings cannot be viewed.
- When the rating type is **unblocked**, the Lock icon appears  unlocked. Content with this rating and all lower ratings can be viewed.
- If you want to block all unrated content, highlight Block Unrated Shows and use the Navigation buttons on the remote to select On.

To enable or disable the Block Unrated Shows setting:

Menu > TV Channels > Parental Controls > Block Unrated Shows > Off/On

Reset Locks

Reset all locks to default and clear all channel or ratings locks to the unlocked state.

To reset locks:

Menu > TV Channels > Parental Controls > Reset Locks

ACCESSIBILITY SETTINGS

VIZIO is committed to providing intuitive, user-friendly products. Your new VIZIO TV offers several accessibility features that can help you with easy navigation.

To access the Accessibility menu:

Menu > Accessibility

1. **Captions** — Activate and customize analog and digital closed captions.
2. **Video Description** — If included by the broadcaster, provides a narrated description of the action for the content.
3. **Talk Back*** — Enables your TV to speak all settings changes and adjustments using the remote in English.
4. **Speech Rate** — Adjusts the rate in which Text-to-Speech is spoken. Select Slow, Normal (default), or Fast.
5. **Zoom Mode** — Enlarges a section of the screen by approximately 200%.

Accessibility	
Captions	
Video Description	Off
Talk Back	Off
Speech Rate	Normal
Zoom Mode	Off



TIP: You can also enable/disable accessibility features using the included remote. See *Using the Remote* on page 5.

To access the Video Description menu:

Menu > Accessibility > Video Description > Off/On

Setting Up Closed Captioning

Your TV can display closed captions for programs that include them. Closed captions display a transcription of a program's dialogue.



TIP: Closed Captioning is available for tuner, composite and streaming content (if supported by the app). Note that most apps will support their own CC from within the app.

To activate or deactivate Close Captions for current content:

Menu > Accessibility > Captions > Closed Captions > Off/On

— or —

Push the CC button  on the remote.

1. Use the **Navigation** buttons on the remote to highlight either Analog or Digital Closed Captions.
2. Use the **Left/Right Navigation** buttons on the remote to select the caption channel you wish to display.

Closed Captions	
Closed Captions	Off
Analog Closed Captions	CC1
Digital Closed Captions	CS1
Digital Style	



TIP: The Closed Captions menu does not appear when an HDMI input is selected. Close captions are available when using the tuner or a composite video cable.

Changing the Appearance of Digital Closed Captions

Digital closed captions can be displayed according to your preference. See the diagram on the next page for an explanation of the parts of the closed caption area.

To change the appearance of digital closed captions:

Menu > Accessibility > Captions > Digital Style

1. Use the **Left/Right Navigation** buttons on the remote to select Custom. The Digital Style menu appears as shown.

*Available only in English.

2. Use the **Up/Down Navigation** buttons on the remote to highlight the setting you wish to change, then use the **Left/Right Navigation** buttons to change the settings (choose "As Broadcast" to keep default setting):

- **Text Style** — Change the font used for the closed captioning text.
- **Text Size** — Make the text larger or smaller.
- **Text Color** — Change the color of the text.
- **Text Opacity** — Change the transparency of the text.
- **Text Edges** — Change the effects at the edges of the text, such as raising the edges or adding drop shadows.
- **Text Edges Color** — Change the color of the text edge effects.
- **Background Color** — Change the color of the background directly behind the text.
- **Background Opacity** — Change the transparency of the background directly behind the text.
- **Window Color** — Change the color of the closed captioning box.
- **Window Opacity** — Change the opacity of the closed captioning box.

Digital Style	
Text Style	As Broadcast
Text Size	Large
Text Color	Blue
Text Opacity	As Broadcast
Text Edges	As Broadcast
Text Edges Color	As Broadcast
Background Color	As Broadcast
Background Opacity	As Broadcast
Window Color	As Broadcast
Window Opacity	As Broadcast

Typical choices include:

- **Opaque background, transparent window** — Only a strip of background appears behind the text, expanding as the text appears. This is the typical "As Broadcast" mode.
- **Opaque background and window in the same color** — When text appears, the entire line fills with color at once.

In the example, the closed caption text is green, the background is black, and the window is red.

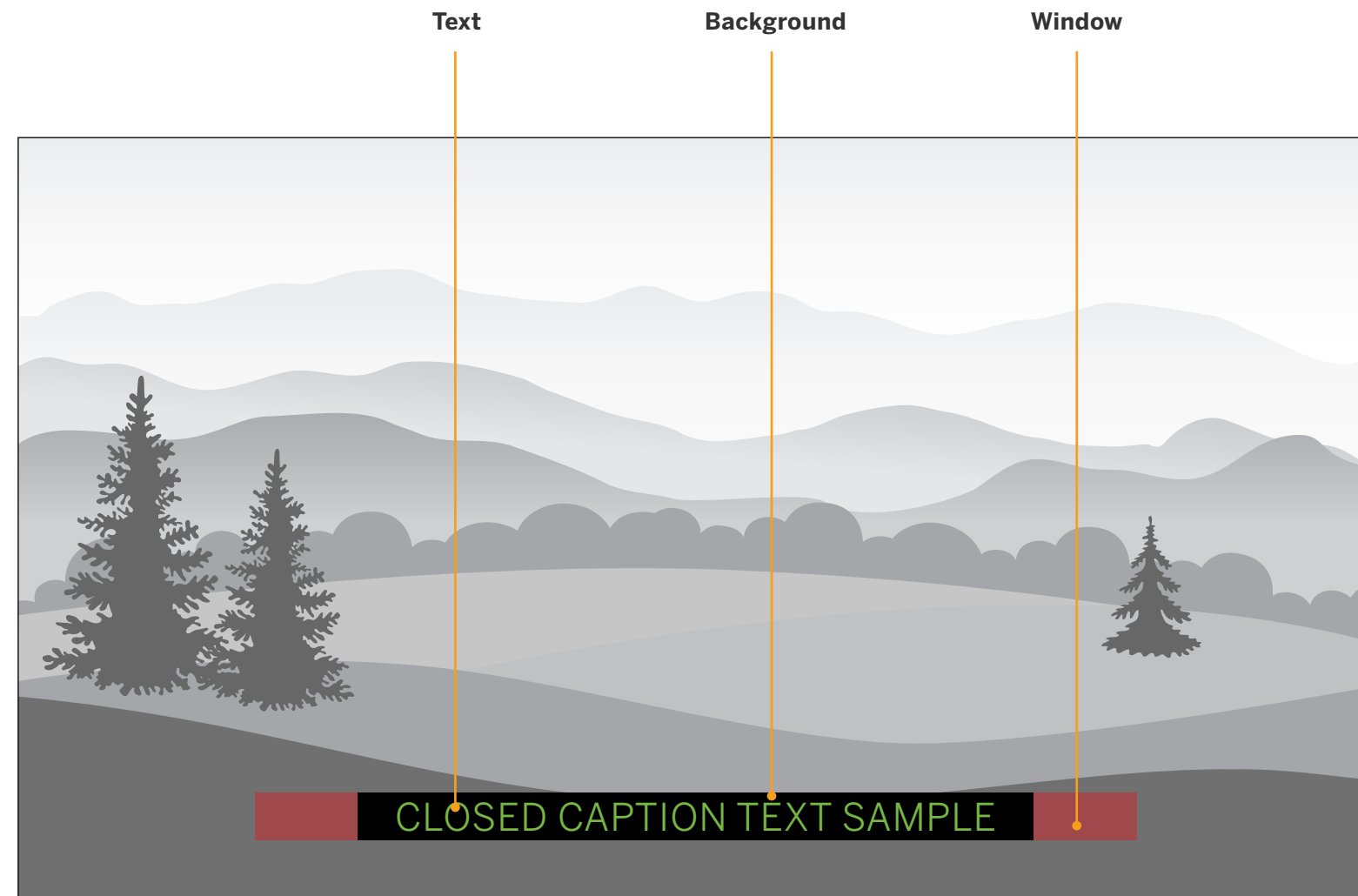

CHANGING THE SYSTEM SETTINGS

Using the System menu, you can:

- Change the on-screen menu language
- Set the time zone and local settings
- Name the TV
- Name an input
- Hide inputs not in use
- Adjust the power mode settings
- Set the USB power mode
- Turn the power indicator on or off
- Set up timers
- Set a system PIN code
- Adjust CEC settings
- Manage paired devices
- Manage a voice remote control

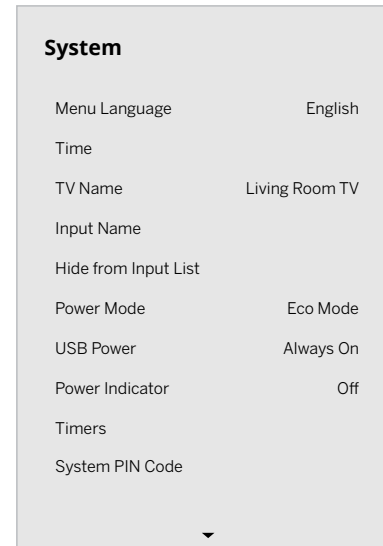

Changing the On-Screen Menu Language

Your TV can display the on-screen menu in different languages.

To change the on-screen menu language:
Menu > System > Menu Language

Highlight your preferred language (English, Español, or Français) and press **OK**.

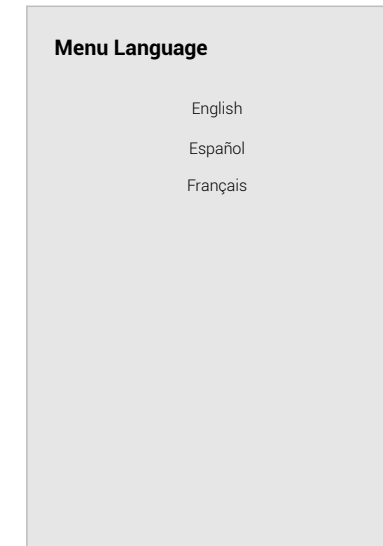

Setting the Time

To ensure the correct time is displayed when you press the **INFO** button, set the TV's time zone:

Menu > System > Time > Time Zone

To turn Daylight Saving Time on or off:

1. Highlight Daylight Saving Time and press **OK**. The Daylight Saving Time menu is displayed.
2. Choose **On** if it is currently Daylight Savings Time, **Off** if it is Standard Time, or **Auto** to have the system automatically detect Daylight Savings Settings.

To change Time Format:

1. Highlight Time Format and use the **Left/Right Navigation** buttons to change between a 12-hour format or 24-hour format.

Changing the TV Name

Naming your TV helps differentiate it from other cast devices you may have in your home.

To edit your TV name:

Menu > System > TV Name > Enter a Name

TV Name

Living Room TV ✕

a	b	c	d	e	f	g	h	i
j	k	l	m	n	o	p	q	r
s	t	u	v	w	x	y	z	0
1	2	3	4	5	6	7	8	9
.@#	↑	äëí	Space	✕				

Renaming Devices on the Input Menu

You can rename the inputs to make them easier to recognize on the Input menu. For example, if you have a DVD player connected to the HDMI-1 input, you can rename that input to display “DVD Player.”

See *Changing the Input Source on page 8*.

To change the name of an input:

Menu > System > Input Name

To enter a custom name:

- Highlight the **Name Input** row and press **OK**.
- Enter your custom label using the on-screen keyboard and press **OK**.



TIP: The current input you are on will be the input name you are changing. You cannot change every input (i.e. WatchFree+ or SmartCast inputs).

To Hide an Input from the List:

Menu > System > Hide from Input List

- Highlight the input name you would like to hide. Hidden inputs will not be displayed in the input list.
- Use the Left/Right Navigation buttons to toggle from visible and hidden.

Adjusting the Power Mode

Your TV is set to Eco Mode by default. When the TV is powered off, the Eco Mode setting uses less than 0.5W of power. Quick Start Mode enables your display to power on faster and also to turn on when powered from another device (such as when you are casting onto the TV).



WARNING: Please note that by changing this setting the energy consumptions required to operate this device will change.

To switch between Eco Mode and Quick Start Mode:

Menu > System > Power Mode

Highlight either Eco Mode or Quick Start Mode and press **OK**.



TIP: If you want to use a voice assistant to turn your TV on, make sure Quick Start Mode is turned on.

Using the USB Power Feature

The USB port can be used to charge devices.

The two options for this feature are:

- **Always On** — Power is always available.
- **Off When TV Off** — Power is only available with the TV is on.



Turning the Power Indicator On or Off

The power indicator on the front of your TV normally does not glow when the TV is on. You can change this setting if you prefer the light to be on.

To turn the Power Indicator Light On or Off:

Menu > System > Power Indicator > Off/On

Setting Timers

When activated, the TV's timer will turn the TV off after a set period of time.

To setup a sleep timer:

Menu > System > Timers > Sleep Timer

Use the **Left/Right Navigation** buttons on the remote to highlight the period of time after which you want the TV to go to sleep: 30, 60, 90, 120, or 180 minutes. If you don't want the sleep timer to activate, change the setting to Off.

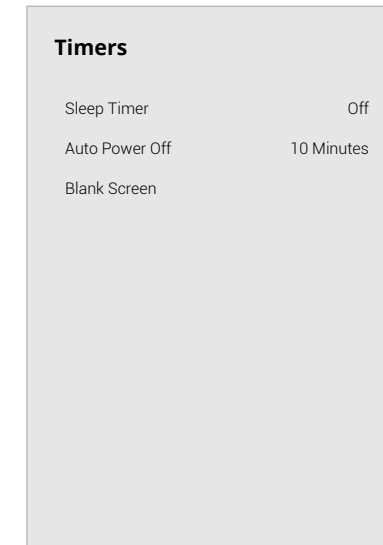

Setting the Auto Power Off Feature

To help save energy, your TV is set by default to turn off after 10 minutes without a video or audio signal. This feature can be deactivated.

To set the Auto Power Off feature:

Menu > System > Timers > Auto Power Off > Off

Using the Blank Screen Feature

To help save LED life, your TV screen can turn on or off while audio is streaming.

To use the Blank Screen feature:

Menu > System > Timers > Blank Screen

To **exit** Blank Screen, press any key (except the volume and mute keys).

Setting a System PIN Code

You can set a system pin to lock content and picture modes, as well as prevent accidental system resets. The first time you select System PIN code, you will need to create a PIN.

To create a PIN:

Menu > System > System PIN Code > Enter Your PIN > Save



WARNING: You will need to enter your current PIN code the next time you access this menu or if you'd like to change your PIN.

Adjusting the CEC Settings

The CEC function on your TV enables you to control devices connected to an HDMI input with the VIZIO TV remote, without any programming

Menu > System > CEC

Select a setting and then press **OK**.

- **CEC** — To use CEC, you must select Enable.
- **Device Discovery** — To determine if your device is connected and supports CEC, select Device Discovery and then press **OK**.

CEC Audio Setup

Connect your audio device to the **HDMI-1 (HDMI eARC)** input on the TV. On your audio device, select the HDMI ARC/eARC input.

Using CEC, your VIZIO TV remote can control such features including (depending on specific device):

- Power On/Off
- Volume and mute
- Play and pause



WARNING: Not all HDMI devices support CEC. See your device's user manual for details.

Managing Mobile Devices

Your TV can be paired with a mobile device so you can easily control your TV across multiple devices.

To see a list of paired devices or unpair a device:

Menu > System > Mobile Devices

Highlight a device name to delete it and press **OK**.

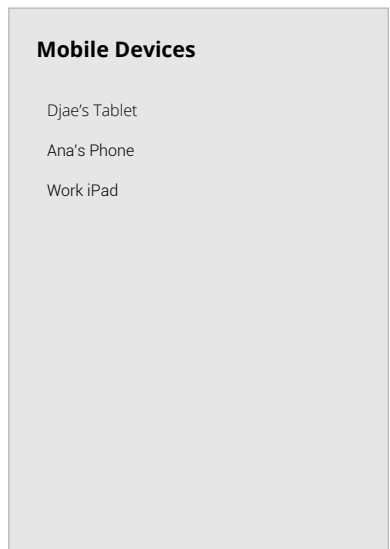



Voice Remote

Your TV can be controlled with a VIZIO Voice Remote.

To pair voice remote:

Menu > System > Voice Remote

Press and hold both the  **MIC** and  **MUTE** buttons for 5 seconds to launch pairing mode.

To use your successfully paired voice remote:

Press and hold the **MIC**  button while speaking a command.

USING THE ADMIN & PRIVACY MENU

You can use the TV's Admin & Privacy menu to restore the TV to its factory default settings as well as access other administrative settings.

Using the ADMIN & PRIVACY menu, you can:

- Force the system to power off and on
- View system information
- View a customer service support code
- Check for system updates
- Reset the TV to factory settings
- Enable or disable viewing data
- Personalize advertising choices
- View the VIZIO Privacy Policy
- Start or stop the store demo mode

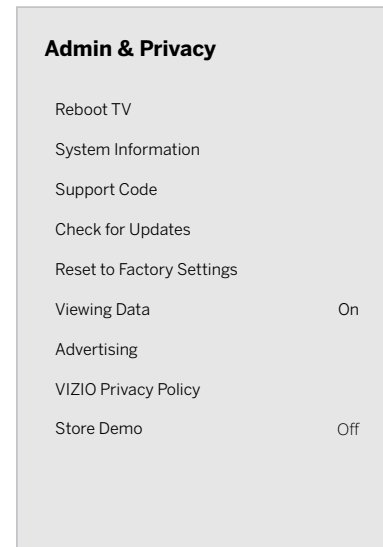

Performing a Reboot

A reboot forces the TV to turn off then on again.

To retrieve your reboot the TV:

Menu > Admin & Privacy > Reboot TV

Viewing System Information

To view technical data and status information about your TV and network connection:

Menu > Admin & Privacy > System Information

Accessing the Support Code

Retrieve a customer service support code/PIN or access basic TV information to assist in a customer service interaction.

To retrieve your support code:

Menu > Admin & Privacy > Support Code

Checking for System Updates

To check for a system update:

Menu > Admin & Privacy > Check for Updates

If an update is found, the TV will ask to confirm the update. If no update is found, the screen will note *The TV is up-to-date.*

Restoring the TV to Factory Default Settings

All of the on-screen menu settings can be reset to the factory defaults.



WARNING: If you restore the TV to the factory default settings, all change you have made to the settings will be lost. This includes any wireless or picture settings.

To restore the TV to its factory default settings:

Menu > Admin & Privacy > Reset to Factory Settings

1. If you set a system PIN code, enter it now.
2. The TV displays, "Select Reset to restore all TV settings to factory defaults."
3. Highlight **Reset** and press **OK**.
4. Wait for the TV to turn off. The TV will turn back on shortly afterward and the setup process will begin.

Viewing Data

To turn viewing data on or off:

Menu > Admin & Privacy > Viewing Data

Use the Left/Right Navigation buttons to toggle from on or off

About Viewing Data

WHAT DATA DOES ACR TECHNOLOGY COLLECT?

When enabled, ACR technology will collect information about the audio and video programming content playing on this internet-connected display unit including broadcast television, advertisements and other commercially available content. We associate this Viewing Data with the IP address for the unit, and a unique device number we assign. You may change your Viewing Data settings at any time within the Settings Menu of your TV. Declining Viewing Data collection will not change the functionality of your device.

WHO DO WE SHARE VIEWING DATA WITH?

When enabled, we share Viewing Data with authorized data partners. We license Viewing Data to analytics companies, media companies, advertisers, ad agencies, and other ad tech companies who measure ad effectiveness or aid personalization of ads. Our authorized cloud service providers may also store this data on and solely on our behalf, and for no other purposes.

WHAT DO WE DO WITH VIEWING DATA?

VIZIO or its authorized data partners may combine Viewing Data with household demographic data, or other data about your digital actions, like smartphone location, web histories or offline purchases, in order to determine the effectiveness of a particular ad, or choose which ads are likely to be useful or timely, including during broadcast, cable, satellite, or internet based television programming. VIZIO and its authorized data partners also use the information to generate summary analysis and reports of how users engage with content on their TVs and other devices.

WHAT ELSE DOES VIEWING DATA SHARING MEAN FOR YOU?

Viewing Data is also used to help content publishers, broadcasters or content distribution services create or recommend more relevant entertainment based on summary insights. For example, if devices sharing your IP address suggest an interest in music, fitness, or sports related topics, advertisers might deliver tailored ads to this display unit or other devices associated with your IP address.

You can easily turn this feature On or Off in the ADMIN & PRIVACY menu. If you have trouble enabling or disabling Viewing Data, please contact VIZIO Customer Support by going to **support.vizio.com** and selecting **Contact Us**.

For more information, see vizio.com/viewingdata and review VIZIO's privacy policy at vizio.com/privacy.

Managing Advertising Settings

Your advertising choices can be personalized.

Limited Ad Tracking

When enabled, TV Ad ID will not be passed or used for personalized ads on this device.

To turn on or off:

Menu > Admin & Privacy > Advertising > Limited Ad Tracking

- Use the **Left/Right Navigation** buttons to toggle from on or off

Reset TV Advertiser ID

An Identifier for Advertising — can be reset to a new identifier at any time.

To reset the TV Advertiser ID:

Menu > Admin & Privacy > Advertising > Reset TV Advertiser ID > OK

Ad Replacement

Replaces Standard Ads with Personalized Ads in Linear TV.

To turn Ad Replacement on or off:

Menu > Admin & Privacy > Advertising > Ad Replacement

- Use the **Left/Right Navigation** buttons to toggle from on or off

View VIZIO Privacy Policy

To view VIZIO Privacy Policy:

Menu > Admin & Privacy > VIZIO Privacy Policy > OK

Store Demo

To set to Off, Demo 1, or Demo 2:

Menu > Admin & Privacy > Store Demo

USING THE INFO WINDOW

Press the **INFO** button to display:

- TV name
- Current input or for tuner: current channel
- Picture resolution
- Picture aspect
- Audio type
- Network name
- Time

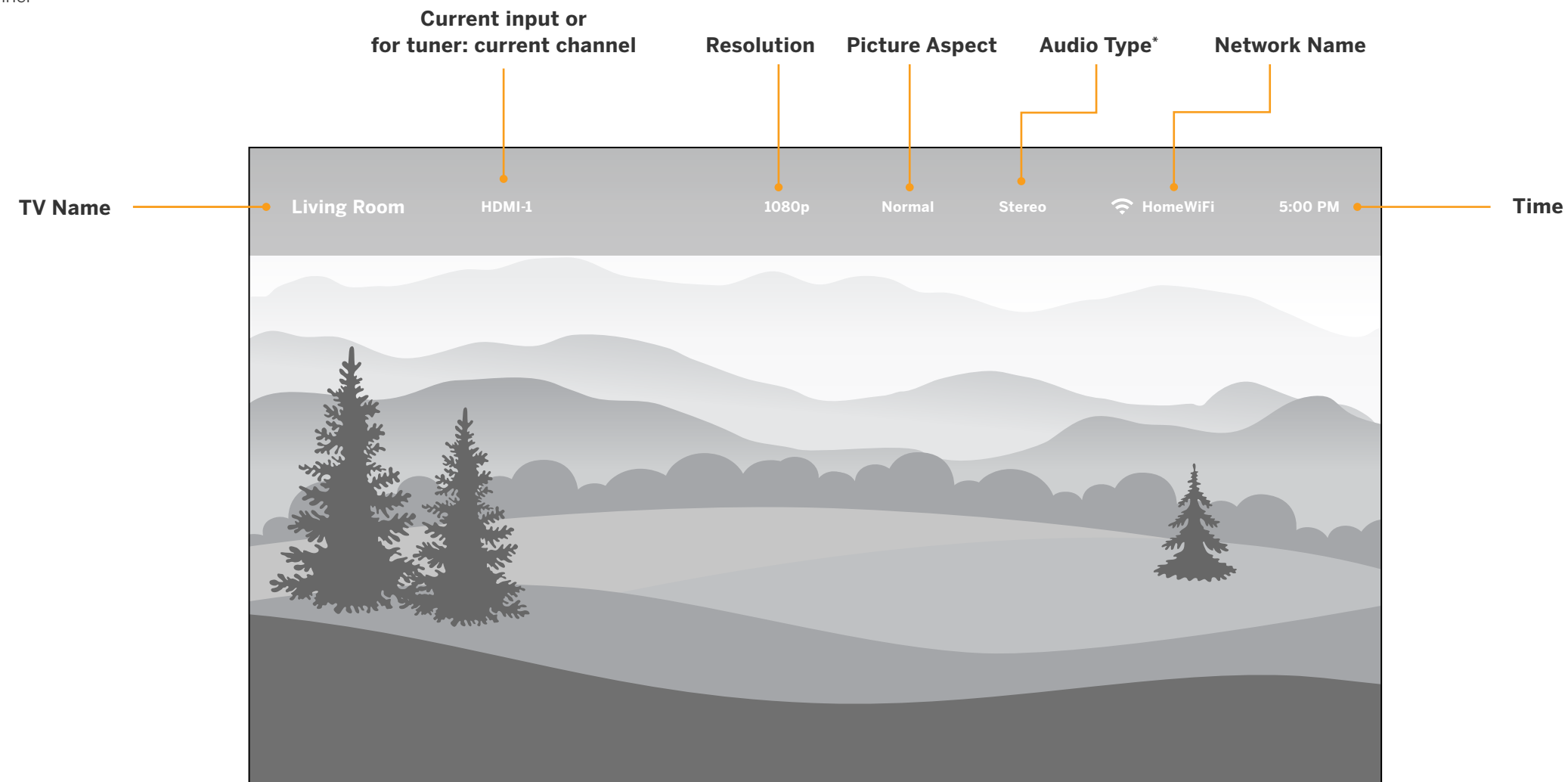

*When TV speakers are off and Dolby Atmos content is passed through the TV to a sound bar or other audio device, the Dolby Atmos icon  will display with "Audio Out."

What is SmartCast Home?

SmartCast Home lets you discover, stream, and control your content like never before! Access top apps, like Netflix, Disney+, and Hulu, by using the remote to easily browse and launch content directly from the home screen. SmartCast Home makes finding something to watch easy and fun.

How to Launch SmartCast Home

To begin streaming with SmartCast Home:

- Press the **SmartCast Home** button  on your remote.
- or—
- Select **SmartCast** from the list of inputs.

What you can do with SmartCast Home

- Stream high quality entertainment.
- Launch top tier apps directly from the home screen.
- Access free channels to watch without a subscription through WatchFree+.
- Rearrange apps on your home screen just the way you like it.
- Mirror your laptop or mobile device onto your TV through Apple Airplay or Chromecast built-in™.



- Works with Google Assistant, Siri, and Alexa-enabled devices for hands-free voice control.



Control your TV with the SmartCast Mobile™ App

Download the VIZIO SmartCast Mobile app and turn your smartphone into a remote to control and configure your TV.

With SmartCast Mobile, you can:

- Power on/off devices, play/pause content, and modify advanced settings, all from the palm of your hand.
- Control playback and TV settings using your voice.
- Easily enter text onto your TV/display from your mobile device using a full keyboard.
- Browse and discover movies, TV shows, music, live streams, and more, across multiple apps at once.
- Access a quick look at show ratings, synopsis, cast, crew, clips, and other details.



Scan to download.
Scan with your phone camera or QR reader.

vizio.com/smartcastapp

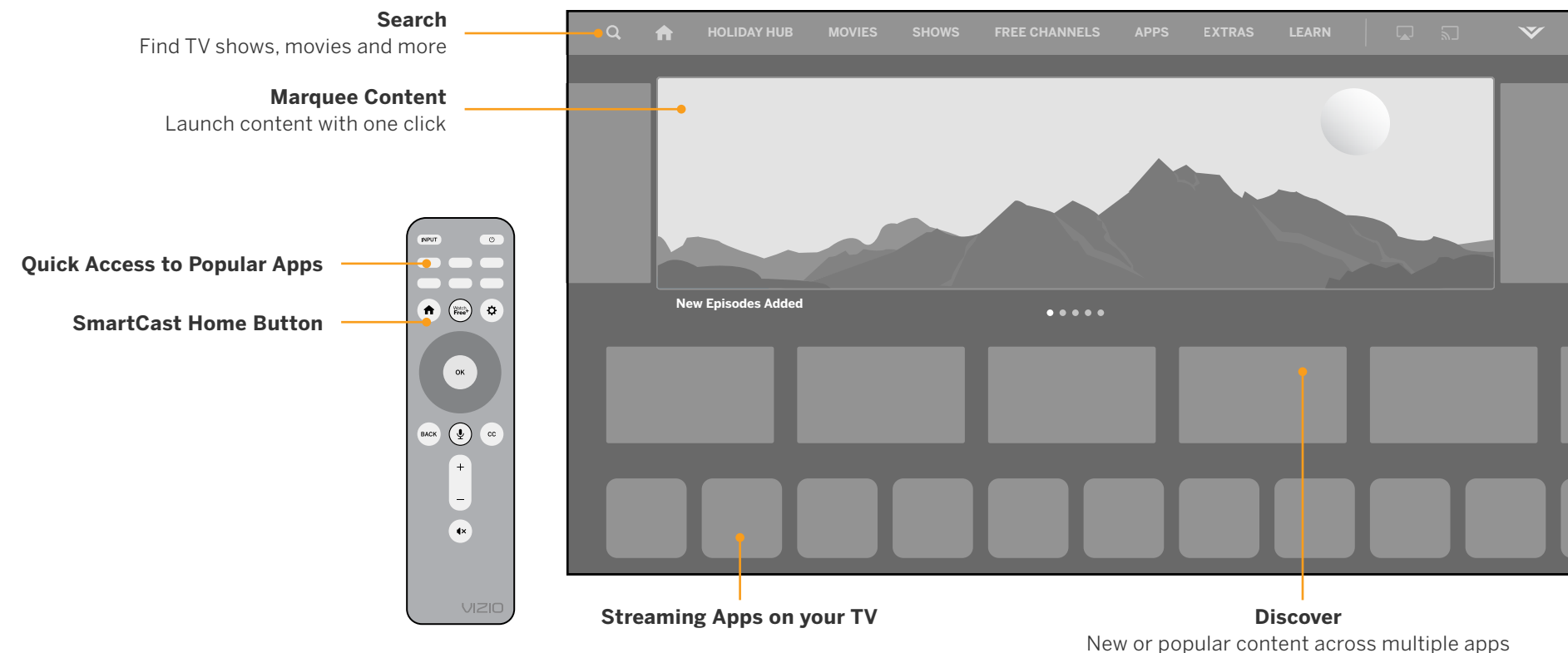
Search
Find TV shows, movies and more

Marquee Content
Launch content with one click

Quick Access to Popular Apps

SmartCast Home Button

Streaming Apps on your TV

Discover
New or popular content across multiple apps

Visit www.vizio.com/smartcastapp for minimum requirements.

What is WatchFree+?

VIZIO WatchFree+ takes your cord-cutting entertainment experience one step further! With the simple press of a button, enjoy free streaming TV with hundreds of live TV channels to choose from – news, movies, sports, comedy, music and more. A built-in on-screen guide makes finding something to watch easier than ever.

And it's all FREE—no fees, no subscriptions, or logins.

What you can do with WatchFree+

- Stream hundreds of live TV channels absolutely free – news, movies, sports, comedy, music and more.
- Navigate through channels, organized by genre, with an intuitive on-screen guide.
- Watch the best of internet TV.
- No logins, subscriptions or transactions fees.

How to Launch WatchFree+

To launch and begin watching entertainment offered on WatchFree+:

- Press the **WatchFree+**  button on your remote.
- or—
- Select **WatchFree+** from the list of inputs or app row.

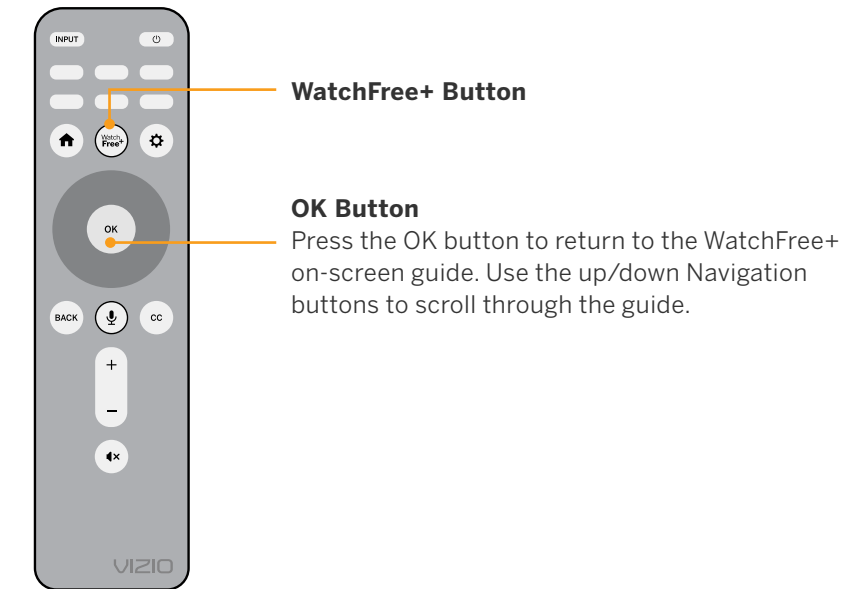
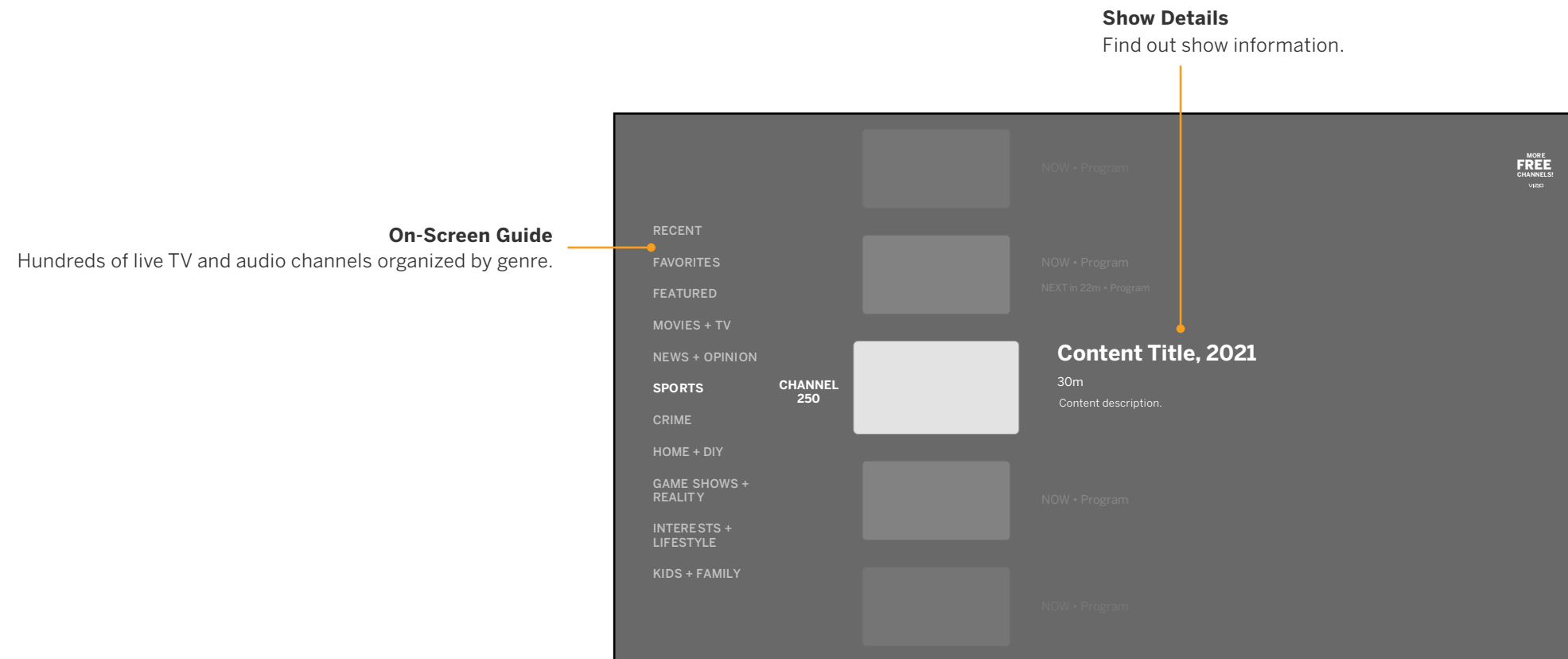

The USB Media Player allows you to connect a USB flash drive to your TV and play music, video, or photos.

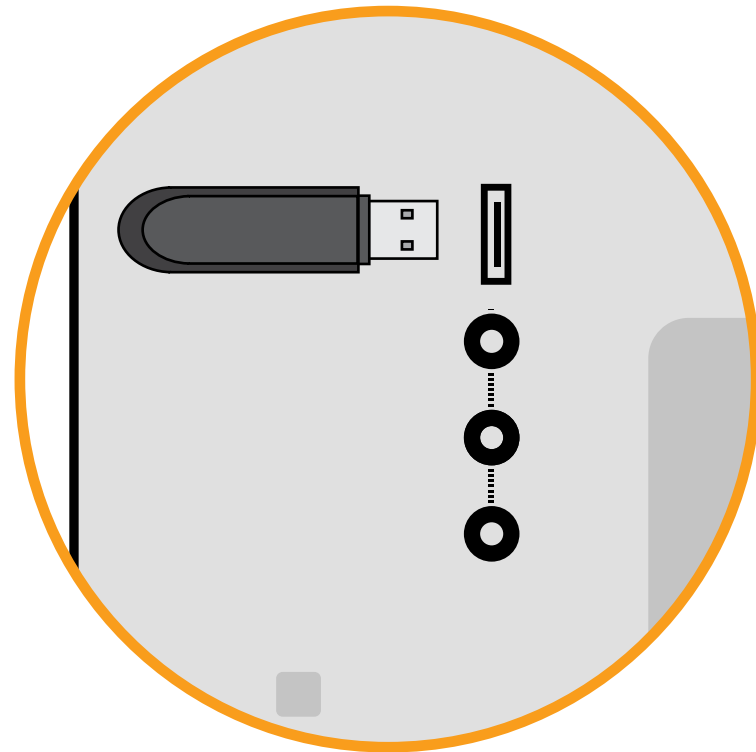

Preparing Your USB Drive to Play USB Media

To display USB media, you must first save your videos onto a USB flash drive:

- The USB flash drive must be formatted as FAT32.
- Files on the USB flash drive must end in a supported file extension (.mp3, .jpg, etc).
- The player is not designed to play media from external hard drives, MP3 players, cameras, or smartphones.

Displaying USB Media

To display your USB media:

1. Connect your USB flash drive to the USB port on the side of the TV.
2. The TV will recognize the USB. Use the **Navigation** Keys on the remote to select the content you want to play.

—or—

3. Select **USB** from the bottom streaming icons on the SmartCast Home™ page.



TIP: You can display your photos in Fullscreen. Select the photo, press **OK**, then highlight **Fullscreen** and press **OK**.

Removing the USB Drive from the TV

To safely remove your USB flash drive from the TV:

1. Turn the TV **off**.
2. Disconnect your USB flash drive from the USB port on the side of the TV.



WARNING: Do not remove the USB drive while the TV is on. Doing so may damage the drive.

Back Button
Highlight this button and press **OK** to return to the previous screen.

Connected Sources
Displays connected USB devices.

Current Folder

Playback Control

Toggle Music/Photos

Sort by Album/Artist/Track

View All or View Folders
Toggle between viewing all content and only viewing folders.

Now Playing Information
Displays song title, album title, and other information.

Progress Bar
Displays the duration of the currently-playing song. The bar will lengthen as the song progresses.

Album Art
If included on the USB thumb drive and associated with your music, the album art will display here.

Folder Contents/Playlist
This area displays the contents of the currently selected folder. You can browse among files using the **Arrow** and **OK** buttons on the remote.

Page Information
If your USB thumb drive has more files than can be displayed on a single screen, the page number is displayed here.

VIZIO

Music

USB1: MyFlashDrive

My Music

MyFlashDrive\Audio\root\My Music

#	Track	Album	Artist	Duration
1	Starry Summer	Summer	JCheesy	2:42
2	Summer Nights	Summer	DJ Sunset	3:11
3	Mango Dream	Beach Mix	Ana Banana	8:46
4	Crystal Waters	Beach Mix	The Dash	4:21
5	Smooth Waves	Breezy Mix	Rio Steve	7:58

Page 1 of 1

Name: 02 Summer Nights
 Title: Summer Nights
 Artist: DJ Sunset
 Album: Summer
 Duration: 00:03:11
 Director: -
 Genre: Electro
 Year: 2020
 Copyright: -
 Protected: No
 File Size: 8.3M

1:50 3:11

Browse Photos

Sort: Artist: A - Z

View: Folders

Back Button
Highlight this button and press **OK** to return to the previous screen.

Connected Sources
Displays connected USB devices.

Current Folder

Sort by Date or File Name

View All or View Folders
Toggle between viewing all content and only viewing folders.

Play once or continuously

Page Information
If your USB thumb drive has more files than can be displayed on a single screen, the page number is displayed here.

Preview Window

Folder Contents/Playlist
This area displays the contents of the currently selected folder. You can browse among files using the **Arrow** and **OK** buttons on the remote.

VIZIO

Video

USB1: MyFlashDrive

My Videos

File Name: Family Vacation - California
Resolution: 3840 x 2160
Audio: AAC
Press **OK** for full screen.
00:03:22 00:23:43

MyFlashDrive\Video\root\My Videos

#	File	Date	Duration
1	Family Vacation - California	-	00:23:43
2	28th Birthday Party	-	00:38:18
3	Korea 2019	-	00:41:08
4	Sunny's Graduation	-	00:25:32

Sort: Date New-Old

View: Folders

Play Once

Page 1 of 1

Back Button
Highlight this button and press **OK** to return to the previous screen.

Back Button
Highlight and press **OK** to return to left column.

Current Folder
Displays the folder path.

Connected Sources
Displays connected USB devices.

Current Folder

Start Fullscreen Slideshow

Sort by Date or File Name

View Thumbnails/Folders

Adjust Slideshow Settings

View Music Files

Folder Contents/Playlist
This area displays the contents of the currently selected folder. You can browse among files using the **Arrow** and **OK** buttons on the remote.

Photo Information
Displays the name, resolution, and file size of the selected photo.

Page Information
If your USB thumb drive has more files than can be displayed on a single screen, the page number is displayed here.

The screenshot shows the VIZIO interface with a top bar containing the VIZIO logo and a breadcrumb path: Photo > VIZIO_2GB\Photo\root. Below the path, a list of connected sources shows 'USB1: MyFlashDrive'. A folder tree on the left shows 'root' selected. A grid of nine photo thumbnails is displayed, labeled A.jpg through I.jpg. At the bottom left, a menu contains options: 'Start Slideshow', 'Sort: Name A-Z', 'View: Thumbnails', 'Settings', and 'Browse Music'. Below the menu, photo information is shown: 'File Name: D 1920x1080', 'Resolution: 1920x1080', and 'Size: 1607270KB'. At the bottom center, 'Page 1 of 1' is displayed.

Get helpful tips and register your TV.

Scan with your phone camera or QR reader.



Customized Support

Get live assistance quickly with your information on hand.



News and Offers

Take advantage of the latest news and special offers from VIZIO.



Updates and Enhancements

Stay up-to-date with important product updates and notifications.

More questions? Find answers at:
SUPPORT.VIZIO.COM

The remote is not responding.

- Make sure the batteries are properly inserted matching the - and + symbols.
- Replace the batteries with fresh ones.

The TV displays “No Signal.”

- Press **INPUT** button on the remote control to select a different input source.
- If you are using cable TV or antenna connected directly to the TV, scan for channels. See *Scanning for TV Channels on page 17*.

There is no power.

- Ensure the TV is plugged into a working electrical outlet.
- Ensure the power cable is securely attached to the TV.
- Press the Power/Standby button on the remote or on the back of the TV to turn the TV on.

The power is on, but there is no image on the screen.

- Ensure all cables are securely attached to the TV.
- Ensure all devices are connected correctly. Devices differ; see your device’s user manual for details.
- Adjust Brightness, Contrast, or Backlight. See *Adjusting the Picture Settings on page 9*.
- Press the **INPUT** button on the remote to select a different input source.

The sound is flat or dialog is not audible.

- Turn off Volume Leveling. See *Adjusting the Audio Settings on page 15*.

Where do I find information on the accessibility features of this product and other VIZIO products?

- Please visit vizio.com/accessibility,
- Email us at: Accessibility@vizio.com, or
- Give us a call at 1-877-698-4746.

How do I stream apps like Netflix to my VIZIO SmartCast® TV?

- Popular apps are located on the SmartCast Home™ screen, so you can simply navigate to the app row on your SmartCast TV to start streaming.
- You can also use Apple AirPlay or Chromecast built-in™ to stream content from your device directly to your SmartCast TV. For more information, please visit:
 - VIZIO.com/Apple
 - VIZIO.com/Google

The colors on the TV don’t look right.

- Adjust the Color and Tint settings in the Picture menu. See *Adjusting the Picture Settings on page 9*.
- Select a pre-set picture mode. VIZIO recommends selecting Calibrated.
- Check all cables to ensure they are securely attached.

The image quality is not good.

- For the best image quality, view high-definition programs using digital sources. Connect your devices with HDMI cables.
- If you are using an antenna, the signal strength of the channel may be low. Ensure your antenna is connected securely to the TV and move the antenna around the room or close to a window for the best signal.

The picture is distorted.

- Move the TV away from electrical appliances, cars, and fluorescent lights.
- Ensure all cables are securely attached.

The TV image does not cover the entire screen.

- If you are using TV, AV, or Component with 480i input, go to Menu > Picture > Picture Aspect.

The TV has pixels (dots) that are always dark.

- Your HD TV is precision-manufactured using an extremely high level of technology. However, sometimes pixels may not display correctly. These types of occurrences are inherent to this type of product and do not constitute a defective product.

The buttons on the remote aren’t working.

- Ensure you are only pressing one button at a time.
- Point the remote directly at the TV when pressing a button.
- Replace the remote batteries with new ones. See *Replacing the Batteries on page 5*.

There is no sound.

- Press Volume Up on the remote control.
- Press the **MUTE** button on the remote to ensure mute is off.
- Check the audio settings. See *Adjusting the Audio Settings on page 15*.
- Check the audio connections of external devices (Blu-ray player, game console, cable/satellite box) that are connected to the TV.
- If you are using an antenna, the signal strength of the channel may be low. Ensure your antenna is connected securely to the TV and move the antenna around the room or close to a window for the best signal.
- Set eARC to Off and use ARC mode.

I see “noise” or static on the screen.

- When your TV's digital capabilities exceed a digital broadcast signal, the signal is up-converted (improved) to match your TV's display capabilities. This up-converting can sometimes cause irregularities in the image.
- If you are using an antenna, the signal strength of the channel may be low. Ensure your antenna is connected securely to the TV and move the antenna around the room or close to a window for the best signal.

When I change input source, the TV image changes size.

- The TV remembers the viewing mode on each input source. If the viewing mode on the new input source differs from the one on the input source you switch from, the difference may be noticeable.
- See *Changing the Picture Aspect Ratio on page 10*.

How do I download the VIZIO SmartCast Mobile™ App?

- Make sure your phone or tablet is connected to a Wi-Fi network. Open a browser on your phone or tablet.
- Navigate to vizio.com/smartcastapp and follow the on-screen instructions to download the VIZIO SmartCast Mobile™ App.

How do I change the Inputs?

- Press the **INPUT** button on the back of the TV to cycle through the Inputs.
- Press the **INPUT** button on the remote to cycle through the Inputs.
- Make sure the VIZIO SmartCast Mobile™ app is installed on your phone or tablet. Open the VIZIO SmartCast Mobile app. Tap on the Device list and select your TV. Tap on the Input key and select the Input of your choice.

How do I connect to my Wi-Fi network?

- On your TV remote, press the **MENU** button then go to Network > Select your Wi-Fi name > Enter password.
- Open the VIZIO SmartCast Mobile™ app on your phone or tablet. Tap on the Menu Tab > SmartCast Devices > Your TV/Device Name > Network
- Tap on the Settings icon > Network > Wireless Access Points. Select your Wi-Fi network from the list, enter the Wi-Fi password, and tap Connect.

How do I exit Demo Mode?

- Press and hold the **INPUT** button on the back of the TV to exit the demo mode.

How do I watch Cable/Antenna TV channels?

- If you subscribe to cable or satellite, simply connect an HDMI cable (not included) to the receiver.
- If you use external antennas to watch local broadcast channels, use a coaxial cable to connect.

Some of my Channels are missing.

- Press the **MENU** button on your TV remote and select the channels option. Then select Find Channels.
- Open the VIZIO SmartCast Mobile app on your phone or tablet.
- **Click on:** Menu Tab > SmartCast Devices > Your TV/Device Name > Channels > Find Channels.

How do I disable/enable Viewing Data?

- Press the **MENU** button on your remote and select ADMIN & PRIVACY. Then select Viewing Data to turn the feature on or off.

The television will not turn on using Alexa or Google Assistant.

- Ensure the television is in Quick Start Mode.
- Tap on Menu > System > Power Mode > Quick Start.

How do I know I am getting 4K resolution or HDR content such as Dolby Vision?

- As you are watching content on the television, press the INFO button on the remote or VIZIO SmartCast Mobile app. You will see the current resolution being displayed along with the version of video.
- HDR will show as a Dolby Vision icon, HDR10 or HLG.

	V435-J01	V505-J01	V505-J09	V555-J01	V585-J01	V655-J04
Size	43"	50"	50"	55"	58"	65"
Viewable Area	42.5"	49.5"	49.5"	54.5"	57.5"	64.5"
PRODUCT DIMENSIONS						
Dimensions w/ Stand	38.31" x 24.52" x 8.35" (973.1 x 622.80 x 212.1 mm)	44.46" x 28.26" x 10.20" (1129.3 x 717.8 x 259.1 mm)	44.20" x 28.06" x 10.01" (1122.6 x 712.8 x 254.2 mm)	49.06" x 30.87" x 10.24" (1246.1 x 784.09 x 260.1 mm)	51.38" x 32.43" x 10.24" (1305.1 x 823.72 x 260.1 mm)	57.70" x 36.10" x 11.00" (1465.6 x 916.94 x 279.4 mm)
Dimensions w/o Stand	38.31" x 22.35" x 3.31" (973.1 x 567.69 x 84.1 mm)	44.46" x 25.85" x 3.36" (1129.3 x 656.59 x 85.3 mm)	44.20" x 25.66" x 2.54" (1122.6 x 651.8 x 64.5 mm)	49.06" x 28.47" x 3.40" (1246.1 x 723.13 x 86.4 mm)	51.38" x 30.02" x 3.39" (1305.1 x 762.50 x 86.1 mm)	57.70" x 33.50" x 3.10" (1465.6 x 850.9 x 78.7 mm)
Weight w/ Stand	15.87 lb (7.2 kg)	22.05 lb (10 kg)	19.29 lb (8.75 kg)	30.78 lb (13.96 kg)	32.19 lb (14.6 kg)	43.60 lb (19.78 kg)
Weight w/o Stand	15.65 lb (7.1 kg)	21.38 lb (9.7 kg)	18.87 lb (8.56 kg)	30.14 lb (13.67 kg)	31.53 lb (14.3 kg)	42.60 lb (19.32 kg)
Mounting Screw Size	M6	M6	M6	M6	M6	M6
Hole Pattern	200 mm x 200 mm	200 mm x 200 mm	200 mm x 200 mm	300 mm x 200 mm	300 mm x 200 mm	400 mm x 200 mm
# of Screws (not included)	4	4	4	4	4	4
PICTURE QUALITY						
Maximum Resolution	3840 x 2160 (UHD)	3840 x 2160 (UHD)	3840 x 2160 (UHD)	3840 x 2160 (UHD)	3840 x 2160 (UHD)	3840 x 2160 (UHD)
LCD Backlight	Full Array LED	Full Array LED	Full Array LED	Full Array LED	Full Array LED	Full Array LED
Dynamic Motion Rate	60Hz	60Hz	60Hz	60Hz	60Hz	60Hz
INPUTS / OUTPUTS						
HDMI Inputs	3	3	3	3	3	3
Composite Video Input	1	1	1	1	1	1
Ethernet Input	1	1	1	1	1	1
RF Antenna Input	1	1	1	1	1	1
USB	1	1	1	1	1	1
Audio Output	HDMI eARC, Analog Stereo Out, Digital Optical	HDMI eARC, Analog Stereo Out, Digital Optical	HDMI eARC, Analog Stereo Out, Digital Optical	HDMI eARC, Analog Stereo Out, Digital Optical	HDMI eARC, Analog Stereo Out, Digital Optical	HDMI eARC, Analog Stereo Out, Digital Optical
OTHER						
Remote Control Type	Voice Remote	Voice Remote	Voice Remote	Voice Remote	Voice Remote	Voice Remote
Power Consumption	70 W	94W	98 W	98 W	93 W	145W
Standby Power	<0.5W	<0.5W	<0.5W	<0.5W	<0.5W	<0.5W
Voltage	120V	120V	120V	120V	120V	120V
OSD Language	English, French, Spanish	English, French, Spanish	English, French, Spanish	English, French, Spanish	English, French, Spanish	English, French, Spanish
Certification	UL, FCC Class B, IC, HDMI (CEC, ARC), Dolby Audio, Dolby Vision	UL, FCC Class B, IC, HDMI (CEC, ARC), Dolby Audio, Dolby Vision	UL, FCC Class B, IC, HDMI (CEC, ARC), Dolby Audio, Dolby Vision	UL, FCC Class B, IC, HDMI (CEC, ARC), Dolby Audio, Dolby Vision	UL, FCC Class B, IC, HDMI (CEC, ARC), Dolby Audio, Dolby Vision	UL, FCC Class B, IC, HDMI (CEC, ARC), Dolby Audio, Dolby Vision

	V655-J09	V705-J01	V705-J03	V705x-J03	V755-J04
Size	65"	70"	70"	70"	75"
Viewable Area	64.5"	69.5"	69.5"	69.5"	74.5"
PRODUCT DIMENSIONS					
Dimensions w/ Stand	57.41" x 35.63" x 11.95" (1458.2 x 905.002 x 303.5 mm)	62.54" x 37.76" x 13.04" (1588.6 x 959 x 331.2 mm)	61.80" x 38.40" x 13.00" (1569.2 x 976.4 x 329.3 mm)	61.80" x 38.40" x 13.00" (1569.2 x 976.4 x 329.3 mm)	66.40" x 41.1" x 13.2" (1686.6 x 1043.94 x 335.3 mm)
Dimensions w/o Stand	57.41" x 33.14" x 2.44" (1458.2 x 841.75 x 62.0 mm)	62.54" x 35.04" x 3.46" (1588.6 x 890 x 87.9 mm)	61.80" x 35.70" x 2.70" (1569.2 x 907.6 x 68.5 mm)	61.80" x 35.70" x 2.70" (1569.2 x 907.6 x 68.5 mm)	66.40" x 38.30" x 3.10" (1686.6 x 972.82 x 78.7 mm)
Weight w/ Stand	40.12 lb (18.2 kg)	50.27 lb (22.8 kg)	53.80 lb (24.40 kg)	53.80 lb (24.40 kg)	61.07 lb (27.7 kg)
Weight w/o Stand	39.24 lb (17.8 kg)	49.3 lb (22.36 kg)	52.70 lb (23.9 kg)	52.70 lb (23.9 kg)	59.97 lb (27.2 kg)
Mounting Screw Size	M6	M8	M6	M6	M8
Hole Pattern	400 mm x 200 mm	400 mm x 200 mm	400 mm x 200 mm	400 mm x 200 mm	400 mm x 400 mm
# of Screws (not included)	4	4	4	4	4
PICTURE QUALITY					
Maximum Resolution	3840 x 2160 (UHD)	3840 x 2160 (UHD)	3840 x 2160 (UHD)	3840 x 2160 (UHD)	3840 x 2160 (UHD)
LCD Backlight	Full Array LED	Full Array LED	Full Array LED	Full Array LED	Full Array LED
Dynamic Motion Rate	60Hz	60Hz	60Hz	60Hz	60Hz
INPUTS / OUTPUTS					
HDMI Inputs	3	3	3	3	3
Composite Video Input	1	1	1	0	1
Ethernet Input	1	1	1	1	1
RF Antenna Input	1	1	1	1	1
USB	1	1	1	1	1
Audio Output	HDMI eARC, Analog Stereo Out, Digital Optical	HDMI eARC, Analog Stereo Out, Digital Optical	HDMI eARC, Analog Stereo Out, Digital Optical	HDMI eARC, Analog Stereo Out, Digital Optical	HDMI eARC, Analog Stereo Out, Digital Optical
OTHER					
Remote Control Type	Voice Remote	Voice Remote	Voice Remote	Voice Remote	Voice Remote
Power Consumption	121 W	132.22 W	156 W	156 W	184 W
Standby Power	<0.5W	<0.5W	<0.5W	<0.5W	<0.5W
Voltage	120V	120V	120V	120V	120V
OSD Language	English, French, Spanish	English, French, Spanish	English, French, Spanish	English, French, Spanish	English, French, Spanish
Certification	UL, FCC Class B, IC, HDMI (CEC, ARC), Dolby Audio, Dolby Vision	UL, FCC Class B, IC, HDMI (CEC, ARC), Dolby Audio, Dolby Vision	UL, FCC Class B, IC, HDMI (CEC, ARC), Dolby Audio, Dolby Vision	UL, FCC Class B, IC, HDMI (CEC, ARC), Dolby Audio, Dolby Vision	UL, FCC Class B, IC, HDMI (CEC, ARC), Dolby Audio, Dolby Vision

FCC Class B Radio Interference Statement

This device complies with Part 15 of the FCC Rules. Operation is subject to the following two conditions: (1) this device may not cause harmful interference, and (2) this device must accept any interference received, including interference that may cause undesired operation.

NOTE: This equipment has been tested and found to comply with the limits for a Class B digital device, pursuant to Part 15 of the FCC Rules. These limits are designed to provide reasonable protection against harmful interference in a residential installation. This equipment generates, uses and can radiate radio frequency energy, and if not installed and used in accordance with the instructions, may cause harmful interference to radio communications. However, there is no guarantee that interference will not occur in a particular installation. If this equipment does cause harmful interference to radio or television reception, which can be determined by turning the equipment off and on, the user is encouraged to try to correct the interference by one or more of the following measures:

- Reorient or relocate the receiving antenna.
- Increase the separation between the equipment and receiver.
- Connect the equipment into an outlet on a circuit different from that to which the receiver is connected.
- Consult the dealer or an experienced radio/TV technician for help.

FCC Caution

Changes or modifications not expressly approved by the party responsible for compliance could void the user's authority to operate this equipment.

Notice

The changes or modifications not expressly approved by the party responsible for compliance could void the user's authority to operate the equipment.

Shielded interface cables and AC power cord, if any, must be used in order to comply with the emission limits.

The manufacturer is not responsible for any radio or TV interference caused by unauthorized modification to this equipment. It is the responsibilities of the user to correct such interference.

This transmitter must not be co-located or operating in conjunction with any other antenna or transmitter.

Operations in the 5GHz products are restricted to indoor usage only.

This equipment complies with FCC/ISED radiation exposure limits set forth for an uncontrolled environment. This equipment should be installed and operated with minimum distance 20cm between the radiator & your body.

Canada Notice for License-Exempt Radio Apparatus

This device complies with Industry Canada's license-exempt RSSs. Operation is subject to the following two conditions: (1) This device may not cause harmful interference, and (2) this device must accept any interference received, including interference that may cause undesired operation.

This device operates on a no-protection no-interference basis. Should the user seek to obtain protection from other radio services operating in the same TV bands, a radio license is required. Please consult Industry Canada's document CPC-2-1-28, Optional Licensing for Low-Power Radio Apparatus in the TV Bands, for details.

Cet appareil est conforme aux CNR exempts de licence d'Industrie Canada. Son fonctionnement est sujet aux deux conditions suivantes:

1. le dispositif ne doit pas produire de brouillage préjudiciable, et
2. ce dispositif doit accepter tout brouillage reçu, y compris un brouillage susceptible de provoquer un fonctionnement indésirable

Cet appareil fonctionne sur une base sans protection et sans interférence. Dans le cas où l'utilisateur cherche à obtenir de la protection des autres services de radio fonctionnant sur les mêmes bandes TV, aucune licence est requise. Veuillez consulter le document CPC-2-1-28 d'Industrie Canada, License optionnelle pour les appareils radio de faible puissance, pour plus de détails.

Industry Canada Class B emission compliance statement

This Class B digital apparatus complies with Canadian ICES-003. Cet appareil numérique de la classe B est conforme à la norme NMB-003 du Canada.

UNITED STATES AND CANADA

By using this VIZIO product, you accept all VIZIO Terms and Conditions, including all the Terms of Warranty, BINDING ARBITRATION AGREEMENT (for U.S. Residents Only), and Class Action Waiver. If you do not agree to the terms of this warranty, do not use the VIZIO product and, within thirty (30) days of the date of purchase, return it for a refund to the authorized retailer where you purchased it. **If you live in the U.S., you have the right to opt out of the Arbitration Agreement and Class Action Waiver within 60 calendar days of your purchase.** Please refer to the full section "Binding Arbitration Agreement; Class Action Waiver" below for more details and instructions for opt-out. Full Terms and Conditions may be viewed at vizio.com/en/terms/terms-of-service.

How Long This Warranty Lasts

For non-commercial use, VIZIO warrants the product on the terms set forth below for one (1) year from the date of original purchase. For commercial use, VIZIO warrants this product on the terms set forth below for ninety (90) days from the date of original purchase.

What This Warranty Covers

VIZIO warrants the product against defects in materials and workmanship when the product is used normally in accordance with VIZIO's user guides and manuals.

Except where restricted by law, this warranty applies only to the original purchaser of a new product. The purchase must have been made from an authorized retailer in the United States (including Puerto Rico) or Canada. The product must also be located in the country where it was purchased at the time of warranty service.

Zero Bright Pixel Defect Guarantee (Displays Only)

Your product may qualify for a warranty against "zero bright pixel" defects for the duration of the warranty on select new product purchases. To determine if this guarantee applies to your product, refer to the model's product information page at www.vizio.com, look for the "zero bright pixel" guarantee on the box, or contact VIZIO Technical Support at the email address or telephone number below.

How to Get Service

Before obtaining warranty service, you may visit www.vizio.com for additional help and troubleshooting. To obtain warranty service, contact VIZIO Customer Support by going to **support.vizio.com** and selecting **Contact Us**.

Your Obligations Before Service

You must obtain pre-authorization before sending your product to a VIZIO service center. You may be required to supply a purchase receipt (or copy) to show that the product is within the warranty period. When you return a product to a VIZIO service center, you must ship the product in its original packaging or in packaging that affords an equal degree of protection. VIZIO Technical Support will provide instructions for packing and shipping the product to the VIZIO service center. **ALL USER DATA AND DOWNLOADED APPLICATIONS STORED ON A PRODUCT WILL BE DELETED IN THE COURSE OF SOME IN-HOME AND ALL SHIP-IN WARRANTY SERVICE.** If this occurs, your product will be restored to its original state. You will be responsible for restoring all applicable user data and downloaded applications. Recovery and reinstallation of user data and downloaded applications is not covered under this warranty. In order to protect your personal information, VIZIO recommends that you always clear all personal information from the product before it is serviced, regardless of the servicer.

VIZIO's Responsibilities

If VIZIO determines that a product is covered by this warranty, VIZIO will (at its option) repair or replace it, or refund the purchase price to you. There will be no charge for parts or labor during the warranty period. Replacement parts may be new or recertified at VIZIO's option and sole discretion. Replacement parts and VIZIO's labor are warranted for the remaining portion of the original warranty or for ninety (90) days from warranty service, whichever is longer.

Types of Service

TVs that are 32 inches or larger will usually be serviced in-home. In-home service requires complete and easy access to the product and does not include de-installation or re-installation of the product. In-home service is subject to availability. VIZIO will provide other service options when in-home service is not available. All other VIZIO products must be sent to a VIZIO service center to obtain warranty service. VIZIO is not responsible for transportation costs to the service center, but VIZIO will cover return shipping to the customer.

What This Warranty Does Not Cover

This warranty does not cover: (a) cosmetic damage; (b) normal wear and tear; (c) improper operation; (d) improper voltage supply or power surges; (e) signal issues; (f) damage from shipping; (g) acts of God; (h) customer misuse, modifications or adjustments; (i) installation, set-up, or repairs attempted by anyone other than by a VIZIO authorized service center; (j) products with unreadable or removed serial numbers; (k) products requiring routine maintenance; or (l) products sold "AS IS", "CLEARANCE", "FACTORY RECERTIFIED", or by a non-authorized reseller.

What to Do If You Are Not Satisfied With Service

If you feel VIZIO has not met its obligations under this warranty, you may attempt to resolve the issue informally with VIZIO. If you are unable to resolve the issue informally and wish to file a formal claim against VIZIO, and if you are a resident of the United States, you must submit your claim to binding arbitration according to the procedures described below, unless an exception applies. Submitting a claim to binding arbitration means that you do not have the right to have your claim heard by a judge or jury. Instead your claim will be heard by a neutral arbitrator.

Binding Arbitration Agreement; Class Action Waiver (U.S. Residents Only)

UNLESS YOU HAVE BROUGHT AN ELIGIBLE CLAIM IN SMALL CLAIMS COURT OR HAVE OPTED OUT AS DESCRIBED BELOW, ANY CONTROVERSY OR CLAIM RELATING IN ANY WAY TO YOUR VIZIO PRODUCT, INCLUDING ANY CONTROVERSY OR CLAIM ARISING OUT OF OR RELATING TO THIS WARRANTY, A BREACH OF THIS WARRANTY, OR THE VIZIO PRODUCT'S SALE, CONDITION OR PERFORMANCE, WILL BE SETTLED BY BINDING ARBITRATION ADMINISTERED BY THE AMERICAN ARBITRATION ASSOCIATION AND CONDUCTED BY A SINGLE ARBITRATOR APPOINTED BY THE AMERICAN ARBITRATION ASSOCIATION, IN ACCORDANCE WITH ITS COMMERCIAL ARBITRATION RULES AND ITS SUPPLEMENTARY PROCEDURES FOR CONSUMER-RELATED DISPUTES. You may learn more about the American Arbitration Association and its rules for arbitration by visiting www.adr.org or by calling 800-778-7879. Since this warranty concerns a transaction in interstate or international commerce, the Federal Arbitration Act will apply.

The filing fees to begin and carry out arbitration will be shared between you and VIZIO, but in no event will your fees ever exceed the amount allowable by the American Arbitration Association, at which point VIZIO will cover all additional administrative fees and expenses. VIZIO waives its right to recover attorneys' fees in connection with any arbitration under this warranty. If you are the prevailing party in an arbitration to which the Supplementary Procedures for Consumer-Related Disputes applies, then you are entitled to recover attorneys' fees as the arbitrator may determine.

The dispute will be governed by the laws of the state or territory in which you resided at the time of your purchase (if in the United States). The place of arbitration will be Irvine, California, or your county of residence (if in the United States). The arbitrator will have no authority to award punitive or other damages not measured by the prevailing party's actual damages, except as may be required by statute. The arbitrator will not award consequential damages, and any award will be limited to monetary damages and will include no equitable relief, injunction, or direction to any party other than the direction

to pay a monetary amount. Judgment on the award rendered by the arbitrator will be binding and final, except for any right of appeal provided by the Federal Arbitration Act, and may be entered in any court having jurisdiction. Except as may be required by law, neither you nor VIZIO nor an arbitrator may disclose the existence, content, or results of any arbitration under this warranty without the prior written consent of you and VIZIO.

ANY DISPUTE, WHETHER IN ARBITRATION, IN COURT, OR OTHERWISE, WILL BE CONDUCTED SOLELY ON AN INDIVIDUAL BASIS. VIZIO AND YOU AGREE THAT NO PARTY WILL HAVE THE RIGHT OR AUTHORITY FOR ANY DISPUTE TO BE ARBITRATED AS A CLASS ACTION, A PRIVATE ATTORNEY GENERAL ACTION, OR IN ANY OTHER PROCEEDING IN WHICH EITHER PARTY ACTS OR PROPOSES TO ACT IN A REPRESENTATIVE CAPACITY. NO ARBITRATION OR PROCEEDING WILL BE JOINED, CONSOLIDATED, OR COMBINED WITH ANOTHER ARBITRATION OR PROCEEDING WITHOUT THE PRIOR WRITTEN CONSENT OF ALL PARTIES TO ANY SUCH ARBITRATION OR PROCEEDING.

Opt-Out Instructions

IF YOU DO NOT WISH TO BE BOUND BY THE BINDING ARBITRATION AGREEMENT AND CLASS ACTION WAIVER, THEN: (1) you must notify VIZIO in writing within sixty (60) days of the date that you purchased the product; (2) your written notification must be mailed to VIZIO at 39 Tesla, Irvine, CA 92618, Attn: Legal Department; and (3) your written notification must include (a) your name, (b) your address, (c) the date you purchased the product, and (d) a clear statement that you wish to opt out of the binding arbitration agreement and class action waiver.

In addition, you may pursue a claim in small claims court in your county of residence (if in the United States) or in Orange County, California. In such case the provisions of the section titled "Binding Arbitration Agreement; Class Action Waiver (U.S. Residents)" will not apply.

Exclusions and Limitations

TO THE GREATEST EXTENT PERMITTED BY APPLICABLE LAW, THERE ARE NO EXPRESS WARRANTIES OTHER THAN THOSE DESCRIBED ABOVE. ANY IMPLIED WARRANTIES, INCLUDING ANY IMPLIED WARRANTY OF MERCHANTABILITY AND FITNESS FOR A PARTICULAR PURPOSE, WILL BE LIMITED IN DURATION TO THE WARRANTY PERIOD SET FORTH ABOVE. SOME STATES AND PROVINCES DO NOT ALLOW LIMITATIONS ON HOW LONG AN IMPLIED WARRANTY LASTS, SO THE ABOVE LIMITATION MAY NOT APPLY TO YOU.

VIZIO WILL NOT BE RESPONSIBLE FOR LOSS OF USE, LOSS OF INFORMATION OR DATA, COMMERCIAL LOSS, LOST REVENUE OR LOST PROFITS, OR OTHER INDIRECT, SPECIAL, INCIDENTAL OR CONSEQUENTIAL DAMAGES, EVEN IF

VIZIO HAS BEEN ADVISED OF THE POSSIBILITY OF SUCH DAMAGES, AND EVEN IF THE REMEDY FAILS OF ITS ESSENTIAL PURPOSE. SOME STATES AND PROVINCES DO NOT ALLOW THE EXCLUSION OR LIMITATION OF INCIDENTAL OR CONSEQUENTIAL DAMAGES, SO THE ABOVE LIMITATION OR EXCLUSION MAY NOT APPLY TO YOU.

IN LIEU OF ANY OTHER REMEDY FOR ANY AND ALL LOSSES AND DAMAGES RESULTING FROM ANY CAUSE WHATSOEVER (INCLUDING VIZIO'S NEGLIGENCE, ALLEGED DAMAGE, OR DEFECTIVE GOODS, NO MATTER WHETHER SUCH DEFECTS ARE DISCOVERABLE OR LATENT), VIZIO MAY, AT ITS SOLE AND EXCLUSIVE OPTION AND IN ITS DISCRETION, REPAIR OR REPLACE YOUR PRODUCT, OR REFUND ITS PURCHASE PRICE. AS NOTED, SOME STATES AND PROVINCES DO NOT ALLOW THE EXCLUSION OR LIMITATION OF INCIDENTAL OR CONSEQUENTIAL DAMAGES, SO THE ABOVE LIMITATION OR EXCLUSION MAY NOT APPLY TO YOU.

How the Law Applies

This warranty gives you specific legal rights, and you may also have other rights, which vary from state to state and province to province. This warranty applies to the greatest extent permitted by applicable law.

General

No employee or agent of VIZIO may modify this warranty. If any term of this warranty, other than the class action waiver, is found to be unenforceable, that term will be severed from this warranty and all other terms will remain in effect. If the class action waiver is found to be unenforceable, then the entire section titled "Binding Arbitration Agreement; Class Action Waiver (U.S. Residents Only)" will not apply. This warranty applies to the maximum extent not prohibited by law.

Changes to Warranty

This warranty may change without notice, but any change will not affect your original warranty. Check www.vizio.com for the most current version.

Software Licenses

All software is provided subject to a software license agreement(s) and you agree that you will be bound by such license agreement(s) in addition to these terms. Your use of this product is subject to VIZIO's privacy policy, which may be updated from time to time, and is available to view at vizio.com/privacy.

Export Regulations

Customer acknowledges that the VIZIO products, which include technology and software, are subject to customs and export control laws in the United States ("US"). The products may also be subject to the customs and export control laws and regulations of the country in which the products are manufactured and/or received.

Internet Connectivity and App Availability

Network conditions, environmental and other factors may negatively affect connectivity and the resulting video quality, if any. The applications and content of the applications pictured herein or described in accompanying documentation may only be available in certain countries or languages, may require additional fees or subscription charges, and may be subject to future updates, modifications or discontinuation without notice. VIZIO has no control over third party applications or content and assumes no responsibility for the availability or interruption of such applications or content. Additional third party terms, conditions and restrictions apply.

© 2021 VIZIO, Inc. All Rights Reserved.

This User Manual may not be copied in whole or in part without the written permission of VIZIO, Inc. VIZIO, Inc. has made reasonable efforts to ensure the accuracy of the information provided herein. All product specifications, functionality, features, configurations, performance, design and other product information described herein are subject to change without notice. VIZIO, Inc. is not responsible for typographical, technical, or descriptive errors. To review the most updated version of this User Manual and the associated Quick Start Guide, go to vizio.com.

VIZIO, the VIZIO logo, the V logo, VIZIO SmartCast, and other terms and phrases are trademarks or registered trademarks of VIZIO, Inc.

The terms HDMI, HDMI High-Definition Multimedia Interface, and the HDMI Logo are trademarks or registered trademarks of HDMI Licensing Administrator, Inc.

For DTS patents, see <http://patents.dts.com>. Manufactured under license from DTS, Inc. DTS, DTS:X, Virtual:X, the DTS:X logo are registered trademarks or trademarks of DTS, Inc. in the United States and other countries. © 2020 DTS, Inc. ALL RIGHTS RESERVED.

Dolby, Dolby Vision, Dolby Audio, and the double-D symbol are trademarks of Dolby Laboratories Licensing Corporation. Manufactured under license from Dolby Laboratories. Confidential unpublished works. Copyright © 1992-2021 Dolby Laboratories. All rights reserved.

Google, Google Play, and Chromecast Built-in are trademarks of Google LLC.

Amazon, Alexa and all related logos are trademarks of Amazon.com, Inc. or its affiliates.

Other names of companies, products, and services used in this User Manual may be trademarks, trade names or service marks of others and VIZIO, Inc. disclaims any interest in trademarks, trade names or service marks other than its own. Mention of non-VIZIO products is for informational purposes only.

App services featured on the included IR remote may vary and may not be available in all regions.

4K or HDR availability varies by app and may be subject to subscription fees, internet service, and device capabilities.

Battery Disposal



Caution: This product may be shipped with batteries. Do not dispose of batteries in a fire or with ordinary household waste. Batteries may explode and can cause damage. Replace batteries only with the same or equivalent type of battery recommended by VIZIO. The disposal of batteries may be regulated by your state. For more information on recycling or properly disposing of your batteries, please check with your state or go to vizio.com/environment.

Product Recycling

The disposal and recycling of consumer electronic products may be regulated by your state. Always properly dispose of your VIZIO products in accordance with local laws and regulations. VIZIO supports the proper recycling of our products. For information on how to properly recycle your VIZIO products and to learn more about consumer electronics recycling laws, please go to vizio.com/environment or call (800) 374-3473.

Packaging Disposal

VIZIO encourages the recycling of the packaging used for this product. Please break-down all boxes and recycle eligible materials according to local laws and regulations. For more information please go to vizio.com/environment or call (800) 374-3473.

Accessibility

For information on the accessibility features of this product and other VIZIO products please visit:

Website: vizio.com/accessibility

Email: Accessibility@vizio.com

Phone: 1-877-698-4746