

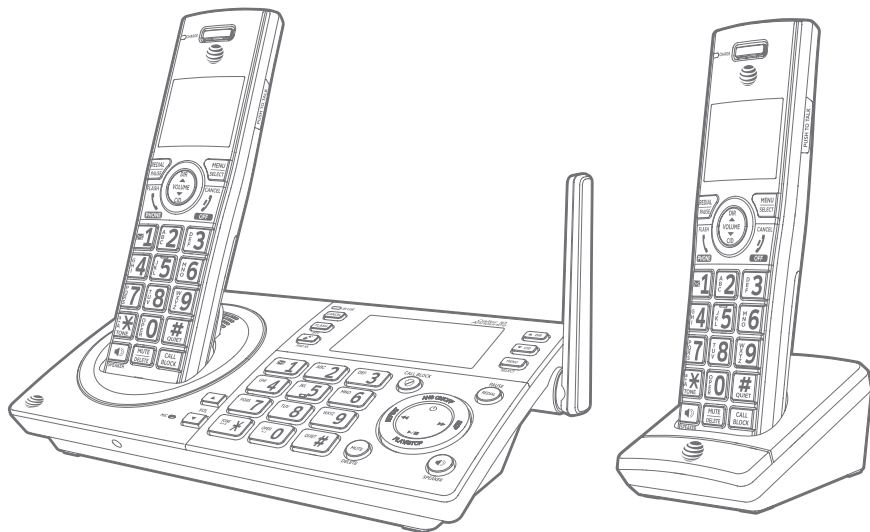

Complete user's manual

CL83107/CL83207/CL83307/
CL83407

DECT 6.0 cordless telephone/
answering system with
caller ID/call waiting



Congratulations

on your purchase of this AT&T product. Before using this AT&T product, please read the **Important safety information** section on pages 158-160 of this manual. Please thoroughly read this user's manual for all the feature operations and troubleshooting information necessary to install and operate your new AT&T product. You can also visit our website at **www.telephones.att.com** or call **1 (800) 222-3111**. In Canada, dial **1 (866) 288-4268**.

This telephone meets the California Energy Commission regulations for energy consumption. Your telephone is set up to comply with the energy-conserving standards right out of the box. No further action is necessary. This telephone system is compatible with certain AT&T DECT 6.0 cordless headsets and speakerphones. Visit **www.telephones.att.com/accessories** for a list of compatible cordless headsets and speakerphones.

Model number: CL83107 (one handset)
CL83207 (two handsets)
CL83307 (three handsets)
CL83407 (four handsets)

Type: DECT 6.0 cordless telephone/answering system with caller ID/call waiting

Serial number: _____

Purchase date: _____

Place of purchase: _____

Both the model and serial numbers of your AT&T product can be found on the bottom of the telephone base.

Save your sales receipt and original packaging in case it is necessary to return your telephone for warranty service.



Telephones identified with this logo have reduced noise and interference when used with most T-coil equipped hearing aids and cochlear implants. The TIA-1083 Compliant Logo is a trademark of the Telecommunications Industry Association. Used under license.



The ENERGY STAR® program (www.energystar.gov) recognizes and encourages the use of products that save energy and help protect our environment. We are proud to mark this product with the ENERGY STAR® label indicating it meets the latest energy efficiency guidelines.

Parts checklist

Your telephone package contains the following items. Save your sales receipt and original packaging in the event warranty service is necessary.

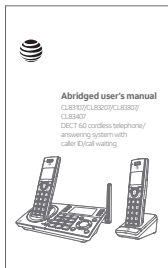

Abridged User's manual



Quick start guide



Cordless handset
(1 for CL83107)
(2 for CL83207)
(3 for CL83307)
(4 for CL83407)

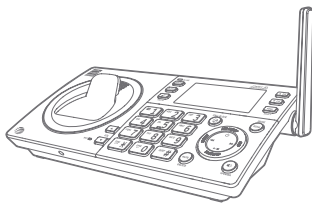

Telephone base

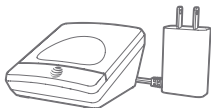

Charger for cordless handset with power adapter installed
(1 for CL83207)
(2 for CL83307)
(3 for CL83407)



Battery for cordless handset
(1 for CL83107)
(2 for CL83207)
(3 for CL83307)
(4 for CL83407)

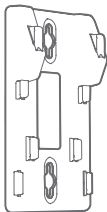

Wall-mount bracket



Battery compartment cover
(1 for CL83107)
(2 for CL83207)
(3 for CL83307)
(4 for CL83407)

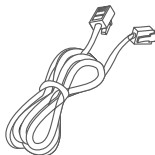

Telephone line cord

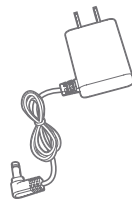

Power adapter for telephone base

Complete user's manual

CL83107/CL83207/CL83307/CL83407
DECT 6.0 cordless telephone/
answering system with
caller ID/call waiting

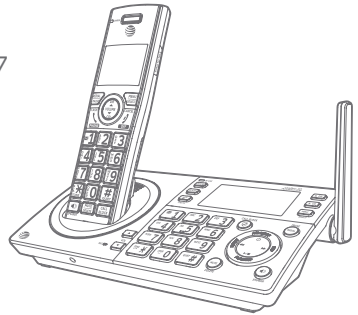

Table of contents

Getting started

Quick reference guide - handset.....	1
Quick reference guide - telephone base	5
Installation	9
Telephone base and charger installation	10
Telephone base installation.....	10
Charger installation.....	10
Battery installation and charging	11
Battery backup mode	14
To activate the mode.....	14
Operation	14
Installation options	15
Tabletop to wall-mount installation	15
Wall-mount to tabletop installation	16

Telephone settings

Handset settings	17
Ringer volume	18
Ringer tone.....	18
Set date/time.....	19
LCD language.....	20
Caller ID announce	21
Set speed dial voicemail number	22

Voicemail (visual message waiting) indicator	22
Clear voicemail indication	23
Rename handset	24
Key tone	24
Use caller ID to automatically set date and time.....	25
Home area code	25
Dial mode	26
Web address	26
QUIET mode.....	27
Telephone base settings.....	28
Ringer volume	29
Ringer tone.....	29
Set date/time.....	30
LCD language.....	31
Caller ID announce	32
Set speed dial voicemail number	33
Voicemail (visual message waiting) indicator	33
Clear voicemail indication	34
Rename base	35
Key tone	35
Use caller ID to automatically set date and time.....	36
Home area code	36
Dial mode	37
Web address	37

Telephone operation

Telephone operation	38
Making a call	38
On hook dialing (predialing)	38
Answering a call	38
Ending a call	39
Auto off	39
Temporary ringer silencing	39
Handset speakerphone	40
Last number redial	40
Equalizer	42
Options while on calls	43
Volume control	43
Call waiting	43
Mute	44
Chain dialing	45
Temporary tone dialing	47
Blind transfer	47

Multiple handset use

Multiple handset use	49
Handset locator	49
Join a call in progress	49
Intercom	50
Answer an incoming call during an intercom call	52
Call transfer using intercom	53
Push-to-talk (PTT)	54
Turn PTT on or off	54
PTT call to a single device	55
PTT call to multiple devices	57
Answer a PTT call	59
Change a one-to-one PTT call to an intercom call	60
Answer an incoming call during a PTT call	60
Make an outgoing call during PTT call	61
End or leave a PTT call	61

Directory

About the directory	62
Shared directory	62
Capacity	62
Create directory entries	63

Create a new directory entry	63
Add a predialed telephone number to the directory	64
Review the directory	65
Review directory entries	65
Search the directory	66
Search by name	66
Dial, delete or edit directory entries	67
Display dial	67
Delete a directory entry	67
Edit a directory entry	68
Speed dial	69
Assign a speed dial number	69
Assign your voicemail speed dial number	70
Reassign a speed dial number	70
Delete a speed dial number	71
Make a call using speed dial	71
Check your voicemail using speed dial	71

Caller ID

About caller ID	72
Information about caller ID with call waiting	72
Caller ID log	73
How the caller ID log works	73
Missed (new) call indicator	73
Caller ID operation	74
Memory match	74
Review the caller ID log	75
View dialing options	76
Dial a caller ID log entry	76
Delete caller ID log entries	76
Save a caller ID log entry to the directory	77
Save a caller ID log entry to the allow list	78
Save a caller ID log entry to the block list	78
Save a caller ID log entry to the star name list	79
Reasons for missing caller ID information	80

Smart call blocker

About Smart call blocker*	81
Call categories	82
Call controls	83
Call block settings	85
Set Smart call blocker on/off	85
Control calls without numbers	85
Control uncategorized calls	86
Block list	88
Allow list	93
Star name list	98
Screening announcement	101
Allowed calls	104
Allow calls without numbers	104
Allow uncategorized calls	105
Blocked calls	106
Block calls without numbers	106
Block uncategorized calls	107
Screen calls without numbers	108
Answer call once	109
Send call to answering system	110
End call	110
Screen uncategorized calls	111
Allow call once	113
Always allow	113
Block call	114
Send call to answering system	114
Option while on a call	115

Answering system

Answering system settings	116
Announcement	116
Answer on/off	119
Voice guide	120
Call screening	121
Number of rings	122
Remote access code	123
Message alert tone	124
Message recording time	125
About the answering system	126
Answering system and voicemail indicators	126

Using the answering machine and voicemail together	127
Message capacity	127
Voice prompts	128
Call screening	128
Call intercept	129
Base ringer	129
Temporarily turning off the message alert tone	129
Message playback	130
Options during playback	131
Delete all old messages	133
Recording and playing memos	134
Record a memo	134
Play back a memo	134
Base message counter displays	135
Message counter displays	135
Remote access	136

Appendix

Adding and registering handsets/headsets/speakerphones	138
Register a handset to the telephone base	138
Deregistering handsets	140
Deregister all handsets from the telephone base	140
Alert tones and lights	141
Handset screen icons	141
Telephone base screen icons	141
Handset alert tones	142
Telephone base alert tones	142
Lights	143
Screen display messages	144
Screen messages	144
Troubleshooting	147
Maintenance	157
Important safety information	158
Safety information	158
Especially about cordless telephones	159
Precautions for users of implanted cardiac pacemakers	160

Pacemaker patients	160
ECO mode	160
Especially about telephone answering systems.....	160
FCC Part 68 and ACTA.....	161
FCC Part 15.....	162
California Energy Commission battery charging testing instructions	163
Limited warranty	164
Technical specifications.....	166
DECT 6.0 digital technology.....	166
Telephone operating range.....	166
Redefining long range coverage and clarity	166
HD audio.....	166
Simulated full-duplex handset and base speakerphones	166

Index

Index.....	167
------------	-----

Quick reference guide - handset

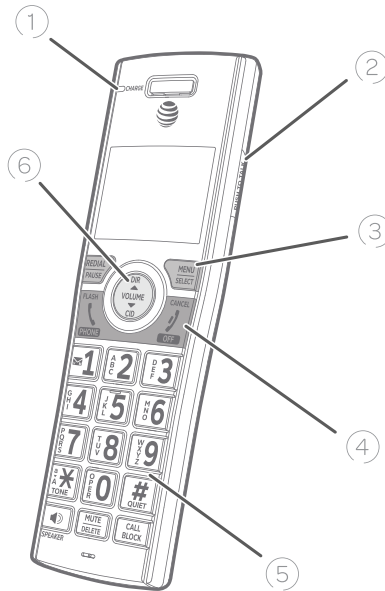

1 CHARGE light

- ▶ On when the handset is charging in the telephone base or charger.

2 PUSH TO TALK

- ▶ Press to initiate a one-to-one (page 55) or one-to-group broadcast (page 57).
- ▶ Press and hold to broadcast to a group of system devices (page 57).

3 REDIAL/PAUSE

- ▶ Press repeatedly to view the last ten numbers dialed (page 40).
- ▶ While entering numbers, press and hold to insert a dialing pause (page 63).

MENU/SELECT

- ▶ When the handset is not in use, press to show the menu.
- ▶ While in the menu, press to select an item or save an entry or setting.

4 PHONE/FLASH

- ▶ Press to make or answer a call (page 38).
- ▶ During a call, press to answer an incoming call when you receive a call waiting alert (page 43).
- ▶ During message playback, press to call back the caller if the caller's number is available (page 131).

/OFF/CANCEL

- ▶ During a call, press to hang up (page 39).
- ▶ While in a menu, press to cancel an operation, back up to the previous menu, or exit the menu display; or press and hold this button to exit to idle mode.
- ▶ When the handset is ringing, press to mute the ringer temporarily (page 39).
- ▶ Press and hold while the telephone is not in use to erase the missed call indicator.

Quick reference guide - handset

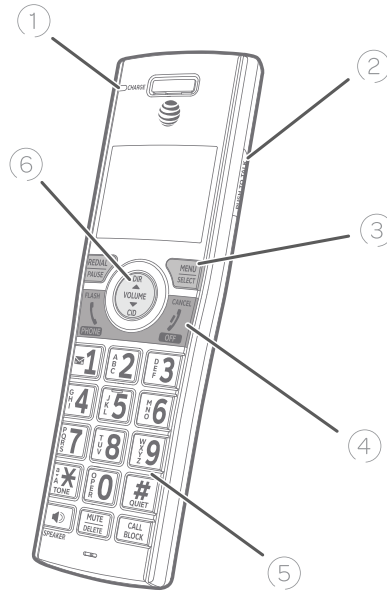

5 1

- ▶ While reviewing a caller ID log entry, press repeatedly to add or remove 1 in front of the telephone number before dialing or saving it in the directory.
- ▶ When the handset is not in use, press and hold to set (page 22) or to dial your voicemail number (page 71).

5 /a>A

- ▶ Press to switch to tone dialing temporarily during a call if you have pulse service (page 47).
- ▶ While entering names, press to change the next letter to upper or lower case.

5 /SPEAKER

- ▶ Press to make or answer a call using the speakerphone (page 38).
- ▶ Press to switch between the speakerphone and the handset (page 40).

5 MUTE/DELETE

- ▶ During a call, press to mute the microphone (page 44).
- ▶ When the handset is ringing, press to mute the ringer temporarily (page 39).
- ▶ While reviewing the caller ID log, directory, redial memory, allow list, block list, or star name list, press to delete an individual entry.
- ▶ While predialing, press to delete digits.
- ▶ During message or announcement playback, press to delete the playing message or the recorded announcement.

5 QUIET# (pound key)

- ▶ Press repeatedly to display other dialing options when reviewing a caller ID log entry (page 76).
- ▶ Press and hold to enter the **QUIET** mode setting screen, or to deactivate **QUIET** mode (page 27).

Quick reference guide - handset

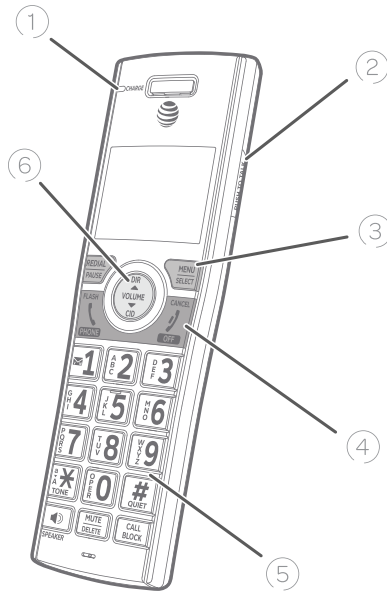

5 CALL BLOCK

- ▶ Press to block the incoming call when the telephone is ringing (page 114).
- ▶ When on a call, press to block the call (page 115).
- ▶ When the handset is not in use, press to show the call block menu (page 85).

6 DIR/▲ VOLUME

- ▶ Press to display the directory entries when the phone is not in use (page 65).
- ▶ Press to scroll up while in menus and lists.
- ▶ While entering names or numbers, press to move the cursor to the right.
- ▶ Press to increase the listening volume when on a call (page 43), or to increase the message playback volume (page 131).

CID/▼ VOLUME

- ▶ Press **CID** to show caller ID log when the handset is not in use (page 75).
- ▶ Press to scroll down while in menus and lists.
- ▶ While entering names or numbers, press to move the cursor to the left.
- ▶ Press to decrease the listening volume when on a call (page 43), or to decrease the message playback volume (page 131).

Main menu

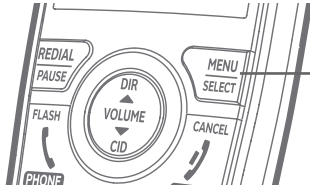

Main menu

- Play messages (page 130)
- Answering sys (page 116)
- Smart call blk (page 81)
- Directory (page 62)
- Caller ID log (page 72)
- Intercom (page 50)
- Ringers (page 18)
- Set date/time (page 19)
- Settings (page 20)
- Web address (page 26)

The > symbol highlights a menu item.

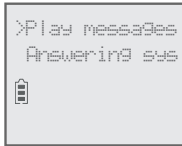

Using menus:

- Press **MENU/SELECT** to show the menu.
- Press **▼CID** or **▲DIR** to scroll through menu items.
- Press **MENU/SELECT** to confirm or save changes to a highlighted menu item.
- Press **⏻/OFF/CANCEL** to cancel an operation, back up to the previous menu, or exit the menu display.

Quick reference guide - telephone base

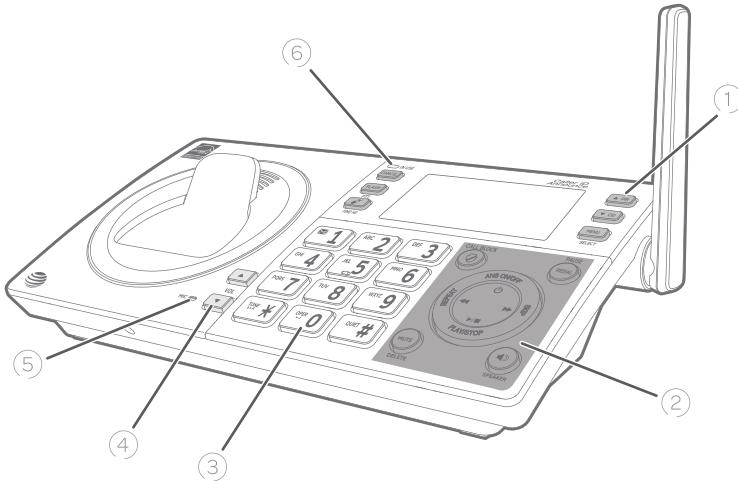

1 ▲DIR

- ▶ Press to display the directory when the phone is not in use (page 65).
- ▶ Press to scroll up while in menus and lists.
- ▶ While entering names or numbers, press to move the cursor to the right.

▼CID

- ▶ Press to display the caller ID log when the phone is not in use (page 75).
- ▶ Press to scroll down while in menus and lists.
- ▶ While entering names or numbers, press to move the cursor to the left.

MENU/SELECT

- ▶ When the telephone base is not in use, press to show the menu.
- ▶ While in the menu, press to confirm or save an entry or setting.

2 ◻/CALL BLOCK

- ▶ Press to block the incoming call when the telephone is ringing (page 114).
- ▶ When on a call, press to block the call (page 115).
- ▶ When the telephone base is not in use, press to show the call block menu (page 85).

RECALL/PAUSE

- ▶ Press repeatedly to view the last 10 numbers dialed (page 40).
- ▶ While entering numbers, press and hold to insert a dialing pause (page 63).

◻/ANS ON/OFF

Press to turn the built-in answering system on or off (page 119).

◀/REPEAT

- ▶ During playback, press to repeat the playing message (page 131).
- ▶ During playback, press twice to play the previous message (page 131).

▶/SKIP

Press to skip a message (page 131).

Quick reference guide - telephone base

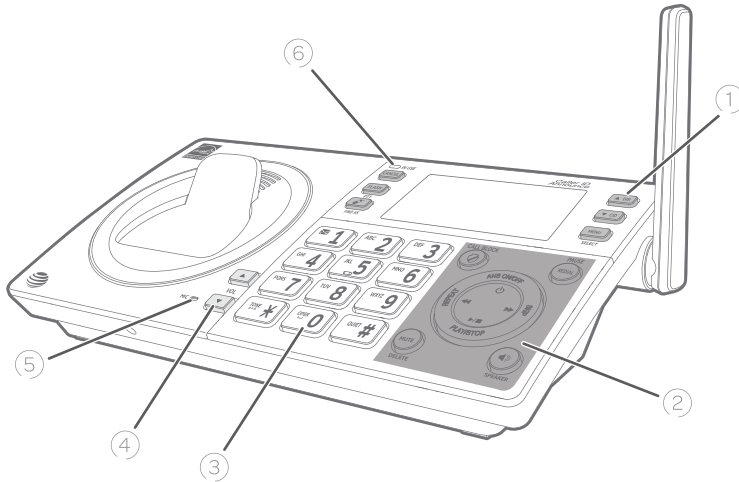

② ▶/■/PLAY/STOP

Press to start or stop message playback (page 130).

MUTE/DELETE

- ▶ While reviewing the caller ID log, directory, redial memory, allow list, block list, and star name list, press to delete an individual entry.
- ▶ While predialing, press to delete digits.
- ▶ During message or announcement playback, press to delete the playing message or announcement.
- ▶ Press twice to delete all old messages when the phone is not in use.
- ▶ During a call, press to mute the microphone (page 44).
- ▶ When the phone is ringing, press to mute the ringer temporarily.

🔊/SPEAKER

Press to make or answer a call using the speakerphone.

TONE✕/a>A

- ▶ Press to switch to tone dialing temporarily during a call if you have pulse service (page 47).
- ▶ While entering names, press to change the next letter to upper or lower case.

QUIET# (pound key)

- ▶ Press repeatedly to display other dialing options when reviewing a caller ID log entry (page 76).
- ▶ Press and hold to enter the **QUIET** mode setting screen, or to deactivate **QUIET** mode (page 27).

④ ▼/VOL/▲

- ▶ During message playback or call screening, press to adjust the listening volume (page 43).
- ▶ While in idle mode, press to adjust the base ringer volume.
- ▶ When on a call, press to adjust the listening volume.

③ 📧 1

- ▶ When the telephone is not in use, press and hold to set (page 33) or to dial your voicemail number (page 71).

Quick reference guide - telephone base

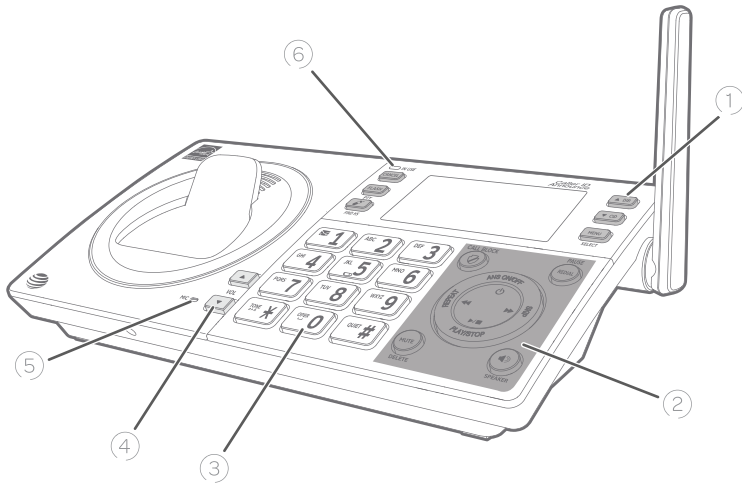

5 **MIC**
Microphone.

- 6** **IN USE light**
- ▶ On when the telephone is in use, or when the answering system is answering an incoming call.
 - ▶ On when a handset is being registered.
 - ▶ Flashes when there is an incoming call or when all handsets are being deregistered.
 - ▶ Flashes when another telephone is in use on the same line.

FLASH/PTT

- ▶ Press to initiate a one-to-one (page 55) or one-to-group broadcast (page 57).
- ▶ Press and hold to broadcast to a group of system devices (page 57).
- ▶ During a call, press to answer an incoming call when you receive a call waiting alert (page 43).

CANCEL

- ▶ While in a menu, press to cancel an operation, back up to the previous menu or exit the menu display; or press and hold to go back to idle mode.
- ▶ When the telephone base is ringing, press to mute the ringer temporarily.
- ▶ When the telephone base is not in use, press and hold to erase the missed call indicator.

/FIND HS

While the phone is idle, press to page all handsets (page 49).

Main menu

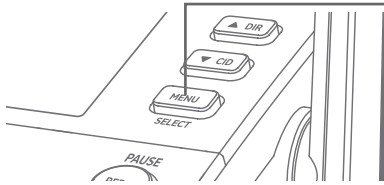

Main menu

- ▶ Play messages (page 130)
- ▶ Answering sys (page 116)
- ▶ Smart call blk (page 81)
- ▶ Directory (page 62)
- ▶ Caller ID log (page 72)
- ▶ Intercom (page 50)
- ▶ Ringers (page 29)
- ▶ Set date/time (page 30)
- ▶ Settings (page 31)
- ▶ Web address (page 37)

The > symbol highlights a menu item.

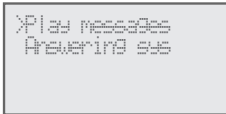

Using menus:

- ▶ Press **MENU/SELECT** to show the menu.
- ▶ Press **▼CID** or **▲DIR** to scroll through menu items.
- ▶ Press **MENU/SELECT** to confirm or save changes to a highlighted menu item.
- ▶ Press **CANCEL** to cancel an operation, back up to the previous menu, or exit the menu display.

You must install and charge the battery before using the telephone.



STOP!

See pages 11-12 for easy instructions.

Install the telephone base close to a telephone jack and a power outlet not controlled by a wall switch. The telephone base can be placed on a flat surface or vertically mounted on the wall (page 15). For optimum range and better reception, place the telephone base in a central and open location.

If you subscribe to high-speed Internet service (DSL - digital subscriber line) through your telephone line, you must install a DSL filter between the telephone line cord and the telephone wall jack (see the following page). The filter prevents noise and caller ID problems caused by DSL interference. Please contact your DSL service provider for more information about DSL filters.

Your product may be shipped with protective stickers covering the handset and telephone base displays - remove them before use.

For customer service or product information, visit our website at **www.telephones.att.com** or call **1 (800) 222-3111**. In Canada, dial **1 (866) 288-4268**.

Avoid placing the telephone base and charger too close to:

- Communication devices such as television sets, VCRs, or other cordless telephones.
- Excessive heat sources.
- Noise sources such as a window with traffic outside, motors, microwave ovens, refrigerators, or fluorescent lighting.
- Excessive dust sources such as a workshop or garage.
- Excessive moisture.
- Extremely low temperature.
- Mechanical vibration or shock such as on top of a washing machine or workbench.

Telephone base and charger installation

Install the telephone base and charger, as shown below.

The telephone base is ready for tabletop use. If you want to change to wall-mounting, see **Installation options** on page 15 for details.

Telephone base installation

Plug the large end of the telephone base power adapter into a power outlet not controlled by a wall switch.

Plug one end of the telephone line cord into a telephone jack or a DSL filter.

Route the power adapter cord through these slots.

Raise the antenna.

Plug the small end of the telephone base power adapter into the power adapter jack on the back of the telephone base.

Route the telephone line cord through this slot.

Plug the other end of the telephone line cord into the telephone jack on the back of the telephone base.

If you have DSL high-speed Internet service, a DSL filter (not included) is required.

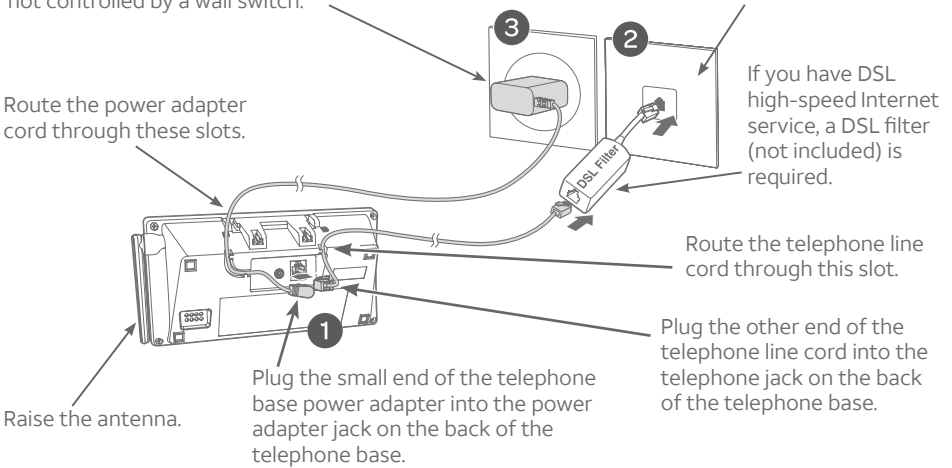

Charger installation

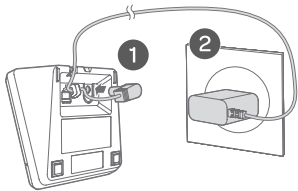

Plug the power adapter into a power outlet not controlled by a wall switch.



IMPORTANT INFORMATION

- Use only the power adapter(s) supplied with this product. To order a replacement power adapter, visit our website at **www.telephones.att.com** or call **1 (800) 222-3111**. In Canada, dial **1 (866) 288-4268**.
- The power adapters are intended to be correctly oriented in a vertical or floor mount position. The prongs are not designed to hold the plug in place if it is plugged into a ceiling, under-the-table or cabinet outlet.

Battery installation and charging

Install the battery, as shown below. Once you have installed the battery, the screen indicates the battery status (see the following table). If necessary, place the handset in the telephone base or charger to charge the battery. For best performance, keep the handset in the telephone base or charger when not in use. The battery is fully charged after ten hours of continuous charging. See the table on page 166 for battery operating times.

If the screen shows **Place in charger** and  flashes, you need to charge the handset without interruption for at least 30 minutes to give the handset enough charge to use the telephone for a short time. The following table summarizes the battery charge indicators and actions to take.

Battery indicators	Battery status	Action
The screen is blank, or shows Place in charger and  (flashing).	Battery has no or very little charge. The handset cannot be used.	Charge without interruption (at least 30 minutes).
The screen shows Low battery and  (flashing).	Battery has enough charge to be used for a short time.	Charge without interruption (at least 30 minutes).
The screen shows HANDSET X .	Battery is charged.	To keep the battery charged, place it in the telephone base or charger when not in use.



Note: If you are on a phone call in low battery mode, you hear four short beeps every minute.

Step 1

Plug the battery connector securely into the socket inside the handset battery compartment. Insert the supplied battery with the label **THIS SIDE UP** facing up, as indicated.

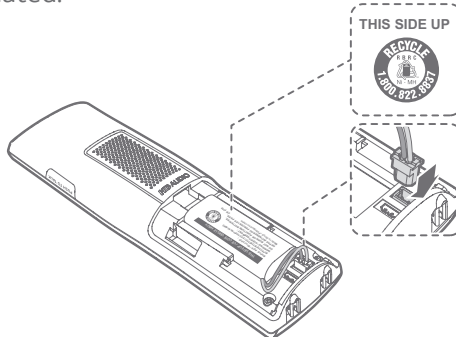

Battery installation and charging

Step 2

Align the cover flat against the battery compartment, then slide it upwards until it clicks into place.

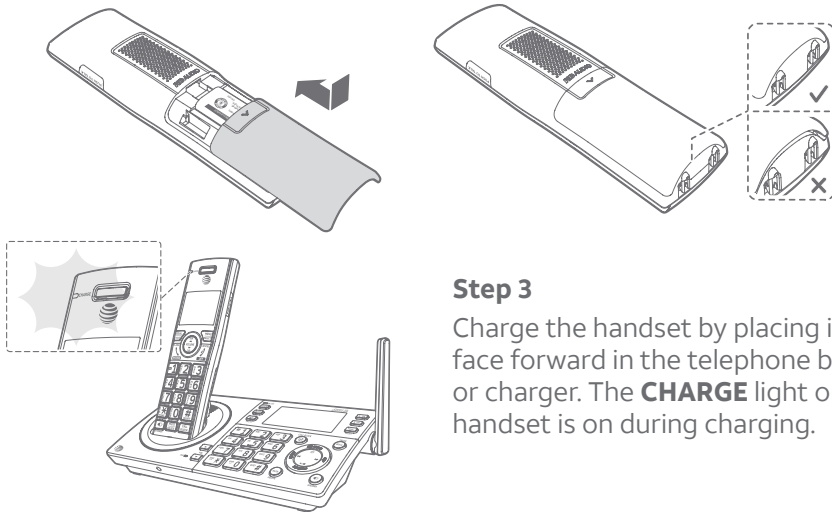

Step 3

Charge the handset by placing it face forward in the telephone base or charger. The **CHARGE** light on the handset is on during charging.

IMPORTANT INFORMATION

- Use only the supplied rechargeable battery or replacement battery (model BT183342/ BT283342). To order, visit our website at www.telephones.att.com or call **1 (800) 222-3111**. In Canada, dial **1 (866) 288-4268**.
- If you do not use the handset for a long time, disconnect and remove the battery to prevent possible leakage.

After you install your telephone or power returns following a power outage, the handset and telephone base will prompt you to set the date and time. For instructions, see **Set date/time** on page 19 or page 30. To skip setting the date and time, press **OFF/CANCEL** on the handset or **CANCEL** on the telephone base.



Battery installation and charging

After the date and time setting are done or skipped, the telephone base then prompts if you want to set Smart call blocker. Press **MENU/SELECT** to start the Smart call blocker setup via voice guide. To skip the setup, press **CANCEL** on the telephone base. For more details, see Smart call blocker on page 81.



Voice Guide set
Smart Call Blk?

Voice guide to set Smart call blocker:

If you choose to set smart call blocker via voice guide, you hear a voice prompt, *“Hello! This voice guide will assist you with the basic setup of Smart call blocker...”*. Listen to the instructions and then choose one of the following options.



Setting up
Smart Call Blk...

On the telephone base:

- Press **1** if you want to turn off default call screening settings, and allow all incoming calls to get through.
- Press **2** if you want to screen calls with telephone numbers that are not saved in your directory, allow list and star name list; or
- Press **3** if you only want to screen calls that do not display a phone number.

If you select option 2 to screen all incoming calls, we recommend that you add the phone numbers of your family members and friends, and desired businesses to your **Directory** (see page 62) or **Allow list** (see page 93), or add their names to the **Star name list** (see page 98). This will avoid Smart call blocker to screen their calls.

After the Smart call blocker setting is done or skipped, the telephone base will prompt if you want to set up the answering system. Press **MENU/SELECT** to start the answering system setup via voice guide. For more details, see **Voice guide** on page 120. To skip the setup, press **CANCEL** on the telephone base.



Voice guide to
set up Ans sys?



Note: Voice guides to set Smart call blocker and answering system are only available on the telephone base.

Battery backup mode

Battery backup mode allows your telephone to function in the event of power outage. The telephone system uses stored power from the handset's battery to operate.

To activate the mode

After the power goes out, if there is already a handset with enough charge placed in the telephone base, the telephone system enters battery backup mode automatically. That handset screen shows **Powering base... Don't pick up**. All other handset screens show **Pwr outage mode**.

-OR-

If there is no handset placed in the telephone base after the power goes out, all handsets show **Out of range OR No pwr at base** and **Put HS on base to power base**, alternatively. Place any handset with enough charge in the telephone base. Its screen shows **Powering base... Don't pick up**. All other handset screens show **Pwr outage mode**.



Note: A handset which does not have enough charge to power up the base, its screen shows **Out of range OR No pwr at base** and **Not enough batt to power base**, alternatively, after the power goes out. Find another system handset that has enough charge to activate the mode.

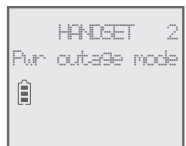
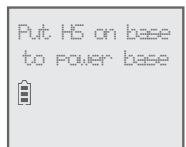
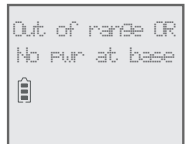

Operation

During battery backup mode, the telephone base and answering system will be disabled. The operating time is subject to the battery level of the handset placed in the telephone base and the actual usage. For optimal performance, you are not recommended to use the handset placed in the telephone base when this mode is on.

Using other system handsets (Recommended):

Operate the handsets the same way as usual, except the answering system which will be disabled.

Using the handset placed in the telephone base:

To maximize the operating time, you are not advised to use this handset. If you do have to use it, make sure you do not lift it from the telephone base. All operations should be done with the handset placed in the telephone base. In this case, calls can only be made and received using the speakerphone.

Installation options

Your telephone base is ready for tabletop use. If you want to mount your telephone on a wall, follow the steps on this page to connect the telephone base with a standard dual-stud telephone wall-mounting plate. You may need a professional to install the mounting plate.

Tabletop to wall-mount installation

1. Plug the telephone line into the telephone base. If you are using a DSL filter, plug the other end of the telephone line into the filter. Route the telephone line cord (or DSL filter) through the wall-mount bracket hole.
2. Align the holes on the wall-mount bracket with the standard wall plate and slide the wall-mount bracket down until it locks securely.
3. Position the telephone base, as shown below. Insert the extended tabs (marked B) of the wall-mount bracket into the slots on the back of the telephone base. Push the telephone base down until it is securely in place.
4. Plug the power adapter into a power outlet not controlled by a wall switch. Plug the other end of the power adapter into the telephone base. Bundle the telephone line cord and power adapter cord neatly with twist ties.

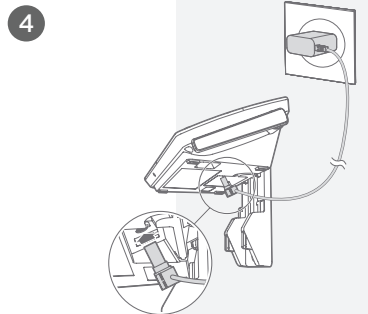
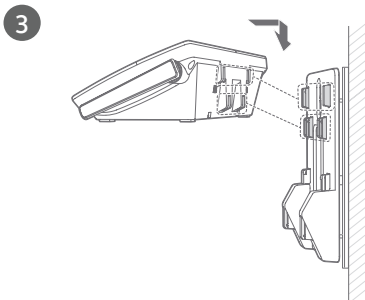
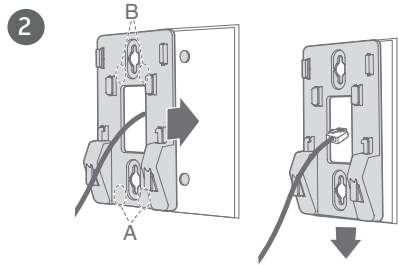
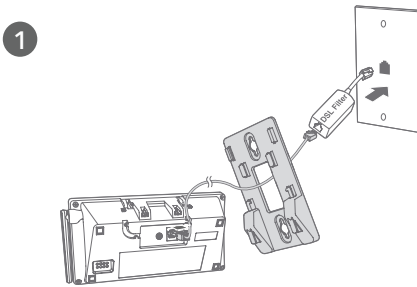

Installation options

Wall-mount to tabletop installation

1. Unplug the large end of the power adapter from the electrical outlet.
2. If the telephone line cord and power adapter cord are bundled, untie them first. Slide the wall-mount bracket up and remove it from the wall-mounting plate.

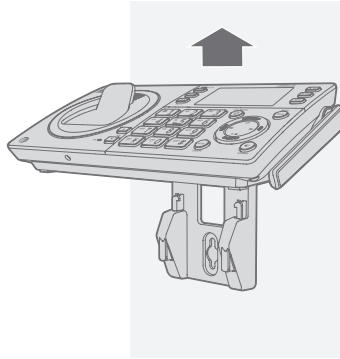

3. Unplug the telephone line cord or the DSL filter from the telephone wall jack. Push the telephone base up and away from the wall-mount bracket to detach it from the wall-mount bracket.

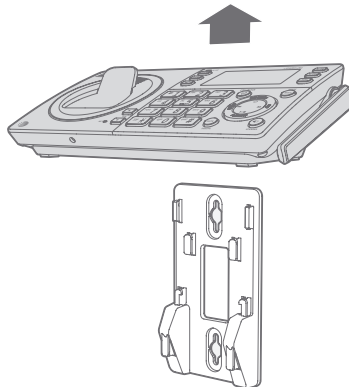

4. See **Telephone base and charger installation** on page 10.

Handset settings

Use the menu to change the telephone settings.

1. Press **MENU/SELECT** on the handset when it is not in use to enter the main menu.
2. Press **▼CID** or **▲DIR** to scroll to the feature to be changed. When scrolling through the menu, the **►** symbol indicates the selected menu item.
3. Press **MENU/SELECT** to select the highlighted item.

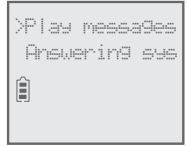

Note: Press **↵OFF/CANCEL** to cancel an operation, back up to the previous menu or exit the menu display.
Press and hold **↵OFF/CANCEL** to return to idle mode.

Handset settings

Ringer volume

You can set the ringer volume level to one of six levels or turn the ringer off. When the ringer is off,  appears on the screen.

1. Press **MENU/SELECT** in idle mode to enter the main menu.
2. Use **▼CID** or **▲DIR** to scroll to **Ringers**, then press **MENU/SELECT**.
3. Press **MENU/SELECT** again to select **Ringer volume**.
4. Press **▼CID** or **▲DIR** to sample each volume level.
5. Press **MENU/SELECT** to save your preference. There is a confirmation tone and the screen returns to the previous menu.



Notes:

- ▶ The handset ringer volume also determines the ringer volume for intercom calls.
- ▶ If the ringer volume is set to off, that handset is silenced for all incoming calls.
- ▶ If the ringer volume is set to off, the caller ID will not be announced and the screen will briefly display **Caller ID won't be announced**.

Ringer tone

You can choose one of ten ringer tones.

1. Press **MENU/SELECT** in idle mode to enter the main menu.
2. Use **▼CID** or **▲DIR** to scroll to **Ringers**, then press **MENU/SELECT**.
3. Press **▼CID** or **▲DIR** to scroll to **Ringer tone**, then press **MENU/SELECT**.
4. Press **▼CID** or **▲DIR** to sample each ringer tone.
5. Press **MENU/SELECT** to save your preference. There is a confirmation tone and the screen returns to the previous menu.



Note: If you turn off the ringer volume, you will not hear ringer tone samples.

Handset settings

Set date/time

The answering system announces the day and time of each message prior to playing it. Before using the answering system, set the date and time as follows. If you subscribe to caller ID service, the day, month and time are set automatically with each incoming call. The year must be set so that the day of the week can be calculated from the caller ID information. You can turn off the date and time settings of the caller ID service and set the date and time manually (see **Use caller ID to automatically set date and time** on page 25).

After a power failure or handset registration, the system prompts you to set the date and time.

To set the date and time manually:

1. When the handset is in idle mode, press **MENU/SELECT** to enter the main menu.
2. Press **▼CID** or **▲DIR** to scroll to **Set date/time** and then press **MENU/SELECT**.
3. Press **▼CID** or **▲DIR** to select the month, then press **MENU/SELECT**, or enter the number using the dialing keys.
4. Press **▼CID** or **▲DIR** to select the day, then press **MENU/SELECT**, or enter the number using the dialing keys.
5. Press **▼CID** or **▲DIR** to select the year, or enter the number using the dialing keys, then press **MENU/SELECT** to move on to set the time.
6. Press **▼CID** or **▲DIR** to select the hour, then press **MENU/SELECT**, or enter the number using the dialing keys.
7. Press **▼CID** or **▲DIR** to select the minute, then press **MENU/SELECT**, or enter the number using the dialing keys.
8. Press **▼CID** or **▲DIR** to highlight **AM** or **PM**, or press **2** for **AM** or **7** for **PM**. Press **MENU/SELECT** to confirm. There is a confirmation tone and the screen returns to the previous menu.

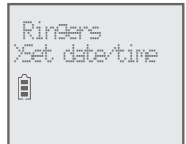

Note: If the clock is not set when a message is recorded, the system announces, “Time and day not set,” before it plays the message.

Handset settings

LCD language

You can select the language used for all screen displays.

1. Press **MENU/SELECT** in idle mode to enter the main menu.
2. Use **▼CID** or **▲DIR** to scroll to **Settings**, then press **MENU/SELECT**.
3. Press **MENU/SELECT** to choose **LCD language**.
4. Press **▼CID** or **▲DIR** to highlight **English**, **Français** or **Español**, then press **MENU/SELECT**. The screen prompts **Set English/Français/Español as LCD language?**.
5. Press **MENU/SELECT** to save your preference. There is a confirmation tone and the screen returns to the previous menu.

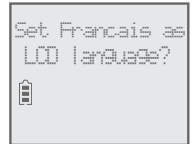

Note: If you accidentally change the LCD language to French or Spanish, you can reset it back to English without going through the French or Spanish menus. Press **MENU/SELECT** on the handset in idle mode, then enter **364#**. There is a confirmation tone.

Handset settings

Caller ID announce

The caller ID announce feature lets you know who's calling without having to look at the display. When you have an incoming call, the handset and/or base speaks "Call from..." and the name of the caller based on the directory or caller ID information. If the caller's name is private or unknown, the phone number up to the last 11 digits will be announced. If the caller's phone number is also private or unknown, no information will be announced. The default setting is On.

To turn on or off the caller ID announce feature:

1. Press **MENU/SELECT** in idle mode to enter the main menu.
2. Use **▼CID** or **▲DIR** to scroll to **Settings**, then press **MENU/SELECT**.
3. Use **▼CID** or **▲DIR** to scroll to **Caller ID annc**, then press **MENU/SELECT**.
4. Use **▼CID** or **▲DIR** to highlight the desired option, then press **MENU/SELECT**.
 - ▶ **Set all On/Off** - Change the setting for the base and all handsets.
 - ▶ **Local handset** - Change the setting for that handset only.
 - ▶ **Base** - Change the setting for the telephone base only.
5. Use **▼CID** or **▲DIR** to highlight **On** or **Off**, then press **MENU/SELECT**. There is a confirmation tone and the screen returns to the previous menu. If you change the setting to **Set all On/Off**, the screen shows **CID Annc ON/OFF on all HS & BS**.

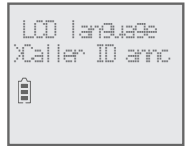

Notes:

- ▶ To use the caller ID announce feature, you must subscribe to caller ID service from your telephone service provider.
- ▶ If you have paired an AT&T **TL80133** DECT 6.0 cordless speakerphone to the telephone base, the caller ID announce setting for all devices also applies to the cordless speakerphone. When the setting is **On**, the cordless speakerphone speaks "Call from..." and the name of the caller based on the directory or caller ID information during an incoming call. If the caller's name is unavailable, the phone number up to the last 11 digits will be announced.
- ▶ When there are up to five handsets registered, the telephone system supports caller ID announce for all handsets. If six or more handsets are registered, the system supports caller ID announce for the first four registered handsets only.
- ▶ This feature does not announce information for call waiting calls.
- ▶ It takes at least two rings for the phone to receive caller ID information and announce it. If the phone is answered before the end of the second ring, the phone won't have time to announce the caller's information.
- ▶ Pronunciation of names may vary with this feature. Not all names may be pronounced correctly.
- ▶ Caller ID announce is available in English only.

Handset settings

Set speed dial voicemail number

This feature lets you save your voicemail number for easy access when you press and hold the  **1** key.

To save your voicemail number:

1. Press **MENU/SELECT** in idle mode to enter the main menu.
2. Use **▼CID** or **▲DIR** to scroll to **Settings**, then press **MENU/SELECT**.
3. Use **▼CID** or **▲DIR** to scroll to **Voicemail #**, then press **MENU/SELECT**.
4. Use the dialing keys to enter the voicemail access number provided by your telephone service provider (up to 30 digits) when prompted.
 - ▶ Press **▼CID** or **▲DIR** to move the cursor to the left or right.
 - ▶ Press **MUTE/DELETE** on the handset to erase a digit.
 - ▶ Press and hold **MUTE/DELETE** on the handset to erase all digits.
 - ▶ Press **REDIAL/PAUSE** to enter a three-second dialing pause (a **p** appears).
5. Press **MENU/SELECT** to save. There is a confirmation tone and the screen displays **Voicemail # saved**, then returns to the previous menu.



Voicemail (visual message waiting) indicator

If you subscribe to a voicemail service offered by your telephone service provider, this feature provides a visual indication when you have new voicemail messages.

New voicemail and the  icon appear on the handset screen.

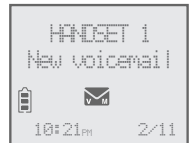

Notes:

- ▶ This feature does not indicate new messages recorded on your phone's built-in answering system.
- ▶ For more information about the difference between your answering system and voicemail, see "Answering system and voicemail indicators" on page 126.

Handset settings

Clear voicemail indication

Use this feature when the telephone indicates there is new voicemail but there is none. For example, when you have accessed your voicemail while away from home. This feature only turns off the displayed **New voicemail** and the  icon; it does not delete your voicemail messages. As long as you have new voicemail messages, your telephone service provider continues to send the signal to turn on the indicators.

To manually turn off the new voicemail indicators:

1. Press **MENU/SELECT** when in idle mode to enter the main menu.
2. Use **▼CID** or **▲DIR** to scroll to **Settings**, then press **MENU/SELECT**.
3. Use **▼CID** or **▲DIR** to scroll to **Clr voicemail**, then press **MENU/SELECT**. The screen shows **Reset Voicemail Indicator?**.
4. Press **MENU/SELECT** again to turn the voicemail indication off. There is a confirmation tone and the screen returns to the previous menu.

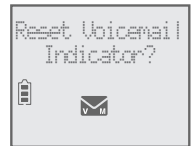
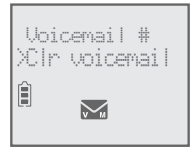

Notes:

- ▶ Your telephone service provider voicemail may alert you to new messages with a stutter (broken) dial tone. Contact your telephone service provider for more details.
- ▶ For information about using your voicemail service, contact your telephone service provider.

Handset settings

Rename handset

You can edit the handset name for each system handset.

1. When the handset is idle, press **MENU/SELECT**.
2. Use **▼CID** or **▲DIR** to scroll to **Settings**, then press **MENU/SELECT**.
3. Use **▼CID** or **▲DIR** to scroll to **Rename handset**, then press **MENU/SELECT**.
4. Change the handset name when prompted.
 - Press **▼CID** or **▲DIR** to move the cursor to the left or right.
 - Use the dialing keys to enter a name (up to 11 characters). Each time you press a key, a character on that key appears. Additional key presses produce other characters on that key. See the chart on page 64.
 - Press **MUTE/DELETE** to backspace and delete a character.
 - Press and hold **MUTE/DELETE** to delete all characters.
5. Press **MENU/SELECT** to save the setting and return to the previous menu. There is a confirmation tone.



Key tone

The handset is set to beep with each key press. You can adjust the key tone volume or turn it off. If you turn off the key tone, there are no beeps when you press the keys.

1. Press **MENU/SELECT** in idle mode to enter the main menu.
2. Use **▼CID** or **▲DIR** to scroll to **Settings**, then press **MENU/SELECT**.
3. Use **▼CID** or **▲DIR** to scroll to **Key tone**, then press **MENU/SELECT**.
4. Use **▼CID** or **▲DIR** to select the desired volume or **Off**.
5. Press **MENU/SELECT** to save your preference. There is a confirmation tone and the screen returns to the previous menu.

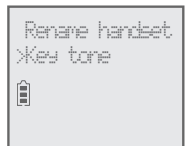

Handset settings

Use caller ID to automatically set date and time

If you subscribe to caller ID service, the day, month and time are set automatically with each incoming call. Follow the steps to turn the **CID time sync** feature on or off. The default setting is **On**.

1. When the handset is in idle mode, press **MENU/SELECT** to enter the main menu.
2. Press **▼CID** or **▲DIR** to scroll to **Settings**, then press **MENU/SELECT**.
3. Press **▼CID** or **▲DIR** to scroll to **CID time sync**, then press **MENU/SELECT**.
4. Press **▼CID** or **▲DIR** to highlight **On** or **Off**, then press **MENU/SELECT** to save. There is a confirmation tone and the screen returns to the previous menu.



Home area code

If you dial seven digits to make a local call (no area code required), enter your area code into the telephone as the home area code. When you receive a call from within your home area code, the caller ID log only displays the seven digits of the telephone number.

This feature makes it easy for you to place a call from the caller ID log. If you dial ten digits to make a local phone call, do not use this home area code feature. If you do, you cannot place local calls from your caller ID log, as they will have only seven digits.

To set the home area code:

1. Press **MENU/SELECT** in idle mode to enter the main menu.
2. Use **▼CID** or **▲DIR** to scroll to **Settings**, then press **MENU/SELECT**.
3. Use **▼CID** or **▲DIR** to scroll to **Home area code**, then press **MENU/SELECT**. The screen briefly shows **Only for 7digit dial from CID**.
4. Use the dialing keys to enter a three-digit home area code.
 - Press **MUTE/DELETE** to delete a digit.
 - Press and hold **MUTE/DELETE** to delete all digits.
5. Press **MENU/SELECT** to save. There is a confirmation tone and the screen shows **Area code will not show in CID** briefly before returning to the previous menu.



Handset settings



Note: If in the future, your telephone service provider requires you to dial ten digits to make a local call (area code plus telephone number), you need to delete your home area code and dial out locally from the call ID log. With the home area code displayed, **press and hold MUTE/DELETE** until the digits are deleted, and then press **MENU/SELECT**. The home area code is now restored to its default setting of ___ (empty).

Dial mode

The dial mode is preset to tone dialing. If you have pulse (rotary) service, you must change the dial mode to pulse dialing before using the telephone.

To set the dial mode:

1. Press **MENU/SELECT** in idle mode to enter the main menu.
2. Use **▼CID** or **▲DIR** to scroll to **Settings**, then press **MENU/SELECT**.
3. Use **▼CID** or **▲DIR** to scroll to **Dial mode**, then press **MENU/SELECT**.
4. Use **▼CID** or **▲DIR** to highlight **Touch-tone** or **Pulse**, then press **MENU/SELECT**. The screen shows **DIAL MODE is touch-tone** or **DIAL MODE is pulse**. There is a confirmation tone and the screen returns to the previous menu.



Web address

Use this feature to view the AT&T website address.

1. Press **MENU/SELECT** in idle mode to enter the main menu.
2. Use **▼CID** or **▲DIR** to scroll to **Web address**, then press **MENU/SELECT**.



QUIET mode

When **QUIET** mode is turned on, the telephone silences all sounds during the set period of time (1-12 hours). However, the handset locator paging tone and any sound-generating operations initiated by users, such as making calls using the speakerphone or setting ringer volume, will sound as normal. After you turn on **QUIET** mode, this feature activates immediately and the answering system turns on automatically. When **QUIET** mode is on, the answering system takes calls and records messages without broadcasting them.

To turn QUIET mode on:

1. Press and hold QUIET # in idle mode to enter the **QUIET** mode setting screen. The screen shows **Quiet: __ hours (1-12 hours)**.
2. Use the dialing keys to enter the desired number of hours (1-12) you would like to turn on **QUIET** mode, then press **MENU/SELECT**. Your screen briefly shows **Answering sys is ON** and then **Quiet mode on**.

To turn QUIET mode off:

- ▶ While **QUIET** mode is on, press and hold QUIET #. The screen shows **Quiet mode is off** and you hear a confirmation tone.



Notes:

- ▶ If you change the base ringer, handset ringer, ringer volume, key tone, or caller ID announce features when **QUIET** mode is on, the sample plays but the feature is still muted after saving the setting.
- ▶ After **QUIET** mode is turned off or the set period of time has expired, all muted features will be activated again.
- ▶ The PTT function is not available when **QUIET** mode is on.
- ▶ Intercom is available during **QUIET** mode, but the handset will not ring.
- ▶ When **QUIET** mode is on, and Smart call blocker is on and in screening mode, all screened calls will be sent to the answering system after screening. For more information on Smart call blocker, see page 81.

Telephone base settings

Use the menu to change the telephone settings.

1. Press **MENU/SELECT** on the telephone base when it is not in use to enter the main menu.
2. Press **▼CID** or **▲DIR** to scroll to the feature to be changed. When scrolling through the menu, the **►** symbol indicates the selected menu item.
3. Press **MENU/SELECT** to select the highlighted item.



>Play messages
Answering sys



Note: Press **CANCEL** to cancel an operation, back up to the previous menu or exit the menu display. Press and hold **CANCEL** to return to idle mode.

Telephone base settings

Ringer volume

You can set the ringer volume level to one of six levels or turn the ringer off. When the ringer is off,  appears on the screen.

1. Press **MENU/SELECT** in idle mode to enter the main menu.
2. Use **▼CID** or **▲DIR** to scroll to **Ringers**, then press **MENU/SELECT**.
3. Press **MENU/SELECT** again to select **Ringer volume**.
4. Press **▼CID** or **▲DIR** to sample each volume level.
5. Press **MENU/SELECT** to save your preference. There is a confirmation tone and the screen returns to the previous menu.



Notes:

- ▶ The telephone base ringer volume also determines the ringer volume for intercom calls.
- ▶ If the ringer volume is set to off, the telephone base is silenced for all incoming calls.
- ▶ If the ringer volume is set to off, the caller ID will not be announced and the screen will briefly display **Caller ID won't be announced**.

Ringer tone

You can choose one of ten ringer tones.

1. Press **MENU/SELECT** in idle mode to enter the main menu.
2. Use **▼CID** or **▲DIR** to scroll to **Ringers**, then press **MENU/SELECT**.
3. Press **▼CID** or **▲DIR** to scroll to **Ringer tone**, then press **MENU/SELECT**.
4. Press **▼CID** or **▲DIR** to sample each ringer tone.
5. Press **MENU/SELECT** to save your preference. There is a confirmation tone and the screen returns to the previous menu.

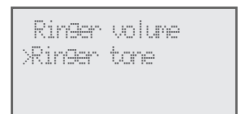

Note: If you turn off the ringer volume, you will not hear ringer tone samples.

Telephone base settings

Set date/time

The answering system announces the day and time of each message prior to playing it. Before using the answering system, set the date and time as follows. If you subscribe to caller ID service, the day, month and time are set automatically with each incoming call. The year must be set so that the day of the week can be calculated from the caller ID information. You can turn off the date and time settings of the caller ID service and set the date and time manually (see **Use caller ID to automatically set date and time** on page 36).

After a power failure, the system prompts you to set the date and time.

To set the date and time manually:

1. When the telephone base is in idle mode, press **MENU/SELECT** to enter the main menu.
2. Press **▼CID** or **▲DIR** to scroll to **Set date/time** and then press **MENU/SELECT**.
3. Press **▼CID** or **▲DIR** to select the month, then press **MENU/SELECT**, or enter the number using the dialing keys.
4. Press **▼CID** or **▲DIR** to select the day, then press **MENU/SELECT**, or enter the number using the dialing keys.
5. Press **▼CID** or **▲DIR** to select the year, or enter the number using the dialing keys, then press **MENU/SELECT** to move on to set the time.
6. Press **▼CID** or **▲DIR** to select the hour, then press **MENU/SELECT**, or enter the number using the dialing keys.
7. Press **▼CID** or **▲DIR** to select the minute, then press **MENU/SELECT**, or enter the number using the dialing keys.
8. Press **▼CID** or **▲DIR** to highlight **AM** or **PM**, or press **2** for **AM** or **7** for **PM**. Press **MENU/SELECT** to confirm. There is a confirmation tone and the screen returns to the previous menu.



Notes: If the clock is not set when a message is recorded, the system announces, "Time and day not set," before it plays the message.

Telephone base settings

LCD language

You can select the language used for all screen displays.

1. Press **MENU/SELECT** in idle mode to enter the main menu.
2. Use **▼CID** or **▲DIR** to scroll to **Settings**, then press **MENU/SELECT**.
3. Press **MENU/SELECT** to choose **LCD language**.
4. Press **▼CID** or **▲DIR** to highlight **English**, **Français** or **Español**, then press **MENU/SELECT**. The screen prompts **Set English/Français/Español as LCD language?**.
5. Press **MENU/SELECT** to confirm and save your preference. There is a confirmation tone and the screen returns to the previous menu.

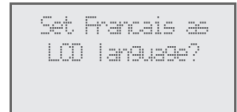
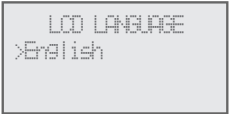

Note: If you accidentally change the LCD language to French or Spanish, you can reset it back to English without going through the French or Spanish menus. Press **MENU/SELECT** on the base in idle mode, then enter **364#**. There is a confirmation tone.

Telephone base settings

Caller ID announce

The caller ID announce feature lets you know who's calling without having to look at the display. When you have an incoming call, the handset and/or base speaks "Call from..." and the name of the caller based on the directory or caller ID information. If the caller's name is private or unknown, the phone number up to the last 11 digits will be announced. If the caller's phone number is also private or unknown, no information will be announced. The default setting is **On**.

To turn on or off the caller ID announce feature:

1. Press **MENU/SELECT** in idle mode to enter the main menu.
2. Use **▼CID** or **▲DIR** to scroll to **Settings**, then press **MENU/SELECT**.
3. Use **▼CID** or **▲DIR** to scroll to **Caller ID annc**, then press **MENU/SELECT**.
4. Use **▼CID** or **▲DIR** to highlight the desired option, then press **MENU/SELECT**.
 - **Set all On/Off** - Change the setting for the base and all handsets.
 - **Base** - Change the setting for the telephone base only.
5. Use **▼CID** or **▲DIR** to highlight **On** or **Off**, then press **MENU/SELECT**. There is a confirmation tone and the screen returns to the previous menu. If you change the setting to **Set all On/Off**, the screen shows **CID Ann ON/OFF on all HS & BS**.

```
LCD language
>Caller ID annc
```

```
BS CID ANNOUNCE
>On
```



Notes:

- ▶ To use the caller ID announce feature, you must subscribe to caller ID service from your telephone service provider.
- ▶ If you have paired an AT&T **TL80133** DECT 6.0 cordless speakerphone to the telephone base, the caller ID announce setting for all devices also applies to the cordless speakerphone. When the setting is **On**, the cordless speakerphone speaks "Call from..." and the name of the caller based on the directory or caller ID information during an incoming call. If the caller's name is unavailable, the phone number up to the last 11 digits will be announced.
- ▶ This feature does not announce information for call waiting calls.
- ▶ It takes at least 2 rings for the phone to receive caller ID information and announce it. If the phone is answered before the end of the second ring, the phone won't have time to announce the caller's information.
- ▶ Pronunciation of names may vary with this feature. Not all names may be pronounced correctly.
- ▶ Caller ID announce is available in English only.

Telephone base settings

Set speed dial voicemail number

This feature lets you save your voicemail number for easy access when you press and hold the  **1** key.

To save your voicemail number:

1. Press **MENU/SELECT** in idle mode to enter the main menu.
2. Use **▼CID** or **▲DIR** to scroll to **Settings**, then press **MENU/SELECT**.
3. Use **▼CID** or **▲DIR** to scroll to **Voicemail #**, then press **MENU/SELECT**.
4. Use the dialing keys to enter the voicemail access number provided by your telephone service provider (up to 30 digits) when prompted.
 - ▶ Press **▼CID** or **▲DIR** to move the cursor to the left or right.
 - ▶ Press **MUTE/DELETE** on the telephone base to erase a digit.
 - ▶ Press and hold **MUTE/DELETE** on the telephone base to erase all digits.
 - ▶ Press **REDIAL/PAUSE** to enter a three-second dialing pause (a **p** appears).
5. Press **MENU/SELECT** to save. There is a confirmation tone and the screen displays **Voicemail # saved**, then returns to the previous menu.

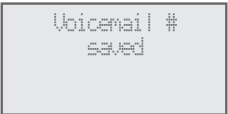
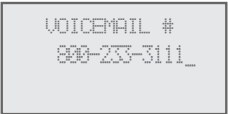

Voicemail (visual message waiting) indicator

If you subscribe to a voicemail service offered by your telephone service provider, this feature provides a visual indication when you have new voicemail messages.

New voicemail and the  icon appear on the telephone base screen.



Notes:

- ▶ This feature does not indicate new messages recorded on your phone's built-in answering system.
- ▶ For more information about the difference between your answering system and voicemail, see page 126.

Telephone base settings

Clear voicemail indication

Use this feature when the telephone indicates there is new voicemail but there is none. For example, when you have accessed your voicemail while away from home. This feature only turns off the displayed **New voicemail** and the  icon; it does not delete your voicemail messages. As long as you have new voicemail messages, your telephone service provider continues to send the signal to turn on the indicators.



To manually turn off the new voicemail indicators:

1. Press **MENU/SELECT** when in idle mode to enter the main menu.
2. Use **▼CID** or **▲DIR** to scroll to **Settings**, then press **MENU/SELECT**.
3. Use **▼CID** or **▲DIR** to scroll to **Clr voicemail**, then press **MENU/SELECT**. The screen shows **Reset Voicemail Indicator?**
4. Press **MENU/SELECT** again to turn the voicemail indication off. There is a confirmation tone and the screen returns to the previous menu.



Notes:

- ▶ Your telephone service provider voicemail may alert you to new messages with a stutter (broken) dial tone. Contact your telephone service provider for more details.
- ▶ For information about using your voicemail service, contact your telephone service provider.

Telephone base settings

Rename base

You can edit the name for the telephone base.

1. When the telephone is idle, press **MENU/SELECT**.
2. Use **▼CID** or **▲DIR** to scroll to **Settings**, then press **MENU/SELECT**.
3. Use **▼CID** or **▲DIR** to scroll to **Rename base**, then press **MENU/SELECT**.
4. Change the telephone base name when prompted.
 - Press **▼CID** or **▲DIR** to move the cursor to the left or right.
 - Use the dialing keys to enter a name (up to 11 characters). Each time you press a key, a character on that key appears. Additional key presses produce other characters on that key. See the chart on page 64.
 - Press **MUTE/DELETE** to backspace and delete a character.
 - Press and hold **MUTE/DELETE** to delete all characters.
5. Press **MENU/SELECT** to save the setting and return to the previous menu. There is a confirmation tone.

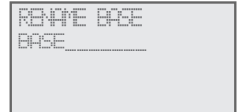

Key tone

The telephone base is set to beep with each key press. You can adjust the key tone volume or turn it off. If you turn off the key tone, there are no beeps when you press keys.

1. Press **MENU/SELECT** in idle mode to enter the main menu.
2. Use **▼CID** or **▲DIR** to scroll to **Settings**, then press **MENU/SELECT**.
3. Use **▼CID** or **▲DIR** to scroll to **Key tone**, then press **MENU/SELECT**.
4. Use **▼CID** or **▲DIR** to select the desired volume or **Off**.
5. Press **MENU/SELECT** to save your preference. There is a confirmation tone and the screen returns to the previous menu.

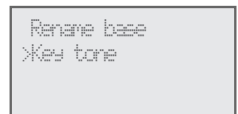

Telephone base settings

Use caller ID to automatically set date and time

If you subscribe to caller ID service, the day, month and time are set automatically with each incoming call. Follow the steps, as mentioned below, to turn the **CID time sync** feature on or off. The default setting is **On**.

1. When the telephone base is in idle mode, press **MENU/SELECT** to enter the main menu.
2. Press **▼CID** or **▲DIR** to scroll to **Settings**, then press **MENU/SELECT**.
3. Press **▼CID** or **▲DIR** to scroll to **CID time sync**, then press **MENU/SELECT**.
4. Press **▼CID** or **▲DIR** to highlight **On** or **Off**, then press **MENU/SELECT** to save. There is a confirmation tone and the screen returns to the previous menu.



Key tone
XCID time sync



CID TIME SYNC
XOn

Home area code

If you dial seven digits to make a local call (no area code required), enter your area code into the telephone as the home area code. When you receive a call from within your home area code, the caller ID log only displays the seven digits of the telephone number.

This feature makes it easy for you to place a call from the caller ID log. If you dial ten digits to make a local phone call, do not use this home area code feature. If you do, you cannot place local calls from your caller ID log, as they will have only seven digits.

To set the home area code:

1. Press **MENU/SELECT** in idle mode to enter the main menu.
2. Use **▼CID** or **▲DIR** to scroll to **Settings**, then press **MENU/SELECT**.
3. Use **▼CID** or **▲DIR** to scroll to **Home area code**, then press **MENU/SELECT**. The screen briefly shows **Only for 7digit dial from CID**.
4. Use the dialing keys to enter a three-digit home area code.
 - Press **MUTE/DELETE** to delete a digit.
 - Press and hold **MUTE/DELETE** to delete all digits.
5. Press **MENU/SELECT** to save. There is a confirmation tone and the screen shows **Area code will not show in CID** briefly before returning to the previous menu.



CID time sync
XHome area code



HOME AREA CODE

Telephone base settings



Note: If in the future, your telephone service provider requires you to dial ten digits to make a local call (area code plus telephone number), you need to delete your home area code and dial out locally from the caller ID log. With the home area code displayed, **press and hold MUTE/DELETE** until the digits are deleted, and then press **MENU/SELECT**. The home area code is now restored to its default setting of ___ (empty).

Dial mode

The dial mode is preset to tone dialing. If you have pulse (rotary) service, you must change the dial mode to pulse dialing before using the telephone.

To set the dial mode:

1. Press **MENU/SELECT** in idle mode to enter the main menu.
2. Use **▼CID** or **▲DIR** to scroll to **Settings**, then press **MENU/SELECT**.
3. Use **▼CID** or **▲DIR** to scroll to **Dial mode**, then press **MENU/SELECT**.
4. Use **▼CID** or **▲DIR** to highlight **Touch-tone** or **Pulse**, then press **MENU/SELECT**. The screen shows **DIAL MODE is touch-tone** or **DIAL MODE is pulse**.

```
Home area code
XDial mode
```

```
DIAL MODE
XTouch-tone
```

There is a confirmation tone and the screen returns to the previous menu.

Web address

Use this feature to view the AT&T website address.

1. Press **MENU/SELECT** in idle mode to enter the main menu.
2. Use **▼CID** or **▲DIR** to scroll to **Web address**, then press **MENU/SELECT**.

```
Settings
XWeb address
```

```
www.telephones.
att.com
```

Telephone operation

Making a call

Using a cordless handset:

- Press **\ PHONE/FLASH** or **📞/SPEAKER**, then enter the telephone number.

The screen displays the elapsed time as you talk (in hours, minutes and seconds).



Using the telephone base:

- Press **📞/SPEAKER**, then enter the telephone number.

The screen displays the elapsed time as you talk (in hours, minutes and seconds).



 Note: Pressing **\ PHONE/FLASH** or **📞/SPEAKER** to access services from your telephone service provider does not affect the elapsed time.

On hook dialing (predialing)

Using a cordless handset:

- Enter the telephone number. Press **MUTE/DELETE** to make corrections when entering the phone number.
- Press **\ PHONE/FLASH** or **📞/SPEAKER** to dial.

Using the telephone base:

- Enter the telephone number. Press **MUTE/DELETE** to make corrections when entering the phone number.
- Press **📞/SPEAKER** to dial.

Answering a call

Using a cordless handset:

- Press **\ PHONE/FLASH** or **📞/SPEAKER**.
- OR-**
- Press any dialing key (**0-9**, **TONE ✕** or **#**).

Using the telephone base:

- Press **📞/SPEAKER**.
- OR-**
- Press any dialing key (**0-9**, **TONE ✕** or **#**).

Telephone operation



Note: Smart call blocker is set to on by default. If your directory, allow list, star name list, and block list are empty, all calls will be classified as unknown calls. The telephone will screen all calls and ask callers to announce their names and press the pound key (#) before the calls ring on your telephone. We recommend that you set up your directory, allow list, star name list, and block list before using your telephone with the Smart call blocker feature. See **About Smart call blocker** on page 81.

Ending a call

Using a cordless handset:

- Press **OFF/CANCEL** or return the handset to the telephone base or charger.

Using the telephone base:

- Press **SPEAKER**.

Auto off

A call ends automatically when you put the handset in the telephone base or charger.

Temporary ringer silencing

Using a cordless handset:

Press **OFF/CANCEL** or **MUTE/DELETE** while the telephone is ringing to silence the ringer temporarily on that handset only. This turns off the ringer without disconnecting the call. The next incoming call rings normally at the preset volume.

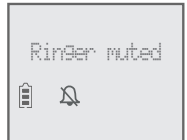

Using the telephone base:

Press **CANCEL** or **MUTE/DELETE** while the telephone is ringing to silence the ringer temporarily on the telephone base only. This turns off the ringer without disconnecting the call. The next incoming call rings normally at the preset volume.



Note: The telephone base and all handsets ring when there is an incoming call unless the ringer volume is turned off on that device.

Telephone operation

Handset speakerphone

During a call, press **🔊/SPEAKER** to switch between handsfree speakerphone and normal handset use. Press **📞/OFF/CANCEL** to hang up.

The speakerphone on the telephone activates as long as you make or answer calls by pressing the **🔊/SPEAKER**. Press **🔊/SPEAKER** to hang up.



Notes:

- ▶ When you use the speakerphone on the handset, the key pad and the **🔊/SPEAKER** button on the handset are lit. When you use the speakerphone on the telephone base, the **🔊/SPEAKER** button on the telephone base is lit.
- ▶ The speakerphone uses more power than the normal handset. If the handset battery becomes very low while you are using the speakerphone, the call remains in speakerphone mode until you hang up or the battery becomes depleted.
- ▶ After installing a battery into the handset, the screen may show **Low battery**. If you use the speakerphone at this time, the battery may become depleted. Follow the instructions in the **Battery installation and charging** section on pages 11-12.

Last number redial

Each handset and the telephone base stores the last ten telephone numbers dialed (up to 30 digits each).

To view the ten most recently dialed numbers:

Using a cordless handset:

- ▶ To display the most recently called number, press **REDIAL/PAUSE**.
- ▶ To view up to ten recently called numbers, press **REDIAL/PAUSE**, then **▼CID**, **▲DIR** or **REDIAL/PAUSE** repeatedly.

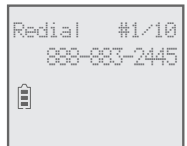

The handset beeps twice at the end of the list. Press **📞/OFF/CANCEL** to exit.

Telephone operation

Using the telephone base:

- ▶ To display the most recently called number, press **REDIAL/PAUSE**.
- ▶ To view up to ten recently called numbers, press **REDIAL/PAUSE**, then **▼CID**, **▲DIR** or **REDIAL/PAUSE**, repeatedly.

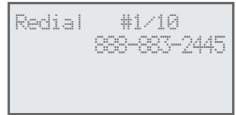

The telephone base beeps twice at the end of the list. Press **CANCEL** to exit.

To redial a number:

Using a cordless handset:

- ▶ To dial the displayed number, press **\PHONE/FLASH** or **📞/SPEAKER**.
-OR-
- ▶ Press **\PHONE/FLASH** or **📞/SPEAKER**, then press **REDIAL/PAUSE** repeatedly to view the redial memory. Press **MENU/SELECT** to dial the displayed number.

Using the telephone base:

- ▶ To dial the displayed number, press **📞/SPEAKER**.
-OR-
- ▶ Press **📞/SPEAKER**, then press **REDIAL/PAUSE** repeatedly to view the redial memory. Press **MENU/SELECT** to dial the displayed number.

To delete a redial entry:

Using a cordless handset:

- ▶ While the screen displays the desired number, press **MUTE/DELETE** to delete the number from the redial memory.

Using the telephone base:

- ▶ While the screen displays the desired number, press **MUTE/DELETE** to delete the number from the redial memory.

Telephone operation

Equalizer

The equalizer feature enables you to change the quality of the audio to best suit your hearing.

Using a cordless handset or the telephone base:

1. While on a call or intercom call, press **MENU/SELECT**.
2. Press **MENU/SELECT** to select **Equalizer**.
3. Press **▼CID** or **▲DIR** to select **Treble 1**, **Treble 2**, **Bass** or **Natural** (the default setting). The current setting is shown on the screen for two seconds.



Notes:

- ▶ If you switch the call between the handset and the speakerphone by pressing **🔊/SPEAKER**, the audio setting remains unchanged.
- ▶ The current equalizer setting remains unchanged until a new setting is selected.

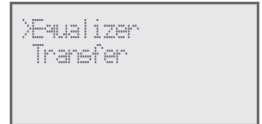

Options while on calls

Volume control

Using a cordless handset:

You can set the listening volume to one of six levels. While on a call, press **▼CID/VOLUME** to decrease or press **▲DIR/VOLUME** to increase the listening volume.

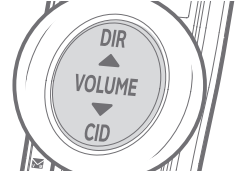

Using the telephone base:

You can set the listening volume to one of eight levels.

While on a call, press **▼/VOL** to decrease or **▲/VOL** to increase the listening volume.

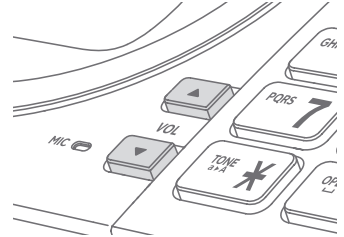

Notes:

- ▶ Handset and speakerphone volume settings are independent.
- ▶ When the volume reaches the minimum or maximum setting, you hear two beeps.

Call waiting

If you subscribe to call waiting service from your telephone service provider, and someone calls while you are already on a call, you hear two beeps.

- ▶ Press **\PHONE/FLASH** on the handset or **FLASH/PTT** on the telephone base to put your current call on hold and take the new call.
- ▶ Press **\PHONE/FLASH** on your handset or **FLASH/PTT** on your telephone base at any time to switch back and forth between calls.



Note:

- ▶ If the Smart call blocker is on and in screening mode, and you receive a call waiting call:
 - If you have already picked up a screened call, the telephone checks whether the call waiting number can be found in the directory, block list or allow list. It also checks whether the caller name is in the star name list. After that, the telephone displays the caller ID information or **Blocked call** accordingly. You can press **\PHONE/FLASH** or **☎/SPEAKER** to take the new call, or press **CALL BLOCK** on the handset or telephone base to block it.
 - If the telephone is screening a call, the call waiting call will be ignored and logged as missed call in the caller ID log.

Options while on calls

Mute

Use the mute function to turn off the microphone. You can hear the caller, but the caller cannot hear you.

Using a cordless handset:

To mute a call:

- While on a call, press **MUTE/DELETE**. When mute is on, the handset shows **Muted** for a few seconds and **MUTE** icon displays until you turn off mute.

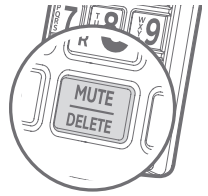

To end mute a call:

- Press **MUTE/DELETE** again. When mute is off, **Microphone ON** appears temporarily on the handset.



Using the telephone base:

To mute a call:

- While on a call, press **MUTE/DELETE**. When mute is on, the telephone base shows **Muted** for a few seconds.

To end mute a call:

- Press **MUTE/DELETE** again. When mute is off, **Microphone ON** appears temporarily on the telephone base.

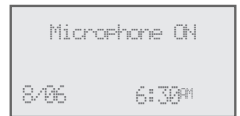
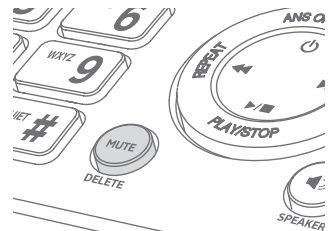

Options while on calls

Chain dialing

Use this feature to initiate a dialing sequence from the numbers in the directory, caller ID log or redial memory while you are on a call.

Chain dialing is useful when you wish to access other numbers (such as bank account numbers or access codes) from the directory, caller ID log or redial list.

Using a cordless handset:

To access the directory while on a call:

1. Press **MENU/SELECT**.
2. Press **▼CID** or **▲DIR** to scroll to **Directory** and then press **MENU/SELECT**.
3. Press **▼CID** or **▲DIR** to scroll to the desired number.
4. Press **MENU/SELECT** to dial the number shown.



To access the caller ID log while on a call:

1. Press **MENU/SELECT**.
2. Press **▼CID** or **▲DIR** to scroll to **Caller ID log**, then press **MENU/SELECT**.
3. Press **▼CID** or **▲DIR** to scroll to the desired number.
4. Press **MENU/SELECT** to dial the number shown.



To access the redial list while on a call:

1. Press **REDIAL/PAUSE** to show the most recently dialed number.
2. Press **▼CID** or **▲DIR** to scroll to the desired number, or press **REDIAL/PAUSE** repeatedly to find the desired number. Press **MENU/SELECT** to dial the number shown.

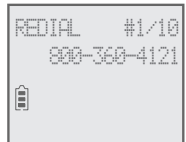

Options while on calls

Using the telephone base:

To access the directory while on a call:

1. Press **MENU/SELECT**.
2. Press **▼CID** or **▲DIR** to scroll to **Directory** and then press **MENU/SELECT**.
3. Press **▼CID** or **▲DIR** to scroll to the desired number.
4. Press **MENU/SELECT** to dial the number shown.

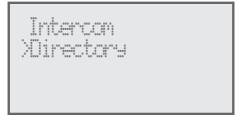

To access the caller ID log while on a call:

1. Press **MENU/SELECT**.
2. Press **▼CID** or **▲DIR** to scroll to **Caller ID log**, then press **MENU/SELECT**.
3. Press **▼CID** or **▲DIR** to scroll to the desired number.
4. Press **MENU/SELECT** to dial the number shown.



To access the redial list while on a call:

1. Press **REDIAL/PAUSE** to show the most recently dialed number.
2. Press **▼CID** or **▲DIR** to scroll to the desired number, or press **REDIAL/PAUSE** repeatedly to find the desired number. Press **MENU/SELECT** to dial the number shown.

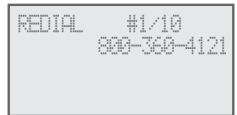

Notes:

- ▶ You cannot edit a directory entry while on a call. For more details about the directory, see pages 62-71.
- ▶ You cannot copy a caller ID entry into the directory while on a call. For more details about the caller ID log, see page 73.
- ▶ If you press **REDIAL/PAUSE** while on a call, you can only view the ten most recently dialed numbers but you cannot erase the entries. For more details about the redial memory, see page 40.
- ▶ Press **OFF/CANCEL** on the handset or **CANCEL** on the telephone base to exit redial, directory or caller ID log when on a call.

Options while on calls

Temporary tone dialing

If you have pulse (rotary) service only, you can switch from pulse to touch-tone dialing temporarily during a call. This is useful if you need to send touch-tone signals to access your telephone banking or long distance services.

1. During a call, press **TONEX**.
2. Use the dialing keys to enter the desired number. The telephone sends touch-tone signals.
3. The telephone automatically returns to pulse dialing after you end the call.

Blind transfer

While on an outside call, you can transfer the call to a specific device or any device without notifying them.

To transfer an outside call from a handset:

1. During the call, press **MENU/SELECT**.
2. Press **▼CID** or **▲DIR** to scroll **Transfer**, then press **MENU/SELECT**.
 - If you have one handset and no other registered devices, the outside call is put on hold and your handset shows **Transferring call...** The telephone base rings and shows **Transfer from HANDSET X**.
 - If you have other registered device(s) or more than one handset, your screen shows **TRANSFER TO:**. Use the dialing keys to enter a specific device number (**0** for the telephone base, **1-9** for handsets 1-9, **TONEX** followed by **0-2** for handsets 10-12, or **TONEX** followed by **#** for all devices), or press **▼CID** or **▲DIR** to scroll to the desired device and press **MENU/SELECT**. The outside call is put on hold and your handset screen shows **Transferring call...** or **Transferring call to all...** The other device rings and shows **Transfer from HANDSET X (HANDSET** represents the handset name, **X** represents the handset number).
3. To answer the call on the destination handset, press **\PHONE/FLASH** or **🔊/SPEAKER**. To answer the call on the telephone base, press **🔊/SPEAKER**. The initiating handset shows **Call transferred** and goes to idle mode.



Options while on calls

To transfer an outside call from the telephone base:

1. During the call, press **MENU/SELECT**.
2. Press **▼CID** or **▲DIR** to scroll **Transfer**, then press **MENU/SELECT**.
 - If you have one handset and no other registered devices, the outside call is put on hold and the telephone base shows **Transferring call...** The handset rings and shows **Transfer from BASE 0** (**BASE** represents the base name).
 - If you have other registered device(s) or more than one handset, the telephone base shows **TRANSFER TO:** Use the dialing keys to enter a specific handset number (**1-9** for handsets 1-9, **TONEX** followed by **0-2** for handsets 10-12, or **TONEX** followed by **#** for all handsets), or press **▼CID** or **▲DIR** to scroll to the desired handset and press **MENU/SELECT**. The outside call is put on hold and the telephone base shows **Transferring call...** or **Transferring call to all...** The other handset(s) rings and shows **Transfer from BASE 0** (**BASE** represents the base name).
3. To answer the call on the destination handset, press **\PHONE/FLASH** or **📞/SPEAKER**. The telephone base shows **Call transferred** and goes to idle mode.

```
Speaker  0:00:12
8/06    6:38PM
```

```
>Transfer
Intercom
```

```
TRANSFER TO:
>Handset      2
```



Notes:

- To cancel the transfer and return to the external call before the blind transfer call is answered, press **📞/OFF/CANCEL**, **\PHONE/FLASH** or **📞/SPEAKER** on your handset, or **CANCEL** or **📞/SPEAKER** on your telephone base.
- If the other device does not answer the transfer within 30 seconds, the transfer ends and the initiating device rings while showing **No response to transfer**. If it does not pick up within 30 seconds, the device returns to idle mode and the outside call ends.

Multiple handset use

Handset locator

The handset locator feature is useful if you misplace any handsets.

To start the paging tone:

- Press **FIND HS** on the telephone base to start the paging tone on all handsets for 60 seconds.

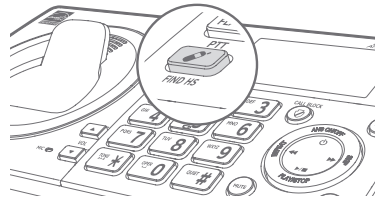

Note: If you press **OFF/CANCEL** or **MUTE/DELETE** on a handset, the ringer of that handset stops, but the paging to the rest of the handsets continues.

To stop the paging tone:

- Press **PHONE/FLASH**, **SPEAKER**, or any dialing key (**0-9**, **TONE** or **#**) on the handset(s).
- OR-
- Press **FIND HS** or **CANCEL** on the telephone base.

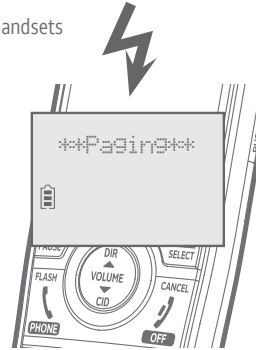

Join a call in progress

When a handset or the telephone base is already on a call and you would like to join the call, press **PHONE/FLASH** or **SPEAKER** on your handset or **SPEAKER** on your telephone base.

To end the call using a handset, press **OFF/CANCEL** or place the handset in the telephone base or charger. To end the call using the telephone base, press **SPEAKER**. The call does not end until all handsets and the telephone base hang up.

Note: You can use up to four system handsets and the telephone base at the same time on an outside call.

Intercom

Use the intercom feature for conversations between two handsets, a handset and the telephone base, or a handset/telephone base and a cordless headset/speakerphone (sold separately). You can buy additional expansion handsets (model AT&T CL80107), cordless headsets and speakerphones for this telephone base to expand your telephone system (up to 12 handsets or 10 cordless handsets and two cordless headsets/speakerphones).

Using a cordless handset:

1. Press **MENU/SELECT** in idle mode to enter the main menu. Press **▼CID** or **▲DIR** to scroll to **Intercom**, then press **MENU/SELECT**.

- If you have one handset and no other registered devices, the handset shows **Calling base**.
- If you have cordless headset(s)/speakerphone(s) or more than one handset, the handset shows **INTERCOM TO:** Use the dialing keys to enter a specific device number (**0** for the telephone base, **1-9** for handsets 1-9, **TONEX** followed by **0-2** for handsets 10-12, **#** for a single headset/speakerphone, **#** followed by **1** or **2** for headset/speakerphone 1 or 2, or **TONEX** followed by **#** for all devices), or press **▼CID** or **▲DIR** to scroll to the desired device and press **MENU/SELECT**. Your handset screen shows **Calling HANDSET X**, **Calling BASE 0**, **Calling headset** or **Calling all devices**.



The destination device(s) rings and shows **HANDSET X is calling** or **HANDSET X is calling all** (**HANDSET** represents the handset name, **X** represents the handset number).

2. To answer the intercom call, press **\PHONE/FLASH, \SPEAKER** or any dialing key (**0-9**, **TONEX**, or **#**) on the called device. Both devices now show **Intercom**.
3. To end the intercom call, one party presses **/OFF/CANCEL**, or place the handset back in the telephone base or charger; or presses **CANCEL** on the telephone base. The other party hears four beeps. Both devices display **Intercom ended**.

Intercom

Using the telephone base:

1. When the telephone base is not in use, press **MENU/SELECT** to enter the main menu. Press **▼CID** or **▲DIR** to scroll to **Intercom**, then press **MENU/SELECT**.
 - If you have one handset and no other registered devices, the telephone base shows **Calling HANDSET X**.
 - If you have cordless headset(s)/speakerphone(s) or more than one handset, the telephone base shows **INTERCOM TO:** Use the dialing keys to enter a specific handset number (**1-9** for handsets 1-9, **TONEX** followed by **0-2** for handsets 10-12, **#** for a single headset/speakerphone, **#** followed by **1** or **2** for headset/speakerphone 1 or 2, or **TONEX** followed by **#** for all devices), or press **▼CID** or **▲DIR** to scroll to the desired handset and press **MENU/SELECT**. The telephone base shows **Calling HANDSET X** or **Calling all handsets**.



The destination device(s) rings and shows **Base 0 is calling** or **BASE 0 is calling all**.

2. To answer the intercom call, press **PHONE/FLASH**, **PHONE/SPEAKER** or any dialing key (**0-9**, **TONEX**, or **#**) on the destination handset. Both the base and the handset now show **Intercom**.
3. To end the intercom call, one party presses **OFF/CANCEL**, or places the handset back in the telephone base or charger; or presses **CANCEL** on the telephone base. The other party hears four beeps. Both devices display **Intercom ended**.



Notes:

- Before the intercom call is answered, you can cancel it by pressing **OFF/CANCEL** on the handset or **CANCEL** on the telephone base.
- If the called device is not answered within 100 seconds, or if it is accessing the directory, caller ID log, on a call or out of range, the initiating device shows **No answer. Try again**.
- To temporarily silence the intercom ringer, press **OFF/CANCEL** or **MUTE/DELETE** on the handset, or press **CANCEL** or **MUTE** on the telephone base.
- You can only use one pair of devices at a time to make intercom calls.
- For cordless headsets and speakerphones, refer to the corresponding user's manual on how to answer and end an intercom call.
- If a total of two cordless headset(s) and/or speakerphone(s) are registered to the telephone base, they appear as **HEADSET 1** and **HEADSET 2**, respectively, in the intercom menu.

Intercom

Answer an incoming call during an intercom call

If you receive an outside call during an intercom call, there is a two-beep call waiting tone.

- To answer the call, press **\ PHONE/FLASH** on the handset, or press **🔊/SPEAKER** twice on the telephone base. The intercom call ends automatically. The party on the intercom call hears four beeps. Other system devices can also answer the incoming call by pressing **\ PHONE/FLASH** or **🔊/SPEAKER** on the handset or **🔊/SPEAKER** on the telephone base.
- To end the intercom call without answering the incoming call, press **/OFF/CANCEL** on the handset or **CANCEL** on the telephone base.



Note: For cordless headsets and speakerphones, refer to the corresponding user's manual on how to answer an incoming call during an intercom call.

Call transfer using intercom

Use the intercom feature to transfer an outside call to another system handset or the telephone base. You can also share an outside call with another system handset or the telephone base.

To transfer or share an outside call using intercom:

Using a cordless handset:

1. During the call, press **MENU/SELECT**.
2. Press **▼CID** or **▲DIR** to scroll to **Intercom** and press **MENU/SELECT**.
3. Choose the device(s) you would like to transfer the call to using the options from Step 1 on page 50.
4. When the destination device picks up, your handset shows **Intercom** and the outside call is put on hold. You have the following options:
 - You can transfer the call. Press **MENU/SELECT**, then press **▼CID** or **▲DIR** to scroll to **Transfer** and press **MENU/SELECT**. The handset shows **Call transferred**. The other device automatically connects to the outside call.
 - You can let the other device join you on the outside call in a three-way conversation. Press **MENU/SELECT**. Press **▼CID** or **▲DIR** to highlight **Share call**, then press **MENU/SELECT**.
 - You can end the intercom call and continue the outside call with your handset. Press **PHONE/FLASH** on your handset (the ended intercom call party hears four beeps).



Using the telephone base:

1. During the call, press **MENU/SELECT**, then press **▼CID** or **▲DIR** to scroll to **Intercom** and press **MENU/SELECT**.
2. Choose the handset(s) you would like to transfer the call to using the options from Step 1 on page 51.
3. When the destination handset(s) picks up, the telephone base shows **Intercom** and the outside call is put on hold. You have the following options:
 - You can transfer the call. Press **MENU/SELECT**, then press **▼CID** or **▲DIR** to scroll to **Transfer** and press **MENU/SELECT**. The telephone base shows **Call transferred**. The other handset automatically connects to the outside call.
 - You can let the other handset join you on the outside call in a three-way conversation. Press **MENU/SELECT**. Press **▼CID** or **▲DIR** to highlight **Share call**, then press **MENU/SELECT**.
 - You can end the intercom call and continue the outside call with the telephone base. Press **CANCEL** on the telephone base (the ended intercom call party hears four beeps).

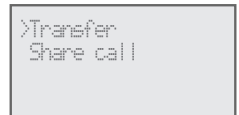

Multiple handset use

Push-to-talk (PTT)

You can directly broadcast messages to the speakerphone of any device. Press and hold **PUSH TO TALK** on a handset or **FLASH/PTT** on the telephone base to begin two-way communication.

- ▶ Only one device can talk at a time. While talking to another device, press and hold **PUSH TO TALK** on the handset or **FLASH/PTT** on the telephone base.
- ▶ You must release **PUSH TO TALK** on the handset or **FLASH/PTT** on the telephone base, so the other person can respond.
- ▶ Only one PTT session can be active at a time.
- ▶ While PTT is in use between two devices, other devices cannot use the intercom feature but can access the answering system.
- ▶ When you attempt to place a PTT call to another device which is accessing the answering system or on an intercom call or outside call, your device screen shows **Not available at this time**.

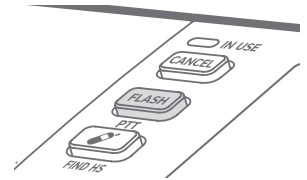
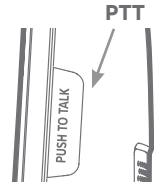

Note: The PTT function is not available when **QUIET** mode is on.

Turn PTT on or off

Using a cordless handset:

1. Press **PUSH TO TALK** when the handset is not in use. The **PUSH TO TALK** menu displays.
2. Press **▼CID** or **▲DIR** to highlight **PTT On/Off**, then press **MENU/SELECT**.
3. Press **▼CID** or **▲DIR** to choose **On** or **Off**, then press **MENU/SELECT**.



Using the telephone base:

1. Press **FLASH/PTT** when the telephone base is not in use. The **PUSH TO TALK** menu displays.
2. Press **▼CID** or **▲DIR** to highlight **PTT On/Off**, then press **MENU/SELECT**.
3. Press **▼CID** or **▲DIR** to choose **On** or **Off**, then press **MENU/SELECT**.



Note: The handset or the telephone base screen displays **No Incoming PTT** when PTT is turned off.

Push-to-talk (PTT)

PTT call to a single device

Using a cordless handset:

1. There are a few ways to begin a PTT call to a single device. When the handset is not in use:
 - If you have one handset, press and hold **PUSH TO TALK**.
 - If you have more than one handset:
 - Press **PUSH TO TALK** on the handset, then use the dialing keys to enter the destination device number.

-OR-

 - Press **PUSH TO TALK** on the handset. Press **▼CID** or **▲DIR** to highlight the destination device number, then press **MENU/SELECT** or **PUSH TO TALK**.

The handset shows **Connecting to HANDSET X...** (**HANDSET** represents the handset name, **X** represents the destination handset number) or **Connecting to BASE 0...** (**BASE** represents the base name) for a few seconds. When the connection is made, both your and the destination device screens display **Press and hold [PTT] to talk**.

2. Press and hold **PUSH TO TALK**. A chirp indicates your microphone is on. Speak towards the device. Your voice is broadcast to the destination device.

While you are speaking, your handset shows **PTT To handset: X** or **PTT To base**.

3. Release **PUSH TO TALK** after speaking. Both devices beep once again and the screens show **Press and hold [PTT] to talk**, then you can press and hold **PUSH TO TALK** to continue speaking or the destination device can respond (see **Answer a PTT call** on page 59).
4. To end the PTT call, press **/OFF/CANCEL** or place the handset in the telephone base or charger. The handset shows **Push to talk ended**.



Push-to-talk (PTT)

Using the telephone base:

1. There are a few ways to begin a PTT call to a single handset. When the telephone base is not in use:
 - If you have one handset, press and hold **FLASH/PTT**.
 - If you have more than one handset:
 - Press **FLASH/PTT**, then use the dialing keys to enter the destination handset number.

-OR-

- Press **▼CID** or **▲DIR** to highlight the destination handset number, then press **MENU/SELECT** or **FLASH/PTT**.



PUSH TO TALK
XHANDSET X

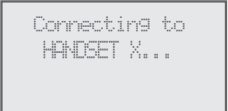

Connecting to
HANDSET X...



Press and hold
[PTT] to talk

The telephone base shows **Connecting to HANDSET**

X... (**HANDSET** represents the handset name, **X** represents the destination handset number) for a few seconds. When the connection is made, both the telephone base and destination handset display

Press and hold [PTT] to talk.

2. Press and hold **FLASH/PTT**. A chirp indicates your microphone is on. Speak towards the telephone base. Your voice is broadcast to the destination handset.

While you are speaking, the telephone base shows

PTT To handset: X.



PTT To
handset: X

3. Release **PTT** after speaking. Both devices beep once again and the screens show **Press and hold [PTT] to talk**, then you can press and hold **FLASH/PTT** to continue speaking or the destination device can respond (see **Answer a PTT call** on page 59).
4. To end the PTT call, press **CANCEL**. The telephone base shows **Push to talk Ended** for a few seconds.

Push-to-talk (PTT)

PTT call to multiple devices

When there are multiple handsets registered to the phone system, PTT supports one-to-group calls. PTT supports a maximum of one-to-five calls when one to five handsets are registered, and a maximum of one-to-four calls when six or more handsets are registered. The first four registered handsets will be able to use this feature. Other handsets can only use PTT for one-to-one calls.

To call multiple devices:

Using a cordless handset:

1. You have three ways to call multiple devices. When the handset is not in use:
 - Press and hold **PUSH TO TALK** until the handset shows **Connecting to group...**
 - Press **PUSH TO TALK**. Press **▼CID** or **▲DIR** to choose **Group**. Press **MENU/SELECT** or press **PUSH TO TALK** and your handset shows **Connecting to group...**
 - Press **PUSH TO TALK**. Press **TONEX** followed by **#** (pound key). The handset shows **Connecting to group...**

When the connection is made, both the caller and the destination parties hear a beep. The speakerphones on all other devices automatically activate.

2. You need to press and hold **PUSH TO TALK** when you want to speak. Speak towards the handset. Your voice is broadcast to all devices.
3. Release **PUSH TO TALK** after speaking.
4. Any extension can reply (see **Answer a PTT call** on page 59).

Push-to-talk (PTT)

Using the telephone base:

1. You have three ways to call multiple handsets. When the telephone base is not in use:
 - Press and hold **FLASH/PTT** until the screen shows **Connecting to group...**
 - Press **FLASH/PTT**. Press **▼CID** or **▲DIR** to choose **Group**. Press **MENU/SELECT** or press **FLASH/PTT** and the telephone base shows **Connecting to group...**
 - Press **FLASH/PTT**. Press **TONEX** followed by **#** (pound key). The screen shows **Connecting to group...**

When the connection is made, both the caller and the destination parties hear a beep. The speakerphones on all other devices automatically activate.
2. You need to press and hold **FLASH/PTT** when you want to speak. Speak towards the telephone base. Your voice is broadcast to all devices.
3. Release **FLASH/PTT** after speaking.
4. Any extension can reply (see **Answer a PTT call** on page 59).



Note: After **PUSH TO TALK** on the handset or **FLASH/PTT** on the telephone base is released, the PTT call remains open for a short time. If no one presses **PUSH TO TALK** on the handset or **FLASH/PTT** on the telephone base within ten seconds, the PTT call ends automatically.

Push-to-talk (PTT)

Answer a PTT call

You can respond to a PTT call, as described below.

1. When your device receives a PTT call, it beeps and shows **Press and hold [PTT] to talk**.
2. When the other party is speaking, your speakerphone light is on, and your device shows:
 - **PTT From HS X To HS X** (the first **X** represents the initiating handset number, and the second **X** represents your handset number; a maximum of four handset numbers appear).
 - OR-
 - **PTT From HS X To Base & HS X** (the first **X** represents the initiating handset number, and the second **X** represents your handset number; a maximum of four handset numbers appear).
 - OR-
 - **PTT From Base To HS X** (the **X** represents your handset number; a maximum of five handset numbers appear).
3. When your speakerphone light is off (the screen shows **Press and hold [PTT] to talk**), press and hold **PUSH TO TALK** on your handset or **FLASH/PTT** on your telephone base. You will hear a chirp. Speak towards the device.
 - While you are speaking, your device shows **PTT To Handset: X** (**X** represents the handset numbers of one or more destination handsets; a maximum of five handset numbers appear) or **PTT To Base & Handset: X** (**X** represents the handset numbers of one or more destination handsets; a maximum of four handset numbers appear).
 - Your voice is broadcast to all destination devices.

After speaking, release **PUSH TO TALK** on your handset or **FLASH/PTT** on your telephone base. Your device will beep. After the beep, if your speakerphone light is off, you can press and hold **PUSH TO TALK** on your handset or **FLASH/PTT** on your telephone base to continue speaking, or the destination device can respond.

Push-to-talk (PTT)

Change a one-to-one PTT call to an intercom call

You can convert a one-to-one PTT session to an intercom call.

1. When your device shows **Press and hold [PTT] to talk**, press **MENU/SELECT**. The screen shows **Intercom**.
2. Press **MENU/SELECT**. Your device displays **Calling BASE 0** or **Calling HANDSET X**. The destination device briefly shows **Push to talk Ended** and then **HANDSET X is calling** or **BASE 0 is calling**. The destination device rings.
3. Press **\ PHONE/FLASH** or any dialing keys (**0-9, #** or **TONEX**) on the destination handset, or press **📞/SPEAKER** or any dialing keys (**0-9, #** or **TOEX**) on the telephone base to answer the intercom call. Both devices now show **Intercom**.
4. To end the intercom call, press **📞/OFF/CANCEL** on your handset or place the handset in the telephone base or charger, or press **CANCEL** on the telephone base. Both screens show **Intercom ended**.

Answer an incoming call during a PTT call

When you receive an outside call during PTT, there is an alert tone.

- During a one-to-one PTT, press **\ PHONE/FLASH** on the initiating or destination handset. The PTT call ends automatically and the outside call is answered.
- During a one-to-group PTT call, press **\ PHONE/FLASH** on the initiating handset or **📞/SPEAKER** on the initiating telephone base. The PTT call ends automatically and the outside call is answered.
- During a one-to-group PTT call, press **\ PHONE/FLASH** on any one of the destination handsets, or press **📞/SPEAKER** on the destination telephone base. That device answers the outside call. The PTT call continues for the rest of the PTT participants.
- To leave the PTT call without answering the incoming call, press **📞/OFF/CANCEL** on your handset or **CANCEL** on your telephone base. The telephone continues to ring.

Push-to-talk (PTT)

Make an outgoing call during PTT call

- ▶ During a one-to-one PTT call, press **\ PHONE/FLASH** on your handset or **🔊/SPEAKER** on your telephone base to get a dial tone. The PTT call ends automatically.
- ▶ During a one-to-group PTT call, press **\ PHONE/FLASH** on the initiating handset or **🔊/SPEAKER** on the initiating telephone base. The PTT call ends automatically and you get a dial tone.
- ▶ During a one-to-group PTT call, press **\ PHONE/FLASH** on any one of the destination handsets or press **🔊/SPEAKER** on the destination telephone base. That device gets a dial tone. The PTT call continues for the rest of the PTT participants.

End or leave a PTT call

For one-to-one PTT calls, both initiating and destination devices can end the PTT call. For PTT calls to multiple devices, the initiating device can end the PTT call. If any one of the destination devices leaves the PTT call, the call continues until all participants or the initiator hangs up.

Press **🔊/OFF/CANCEL** on the handset, or press **CANCEL** on the telephone base. The screen shows **Push to talk Ended**.

-OR-

Place the handset in the telephone base or charger, then the handset returns to idle mode.



Note: After **PUSH TO TALK** on the handset or **FLASH/PTT** on the telephone base is released, the PTT call remains open for a short time. If no one presses **PUSH TO TALK** on the handset or **FLASH/PTT** on the telephone base within ten seconds, the PTT call ends automatically.

About the directory

Shared directory

The directory is shared by all handsets and the telephone base. Changes made to the directory from any device apply to all.



Notes:

- ▶ Only one handset or the telephone base can review the directory at a time. If another device tries to enter the directory, the screen shows **Not available at this time**.
- ▶ Directory entries can also be saved to the allow list or block list. See **Allow list** on page 93 and **Block list** on page 88.
- ▶ When Smart call blocker is on, calls with numbers saved in the directory will get through and ring on your telephone. If a number saved in the directory is also saved in the block list, calls from this number will be blocked.

Capacity

The directory can store up to 50 entries, with a maximum of 15 alphanumeric characters (including spaces) for names and 30 digits for telephone numbers. A convenient search feature can help you find and dial numbers quickly (page 66).

If you try to save an entry when there are already 50 entries, the screen shows **Directory full**. You cannot store a new number until you delete one.

Create directory entries

Create a new directory entry

1. Press **MENU/SELECT** in idle mode to enter the main menu.
2. Press **▼CID** or **▲DIR** to scroll to **Directory**, then press **MENU/SELECT**.
3. Press **▼CID** or **▲DIR** to highlight **Add contact**.
4. Press **MENU/SELECT**.
5. Use the dialing keys to enter a telephone number (up to 30 digits) when prompted.
 - Press **▼CID** or **▲DIR** to move the cursor to the left or right.
 - Press **MUTE/DELETE** on the handset or the telephone base to erase a digit.
 - Press and hold **MUTE/DELETE** on the handset or the telephone base to erase all digits.
 - Press and hold **REDIAL/PAUSE** to enter a three-second dialing pause (a **p** appears).

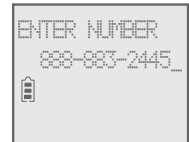

-OR-

Copy a number from the redial list by pressing **REDIAL/PAUSE**, then **▼CID**, **▲DIR**, or pressing **REDIAL/PAUSE** repeatedly to locate the number. Press **MENU/SELECT** to copy the number.

6. Press **MENU/SELECT** to move on to the name.
 - The display shows **Number already saved** if the number is already in the directory. You cannot save the same number twice.
7. Use the dialing keys to enter a name (up to 15 characters) when prompted. Each time you press a key, the character on that key appears. Additional key presses produce other characters on that key. See the chart on next page.
 - Press **▼CID** or **▲DIR** to move the cursor to the left or right.
 - Press **0** to add a space.
 - Press **MUTE/DELETE** on the handset or the telephone base to erase a character.
 - Press and hold **MUTE/DELETE** on the handset or the telephone base to erase all characters.
 - Press **TONE X** to change the next letter to upper or lower case.



Create directory entries



Note: The first letter of every word is a capital letter. The remaining letters in a word start as lower case letters, as shown in the chart below.

Dialing keys	Characters by number of key presses										
	1	2	3	4	5	6	7	8	9	10	11
1	1	.	-	'	()	*	#	&	/	,
2	A	B	C	a	b	c	2				
3	D	E	F	d	e	f	3				
4	G	H	I	g	h	i	4				
5	J	K	L	j	k	l	5				
6	M	N	O	m	n	o	6				
7	P	Q	R	S	p	q	r	s	7		
8	T	U	V	t	u	v	8				
9	W	X	Y	Z	w	x	y	z	9		
0	space	0									
*											
#											

8. Press **MENU/SELECT** to store your new directory entry. There is a confirmation tone and the screen shows **Saved to directory**. To change the entry later, see page 68.

Add a predialed telephone number to the directory

You can save a predialed telephone number to the directory.

1. Enter the telephone number when in idle mode.
2. Follow the steps in **Edit a directory entry** on page 68.

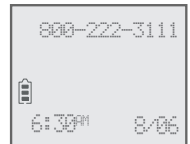

Review the directory

Review directory entries

1. Press **▲DIR** when in idle mode. The summary screen shows briefly and then the first entry in the directory shows.

-OR-

Press **MENU/SELECT** when in idle mode, then press **▼CID** or **▲DIR** to scroll to **Directory**. Press **MENU/SELECT** twice.

2. Press **▼CID** or **▲DIR** to browse through the directory. Entries appear alphabetically by the first letter in the name.



Notes:

- ▶ If the telephone number in the directory exceeds 15 digits, **<x** appears in front of the telephone number. Press **TONE*** to move towards the end of the telephone number or press **#** (pound key) to move towards the beginning of the telephone number.
- ▶ If there are no directory entries, **Directory empty** appears briefly on the screen, followed by **Add contact?**. If you would like to add a new contact, press **MENU/SELECT** and refer to page 63-64 for instructions on creating a new directory entry. Otherwise, press **OFF/CANCEL** on the handset or **CANCEL** on the telephone base to cancel.

Search the directory

Search by name

1. Press **▲DIR** in idle mode to show the first listing in the directory.
2. When an entry appears, press the dialing keys (**0-9**) to start a name search. The directory shows the first name beginning with the first letter associated with the dialing key, if there is an entry in the directory beginning with that letter. Press **▼CID** or **▲DIR** to scroll through the directory.
3. To see other names starting with the letters on the same dialing key, keep pressing the key. The names appear in alphabetical order.

For example, if you have the names Jennifer, Jessie, Kevin and Linda in your directory:

- If you press **5 (JKL)** once, you see **Jennifer**. Press **▼CID** and you see **Jessie**.
- If you press **5 (JKL)** twice, you see **Kevin**.
- If you press **5 (JKL)** three times, you see **Linda**.
- If you press **5 (JKL)** four times, you see **5** and then the directory entry beginning with 5 or the next closest entry after 5.
- If you press **5 (JKL)** five times, you see **Jennifer** again.



Notes:

- If there is no name matching the first letter of the key you press, the directory shows a name matching the following letters of the key.
- If you press a key (**0-9**) and no name starts with any of the letters on that key, the directory shows the entry matching the next letter in the directory.

Dial, delete or edit directory entries

To dial, delete or edit a directory entry (name and number), the entry must be displayed on the screen. Use **Review the directory** (page 65) or **Search by name** (page 66) to show an entry.

Display dial

To dial a displayed number from the directory, press **\PHONE/FLASH** or **📞/SPEAKER** on the handset, or **📞/SPEAKER** on the telephone base.

Delete a directory entry

Using a cordless handset or the telephone base:

To delete the displayed directory entry, press **MUTE/DELETE**. Press **MENU/SELECT** to confirm. You cannot retrieve a deleted entry.

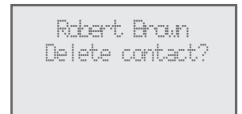

Dial, delete or edit directory entries

Edit a directory entry

- When a directory entry displays, press **MENU/SELECT**. The screen shows **EDIT NUMBER** along with the phone number to be edited. If you only want to edit the name, skip to Step 3.
- To edit the number:
 - Press the dialing keys to add digits.
 - Press **▼CID** or **▲DIR** to move the cursor to the left or right.
 - Press **MUTE/DELETE** on the handset or the telephone base to erase a digit.
 - Press and hold **MUTE/DELETE** on the handset or the telephone base to erase all digits.
 - Press and hold **REDIAL/PAUSE** to add a three-second dialing pause (a **p** appears).
- Press **MENU/SELECT** to move on to the name. The screen shows **EDIT NAME** along with the name to be edited.
- To edit the name:
 - Press the dialing keys to add characters (page 64).
 - Press **▼CID** or **▲DIR** to move the cursor to the left or right.
 - Press **MUTE/DELETE** on the handset or the telephone base to erase a character.
 - Press and hold **MUTE/DELETE** on your handset or the telephone base to erase all characters.
- Press **MENU/SELECT** to save the entry. There is a confirmation tone and the screen shows **Saved to directory**.

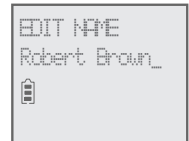

Speed dial

The telephone system has nine speed dial locations (**2-9, 0**) and a voicemail access location  **1** where you can store the telephone numbers you wish to dial more quickly. You can store up to 30 digits in each location. Speed dial assignments can only be selected from the existing directory entries. The voicemail access number must be manually entered. In the directory, speed dial locations are indicated by their number on the bottom right hand corner of the entry.



Speed dial location



Speed dial location

Assign a speed dial number

1. When the telephone is idle, press **MENU/SELECT**.
2. Press **▼CID** or **▲DIR** to scroll to **Directory**. Press **MENU/SELECT**.
3. Press **▼CID** or **▲DIR** to scroll to **Speed dial**. Press **MENU/SELECT**.
4. Press **▼CID** or **▲DIR** to choose your desired speed dial location (**0** or **2-9**), then press **MENU/SELECT**. The screen briefly shows **Copy from Directory...**, then displays the directory list.
5. Press **▼CID** or **▲DIR** to scroll to the phone number you wish to assign to the selected speed dial location.
6. Press **MENU/SELECT** to save the setting and return to the previous menu. There is a confirmation tone and the screen returns to the speed dial list.

-OR-

1. When the telephone is idle, press and hold any dialing keys (**0** or **2-9**).
2. Press **▼CID** or **▲DIR** to choose your desired speed dial location (**0** or **2-9**), then press **MENU/SELECT**. The screen briefly shows **Copy from Directory...**, then displays the directory list.
3. Press **▼CID** or **▲DIR** to scroll to the phone number you wish to assign to the selected speed dial location.
4. Press **MENU/SELECT** to save the setting and return to the previous menu. There is a confirmation tone and the screen returns to the speed dial list.

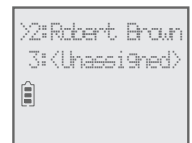
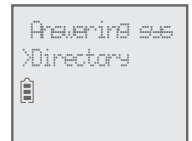

Assign your voicemail speed dial number

To assign your voicemail speed dial number to location  **1**, see page 33. The voicemail speed dial entry does not show in the bottom right corner.

Reassign a speed dial number

1. When the telephone is idle, press **MENU/SELECT**.
2. Press **▼CID** or **▲DIR** to scroll to **Directory**. Press **MENU/SELECT**.
3. Press **▼CID** or **▲DIR** to scroll to **Speed dial**. Press **MENU/SELECT**.
4. Press **▼CID** or **▲DIR** to choose the location you wish to reassign, then press **MENU/SELECT** to show the directory entry.
5. Press **MENU/SELECT** again.
6. Scroll to **Change SD** and then press **MENU/SELECT**. The screen briefly shows **Copy from Directory...**, then displays the directory list.
7. Press **▼CID** or **▲DIR** to scroll to the phone number you wish to reassign to the selected speed dial location.
8. Press **MENU/SELECT** to save the setting and return to the speed dial list. There is a confirmation tone.

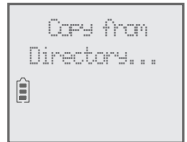

Delete a speed dial number

1. When the telephone is idle, press **MENU/SELECT**.
2. Press **▼CID** or **▲DIR** to scroll to **Directory**. Press **MENU/SELECT**.
3. Press **▼CID** or **▲DIR** to scroll to **Speed dial**. Press **MENU/SELECT**.
4. Press **▼CID** or **▲DIR** to scroll to the location you wish to delete the speed dial number from, then:
 - Press **MUTE/DELETE** to delete the displayed speed dial number. There is a confirmation tone and the screen shows **Speed dial empty** before returning to the speed dial list.



-OR-

- i. Press **MENU/SELECT** to show the directory entry.
- ii. Press **MENU/SELECT** again.
- iii. Scroll to **Clear SD** and then press **MENU/SELECT** to delete the displayed speed dial number. There is a confirmation tone and the screen shows **Speed dial empty** before returning to the speed dial list.

Make a call using speed dial

When in idle mode, press and hold the dialing key (**0** or **2-9**) corresponding to the assigned location you wish to call.

-OR-

1. Press **MENU/SELECT** when in idle mode.
2. Press **▼CID** or **▲DIR** to scroll to **Directory**, then press **MENU/SELECT**.
3. Press **▼CID** or **▲DIR** to scroll to **Speed dial**, then press **MENU/SELECT**.
4. Press **▼CID** or **▲DIR** to scroll to the desired location (**0** or **2-9**) and then press **\PHONE/FLASH** or **📞/SPEAKER** on the handset, or **📞/SPEAKER** on the telephone base.

Check your voicemail using speed dial

When in idle mode, press and hold **✉1** to dial the voicemail number you have set. See page 33 to set your voicemail speed dial number.

About caller ID

This product supports caller ID services offered by most telephone service providers. Caller ID allows you to see the name, number, date and time of calls. The available caller ID information will appear after the first or second ring.

Information about caller ID with call waiting

Caller ID with call waiting lets you see the name and telephone number of the caller before answering the call, even while on another call.

It may be necessary to change your telephone service to use this feature. Contact your telephone service provider if:

- You have both caller ID and call waiting, but as separate services (you may need to combine these services).
- You have only caller ID service, or only call waiting service.
- You don't subscribe to caller ID or call waiting services.

There are fees for caller ID services. In addition, services may not be available in all areas.

This product can provide information only if both you and the caller are in areas offering caller ID service and if both telephone service providers use compatible equipment. The time and date, along with the call information, are from the telephone service provider.

Caller ID information may not be available for every incoming call. Callers may intentionally block their names and/or telephone numbers. You can only view a maximum of 15 digits of every caller ID log entry. To view caller ID log entries with numbers between 16 and 24 digits, you must save the entry to the directory (see page 77).

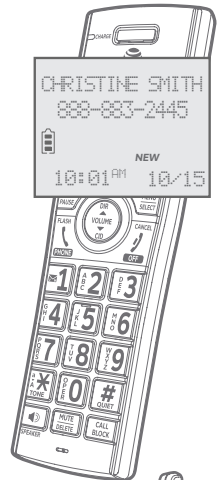

Note: You can use this product with regular caller ID service, or you can use this product's other features without subscribing to caller ID or combined caller ID with call waiting service.

Caller ID log

How the caller ID log works

The telephone stores caller ID information about the last 50 incoming calls in the telephone base. Entries are stored in reverse chronological order. The phone deletes the oldest entry when the log is full to make room for new calls. This information is common to the telephone base and all handsets, so changes made using any handset or the telephone base are reflected in all other devices. If you answer a call before the information appears on the screen, it does not show in the caller ID log.



Note: Each entry may have up to 24 digits for the phone number and 15 characters for the name.

Missed (new) call indicator

When a handset or the telephone base is in idle mode and has new or missed calls, its screen shows **XX Missed calls**.

All new and missed entries are counted as missed calls. Each time you review a new caller ID log entry (indicated by **NEW** on the screen), the missed calls message goes away.

If you do not want to review the missed calls one by one, but still want to keep them in the caller ID log, you can press and hold **OFF/CANCEL** on the handset for four seconds when the handset is idle, or press and hold **CANCEL** on the telephone base for four seconds when the telephone base is idle. You will hear a confirmation tone. All the entries in the caller ID log become old (reviewed already), and the missed calls message goes away.

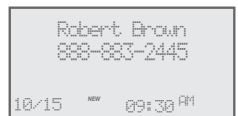
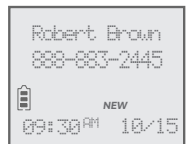

Caller ID operation

Memory match

If the incoming telephone number matches the last 7 digits of a telephone number in your directory, the name that appears on the screen matches the corresponding name in your directory.

For example, if Christine Smith calls, her name appears as **Chris** if this is how you entered it into your directory.



Note: The number shown in the caller ID log will be in the format sent by the telephone service provider. The telephone service provider usually delivers ten-digit phone numbers (area code plus telephone number). If the telephone number of the caller does not match a number in your directory, the name will appear as it is delivered by the telephone service provider.

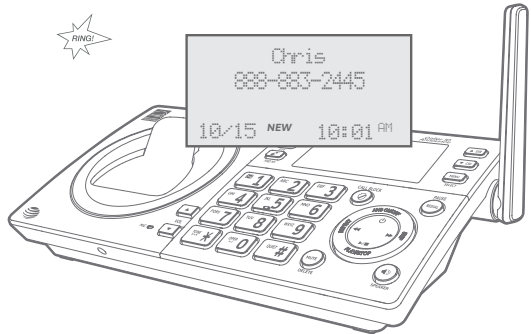
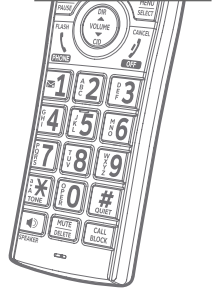

Caller ID operation

Review the caller ID log

Review the caller ID log to find out who called, to return the call, or to copy the caller's name and number into your directory. **Caller ID log empty** appears if there are no records in the caller ID log.

1. When the handset or the telephone base is in idle mode, press **▼CID** to review the caller ID log in reverse chronological order starting with the most recent call.

-OR-

Review the caller ID log by pressing **MENU/SELECT**. Press **▼CID** or **▲DIR** to scroll to **Caller ID log**, then press **MENU/SELECT** twice to select **Review**.

2. Press **▼CID** or **▲DIR** to scroll through the list.
3. Press **/OFF/CANCEL** on the handset or **CANCEL** on the telephone base to exit the caller ID log.

You hear a double beep when the list reaches the beginning or end of the caller ID log.



Note: Only one handset or the telephone base can review the caller ID log at a time. If another device tries to enter the directory or caller ID log, it shows Not available at this time.

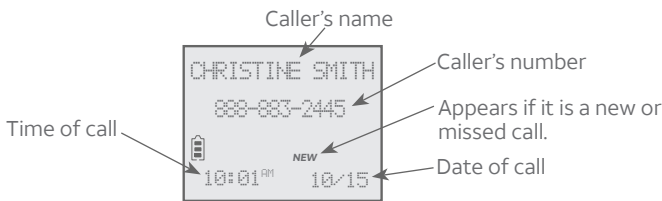
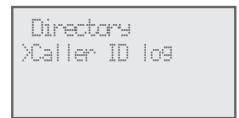
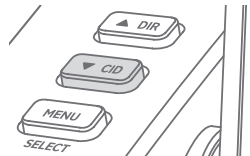
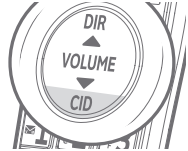

Caller ID operation

View dialing options

Although the incoming caller ID log entries have ten digits (the area code plus the seven-digit number), in some areas, you may need to dial only the 7 digits, 1 plus the seven digits, or 1 plus the area code plus the seven digits. You can change and store the number of digits that you dial in the caller ID log.

While reviewing the caller ID log, press # (pound key) repeatedly to show different dialing options for local and long distance numbers before dialing or saving the telephone number in the directory.

Press 1 repeatedly if you need to add or remove 1 in front of the telephone number before dialing or saving it in the directory.

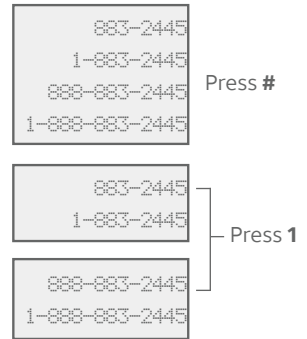

When the number is in the correct format for dialing, press **\PHONE/FLASH** or **📞/SPEAKER** on the handset, or **📞/SPEAKER** on the telephone base to call the number.

To save the number to the directory, allow list, block list or star name list, see page 77, page 78 and page 79.

Dial a caller ID log entry

1. When in the caller ID log, press **▼CID** or **▲DIR** to browse.
2. Press **\PHONE/FLASH** or **📞/SPEAKER** on the handset, or **📞/SPEAKER** on the telephone base to dial the displayed entry.

Delete caller ID log entries

To delete an entry:

- Press **MUTE/DELETE** to delete the shown entry.

To delete all entries:

1. Press **MENU/SELECT** when in idle mode.
2. Press **▼CID** or **▲DIR** to scroll to **Caller ID log**, then press **MENU/SELECT**.
3. Press **▼CID** or **▲DIR** to scroll to **Del all calls**, then press **MENU/SELECT**.
4. When the screen shows **Delete all calls?**, press **MENU/SELECT** to confirm. There is a confirmation tone and the screen returns to the previous menu.

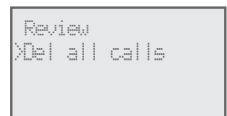

Caller ID operation

Save a caller ID log entry to the directory

1. When in the caller ID log, press **▼CID** or **▲DIR** to browse.
2. When the desired entry displays, press **MENU/SELECT**.
3. Press **MENU/SELECT** to choose **Directory**.
4. When the screen displays **EDIT NUMBER**, use the dialing keys to edit the number.
 - Press **▼CID** or **▲DIR** to move the cursor to the left or right.
 - Press **MUTE/DELETE** to backspace and erase a digit.
 - Press and hold **MUTE/DELETE** to erase the entire entry.
 - Press and hold **REDIAL/PAUSE** to insert a three-second dialing pause (a **p** appears).
5. Press **MENU/SELECT** to move to the name.
6. When the screen displays **EDIT NAME**, use the dialing keys (page 64) to edit the name.
 - Press **▼CID** or **▲DIR** to move the cursor to the left or right.
 - Press **MUTE/DELETE** to erase a character.
 - Press and hold **MUTE/DELETE** to erase all characters.
 - Press **TONE X** to change the next letter to upper or lower case.
 - Press **#** (pound key) to move the last word to the front. For example, **Johnson Charlie** becomes **Charlie Johnson** when you press **#** (pound key).
7. Press **MENU/SELECT** when done. The screen shows **Saved to directory**.



Notes:

- You may need to change how a caller ID number is dialed if the entry does not appear in the correct format. Caller ID numbers may appear with an area code that is not necessary for local calls, or without a 1 that is necessary for long distance calls (see **View dialing options** on page 76).
- If the caller's name you received from the telephone service provider is all in capital letters, the first letter of every word remains a capital letter, while other letters become lower case. However, the next letter after the prefix "Mac", "Mc", "D", "C" or "O", is kept as a capital letter. For example, the "D" in "MacDonald" is kept as a capital letter. Another exception is that "VAN DER" will be changed to "Van der".
- If the telephone number from the caller ID information has already been saved in the directory under a different name, the new name will overwrite the old one.
- If you save a blocked number in the caller ID log to the directory, the original name from the caller ID information will be saved.

Caller ID operation

Save a caller ID log entry to the allow list

1. When in the caller ID log, press ▼ **CID** or ▲ **DIR** to browse.
2. When the desired entry displays, press **MENU/SELECT**.
3. Press ▼ **CID** or ▲ **DIR** to scroll to **Allow list**, then press **MENU/SELECT**.
4. When the screen displays **EDIT NUMBER**, use the dialing keys to edit the number.
 - Press ▼ **CID** or ▲ **DIR** to move the cursor to the left or right.
 - Press **MUTE/DELETE** to backspace and erase a digit.
 - Press and hold **MUTE/DELETE** to erase the entire entry.
 - Press and hold **REDIAL/PAUSE** to insert a three-second dialing pause (a **p** appears).
5. Press **MENU/SELECT** to move to the name.
6. When the screen displays **EDIT NAME**, use the dialing keys (page 64) to edit the name.
 - Press ▼ **CID** or ▲ **DIR** to move the cursor to the left or right.
 - Press **0** to add a space.
 - Press **MUTE/DELETE** to erase a character.
 - Press and hold **MUTE/DELETE** to erase all characters.
 - Press **TONE X** to change the next letter to upper or lower case.
 - Press **#** (pound key) to move the last word to the front. For example, **Johnson Charlie** becomes **Charlie Johnson** when you press **#** (pound key).
7. Press **MENU/SELECT** when done. The screen shows **Saved to allow list**.

Save a caller ID log entry to the block list

1. When in the caller ID log, press ▼ **CID** or ▲ **DIR** to browse.
2. When the desired entry displays, press **MENU/SELECT**.
3. Press ▼ **CID** or ▲ **DIR** to scroll to **Block list**, then press **MENU/SELECT**.
4. When the screen displays **EDIT NUMBER**, use the dialing keys to edit the number.
 - Press ▼ **CID** or ▲ **DIR** to move the cursor to the left or right.
 - Press **MUTE/DELETE** to backspace and erase a digit.
 - Press and hold **MUTE/DELETE** to erase the entire entry.
 - Press and hold **REDIAL/PAUSE** to insert a three-second dialing pause (a **p** appears).

Caller ID operation

5. Press **MENU/SELECT** to move to the name.
6. When the screen displays **EDIT NAME**, use the dialing keys (page 64) to edit the name.
 - Press **▼CID** or **▲DIR** to move the cursor to the left or right.
 - Press **0** to add a space.
 - Press **MUTE/DELETE** to erase a character.
 - Press and hold **MUTE/DELETE** to erase all characters.
 - Press **TONE X** to change the next letter to upper or lower case.
 - Press **#** (pound key) to move the last word to the front. For example, **Johnson Charlie** becomes **Charlie Johnson** when you press **#** (pound key).
7. Press **MENU/SELECT** when done. The screen shows **Saved to block list**.

Save a caller ID log entry to the star name list

1. When in the caller ID log, press **▼CID** or **▲DIR** to browse.
2. When the desired entry displays, press **MENU/SELECT**.
3. Press **▼CID** or **▲DIR** to scroll to **Star name list**, then press **MENU/SELECT**.
4. When the screen displays **Star this name?** and the caller's name, press **MENU/SELECT** to confirm. The screen shows **Saved to star name list**.



Reasons for missing caller ID information

There are occasions when other information or no information shows for various reasons:

On-screen message	Reason
PRIVATE NUMBER	The caller prefers not to show the phone number.
PRIVATE NAME	The caller prefers not to show the name.
PRIVATE CALLER	The caller prefers not to show the phone number and name.
UNKNOWN NUMBER	Your telephone service provider cannot determine the caller's number.
UNKNOWN NAME	Your telephone service provider cannot determine the caller's name.
UNKNOWN CALLER	Your telephone service provider cannot determine the caller's name and telephone number. Calls from other countries may also generate this message.

About Smart call blocker*

If you have subscribed to caller ID service, then you can use Smart call blocker to filter robocalls, telemarketing calls and unwanted calls for you, while allowing welcome calls to get through.

You can set up your lists of welcome callers and unwelcome callers. Smart call blocker allows calls from your welcome callers to get through, and it blocks calls from your unwelcome callers.

For other unknown calls, you can allow these calls, block these calls, or forward these calls to the answering system.

With some easy configurations, you can set to only filter robocalls by asking the callers to press the pound key (#) before the calls are put through to you.

You can also set Smart call blocker to screen unknown calls by asking the callers to record their names and press the pound key (#). After your caller completes the request, your telephone rings and announces the caller's name. You can then choose to block or answer the call, or you can forward the call to the answering system. If the caller does not respond or record his/her name, the call is blocked from ringing through. When you add your welcome callers to your allow list, they will bypass all screening and ring directly to your handsets.



Notes:

- ▶ Smart call blocker is on and in default screening mode, once you install your telephone. It will screen all incoming calls and asks callers to announce their names. We recommend that you set up your directory, allow list, and star name list before using your telephone with Smart call blocker. This can avoid calls from your business associates, family members and friends to go through the screening process. See **Directory** on page 62, **Allow list** on page 93 and **Star name list** on page 98.
- ▶ With call screening active, Smart call blocker screens and filters all incoming calls from numbers or names that are not yet saved in your directory, allow list, block list, or star name list. You can easily add incoming phone numbers to your allow list and block list. This allows you to build up your lists of allowed and blocked numbers, and Smart call blocker will know how to deal with these calls when they come in again.
- ▶ To turn off Smart call blocker, see **Set Smart call blocker on/off** on page 85.

* Includes licenced Qalite™ technology.

Qalite™ is a trademark of Truecall Group Limited.

About Smart call blocker

Call categories

Calls are classified into four categories:

Welcome calls

Welcome calls are calls with telephone numbers saved in your allow list or directory, and not in your block list. Welcome calls also include calls with caller names saved in your star name list.



Note: There are many organizations like schools, medical offices, and pharmacies that use robocalls to communicate important information to you. Robocall uses an autodialer to deliver pre-recorded messages. By entering the name of the organizations into the star name list, it ensures these calls will ring through when you only know the caller names but not their numbers.

Unwelcome calls

Unwelcome calls are calls with telephone numbers saved in your block list, and you want to block their calls.

Calls without numbers

Calls without numbers are calls that are “out of area“ or with numbers set to “Private“.

Uncategorized calls

Uncategorized calls include calls with absent caller ID number, calls with numbers that are not in your directory, allow list, or block list, or calls with caller ID names that are not in your star name list.



Note: The allow list stores up to 200 entries, the block list stores up to 1,000 entries, and the star name list stores up to 10 names.

About Smart call blocker

Call controls

- Smart call blocker is set to on, and to screen calls without numbers and uncategorized calls by default. When Smart call blocker is on, the first ring of all incoming calls will be muted.
- If your directory, allow list, star name list and block list are empty when Smart call blocker is on, all calls will be classified as unknown calls. The telephone will screen all calls and ask callers to announce their names.
- If Smart call blocker is off, all incoming calls ring, including numbers saved in the block list.
- If **QUIET** mode is on, and Smart call blocker is on and in screening mode, all screened calls will be sent to the answering system after screening.

Smart call blocker handles calls in the following ways:

Call category	Call control
Welcome calls	Allow The telephone rings when there is an incoming call with number saved in your allow list or directory, but not in your block list. Robocalls with caller names saved in your star name list will also ring.
Unwelcome calls	Block The telephone does not ring when there is an incoming call with number saved in your block list, and the call will be rejected.

About Smart call blocker

Call category	Call control
<p>Calls without numbers</p> <ul style="list-style-type: none"> You can set to screen, allow, or block all calls of this call category, or to send these calls to the answering system. Screening with caller name is the default setting. To change the setting, see Control calls without numbers page 85. 	<p>Screening with caller name (default settings)</p> <p>The telephone plays the screening announcement, and then asks the caller to say his/her name before the call rings on your telephone. You can then answer the call, and hear the caller's name announced. You can decide whether to accept or reject the call, or to forward the call to the answering system.</p> <p>Screening without caller name</p> <p>If you have selected this option, the telephone plays the screening announcement, and then asks the caller to press the pound key (#) before the call rings on your telephone. You can then answer the call.</p>
<p>Uncategorized calls</p> <ul style="list-style-type: none"> You can set to screen, allow, or block all calls of this call category, or to send these calls to the answering system. Screening with caller name is the default setting. To change the setting, see Control uncategorized calls on page 86. 	<p>Allow</p> <p>If you have selected this option, the telephone allows the calls to get through and ring. The caller's name and number, if available, will be saved to the allow list.</p> <p>Answering system</p> <p>If you have selected this option, the telephone forwards the calls to the answering system without ringing.</p> <p>Block</p> <p>If you have selected this option, the telephone rejects the calls with block announcement without ringing. The caller's name and number, if available, will be saved to the block list.</p>

Call block settings

Set Smart call blocker on/off

The Smart call blocker feature is set to on by default.

Using a cordless handset or the telephone base:

1. Press **CALL BLOCK** when it is not in use, and then press **MENU/SELECT** to select **SCB On/Off**.

-OR-

Press **MENU/SELECT** to enter the main menu when it is not in use. Press **▼CID** or **▲DIR** to scroll to **Smart call blk**, then press **MENU/SELECT** twice.

2. Press **▼CID** or **▲DIR** to highlight **On** or **Off**, then press **MENU/SELECT** to save the setting. You hear a confirmation tone.

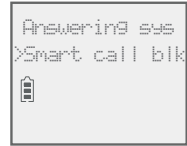
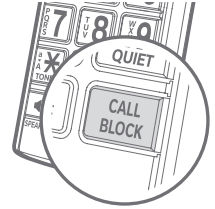

Control calls without numbers

Use this setting to control “out of area” or “Private” calls. You can choose to allow or reject these calls directly. You can also choose to screen them with or without learning the callers’ names before you decide whether to answer or reject these calls. Moreover, you can forward these calls to the answering system.

To change the setting:

Using a cordless handset or the telephone base:

1. Press **CALL BLOCK** when it is not in use.

-OR-

Press **MENU/SELECT** to enter the main menu when it is not in use. Press **▼CID** or **▲DIR** to scroll to **Smart call blk**, then press **MENU/SELECT**.

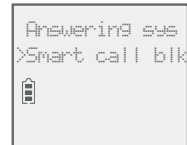

Call block settings

- Press **▼CID** or **▲DIR** to scroll to **Calls w/o num**, then press **MENU/SELECT**.
- Press **▼CID** or **▲DIR** to choose one of the following options, then press **MENU/SELECT**.
 - Screening** - ask the caller to press the pound key (#) or to say his/her name before the call rings on your telephone.
 - Allow** - allow the calls to get through and ring.
 - Answering sys** - forward the calls to the answering system without ringing.
 - Block** - reject the calls with block announcement.
- If you select **Screening**, press **▼CID** or **▲DIR** to choose one of the following options, then press **MENU/SELECT**.
 - w/ Caller name** - ask the caller to say his/her name before the call rings on your telephone. You can then answer the call, and hear the caller's name announced. You can decide whether to answer or reject the call, or to forward the call to the answering system.
 - w/o Caller name** - ask the caller to press the pound key (#) before the call rings on your telephone. You can then answer the call.

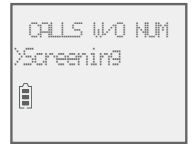
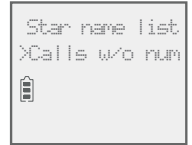
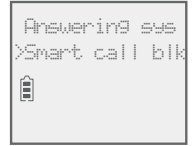

Control uncategorized calls

Use this setting to control calls with numbers that are not on your directory, allow list or block list, or have no caller ID number display. You can choose to allow or reject these calls directly. You can also choose to screen them with or without learning the callers' names before you decide whether to answer or reject these calls. Moreover, you can forward these calls to the answering system.

To change the setting:

Using a cordless handset or the telephone base:

- Press **CALL BLOCK** when it is not in use.

Call block settings

-OR-

Press **MENU/SELECT** to enter the main menu when it is not in use. Press **▼CID** or **▲DIR** to scroll to

Smart call blk, then press **MENU/SELECT**.

2. Press **▼CID** or **▲DIR** to scroll to **Uncategorized**, then press **MENU/SELECT**.
3. Press **▼CID** or **▲DIR** to choose one of the following options, then press **MENU/SELECT**.
 - **Screening** - ask the caller to press the pound key (#) or to say his/her name before the call rings on your telephone.
 - **Allow** - allow the calls to get through and ring.
 - **Answering sys** - send the calls to the answering system without ringing.
 - **Block** - reject the calls with block announcement.
4. If you select **Screening**, press **▼CID** or **▲DIR** to choose one of the following options, then press **MENU/SELECT**.
 - **w/ Caller name** - ask the caller to say his/her name before the call rings on your telephone. You can then answer the call, and hear the caller's name announced. You can decide whether to answer or reject the call, or to forward the call to the answering system.
 - **w/o Caller name** - ask the caller to press the pound key (#) before the call rings on your telephone. You can then answer the call.

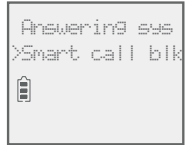

Note: Robocalls will be classified as uncategorized calls. If you select **Screening**, the telephone screens and filters these calls. It asks the caller to press the pound key (#) or announces his/her name before putting the call through to you. There may be robocalls that you do not want to miss. For example, robocalls with announcements or notices from schools or pharmacies. You can set up your star name list with these caller names to allow their calls to get through to you. See **Star name list** on page 98.

Call block settings

Block list

Add numbers that you want to prevent their calls from ringing through. The block list stores up to 1,000 entries.

Add a block entry:

Using a cordless handset or the telephone base:

1. Press **CALL BLOCK** when it is not in use.
-OR-
Press **MENU/SELECT** to enter the main menu when it is not in use. Press **▼CID** or **▲DIR** to scroll to **Smart call blk**, then press **MENU/SELECT**.
2. Press **▼CID** or **▲DIR** to scroll to **Block list**, and then press **MENU/SELECT**.
3. Press **▼CID** or **▲DIR** to scroll to **Add new entry**, then press **MENU/SELECT**.
4. When the screen displays **ENTER NUMBER**, use the dialing keys to enter a number (up to 30 digits).
 - Press **▼CID** or **▲DIR** to move the cursor to the left or right.
 - Press **MUTE/DELETE** to erase a digit.
 - Press and hold **MUTE/DELETE** to erase all digits.
 - Press and hold **REDIAL/PAUSE** to enter a three-second dialing pause (a **p** appears).**-OR-**
Copy a number from the redial list by pressing **REDIAL/PAUSE**. Then, press **▼CID**, **▲DIR** or **REDIAL/PAUSE** repeatedly to find the desired number. Press **MENU/SELECT** to copy the number.
5. Press **MENU/SELECT** to move on to the name.
 - The screen shows **Number already saved** if the number is already in the block list. You cannot save the same number twice.



Call block settings

- When the screen displays **ENTER NAME**, use the dialing keys to enter a name (up to 15 characters). Press a key repeatedly until the desired character appears. The first character of every word is capitalized.
 - Press **▼CID** or **▲DIR** to move the cursor to the left or right.
 - Press **0** to add a space.
 - Press **MUTE/DELETE** to erase a character.
 - Press and hold **MUTE/DELETE** to erase all characters.
 - Press **TONE X** to change the next letter to upper or lower case.
- Press **MENU/SELECT** to store your block entry.



Notes:

- Numbers saved in your directory can also be saved to the block list.
- If you save a block entry that has already been saved to the allow list, the entry in the allow list will be removed.

Review block list:

Using a cordless handset or the telephone base:

- Press **CALL BLOCK** when it is not in use.
-OR-
Press **MENU/SELECT** to enter the main menu when it is not in use. Press **▼CID** or **▲DIR** to scroll to **Smart call blk**, then press **MENU/SELECT**.
- Press **▼CID** or **▲DIR** to scroll to **Block list**, and then press **MENU/SELECT**.
- Press **MENU/SELECT** to choose **Review**.
- Press **▼CID** or **▲DIR** to browse through the block entries.



Note: **Block list is empty** appears if there are no block entries.

Call block settings

Save a caller ID log entry to block list:

Using a cordless handset or the telephone base:

1. Search for the desired caller ID log entry (see **Review the caller ID log** on page 75).
2. When the desired entry displays, press **MENU/SELECT**.
3. Press **▼CID** or **▲DIR** to scroll to **Block list**, then press **MENU/SELECT**.
4. The handset displays **EDIT NUMBER**. Use the dialing keys to edit the number, when necessary.
 - Press **▼CID** or **▲DIR** to move the cursor to the left or right.
 - Press **MUTE/DELETE** to backspace and erase a digit.
 - Press and hold **MUTE/DELETE** to erase the entire entry.
 - Press and hold **REDIAL/PAUSE** to insert a three-second dialing pause (a **p** appears).
5. Press **MENU/SELECT** to move to the name. The screen displays **EDIT NAME**.
6. Use the dialing keys to add or edit the name.
 - Press **▼CID** or **▲DIR** to move the cursor to the left or right.
 - Press **0** to add a space.
 - Press **MUTE/DELETE** to erase a character.
 - Press and hold **MUTE/DELETE** to erase all characters.
 - Press **TONE ✕** to change the next letter to upper or lower case.
 - Press **#** (pound key) to move the last word to the front. For example, **Johnson Charlie** becomes **Charlie Johnson** when you press **#** (pound key).
7. Press **MENU/SELECT** when done and the screen shows **Saved to block list**.

Call block settings

Edit a block entry:

Using a cordless handset or the telephone base:

1. Search for the desired entry in the block list (see **Review block list** on page 89).
2. When the desired entry displays, press **MENU/SELECT**.
The screen displays **EDIT NUMBER** along with the phone number to be edited. If you only want to edit the name, skip to Step 4.
3. To edit the number:
 - Use the dialing keys to enter digits.
 - Press **▼CID** or **▲DIR** to move the cursor to the left or right.
 - Press **MUTE/DELETE** to erase a digit.
 - Press and hold **MUTE/DELETE** to erase all digits.
 - Press and hold **REDIAL/PAUSE** to enter a three-second dialing pause (a **p** appears).
4. Press **MENU/SELECT** to move on to the name. The screen displays **EDIT NAME** along with the name to be edited.
5. To edit the name:
 - Use the dialing keys to enter characters.
 - Press **▼CID** or **▲DIR** to move the cursor to the left or right.
 - Press **0** to add a space.
 - Press **MUTE/DELETE** to erase a character.
 - Press and hold **MUTE/DELETE** to erase all characters.
6. Press **MENU/SELECT** to save the entry. The screen displays **Saved to block list**.



Call block settings

Delete a block entry:

Using a cordless handset or the telephone base:

1. Search for the desired entry in the block list (see **Review block list** on page 89).
2. When the desired entry displays, press **MUTE/DELETE**. The screen shows **Delete entry?**
3. Press **MENU/SELECT** to confirm. The screen show **Entry deleted**, and the next entry displays. You cannot retrieve a deleted entry.



Note: If the call block list is empty after an entry is deleted, the screen displays **Block list is empty**.

Delete all block list entries:

Using a cordless handset or the telephone base:

1. Press **CALL BLOCK** when it is not in use.

-OR-

Press **MENU/SELECT** to enter the main menu when it is not in use. Press **▼CID** or **▲DIR** to scroll to **Smart call blk**, then press **MENU/SELECT**.

2. Press **▼CID** or **▲DIR** to scroll to **Block list**, and then press **MENU/SELECT**.
3. Press **▼CID** or **▲DIR** to highlight **Delete all**, then press **MENU/SELECT**. The screen shows **Delete all in block list?**
4. Press **MENU/SELECT** again to confirm. The screen displays **Deleted**. There is a confirmation tone.

Call block settings

Allow list

Add numbers that you want to allow their calls to get through to you. The allow list stores up to 200 entries.

Add an allow entry:

Using a cordless handset or the telephone base:

1. Press **CALL BLOCK** when it is not in use.

-OR-

Press **MENU/SELECT** to enter the main menu when it is not in use. Press **▼CID** or **▲DIR** to scroll to **Smart call blk**, then press **MENU/SELECT**.

2. Press **▼CID** or **▲DIR** to scroll to **Allow list**, and then press **MENU/SELECT**.
3. Press **▼CID** or **▲DIR** to scroll to **Add new entry**, then press **MENU/SELECT**.
4. When the screen displays **ENTER NUMBER**, use the dialing keys to enter a number (up to 30 digits).
 - Press **▼CID** or **▲DIR** to move the cursor to the left or right.
 - Press **MUTE/DELETE** to erase a digit.
 - Press and hold **MUTE/DELETE** to erase all digits.
 - Press and hold **REDIAL/PAUSE** to enter a three-second dialing pause (a **p** appears).

-OR-

Copy a number from the redial list by pressing **REDIAL/PAUSE**. Then, press **▼CID**, **▲DIR** or **REDIAL/PAUSE** repeatedly to find the desired number. Press **MENU/SELECT** to copy the number.

5. Press **MENU/SELECT** to move on to the name.
 - The display shows **Number already saved** if the number is already in the allow list. You cannot save the same number twice.

Call block settings

- When the screen displays **ENTER NAME**, use the dialing keys to enter a name (up to 15 characters). Press a key repeatedly until the desired character appears. The first character of every word is capitalized.
 - Press **▼CID** or **▲DIR** to move the cursor to the left or right.
 - Press **0** to add a space.
 - Press **MUTE/DELETE** to erase a character.
 - Press and hold **MUTE/DELETE** to erase all characters.
 - Press **-tone X** to change the next letter to upper or lower case.
- Press **MENU/SELECT** to store your allow list entry.



Notes:

- Numbers saved in your directory can also be saved to the allow list.
- If you save an allow entry that has already been saved to the block list, the entry in the block list will be removed.

Review allow list:

Using a cordless handset or the telephone base:

- Press **CALL BLOCK** when it is not in use.

-OR-

Press **MENU/SELECT** to enter the main menu when it is not in use. Press **▼CID** or **▲DIR** to scroll to **Smart call blk**, then press **MENU/SELECT**.

- Press **▼CID** or **▲DIR** to scroll to **Allow list**, and then press **MENU/SELECT**.
- Press **MENU/SELECT** to choose **Review**.
- Press **▼CID** or **▲DIR** to browse through the allow entries.



Note: **Allow list is empty** appears if there are no allow entries.

Call block settings

Save a caller ID log entry to allow list:

Using a cordless handset or the telephone base:

1. Search for the desired caller ID log entry (see **Review the caller ID log** on page 75).
2. When the desired entry displays, press **MENU/SELECT**.
3. Press **▼CID** or **▲DIR** to scroll to **Allow list**, then press **MENU/SELECT**.
4. The handset displays **EDIT NUMBER**. Use the dialing keys to edit the number, when necessary.
 - Press **▼CID** or **▲DIR** to move the cursor to the left or right.
 - Press **MUTE/DELETE** on the handset to backspace and erase a digit.
 - Press and hold **MUTE/DELETE** to erase the entire entry.
 - Press and hold **REDIAL/PAUSE** to insert a three-second dialing pause (a **p** appears).
5. Press **MENU/SELECT** to move to the name. The screen displays **EDIT NAME**.
6. Use the dialing keys to add or edit the name.
 - Press **▼CID** or **▲DIR** to move the cursor to the left or right.
 - Press **0** to add a space.
 - Press **MUTE/DELETE** to erase a character.
 - Press and hold **MUTE/DELETE** to erase all characters.
 - Press **TONE ✕** to change the next letter to upper or lower case.
 - Press **#** (pound key) to move the last word to the front. For example, **Johnson Charlie** becomes **Charlie Johnson** when you press **#** (pound key).
7. Press **MENU/SELECT** when done and the screen shows **Saved to allow list**.

Call block settings

Edit an allow entry:

Using a cordless handset or the telephone base:

1. Search for the desired entry in the allow list (see **Review allow list** on page 94).
2. When the desired entry displays, press **MENU/SELECT**. The screen displays **EDIT NUMBER** along with the phone number to be edited. If you only want to edit the name, skip to Step 4.
3. To edit the number:
 - Use the dialing keys to enter digits.
 - Press **▼CID** or **▲DIR** to move the cursor to the left or right.
 - Press **MUTE/DELETE** on the handset to erase a digit.
 - Press and hold **MUTE/DELETE** to erase all digits.
 - Press and hold **REDIAL/PAUSE** to enter a three-second dialing pause (a **p** appears).
4. Press **MENU/SELECT** to move on to the name. The screen displays **EDIT NAME** along with the name to be edited.
5. To edit the name:
 - Use the dialing keys to enter characters.
 - Press **▼CID** or **▲DIR** to move the cursor to the left or right.
 - Press **0** to add a space.
 - Press **MUTE/DELETE** to erase a character.
 - Press and hold **MUTE/DELETE** to erase all characters.
6. Press **MENU/SELECT** to save the entry. The screen displays **Saved to allow list**.



Call block settings

Delete an allow entry:

Using a cordless handset or the telephone base:

1. Search for the desired entry in the allow list (see **Review allow list** on page 94).
2. When the desired entry displays, press **MUTE/DELETE**. The screen shows **Delete entry?**.
3. Press **MENU/SELECT** to confirm. The screen shows **Entry deleted**, and the next entry displays. You cannot retrieve a deleted entry.

Delete all allow list entries:

Using a cordless handset or the telephone base:

1. Press **CALL BLOCK** when it is not in use.
-OR-
Press **MENU/SELECT** to enter the main menu when it is not in use. Press **▼CID** or **▲DIR** to scroll to **Smart call blk**, then press **MENU/SELECT**.
2. Press **▼CID** or **▲DIR** to scroll to **Allow list**, and then press **MENU/SELECT**.
3. Press **▼CID** or **▲DIR** to highlight **Delete all**, then press **MENU/SELECT**. The screen shows **Delete all in allow list?**.
4. Press **MENU/SELECT** again to confirm. The screen displays **Deleted**. There is a confirmation tone.

Call block settings

Star name list

There are many organizations like schools, medical offices, and pharmacies that use robocalls to communicate important information to you. Robocall uses an autodialer to deliver pre-recorded messages. By entering the name of the organizations into the star name list, it ensures these calls will ring through when you only know the caller names but not their numbers.

If the first 15 characters of the incoming caller ID's name match a name saved in your star name list, the call will get through and ring. The star name list stores up to 10 names.

Add a star name entry:

Using a cordless handset or the telephone base:

1. Press **CALL BLOCK** when it is not in use.
-OR-
 Press **MENU/SELECT** to enter the main menu when it is not in use. Press **▼CID** or **▲DIR** to scroll to **Smart call blk**, then press **MENU/SELECT**.
2. Press **▼CID** or **▲DIR** to scroll to **Star name list**, and then press **MENU/SELECT**.
3. Press **▼CID** or **▲DIR** to scroll to **Add new entry**, then press **MENU/SELECT**.
4. When the screen displays **ENTER NAME**, use the dialing keys to enter a name (up to 15 characters). Press a key repeatedly until the desired character appears. The first character of every word is capitalized.
 - Press **▼CID** or **▲DIR** to move the cursor to the left or right.
 - Press **0** to add a space.
 - Press **MUTE/DELETE** to erase a character.
 - Press and hold **MUTE/DELETE** to erase all characters.
 - Press **TONE ✕** to change the next letter to upper or lower case.
5. Press **MENU/SELECT** to store your star name entry. The display shows **Name already saved** if the name is already in the star name list. You cannot save the same name twice.



Call block settings

Review star name list:

Using a cordless handset or the telephone base:

1. Press **CALL BLOCK** when it is not in use.
-OR-
Press **MENU/SELECT** to enter the main menu when it is not in use. Press **▼CID** or **▲DIR** to scroll to **Smart call blk**, then press **MENU/SELECT**.
2. Press **▼CID** or **▲DIR** to scroll to **Star name list**, and then press **MENU/SELECT**.
3. Press **MENU/SELECT** to choose **Review**.
4. Press **▼CID** or **▲DIR** to browse through the star name entries.



Note: **Star name list is empty** appears if there are no star name entries.

Save a caller ID log entry to star name list:

Using a cordless handset or the telephone base:

1. Search for the desired caller ID log entry (see **Review the caller ID log** on page 75).
2. When the desired entry displays, press **MENU/SELECT**.
3. Press **▼CID** or **▲DIR** to scroll to **Star name list**, then press **MENU/SELECT**.
4. The handset displays **Star this name?**, and the caller ID name of the caller.
5. Press **MENU/SELECT**, and the screen shows **Saved to star name list**.

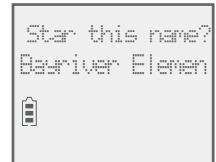

Call block settings

Edit a star name entry:

Using a cordless handset or the telephone base:

1. Search for the desired entry in the star name list (see **Review star name list** on page 99).
2. When the desired entry displays, press **MENU/SELECT**. The screen displays **EDIT NAME** along with the name to be edited.
3. To edit the name:
 - Use the dialing keys to enter characters.
 - Press **▼CID** or **▲DIR** to move the cursor to the left or right.
 - Press **0** to add a space.
 - Press **MUTE/DELETE** to erase a character.
 - Press and hold **MUTE/DELETE** to erase all characters.
4. Press **MENU/SELECT** to save the entry. The screen displays **Saved to star name list**.



Delete a star name entry:

1. Search for the desired entry in the star name list (see **Review star name list** on page 99).
2. When the desired entry displays, press **MUTE/DELETE**. The screen shows **Delete entry?**
3. Press **MENU/SELECT** to confirm. The screen show **Entry deleted**, and the next entry displays. You cannot retrieve a deleted entry.

Call block settings

Delete all star name entries:

Using a cordless handset or the telephone base:

1. Press **CALL BLOCK** when it is not in use.
-OR-
Press **MENU/SELECT** to enter the main menu when it is not in use. Press **▼CID** or **▲DIR** to scroll to **Smart call blk**, then press **MENU/SELECT**.
2. Press **▼CID** or **▲DIR** to scroll to **Star name list**, and then press **MENU/SELECT**.
3. Press **▼CID** or **▲DIR** to highlight **Delete all**, then press **MENU/SELECT**. The screen shows **Delete all in star name list?**.
4. Press **MENU/SELECT** again to confirm. The screen displays **Deleted**. There is a confirmation tone.

Screening announcements

If you have set to screen calls without numbers and/or screen uncategorized calls, the callers of one or all of the following incoming call categories will hear a screening announcement.

- Calls that are “out of area” or with numbers set to “Private”.
- Calls with numbers that are not on your directory, allow list, or block list, or with absent caller ID number.
- Calls with caller ID names that are not on your star name list.

The telephone has two screening options, and each option has its default screening announcements.

Screening with caller name - *“Hello. Calls to this number are being screened by Smart call blocker. Please say your name after the tone, then press pound.”*

-OR-

Screening without caller name - *“Hello. Calls to this number are being screened by Smart call blocker. If you’re a family member, friend or invited caller, please press pound to be connected. If you’re a solicitor, please hang up now.”*

You can use these announcements, or record your own name to replace “*this number*” in both announcements. Please refer to “**Record your name for all screening announcements**” on page 103.

Call block settings

Play your current announcement of screening with caller name:

Using a cordless handset or the telephone base:

1. Press **CALL BLOCK** when it is not in use.
-OR-
Press **MENU/SELECT** to enter the main menu when the it is not in use. Press **▼CID** or **▲DIR** to scroll to **Smart call blk**, then press **MENU/SELECT**.
2. Press **▼CID** or **▲DIR** to scroll to **Screening ann**, then press **MENU/SELECT**.
3. Press **▼CID** or **▲DIR** to scroll to **Play ann**, then press **MENU/SELECT**.
4. Press **MENU/SELECT** again to select **w/ Caller name**.



Play your current announcement of screening without caller name:

Using a cordless handset or the telephone base:

1. Press **CALL BLOCK** when it is not in use.
-OR-
Press **MENU/SELECT** to enter the main menu when it is not in use. Press **▼CID** or **▲DIR** to scroll to **Smart call blk**, then press **MENU/SELECT**.
2. Press **▼CID** or **▲DIR** to scroll to **Screening ann**, then press **MENU/SELECT**.
3. Press **▼CID** or **▲DIR** to scroll to **Play ann**, then press **MENU/SELECT**.
4. Press **▼CID** or **▲DIR** to scroll to **w/o Caller name**, then press **MENU/SELECT**.

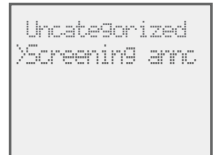

Call block settings

Record your name for all screening announcements:

Using a cordless handset or the telephone base:

1. Press **CALL BLOCK** when it is not in use.
-OR-
Press **MENU/SELECT** to enter the main menu when it is not in use. Press **▼CID** or **▲DIR** to scroll to **Smart call blk**, then press **MENU/SELECT**.
 2. Press **▼CID** or **▲DIR** to scroll to **Screening annnc**, then press **MENU/SELECT**.
 3. Press **MENU/SELECT** to select **Rec your name**. The system announces, *"Record after the tone. Press 5 when you are done."*
 4. Speak towards it to record your name. Press **5** to end recording.
- To listen to the announcement with your recorded name again, scroll to **Play annnc** and press **MENU/SELECT**.

Reset all your screening announcements:

Using a cordless handset or the telephone base:

1. Press **CALL BLOCK** when it is not in use.
-OR-
Press **MENU/SELECT** to enter the main menu when it is not in use. Press **▼CID** or **▲DIR** to scroll to **Smart call blk**, then press **MENU/SELECT**.
2. Press **▼CID** or **▲DIR** to scroll to **Screening annnc**, then press **MENU/SELECT**.
3. Press **▼CID** or **▲DIR** to scroll to **Reset annnc**, then press **MENU/SELECT**. The screen shows **Reset to default annnc?**. Press **MENU/SELECT** again to confirm. The screen shows **Annnc. reset to default** before returning to the previous menu.



-OR-

While an announcement is playing, press **MUTE/DELETE**. The screen shows **Annnc. Deleted** before returning to the previous menu.

Your name will be deleted from all the screening announcements, and the telephone will use the default screening announcements described on page 101.

Allowed calls

If Smart call blocker is on, the following types of incoming calls can get through to you and ring on your telephone system:

- Calls with numbers saved in your allow list.
- Calls with numbers saved in your directory, but not on your block list.
- Calls with caller ID names saved in your star name list.



Note: When Smart call blocker is off, all incoming calls will ring on your telephone system, including calls with numbers saved in the block list.

Allow calls without numbers

If Smart call blocker is on, and you have set to allow calls without numbers, the following type of incoming calls will ring on your telephone system.

- Calls that are “out of area” or with numbers set to “Private”.

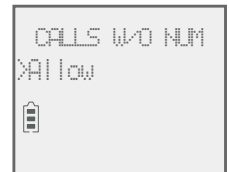
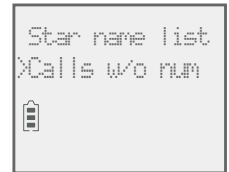

Allowed calls

Allow uncategorized calls

If Smart call blocker is on, and you have set to allow uncategorized calls, the following type of incoming calls will ring on your telephone system.

- ▶ Calls with numbers that are not on your directory, allow list or block list, or with absent caller ID number.
- ▶ Calls with caller ID names that are not on your star name list.



Note: If you have set to allow all uncategorized calls, the caller's number will not be saved to the allow list. If you want to save the caller's number to your allow list or block list, you can retrieve the number from caller ID log and save it to the allow list or block list. See **Save a caller ID log entry to the block list** on page 78 and **Save a caller ID log entry to the allow list** on page 78. If you want to retrieve the name from caller ID log and save it to the star name list, see **Save a caller ID log entry to the star name list** on page 79.

```
>SCB On/Off  
Block list  
☎
```

```
Calls w/o num  
>Uncategorized  
☎
```

```
UNCATEGORIZED  
>Allow  
☎
```

Blocked calls

If Smart call blocker is on, incoming calls with numbers saved in your block list will not ring. The telephone plays the block announcement “*Calls to this number are being screened by Smart call blocker. The number you are calling is not accepting your call. Please hang up.*” to the caller, and the call will be terminated.



Note: If Smart call blocker is off, incoming calls with numbers saved in your block list will ring on your telephone system.

Block calls without numbers

If Smart call blocker is on, and you have set to block calls without numbers, the following type of incoming calls will not ring, and the calls will be terminated.

- Calls that are “out of area” or with numbers set to “Private”.

The telephone plays the block announcement “*Calls to this number are being screened by Smart call blocker. The number you are calling is not accepting your call. Please hang up.*” to the caller.



Note: The telephone can respond to remote access code while it is playing the block announcement. This allows you to access your answering system from an unknown number remotely. See **Remote access** on page 136.



Blocked calls

Block uncategorized calls

If Smart call blocker is on, and you have set to block uncategorized calls, the following type of incoming calls will not ring, and the calls will be terminated.

- ▶ Calls with numbers which are not on your directory, allow list or block list, or with absent caller ID number.
- ▶ Calls with caller ID names that are not on your star name list.

The telephone plays the block announcement “*Calls to this number are being screened by Smart call blocker. The number you are calling is not accepting your call. Please hang up.*” to the caller.



Notes:

- ▶ If you have set to block all uncategorized calls, the caller’s numbers will not be saved to the block list. If you want to save the caller’s number to your allow list or block list, you can retrieve the number from caller ID log and save it to the allow list or block list. See **Save a caller ID log entry to the block list** on page 78 and **Save a caller ID log entry to the allow list** on page 78. If you want to retrieve the name from caller ID log and save it to the star name list, see **Save a caller ID log entry to the star name list** on page 79.
- ▶ The telephone can respond to remote access code while it is playing the block announcement. This allows you to access your answering system from an unknown number remotely. See **Remote access** on page 136.

```
>SCB On/Off
Block list
```



```
Calls w/o num
>Uncategorized
```



```
UNCATEGORIZED
>Block
```



Screen calls without numbers

If Smart call blocker is on, and your telephone is set to screen calls without number, the telephone will not ring when receiving incoming calls that are “out of area” or with numbers set to “Private”. It plays a screening announcement to the caller and asks the caller to respond before putting the call through to you.

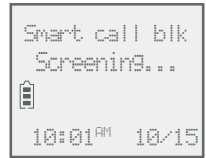

The telephone has two screening options. You can set your Smart call blocker to screen these calls by asking the callers to record their names and then press the pound key (#). Alternatively, you can screen these calls by only asking the callers to press the pound key (#).



Screen calls without numbers and ask for caller names (default screening mode)

When the telephone is screening a call, the caller hears the telephone announces “*Hello. Calls to this number are being screened by Smart call blocker. Please say your name after the tone, then press pound.*” After the caller completes the request, the telephone announces to the caller “*Please wait a moment while your call is connected.*”. The telephone starts ringing and announces the caller’s name. The telephone screen displays **Screened call** and you can pick up the call. The telephone will then ask whether you want to answer or reject the call, or to forward the call to the answering system.

Screen calls without numbers and do not ask for caller names

When the telephone is screening a call, the caller hears the telephone announces “*Hello. Calls to this number are being screened by Smart call blocker. If you’re a family member, friend or invited caller, please press pound to be connected. If you’re a solicitor, please hang up now.*” After the caller presses the pound key (#), the telephone announces to the caller “*Please wait a moment while your call is connected.*”. The telephone starts ringing, and you can answer the call. This setting enables you to filter unwanted calls that uses autodialers to deliver pre-recorded messages, for example, robocalls and telemarketing calls.



Notes:

- ▶ Screening and asking for caller name is the default setting for calls without numbers. To change the setting, see **Control calls without numbers** on page 85.
- ▶ The telephone announces to the caller with “*Hello. Calls to this number are being screened by Smart call blocker...*” If you have recorded your name in the screening announcements, your recorded name will replace “*this number*” in the announcements. See **Screening announcement** on page 101.

Screen calls without numbers

- ▶ If the caller hangs up before the call is screened, or without leaving his/her name while the call is being screened, the call will be logged as missed call in the caller ID log.
- ▶ While a call is being screened, you can press **\ PHONE/FLASH** or **📞/SPEAKER** to stop screening and answer the call.
- ▶ After the telephone screened a call, and is ringing and announcing the caller's name to you, you can press **🔇/OFF/CANCEL** to mute the ringer, or press **CALL BLOCK** to reject the call directly.
- ▶ After you picked up a screened call and the telephone is announcing the screening options to you, you can press **🔇/OFF/CANCEL** to hang up the call.
- ▶ If you receive a call waiting call without number while on a call, Smart call blocker will not screen the new call. You can press **\ PHONE/FLASH** or **📞/SPEAKER** to take the new call.
- ▶ Robocalls are unable to respond to the screening announcement, and therefore, will not get through and ring. If you want to allow some robocalls to get through, save their names in the star name list. See page 98.
- ▶ The telephone can respond to remote access code while it is playing the screening announcement. This allows you to access your answering system from an unknown number remotely. See **Remote access** on page 136.

Answer call once

1. When the telephone starts ringing, and the screen displays **Screened call**, press **\ PHONE/FLASH** or **📞/SPEAKER** to pick up the call. If you have turned on the caller ID announce feature, the telephone announces “*You have a call from...*” and the caller's name. After you picked up the call, the telephone announces “*To answer the call, press 1. To send this call to the answering system, press 4. To repeat these options, press **”.
2. Press **1** to answer the call. The telephone number will not be added to your allow list.



Notes:

- ▶ To turn on or off caller ID announce, see page 21 and page 32.
- ▶ When the telephone is ringing, you can press **🔇/OFF/CANCEL** to mute the ringer temporarily.

Screen calls without numbers

Send call to answering system

- When the telephone starts ringing, and the screen displays **Screened call**, press **\ PHONE/FLASH** or **📞/SPEAKER** to pick up the call. If you have turned on the caller ID announce feature, the telephone announces “*You have a call from...*” and the caller’s name. After you picked up the call, the telephone announces “*To answer the call, press 1. To send this call to the answering system, press 4. To repeat these options, press *.*”
- Press **4** to send the caller to the answering system.

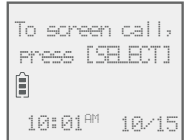

Notes:

- ▶ The caller is sent to the answering system and can leave a message even if the answering system is off.
- ▶ To turn on or off caller ID announce, see page 21 and page 32.
- ▶ When the telephone is ringing, you can press **📞/OFF/CANCEL** to mute the ringer temporarily.



End call

- When the telephone starts ringing, and the screen displays **Screened call**, press **\ PHONE/FLASH** or **📞/SPEAKER** to pick up the call. If you have turned on the caller ID feature, the telephone announces “*You have a call from...*” and the caller’s name. After you picked up the call, the telephone announces “*To answer the call, press 1. To send this call to the answering system, press 4. To repeat these options, press *.*”
- If you do not want to take the call, press **📞/OFF/CANCEL** to end the call.

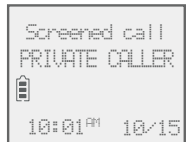

Screen uncategorized calls

If Smart call blocker is on, and your telephone is set to screen uncategorized calls, the telephone will not ring when receiving the following incoming calls:

- ▶ Incoming calls with absent caller ID numbers;
- ▶ Incoming calls with numbers that are not in your directory, allow list, nor block list; or
- ▶ Incoming calls with names that are not in your star name list.

The telephone plays a screening announcement to the caller and asks the caller to respond before putting the call through to you. There are two screening options. You can set your Smart call blocker to screen these calls by asking the callers to record their names and then press the pound key (#). Alternatively, you can screen these calls by only asking the callers to press the pound key (#).

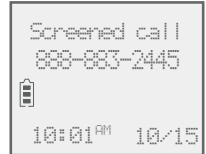
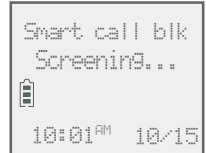

Screen uncategorized calls and ask for caller names (default screening mode)

When the telephone is screening a call, the caller hears the telephone announces *"Hello. Calls to this number are being screened by Smart call blocker. Please say your name after the tone, then press pound."* After the caller completes the request, the telephone announces to the caller *"Please wait a moment while your call is connected."* The telephone starts ringing and announces the caller's name. The telephone screen displays **Screened call** and you can pick up the call. The telephone will then ask whether you want to answer or reject the call, or to forward the call to the answering system.

Screen uncategorized calls without asking for caller names

When the telephone is screening a call, the caller hears the telephone announces *"Hello. Calls to this number are being screened by Smart call blocker. If you're a family member, friend or invited caller, please press pound to be connected. If you're a solicitor, please hang up now."* After the caller presses the pound key (#), the telephone announces to the caller *"Please wait a moment while your call is connected."* The telephone starts ringing, and you can pick up the call. This setting enables you to filter unwanted calls that uses autodialers to deliver pre-recorded messages, for example, robocalls and telemarketing calls.

Screen uncategorized calls



Notes:

- ▶ Screening and asking for caller name is the default setting for uncategorized calls. To change the setting, see **Control uncategorized calls** on page 86.
- ▶ In default screening mode, Smart call blocker screens and filters all incoming calls from numbers or names that are not yet saved in your directory, allow list, block list, or star name list. You can easily add incoming phone numbers to your allow list and block list. This allows you to build up your lists of allowed and blocked numbers, and Smart call blocker will know how to deal with these calls when they come in again.
- ▶ The telephone announces to the caller with *"Hello. Calls to this number are being screened by Smart call blocker..."* If you have recorded your name in the screening announcements, your recorded name will replace *"this number"* in the announcements. See **Screening announcements** on page 101.
- ▶ If the caller hangs up before the call is screened, or without leaving his/her name while the call is being screened, the call will be logged as missed call in the caller ID log.
- ▶ While a call is being screened, you can press **PHONE/FLASH** or **SPEAKER** to stop screening and answer the call.
- ▶ After the telephone screened a call, and is ringing and announcing the caller's name to you, you can press **OFF/CANCEL** to mute the ringer, or press **CALL BLOCK** to reject the call directly. The caller's number will be added to the block list.
- ▶ After you picked up a screened call and the telephone is announcing the screening options to you, you can press **OFF/CANCEL** to hang up the call. The caller's number will not be saved to the block list.
- ▶ If the Smart call blocker feature is on and in screening mode, and you receive a call waiting call:
 - If you have already picked up a screened call, the telephone checks whether the call waiting call's number can be found in the directory, block list or allow list. It also checks whether the caller name is in the star name list. After that, the telephone displays the caller ID information or **Blocked call** accordingly. You can press **PHONE/FLASH** or **SPEAKER** to take the new call.
 - If the telephone is screening a call, the call waiting call will be ignored and logged as missed call in the caller ID log.
- ▶ Robocalls are unable to respond to the screening announcement, and therefore, will not get through and ring. If you want to allow some robocalls to get through, save their names in the star name list. See page 98.
- ▶ The telephone can respond to remote access code while it is playing the screening announcement. This allows you to access your answering system from an unknown number remotely. See **Remote access** on page 136.

Screen uncategorized calls

Allow call once

- When the telephone starts ringing, and the screen displays **Screened call**, press **\ PHONE/FLASH** or **🔊/SPEAKER** to pick up the call. If you have turned on the caller ID announce feature, the telephone announces “*You have a call from...*” and the caller’s name. After you picked up the call, the telephone announces “*To answer the call, press 1. To answer and always allow this number, press 2. To block this number, press 3. To send this call to the answering system, press 4. To repeat these options, press **”.
- Press **1** to answer the call. The telephone number will not be added to your allow list.



Notes:

- ▶ To turn on or off caller ID announce, see page 21 and page 32.
- ▶ When the telephone is ringing, you can press **🔊/OFF/CANCEL** to mute the ringer temporarily.

Always allow

- When the telephone starts ringing, and the screen displays **Screened call**, press **\ PHONE/FLASH** or **🔊/SPEAKER** to pick up the call. If you have turned on the caller ID announce feature, the telephone announces “*You have a call from...*” and the caller’s name. After you picked up the call, the telephone announces “*To answer the call, press 1. To answer and always allow this number, press 2. To block this number, press 3. To send this call to the answering system, press 4. To repeat these options, press **”.
- Press **2** to answer the call. The telephone number will be added to your allow list.

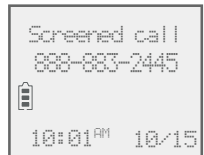

Notes:

- ▶ To turn on or off caller ID announce, see page 21 and page 32.
- ▶ When the telephone is ringing, you can press **🔊/OFF/CANCEL** to mute the ringer temporarily.

Screen uncategorized calls

Block call

- When the telephone starts ringing, and the screen displays **Screened call**, press **\ PHONE/FLASH** or **🔊/SPEAKER** to pick up the call. If you have turned on the caller ID announce feature, the telephone announces “*You have a call from...*” and the caller’s name. After you picked up the call, the telephone announces “*To answer the call, press 1. To answer and always allow this number, press 2. To block this number, press 3. To send this call to the answering system, press 4. To repeat these options, press **”.
- Press **3** or **CALL BLOCK** to block the call. The telephone plays the block announcement “*The number you are calling is not accepting your call. Please hang up.*” to the caller. The telephone number will be added to your block list.



Send call to answering system

- When the telephone starts ringing, and the screen displays **Screened call**, press **\ PHONE/FLASH** or **🔊/SPEAKER** to pick up the call. If you have turned on the caller ID announce feature, the telephone announces “*You have a call from...*” and the caller’s name. After you picked up the call, the telephone announces “*To answer the call, press 1. To answer and always allow this number, press 2. To block this number, press 3. To send this call to the answering system, press 4. To repeat these options, press **”.
- Press **4** to forward the call to the answering system.

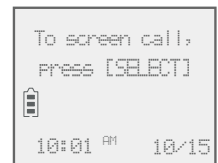
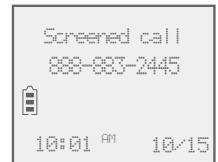

Note: The call is forwarded to the answering system and the caller can leave a message even if the answering system is off.

Option while on a call

When you are on a call with the handset or the telephone base and speaking to the caller, and you do not want to continue the call, you can press the **CALL BLOCK** button to end the call. The telephone plays the block announcement “*The number you are calling is not accepting your call. Please hang up.*” to the caller, and the call will be terminated. The caller’s number will be added to your block list.

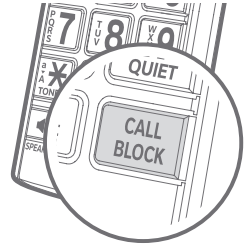

- Press **CALL BLOCK**. The screen displays **Block and end?** and the caller’s number, if available. Press **MENU/SELECT** to end the call.



Notes:

- The caller’s number, if available, will be saved to the block list. The screen displays **Added to block list** after pressing **CALL BLOCK**. If caller’s number is not available, the screen displays **No number to block.**
- You can press **CALL BLOCK** to end the call even if Smart call blocker is turned off.



Answering system settings

Use the answering system menu of a system handset or the telephone base to set up the announcement message, turn on or off the answering system or message alert tone, activate call screening, or change the number of rings, remote access code or message recording time. If you turn off the answering system and you change any setting in the answering system setup menu, the answering machine automatically turns on again.



1. When the device is in idle mode, press **MENU/SELECT** to enter the main menu.
2. Press **▼CID** or **▲DIR** to scroll to **Answering sys**, then press **MENU/SELECT**.

Announcement

Your outgoing announcement plays when calls are answered by the answering system.

The telephone has a default outgoing announcement, *"Hello. Please leave a message after the tone."* You can use this announcement, or record your own.

You can record an announcement up to 90 seconds. The system does not record any announcement shorter than two seconds.

To play your current outgoing announcement:

Using a cordless handset or the telephone base:

1. When the handset is in idle mode, press **MENU/SELECT** to enter the main menu.
2. Press **▼CID** or **▲DIR** to scroll to **Answering sys**, then press **MENU/SELECT**.
3. Press **MENU/SELECT** again to select **Announcement**.
4. Press **▼CID** or **▲DIR** to scroll to **Play annc**, then press **MENU/SELECT**.

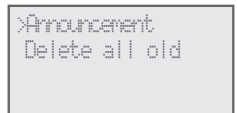
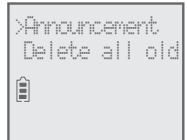

Answering system settings

To record a new outgoing announcement:

Using a cordless handset or the telephone base:

1. When the handset is in idle mode, press **MENU/SELECT** to enter the main menu.
2. Press **▼CID** or **▲DIR** to scroll to **Answering sys**, then press **MENU/SELECT**.
3. Press **MENU/SELECT** again to select **Announcement**.
4. Press **MENU/SELECT** to select **Record annc**. The system announces, *"Record after the tone. Press 5 when you are done."*
5. Speak towards the handset to record your announcement. Press **5** to end recording. Your recorded announcement plays.



To listen to the recorded announcement again, scroll to **Play annc** and press **MENU/SELECT**.

Answering system settings

To delete or reset your outgoing announcement:

Using a cordless handset:

1. When the handset is in idle mode, press **MENU/SELECT**.
2. Press **▼CID** or **▲DIR** to scroll to **Answering sys**, then press **MENU/SELECT**.
3. Press **MENU/SELECT** again to select **Announcement**.
4. Press **▼CID** or **▲DIR** to scroll to **Play annnc**, then press **MENU/SELECT**.
5. While the announcement is playing, press **MUTE/DELETE** to delete the announcement. The system announces *"Announcement deleted"* and the screen shows **Annnc. Deleted**.

-OR-

1. When the handset is in idle mode, press **MENU/SELECT**.
2. Press **▼CID** or **▲DIR** to scroll to **Answering sys**, then press **MENU/SELECT**.
3. Press **MENU/SELECT** again to select **Announcement**.
4. Press **▼CID** or **▲DIR** to scroll to **Reset annnc**, then press **MENU/SELECT**. The screen shows **Reset to default annnc?**.
5. Press **MENU/SELECT** again. The screen shows **Annnc. reset to default**.

When your announcement is deleted, the system answers calls with the default announcement described on page 116. You cannot delete the default announcement.

Answering system settings

Answer on/off

Unless you change it, the answering system is on and ready to record messages. You can turn the answering system off, but if you do so, the answering system does not answer calls and record incoming messages.

To turn the answering system on or off:

Using a cordless handset:

1. When the handset is in idle mode, press **MENU/SELECT** to enter the main menu.
2. Press **▼CID** or **▲DIR** to scroll to **Answering sys**, then press **MENU/SELECT**.
3. Press **▼CID** or **▲DIR** to scroll to **Answer ON/OFF**, then press **MENU/SELECT**.
4. Press **▼CID** or **▲DIR** to highlight **On** or **Off**, then press **MENU/SELECT** to save the setting. You hear a confirmation tone.

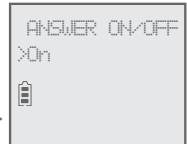

When the answering system is on, the handset shows **ANS ON**.

Using the telephone base:

- Press **Ⓞ/ANSWER ON** to turn the answering system on or off. If the answering system is turned on, it announces, "Calls will be answered." If the answering system is turned off, it announces, "Calls will not be answered."

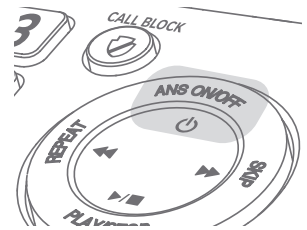

-OR-

1. When the telephone base is in idle mode, press **MENU/SELECT** to enter the main menu.
2. Press **▼CID** or **▲DIR** to scroll to **Answering sys**, then press **MENU/SELECT**.
3. Press **▼CID** or **▲DIR** to scroll to **Answer ON/OFF**, then press **MENU/SELECT**.
4. Press **▼CID** or **▲DIR** to highlight **On** or **Off**, then press **MENU/SELECT** to save the setting. You hear a confirmation tone.



Notes: If the answering system is off and there is an incoming call, the system answers after ten rings and announces, "Please enter your remote access code." For more information about remote access, see page 136.

Answering system settings

Voice guide

This feature is an alternative way for you to do the basic setup of the answering system. You can follow the voice guide to record your own announcement, set the number of rings, and set the message alert tone.

This feature is only available in the telephone base.

1. When the telephone base is in idle mode, press **MENU/SELECT**.
2. Press **▼CID** or **▲DIR** to scroll to **Answering sys**, then press **MENU/SELECT**.
3. Press **▼CID** or **▲DIR** to scroll to **Voice guide**, then press **MENU/SELECT**.
4. You hear a voice prompt *“This voice guide will assist you with the basic setup of your answering system.”*
5. Set up your answering system by inputting the designated numbers, as instructed in the voice guide.



Notes:

- ▶ You can press **CANCEL** to quit the voice guide at any time.
- ▶ If the system does not receive any input, it will play an alert message. If there is still no input, it will announce *“Sorry, I still have not received any input. If you want to restart the voice guide, please enter the menu and select Voice guide under Answering system. Good bye.”*
- ▶ After a power outage, the system prompts you to set the date and time. After the date and time setting is done or skipped, the system will prompt if you want to set up the answering system via **Voice guide**. Press **MENU/SELECT** to start the setup.
- ▶ If the answering system is off and there is an incoming call, the system answers after ten rings and announces, *“Please enter your remote access code.”* For more information about remote access, see page 123

Answering system settings

Call screening

Use this feature to choose whether incoming messages can be heard over the speaker when they are being recorded. If you turn call screening on, you hear the incoming message. While monitoring an incoming message, you can answer the call by pressing **PHONE/FLASH** on the handset, or **PHONE/SPEAKER** on the telephone base.

To change the setting:

Using a cordless handset or the telephone base:

1. When the handset or telephone base is in idle mode, press **MENU/SELECT** to enter the main menu.
2. Press **DOWN/CID** or **UP/DIR** to scroll to **Answering sys**, then press **MENU/SELECT**.
3. Press **DOWN/CID** or **UP/DIR** to scroll to **Ans sys setup**, then press **MENU/SELECT**.
4. Press **MENU/SELECT** to select **Call screening**.
5. Press **DOWN/CID** or **UP/DIR** to choose **On** or **Off**.
6. Press **MENU/SELECT** to save the setting. You hear a confirmation tone.



Note: For more information on call screening, see page 128.

```
Answer ON/OFF
>Ans sys setup
[phone icon]
```

```
>Call screening
# of rings
[phone icon]
```

```
CALL SCREENING
>On
[phone icon]
```

```
Answer ON/OFF
>Ans sys setup
```

```
>Call screening
# of rings
```

```
CALL SCREENING
>On
```

Answering system settings

Number of rings

You can set the answering system to answer an incoming call after two, three, four, five or six rings. You can also select toll saver. If toll saver is selected, the answering system answers a call after two rings when you have new messages, and after four rings when there are no new messages. This feature allows you to check for new messages and avoid paying long distance charges when calling from out of your local area. By default, the answering system answers an incoming call after four rings.

To set the number of rings:

Using a cordless handset or the telephone base:

1. When the handset or telephone base is in idle mode, press **MENU/SELECT** to enter the main menu.
2. Press **▼CID** or **▲DIR** to scroll to **Answering sys**, then press **MENU/SELECT**.
3. Press **▼CID** or **▲DIR** to scroll to **Ans sys setup**, then press **MENU/SELECT**.
4. Press **▼CID** or **▲DIR** to scroll to **# of rings**, then press **MENU/SELECT**.
5. Press **▼CID** or **▲DIR** to choose among **2, 3, 4, 5, 6** or **Toll saver**.
6. Press **MENU/SELECT** to save the setting. You hear a confirmation tone.



Notes:

- ▶ If you subscribe to voicemail service through your telephone service provider, see **Answering system and voicemail indicators** on page 126.
- ▶ If you set the number of rings for the answering system as two or three rings, the caller ID announce feature may not have enough time to announce the caller's full information.
- ▶ If Smart call blocker is on, the first ring of all calls will be muted.

Answering system settings

Remote access code

To access your answering system remotely from any touch-tone phone, you need to enter a two-digit number (00-99). By default, the remote access code is **19**.

To change the remote access code:

Using a cordless handset or the telephone base:

1. When the handset or telephone base is in idle mode, press **MENU/SELECT** to enter the main menu.
2. Press **▼CID** or **▲DIR** to scroll to **Answering sys**, then press **MENU/SELECT**.
3. Press **▼CID** or **▲DIR** to scroll to **Ans sys setup**, then press **MENU/SELECT**.
4. Press **▼CID** or **▲DIR** to scroll to **Remote code**, then press **MENU/SELECT**.
5. Use the dialing keys to enter a two-digit number. Press **MUTE/DELETE** to backspace and delete a digit.
6. Press **MENU/SELECT** to save the setting. You hear a confirmation tone.

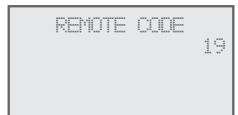
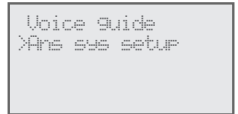
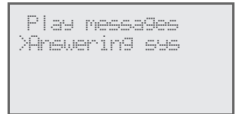

Answering system settings

Message alert tone

When the message alert tone is set to **On**, and there is at least one new message, the telephone base beeps every ten seconds. Unless you change it, the message alert tone is set to off.

There is no audible alert at the handset.

To change the setting:

Using a cordless handset or the telephone base:

1. When the handset or telephone base is in idle mode, press **MENU/SELECT** to enter the main menu.
2. Press **▼CID** or **▲DIR** to scroll to **Answering sys**, then press **MENU/SELECT**.
3. Press **▼CID** or **▲DIR** to scroll to **Ans sys setup**, then press **MENU/SELECT**.
4. Press **▼CID** or **▲DIR** to scroll to **Msg alert tone**, then press **MENU/SELECT**.
5. Press **▼CID** or **▲DIR** to choose **On** or **Off**.
6. Press **MENU/SELECT** to save the setting. You hear a confirmation tone.



Notes:

- ▶ The message alert tone beeps only if all the following conditions are met:
 - Answering system is on.
 - Message alert tone setting is on.
 - There are new messages.
- ▶ To temporarily turn off the message alert tone, see page 124.

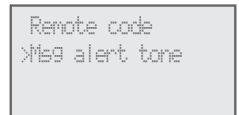

Answering system settings

Message recording time

You can set the recording time allowed for incoming messages. The message length is three minutes by default.

To change the setting:

Using a cordless handset or the telephone base:

1. When the handset or telephone base is in idle mode, press **MENU/SELECT** to enter the main menu.
2. Press **▼CID** or **▲DIR** to scroll to **Answering sys**, then press **MENU/SELECT**.
3. Press **▼CID** or **▲DIR** to scroll to **Ans sys setup**, then press **MENU/SELECT**.
4. Press **▼CID** or **▲DIR** to scroll to **Recording time**, then press **MENU/SELECT**.
5. Press **▼CID** or **▲DIR** to choose **3 minutes**, **2 minutes** or **1 minute**, then press **MENU/SELECT** to save the setting. You hear a confirmation tone.

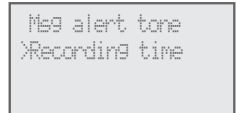

About the answering system

Answering system and voicemail indicators

Your telephone has separate indicators for two different types of voice messages: those left on its built-in digital answering system and those left at your telephone service provider's voicemail (fees may apply). Your telephone's built-in digital answering system messages and voicemail messages are separate. Each alerts you to new messages differently.

- ▶ If **OO** and **XX New messages** show on the handset and the telephone base, there are new messages in the built-in answering system. To listen to messages recorded on your digital answering system, press **▶/■/PLAY/STOP** on the telephone base (page 130).
- ▶ If **☒** and **New voicemail** display on the handset and the telephone base, your telephone service provider is indicating that it has new voicemail for you. To listen to your voicemail, dial an access number provided by your telephone service provider, followed by a security code or PIN.

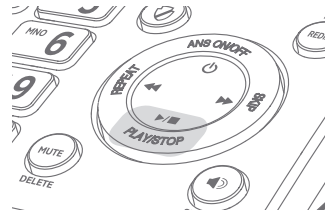

Some telephone service providers bundle or combine multiple services like voicemail and call waiting, so you may not be aware that you have voicemail. To check what services you have and how to access them, contact your telephone service provider.

To use your voicemail service rather than the answering system, turn off the answering system. To use the answering system rather than your voicemail service, contact your telephone service provider to deactivate the voicemail service.



Note: After reviewing all new messages, the number of old messages appears on the message counter.

About the answering system

Using the answering machine and voicemail together

You can also use your telephone answering system and voicemail together by setting your built-in answering system to answer before voicemail answers, as described below. To learn how to program your voicemail settings, contact your telephone service provider. If you are on a call, or the answering system is busy recording a message and you receive another call, the second caller can leave a voicemail message.

Set the answering system to answer calls at least two rings earlier than your voicemail is set to answer. For example, if your voicemail answers after six rings, set the answering system to answer after four rings. Some voicemail providers may program the delay before answering calls in seconds instead of rings. In this case, allow six seconds per ring when determining the appropriate setting.

Message capacity

The answering system can record up to 99 messages, depending on the length of each message. Individual messages can be up to three minutes, and the maximum recording time is approximately 22 minutes. The actual recording time depends on individual message characteristics. Messages remain available for replay until you delete them.

When there are new messages (including memos) on the answering system, the number of messages stored shows in the message counter.

If the answering system has less than three minutes of recording time left, it announces, "*Less than three minutes to record,*" before message playback at the handset or the telephone base. **Rec mem low** displays on the device screen in idle mode. When you turn on the answering system at the telephone base, it announces, "*Calls will be answered. Less than three minutes to record.*"

If the memory is full, the answering system announces, "*Memory is full,*" before message playback. The device screen displays **Rec mem full** in idle mode. Once the memory is full, you cannot turn the answering system back on if it has been turned off, nor can you record new messages until old ones have been deleted. **Memory full** displays if you want to turn on the answering system on the handset but there is no memory.

About the answering system

Voice prompts

The system provides voice prompts to guide you through the setup procedures at the telephone base, message playback, remote access and recording outgoing announcements.

Call screening

To screen a call at the telephone base:

If the answering system and call screening are on (see **Call screening** on page 128), the announcement and the incoming message broadcast at the telephone base when a call is answered by the answering system.

Options while a message is being recorded:

- ▶ Press **▼/VOL/▲** on the telephone base to adjust the call screening volume.
- ▶ Press **▶/■/PLAY/STOP** or **CANCEL** to temporarily silence the call screening.
- ▶ Press **▶/■/PLAY/STOP** to temporarily turn on the call screening if call screening is set to off.
- ▶ Press **🔊/SPEAKER** to answer the call.

To screen a call at the handset:

If the answering system is on, you can hear the incoming message with the handset when a call is answered by the answering system. While a message is being recorded, the handset shows

To screen call, press [SELECT]. Press **MENU/SELECT** to screen the call.

Options while a message is being recorded:

- ▶ Press **▼CID/VOLUME** or **▲DIR/VOLUME** on the handset to adjust the call screening volume.
- ▶ Press **🔊/OFF/CANCEL** to temporarily silence the call screening.
- ▶ Press **MENU/SELECT** to temporarily turn on the call screening if call screening is set to off.
- ▶ Press **🔊/SPEAKER** to broadcast the announcement and the incoming message through the speakerphone. Press again to turn off the speakerphone.

About the answering system

Call intercept

While screening a call, you can stop recording and speak to the caller by pressing **PHONE/FLASH** on the handset or **SPEAKER** on the telephone base.

Base ringer

Press **VOL/▲** on the telephone base to adjust the ringer volume when the telephone is not in use.

You hear a sample of the ringer while adjusting the volume. The telephone base shows **Ringer off**  when you set the volume to **0**.

Temporarily turning off the message alert tone

If the message alert tone is turned on, the telephone base beeps every ten seconds when there are new messages. Pressing any telephone base key (except **FIND HS**) temporarily silences the message alert tone.

If you press **MUTE/DELETE** when in idle mode to temporarily turn off the message alert tone, there is a voice prompt directing you to press **MUTE/DELETE** again to delete all old messages. The message alert tone is temporarily off. Only press **MUTE/DELETE** a second time if you wish to erase all old messages in your answering system.

The message alert tone resumes when you receive another message.

Message playback

If you have new messages, you hear only the new messages in chronological order. If there are no new messages, the system plays back all the messages (in chronological order). If there are both new and old messages, you have the option of playing the new or old messages.

When playback begins, the total number of messages is announced. Before each message, you hear the day and time of the recording. If the date and time are not set, you hear, *“Time and date not set,”* before playback. After the last message, you hear, *“End of messages.”* If the recording time is less than three minutes, you hear, *“Less than three minutes to record”* before playback (see **Message capacity** on page 127).

To listen to messages at the telephone base:

Press ►/■/PLAY/STOP on the telephone base to listen to the messages.

- ▶ If there are new and old messages, the base only plays new messages automatically.
- ▶ If there are only new or only old messages, they will play automatically.

-OR-

1. When the telephone base is in idle mode, press **MENU/SELECT** to enter the main menu.
2. Press **MENU/SELECT** again to select **Play messages**.
 - ▶ If there are new and old messages, press ▼CID or ▲DIR to select **Play new msgs** or **Play old msgs**, then press **MENU/SELECT** or ►/■/PLAY/STOP.
 - ▶ If there are only new or only old messages, they will play automatically.

The system announces the number of messages, then begins playback. The message sequence is shown on the telephone base. If there are no recorded messages, the telephone base shows **No messages** and you hear, *“You have no message.”*

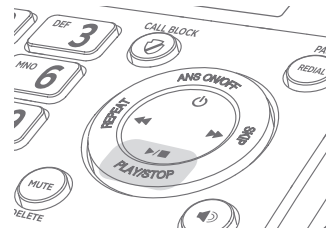

```
>Play messages
  Answering sys
```

```
>Play new msgs
  Play old msgs
```

```
You have:
  3 New messages
```

```
NEW MSG #1/3
  Charlie Johnson
  10/15 10:01AM
```

Message playback

To listen to messages on a cordless handset:

1. When the handset is in idle mode, press **MENU/SELECT** to enter the main menu.
2. Press **MENU/SELECT** again to select **Play messages**.
 - If there are new and old messages, press **▼CID** or **▲DIR** to select **Play new msgs** or **Play old msgs**, then press **MENU/SELECT**.
 - If there are only new or only old messages, they will play automatically.

The system announces the number of messages, then begins playback. The message sequence is shown on the handset. If there are no recorded messages, the handset shows **No messages** and you hear, “*You have no message.*”



Options during playback

When a message is playing, you can adjust the playback volume, skip, repeat, pause or delete the message.

When messages are playing on the telephone base:

- Press **▼/VOL/▲** to adjust the message playback volume.
- Press **▶▶/SKIP** to skip to the next message.
- Press **◀◀/REPEAT** to repeat the message. Press twice to hear the previous message.
- Press **MUTE/DELETE** to delete the message.
- Press **▶/■/PLAY/STOP**, or **/OFF/CANCEL** to stop the playback.
- Press **📞/SPEAKER** to stop playback. The screen shows **Call back?**, then press **MENU/SELECT**, or **📞/SPEAKER** to call back the caller if the caller's number is available. If the dialing format used is not correct, then use the option, as mentioned below, to choose the correct dialing format before calling back the caller.
- Press **MENU/SELECT** to pause playback and show the caller ID information if available. From here, you can press **CANCEL** to resume playback, or press **#** (pound key) repeatedly to show the desired dialing option (page 76), then press **📞/SPEAKER** to call back the caller. If you do not call back within ten seconds, message playback resumes automatically.

Message playback

When messages are playing on the handset:

- ▶ Press **▼CID/VOLUME** or **▲DIR/VOLUME** to adjust the message playback volume.
- ▶ Press **6** to skip to the next message.
- ▶ Press **4** to repeat the message. Press twice to hear the previous message.
- ▶ Press **MUTE/DELETE** to delete the message.
- ▶ Press **5** or **/OFF/CANCEL** to stop the playback.
- ▶ Press **📞/SPEAKER** to switch between speakerphone mode and handset mode.
- ▶ Press **\PHONE/FLASH** to stop playback. The screen shows **Call back?**, then press **MENU/SELECT**, **\PHONE/FLASH**, or **📞/SPEAKER** to call back the caller if the caller's number is available. If the dialing format used is not correct, then use the option, as mentioned below, to choose the correct dialing format before calling back the caller.
- ▶ Press **MENU/SELECT** to pause playback and show the caller ID information if available. From here, you can press **#** (pound key) repeatedly to show the desired dialing option (page 76), then press **\PHONE/FLASH** to call back the caller. You can also press **/OFF/CANCEL** to resume playback. If you do not call back within ten seconds, message playback resumes automatically.

Message playback

Delete all old messages

You can only delete old (reviewed) messages. You cannot delete new messages until you review them. You cannot retrieve deleted messages.

To delete all old messages on the telephone base:

1. When the telephone is idle, press **MUTE/DELETE**. The system announces, *“To delete all old messages, press DELETE again.”*
2. Press **MUTE/DELETE** again. The system announces, *“All old messages deleted.”*

-OR-

1. Press **MENU/SELECT** when in idle mode to enter the main menu.
2. Press **▼CID** or **▲DIR** to scroll to **Answering sys.** Press **MENU/SELECT**.
3. Press **▼CID** or **▲DIR** to highlight **Delete all old**, then press **MENU/SELECT**. The screen shows **Delete all old messages?**
4. Press **MENU/SELECT** again to confirm. The screen displays **Deleting...**, then **All old msgs deleted!**. There is a confirmation tone.

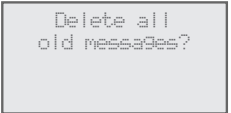
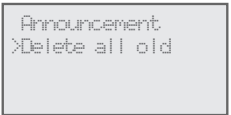

To delete all old messages on the handset:

1. Press **MENU/SELECT** when in idle mode to enter the main menu.
2. Press **▼CID** or **▲DIR** to scroll to **Answering sys.** Press **MENU/SELECT**.
3. Press **▼CID** or **▲DIR** to highlight **Delete all old**, then press **MENU/SELECT**. The screen shows **Delete all old messages?**
4. Press **MENU/SELECT** again to confirm. The screen displays **Deleting...**, then **All old msgs deleted!**. There is a confirmation tone.



Recording and playing memos

Memos are your own recorded messages used as reminders for yourself or others using the same answering system. You can record your own memos using a system handset or the telephone base. Play and delete them in the same way as incoming messages.

Record a memo

Using a cordless handset or the telephone base:

1. When it is in idle mode, press **MENU/SELECT** to enter the main menu.
2. Press **▼CID** or **▲DIR** to scroll to **Answering sys**. Press **MENU/SELECT**.
3. Press **▼CID** or **▲DIR** to highlight **Record memo**, then press **MENU/SELECT**. The system announces, *“Record after the tone. Press 5 when you are done.”* You can record a memo for up to four minutes.
4. Speak towards it to record a memo.
5. Press **5** to stop recording. The system announces, *“Recorded.”* The system does not save memos shorter than two seconds.

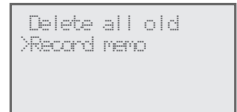
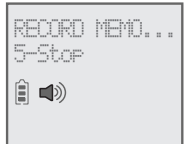
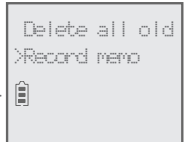

Play back a memo

Play memos the same way as messages. See **Message playback** on page 130.

Base message counter displays

The base message counter shows the total number of answering system messages. See the following table for other message counter displays.

Message counter displays

0	No messages.
1-99	Total number of messages and memos.
....	The system is answering a call, or someone is trying to reach it remotely. The system is in program mode.

Remote access

You can reach your answering system remotely by dialing your home telephone number from any touch-tone telephone.

To remotely reach your answering system:

1. Dial your telephone number from any touch-tone telephone.
2. Once the system answers, enter the two-digit remote access code (**19** is the default code. See page 123 to change it).
 - The system automatically announces the number of new or old messages (if any), and then begins to play them.
3. You can also enter the following remote commands:

Remote commands

1	Press to listen to all messages.
2	Press to listen to new messages only.
3	Press to delete the current message (during playback).
33	Press twice to delete all old messages.
4	Press to repeat the current message (during playback).
5	Press to stop any operation (including recording).
*5	Press to listen to a list of remote commands.
6	Press to skip to the next message (during playback).
*7	Press to record a new announcement.
8	Press to end remote access (the call will be terminated).
0	Press to turn the answering system on or off.

4. Hang up or press **8** to end the calls.

Remote access

Cut out and carry the remote access wallet card at the back of this user's manual for quick reference.



Notes:

- ▶ If you do not enter a valid remote access code, the system answers the call automatically.
- ▶ If you pause for more than four seconds during remote access, you hear a help menu listing all features and commands. If there is no command for another 20 seconds, the call ends automatically.
- ▶ If the memory is full, the answering system answers after ten rings and announces, *"Memory is full. Enter the remote access code."* Enter your remote access code to access the messages and announcements.
- ▶ The telephone can respond to remote access code while it is playing the screening announcement or block announcement. This allows you to access you answering system from an unknown number remotely. See **Screen calls without numbers** on page 108 and **Screen uncategorized calls** on page 111.

Adding and registering handsets/headsets/speakerphones

Your telephone can support up to 12 DECT 6.0 cordless handsets (AT&T model CL80107, sold separately) or up to ten cordless handsets and two cordless headsets or speakerphones (sold separately). Visit

www.telephones.att.com/accessories for a list of compatible DECT 6.0 cordless headsets and speakerphones. Each new handset, headset or speakerphone must be registered to the telephone base before use. You must register each handset, headset or speakerphone separately.

To register a cordless headset or speakerphone to this telephone system, please refer to the corresponding user's manual for more details. To register a cordless handset, see below.

The handsets provided within your product box are already registered as **HANDSET 1**, and so forth. Additional handsets are assigned numbers in the sequential order they are registered (up to **HANDSET 12**).

Register a handset to the telephone base

1. Before you begin registration, make sure the handset is out of the telephone base or charger and shows **To register HS, see manual.**
2. Put the handset you wish to register on the telephone base cradle.
3. Both the handset and the telephone base show **Registering... Please wait.** and the **IN USE** light on the telephone base turns on. **HANDSET X Registered** appears on the handset screen (**HANDSET** represents the handset name, **X** represents the handset number). Both the handset and the telephone base beep and the **IN USE** light turns off. The handset is now registered with the telephone base.

To register HS,
see manual.



Registering...
Please wait



HANDSET X
Registered



Adding and registering handsets/headsets/speakerphones

If registration fails, the system will automatically try to register again. If registration fails after the third try, **Registration Failed** appears on both screens. The handset shows **To register HS, see manual.** and the telephone base returns to idle mode. This may take up to five minutes to occur. Please start again from Step 1.

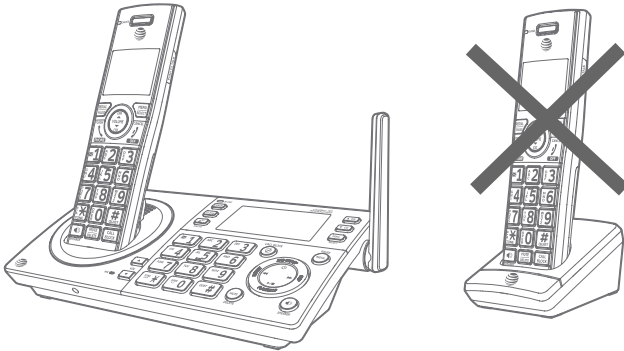

For registration, put the handset on the telephone base, not the handset charger.



Notes:

- ▶ You cannot register a handset if any other system handset is in use.
- ▶ If you try to register more than 12 handsets to the telephone base, the telephone base shows **Registration slots are full** and sounds two beeps.

Deregistering handsets

You may need to deregister your handsets if:

- You have 12 registered handsets and need to replace a handset.

-OR-



- You wish to change the designated handset number of your registered handsets.

You must first deregister ALL handsets, and then register each handset you wish to use again, one at a time.

Please read carefully through all the instructions on this page before beginning the deregistration process.

Deregister all handsets from the telephone base

In addition to the cordless handsets, this operation will also deregister all cordless headsets and speakerphones registered to your telephone base.

1. Make sure that all handsets are out of the telephone base and chargers before you begin deregistration.
2. Press and hold /**FIND HS** on the telephone base for about ten seconds (until the **IN USE** light starts to flash). The telephone base screen shows **Registering... Please wait** for five seconds, then it shows **Deregister all devices?**. Release /**FIND HS**.
3. Immediately press /**FIND HS** while the **IN USE** light is still flashing. (If the light stops flashing, start again with Step 1.)
4. It takes up to ten seconds to complete the deregistration process. Before registering the handset again, wait for the cordless handset screen to display **To register HS, see manual**.
5. To register the handset(s) to the telephone base again, follow the registration instructions on pages 138-139.

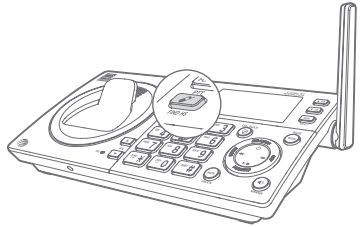







Notes:

- If the deregistration process fails, you may need to reset the system and try again. To reset, unplug the power from the telephone base and plug it back in.
- You cannot deregister the handsets if any other system handset is in use.
- Even if the battery is depleted, you can still deregister the handsets by following the steps mentioned above. After the handset is charged for at least ten minutes, the screen shows **To register HS, see manual**.
- If in Step 2 you already have 12 registered handsets, the telephone base shows Registration slots are full and sounds two beeps. Continue holding /**FIND HS** until **Deregister all devices?** displays.



Alert tones and lights

Handset screen icons

	Battery status - battery is charging (animated display).
	Battery status - low battery (flashing); place the handset in telephone base or charger to recharge.
	Speakerphone - the speakerphone is in use.
	Ringer off - the handset ringer is off.
	New voicemail - you have new voicemail from your telephone service provider.
ANS ON	Answering system on - the answering system is turned on to answer calls.
	Message - new message in the built-in answering system.
NEW	New caller ID log - new and missed calls.
MUTE	MUTE - the handset microphone is off.



Telephone base screen icons

	Ringer off - the telephone base ringer is off.
	New voicemail - you have new voicemail from your telephone service provider.
NEW	New caller ID log - new and missed calls.
	Message counter - total number of messages.

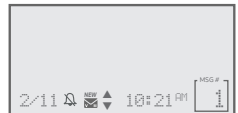

Alert tones and lights

Handset alert tones

One short beep	Tone of each key press, if key tone is turned on.
One long beep	Indication to begin recording a message, memo or announcement.
Two short beeps	You are pressing ▼CID or ▲DIR on a cordless handset when the volume is already at its highest or lowest setting. -OR- Call waiting tone. -OR- Error tone.
Confirmation tone (three rising tones)	The system has completed the command successfully.
Four beeps	The other party has ended your intercom call. -OR- The handset has gone out of range from the base during a call.
Four short beeps	Low battery warning.

Telephone base alert tones

One short beep	Tone of each key press, if key tone is turned on.
One long beep	Indication to begin recording a message, memo or announcement. Indicates the start of message recording during call screening or the end of a message playback session.
Two short beeps	You are pressing ▼/VOL/▲ on the telephone base when the volume is already at its highest or lowest setting. -OR- Call waiting tone. -OR- Error tone. -OR- Registration slots are full.
Confirmation tone (three rising tones)	The system has completed the command successfully.
Four beeps	The other party has ended your intercom call.
Four short beeps	Registration failure tone.
Beeps every ten seconds	Message alert.

Alert tones and lights

Lights

IN USE

- ▶ On when the telephone is in use, or when the answering system is answering an incoming call.
- ▶ On when a handset is being registered.
- ▶ Flashes quickly when there is an incoming call or when handsets are being deregistered.
- ▶ Flashes when another telephone is in use on the same line.

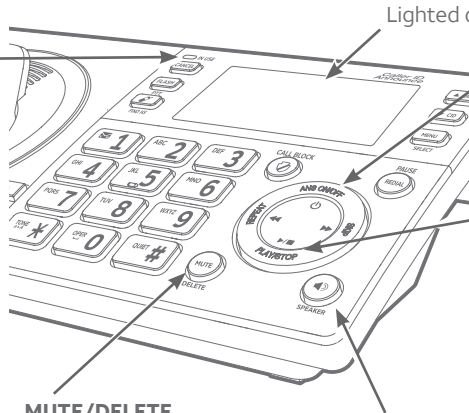

MUTE/DELETE

On when the microphone is muted.

ANSWER ON

On when the answering system is on.

PLAY/STOP

- ▶ On when a message is playing.
- ▶ Flashes when there are new messages.

On when the speakerphone is on.

CHARGE light

On when the handset is charging in the telephone base or charger.

Extra large display

Big lighted buttons

SPEAKER

On when the speakerphone is on.

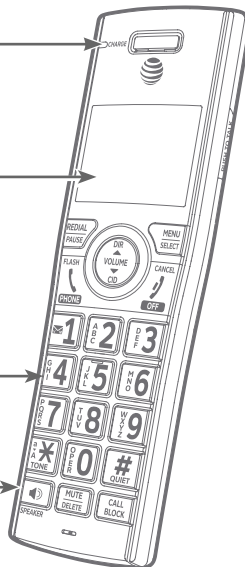

Screen display messages

Screen messages

Added to allow list	An entry has been added to the allow list.
Added to block list	An entry has been added to the block list.
Added to star name list	An entry has been added to the star name list.
BASE 0 is calling	The telephone base is calling.
Blocked call	An incoming call is blocked.
Block list is empty	There are no block list entries.
Call transferred	You have transferred an outside call to another device.
Caller ID log empty	There are no entries in the caller ID log.
Calling BASE 0	The handset is calling the telephone base (for intercom calls).
Calling HANDSET X	The handset or telephone base is calling another handset (for intercom calls). The telephone base is transferring an outside call to a handset.
Call answered	The answering system has answered an incoming call.
Contact deleted	A directory entry is deleted.
Directory empty	There are no directory entries.
Directory full	The directory is full. You cannot save any new entries unless you delete some current entries.
Ended	You have just ended a call.
HANDSET X is calling	Another system handset is calling.
Incoming call	There is a call coming in.
Intercom	The device is on an intercom call.
Intercom ended	The intercom call has just ended.
INTERCOM TO:	You have started the intercom process, and need to enter the number of the device you wish to call.
Line in use	An extension phone, or one of the devices is in use.

Screen display messages

Screen messages

Low battery	The battery is low. You should charge the battery.
Microphone On	Mute is off so the other party can hear your voice.
Muted	The microphone is off. The other party cannot hear you.
New voicemail	There are new voicemail messages from your telephone service provider.
No answer. Try again	The device(s) you are trying to transfer a call to is out of range, off hook, or has no power.
No battery	The handset in the charger has no battery installed.
No caller info	The caller information is unavailable.
Not enough batt to power base	The handset does not have enough charge to power up the telephone base.
No line	There is no telephone line connection.
Number already saved	The telephone number you have entered is already in the directory or call block list.
Not available at this time	Someone else is already using the directory or caller ID log.
No Incoming PTT	The incoming PTT function is turned off. The handset will not receive PTT calls.
Out of range OR No Pwr at base	The telephone base has lost power, or the handset is out of range.
** Paging **	The cordless handset is paged by the telephone base.
Paging all handsets	The telephone base is paging all cordless handsets.
Phone	The handset is on a call.
Place in charger	The battery is very low. The handset should be charged.
Powering base... Don't pick up	The handset on the telephone base is powering up the telephone base in the event of power outage.
Put HS on base to power base	There is no handset placed in the telephone base during power outage.
Pwr outage mode	Battery backup mode is activated.
Quiet mode on	QUIET mode is on.
Quiet mode is off	QUIET mode is turned off.
Rec mem full	The system recording time is full.

Screen display messages

Screen messages

Rec mem low	The system recording time is low.
Recording message	The telephone is recording a message.
Registering... Please wait	The handset is registering to the telephone base.
Registration slots are full	The telephone base has the maximum of 12 handsets registered to it.
Registration Failed	The handset registration is not successful.
Ringer off	The ringer is turned off.
Ringer muted	The ringer is off temporarily while the device is ringing.
Saved to directory	An entry has been successfully saved to the directory.
Screened call	The Smart call blocker feature of the telephone has screened a call and is putting the call through to you.
Setting up Answering sys...	The telephone base is playing voice guide to set up the answering system.
Smart call blk screening	The telephone is screening an incoming call.
Speaker	The handset or telephone base speakerphone is in use.
Voice guide set Smart call blk?	After you install your telephone or power returns following a power outage, the handset and telephone base will prompt you to set the date and time. After the date and time setting is done or skipped, the telephone base will then prompt if you want to set up the Smart call blocker feature via voice guide.
TRANSFER TO:	You have started transferring a call, and need to enter the desired device number or choose all devices.
To register HS, see manual.	Screen display before handset registration.
To screen call, press [SELECT]	Press MENU/SELECT to activate call screening.
Unable to call. Line in use	Failed phone call (the telephone line is in use).
Unable to call. Try again	You try to join a call when there are already four handsets on that call. You try to make an outside call when another device is transferring a call with the intercom feature.
XX Missed calls	There are new calls in the caller ID log.
XX New messages	There are new messages in the answering system.

Troubleshooting

If you have difficulty with your phone please try the following suggestions. For Customer Service, visit our website at www.telephones.att.com or call **1 (800) 222-3111**. In Canada, dial **1 (866) 288-4268**.

My telephone doesn't work at all.

- ▶ Make sure the power cord is securely plugged in.
- ▶ Make sure you plug the battery connector securely into the cordless handset.
- ▶ Make sure you plug the telephone line cord securely and firmly into the telephone base and the telephone wall jack.
- ▶ Charge the battery in the cordless handset for at least ten hours. For optimum daily performance, return the cordless handset to the telephone base or charger when not in use.
- ▶ If the battery is depleted, it may take approximately 30 minutes to charge the handset before it shows **Low battery**. See page 11 for details.
- ▶ Reset the telephone base. Unplug the electrical power. Wait for approximately 15 seconds, then plug it back in. Allow up to one minute for the cordless handset and telephone base to reset.
- ▶ You may need to purchase a new battery. Please refer to **Battery installation and charging** in this user's manual on pages 11-12.

The display shows No line. I cannot get a dial tone.

- ▶ Try all the suggestions mentioned above.
- ▶ If the previous suggestions do not work, disconnect the telephone line cord from your telephone and connect the telephone line cord to another telephone.
 - ▶ If there is no dial tone on that other telephone either, your telephone line cord may be defective. Install a new telephone line cord.
 - ▶ If changing the telephone line cord does not help, the wall jack (or the wiring to this wall jack) may be defective. Try using a different wall jack in your home to connect your CL83107/CL83207/CL83307/CL83407 telephone, or contact your telephone service provider (charges may apply).

Troubleshooting

I cannot dial out.

- Try all the suggestions mentioned above.
- Make sure you have a dial tone before dialing. The cordless handset may take a second or two to find the telephone base and produce a dial tone. This is normal. Wait an extra second before dialing.
- Eliminate any background noise. Noise from a television, radio or other appliances may cause the phone to not dial out properly. If you cannot eliminate the background noise, first try muting the cordless handset before dialing, or dialing from another room with less background noise.
- If other phones in your home are having the same problem, contact your telephone service provider (charges may apply).

My cordless handset isn't performing normally.

- Make sure you plug the power cord securely into the telephone base. Plug the power adapter into a different working electrical outlet without a wall switch.
- Move the cordless handset closer to the telephone base. You may have moved out of range.
- Reset the telephone base. Unplug the electrical power. Wait for 15 seconds, then plug it back in. Allow up to one minute for the cordless handset and telephone base to reset.
- Other electronic products such as HAM radios and other DECT phones, can cause interference with your cordless phone. Try installing your phone as far away as possible from these types of electronic devices.

Out of range OR No pwr at base appears on my cordless handset.

- Ensure you plug the telephone base in properly and the power is on.
- Place the cordless handset in the telephone base for one minute to allow the cordless handset and base to synchronize.
- Move the cordless handset closer to the telephone base. You may have moved out of range.
- Reset the telephone base. Unplug the electrical power. Wait for 15 seconds, then plug it back in. Allow up to one minute for the cordless handset and telephone base to reset.
- Other electronic products such as HAM radios and other DECT phones, can cause interference with your cordless phone. Try installing your phone as far away as possible from these types of electronic devices.

Troubleshooting

The batteries do not hold a charge.

- ▶ If the cordless handset is in the telephone base or charger and the charge light is not on, refer to **The charge light is off or blinking** (page 151).
- ▶ Charge the battery in the cordless handset for at least ten hours. For optimum daily performance, return the cordless handset to the telephone base or charger when not in use.
- ▶ If the battery is depleted, it may take approximately 30 minutes to charge the handset before it shows **Low battery**. Refer to the table on page 11 for details.
- ▶ You may need to purchase a new battery. Please refer to **Battery installation and charging** in this user's manual on pages 11-12.

I get noise, static, or weak signals even when I'm near the telephone base.

- ▶ If you subscribe to high-speed Internet service (DSL - digital subscriber line) through your telephone line, you must install a DSL filter between the telephone line cord and the telephone wall jack (page 10). The filter prevents noise and caller ID problems as a result of DSL interference. Please contact your DSL service provider for more information about DSL filters.
- ▶ You may be able to improve the performance of your cordless phone by installing your new telephone base as far as possible from any other existing cordless telephone system that may already be installed.
- ▶ Other electronic products such as HAM radios and other DECT phones, can cause interference with your cordless phone. Try installing your phone as far away as possible from these types of electronic devices.
- ▶ Do not install this phone near a microwave oven or on the same electrical outlet. You may experience decreased performance while the microwave oven is operating.
- ▶ If you plug your phone in with a modem or a surge protector, plug the phone (or modem/surge protector) into a different location. If this does not solve the problem, relocate your phone or modem farther apart from one another, or use a different surge protector.
- ▶ Move your phone to a higher location. The phone may have better reception in a high area.
- ▶ If other phones in your home are having the same problem, contact your telephone service provider (charges may apply).

Troubleshooting

I experience poor sound quality when using the handset speakerphone.

- ▶ For increased sound quality while using the handset speakerphone, place the handset on a flat surface with the dial pad facing up.

I hear other calls while using my phone.

- ▶ Disconnect the telephone base from the telephone jack, and plug in a different telephone. If you still hear other calls, call your telephone service provider.

My cordless handset does not ring when I receive a call.

- ▶ Make sure that the ringer is not off. Refer to **Ringer volume** on page 18 in this user's manual.
- ▶ Make sure you plug in the telephone line cord securely into the telephone base and the telephone jack. Make sure you plug in the power cord securely.
- ▶ The cordless handset may be too far from the telephone base.
- ▶ Charge the battery in the cordless handset for at least ten hours. For optimum daily performance, return the cordless handset to the telephone base or charger when not in use.
- ▶ You may have too many extension phones on your telephone line to allow all of them to ring simultaneously. Try unplugging some of the other phones.
- ▶ The layout of your home or office may be limiting the operating range. Try moving the telephone base to another location, preferably to a higher location.
- ▶ If other phones in your home are having the same problem, contact your telephone service provider (charges may apply).
- ▶ Test a working phone at the phone jack. If another phone has the same problem, contact your telephone service provider (charges may apply).
- ▶ Other electronic products can cause interference with your cordless phone. Try installing your phone as far away as possible from electronic devices such as television sets, VCRs, or other cordless telephones.
- ▶ Remove the battery. Install the battery again and place the cordless handset into the telephone base. Wait for the cordless handset to reestablish its connection with the telephone base. Allow up to one minute for this to take place.
- ▶ Your line cord may be defective. Try installing a new line cord.

Troubleshooting

My calls cut in and out while I'm using my cordless handset.

- ▶ Other electronic products such as HAM radios and other DECT phones, can cause interference with your cordless phone. Try installing your phone as far away as possible from these types of electronic devices.
- ▶ Do not install this phone near a microwave oven or on the same electrical outlet. You may experience decreased performance while the microwave oven is operating.
- ▶ If you plug your phone in with a modem or surge protector, plug the phone (or modem/surge protector) into a different location. If this does not solve the problem, relocate your phone or modem farther apart from one another, or use a different surge protector.
- ▶ Move your telephone base to a higher location. The phone may have better reception when installed in a high area.
- ▶ If other phones in your home are having the same problem, contact your telephone service provider (charges may apply).

The charge light is off or blinking.

- ▶ Make sure you plug the power and line cords in correctly and securely.
- ▶ Unplug the electrical power. Wait for 15 seconds, then plug it back in. Allow up to one minute for the cordless handset and telephone base to reset.
- ▶ Clean the cordless handset, charger and telephone base charging contacts each month with a pencil eraser or cloth.
- ▶ A blinking **CHARGE** light is an indication that the battery is not connected to the handset or is missing completely. Ensure that the battery is installed properly.

My caller ID isn't working.

- ▶ Caller ID is a subscription service. You must subscribe to this service from your telephone service provider for this feature to work on your phone.
- ▶ The caller may be calling from an area that supports caller ID.
- ▶ Both your and the caller's telephone service providers must use caller ID compatible equipment.

Troubleshooting

- ▶ If you subscribe to high-speed Internet service (DSL - digital subscriber line) through your telephone line, you must install a DSL filter between the telephone line cord and the telephone wall jack (page 10). The filter prevents noise and caller ID problems resulting from DSL interference. Please contact your DSL service provider for more information about DSL filters.

System does not receive caller ID when on a call.

- ▶ Make sure you subscribe to caller ID with call waiting features from your telephone service provider. Caller ID features works only if both you and the caller are in areas offering caller ID service, and if both telephone service providers use compatible equipment.

System screens all my incoming calls.

- ▶ Smart call blocker is set to on by default. If your directory, allow list, block list, and star name list are empty, all calls will be classified as unknown calls. The telephone will screen all incoming calls and asks callers to announce their names or press the pound key (#). We recommend that you set up your directory, allow list, block list, and star name list before using your telephone with the Smart call blocker feature. See **Block list** on page 88, **Allow list** on page 93, and **Star name list** on page 98.
- ▶ To turn Smart call blocker off, see **Set Smart call blocker on/off** on page 85.

While screening a call, the telephone suddenly stops screening and connects to the call.

- ▶ Another handset may have picked up the screening call.
- ▶ If you have other telephone system sharing the same telephone line, and someone picks up the call on the other telephone system while the screening is in progress, the screening process will be terminated and connect you to the caller.

My telephone block calls from someone I know.

- ▶ You may have saved the caller's number to your block list. To remove the number from the block list. See **Delete a block entry** on page 92.

Blocking calls with numbers saved in my block list only.

- ▶ If you want to block calls with numbers saved in your block list only, and allow all other calls to get through to you, change the settings to accept calls without numbers and uncategorized calls. See **Control calls without numbers** on page 85 and **Control uncategorized calls** on page 86.

Blocking all unknown calls.

- ▶ If you want to block all unknown calls with numbers or names that are not in your directory, allow list or star name list, change the settings to block calls without numbers and uncategorized calls. See **Control calls without numbers** on page 85 and **Control uncategorized calls** on page 86.

Forwarding all unknown calls to the answering system.

- ▶ If you want to forward all unknown calls with numbers or names that are not in your directory, allow list or star name list to the answering system, see **Control calls without numbers** on page 85 and **Control uncategorized calls** on page 86 to change the settings.

Incomplete messages.

- ▶ If a caller leaves a very long message, part of it may be lost when the system disconnects the call after the maximum recording time you have set.
- ▶ If the caller pauses for longer than seven seconds, the system stops recording and disconnects the call.
- ▶ If the system's memory becomes full during a message, the system stops recording and disconnects the call.
- ▶ If the caller's voice is very soft, the system may stop recording and disconnect the call.

Difficulty hearing messages.

- ▶ Press **▲/VOL** to increase the telephone base speaker volume.
- ▶ Press **▲DIR/VOLUME** to adjust the message playback volume on a handset.

System does not answer after the correct number of rings.

- ▶ Make sure that the answering system is on. **ANS ON** should show on the handset and the **📞/ANSWER ON** light on the telephone base should be on.

Troubleshooting

- ▶ If toll saver is activated, the number of rings changes to two when you have new messages stored (page 122).
- ▶ If the memory is full or the system is off, the system will answer after ten rings.
- ▶ In some cases, the answering system is affected by the ringing system used by your telephone service provider.
- ▶ If you subscribe to voicemail service, change the number of rings so that your answering system answers before your voicemail (page 122). To determine how many rings activate your voicemail, contact your telephone service provider.
- ▶ If there is a fax machine connected to the same telephone line, try disconnecting the fax machine. If that solves the problem, consult your fax machine documentation for information on compatibility with answering systems.

System does not respond to remote commands.

- ▶ Make sure to enter your remote access code correctly (page 123).
- ▶ Make sure you are calling from a touch-tone phone. When you dial a number, you should hear tones. If you hear clicks, the phone is not a touch-tone telephone and cannot activate the answering system.
- ▶ The answering system may not detect the remote access code while your announcement is playing. Try waiting until the announcement is over before entering the code.
- ▶ There may be interference on the phone line you are using. Press dialing keys firmly.

System does not record messages.

- ▶ Make sure the answering system is on. **ANS ON** should show on the handset and the **📞/ANSWER ON** light on the telephone base should be on.
- ▶ Make sure the memory of the answering system is not full.
- ▶ If you subscribe to voicemail service, change the number of rings so that your answering system answers before your voicemail (page 122). To determine how many rings activate your voicemail, contact your telephone service provider.

Troubleshooting

- ▶ If there is a fax machine connected to the same telephone line, try disconnecting the fax machine. If that solves the problem, consult your fax machine documentation for information on compatibility with answering systems.

System announces, “Time and day not set.”

- ▶ You need to reset the system clock (page 19).

Outgoing announcement is not clear.

- ▶ When you record your announcement, make sure you speak in a normal tone of voice, about nine inches from the handset or the telephone base.
- ▶ Make sure there is no background noise (TV, music, etc.) while recording.

New voicemail and show on the screens, and I don’t know why.

- ▶ Your telephone has both a built-in answering system and voicemail indication. If **New voicemail** and  appear on the screens, then your telephone has received a signal from your telephone service provider that you have a voicemail message waiting for you to retrieve from them. Contact your telephone service provider for more information on how to access your voicemail.

I cannot retrieve voicemail messages.

- ▶ Your telephone has both a built-in answering system and voicemail indication. They are independent features and each alerts you to new messages differently (page 126). If you subscribe to voicemail service from your telephone service provider, contact your telephone service provider for more information on how to access your voicemail.

I’ve set my LCD language to Spanish or French and I don’t know how to change it back to English.

- ▶ Press **MENU/SELECT** on your handset or base in idle mode, then enter **364#** on the handset or base. You hear a confirmation tone.

I subscribe to a nontraditional telephone service that uses my computer to establish connections, and my telephone doesn’t work.

- ▶ Make sure your computer is powered on.

Troubleshooting

- ▶ Make sure your Internet connection is working properly.
- ▶ Make sure that the software is installed and running for your nontraditional telephone service.
- ▶ Make sure to plug your USB telephone adapter into a dedicated USB port on your computer. Do not plug it into a multiple port USB hub (USB splitter) that is not powered.
- ▶ In a few rare instances, the USB port on your computer may not have enough power. Try using a USB hub with its own external power supply.
- ▶ If you are using a firewall, it may prevent access to your nontraditional telephone service provider. Contact your service provider for more information.

Common cure for electronic equipment.

If the telephone does not seem to be responding normally, try putting the cordless handset in the telephone base or charger. If it does not fix the problem, do the following (in the order listed):

1. Disconnect the power to the telephone base.
2. Disconnect the cordless handset battery.
3. Wait a few minutes.
4. Connect power to the telephone base.
5. Remove the battery. Replace the battery and place the cordless handset into the telephone base or charger.
6. Wait for the cordless handset to reestablish its connection with the telephone base. Allow up to one minute for this to take place.

Maintenance

Taking care of your telephone

- ▶ Your cordless telephone contains sophisticated electronic parts, so you must treat it with care.
- ▶ Avoid rough treatment.
- ▶ Place the handset down gently.
- ▶ Save the original packing materials to protect your telephone if you ever need to ship it.

Avoid water

- ▶ You can damage your telephone if it gets wet. Do not use the handset in the rain, or handle it with wet hands. Do not install the telephone base near a sink, bathtub or shower.

Electrical storms

- ▶ Electrical storms can sometimes cause power surges harmful to electronic equipment. For your own safety, take caution when using electric appliances during storms.

Cleaning your telephone

- ▶ Your telephone has a durable plastic casing that should retain its luster for many years. Clean it only with a soft cloth slightly dampened with water or mild soap.
- ▶ Do not use excess water or cleaning solvents of any kind.

Remember that electrical appliances can cause serious injury if used when you are wet or standing in water. If the telephone base should fall into water, DO NOT RETRIEVE IT UNTIL YOU UNPLUG THE POWER CORD AND TELEPHONE LINE CORDS FROM THE WALL. Pull the unit out by the unplugged cords.

Important safety information



This symbol is to alert you to important operating or servicing instructions that may appear in this user's manual. Always follow basic safety precautions when using this product to reduce the risk of injury, fire, or electric shock.

Safety information

- ▶ Read and understand all instructions in the user's manual. Observe all markings on the product.
- ▶ Avoid using a telephone during a thunderstorm. There may be a slight chance of electric shock from lightning.
- ▶ Do not use a telephone in the vicinity of a gas leak. Under certain circumstances, a spark may be created when the adapter is plugged into the power outlet, or when the handset is replaced in its cradle. This is a common event associated with the closing of any electrical circuit. In an inadequately ventilated environment, the user should not plug the phone into a power outlet, nor put a charged handset into the cradle where there are concentrations of flammable or flame-supporting gases. A spark in such an environment could create a fire or explosion. Such environments may include: medical use of oxygen without adequate ventilation; industrial gases (cleaning solvents; gasoline vapors; etc.); a leak of natural gas; etc.
- ▶ Do not use this product near water or when you are wet. For example, do not use it in a wet basement or shower, nor next to a swimming pool, bathtub, kitchen sink, and laundry tub. Do not use liquids or aerosol sprays for cleaning. If the product comes in contact with any liquid, unplug any line or power cord immediately. Do not plug the product back in until it has dried thoroughly.
- ▶ Install this product in a protected location where no one can trip over any line or power cords. Protect cords from damage or abrasion.
- ▶ If this product does not operate normally, see the **Troubleshooting** section on pages 147-156 of this user's manual. If you cannot solve the problem, or if the product is damaged, refer to the **Limited warranty** section on pages 164-165. Do not open this product except as directed in your user's manual. Opening the product or reassembling it incorrectly may expose you to hazardous voltages or other risks.
- ▶ Replace batteries only as described in your user's manual (pages 11-12). Do not burn or puncture batteries — they contain caustic chemicals.
- ▶ The power adapters are intended to be correctly oriented in a vertical or floor mount position. The prongs are not designed to hold the plug in place if it is plugged into a ceiling, under-the-table or cabinet outlet.



Caution: Use only the power adapters provided with this product. To obtain a replacement, visit our website at **www.telephones.att.com** or call **1 (800) 222-3111**. In Canada, dial **1 (866) 288-4268**.

Important safety information

Especially about cordless telephones

- ▶ **Privacy:** The same features that make a cordless telephone convenient create some limitations. Telephone calls are transmitted between the telephone base and the handset by radio waves, so there is a possibility that your cordless telephone conversations could be intercepted by radio receiving equipment within range of the cordless handset. For this reason, you should not think of cordless telephone conversations as being as private as those on corded telephones.
- ▶ **Electrical power:** The telephone base of this cordless telephone must be connected to a working electrical outlet which is not controlled by a wall switch. Calls cannot be made from the handset if the telephone base is unplugged, switched off or if the electrical power is interrupted.
- ▶ **Potential TV interference:** Some cordless telephones operate at frequencies that may cause interference to TVs and VCRs. To minimize or prevent such interference, do not place the telephone base of the cordless telephone near or on top of a TV or VCR. If interference is experienced, moving the cordless telephone farther away from the TV or VCR will often reduce or eliminate the interference.
- ▶ **Rechargeable batteries:** This product contains nickel-metal hydride rechargeable batteries. Exercise care in handling batteries in order not to create a short circuit with conductive material such as rings, bracelets and keys. The battery or conductor may overheat and cause harm. Observe proper polarity between the battery and the battery charger.
- ▶ **Nickel-metal hydride rechargeable batteries:** Dispose of these batteries in a safe manner. Do not burn or puncture. Like other batteries of this type, if burned or punctured, they could release caustic material which could cause injury.



The RBRC® Seal means that the manufacturer is voluntarily participating in an industry program to collect and recycle nickel-metal hydride rechargeable batteries when taken out of service within the United States. These batteries may be taken to a participating local retailer of replacement batteries or recycling center. Or you may call 1-800-8-BATTERY® for locations accepting spent Ni-MH batteries. RBRC® and 1-800-8-BATTERY® are registered trademarks of the Rechargeable Battery Recycling Corporation.

Important safety information

Precautions for users of implanted cardiac pacemakers

Cardiac pacemakers (applies only to digital cordless telephones):

Wireless Technology Research, LLC (WTR), an independent research entity, led a multidisciplinary evaluation of the interference between portable wireless telephones and implanted cardiac pacemakers. Supported by the U.S. Food and Drug Administration, WTR recommends to physicians that:

Pacemaker patients

Should keep wireless telephones at least six inches from the pacemaker.

Should NOT place wireless telephones directly over the pacemaker, such as in a breast pocket, when it is turned ON.

Should use the wireless telephone at the ear opposite the pacemaker.

WTR's evaluation did not identify any risk to bystanders with pacemakers from other persons using wireless telephones.

ECO mode

This power conserving technology reduces power consumption for optimal battery performance. The ECO mode activates automatically whenever the handset is synchronized with the telephone base.

Especially about telephone answering systems

Two-way recording: This unit does not sound warning beeps to inform the other party that the call is being recorded. To ensure that you are in compliance with any federal or state regulations regarding recording a telephone call, you should start the recording process and then inform the other party that you are recording the conversation.

SAVE THESE INSTRUCTIONS

FCC Part 68 and ACTA

This equipment complies with Part 68 of the FCC rules and with technical requirements adopted by the Administrative Council for Terminal Attachments (ACTA). The label on the back or bottom of this equipment contains, among other things, a product identifier in the format US:AAAEQ##TXXXX. This identifier must be provided to your telephone service provider upon request.

The plug and jack used to connect this equipment to premises wiring and the telephone network must comply with the applicable Part 68 rules and technical requirements adopted by ACTA. A compliant telephone cord and modular plug is provided with this product. It is designed to be connected to a compatible modular jack that is also compliant. An RJ11 jack should normally be used for connecting to a single line and an RJ14 jack for two lines. See the installation instructions in the user's manual.

The Ringer Equivalence Number (REN) is used to determine how many devices you may connect to your telephone line and still have them ring when you are called. The REN for this product is encoded as the 6th and 7th characters following the US: in the product identifier (e.g., if ## is 03, the REN is 0.3). In most, but not all areas, the sum of all RENs should be five (5.0) or less. For more information, please contact your telephone service provider.

This equipment must not be used with Party Lines. If you have specially wired alarm dialing equipment connected to your telephone line, ensure the connection of this equipment does not disable your alarm equipment. If you have questions about what will disable the alarm equipment, consult your telephone service provider or a qualified installer.

If this equipment is malfunctioning, it must be unplugged from the modular jack until the problem has been corrected. Repairs to this telephone equipment can only be made by the manufacturer or its authorized agents. For repair procedures, follow the instructions outlined under the limited warranty.

If this equipment is causing harm to the telephone network, the telephone service provider may temporarily discontinue your telephone service. The telephone service provider is required to notify you before interrupting service. If advance notice is not practical, you will be notified as soon as possible. You will be given the opportunity to correct the problem and the telephone service provider is required to inform you of your right to file a complaint with the FCC. Your telephone service provider may make changes in its facilities, equipment, operation, or procedures that could affect the proper functioning of this product. The telephone service provider is required to notify you if such changes are planned.

If this product is equipped with a corded or cordless handset, it is hearing aid compatible.

If this product has memory dialing locations, you may choose to store emergency telephone numbers (e.g., police, fire, medical) in these locations. If you do store or test emergency numbers, please:

Remain on the line and briefly explain the reason for the call before hanging up.

Perform such activities in off-peak hours, such as early morning or late evening.

Industry Canada

This device complies with Industry Canada licence-exempt RSS standard(s).

Operation is subject to the following two conditions: (1) this device may not cause harmful interference, and (2) this device must accept any interference received, including interference that may cause undesired operation.

Privacy of communications may not be ensured when using this telephone.

The term "IC:" before the certification/registration number only signifies that the Industry Canada technical specifications were met.

The Ringer Equivalence Number (REN) for this terminal equipment is 1.0. The REN indicates the maximum number of devices allowed to be connected to a telephone interface. The termination of an interface may consist of any combination of devices subject only to the requirement that the sum of the RENs of all the devices not exceed five.

This product meets the applicable Innovation, Science and Economic Development Canada technical specifications.

Appendix FCC Part 15

NOTE: This equipment has been tested and found to comply with the requirements for a Class B digital device under Part 15 of the Federal Communications Commission (FCC) rules. These requirements are intended to provide reasonable protection against harmful interference in a residential installation. This equipment generates, uses and can radiate radio frequency energy and, if not installed and used in accordance with the instructions, may cause harmful interference to radio communications. However, there is no guarantee that interference will not occur in a particular installation. If this equipment does cause harmful interference to radio or television reception, which can be determined by turning the equipment off and on, the user is encouraged to try to correct the interference by one or more of the following measures:

- ▶ Reorient or relocate the receiving antenna.
- ▶ Increase the separation between the equipment and receiver.
- ▶ Connect the equipment into an outlet on a circuit different from that to which the receiver is connected.
- ▶ Consult the dealer or an experienced radio/TV technician for help.

WARNING: Changes or modifications to this equipment not expressly approved by the party responsible for compliance could void the user's authority to operate the equipment.

This device complies with Part 15 of the FCC Rules. Operation is subject to the following two conditions: (1) this device may not cause harmful interference, and (2) this device must accept any interference received, including interference that may cause undesired operation. Privacy of communications may not be ensured when using this telephone.



To ensure safety of users, the FCC has established criteria for the amount of radio frequency energy that can be safely absorbed by a user or bystander according to the intended usage of the product. This product has been tested and found to comply with the FCC criteria. The handset may be safely held against the ear of the user. The telephone base shall be installed and used such that parts of the user's body other than the hands are maintained at a distance of approximately 20 cm (8 inches) or more.

This Class B digital apparatus complies with Canadian requirement:
CAN ICES-3 (B)/NMB-3(B)

California Energy Commission battery charging testing instructions

This telephone is set up to comply with the energy-conserving standards right out of the box. These instructions are intended for California Energy Commission (CEC) compliance testing only. When the CEC battery charging testing mode is activated, all telephone functions, except battery charging, will be disabled.

To activate the CEC battery charging testing mode:

1. Unplug the telephone base power adapter from the power outlet. Make sure all cordless handsets are inserted with charged batteries and out of the chargers before proceeding.
2. While you press and hold  /**FIND HS**, plug the telephone base power adapter back to the power outlet.
3. After about 20 seconds, when the **IN USE** light starts flashing, release  /**FIND HS** and then press it again within two seconds.



The process takes up to one minute to complete. When the cordless handsets successfully enter the CEC battery charging testing mode, the **IN USE** light turns off and all handsets display **To register HS, see manual**. You hear a confirmation tone.

When the cordless handsets fail to enter this mode, repeat the steps mentioned above.

Note: The telephone base will be powered up as normal if you fail to press  /**FIND HS** within two seconds in Step 3.

To deactivate the CEC battery charging testing mode:

1. Unplug the telephone base power adapter from the power outlet, then plug it back in. The telephone base is powered up as normal.
2. Register your handsets back to the telephone base. See pages 138-139 for handset registration instructions.



Limited warranty

The AT&T brand is used under license - any repair, replacement or warranty service, and all questions about this product should be directed to our website at www.telephones.att.com or call **1 (800) 222-3111**. In Canada, dial **1 (866) 288-4268**.

1. What does this limited warranty cover?

The manufacturer of this AT&T branded product warrants to the holder of a valid proof of purchase (“CONSUMER” or “you”) that the product and all accessories provided in the sales package (“PRODUCT”) are free from defects in material and workmanship, pursuant to the following terms and conditions, when installed and used normally and in accordance with the PRODUCT operating instructions. This limited warranty extends only to the CONSUMER for products purchased and used in the United States of America and Canada.

2. What will be done if the PRODUCT is not free from defects in materials and workmanship during the limited warranty period (“materially defective PRODUCT”)?

During the limited warranty period, the manufacturer’s authorized service representative will repair or replace at the manufacturer’s option, without charge, a materially defective PRODUCT. If the manufacturer repairs the PRODUCT, they may use new or refurbished replacement parts. If the manufacturer chooses to replace the PRODUCT, they may replace it with a new or refurbished PRODUCT of the same or similar design. The manufacturer will retain defective parts, modules, or equipment. Repair or replacement of the PRODUCT, at the manufacturer’s option, is your exclusive remedy. The manufacturer will return repaired or replacement products to you in working condition. You should expect the repair or replacement to take approximately 30 days.

3. How long is the limited warranty period?

The limited warranty period for the PRODUCT extends for ONE (1) YEAR from the date of purchase. If the manufacturer repairs or replaces a materially defective PRODUCT under the terms of this limited warranty, this limited warranty also applies to repaired or replacement PRODUCT for a period of either (a) 90 days from the date the repaired or replacement PRODUCT is shipped to you or (b) the time remaining on the original one-year limited warranty; whichever is longer.

4. What is not covered by this limited warranty?

This limited warranty does not cover:

- ▶ PRODUCT that has been subjected to misuse, accident, shipping or other physical damage, improper installation, abnormal operation or handling, neglect, inundation, fire, water, or other liquid intrusion; or
- ▶ PRODUCT that has been damaged due to repair, alteration, or modification by anyone other than an authorized service representative of the manufacturer; or
- ▶ PRODUCT to the extent that the problem experienced is caused by signal conditions, network reliability or cable or antenna systems; or
- ▶ PRODUCT to the extent that the problem is caused by use with non-AT&T accessories; or
- ▶ PRODUCT whose warranty/quality stickers, PRODUCT serial number plates or electronic serial numbers have been removed, altered or rendered illegible; or
- ▶ PRODUCT purchased, used, serviced, or shipped for repair from outside the United States of America or Canada, or used for commercial or institutional purposes (including but not limited to products used for rental purposes); or
- ▶ PRODUCT returned without valid proof of purchase (see item 6 on next page); or
- ▶ Charges for installation or setup, adjustment of customer controls, and installation or repair of systems outside the unit.

Limited warranty

5. How do you get warranty service?

To obtain warranty service, visit our website at **www.telephones.att.com** or call **1 (800) 222-3111**. In Canada, dial **1 (866) 288-4268**.

NOTE: Before calling for service, please review the user's manual; a check of the PRODUCT's controls and features may save you a service call.

Except as provided by applicable law, you assume the risk of loss or damage during transit and transportation and are responsible for delivery or handling charges incurred in the transport of the PRODUCT(s) to the service location. The manufacturer will return repaired or replaced PRODUCT under this limited warranty to you. Transportation, delivery or handling charges are prepaid. The manufacturer assumes no risk for damage or loss of the PRODUCT in transit. If the PRODUCT failure is not covered by this limited warranty, or proof of purchase does not meet the terms of this limited warranty, the manufacturer will notify you and will request that you authorize the cost of repair prior to any further repair activity. You must pay for the cost of repair and return shipping costs for the repair of products that are not covered by this limited warranty.

6. What must you return with the PRODUCT to get warranty service?

You must:

- ▶ Return the entire original package and contents including the PRODUCT to the service location along with a description of the malfunction or difficulty; and
- ▶ Include a "valid proof of purchase" (sales receipt) identifying the PRODUCT purchased (PRODUCT model) and the date of purchase or receipt; and
- ▶ Provide your name, complete and correct mailing address, and telephone number.

7. Other limitations

This warranty is the complete and exclusive agreement between you and the manufacturer of this AT&T branded PRODUCT. It supersedes all other written or oral communications related to this PRODUCT. The manufacturer provides no other warranties for this PRODUCT. The warranty exclusively describes all of the manufacturer's responsibilities regarding the PRODUCT. There are no other express warranties. No one is authorized to make modifications to this limited warranty and you should not rely on any such modification.

State/Provincial Law rights: This warranty gives you specific legal rights, and you may also have other rights which vary from state to state or province to province.

Limitations: Implied warranties, including those of fitness for a particular purpose and merchantability (an unwritten warranty that the PRODUCT is fit for ordinary use) are limited to one year from date of purchase. Some states/provinces do not allow limitations on how long an implied warranty lasts, so the above limitation may not apply to you. In no event shall the manufacturer be liable for any indirect, special, incidental, consequential, or similar damages (including, but not limited to lost profits or revenue, inability to use the PRODUCT or other associated equipment, the cost of substitute equipment, and claims by third parties) resulting from the use of this PRODUCT. Some states/provinces do not allow the exclusion or limitation of incidental or consequential damages, so the above limitation or exclusion may not apply to you.

Please retain your original sales receipt as proof of purchase.

Technical specifications

RF frequency band	1921.536MHz - 1928.448MHz
Channels	5
Telephone base voltage (AC voltage, 60Hz)	96Vrms - 130Vrms
Telephone base voltage (AC adapter output)	6VDC @ 600mA
Handset battery	2.4V 400mAh, 2xAAA Ni-MH
Charger voltage (AC adapter output)	6VDC @ 100mA

Operation	Operating time*
Talk time (cordless handset)	Up to 7 hours
Talk time (cordless handset speakerphone)	Up to 5 hours
Standby	Up to 7 days

* Operating times vary depending on your actual use and the age of the battery.

DECT 6.0 digital technology

The AT&T DECT 6.0 products offer unsurpassed range performance and sound clarity. This is achieved through a unique antenna design and advances in noise-filtering technology. An independent laboratory has confirmed that AT&T DECT 6.0 products perform up to 45% better in range competitions against similarly equipped phones of the leading competition. Now, calls can be taken in the basement, backyard and garage with exceptional sound quality.

Telephone operating range

This cordless telephone operates within the maximum power allowed by the Federal Communications Commission (FCC). Even so, this handset and telephone base can communicate over a certain distance — which can vary with the locations of the telephone base and handset, the weather, and the construction of your home or office.

Redefining long range coverage and clarity

This telephone base comes with an antenna which gives much better clarity and covers a longer range than before.

HD audio

HD audio improves sound quality by expanding and rebuilding frequencies that are lost with traditional phone calls. There is no additional telephone service requirement to use HD audio. It is designed to work with standard telephone service. Your system will automatically enhance all received sound with HD audio.

Simulated full-duplex handset and base speakerphones

The simulated full-duplex speakerphones on your handset and telephone base allow both ends of a call to speak and be heard at the same time. Optimal performance is subject to external factors and individual usage.

A

- Alert tones
 - handset 142
 - telephone base 142
- Allow list 93
- Announcement 116
- Answer an incoming call
 - during an intercom call 52
 - during PTT 60
- Answering calls 38
- Answering system 116–137
- Assign a speed dial number 69
- Auto off 39

B

- Battery backup mode 14
- Battery charging 12
- Battery installation 11
- Blind transfer 47
- Block list 88

C

- Caller ID announce
 - telephone base 32
- Caller ID (CID)
 - add entries to phone directory 77, 78
 - delete entries 76
 - dial entries 76
 - review entries 75
- Call transfer 53
- Charger installation 10
- Clear voicemail indication
 - handset 23
 - telephone base 34

- Clock
 - handset 19
 - telephone base 30

D

- Day and time
 - handset 19
 - telephone base 30
- Delete
 - a caller ID log entry 76
 - a directory entry 67
 - a speed dial number 71
- Dialing
 - from a record in the caller ID log 76
 - from the directory 67
- Directory
 - dial a number 67
 - edit entries 68
 - name search 66
 - new entries 63
- Display dial 67
- DSL 10

E

- Elapsed time 38
- Ending a call 39

H

- Handset
 - handset locator 49
 - quick reference guide 1–4
 - ringer tone 18
 - ringer volume 18
 - screen icons 141
 - temporary ringer silencing 39
 - voicemail indicator 23
- HD audio 166

I

Important safety information
158–160
Installation 9–16
Intercom 50–52

L

Last number redial 40
LCD language 20, 31
reset LCD language 20, 31
Lights 143
Limited warranty 164–165

M

Maintenance 157
Make an outgoing call during PTT 61
Making calls 38
Memory match 74
Message
alert tone 124
counter display 135
playback 130–133
Mute 44

N

Names
search 66
Number of rings 122

O

On-hook dialing (predialing) 38
Outgoing announcement 116

P

Paging tone 49
Power adapter 10
Predialing 38
Push-to-talk 54–61

Q

Quick reference guide 1–8
Quiet mode 27

R

Reassign a speed dial number 70
Receiving calls 38
Recharging 12
Redial 40–41
Remote access 136–137
Ringer silencing 39
Ring tone options
handset 18
telephone base 29

S

Safety information 158–160
Screen display message 144–146
Smart call blocker 81–115
allowed calls 104
blocked calls 106
screen calls without numbers 108
screening announcement 101
screen uncategorized calls 111
Speakerphone 40
Speed dial
delete a number 71
edit a number 70
enter a number 69
Star name list 98

T

- Technical specifications 166
- Telephone base
 - quick reference guide 5–8
 - ringer tone 29
 - ringer volume 29
 - screen icons 141
- Temporary ringer silencing 39
- Time
 - handset 19
 - telephone base 30
- Troubleshooting 147–156

U

- Unwelcome calls 83

V

- Visual message waiting indicator
 - handset 22
 - telephone base 33
- Voice announce caller ID
 - telephone base 32
- Voice guide 13, 120
- Voicemail 22, 126
 - quick access 70, 71
- Voice prompts 128
- Volume control
 - handset 18, 43, 131
 - telephone base 29, 43, 131

W

- Wall-mount installation 15
- Warranty 164–165
- Welcome calls 83

Remote access wallet card

Use the wallet card to help you remember commands to control your answering system from any touch-tone telephone.

Cut along dotted line.



Call your phone number, then enter your two-digit access code (preset to **19**).

Action	Remote command
--------	----------------

Play all messages.....	1
Play new messages.....	2
Delete the message	3
Delete all old messages	33
Repeat or go back.....	4
Stop	5
Help menu.....	*5

Fold here.

Skip the message.....	6
Record announcement.....	*7
End remote access call	8 (or hang up)
Turn system off or on	0

Models: CL83107/CL83207/CL83307/CL83407

Type: DECT 6.0 cordless telephone/answering system with caller ID/call waiting

© 2017 Advanced American Telephones. All Rights Reserved.

AT&T and the AT&T logo are trademarks of AT&T Intellectual Property licensed to Advanced American Telephones, San Antonio, TX 78219.

Printed in China.



www.telephones.att.com

© 2017 Advanced American Telephones. All Rights Reserved.

AT&T and the AT&T logo are trademarks of AT&T Intellectual Property licensed to
Advanced American Telephones, San Antonio, TX 78219.

Qaltel™ is a trademark of Truecall Group Limited.

RBRC® and 1-800-8-BATTERY® are registered trademarks of the Rechargeable Battery Recycling
Corporation.

Printed in China. Issue 1.0 AT&T 03/17.