

NEW! 68030 SE FROM APPLE

MACWORLD

The Macintosh Magazine

March 1989 \$3.95

Canada \$4.95

SE/30

Apple's New Macintosh

6 Fax Modems Compared

**Do Color Separations
on the Mac Save
Time or Money?**

**19 Accelerator Boards:
68020/030 Test Results**

**The 21 Best Utilities
for the Mac II**



Macintosh SE/30



True Macintosh Microsoft acro

Editor's Corner

By B. R. Ross

*Mike
THIS IS WHAT
I've BEEN
talking
about.
IT'S HOT!!
-P*

Fasten your seatbelts, Mac® fans. You're about to enter the Microsoft Zone.

Earlier this week I witnessed a demo of Microsoft's products that left me feeling as enlightened as the day I first set my eyes on a Macintosh®.

Here's a company with a reputation for singularly superior products. But what they showed me pushed the envelope of software productivity:

A complete line of products for the Mac that all work together.

The significance of which hit me like a ton of bricks when I saw them in action.

For instance, I saw a **chart** in your very favorite **spreadsheet** and mine, **Microsoft® Excel**, updated from within **Microsoft Word 4.0** using just a few **keystrokes**. And then pasted into **PowerPoint®** for an incredible looking presentation.

And with just as little effort, the ever-capable **Microsoft Word 4.0** was merged with **Microsoft's database application, File**, for a mass mailing.

As if that wasn't enough, I saw their versatile integrated program **Works** share files with **Microsoft Excel** and **Word**.

What really blew me away is Micro-

soft Mail. You can send and receive information between members in your workgroup even if they're on a PC. Nice.

But the real beauty is that you can **access Microsoft Mail directly from the File menu when you're in Microsoft Word 4.0**. No other company can offer that kind of integration. Or this kind:

A product line that all works together.

With other applications on the Mac. And even with such PC standards like **Lotus® 1-2-3®**, **Microsoft Word 5.0** and **WordPerfect®**.

What's more, every product is supported by **on-line help and a comprehensive manual**. Or you can call one number for unlimited technical support.

Obviously, I'm impressed. So much so, that I've asked Microsoft to send copies of their Macintosh product line brochure in time for our next meeting. If you can't make it, you can always **get a free copy** by calling **(800) 541-1261, Dept. I92**.

Fellow Macphiles, man your Macs. Because we're entering a new age of compatibility—or at least Microsoft is.

And I don't know about you, but I plan on going along for the ride.

Here's a company with a reputation for singularly superior products. But what they showed me pushed the envelope of software productivity: A complete line of products that all work together.

WEST SIDE USERS GROUP

enthusiasts use ss the board.

This workstation is running
Microsoft Mail



**MICROSOFT
WORD
SWEEPS THE
NATION!**

A person of great vision
will come into your life.



USER GROUP
MEETING
WED. 6:00 PM
RE: CUSTOMIZING
MS EXCEL



Microsoft
Making it all make sense.

MACWORLD

March 1989

The Macintosh® Magazine

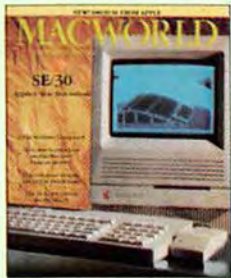

On the Cover

It may look essentially the same, but on the inside the SE/30 is a whole new machine—in fact, it may become the next Macintosh standard (p. 112). (Photo by Paul Franz-Moore.)

Departments

- 13 **Mac Bulletin**
Late-breaking news.
- 19 **Commentary/Jerry Borrell**
Reflections on software trends.
- 31 **Letters**
- 41 **David Bunnell**
Examining the latest virus invasion.
- 45 **Steven Levy**
Advice for Mac owners with CPU envy.
- 61 **State of the Mac**
Thom Hogan
Our new columnist wonders if the Mac II is showing signs of age.
- 75 **How To/Insights on QuarkXpress 2.0**
Steve McKinstry
Exploit the power of the press.
- 199 **New Products**
A quick look at new Macintosh hardware, software, and accessories.
- 227 **How To/Quick Tips**
Lon Poole
Avoiding ImageWriter paper jams, indents and subheads in MacWrite, finding time zones, and more.
- 237 **How To/Getting Started with Tax Software**
Jim Heid
Proceed with caution if you decide to computerize your return.
- 249 **Updates**
The latest software upgrade news.
- 253 **Where to Buy**
Contact information for products in this issue.
- 292 **Best-Sellers**

85 Macworld News

- *Better Color for the II* New color printers from Tektronix.
- *Hot Wires* A modem that transmits at 19,200 bits per second.
- *Let Milo Handle the Math* Paracomp's Milo executes common math operations.
- *LightningScan* A low-cost, hand-held scanner.

Plus OS/2 1.1, micro-mainframe connectivity, Hayes modems, CAD/CAM, broadband LAN adapter for the II, and more.

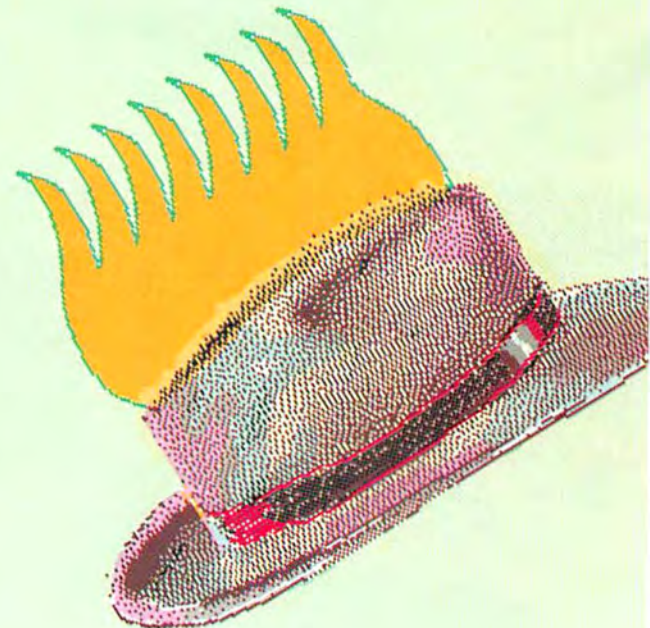



Tabulating opinion polls on the Mac, Macworld News (p. 85).

Features

- 112 **The Mac SE Turns 030**
Bruce F. Webster
Squeezing the Mac II's power into the SE.
- 118 **Processors: Is Faster Better?**
Bruce F. Webster
We put SE and II accelerator boards through their paces.
- 128 **Selecting a Color Separator**
Steve Roth
Strategies for becoming a color Mac publisher.
- 138 **Mac Fax: Not Ready for Prime Time**
Dave Kosiur
Fax modems might sound appealing, but can they really deliver?
- 146 **Mac II Utility Kit**
Thom Hogan
A grab bag of Mac II utilities that handle problems ranging from color to compatibility.

Should you automate your tax return? See "Getting Started with Tax Software" (p. 237).

Reviews

- 156 **Studio/8 1.0**
Color bitmap painting software.
- 158 **OmniPage**
Scanning software package.
- 160 **G330-70 Color Thermal Transfer Printer**
Thermal color printer.
- 163 **Findswell 2.0**
Utility for locating documents in folders.
- 165 **Springboard Publisher 1.0**
Page-layout program.
- 167 **FORTTRAN Compilers**
Language Systems Fortran Compilers, Mactran Plus, MacFortran/MacFortran/020.
- 172 **StandOut**
Desktop presentation program with style sheets.
- 174 **Desktop Printer and Printer Driver**
Brother HL-8 Laser Printer and Printworks for the Mac/Laser Version.
- 179 **FastPath 4**
Gateway for connecting LocalTalk LANs and Ethernet networks.
- 181 **BackFax**
Fax software for AppleFax modem.
- 183 **Animated Adventure Games**
Space Quest II: Vohaul's Revenge 1.50 and Police Quest: In Pursuit of the Death Angel 1.50.
- 186 **DTP Advisor**
Desktop publishing tutorial and project-management HyperCard stack.
- 188 **V.I.P. 2.51**
Interactive Macintosh software development.
- 190 **HyperCard Entertainment Stacks**
Amanda Stories, Volume I and II, and The Manhole 1.2.
- 192 **Mac II 19-inch Monochrome Displays**
Nutmeg 19 and DualPage Display System.
- 195 **Window Shopping**
Icon Factory, scriptExpert, and more.

Should you do your own four-color-process separations on the Mac? See "Selecting a Color Separator" on p. 128.



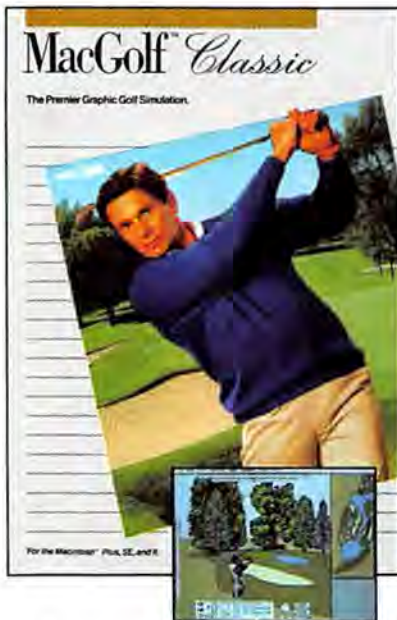

A premium edition of the best selling Macintosh game in the world.

MacGolf Classic puts you into a full perspective 3-D simulation of realistic golf action. You match your skills against fairways, roughs, sand traps, water hazards and trees.

MacGolf's two courses are together with the four MacCourses™ for a total of 108 holes, all in vivid full screen color on the Macintosh II.

MacGolf Classic gives you a player's eye view and an aerial over-view of each hole with close up options. You have complete control of your position, ball placement, ball speed and direction, and selection of all 14 clubs. Spectacular digitized graphics and sounds add to the excitement.

MacGolf Classic is so close to the real thing it will improve your golf game. Every challenge should be this spectacular.



©1988 PCAI 612/427-4789 MacGolf and MacCourses are trademarks of PCAI.

MACWORLD

Editor-in-Chief

Jerry Borrell

Executive Editor: David Ushijima
Managing Editor: Charles Barrett
Senior Editor: Adrian Mello
Editorial Manager: Jane Lagas
Associate Editors: Deborah Branscum, Joe Matazzoni, Tom Moran, Carol Person, Cheryl Spencer, Suzanne Stefanac
East Coast Editor: Brita Meng
Senior Production Editor: Luis A. Camus
Assistant Editors: Cathy E. Abes, Mark Hurlow, Mary Margaret Lewis, Liza Weiman
Senior Copy Editor: Ruth Henrich
Copy Editors: Emily Bower, William Freais, Felicity O'Meara, Katherine L. Ulrich, O'Brien Young
Editorial Assistants: Pamela T. Creighton, Ann Garrison
Editorial Administrative Assistants: Lyn Taylor, Joyce C. Ripp
Contributing Editors: Nancy E. Dunn, Robert C. Eckhardt, Erfert Fenton, Danny Goodman, Rob Hahn, Jim Heid, Dave Kosiur, Steven Levy, Lon Poole, Charles Seiter, Franklin Tessler, Bruce F. Webster

Art and Design

Art Director: Christopher Burg
Designer: Dennis McLeod
Associate Art Director: Joanne Hoffman
Senior Design Associates: Leslie Barton, Tom Morgan
Design Associate: Hae Yuon Kim

James E. Martin

President and Publisher
 Macworld Communications

Steven J. Rosenfield

Associate Publisher

Production

Senior Production Manager: Anne Foley
Editorial Production Manager: Ellyn L. Hament
Production Editor: Susan M. Ford
Assistant Production Manager: Claudia Dawn Smukler
Lead Typesetter: Mark L. Duran
Typesetter: Barbara Tannenbaum
Advertising Booking Coordinator: Stephanie Cady
Advertising Billing Coordinator: So Fong Yip

Marketing and Advertising Sales

Director of Advertising Sales: Patricia Navone (415/243-0505)
Senior Account Manager/No. California (San Francisco): Penny Rigby (415/243-0505)
No. California (San Jose): Cherie La France (415/243-0505)
Northwest: Regina T. Salaces (415/243-0505)
Midwest: Shannon Dolan (312/827-4477)
Southeast: Kathy Isaacs (404/394-0758)
New England: Joan Flynn (508/879-0700)
Eastern Advertising Manager: Bill Thompson (201/967/1350)
Mid-Atlantic: Annette Bremer (201/967-1350)
So. California, Southwest, Texas: Lisa Hillgren, Cathi Tucker (714/250-1307)
Macworld Catalog: Carol Felde, Niki Stranz
Director of Marketing Services: Sandi Vargas

Circulation

Circulation Director: Daniel Orum
Circulation Manager: Lindsay Davidson
Fulfillment Coordinator: Evelyn Adenau
Promotion Coordinator: Lori Hitchcock
Circulation Assistant: Catherine Huchting
Single-Copy Sales Director: George Clark
Single-Copy Sales Rep: Martin Garchar

Research

Director: Cheryl Woodard
Manager: Ralph Ames
Market Analyst: Dusty Rody Pedersen
Research Assistants: Bill Segovia, Scott Shores

March 1989

Volume 6, Number 3

Macworld® (ISSN 0741-8647) is published monthly by PCW Communications, Inc., 501 Second St., San Francisco, CA 94107. Subscription rates are \$30 for 12 issues, \$60 for 24 issues, and \$90 for 36 issues. Foreign orders must be prepaid in U.S. funds with additional postage. Add \$16 per year from Canada and Mexico; add \$16 per year for surface mail or \$95 per year for airmail from all other countries. Second-class postage paid at San Francisco. POSTMASTER: Send address changes to Macworld, P.O. Box 54529, Boulder, CO 80323-4529. For dealer inquiries call 800/621-5461, in California 800/521-8455. Editorial and business offices: 501 Second St., San Francisco, CA 94107, 415/243-0505. For subscriber services call toll-free 800/525-0643 (in Colorado 303/447-9330) or write: Subscriber Services, P.O. Box 54529, Boulder, CO 80322-4529. Macworld is a publication of PCW Communications, Inc. Macworld is an independent journal not affiliated with Apple Computer, Inc. APPLE, the APPLE LOGO, MAC, MACINTOSH, and MACWORLD are registered trademarks, and MACLETTER is a trademark of Apple Computer, Inc. Printed in the United States of America. Copyright © 1989 PCW Communications, Inc. All rights reserved. Macworld is a member of IDG Communications, the world's largest publisher of computer-related information. IDG Communications publishes over 80 computer publications in more than 28 major countries. Fourteen million people read one or more IDG Communications publications each month.

Circle 290 on reader service card



Use Daily To Prevent Network Decay.

It used to be a fact of life: as the size of your PhoneNet® or AppleTalk® network went up, its performance went down. But the Shiva NetBridge has changed that for good. Just plug one in every 10th

“Best value in AppleTalk bridges”
— MacWEEK

node or so and you'll keep all the performance you paid for. Because the NetBridge maintains performance by reducing network congestion. You can plug in additional NetBridges to build an expanded 'internetwork,' including hundreds of Macs and

peripherals. It's as easy to manage as it is to set up. The NetBridge lets you define, add and delete internetwork 'zones' to match workflow or office layout. You can also control file and peripheral access privileges zone by zone. And even get a quick status report on your entire network or any part of it. You can see at a glance how many devices are connected and where they are along the internetwork. Get all the network performance you paid for with a Shiva NetBridge. Call 1-800-458-3550, or write Shiva, 155 Second St., Cambridge, MA 02141, for the name of your nearest Shiva dealer.

NetBridge[™]
by Shiva

We're Putting Networks To Work[™]

OK, we admit you can't buy a NetModem for \$19.52. But if you divide the NetModem's \$599 list price by 31 Macs on an AppleTalk network - the nominal limit - the cost per Mac is \$19.52. Still the best deal around.
Trademarks: NetModem - Shiva Corporation. Registered Trademarks: Hayes - Hayes Microcomputer Products, Inc.; LaserWriter, AppleShare - Apple Computer, Inc.; Tops - Sun Microsystems, Inc.

Circle 421 on reader service card



Radius Full Page Display™



Radius Two Page Display™

FOUR CLEAR YOU SHOULD BUY YO A RADIUS AUTH

Now you can buy your Macintosh II with a powerful tool which will dramatically increase your productivity with every use.

A Radius Display.

Radius offers displays for every type of Macintosh user and every Macintosh software application.

If you're involved primarily in intensive word processing and database management, we heartily recommend our FPD.

The Radius Full Page Display™ shows you an entire 8½" x 11" paper-like page. With a refresh rate of 69 Hz, it is virtually flicker-free.

Our display is perfectly suited for working with software like Microsoft Word and 4th Dimension.

If you're incorporating your word processing into page layout and design, we suggest that the Radius Two Page Display™ is clearly the choice for you.

You have the same flicker-free resolution of the FPD with a full two-page horizontal layout. Ideal for viewing a magazine spread. Essential for creating architectural plans.

Or, if you're putting photographs into your Macintosh, our Radius Gray Scale Display™ lets you create and manipulate life-like images in 256 shades of gray across the same expansive TPD.

Scan your photographs, then do your own retouching using Image Studio or Digital Darkroom.

When you're ready, just print out on a LaserWriter or download to a Linotronic. You'll get startlingly beautiful and gratifying results.



Radius Gray Scale Display™



Radius Color Display™

REASONS WHY OUR MACINTOSH II AT AUTHORIZED DEALER.

For professional publishers and engineering designers, the Radius Color Display™ offers you the latest in digital design, Radius innovation and Trinitron color technology.

You can work with 256 brilliant colors at one time from the Macintosh palette of 16.7 million hues.

Create dazzling layouts with color photos. Draw dynamic 3D color illustrations. Design a new circuit board. Or, simplify a complicated catalogue. All in vivid, living color.

And should you need it, our Color Display is more than willing to work instantly in gray scale. With sharp, crystal clear resolution.

Best of all, no matter which Radius display you do choose, you get the classic Radius firmware.

All of our displays offer you Tear-off Menus which can be positioned anywhere on the screen. And built-in screen savers, control panel access, as well as adjustable menu and menu bar type size.

Our Full Page and Two Page Displays allow you to create bit-map screen dumps. And our Gray Scale and Color Displays let you save any part of your screen in a PICT file.

So before you buy your Macintosh II anywhere else, call 1-408-434-1010 for a brochure and the name of your nearest Radius Authorized Dealer.

It's clearly the thing to do.

radius™
Intelligent Hardware™

Circle 46 on reader service card



Extend the power...

The ultimate utility...

Teach Your Mac To Juggle

Font/DA Juggler™ Plus

Juggling fonts, desk accessories (DA's), FKeys and sounds may be a feat for some utilities—but not for Font/DA Juggler Plus.

With an agility that would amaze even the keenest eye, Font/DA Juggler Plus provides unlimited access to fonts, DA's, FKeys and sounds without having to install them in your system file and eat up valuable memory space. In fact, Font/DA Juggler Plus sets the pace that similar utilities follow. For example, DA/Font Juggler was the first to:

- Provide 100% Multifinder compatibility
- Automatically reopen user-selected files
- Incorporate a view function to inspect files
- Display sample fonts in nine styles
- Resolve numbering conflicts
- Network downloadable printer and screen fonts
- Merge screen font style variations into one family
- Convert fonts to the new type NFNT
- Font Compression

Font/DA Juggler Plus continues to surpass even the newest release of its nearest competitor (... II) with the following exclusive capabilities:

- Display and print a font or list of fonts in hundreds of size and style combinations
- Copy and renumber Fonts, DA's, Fkeys and Sounds.

So, if your Mac could use juggling lessons, put Font/DA Juggler Plus to work on your system and sit back and enjoy the show.

Still only

\$59.95

MasterJuggler™

Add applications, windows and sound play to the talents of the popular Font/DA Juggler Plus and you have the amazing MasterJuggler. Now, one utility has the expertise to provide comprehensive management of fonts, DA's, FKeys, sounds, applications, windows and sound play.

In addition to being first to compress sounds, MasterJuggler has an extensive list of exclusive features including the ability to:

- Open applications and documents without returning to the finder
- Open multiple applications or play multiple sounds with single commands
- Switch between open applications from a pop-up menu under MultiFinder
- Hide the current application windows before switching under MultiFinder
- Bring to the front any selectable window in the open application via a pop-up menu
- View font faces and sizes in a file before or after opening the file
- Display and print name or number conflicts among the available fonts, DA's, FKeys and sounds
- Set the default application font
- Assign sounds to seven different Macintosh operations and assign application—and alert—specific sounds
- Play random sounds and continuous sound
- Convert digitized sound files into Macintosh and HyperCard sound resources

So, watch the amazing MasterJuggler at work and see how easily your Mac learns to juggle even the toughest situations.

Suggested Retail

\$89.95

ALSoft, Inc./P.O. Box 927, Spring, Texas 77383-0927, (713) 353-4090

ALSoft, MasterJuggler, Font/DA Juggler are trademarks of ALSoft, Inc.

©1989 ALSoft, Inc.

Circle 35 on reader service card

Corporate

PCW Communications, Inc.

David Bunnell

Founder

Lee Vidmer

President

John Griffin

Vice President

James E. Martin

Vice President

Jacqueline Poitier

Vice President

Cheryl Woodard

Vice President

Andrew Fluegelman

1943-1985

Founding Editor

Administration

Director of Finance: Vicki Peilen

Corporate Business Manager:

Christina W. Spence

Accounting Manager: Pat Murphy

Administrative Services Manager:

Joseph Wollenweber

Employee Relations Manager: Shelly Ginenthal

Technical Services Manager: Wally Clegg

Assistant to the President (Macworld Communications): Susan Miller

Assistant to the Associate Publisher (Macworld Communications): Cynthia J. Meade

 IDG
COMMUNICATIONS

 BPA



#1 - Arthur Young uses SUM



#2 - Hughes Aircraft Company uses SUM



#3 - Northern Telecom uses SUM

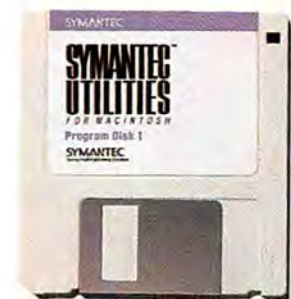

#4 - ACIUS, Inc. uses SUM



#5 - Apple Computer, Inc. uses SUM



#6 - American President's Co. uses SUM

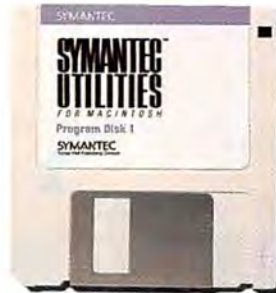

#7 - Mastercard uses SUM

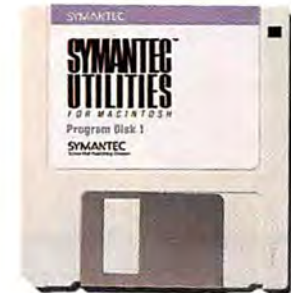

#8 - Paramount Pictures uses SUM



#9 - The Prudential uses SUM



#10 - Radius, Inc. uses SUM

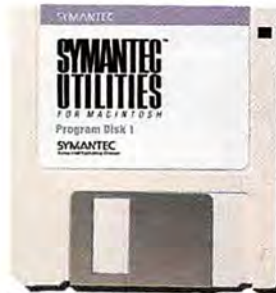

#11 - 100's of Positive Reviews



#12 - 7 Powerful Utilities



#13 - 3 Minute Data Recovery



#14 - #1 Selling Macintosh Utility

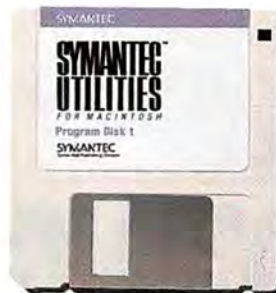

#15 - Over 40,000 Users



#16 - Only \$99.95

FOR HARD DISK PROTECTION, CORPORATE AMERICA FINDS SAFETY IN NUMBERS.

Symantec Utilities for Macintosh (SUM) is Corporate America's #1 choice for fail-safe hard disk protection. Because in addition to six other indispensable utilities, SUM features Guardian, the ultimate software for protecting your Mac's hard disk *before* a crash. Just like an air bag in a car,

SEVEN INDISPENSABLE HARD DISK UTILITIES:

Guardian—protects and restores hard disk data and deleted files. *Disk Clinic*™—easy-to-use troubleshooting interface. Restores hard disk data in case you have a crash before you can install Guardian. *Virus Protection*—protects systems against "viruses." *HD TuneUp*™—optimizes hard disks. *Symantec Tools*—views and edits data and resource forks of a file or volume in HEX or ASCII. *QuickCopy*™—makes fast floppy copies. *HD Partition*—separates hard disks into separate volumes which can be encrypted.

Five Mice, MacUser Magazine's Highest Rating 

Guardian stays out of sight, loading automatically every time you turn on your Mac. It protects invisibly by updating a "map" of your hard disk data. So that, in a crash, your data is safe. Because Guardian uses the "map" to locate and recover it. In minutes.

Seven smart utilities. 5 Mice, *MacUser* magazine's highest rating. Tens of thousands of satisfied customers in hundreds of companies. No wonder Corporate America is turning to SUM for hard disk safety... in numbers.

See your dealer or order today: (800) 228-4122 Ext. 680G



SYMANTEC™ Symantec Corporation, 10201 Torre Avenue, Cupertino, CA 95014. 408/253-9600.

Current SUM Users can upgrade to new Version 1.1 by sending your current SUM disk and check or money order for \$10.00 to SUM Upgrade, Symantec Corporation, 10201 Torre Ave., Cupertino, CA 95014. MacZap users call 408/446-9994 for a low cost upgrade. HD TuneUp, QuickCopy, and Disk Clinic are all trademarks of Symantec Corporation. Other products are trademarks of their respective holders. © 1989 Symantec Corporation

Circle 237 on reader service card

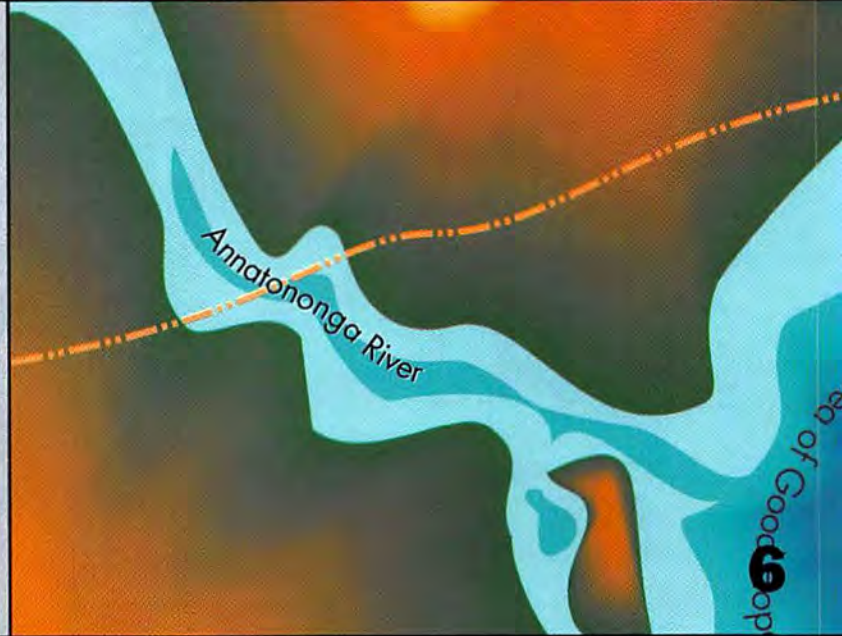

INTRODUCING CREATIVE FRE

Imagine what you could do with an advanced drawing program that was actually easy to use.

A program that could give you the freedom to create more with your Macintosh® than any other drawing program; even work as sophisticated as the illustrations in this ad.

That's the power of Aldus® FreeHand™ 2.0. And here are some of the things you'll be able to do with it.

1. Achieve unequalled control over your type. Curve text on a path, create stroked and filled

type, and mix sizes, styles, fonts and colors in the same type block. **2.** Not only can you import PICT, EPS and TIFF images, you can actually work with them. There's no easier way to enhance existing artwork. **3.** Choose graduated, radial and patterned fills from our extensive library, or create your own PostScript®-language fill patterns for special effects. **4.** Now PANTONE®* Colors are available in Aldus FreeHand 2.0. So it's easy to see and specify the colors you want. **5.** Use the autotrace function to convert any PICT or

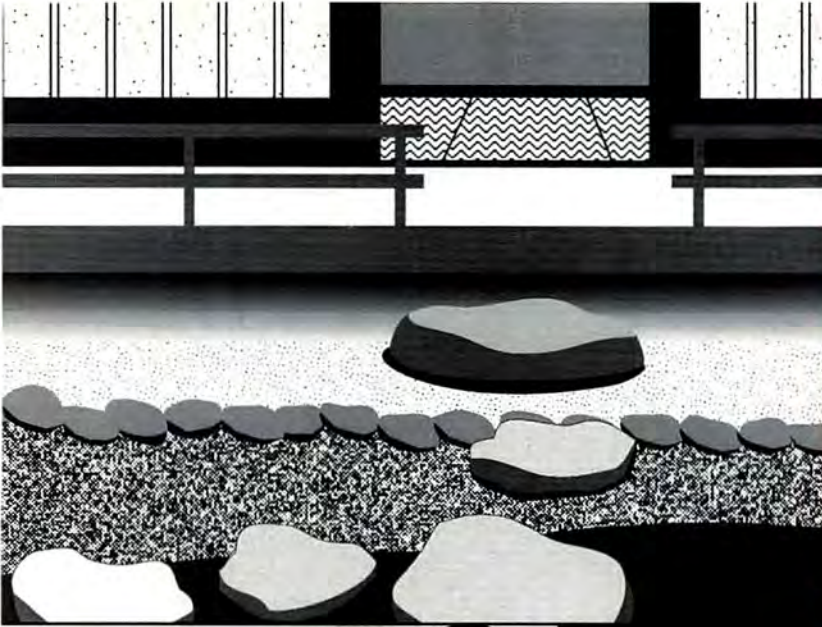

EDOM. ALDUS FREEHAND 2.0

scanned TIFF image to instant line art. It'll both save time and expand your options. **6.** Our blend feature allows you to transform one shape into another and produce airbrush effects with colors. **7.** A built-in color separation capability for spot and process color makes it easy to output separated film—saving hours of production time. **8.** Make short work of technical drawings with the most comprehensive set of advanced PostScript-language tools available; plus a set of familiar Macintosh drawing tools.

To experience creative freedom first-hand visit an authorized Aldus dealer, or call 1-800-333-2538, Department C-2 to order a free self-running demo disk.†



Aldus FreeHand™

411 First Avenue South, Seattle, WA 98104 (206) 622-5500.
 *Pantone, Inc.'s check-standard trademark for color reproduction and color reproduction materials.
 †Offer expires April 30, 1989 and is good in U.S. and Canada only. The demo disk requires a Macintosh Plus, SE or II.
 Aldus and the Aldus logo are registered trademarks and Aldus FreeHand is a trademark of Aldus Corporation. PostScript is a registered trademark of Adobe Systems Inc. Macintosh is a registered trademark of Apple Computer, Inc. PANTONE® is a registered trademark of Pantone, Inc. Process color reproduction may not match PANTONE® identified solid color standards. Refer to current PANTONE® Color Publications for the accurate color. ©1988 Aldus Corporation. All rights reserved.

WHEN YOU'RE MORE PRODUCTIVE, IT SHOWS.

MORE II: PLANNING, WRITING AND DESKTOP PRESENTATIONS.

Being MORE productive means everything you plan, write, or present is MORE organized. And it shows in everything you do.

MORE II's advanced outlining makes it easy to capture, plan, and organize ideas into clear, action-oriented information. Simply type in "To-Do" lists, project schedules, proposals, plans... everything. MORE II automatically creates the outline for you.

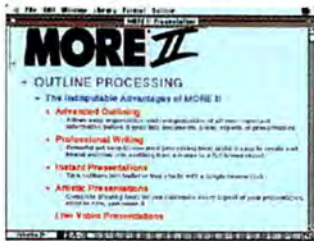

Outlines make MORE II productivity easier. Just click the mouse on any part of an outline and get charts and slides, instantly.



Customize presentations with MORE II's complete set of drawing tools.

THE OUTLINE MAKES THE SHOW.

Once you have an outline, your art work is done. Because with a double-click of the mouse, any outline becomes a perfectly spaced bullet or organization-type chart instantly. Complete with company logos or art pulled in from other programs. Print the charts and get overheads fast. Or turn them into 35mm slides overnight. For even more graphics, click again and get every art tool imaginable. And because of MORE II's outline, when you change the master slide, the rest change automatically. So making 1000 slides is as easy as making one.

Click on another outline, add a few paragraphs using MORE II's full-power word processing and bingo. You've got a memo. Or a letter. Or a proposal. Add pages, pull in some charts and there's a full-scale report or a board-room quality presentation... totally spell-checked, with text, graphics, fonts and styles to rival anything created on any other program.

Now go live. MORE II includes advanced, live-action meeting technology for slide shows (complete with video effects like dissolves, builds, wipes, and fades) on any MAC connected to virtually any projection device.

BE MORE PRODUCTIVE TODAY.

For planning, writing, and presentations, MORE II shows results. It's the only software that helps you master all three stages in the art of persuasion. Without becoming an artist. For MORE II product and upgrade* information, call (800) 228-4122 Ext. 747G.



Write beautifully with MORE II's complete word processing.

Show slides in 35mm, or present them live on-screen, complete with wowing video effects.



WHEN YOU'RE MORE PRODUCTIVE, IT SHOWS™

SYMANTEC™ *MORE owners, upgrade to MORE II now, send \$89 plus \$10 for shipping/handling (check or money order) along with your MORE registration number to MORE II upgrade, Symantec Corp., 10201 Torre Ave., Cupertino, CA 95014 or call (415) 964-4440. Suggested retail price \$395. MORE and MORE II are trademarks of Symantec Corp., 10201 Torre Ave., Cupertino, CA 95014 (408) 253-9600. ©1988

Circle 215 on reader service card

Wingz Flies at Last

▶ Wingz, the long-awaited super spreadsheet from Informix Software, began shipping in January. The program includes innovative cell-definition capabilities, 3-D charting, and a scripting language that replaces macros. In Learn mode Wingz displays mouse and keyboard commands within the scripting language on a split screen. Perhaps Wingz's most impressive feature, however, is its extremely powerful interface-definition capability, which enables users to write their own command bar and pull-down menus and save one or more interfaces for each application.

Wingz sells for \$395. For more information, contact Informix Software, in Lenexa, Kansas, at 913/492-3800.

Barneyscan Ships Color-Retouching Software

▶ Barneyscan Corporation has added Barneyscan XP, a powerful color-graphics software package, to its Barneyscan Mac II 35mm color slide scanner. The software, which runs in either 8-bit or 24-bit mode, is compatible with Apple's 32-bit version of QuickDraw. It adds photo enhancement, manipulation, and retouching capabilities to the Barneyscan Mac II, which has a hardware resolution of 1000 dots per inch, with built-in software dou-

bling to 2000 dpi. The scanner comes bundled with the new software and retails for \$8995. Anyone who purchased the scanner before the software was included will receive the software free. For further information, contact Barneyscan, in Berkeley, California, at 415/524-6648.

What's Next from Lotus?

▶ Software giant Lotus Development Corporation has reportedly agreed to acquire all the assets of PS Publishing, a developer of Macintosh applications. Lotus, which does not currently offer a text and graphics package for the Mac, will gain the rights to PS Compose, a typesetting package, and PS Collage, a sophisticated graphics program. Both products are in development.

PS Publishing president Robert Simon will remain on board and oversee expansion of the Sausalito, California-based company's staff. For further information, contact PS Publishing at 415/331-1285.

4MB SIMMs from Clearpoint

▶ Clearpoint Research Corporation is currently testing its 4MB single inline memory module (SIMM), which the company expects

to make available in the first quarter of 1989. The SIMMs will run in the Mac IIX or the Mac II with A/UX installed. In a few months when Apple releases system software with true (or "clean") 32-bit capability, Mac II users with the 4MB SIMMs installed will be able to access 32MB of memory. Sophisticated graphics applications, complex mathematical programs, and engineering workstations will all run much faster with 32MB of resident memory.

For more information, contact Clearpoint Research Corporation, in Hopkinton, Massachusetts, at 508/435-2000.

Enhancing Illustrator 88

▶ Adobe Systems has developed two new tools to enhance Adobe Illustrator 88: Collector's Edition 2—Patterns and Textures, and Adobe Streamline. Collector's Edition 2 is a series of 400 standard U.S. Geological Survey and American Institute of Architects patterns and textures, divided into the following five categories: basic graphic patterns; classics geometric; ornamental; geological and cartographic; topographic and weather patterns.

Adobe Streamline is the high-speed new generation of Adobe Illustrator's auto-trace tool for converting bit-map artwork into Illustrator files. It is designed for desktop publishers, graphic de-

signers, and technical illustrators.

Adobe has also announced ten additions to the Adobe Type Library: Avenir, Sabon, ITC Bauhaus, Caslon Open Face, Life, Frutiger, Linotype Centennial, Serifa, Stempel Garamond, and Garamond 3.

Collector's Edition 2—Patterns and Textures lists for \$225; Adobe Streamline lists for \$395. Each requires only a Mac Plus and Adobe Illustrator 88, but a 2MB SE, II, or IIX and a PostScript printer are recommended. For further information, contact Adobe Systems, in Mountain View, California, at 415/961-4400.

Many Fonts, Many Printers

▶ Bitstream, a major player in the font game, has announced that it will soon release its entire typeface library for use with Macintosh-driven PostScript page-description language typesetters, typically used in commercial print shops and service bureaus. The Bitstream fonts will work on any PostScript-controlled typesetter, such as the Linotronic, the Tegra/Varietyper VT600, and Compugraphic's CG-9400-PS, and will offer the same quality and func-

(continues)

tionality as Adobe fonts but in much greater variety. The Bitstream fonts will also work on so-called PostScript-clone printers such as the Itek Graphix IGX 7000 PS and Compugraphic's Genics typesetters. The first batch of fonts, released in February, features typefaces that Adobe does not offer. Bitstream's plan is to release a total of 1000 fonts by the second quarter of 1989.

The Bitstream Typeface Library will be available from Bitstream at a list price of \$50 per font, with a minimum purchase of four fonts. For more information, call Bitstream, in Cambridge, Massachusetts, at 617/497-6222.

Fast New Graphics Board from Matrox

▶ Quebec-based Matrox Electronics Systems has announced the NG-1281, the first Mac II color graphics board that can display 1280 by 1024 pixels. Intended for applications including high-end CAD, simulations, and process control, the board is scheduled to ship in April and will cost about \$5000.

A Mac II with the NG-1281 board will be able to run major CAD packages such as VersaCad and AutoCAD at a speed comparable to that of a well-equipped Apollo workstation. The board runs under Apple's 32-bit QuickDraw, also slated for April release. Expected drawing performance is in the neighborhood of 12.5 million 8-bit pixels per second and 35,000 characters per second. For

more information about the Matrox NG-1281, call Matrox, in Montreal, Quebec, Canada, at 514/685-2630.

Beware of Green Stripes

▶ Beware of the Mega-ROM 1.1, a green-striped CD ROM disk that contains over 335MB of public domain and shareware files, produced by Nimbus Information Systems of Charlottesville, Virginia, in cooperation with Quantum Leap Technologies of Coral Gables, Florida. The data-eating, hard disk-crashing nVIR virus infected the disks during duplication. You don't have to worry about the red-striped demo version 1.0 or the blue-striped version 2.0 that replaced the infected version.

Quantum Leap discovered the virus shortly after shipping on Friday, December 9, 1988. It quickly notified all customers and began replacing the infected disks on December 12. According to Quantum Leap, the virus had infected a utility program bundled with hard disks manufactured by CMS Enhancements. CMS says that it is not sure if the virus originated with its utilities, but that it has implemented six or seven procedures to eliminate future occurrences. The company is also providing free software that eliminates the virus.

For further information, contact Quantum Leap, in Coral Gables, Florida, at 305/446-2477.

Image Capture 2

▶ Scion Corporation has introduced the Image Capture 2 Board for the Mac II. The board allows users to capture, crop, and automatically center black-and-white or 24-bit color images in real time, and it requires no additional monitor. It also translates and displays images as a bitmap in 256 levels of gray, and provides high-quality halftone images when used with high-resolution output devices such as the Liotronic 100 or 300.

The Image Capture 2 Board lists for \$1195 including software, and comes with a cable and, for a limited time, a free color upgrade. For further information, contact Scion Corporation, in Walkersville, Maryland, at 301/845-4045.

RenderMan for the Mac II

▶ Levco has ported the 1.0 version of Reyes, the renderer that uses Pixar's RenderMan protocol, to the Mac II. RenderMan is a machine-independent interface between programs that produce imaging information and programs that use that information to produce high-quality renderings.

The Mac II version of Reyes 1.0 makes use of Levco's TransLink, a transputer-based accelerator, to perform the rendering. The renderer is source-code identical to Pixar's renderer for the Sun and other computers, and it supports advanced techniques such as

motion blur, programmable shading, and texture maps.

The program operates in two modes: an interactive mode for tweaking images, and a batch mode for producing large-scale animations. It reads and writes PICT, PICT II, and the new 32-bit QuickDraw formats, as well as Pixar-format image files such as PICIO and Texture. The program requires at least one 1MB T-800 module containing four transputers.

Reyes 1.0 for the Mac II is expected to list for \$2000. A developer version is scheduled for release in March 1989, and an end-user version for the third quarter. For more information, contact Levco, in San Diego, California, at 619/457-2011, or Pixar, in San Rafael, California, at 415/258-8100.

Viking Files Chapter 11

▶ Viking Technologies has filed for bankruptcy under Chapter 11 in an effort to clear its debts and start over. A company spokesperson stated that Viking is still accepting and filling orders and has not ceased to do so at any time. The company distributes games and desk accessories including Cyclops and Menu Clock. Its subsidiary, Uptime, distributes Ez-Typer DA.

For further information, contact Viking Technologies, in Newport, Rhode Island, at 800/437-1033. □

PRESENTING THE WRITEMOVE
PORTABLE PRINTER.

Most printers are sentenced by their own sheer bulk to lifelong confinement on a desktop.

But now GCC Technologies™ has created a printer for the Macintosh® with considerably more freedom than that. It's called WriteMove™: the "biggest" printer ever to come in an incredibly small package.

WriteMove weighs a scant three pounds. It measures just 2"x6½" x10¾". (Any smaller and you couldn't get the paper in.)

But it's the only ink jet printer of any size that gives you almost unlimited freedom to reduce and enlarge type and documents. Because it's the only one with outline fonts—imaging software that provides functionality otherwise available only with laser printers.

As a result, you can use WriteMove to compose documents with word processing software like Microsoft® Word, or desktop publishing programs like PageMaker.® And then silently print them out at 192-DPI resolution. In other words, you get much

higher print quality than the ImageWriter® II, for not much more money.

Which could bring a whole new meaning to the phrase "freedom of the press."

To exercise that freedom, see your authorized GCC Technologies dealer for a WriteMove demonstration. For the one nearest you, call (617) 890-0880.*



*In Canada, (800) 263-1405 ©1988 GCC Technologies, Inc. GCC Technologies and WriteMove are trademarks and the GCC Technologies logo is a registered trademark of GCC Technologies, Inc. Macintosh and ImageWriter are registered trademarks of Apple Computer, Inc. PageMaker is a registered trademark of Aldus Corp. Microsoft is a registered trademark of Microsoft Corp. Suggested manufacturer's retail price: \$699

INTRODUCING THE MOST INGENIOUS PORTABLE PRINTER SINCE THE PENCIL.



Circle 177 on reader service card



Novell presents a net even the pickiest

Macintosh owners have a reputation for being fanatical about their Macs. And rightfully so, when you consider the elegance of the Macintosh user interface.

So when Novell set out to network the Macintosh with PCs, it was with one clear caveat: preserve the Mac environment. Create network software that would feel right to the pickiest of all Macintosh users. And none are pickier than the ones at Apple.

Full AppleTalk compatibility. Working directly with Apple, Novell's programmers created a version of NetWare® that is compatible with the AppleTalk Filing Protocol (AFP). It's

an achievement hailed by Apple President and CEO John Sculley as "a very significant event for the industry." And it means that Mac users can now get all the power and flexibility of the number one local area network in the world, without sacrificing any Macintosh functionality.

AFP compatibility also means that NetWare for Macintosh will be fully compatible with future Macintosh hardware and operating system versions. So you can take advantage of new Macintosh product releases as soon as they become available.

Freedom to choose. NetWare for Macintosh lets you connect Macs with a

product introduction, Apple
chairman John Sculley lauded
Novell for its AFP support and
contrasted Novell's product with
serve
to

InfoWorld, June 20, 1988

work made to satisfy Macintosh user.

myriad of PC, minicomputer and mainframe environments, including OS/2. So you can choose the workstation environment that best suits your needs while communicating easily between dissimilar operating systems and sharing files and peripherals.

You get all the performance, security, fault tolerance and functionality of NetWare without changing the way you work with your Macintosh. And you get the power to transparently connect to over two million NetWare users worldwide.

To satisfy your need for a powerful Macintosh network, plug into NetWare—the

network that passed the ultimate Mac test drive. See your Gold Novell Authorized Reseller, or call 1-800-LANKIND.

For more information, call from your modem 1-800-444-4472 (8 bit, no parity, 1 stop bit) and enter the access code NVMC17.



For network solutions,
you should be seeing red.

Compare and see how easy choosing a hard drive can be.

"Superlative performance with exceptional utility software."

David Pogue, MacWorld writer

With so many hard drives available today, selecting the best one could be difficult. Luckily, Cirrus Drives from LaCie offer such an outstanding combination of speed, reliability and software power that your choice is quite simple.

But don't take our word for it — compare for yourself.

Compare the Value

CAPACITY	SPEED	PRICE
30mb	40ms	\$599 \$549
42mb	25ms	\$699 \$649
70mb	25ms	\$899 \$799
80mb	12ms	\$1049 \$999
100mb	25ms	\$1149 \$999
140mb	15ms	\$1499 \$1299
45R Removable Disk Drive	25ms	\$1199

Compare the Specs

We use superior 3-1/2" SCSI drive technology with access times as low as 12ms. Drives include 2 SCSI ports, easy SCSI address selection, terminators and quiet, efficient half-speed fan. Drives measure just about 3 x 6 x 9 and weigh in at 4-1/2 lbs. Drives are available in our award winning external case shown here or in easily installed internal models for Mac SE and II.



"Convenient size is perfect. Very fast, reliable and quiet. Software is great... my personal choice."

Van Gray, President
STF Technologies, Inc. Creators of FAX STF

Compare the Extras

We include a rugged Cordura™ carrying case, our Silverlining high performance hard disk utilities and Silverserver software for local and remote hard disk sharing.



We'll also throw in Silverplatter so you can share most serial devices on your LocalTalk network. In all a \$185 value — free.

So compare. You'll find there's really no comparison at all — just lots of great reasons to order your Cirrus drive today.

If you're still undecided, we'll even give you a 30 day money back guarantee so you can test drive a Cirrus for yourself.

Now what have you got to lose? Phone us today. Even the call is free:

1-800-999-0143

LaCie, Ltd. • 16285 SW 85th • No. 306
Tigard, OR 97224 • (503) 684-0143

LaCie
LTD.

CIRRUS DRIVES: Compare the Features

Complete the "other" column to see if any other drive measures up.

	CIRRUS	OTHER
■ Drives require no initialization to start-up.	<input checked="" type="checkbox"/>	<input type="checkbox"/>
■ Hardware and software auto-park feature.	<input checked="" type="checkbox"/>	<input type="checkbox"/>
■ Software maps out bad sectors on hard disk.	<input checked="" type="checkbox"/>	<input type="checkbox"/>
■ Share volumes over LocalTalk or modem.	<input checked="" type="checkbox"/>	<input type="checkbox"/>
■ Software supports hard and soft volumes.	<input checked="" type="checkbox"/>	<input type="checkbox"/>
■ Share most serial devices over LocalTalk.	<input checked="" type="checkbox"/>	<input type="checkbox"/>
■ Change volume size without reinitializing.	<input checked="" type="checkbox"/>	<input type="checkbox"/>
■ Create file volumes on a fragmented disk.	<input checked="" type="checkbox"/>	<input type="checkbox"/>
■ Software compacts & defragmentizes files.	<input checked="" type="checkbox"/>	<input type="checkbox"/>
■ Software includes read, write & seek tests.	<input checked="" type="checkbox"/>	<input type="checkbox"/>
■ Software selection of the interleave factor.	<input checked="" type="checkbox"/>	<input type="checkbox"/>
■ Password protect and write-lock volumes.	<input checked="" type="checkbox"/>	<input type="checkbox"/>
■ Link up to 7 drives into one large volume.	<input checked="" type="checkbox"/>	<input type="checkbox"/>
■ Volumes support UNIX and other systems.	<input checked="" type="checkbox"/>	<input type="checkbox"/>
■ Drive compatible with accelerated systems.	<input checked="" type="checkbox"/>	<input type="checkbox"/>
■ 6 SCSI driver choices for best performance.	<input checked="" type="checkbox"/>	<input type="checkbox"/>
■ Auto testing to determine best SCSI driver.	<input checked="" type="checkbox"/>	<input type="checkbox"/>
■ Drive won Industrial Design Review award.	<input checked="" type="checkbox"/>	<input type="checkbox"/>
■ 800 phone number for technical support.	<input checked="" type="checkbox"/>	<input type="checkbox"/>
■ Includes a 30 day money back guarantee.	<input checked="" type="checkbox"/>	<input type="checkbox"/>

Plus 31 other features! Call us for a full list.

Prices shown are cash prices and do not include shipping. Add 3% for VISA or Mastercard, 5% for American Express. Add 7% for rush handling. Cirrus, LaCie, Silverlining, Silverserver and Silverplatter are trademarks of LaCie Ltd. Macintosh and LocalTalk are trademarks of Apple Computer. Prices and specifications shown are subject to change without notice.

Circle 145 on reader service card



Software: Where's It All Going?

Reflections on software trends

After a year-long spate of vaporware, preannouncements, and consumer beta testing, Macintosh software has entered a new era of maturity. A lot of good products are being shipped. One of the most interesting aspects of the new software is the thinking behind it all, the corporate strategies.

In the "ole days," a software company could bring out a single product, then sit back and write printer drivers and new versions—and make a good deal of money doing it. End of story. But with the examples of Microsoft and Software Publishing, developers began to think that they needed a product family. The broader the product line, I suppose the thinking went, the more likely a person would be to own several products from a single company—particularly if the products were good, with good support, upgrades, and similar interface functions across several products.

At first software developers took the approach of producing a product for each of the major categories. Companies would strive to develop a word processor, a spreadsheet, a database. Such an approach means that precious retail shelf space is absorbed by the major developers' products, which the dealers often prefer. When a dealer works with only a few companies, training store staff is easier, paperwork is simpler, and there may be better volume discounts for dealer purchases. And it's often easier to sell products from a well-known company. If the products are respected and attractively packaged *and* they sell well, many dealers want nothing more. So the shelves tend to fill up with multiple copies of software from the better-known developers.

Today, software is evolving beyond product families and the advantages they offer in training, distribution, and retail. Developers want to build products around core technology or around a central product. This idea somewhat resembles the approach to core code or development platform technologies espoused by Bill Gates and others. Gates promotes the concept of a common core of code that is adapted to different computers. He has two reasons: first, software developers need to amortize the cost of development over several platforms; and second, software companies cannot afford to maintain huge staffs of programmers for different machines. In the future, 80 percent of applications code will be common and the remainder will relate to the unique interface of a given machine, says Gates. (Some suggest this smacks of programming by committee toward the lowest common denominator.)

Core Technology

The core technology concept is similar to the core code concept, but goes beyond it in focusing on how different applications should communicate with one another. Microsoft makes no bones about planning to accomplish this. At present, Microsoft's applications share very little underlying code. For instance, Microsoft Mail, PowerPoint, Word, Excel, and Works are each quite distinct.

Microsoft's goal is to ensure that a future version of Mail will allow users of the Microsoft product family to gain greater efficiency. Say you're working on a document in Word, and you want to incorporate the file or a portion of it in a message. Ideally, you could just select the text and send it as an E-mail message from within Word. Instead, you must quit your application in the Finder, launch

another application, and paste or attach material. It's easier, of course, if you have MultiFinder. Then you can open multiple windows and copy and paste between applications. Still, going back and forth for operations, such as making changes to a graphic you want to incorporate into Word, is a real pain.

The basic concept of core technologies is that data flows between applications and documents—with minimal work on the user's part. This is where you say, "Yeah, Microsoft developed Hot Links some while ago, and they already do that." True, but only for some products, and the usefulness is quite limited. The next step is the development of links that update other documents or applications automatically. Let's say you make a change in your organization chart. You want a copy sent to your printer, you want the employee manual updated, you want a copy sent via E-mail to all your employees.

Or let's use this column as an example. When I'm done I want to send it to my editor, Deborah Branscum. I want a notice sent to the managing editor to notify him that it's in to Deb. I want a copy sent to a PageMaker template and printed out in the production department so that its length can be determined. And I want the same printout sent to the art department so designers can consider layout alternatives. What's more, I want to push one button to do all that. Automatic links between programs will make

(continues)

**AutoCAD[®]
on the Mac.[™]
A new window of
opportunity
opens.**

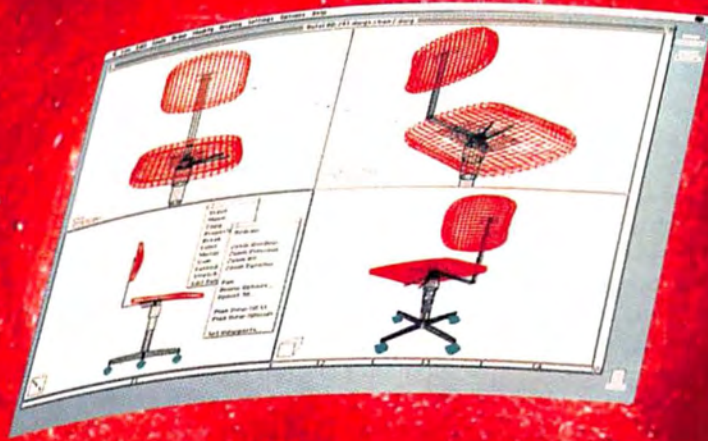

AutoCAD, the world-standard CAD software, now runs on your Macintosh® II.

Your designs reflect the quality of your thinking. And your drawings reflect the quality of your designs. Put AutoCAD on your Mac II and nothing gets lost in the translation.

AutoCAD's extensive set of drawing tools enhances your productivity. Its effectiveness is proven every day by over 175,000 architectural, civil, construction, aerospace, electrical, cartographic, facility, industrial, manufacturing and mechanical design professionals around the world.

AutoCAD has been refined through ten major upgrades. You get menus full of powerful, high-precision drawing and editing commands, numerous drawing entities, and a multitude of easy-to-use features. You can window, zoom, fillet, scale, layer, annotate and associatively dimension, hatch, stretch and scale. And a simple click can undo anything or everything.

AutoCAD on the Macintosh also supports the features that have made Apple the acknowledged leader in user interface design, offering pull-down, tear-off, and pop-up menus,

complete support for Multifinder™ and the Mac windowing system, along with file dialog boxes to make access to your drawing files quick and easy. Clipboard support allows the transfer of AutoCAD drawings to a wide variety of Macintosh applications software.

A Better Perspective. AutoCAD is an advanced three-dimensional modeler that helps you solve design challenges on your Mac the way you would with physical prototypes. AutoCAD makes 3-D easy with user-defined construction planes, dynamic viewing and multiple viewpoints.

You can also model complex surfaces with AutoCAD using sophisticated tools such as tabulated cylinders, surfaces of revolution, ruled surfaces and Coons patches so you can represent surfaces accurately.

For even greater utility, AutoCAD provides entity handles that allow external applications to associate alphanumeric information, such as part numbers and capacity ratings, with graphical elements in the drawing. This associativity is creating an entirely new generation of useful third-party applications software.

A Reflection of You. AutoCAD is an open-architecture system

including AutoLISP,* an embedded programming language that lets you program AutoCAD to reflect your way of doing things. Add your own menus to enter your own commands, write macros, develop custom symbols and drawing functions, or program standard procedures for document production and management.

Hundreds of third-party programmers have used AutoLISP to develop entire systems that make AutoCAD perfect for applications ranging from chemical engineering to technical publishing. Many of these programs run on the Mac II and more are on their way.

Maintain Your Standards. AutoCAD is the most extensively used, most broadly supported, widely taught design software in the world. AutoCAD is backed by over 1,400 highly-trained dealers and 150 Authorized Training Centers in 60 countries. We'll make sure you get what you expect from your CAD investment. That's what standards are all about.

Opportunity knocks just once. The CAD software you standardize on today will determine your productivity for years to come. To see a demonstration at the dealer nearest you, call Autodesk at 800/445-5415, extension 25, at your earliest opportunity.



AutoCAD makes Macintosh a standard player in CAD applications ranging from architecture to automated manufacturing. And AutoCAD is the standard for communication in the CAD world. AutoCAD's file portability allows seamless transfer of drawings and applications between different platforms and operating systems — without conversion to a generic format.



AUTODESK

2320 Marinship Way • Sausalito, CA 94965

800/445-5415, Extension 25

Autodesk, the Autodesk logo, AutoCAD and AutoLISP are registered in the U.S. Patent and Trademark Office by Autodesk, Inc. Apple, Mac, and Macintosh are registered trademarks of Apple Computer. Multifinder is a trademark of Apple Computer.

Circle 454 on reader service card

Once You Try A QuickCard™ Reference Guide You'll Never Go Back To Your Software Manual. We Guarantee It!

ONLY **\$14.95** PLUS SHIPPING

To use today's complex Macintosh software, you have two choices. You can puzzle over lengthy, hard-to-use manuals. Or use QuickCard™ Reference Guides which provide concise step-by-step instructions for every feature plus keyboard commands. You'll also discover those special features buried in the manuals. QuickCard Reference Guides save time—and increase the value of your software. Get the guides used by corporations, universities and professionals!

- All information on one 8½"×11" reference card
- Step-by-step instructions for each feature
- Dozens of tips and shortcuts
- All the special techniques "hidden" in the manuals
- Organized for instant use
- New users get up to speed quickly
- Experienced users learn new skills
- Highest quality non-glare laminated vinyl
- Quick, easy, enjoyable to use!

- Microsoft Excel 1.x
 - Microsoft Works 1.x
 - Microsoft Word 3.x
 - Microsoft Works 2.x
 - PageMaker 3.x
 - Ready Set Go! 4.x
 - Word Perfect 1.x
 - Universal Mac Guide (step-by-step guide to all of the Macintosh's features)
- "x" means all versions

To order, phone or send your name, address and check for \$14.95 for each QuickCard Reference Guide plus \$1.95 shipping per order. Or charge to your VISA/MC by sending complete card number and expiration date. Be sure to specify which guides you want.

Round Lake Publishing Co. Dept. MW-3
415 Main St., Ridgefield, CT 06877
Order line—(203) 438-5255

30-DAY MONEY-BACK GUARANTEE

DON'T DELAY—ORDER TODAY!

Indenting paragraphs

1. Select paragraph(s) to indent
 2. Choose **Show Ruler** from Format menu
 3. To indent entire paragraph, drag bottom-left triangle right
 4. To indent first line, drag top-left triangle right
 5. To indent right margin, drag right triangle left
- To set left negative indent, press <SHIFT> clicking left scroll arrow

Actual size detail

Commentary/Jerry Borrell

that possible. No doubt I'll have to walk through all of those steps once to create a macrolike function that performs all the steps. But the point is that applications will talk to one another in many new and useful ways.

Several companies are obviously thinking about how to do this: Microsoft, Aldus, Cricket, Letraset, Lotus (yes, I said Lotus), Claris, and Ashton-Tate. True, not all of those companies have a word processor, a spreadsheet, and a database. But the core technologies approach is extending to all areas of software, from the big three of applications to areas such as desktop publishing, graphics, and communications. You should expect to see strategic alliances between companies whose products do not compete but who can benefit from easy transfer of data.

The motivation behind this evolution is the hope that companies can lock customers into their product families. A company's success will depend upon how well it manages to build integrated applications based on core technologies.

There are two possible results. Newer developers with innovative products may be frozen out of the market by the bigger companies. Or Mac software may be on the way to a new and higher level of performance and efficiency.

System 7.0

Additional advances will depend upon what Apple does next. More significant changes in how we use software will be based upon the evolution of system software. And Apple is not simply sitting by while these trends develop.

Despite the fact that Apple spun off its software division to form Claris, many developers believe that the company has merely changed its approach and is still in the business of applications software. For example, AFP, the AppleTalk Filing Protocol included with Apple system software, allows the Mac to translate files from one computer to another (PC to the Mac) and from one application to another (Lotus to Excel). Formerly these functions were provided by third-party products such as DataVis from Tangent Technologies. Macros once created by Affinity's Tempo can now be accomplished with MacroMaker in Apple's system software. Communications links once made through products from Alisa Systems or

(continues)

INSPIRATION™— Diagraming and Outlining to Communicate Ideas and Information.

- Capture ideas quickly in graphic or outline form.
- Organize and refine information easily and efficiently.

"Inspiration is a neat way to take an idea and represent it in a visual format. It lets you see your ideas, making them easier to understand."

—Michael J. Miller *INFOWORLD*

INSPIRATION.™ CAPTURE... ORGANIZE... COMMUNICATE.

- Communicate effectively to a wide range of audiences.
- Fully Integrated: change the diagram, the outline changes also, and vice versa.
- Reports & Proposals—
Project Planning & Timelines
— Outlines— Charts &
Diagrams— Action Items &
Notes— Managing Meetings

"Inspiration from Ceres Software offers building blocks for creating easy cut and paste diagrams and outlines."

—MacWeek

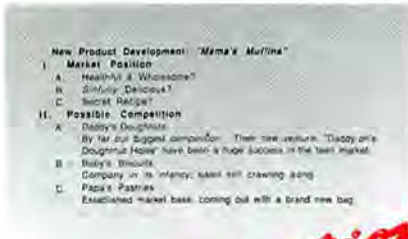

inspiration

NEW VERSION
INSPIRATION \$175 Visa/MC
Demo also available.
Call 800-366-4565

Ceres Software, Inc.
9498 S.W. Barbur Blvd. #103
Portland, OR 97219

Circle 365 on reader service card

A To an architect, fine hairlines like ours are pure poetry.

B Auto-tracing built this banana from a scanned-in produce ad. In split seconds.

C Multi-point bezier curves make drawing a bunch easier. Colors are added in layers.

D Auto-resizing helped this V.P. of Sales display the fruits of his labor, graphically.

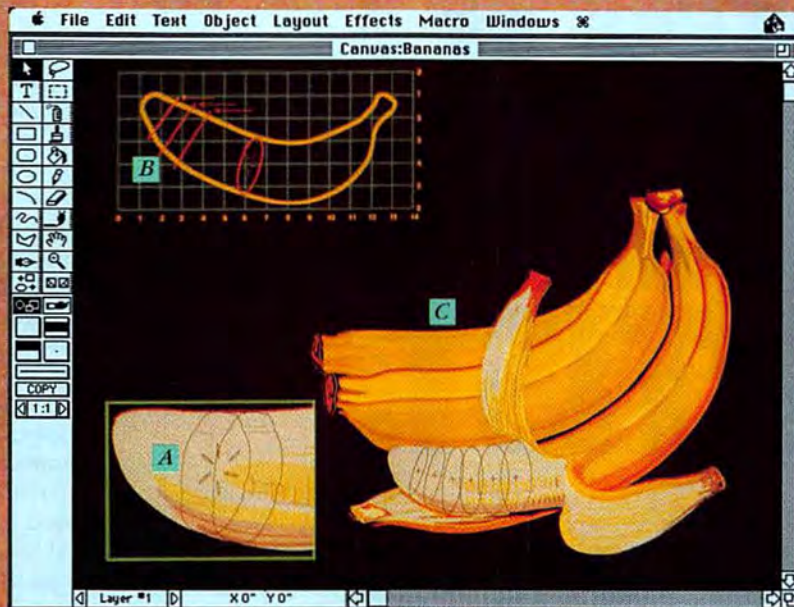

E Smooth continuous color blending inspired this art director to new heights.

F What are mere words compared to WYSIWYG text with special effects?

G After he slipped away, we added rich Postscript® gray scales to the gorilla's leftovers.



FOUR INDIVIDUALS WERE GIVEN AN HOUR
WITH THE NEW CANVAS 2.0.™

THREE WENT BANANAS.
ONE ATE THEM.

How an architect, an MBA, and an art director developed instant talent in precision drawing. And a gorilla developed mild indigestion.

Meet Canvas 2.0. The new top banana. Able to help even ordinary people draw extraordinary things.

Easy enough for almost any primate to master.

Use our Bezier curves and smooth polygons to build any shape. Add or delete control points and join, split, open or close them at will.

Use Auto-Tracing to save countless hours by converting existing bit-mapped images – pictures like clip art or scanned graphics – into easily manipulated Canvas 2.0 objects.

Work across unlimited layers. View, print or save them in any combination. Draw in millions of colors, or with Postscript® gray scales and patterns.

Experience heart-stopping accuracy (64,000 DPI) and fineness of line (1/1000"). Zoom around from 3% to 3200% of original size. Draw continuously up to 9 feet square. Import and export freely, using PICT, PICT2, TIFF, MacPaint™ or MacDraw™ formats. Output to any Mac compatible printer,

typesetter, or film printer you want.

Like we said: go bananas.

But do it soon. While we're still throwing in Canvas 2.0 DA for free. It's a special desk accessory version that puts some 80% of these features right under your Apple menu.

And if all this hasn't convinced you that Canvas 2.0 is the drawing program you've been waiting for, send us \$9.95 to receive a fully featured Demo Copy. With which you can finish convincing yourself.

After all, power like this can be *very* appealing.

Canvas 2.0 (including Canvas 2.0 DA) \$299.95

Site licenses available

Canvas 2.0 Demo Disk \$9.95

For more information or a demonstration of this or any of Deneba's other products, see your local dealer or call us at 1-800-6-CANVAS. In Florida, call (305) 594-6965.

3305 Northwest 74th Avenue, Miami, Florida 33122

*Read only.

© 1988 Deneba Systems, Inc.

All product names mentioned are trademarks of their respective holders.

Deneba
SOFTWARE

These unretouched drawings were created in Canvas 2.0 and output to a Mirrus film printer.

Circle 217 on reader service card

QUICK CHANGE ARTIST.

You need a gray scale scanner for your Mac. So you go to your ImageWriter.[®] Pop out the ribbon cartridge. Snap in ThunderScan.[®] Insert your artwork. And quicker than you can say Van Gogh, you're already going.

ThunderScan lets you import quality images into all painting, drawing and desktop publishing programs.

Contrast and brightness are fully adjustable.

And now ThunderScan 5.0 loads TIFF files and lets you display and edit grays on your Mac II.

Priced at just \$249, ThunderScan proves you can become an artist, with just a little change.



ThunderScan
FOR MACINTOSH

21 Orinda Way, Orinda, CA 94563
415/254-6581 FAX: 415/254-3047

ThunderScan is compatible with the Macintosh 512K enhanced, Plus, SE and Mac II and all ImageWriter models except the LQ. Use on the Mac II requires our *Power Accessory for Macintosh II*. ThunderScan, Thunderware and its logo are trademarks of Thunderware, Inc. Macintosh and ImageWriter are trademarks of Apple Computer, Inc. ©1989 Thunderware, Inc.



Circle 176 on reader service card

Commentary/Jerry Borrell

Pacer Software can now be made by other third-party developers for their own applications through the Apple Communications Toolkit, which became available last year.

So what's next? There are major expectations for system software version 7.0. Reportedly it will contain broadcast-standard video, 32-bit color, graphics, and E-mail functions. Designing system software is a black art, so 7.0 may not include all of these functions. Still, they are likely extensions to the operating system—especially E-mail. Since many Macs are connected through LocalTalk to printers, why not add a simple E-mail function? And how many times have you wanted to use a graphic tool to modify the application you were working with? Wouldn't it make sense to be able to pull down a paint/draw palette from the menu bar within the application?

In fact, one logical evolutionary step for the entire Desktop/Finder metaphor would be to lessen the distinctions between applications. Applications could reside in a menu bar, and could be accessible to any window or windows we might need. Subsets of applications should be accessible from within other applications.

This is, perhaps, the real crux of current trends in software evolution for microcomputers. While the OS/2 machines are coming up to speed with a graphical interface, Apple must come up with an advance in system software. We all repeat the mantra that multitasking is the next hurdle. But to date, only background printing, fax, and other less-than-revolutionary uses are appearing. Multitasking is certainly important, but the ways in which we use applications seem fundamentally more important.

Apple is, no doubt, deep in discussion on ways to advance its system software architecture. One possibility is that Apple bring about a new definition of system software.

Apple could approach this redefinition in two ways. One way would be to make system software with an open architecture so that third-party developers could add functionality. Remember how well this works with CPUs? You build a machine with an open backplane. Competition creates low prices. And devel-

(continues)

FOR A MERE \$99⁹⁵, BIGTHES™ WILL MAKE
EVERY ONE OF YOU UNDERACHIEVERS OUT THERE
EXACTLY 6²/₃ TIMES SMARTER
THAN BILL BUCKLEY.

You've probably seen our competitor's ads. The ones touting Wm. F. Buckley, Jr.'s fondness for their electronic thesaurus.

"It's a bloody miracle..." Mr. Buckley enthuses.

Heck. Even Microsoft® believed him enough to include a copy with their popular word processor.

Well.

All we can say is "Sorry, Bill." And "Sorry, Microsoft," too. Apparently even smart guys like you get fooled sometimes.

Because at 100,000 root words – and an utterly humongous 1.4 *million* combined synonyms, antonyms, related, compared and contrasted offerings – our BigThes weighs in at some 6²/₃ times the vocabulary power of that little program you're using.

And ours is the only one based on the renowned Merriam-Webster Thesaurus®, the world's most popular.

And the

only one organized the same way a user thinks – by contextual meaning, instead of by part of speech.

And the only one that provides separate short definitions for every meaning group.

BigThes is very fast: under a second, on average. It's also very easy to use: simply double-click on any word in your open document for an instant lookup.

It provides unlimited cross referencing, remembers the last 20 words you've worked with, and supports multiple open lookup windows.

Installed as a desk accessory, BigThes is compatible with

MultiFinder® and HyperCard® and works smoothly and simultaneously with 95% of all Macintosh® software. Including every major word processing or desktop publishing program on the market.

So.

If *how* you say what you say is important to you, here's your one chance at catching up with Buckley before he catches on.

BigThes. It's positively the last word in words.

BigThesaurus™ \$9995
(Hard disk required)

For more information or a demonstration of this or any of Deneba's other products, see your local dealer or call us at 1-800-622-6827. In Florida, call (305) 594-6965.

Deneba
SOFTWARE

3305 Northwest 74th Avenue, Miami, Florida 33122

© 1988 Deneba System, Inc.
All product names mentioned are trademarks of their respective holders.



Circle 346 on reader service card

MAX[®] YOUR MAC



Printer Stand
\$22.95



Accessories
you've been
looking for!

Power Base
\$129.95

Turbo Mouse
\$134.95

Copy Stand
\$26.95

To place an order or for more information, call our Toll Free number.

If you prefer, circle the number below on the reader service card and we'll send you a free brochure with these and other items of interest.

1-800-882-9199

microvision

28045 Ranney Pkwy., Westlake OH 44145

Circle 388 on reader service card

THE BEST TYPE BOOK MONEY CAN BUY.

This priceless professional tool is yours free. Simply mail the coupon below or call Adobe Systems toll-free at 800-83-FONTS.

Adobe, developer of the Adobe[®] Type Library and PostScript[®] software, is the world's authority on electronic publishing.

This full-color, 11" x15", 32-page *Font & Function*[™] catalog is jam-packed with helpful tips and problem-solving advice from Adobe type and design experts. Plus, it's got samples, interviews and more than 300 high-quality Adobe typefaces for you to order. You'll see

FONT & FUNCTION



how easy it is to publish like a pro with your Macintosh[™] or IBM[®] PC computer, PostScript printer and a little help from *Font & Function*, the Adobe Type Catalog.

Get yours today. FREE. Just call 800-83-FONTS. Or write *Font & Function*, P.O. Box 7900, Mountain View, CA 94039-7900.

ADOBE[™]
SYSTEMS INCORPORATED

Adobe and PostScript are registered trademarks and the Adobe logo and Font & Function are trademarks of Adobe Systems Incorporated. Macintosh is the registered trademark of Apple Computer, Inc. IBM is the registered trademark of International Business Machines.

FREE.

01-12-02-2

To receive your free *Font & Function* Adobe Type Catalog, mail to: Font & Function, P.O. Box 7900, Mountain View, CA 94039-7900. Please allow 4 weeks for delivery.

I use a Macintosh IBM PC computer (Check appropriate box(es))

NAME _____

TITLE _____

COMPANY _____

ADDRESS _____ CITY _____

STATE _____ ZIP _____ PHONE _____

Commentary/Jerry Borrell

opers have room to innovate within a stable environment.

If Apple were able to advance the Finder by taking the concept of software modules and building hooks into system software so that applications could communicate or interact more easily, it would allow third-party developers to thrive and innovate while moving the Mac interface forward. Apple could spend its precious resources on advancing the underlying functions of system software rather than using staff and time in application development. It might also dissipate some of the fervor developers express toward advancing the interface along nonsanctioned paths (Silicon Beach's SuperCard is an example of this).

I think pragmatism will force Apple to limit the kinds of functions it can add to system software. But I'm often wrong, and in some ways it looks like Apple will continue to add application functions to system software such as graphics, E-mail, word processing, and spreadsheets.

Apple may need to create products that demonstrate the environment that it envisions just as MacPaint and MacWrite were considered (at times) to be demonstrations of the Macintosh approach for third-party developers.

Frankly, I don't know if an open software architecture approach is possible with existing operating system code, or whether this will require the complete rewrite of system software for 1990 already announced by John Sculley. As a new version of the Finder is said to be a couple of years away, it's possible.

I do know that Apple wants to take advantage of the built-in memory management unit of the Motorola 68030. I also believe that the 68030 will become the base level CPU chip for the Mac over the next several years and that the system architecture will more easily evolve from the 68030 toward future hardware and software architectures.

What's It All Mean?

Apple's next version of system software is all-important. It is such a complex release that there may have to be an interim release (forget the numbers), but the next one will determine how the Mac will fare in its battle with OS/2 and PS/2 machines. You can bet that we'll be looking closely when it comes out. □

AT THE RISK OF SEEMING GRANDILOQUENT
IN OUR PREDILECTIONS, WE SIMPLY SEE NO REASON
FOR ANY MAC OWNER TO SETTLE FOR ABJECT MEDIOCRITY
MASQUERADING AS SUBLIME PERSPICACITY.

EVEN IF IT DOES COME FROM MICROSOFT.™

It's quite simple, really.

All we're saying is that the limited scale spell checkers that come tacked onto today's word processing packages are, in a word, underpowered.

Oh, they work okay as long as everyone's content to use more or less the same words all the time. But then, sameness is not exactly a highly regarded concept amongst Macintosh users.

Thank goodness there's an alternative. A program designed to help you forge ahead into brave new worlds of verbal individuality. With Merriam-Webster at your side.

Spelling Coach Professional.™ A program applauded regularly over the years, by reviewers and users alike. Many felt Coach's powerful and cleverly interwoven spell checking, dictionary definition and thesaurus functions were unbeatable. Hypertext taken to the final frontier.

Yet our brand new Version 3.1 proves them wrong. For now, we've made what was solidly hefty utterly gargantuan.

Consider the following. A 193,000 word user-amendable Proximity/Merriam-Webster™ spelling dictionary (with medical, legal, technical, geographical & biographical

supplements included).

Plus instant access to Proximity/Merriam-Webster's Concise 85,000 word reference dictionary with complete definitions, hyphenation, uses and tenses.

And a new little something we call **BigThes.™** by far the most complete electronic thesaurus available today. Based on over 100,000 root words from the renowned Merriam-Webster Thesaurus, this 1.4 million word interactive thesaurus dwarfs its closest competitor by a factor of more than six times.

Simply install Spelling Coach Professional as a desk accessory – for smooth use with over 95% of all Mac software including MultiFinder™ and

HyperCard™ – or use it as the ultimate stand-alone batch checker, if you prefer.

Let Coach™ work with you interactively (as you type), or use it to scan your completed documents at high speed, identifying and suggesting corrections to any grammar or spelling problems it encounters.

You see, despite all its power, we've made Spelling Coach Professional very easy to get along with. And, once you've used it, downright impossible to get along without.

To settle for anything less would be, in a word, incogitant.



Spelling Coach Professional™ Ver 3.1 \$195.00

(Hard disk required)
Site licenses and network versions available.

BigThesaurus™ only \$99.95
(Hard disk required)

For more information or a demonstration of this or any of Deneba's other products, see your local dealer or call us at 1-800-622-6827. In Florida, call (305) 594-6965.

3305 Northwest 74th Ave., Miami, FL 33122



© 1988 Deneba Systems, Inc.
All product names mentioned are trademarks of their respective holders.



Varityper

a Tegra Company

The Number



Whether you want your output on plain paper or photo-media, Varityper is the #1 Choice for PostScript Imagesetters.

BROADEST CHOICE

Varityper is the only supplier to offer a choice of four high resolution, PostScript imagesetters. From 600 dpi plain paper output to 2400 dpi photo-media output, Varityper has the choices for your precise needs.

BEST TECHNOLOGY

All Varityper's PostScript imagesetters employ laser diode technology with full page buffering to give you the highest quality, fastest and most precise imagesetters . . . at prices up to 1/3 less than other equipment.

MAXIMUM FLEXIBILITY

No matter what your needs . . . whether it's plain paper or photo-media, for forms, brochures, newspapers, ads, proposals, newsletters, books or reports . . . Varityper has a PostScript imagesetter to help you create more effective communications. With Varityper, you're governed by the job and never by the limitations of your equipment.

For more information about any of Varityper's full line of imagesetters using the PostScript page description language from Adobe Systems, Inc., call today

1-800-631-8134

(In New Jersey 201/887-8000 x-999)



VT600

600 dpi plain paper imagesetter
8½" x 11" format, 10 pages/min.
PostScript Interpreter
6Mb RAM, 20Mb disk for approx. 100 fonts
35 fonts standard



VT600W

600 dpi plain paper imagesetter
Up to 11" x 17" format, 7 pages/min.
PostScript Interpreter
12Mb RAM, 20Mb disk for approx. 100 fonts
35 fonts standard

yper

IDE

Supplier Of Imagesetters with Adobe's PostScript[®] Interpreter



4200P

1200 dpi photo-media imagesetter
150 ft. media supply, 15 inches/min.
PostScript Interpreter
4Mb RAM, 20Mb font disk for approx. 100 fonts
35 fonts standard
40Mb Page Buffer Winchester
Optional disk for approx. 200 fonts



4300P

1200 to 2400 dpi photo-media imagesetter
150 ft. media supply, 20 inches/min.
PostScript Interpreter
8Mb RAM, 40Mb font disk for approx. 200 fonts
35 fonts standard
91Mb Page Buffer Winchester
Optional disk for approx. 500 fonts

Circle 93 on reader service card



NOW FEED YOUR COMPUTER DELICIOUS COLORS, AT A PRICE THAT'S EASY TO SWALLOW.

Introducing the Sharp JX-300 letter size color scanner.

Our affordable, new JX-300 can scan the most appetizing color originals up to 8½" x 11". It also has a small footprint and fixed scanning bed to give you more usable desk space.

This new color scanner joins our larger, widely acclaimed JX-450, which handles originals up to 11" x 17". The JX-450 also scans 35mm slides and overhead transparencies with an optional mirror unit.

Both units scan at 300 d.p.i. resolution and 256 shades for

each element to give a range of 16.7 million colors. Not to mention 256 gray scales for monochrome systems. Both are compatible with the leading PC systems.

Sharp also offers the JX-730 color inkjet printer to give you plain paper color printouts that are faithful to your originals.

If you're looking into scanners—even black and white scanners—don't overlook the future. The future is mouth watering color.

For information, call 1-800-BE-SHARP.



© 1988 Sharp Electronics
Simulated Picture on Monitors

SHARP
FROM SHARP MINDS
COME SHARP PRODUCTS™

Circle 327 on reader service card

Letters

A forum for Macworld readers

Tipping the Scales

In "The Great Write-Off" (November 1988), Jim Heid compared three word processing programs and eventually declared Microsoft Word to be the winner. Although Heid's comparisons are quite good as far as they go, he did not include symbolic referencing. If I have a 20-page report with 19 figures in it and I insert a new figure as the first figure in the document, I must go meticulously through the article and change all counting numbers referring to figures. Unless, of course, I am using FullWrite Professional. Then the program itself will do

Corrections

The phone number for Spectral Software, maker of MacAuto (New Products, November 1988), is 415/964-9580.

MacNet provides access to Connect's PC/Mac network services (New Products, November 1988).

The phone number for Opcode Systems, maker of Timecode Machine Desk Accessory (New Products, November 1988), is 415/321-8977.

Everex and Tecmar tape drives do use write verification ("Why Say No to Backup?" November 1988).

To enter a user ID and a password on the same line, you must separate them with a backslash, not a semicolon (Insights on CompuServe, January 1989).

The phone number for Advanced Logical Software, maker of Anatool 2.0 and BLUE/60 (Letters, January 1989), is 213/653-5786.

The phone number for Siclone Corporation, maker of the Si3033 accelerator board, is 408/734-9151.

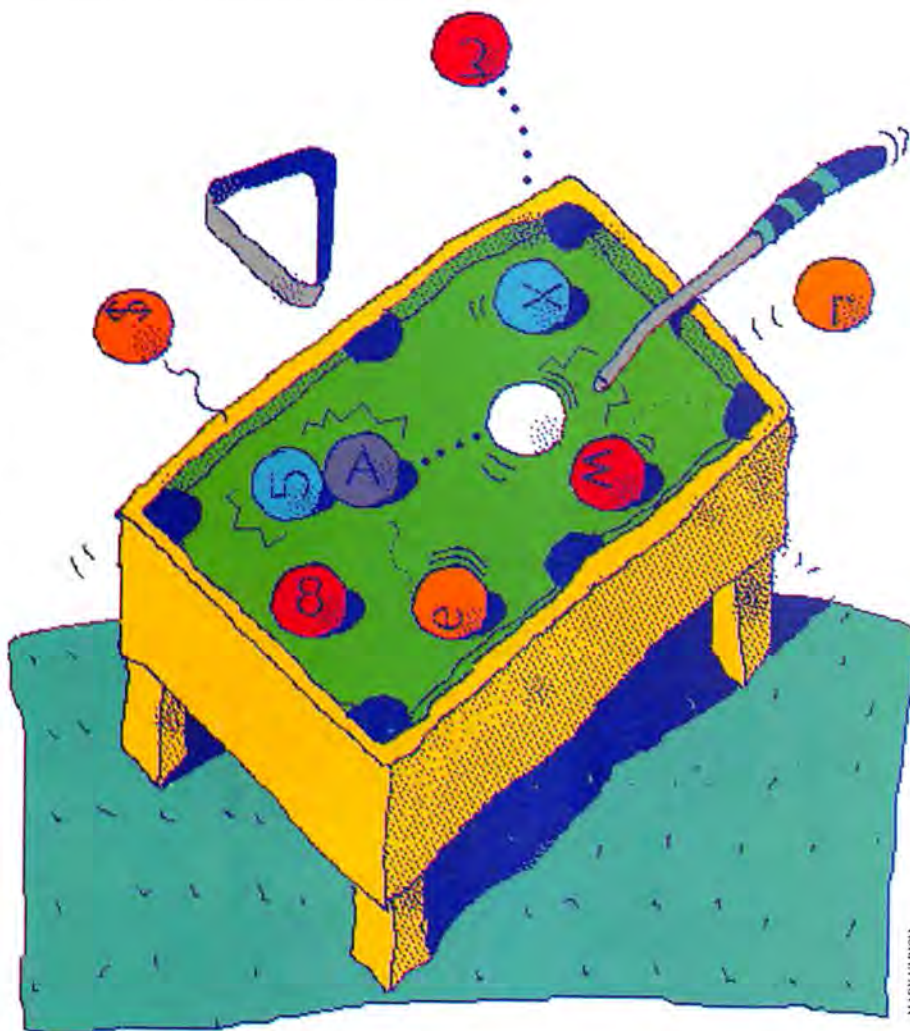

the updating. And figure counting is just one example of FullWrite's superior symbolic referencing ability. If Heid had considered this variable, then at least for users who have to create long and complex documents (such as scholarly articles), the scales would have come down resoundingly on the side of FullWrite.

*Jon Sticklen
East Lansing, Michigan*

Still Staggering

Many thanks for Jim Heid's superb review of the three leading word processors ("The Great Write-Off," November 1988). As a

beta tester for FullWrite, I winced audibly throughout, but I can find no fault.

I upgraded my SE to 2MB so that I could use FullWrite. I recommended it to friends and was responsible for my department ordering it. However, what reviewers had little chance to test—and what a large number of users need—is the use of the word processor for large documents. Recently I had the gruesome experience of transferring a 317-page document to FullWrite. And I am still staggering.

FullWrite claims to be chapter-oriented; hence, I formatted a segment of the work into a document of 100 pages with 25-page chapters, but even so, in the

(continues)

"It's not just a document,

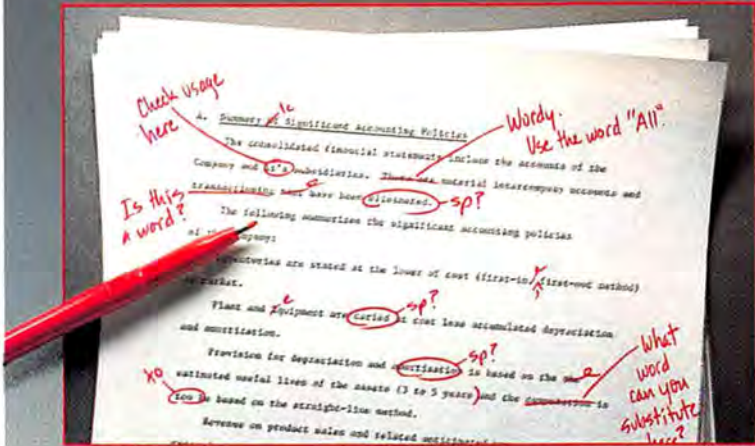

it's your business!"

Only one thing could be worse than a document arriving *late*: arriving *wrong*!

A poor impression made by a badly written letter or report, littered with errors, can lose a contract or a sale.

MacProof™ points out possible errors in style, usage, spelling, punctuation, and capitalization. It also allows you to analyze the structure and flow of a document.

Since **MacProof** works as a Desk Accessory, you can check for errors, review solutions, and make corrections without ever leaving your document.

A few clicks of the mouse turns suggestions into corrections.

With **MacProof** your document arrives on time and *right*!

Circle 472 on reader service card



Ask your local dealer for **MacProof™** or call at (800) 354 5656 for information about the dealer nearest you.

MacProof is a trademark of Lexpertise Linguistic Software SA

Lexpertise USA, Inc.
175 East 400 South
Suite 1000
Salt Lake City, Utah 84111

Tel.: (801) 350 9100 Fax: (801) 350 9051

Letters

last chapter the application slowed to a crawl. I could type four letters before one of them showed on the screen. To move the cursor a few lines required at least five seconds, and to close the document, I waited five minutes! Ashton-Tate advises reducing chapters to 10–15 pages, which is ridiculous, and doesn't change the end result. If I were to break up the book into a series of documents, I could use neither the Index Entry nor the Contents function.

Spurred by your review, I also tested WordPerfect (its manual recommends a maximum length of 70 pages per document), only to find that it too took an eternity to get to a given page, even with a 67-page segment. On the other hand, Microsoft Word (which I hate) reacted instantly to the Go To and Close commands and kept up the same typing-response speed at the end of the document as at the beginning, even when pushed to 167 pages. (Word 3.0's manual recommends a maximum of 250 pages per document, but offers the opportunity to merge documents, thus affording the indexing and table-of-contents possibilities.)

Conclusions: It is impossible to write a full-length book with FullWrite and almost impossible with WordPerfect. With great regret, I am returning to Microsoft Word. I will miss the Posted Notes, the convenient pagination, the sidebars, and the ease of use of FullWrite, but its sluggishness and the impossibility of long documents give me no choice.

*Blake Lee Spahr
Berkeley, California*

A Prized Stack

I was disappointed that Steve Drazga's Developer Stack did not win the grand prize in *Macworld's* SuperStacks contest. Because his stack is a useful tool provided at such generous terms to the Mac community, I hope you will reconsider your decision. Steve Drazga deserves credit for opening up HyperCard development to the beginning user, as he has for me.

*Daniel W. Collison
Detroit, Michigan*

We certainly didn't mean to damn with faint praise Developer Stack or the other applications that received Honorable Mention. We meant to honor them as the outstanding works they are. Although the judges had some reservations about the user interface of both Developer Stack

(continues)

NOW MACINTOSH AND WANG CAN COMMUNICATE AND NOTHING GETS LOST IN THE TRANSLATION



Transferring files from one system to another is somewhat pointless if you spend most of your time re-formatting the data.

Which is why we introduced

MacLinkPlus for Wang. Whether you're running a Wang VS system, an OIS or a Wang PC, MacLinkPlus provides a complete solution for document transfer and file conversion.

MacLinkPlus includes the entire collection of more than 40 translators — the key to accurate conversion of file formats such as rulers, indents, bold and plain text styles, margins, tabs, underlines, superscripts, subscripts, paragraphs, and tabular tables. If it looks a certain way on a Wang, it will look the same way on a Mac. And, of course, vice-versa. No time-wasting and difficult pre-conversion



Wang Word Processing



Microsoft Word

to ASCII or print files is necessary.

MacLinkPlus doesn't stop there, however. It offers full Wang VS Workstation capabilities, allowing easy access to Wang word processing, data processing and electronic mail. All 32 Wang Workstation functions can be executed through familiar Macintosh menus or command keys, and you'll even be able to use the mouse on Wang displays.

Software for the Macintosh, software for the Wang (8" or 5.25"), software for the PC and a direct connect cable (you can use a Hayes or compatible modem if you prefer), is included in the MacLinkPlus package; everything you need to be up and running in minutes.

So call (203) 268-0030 for your nearest DataViz dealer, because no matter which Wang system you're using, there's a MacLinkPlus solution to connect it to the Mac.

Who says you can't have the best of both worlds.



Wang 2110 Terminal



Macintosh 2110 Terminal Emulation

DATAVIZ

35 Corporate Drive
Trumbull, Connecticut 06611

MACLINKPlus™/Wang

Circle 281 on reader service card

ART. FOR FONTS, CLIPS, SYMBOLS AND YOUR SAKE.



ART-FONTS

1, 2 & 3 — Three volumes consisting of six different original laser fonts. Each volume includes a FREE "Picture-Keys" symbol laser font and a "Typeface Use And Selection Guide" HyperCard Stack. Only \$99 — suggested retail price per volume.

ARTCLIPS

Your designer on a disk; actually four disks of highly-detailed PostScript® (EPS) illustrations to take your desktop publishing out of the ordinary. Includes a FREE "ArtSymbol" laser font and a "Graphic Design Tips" HyperCard Stack. Only \$99 — suggested retail price.

To order, call TOLL-FREE 1-800-822-0772 or see your dealer. For a FREE demo disk and printed samples, just send us a blank disk.

OLDUVAI Corporation, 7520 Red Road, Suite A, South Miami, FL 33143 (305) 665-4665-Fax (305) 665-0671

Circle 284 on reader service card

MISSING ANY BACK ISSUES?

Macworld is a popular item around the office, and your copy may wind up on someone else's bookshelf. But you can replace your "borrowed" copies of *Macworld* easily. Back issues are available, postage-free, for just \$6 each while supplies last.

Send your check or money order, payable to *Macworld*, along with the issue date and number of copies desired to *Macworld*, 144 Townsend Street, San Francisco, CA 94107.

Letters

and Robertson Reed Smith's *Stack Starter*; both are valuable tools for stack builders. Developers like Drazga and Smith have made exceptional contributions to the vast community of stack designers. —Ed.

The Beast Bytes Back

In response to your review of our TG-4000 tape backup unit ("40MB Tape Backups," *Reviews*, November 1988), we at Tallgrass would like to suggest an alternative to the analogy of Beauty and the Beast: Form Follows Function.

We are in the systems business, and the 4000 was designed to provide systems flexibility to our customers. Although you can order it as a stand-alone tape backup unit or as a stand-alone disk product, the "Beast" was also designed to be field upgradable. That same functional cabinet can house a 40MB tape drive plus a 40MB or a 100MB hard disk, or dual disk drives, if you prefer. Additionally, the Tallgrass 4000 user has the option of beginning with any component and upgrading with any other at any time. That translates into an external SCSI disk tape combination with capacities from 40MB to 200MB.

We feel that, coupled with the best pricing and the only three-year warranty in the industry, the Beast is the best buy for your backup buck.

David F. Horton
Tallgrass Technologies
Overland Park, Kansas

Scanners Revealed

I want to commend Jim Heid for his clear and accurate article on scanners in the November issue of *Macworld* ("Getting Started with Scanners"). Subjects such as scanned images and halftones are becoming increasingly important, yet are difficult for most people to grasp. This article should go a long way toward demystifying the subject.

Steve Carlsen
Aldus Corporation
Seattle, Washington

Who Keeps the Books?

Your article "Who Keeps the Books?" (September 1988) was excellent. It shows that you did your homework quite well. (I write accounting packages for the MS-DOS world.)

What interests me is the address and phone number of P. G. Backhelpers, whose reclining chair you featured so promi-

(continues)

Are Your Files Stacked Against You?

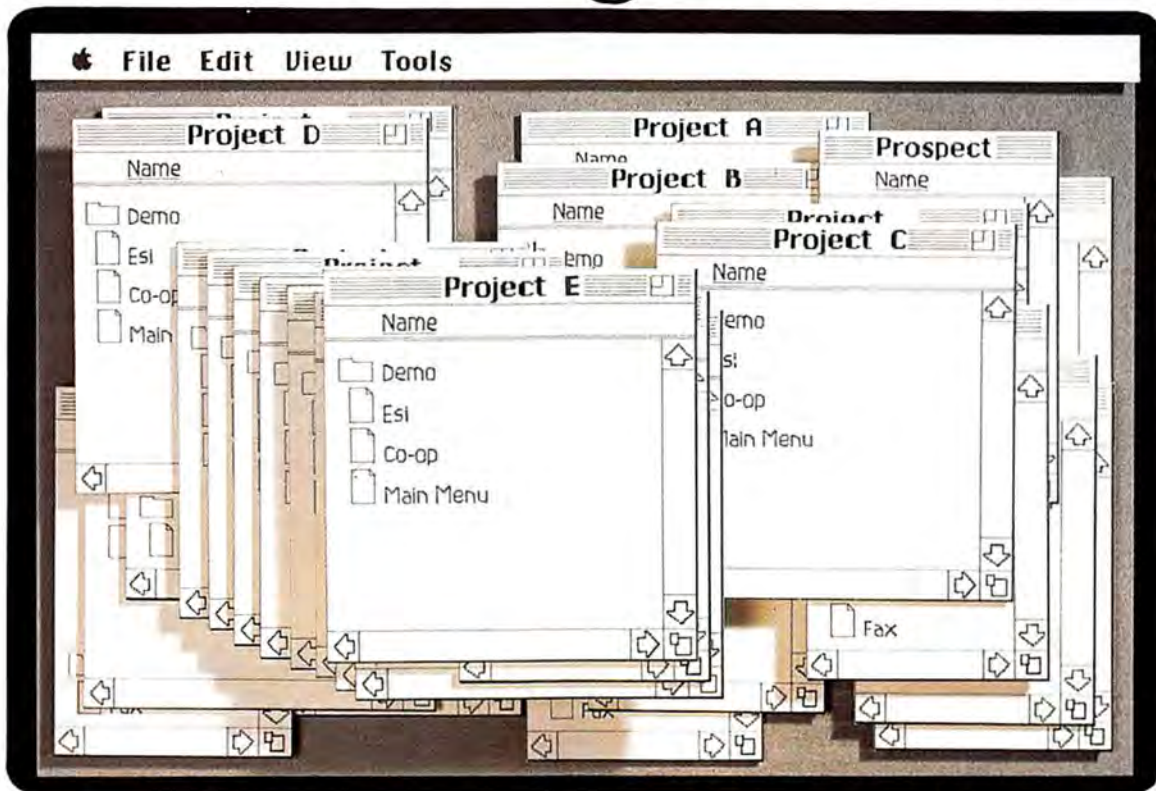

Stack them in your favor with XTreeMac™ The Complete Disk Management Environment.

With the Macintosh® it's so easy to organize files in folders... within other folders. But climbing through stacks of windows to get to the right file takes time. Opening. Closing. Resizing. Rearranging.

With XTreeMac™ you can perform your disk management tasks from a single window.

No matter where files are located — on hard disks or floppies. Disk management has never been easier.

XTreeMac's unique Directory Tree™ lets you see your disk organization at a glance.

XTreeMac's Deskpad™ provides a convenient surface for gathering files, folders and applications from multiple disks.

XTreeMac is an integrated disk management application that enhances Finder®. Using familiar Finder commands, you can copy, move, rename, or delete files right on the Directory Tree or Deskpad. And you can find and launch applications directly from XTreeMac. You'll save stacks of time.

If you inadvertently delete files, don't worry. XTreeMac's Revive-A-File™ recovers them. Even after you've emptied the trash or turned off the power.

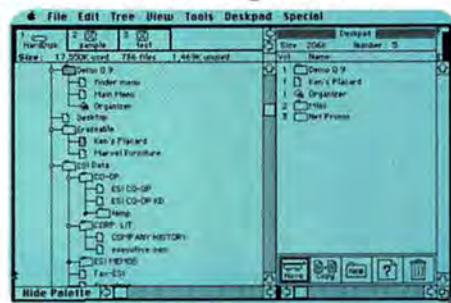

Directory Tree

Deskpad



XTREE
COMPANY

A Division of Executive Systems, Inc.
4330 Santa Fe Road
San Luis Obispo, California 93401

See how XTreeMac stacks up to your requirements. Contact your local dealer or call XTree Company at (805) 541-0604, (800) 634-5545 or in CA (800) 551-5353.

XTreeMac, Deskpad and Revive-A-File are trademarks of XTree Company. Macintosh and Finder are registered trademarks of Apple Computer, Inc.

Circle 470 on reader service card



The original AnthroCart. Mobile.
Incredibly strong. So many ways to solve
your space and equipment problems.
Choose different sizes. Move
shelves around. Add space saving
options.

AnthroCart. Well designed
Technology Furniture.

Look for our name.

AnthroCart®

Call us for more information: 800-325-3841



Made in U.S.A.
All steel frame construction
Easily holds up to 150 lbs.



AnthroCart and Technology Furniture are
registered trademarks of Anthro.

**Anthro®
Technology Furniture®**

3221 N.W. Yeon St.
Portland, OR 97210
503-241-7113
Telex: 940103

Letters

nently in your article. All my years of sitting
at my computer have led to a back problem
that just might be helped by this company's
products.

*William McDonald
Leeds, New York*

*P. G. Backbelters is a retail store in Fair-
field, New Jersey, that caters to its own
geographical area because the owners
feel they can properly serve customers
only through personal consultation.
They suggest that those outside the area
consult a physical therapy practice, or-
thopedic surgeon, or chiropractor to find
a local source of similar products.—Ed.*

Plastic Fantastic

What happened to the plastic mailing cover
to which we have become accustomed?
Macworld used to arrive in mint condition.
The October 1988 issue, however, looked
like it had been in a dentist's reception of-
fice for a few months. The cover was
scratched beyond recognition.

I have every issue from your premier
issue in 1984, all in perfect condition.
Please bring back the plastic bag.

*Orian Watts
Sidney, Montana*

*We apologize for the inconvenience. Your
copies should once again be arriving
safely wrapped in plastic.—Ed.*

Prolix Charm

Since reading the words *gormless syco-
phant* in Jerry Borrell's column in the Oc-
tober 1988 issue (my spell checker didn't
choke on either word), I haven't been able
to watch the *Tonight Show* without dou-
bling up with laughter. Thanks very much
for the bit of joy those words inspired.

*Gordon Snyder
Sacramento, California*

*Letters should be mailed to Letters,
Macworld, 501 Second St., San Francisco,
CA 94107, or sent electronically to
CompuServe (70370,702) or MCI Mail
(addressed to Macworld). Include a re-
turn address. We regret that, due to the
high volume of mail received, we're un-
able to respond personally to each letter.
We reserve the right to edit all letters. All
published letters become the property of
Macworld. □*

Put a Seagate drive at the core of your computer

If you're one of the millions of people who have adopted computers with an SCSI interface, then you should be one of the millions who can use a drive from Seagate, the world's largest manufacturer of SCSI disc drives. These drives come in a wide variety of sizes, capacities and access times, making them ideal for every application.

Whether you're searching for an add-in or add-on subsystem, look for the drive that stands for quality and reliability worldwide and has made Seagate the first name in disc drives. Call us at 800-468-DISC or 408-438-6550 for information on where to purchase SCSI storage solutions.

Form Factor	Model	Capacity	Access Time
3.5" HH	ST125N	21 MB	<30 msec
	ST138N	32 MB	<30 msec
	ST157N	48 MB	<30 msec
	ST177N	60 MB	20 msec
	ST1096N	83 MB	20 msec
5.25" HH	ST225N	21 MB	65 msec
	ST251N	43 MB	28 msec
	ST277N	64 MB	28 msec
	ST296N	84 MB	28 msec
5.25" FH	ST4192N	168 MB	17 msec

 **Seagate**
The first name in disc drives

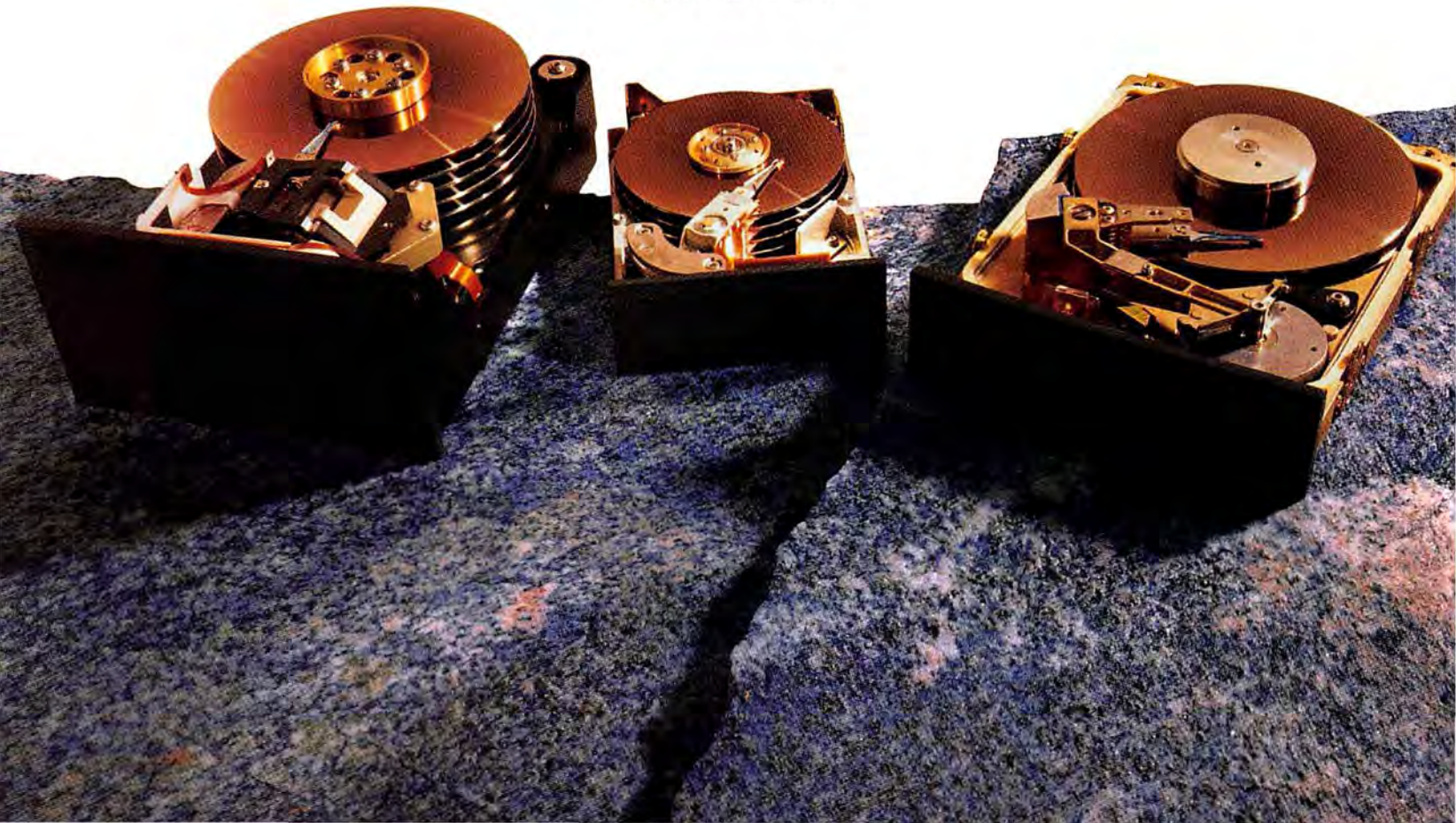

TRY FULL IMPACT AND SEE WHY EXCEL DOESN'T.

HOW SPREADSHEETS COMMUNICATE #3 in a series

A recent tracking study performed by Numerical Understanding Methods Bureau, Inc. has determined that constant and prolonged exposure to spreadsheet output may result in cases of extreme drowsiness and lethargy. Contributing factors have been numbers with no context, lack of graphic elements, and limited abilities in the treatment of text.

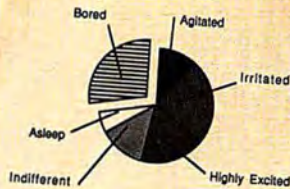

SPREADSHEET USAGE

User Category	WEST	SOUTH-WEST	NORTH	EAST	SOUTHEAST	TOTAL
Records	21	38	93	65	32	249
Analysis	43	47	26	38	43	197
Budgeting	36	64	39	93	45	277
Cost Acctg	24	45	64	48	73	274
Scratch Paper	11	81	58	19	18	187
Tranquillizer	52	13	76	46	44	231
Fishwrap	24	53	73	63	92	305
To Impress Boss	14	41	83	27	38	203

ARE SPREADSHEETS EFFECTIVE?



As seen in the Usage chart above, the NUMB study has demonstrated that people in fact use spreadsheets for a wide variety of purposes. As a general rule, excitement levels tend to increase in correlation with the more non-traditional uses. A subset of the findings of the preliminary data from the largest universe of the NUMB research has shown that spreadsheets are greatly in effectiveness (see chart to the right). Why this may be is outside the purview of this fictitious research; however, a tracking study conducted by the Sorbonne Research Enterprise has shown that spreadsheets are greatly in effectiveness (see page 27).

How Spreadsheets Communicate #3 IN A SERIES

A recent tracking study performed by Numerical Understanding Methods Bureau, Inc. has determined that constant and prolonged exposure to spreadsheet output may result in cases of extreme drowsiness and lethargy. Contributing factors have been shown to be an emphasis on raw numbers with no context, lack of graphic elements, and limited abilities in the treatment of text, (and, in some instances, an over-reliance on dry language, like this).

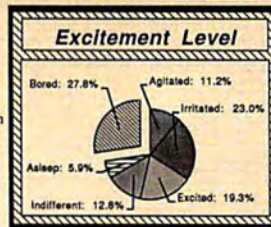

SPREADSHEET USAGE

User Category	WEST	SOUTH-WEST	NORTH	EAST	SOUTHEAST	TOTAL
Records	21	38	93	65	32	249
Analysis	43	47	26	38	43	197
Budgeting	36	64	39	93	45	277
Cost Accounting	24	45	64	48	73	274
Scratch Paper	11	81	58	19	18	187
Tranquillizer	52	13	76	46	44	231
Fishwrap	24	53	73	63	92	305
To Impress Boss	14	41	83	27	38	203

ARE SPREADSHEETS EFFECTIVE?

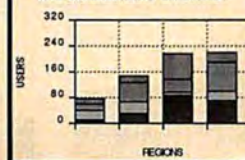

As seen in the Usage chart above, the NUMB study has demonstrated that people in fact use spreadsheets for a wide variety of purposes. As a general rule, excitement levels tend to increase in correlation with the more non-traditional uses. A subset of the findings of the preliminary data from the largest universe of the NUMB research has shown that spreadsheets vary greatly in effectiveness (see graph at left). Why this may be is outside the purview of this fictitious research; however, a tracking study conducted by the Sorbonne Research Enterprise has shown that spreadsheets are greatly in effectiveness (see page 27).



It's the difference between merely analyzing something, and actually seeing what it means.

Introducing Full Impact™, from Ashton-Tate.

Full Impact is a spreadsheet program designed expressly for the Macintosh that goes beyond the basic number-crunching capabilities of Microsoft Excel: it gives you the ability to easily turn your work into clean, crisp—and understandable—documents.

How? By letting you take full advantage of the way you're already used to working on the Macintosh.

Start by simply entering your data. Then, select all or part of it, and instantly create a chart using those values—simply by clicking on the appropriate chart icon from the icon bar.

Need to write some text explaining your analysis? And highlight certain passages? Full Impact's text editor gives you plenty of fonts, sizes, and styles to choose from.

What if that block of text would look better somewhere else? Fine. Just click on it, and drag it there. You

can even bring in art from other programs, then merge it with your text and data, all on the same page.

But lest you get the impression that Full Impact is merely a presentation program disguised as a spreadsheet, consider this: with over half a million usable cells (far more than any other Macintosh spreadsheet), Full Impact



gives you more than enough room to handle even the largest projects. And more than enough speed to recalculate them quickly.

You can work with as many as eight spreadsheets simultaneously. And then link them all together. Or create powerful, time-saving macros, and even customizable icons to tie them to.



ASHTON • TATE®

FULL IMPACT vs. EXCEL

Full Impact 1.0 Excel 1.5

Power

Usable cells with 1 Mb RAM	512,000	50,000
Linked spreadsheets	Yes	Yes
"C"-like macro language	Yes	No
Customizable icon bars	Yes	No

Presentational Capabilities

Print charts and spreadsheets on one page	Yes	No
Mix fonts, sizes, styles cell by cell	Yes	No
Drawing tools	Yes	No
Easy-to-move, formattable text blocks	Yes	No

You can also exchange files with many other popular programs, including Excel and Microsoft Works, Lotus 1-2-3, all of Ashton-Tate's dBASE® products, and much more. So you won't lose your investment in your current data.

SAMPLE FULL IMPACT FOR FREE.

We'd like to make it easy for you to get the full impact of Full Impact. Just call 800 437-4329, ext. 3501, and we'll send you a full-capability product sampler.

What could be more impactful?

Back up very carefully.

If you don't back up data, you can throw your entire office into reverse.

That's the most eloquent argument for backing everything up very carefully. And for using Jasmine DirectTape™ to do so.

DirectTape is different from most Mac backup systems. The reason? It's fully Apple compatible.

So we work with the data on any Apple-originated tape, regardless of the software that put the data there. We also have full support for the major applications that will soon be packaged on software

cartridges. Which means besides data transfer, DirectTape also expertly handles software distribution.

We work faster, too. By the time it takes others to back up your data, we'll have already backed it up *and* automatically double-checked it. All while you're still using your Mac. Because with MultiFinder™, DirectTape can work in the background.

DirectTape even prompts you to insert your second Jasmine preformatted cartridge when your first one is full. And with extra tape cartridges, you have unlimited backup capacity.

That's why the lightweight, portable DirectTape is perfectly geared for workgroups and departments. Attaching to Macs in seconds, without extra cabling.

Finally, we back you up in yet another way. Our No-nonsense 2-Year Warranty.

So before you move forward from this ad, remember how important it is to back up. Call us toll free to charge a DirectTape today.

Because given the value of your data, you can't be too careful.



DirectTape is priced at an extremely affordable \$1099. (Available at \$899 when purchased with any Jasmine Hard Disk Drive.) Prices include two 40 MB tape cartridges and all cables and connectors needed for any Mac SCSI configuration.

 **Jasmine**
1-800-347-3228

Jasmine Technologies, Inc.
1740 Army Street, San Francisco, CA 94124
Phone: 415-282-1111 Worldwide.
Fax: 415-648-1625



Safety Last?

Is Robert Morris guilty as charged, or shall we let him off with a slap on the wrist?

It had to happen. Someone was bound to write a virus that would invade a large number of computers and gain national attention. Even though this invasion occurred last fall, it's worth discussing now, because any computer virus raises issues beyond the immediate havoc it creates.

The news coverage about Robert T. Morris, a graduate student at Cornell University, and the virus he wrote, was so pervasive for a time that you'd think he had perpetrated something akin to a nuclear meltdown. But although it created many headaches and much embarrassment, Morris's virus, which invaded some 6000 university and defense computers linked to ARPANET, did not cause any lasting damage.

I had to laugh at much of the hysterical tone (and inaccurate information) of the news coverage of this story. The reporter on one of my local TV stations kept using *worm* and *virus* interchangeably. Had he read the November issue of *Macworld*, he'd have known that a worm is a piece of code that eats into a program's memory but does not travel, while a virus replicates itself, often in order to rewrite code, erase sectors, or even bomb whole programs.

It seems to me that Morris has done us a big favor by exposing the vulnerability of many of our computer systems, which too often are like houses with doors and windows that don't lock. They invite mischief. And mischievous is how we should describe this incident, rather than malevolent. Just as vandalism is mischievous, I think letting a virus loose is destructive, but it doesn't call for life imprisonment.

What Morris has done is a variation on the story we've gotten accustomed to hearing, that security bloop most often happens in mundane, hands-on situations rather than at the conceptual, "top brass" level. Remember *The China Syndrome*? It was a stuck valve, not a geopolitical shoving match, that caused the destructive cycle to kick in. Same with a virus. By and large, creating one is intended to be more of a nose tweak than a punch to the solar plexus.

One aspect of this newest postvirus debate revolves around Morris himself. Should he be severely punished so that other hackers will think twice before attempting similar feats, or should he be put on a high-tech work furlough to use his considerable skills in making computer systems more secure?

Unlike some hackers, I don't see Morris as a hero, the D. B. Cooper of computerdom. The old hacker ethic that encourages invasion and tampering with computer systems evolved at a time when mainframe computers were controlled entirely by large institutions. Hackers believed that they had a certain moral imperative to liberate computer power. Although my experience has been solely on the personal computer side, I was sympathetic to these early mainframe hackers. The computer priesthood had to be infiltrated, and hackers were the first to recognize that unless computer power was in more hands, computing in general could all too easily become an oppressive institution in its own right. Now, years after that political struggle began, the computer world is completely transformed, and the hacker ethic needs to be updated. Considering the lip service they have given to computer democracy, hackers themselves have created

an elite, and the kind of computer power they have espoused is still not in enough hands. What Morris and other adept hackers have done in the realm of breaking into systems is still outside the ken of most users. It's not so much that power is still synonymous with break-in, but that the skill to program, customize, and spread certain functions throughout computer systems can be put to some good uses.

But I don't think Robert Morris should be tarred and feathered, either. It seems clear from his public statements that he never intended his virus to cause massive havoc. It was simply more clever (and traveled further) than he expected. Apparently he is remorseful about the chaos he caused, and I doubt that he will go this far again. It turns out that Morris is a super-talented programmer, and it's unlikely that many other programmers have the skill to create similar viruses. He has the potential to make major contributions to software development and computer security. Directing his skill to these more positive (and lucrative) pursuits seems to be the best course of action. I've always liked the fact that some reformed burglars go into the business of advising us on how to secure our valuables. It makes sense to me that they would have the best advice. So could Morris.

Meanwhile, we all need to take precautionary measures to ensure the integrity of our systems. A more malevolent hacker might strike next time. Don't forget to install locks on your doors and windows, and then use them. □

THIS IS WAY TOO EASY. UNSURPASSED NUMBER-CRUNCHING POWER. CHARTS SO GRAPHIC, THEY JUMP OFF THE SCREEN INTO PAGE PERFECT PRESENTATIONS. YOU'RE ACTUALLY LOOKING FORWARD TO YOUR NEXT MEETING. BECAUSE YOU'RE NOT JUST GOING TO SHOW THEM NUMBERS. YOU'RE GOING TO WIN THEM OVER WITH WINGZ.™

United Wares Assets

	1985	1986	1987	1988
Current Assets	501.99	331.75	327.82	135.01
Accounts receivable	175.58	145.36	138.32	78.25
Property held for resale	21.49	222.39	142.76	22.02
Developed property	204.41	146.20	157.74	300.47
Other current assets	297.51	557.00	142.60	78.39

Revenues

Five Year Summary

National revenues decreased over five years in 1988 thus lower revenues

1988 Financial Highlights

Operating Data

	1988	1987
Net sales	\$124,325	\$119,437
Operating costs and expenses	\$140,863	\$139,437
Percent of net sales	113%	117%
Income from continuing operations	\$25,006	\$21,544
Per common share outstanding	\$22	\$24
Dividends declared	\$28,000	\$12,000
Per common share	\$247	\$29

FY '88 Advertising Media Insertions

TIME **Newsweek** **US News** **Revenues**

3D Info

This graph represents the 3 dimensional step. Located in 3D Info under the Graph menu, you will find its altitude in the view automatic to be 50, giving the graph a wide angle viewpoint.

WINGZ™

File Edit Go

PRODUCT

Standard

Overnight

Fax Pack

Cold Pack

Second Day

INFORMATION MANAGEMENT SOFTWARE FROM INFORMIX®

LEARN TO FLY FREE.

For a limited time only, the instructional video, "Learn To Fly," is yours free when you buy Wingz.

You'll learn about the basic spreadsheet, advanced graphics capabilities and HyperScript™ programmability. And it's absolutely free. But you must hurry. Call now for the location of your nearest Wingz dealer, 1-800-331-1763 ext. 3800. In Kansas, Alaska or Canada, call (913) 492-3800.

United Wares

Current Assets
Accounts receivable
Property held for resale
Developed property
Other current assets

	1985	1986	1987	1988
Current Assets	580.60	211.73	637.61	115.67
Accounts receivable	372.19	245.66	365.33	798.15
Property held for resale	21.47	737.36	443.78	13.62
Developed property	204.43	340.20	973.76	950.67
Other current assets	287.61	533.20	476.00	746.98

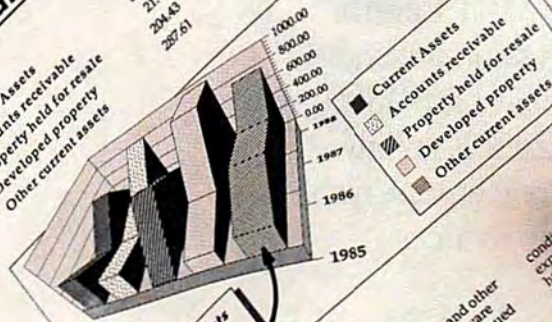

Other current assets include undeveloped properties owned by United Wares.

Asset Restructuring Program

In the fourth quarter, the Company undertook a major restructuring program which resulted in the recognition of a \$6 million pretax gain. This program contains costs associated with excess capacity adjustments, branch rolling stock, terminal and other ware facilities not being completely utilized, excess capacity associated with the Company's Louisiana wood treating plant and its Arkansas sawmill, impairment of carrying values of other non-operating properties and investments and other related costs. Hardware Properties have continued to experience declining levels of sales in a number of regions, with future prospects uncertain. Considering current business capacity and excess capacity of future properties, the Company's energy investments (hardware price and declining demand) reflects current conditions being experienced by the hardware industry as a whole. Although results in a \$43 million reduction in net worth, the program has no immediate impact on cash flow, liquidity, fundamental value or capabilities of the Company. In the longer term the results of the program are expected to enhance future earnings as a result of reduced depreciation expense applicable to excess capacity and also place a basis comparable with other hardware companies who have recently undertaken similar programs.

This program is similar to programs and write-offs announced earlier in 1985 and 1986 by numerous other hardware property companies, and represents a recognition of



THE FIRST GRAPHIC SPREADSHEET

Circle 360 on reader service card

Our new Mac II modem has great inner strength.



From the moment you slip Ven-Tel's new Mac2400E™ internal modem into your Mac II, you'll see that it's quite a bright performer.

Using MNP Level 5 data compression to send and receive at a sharp 4800 bps, the Mac2400E greatly reduces telephone time. Which, of course, nicely reduces telephone bills.

Plus, the Mac2400E supports both X.PC and MNP Level 5 error correction protocols. So you can rest assured that the integrity of your data won't be dimmed.

In the unlikely event the Mac2400E doesn't perform, it's covered by our free, five-year warranty. However, before it comes to that, just call our 800 Help Line. Ven-Tel's technical staff can probably shine a little light on the problem and get you going again quickly.

So don't just put any modem in your Mac II. Go with the one that outshines all the rest.

Ven-Tel
Modems
YOUR FUTURE IS ON THE LINE

For complete details about our new Mac2400E internal modem, call 800-538-5121.

MNP is a trademark of Microcom, Inc.

The Mac2400E is a trademark of Ven-Tel, Inc.

Circle 469 on reader service card

Steven Levy



The Next Best Thing

Advice for Mac owners with CPU envy

On the day after, I found myself in a room with two objects of desire. Black cubes stuffed with unspeakably wondrous digital mojo. Machines that had Silicon Valley squirming with ecstasy. (Maybe the whole country squirming with ecstasy.) These were prototypes of the Next computer, which had been introduced the previous day.

You have heard news of this event perhaps? It was described as a computer Woodstock, though in reality it bore little resemblance to that serendipitous outburst that became cultural history. It was more like the computer industry's version of the ultimate film premiere, the difference being that no one seemed to mind that, save for a few well-crafted scenes, the movie wasn't exhibited. It was like Steven Spielberg renting an opera house in October and *describing* his sequel to *E.T.*, planned for release next summer. And then stepping out of the way so he wouldn't be flattened by the herd of theater operators stampeding to reserve their prints.

Now, after months of speculation, I and some fellow writers were alone with the machines, which, significantly, were not turned on. That was no surprise: after all, there won't be crash-proof versions of the software until well into 1989. Still, the computer was impressive, especially in light of what we had learned about it yesterday: the power of a mainframe in a 12-inch cube. A visual display crisper than Melba toast. More storage than Allied Van Lines. A sound system that will make Dolby look like a piker. All in all, the litany went, this would be the hottest machine in creation, the one the dead would rise up for, the computer that was so cool that the upcoming decade had inked it in as its steady



RON CHAN

date. But we weren't looking at the computers. Journalists all, the seven of us in the room were looking at the door. Because that was where the real story was going to appear. And sure enough, before we could fully savor the aroma of the coffee poured in mugs emblazoned with the \$100,000 Next logo, the story appeared, in the form of a trim, slickly dressed, neatly coiffed 33-year-old who looked like the cat who just swallowed the computer industry.

Guess who.

Heeee's Back

You don't have to guess, do you? You know this man. He was the force behind

the Macintosh. The former chairman of the board at Apple Computer. Known to MBAs as "Mr. Entrepreneur." Known to IBM as "partner" (Big Blue has licensed NextStep, a software-development system; for this privilege they reportedly gave Jobs a \$10 million fee and respectability worth several times that figure). Known to his employees as a cross between Simon Legree, Preston Tucker, and George Gipper, Steve Jobs, blazing onto the comeback trail, on the covers of *Business Week* and *Newsweek*; the visionary behind the Next computer.

(continues)

Steven Levy is a Macworld columnist and the author of The Unicorn's Secret: Murder in the Age of Aquarius (Prentice-Hall, 1988).

SOFTWARE LIBRARY

We **HAVE SLASHED** Our Ad Budget to provide you with every benefit possible. Compare us to all the rest. It's a deal you can't refuse!

Sample List Of **RENTALS**

Best-selling Software

Business Sense 1.01	\$ 70.56
DeskPaint 2.0	18.52
Digital Darkroom	37.53
PowerMath II	24.29
Symantec Utilities	13.97

Sample List Of **SUPER-SAVERS**

Compare!

Fax STF Modem	\$ 565.00
Gemini 030 Accel/ 20 MHZ	1383.60
Proviz Color Video Digitizer	1322.10
Cornerstone sgl. pg. 15"/SE	889.20
Tempo II	79.00

Sample List Of **PERIPHERALS**

Lowest Prices!

Black Ribbons	\$ 3.75
Mac Flip (Holds 80 disks)	14.40
MacOpener (Opens Mac case)	16.75
Sony DS/DD (10 Boxed)	17.50

FREE

- Order Line
- Customer Service
- Shipping-rentals over \$150
- Catalog & the DESKTOP™
- Tech Support (713) 529-1100

\$3 Shipping • Visa & MasterCard

1-800-847-5775

P.O. Box 980305 • Houston, Tx • 77098

- MacTips™
- Specials
- Time-Saving Tricks

(\$5 Value)

Over 800 Mac Products

CALL

For FREE Catalog & the DESKTOP™

Circle 473 on reader service card

Steven Levy

"Well," he asks us, still with that grin. "What do you think?"

There is some ambivalent mumbling from the peanut gallery. After all, as journalists, we have to be, uh, objective, don't we?

We don't. More to the point, we aren't. Though to our credit we did not sink to the bait and bleat out the words that Steve Jobs longed to hear (*Oh Steve your machine is marvelous, Apple is a goner, you've done it again!*), we did just as good—we gave Jobs and the unveiling coverage as if it were the event of the decade. How much of this was due to the man, and not the technology? Just about all of it. It was a rare chance for business reporters to practice gut celebrity journalism, and since the nation at large cares more about celebrity than it does about computers, editors regarded too much coverage of Next as just about the right amount. Steve Jobs was smart enough to go with the flow; indeed, he was canny enough to direct it, so he and his company could get maximum impact from the long-postponed introduction.

Make no mistake about it: the press, and the computer press in particular, wanted Jobs's machine to be a hit. That way, our coverage would be justified, and we'd have the colorful CEO to write about for the next few years. Never before in the computer field has the line between journalism and public relations been so blurred.

But it would be unfair to say that the accolades bestowed upon the Next computer were groundless. On first impression the Next machine looks like a winner. It is a well-conceived computing engine for the 1990s. It also benefits from the same *je ne sais quoi* with which the Macintosh brimmed upon its introduction.

It incorporates several state-of-the-art innovations (most notably a rewritable optical disk drive that cheaply stores enough information to fill a small library), and unveils a daring new architecture centered around a virtual "mainframe-on-two-chips." It includes a development system that allows even novice programmers to dramatically cut the time it takes to create software for the machine. Its audio capabilities enable it not only to synthesize music, but to carry on the practical work of voice-mail and other digital-sound tasks.

At \$8500 for a machine and printer, Next delivers the power and features of technology that costs more than twice that

price. It also *looks* hot, with its hardware stuffed in a black cube that could have been salvaged from a George Lucas film. All this and cursor keys! Is it any wonder that I want one? Because, although I did not reply to Steve Jobs that day, I was thinking exactly what he wanted me to think.

Pain in the Next

But first impressions aren't everything. Now that I've had some time to mull over the Next computer, I think I can safely assure my fellow Macintosh owners that we have no cause to junk our machines anytime soon. Of course, this early reevaluation is largely speculative, since there are no Next computers available for hands-on testing. But I can see several obstacles on the path to Next's goal—to be the "computer of the nineties"—and Jobs, celebrity or not, will have to address them before his company fulfills its considerable potential.

First of all, he will have to figure out some way to deal with the problem of software distribution. Though one of the nicest features of the Next machine is the brand-new optical disk technology, the computer is handicapped by the lack of any other built-in storage medium. No floppy disk, for instance. I suspect that this choice was motivated by "religion," the same Jobs-inspired perfectionism that dictated five years ago just what the Macintosh would and would not have. As a result, the Mac appeared with brand-new 3½-inch disk technology but no external storage, and users got sore wrists swapping disks back and forth. With the Next machine users look forward to the ultimate disk swap: backing up a 256-megabyte optical disk.

Jobs himself suggested ways to get around that problem (users can plug in SCSI storage devices for backup, for instance). But his response was weak when someone asked him how commercial software would be distributed. Those optical disks will cost about \$50 each, and few developers see them as a good medium for distribution. Jobs said that developers could save money by putting documentation on the disk and not printing it. (This suggestion ignores the fact that hard-copy documentation is the best hedge against piracy.) Jobs's other suggestions ranged from "getting programs from the network" (good for shareware, not good for commercial software) to the idea of a Next-

(continues)

Road-test a Buick in your home.

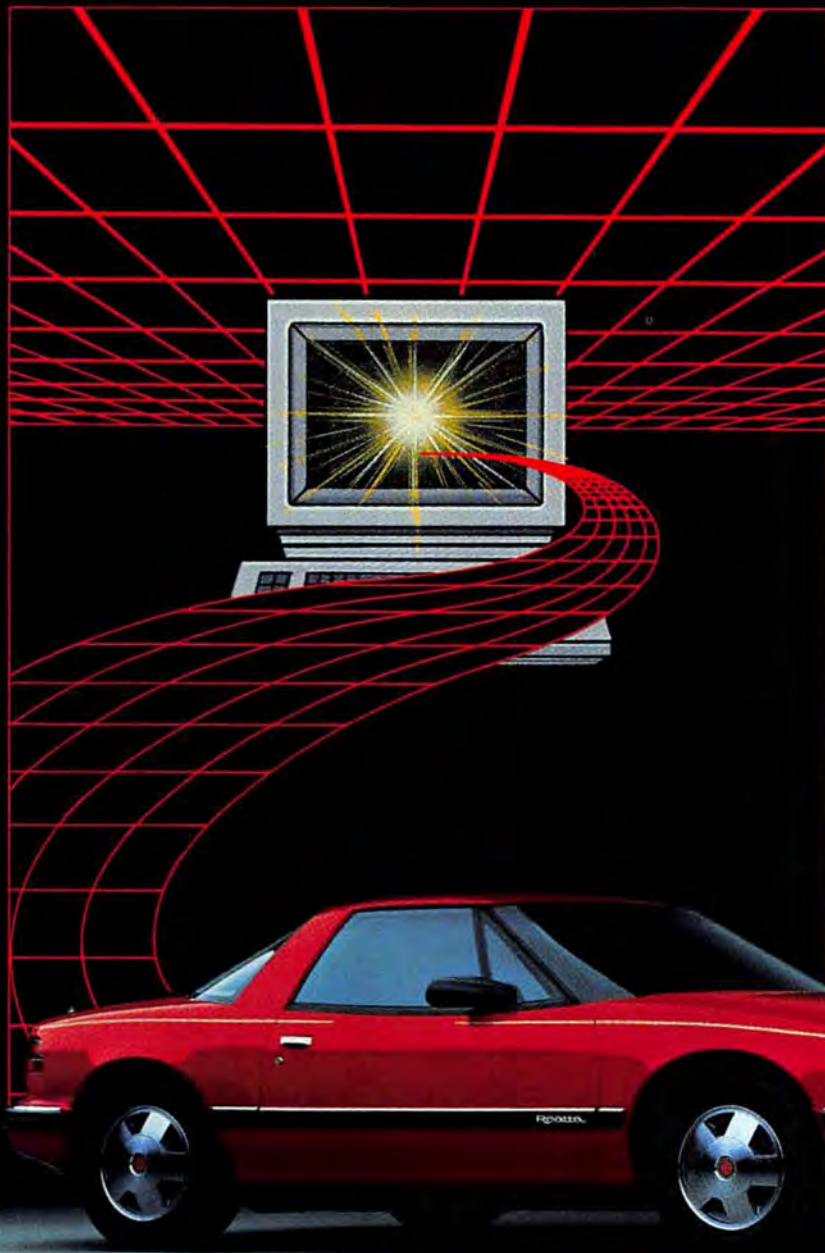

Send for a free Buick disk.

■ If you have a personal computer, you have everything you need to be a smarter Buick shopper. ■ Send for our 1989 Buick Dimensions Disk today. ■ It gives you specifications, standard equipment, option package and pricing information on the 1989 Buicks. ■ And it's all presented with exciting illustrations and animated graphics that let you actually select option packages for the Buick of your choice, make product comparisons, play the Buick challenge trivia game, and do much more. ■ Running this package requires an IBM PC, IBM PS/2, IBM compatible, or Apple Macintosh computer, with 512K RAM. ■ Don't miss the fun and valuable information. ■ Use the coupon below, or write to: Buick Dimensions Distribution Center, c/o Tuar Co., P.O. Box 354, Flint, MI 48501. ■ Please indicate which disk format you have.



The Great American Road belongs to
BUICK

1989 REATTA

Let's get it together... buckle up.

© 1989 GM Corp. All rights reserved.

Yes! Please rush me your free 1989 Buick Dimensions Disk package,
in the following format: () IBM 5-1/4"
() IBM 3-1/2"
() Apple Macintosh 800K

Name: _____

Street Address: _____

City: _____ State: _____ Zip: _____

Apple and Macintosh are registered trademarks of Apple Computer, Inc. IBM is a registered trademark of International Business Machines Corp.



distributed disk loaded with hundreds of intentionally disabled programs that could be activated by getting (for a price) the code that unleashes the program. Developers are not wild about that idea, either. Eventually, Jobs mumbled something about site licensing on campus. Software distribution is an issue that Next must work out more carefully.

The second big problem is the machine's price. It is very low for a powerful workstation, but high for a personal computer. Most college students can get Mac SE-ImageWriter combinations at a third of the cost of the Next line. Jobs points out that since Next technology is brand-new, the component prices are at their peak and will eventually come down considerably. (This statement, though, is at odds with his boasting about the allegedly huge price breaks he has gotten from suppliers.) In any case, the price had better come down, because right now the Next machine is too costly for students.

Jobs concedes this, but says that his initial market will be the universities themselves, and some faculty. But what good is it to put easy-to-program Next boxes in the hands of professors if the courseware they

produce can't run on the students' own computers? It is a huge step backward if Next is proposing a series of computing centers on campuses where students will have to wait in line to use the machines. We've all fought long and hard for the "one person, one machine" concept. Why give it up for multipixel graphics and Shakespeare-online? (I have heard that books are a low-cost and user-friendly medium, ideal for students.) I don't think Jobs wants us to give up the personal computing ideal—he'd prefer a price closer to the \$3000 he originally shot for, but he can't do it now.

Strange-Attractor Processing

Finally, I think that as people get accustomed to what the Next machine can and can't do, Jobs will have to cope with an increasingly vocal "so-what" factor. While the Next technology is truly amazing, until we see conceptual breakthroughs in software applications, the machine really won't do more for most people than a plain old SE will. The Macintosh popularized a revolutionary form of computing clearly visible in every application. The Next machine provides a clear advantage only to those who are attempting the kinds of tasks that a Macintosh can't easily perform.

For instance, I hear that WriteNow's performance on the Next machine is not significantly better than it is on the Mac. Keep in mind that most computer users stick to simple applications like word-processing, spreadsheets, page layout, and databases. When Jobs demonstrated the Next machine, he didn't use any of those programs—he had some wirehead professor from Reed College come onstage and use the Next machine to visually plot the mathematically challenging problem of *strange attractors*. A certain percentage of computer users on campuses will find this useful, but I suspect that, like myself, most folks have relatively little need to plot strange attractors during the course of a day. Nor are we constantly performing the other kinds of simulations that the Next machine seems to specialize in, stuff like rotating pictures of complex molecules.

Right now, Jobs's answer to the practicality question is that the Next machine is directed at a special audience—those involved in higher education, who do have reasons to rotate molecules and explore other esoteric pursuits. But this disclaimer

If you missed MacUser Labs' color

If E-Machines told you the T16™ color Macintosh monitor set the standard to which all others aspire, you'd probably think we were tooting our own horn.

But what would you think if we told you MacUser Labs made the T16 the standard bearer? It's true. Of the 25 color monitors they tested, MacUser Labs scaled their ratings of all the monitors against the best monitor—the T16.

Nearly two Apples for the price of one.

With a T16, you'll have almost twice the working space of Apple's 13" monitor. Yet your color display won't cost any more than your Macintosh II.

As our top-ranked monitor, the T16 wins the MacUser Labs Seal of Approval.

Its (T16) impressive gray purity and color saturation provide excellent image quality for both color and shading. It has a pleasing white screen and the sharpest image of all the large-screen monitors we tested. In short, it makes no compromises. The T16 is an excellent choice for CAD/CAM or color graphics work.

This is the value you've been demanding. Actual size 72 dpi, with a palette of 16.7 million brilliant colors on a Sony Trinitron modified to E-Machines' exacting specs.

You can put a little color in the cheeks of your company president next time you produce the newsletter. Or use color to distinguish multiple layers and objects in CAD drawings. Or create charts to transform complex numbers into easily understood color graphs.

Whatever you do on your Macintosh, you'll do it more productively with a T16.

seems coy. After all, at the introduction Jobs proudly showed slides illustrating the Next machine ascending to operating system supremacy in the entire computer world around 1992—thus accepting the baton from the Mac operating system, which, Jobs opined, would peak in 1989 and then begin its decline. (He says he already has noted “cracks in the Mac operating system,” presumably cracks that will widen to chasms by the time the Next machine is ready for mass production.)

Is this admittedly self-serving prediction credible? If and only if software developers—big companies, not just the elbow-patch crowd Jobs is currently wooing—come up with as-yet-undreamed-of ways to exploit the terrific powers of the Next machine. The big danger for Jobs is that his competitors, notably Apple, might well incorporate many of his innovations into its future offerings and win the customers that Next is aiming for. In that case, the Next machine will have benefited all of us by raising the technological ante—while failing in the marketplace.

The rosy scenario, though, is that the talented Jobs will once again have the benefit of luck on his side—as he did with the

Macintosh. At one point in the Mac's life cycle it appeared that innovation would not be enough, and the machine needed some outside boosts to become successful. If similar, unforeseen boosts aid the Next machine, Steve Jobs will have done it again, and those magazine cover stories will seem prescient.

Election, What Election?

A final anecdote about the well-documented Mr. Jobs. At the end of our conversation that day, someone mentioned that Steve's duties at this day-after-the-intro session were akin to a *spin doctor's*. This term—referring to someone who puts the most positive face on events—had become well known during the presidential election campaign, then nearing a climax. But Jobs was totally unfamiliar with the term. It seems that his dedication to bringing his computer to market had been so complete that he totally missed the gist of the Dukakis-Bush battle. Knowing that both candidates had made certain promises concerning higher education—the federal

funding of which would be relevant to Next, which hopes to sell computers in droves to colleges—I asked Jobs which candidate would better help his company if elected. He didn't have the slightest idea.

Once again, Jobs had zipped himself and his team into a cocoon where developing ground-breaking technology was the obsessive function. Though that degree of solipsism can be dangerous, it can also break a team from the bounds of conventional thinking. Great things can emerge. This is what has happened with the Next machine, and it has already had a beneficial effect on the industry. I can now go back to my Macintosh knowing that future versions of the Mac will be better than they would have been otherwise—because Apple *has* to respond to the Next machine.

No one is happier with the way things unfolded than Steve Jobs, who ended our meeting with many questions yet unanswered. But we do have answers to at least two big questions.

Is the Next machine great? Looks that way. What should Mac owners do? Unless you're into the scientific simulations and such, go back to your MultiFinders. And check out Next in 1992 or so. □

report, here's a condensed version.

As with other E-Machines models, the T19 screen image is very sharp and has excellent color quality and gray purity. Image quality is comparable to the T16, and for those who want a larger screen, the T19 is the way to go. E-Machines has once again produced a winner in the color monitor market.

**72 hertz
eliminates
flflflflicker.**

Try starting into a 19-inch monitor with a 60 hertz refresh rate for an 8-hour day. You'll be watching a constantly throbbing screen, and your eyes will feel like they put in a 24-hour day. Not exactly conducive to getting things done. The T19 has the fastest available refresh rate of 72 Hz. Now that's refreshing.

Even more refreshing, the T16 and T19 are the only color monitors certified to comply with ANSI Human Factors Specification 100.

**We'd like
to color your
thinking.**

Of course we would—but you should decide for yourself if the T16 and T19 are as good as MacUser thinks. Go see one and conduct your own review. For details, write E-Machines at 9305 SW Gemini Drive, Beaverton, OR 97005 or call us direct for your nearest dealer: 1-503-646-6699.



E-MACHINES

We make room for your ideas.

Circle 101 on reader service card

©1988, E-Machines.

Macintosh, Macintosh II are trademarks of Apple Computer.

*InnerDrive 100 II
For Mac II
Was \$1199, now \$999*

*InnerDrive 100/SE
For Mac SE
Was \$1349, now \$999*

*DirectDrive 100
For Mac Plus, SE and Mac II
Was \$1249, now \$1099*



*BackPac 100
For Mac Plus and SE
Was \$1479, now \$1199*

We've taken the bite out of moving up to a 100 megabyte hard disk drive.

It's never been more
affordable to drive safely.

If you thought you'd have to settle
for less storage and power than you
really want or need, surprise! We've
cut our already low prices on 100
megabyte hard disk drives.

This means you can save an
additional \$150 to \$350 on the most
reliable, most talked about, most
desireable 100 megabyte hard disk
drives in the industry.

And, yes, we've included the rev-
olutionary BackPac 100 that can turn
a Plus or an SE into a take-along
powerhouse!

More bytes for your
buck than ever.

Whether your Mac is a Plus, SE or II,
Jasmine's 100 MB hard disk drives are
loaded with power and performance
that's just right for you. And are now
more affordable than ever.

DirectDrive 100

For Mac Plus, SE and Mac II
Was \$1249, now \$1099

InnerDrive 100/SE

For Mac SE
Was \$1349, now \$999

InnerDrive 100/II

For Mac II
Was \$1199, now \$999

BackPac 100

For Mac Plus and SE
Was \$1479, now \$1199

Every Jasmine 100 megabyte hard
disk drive comes to your door loaded
with these extras:

DriveWare™ true SCSI
partitioning, password protection,
AUX support, and exclusive control
panel access.

**Symantec™ Utilities for
Macintosh** insure against data loss
and keep the hard disk operating at
optimum level.

Redux™ from Microseeds.
Arguably the best backup software
ever written for the Mac.

DEScriptor™ our proprietary

encryption utility that follows the
federal government's super-secure
Data Encryption Standard.

DemoWare™ A collection of
demonstration versions of some of the
most popular programs available.

Worldwide doorstep delivery
is just a phone call away.

It's easy to order a Jasmine 100 mega-
byte hard disk drive.

Our knowledgeable sales staff is
on duty Monday through Friday from
8am to 6pm (Pacific Standard Time).

We welcome your MasterCard,
Visa, and American Express.

Dial 1-800-347-3228 in the U.S.,
415-282-1111 worldwide.



*We've taken the bite out of
buying hard disk drives.*

1740 Army Street San Francisco, California 94124 415-282-1111 FAX: 415-648-1625

©1988 Jasmine Technologies, Inc. DirectDrive, InnerDrive, DriveWare, DEScriptor, DemoWare, BackPac are trademarks of Jasmine Technologies, Inc. Macintosh is a registered trademark of Apple Computer, Inc. Symantec™ Utilities for Macintosh is a trademark of Symantec Corp. Redux is a trademark of Microseeds.

Circle 457 on reader service card

Win a Macintosh SE, a Jasmine DirectDrive 45, or a National Semiconductor memory upgrade

SuperStacks!

The second

annual

HyperCard

application

contest

sponsored by

Apple Computer,

Bantam Books,

and Macworld

Send us your best stackware by **March 15, 1989**. We'll award prizes to the most outstanding HyperCard applications and describe the winning SuperStacks in a feature article in the November 1989 issue of *Macworld*. Judging criteria will include creative and appropriate use of HyperCard, interface design (including use of graphics and sound), programming elegance, and success in meeting the goal of the program for the intended audience. We reserve the right to change an entry's category, if appropriate. Judges may elect not to make an award in each category.

Categories

COMMERCIAL Stacks distributed for a fee.

CUSTOM Stacks custom-made for a business, government agency, or non-profit organization.

EDUCATIONAL Curriculum, teacher-training, and teacher/administrator productivity materials, as well as training or self-instruction stacks for the general public.

NONCOMMERCIAL HyperCard applications available through noncommercial channels (shareware, freeware), plus stacks designed for personal use and not distributed at all.

How to Enter

Entries are due in our office on **March 15, 1989**. No more than two (2) entries per contestant. Each entry must include disks (clearly labeled with the stack name, your name, address, and phone numbers); documentation (if necessary); a \$5 entry fee; and a *one-page* summary headed with the stack name, contest category (commercial, noncommercial, educational, or custom), and K-count, as well as your name, address, and phone numbers. In

the summary, state the purpose and intended audience of your entry and note if it requires any special hardware (CD ROM drive, for example). Mention the list price or suggested shareware fee and explain how the stack is being distributed. You may also mention any special features you want to call to the attention of the judges.

Sorry, disks will not be returned. Employees of the sponsors are not eligible to enter.

Winning stacks from the 1988 SuperStacks contest are not eligible. Make your check or money order payable to PCW Communications. Send entries to SuperStacks, *Macworld*, 501 Second St., San Francisco, CA 94107; Attn.: Macworld Editorial.

Plus, a special award of a 4MB memory upgrade from National Semiconductor for best HyperCard interface design, best HyperCard multimedia application, best HyperCard development tool, and best stack available for under \$20.

FIRST PRIZE IN EACH CATEGORY: MACINTOSH SE

RUNNERS-UP PRIZE: JASMINE DIRECTDRIVE 45

SHARP COOKIE.

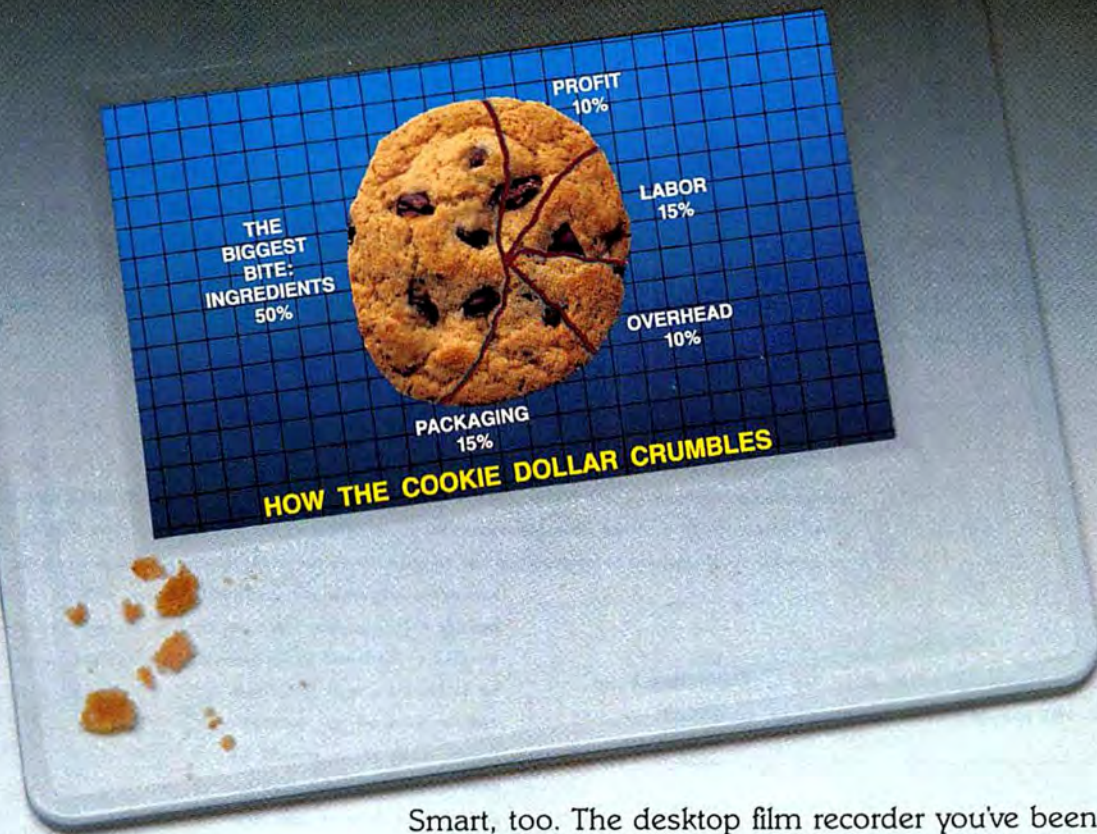

Smart, too. The desktop film recorder you've been waiting for. ProColor.[®] From Matrix.

Super-sharp, artist-quality graphics on 35mm slides or Polaroid[®] instant prints.

Millions of colors. For the most stunning presentations you've ever seen ... or shown.

Compatibility? Total. **1-800-852-8533**

In NY: 1-914-365-0190

Mac II. IBM[®] PC. Popular graphics software. Plus every Matrix film recorder, thermal printer and presentation system. And if you've been printing on a laser printer or a plotter, you can output to a ProColor just as easily.

All for about six grand.

How do we do it? Easily. We've been at it a long time. Ask anyone who uses our recorders. Such as Allstate. AT&T. Lotus Development Corp. And GM.

They're pretty smart cookies themselves. Guess it takes one to know one.

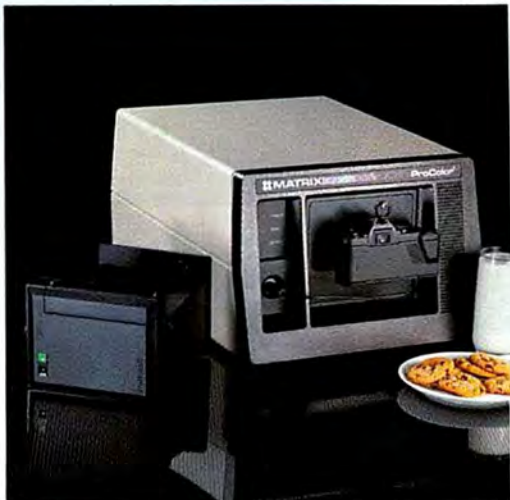

WHEN YOUR IMAGE IS ON THE LINE.

MATRIX

Circle 460 on reader service card

Win a Mac II, a Truevision 32-bit color board, or a Tektronix color printer!

Macintosh Masters II Art Contest



Categories

Fine Arts
Illustration
Graphic Design
Animation/Video
Technical Illustration
3-D/Image Synthesis
Architectural Rendering/Elevations
Business/Informational Graphics
Wild Card*

*Projects that don't fit into any of the other categories. Try us.

Prizes

Three grand-prize winners will take away a Macintosh II, a 32-bit NuVista color capture and display board, or a Tektronix color image printer. Winners in each contest category will choose one product from a selection of top programs, including Adobe Illustrator, Aldus FreeHand, PageMaker 3.0, ImageStudio, ReadySetGo, VideoWorks II, PowerPoint, SuperPaint, Digital Darkroom, and PixelPaint Professional. In addition, winners' work will be published in a *Macworld* feature article and in our 1990 graphics calendar. Grand-prize winners will also receive an expenses-paid trip to Macworld Expo Boston to claim their prizes.

Rules

Entries must be received no later than March 10, 1989, and must be accompanied by an entry form. Please send hard and disk copies of each piece (disks may be omitted when pieces run



however, originals are preferable; these will be returned if you include return postage and packaging. Animated entries may be on disk or half-inch videotape, as appropriate. Since work will be judged on technical innovation as well as aesthetic value, each piece should be accompanied by a detailed description of how it was produced. Please submit no more than four works (include an entry form for each). *Macworld* reserves the right to reproduce winning entries.



however, originals are preferable; these will be returned if you include return postage and packaging. Animated entries may be on disk or half-inch videotape, as appropriate. Since work will be judged on technical innovation as well as aesthetic value, each piece should be accompanied by a detailed description of how it was produced. Please submit no more than four works (include an entry form for each). *Macworld* reserves the right to reproduce winning entries.

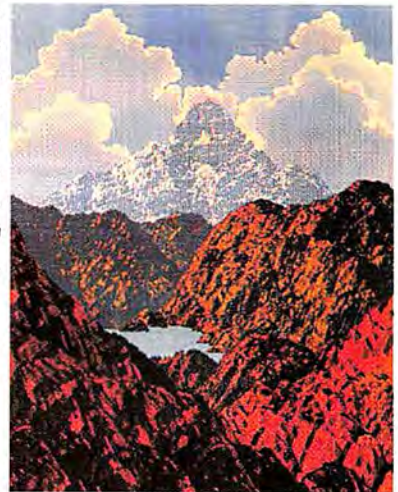

[art credits]

Dick Hodges (vessel), Concept-Exclusif (brochure),
Brian E. Pinz (dog), David C. Dickinson (mountain),
Gunter Dunze-Wolff (camera)

Entry Form

Send one entry form with each submission to Macintosh Masters, *Macworld*, 501 Second Street, San Francisco, CA 94107.

Name _____

Phone #(s) _____

Address _____

Title of work _____

Contest category _____

Submission format(s):

On disk Hard copy Slide VHS video Beta video

Required to view disk copy:

Software _____

Hardware _____

All submissions must be received by March 10, 1989

MACROMIND

Letraset

ADOBE

TRUEVISION

Microsoft

SUPERMAC

Tektronix



Fast Forms™

Paperwork Without The Work.

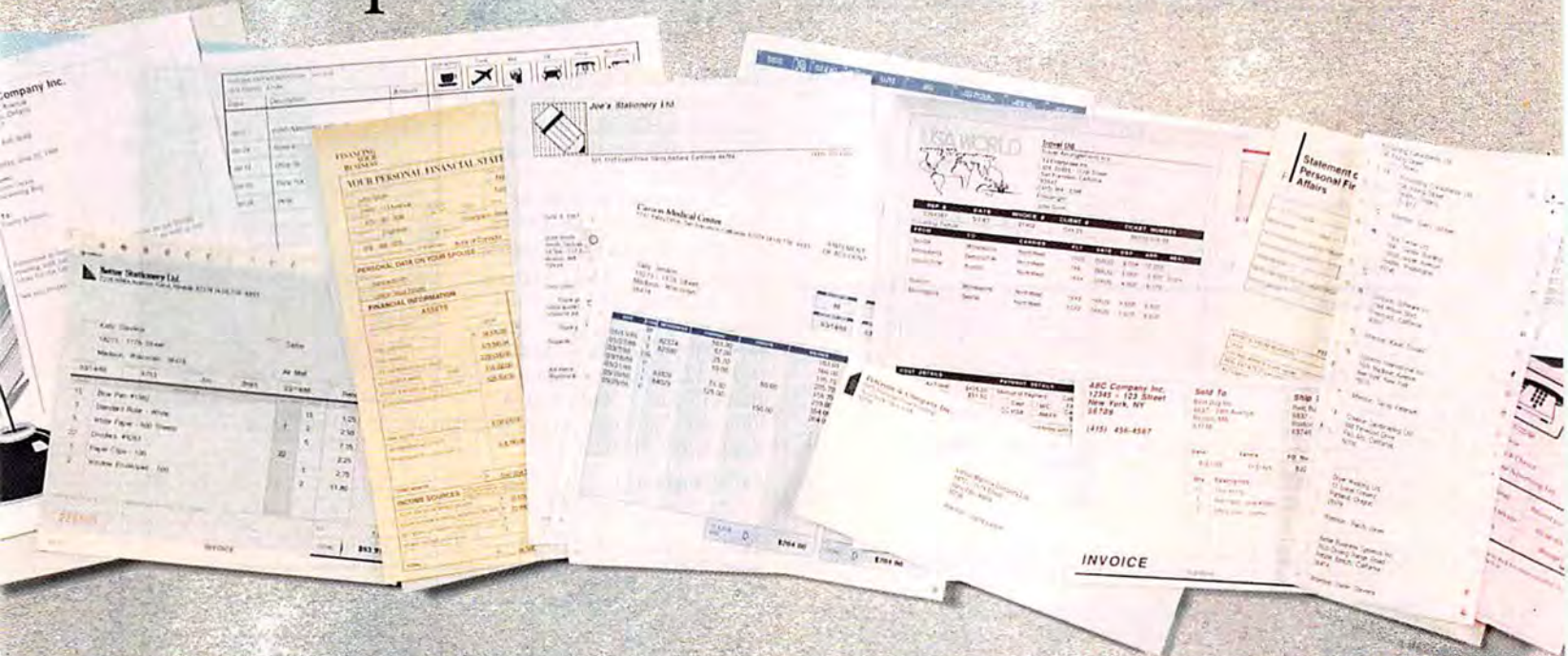

When presenting business information, it is important to portray a professional and consistent image. Business forms are no exception.

Fast Forms gives you the **power and freedom** to create, customize, and use professional forms on your Apple® Macintosh® computer.

You can use Fast Forms for tasks ranging from simple office memos to order forms, packing slips, complex invoices or even annual tax forms.

All with the flexibility to match the look of your most familiar forms.

And once you've drawn or scanned your forms, use the **Fast Forms desk accessory** (also included) to fill in and print while using any other program.

At last you can quickly address an envelope or print an invoice without interrupting your more important work.

Design features such as gray screens, hairlines, variable type sizes, text editing, customizable grids, and printing and

non-printing drawing planes have made Fast Forms the drawing program of choice by **thousands of users.**



pen / fill patterns

Place **data entry fields** on your form where information is filled in. Fast Forms will format fields and even perform **calculations** for you automatically.

Since version 1.2 now supports both **import and export**, Fast Forms works even better with your other Macintosh programs.

Now you can import information from your database to fill in and print any form, or export information while using Fast Forms as an effective data entry tool.

For offices with more than one Macintosh, additional desk accessories can be purchased separately.

And yes, for those of you who want some help getting started, Fast Forms still comes with a **free template disk** filled with forms ready to use.

Since Fast Forms is still **only \$149**, you're guaranteed great value for your money.



filling out a form

Plus, if you buy Fast Forms today, we'll refund your money tomorrow (early 1989) when you purchase **INFORM™**, the next generation of forms management solutions.

For more information on Fast Forms, please call or write:

Shana Corporation

Advanced Technology Center
105, 9650 - 20 Avenue
Edmonton, Alberta Canada T6N 1G1

(403) 463 - 3330



drawing a form

Programs & Peripherals

Networking Software & Hardware

CE Software Quick Mail	165.	Shiva NetModem V1200	359.
Farrallon PhoneNET AppleTalk	9.	NetModem V2400	479.
PhoneNET Din 8 or DB9	35.	SuperMac Software Acknowledge	349.
Timbuktu	65.	Multi-User SuperLaserSpool	199.
TrafficWatch	149.	Symantec InBox-MacConnection	75.
Infosphere		InBox-Starter Kit V2.0	
MacServe (Network Software)	155.	(3 Personal Connections)	199.
LaCie Silverserver	92.	TOPS	
Microsoft		Tops 2.0, Tops Dos or Net Print	119.
Microsoft Mail 1-4 users	195.	Tops Repeater or Flashbox	129.
Olduvai Software Clip Share	109.	Tops FlashCard	169.
Font Sharer	149.	Tops Teleconnector Din8 or DB9	39.

Desk Accessory Programs

Affinity Microsystems Tempo II	89.	Imagine Software	
AffiniFile	46.	Smart Alarms & Appointment Diary	35.
Beyond Inc. Menu Fonts 2	30.	Mainstay	
Borland SideKick V2.0	65.	Think'n Time	61.
Cassady & Greene, Inc.		Olduvai Software	
HyperDialer	26.	DA Switcher	25.
QuickDex 1.4A	32.	Solutions, International	
CE Software DiskTop 3.0	27.	Super Glue	52.
Deneba Software		SmartScrap & The Clipper V2.0	46.
Comment 2.0	54.	Symmetry	
Electronic Arts Disk Tools Plus	31.	HyperDA (Req. 512K)	38.
Exodus Software Retriever	59.	TENpointO OpenIt!	59.

MAC-101 Keyboard by DataDesk



If you are looking to replace your Mac's keyboard, the **MAC-101** by DataDesk is the way to go. It comes in an ADB version for the Mac SE and II, and a non-ADB version for the Mac 512 and MacPlus. The positive tactile, firm feel 101 includes a full numeric keypad, 15 function keys, 6 page control keys, and a T-style cursor pad.

Keyboard status indicator lights let you know when everything is going smoothly. Includes **101-Keys** desk accessory software, a powerful macro utility which allows you to exploit the full power of the function keys with almost any Macintosh application.

MAC-101 Keyboard (Specify ADB or non-ADB)..... 145.

Communications Software

Compuserve		Insigna SoftPC	479.
Compuserve Starter Kit	24.	Software Ventures	
Grolier On Line Encyclopedia	32.	Microphone II (Includes Glue)	225.
Compuserve Navigator	45.	Solutions, International	
DataViz MacLink Plus with Cable	145.	BackFax	129.
Dow Jones		Synergy Software	
Desktop Express	95.	VersaTerm	69.
FreeSoft Red Ryder V10.3	54.	VersaTerm-Pro	195.
Hayes Smartcom II 3.0	88.	Traveling Software LAP-LINK	84.

Word Processors & Desktop Publishing

Access Technology Mind Write 2.0	95.	Microsoft Microsoft Word 4.0	255.
Mind Write Express	149.	Postcraft International, Inc.	
Allan Bonadio Associates		Laser Fx Font Packs 1-6 ea.	29.
Expressionist 2.0	79.	Laser Fx	114.
Aldus Corporation		Quark, Inc. QuarkXPress V2.0	499.
PageMaker 3.0	399.	Silicon Beach Software	
Ashton Tale		Silicon Press	41.
FullWrite Professional	269.	Symantec More II	Call
Broderbund DTP Advisor	47.	Symmetry Acta V2.0	46.
Caere Omnipage	569.	Acta Advantage	69.
Claris MacWrite 5.0	105.	T/Maker Company	
Letraset		WriteNow V2.0	109.
Ready, Set, Go! 4.5	279.	Word Perfect Corporation	
Letra Studio	369.	Word Perfect	185.
LetraFonts (Various Vol. 1-45 ea.)	69.	Working Software QuickLetter	79.

MacKids Educational Programs by Nordic Software

MacKids is a complete series of twelve quality educational software products for the Mac specifically designed to teach and entertain kids. Whether your children are preschoolers or young adults, there's a **MacKids** package that will give them the learning edge.

Preschool Disk 1 (3-7), Preschool Disk 2 (3-7), CoinWorks (4-12), ClockWorks (4-10), Early Elementary I (6-9), Lemonade Stand (6-16), FlashWorks (6-adult), Naval Battle (6-adult), Word Search (6-adult), Alphabetizer (7-adult), EarthWorks (10-adult), or BodyWorks (10-adult).

Each Program 28.



Spelling & Grammar Checkers

Aegis Development		Electronic Arts Thunder! 1.23	30.
Doug Clapp's Word Tools 2nd Edition	42.	Lundeen & Associates WorksPlus Spell 1.1	46.
A.L.P. Systems MacProof 3.0	115.	Microlytics, Inc.	
Deneba Software Spelling Coach 3.0		Word Finder (Synonym Finder)	33.
(Webster's/Medical/Legal/Hyphenation)	54.	Sensible Software Sensible Grammar	54.
Coach Merriam Webster's Thesaurus 2.0	35.	Working Software Spellswell 2.0	45.
Spelling Coach 3.0 Professional	105.	Lookup (Makes Spelling Suggestions)	30.

Accounting Packages

Aatrix Software Aatrix TimeMinder	109.	Insight Expert GL, AR, or AP	455.
Aatrix Payroll Plus	159.	MECA Managing Your Money	128.
Bedford Software Simply Accounting	219.	Monogram Business Sense	279.
Chang Labs		Dollars & Sense 4.0	81.
New Enhanced Version III Modules!		North Edge Software Timeslips III	117.
Rags to Riches Gen. 3-Pak		Peachtree Back To Basics Professional	
(GL/AR/AP)	289.	(GL/AR/AP/INV)	159.
Rags to Riches GL, AR, or AP	120.	Softview Taxview Planner	65.
Dac Software Dac-Easy Light	45.	California or New York Supplements	39.
Intuit Quickken		MacinTax Federal	69.
Layered Insight One Write	185.	Survivor Software MacMoney 3.0 (En. Ver.)	62.

Macinware SE Ext. Carrying Case by I/O Design

The **Macinware SE Ext. Carrying Case** protects your Mac SE, Plus, or 512K and its extended keyboard in safety and style. It's made of rugged 1000 Denier Dupont Cordura nylon, and surrounds your machine with a full half-inch of high-density foam padding. There's room for an external hard drive, a mouse, cords, and disks, so your complete system travels with you in one compact unit. All stress points are cross-box stitched for added safety. A convenient shoulder strap is included, and you can choose platinum grey or navy blue colors.

SE Carrying Case 75.



Visit us in the **Electronic Mall™** on Compuserve - GO PP

to Polish Up Your Mac

Game Software

Access World Class Leader Board Golf	34.	Microsoft Flight Simulator 1.02	32.
Accolade Hard Ball or Mean 18 4th & Inches	23.	Micro Sports MSFL Pro Draft	26.
Activision Shanghai or Jinxter	24.	MSFL Pro League Football or 500 Great Teams	32.
Corruption	27.	Miles Computing Inc. Down Hill Racer	24.
Universal Military Simulator or Manhole	30.	Harrier Strike Mission II	
Might and Magic	36.	or The Fool's Errand	27.
Sky Travel	45.	Mindscape Balance of Power 1990, Crossword Magic or Citadel	30.
Artworx Bridge 5.0	22.	Deja Vu: A Nightmare Comes True	30.
Avalon Hill Mac Pro Football	28.	King Of Chicago, Shadowgate or Joker Poker	30.
Broderbund Ancient Art of War or At Sea	27.	Defender of the Crown, Colony or The Uninvited	30.
ShufflePuck Cafe or Ultima III	24.	Practical Computer Applications MacGolf or Lunar Rescue	35.
Poster Maker Plus	36.	MacCourses	32.
Bullseye Software		Road Racer	41.
P51 Mustang or Ferrari Grand Prix	32.	Mac Golf Classics	54.
Cassidy & Greene, Inc. Crystal Quest	26.	Primer Smash Hit Racquetball II	21.
Crystal Quest w/ Critter Editor	42.	Sierra On-Line Leisure Suit Larry	23.
Centron Crapsmaster,		Space Quest or Space Quest II	29.
Roulettemaster or BlackJack Ace	27.	Police Quest	29.
Discovery Software Arknoid	27.	Silicon Beach Software	
Electronic Arts ChessMaster 2000	28.	Dark Castle or Apache Strike	27.
Chuck Yeager Flight Simulator or Life & Death	32.	Beyond Dark Castle	27.
Starfleet I	37.	Sir-Tech Mac Wizardry	35.
Scrabble	26.	SoftStream, Inc. Colour Billiards	35.
One-On-One, Pinball Construction Set, Seven Cities of Gold, SkyFox, or Patton vs Rommel	15.	Mac Man or Solitaire DA	24.
EPYX Sub Battle Simulator (Mac or MacII)	29.	Sphere, Inc. Tetris	20.
Hayden Software Sargon IV	29.	GATO, Orbiter or PI-109	26.
Infinity Software, LTD.		Solitaire Royale (Mac or MacII)	20.
Go or GrandSlam Tennis	27.	Falcon 2.0	32.
Infocom Leather Goddesses of Phobos or Hitchhiker's Guide	15.	Studio Zero Orbital Mech	29.
Beyond Zork, Zork Trilogy or QuaterStaff	30.	XOR Software NFL Challenge	29.
Zork Zero	36.	Pro Challenge or Basketball Challenge	29.

Specials good through
March 31, 1989.



Now Shipping
Standard Air by



Customer Service (203) 378-3662 • FAX (203) 381-9043
Monday thru Friday 9 A.M. to 9 P.M.
Saturdays 10 A.M. to 6 P.M. (Eastern Time)

OUR POLICIES

- We accept MASTERCARD and VISA with no added surcharge.
- Your credit card is not charged until we ship.
- If we must ship a partial order the shipment that completes the order is sent freight free.
- If you are ordering by mail, we accept private and company checks. With MASTERCARD and VISA orders include card number and expiration date. Connecticut residents add 7.5% sales tax.
- Locations more than 1 day away shipped via Federal Express Standard Air service.
- Federal Express Priority 1 service also available.
- Sorry, we cannot accept COD orders.

SHIPPING

- **Continental United States:** Add \$3.00 per order to cover Federal Express Standard Air service. APO/FPO orders shipped 1st Class Mail (add 3% \$5.00 Min charge). Alaska, Hawaii and Outside Continental US: call or write for information.

RETURNS

- Defective software will be replaced immediately by the same item. Defective hardware will be replaced or repaired at our own discretion. Call customer service at (203) 378-3662 to obtain a Return Authorization Number before returning goods for replacement. Products purchased in error subject to a 20% restocking fee.

All items subject to availability. Prices subject to change without notice.

Mail-in orders (especially from foreign countries), please furnish telephone number.

SuperSpool, SuperLaserSpool, DiskFit & Sentinel by SuperMac Software



Sooner or later you'll find that you have to spool-up, back-up or lock-up your data and it's a safe bet that *SuperMac* has just the programs you'll be looking for. *SuperSpool* and *SuperLaserSpool* return control of your Mac to YOU while your printer is busy printing. *DiskFit* is a utility that let's you quickly backup your hard disk to floppies keeping your data protected from electronic tribulations. And, *Sentinel* allows you to lock up your private documents

by encrypting the data, keeping it safe from prying eyes!

SuperSpool 5.0	54.
SuperLaserSpool 2.0	82.
Diskfit 1.4	54.
Sentinel 2.0	155.

Modems

Abaton InterFax 12/48	329.	Practical Peripherals	
Anchor Automation		Practical Modem Mini 1200SA	79.
MacPac 2400E w/software & cable	179.	Practical Modem 1200SA	109.
Epic		Practical Modem 2400SA	181.
Epic 2400 Int SE	315.	MacCommpack	
Epic 2400 Int Mac II	315.	(2400SA w/Microphone II & Cable)	229.
Epic 2400 Mini Ext		Prometheus	
(Hayes Compatible)	179.	Promodem 2400M Ext.	
Everex Emac 2400 Baud	225.	(Software & Cable)	199.
Hayes Microcomputing		Promodem 2400	
Smartmodem 1200	299.	(Hayes Compatible)	255.
Smartmodem 2400	449.	Supra Corporation Supra Modem 2400	149.
MDIdeas Commlink 2400	189.	U.S. Robotics	
Migent		Courier 1200 (Hayes Compatible)	199.
Migent Pocket Modem		Courier 2400 (Hayes Compatible)	349.
(ext. 300/1200 Baud)	115.	Courier 2400E (Hayes Compatible)	379.
Novation Novation Parrot 1200	109.	Courier HST 9600 (Hayes Compatible)	689.

Positively A Plus

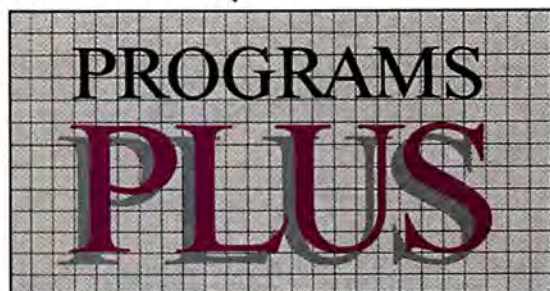

75 Research Drive,
Stratford, CT 06497

800/832-3201

Circle 44 on reader service card

... Positively A Plus!

Utility Software

ALSoft Disk Express	35.	Olduvai Software	
Font/DA Juggler Plus		Icon-It! or MultiClip	39.
Berkeley System Design		Read-It! TS (For Thunderscan)	79.
Stepping Out II	Special 52.	Read-It! O.C.R. 2.0 (For Image Scanners)	199.
CE Software		PCPC HFS Back-Up 3.0	54.
QuickKeys (Macro Program)	53.	Softworks	
Central Point Software Copy II Mac		Stack Cleaner	29.
(Includes MacTools)	20.	HyperTools 1 or 2	59.
PC Tools Deluxe Mac	45.	SuperMac Software	
Emerald City Software LaserTalk	187.	SuperSpool 5.0	Special 54.
Fifth Generation Systems Suitcase II	44.	SuperLaserSpool 2.0	Special 82.
FastBack For The Macintosh	54.	Diskfit 1.4	Special 54.
Power Station	32.	Sentinel 2.0	Special 155.
HJC Virex	69.	Symantec MacSOZ!	49.
Icom Simulations On Cue	36.	Symantec Utilities for Mac (S.U.M.)	59.
TMON	89.	Williams & Macias	
Infosphere Liaison	179.	myDiskLabeler w/Color	31.
Microlytics, Inc. G.Ofer	44.	myDiskLabeler w/LaserWriter Option	34.
Microseeds Redux	65.	Working Software	
ScreenGems	49.	Findswell 2.0 (Document Finder)	36.

Printers & Digitizers

Digital Vision		Seikosa	
Computer Eyes-Mac	209.	SP1000 (Imagewriter Comp.)	235.
Koala Technologies Corp.		Summagraphics Bit Pad Plus	329.
MacVision 2.0 (Digitizer)	219.	ThunderWare	
Kurta IS ADB Tablet	255.	ThunderScan V4.0 with Power Port	199.
Cordless 4 Button Cursor	95.	Mac II Power Accessory	42.

Stepping Out II by Berkeley System Design, Inc.



Stepping Out II is a program designed to expand the capabilities of any standard Macintosh display to give it the same feel and features as a full page display. Now you can choose the screen size which is most comfortable for you. Working with large spreadsheets and full page layouts becomes easy since you are no longer limited by small windows and slow scrolling. For detail work on small areas you can enlarge any portion of the big screen up to sixteen times. Handy features and ease

of use makes *Stepping Out II* the ultimate viewing tool for any Mac.

Disk Drives/Hard Disks/Upgrades

Applied Engineering MacRAMS (1 MB SIMMS Mac+, SE, II)	489.	MacSnap 548S (512E to 2MB w/SCSI)	599.
AST Research		MacSnap Plus 2 (MacPlus to 2MB Non Expandable)	439.
Mac286 Co-Processor (Mac II)	Call	MacSnap 2SE or 1024 Option (1MB or MacII Memory Exp.)	439.
CMS		SCSI Interface/Port	109.
Compact Series SC30 (Mac+/SE/II)	649.	MacSnap Toolkit (torx driver, opener & grounding set)	15.
Compact Series SC45 (Mac+/SE/II)	859.	Everex	
SD Series MacStack SD20 (Mac+/SE/II)	569.	Emac 20D (20Mg Hard Disk)	520.
SD Series MacStack SD60 (Mac+/SE/II)	849.	Emac 20 Deluxe	585.
Cutting Edge		Personal Computer Peripherals	
Cutting Edge 800k Drive	Special 175.	Beige or Platinum Color. Optional Built-In Modems Available.	
Cutting Edge Wedge XL 30 Plus SCSI Hard Drive	629.	MacBottom HD-21 (20+MB SCSI Hard Disk)	659.
Cutting Edge Wedge XL 45 Plus SCSI Hard Drive	829.	MacBottom HD-32 (32MB SCSI HD)	699.
Cutting Edge XL 30 Internal Hard Drive	505.	MacBottom HD-45 (45MB SCSI HD)	859.
Cutting Edge XL 45 Internal Hard Drive	645.	MacBottom HD-70 (70MB SCSI Hard Disk) Plat only	999.
Dove Computer Corporation		Rodime Rodime 20 Plus Ext.	629.
Marathon 020 Accelerator		Rodime 45 Plus (Ext. 45MB SCSI)	939.
MSE 1 (16 Mhz)	585.	Rodime 450RX (Int. 45MB Mac SE/II)	829.
MSE 2 (16 Mhz w/1MB)	979.	Rodime 100 Plus (Ext. 100MB SCSI)	1169.
MSE 3 (16 Mhz w/Math Co-processor)	779.	Rodime 140 Plus (Ext. 140MB SCSI)	1319.
MSE 4 (16 Mhz w/1MB & Math Chip)	1159.	Rodime 1000 RX (Int. 100MB MacII)	1045.
MacSnap 524 (512K to 1MB)	315.	Video Technology	
MacSnap 524E (512E to 1MB)	289.	Laser 800k External Drive	185.
MacSnap 524S (512E to 1MB w/SCSI)	379.		
MacSnap 548 (512K to 2MB)	459.		
MacSnap 548E (512E to 2MB)	549.		

Quicken by Intuit

Quicken is the fastest, easiest way to cut through personal and small business paper work. In minutes you'll get a handle on your finances without having to bother with any of the burdensome terminology and repetitive entry that most accounting packages require. *Quicken* is flexible; it lets you enter an unlimited number of transactions, expense and income categories, and checking accounts. *Quicken* lets you write checks, make and track budgets, manage cash flow, and even reconcile unbalanced accounts. Now *Quicken* links directly with MacinTax to save you even more time at tax time!



Quicken 33.

DataBase Management

Acius 4th Dimension	489.	Claris FileMaker II	239.
4D Runtime	239.	Fox Software Fox Base Plus	208.
Activision Reports for Hypercard	75.	Microsoft Microsoft File 2.0	120.
Focal Point & Business Class Bundle	65.	Nordic HyperCONTROL	42.
City To City	30.	Odesta Double Helix II	339.
Apple Computer HyperCard	42.	DataDesk Professional	289.
Ashlon Tale dBASE Mac 1.0	295.	GeoQuery	199.
Blythe Software Omnis 3 Plus/Express	129.	Software Discoveries RecordHolderPlus	45.
Borland Reflex Plus	165.	TENpointO FocalPoint II	125.

Educational/Creative Software

Ars Nova Practica Musica	79.	Electronic Arts Mavis Beacon Typing	36.
Barron's Barron's SAT	35.	Venture's Business Simulator	47.
Bible Research The Word (KJV or NIV)	165.	Deluxe Music Construction Set V2.5	85.
Bogus Productions Studio Session	49.	1st Byte/Electronic Arts Kid Talk, Speller	
String Quartet, Country or Heavy Metal	15.	Bee, First Shapes, or Math Talk	32.
Super Studio Session	79.	Great Wave Software KidTime	26.
Bright Star Technology Alphabet Blocks	32.	Number Maze	27.
Talking Tiles	69.	Crystal Paint	27.
Broderbund Clip Sounds	36.	Individual Typing Instructor Encore	26.
Jam Session or Black & White Movies	30.	Learning Company Reader Rabbit	33.
Sense Geometry, Calculus or Physics	59.	Mindscape Perfect Score SAT	
Type!	20.	w/The Perfect College	46.
Where in the World is Carmen SanDiego?	27.	Niles & Associates End Note	82.
Coda Mac Drums	32.	Nordic	
Perceive	65.	MacKids Educational Prog. (ea)	Special 28.
Davidson & Associates		Simon & Schuster Typing Tutor IV	35.
Speed Reader II	39.	Springboard Top Honors	59.
Math Blaster or Word Attack!	27.	Family Matters or Atlas Explorer	28.

Studio/8 by Electronic Arts

Professional artists and amateurs alike will enjoy the power that *Studio/8* reveals in the Mac II. *Studio/8* is the first full-color, full-feature user friendly paint program designed specifically for artists. It features versatile airbrush, paint-brush, icon-based drawing tools, and color routines that you can customize. You'll be rid of hassles with custom typesetting because *Studio/8* supports full text-editing features in the same text box and allows you to dynamically resize and redefine blocks of type, plus shear, rotate, and skew text. *Studio/8* comes bundled with on-line help, a slide show program with built-in production features, a free font disk, and a library of backgrounds and textures.



Studio/8 319.

Shipped Federal Express

Business Software

Abacus Concepts		Mainstay	
StatView II		Capture	42
(Mac+, SE, II w/68020 & 68881)	349.	Mac Flow 2.0 or Mac Schedule	115.
StatView SE+ Graphics	229.	Meta Software MetaDesign	199.
Access Technology Trapezoid 2.1	159.	Micro Planning Software	
Ashton Tate Full Impact	249.	Micro Planner 6.0	325.
Borland Eureka! The Solver	129.	Microsoft Microsoft Works 2.0	189.
BrainPower ArchiText	182.	Microsoft Excel 1.5	255.
StatView 512 Plus	175.	Satori Software	
Math View Professional	144.	Bulk Mailer 3.2	79.
DataScan	118.	Bulk Mailer Plus	195.
Bravo Technologies MacCalc	79.	Components GL	389.
Chang Laboratories		Select Micro Systems, Inc.	
C.A.T. Contacts*Activities*Time	229.	Exstatix or MapMaker	219.
Claris MacProject II	395.	Shana Corporation	
Cognition Technology MacSMARTS	135.	Fast Forms	89.
D2 Software MacSpin 2.0	189.	Softworks Client	129.
Individual 101 Macros For Excel	37.	Synex Mac Envelope 4.0	59.
Legislot WillMaker 3.0	34.	Mac Invoice	32.
Lundeen & Associates		Systat Systat 3.2	459.
WorksPlus Commands	59.	(Specify MacPlus, SE or Mac II)	

Cutting Edge 800K External Drive by Cutting Edge



The **Cutting Edge 800K External Disk Drive** is the solution for Mac owners who are tired of swapping disks when using large programs or files. This external drive does everything that Apple's does, at a much more reasonable price. It's fully compatible with the Mac 512KE, MacPlus, SE, and II. Use of the drive is exactly the same as for the internal drive you already own, so there are no new keyboard

commands or other tricks to learn. Increase your computing efficiency economically with the **Cutting Edge 800K External Disk Drive** today!

Cutting Edge 800K External Disk Drive..... 175.

Graphics Software

3G Graphics Images With Impact!	59.	Laserware Laserpaint Color II	359.
Images With Impact Business 1	75.	Letraset	
ABA Software Draw It Again Sam 2.0	79.	ImageStudio 1.5 or StandOut	279.
Graphist Paint II	289.	Macromind Videoworks II	175.
Adobe Systems Adobe Illustrator 88	319.	Videoworks II Accelerator	118.
Adobe Fonts (Various volumes)	Call	Videoworks II Driver for Hypercard	60.
Aldus Freehand	349.	Micro Illusions	
Allsys Corp. FONTastic Plus 2.0	54.	Photon Paint	179.
Fontographer 2.2	239.	Micro CAD/CAM MGMStation	685.
Ashton Tate Full Paint	69.	Micro: Maps	
Broderbund Print Shop or Clip Charts	36.	MacAtlas Paint 2.0 (MacPaint Format)	45.
Drawing Tables	79.	MacAtlas Hyper Atlas	64.
CE Software Calendar Maker 3.1	27.	MacAtlas Professional	
Claris MacPaint II	105.	(PCT/MacDraw Version)	129.
MacDraw II	309.	Microsoft Microsoft PowerPoint 2.0	255.
Cricket Software Cricket: Draw	169.	Olduvai Software	
Cricket Paint or Pictograph	99.	Post-ART II (4-Disk Set)	59.
Cricket Graph	119.	ArtFonts 1, 2 or 3	59.
Cricket Presents	289.	Silicon Beach Software	
Deneba Software Canvas DA 1.0	56.	SuperPaint 2.0	109.
Canvas 2.0 (Includes Desk Accessory)	169.	Digital Darkroom	157.
Dream Maker		Super 3D	157.
MacGallery (Hypercard or Paint)	28.	Solutions International	
Clptures	97.	The Curator (Catalog Your Art)	79.
Dubl-Click Software		Springboard Certificate Maker	24.
World Class Fonts. Various Vol. 1-6 (ea)	45.	Works of Art Assortment,	
WetPaint. Various Vol. 1-15 (ea)	45.	Holiday, or Education	28.
Electronic Arts		Works of Art Laser Art or Fonts	59.
Studio 8 (MacII)	Special 319.	Springboard Publisher	109.
Enzan-Hoshigumi USA		SuperMac Software Pixel Paint	209.
MacCalligraphy 2.0	105.	Symmetry	
Japanese Clip Art	Call	Picture Base & Wet Paint Bundle	95.
Foundation Publishing Comic People	25.	T/Maker Click Art Letters I, Letters II,	
Comic Strip Factory	44.	Personal Graphics, Effects,	
Generic Software Generic CADD	54.	Business Image, or Holidays (each)	28.
Graphsoft Mini Cad 4.0	375.	Christian Images	35.
Innovative Data Design Dreams	279.	Click Art EPS Illustrations	75.
MacDraft 1.2B	149.	Zedcor DeskPaint 2.0	69.

Accessories

Abaton ProPoint (ADB Mouse for Mac SE & Mac II)	89.	Apple Security Kit	34.
Asher Engineering		Antiglare Polarizing Filter	33.
Turbo Trackball (Mac & Mac+ or Mac SE & Mac II)	69.	Modem/Fax Protector 10	15.
CH Products Mirage: Quad or ADB (Turns Joystick Into Mouse)	39.	Modem/Fax Protector 20	25.
Mach IV Plus: Quad or ADB	65.	Power Tree Surge Suppressors (10, 20, or 50)	Call
Curtis Manufacturing		Printer Muffler Stand (80 & 132)	24.
Emerald-Surge Suppressor-SP-2	36.	Printer Muffler 80	43.
Ruby-Surge Suppressor-SPF-2	55.	System Saver Mac (Beige or Platinum)	64.
Cutting Edge Cutting Edge MCK-105QK Keyboard w/Quickkeys	149.	Super Base	34.
DataDesk		System Saver SE	55.
MAC-101 Keyboard/Beige (128k/512k & MacPlus)	Special 145.	Masterpiece Mac II	105.
MAC-101 ADB Keyboard/Platinum (Mac SE & Mac II)	Special 145.	New Turbo Mouse (Reg or ADB)	119.
Ergotron Mousecleaner 360° MacTilt (Mac, SE or II)	68.	Mobius	
Farallon		Fanny Mac QT (Beige or Platinum)	60.
MacRecorder Sound System (Mac SE or Mac II)	139.	Mouse Systems	
Impulse Audio Digitizer w/soundware	145.	A+ Mouse (MacPlus)	65.
I/O Design Mac Luggage in Navy		A+ ADB Mouse (Mac SE/Mac II)	85.
Macinware Plus Carrying Case	Special 75.	Moustrak MousePad 7" x 9" Size	8.
Macinware SE Carrying Case	49.	MousePad 9" x 11" Size	9.
Imageware II Carrying Case	54.	Orange Micro Grappler Spooler	39.
HDware		Grappler C/Mac/GS	79.
Kalmar Designs		Grappler L/Q or Grappler L/S	92.
Teakwood Roll-Top Disk Cases:		Ribbons	
Micro Cabinet (holds 45 disks)	14.	Available in Black, Blue, Brown, Green, Orange, Purple, Red, Yellow, Silver & Gold	
Double Micro Cabinet (holds 90 disks)	21.	ImageWriter Ribbon	4.
Triple Micro Cabinet (holds 135 disks)	31.	ImageWriter Black 6-pack	20.
Kensington External Disk Drive Cover	8.	ImageWriter Rainbow Pack (6 Colors)	20.
Extra Long ADB Keyboard Cable	25.	ImageWriter II-Four Color Ribbon	9.
Macintosh II Stand	20.	ImageWriter II-Black	17.
Macintosh II Monitor Extension Cable	33.	ImageWriter LQ Four Color	20.
Mouse Pocket (Reg. or ADB)	8.	Seikosha Ribbon Black	6.
Mouseway (Mousepad)	8.	Silicon Comforts MacChimney (Very Effective Cardboard Laminate Convection Cooling Device)	16.
ImageWriter or ImageWriter II Cover	9.	Smith & Bellows	
Macintosh Plus/SE Dust Cover	9.	Mahogany Disk Case (holds 96)	30.
Macintosh SE w/extended Kybd Cover	9.	Sopris Softworks	
Mouse Cleaning Kit w/Pocket	17.	High Trek Carry Cases - Platinum Gray, Navy	
Disk Drive Cleaning Kit	20.	ImageWriter II Case	49.
Tilt/Swivel	22.	Macintosh Plus, SE w/Standard Kybd	59.
		Macintosh SE & Extended Kybd Case	69.
		Targus ImageWriter II Carry Case Blk.	49.
		Macintosh Plus Carry Case Blk.	59.
		Deluxe MacPlus-XKB Blk.	69.

Blank Media

Single Sided 3 1/2" Diskettes		Sony 3 1/2" DS/DD Disks (box of 10)	19.
Bulk (Sony) 3 1/2" SS/DD Disks (10)	12.	Fuji 3 1/2" DS/DD Disks (box of 10)	19.
Sony 3 1/2" SS/DD Disks (box of 10)	13.	Maxell 3 1/2" DS/DD Disks (box of 10)	20.
Double Sided 3 1/2" Diskettes		Verbatim 3 1/2" DS/DD Disks (box of 10)	19.
Bulk (Sony) 3 1/2" DS/DD (10)	17.	3M 3 1/2" DS/DD Disks (box of 10)	20.
Centech 3 1/2" DS/DD Color Disks (10)	19.		

Languages

Borland Turbo Pascal	65.	Microsoft Microsoft Quick Basic	65.
Turbo Pascal Tutor	46.	Smethers & Barnes Prototyper	72.
Consular Mac 68000 Dev. System	59.	Symantec Lightspeed C	95.
Mainstay V.I.P. 2.5 (Visual Interactive Programming)	109.	Lightspeed Pascal	65.
Manx Aztec C	65.	T.M.L.	
Aztec MPW C	99.	TML Pascal II (Includes MPW)	79.
Aztec C + SDB	99.	TML Source Code Library II	42.
		Zedcore ZBasic 5.0	105.



75 Research Drive, Stratford, CT 06497 **800/832-3201**

"... the clear leader 4th DIMENSION..."

MacUser

"Although this category, unlike spreadsheets and word processors, had a lot of new players this year, one seemed to us to be the clear leader.

4th Dimension, the powerful first product from ACIUS, takes the kudos."

MacUser, February 1988 ■

"Congratulations! InfoWorld's readers have chosen

4th Dimension as the Product of the Year in the Macintosh Database Systems category."

Jonathan Sacks, InfoWorld, April 1988 ■

"I can't imagine a data-management problem that you won't be able to solve with 4th Dimension."

Steve Mann, Macintosh Today August 11, 1987 ■

"Users with no experience or interest in programming can build a barebones database in 4D's 'Design Environment' just by pointing, clicking, and naming files and fields."

"For searches and sorts - database operations that are performed interactively - 4D's performance curve is probably the best of the four programs (Omnis 3 Plus, Double Helix II, dBASE Mac, and 4th Dimension)."

David Brandt, MacWEEK, January 19, 1988 ■

"It will do everything you need, and then some, and will prove itself well worth the cost."

Jan L. Harrington, MacUser, November 1987 ■

"I'm convinced that many users of other Mac databases and even PC databases will want to switch over to 4th Dimension."

Adam Green, Macworld, July 1987 ■

"In general, Macintosh software is better than software for other personal computers..."

4th Dimension redefines those high standards."

Andrew Gore, The Macintosh Buyer's Guide, Spring 1988 ■

"4th Dimension from ACIUS, Inc. of Cupertino, California, outshines the other databases we tested both in number of features and in rich database development environment."

Don Crabb, InfoWorld, January 11, 1988 ■

Want to try it out ?

For \$20, we'll send you a demo disk and comprehensive 50-page user's manual.

Call today and find out what 4th Dimension can do for you.

- Relational database
- Multi-user
- Intuitive interface
- Graphics and pictures
- Automatic forms & reports

Yes you can !

\$20 Demo Offer

1-800-952-6300 Ask for Dept. A22



Demo version bundled on all Jasmine Hard Disk Drives.



ACIUS

4th DIMENSION is a trademark of ACIUS, Inc. and ACI. All other brand names are trademarks of their manufacturers.

10351 Bubba Road
Cupertino, CA 95014
(408) 252-4444



Pondering Performance

The Macintosh II may be showing signs of age

by Thom Hogan

This column is about the state of the art in the Macintosh world. I'll give you insight into what's happening on the leading edge of development, both inside and outside Apple.

When I received a preproduction Macintosh from Apple in late 1983, I thought the machine was nirvana incarnate. I spent the next two days filling up a 400K disk by drawing pictures one bit at a time. It didn't matter to me that drawing pixel by pixel was an inefficient way to work—until the Mac came around, I didn't have any way of doing the same thing, especially if my goal was to place a picture into something I was writing.

Like all early Mac worshippers, I ignored the slow scrolling, the agonizingly slow disk I/O, the long wait for a crude printed copy of my work, the incessant disk swapping, and so on. But it didn't take long before speed became critical to me. And so I continued to use my IBM AT to do most of the work around the office.

In 1987 the introduction of the Macintosh II changed all that. Here was a machine that used all the Mac's graphics-oriented software and peripherals, but

Thom Hogan is the president of Macreations, a Macintosh software developer, and the publisher of the Macintosh II Report. His reference book, Programmer's Macintosh Sourcebook, was recently published by Microsoft Press.



it astounded me with its speed, huge amounts of memory, large-capacity hard disks, detailed color displays, and more. Suddenly, doing my work on the Mac seemed a reasonable choice. With a crop of new software, a Mac II, a LaserWriter, MultiFinder, and 8 megabytes of RAM, I could load up my workspace, cut and paste things between applications, and create masterpiece documents to my

heart's content. Once again I fell in love and experienced a technology-induced high.

But now the Mac II may be showing signs of old age. What was once the speed demon of Macdom is now outrun by mere accelerator-equipped SEs. The Next computer uses many of the same

(continues)

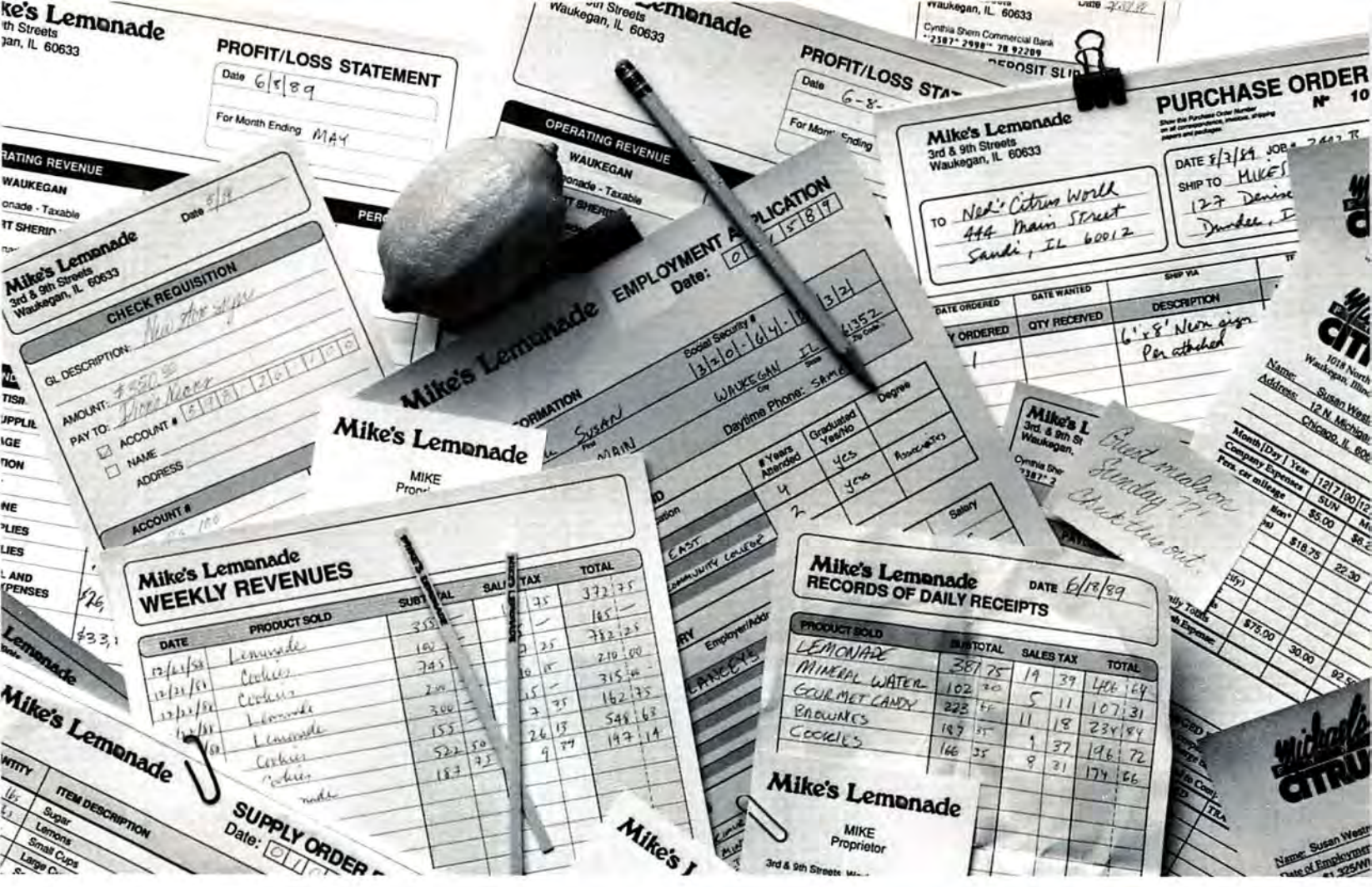

components as a Mac II but runs so much faster that those of us who require performance computers are trying to figure out how to get one without reenrolling in college. Was the Mac II a two-year performance patch on the aging Mac architecture? Does the introduction of superfast personal machines like the Next cube mean the end of the Mac II?

In this first column I want to tackle the very questions I just posed about the Mac II's architecture. What we all want to know is this: Has Apple left enough room in the current Mac II design for performance improvements that might restore the II's stature as a leading-edge machine? By the end of this column, I hope you'll be able to make an informed guess at the answer.

Beyond the Marketing Hype

Those of us who've used Mac IIs for any length of time will never be able to go back to an unaccelerated Plus or SE. But few of us have stopped to determine just what it was that gave the Mac II its apparent speed advantage over a stan-

Macintosh Features

Macintosh model	128K/512K	Plus	SE	II	IIx*	Future
Processor speed	8MHz	8MHz	8MHz	16MHz	16MHz	25-33MHz
Internal/external bus width	32/16	32/16	32/16	32/32	32/32	32/32
Memory speed	150ns	150ns	120ns	120ns	120ns	60-100ns
Coprocessors	none	none	none	68881	68882/68851	68882/68851
Additional tasks	video/sound	video/sound	none	none	none	none

*The 68030-based SE introduced in January is virtually identical in features to the IIx.

dard Macintosh. For the most part, we've simply believed Apple's marketing hype.

Apple told us that the speed of the Mac II came from the 32-bit abilities of the 68020 processor, the presence of a floating-point processor (the 68881), and the NuBus video solution (which relieved the processor of having to handle screen updates). When the Mac IIx was introduced last October, Apple's public relations machine refocused around the 68030 and the 68882, new generations of the chips used in the Mac II. At one time I, too, tacitly accepted Apple's explana-

tions about the Mac II's generally fast performance. But the fact that the IIx only improved performance 10 to 15 percent over the II bothered me just enough to make me start looking deeper. And the answers I found were not the ones I expected.

A finite number of things can affect system processing speed (see "Macintosh Features"). The most important factors for the Macintosh lineup are



How Features Enhance System Performance

Macintosh model	128K/512K	Plus	SE	II	IIx*	Future**
Processor speed	-	0%	0%	80%	0%	50-100%
Internal/External bus width	-	0%	0%	<5%	0%	0%
Memory speed	-	0%	<1%	0%	10-15%	25-50%
Coprocessors	-	0%	0%	15-25%	10-30%	0%
Additional tasks	-	0%	7-10%	0%	0%	0%
Overall increase	-	0%	10%	80-100%	10-15%	100%

*The 68030-based SE introduced in January shares the same performance characteristics as the IIx.

** The performance increases for future models are estimates. The 0 percent figure for additional tasks could be changed dramatically by dedicated SCSI, I/O, and bus controllers; you can speed up hard disk I/O 50 percent or more by adding a dedicated, caching SCSI controller that performs direct memory access, for example. Such a change would also affect any overall increase, of course.

The numbers here show the improvement in performance for each feature over the earlier model (for example, the SE's lack of additional task load improves performance about 7 to 10 percent over the Plus and 128K/512K models).

- the clock speed of the processor—faster processors mean faster computing;
- the number of bits of data a processor can handle internally and externally at one time—the more bits the machine can handle at once, the more

information it can pass through the processor;

- the speed with which memory responds to processor requests—the processor shouldn't have to wait for any component in the machine, especially the memory, which is accessed almost

continuously;

- the presence or absence of coprocessing chips that perform tasks faster or more efficiently than the central processor—in the Motorola chip family, coprocessor chips can perform critical numerical or memory-intensive work while the main processor goes on to the next task;

- additional system tasks, like sound, video, or disk manipulation performed by the processor (instead of by subsystems)—every additional task the CPU has to perform cuts into the amount of time it can devote to your application.

Since each element in "Macintosh Features" affects the overall performance of the Macintosh, you're probably wondering how each of them contributes to or steals from the overall speed of the machine. "How Features Enhance Performance" has the same feature matrix, but now shows what kind of improvement each item makes. These numbers are based on tests I conducted in an

(continues)

Success

The road to success will always be paved in triplicate. But with new SmartForm™ software and Macintosh personal computers, it's no longer the tollway it once was.

The SmartForm concept is simple: you can't reduce the paperwork, so reduce the amount of paper. And the printing, shipping and storage costs that go with it.

SmartForm Designer™ includes all you need to whip out crisp, professional forms in a hurry. Fields, lists, check boxes, grids, combs, lines, ovals, rectangles—everything. And their sizes and locations can be pinpointed to the exact inch, centimeter, point or pica.

Type flexibility is almost unlimited. You can reverse, condense and expand fonts, adjust leading and

© 1989 Claris Corporation, 440 Clyde Avenue, Mountain View, CA 94043.



effort to isolate the speed contributions of individual features, and they should be used as rough estimates only. Word processors and spreadsheets work in decidedly different ways. (The word processor's speed is mostly dependent on screen display speed, while the spreadsheet's abilities are more directly affected by a number-crunching coprocessor, for example.) To make the results reasonably predictive, therefore, I averaged speed tests for four or five typical software tasks to come up with each of the numbers in "How Features Enhance Performance." Admittedly, my tests were not exhaustive, but the results should be indicative of what's happening, on average, in the Macintosh line.

The only things that make a significant difference in the Mac II's overall speed over previous models are the processor's clock speed and the presence of a 68881 coprocessor for floating-point math work. Moreover, almost all the improvement in future models will come

solely through faster processors and memory. Examination of Motorola's literature on the 68030 (the processor used in the Ix and expected in most future Macs) shows that the chip itself only improves overall performance about 10 to 15 percent over a same-speed 68020 (the chip in the original Mac II). Indeed, in some cases, the 68020 and 68030 perform some benchmark tests in the same amount of time. The 68030 does offer improved memory handling. It keeps internal copies both of frequently used data and instructions (that is, it caches them); the 68020 remembers only frequently used instructions. In addition, the 68030 requires only one wait state for memory accesses, unlike the 68020/68851 combination. (During a wait state, a CPU waits an entire clock cycle for the memory to get the requested data ready before it attempts to retrieve the information.) The difference in speeds between the 68020 and 68030 is not due to any fundamental change in internal structure, instruction set, or additional processing efficiencies, but is strictly due to its memory handling.

Playing the Numbers

But the tables don't tell the whole story. Note that the 68881 numeric processor in the II seems to give only a marginal (less than 25 percent) improvement on system speed. The 68882 in the Ix can achieve up to 30 percent improvement on some instructions but generally averages only a 10 to 15 percent improvement over the 68881. Yet Apple has claimed from day one that the presence of a 68881 or 68882 floating-point coprocessor means that numeric calculations really fly on the II compared to previous models. And all computers are constantly working with numbers, right? Wrong.

The 68881 doesn't seem to contribute much to the Mac II's performance because it isn't used very often. The trouble, it seems, is Apple's SANE (Standard Apple Numerics Environment) routines in ROM. SANE is a set of numeric floating-point calculation routines that Apple designed many years ago. Float-

THE RIGHT



M20 20 Mb External

\$527

Economy. Mirror's great looks in a zero-footprint design that brings mass storage within anyone's budget, yet includes - free of charge as with all Mirror hard drives - Mirror's hard drive value package*. And with Mirror Technologies' return policy and one-year warranty, you can't go wrong.

*Includes Mirror Technologies' Hard Drive Value Package.



M30 30 Mb External

\$597

Our most popular drive. Enough storage for most personal applications at manufacturer-direct prices. Preformatted and easy to use - just plug in and play! Super reliable, and with all the extras at factory-direct prices.

*Includes Mirror Technologies' hard drive value package.



M40 & M40+ 40 Mb Externals

\$687

Your choice. Lower price or blistering speed. The "Plus" version screams along at an amazing 19ms! And our "Plus" drives carry a two-year warranty. Heavy gauge steel cases, the finest hardware, and power supplies that just won't quit.

*Includes Mirror Technologies' hard drive value package.

M40+: Call for price.



M80 & M80+ 80 Mb Externals

\$947

Again, your choice: high speed or lower price. We'll double our usual one-year warranty on the 19ms "Plus" drive to two years. 80 Mb is enough for highly complex networking and accounting applications. Shop the price on other 80 Mb drives. Ours is less expensive, and you still get all of the Mirror extras!

*Includes Mirror Technologies' hard drive value package.

M80+: Call for price.

Our numbers look as good as our products.

It's because you buy straight from the manufacturer. No commissions. No markups. Just prices up to 40% less than you'd pay in a computer store. You still get all of the extras like our hard drive value package. And friendly, intelligent people who understand the Macintosh.



M100, M200 100 & 200 Mb Externals

\$1197

Mega-memory at a micro price. And talk about speed! The M100 is fast, but the M200, at 15ms, is awesome! Fan-cooled reliability, and Mirror's conservative philosophy means you can't find a more secure storage medium. Preformatted. Just plug and play!

*Includes Mirror Technologies' hard drive value package.

M200: Call.

***Mirror Hard Drive Value Package:**

- Preformatted • Embedded SCSI; NTX compatible • AC EMI/RFI filters • Rear-panel AC outlet • External SCSI address selector • SCSI cable • Whisper-quiet cooling fan • Hard Driver™ formatting and diagnostic utility • LaserSpeed™ • Numerous other utilities, backup utility • 10 Mb of Public-domain software stacks • 1-year warranty, two years on "Plus" drives.



RM.8 Floppy Disk Drive

\$167

We set the standards for low-cost removable storage. This little drive packs .8 Mb (800K) of data on each 3½ disk! *MacWorld* says of our RM.8, "So quiet it would be unobtrusive anywhere except a library on a Friday night." Try it for 30 days, and if you don't like it, we'll take it back. You won't find a similar brand-name product for less!

Quality is always a better value. Especially if it costs less.

Lost data can put you out of business. That's why Mirror Technologies uses only the best. And why we build in those extras that mean greater data security. When integrated with rugged power supplies and whisper-quiet cooling systems in our steel chassis, you can double-click "Save" with confidence.

THE RIGHT NUMBER

1-800-654

NUMBERS.



M60 60 Mb External

\$757

You won't find a brand-name 60 Mb drive for less. And you *still* get Mirror's EMI/RFI protection, heavy-duty power supply, AC convenience outlet, whisper-quiet cooling fan, rear-panel SCSI address, and other standard Mirror features. Compare. Then give us a call!

*Includes Mirror Technologies' hard drive value package.



VisionScan 200

\$597

A VisionScan scanner—an unlimited supply of art & graphics! Anything you can lay on the flatbed can be quickly and easily entered into and manipulated with your Mac at half the price of competing flatbed scanners! A *BYTE* reviewer wrote, "If it were my money, I'd buy the Mirror Technology VisionScan. Its price/performance ratio is unequalled".

VisionScan 300

\$797

VisionScan works as a DA so you don't have to exit the program you're using! Get the 200 dpi *VisionScan 200* for excellent line art and affordable halftones, or the 300 dpi *VisionScan 300* for excellent line art and excellent halftones, and we'll send you Zedcor's DeskPaint, free! Optical character recognition software available.



Internal Hard Drives: 30, 40, 80, 100, 200

\$497

Only Mirror Technologies allows you to add an internal hard disk in an SE already containing either two floppies or a floppy and a hard disk! Up to 200 additional Mb in your SE! And Mac II users can add two of our drives; up to 400Mb of internal storage, another Mirror exclusive!

*Includes Mirror Technologies' hard drive value package. 40, 80, 100, & 200 Mb: Call.



RM20 Removable Flexxy Disk Drive

\$897

Think of it as a huge floppy disk. Using media developed by Kodak and Verbatim, the flexxy disks carry a lifetime guarantee! Speed? Our RM20 is as fast as most 20 Mb hard drives! An extremely low cost per Mb for backup, for archiving, or for your primary storage medium. And we sell our RM20 for over a

hundred dollars less than the competition, complete with Hard Driver™ formatting and diagnostic utility, Symantec's LaserSpeed™ LaserWriter print spooler, and numerous other utilities, including a backup utility. External SCSI address selector, our whisper-quiet cooling fan, built in AC EMI/rRFI noise filter.

Another number you'll love.
30 days at our risk.

We know you can't get a better value anywhere. It's up to us to prove it to you. Try a Mirror product for 30 days; if you don't think it's a great value, call us, send it back, and we'll refund the price of your unit. We're confident that you will like our prices, our products and our service.

You'll get better help than from a computer store salesman.

If you need to know about any product, ask its maker. At Mirror, our Mac experts have been hand-picked and trained to be able to answer your questions. Better help than you'll get from salesmen in most computer stores. If you've ever had trouble getting help before, you'll find welcome relief at our number.

You could be using a Mirror Technology drive tomorrow.

We almost always ship within 24 hours. If we don't ship within 24 hours of credit approval, we'll pay the freight! And with optional express shipping, you could be up and running by noon tomorrow. You simply can't find better products, with better service, at a better price—anywhere. Call today.

**NUMBER
-5294**

**MIRROR
TECHNOLOGIES**

2644 Patton Road, Roseville, MN 55113
Phone: 612-633-4450 Fax: 612-633-3136
Hours: Mon.-Fri. 8 a.m.-6 p.m. CST

Macintosh and Mac are trademarks of Apple Computer, Inc. LaserSpeed is a trademark of Symantec Corporation. Verbatim is a trademark of Verbatim Corporation, a Kodak company. Kodak is a trademark of Eastman Kodak Company. DeskPaint is a trademark of Zedcor, Inc. MacWorld is a publication of PCW Communications, Inc. Byte is a publication of McGraw-Hill.



Circle 424 on reader service card

INTRODUCING

2.0

ArchiText

"a tool for linking and retrieving megapages of information, both text and graphics, in a remarkably easy way... proves the power and beauty of hypertext"

-BYTE, December 1988

ArchiText is a versatile and practical application that lets you retrieve, organize and analyze large amounts of text quickly and efficiently. It is the perfect research tool for graduate students, medical or legal professionals, writers or anyone involved in research on a day-to-day basis.

You enter text into **ArchiText** by typing it directly into the program, pasting it from the Clipboard, or by importing ASCII text documents. You can then split, combine and/or link together any number of related items within your text on easy-to-use graphic "maps". You can search for words or word combinations using the Boolean operators AND and OR. Searches may be conducted at the sentence, paragraph or document level. *ArchiText, Version 2.0 gives you even more power for your research needs:*

- Import a virtually unlimited amount of text in one operation.
- Import native word processing files such as Microsoft Word™, MacWrite™, and WordPerfect™ in addition to text files.
- Search and link external native word processing files on disk without converting them to ArchiText format.
- Access a keyword frequency list (alphabetically or by frequency order) for all or parts of the document.

Call or write us today for a Free ArchiText demo disk!

ArchiText 2.0... \$349.95. Demo Disk is free. Requires at least a Macintosh Plus using System 4.2 or later and Finder 6.0 or later.

BRAINPOWER, INC.

30497 Canwood St. • Agoura Hills, CA 91301
800-345-0519 • 818-707-1712 (in CA) • FAX 818-707-0114

Circle 383 on reader service card

State of the Mac

memory SIMMs (Single Inline Memory Modules) in the Mac II as it used in the SE. Comparing the numbers is telling: 120ns memory cannot possibly keep up with the 16MHz CPU in the Mac II, since the CPU wants everything in about 60ns. (Indeed, Mac SIMMs can't even keep up with the 8MHz CPU in the Mac SE.) In order to get all the components talking at the same time, Apple imposes a penalty of two wait states on the processor in the II (one wait state in the Plus and SE). In the Iix, the presence of the built-in 68851 reduces this to one wait state. The numbers don't quite seem to add up because of an added factor—memory refresh, a process required to recharge every memory location at periodic intervals. We'll ignore the refreshing of the Mac's dynamic RAM because virtually all personal computers currently pay this small performance penalty. What's important is those two cycles the CPU waits every time it needs a piece of data or a new instruction.

I've mentioned that the 68030 chip has built-in data and instruction caches. Caching is the process of keeping a small amount of often used information available for high-speed access. The built-in caches in the Iix's 68030 are 128 bits in size. That's not very big, and that's one of the reasons why the on-chip caching doesn't make a lot of difference in the Iix's overall speed. The original II has only 128 bits of instruction cache (and no data cache).

Computer design theory says that a well-designed, memory-based cache of between 32K and 128K should improve general memory access enough to improve performance by some 60 percent. Does design theory come close to predicting what happens in the real world of computer applications?

The improvement comes because items in the cache are in special high-speed memory that is available to the processor immediately (in about 60ns on the II) instead of after two extra clock cycles. That is, data in cached memory can be accessed in less than half the time it takes to access data in noncached memory, a performance gain of at least 100 percent. The question is, how often is the data the CPU wants in the cache?

According to Ron Garrett, DayStar Digital's director of engineering, the

(continues)



"This baby is loaded with extras..."

Kristi Coale,
MacUser magazine

Master Piece® Mac II, \$159.95



System Saver® SE, \$79.95



Apple® Security System, \$49.95



Mouseway, Mouse Pockets, \$9.95 ea.



Maccessories SuperBase™, \$49.95



Macintosh® II Stand and Cables, \$29.95 to \$49.95



Maccessories® Anti-Glare Filter, \$49.95



Universal Printer Stand, \$24.95



Power Backer™ UPS's, \$399 to \$1,399

When Kristi Coale of MacUser magazine looked at our Master Piece® Mac II, she had expected it to have extra outlets, individual and master switches, surge suppression, and noise filtering. But she was impressed to find modem surge suppression and a swivel base, too. All for \$159.95.

And we were delighted with her comment, since that's exactly what we aim for when we design accessories for the Mac — to build in the most benefits at the best price possible.

That's how we came to feature a fan in our System Saver Mac. How we slipped an extra shelf under our SuperBase. And popped a paper catcher in behind our Printer Stand.

In fact, we've figured out so many ways to enhance and protect your Macintosh, we can't fit them all on one page.

So, give us a call, and we'll send you a free 20 page brochure. And we guarantee — this baby's loaded!

Call (800) 535-4242



251 Park Avenue South NY, NY 10010
(212) 475-5200, Fax (212) 475-5996

Circle 30 on reader service card



Database™

The First Full Featured Desk Accessory Database
for Text, Color Images, and Graphics

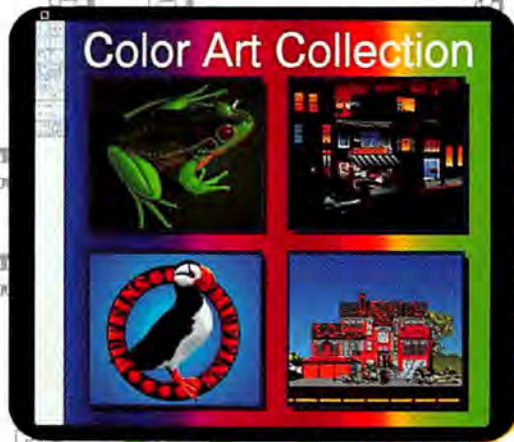

- ON-LINE HELP
- Up To 80 FIELDS PER RECORD
- COMPLETE TELEPHONE DIALING
- CHECK BOXES & POP-UP FIELDS
- SOPHISTICATED ART GRABBER FOR ALL PICTURE FORMATS
- UNIQUE MINIFINDER INTERFACE FOR FREQUENTLY USED FILES
- VARIABLE WINDOW SIZES & COLOR FOR ALL TYPES OF FILES
- CALCULATION FIELDS FOR FORM GENERATION
- TIME & DATE STAMP ON EACH RECORD
- UNIQUE CONVERTER FOR MERGING YOUR FREQUENTLY USED FILES
- DETAILED REPORTING ON MULTIPLE RULE SEARCHES
- EXTENSIVE IMPORTING/EXPORTING FUNCTIONS
- WORKS WITH MAC-512E+ COLOR DISPLAYS, & MULTIFINDER
- MULTIPLE PICTURE FIELDS PER PAGE
- PASSWORD PROTECTION FOR EACH FILE
- AUTO COPY COMPLETE RECORDS
- GLOBAL OR FIELD SPECIFIC FIND
- MARKING ON SELECTED RECORDS
- EXTENSIVE PRINTING OPTIONS



Preferred Publishers, Inc.
5100 Poplar Ave., Suite 706
Memphis, TN 38137
(800) 446-6393 • (901) 683-3383

© 1988 Preferred Publishers, Inc.
All Referenced Trademarks are property of their respective holders

Circle 317 on reader service card

highest percentage of "hits" on data in the cache attainable in a standard Mac work session would be in the 70 to 80 percent range. With the right size cache, then, about 75 percent of the time the cache would contain the data the CPU was requesting. The rest of the time, the data would have to be loaded from regular memory. Overall, then, cached memory accesses data in about 66 percent of the time it takes noncached memory to access the same information, for the average performance gain of slightly more than 60 percent.

Garrett took a careful look at the code the CPU in a Mac was executing and how much of it, on average, was repetitions of the same items. Fortunately, in the Mac design, repetition is high because all applications are constantly calling pieces of the Macintosh Toolbox (the ROM). As it turns out, sections of the ROM code are called so often by most programs that most of the data that ends up in a well-designed cache is actually ROM code, and thus the speed improvement from using a memory cache applies about equally to software. There are exceptions to this rule, however (HyperCard doesn't like other caches—it uses its own), so you may find that some programs do a little better than 60 percent, some a little worse.

Indeed, caching is exactly the tack taken by the Radius 25MHz accelerator for the SE. Despite its use of the Mac's slow memory and the lack of a true 32-bit bus, it still outperforms the standard Mac II by a significant margin on CPU-only tests (see "Processors: Is Faster Better?" in this issue). When disk I/O, specifically write-to-disk, is a significant factor in a test, the Radius Accelerator 25 loses its advantage over the standard Mac II. (The recompile test is an example. Compiling is a sequential task, and the cache becomes a disadvantage at that point.)

DayStar Digital's Mac 20MX-25 accelerator board also uses memory caching. At the CPU-intensive tasks, the caching is so effective that this board easily outperforms the unenhanced Mac II—it manages to cut times for CPU-intensive work by 30 to 40 percent. But the Mac 20MX-25 slows down the minute it has to perform writes to disk. Obvious-

(continues)

The table Apple would have designed, had they gone into the furniture business.



Any company with the vision to create a product as elegant and useful as the Macintosh® would have hit it big in any industry.

Fortunately, Apple® chose computers.

We, on the other hand, chose to make furniture. More specifically, the MacTable.

Like the Macintosh itself, the MacTable was created to put information at your fingertips, quickly and easily. We accomplish this by thinking of the workspace not as an inflexible monolith, but as a network of individual surfaces onto which you can place each of your Mac components, like your printer, modem, external drive, mouse, even manuals. Everything with plenty of elbow room, easily within reach, and there when you need it.

Next, each surface tilts to optimize your eye-to-screen and hand-to-component

efficiency. Rest assured that as your comfort increases, so does your productivity.

Finally, there's the overall design — sleek, contemporary, and mindful of the future of your computing needs. Because MacTable's surface panels can be arranged, your workspace can accommodate any model of Macintosh, from the Plus to the Mac II... to who knows what.

Surprisingly enough, all of this Mac-like versatility and European beechwood framing is more than affordable: only \$289 for MacTable and \$139 for the optional roll-away cabinet (doubles as a Laserwriter stand); \$269 for the matching, ergonomically balanced chair; lateral file cabinet \$239; bookshelves \$119; and two-door cabinet \$159.

MacTable. It's the workspace that organizes the tools that organize your life. And it's available by calling (800) 722-6263 which, by the way, is not Apple's phone number.

MacTable®

The ultimate Mac peripheral.



To order your MacTable or for more information call:



TOLL FREE (800) 722-6263
in WA state (206) 481-5434
Prices do not include U.P.S. shipping.

ScanCo

P.O. Box 3217, Redmond, WA 98073-3217

MacTable design patent-pending. MacTable is a registered trademark of Scandinavian Computer Furniture, Inc. Apple is a trademark of, and Macintosh is a trademark licensed to, Apple Computer, Inc. Prices and designs subject to change without notice.

Circle 296 on reader service card

MathType 2.0

Equations for Word Processing

If you need an easy way to create technical reports, slides, class notes, research papers, or even entire books, then MathType is the tool you've been looking for. It's an intelligent equation editor for the Apple Macintosh or for IBM PCs and compatibles that lets you build up complex equations using simple point-and-click techniques ...

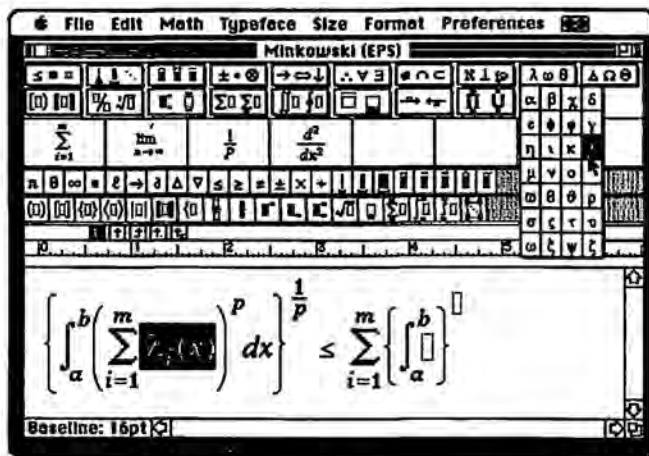

Import the finished equation into your word-processing document, and get publication-quality results like this ...

$$\left\{ \int_a^b \left(\sum_{i=1}^m \lambda_i(x) \right)^p dx \right\}^{\frac{1}{p}} \leq \sum_{i=1}^m \left\{ \int_a^b [\lambda_i(x)]^p dx \right\}^{\frac{1}{p}}$$

MathType 2.0 has all the highly-acclaimed features of earlier versions, and some important new ones, too:

- Automatically applies the rules of mathematical typesetting
- Encapsulated PostScript (EPS), Pict, and TIFF output
- Optional T_EX, Mathematica, Excel, Lotus 1-2-3 interfaces
- User-defined palettes and expression macros
- Runs as a DA on the Mac, under MS Windows on the PC
- Fractional type sizes and positioning to 1/32nd of a point
- On-line context-sensitive Help system
- Fast keyboard access to all symbols, templates, and expressions

All this, and much more, and the price is still only \$149. Call or write for a FREE brochure and working demo disk.



Design Science

6475-B East Pacific Coast Highway, Suite 392
Long Beach, CA 90803 • (213)433-0685

Circle 165 on reader service card

State of the Mac

ly, caching can improve performance. Has Apple gotten around to caching? No. Will it? Let's hope so. Memory caching is about the only way to offset the high price of memory upgrades. If Apple would couple caching with direct memory access disk I/O, a technique in which data is moved to and from memory without the CPU's intervention, the overall result would be a spectacular improvement in performance.

The Bottom Line

I haven't begun to exhaust the subject of how Apple could improve the performance of the Mac II. (In fact, any discussion of the Mac II's performance has to get around to the video display. Next month I'll tackle Apple's new 24/32-bit QuickDraw color standards in depth.) Yet one thing should be clear from the discussion so far: the Mac II is faster mostly because the CPU runs at a higher speed. I find that quite ironic. If that had been known back in 1987, many of us might have waited and bought an accelerator card for our SEs. True, the Mac II has other attractive features, and speed isn't the only attribute that made us pull out our wallets and contribute to Apple's rise in the Fortune 500. But now that the speed high has worn off, I can only question what Apple is spending its \$65 million R&D budget on—it certainly isn't in building a state-of-the-art machine.

I'm about out of room, and I've wandered a bit from where I started. But I do hope that you've gotten an idea of things to come. The Macintosh II is a near state-of-the-art machine. As such, it is driving Apple's development teams to test the limits of what is possible. I'll be tackling tough, technology-related issues in upcoming columns, issues that you'll need to be aware of to take best advantage of the Mac II.

In the meantime, some of you may have specific questions or comments about the Macintosh II. I try to answer as much of my mail as possible; a question with a self-addressed stamped envelope almost always gets a reply. But a better way is to leave me an electronic mail query. I can be reached as THOGAN on GENIE, minniefloppy on Bix, or as THOGAN on MacNET. □

Quicken automatically updates your check register, recalculates balances, and prints your checks.

Quicken is easy because it looks like your paper checkbook. There's nothing new to learn.

Quicken prints checks even on laser printers. Preapproved by all financial institutions, Quicken checks are easily ordered through the form in the package.

Quicken gives you these reports in seconds:

- Budget vs. Actual
- Taxable Income/Deductions
- Income and Expense (P&L)
- Rental Property/Job Costs
- Accounts Payable
- Cash Flow/Cash Needs
- Payroll Taxes.

Quicken eliminates work. It instantly writes recurring checks without typing.

Now Links with Tax Software

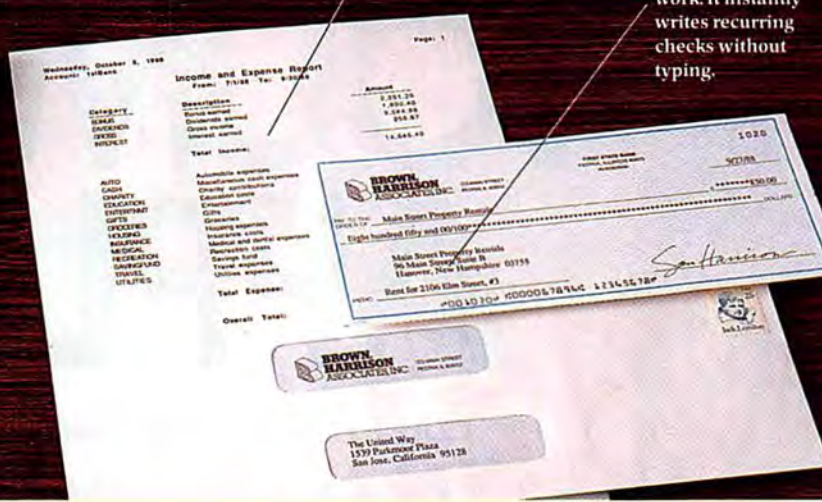
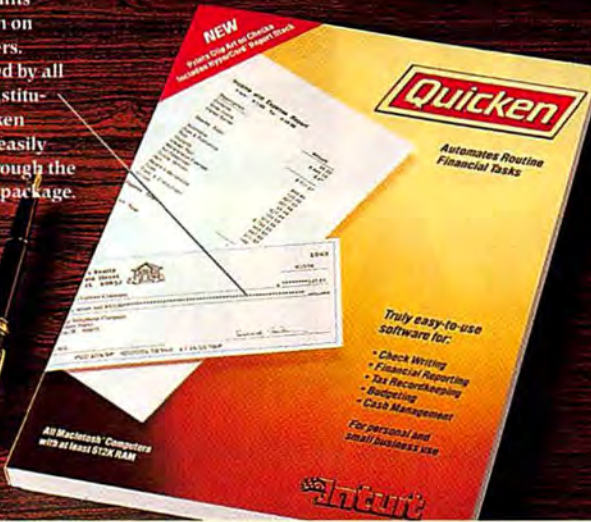
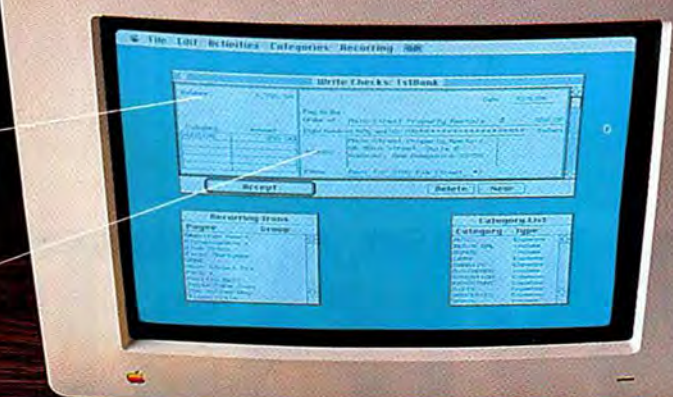

Stop Taxing Yourself. Quicken®, \$49.95

Quicken® is the absolute fastest, easiest way to do your personal and small business finances. You'll slash time and effort every month, plus have perfectly organized financial records. Now instead of dreading tax time, you'll save even more hours, because Quicken links directly with the top selling Macintosh® tax software, MacInTax®

Forget Financial Hassle

Quicken is so automatic, it does your monthly financial work for you. It actually learns your regular bills. Just click to confirm the payment amounts on your auto loan, utilities, and other bills. Quicken does 14 bookkeeping steps and hands you the printed checks already addressed for mailing. All you do is sign them and seal the envelopes.

Automate Your Taxes, Too!

Quicken saves you hours at tax time, because all your tax information is right at your fingertips. It prints itemized lists supporting tax deductions in just seconds. Or, let MacInTax quickly and accurately read income and deductions from your Quicken records and directly transfer that data to your tax forms. Click on any total and MacInTax displays the supporting list of every transaction from Quicken comprising that total.

Know Your Financial Situation in Seconds

Quicken gives you detailed reports such as budget vs. actual comparisons, income and expenses by category, accounts payable, accounts receivables, or P&Ls, on screen or on paper, almost instantaneously.

The World's #1 Selling Financial Software

Here's why Quicken is the world's most popular:

Quicken is a great program... Its combination of an outstanding implementation of the Mac interface, sophisticated keyword-searching techniques, and a readable, well-designed manual make it the industry standard. ★★★★★

—Ken Landis, MacUser

Absolutely the best small accounting program made.

—Bob Schwabach, Universal Press Syndicate

No Accounting Mumbo Jumbo

Quicken is as easy as the pen and paper you use now. You'll see the familiar checkbook and check register right on your screen. The only thing that changes is how fast you finish your financial chores. This is bookkeeping that's totally hassle-free.

For Personal and Business Use

No other financial software provides more flexibility to handle the wide range of personal or business needs. Quicken is for service and manufacturing businesses, doctors, consultants, designers and retailers, as well as for households. Quicken is ideal for anyone who wants relief from bookkeeping hassles.

Specifications
Software Compatibility: Exports data in SYLK format for use in spreadsheets like Excel®. Exports data to HyperCard™
Hardware Compatibility: All Macintosh with 512K RAM. All printers, including laser printers. Also available for IBM and compatibles. Apple IIe, IIc, IIx Plus, and IIgs.
Capacity: Unlimited number of bank accounts. Unlimited number of transactions. Unlimited number of income/expense categories. Maximum amounts to \$9,999,999.99.
Other: Unlimited FREE technical support. Not copy-protected. Checks are preapproved by all financial institutions in the U.S. and Canada. Sample checks and order form are enclosed in Quicken package.

Try Quicken FREE for 30 Days

Order Quicken today from the coupon below, or through our toll-free 800 number. If you're not completely satisfied with Quicken for any reason, simply return it for a full, no-questions-asked refund.



I want to try Quicken on your no-risk 30-day guarantee. If I'm not completely satisfied, I may return it within 30 days for a full refund. Quicken, \$49.95 plus \$3.00 shipping and handling. California residents add sales tax.

Call 800-624-8742

or, send this coupon with your check or credit card number to Intuit.

Name _____
 Address _____
 City _____ State _____
 Zip _____ Phone _____
 Macintosh version 3 1/2" disk
 Apple II version 5 1/4" disk
 Check enclosed (no purchase orders, please)
 Visa MasterCard Am Ex
 Card No. _____
 Expiration Date _____

Intuit 540 University Avenue
 Palo Alto, California 94301
 MW 0389

HOW FAST CAN YOU MAKE AN APPLETALK?

Up to three times faster. With the new TOPS FlashBox.™

Most people wouldn't change a thing about their AppleTalk® network. Except to make it faster.

Now you can do that — easily and inexpensively. With FlashBox.

Simply plug FlashBox into the back of any networked Macintosh.* And in a flash, information will speed along your existing twisted-pair cabling (such as Apple's LocalTalk™ or regular telephone wire) at the FlashTalk™ speed of 770Kbps— up to three times the AppleTalk data rate.

What's more, FlashBox is only \$189 per node, and can be installed on only those Macs you want. And because FlashBox can communicate at both FlashTalk and AppleTalk rates, it will automatically select the right speed to talk to any other Mac, PC, LaserWriter® or peripheral on your network.

In fact, you don't even need to be running TOPS — FlashBox can also quicken the pace of AppleShare®, InBox™ and multi-user applications. And networked PCs equipped with a FlashTalk compatible card (such as the TOPS FlashCard™) can talk with Macs at FlashTalk speed.

Only FlashBox can make AppleTalk faster without putting you through major changes.

So call your nearest TOPS dealer. Just dial 800-445-TOPS (or 415-769-8700 from outside the U.S. and Canada). Or drop a card to TOPS, 950 Marina Village Parkway, Alameda, CA 94501.



TOPS®

A Sun Microsystems Company



TOPS, Sun and the Sun logo are registered trademarks and TOPS FlashBox and FlashTalk are trademarks of Sun Microsystems, Inc. Other brand and product names or registered trademarks are of their respective holders. Actual application speeds may vary based on network traffic. Prices are subject to change.

Insights on QuarkXpress 2.0

*Find the freedom of the press
at your fingertips*

by Steve McKinstry

If freedom of the press belongs only to the individual who owns one, then anyone with QuarkXpress 2.0 and a Macintosh can raise a little Citizen Kane. The newest and most important features in Xpress 2.0 are tools that manage style, color, and imaging. Styles in Xpress 2.0 allow complex formats to be applied quickly and easily. Using the new color enhancements, process CMYK (cyan, magenta, yellow, and black) separations can be printed directly to film. And imaging controls offer special contrast and color effects. What follows are some tips on applying these new tricks to your own documents.

Between a Rock and a Hard Space

Each style sheet is designed with its own leading (the space between lines), which can create awkward spacing between paragraphs and can throw baseline alignment off in parallel columns. To reduce or increase the carriage return space between paragraphs, you can choose various leading increments by selecting Size under the Style menu; for custom spacing between paragraphs, you can create a style for *hard spaces* (see "Hard Spaces").

Select Show Invisibles under the View menu to see where carriage returns and other punctuation marks fall. To create this hard-space style, go to the Edit menu and select Style Sheets. Choose New and give the style a name (Hspace-spt, for example). Now choose Character; for this example, set a Helvetica Bold type style at 2 points. (Xpress doesn't allow font point sizes be-

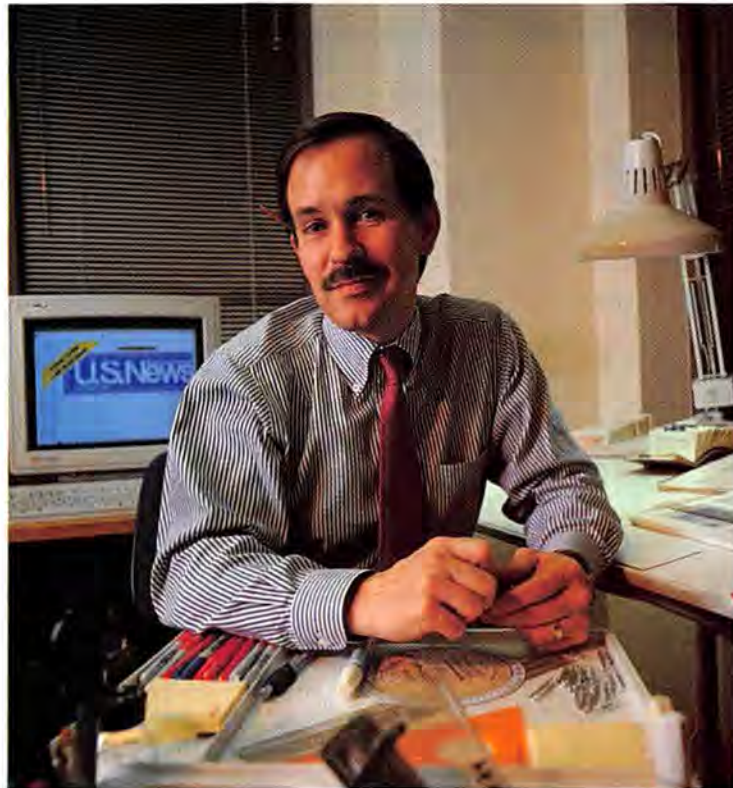

At U.S. News and World Report, art director Rob Covey uses QuarkXpress as a quick color-proofing and mock-up tool for covers and inside pages.

Designer Steve McKinstry specializes in publishing design and consultation. Formerly associate design director for the Chicago Tribune, he now runs a company called Media Design, based in Anacortes, Washington.

low 2 points, and making the type style bold will make the carriage returns wider and easier to see with Invisibles turned on.) Close Character, select Formats, and set the leading to 2 points. Alignment should be on the left side for easy viewing. Highlight the carriage return between paragraphs and choose the Hspace-2pt style you created. The spacing between paragraphs will shrink to 2 points, and each additional carriage return will add another two points of leading. You can now adjust the alignment of text until it's where you want it.

You can base other hard-space styles on this one by renaming the style and

changing the leading and point size to 3, 6, 9, or 12 points. You can also "cheat" a 1-point hard space based on the 2-point style by changing the leading to 1 point under Formats when altering the style.

Adding Bullets to Your Arsenal

Although QuarkXpress 2.0 has no programmed bullet-creation function, here are two methods for producing bullets.

The first method produces indented text with standard fill-character bullets. After creating style attributes for font, size (use 10 point for this example), style, and leading, choose Formats from the Style Sheets dialog box. For this example, set the

(continues)

13

IS NOW YOUR
LUCKY NUMBER



1. 9" x 9" x 3" Padded Pocket for External Disk Drive, Modem, or Accessories.
 2. Padded Compartment for Mouse and Cords.
 3. Padded Compartment fits ANY Extended Keyboard.
 4. Padded Flap separates Hard Disk from Computer.
 5. 1/2" High Density Foam for Maximum Protection.
 6. Navy Blue, Platinum Grey, Jet Black or Burgundy Cordura™ Nylon Outer Shell
 7. Heavy Duty Metal Hardware Throughout.
 8. Stress Points Cross and Box Stitched for Added Support.
 9. Padded Handle for Comfort, features Velcro Enclosure.
 10. 2" Stiff Nylon Webbing Maintains Shape.
 11. Shoulder Strap with Slip Stop Pad.
 12. Outer Handle to Assist in Shoulder Carrying.
- 13. LIFETIME WARRANTY**

Mac Luggage™
ONLY
The Right Choice



For more info on our complete line of Luggage Products. Call or write for a free Color Brochure

or for the dealer nearest You.
1-800-241-2122
IN PA. (215) 524-7277

I/O DESIGN INC.

P.O. Box 156 • EXTON • PA • 19341

ALL TRADEMARKS
ACKNOWLEDGED

Circle 385 on reader service card

How To/Insights



Hard Spaces

Style sheets can be created for "hard spaces" to adjust carriage return space between paragraphs. The style sheets shown here have user-defined \mathbb{R} -key equivalents, an option available in Xpress 2.0 for users with extended keyboards.

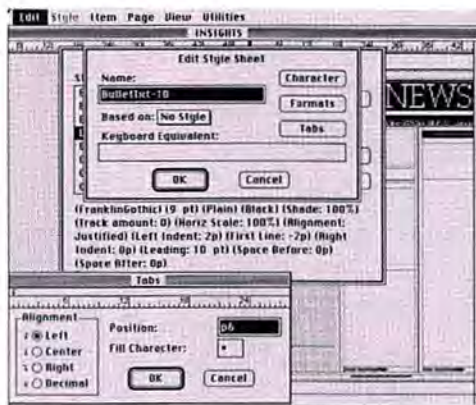

Simple Bullets

Simple bullets can be created by setting tab stops and using a fill character, such as the round bullet selected when choosing Option-8.

right indent to 2 picas. Set the first line indent to -2 picas. And set the space below each paragraph to 1 pica. Next choose Tabs to set one left alignment tab at 6 points (see "Simple Bullets"). Click inside the Fill Character box and press Option-8 to create a circular bullet. This allows just enough space for one solid leader dot to show before the first tab. If you allow too much space, several dots will show; if you allow too little space, no dots will show. Now place a second left alignment tab at 2 picas. Save the changes and apply the style to each paragraph you wish to begin with a standard bullet.

This style will indent each paragraph of bulleted items 2 picas, with 1 pica between each item. The first line of each item will be flush left. At the beginning of each first line, manually tab twice. One solid leader dot will appear in the first 6 points. (10-point type was used for this example. The first tab will need to be set wider when using larger point sizes.)

Use the style above as a basis for the second method, which produces indented text with a custom bullet. Set Tabs for one, and only one, left alignment tab at 2 picas. Delete any fill characters. Save and tag each paragraph you wish to begin with a bullet with this new style. Manually tab once in front of each first line.

Now highlight all paragraphs tagged with this style. Go to the Edit menu and choose Find/Change (\mathbb{R} -F). Click off Ignore Attributes to expand the Find/Change dialog box. Under Find What, enter $\backslash t$ to search for the single tab space in front of the first line of each bulleted item. Under Change To, enter $n \backslash t$ to insert a lowercase n in front of the tab (see "Sophisticated Bullets"). Click on Font and choose Zapf Dingbats. Click on Point Size and choose a desired size. Click on Find Next, then on the Change and Find button. This will replace the tab with a square bullet (the equivalent of a lowercase n). To choose other Zapf Dingbats, substitute their keyboard equivalents for the n in the above example.



Sophisticated Bullets

More sophisticated formatting can be done on bulleted items by using Xpress's Find/Change box. Here a special character and tab stop are searched and replaced with a bullet of a different font and size.

LARRY R. BUYS A POSTSCRIPT® IMAGESETTER.

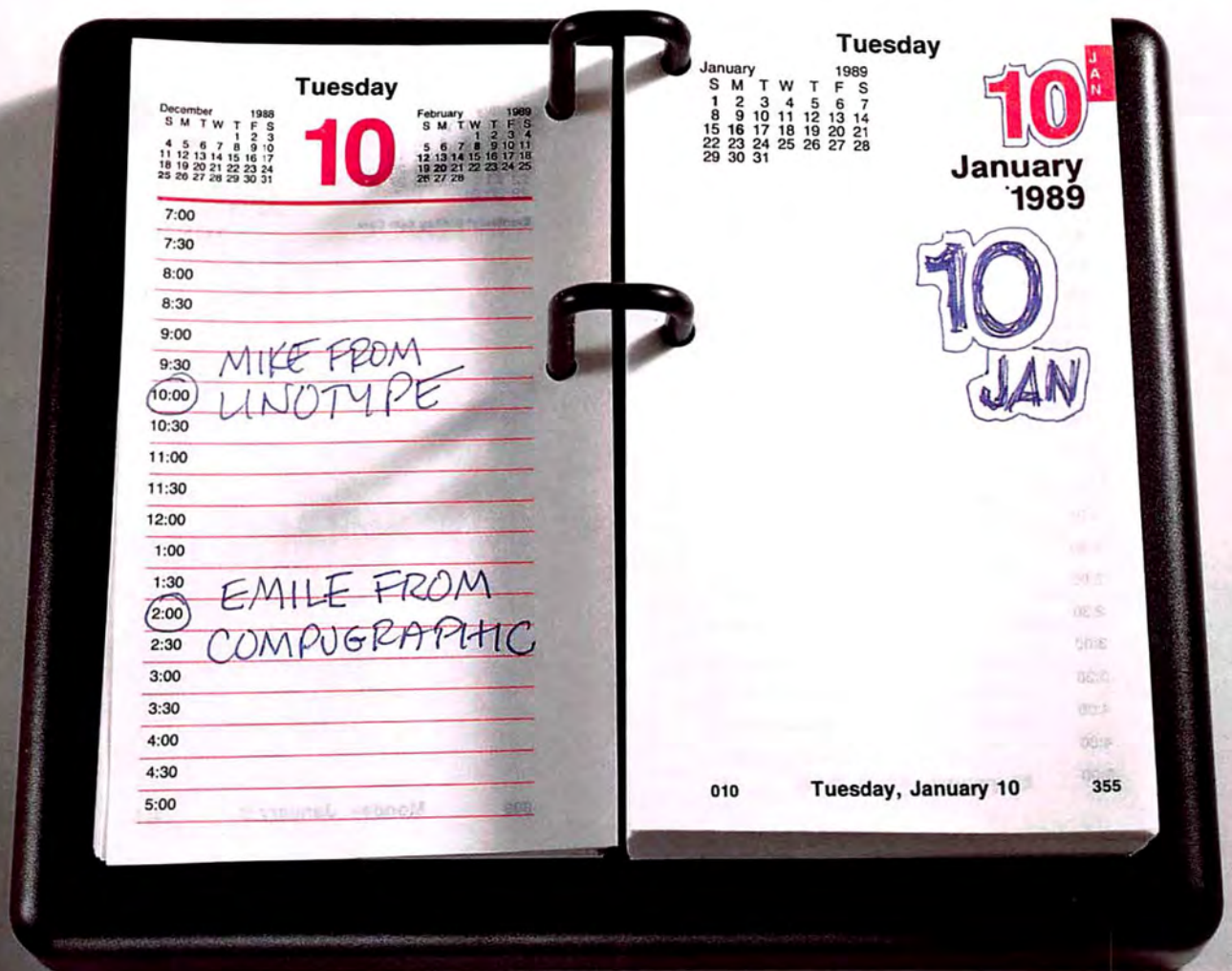



otype Company
Unicorn Park Drive
burn, M
epnor



LINOTYPE - ~~40300~~ - MIKE
10:15

L-300 - 63 K!?. (FONTS EXTRA?)

ARE YOU ONLY
ONE WHO SELLS
POSTSCRIPT
OUTPUT? ~~YES~~

(NO)



L-200 - LOWER RESOLUTION
↑ 1700 DPI NOT ENOUGH

ONLY 3 MB RAM?
GRAPHICS? PERFORMANCE?

CAN L-200 HANDLE NON-POSTSCRIPT
OUTPUT?

(NO)

CAN I USE THIS WITH
MY CURRENT
SYSTEM?

NO



L-200 - "RIP" INTERNAL
HARD TO UPGRADE ??

SERVICE ??



Great Lemon-Lime Soda
12 FL OZ 354 mL

1/89

A
H
C



Utilize
ware
printer
paper
and
images
it has
per inch
the res
printer
of up
CG
fast

AGFA
 AGFA COMPUTOGRAPHIC DIVISION
 Emile Tabassi
 District Sales Manager/Central Region
 1605 Penny Lane Schaumburg, IL 60173 (312) 519-9500



AGFA
 → COMPUTOGRAPHIC - 2:00 PM
 EMILE

9400 PS

IS THIS REAL POSTSCRIPT?

POSTSCRIPT

YES

2400 DPI
 UNDER 40 K!

L-300 RESOLUTION
 L-200 PRICE

- 6 Mb RAM

- 73 FONTS - NO EXTRA \$

SEPARATE "RIP" - EASIER TO UPGRADE

MAC'S, PC'S

CURRENT SYSTEM

9400

LETS YOU KEEP
 OLD SYSTEM
 ADD POSTSCRIPT!

SERVICE - LARGEST IN BUSINESS
 SAME DAY GUARANTEED

WHAT ABOUT AGFA? - SOUND COMPANY
 - PLAIN PAPER PRINTERS
 - HIGH QUALITY FILM
 - "TOTAL PRE-PRESS SUPPLIER"



MAC



BY EMILE TABASSI

DATE 1/23/89

AGFA



AGFA COMPUGRAPHIC DIVISION

DISPATCHED BY

LARRY ROBERTS

NAME (Please Print)

DATE 1/23/89

BY

Larry Roberts
(Signature)

(Effective Date of Agreement)

Like many of you, Larry R. decided it was time to add a POSTSCRIPT® imagesetter to his operation.

So he called in the leading imagesetter vendors—Linotype and AGFA Compugraphic—and listened to what they had to say. He asked a lot of questions. And checked into what their machines could do for him.

Then Larry decided to buy a CG9400-PS POSTSCRIPT laser imagesetter from AGFA Compugraphic.

Why?

Larry found that while many companies now offer POSTSCRIPT imagesetters, the 9400-PS was the only machine that offered the features he needed at a price he could afford.

2400 DPI POSTSCRIPT OUTPUT

Larry's 9400-PS gives him the high-resolution, 2400 dpi output his customers want. Yet it costs less than \$40,000. That's about *half* the cost of a Linotype® L-300. (Their comparably-priced L-200 has a maximum resolution of only 1700 dpi.)

Larry was also concerned about throughput, especially for pages with graphics. He found that the 9400-PS's standard 6MB RAM—two times what the L-200 offers—would let him run complicated jobs without lengthy processing times.

73 ADOBE® FONTS—STANDARD

Of course, to run an imagesetter you need to invest in type fonts. But Larry found that the 9400-PS comes with 73 POSTSCRIPT fonts included *at no extra charge*. That's *sixty* more fonts than Linotype gives you.



POSTSCRIPT

When Larry wants to add type styles to his font library—including new CG TYPE™ for the Macintosh®—he has the room to do so. The 9400-PS can

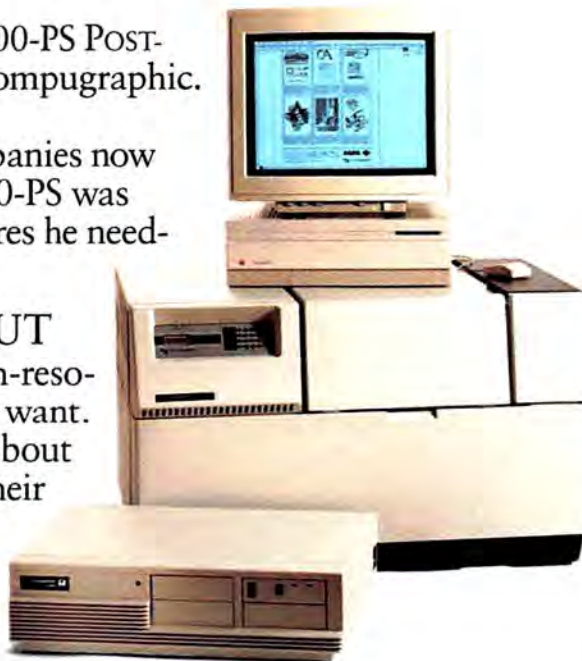

store up to 1,000 fonts on-line, because it has the most standard storage capacity available in a POSTSCRIPT imagesetter.

A BETTER WAY TO ADD POSTSCRIPT

What's more, Larry knows that he can also use the 9400's writing engine to output the non-POSTSCRIPT files that are still a major part of his business—and probably yours.

The 9400-PS was designed with its Adobe® Atlas raster image processor (RIP) as a separate unit. This design lets Larry add our Genics™ RIP to his system to output files from his current Compugraphic front-end system, plus other selected input systems.

The separate RIP concept also means that Larry can upgrade either his RIP or writing engine in the future without having to replace his entire machine.

WORRY-FREE SERVICE AND SUPPORT

Most important, Larry knows that if he needs service, an AGFA Compugraphic service technician will be in his shop within a single business day, guaranteed. AGFA Compugraphic has over 400 service engineers nationwide, *five* times as many as our closest competitor. We can even train his operators to use Macintoshes and popular page layout applications at one of our classrooms around the country.

DOES LARRY SOUND LIKE YOU?

Whether you're a typesetter, printer, publisher, designer, or run an in-plant shop, the 9400-PS is the most cost-effective way to add high-resolution POSTSCRIPT output to your operation.

If you'd like to speak to an AGFA Compugraphic representative or get more information on what the 9400-PS can do for you, send in the attached reply card or give us a call toll-free at 1-800-227-2780.

We'll also send you our free HyperCard™ POSTSCRIPT Overview diskette. It will introduce you to AGFA Compugraphic's family of POSTSCRIPT output devices. (You'll need a Macintosh with HyperCard to view this diskette).



AGFA COMPUGRAPHIC. LARRY'S NEW FAMILY IN POSTSCRIPT® OUTPUT.



Larry's new 9400-PS is part of a growing family of POSTSCRIPT output devices from AGFA Compugraphic. We also offer our new CG9600-PS, our faster POSTSCRIPT imagesetter, and the CG9700-PS, which offers wide-carriage POSTSCRIPT imagesetter output.

AGFA Compugraphic also offers high-performance POSTSCRIPT plain-paper printers. And a full line of high-resolution scanners that let you add line art and continuous tone images to your POSTSCRIPT files.

If you'd like to know more about our imagesetters, plain-paper printers and scanners, call us toll-free at 1-800-227-2780. We'll put you in touch with an AGFA Compugraphic representative or a dealer near you.

AGFA 

AGFA COMPUGRAPHIC DIVISION

Rules that Go with the Flow

Rules placed within a paragraph will not move with the text. Although Xpress doesn't address this problem directly, there is a solution, and it is much like the one for creating a style for hard spaces. But instead of replacing a carriage return with a hard space, you replace it with the underscore feature of the keyboard. Here's how it works. Begin by selecting Style Sheets from the Edit menu. In this example, you will create a style that places a 1-point rule under a 10-point, all caps, subhead style. First create the subhead style in Franklin Gothic Bold (or similar face) with the following attributes: 9 points, all caps, Alignment Left, 9-point leading, and 6 points of space above. Name it HedSubBld-9.

Next create the rule style. Name the style RuleBlk-1 for 1-point black rule. Click on Character, choose a light typeface such as Helvetica Light, and enter 3 points for size. If you choose the underscore key, this will produce a line weight close to 1 point. If you set the horizontal scaling to 300 percent, you will need fewer keystrokes to create a line based on 3 points. Click OK, and then Formats. Set the leading to +0 and the alignment to Left.

Tag the subhead text with the style HedSubBld-9. Add another paragraph return and highlight it. Tag it with the style RuleBlk-1. Using the underscore key, create a rule under the subhead. When the line begins to wrap under the first line, use the Backspace key to return the line to the end of the first line. If the line has a bad fit with the column width, use ⌘- to widen or ⌘ to shorten the line. You now have a 1-point line 6 points under the subhead that will move with the type.

With a little experimentation, you can also create 3-point rules and 6-point rules by substantially increasing the rule's point size and decreasing the scaling and leading. Choosing an extrabold type works best for creating thicker rules.

Forced Justification

The last line in a paragraph of justified text is usually flush with the left-hand margin. You can force that line, or any line, to justify across the column measure. This is particularly useful when you must cut a story in the middle of a paragraph and send the remainder as a text file to someone working on a separate page on another computer. Click the text insertion tool at

the end of the last paragraph line and press Shift-Return. Paragraphs must be in justified text. This feature can also be used to stretch headlines across columns.

Showing Off Your Best Attributes

You don't need style sheets to carry over the alignment, leading, and indent attributes of one paragraph to another. You can use one formatted paragraph to format others.

Make sure the text is in the same text frame, or linked. Format one paragraph, then highlight the others you wish to change to the same style. Position the cursor arrow over the formatted paragraph and use Option-Shift-click. The highlighted paragraphs will change to the formatted style.

Mixing Type Styles

You can change a word or words in a paragraph to another style by highlighting it and changing the attributes one by one under the Style menu. But highlighting a single word in a paragraph and tagging it with a new style converts the entire paragraph to that style. To speed up the process of changing attributes, or to use formatted style sheets, insert a carriage return before and after the word to make it a separate paragraph. Tag the word with a style and delete the carriage returns. Make sure the paragraph is set for absolute leading so spacing from baseline to baseline is the same.

Style Sheet Libraries

A lot of time and effort are invested in creating text and color styles for a publication. Currently, QuarkXpress is unable to export individual styles, although it can copy a document's complete set of styles.

You can create specific libraries of style sheets, however, and here's how: Open a new document and append styles from existing documents to its style sheets. Delete unwanted styles from the list and save the new document, as Style Library-Features Section, for example. Do this for each library needed. This will organize your styles on a more selective basis and minimize the number of style lists.

Because you can export styles to word processing programs, you can speed up the production cycle by having writers use only the styles you want them to use when

(continues)



68030 for the Mac II & the Mac IIX

Step a Generation Ahead

Powerful new Macintosh™ software needs a new generation of hardware. Advanced graphics and engineering software now has the potential to make your Mac II or Mac IIX perform better than high-end workstation costing \$25,000 or more. But software alone won't get you the workstation you need — the DayStar™ 33/030 Accelerator II™ will upgrade your Mac II/IIX hardware into a powerhouse workstation, and at a fraction of the cost.

Take Your Mac II Past Its Limits

Complex illustrating, drawing and CAD layout is no longer a drag, click and wait. The DayStar 33/030 Accelerator II can increase your Mac II/IIX speed from 16 MHz to a blazing fast 33 MHz. A state-of-the-art 33 MHz 68030 processor and high speed data cache adds the power that lets you fly — everything runs at well over twice the speed, and up to four times faster than your standard Mac II/IIX. Kick in the afterburner with the optional 33 MHz 68882 math coprocessor, or use your existing 68881.

The Accelerator II is fully compatible with standard Mac II/IIX software, including A/UX™.



Call our toll-free hotline today to receive the name of the nearest DayStar dealer.

1-800-962-2077

Other brands and product names are trademarks or registered trademarks of their respective holders. Product specifications are subject to change without notice. ©1988 DayStar Digital, Inc.

DAYSTAR

D I G I T A L

5556 Atlanta Highway • Flowery Branch, Georgia 30542
(404) 967-2077 • FAX (404) 967-3018

Circle 477 on reader service card



William Lombardo, Modelmaking & Illustration
Created with Swivel 3D and PixelPaint

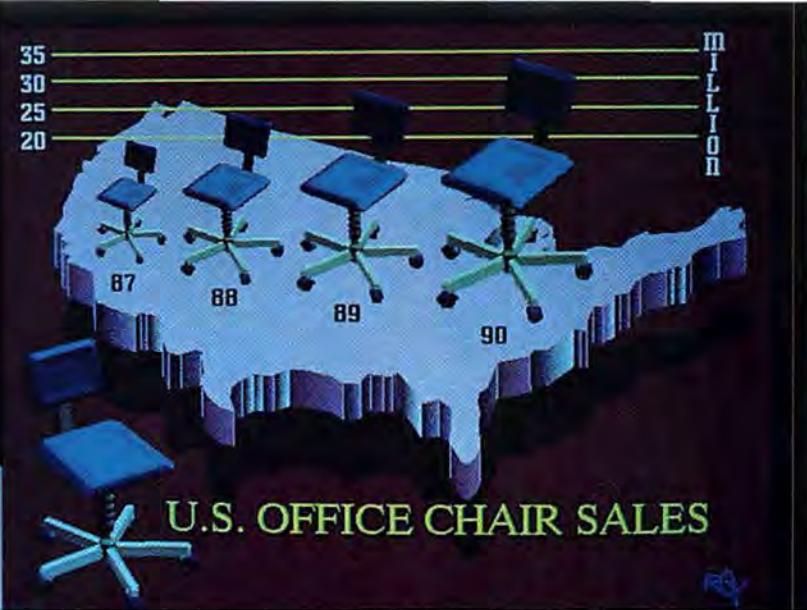

Roy Santiago, Business Presentation
Animated Swivel 3D images in VideoWorks

*"A superb presentation tool...
Swivel 3D raises the standard of
3-D graphics on the Macintosh."*
Joost Romeu, MacWeek

*"It's a speed-demon. It's your
basic \$395 must-have."*
Salvatore Parascadolo, MacUser

*"Creating objects with complex
surfaces couldn't be easier...only
Swivel 3D lets you cast shadows
on images."*
David Peltz, MacWorld



Jim Ludtke, Graphic Artist
Magazine illustration created with Swivel 3D.

*"An amazing 3-D visualization
tool that is easier to use than
any of the 3-D packages...."*
Laslo Vespremi, MacWeek

*"The most intuitive interface ever
created for moving around in a
computer environment....
A visualization tool that will keep
you up around the clock —
with a smile on your face."*
Jack Davis, Verbum

Paracomp Redefines the Graphics Standard

Swivel 3D, the essential Graphics Tool

Swivel 3D lets you create stunning graphics never before possible. By simply rotating, scaling and casting shadows, Swivel 3D generates a limitless amount of images from a single 3D drawing. Explore presentation ideas quickly — you have the power to produce your best graphic presentations and animations.

Create beautiful illustrations by combining the visual power of Swivel 3D's images with the special effects found in today's graphic applications. Swivel 3D's presentation images can be easily moved to popular paint and draw programs. For animation, Swivel 3D pastes a series of color animation frames to the Scrapbook which you can easily import into VideoWorks or Hypercard.

Swivel 3D is the first and only program to feature Linking. Linking allows you to create realistic images with wheels, doors, levers, arms, legs, and objects that move.

An extensive library of images, shapes and alphabets, is included. Swivel 3D is a powerful graphics program for anyone involved in animation, business presentations, and graphic design — *it is the essential tool for all of your graphic needs.*



Three-Dimensional
Drawing/Modeling
for the Macintosh.

Suggested Retail
Price: \$395

Minimum System
Requirements: 1 meg

PARACOMP

Paracomp, Inc.
123 Townsend Street, Suite 310
San Francisco, CA 94107, 415-543-3848

preparing a document. This encourages consistency in formatting and helps writers organize their information. It also saves paragraph tagging during pagination.

To make your styles part of the default system, use the menu selections available after launching Xpress (before opening a document on the desktop) to append styles and colors.

Using PageMaker Style Sheets

You can use Microsoft Word to import PageMaker style sheets into Xpress. In PageMaker, use the Export command under the File menu to export selected document text using the Microsoft Word 3.0 file format. Do not select the Export Tags option. The file, with its text and tagged styles, can be opened in Xpress using the Get Text command in the File menu. Click on Include Style Sheets when selecting the text file to be placed. Most of the style attributes (font, size, indents, leading, tabs, and so on) are carried over as new styles in Xpress. Attributes (color, for one) that are not supported by style sheets in Microsoft Word cannot be carried over. Xpress style sheets can be imported into PageMaker by opening them in Microsoft Word and saving them as Word files.

Tempting Templates

Creating templates saves time. They can include positioned-picture frames and text frames with all the style attributes of color, shading, rules, spacing, tabs, indents, font, and size. When you open a saved template and enter type in the formatted text frame, the style attributes assigned to that frame automatically apply to the typed text.

This also works when you're placing text from a document, but there's a hitch. If the text is placed from a word processor, the style attributes of the word processor file override the formatted text frame's style attributes and you will have to format all over again. However, if you save the text from the word processor in ASCII format first and then place it, the style attributes of the formatted text frame will apply to the placed text.

Minitemplates can be created as a library of formatted elements. Because Xpress can open more than one document

at a time, separate documents of elements such as jump lines, quotes, and drop caps can be created in library documents (see "Format Libraries"). You can open this

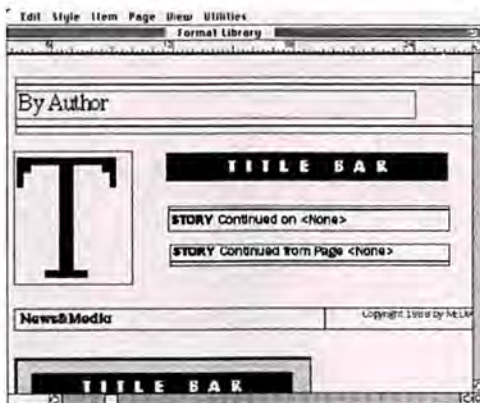

Format Libraries

Additional Xpress libraries can store design elements that are resized, colored, and formatted. Users can cut and paste these elements into documents as needed, saving formatting time.

document as a second window while working on a page and copy the items into position as needed.

You can design, store, and position quote styles, logos, and photographs as needed. Remember to design their elements within their own parent box so they can be moved together. Here are a few more examples:

A customized dummy initial cap (*T*, for example) can be stored within a small text frame in a variety of line depths, point sizes, font styles, and colors. When you need a drop cap, go to your library of formatted elements and copy and position the cap into a text paragraph for an automatic wrap. Delete the first text character in the paragraph and retype it or paste it in place of the dummy initial cap. Adjust the width of the text box as needed.

Jump lines can be stored with their automatic page-numbering information. Then they can be copied from the library and positioned for instant numbering of jump lines to the next page. Real keywords (or story slugs) typed over these dummy positions will pick up the underlying style attributes.

(continues)

Whooshhhhh!



Mac20MX Accelerator

For the SE, Plus and 512Ke

The highly rated Novy Mac20MX accelerator can move your Macintosh™ into high gear. Upgrade our SE, Plus, or 512Ke for less than one-third the price of a Mac II and achieve equal or better speed. The Mac20MX will dramatically increase your desktop performance. Move through page layout as fast as you can move your mouse. Spreadsheets scroll and calculate in a fraction of the time. Engineering CAD is a breeze.

Go Fast or Faster

The Mac20MX uses a 32-bit 68020 processor and comes in 16 or 25 MHz speeds. The 16 MHz version races with the Mac II—that's four times faster than your basic Macintosh. You will speed your Macintosh up an amazing six times faster with the 25 MHz version. Or purchase the 16 MHz version today and you can upgrade to 25 MHz at any time. On top of this, spreadsheet and CAD number crunching will fly up to one hundred times faster with the optional 68881 math coprocessor.

Easy to Handle

Our special features can optimize your Macintosh operations. Hard drives will operate properly, and most big screen monitors will plug right in and go to work. Sound quality is faithfully maintained at all speeds. Games and old software can still run with the original 68000 processor.

Call our toll-free hotline today to receive the name of the nearest DayStar dealer.

1-800-962-2077

Other brands and product names are trademarks or registered trademarks of their respective holders. Product specifications are subject to change without notice. © 1988 DayStar Digital, Inc.

DAYSTAR

D I G I T A L

5556 Atlanta Highway • Flowery Branch, Georgia 30542
(404) 967-2077 • FAX (404) 967-3018

Circle 476 on reader service card

Before you give your next presentation, press this button.

**NEW!
VIDEOSHOW®
FOR YOUR
MACINTOSH**

Turn Desktop Presentations Into Conference Room Power

Your Macintosh® is one of the best tools around for creating great presentation images. Now VideoShow® can take those images into the conference room where you'll really impress your audience with high-resolution presentations in up to 100,000 brilliant colors on screen. And it's as easy as pressing a button.

Create your images with your favorite graphics or presentation software like Microsoft® PowerPoint™, Aldus® Persuasion™, Symantec™ MORE II™, etc. Then take your presentation diskette from your Macintosh into the conference room. Insert it into VideoShow and press the button.

VideoShow turns your images into exciting, board-room-quality presentations with dynamic transition effects, all in brilliant full color. Even if you've created your images on a Mac® SE or Plus.

And your Macintosh can remain in your office while you're in the conference room. Just connect VideoShow to a color monitor or large-screen video projector. Insert your presentation disk, and press the button.

Easy On Your Budget

With three models, starting at \$1795, there's a VideoShow unit to fit every budget and presentation



VideoShow's wireless remote control puts you in complete command of your presentation.

need. And VideoShow can operate as the cornerstone of a full system for creating presentations in a variety of media.

Brilliant Slides, Too

When you need professional quality high-resolution slides, simply add PhotoMetric® SlideMaker® to turn your great images into great slides. At your desk. No guesswork. No service bureaus. No delays. No problems.

And Instant Overheads

VideoShow with PrintMaker® software and a color printer, produces sharp, brilliantly colored overhead transparencies and hard-copy handouts. Easily and instantly.

You have to see VideoShow to believe it. Call today 800-556-1234, ext. 234. In California, call 800-441-2345, ext. 234.

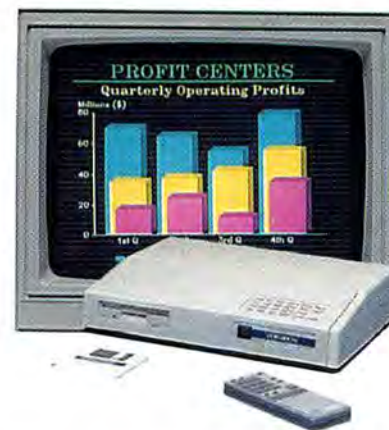

VideoShow is an electronic presentation unit for outstanding conference room presentations.

General Parametrics Corporation The leader in desktop presentation products

Trademark/Owner: Aldus, Persuasion/Aldus Corporation; Mac, Macintosh/Apple Computer, Inc.; PhotoMetric, PrintMaker, SlideMaker, VideoShow/General Parametrics Corporation; Microsoft, PowerPoint/Microsoft Corporation; MORE II, Symantec/Symantec Corporation.

Circle 467 on reader service card

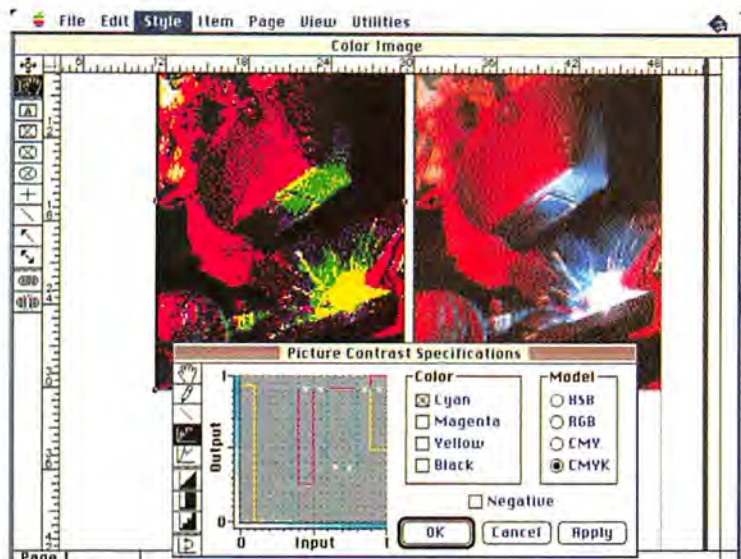

Contrast Control
These two images illustrate Xpress's ability to alter the contrast curves in all four colors for special effects.

Color Kudos

Xpress offers separation features for spot colors or combined four-color plates made up of CMYK values. Unfortunately, you can't see Illustrator images in color because Illustrator does not save and load a color bitmap image of the file. You can see FreeHand illustrations in color, but they don't separate out with the Xpress colors in CMYK.

Mixing colors in Xpress is similar to creating style sheets. According to Xpress's manual, you can mix colors by dragging the cursor through a color wheel. This feature does not work in Xpress 2.0, however, and you must enter CMYK percentages numerically, creating a small color swatch along with the color. Name the new color and it, as well as the swatch, becomes part of your permanent color style for that document.

For accurate color percentages, mix your colors according to a printer's color guide, not according to the colors appearing on the screen. You will have a better chance of getting the correct screen values for the final printing. Like the style sheets, colors can be appended and managed through custom libraries. The same percentages of color mixed in Illustrator and QuarkXpress will print differently. Quark is planning to fix this problem in a future release.

Xpress offers a complete line of Pantone colors that are truer to their on-screen representation than CMYK colors because they were created with their RGB (red-green-blue) counterparts. Pantone colors can be selected by color or number. You can separate the colors into CMYK values

by selecting CMYK after selecting the Pantone color and turning on the separation process.

Changing Your Image

QuarkXpress's imaging features now offer expanded controls over modifying color images. Achieve special contrast effects on color images by manipulating the contrast line (see "Contrast Control"). You can alter individual color contrast on imported color images for HSB (hue, saturation and brightness), CMYK, CMY (cyan, magenta, and yellow), and RGB values.

Although Xpress's black-and-white controls can't compete with the editing features of stand-alone programs like ImageStudio and Digital Darkroom, they do have their uses. For example, you can change the screen pattern from dot to line. (Note, however, that you won't see these changes until printed.) You can change black-and-white bitmapped, TIFF, and other image formats supported by Xpress by adding a color or screen tint in addition to the special contrast effects.

Other Tips?

If you've found a shortcut or undocumented trick that's not mentioned here, share it with other *Macworld* readers by sending it to *Quick Tips*, *Macworld*, 501 Second St., San Francisco, CA 94107. □

See *Where to Buy* for contact information.

AppleShare Clone.



Affordable AppleShare Compatible File Server

Convert your PC or PS/2® into an AppleShare™ compatible file server with the DayStar FS100 File Server System. It works just like a dedicated AppleShare server, allowing Macs and PC's to share storage space and exchange files on the server. The FS100 is the most cost-effective server available. Take advantage of inexpensive PC, XT and AT clones, or bring your old surplus machines back into service. It's simple to install and offers remote administration from both Macs and PC's.

Plug Micro Channel into LocalTalk™

Connect the IBM® PS/2 Micro Channel or PC, XT, AT and compatibles directly into the LocalTalk network with the DayStar LT200 Interface Boards. With the LT200, a PS/2 or PC will access TOPs, E-Mail, or AppleShare programs. Additionally, you can print from virtually any DOS application to PostScript® compatible printers, including the Apple® LaserWriter.®



Call our toll-free hotline today to receive the name of the nearest DayStar dealer.

1-800-962-2077

Other brands and product names are trademarks or registered trademarks of their respective holders. Product specifications are subject to change without notice. ©1988 DayStar Digital, Inc.

DAYSTAR

D I G I T A L

5556 Atlanta Highway • Flowery Branch, Georgia 30542
(404) 967-2077 • FAX (404) 967-3018

Circle 404 on reader service card

I N T R O D U C I N G



GRAPHICIST Paint III

**A new and advanced paint,
editing and special effects program.**

For the serious artist, with capabilities and speed
beyond any other Macintosh paint software

CUSTOMIZING COLOR PALETTES Create and save your own set of colors — one at a time with color picker, or a range of colors using RGB and/or HLS tables. Blend any range of colors from 2 to 256. Change palettes to change the color scheme of any illustration.



New, Exclusive "Magic-like" Special Effects

- 2 Layers with Paint and Edit features on both.
- Incrust selected images from Stencil layer onto top layer.
- New Pixel Brush allows you to create customized paint brushes.
- New "water drop" tool allows selective blending of colors.
- New "thermometer" displays colors on the palette.
- New spherization of any image including text.
- Two to ten times faster than any other advanced Macintosh paint or draw program.

Graphist Paint II is a new hi-end paint program with all of the standard painting tools, file formats and 16 Macintosh standard modes . . . PLUS you can:

- Import all of the standard formats, PixelPaint and video inputs (driver built-in) including PAINT, PICT I and II, TIFF and RIFF.
- Export many different formats for direct integration with other software to provide a more complete and better art solution.
- Digitize existing images from a video camera or a television (NTSC or PAL) with on-screen viewing, for subsequent editing.
- Select from 16.7 Million colors, supporting 1 palette of 256 colors at a time, on each of 2 screens.
- Pixel by pixel editing.

INCRUSTING

Take any two images, on two layers . . . incrust an image from one onto the other — in any position — or onto any other illustration — in any position — or back onto the full original.



Main original



Incrusting in progress



Incrusting completed

SPHERIZATION

Take any image, or text . . . define the area . . . and create a 3-D sphere of the entire image, or text.



Spherize Type



Spherize Art



Create Custom Spheres

CUSTOM COLOR MANAGEMENT

Customize color palettes by changing RGB and/or HLS wave forms — or use the standard Macintosh color picker.

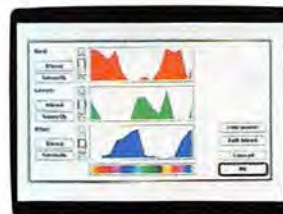

Red, Green, Blue wave form

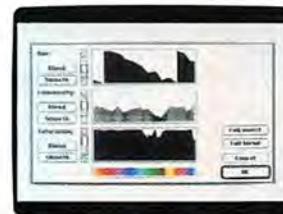

Hue, Luminosity, Saturation wave form



Macintosh Color Picker

Graphist Paint II is packed with so many new features you'll want to get your hands on it right away. For full information and the name of the Graphist Paint dealer nearest to you call:
1-800-234-0230.



SOFTWARE

Aba Software, Inc.
41 Great Valley Parkway
Malvern, PA 19355

Circle 340 on reader service card

PixelPaint is a registered trademark of SuperMac Software, a Division of Scientific Micro Systems.



United Stations.



If your business is using AppleTalk networks, then you're ready for the next big advance in office communications.

Introducing Timbuktu, the new application for your network that lets you access and share resources. It's just what you'd expect from the people who brought you the PhoneNET System.

Granted, the name is a little unconventional. But the time and money Timbuktu saves will appeal to even the most conservative minds.

Install Timbuktu on each Macintosh, and everyone on the network can access other Macintoshes, share screens, and control the operation of each other's computers. In fact, you can access your own computer from another computer on the network. (Our companion product, Timbuktu/Remote, works the same way over modems.)

So, if you're the one who's always fixing things on the network, helping solve computer puzzles, and other office heroics, then leave your running shoes at home.

Now, you can identify problems on any Macintosh, reconfigure or update software, teach people new applications, or manage servers and other shared resources. Right from your own Macintosh. Or any other Macintosh, for that matter.

For those pressured with meeting the demand for more computing power, while justifying the cost to management, Timbuktu offers a profitable solution. And relief.

Timbuktu lets everyone access any workstation and its databases, FAX modems, print spoolers, servers, and main-frame connections. If you're concerned about security, the password protection feature will limit access to any device. You can also use Macintosh IIs as servers without buying keyboards, monitors, or video cards.

Timbuktu. What we're talking about is people working together, sharing resources, and helping each other get the job done. Only now you can do it over the network, with united stations. To find out more about Timbuktu and the rest of the PhoneNET System, call (415) 849-2331 for the Farallon dealer nearest you.

 **Farallon**™

2150 Kittredge Street, Berkeley, CA 94704

Macworld News

by Tom Moran

Tektronix Color Printer

 In answer to the Macintosh II world's clamor for a better color printer, Tektronix has rolled out a color ink-jet printer and an upgraded version of its existing 4693D, a 300-dpi thermal transfer printer. In addition, Tektronix introduced a three-part family of phaser printers. One part, the printer controller, drives the other two parts—a PostScript-compatible, thermal color printer, and a monochrome laser printer.

The heart of the Phaser family is a Mac II-size box called the Phaser PrintStation. The box contains a printer controller with 8MB of memory (expandable to 11MB), a 40MB hard disk, and an AppleTalk connector. A color interpreter supports both PostScript and *HPGL* (the language that drives most pen plotters), and you can reprogram the interpreter to work with any Tektronix color printer (only one at a time, however). The 40MB hard disk contains the same 35 fonts available on an Apple LaserWriter, and it can spool images. PrintStation software lets users on a network check the spooler in order to see what jobs are there and to control their own print jobs.

The Phaser PrintStation, bundled with the PostScript color printer engine, costs under \$16,000—\$6000 less than the equivalent QMS PostScript



MIKE DAHLSTROM

Tektronix's Phaser PrintStation can drive the company's thermal color printer and monochrome laser printer. Its ColorQuick Ink-Jet Printer is specially designed for the Mac II.

thermal printer. The laser printer costs another \$3000, still keeping the cost below that of the QMS printer. You can attach an Apple LaserWriter to the PrintStation through a serial port, and use the LaserWriter as a spool server. In addition, you can purchase a second controller board so you can have two color printers, two black-and-white printers, and a LaserWriter, all attached to a network at once.

Even though the Phaser family's price is comparatively low and the set-up flexible, you may well question whether the output you get from any PostScript color thermal printer is worth the cost. In order to produce a large palette of colors, the

printer dithers seven basic colors. (Dithering involves alternating the dots of different colors to produce a new color.) Thus the apparent resolution dips far below the actual 300 dots per inch (dpi), making the output unsuitable for camera-ready art. In addition, it's nearly impossible to match colors on the Mac II's screen with colors on the printout.

On the other hand, Tektronix has given users an inexpensive way to get reasonable color printouts from a Mac II. The new ColorQuick Ink-jet Printer, which costs less than \$3000, is the first color ink-jet printer specifically designed for the Macintosh. Others, such as Hewlett-Packard's PaintJet (which was originally designed to work with IBM PCs), require special third-party drivers,

making them incompatible with much of the available software. The ColorQuick, however, uses a Chooser-level QuickDraw driver that works with all QuickDraw applications and supports bitmap fonts.

Even better, the ColorQuick can produce 4096 colors at 216 dpi, by *manual dithering*—you create colors by making patterns of dots. In comparison, both the PaintJet and the Sharp JX-730 print at only 180 dpi. Also unlike the PaintJet and the Sharp, the ColorQuick can be ordered with a SCSI port for faster printing speeds. The printer can print on plain or coated paper, or on transparency film at one minute per

(continues)



**Create a 3.5"
Micro Diskette
with unlimited
protection against
a hostile world.**

You're covered. BASF molds the rigid plastic jacket of its 3.5" Micro Diskette to its own specifications, providing unsurpassed protection for the flexible disk within. Call 800-343-4600 for the name of your nearest supplier.

The Spirit of Innovation.



Circle 479 on reader service card

page in draft mode (lower resolution), and two minutes per page in full resolution mode. The printer accepts letter- or legal-size paper, as well as 11-by-17-inch and 12-by-18-inch paper, so you can produce full 11-by-17-inch prints with margins and no image loss.

If you want to use the ColorQuick on an AppleTalk network, you can attach it to the Phaser PrintStation. Later versions of the ColorQuick will support the SE directly and include outline fonts.

For an encore, Tektronix has enhanced its 4693D Color Image Printer. This 300-dpi thermal printer now accepts full resolution, 24-bit color images in its minimum configuration of 4MB of memory, and prints those images at 300 dpi. Fully loaded with 12MB the printer can hold three full images instead of the previous limit of two. And Tektronix has tweaked the color matching capabilities so that printed blues and greens match the screen slightly better. But don't plan to sell that Scitex system any time soon. For more information, contact Tektronix, P.O. Box 14689, Portland, OR 97215; 800/225-5434. —Cheryl Spencer

Identity Online



Wolff Olins, one of Europe's oldest and largest design firms, has gone all-Mac. The London-based company, known for its pioneering work in the field of corporate identity, has 30 Macs in place, 6 of them Mac IIs. It uses the machines to design total corporate-image packages—everything from offices to office forms to vehicles to products. The company's directors believe that the Mac offers unique design solutions and makes design modification more efficient.



Wolff Olins designed this logo when the FFI Group became the 3I Corporation.

Claude Alverson, director of Wolff Olins's new San Francisco branch office, envisions even more far-reaching uses for the Mac. His corporate-design proposals always state that the client must acquire a Mac. Then the Corporate Book, which is a recipe book containing all graphic representations of a company's symbol and specifications about how it should appear, is created and delivered online to the client for ongoing use. When an employee is hired, for example, new business cards can be instantly created from the database of designs in the Corporate Book without the original artwork.

The result? A consistent visual identity. And Wolff Olins plans to market software that

will enable any company to create its own recipe book from all of its pre-existing symbols.

Company chairman Wally Olins states the organization's design philosophy: "Strategy, structure, and style, rather than mere logos, are the basis for a good corporate identity." For further information, contact Claude Alverson at Wolff-Olins, in San Francisco, California, at 415/981-2400.—Fern Friedman

Workstation-Class CAD/CAM for the Mac II



Apple has always touted the Mac II as a good computer for CAD/CAM. Now the fourth-largest mechanical CAD/CAM software company in the world—The Schlumberger Technologies CAD/CAM Division of Ann Arbor, Michigan—is making its existing Bravo3 CAD/CAM software available on the Macintosh. Called MacBravo, this product line uses source

code that is the same as that of Schlumberger's VAX main-frame version.

MacBravo consists of three very Mac-like elements: MacBravo Modeler, a \$1495 3-D wireframe and surface modeler package; MacBravo Detailer, a \$1995 drafting package; and a \$495 IGES translator. The three may also be obtained together for \$3295.

MacBravo Modeler supports warped, swept, ruled, and offset surfaces, as well as surface intersections. It provides extensive geometric construction capability and lets you work in 2-D work planes, which are then combined to form precise 3-D models. These models incorporate IEEE standard dou-



Schlumberger's Bravo3 CAD/CAM software is now available as MacBravo for the Mac.

ble-precision floating point calculations, which is important for machining accuracy. The software allows up to eight model viewports to be simultaneously displayed; each can be saved, zoomed, and rotated. MacBravo Detailer also references the 3-D models.

In addition to doing 2-D mechanical detail drafting, MacBravo Detailer also operates in conjunction with MacBravo Modeler for detailing 3-D models. It conforms with ANSI, ISO, and DIN dimensioning standards, and has extensive geometric construction, dimensioning, text, and labeling facilities. You can display 3-D models in a 3-D viewport while 2-D views are being created.

(continues)

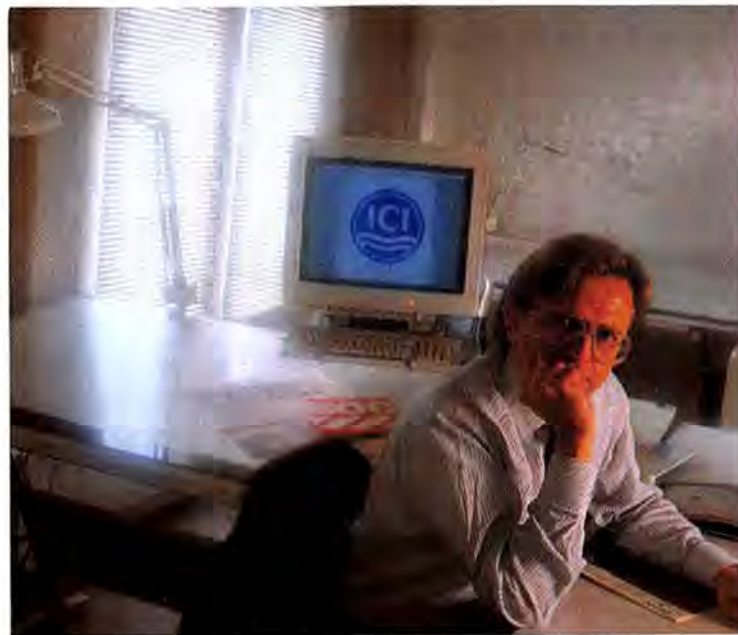

Claude Alverson heads the San Francisco office of Wolff Olins, a London-based international design firm that has gone all-Mac.

DAN ENCOBAR

Built to scale

If you design on a Mac II, a screen that's too small will cramp your style. That's why you should be looking into a SilverView from Sigma Designs.

At 21", this landscape monitor offers the biggest viewing area anywhere. A full 16" x 12" 2-page spread including rulers and margins.

Which means you can finally work in actual size. A fact that's also made possible by SilverView's 72 dots per inch typesetting standard.

Something else should weigh in our favor.

The gray scale.

Besides black and white, there are SilverView models offering 16 or all 256 different shades of gray. So what you used to leave up to the imagination can now be in all your work. Like subtle halftones or delicate shadings.

SilverView's also remarkably comfortable to work with. Its high contrast flat-screen virtually eliminates glare and distortion. And its unusually high refresh rate delivers rock solid images that never flicker.

To find out just how much better your work can look, call Sigma Designs at (415) 770-0100 today.

Then never scale down your ideas.



Sigma Designs, Inc.
46501 Landing Parkway
Fremont, CA 94538

PageView, SilverView and ColorMAX are trademarks of Sigma Designs, Inc.
MAC SE and Mac II are registered trademarks of Apple Computer, Inc.

Circle 117 on reader service card

MacBravo Modeler and Detailer both are user-customizable and provide parametric programming and a unique (patented) Mousestroke Recognition System, which lets you draw symbols with the mouse to initiate common operations. Both packages support the LaserWriter, the ImageWriter, and a variety of pen plotters. You can import and export files in Clipboard, IGES, PICT, and Interleaf publishing system formats, and NFA (Network File Access) format for VAX systems.

MacBravo will be marketed exclusively through a cadre of Apple-trained resellers. For further information, contact Schlumberger Technologies in Ann Arbor, Michigan, at 313/995-6000.—David L. Peltz

Hey Milo, Can You Help Me with My Math?

M Got the concept of step-functions, but too tired to calculate another step? Paracomp's Milo, the first WYSIWYG mathematical problem solver for the Macintosh, helps execute common math operations quickly and easily. Milo includes a technical word-processing capability, graphics tools, and a symbolic algebra program.

"Milo is like an intelligent piece of paper," according to Ron Avitur, who developed the program as a student at Stanford University. "The user guides the mathematics, but Milo does all the work." The program lets you manipulate complicated math expressions by clicking the mouse, and create scientific documents with the word processor while performing algebraic computations. Another first for Milo is that the documents can contain

mathematical expressions combined with normal text and graphics. Milo has a suggested retail price of \$249.95 and is available from Paracomp or from distributors including Softsel and Bonsu.

Adding credence to the notion that the Mac is becoming a complete CAD machine, Paracomp is also introducing MacVLSI, a software package for designing and laying out Very Large Scale Integrated (VLSI) chips. MacVLSI will cost about \$3000 when it becomes available in March (a less expensive academic version with fewer features will also be offered). For more information call Paracomp in San Francisco, at 415/543-3848.

Cactus Slices Up Broadband

C Cactus Computer has introduced the BroadTalk adapter board for connecting the Mac II to a broadband network.

A broadband network, unlike other LANs such as LocalTalk and Ethernet, divides the transmission capacity on the wire into *segments*, in much the same way that a cable TV transmission supports multiple channels on one cable. (In fact,

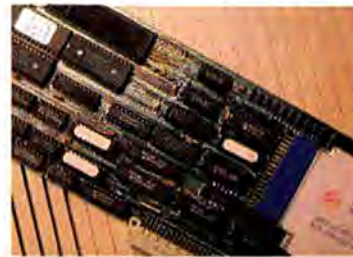

Cactus's board connects the II to a broadband network.

some broadband networks also carry closed-circuit video.) Each channel transmits at a different frequency, and you adjust the boards on your computer to receive that frequency.

The BroadTalk board allows the user to choose among four frequencies, one of which is used by the IBM PC Network, meaning that Mac users can communicate with PCs on that kind of LAN. The board includes a plug-in, 2 megabit-per-second broadband modem module that you can easily replace to change frequencies.

With an Ethernet Adaptor Module, the board can also be used as a standard Mac II Ethernet adapter, transmitting at 10 megabits per second.

Cactus also offers a BroadTalk-Ethernet gateway, which allows users on a broadband network to communicate with users on an Ethernet network.

The BroadTalk Adaptor Board with a Broadband Module costs \$895, while an adapter with an Ethernet Adaptor

Module costs \$745. The Broadband Module and the Ethernet Adaptor Module are also available separately for \$350 and \$200, respectively. The BroadTalk-Ethernet Gateway costs \$3550. For further information, contact Cactus Computer, in Carrollton, Texas, at 214/416-0525.—Sharon Fisher

A Mac's Brain in a PC Body?



In a continuing attempt to make the IBM PC look more like a Macintosh, IBM and Microsoft have shipped version 1.1 of Operating System/2 (OS/2) with the Presentation Manager graphical user interface—a



OS/2 1.1 ships with the Presentation Manager graphical user interface.

multitasking, single-user operating system that uses the protected-mode operation of PCs based on 80286 and 80386 microprocessors. It allows users to tap up to 16MB of memory or up to 1GB of virtual memory.

Other features new in OS/2 1.1 include allowance for a single file to be larger than 32MB, as well as support for the named-pipes interface, a method for communicating between processes and programs that is easier and faster than existing methods on the PC.

It's recommended that PCs running OS/2 have at least 2MB of memory, or 2.5 MB if they're

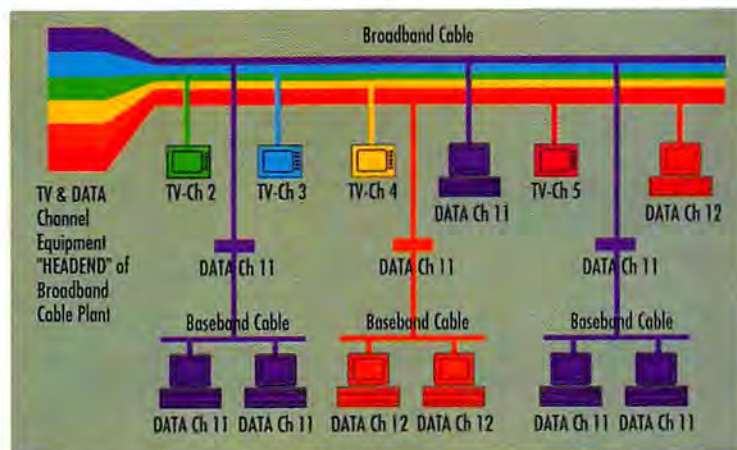

Cactus Computer helps Mac II users connect to broadband networks, which divide the transmission capacity into segments. You adjust your computer's boards to receive at different frequencies.

(continues)

OVERNIGHT • EXPRESS • SERVICE*

Accessories

Abaton	
Pro Point (Mac SE/II)	113.
Addison Wesley	
Inside Macintosh, Vol. 1-4 ea.	21.
Inside Macintosh, Vol. 5	23.
Asher Engineering	
Turbo Trackball ADB (Mac SE/II) ..	85.
Bantam Books	
Adobe Illustrator: Handbook	19.
Hypercard Handbook	23.
Benko-Wren	
Macstation II	75.
Datadesk	
Hyper Dialer	29.
Mac 101 Keyboard	149.
Ergotron	
MacTilt SE/512k/Plus	72.
Mouse Cleaner 360°	12.
Golden Ribbons	
Imagewriter Ribbons -Black	4.
Kalmar Designs - Teakwood Disk File	
Cabinet (Holds 45 Disks)	19.
Cabinet (Holds 90 Disks)	29.
Kensington Microware	
System Saver Mac Fan	68.
Turbo Mouse	119.
Kraft	
Joystick (Quickstick) ADB	39.
Mac Packs - Grey, Wine, Navy	
Imagewriter Bag	49.
Mac Plus/SE Bag	68.
Mac SE Bag XI (Extended Keyboard) ..	74.
Mac Zone	
Noise & Surge Protector	24.
800k Disk Drive	189.
Mouse Pad	6.
Tool Kit To Open Mac	20.
MSC Technologies	
A+ Mouse ADB (SE/Mac II)	85.
A+ Mouse (512/Plus)	65.
Orange Micro	
Grappler Mac	78.
Grappler Mac LO	91.
Grappler Mac LS	99.
Scancofurn	
Mac Table With Cabinet	375.
Smith & Bellows - Diskette Chest	
Mahogany (Holds 96 Disks)	35.
Sony Disks	
Double Sided - 10 Pack	18.
Double Sided - Bulk	1.75 each
Single Sided - 10 Pack	14.
Single Sided - Bulk	1.20 each
Sopris Softworks - Blue, Wine, Grey	
Imagewriter I or II Bag	45.
Mac 512/Plus/SE Bag	50.
Mac SE (Ext. Keyboard) Bag	68.

Business

Acius	
4th Dimension	Call
AEC Information Management	
AEC Information Manager	575.
Aegis Development	
Doug Clapp's Word Tools	45.
Ashton Tate	
Dbase Mac	298.
Full Write Professional	248.
Borland	
Reflex Plus	189.
Compuserve	
Compuserve Starter Kit	25.
Cricket Software	
Cricket Graph	118.
Dataviz	
Mac Link Plus W/Cable	139.

Deneba Software	
Coach Professional	109.
Coach Thesaurus	36.
Electronic Arts	
Thunder	32.
Fox Software	
Foxbase+/Mac	209.
Freesoft	
Red Ryder 10.3	54.
Lundeen & Associates	
Works Plus Command	62.
Works Plus Spell 1.1	47.
Mecca	
Managing Your Money	128.
Mediagenic	
Focal Point II	128.
Reports	68.
Micro Lytics	
Gofer	44.
Word Finder	34.
Microsoft	
Excel	249.
File 2.0	139.
Word	249.
Works 2.0	198.
Write	113.
Monogram	
Dollars & Sense 4.0	80.
Business Sense	262.
Odesta	
Double Helix Release 2	337.
Olduvai Software	
Read-It!	199.
Read-It! (for Thunderscan)	79.
Peripherals Computers & Supplies	
Kaleidagraph V1.1	124.
Versa Term Pro 2.20	198.
Versa Term V 3.20	68.
Personal Bibliographic	
Pro-Cite	295.
Select Micro Systems	
Map Maker 3.X	221.
Softview	
MacinTax 1988	64.
Tax View Planner	48.
Software Discoveries	
Record Holder Plus	44.
Software Ventures	
Microphone 1.5	109.
Microphone II	221.
Survivor Software	
Mac Money V. 3.0	64.
Symantec	
MacSQZ! 1.5	49.
More II	249.
T/Maker	
Write Now 2.0	119.
Traveling Software	
Laplink	89.
Wordperfect Corp	
Wordperfect	189.

Graphics

3G Graphics	
Business I	65.
Graphics & Symbols I	58.

Aba Software	
Draw It Again Sam!	88.
Graphist Paint II	375.
Aldus	
Freehand	445.
Pagemaker 3.0	510.
Altsys	
Fontastic Plus	75.
Fontographer	239.
Brøderbund	
Poster Maker Plus	39.
Print Shop	39.
Compucraft	
Mac Art Library	159.
Cricket Software	
Cricket Draw	168.
Cricket Presents	285.
Pict-O-Graph	104.
Deneba Software	
Canvas 2.0	168.
Dubl-Click Software	
Welpaint: Vol 1 & 2 (Classic Clip Art)	
Vol 3 & 4 (For Publishing)	
Vol 5 & 6 (Animal Kingdom)	
Vol 7 & 8 (Special Occassions)	
Vol 9 & 10 (Printer's Helper)	
Vol 11 & 12 (Industrial Revolution) ..	
Vol 13 & 14 (Old Earth Almanac)	
Vol 15 & 16 (Island Life)	each 43.
World Class Fonts:	
Vol 1 & 2 (The Originals)	
Vol 3 & 4 (The Stylish)	
Vol 5 & 6 (The Giants)	each 43.
Foundation Publications	
Comic Strip Factory	40.
Comic People (Vol. 1 Office Days)	25.
Innovative Data Design	
Dreams	398.
Macdraft 1.2b	149.
Laserware	
Laserprint Color II	359.
Letraset	
Image Studio	299.
Letra Studio	327.
Ready, Set, Go 4.5	289.
Ready, Set, Show	189.
Macromind	
Video Works II	179.
Video Works II Hypercard Driver	62.
Microsoft	
Power Point 2.0	249.
Postcraft International	
Laser Fx	117.
Shana Enterprises	
Fast Forms Construction Kit	96.
Silicon Beach Software	
Digital Darkroom	179.
Silicon Press	48.
Super 3-D	177.
Super 3-D (Enhanced)	297.
Super Paint	89.
Supermac Software	
Pixel Paint 2.0	289.
Symmetry	
Picture Base 1.2 & Pb Retriever	62.
T/Maker	
Click Art Business Images	33.
Click Art Christian Images	36.
EPS Illustrations	75.

Zedcor Inc	
Deskpaint V.2.0	65.

Educational

Bible Research Systems	
The Word - NIV & KJV.	179.
Borland	
Eureka: The Solver	128.
Bright Star Technology	
Alphabet Blocks (Requires 1 Meg)	30.
Broderbund	
Type!	25.
Great Wave Software	
Kids Time	26.
Mindscape	
S.A.T./ Perfect Score	47.
Nordic	
• Alphabetizer	• Bodyworks
• Clockworks	• Coinworks
• Earthworks	• Flashworks
• Lemonade Stand	• Naval Battle
• Preschool Disk 1	• Word Search
• Preschool Disk 2	each 28.
The Learning Company	
Reader Rabbit	36.
True Basic	
• Algebra	• Arithmetic
• Calculus	• Discrete Mathematics
• Pre-Calculus	• Probability Theory
• Truestat	each 35.

Games

Access Software	
World Class Leader Board	30.
Accolade	
Hardball	27.
Activision	
Universal Military Simulator	34.
Broderbund	
Ancient Art Of War	30.
Ancient Art Of War At Sea	30.
Autoduel	28.
Moebius	28.
Shufflepuck Cafe	28.
Bullseye Software	
Ferrari Grand Prix	32.
P-51 Mustang Flight Simulator	31.
Discovery Software	
Arkanoid	30.
Electronic Arts	
Chessmaster 2000	28.
Chuck Yeager's Adv. Flight Trainer ...	32.
Scrabble	25.
Epyx	
Sub Battle	31.
Greene Inc	
Crystal Quest 2.2	26.
Henderson & Associates	
Real Poker	25.
Infinity	
Go	27.
Grand Slam Tennis	27.
Infocom	
Quarterstaff	35.
Mediagenic	
Might & Magic	38.
Shanghai	24.

Ordering Information

• If we must ship a partial order, we never charge freight on the shipments that complete the order (U.S. only).
 • 120 day limited warranty on all products.
 • Personal and company checks under \$1,000 clear immediately.
 • Please allow one week for checks over \$1,000.
 • Fortune 1,000 and Government checks clear immediately.
 • Purchase orders pay actual shipping charges by weight.
 • No sales tax, except for WA residents add 8.1% to total including shipping.
 • Loan drives subject to availability.

The MacZone is a trademark of Multiple Zones International.
 7102 180th Ave. N.E. Bldg. A107, Redmond, WA 98052

Shipping Information

• Federal Express overnight service \$4.00/order (software orders, Continental U.S. only). Hardware items over 4 lbs incur additional shipping charges. All shipments insured at no extra cost.
 • APO/FPO orders shipped 1st class mail, charged by weight.
 • Overseas: We ship to any destination in the Free World. We use the quickest and least expensive methods possible. Second day air service is available to most of Europe, Australia, and Japan.
 • Software and hardware is subject to manufacturer's warranty. Defective items will be replaced immediately with like item. All opened software sales are final. Hardware and unopened software ordered by mistake is subject to a 20% restocking fee. Defective hardware replaced or repaired at our discretion.
All returns must have an authorization number, call (206) 883-1975.

Our phone lines are open for orders:
Monday - Friday: 6AM to 8PM PST
Saturday: 7AM to 5PM PST
 Our Customer Service line is open:
Monday - Friday: 8AM to 4PM PST
 We accept VISA, MASTERCARD
 AMERICAN EXPRESS & Optima Card
No surcharge added.



* All prices subject to change without notice.
 * All items subject to availability.



The MAC ZONE

Serving the Macintosh community since 1985.

Microsoft	
Flight Simulator	36.
Miles Computing	
Downhill Racer	23.
The Fool's Errand	27.
Harrier Strike Mission II	26.
Mindscape	
Aussie Joker Poker	34.
• Balance Of Power (1990 Edition)	
• Colony • Crossword Magic	
• Deja Vu • Shadowgate	
• Uninvited • Trust & Betrayal	ea. 30.
Deja Vu II (Lost In Las Vegas)	32.
PBI Software	
Strategic Conquest Plus	34.
PCAI	
Lunar Rescue	32.
Mac Golf	35.
Mac Courses	28.
Mac Golf Classic	54.
Mac Racquetball	36.
Road Racer	49.
Silicon Beach Software	
• Apache Strike • DarkCastle	
• Beyond Dark Castle	each 27.
Sir Tech	
Wizardry	40.
Sphere	
Pt 109	32.
• Gato 1.4 • Orbiter	each 28.
Solitaire Royale	21.
Tetris - Mac II (In color)	25.
Tetris - Mac Plus, SE & II	22.
Spinnaker	
Sargon IV	30.

Hardware

All hardware items with memory chips - Prices are subject to change on a daily basis.

External Hard Drives

Cms - Scsi External Hard Drives	
Macstack 20 Meg	529.
Macstack 30 Meg	615.
Macstack 43 Meg	785.
Macstack 60 Meg	849.
Macstack 81 Meg	1235.
Macstack 140 Meg	1495.
Macstack 170 Meg	1695.

Everex

EMAC 20D	520.
EMAC 40-IMP + Impact Series	850.
EMAC 60-IMP Impact Series	998.
EMAC 80-IMP Impact Series	1295.
EMAC 40 DLX Deluxe	995.
EMAC 60 DLX Deluxe	1075.
EMAC 80 DLX Deluxe	1325.

We also carry drives from 150 meg to 1.2 Gigabytes - Call for latest prices.

Internal Drives for Mac SE

CMS	
Pro 30-SE/I R	505.
Pro 45-SE/I R	725.
Pro 100-SE/I R	1493.
Everex	
EMAC 40SE Internal	730.
EMAC 60SE Internal	929.
EMAC 80SE Internal	1180.
Seagate	
30-SE/II	445.
45-SE/II	625.
100-SE/II	1045.

Internals for the Mac II

CMS	
Pro 20 II	459.
Pro 60 II/I	725.
Pro 81 II/I	1175.
Pro 102 II/I	1325.
Pro 140 II/I	1295.

Everex

EMAC 20-ID	470.
EMAC 40ID Internal	730.
EMAC 60ID Internal	898.
EMAC 80ID Internal	1180.

Seagate

Zone 81-II	998.
------------------	------

Tape Back Up Systems

CMS

Tapestack 60 Meg	725.
------------------------	------

Everex

EMAC 40/60 DTL Dlx	1795.
EMAC 60/60 DTL Dlx	1895.
EMAC 60T Tape Back Up	845.

Datadesk

Mac 101 Keyboard	149.
------------------------	------

Memory/Accelerator Boards

Dove

Macsnap 2SE	439.
Macsnap 524 (512k to 1meg)	312.
Macsnap 524e (512ke to 1meg)	284.
Macsnap 524s (512ke to 1meg w/SCSI Port)	378.
Macsnap 548 (512k To 2meg)	575.
Macsnap 548e (512ke To 2meg)	539.
Macsnap 548s (512ke To 2meg w/SCSI Port)	598.
Marathon 020: Mse2	975.
Marathon 020: Mse3	774.
Marathon 020: Mse4	1154.
Plus 2 (2 Meg Upgrade, Plus Only)	429.
SCSI Port Adapter	115.

Daystar Digital

33/030 Accelerator II	4680.
Novy Mac20mx-16mhz (SE/+)	699.

Macintosh

256k SIMM Module (120 Ns) ..	CALL
2 One Megabyte Surface Mount SIMMs (120 Ns)	CALL

Hayes

Smartmodem 1200	299.
Smartmodem 2400	467.

Incomm

Turbo 1200 Baud Modem	99.
Turbo 2400 EC Baud Modem ..	274.
Turbo 4800 EC Baud Modem ..	339.
Turbo 9600 EC Baud Modem ..	599.

Megagraphics

2008 8 Bit Color Board //II	1369.
Megascreen 19" Display	1298.
Megascreen 2008 Color //II	3945.

Nuvotech

Turbo Net: *PN-208*	30.
Turbo Net: *PN-209*	30.

Sharp

Jx 450 Color Scanner	5995.
----------------------------	-------

Shiva Corporation

Netbridge	319.
Netmodem V1200	335.
Netmodem V2400	459.
Netserial X232	308.

Solana Electronics

R-Server	516.
----------------	------

STF Technologies

Fax STF	554.
---------------	------

Supra Corp.

Supra Modem 2400 Baud	145.
-----------------------------	------

Telebit

T-1000 9600 Bps Modem	749.
Trailblazer + 18,000 Bps Modem ..	1228.

Thunderware

Thunderscan 4.0	199.
-----------------------	------

U.S. Robotics

1200 Baud Modem	199.
2400 Baud Modem	359.
9600 Hst Baud Modem	799.

Languages

Borland

Turbo Pascal 1.1	65.
------------------------	-----

Microsoft

Quick Basic	69.
-------------------	-----

Symantec

Lightspeed C	107.
Lightspeed Pascal 2.0	77.
Just Enough Pascal	48.

Tml Systems

Tml Pascal II	79.
---------------------	-----

True Basic

3-D Graphics Toolkit	49.
Business Graphics Toolkit	35.
Scientific Graphics Toolkit	35.
True Basic Version 2.0	59.

Zedcor Inc

Z Basic 5.0	115.
-------------------	------

Music

Ars Nova

Practica Musica 2.0	78.
---------------------------	-----

Bogas Productions

Super Studio Session	79.
Studio Session	49.
• Country • String Quartet	
• Heavy Metal	each 15.

Brøderbund

Jam Session	30.
-------------------	-----

Coda

Mac Drums	38.
-----------------	-----

Electronic Arts

Dlx Music Construction Set 2.0	69.
--------------------------------------	-----

Great Wave Software

Concertware + 4.0	39.
Concertware + Midi 4.0	78.

Farallon

Mac Recorder	150.
--------------------	------

Impulse

Audio Digitizer	145.
-----------------------	------

Mark Of The Unicorn

Professional Composer V.2.2	395.
Pro. Performer V. 2.3.1	325.

Passport Designs

Master Tracks Jr	102.
Master Tracks Pro 3.0	275.
Notewriter	199.
Passport Midi Interface	97.

Resonate

Listen 2.0	65.
------------------	-----

Utilities

Affinity

Affini File	45.
Tempo II	88.

Alsoft

Disk Express	33.
Font/Da Juggler Plus	41.
Master Juggler	63.

Berkley System Design

Stepping Out 2.0	60.
------------------------	-----

Beyond

Menufonts 2 Version 2.01	31.
--------------------------------	-----

Borland

Sidekick 2.0	65.
--------------------	-----

CE Software

Calendarmaker Ver. 3.0	27.
Disktop	27.
Quick Keys	54.
Quick Mail (10 Users)	174.

Central Point Software

Copy II Mac	22.
PC Tools Deluxe	48.

Datashield

MacDirector	120.
-------------------	------

Dubl-Click Software

Calculator Construction Set	36.
-----------------------------------	-----

Fifth Generation

Fast Back	53.
Power Station 2.3	36.
Suitcase II	44.

Greene Inc

Quickdex	32.
----------------	-----

HJC Software

Virax	68.
-------------	-----

Imagine Software

Smart Alarms	34.
Smart Alarms Multiuser	82.

Kent Marsh

Mac Safe	88.
Night Watch	88.

Mac Master

Fedit + Version 1.07	28.
----------------------------	-----

Mainstay

Think N Time	59.
Typenow	27.

Meta

Design 2.3	220.
------------------	------

Microseeds

Redux	65.
-------------	-----

Paragon Courseware

Qued-M	105.
--------------	------

Solutions

Backfax	139.
Smartsrap & The Clipper 2.0	49.
Super Glue	51.
The Curator	79.

Supremac Software

Disk Fit 1.4	60.
Network Disk Fit	245.
Sentinel	149.
Super Laser Spool - Multi User	240.
Super Laser Spool - Single User	79.
Superspool 5.0	55.

Order your products today by calling:

1-800-248-0800

FAX# (206) 881-3421

Your credit card will not be charged until your products ship.

CLEARPOINT

Delivering Memory That Won't Stop— Guaranteed!



The MC2RAM, Version S1
for the Complete Macintosh Family

The MC2RAM, Version D
for the Mac II and SE

Only Clearpoint can offer an unconditional lifetime warranty, 24-hour-a-day service and delivery from stock. Call today and ask for the MC2RAM, the fully-compatible Macintosh memory.

Choose either Version S1 (megabit SOJs, identical to the Apple SIMM) or the cost-effective Version D* (megabit DIPs). Coming from the largest manufacturer of workstation memory, the MC2RAM SIMMs are guaranteed to provide optimal performance with either state-of-the-art design.

Order your Clearpoint MC2RAM memory today and get the only Macintosh memory that won't leave you in the lurch. With Clearpoint you know you're buying everything that memory should be.

* Does not fit in Mac IIs with full-height disk drives or SEs with CPU Accelerator boards.

Clearpoint is a registered trademark of Clearpoint Research Corporation. Apple, Macintosh and Mac are trademarks of Apple Computer, Inc. DEC and MicroVAX 2000 are trademarks of Digital Equipment Corporation. Sun is a trademark of Sun Microsystems Inc. DN 3000, DN 3500, and Apollo are trademarks of Apollo Computer. COMPAQ and DESKPRO are registered trademarks of Compaq Computer Corporation.

Dealers circle 127 on reader service card

The Clearpoint Difference

◆ Lifetime Warranty

With the strictest dynamic and thermal testing in the industry, Clearpoint confidently offers a lifetime warranty—Then backs it up with a 24-hour Repair/Replacement policy and an 800 service number for a warranty with teeth.

◆ Superior Memory Design

Across the board, Clearpoint brings the workstation marketplace better memory design. Whether it's higher density or state-of-the-art DRAM technology—Clearpoint designs it better.

◆ Guaranteed Buyer Satisfaction

Long-term satisfied customers is Clearpoint's goal. With comprehensive, user-friendly documentation, trade-up credits and competitive pricing, Clearpoint guarantees buyer satisfaction.



CLEARPOINT

Other Clearpoint Workstation Memory

COMPAQ 386

COMRAM (compatible with the Compaq DESKPRO 386/20 and /25) 4 MB boards.

SUN FAMILY

SNXSM (compatible with Sun 3/60): Available in 1 MB SIMMs, four in a set.
SNXSC (compatible with Sun 4/110 and 386i): 1 MB SIMMs.

DEC

DCME-M20 (compatible with the MicroVAX 2000): 8 and 16 MB boards.

APOLLO FAMILY

DNXRAM (compatible with the DN 3000 and DN 3500): 1 and 2 MB boards.

Call or write for an MC2RAM Product Marketing Update, a free catalog, and our Memory Pointers newsletter.



Dealer Inquiries Invited.



Credit
Card
Orders
Accepted

Clearpoint Research Corporation, 99 South Street, Hopkinton, MA 01748
1-800-CLEARPT (1-800-253-2778) or 508-435-2000

End Users circle 375 on reader service card

running both MS-DOS and OS/2 applications. However, up to 4MB may actually be necessary.

A number of applications that use OS/2 with the Presentation Manager, including Microsoft Excel, have also been announced. IBM sells OS/2 1.1 for \$340. Users of OS/2 1.0 can upgrade free of charge, while MS-DOS users can upgrade for \$283.—*Sharon Fisher*

What's Your Opinion?



Can public opinion polls predict the outcome of major elections? Students in Austin, Texas, set out to find the answer last November with a major national opinion poll of nearly 30,000 voters—a sample size larger than that of any other poll surveying the 1988 presidential election. Students in the 5th, 8th, 11th, and 12th grades conducted the survey with the help of ten networked Mac Pluses, SEs, and IIs donated by Apple Computer, and an easy-to-learn data-entry application based on Omnis 3 Plus from Blyth Software. In all, 4500 students par-

ticipated in the project, part of the Eanes Independent School District's "Learning Today... Leading Tomorrow" program, designed to help students learn by experience about politics and leadership.

Dan Hampton, a consultant and developer with Strata Systems in Austin, chose the multi-user version of Omnis 3 Plus version 3.3 as a platform for creating the data-entry and reporting application for the poll. Using Omnis's basic push-button screen, Hampton created a straightforward three-button interface: Dukakis, Bush, and Undecided. It took 20 students six minutes to learn the system, a simple matter of clicking the mouse button on the appropriate choice.

On the evenings of November 2 and 3, students placed calls from a phone bank of 100 phones on stage at the school auditorium. Twenty-five runners brought results from the phone bank to the students at the Macs, who entered the data instantly and produced tally sheets every half-hour.

The results? In the national poll, 46 percent were for Bush, 33 percent chose Dukakis, and 19 percent were undecided. In Texas it was 51 percent Bush, 40 percent Dukakis, and 9 percent undecided. These results



Students in Austin, Texas, used ten networked Mac Pluses, SEs, and IIs to conduct their own presidential election poll.

proved accurate in predicting the actual outcome of the election. But the main winners here were the students, who learned first-hand about the political process as a real event, not a canned TV production.

—*Felicity O'Meara*

Me, My Mac, and My Mainframe



Avatar and Digital Communications Associates have each announced micro-to-mainframe products that make it easier for Macintoshes to communicate with IBM mainframes.

Avatar's MacMainFrame II/DFT (Distributed Function Ter-



Avatar's MacMainFrame II/DFT software allows the Mac II to emulate an IBM 3270 terminal.

minal) support for the Mac II means that users can have up to five host sessions running simultaneously, including applications and file transfers, over a single cable. This software, which allows the Mac II to emulate an IBM 3270 terminal, is available for \$495 (\$1295 including a MacMainFrame II board).

DCA's MacIRMA TLPM (Transport Layer Protocol Module) enables users of MacWorkStation to graphically display IBM mainframe applications. It also permits graphical user interfaces to be added to mainframe applications.



DCA's MacIRMA TLPM lets MacWorkStation users display IBM mainframe applications.

MacIRMA TLPM is bundled with Apple's MacWorkStation software and is licensed to corporations for \$2500. MacIRMA TLPM requires MacIRMA, a Macintosh-to-IBM mainframe hardware/software connectivity product that lists for \$1195.

For further information, contact Avatar Corporation in Hopkinton, Massachusetts, at 508/435-6872, or Digital Communications Associates in Alpharetta, Georgia, at 404/442-4000.—*Sharon Fisher*

Movement Music



We all dance to the music, right? But we can't easily jitterbug to Tchaikovsky, pirouette *en pointe* to the Pointer Sisters, waltz to Led Zeppelin, or bump and grind to Mantovani. Our limbs may know how they want to move, but we still have to spin the right record and then

(continues)

THE BEST ACCOUNTING PACKAGE FOR YOUR SMALL BUSINESS.

WE GUARANTEE IT.

About two dozen accounting packages run on the Macintosh®. How can you be sure you're choosing the one that's just right for you?

Monogram Business Sense™ makes it simple. Buy it. Try it. If you're not completely satisfied, return it to us within 60 days and we'll exchange it for any accounting program of equal value. *Any accounting program.* We're that confident.

Business Sense is a fully-integrated, full-featured program that's exceptionally easy to learn and use. There simply isn't a better accounting package for small businesses.

Vendors	Due Date	Invoice #	0-7	8-14	15-30	
LEARNED LUMBER CO. 2/28/1988						
	01/30	RS 3258	822.00			
	03/17	RS 3350			825.00	
Totals:			822.00		825.00	1447.00
Clark Products	03/27	55703C			242.86	
Totals:					242.86	242.86
Dover Lumber #11	02/09	D 778225	3595.47			
	03/08	D 780115		2362.88		
Totals:			3595.47	2362.88		5958.35
Frank Wilson & S	03/01	22591	278.88			
	03/24	22690		300.52		
Totals:			278.88	300.52		579.40

Business Sense helps you anticipate your cash flow needs by aging forwards as well as backwards.

It's ideal for companies of one to 50 employees; up to 500 vendors and 2,000 customers. It handles checks up to a trillion dollars! It's powerful enough for a CFO, but accessible enough for a CEO.

Other accounting software can be difficult to use—even user-hostile. Business Sense is easy to use—

even for non-accounting personnel. Instead of dealing with "integratable modules," you have one program disk with all the functions built in: General Ledger, Accounts Payable, Accounts Receivable, Payroll, Invoicing and Budgeting. They all work alike. Moving from one to another is as easy as pulling down a menu.



Nearly every aspect of your financial situation can be reported in tabular or graphic format.

This extraordinary ease of use comes from the fact that Business Sense was designed for the Macintosh *from scratch*.

You won't find any of the balkiness of programs designed for other computers.

It's a bargain at under \$500.

And it's from Monogram, publishers of Dollars and Sense®, the world's best-selling personal financial management program.

So now your choice is easy.

Business Sense. The best accounting program for your business. We guarantee it.

General Ledger • Manages multiple companies, up to 2,000 accounts, five bank accounts, 99 departments or profit centers; unlimited transactions. • Handles checks to \$1 trillion. • Automates recurring entries. • Distributes data automatically on posting. • Transactions can be reversed. • Provides multiple open months. • Imports Dollars and Sense files.

Invoicing • Easy to use • Fully integrated into AR and GL.

Accounts Receivable • Provides detailed history and analysis for up to 2,000 customers, with credit limit warning and automatic credit memos. • Calculates and applies finance charges and discounts. • Handles partial payments. • Tracks commissions. • Produces aging reports.

Accounts Payable • Manages up to 500 vendors. • Tracks invoice date, due date and discount date. • Details aging for cash flow analysis. • Allows partial payments. • Prints 1099 forms. • Provides vendor analysis.

Payroll • Manages up to 100 employees, 10 withholding and wage categories plus tips and fringes. • Prints W-2 forms and checks and handles federal and state taxes.

Budgeting • Sophisticated and flexible, reporting on departments, divisions and projects for any time period.

See your dealer or call Monogram for a brochure with a complete feature list.

MONOGRAM

531 Van Ness Avenue, Torrance, CA 90501
(213) 533-5120 FAX: (213) 533 1365

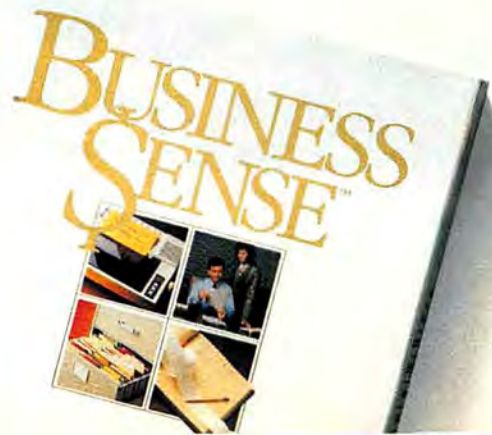

Guarantee: Purchase Business Sense Version 1.2 between January 1, 1989 and June 30, 1989. If for any reason you are dissatisfied with it, return the complete package to us within 60 days of the purchase date and indicate which software program you would like in exchange. You may choose any Macintosh accounting program generally available at retail, regardless of publisher, with a publisher's suggested retail list price up to the \$495 suggested retail list price of Business Sense. If you wish to trade for a more expensive program, you must make up the retail price difference. No cash refunds.

Circle 87 on reader service card



Mark Coniglio, a student at California Institute of the Arts, has created a system that translates a dancer's movements directly into music.

follow the beat. That fundamental fact is changing, however, at least in the realm of high culture; experimental composer Mark Coniglio has created a system called MidiDancer that translates a dancer's movements directly into music.

Coniglio, a student at California Institute of the Arts' (CalArts) music school in Valencia, California, attaches position sensors to a dancer's joints, such as the elbows and knees, and connects the sensors to a small radio transmitter worn by the dancer. As the dancer moves, the transmitter sends signals to a Macintosh computer running Coniglio's Interactor software. The Mac converts those signals into MIDI information and routes it to synthesizers that play it as music.

Interactor can translate a dancer's movements in a variety of ways, depending on the score Coniglio composes. An arm movement may produce a chord; a hip-twist, a melodic fragment; a knee-bend, a change in volume. Interactor can also respond rhythmically, but Coniglio's scores generally allow the rhythm to reflect the

dancer's movement so that the audience continues to experience synchrony.

The program responds intelligently to music as well as to movement, and can thus provide a live musician with interactive accompaniment.

For further information, write to Mark Coniglio, 24700 McBean Pkwy., Valencia, CA 91355.—Ann Garrison

Real-World Computing

Speeches, chorales, and landscapes may set the tone for the next generation of personal computer software. With the addition of a device called a digital signal processor (DSP) to the Macintosh, Mac software could take a giant step forward.

Two boards, DigiDesign's Sound Accelerator and Spectral Innovations' MacDSP, both shipping for the Mac, anticipate the coming of real-life interfaces. Both boards contain digital signal processors that let them manipulate data at speeds up to ten times faster than the

Mac II's 8-megahertz 68020. The boards foreshadow the arrival of realistic sounds and striking scenes that can be incorporated into software applications.

DigiDesign's Sound Accelerator for the SE and II is aimed squarely at audio applications, although the company offers a developer package that also encourages applications outside the music and recording markets. The \$1295 board contains a 20-MHz Motorola 56001 chip, the same DSP used in the Next machine. Two 16-bit digital-to-analog converters allow the board to output stereo sound at CD audio-quality sample rates (44.1 kHz).

DigiDesign's external AD IN box, when connected to the Sound Accelerator's expansion port, lets the board process stereo sound for applications like direct-to-disk recording. Using the company's Sound Designer software, a sound accelerator-equipped Mac can record, compress, process, and play back CD-quality sound in real-time from disk. DigiDesign's sound drivers let you

play synthesized or recorded sounds directly from HyperCard or VideoWorks applications.

Spectral Innovations' MacDSP is a more general-purpose processor board containing a 16- or 24-megahertz DSP32 chip from AT&T. The DSP32 is capable of 12 million floating-point operations per second, providing greater accuracy and access to a wider range of data than the Motorola 56001.

The board, in its \$2249 standard configuration, accepts add-on piggyback boards; the 16-bit analog-to-digital and digital-to-analog option lists for \$486. A version of the board that uses AT&T's next-generation DSP32C chip will operate at over twice the speed (50MHz) of the DSP32 board and will be able to address over 16MB of data, letting the board process true color 24-bit images on the fly. To simplify application development, Spectral Innovations offers an MPW-compatible C compiler that compiles DSP code.

(continues)

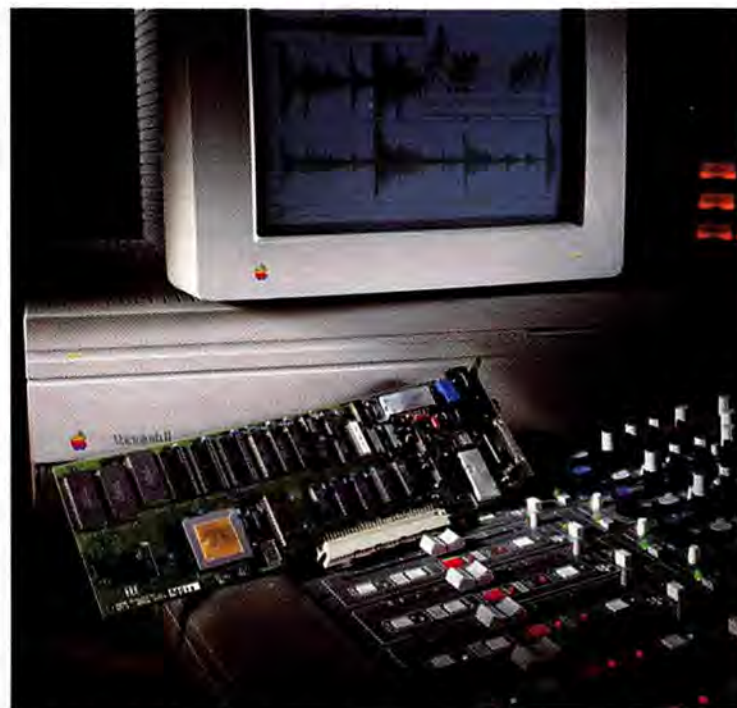

DigiDesign's Sound Accelerator contains a digital signal processor that lets it manipulate data ten times as fast as the II's 68020.

45 MB Removable Cartridge SCSI Hard Disk Drive



Micro/Removable Cartridge Hard Disk Drive

The Micro/Removable, 25 ms, 45 MB winchester hard disk is faster than some fixed hard disks. They are excellent for organizing related data or for fast back-up of fixed hard disk drives. The cartridges can be locked away for security or safely mailed to remote locations and have the reliability of a floppy diskette. You can boot from the removable, if needed, and the system is compatible with the Macintosh Plus, SE or Macintosh II. Utility includes password protection and a DA to mount volume.

Micro/Stack Series Fixed Hard Disk Drives

MicroNet offers 30, 46, 62, 91, 173 MB, fast access hard disk drives, as well as a 150 and 300 MB streaming tape backup system in a stackable cabinet. Internal brackets available for the Macintosh SE or II. Great care was taken in the design of these systems to ensure reliability. **150, 300, 600 MB, 16.5 ms, Wren III, IV and V Systems.** MicroNet specializes in Control Data drives that are industry known for their reliability and speed. Internal and external systems with tape combinations available.

We are dedicated Macintosh only developers.

Call for the name of your nearest dealer. Product data sheets gladly sent on request.

Charles F. McConathy, President

Macintosh is a registered trademark of Apple Computer, Inc.



MicroNet Technology, Inc.

13765-A Alton Parkway • Irvine, CA 92718 • Telephone: (714) 837-6033
FAX: (714) 837-1164 • AppleLink: D1656 • Compuserve: 76004,1611

Dealers circle 275 on reader service card

End Users circle 398 on reader service card

For more information contact DigiDesign in Menlo Park, California, at 415/327-8811, and Spectral Innovations in Sunnyvale, California, at 408/734-1314. —David Ushijima

Where There's Thunder...



Looking for a low-cost scanner, but don't have an ImageWriter to latch it onto? You might want to take a look at ThunderScan's successor, due to ship in December 1988.

LightningScan, Thunderware's new \$495 handheld scanner, will capture a 4½-inch-wide strip at up to 400 dpi, in either line-art mode or any of three halftone/dither modes. The device connects to the Mac's SCSI port through an interface box, and you adjust scanning mode and brightness on the scanning unit itself. You set it up, start the software, then roll the scanner over the image you want to capture.

LightningScan comes with the latest incarnation of Thunderware's software, ThunderScan version 5.0, which lets you control an image's contrast and brightness after it's been scanned, even though the hand scanner itself can't capture gray-scale images. The software

works this magic by deducing gray values from the dithered bitmap provided by the scanner. What results is a lower-resolution image that includes gray scales. You can save the image as a flat, dithered bitmap or as a gray-scale image in TIFF, EPS, PICT, or Paint format, or in ThunderScan's native format.

The prerelease version I looked at required a steady hand for high-resolution scanning (it beeps at you if you move too fast), but more speed is top on the list of improvements for the release version. In addition, the software will include a DA that lets you use the scanner from within an application while retaining most of the application's capabilities, including cutting, copying, rotating, and saving selections. For further information, contact Thunderware in Orinda, California, at 415/254-6581.

—Steve Roth

Macs and IBM PCs Share Backup



Macs and IBM PCs keep moving in together, and developers keep working to make sure that the two systems learn to talk things out. Now Tecmar offers



Tecmar's NuLink System allows Mac IIs and IBM PCs and PS/2s to share cartridge tape drives.

an adapter board that allows Mac IIs and IBM PCs and PS/2s to share the company's Quality Tape family of DC600 cartridge tape drives.

The NuLink System includes a single-slot interface board that's compatible with the Mac II's NuBus design, a connecting cable, and QTBackup software. The company hopes to release software this year that will let the different computers share files as well as tape drives.

Tecmar is also introducing two additional QT-Mac tape drives. The QT-Mac80, an 86MB tape drive system based on a DC2000-type mini ¼-inch data cartridge, connects directly to the SCSI port on the Mac Plus, SE, and II and includes all the features of the QT-Mac40 but with twice the backup speed—6MB per minute. The tape drive enables you to back up any size disk on multiple cartridges, and it reproduces Apple A/UX partitions.

The QT-Mac150, a 150MB subsystem, is reportedly the highest-capacity cartridge tape drive for the Mac yet. Based on a DC600 data cartridge, it uses the NuLink adapter board to attach to any high-speed NuBus expansion slot in the Mac II, thus capitalizing on the system's near-1MB-per-second

transfer rate and freeing the SCSI port for use with other peripherals.

The NuLink System lists for \$395, the QT-Mac80 for \$1795, and the QT-Mac150 for \$2795. For further information, contact Tecmar in Solon, Ohio, at 216/349-0600. —Ann Garrison

Gentlemen, Choose Your Modems



Hayes Microcomputer Products has introduced the Smartmodem 2400M, a 2400-baud modem, and version 3.1 of its Smartcom II communications software. The Smartcom II V3.1 utility lets a Mac II support up to five Smartmodem 2400Ms, which Mac users on an AppleTalk network can access via HayesConnect, a utility included with each modem. HayesConnect reportedly lets you access the modems while still using your existing communi-

(continues)

Lightning Scan, Thunderware's handheld scanner, connects to the Mac's SCSI port through an interface box. You adjust the scanning mode and brightness on the unit itself.





This gray scale monitor won't display *dull fins!*

Whether you're a desktop publisher or a graphic designer, the SHADOWGRAPH gives you impressive detailing. With its high resolution display of 1024 by 768 pixels, you get up to 256 of the sharpest grays at 72 dots per inch.

And, while your editor may not like the copy, he or she will *love* the image.

Call PCPC for more details.



**Personal Computer
Peripherals Corporation**
(800) 622-2888 (813) 884-3092

Circle 223 on reader service card

your MAC + LightFax 9624 FaxModem = the World at your fingertips

new



\$799.00

complete with LightFax-MAC software

It's a state-of-the-art, external, high-speed fax and a 2400 baud 100% Hayes™ compatible modem. LightFax 9624 turns your Mac into a powerful world communication machine at a lower cost than a standard fax. Plus it offers sophisticated capabilities not found on standard fax machines, including **document composition/editing, file storage, name card data management, scheduled sending** (when the phone rates are cheaper), **broadcasting** (sending documents to multiple addresses), **file queuing** (sending multiple files), etc. LightFax 9624 has **BACKGROUND OPERATION**, that is you don't have to quit your application for your MAC to receive a fax. With optional **LightSpeed 200 dpi scanner** you can scan documents into your MAC, for fax transmission or for use with your favorite paint program. Use

LightFax 9624 also with your PC, with optional software. Finally click the mouse and your LightFax 9624 becomes a 2400 baud modem with Bell & CCIT standards for worldwide standards compatibility. To learn more about all the exciting capabilities of LightFax 9624 consult your nearest Apple dealer or call us for information.

Never buy another ribbon !!!

Special Offer: FREE MOUSEPAD or a PhotoArt Disk with any order >60.00, a \$12.00 value

Over 100,000 sold since 1982



MacInker \$42.00

Imagewriter I & II **MacInker**, complete with free bottle of ink, reservoir cover and ink meter/dispenser.

MacInker™, the original, automatic ribbon re-inker. The Imagewriter MacInker (mod 234IM) re-inks Imagewriter I/II black & single color cartridges. The Universal MacInker also re-inks hundreds of different cartridge types (including the Imagewriter LQ) with suitable adaptors. Extra dark, dot matrix, lubricated ink yields a truly better than new print quality and extends print-head life. New feltless dispenser ensures precise ink metering. Number of re-inkings/cartridge is 60-100. With the **Multicolor Adaptor (mod M422, \$40.00)** MacInker can re-ink the multicolor Imagewriter II cartridges. We have a full range of optional accessories, inks & cartridges, indelible ink, heat transfer etc. Colors: red, green, blue, yellow, purple, brown, orange, silver, gold. Ask for free catalog. In 1982 we pioneered re-inking technology and are dedicated to its development.

Imagewriter I/II MacInker (mod 234IM).....	42.00
Multicolor Adaptor (mod M422).....	40.00
Heat Transfer Adaptor	30.00
Epson MacInker (mod 271EP)	42.00
Universal Cartridge MacInker	68.50
Imagewriter cartridges ...3.15/ea.....	4-color10.00/ea
Heat Transfer cartridges	9.00/ea
Extra ink bottle.....	3.00/ea... pint18.50

Macintosh Disks 3.5" DS (pack of 10) ...	15.00
Mouse Pad (sale)	5.00
Classic PhotoArt collection (5 disks)	59.00

Moby Dick 120 wall disk holder	39.95
Moby Dick 240 wall disk holder	49.95



DATA SWITCHES



MS4-MAC8, 4 port 8 pin DIN-8 connectors	50.00
MS4-MAC9, 4 port 9 pin connectors	50.00
SCSI Switch 2 port	46.00
SCSI Switch 4 port	59.00
Cables	16.00

MODEMS



All our modems are 100% guaranteed Hayes™ compatible and have a 2 year warranty. Full front panel lights, auto answer, dial, repeat, call progress monitoring and speaker control. Superior signal to noise ratio and noise rejection. Includes software

1200 AT 300/1200 baud	99.00
Mercury 2400 baud (also supports Europe V21,V22)	239.00
Capricorn World Minimodem, 300/1200 baud, pocket size	
Bell 103/212A & European CCIT V21,V22 standards	136.00
Cable Mac to Modem (specify Macintosh type)	16.00
QuickLink™ Software (if purchased separately)	29.95

Order Toll Free 800-547-3303

in Oregon (503)626-2291 - fax(503)643-5379

Immediate shipment - 30 days money back guarantee

Computer Friends, Inc.

14250 NW Science Park Dr. Portland OR 97229

Right, it's efficient.
Right, it's great looking.
Costs an arm and a leg, right?

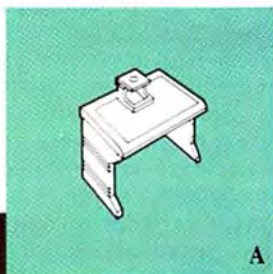

A

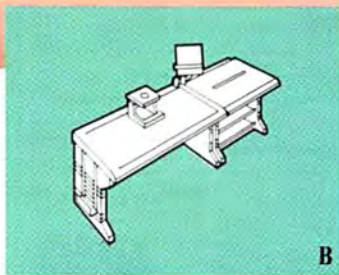

B

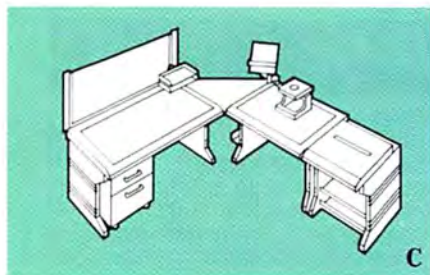

C

Wrong.

If you think you can't afford computer workstation furniture as up-to-date as your Macintosh, think again.

Breakthrough prices. The basic workstation (drawing A) costs less than \$305. For under \$635, you can set up the intermediate workstation (drawing B). And the full featured workstation (drawing C and photo) is less than \$1300. Since the WorkManager™ System is modular, you can start small and add on as your needs—and resources—grow.

Breakthrough design. The WorkManager™ System has the ergonomics of high-priced designer furniture systems. The work surface

is the perfect typing height for Mac keyboards, and features a comfortable beveled leading edge. A covered, recessed channel holds cables and surge protectors. Built-in sockets handle WorkManager™ accessories.

Breakthrough construction. Strong, lightweight structural components are molded of steel reinforced Resinite™ composite. Molded-in color makes surfaces highly scratch resistant.

The WorkManager™ System. For people who need workstations as advanced as their computers—from the people at MicroComputer Accessories, Inc.

WORKMANAGER™
S Y S T E M



Need a hand? Call our MicroComputer ACCESS(ories) LINE: 800/521-8270. In CA call 213/301-9400.
USA: 5405 Jandy Place, P.O. Box 66911 • Los Angeles, CA 90066-0911 • Fax 213/306-8379
CANADA: Call 416/259-5051 • In Canada call 800/387-7300 • Telex 06067768 FABCAN • Fax 416/259-5137
EUROPE: Call 32.2.538.6173 • Telex 24088 CETREL • Fax 32.2.537.3777
© Copyright 1988 MicroComputer Accessories, Inc.

Circle 276 on reader service card

MicroComputer
Accessories, Inc.™

cations program such as Red Ryder or Crosstalk.

Other new features of Smartcom II V3.1 include the capability to "learn" Autopilot sequences, define multiple sets of clickable buttons, and send files, groups of files, or the contents of a folder. The clickable buttons can initiate an Autopilot sequence, and Autopilot can prompt you to key in additional information when required. In addition, HyperCard applications can automatically link to and return from Smartcom II.

Another utility included with the Smartmodem 2400M is HayesConnect Server, which Hayes says is the first data communications program to use the Apple Data Streaming Protocol to support communications via modem over Apple-



Portland artist Bonnie Meltzer uses the Mac in every aspect of her art and gives workshops and lectures on the Macintosh as an artist's tool.

the modem alone, \$599 bundled with the new version of Smartcom II. For more information, contact Hayes Microcomputer Products in Atlanta, at 404/449-8791.

Combating Computer Phobias

 If you're reading this, chances are you're a Macintosh enthusiast—and maybe you think computerphobia is a thing of the past. But according to Bonnie Meltzer, an artist in Portland, Oregon, it's very common for artists (and university art departments) to fear and distrust computers. All computers, even the friendly, icon-based Mac—graphical interface notwithstanding. Meltzer uses the Macintosh in every aspect of her art, from sketching and draw-

ing basic ideas to creating the final designs for her large-scale sculptures—and also for grant proposals, mailing lists, and invitations to openings. She compares the computer's reception among artists to that of past innovations like oil paint, stretched canvas, and the mechanical loom: all were mistrusted at first.

To help clear up this misunderstanding, Meltzer gives workshops and lectures on the Macintosh as an artist's tool. She introduces her students to basic Mac concepts and techniques, then guides them through hands-on sessions with draw and paint programs. The workshops culminate in the students' making a collaborative, large-scale work of art using the computer along with traditional art materials.

Zipperpillar Park, a popular, interactive sculpture environment at the Portland Children's Museum, is a high-visibility example of Meltzer's recent Mac-assisted work. Creatures like the 8-foot-long Silvergater, with its flippable hinged scales,

and the imposing Chameleox, whose colors children can change, were created in MacDraw and printed out in sections in actual size.

"We are going to see an explosion of Macintosh-generated art in the near future," Meltzer says. And thanks to her efforts, some of that art will be created by people who used to be scared of computers. For information on Meltzer's workshops, call her at 503/285-3131 in Portland, Oregon.—Felicity O'Meara

OSI for the Rest of Us

 In a move that should help integrate Macintoshes with heterogeneous networks, Touch Communications has announced Open Systems Interconnect (OSI) client software for the Mac.

Client software runs on the user's machine and communicates with a server machine, such as a DEC VAX (standard Macintosh network access is mapped onto VMS security mechanisms to protect the VAX's files). The software is also designed to communicate with OSI server implementations from other vendors, such as Sunlink OSI from Sun Microsystems.

With this software, users can also redirect print requests to remote network printers; store and gain access to files on remote Touch OSI servers using Macintosh commands; and communicate with Touch OSI servers by emulating a terminal, so that existing terminal-emulation applications can continue to work.

OSI is a set of internationally standard communications protocols that is supported by a

(continues)



This series of modem boards in the Mac II lets the II work as a network modem-server.

ing networks. With the software and multiple modems on the Mac II, the computer becomes a modem server, eliminating the need to dedicate a phone line to every system. "You can click on HayesConnect, see the status of the modems, then choose a modem and configure the software to work with that modem," said Dennis Hayes, president of the company.

The Smartmodem 2400M and Smartcom II V3.1 began shipping in January. The estimated retail price is \$549 for

**CREATIVE TOOLS FOR BETTER DESIGN
WITH THE ARTROOM CD ROM**



**ArtRoom™ 3.0
NOW COMPATIBLE WITH
YOUR MAC OR PC!
Now 125MB - Same Price!**

You are looking at the leading edge in desktop publishing design. The distinctive documents featured here were created using ordinary page layout software programs such as PageMaker™, ReadySetGo™ and X-Press™. What makes them extraordinary is the innovative use of PostScript™ clip art, fonts and clip photography by Image Club.

Take a look at the art room of the future. The ArtRoom™ is a CD ROM disc which contains over 100 MB (125 disks) of Image Club EPS clip art and PostScript fonts - our entire library on one convenient compact disc. The ArtRoom is compatible with your Macintosh (HFS format) or PC (High Sierra format) and any PostScript printer such as the LaserWriter or Linotronic.

The DarkRoom™ is our newest CD ROM - a 500 MB stock photo library containing over 350 useful clip photographs ideal for any publishing project.

The ArtRoom and DarkRoom CD ROM require a Mac or PC compatible CD ROM disc drive.

THE ARTROOM CD ROM FEATURES:

- DIGIT-ART™** - Over 1500 high resolution encapsulated PostScript clip art images
- HOTTYPE™** - The complete set of over 100 fonts
- PAGES™** - Over 50 pages of publishing templates
- ARTROOM RETRIEVER™** - A handy desk accessory that lets you quickly access any image with the push of a button (Mac version only)
- FONT JUGGLER™** - Instantly installs fonts (Mac version)

- NETWORK COMPATIBILITY** - Your entire office can access the worlds grandest collection of clip art and fonts from one single CD ROM unit
- ARTROOM SUBSCRIPTION** - Keep your ArtRoom growing with our \$249 quarterly subscriptions. You get a new ArtRoom disc every 4 months that will feature more art, fonts and templates.
- THE DARKROOM CD ROM FEATURES:**
- 375 PHOTOGRAPHS** - in 256 grey scale TIFF format
- ENLARGE**, reduce or crop without loss of quality
- EDIT** with Digital DarkRoom or Image Studio.

Image Club's famous clip art and font collections are available for your Macintosh or PC as separate floppy disk packages starting from \$99 or the entire \$2500 library on the ArtRoom CD ROM disc for \$999. The DarkRoom clip photography library is available only on CD for \$499. If you would like to try Image Club's clip art and fonts, ask for the State of the Art trial package. A volume of PostScript clip art, the ArtRoom guided tour, a PostScript type face and our 1988 product catalog for only \$59. To order the trial package or any Image Club product call 1-800-661-9410 or see your dealer. For more information and PC compatibility information call 403-262-8008.

Image Club Digit-Art clip art, HotType fonts, The ArtRoom CD and the DarkRoom CD are your creative tools for better design. **Sales Agent Inquiries invited.**



*Image Club Graphics Inc.
1902 11 St. S.E.
Calgary, Alberta T2G 3G2
(403) 262-8008 Fax (403) 261-7013*

CD ROM DISC DRIVE OFFER

Purchase the ArtRoom CD ROM Mac or PC version for \$999 direct from Image Club and receive a Toshiba or NEC CD drive for only \$600

\$1599

Includes The ArtRoom CD ROM disc and a Toshiba or NEC disc drive.

number of vendors. Because the Touch OSI software supports OSI profiles such as Technical and Office Protocol 3.0 (TOP 3.0), Manufacturing Automation Protocol 3.0 (MAP 3.0), and Government OSI Profile (GOSIP), a Macintosh running Touch OSI can communicate with other vendors' implementations of those protocols.

The Touch OSI client software costs \$395 (\$940 if bundled with Ethernet network controller hardware). Touch OSI VMS server software for the VAX starts at \$3000.

For further information, contact Touch Communications in Scotts Valley, California, at 408/438-4800.—*Sbaron Fisher*

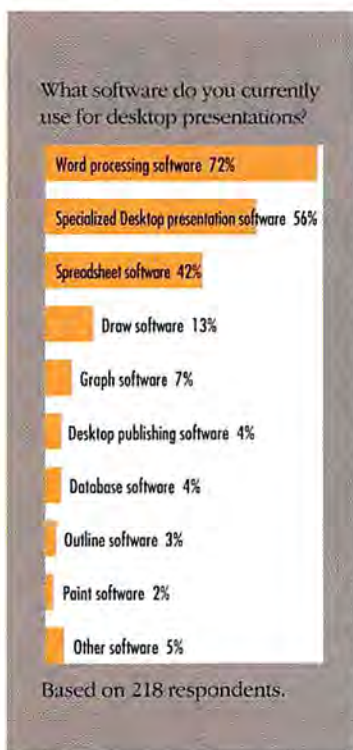

Most of the respondents to our survey use word processing software to create desktop presentations.

use spreadsheet software, and 33 percent use other software.

When actually giving presentations, 59 percent use overhead transparencies, 19 percent use the Mac screen, 13 percent use slides, 4 percent combine overhead transparencies and slides, and 4 percent combine overhead transparencies and the Mac screen. Not surprisingly, only 15 percent said that connection to a slide-making service was very important.

New Hard Disks

There are some new external, internal, magnetic, optical, 32-megabyte to 1.2-gigabyte, \$499 to \$2095 hard disk options for you data savers.

The Ehman Engineering HDD32 is a 32MB external hard disk that connects to the SCSI port and has an access time of 12 milliseconds. Automatic

head parking protects your data, and an external SCSI address switch means you don't have to open your drive and go to the back and get out your tweezers to move plastic jumpers around on pins: the address comes up in a window and you change it by pressing a button. The \$499 HDD32 is preformatted, so you can take the hard disk out of the box, hook up two cables, and get back to work.

Ehman's hard disk was designed in the tradition of the Mac as an easy computer to use, and the company claims that its price is also easy to pay—at least \$100 less than anything comparable.

Next is the Wren family of internal 5¼-inch hard drives from Imprimis Technologies, a subsidiary of Control Data Corporation. The new Wren drives range from 383MB before formatting to 1.2GB before formatting. Access times range from

and voice messaging. Wren drives are available through value-added resellers, including Relax, Jasmine, MicroNet Technology, CMS Enhancements, FWB Software, and GCC Technologies.

Then there are the MacinStor products, a whole gang of 45MB to 800MB optical and hard disks from Storage Dimensions. The 800MB product is the LaserStor, a write-once, read-many (WORM) optical drive for data-intensive applications such as desktop publishing, CAD/CAM, image processing, database distribution, and document storage and retrieval.

Internal MacinStor hard disks for the SE range from 45MB (\$1249) to 90MB (\$1649), internal hard disks for the II and IIX range from 45MB (\$1249) to 630MB (\$7799), and external hard disks for the Plus and up range from 45MB (\$1449) to 180MB (\$3199). The



MacinStor's 45MB to 800MB optical and hard disks are some of the many new storage options.

10 to 16½ milliseconds, and data transfer rates range from 15 to 21 megabits per second. Standard features include 40,000 hours mean time between failures, balanced rotary voice-coil actuator, automatic head parking, and a dedicated head landing zone.

The 1.2GB Wren VII is made possible by zoned-bit recording technology; it is designed for office equipment manufacturing and for building systems for high-performance 3-D visualization, high-end text retrieval,

hard disks have an average access time of 14 ms and data transfer rates of up to 15 megabits per second. Their standard features include automatic head parking, dual 50-pin SCSI connectors, external termination, and power and access indicators.

For further information, contact Ehman Engineering in Evanston, Wyoming, at 307/789-3830; Storage Dimensions in San Jose, California, at 408/879-0300; or Imprimis Technology in Minneapolis, at 612/936-6271.—*Ann Garrison*

Reader Survey: Desktop Presentations

We mailed our reader's survey on desktop presentations to 1000 randomly selected *Macworld* readers, and received 450 responses. Of those respondents, 218 (48 percent) use a personal computer to prepare desktop presentations. Among those 218, 72 percent use word processing software, 56 percent use specialized desktop presentation packages, 42 percent

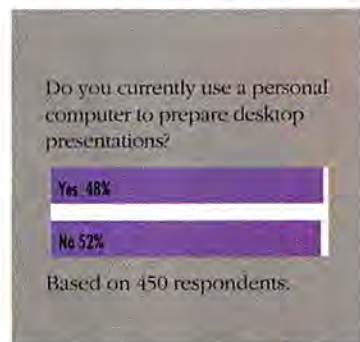

Forty-eight percent of the 450 respondents to our survey use PCs for desktop presentations.

Call from near.

The four-digit number next to each product is the product's ITEM NUMBER. Please refer to this number when ordering. Thank you.

SOFTWARE

We only carry the latest versions of products. Version numbers in our ads are current at press time.

CP denotes copy-protected.
NCP denotes not copy-protected.

Aatrix Software ... NCP

3976	Aatrix Payroll 3.05	\$99.
4020	Aatrix TimeMinder 1.7	109.
3958	Aatrix Payroll PLUS 3.02	159.

Abacus Concepts ... NCP

4482	StatView SE + Graphics 1.03	229.
4481	StatView II 1.03	349.

Access Technology ... NCP

3959	MindWrite 2.0	95.
4109	MindWriteExpress 2.0	145.



LaCie ... NCP

Silverserver 1.1—Powerful server utility lets local and remote users share hard drives and modems. Also provides complete hard disk management, fast disk duplication and network chatter. \$92.

1346	Trapeze 2.1	155.
	Acius ... NCP	
1010	4th Dimension 1.0.6	469.
4024	4th Dimension Runtime	235.
	Adobe Systems ... NCP	
1137	Adobe Illustrator '88 1.6	309.
1138	The Collector's Edition	79.
1142	Newsletters/Publishing Pack 1	255.
4565	Forms and Schedules Pack 2	309.
4566	Presentations Pack 3	309.

MacConnection carries the entire Adobe Type Library (volumes 1-69). Listed below are Adobe's newest typefaces at press time.

4567	57 ITC Kabel	127.
4568	58 OCR A, OCR B, MICR	97.
4569	59 Helvetica #1	127.
4570	60 Helvetica #2	187.
4571	61 Helvetica #3	187.
4572	62 Times Ten	127.
4573	63 Kaufmann	97.
4574	64 Clarendon	97.
4575	65 Peignot	97.



SuperMac Software ... NCP

Sentinel 2.0—Keep confidential files private—conveniently. Sentinel will encrypt and secure your files over 100 times faster than competing Macintosh encryption software. \$155.

4576	66 New Caledonia	257.
4577	67 ITC Clearface	257.
4578	68 Americana	127.
4579	69 ITC Serif Gothic	187.
	Affinity Microsystems ... NCP	
1014	Alfinifile 1.1	46.
1016	Tempo II 1.0	89.
	Aldus ... NCP	
1330	Freehand 2.0	349.
1331	PageMaker 3.01	399.
	Altsys ... NCP	
1194	FONtastic Plus 2.01	54.
1195	Fontographer 2.4.1 (CP)	239.
	Apple Computer ... NCP	
1118	HyperCard 1.2.1	42.
	Ars Nova ... NCP	
1215	Practica Musica 2.07	75.
	Ashton-Tate ... NCP	
1323	FullPaint 1.0SE	69.
4098	Full Impact 1.0	249.
1324	FullWrite 1.0	269.
1322	dBASE Mac 1.0	295.
	Berkeley System Design ... NCP	
1541	Stepping Out II 2.01	52.
	Beyond, Inc. ... NCP	
4203	MenuFonts 2.02	30.
	Blyth ... NCP	
1470	Omnis 3 Plus/Express 3.25	129.
4318	Omnis 3 Plus/Express 3.3 (3 users)	399.
	Bogas Productions ... NCP	
1461	Studio Session 1.2SE	49.
4255	Super Studio Session 1.0	75.
1458	Country Disk	15.
1459	Heavy Metal Disk	15.
1460	String Quartet Disk	15.
	Borland International ... NCP	
1512	Turbo Pascal Tutor 1.0	46.
1511	Turbo Pascal 1.1	68.
1507	Numerical Methods Toolbox	68.
1510	Sidekick 2.0	68.
1506	Eureka: The Solver 1.0	133.
1508	Reflex Plus 1.01	189.
	BrainPower ... NCP	
1532	DataScan 1.0	118.
1535	DesignScope 1.15	128.
1534	MathView Professional 1.0	144.
1537	StatView 512+ 1.2	175.
3960	ArchiText 1.03	182.

4066	The Analyzer Bundle (includes DataScan, DesignScope, and StatView 512+)	\$325.
	Bravo Technologies ... NCP	
1539	MacCalc 1.2D	79.
	Bright Star Technology ... NCP	
1402	Alphabet Blocks 3.01	32.
3961	Talking Tiles 1.0	69.
3962	HyperAnimator 1.5 (includes Stax, a MacConnection exclusive!)	79.
	Broderbund Software ... NCP	
4314	Type! 1.0	20.
1423	Jam Session 1.1 (CP)	30.
1427	Print Shop 1.3	36.
4065	PosterMaker Plus 2.5	36.
4465	DTP Advisor 1.0	47.
1422	Geometry 1.0 (CP)	59.
1426	Physics 1.1 (CP)	59.
4067	Calculus 1.0 (CP)	59.
4501	Drawing Table 1.0	78.
4291	Clip Animations	36.
4110	Clip Sounds (sound effects/music)	36.
1430	VideoWorks II HyperCard Driver 1.2	60.
1432	VideoWorks II Accelerator 1.1	118.
1431	VideoWorks II 2.0	118.
	Caere ... NCP	
4476	OmniPage 1.0	565.
	CAMDE ... NCP	
1635	Nutri-Calc Plus 1.1	169.
	Casady & Greene ... NCP	
2269	QuickDEX 1.4A	32.
1575	Fluent Fonts 2.0	27.
	FLUENT LASER FONTS	
1576	Bodoni (V1)	46.
1587	San Serif (V2)	46.
1588	Ritz/Right Bank (V3)	46.
1589	Monterey (V4)	46.
1590	Regency Script/Calligraphy (V5)	46.
1591	Prelude Script (V6)	46.
1592	Coventry Script/Zephyr (V7)	46.
1593	Gregorian/Dorovar (V8)	46.
1594	Cyrillic (V9)	46.
1577	Bodoni Ultra (V10)	46.
1578	Sans Serif Bold (V11)	46.
1579	Sans Serif Extra Bold (V12)	46.
1580	Gatsby Light (V13)	46.
1581	Micro (V14)	46.
1582	Micro Extended (V15)	46.



SoftView ... NCP

MacInTax 1988—A sophisticated income tax preparation program that allows you to organize, store, and print out tax information. Includes 74 IRS forms and schedules. \$65.

Call from far.

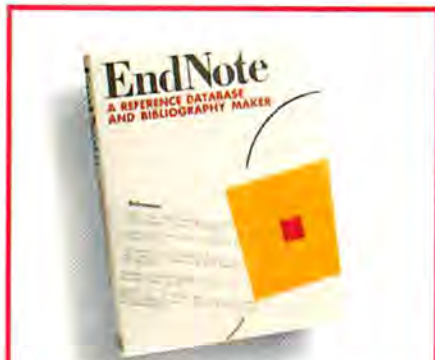

Niles & Associates ... NCP
EndNote 1.0—Stop typing bibliographies!
 EndNote will do it for you. Stores 32,000
 references. Adds bibliographies to all major
 word processor documents. \$82.

1583	Galileo Roman (V16)	46.
1584	Campanile-Giotto (V17)	46.
1585	Alexandria (V18)	46.
1586	Jott Casual (V19)	46.
4204	Gazelle & Kells Meath (V20)	46.
4205	Paladin & Abalene (V21)	46.
4206	Collegiate (V22)	46.
CE Software ... NCP		
1727	CalendarMaker 3.0	27.
1728	Disktop 3.04	27.
4689	MockPackage Plus Utilities 4.4	27.
1729	QuickKeys 1.1	53.
3963	QuickMail 1.05	159.
Challenger Software ... NCP		
1610	Mac3D 2.1	119.
Chang Labs ... NCP		
1613	Rags to Riches Ledger 3.1	120.
1617	Rags to Riches Receivables 3.1	120.
1614	Rags to Riches Payables 3.1	120.
1622	Rags to Riches 3-Pak	289.
1611	C.A.T. 2.0	229.
1615	Professional Billing 2.9	239.
1612	Inventory Control 2.6	239.
1616	Professional 3-Pak	359.
1618	Retail Business 3-Pak	359.
Claris ... NCP		
1123	MacPaint II 2.0	102.
1129	MacWrite 5.0	102.
4196	FileMaker II 4.0	237.
1117	MacDraw II 2.0	325.
1125	MacProject II 2.0	395.
Coda Music Systems ... CP		
4367	MacDrums 1.01	32.
4483	Perceive 1.0 (NCP)	52.
Cricket Software ... NCP		
1669	Pict-O-Graph 1.0	89.
4346	Cricket Paint 1.0	99.
1668	Cricket Graph 1.3	119.
1667	Cricket Draw 1.1	169.

1670	Cricket Presents 2.0	\$289.
Dac Software ... NCP		
4502	Dac-Easy Light 1.0	44.
DataViz ... NCP		
1823	MacLink Plus 3.0	145.
Davidson ... CP		
1734	Math Blaster! 1.0	27.
Deneba Software ... NCP		
1770	Merriam-Webster's Thesaurus 2.0	35.
4700	BigThesaurus (1.4 million words!)	54.
1767	Comment 2.0	54.
1768	Coach Professional 3.0A	105.
1769	Canvas 2.0	159.
DreamMaker ... NCP		
4115	MacGallery (HyperCard format)	28.
4088	MacGallery (MacPaint format)	28.
Dubl-Click Software ... NCP		
1824	Calculator Construction Set 1.04	36.
3972	World-Class Fonts! Originals (1-2)	45.
3973	World-Class Fonts! The Stylish (3-4)	45.
3974	World-Class Fonts! The Giants (5-6)	45.
3964	WetPaint Classic Clip-Art (1-2)	45.
3965	WetPaint For Publishing (3-4)	45.
3966	WetPaint Animal Kingdom (5-6)	45.
3967	WetPaint Special Occasions (7-8)	45.
3968	WetPaint Printer's Helper (9-10)	45.
3969	WetPaint Industrial Revolution (11-12)	45.
3970	WetPaint Old Earth Almanac (13-14)	45.
3971	WetPaint Island Life (15-16)	45.
Electronic Arts ... NCP		
1543	Thunder! 1.1 (Batteries Included)	30.
1843	Disk Tools Plus 1.01	31.
4619	Mavis Beacon Typing 1.2B	35.
1846	Deluxe Music Construction Set 2.0	61.
4315	Studio/8 1.0	319.
3941	SmoothTalker 2.0	33.
3940	First Shapes	33.
3936	KidTalk	33.
3939	MathTalk	33.

3938	MathTalk Fractions	\$33.
3935	Speller Bee	33.
Enzan-Hoshigumi USA ... NCP		
1879	MacCalligraphy 2.0	99.
1880	Year of the Dragon	21.
1881	Japaneze Clip Art Scroll 1 "Heaven"	52.
1882	Japaneze Clip Art Scroll 2 "Earth"	52.
1878	Japaneze Clip Art "Borders" Scroll	65.
Farallon Computing ... NCP		
4208	Timbuktu 2.0.1	69.
2199	MacRecorder 1.1	135.
4684	ScreenRecorder 1.0	135.
Fifth Generation Systems ... NCP		
4287	Pyrol 3.0 (screen saver)	15.

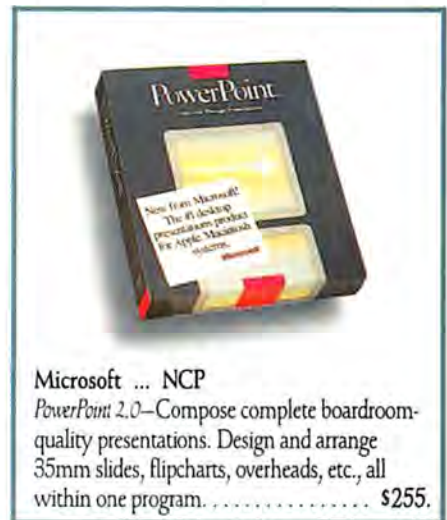

Microsoft ... NCP
PowerPoint 2.0—Compose complete boardroom-
 quality presentations. Design and arrange
 35mm slides, flipcharts, overheads, etc., all
 within one program. \$255.



Intuit ... NCP
Quicken 1.01—Complete, easy-to-use personal
 and small business accounting software.
 Automates check writing, budgeting, tax
 recordkeeping, and more. Now links direct to
 MacIntax. \$33.

3954	PowerStation 2.5	special 29.
3955	Suitcase II 1.2	44.
3953	FastBack Mac 1.03	54.
Foundation Publishing ... NCP		
2384	Comic Strip Factory 1.6	44.
2385	Comic People	25.
Fox Software ... NCP		
4195	FoxBASE +/Mac 1.1	208.
4580	FoxBASE +/Runtime 1.1	158.
Freesoft ... NCP		
2219	Red Ryder 10.3	54.
FWB Software ... NCP		
2232	Hard Disk Partition 2.0	40.
2231	Hard Disk Util 2.03	53.
4683	Hard Disk DeadBolt 1.0	53.
Generic Software ... NCP		
4319	Generic CADD Level 1 1.0.1	54.
4411	Flow Charts & Schedules	18.
4402	Home Landscaping	18.
4401	Basic Home Design	35.
4410	Commercial/Residential Furnishings	35.
4400	Heating/Ventilation/Air Conditioning	35.
4409	Bathroom Design	49.
4403	Kitchen Design	49.
4404	Landscaping Architecture	49.



1-800/622-5472
MacConnection™

MacConnection, 14 Mill Street, Marlow, NH 03456 1-800/622-5472 603/446-7711 FAX 603/446-7791

Call from your office.



SubLOGIC ... NCP
Jet 1.0—Fly land or carrier-based missions with Macintosh Jet! Features include enhanced graphics and optional multi-player flight mode. \$32.

4405	Pipe Fittings	49.
	Great Wave Software ... NCP	
2277	TimeMasters 1.0	22.
2276	KidsTime 1.2	26.
4334	NumberMaze 1.0	27.
2270	American Discovery 2.1	27.
2272	Crystal Paint 1.0	27.
2273	ConcertWare+ 4.0	39.
2271	ConcertWare+ MIDI 4.0	79.
	ICOM Simulations ... NCP	
4084	On Cue 1.3	36.
4085	TMON 2.8.1	89.
	Ideaform ... NCP	
2419	DiskQuick 2.10	27.
2418	HyperBook Maker 1.0	31.
2420	MacLabeler Plus 3.0	42.
	Individual Software ... NCP	
4209	Typing Instructor Encore	26.
4491	101 Scripts & Buttons for HyperCard	37.
2943	101 Macros for Excel	37.
	Infosphere ... CP	
2513	LaserServe 2.0	62.
2514	MacServe 2.4	155.
4595	Liaison 1.0A	185.
	Innovative Data Design ... NCP	
2417	MacDraft 1.2B	149.
4707	Dreams 1.0	279.
4710	Residential Construction 1.0	139.
	Insignia ... NCP	
4089	SoftPC 1.2	479.
	Intuit ... NCP	
2425	Quicken 1.01	33.
	Kent Marsh Ltd. ... NCP	
2591	The NightWatch 1.02	89.
2592	MacSafe 1.08C	89.
	LaCie ... NCP	
4335	Silverserver 1.1	92.
	Layered ... NCP	
2613	Insight OneWrite 1.0	185.
2609	Insight Expert AP 2.02	459.
2610	Insight Expert AR 2.10	459.
2611	Insight Expert GL 2.02	459.
2612	Insight Expert Inventory 2.0	459.
2614	Insight Expert Time Billing 2.0	459.
	Learning Company ... CP	
2670	Reader Rabbit 2.0	33.
	Letraset ... NCP	
2621	Ready,Set,Go!4 4.5	275.

2619	Image Studio 1.5	\$279.
4709	LetraStudio 1.0	289.
	Linguist's Software ... NCP	
2649	Tech	59.
2643	LaserTech	79.
4681	RSV Bible	79.
4682	Vulgate (Latin Bible)	79.
	FOREIGN LANGUAGE FONTS	
2628	SuperFrench/German/Spanish	39.
2635	MacKana/Basic Kanji	39.
2630	MacGreek	59.
2631	MacHebrew	59.
2636	MacKanji 2.0	59.
2637	MacKorean	59.
2637	MacThai	59.
2625	MacChinese Cantonese	79.
2626	Cantonese Supplement	39.
2645	MacChinese Mandarin	79.
2646	Mandarin Supplement	39.
2647	Greek/Hebrew/Phonetic	89.
	FOREIGN LASER FONTS	
2639	LaserFrench/German/Spanish	79.
2640	LaserGreek	79.
2642	LaserKorean	89.
2638	LaserCyrilic	115.



ProVUE ... NCP
Panorama 1.0—Database that combines the speed and simplicity of a spreadsheet with powerful forms capabilities. Includes clairvoyance, outlining, Flash Art, charts, and macros. \$209.

	Lundeen & Associates ... NCP	
2684	WorksPlus Spell 1.1	46.
2683	WorksPlus Command 1.1	57.
	Manx Software ... NCP	
4068	Aztec C 3.6B	65.
4316	Aztec C UniTools	65.
4317	Aztec SDB 3.6B	65.
4069	Aztec MPW C 3.6B	99.
4075	Aztec C + SDB 3.6B	99.
	MECA ... NCP	
2796	Managing Your Money 2.0	128.
	MEDIAGENIC ... NCP	
1334	City to City 1.0	30.
4295	Focal Point/Business Class Bundle	48.
4591	Open It! 1.0	54.
1338	Reports! 1.2	59.
4638	Focal Point II 1.0	119.
	Microlitics ... NCP	
2733	Word Finder 2.0	33.
2732	GOfer 1.0	44.
	Microseeds Publishing ... NCP	
4210	Screen Gems 1.0	47.
2913	Redux 1.5	59.

	Microsoft ... NCP	
4471	QuickBasic 1.0	\$69.
2863	Chart 1.02	79.
2885	Write 1.0	79.
2866	File 2.0	129.
2884	Works 2.0	189.
2865	Excel 1.5	255.
2882	Word 3.02	255.
2878	PowerPoint 2.0	255.
2875	Microsoft Mail 1.36 (1-4 users)	195.
2872	Microsoft Mail 1.36 (5-10 users)	325.
2873	Microsoft Mail 1.36 (11-20 users)	489.
2874	Microsoft Mail 1.36 (21-32 users)	639.
	Miles Computing ... NCP	
2768	Orchestra of Fonts Vol. 4special	15.
2771	Mac the Ripper Vol. 3	32.
2769	Peoples, Places & Things Vol. 5	32.
	Mindscape ... CP	
2748	The Perfect Score: SAT 1.0	46.
	Monogram ... NCP	
2780	Dollars & Sense 4.1C	81.
2779	Business Sense 1.01	279.
	Niles & Associates ... NCP	
4602	EndNote 1.0	82.
	Nolo Press ... NCP	
4228	For the Record 1.0	29.
2981	WillMaker 3.0	34.
	North Edge Software ... NCP	
2986	Timeslips III 1.06A	117.
	Odesta ... NCP	
4211	DataDesk Professional 2.0	289.
3014	GeoQuery 1.0	205.
3013	Double Helix II 2.0R51	339.
	Olduvai Software ... NCP	
3031	Icon-It! 1.01	39.
4667	Art Clips (formerly Post-Art)	51.
3035	Read-It!TS 1.06	79.
3030	FontShare 1.01	149.
3034	Read-It! 2.0	199.
	OWL International ... NCP	
3082	Guide 2.0	99.
	Paracomp ... NCP	
4664	Milo 1.0	159.
4597	Swivel 3D 1.0	249.
	PCPC ... NCP	
3175	HFS Backup 3.0	54.
	Postcraft International ... NCP	
3157	Laser FX 1.6	114.



Solutions ... NCP
SmartScrap & the Clipper 2.0—Lets you easily find pictures in any scrapbook by name or with a pictorial table of contents. The Clipper is a cropping and scaling tool that is used to reduce or enlarge graphics. \$46.

Call from your car.

4058	Laser FX Pack I	\$29.
4059	Laser FX Pack II	29.
4060	Laser FX Pack III	29.
4061	Laser FX Pack IV	29.
4062	Laser FX Pack V	29.
4063	Laser FX Pack VI	29.
Pro Plus ... CP		
4310	Wall Street Investor 3.0	469.
ProVUE Development ... NCP		
4582	Panorama 1.0	209.
Quark ... NCP		
3230	Quark XPress 2.0	call
4621	QuarkStyle	call
Rubicon Publishing ... CP		
3272	Dinner At Eight-Encore Edition 1.03	45.
Satori ... NCP		
3320	BulkMailer 3.22	79.
3321	BulkMailer Plus 3.22	195.
3322	Legal Billing 1.85	369.
3323	Legal Billing II 2.56	539.
3324	Project Billing 1.54	409.

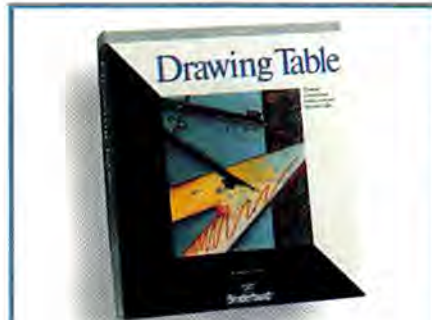

Broderbund Software ... NCP
Drawing Table 1.0—A professional quality drawing tool for creating a range of illustrations, maps, diagrams, etc. Supports import of EPS, PICT, and Paint files and includes extensive clip-art libraries. Color on the Mac II ... \$78.



Generic Software ... NCP
Generic CADD Level 1 1.0.1—Gives users true CAD capabilities including a variety of drawing tools, floating point precision to 16 decimal places, 256 different layers, and more. ... \$54.

3978	Components GL 1.0	389.
Sensible Software ... NCP		
4692	BookEnds 1.0	54.
3375	Sensible Grammar 1.1D	54.
Silicon Beach Software ... NCP		
3504	Silicon Press 1.1	41.
3508	World Builder 1.0	41.
3506	SuperPaint 2.0	129.
3507	Super3D 1.0	157.
3980	Digital Darkroom 1.0	157.
Simon & Schuster ... NCP		
4230	The Fully Powered Mac Book	24.
3305	Typing Tutor IV 1.2	35.
SmethersBarnes ... NCP		
1478	Prototyper 1.0	72.
SoftStyle ... NCP		
3282	Printworks (Dot Matrix) 3.5	43.
3281	Printworks (Daisywheel) 3.0	56.

3283	Printworks (HP laser) 3.0	85.
SoftView ... NCP		
3471	MacInUse 2.0	42.
3981	FormSet Business Forms Edition 1.1	55.
3473	TaxView Planner 2.0 (1988-1992)	64.
3470	MacInTax 1988	65.
Software Discoveries ... NCP		
3374	Merge Write 1.0	34.
3373	Record Holder Plus 3.0	45.
Software Ventures ... NCP		
3454	Microphone 1.5	119.
3455	Microphone II 2.0	225.
Softworks, Inc. ... NCP		
4601	Stack Cleaner	29.
4599	HyperTools #1	59.
4600	HyperTools #2	59.
Solutions, International ... NCP		
3448	SmartScrap & The Clipper 2.0	46.
3449	SuperGlue 1.05	52.
3446	The Curator 1.05	79.
4308	BackFAX (reqs. Apple FAX modem)	129.
Spinnaker/Hayden ... CP		
2329	SAT Score Improvement 1.0	58.
Springboard ... CP		
3530	Certificate Maker 2.0	24.
3532	Certificate Maker Library Vol. 1	18.
3531	Early Games	28.
4493	Atlas Explorer	28.
4495	Family Matters	28.
4492	Works of Art Assortment Series	28.
4494	Works of Art Education Series	28.
4496	Works of Art Holiday Series	28.
4498	Works of Art Laser Art Business	59.
4499	Works of Art Laser Fonts Vol. 1	59.
4497	Top Honors	59.
4500	Springboard Publisher 1.0	109.
SuperMac Software ... NCP		
3383	SuperSpool 5.0	54.
3382	SuperLaserSpool 2.0	82.

3378	Multi-User SuperLaserSpool 2.0	\$199.
3377	Diskfit 1.4.1	54.
3379	Network Diskfit 1.4.1	199.
3381	Sentinel 2.0	155.
3380	PixelPaint 1.1	199.
4086	Acknowledge 1.0	329.
Survivor Software ... NCP		
3289	MacMoney 3.02	62.
Symantec ... NCP		
3982	MacSOZ! 1.5	49.
3983	S.U.M. 1.02	59.
3422	More II 2.0	225.
4644	Just Enough Pascal 1.0	45.
3421	Lightspeed Pascal 2.0	65.
4645	Lightspeed Pascal/Just Enough Pascal Bundle	87.
3420	Lightspeed C 3.01	95.
Symmetry ... NCP		
3318	HyperDA 1.1	35.
4504	Acta Advantage 1.0	65.
4160	PictureBase 1.23-WetPaint Bundle	95.
Synergy ... NCP		
3130	VersaTerm 3.20	65.
3129	KaleidaGraph 1.10	120.
3131	VersaTerm-PRO 3.0	195.
3G Graphics ... NCP		
3942	Images with Impact! Graphics and Symbols 1	59.
4583	Images with Impact! Business 1	69.
Think Educational ... CP		
3615	MacEdge II 1.0	27.
3616	Mind Over Mac 1.4	27.
T/Maker ... NCP		
3640	ClickArt Personal Graphics	28.
3642	ClickArt Publications	28.
3632	ClickArt Business Images	28.
3636	ClickArt Holidays	28.
3637	ClickArt Letters Vol. 1	28.
3638	ClickArt Letters Vol. 2	28.



CE Software ... NCP
MockPackage Plus Utilities 4.4—A professional desk accessory set designed for increased productivity. Plus six outstanding utilities, including Aask (an INIT manager). ... \$27.



1-800/622-5472
MacConnection™

MacConnection, 14 Mill Street, Marlow, NH 03456 1-800/622-5472 603/446-7711 FAX 603/446-7791

We'll get it there

3634	ClickArt Effects 1.01	\$28.	3783	myDiskLabeler w/Color 2.8.11	\$31.
3633	Christian Images	35.	3784	myDiskLabeler w/LaserWriter 2.8.1LI	34.
3635	EPS Illustrations	75.		WordPerfect ... NCP	
3639	WriteNow 2.0	109.	3800	WordPerfect Mac 1.0.1	185.
	TML Systems ... NCP			Working Software ... NCP	
3548	Source Code Library II 1.0	42.	3790	Lookup 1.0C	29.
3549	TML Pascal II 3.0 (W/MPW 3.0)	75.	3788	Findswell 2.0	36.
	TOPS ... NCP		3792	Spellswell 2.0G	45.
4189	TOPS Teleconnector (DB-9)	39.	3789	Spellswell Legal Dictionary 1.0	60.
4188	TOPS Teleconnector (DIN-8)	39.	3791	Spellswell Medical Dictionary 1.0	60.
3726	TOPS for DOS 2.0	119.	4693	Quick Letter 1.0	75.
3724	NetPrint 2.0	119.		Zedcor ... NCP	
3723	TOPS Mac 2.1	149.	3986	DeskPaint 2.0	69.
4598	TOPS FlashBox (90 days)	125.	3985	ZBasic 5.0	99.
3725	TOPS Repeater (90 days)	132.			
3720	TOPS Flashcard (90 days)	169.			
3417	InBox Starter Kit 2.2	199.			
3418	InBox Connection Mac 2.2	75.			

	Traveling Software ... NCP	
3729	LAP-LINK Mac 2.0	84.
	True BASIC, Inc. ... NCP	
	LANGUAGE & TOOLKITS	

3587	True BASIC 2.01	59.
3570	Advanced String	49.
3574	Business Graphics	49.
3579	Mathematicians Toolkit 1.0	49.
3583	Scientific Graphics	49.
3584	Sorting & Searching	49.
3588	3D Graphics 1.2	49.
4178	Communications 2.0	49.

	EDUCATIONAL SOFTWARE	
3571	Algebra 3.0	35.
3573	Arithmetic 1.2	35.
3575	Calculus 1.2	35.
3577	Discrete Math 1.2	35.
3580	Pre-Calculus	35.
3581	Probability 1.2	35.
3586	Trigonometry 1.2	35.
3585	TrueSTAT 3.0	49.

	Unicorn ... CP	
3751	Animal Kingdom	27.
3752	Decimal Dungeon	27.
3753	Fraction Action	27.
3755	Mac Robots	27.
3756	Math Wizard	27.
3754	Read-A-Rama	32.

	William & Macias ... NCP	
3779	DiskFinder 1.07	29.

ENTERTAINMENT

	Addison-Wesley ... NCP	
4407	The Hobbit	24.
4474	Fellowship of the Ring	24.
	Accolade ... CP	
1184	Hardball	23.
4484	Mean 18	24.
4485	4th & Inches	24.



Silicon Beach Software ... NCP
SuperPaint 2.0—Award-winning graphics software for the Mac combines painting and drawing capabilities in a single program with a simple, elegant interface \$129.

	Access Software ... NCP	
4655	World Class Leader Board Golf	28.
	Blue Chip ... CP	
1441	Millionaire	35.
	Broderbund Software ... CP	
4099	Shufflepuck Cafe (air hockey)	24.
4111	Moebius (adventure & arcade)	24.
4229	Where in World Carmen San Diego?	27.
1421	Ancient Art of War	27.
4540	Ancient Art of War at Sea	27.
	Bullseye ... CP	
1544	Ferrari Grand Prix	32.
4074	P51 Mustang Flight Simulator	32.
	Casady & Greene ... CP	
2268	Crystal Quest 2.2C	26.
4119	Crystal Quest w/Critter Editor (NCP)	42.
	Discovery Software ... NCP	
4408	Arkanoid	27.
	Electronic Arts ... CP	
1851	Scrabble	26.
1850	Reach for the Stars	26.
1842	Chessmaster 2000	28.
4064	Chuck Yeager Flight Simulator	32.
4588	Life & Death (surgery simulation)	32.

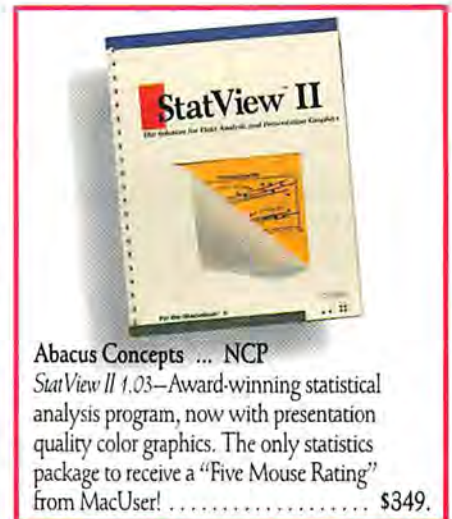

Abacus Concepts ... NCP
StatView II 1.03—Award-winning statistical analysis program, now with presentation quality color graphics. The only statistics package to receive a "Five Mouse Rating" from MacUser! \$349.

	Epyx ... NCP	
2037	Sub Battle Simulator	29.
4660	Sub Battle Simulator for Mac II	29.
	Infinity Software ... CP	
2518	GO	27.
2519	Grand Slam Tennis	27.
	MEDIAGENIC ... CP	
4590	Corruption	27.
4486	Manhole	30.
4475	Quarterstaff	30.
4679	Universal Military Simulator	30.
4490	Might and Magic	36.
4592	Zork Zero	36.
	MicroProse ... CP	
4697	Pirates!	32.
	Microsoft ... CP	
2868	Flight Simulator	33.
	Micro Sports ... NCP	
2787	MSFL Pro League Football	32.
	Miles Computing ... CP	
2764	Down Hill Racer	24.
2767	Harrier Strike Mission II 1.2	32.
2765	Fool's Errand 1.1	32.
2763	Fool's Errand Hint booklet	7.
	Mindscape ... CP	
4083	Balance of Power 1990	30.
3987	Colony	30.
2743	Crossword Magic	30.
2745	Deja Vu	30.
4596	Deja Vu II	30.
2749	Shadowgate	30.
2750	Trust & Betrayal: Legacy of Siboot	30.
2751	Uninvited	30.
	PBI Software ... CP	
3110	Strategic Conquest Plus 1.3	35.
	PCAI ... CP	
4321	Lunar Rescue	34.
4517	Road Racer	39.
4212	MacCourses	29.
3144	MacGolf 2.0	35.
4320	MacGolf Classic	54.
	Primera Software ... NCP	
3169	Smash Hit Racquetball II	22.
	Sierra On-Line ... CP	
4161	Mother Goose	19.
3397	Leisure Suit Larry	23.
3394	King's Quest I	29.
3395	King's Quest II	29.



Satori ... NCP
Components GL 1.0—Customize your accounting with this flexible system. Build special journals and reports. Fast and intuitive. Includes presentation quality forms capability \$389.



“The package beat me home!”

Dear MacConnection,

I am writing to tell you that an item which I ordered beat me home. I was visiting my brother and his family who live about two hours from my home. While I was there, I decided to order an item for my Mac. Well, I ordered it before

8:00 PM and before I could drive home the next morning, the package arrived.

To top it off, I live in a small Kentucky town, about an hour's drive from the nearest airport. What service! I don't know how you do it. Keep up the good work.

A handwritten signature in cursive script that reads "Sallie Evans".

Sallie Evans
North Middletown, KY

MacConnection TM **1-800/622-5472**

MacConnection, 14 Mill Street, Marlow, NH 03456 1-800/622-5472 603/446-7711 FAX 603/446-7791

©Copyright 1989 PC Connection, Inc. MacConnection is a division and trademark of PC Connection, Inc.

Just for the record, all the ads in this series feature real live MacConnection customers and the real live letters they wrote us. Really!

Overnight. \$3.

4002	19" Monitor for Mac Plus	\$1349.
4003	19" Monitor for Mac SE	1349.
4004	19" Monitor for Mac II	1449.
Nuvotech ... 1 year		
3001	TurboNet ST (DB-9)	30.
3000	TurboNet ST (DIN-8)	30.
Orange Micro ... 1 year		
4488	Grappler Spooler	39.
3036	Grappler C/Mac/GS	79.
4487	Grappler LS	92.
4076	Grappler LQ	103.
PCPC ... 2 years		
3177	HD-WSI (Apple HD-20 to SCSI)	269.
3181	MacBottom HD 21 SCSI	659.
3180	MacBottom HD 21 w/Modem	759.
3185	MacBottom HD 32 SCSI	699.
3184	MacBottom HD 32 w/Modem	829.
3189	MacBottom HD 45 SCSI	859.
3188	MacBottom HD 45 w/Modem	979.
3190	MacBottom HD 70 SCSI	999.
4658	MacBottom HD 84 SCSI	1249.
3176	MacBottom IHD 144 Meg (1 yr)	1495.
Practical Peripherals ... 5 years		
3100	1200 Baud External Modem	79.
3102	2400 Baud External Modem	181.
3089	Mac Communications Pack	229.
Sharp ... 90 days		
3453	JX-450 Color Scanner (includes IEEE card and cable)	5895.
Shiva ... 1 year		
4347	NetBridge	279.
3444	NetSerial X232	289.
3443	NetModem V2400	479.
Summagraphics ... 90 days		
4298	BitPad Plus ADB	329.
Thunderware ... 90 days		
3648	ThunderScan 5.0 with PowerPort	189.
3646	MacPlus/SE Power Accessory	29.
3645	Mac II Power Accessory	42.

DISKS

2214	Fuji 3 1/2" DS/DD Disks	19.
3297	Sony 3 1/2" DS/DD Disks	19.
3772	Verbatim 3 1/2" DS/DD Disks	19.
2792	MAXELL 3 1/2" DS/DD Disks	19.

INFORMATION SERVICES

CompuServe

1676	CompuServe Information Service	\$24.
1671	Grolier's Online Encyclopedia	32.
1673	CompuServe Navigator 2.02	45.
1674	Standard Service/Navigator Bundle	59.
Dow Jones		
1789	Dow Jones Membership Kit	24.
1785	Desktop Express 1.03	95.
1786	Market Manager Plus 2.0	189.

ACCESSORIES

Bantam Books

1403	Complete HyperCard Handbook	23.
Computer Coverup		
1723	ImageWriter II Cover	8.
1722	ImageWriter LQ Cover	8.
1720	Mac Plus Cover Set	10.
1725	Mac SE Ext. Keyboard Cover Set	10.
4657	LaserWriter II Cover	10.
Goldstein & Blair		
2267	The Macintosh Bible (2nd Edition)	21.



Nutmeg Systems ... 90 days
15" Monitor—A superb full page display designed to be the ultimate in rock-solid image clarity and ergonomic design for professional use.
 For Mac II or SE, please specify \$999.

I/O Design ... lifetime

2378	MacLuggage HDware	49.
2379	MacLuggage Imageware II	49.
2376	MacLuggage Macinware Plus	64.
2381	MacLuggage Macinware SE	75.

MacConnection

4623	Solid Oak Disk Case, made by New England craftsman (holds 90 disks)	29.
------	---	-----

Moustrak

2694	Moustrak Pad (standard 7"x9")	8.
2692	Moustrak Pad (large 9"x11")	9.
2693	Moustrak Pad L/F (9"x11")	10.

Moustrak Designer Series

(Features selected photos from the book, "A Day in the Life of America.")

4077	Window Washer 1	12.
4006	Thunderstorm 2	12.
4007	Old Cajun 3	12.
4008	Vietnam Memorial 4	12.
4009	Dance Class 5	12.
4010	Tea Lesson 6	12.

Ribbons

3255	ImageWriter II Ribbon	4.
3261	ImageWriter II 4-color Ribbon	9.



Practical Peripherals ... 5 years
Mac Communications Pack—Includes external 2400SA Modem, cable, and top-selling communication software. Hayes compatible, auto-answer. A superior value! \$229.

3270	ImageWriter II Rainbow Six Pack	20.
3260	ImageWriter LQ Black Ribbon	17.
4011	ImageWriter LQ 4-color Ribbon	20.
Sopris Softworks ... lifetime		
4017	ImageWriter II Cover	11.
4019	Mac SE & Ext. Keyboard Cover	15.
4012	High Trek ImageWriter II carry case	49.
4013	High Trek Mac Plus carry case	59.
4014	High Trek Mac SE & ext. kybd. case	69.
Targus		
3618	ImageWriter II Carry Case	49.
3617	Mac Plus/SE Carry Case	59.
4015	Mac SE & Ext. Kybd. Carry Case	69.

OUR POLICY

- We accept VISA and MASTERCARD.
- No surcharge added for credit card orders.
- Your card is not charged until we ship.
- If we must ship a partial order, we never charge freight on the shipment(s) that complete the order.
- No sales tax.
- All U.S. shipments insured; no additional charge.
- APO/FPO orders shipped 1st Class Mail, charged by weight.
- Upon receipt and approval, personal and company checks now clear the same day for immediate shipment of your order.
- COD max. \$1000. Cash or certified check.
- 120 day limited warranty on all products. Defective software replaced immediately. Defective hardware repaired or replaced at our discretion. All items subject to availability. Prices subject to change without notice.
- To order, call us anytime Monday through Friday 9:00 to 9:00 EST, or Saturday 9:00 to 5:30 EST. You can call our business offices at 603/446-7711 Monday through Friday 9:00 to 5:30 EST.

SHIPPING

Continental US: Barring massive computer failures and other natural or unnatural catastrophes, all non-C.O.D. orders phoned into MacConnection by 8 PM EST will ship Airborne the same night for next day delivery, except for those within UPS Ground Zone 1 (which is also an overnight service). The total freight charge on any order placed with MacConnection is now \$3. Backorders will also ship Airborne overnight at no additional charge. Some areas require an additional day delivery.

Hawaii, Alaska and Outside Continental US: Call 603/446-7711 for information.



Dove Computer ... 90 days
 The Marathon Family of workstation products are designed to expand productivity and system flexibility. Included are accelerator boards for the Mac II and SE, combination EtherNet adaptors, and serial/parallel boards. Call to learn more.

from 'most anywhere.

3396 King's Quest III	\$29.	4589 InterFax Modem	\$329.
3399 Space Quest	29.	Asher Engineering ... lifetime	
3400 Space Quest II	29.	1212 Turbo Trackball ADB	69.
3398 Police Quest	29.	1211 Quadlynx Trackball (non ADB)	69.
Silicon Beach Software ... NCP		AST Research ... 6 months	
3500 Airborne! (CP)	20.	4666 Mac 86	call
3505 Enchanted Scepters (CP)	21.	1229 Mac 286	call
3503 Dark Castle 1.1	27.	Cutting Edge ... 1 year	
3502 Beyond Dark Castle	27.	3988 CE 105ADB Keyboard w/QuickKeys	149.
3501 Apache Strike 1.1 (MacSE & II)	27.	3989 800k Disk Drive (platinum)	175.
Simon & Schuster ... CP		3990 The Wedge XL 30 + SCSI Drive	579.
3303 Star Trek—Kobayashi Alternative	24.	3991 The Wedge XL 45 + SCSI Drive	729.
3304 Star Trek—Promethian Prophecy	24.	Datadesk ... 2 years	
Sir-Tech ... CP		1819 MAC-101 Keyboard (beige)	145.
3347 Mac Wizardry	35.	1820 MAC-101 Keyboard (platinum)	145.
Softstream, Inc. ... NCP		1821 MAC-101 Keyboard (ADB)	145.
4071 Mac•Man (w/adaptor)	24.	Dove Computer ... 90 days	
4072 The Solitaire DA	24.	FastNet networking products	call
4073 Colour Billiards	35.	1801 SCSI Interface/Port	109.
4078 Game Pak (above 3 titles)	75.	1807 MacSnap 524E	289.
SPHERE, Inc. ... NCP		1809 MacSnap 524S	379.
4175 Solitaire Royale 1.1 (for Mac SE)	20.	1811 MacSnap 548	special 499.
4001 Solitaire Royale (for Mac II)	20.	1812 MacSnap 548S	599.
3464 Tetris 1.1	20.	1800 MacSnap 2SE	439.
4472 Tetris (for Mac II)	24.		
3462 PT-109	26.		
3460 GATO 1.42	26.		
3461 Orbitor 1.1	26.		
3459 Falcon 2.0	32.		
Spinnaker/Hayden ... CP			
2328 Sargon IV	29.		
SubLogic ... CP			
4698 Jet 1.0	32.		
XOR ... NCP			
3816 Pro Challenge	29.		
3815 NFL Challenge	59.		

HARDWARE

Manufacturer's standard limited warranty period is listed after each company name. Some products in their line may have other warranty periods.

1 Meg SIMMs call
Abaton ... 5 years

1188 ProPoint ADB 89.



Farallon ... NCP
 ScreenRecorder 1.0—Lets you create a continuous "tape" of any activity on your screen. Tapes can be combined with HyperCard and MacRecorder to create multimedia presentations. \$135.



Thunderware ... 90 days
 ThunderScan 5.0 with Power Port—Turns an ImageWriter into a high-resolution image scanner. Images look better than ever with new version 5.0 software. Now with gray scale display and editing on the Mac II. \$189.

1797 MacSnap Plus 2	439.
ACCELERATOR BOARDS	
1793 MaraThon 020 MSE1	585.
1794 MaraThon 020 MSE2 (1 Meg)	979.
1795 MaraThon 020 MSE3 (math chip)	779.
1796 MaraThon 020 MSE4 (1 Meg/chip)	1159.
4231 MaraThon 020 MSE4x4	2195.
1803 1024 Option	439.
4663 Marathon 030 Accelerator 32 Mhz	1039.
Ergotron ... 1 year	
2004 Mouse Cleaner 360°	15.
3992 The Muzzle (covers power outlet)	62.
1998 MacTilt (platinum)	68.
2000 MacTilt SE	68.
1999 MacTilt Large	85.
Farallon Computing ... 1 year	
2202 PhoneNET-AppleTalk 120	9.
2203 PhoneNET PLUS (DIN-8)	35.
2204 PhoneNET PLUS (DB-9)	35.
2205 PhoneNET Punch Down Block	69.
2201 TrafficWatch 1.08	145.
2206 PhoneNET StarController	1199.
FWB Software ... 1 year	
4263 PocketHammer40	999.



Olduvai Software ... NCP
 Read-It! O.C.R. 2.0—Fully trainable O.C.R. for use with any scanner. Creates text files from books, newspapers, price lists, etc. New super-fast version 2.0 includes "EasyLearn".... \$199.

4264 PocketHammer80	\$1499.
3999 Hammer155	2899.
4000 Hammer300	3999.
Hayes ... 2 years	
2300 Smartcom II 3.0B	88.
2304 Smartmodem 1200	299.
2307 Smartmodem 2400	449.
Kensington ... 1 year	
2563 Mouse Pocket ADB	8.
2577 Mouseway (mouse pad)	8.
2569 Mac Plus or SE Cover	9.
4126 LaserWriter II Cover	17.
2589 Universal Printer Stand	15.
2562 Mouse Cleaning Kit w/Pocket	17.
2545 Universal Copy Stand	22.
2573 Maccessories Tilt/Swivel	22.
4643 Mac II Stand and Cable Kit	65.
2556 Maccessories Anti-Glare Filter	33.
2559 Apple Security System	34.
2568 Maccessories SuperBase	34.
2585 Printer Muffler 80	43.
2586 Printer Muffler 80 Stand	24.
2583 Printer Muffler 132	58.
2584 Printer Muffler 132 Stand	24.
4070 System Saver SE	52.
2566 System Saver Mac (platinum)	64.
2546 Maccessories A-B Box	64.
2560 MasterPiece 400	64.
2561 MasterPiece Mac II	105.
2547 New Turbo Mouse ADB	109.
2576 New Turbo Mouse for Mac Plus	109.
Koala Technologies ... 90 days	
2593 MacVision 2.0	219.
Kraft Systems ... 5 years	
2600 3-Button QuickStick	39.
4082 3-Button QuickStick ADB	51.
Kurta ... lifetime	
2604 IS ADB Tablet	255.
2605 Cordless 4 Button Cursor (1 year)	65.
Mobius Technologies ... 1 year	
4470 Fanny Mac QT	65.
MSC Technologies ... lifetime	
2808 A+ Mouse	65.
2809 A+ Mouse ADB	85.
Nutmeg Systems ... 90 days	
2992 15" Monitor for Mac Plus	call
2994 15" Monitor for Mac SE	special 999.
2993 15" Monitor for Mac II	special 999.

The Mac SE Turns 030

Apple squeezes 68030 power into a small box. Now you can have your 030 and travel with it too.

by Bruce F. Webster

Anyone who has lugged around a Mac II can attest to its size and weight. Powerful it is; portable it's not. Since Apple introduced the Macintosh SE and the Macintosh II two years ago, there's been a large gap in the product line. The descendant of the classic Macintosh—the SE—was small, transportable, somewhat expandable, and slightly faster than its predecessors. By contrast, the Mac II offers a tremendous boost over the SE in computing power, full support for color, and a wide-open architecture; but it also eats up more desk space than a typical MS-DOS computer.

After two years, Apple is finally taking the first step toward bridging that chasm. The newest version of the Mac SE transplants the Mac IIx's architecture—and power—to an SE box.

The IIx Reduced

On the outside, the new machine looks pretty much like an SE, with just a few minor differences. The ports along the back are identical to the SE's, but since there's no space for a second internal floppy drive, the case no longer sports a pop-out cover for a second drive. The new

Bruce F. Webster is a free-lance writer and software engineer living out amongst the redwoods near Soquel, California.

models come with an internal hard disk—40 or 80 megabytes.

The internal floppy drive has also changed: it's a Floppy Drive High Density (FDHD), the same kind that's in the Mac IIx. This drive formats, reads, and writes to 400K, 800K, and 1.2MB Macintosh floppy disks. It can also read from and write to MS-DOS disks formatted at 720K and 1.44MB (with help from Apple File Exchange software). It does this thanks to the SWIM (Super Wozniak Integrated Machine) disk controller chip. A revised (and improved) version of the Apple File Exchange utility, which transfers data between Mac and MS-DOS formats, is included with the new machine's System (version 6.0.3).

There are other major changes inside. Like the Mac IIx, the Macintosh SE/30 uses a 16-MHz 68030 chip as its central processing unit (CPU), as well as a 16-MHz 68882 chip for doing floating-point math. By contrast, the Mac SE's CPU is an 8-MHz 68000, and it has no floating-point chip. The result: a five-fold improvement in general performance over the SE, and a much greater speed-up for math-intensive applications. Also, the 68030 (unlike the 68020 and 68000) has a built-in Paged Memory Management Unit (PMMU), aiding support of a true multitasking operating system. However, until Apple ships System 7 later this year, the Mac operating system will be un-



able to utilize the PMMU. Ironically, Apple is not offering A/UX, its multitasking UNIX software, on the new machine.

Memory is another area where the Mac SE/30 differs from the SE. The number of SIMM slots doubles from 4 to 8. This means that you can expand an SE/30 to 8MB of RAM with no difficulty (other than paying for the RAM). Apple says that the slots are designed to accommodate higher-density SIMMs; this means that when 4MB SIMMs become available, you'll be able to

expand the Mac SE/30 to 32MB of RAM. Note that RAM access times are the same as on the Mac II and Ix: 120 nanoseconds (or faster).

The Macintosh SE/30 also uses a 256K ROM SIMM that is essentially identical to the Mac Ix's. In other words, the ROM used by the SE/30 isn't soldered in place or even socketed; instead, it's on a module, just like the RAM. This makes ROM upgrades very easy—snap out the old ROM SIMM and snap in the new one.

A/UX Version 1.1

The latest revision of A/UX grants Macintosh applications and desk accessories exit visas from the land of the Finder and work permits in the land of UNIX. A/UX version 1.1 can run one Macintosh-compatible application and multiple UNIX background tasks at the same time.

Program developers and users can transfer Mac applications and documents from the Mac operating system to A/UX using a file-exchange application called HFX. You launch applications under A/UX using the standard UNIX shell. There is still no Finder-like interface for starting A/UX applications and managing A/UX files.

For a standard Mac application to work in A/UX 1.1, it must be *32-bit clean*, a requirement that concerns its program code. Basically, an immigrant application must not make assumptions about its environment and must not take shortcuts (Apple publishes detailed compatibility guidelines for software developers). Many popular applications and desk accessories are compatible, including the Chooser and the Control Panel. This degree of compatibility is possible because the new version of A/UX supports most of the Mac User

Interface Toolbox, the standard software all Mac applications use to communicate with the Mac and with the outside world (see "UNIX and the Toolbox").

A/UX version 1.1 supports direct and spooled printing on LaserWriters and other LocalTalk network printers, so UNIX users can share printers with standard Mac operating system users. A/UX still does not recognize AppleShare file servers on a LocalTalk network, however.

Tape and CD ROM support are also new in A/UX 1.1. For the first time, Apple is distributing A/UX software on 40MB tape cartridges, and standard UNIX tape backup commands can now be used with the Apple Tape Backup 40SC tape drive. In addition, A/UX 1.1 recognizes the Apple CD ROM drive as a 500MB read-only disk drive. The new release thereby

enables developers or publishers to distribute large numbers of A/UX files for less than \$2 per disk—the current CD ROM duplication price.

Apple remains uncommitted in the battles for UNIX-standard supremacy that are being fought by UNIX-founder AT&T and its partner Sun Microsystems on one side, and OSF (the Open Software Foundation—a coalition of computer makers including Digital Equipment Corporation, Apollo, Hewlett-Packard, and IBM) on the other side. The new version of A/UX conforms to the POSIX Draft 12 set of standards, which positions Apple to be able to sell Mac IIs to the federal government as UNIX workstations. It also includes the X Window System version XI1.3, the current de facto standard low-level window communication system for UNIX. —*Lon Poole*



UNIX and the Toolbox

As for sound, the SE/30 comes with the Apple Sound Chip, also the same as the Mac II's and Mac Ix's. This chip is capable of synthesizing up to four voices, and it outputs sound in true stereo. To accommodate these sound capabilities, the SE/30 has a stereo jack on the back, instead of an SE-type sound port.

Like the SE, the SE/30 offers a single expansion port, but the similarity ends there. The port, called the 030 Direct Port, uses a 120-pin connector, instead of the 96-pin connector on the Mac SE. The new connector gives boards direct access to all the 68030 signals. It also has full 32-bit address and data lines, and works with existing NuBus software drivers. So far, developers who are announcing expansion boards for the Macintosh SE/30 include Avatar, Kinetics, SuperMac, and DigiDesign. Avatar will ship a 3270 mainframe communications board. Kinetics is producing a new version of its EtherPort series of Ethernet boards. SuperMac will ship an 8-bit gray-scale and color video board. And DigiDesign will ship its Sound Accelerator digital signal processing board.

One result of cramming the equivalent of a Mac Ix into such a small box is a loss of space. The expansion boards no longer sit on top of the system board. In-



RAM and an 80MB hard disk—essentially the same configuration as a Mac Ix—and will list for \$6569 without the keyboard, as opposed to just under \$9700 for a similarly equipped Mac Ix. See *State of the Mac*, in this issue.

If you have a Mac SE, you haven't been left out. Apple plans to offer a logic-board-and-chassis upgrade starting in March; pricing information was unavailable at press time. The upgrade will provide a new board-mounting scheme that solves the expansion board problem. Apple will also sell an internal version of the FDHD drive, so that you can upgrade your disk drive if you want; if not, your old 800K drive will work just fine.

The Mac SE/30 will ship with System 6.0.3, which offers some minor revisions specific to the SE/30, and will include an improved Apple File Exchange utility. Apple has stressed that only two groups of people need 6.0.3: SE/30 users, who will get it with the machine, and users of the Apple File Exchange program.

Which Road to Take

Apple sees the Mac SE/30 addressing the same markets as the Mac SE, but with a higher price tag. The overall market is

Inside the Cage

Expansion boards now mount vertically in the SE/30, along the edge of the chassis and next to the high-density floppy drive. The new 120-pin expansion connector doesn't accept boards designed for the SE's 96-pin connector. Shown here is SuperMac's Spectrum/SE for the SE/30. The board displays 256 colors and displays 640 by 480 pixels on Apple's 13-inch color monitor or 1024 by 768 pixels on SuperMac's 19-inch Spectrum monitor. SuperMac claims the SE/30's color display updates faster than the Mac II's.



Rear Connectors

The SE/30's back panel is identical to the Mac SE's. The connectors from left to right are for the Apple Desktop Bus (2), an external floppy drive, a SCSI device, a serial printer or AppleTalk, a modem, and an amplifier or headphones. Unlike on the SE, the headphone connector is now a true stereo jack.

stead, the chassis has been redesigned so that the boards stand straight up along one side. The new design allows for better cooling and avoids the problem of trying to squeeze the expansion board in between the system board and the bottom of the chassis.

Price Tags Compared

The Macintosh SE/30 should be shipping even as you read this. Apple is offering two configurations. The low-end system comes with 1MB of RAM and a 40MB hard disk and will sell for \$4869 without the keyboard. By comparison, a somewhat slower Mac II with 1MB of RAM, a 40MB hard disk, and a 4-bit monochrome display lists for around \$6457. The more powerful version of the SE/30 comes with 4MB of

Macintosh SE/30 Specifications

Here are the Macintosh SE/30's technical specifications according to Apple at the time of the product preview.

■ **Processor:** Motorola MC68030 (32-bit data and address paths, built-in Paged Memory Management Unit), running at 15.6672 MHz.

■ **Coprocessor:** Motorola MC68882, running at 15.6672 MHz.

■ **RAM:** Holds up to 8MB (using 1MB SIMMs) on system board; supports memory expansion via 030 Direct Slot. System board SIMM slots also support higher density SIMMs (4MB, 16MB). Has 256 bytes of battery-backed parameter RAM.

■ **ROM:** Has 256K of ROM; ROM code almost identical to that of the Mac IIx, including full support of color and gray-scale graphics and video. Mounted via a SIMM socket, allowing easy ROM upgrades.

■ **Mass storage:** Comes standard with both an internal Floppy Drive High Density (FDHD), supporting formats

of up to 1.4MB, and with an internal SCSI hard disk (either 40MB or 80MB); can also support an external floppy drive and one or more external SCSI hard disks.

■ **Video display:** Standard Macintosh display (9-inch diagonal tube, 512-by-342-pixel resolution, monochrome); can support external monochrome, gray-scale, or color monitor via the 030 Direct Slot.

■ **Sound:** Apple Sound Chip is capable of synthesizing four voices using wave-tables and playing back sampled sounds in stereo. Internal monaural speaker and external stereo output jack.

■ **Clock/calendar:** CMOS custom chip with long-life lithium battery.

■ **Internal expansion:** Internal 030 Direct Slot (120-pin Euro-DIN connector), giving full 68030 signals and 32-bit address and data lines.

■ **Ports:** Floppy drive port, capable of supporting either a regular or an FDHD.

SCSI port (DB-25 pinout), capable of supporting up to six external devices (hard disk, scanner, tape backup unit, and so on).

Two Apple Desktop Bus (ADB) connectors for keyboard, mouse, and other low-speed serial devices. Two RS-232/RS-422 serial ports (Apple standard).

Stereo sound output mini-phone jack (Sony Walkman standard).

■ **Mouse:** Standard ADB mouse (mechanical tracking, optical shaft, tracking 100 ± 10 pulses per inch).

■ **System software:** Released with System 6.0.3 (6.0.2 with minor revisions for SE/30).

■ **Power:** Autoconfiguring power supply (120/240 volts, frequency from 48 Hz to 62 Hz); produces up to 75 watts for internal use.

■ **Fan:** 10 CFM Radial.

■ **Size:** 13.6 inches high by 9.6 inches wide by 10.9 inches deep (standard Mac SE case).

■ **Weight:** 21½ pounds.

what Apple terms *general productivity*—meaning anyone who wants to work on a Mac and who can afford the system. The company is targeting a number of specific markets, though, most notably higher education, consultants, accountants, business, and government.

It looks as though the Next computer has highly influenced the marketing plans at Apple. The higher-education marketplace was mentioned repeatedly during the recent Macintosh SE/30 preview, as was the concept of the SE/30 as a music workstation. The Apple marketing team put a lot of emphasis on the machine's sound and music capabilities and referred repeatedly to third-party expansion boards containing digital signal processor (DSP) chips. Digi-design plans to announce an SE/30 version of its Sound Accelerator board containing the Motorola 560001 DSP chip, the same

chip used in the Next machine.

At university pricing levels—typically 50 percent of list price—the SE/30 could be a very enticing workstation when compared with the Next, with its \$6500 price tag. On the other hand, in the university market, Apple's current lack of support for A/UX on the Macintosh SE/30 is curious.

Fight or Switch

For those of us already stung by the Mac price increases in the fall, the economics of the Macintosh SE/30 are a bit more questionable, especially given the 9-inch screen. If you don't have a computer at all, you may want to consider buying a Mac II instead; it's somewhat slower, but it's far more flexible and expandable. Or, if you like the portability of the smaller Macs, you

might find it cheaper and easier to get an SE and one of the high-end accelerator boards (see "Processors: Is Faster Better?" in this issue). A number of accelerators offer performance close to or even better than that of the Macintosh SE/30, and if Apple's history is any guide, the SE/30 upgrade will be at a premium price.

So, why would you want to buy a Mac SE/30, instead of, say, a Mac SE or even a Mac II? Aside from the boost in computing power, and the compatibility with the leading edge of Mac architecture, there are a few reasons (see "A/UX Version 1.1").

One obvious reason would be if you could run A/UX. But A/UX on the Macintosh SE/30 remains a question mark; at the product preview, Apple officials stated that the SE/30 would not support A/UX. This is curious, since there are probably lots of power users out there who would welcome a self-contained, transportable UNIX workstation—and they may see one in the future.

Another reason is the fact that the Mac SE/30 uses the same ROM as the Mac IIx. This means that the Macintosh SE/30 has full support for Color QuickDraw in ROM, unlike the Mac SE. Because of the Mac SE/30's 030 Direct Slot, expect to see third-party video boards allowing you to hook up color and gray-scale monitors to the

Macintosh SE/30. In fact SuperMac, the first company to announce such a board, will offer an 8-bit color and gray-scale video board that works with an external color or monochrome monitor.

The most compelling reason to buy a Mac SE/30, though, might be to avoid obsolescence. It's interesting to note that Apple went straight to the 68030/68882, bypassing the original Mac II architecture (68020/68881/68851). It looks as though Apple has

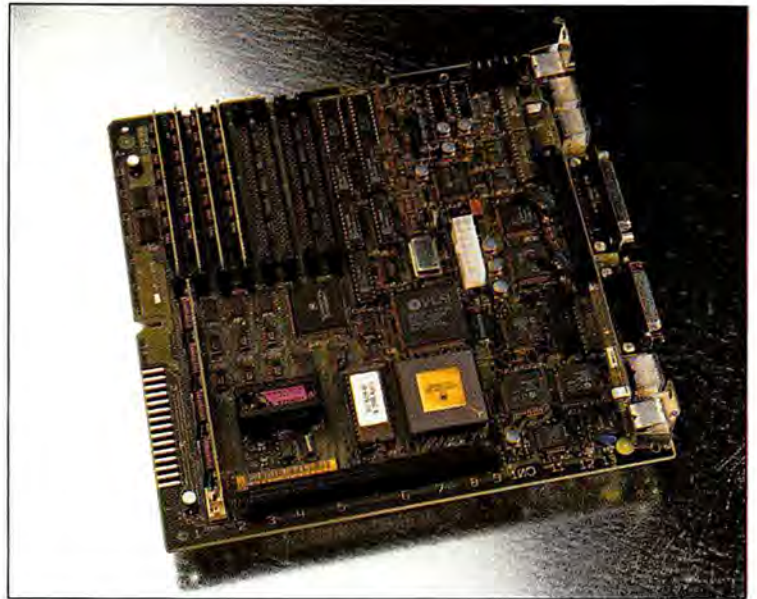

Performance Compared

I ran this simple set of benchmarks on four Apple machines. Lower times represent faster performance. Computation time is the sum of the Sieve, Matrix, and Sort test times. Floating Point is the sum of the Float and Savage benchmark times. The Graphical test measures the time it takes to draw 200 circles and 2000 rectangles. The spreadsheet was run with Excel 1.5 and a 235K document. The recalc test document contained 300 rows and 26 columns, each cell being multiplied by two others.

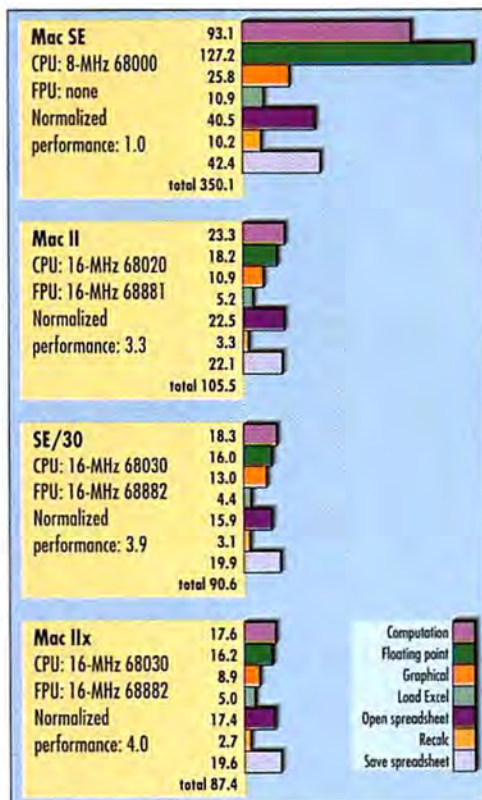

chosen the 68030 as the new standard for the Macintosh line. The 8-MHz 68000 in the Mac Plus and Mac SE is getting a bit dated, and even the 16-MHz 68020 in the Mac II is no longer a performance standout. Using the 68030 in the Mac SE/30 bodes well for the machine's long-term prospects. Add to that the completeness of the 030 Direct Slot, and you have a machine that will probably survive longer than its predecessors, most of which have been discontinued within about three years of their introductions.

The announcement of the Macintosh SE/30 is not earthshaking, nor does it break new ground. It does, however, establish Apple's commitment to the classic Mac product line, and it provides users with an Apple-supported alternative to either a small, slow Mac or a large, powerful one. Most important, it fills a gap in the Macintosh family, which has threatened to split into two separate product lines. And in doing so, the SE/30 offers a new level of power and portability for the Macintosh community. □

SE/30 Circuit Card

The SE/30's circuit card contains SIMM slots for up to 8MB of RAM (top left). The 256K ROM now plugs into a SIMM socket (lower left) like on the Mac IIx. The 120-pin expansion connector is on the bottom edge of the board, below the 68030 CPU (lower center) and the lithium battery (lower left). The 68882 is located just below the RAM SIMM sockets. Note the extensive use of VLSI chips to reduce the overall parts count.

See *Where to Buy* for contact information.



Processors: Is Faster Better?

by Bruce F. Webster

You can speed up an SE and a Mac II by adding an accelerator board. But just how powerful is that boost?

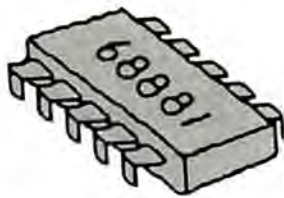

The fates can be cruel at times. When Apple announced the Macintosh SE and II, the SE was something of an improvement over the Plus, but the Mac II had all the horsepower: a 16-MHz 68020, 68881 floating-point processor, 32-bit data bus, and so on. Unfortunately, the II also had a high price. Even worse, just when you finally had the money together for a Mac II, Apple went and raised the price of an entry-level system by \$1100, or nearly 30 percent. And, of course, you also learned that a Mac II was no longer the top-of-the-line system; the Mac IIx with its 68030 processor was taking top honors.

Dove's MarAThon 030 contains a 68030 processor on a small piggy-back board, providing a quick and simple upgrade.



The DayStar Mac 20MX-25 has some of the fastest times in our benchmarks. The board also has one of the fastest clock speeds.

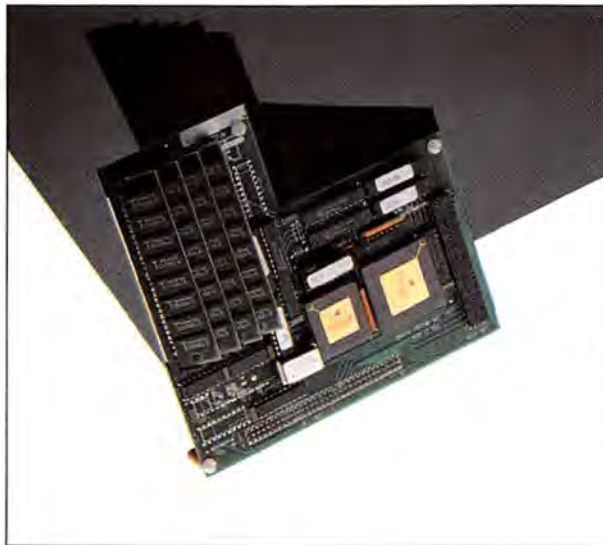

The Radius boards were price and performance champs. Both sped up a Mac SE using 32K caches—no extra RAM was required.

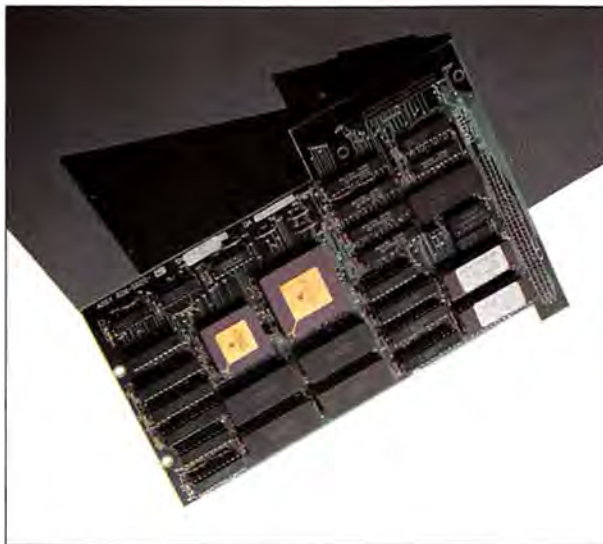

Well, cheer up, pilgrim—there are some options available to you. For about \$1000–\$2000, you can turn a Mac SE into a system that outperforms a Mac II in many areas. And if you've got a Mac II, you can boost its power beyond that of a Mac IIx.

You can boost a Mac SE's or II's power by adding an *accelerator board*—a circuit board containing a high-speed processor (68000, 68020, 68030) most often running at a higher rate of speed than your current system. These boards usually have an optional floating-point processor (68881/882) and sockets for high-speed RAM. The result: higher performance for your system.

A number of boards are currently available, with more cropping up all the time. For this article, I looked at ten 68020 boards for the SE. For comparison I also looked at one high-speed 68000 board, the Turbo SE from Siclone (see "Accelerator Features").

All the SE boards are designed to plug into the Mac SE's system board, using the expansion slot. All offer an optional 68881 floating-point chip; if you wish, you can substitute the 68882 chip instead—it's pin compatible (you just plug it into the same socket the 68881 would use) and runs about twice as fast as the 68881. Each board accepts a varying amount of memory and some can also use memory on the SE system board. A few boards offer a connector for a large-screen display, usually from a specific vendor (the same company, in at least one case). And each board comes with some software to help you get the most speed from that board, as well as to give you some control over its features.

I also looked at three 68030 accelerator boards for the Mac II. Because of bus and timing considerations, these boards don't plug into one of the Mac II slots; instead, they replace the 68020 processor on the Mac II system board. MarAThon 030 from Dove and the Over 030 from Computer System Associates have no RAM and, in fact, contain little more than the 68030 processor and a few control chips. The Accelerator 33/030 from DayStar Digital is a larger, more complex board that includes a 32K static RAM cache; a 68882 floating-point chip is optional.

'020 Questions

Why do these various accelerator boards (and the Mac II) get work done so fast? There are four major reasons:

- high clock speed

- wide data path
- floating-point hardware
- instruction and data caches

Let's look at each of these factors and how they contribute to improved performance.

Think of a complex mechanical device, sitting in a barn somewhere. To perform a particular function, you push a given button and crank a handle so many times. To do the next function, you push another button and again crank the handle some number of times. Each type of operation requires a certain number of cranks; some require more cranks, others less. But the time it takes for a given function to be completed depends not just on the number of cranks required, but on how fast you turn the crank.

A microprocessor is something like that mechanical device. Each instruction that the processor executes requires a certain number of cranks, known as *clock cycles* (or simply *cycles*). The clock speed of a microprocessor tells you how many cycles that unit runs in a second. The M68000 chip that serves as the CPU (central processing unit) of the Mac SE runs at 7.8336MHz, or roughly 7,833,600 cycles per second. This means that if the average CPU instruction takes 7 cycles to run, then the M68000 is performing about one million instructions each second.

All of these accelerator boards gain part of their speed by increasing the clock rate of the 68020 by anywhere from 16MHz to 33MHz, making the CPU two to four times faster than the SE's CPU. This doesn't mean that every application or operation will run two to three times faster, though, since various elements of the system (such as the disk drives, memory, and the design of the board itself) can slow a task down, regardless of how fast the CPU runs.

The speed of transmitting data and instructions has two components: the width of the data path and the speed of the memory. The M68000 has a 16-bit data bus, which means that it can only fetch two bytes (16 bits) at a time. By contrast, the M68020 has a 32-bit data bus, so that it can read four bytes at a time (and it does so faster than the M68000 reads two bytes, due to the higher clock speed).

The Mac SE usually comes with 150-nanosecond dynamic RAM (150-ns DRAM). This means that it takes 150 ns—150 billionths of a second, or about half the time it takes light to travel the length of a football field—to complete a memory access. This is pretty fast, but accelerator boards that can hold additional memory usually require 120-ns (or faster) DRAM, because the processor on them runs at such a high speed.

A third factor, the presence of a floating-point unit (FPU), can make an enormous difference in situations where lots of floating-point (real-number) calculations are going on. You'll often hear claims of performance

improvement by a factor upwards of 100; a more realistic figure would be 2 to 25 times faster, depending on the application and how much calculation it's actually doing.

A fourth, minor factor involves the 68020's *instruction cache*. This tiny piece of memory on the 68020 holds a copy of the last 64 instructions that the 68020 executed, along with their addresses. When the 68020 goes to fetch the next instruction, it first checks to see if that instruction is already in the cache; if so, then the 68020 loads the instruction from the cache, eliminating the entire process of fetching that data from memory.

Selecting an Accelerator

Once you've decided to supercharge your Mac SE with an accelerator, you need to figure out what factors are important to you. Let's look at some possibilities.

■ *Specific performance* You might expect that boards with identical configurations (processors, clock speed, memory) would yield identical results, but that is not the case. For example, The HyperCharger 020 and the Mac 20MX-16 both have 16-MHz 68020 CPUs and 16-MHz 68881 FPUs. I tested both with 4MB of 100-ns DRAM. They were run on the same Mac SE, using the same programs and files, under the same version of the operating system. And yet the Mac 20MX-16 was an average of 50 percent faster in "Pure Tests." A closer analysis, however, shows that most of the speed differences occurred in the General, Floating-Point, and Graphical benchmarks, and that the HyperCharger held its own in the Application Load test, even beating the Mac 20MX-16 in one. Note also the wide variation in times for the floating-point benchmarks; the Radius boards came out faster than just about anything else. These are not comprehensive benchmarks, but they do show that each board has its own strengths and weaknesses.

■ *Clock speed* A few of the boards offer 20-MHz or 25-MHz versions in addition to the regular 16-MHz version; on the Mac II the chips go up to 33MHz. So you can buy 20-MHz versions of the Orion and Gemini boards, and 25-MHz versions of the Radius and Mac 20MX boards. However, with the higher megahertz boards the speed increase usually isn't that dramatic. For example, the Radius 25-MHz board was only about 15 percent faster than the Radius 16-MHz board, but it costs 70 percent more. The Mac20MX showed more improvement—the 25-MHz version was about 30 percent faster than the 16-MHz board—but the price difference was even greater, almost 90 percent.

Accelerator Features

Accelerator Boards for Mac SE	Manufacturer	Base Price	Processors	68851 PMMU	RAM Configurations
Excellerator XL 20	Irwin Magnetics	\$995	20-MHz 68020	optional	1MB, 2MB, 4MB, 5MB, 8MB
Excellerator XL 25	Irwin Magnetics	\$1595	25-MHz 68020	optional	1MB, 2MB, 4MB, 5MB, 8MB
Gemini 020/030	Total Systems	\$995	16-MHz 68020		0MB, 1MB, 4MB
Gemini 020/030	Total Systems	\$1495	20-MHz 68020		0MB, 1MB, 4MB
Gemini 020/030	Total Systems	\$1695	20-MHz 68030		0MB, 1MB, 4MB
HyperCharger 020	GCC Technologies	\$999	16-MHz 68020		0MB, 1MB, 4MB
Mac 20MX-16	DayStar Digital	\$895	16-MHz 68020		0MB, 1MB, 4MB
Mac 20MX-25	DayStar Digital	\$1695	25-MHz 68020		0MB, 1MB, 4MB
MaraThon 020	Dove Computer	\$899	16-MHz 68020		0MB, 1MB, 4MB
Orion Accelerator	MacPeak	\$1020 (w/1MB)	16-MHz 68020	optional	1MB, 2MB, 4MB, 5MB, 8MB
Orion Accelerator	MacPeak	\$1220 (w/1MB)	20-MHz 68020	optional	1MB, 2MB, 4MB, 5MB, 8MB
Prodigy SE	Levco	\$1499 (w/1MB and 881)	16-MHz 68020	optional	1MB, 2MB, 4MB
Radius Accelerator 16	Radius	\$995 (w/32K cache)	16-MHz 68020		32K static RAM cache
Radius Accelerator 25	Radius	\$1695 (w/32K cache)	25-MHz 68020		32K static RAM cache
Turbo SE	Siclone Sales & Engineering	\$398	16-MHz 68000		0MB, 1MB, 2.5MB, 4MB
68030 Boards for Mac II					
33/030 Accelerator II	DayStar Digital	\$6000 (\$7000 w/882)	33-MHz 68030	optional	32K cache
MaraThon 030	Dove Computer		25-MHz 68030		none
MaraThon 030	Dove Computer		33-MHz 68030		none
Over 030	CSA		25-MHz 68030		none

■ *Floating point processor support* All the SE accelerator boards I surveyed have a socket for a 68881 floating-point chip. Motorola's newer chip, the 68882, is pin compatible and (according to Motorola) works about twice as fast; Motorola plans to discontinue the 68881 completely sometime in the future. All the board manufacturers will sell you a 68881, but you might want to shop around or consider mail order for a better deal. And if you can't afford a floating-point chip right away, you can always buy it later and plug it in.

More important, you should know that there are some dramatic variations in how the various accelerators support 68881 for existing applications via the SANE (Standard Apple Numerics Environment) library. SANE automatically links into the 68881/882, except

for transcendental functions (such as sine, cosine, or logarithms), which SANE handles itself for greater precision. Most of the manufacturers let applications access the 68881 directly; Radius even offers its own highly optimized SANE package, which probably accounts for them beating the pants off everyone else in the floating-point benchmark.

■ *Control software* Each board comes with software that lets you control its features, such as turning the accelerator off or disabling the 68020 cache, usually from within the Control Panel. Some boards offer a lot of options. For example, the Orion software lets you set clock speed for both processors, memory speed, 68881 usage, whether or not to copy the ROM to high-speed RAM at startup, and whether or not to recognize more than 4MB of memory.

Most of the boards let you enable or disable the accelerator. However, they usually have you do it via a



System Board RAM Used	Expansion Ports
512K (for video, sound)	proprietary bus
512K (for video, sound)	proprietary bus
1-4MB (depends on board RAM)	SCSI, 68000 bus signals
1-4MB (depends on board RAM)	SCSI, 68000 bus signals
1-4MB (depends on board RAM)	SCSI, 68000 bus signals
1-4MB (as memory and/or disk cache)	SCSI port
0-4MB (depends on board, user)	proprietary bus
0-4MB (depends on board, user)	proprietary bus
1-4MB (depends on board RAM)	SCSI port
512K (for video, sound)	proprietary bus
512K (for video, sound)	proprietary bus
part to all (as RAM disk)	proprietary bus
any amount up to 4MB	proprietary bus
any amount up to 4MB	proprietary bus
128K (for video, sound)	none
any amount	none
any amount	none
any amount	none
any amount	none

you can use the same board in a Mac 512KE, Mac Plus, or Mac SE.

■ *Price* This may be the major factor for many of you. No matter how nifty a given board is, if you can't afford it, you'll have to get something less expensive. The prices listed in "Accelerator Features" can be misleading, since most boards won't perform at their peak without high-speed RAM on them. The major exceptions are the Radius boards, which perform at top speed with no additional RAM, because they have a built-in 32K cache. Of course, if you compare them to a Mac II with 4MB of RAM, all of the accelerator boards are inexpensive.

Memory Trade-Offs

This is such a major topic for accelerator boards that it deserves a section all to itself. When you buy and install an accelerator board, you have to think a lot about memory. Specifically, you have to think about the following:

- How much memory do you have in your SE currently?
- What kind of memory is it?
- How much memory do you have on your accelerator board?
- How much memory can you actually use?

The Mac SE can have one of four memory configurations: 1MB, 2MB, 2.5MB, and 4MB. Likewise, most accelerator boards accept a variety of configurations, ranging from no memory at all to 8MB, depending on the board. It is possible, with the right board and enough memory modules, to stick 12MB into a Mac SE, but you can't use it all.

Each board has limitations on its use of system board RAM. Some boards, such as the Orion, won't

programmer's switch, which Apple does not ship with the Mac SE. If you buy an accelerator board, check to see if it requires a programmer's switch; if so, have your dealer stick one on for you.

■ *Flexibility* This is a combination of factors, most of which have to do with the ability to upgrade and enhance the board. Some boards don't give you a lot of options. For example, the Prodigy SE comes with a 68881 chip and you have to purchase some memory (1MB, 2MB, or 4MB). Furthermore, the Prodigy doesn't use the standard SIMM modules, so you can upgrade only through Levco. By contrast, the Gemini 020/030 lets you start out with a 16-MHz 68020 and no memory, and then upgrade through various configurations to a 20-MHz 68030, 20-MHz 68882, and 4MB of RAM. And



use it at all, except for low-level video and sound. The Orion Accelerator requires only that two 256K SIMMs be installed on the system board.

Other boards accept certain combinations of accelerator- and system-board RAM. For example, you don't have to have any memory at all on the Mac 20MX, HyperCharger 020, MaraThon 020, or Gemini 020/030 boards. However, without their own memory, these boards run at less than full speed, since they must use the slower memory on the SE system board.

Once you start adding memory, certain restrictions apply, depending on the board. Dove's MaraThon 020 comes with software modules for one of six or so configurations; other setups aren't allowed. Along the same lines, I had to do some minor soldering, reconnecting a clipped resistor on the SE system board, because the Gemini 020/030 wouldn't work with the 2.5MB configuration that the SE had.

Some boards will use leftover system board RAM as a disk cache or *RAM disk*, even if the accelerator board is fully loaded with memory. For example, the Prodigy SE lets you use all of system board RAM as a recoverable RAM disk that can survive a system crash or restart (though not, obviously, a power failure). Likewise, the HyperCharger 020 can use portions of system board RAM as a disk cache (to help improve disk-access speed).

Once you start talking about system board and accelerator RAM, you run into the issue of RAM speed,

mentioned earlier. The Mac SE is quite content with 150-ns DRAM, but such memory would slow down most accelerator boards. Some boards won't even work with 150-ns DRAM, which means that you'll have to buy additional (and more expensive) memory to get full performance out of your system. All the boards except the Prodigy SE (from Levco) and the Radius boards accept regular SIMM modules, like those used in the Macintosh SE itself.

The bottom line is: look before you leap. Memory is a very expensive commodity right now and may be for some time to come. It could be frustrating to spend \$1000–\$2000 on an accelerator board, only to find out that you need to spend another \$1000–\$2000 on high-speed RAM to get any performance out of it.

The Radius boards take a different approach from the others. There is no RAM expansion on the board itself; instead, each board uses 32K of high-speed static RAM, along with special circuitry, as a code-and-data *write-through* cache. This cache works like the instruction cache on the 68020, but on a grander scale, since it stores both code and data in the cache. It's called a *write-through* cache because whenever the 68020 writes data back out to memory, it actually writes to the cache, which then (independent of the CPU) transfers the data on down to the system board RAM. Radius claims a 98 percent *bit rate*, which means that during a typical period of usage, the 68020 finds what it needs in the cache 98 percent of the time.

Installation

If you buy one of these boards, how are you going to get it in? The safest way is to have your dealer install it; then if anything goes wrong, it's the dealer's fault, and the dealer has to fix it, presumably at no extra cost.

You might, however, decide to buy a board via mail order and install it yourself. Having received a dozen or so different accelerator boards, and having put each one in several times, I got very good at installing and taking them out. However, as the commercials say, we're professional dummies, and you shouldn't try this at home.

WARNING: *High-voltage components may cause physical harm to you as well as to the machine. In addition, you may void the Apple warranty the minute you open the machine.*—Ed.

Once you have installed the accelerator board in the Mac, you need to install the accompanying software. Most of the accelerator companies have kept up with the times, and installing their software consists of dropping an INIT file into the System Folder on the start-up device. When you restart, the System loads the

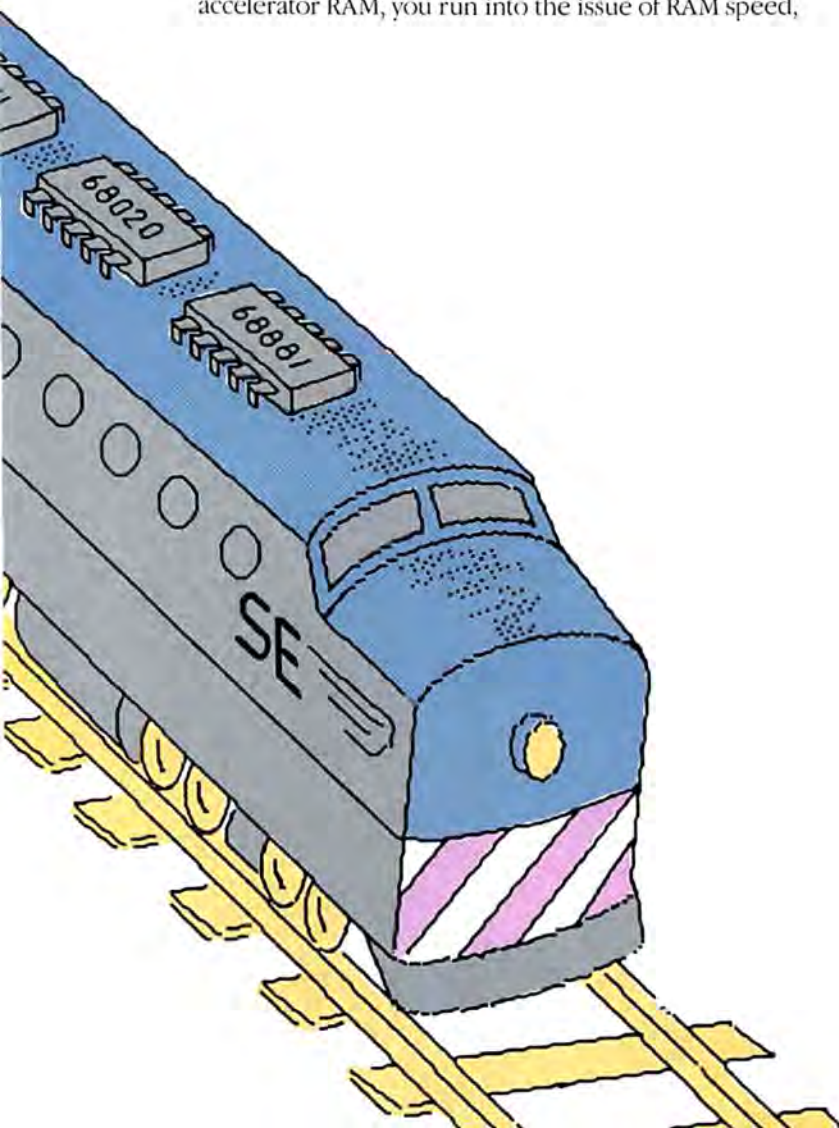

Is the '030 Something?

If the 68020 is good, the 68030 must be better, right? After all, Apple has included it in their top-end Mac IIx. Well, yes, the 68030 is better, but the question is: how much better? The major difference between the two processors is that the 68030 has *memory management logic* built-in. You may be aware that the Mac II and a few of the accelerator boards have a socket for a 68851 Paged Memory Management Unit (PMMU). This chip is designed to simplify implementation of a multitasking, multiuser operating system, such as A/UX. With the 68030 you no longer need the extra chip; the 68030 does everything for you. Also the 68030 has a *data cache* that keeps track of up to 16 long-words (8 bytes each) of data and the addresses that go with them.

How much performance difference is there between the

'020 and the '030? Some, but not a large amount. Note, for example, the difference between the Mac II and the Mac IIx in the benchmarks "Testing for Speed." The Mac IIx, which has a 68030 running at the same clock speed (16 MHz) as the 68020 in the Mac II, does perform better, but not by a great amount: only by about 20 percent overall.

The Gemini 020/030 board lets you put a 68030 into a Mac SE. You can also upgrade a Mac II with one of three products. Two of the products, the Over 030 from Computer System Associates and the MaraThon 030 from Dove, provide quick and simple upgrades. Both are just a 68030 on a small piggy-back board, with the minimal logic required to interface with the regular 68020 socket on the Mac II system board; both products provide improve-

ment, though not as dramatic as you might want.

The 33/030 Accelerator II from DayStar Digital, does provide a significant performance improvement, but at a price. That board has a 33-MHz 68030, a 33-MHz 68882, and a 32K static RAM cache (much like that on the Radius boards); the resulting improvement in speed is just under 100 percent (twice as fast as a Mac II) for most tests. The price is steep: \$6000 for a regular board, \$7000 for one with a 68882 floating-point unit.

In short, most 68030 upgrades aren't worth the cost, unless you have a lot of money to spend and really, really need that last 20+ percent of speed. As the price comes down and the clock speeds go up, though, these boards will provide yet another way to increase the performance of the Macintosh.

necessary software and executes it; you can usually select options from the Control Panel. A few boards, such as the Prodigy SE, let you set options through a desk accessory; others such as DayStar's Mac 20MX use a stand-alone application for configuration. Don't worry about chicken-and-egg problems; you can start up your system before installing this software, drop the INIT into the System Folder, and then restart to make sure everything's been done correctly.

System Configuration

Most of the accelerators run faster with the Macintosh disk cache enabled. The cache reduces the impact of the biggest bottleneck remaining on a system: the disk drives. For example, the Turbo SE performed the Recompile benchmark in 121 seconds with a 256K cache enabled, as opposed to 192 seconds with no cache enabled. By assigning some of the SE system

board's "slow" RAM to the disk cache, you force applications to load into the faster RAM on the accelerator board.

Next, be sure that the accelerator and the floating-point processor are both enabled. You do that via whatever control software comes with the board. You should also enable the 68020 instruction cache, unless you come across a program that can't run with it on because of self-modifying code. This problem is increasingly rare, since such programs also crash on the Mac II, and Apple doesn't provide software control of the 68020 instruction cache on that system.

Testing for Speed

To paraphrase Disraeli, there are three types of dishonesty: lies, damned lies, and benchmarks. Or that's how it seems in an industry where competitors and fans throw conflicting figures back and forth. Still, benchmarks (like IQ tests) measure whatever they measure, and we gain some benefit by looking at them.

I used eight different benchmarks to test the accelerator boards. I selected these benchmarks to test both pure and real-world performance. All benchmarks were run under the following configuration:

- System release 5.0 (System 4.2/Finder 6.0)
- Disk cache disabled
- QuickerGraf 1.1 installed
- 1 bit per pixel (the Mac II)
- Finder for Pure Tests, MultiFinder (with no other applications loaded) for all others
- All files residing on the internal Mac SE hard disk
- 020 boards had a 68881 chip installed; 030 boards had a 68882 chip installed; the unenhanced SE did not have a math coprocessor.

"Pure Tests" shows the results from three sets of tests.

■ **General** adds up the times of three pure benchmarks: the standard Sieve of Eratosthenes (100 iterations), a selection sort on 1000 seven-character strings that were in reverse order, and multiplying two 64-by-64-integer matrices.

■ **Floating Point** adds the results of two floating-point tests. The first test performs 10,000 additions, subtractions, multiplications, and divisions; the second (the Savage benchmark), executes 1000 times a statement containing calls to Tan(), ArcTan(), Exp(), Ln(), and Sqrt(), and also contains a multiplication and an addition.

■ **Graphical** adds the results of two benchmarks; the first puts up 200 circles with a radius of 100 pixels, alternating black and white; the second puts up 2000 rectangles that are 200 pixels by 200 pixels, alternating black and white.

"Real World" shows the accelerated speed of some everyday activities on an Excel 1.5 spreadsheet with 26 columns and 300 rows. Several timings were made for each test and the results were averaged.

Recompile measures the time it takes for TML Pascal II, running under the Macintosh Programmer's Workshop (MPW), to recompile all its unit interfaces (some 20 files).

"Totals" adds up the times displayed in the other three graphs. You can clearly see which boards excel at which tests, and which boards come out overall. You'll need to refer to "Accelerator Features" to choose a price/performance trade-off you can live with.

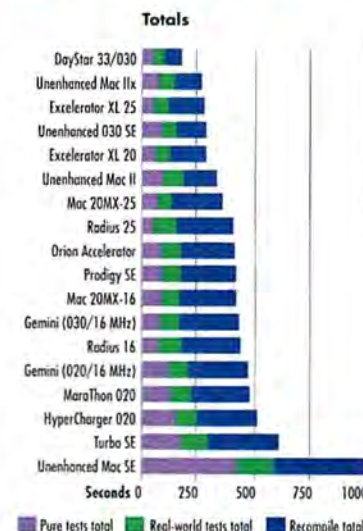
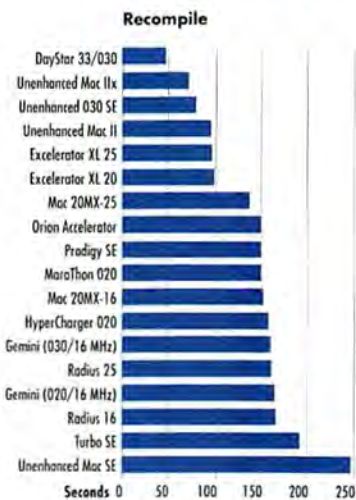
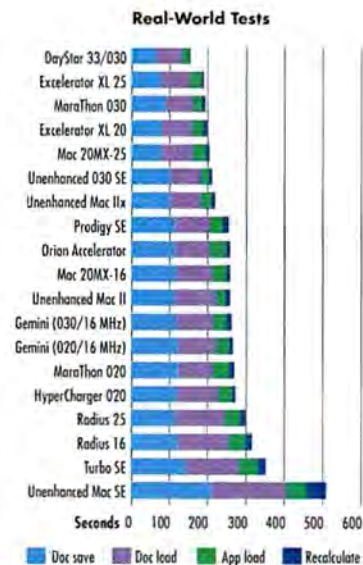
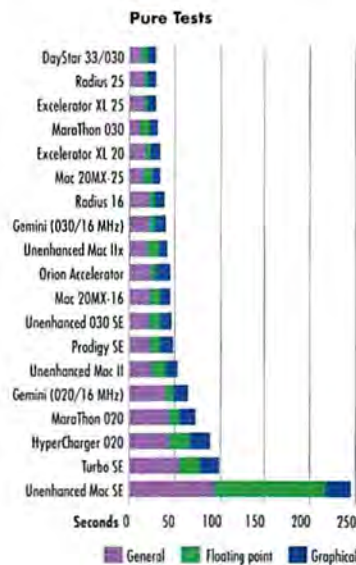

Third, if you want to, and if you can, set up a RAM disk. The Prodigy SE and both Mac 20MX boards come with RAM disk software. The Prodigy RAM disk is great; it uses leftover RAM on the SE system board and preserves its contents in case the system crashes or you accidentally restart. The Mac 20MX boards come with two RAM disk programs; one of them, RAMStart 1.4, doesn't work properly under System 5.0, but the other one does work and makes for some significant improvements.

Performance

The benchmarks provide a simple review of the relative performance of the accelerator boards. While they were done carefully and rigorously, they still shouldn't be construed as anything more than simple comparisons; they certainly don't establish the superiority or inferiority of a given board. "Testing for Speed" discusses the benchmarks and how they were set up.

The closest thing to a clear winner in this less-than-stiff competition is Irwin's Excelerator board. The 20-MHz 68020 version was faster than any of the other Mac SE boards and the 25-MHz version was even faster than that. Since the Excelerator is almost identical to the Orion Accelerator, I can chalk the performance difference up to one major factor: the ability to load the contents of the 256K Mac SE ROM in the high-speed memory on the board. The Orion software had this option, but I was never able to get it to work; nor did this feature work in the software that accompanied the 20-MHz Irwin board which, consequently, gave a decent but unspectacular performance. When I tried the software for the 25-MHz Irwin board, it loaded ROM into RAM just fine. That same software also worked with the 20-MHz board. The performance for both boards increased dramatically when I loaded their ROM into RAM.

The Radius Accelerator 25 and DayStar's Mac 20MX-25 were close behind the Irwin boards; no big surprise, since they also had fast clock speeds. The Radius had an edge on instruction execution, while the DayStar had the best disk-access times. Use of a RAM disk on the DayStar makes performance really sing; the Recompile result dropped from 138 seconds to 27 seconds, which is an amazing improvement over the 247-second time for a regular Mac SE (running off the hard disk, no less).

The Recompile benchmark also reflects the difference in hard disk access times for the Mac SE and Mac II. This suggests another source of improvement: a

faster SE hard disk, either from Apple or from a third party.

Floating-point performance varied significantly among the boards, though even the slowest was a great improvement—five times faster than the unenhanced Mac SE. The fastest SE board (the Radius 25) was another five-fold improvement over the slowest board (the Turbo SE), making it about 25 times faster than a regular Mac SE. The differences have to do with how well the software supplied with the board patches in the SANE (Standard Apple Numerics Environment) routines to the M68881 floating-point processor.

A Real Boost

If the Macintosh SE seems slow to you, there are definitely ways to perk it up. Accelerator boards are one answer, provided you can afford one of them. On



The Mac IIx has a 68030 processor running at 16Mhz, but its performance is only about 20 percent better than a Mac II using a 68020 processor running at 16MHz.

the other hand, compared with the cost of a Mac II, most of these boards look pretty good. And besides: it's hard to carry a Mac II with a monitor onto a plane.

The best performance was by the two boards from Irwin, and since the 25-MHz board is only marginally faster than the 20-MHz board, you're best off buying the 20-MHz board and using the extra \$700 toward high-speed RAM. The price/performance winners, though, are the Radius boards. All the other Mac SE boards require high-speed RAM (100-ns or faster) to achieve highest performance. And while RAM prices may finally be on the way down, RAM's still going to cost a fair amount. The Radius boards achieve their performance without any additional RAM costs.

Accelerating a Mac SE can increase productivity and provide a psychological boost as well. An accelerator helps bring you to the point where you're not waiting for the Mac to finish a task, it's waiting for you. Just be sure that it's going to do what you need it to do, at a price you're willing to pay. □

See *Where to Buy* for contact information.

Bruce F. Webster is a Macworld contributing editor and a freelance writer living in the redwoods near Santa Cruz, California.



Selecting a Color Separator

*The ABCs of CMYK:
part two in our series
on color separation*

by Steve Roth

Screen frequencies, traps, overlays, UCR, GCR, overprinting, knockouts, tints, Pantone palettes.

Hoopla.

The buzzwords of color separation are everywhere in the Macintosh world these days. But in fact only a handful of programs and services for producing four-color process separations from Mac files actually exist, and none of them offer everything you might dream of. Some programs create separations only from their own files, for instance. Some handle only objects, others only bitmaps. Some give you a finished page, while others require that you separate graphics and then have your printer strip (assemble) the film into final pages.

The capabilities of your separation tool directly affect the publishing process—who does what and when, how much it costs, and how long it takes—so if you decide to pursue color desktop publishing, you'll obviously need to take a close look at program features when you plan your system. On the other hand, before you plunge into feature comparisons, it's a good idea to stand back and consider which overall approach to color separation suits your operation best. The prospective color publisher has four basic strategies to choose among.

Strategies

The first approach is to do your color traditionally: print black-and-white pages, mark the areas where you want color, have professional separations made of any color art, and then send the entire package to the printer's, where it can be assembled by hand.

The next possibility is to turn to a service that will produce separations for you from your electronic files. There's only one full-service bureau right now: Image South's Color Cutter service, which separates PageMaker files that contain Adobe Illustrator and Aldus FreeHand images.

If you use color photographs and have deep pockets, you can consider a hybrid desktop/workstation arrangement. Such systems cost tens of thousands of dollars and employ a high-end scanner and dedicated image-processing software. The Mac handles type and page design and uses low-resolution color scans on a for-position-only basis. When it's time to produce the final film, the Mac pages are passed to the workstation, where the high-resolution scans are merged in. None of these systems is online yet, which is why I cover them in the "In the Works" section of this article.

The three solutions just discussed don't sound much like desktop publishing, which is why the last option is the one that generates the most excitement. This route is for do-it-yourselfers: build the color images on screen, use Mac software to separate them, send the PostScript output to a Linotronic, and present

your printer with the four film negatives, ready to go. You may or may not need to have the graphics stripped in, depending on the software and type of graphics you use.

Do It Yourself

The obvious question to ask about this approach is whether going to all that trouble will save you any money. The answer, as usual, is that it depends—in this case mostly on the type of work you do and on how good you are at making the technology work for you.

Let's leave aside the efficiencies you may derive from doing design, layout, and art-creation on the computer, and concentrate on production. Linotronic film costs between \$10 and \$14 a page; that's \$40 to \$56 for four process separations if all goes well. Add \$50 for a color proof, and you're at about \$100. Conventional separation costs vary widely, depending on the size of the image and the level of quality you demand, but \$150 is a ballpark figure for separating a color slide to 3-by-5-inch film (including the proof). If you do *lots* of work with a separation house, that figure can go as low as \$60. On the other hand, if you want any color correction, it can easily mount to \$300.

The other major cost consideration has to do with stripping. No matter how you create separations, stripping them into a page costs about \$15. Prices for creating tinted sidebars, rules, and type vary widely, depending on the printer, how many times you use a tint in a document, how many of the process colors are included in the tint, and even the width of lines surrounding tinted elements (hairline boxes cost more to fill with tints, because they require more accuracy). One major commercial printer charges \$5 per color for dropping in square tints—into a sidebar, for instance. Reverse or solid type in a tint will run you \$16 a color. So if you have a headline, a sidebar, and a sidebar head, each in a two-color tint, plus one four-color graphic, you're in for \$90. A color key of that page (four overlaid color films that enable you to proof the stripper's work) will cost another \$30 or so.

Of course, some pages are much more complex than the one just described, and some graphics demand expensive film work as well. It's not unusual for stripping on a complex color page to run anywhere from \$200 to \$1000—plus the cost of separations. If you use QuarkXpress and Illustrator or the PageMaker/Separator combination, you can produce film for the same complex page with no stripping charges at all (see "Take the Xpress Way").

Those savings sound wonderful, but this is where the quality problems associated with Linotronic separations come in. You may run into moiré patterns or banding on your separations, and have to rerun the film. That's another \$100 for the film and proof. \$100 here and \$100 there, and pretty soon you've erased your savings. On the other hand, if you know how to work within the system's limitations (see "Color Separation Explained," part one of this two-part series, in last month's *Macworld*), you can usually get by with one trip to the Lino.

Take the Xpress Way

This QuarkXpress page is made up of type and graphics created in Xpress, a low-resolution black-and-white scan (the dog) that was colorized, a page of color swatches created in Adobe Illustrator, and a scanned color TIFF image (which Xpress is not able to separate). The separations were output as film at 133 lpi.





Illustrator Two Ways

The graphic at the upper left was created in Illustrator and separated in Separator. Notice the very complete printing information, which Separator includes automatically when it prints a separation. On the lower right, the same Illustrator file has been incorporated in a PageMaker page, which was separated by the Color Cutter Service.

The bottom line is that as far as making separations goes, if you're using object-oriented Mac graphics and tints, you can probably save some money, since the results for these elements are pretty consistent. You can also separate bitmapped, paint-type graphics and color screen shots with good results, though final colors may not match the on-screen versions exactly. Separating photographs is much harder than doing graphics, so the need to rerun film may well eat away any savings on separations you might have realized. Stripping is where the big savings come in. The more complex your pages and the bigger your stripping bills, the more you stand to save.

Available Software

With these strategy issues in mind, let's take a look at the software tools that can take you from on-screen to linescreens.

Color Cutter

Color Cutter is not actually a software program, or to be more precise, it's a program that you can't buy. Image South (formerly People's Publishing) uses Color Cutter to separate electronic files for you. You send the files, Image South sends you back the film. Color Cutter will separate color Illustrator files, either by themselves or on PageMaker pages (see "Illustrator Two Ways"). You can also use FreeHand, but Image South recommends Illustrator for graphics because it saves CMYK percentages, not RGB, in its EPS files (see "Color Models and Color Palettes"). *Note: FreeHand 2.0, just shipping as this article went to press, does save CMYK values.* —Ed.

Even if you use PageMaker to build pages for Color Cutter, all the color elements come from Illustrator—sidebars, colored type, and so on. You don't use PageMaker's color specifications. This is bothersome if you want, for example, color subheads, since you have to place them as graphics rather than include them in the text where they will flow with design and editing changes.

Also, you're limited to Illustrator's spacing controls (no manual kerning), you can't specify a column width for colored type or justify a column (you use a hard return for each line in Illustrator), and the color elements don't show up in color in PageMaker. FreeHand doesn't have any of these problems, which is why Image South recommends using it for creating colored type.



Once you've built your pages and placed all the color elements, you save the file as PostScript and send it to Image South. The company sends you back the separated pages for \$72 a page plus \$10 for every minute of Lino time above three minutes per piece of film. For that price, you get all four layers plus masks as necessary for color photos, and Image South will go in and build traps for you. The company also offers training and consulting, and may help subsidize your equipment purchases, depending on the volume of your business.

One key component of the Color Cutter service is that Image South provides its customers with a program called MultiSend. MultiSend does several things, but the most important is that it reads Illustrator EPS files and

Color Models and Color Palettes

Different programs take different approaches to specifying colors for four-color process separation. The four predominant models are red/green/blue (RGB), hue/saturation/brightness (HSB), cyan/magenta/yellow/black (CMYK), and palette color. While each of these schemes has its place, the variety of models often makes it hard to move images between programs, or to separate the output from one program using another.

Since final output of separations is always based on CMYK values, that system is the model of choice for specifying colors. It lets you explicitly control all four values, and you can use widely available printed CMYK charts to see what colors will come off press. The CMYK model is standard in object-oriented programs such as FreeHand, Illustrator, and QuarkXpress, and it's also available in some bitmapped painting programs, such as PixelPaint.

The RGB and HSB models are most common with scanned images, since most color scanners capture information in RGB form. Since there is no such thing as a printed RGB or HSB color chart, it's hard to know how the color you see on screen will actually print once it's been converted to CMYK.

To make things confusing, some programs let you specify colors using one model, but they store the color values using another. When you export a CMYK-specced Free-Hand image in EPS format, for instance, it saves RGB values, not CMYK, making the file much less useful if color separations are the goal.

A color palette can use any of the three color models to store colors, but the values are accessed by selecting from a menu, or palette, of (usually 256) colors. If the palette changes, as when you open a file created with one program in another, the colors change as

well. Modern Artist has the greatest problems with mismatched color palettes.

PMS (Pantone Matching System) palettes constitute a special case. In standard printing, Pantone colors are typically printed using special inks that produce particular shades. On the Mac, software makers provide a library of Pantone shades that can be simulated using CMYK. Thus the Pantone system is used only as a color standard. Since CMYK equivalents don't exactly match the PMS charts, however, it's more reliable to simply specify CMYK colors to begin with, using a CMYK chart.

There is a simple rule here: use CMYK specifications whenever possible. (It's not generally possible with scanned images, in which case you have to rely on the limited color correspondence between your color display and the printed results.) Don't use PMS palettes, and don't use RGB or HSB if you have CMYK available.

builds dummy files. The dummies contain a PICT representation for placing in PageMaker, along with a few lines of the actual PostScript that point to the full PostScript file on disk. This lets you place the same image numerous times without eating disk space, and lets you change the image throughout a document without going through and replacing it. When MultiSend prints a document, it incorporates the external PostScript files where they're required.

The Color Cutter process doesn't let you control everything yourself, it costs more than doing everything yourself, and it forces you to use Illustrator or FreeHand for color elements. On the other hand, it's great not to have to worry about traps, it's cheaper than traditional methods (at least with complex pages), the quality is excellent (screen tints are guaranteed to within 2 percent), and the turnaround is fast.

Adobe Separator

Adobe Illustrator 88 comes with a stand-alone application called Adobe Separator, which separates Illustrator and some other PostScript files. If you specify CMYK colors to create your Illustrator document, Separator simply separates out those colors. If you use the PMS palette included with Illustrator 88, the program either produces a separate piece of film for each PMS color or converts any of those PMS colors to their process equivalents. Separator includes more information on the final film—including file name, process-color name, and even color bars—than any other Mac program (see "Separators Compared").

Separator provides only limited options for modifying screen frequency, and the angles for each frequency are fixed (see "Separator Pros and Cons"). If you really want that control, you have to use a word processor to change the (commented but undocumented) PostScript Printer Description files.

Separator's separations are consistently good, though there are still some problems with banding at line screens over 120 lines per inch (lpi) and when producing large areas covered by gradations. Moirés make their appearance, but they're not as frequent or as bad as those produced by Aldus FreeHand. If there is no black in the colors specified, Separator rarely troubles you with moirés. The difficulty of changing screen angles in order to eliminate moirés when they do occur, however, is inexcusable.

Nevertheless, Illustrator and Separator are programs of choice for color illustration on the Mac, especially since the Illustrator PostScript format has become something of a standard.

Separator and PageMaker

For those who want to use PageMaker to create full-color pages, there's good news and bad news and good news. The good news is that you can specify col-

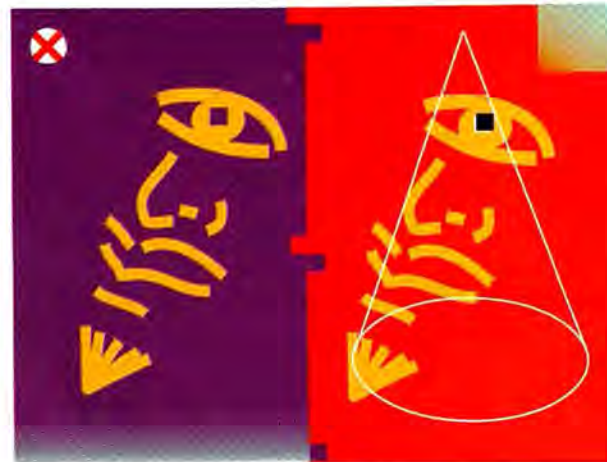
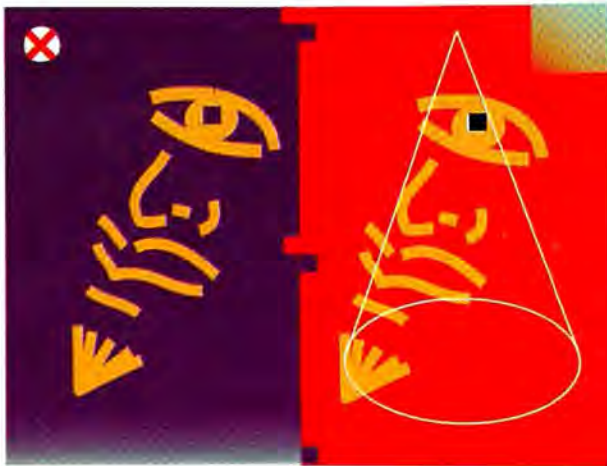

Am I Normal?

These images were created and separated with FreeHand. The image on the bottom was printed using the Normalize transfer option, which adjusts the gray transition specifically for Linotronic Imagesetters.

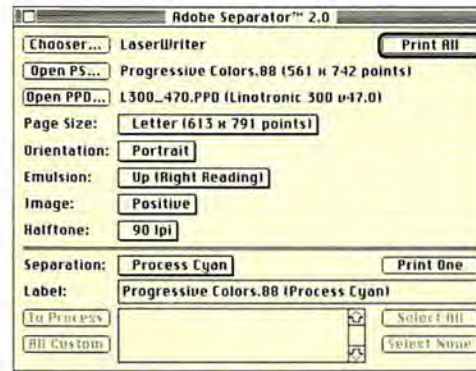

Separator Pros and Cons

There's only one dialog box in Separator, so all the separation controls are in one place. The drawback is that no options are given for changing screen angle.

ors for page elements in PageMaker, creating full-color, CMYK-specced pages, right on screen. The bad news is that you can't do anything with those color pages except print spot-color overlays or black-and-white renditions—no process seps.

The good news is that you can create color elements with Illustrator or FreeHand, place them on PageMaker pages, save those pages to disk as encapsulated PostScript (choose print, select a single page, hold down Option-⌘, and click OK in the print dialog box), and separate them with Separator. You still need to separate color bitmaps and PICT files separately and strip them in, but everything else comes out in place.

This combination approach to building pages has all the limitations discussed in the section on Color Cutter. You can't see the color on the page, color sub-heads don't flow with the text, and if you are using Illustrator, you are stuck with its limited type-handling for color type.

The other problem with this approach is the number of large, redundant files you end up with: the Illustrator color elements, the PageMaker pages, and the printed-to-disk PostScript pages. And if you want to change any color elements, you have to modify them in Illustrator or FreeHand, then place them again in PageMaker.

All those limitations make the Illustrator/FreeHand/PageMaker/Separator scenario a bit unwieldy, but in return you get to work with the most popular tools on the market.

Aldus FreeHand

FreeHand gives you more control over the separation process than any program, and aside from color bars, includes everything on the final film that a printer might need.

The overprint feature in FreeHand applies only to "Custom" colors, which generally means those colors that will be printed with PMS inks. This is useful when you want your printer to create knockouts and traps for two- and three-color printing, but it can't be used to overprint black, and you can't overprint selected objects, as you can in Illustrator.

FreeHand's separations are every bit as good as Separator's, except with fountains. FreeHand's fountains employ a complex PostScript method that doesn't bear description here. The result is a propensity for serious moiré patterns (see "Am I Normal?")—that is, when the fountains don't crash the Lino. Altsys, creator of FreeHand, is working on a fix for these problems, and version 49.4 of PostScript, which should be available soon as an upgrade to L-300 owners, should help solve the problem of crashes. If you avoid fountains, or keep them simple, FreeHand produces top-notch separations.

Note: FreeHand 2.0, released as this article was going to press, adds overprinting for lines and fills and a Pantone palette. CMYK color specs are now saved in EPS files using CMYK values, not RGB. Dialog boxes have also been consolidated, so separation controls are more easily accessible. We were unable to test for quality and compatibility in the latest version.—Ed.

LaserPaint Color II

LaserPaint is like a precocious, annoying child. It bothers the heck out of you when you first meet it, but you can't help being impressed by its abilities and may even come grudgingly to like it. LaserPaint separates more file types than anything else on the market does. But its features are implemented in odd ways, and some obvious things are missing (such as including a color name on each piece of film).

LaserPaint's method of specifying colors is infuriating. In earlier versions you could specify CMYK percentages, although the resulting colors were accessible only as color swatches on a palette or as PMS numbers that you assigned (at random, or according to any scheme you devised). In the latest release, Laserware has eliminated CMYK specking entirely! All that's left is RGB. The whole approach to specifying colors, especially with the Auto-Airbrush (fountain) tool, is incredibly wrongheaded.

To its credit, LaserPaint is the first commercially available Mac program (and at this writing still the only one) to produce separations from 8-bit as well as 24-bit color TIFF and PICT2 bitmapped images. It is the only program implementing undercolor removal and gray-component replacement when it creates seps, and it even lets you do your own gamma color correction for color bitmaps (PhotoMac and PixelPaint Professional will do all these things when they ship).

LaserPaint takes an unusual but flexible approach to separations. After importing or creating your art, you choose Four Color Separate, and LaserPaint creates four new LaserPaint files, one for each color. You can open each of those files and edit it (and you need to, if only to write the color name on the layers). When you print from the original, full-color file, LaserPaint opens and prints each of the separated files, one after the other. You can also choose Line Color Separate if you want color overlays for each color in the document.

Separators Compared

	ColorSep 1.0	Adobe Separator 2.0	Aldus FreeHand 1.0	LaserPaint Color II 1.9.2C	Color Cutter (service)
File types separated	Modern Artist PICT files	Illustrator, some imported EPS (including PageMaker), some other PostScript	FreeHand files, some imported EPS	8- and 24-bit TIFF and PICT2 bitmaps and objects, LaserPaint	PageMaker with Illustrator and FreeHand
UCR ²	•			•	
GCR ²	•			•	
Set frequency	•	• ³	•	•	•
Set angle	•	†	•	•	n/a
Automatic trapping					•
Overprint colors	n/a		•	•	•
Overprint objects	n/a	•			•
Control dot shape			•	•	•
Adjust transfer	•		•		•
Prints on film					
registration marks	•	•	•	•	•
crop marks	•	•	•	•	•
color bars		•			•
color name	•	•	•		•
file name	•	•	•		•
date	•	•	•		•
Price	\$495 ⁵	\$495 ⁵	\$495	\$595	\$72/page +

¹ Specifications subject to change. ² Undercolor removal/gray-component replacement. ³ Limited selection available. ⁴ Possible to set angle by editing PPD file.

LaserPaint is the best choice around if you want to separate color screen shots or other images created with color paint programs. It handles colors very well, without modifying the palette and screwing up the color scheme. It also works with color scans, though the quality still doesn't match that of commercial separations and the program is very slow in 24-bit mode (see "The Face of the Future"). It also works well with objects created and colored within the program, though the Auto Airbrush-created fountains consistently fail to separate properly.

Modern Artist

Modern Artist is well known as a color paint program, but until recently there hasn't been a good method for getting Modern Artist images into print. The new ColorSep utility that comes with Modern Artist 2.0 solves that problem, although the version I tested, 1.0, had some serious problems. It generally works with images saved in Modern Artist's proprietary PICT mode, but when I tried to separate Modern Artist standard PICT files or a PixelPaint PICT file, the program had a variety of difficulties, from crashing repeatedly to changing the color palette to printing separations with a distinctly underwater appearance. Even with proprietary files the program has a tendency to crash.

Computer Friends says it tested ColorSep 1.0 with Apple's System version 5.0, and that it works fine with any System version up through that number. As I write



The Face of the Future

Images A, B, and C are 133-lpi Mac separations made from a 24-bit BarneyScan scan of a 35mm slide. D is a conventional separation of the same slide. Image A, separated using Avalon's PhotoMac, augurs a better future for the Mac as a pre-press tool. B and C reflect the level of quality we're used to seeing from Mac photo separations: B was made in LaserPaint Color II, and C was separated by PrePress Technologies' SpectrePrint. (PhotoMac and SpectrePrint were both in pre-release form when these separations were made.)

this, the company is working on an upgrade for System 6.0 and above. The upgrade will be shipped free to registered users; call or write Computer Friends if you haven't received it yet. If you're thinking of buying Modern Artist and need ColorSep, be sure you get a good demo of the separation-printing function first to be sure the corrections are in place.

When you are working with proprietary files, ColorSep lets you control the brightness of the entire image on each of the process colors individually, as well as specify percentages for undercolor removal. You can also sharpen or smooth any image. Another useful feature lets you enter an identifier that is printed on each layer. If you choose to Spool the seps, ColorSep will save four PostScript files on disk, which you can then download.

QuarkXpress

If you want full-color pages, right from your Mac to the Lino, using a single program, QuarkXpress is the only choice right now. The program lets you specify the fill and outline colors for any frame on the page, select colors for type (but not different colors for outlines and fills), and even colorize a black-and-white

QuarkXpress 2.0	Beta Software ¹	
	PixelPaint Professional	PhotoMac
Xpress with Illustrator	8-bit TIFF and PICT bitmaps	8- and 24-bit TIFF and PICT
	•	•
	•	•
•	•	•
	•	•
	n/a	n/a
	n/a	n/a
	•	
•	•	•
•	•	•
•		•
\$795	\$595	\$695

¹ Price includes graphics application.

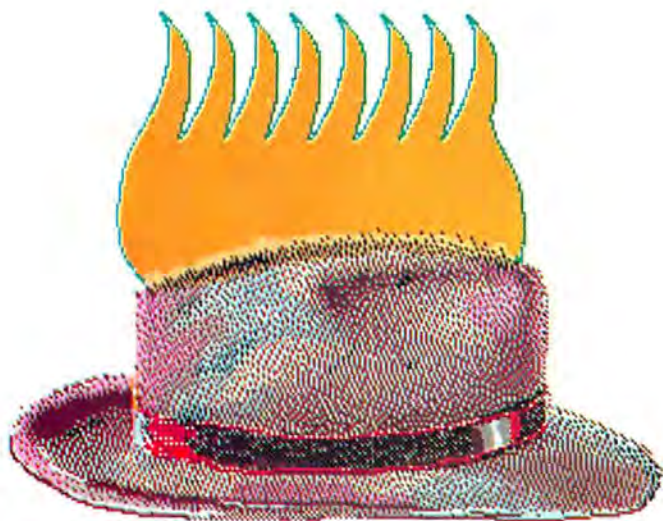

(A)

Bitmap Comparison

This image was created in PixelPaint version 1.0 and separated with three paint program facilities. A is a LaserPaint separation at 133 lpi; B was separated in PixelPaint Professional at 120 lpi; C, also at 120 lpi, shows the difficulties Computer Friends' ColorSep 1.0 has separating non-native files.

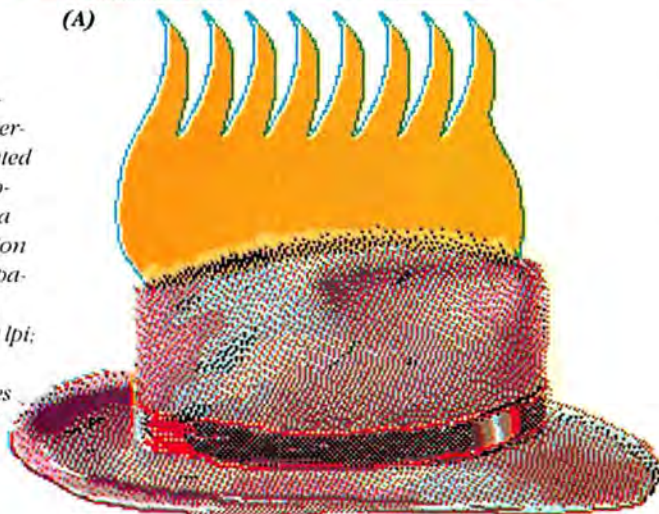

(B)



(C)

bitmap (not dot-by-dot, however—one color for the whole bitmap). Most desktop publishers simply want something on the order of a headline in ruby red and subheads in royal blue with a green background tint, and Xpress can give you just that, easily and quickly.

If you want more complex graphics on the page, Xpress can import and separate Illustrator 88 color images (though it won't display them in color). Between Xpress and Illustrator, you can include almost all the color elements you might need.

There is one fatal flaw in this magnificent scenario, however: the colors you specify in Xpress don't match printed process color charts. They come out too dark. If you specify some color swatches in Illustrator, specify the same colors in Xpress, and separate them side-by-side on an Xpress page, the Illustrator colors come out fine, but the Xpress colors are way off. Quark says it's working on this problem, and should have it fixed by the time you read this. Watch for version 2.01.

In the Works

In addition to the programs mentioned above, there are a few packages that are on the verge of release at this writing, including two correction and separation programs for color scans.

■ *PhotoMac*, from Avalon, at first glance may look like another color paint program, but it's actually a tool for manipulating and separating color scans. Its tools for lassoing noncontiguous areas (even finding boundaries automatically, within limits) and modifying the colors for those selections far surpass anything currently available on the Mac.

The beta version I worked with lets you control the percentages for gray-component enhancement (encompassing both undercolor removal and gray-component replacement) and control the percentages for gray balance—a key factor in getting accurate colors on press. The gray-balance controls let you specify percentages of cyan, magenta, and yellow that combine to create gray. The program will also correct colors automatically for coated stock, uncoated stock, and newsprint (see "Expert Color Control").

PhotoMac is designed to work with scanned images, which use RGB values, so all colors are specced using RGB or hue/saturation/brightness (HSB). Since there is no method for calibrating the monitor to match printed results, it's difficult to know what screen colors will come out looking like.

■ *PixelPaint Professional* is a color paint program with built-in separation capabilities. It's limited to working with 8-bit images, though PixelScan, included with the program, converts 24-bit images to 8-bit. You can set the percentage of undercolor removal and the maximum ink buildup (how much total ink is permissible for a given spot), and the density ranges for all four process colors (specifying the minimum and maximum percentages for each).

PixelPaint Professional stands out among paint programs, because you can specify colors using CMYK percentages, in addition to being able to use RGB, HSB, and the most complete electronic Pantone library on the market (for whatever that's worth). PixelPaint Professional is a promising contender, though its inability to handle 24-bit images restricts it to paint-variety graphics.

■ *PhotoShop* is the name going around for a hot new color-scanning and image-editing tool that promises to put the current crop of applications to shame. It will be marketed with the BarneyScan slide scanner under the name BarneyScan XP, and it has also been licensed to Adobe Systems. PhotoShop allows images to be split into separate RGB or CMYK channels; each channel can be edited, corrected, and merged with other channels before separations are made.

■ *Color System I* is a complete scanning/image editing/page makeup/color separation hardware and software system based on the Macintosh II and the UltraSetter, a high-resolution (up to 3000 dpi) output device. The system will work with BarneyScan, Eikonix, and other color scanners. It will output to film, RC paper, and 3M dry silver material (for proofing). And it will support typefaces from the Compu-graphic, Adobe, and Bitstream libraries. Complete turnkey systems will cost \$40,000 and up.

■ *Enterprise*, which may have been released by the time you read this, is the only moderately priced Mac program besides QuarkXpress that will produce and separate pages with color type and graphics in place. Enterprise works with single pages only, but you can specify CMYK colors for any page element. At \$795, it's targeted for those who produce high-quality, single-page display ads.

■ *ImageStudio*, the color version. Watch for this in the first quarter of '89. It will handle 24-bit TIFF and PICT, but will include "simple default-level separation capabilities" only, according to Letraset. A follow-up stand-alone utility will offer full-blown separation control.

■ *SpectreMatch* and *SpectrePrint* are two products from PrePress Technologies. Originally created for IBM compatibles, these programs are now being ported to the Mac. They run \$3000 and \$6000, respectively, and require a 4MB Mac II with a 24-bit card, so they aren't for casual separators. For professionals, however, they offer control that's unavailable with other Mac programs, such as highlight and shadow control for cyan, magenta, and yellow, and adjustment of gradations for highlight, ¼-tone, midtone, ¾-tone, and shadow areas.

Hybrid Systems

When you get into the area of color scans, especially when you want a full-page output with separated color photos in place, you are beyond the realm of current Macintosh software. Several systems are emerging, however, that combine the page-making powers of Macintosh software with the scanning and color separation prowess of expensive prepress systems. Crosfield has announced an interface that will import ReadySetGo pages, so scanned separations can be merged on the Crosfield system. And Cyber-Publishing's CyberChrome system will merge scanned separations onto pages from either PageMaker or QuarkXpress.

The advantages of these systems remain to be determined. The disadvantage is obvious: the relatively high initial cost. Even if service bureaus spring up to

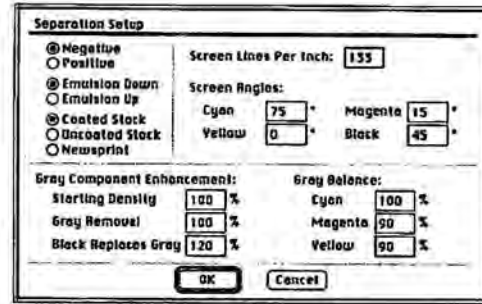

Expert Color Control
PhotoMac offers the most sophisticated CMYK separation and correction capabilities of any Mac program to date.

handle the electronic stripping and image-management end of this arrangement, whether such a service will save you money will depend on overall economies of computer versus manual business. No single part of the process will be a big saver. True, you'll avoid mechanical stripping, but you'll have to pay much higher rates for the digital stripping you'll still require. And you'll still be paying to have a professional separation made.

Final Advice

As things stand now, QuarkXpress, Image South's Color Cutter Service, and the PageMaker/Separator combination promise the greatest savings for color publishers using the Mac (along with Enterprise, when it's released), because you can create full-color pages with type, graphics, rules, and tint boxes all in place, saving the stripping costs that add up so fast.

The object programs Illustrator and FreeHand offer the most consistent results if you want to separate Mac graphics. The bitmap separators like LaserPaint and ColorSep work well, though the color correspondence they provide isn't as good as that of the object programs. And as the photos in "The Face of the Future" show, new software is even making separations of scans an economic reality.

In parting I have to offer just one caveat: you never get something for nothing. Making your own separations can give you a new level of control, save you money, and in some instances speed turnaround time, but you have to be ready for the difficulties that always arise when you bring an out-of-house job in-house. Learning to set your own type wasn't that hard, and the slight drop in typographic quality it involved was more than offset by the advantages. But as these articles have demonstrated, the world of color printing is far more complex. Before you cross the final desktop publishing frontier, think twice about whether you're ready for the inevitable challenges you'll face as a Macintosh pioneer. □

See *Where to Buy* for contact information.

Steve Roth is the editor of *Real World PostScript* (Addison-Wesley, 1988) and the former editor of *Personal Publishing Magazine*.



*You'd better look long
and hard before picking
a Macintosh fax modem
over a regular fax unit*

Mac Fax: Not Ready for Prime Time

For sending and receiving documents on the spot, the latest weapon of business is the facsimile, or *fax* for short. There are currently over one million fax units in operation in the United States, with another two million units installed worldwide. Now that fax modems are available for the Macintosh, you and your Mac won't be left outside of this worldwide networking system.

A fax modem lets you automatically receive faxes on a Mac. (But you will need a hard disk, because the faxes take up so much space.) You can send electronic files stored on a Mac directly to stand-alone fax units and other fax modems. You don't have to print documents to transmit them. In fact, sending a fax is just as simple as printing a document on a LaserWriter or an ImageWriter—a few clicks of the mouse and it's off.

Let's delve into the machine for a moment to see how the fax-Mac marriage works. You might already be familiar with the basic components of a fax machine: a scanner, a printer, a modem, and a control panel (see "Putting the Pieces Together").

Since a fax modem can automatically send documents from the Mac's hard disk, you can dispense with the scanner—unless, of course, you also have hard copy to send. As far as the printer is concerned, you may find that when you receive a fax, the electronic document is all you need. In any case, the printer you already use should be good enough for printing most faxes.

Fax modem parameters—telephone numbers, transmission quality, and so forth—are controlled by Mac software, rather than with a physical control panel. It's this software that determines how easy and convenient a fax modem is to use. Thus, the fax software is at least as important as the fax modem in establishing a fax system's desirability and efficiency.

As this article is being written, two companies are shipping fax modems for the Mac: Apple and its Apple-Fax Modem, and STF Technologies and the FAXstf. In

by Dave Kosiur

Dave Kosiur, a Macworld contributing editor, is the publisher of Connections, an international newsletter concerned with Macintosh networking. He has two AppleTalk network zones in his house.

Putting the Pieces Together

The diagram below shows how two Macs equipped with fax modems duplicate the transmission process of two stand-alone facsimile machines. Most of the time Mac fax modem users will probably send files produced on the Mac, a process that doesn't require scanning. But if you want to send a copy of a paper original (as you would with a fax machine), you'll have to use a Mac scanner (1). A typical scanned docu-

ment has 3.7 million dots per page; the Mac's fax software compresses the image to reduce transmission time (2).

The Mac fax modem then converts the compressed digital data into an analog signal that is compatible with the telephone network and sends it to another Mac fax modem (3).

Reversing this process, the receiving Mac answers the phone transmission and converts the analog phone signal

back into digital form (4). The fax software decompresses the document, restoring the original image (5). The receiving Mac can either view this image onscreen or print it on a laser printer (6). When you send copy between two stand-alone facsimile machines, the same process takes place, but the fax machines themselves handle all the steps.

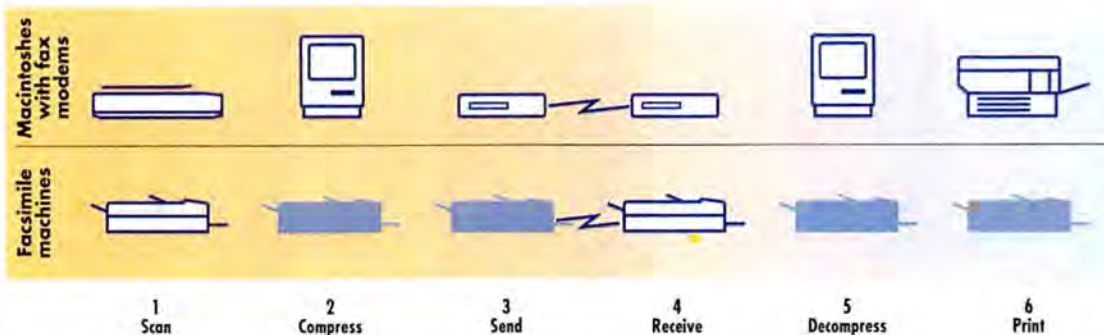

addition, Solutions International offers BackFax, a software product designed specifically for use with Apple's AppleFax Modem. I was able to actually test the AppleFax Modem and the FAXstf, as well as BackFax. Abaton's InterFax was also available for testing in the final stages of its development, but Cypress Research's FaxPlus and Genius's TransFax were only available for examination, not testing.

Getting Connected

What should you look for in a fax modem? Certain capabilities emerge as the bare minimum for an acceptable fax modem. These include compatibility with fax standards, transmission speed, on-screen viewing of received faxes, user-defined address books and distribution lists, scheduling for delayed fax transmissions, and background operation. You can see how the various Mac fax offerings compare in the table "Facts on Fax."

You wonder why you can't use a regular modem to send and receive faxes? The answer is that fax mo-

dem and regular modems use different communications standards. Standards for fax transmission are dictated by the Consultative Committee for International Telegraph and Telephone (CCITT). Fax modems use the CCITT standard for Group 3 faxes, which requires devices to send and receive images in a line-by-line raster format (unlike the bit-by-bit format used by regular modems) and has no error-checking capability so the receiving modem can't resend incorrect lines. If a fax modem is designed with both fax chips and regular modem chips, however, it can perform double duty.

When choosing a fax modem you should consider which CCITT standards it conforms with. Of the four sets of standards, Group 3 is currently the most popular (see "What Group Does What?"). At the very least, a fax modem should be compatible with Group 3 fax units.

Standard Group 3 fax machines recognize 9600 bits-per-second (bps) transmissions; however, they can lower their speeds to match the transmission speed of another fax station. For the fax, transmitting at 4800 bps will take twice as long as transmitting at

Facts on Fax



AppleFax Modem



BackFax



FaxPlus



FAXstf



InterFax



TransFax

Company	Apple Computer	Solutions	Cypress Research	STF Technologies	Abaton	Genius
Price	\$729	\$245	\$995	\$695	\$495	\$1295
Polling	•	•			•	•
Background operation		•	•	•	•	•
File translations		•	•	•	•	•
TIFF	n/a	•	•		•	•
Glue	n/a	•				•
PICT	n/a	•	•	•	•	•
MacPaint	n/a	•	•	•	•	•
EPS	n/a	•				•
Regular modem		n/a	2400 bps		1200 bps	
Speed of fax modem (in bps)	9600	n/a	9600	4800	4800	9600
Auto redialing	•	•	•	•		•
Forwarding	•					•
Binary file transfers	•	•	•			•
Speed (in bps)	9600	9600	9600	n/a	n/a	9600
Magnification of received fax file			variable	25%, 50%, 200%, 300%	5%–100%	
Pass-through for external modem	•	n/a				
Pass-through for external phone	•	n/a	•	•	•	•
Multiple address books	•	•	•	•	•	•
Import text address files			•		•	
Group distribution lists	•	•	•		•	•
Scheduled transmissions	•	•	•	•	•	•
Multiple files to one recipient	•	•	•		•	•
Multiple recipients for one file	•	•	•	•	•	•
Activity log	•	•	•	•	•	•
Cover sheet		•	•			•
Resizable facsimile original	33%, 66%	33%, 67%	variable			33%, 67%
Manual connection			•	•		
Adjustable length to fax page		•	•		•	•
Image rotation			•		•	

9600 bps. The longer the transmission, the more expensive the phone bill. Unless you have money to burn, and don't care if fax transmission takes longer, look for a 9600-bps fax modem.

You'll need to view received documents on the Mac's screen, if only to determine their contents. Unfortunately, most fax documents are illegible on the Mac's screen, which displays at only 72 dots per inch (dpi). Because fax documents have a resolution of 200 dpi, a lot of detail in the fax document can get lost on-screen without magnification. If the fax document is skewed a little while being fed into the fax, the characters probably look even worse. Remember, you're not

substituting nicely designed screen fonts for the characters, you're looking at bitmaps that once were characters. Good fax modem software not only displays the images, but also magnifies them.

Many stand-alone fax machines allow you to store frequently used telephone numbers in their memories for easy access. Similarly, fax modems should be able to access numbers stored in an *address book* on the Mac. The ability to keep multiple address books and to group addresses into distribution lists are also handy features for heavily used faxes.

You may not want to send all faxes immediately. Some information might not have to get to the recipient until the next day, or the recipient's fax machine might be available only at certain hours of the day. If

CCITT fax standards have evolved to take advantage of improvements in technology. For example, many Group 3 faxes can communicate with Group 2 faxes, but the inverse isn't true.

AppleFax Envelopes
The AppleFax software uses different envelope icons to represent different stages of fax preparation. Of the four envelopes shown in the window (note the lack of a zoom box), the one on the upper left is new; the one on the upper right has been addressed, but has no contents; the envelope in the second row is ready to be sent; while the one at the bottom is a fax received from another station. Double-clicking on any envelope displays its contents.

What Group Does What?

Group	Signal Type	Compression	Speed
1	Analog	None	6 minutes
2	Analog	Limited	3 minutes
3	Digital	Complex	< 1 minute
4	Digital	Complex	< 10 seconds



that's the case, the ability to schedule fax transmissions—for any time of day or even on a different day—is becomes important.

Unless you're willing to devote a Mac to serve as a fax unit (an expensive proposition), fax modem software should run in the background on the Mac. By this, I don't mean just compatible with MultiFinder, but actual background operation: the open application runs whether it's active (in the foreground) or inactive (in the background). If you have fax software that operates only in the foreground, you'll find that you miss some incoming fax traffic simply because you don't have the application active.

Another feature, called *polling*, can make using fax modems more efficient and cost-effective. Polling enables a fax modem to send documents to and receive documents from another fax in one phone call. Without polling, it would take two phone calls to get everything done—one to send your faxes to a fax station, the second to receive your faxes from that same station. Since the first minute of a phone call is the most expensive, reducing the number of short phone calls between fax units with polling can reduce operating costs.

The Lineup

A Mac fax modem consists of two parts, the actual hardware and the software that controls that hardware. To the Mac, a fax modem looks like just another output

device (a LaserWriter, for example) that's connected to the computer. When you want to send a fax, you select the fax driver from the Chooser; then you "print" to it as you would to a LaserWriter from within an application.

The software then converts the document into facsimile format and either sends it immediately, or stores it on disk if you schedule the document for transmission at a later time. All of the current fax software allows you to modify transmission times, delete unsent faxes, or resend them in the event of a communications problem.

AppleFax Modem

Even after a one-year delay in its introduction, the AppleFax Modem still has problems, especially as far as engineering is concerned. I've seen units that had trouble with the power switch, as well as with the switch that lets you change between fax modem operation and pass-through mode. The pass-through mode prevents the AppleFax modem from interfering with other serial devices which can be attached to the fax modem's second serial port.

Although it's one of the smallest modem units (only the FAXstf is smaller), the separate power supply for the AppleFax Modem is the largest. The AppleFax Modem cannot act as a regular modem because it communicates according to the CCITT standard. There is a provision for sending Mac files to another AppleFax Modem at 9600 bps. This file-transfer capability is nice to have.

The AppleFax software leaves much to be desired. I didn't find the interface of the program to be terribly intuitive. And Apple's is the only software of the lot that does not operate in the background, under either Finder or MultiFinder. To make matters worse, you must have the fax modem turned on and connected if you want to use the AppleFax application, even if you only want to view a received fax or simply update a phone book. That's bad design.

There are no magnification options for viewing fax documents; none of the windows has a zoom box to fill up the screen automatically (see "AppleFax Envelopes"). On the positive side, you can use the AppleFax Modem to poll other fax units for messages. You can also route faxes to a second destination via other AppleFax Modems.

BackFax

BackFax manages to fill most of the holes in Apple's own AppleFax software. For instance, BackFax—as the name implies—allows you to run an AppleFax Modem in the background, with or without MultiFinder. It also includes file translations to MacPaint, PICT, Encapsulated PostScript (EPS), TIFF, and Glue formats. One nice feature is BackFax's support of user-created cover pages. You can create and store up to five different cover pages and assign a different one to each transmitted document (see "BackFax").

Facts on Fax



AppleFax Modem



BackFax



FaxPlus



FAXstf



InterFax



TransFax

Company	Apple Computer	Solutions	Cypress Research	STF Technologies	Abaton	Genius
Price	\$729	\$245	\$995	\$695	\$495	\$1295
Polling	•	•			•	•
Background operation		•	•	•	•	•
File translations		•	•	•	•	•
TIFF	n/a	•	•		•	•
Glue	n/a	•				•
PICT	n/a	•	•	•	•	•
MacPaint	n/a	•	•	•	•	•
EPS	n/a	•				•
Regular modem		n/a	2400 bps		1200 bps	
Speed of fax modem (in bps)	9600	n/a	9600	4800	4800	9600
Auto redialing	•	•	•	•		•
Forwarding	•					•
Binary file transfers	•	•	•			•
Speed (in bps)	9600	9600	9600	n/a	n/a	9600
Magnification of received fax file			variable	25%, 50%, 200%, 300%	5%–100%	
Pass-through for external modem	•	n/a				
Pass-through for external phone	•	n/a	•	•	•	•
Multiple address books	•	•	•	•	•	•
Import text address files			•		•	
Group distribution lists	•	•	•		•	•
Scheduled transmissions	•	•	•	•	•	•
Multiple files to one recipient	•	•	•		•	•
Multiple recipients for one file	•	•	•	•	•	•
Activity log	•	•	•	•	•	•
Cover sheet		•	•			•
Resizable facsimile original	33%, 66%	33%, 67%	variable			33%, 67%
Manual connection			•	•		
Adjustable length to fax page		•	•		•	•
Image rotation			•		•	

9600 bps. The longer the transmission, the more expensive the phone bill. Unless you have money to burn, and don't care if fax transmission takes longer, look for a 9600-bps fax modem.

You'll need to view received documents on the Mac's screen, if only to determine their contents. Unfortunately, most fax documents are illegible on the Mac's screen, which displays at only 72 dots per inch (dpi). Because fax documents have a resolution of 200 dpi, a lot of detail in the fax document can get lost on-screen without magnification. If the fax document is skewed a little while being fed into the fax, the characters probably look even worse. Remember, you're not

substituting nicely designed screen fonts for the characters, you're looking at bitmaps that once were characters. Good fax modem software not only displays the images, but also magnifies them.

Many stand-alone fax machines allow you to store frequently used telephone numbers in their memories for easy access. Similarly, fax modems should be able to access numbers stored in an *address book* on the Mac. The ability to keep multiple address books and to group addresses into distribution lists are also handy features for heavily used faxes.

You may not want to send all faxes immediately. Some information might not have to get to the recipient until the next day, or the recipient's fax machine might be available only at certain hours of the day. If

CCITT fax standards have evolved to take advantage of improvements in technology. For example, many Group 3 faxes can communicate with Group 2 faxes, but the inverse isn't true.

What Group Does What?

Group	Signal Type	Compression	Speed
1	Analog	None	6 minutes
2	Analog	Limited	3 minutes
3	Digital	Complex	< 1 minute
4	Digital	Complex	< 10 seconds

AppleFax Envelopes

The AppleFax software uses different envelope icons to represent different stages of fax preparation. Of the four envelopes shown in the window (note the lack of a zoom box), the one on the upper left is new; the one on the upper right has been addressed, but has no contents; the envelope in the second row is ready to be sent; while the one at the bottom is a fax received from another station. Double-clicking on any envelope displays its contents.



that's the case, the ability to schedule fax transmissions—for any time of day or even on a different day—becomes important.

Unless you're willing to devote a Mac to serve as a fax unit (an expensive proposition), fax modem software should run in the background on the Mac. By this, I don't mean just compatible with MultiFinder, but actual background operation: the open application runs whether it's active (in the foreground) or inactive (in the background). If you have fax software that operates only in the foreground, you'll find that you miss some incoming fax traffic simply because you don't have the application active.

Another feature, called *polling*, can make using fax modems more efficient and cost-effective. Polling enables a fax modem to send documents to and receive documents from another fax in one phone call. Without polling, it would take two phone calls to get everything done—one to send your faxes to a fax station, the second to receive your faxes from that same station. Since the first minute of a phone call is the most expensive, reducing the number of short phone calls between fax units with polling can reduce operating costs.

The Lineup

A Mac fax modem consists of two parts, the actual hardware and the software that controls that hardware. To the Mac, a fax modem looks like just another output

device (a LaserWriter, for example) that's connected to the computer. When you want to send a fax, you select the fax driver from the Chooser; then you "print" to it as you would to a LaserWriter from within an application.

The software then converts the document into facsimile format and either sends it immediately, or stores it on disk if you schedule the document for transmission at a later time. All of the current fax software allows you to modify transmission times, delete unsend faxes, or resend them in the event of a communications problem.

AppleFax Modem

Even after a one-year delay in its introduction, the AppleFax Modem still has problems, especially as far as engineering is concerned. I've seen units that had trouble with the power switch, as well as with the switch that lets you change between fax modem operation and pass-through mode. The pass-through mode prevents the AppleFax modem from interfering with other serial devices which can be attached to the fax modem's second serial port.

Although it's one of the smallest modem units (only the FAXstf is smaller), the separate power supply for the AppleFax Modem is the largest. The AppleFax Modem cannot act as a regular modem because it communicates according to the CCITT standard. There is a provision for sending Mac files to another AppleFax Modem at 9600 bps. This file-transfer capability is nice to have.

The AppleFax software leaves much to be desired. I didn't find the interface of the program to be terribly intuitive. And Apple's is the only software of the lot that does not operate in the background, under either Finder or MultiFinder. To make matters worse, you must have the fax modem turned on and connected if you want to use the AppleFax application, even if you only want to view a received fax or simply update a phone book. That's bad design.

There are no magnification options for viewing fax documents; none of the windows has a zoom box to fill up the screen automatically (see "AppleFax Envelopes"). On the positive side, you can use the AppleFax Modem to poll other fax units for messages. You can also route faxes to a second destination via other AppleFax Modems.

BackFax

BackFax manages to fill most of the holes in Apple's own AppleFax software. For instance, BackFax—as the name implies—allows you to run an AppleFax Modem in the background, with or without MultiFinder. It also includes file translations to MacPaint, PICT, Encapsulated PostScript (EPS), TIFF, and Glue formats. One nice feature is BackFax's support of user-created cover pages. You can create and store up to five different cover pages and assign a different one to each transmitted document (see "BackFax").

But the product, compatible only with the Apple-Fax Modem, has its own problems. For example, Solutions, the program's developer, seems to have forgotten that users may want to view their faxes. There are no magnification options in BackFax.

FAXstf

STF Technologies' FAXstf is the most compact unit of all, about the size of a pocket calculator. The FAXstf's size is an indicator of its simplicity: It's only a 4800-bps fax modem with no frills.

STF's FaxManager software also has a clean, simple look. It's not too difficult to figure out how to use the program to create phone entries and send faxes (see "FAXstf Phone Book"). A Manual Send feature allows you to dial a number, speak to the person on the other end, and then start a fax transmission without hanging up. If you use the FAXstf in the background, then you'll need to launch another application, the FaxMonitor, which controls the fax modem. FaxMonitor operates independently of FaxManager.

FAXstf includes a few reductions and magnifications for viewing faxes, good enough for most purposes. You can print, or cut and paste, bitmaps of received files. Also, the software does not support group-distribution lists.

InterFax

Abaton's InterFax 12/48 is a 4800-bps fax modem that includes an additional 1200-bps modem. But as with the FAXstf, sending faxes at the InterFax's maximum 4800 bps will up your transmission costs.

The InterFax software consists of three components: the fax driver (selectable via the Chooser), an InterFax Control file, and the InterFax application. The InterFax Control file installs a CDEV file that, when accessed from the Control Panel, controls the fax modem. You can turn the receive/send function of the fax modem on or off, view the status of fax traffic, or cancel a fax receipt or transmission. You use the InterFax application to set up an address/phone book and to view fax documents.

When you view a document, there are two methods for setting magnification: type in a percentage, or ask the program to map a specified number of fax pixels to one screen pixel (see "InterFax Software"). You can also change the orientation of the image on the page. As an added feature, InterFax has a menu choice for converting fax documents to and from certain graphics formats, namely MacPaint, PICT, or TIFF.

FaxPlus

At first glance, the FaxPlus from Cypress Research looks like a regular modem; it actually contains a 9600-bps fax modem and a 2400-bps modem. From a hardware viewpoint, the FaxPlus thus offers you the most communications capabilities for your money.

The software has many of the features you'd expect to find in a good fax program. There is variable magnification for viewing documents, as well as support for saving faxes in different file formats and image

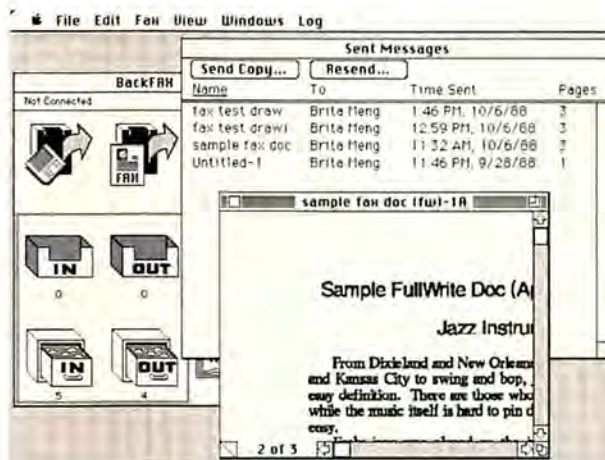

orientations. The address/phone book—which is actually a DA—is one of the most complete I've seen; you can enter not only a street address, but also electronic mail information for each recipient (see "FaxPlus Software"). And the software functions in the background, even without MultiFinder.

If you must use the same phone line for voice and fax transmissions, the FaxPlus lets you converse with the receiving party, then switch over to fax transmission.

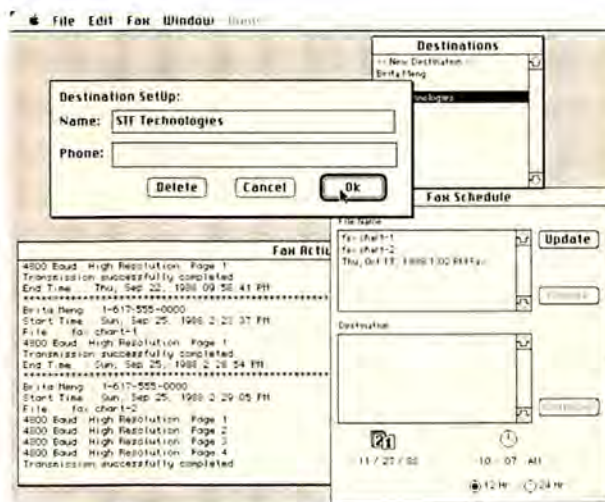

Transfax

The TransFax includes an on-board microprocessor and 256K of RAM so that the unit can function independently of the Mac. With 256K of RAM, for instance, the TransFax can receive up to eight fax pages when the Mac is turned off. Once the Mac is on, you can transfer the received faxes to the Mac. You can also store up to eight fax pages in the TransFax's memory for later transmission to other clients.

TransFax's software is a specially written version of BackFax, so it works just like BackFax with the

BackFax

Part of the BackFax interface resembles that of Solutions' sister product, Desktop Express. You can view separate logs for sent and received messages. Double-clicking on the name of a fax—in this case, a message that has already been sent—displays a zoomable window with the contents of the document (front-most window).

FAXstf Phone Book

FAXstf's phone book does not allow you to assign names to groups to simplify widespread fax transmissions. Shown here is a sample phone entry, along with the activity log and fax schedule windows. The calendar and clock in the lower right of the figure enable you to reschedule any fax's transmission date and time.

InterFax Software
InterFax is the only software that shows you the time it takes to send or receive a fax. It also offers the most flexible options for changing the magnification of a fax document for viewing.

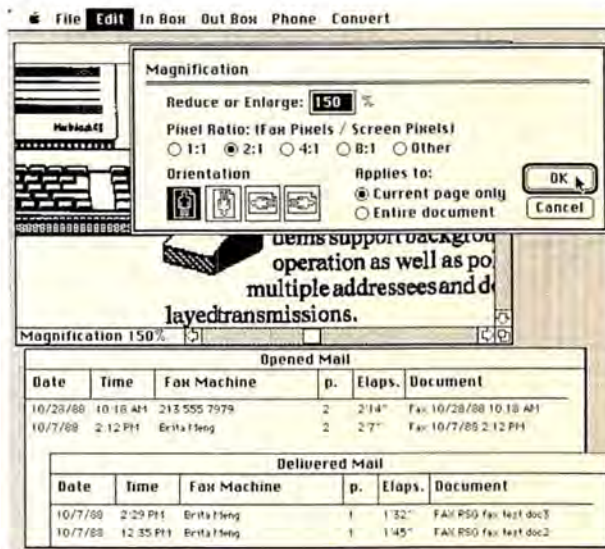

FaxPlus Software
The window used to address a fax envelope and determine its contents resembles an actual envelope. The address goes into the upper half of the window; enclosed files appear in the lower half of the window. You can select from an address book (foreground), or you can add new addresses and phone numbers with the text-entry box at the bottom of the address book window.



AppleFax Modem. The major changes to the software handle communications with TransFax's processor and memory.

On Different Scales

When is a pixel not a pixel? The answer is, when you send it via fax modem. You can get documents into, and out of, Macs using a fax modem, but my tests with the AppleFax Modem and FAXstf uncovered some scaling problems that result from dealing with the unusual specifications of fax documents.

The CCITT defines Group 3 faxes as having either a standard resolution of 203 by 98 dpi or a fine resolution of 203 by 196 dpi. Since none of these numbers translate easily to the 72-dpi screen resolution of the Mac, the 216-dpi resolution of the ImageWriter LQ, or the 300-dpi resolution of the LaserWriter, it appears that the Apple and STF developers have cut some corners in translating the fax resolutions into something usable on the Mac. And therein lie the problems.

Both the AppleFax Modem and the FAXstf ship with ImageWriter LQ fonts, which are defined for a

216-dpi resolution. If you want to send crisp, readable text via either of these fax modems, I advise you to use only the ImageWriter LQ fonts. If you don't, you'll end up with a case of the jaggies as the programs attempt to deal with the regular 72-dpi screen fonts.

The InterFax uses a slightly different approach to font representation. Instead of using the LQ fonts, Abaton includes two of Bitstream's outline fonts, SWA Swiss (which resembles Helvetica) and SWA Dutch (which resembles Times). Again, if you use other fonts, they will often appear jagged.

Unless my math is wrong, 216 isn't equal to 196 or 203. Because of that inequality, the AppleFax and FAXstf software each introduce a scaling factor for all faxes. Any fax you receive looks smaller than the original, and any fax you send out is larger than the original (see "What You See Is Not What You Get").

Also, since the fax resolution is not the same in the vertical and horizontal directions, the current software does not scale documents the same in both directions. This problem doesn't affect text-only documents very much, but it can be very noticeable in drawings. Any drawing that you send or receive will have neither the correct size nor the correct proportions ($203/216$, or 0.9398, in the horizontal direction, and $196/216$, or 0.9074, in the vertical direction). Thus CAD/CAM drawings or precision artwork are nearly worthless when sent over these two fax modems.

BackFax attempts to get around this problem by offering what it calls Best Resolution and Exact Resolution options when viewing or printing faxes. When you're printing to a LaserWriter, the Best Resolution option maps every fax pixel to a LaserWriter pixel, reducing a fax page to about two-thirds of its original size. On the other hand, the Exact Resolution option attempts to match the original page size; this is the only means I've found for retaining an image's exact dimensions when using a fax modem.

There Are Advantages . . .

If you don't already have a fax machine in your office, then the idea of linking a fax modem to the Mac might be appealing. After all, a fax modem occupies less room than a fax machine and provides a direct link between the computer and your fax-based clients. And well-written fax modem software provides you with fax features, such as scheduling, address books, document storage, and unattended operation, that only the higher-end, more expensive fax machines offer.

One feature that low-end fax units don't include is a distribution list. Distribution lists simply enable you to send the same fax document to all members of a group by selecting the group's name. Except for the ones in FAXstf, address books can also group phone numbers, for example, under the names Midwest Offices or Sales Reps.

If all fax-related correspondence that you'd handle is Mac-based, then the fax modem is a definite plus

over the regular fax. You can send any Mac document to someone else without printing a hard copy and scanning it through a fax. And you can store anything you receive directly on a hard disk.

Abaton's InterFax and Cypress Research's FaxPlus can operate as regular modems. If you're inclined to dial information services and bulletin boards or transfer files, these fax modems offer you more bang for your buck. Not only that, but getting two functions in one box might reduce clutter around your desk.

...and There Are Disadvantages

Since all fax transmissions are bitmaps, the files can take up a lot of disk space. Even simple word processor files will increase in size. For example, a 10-page, double-spaced MacWrite file that's all text occupies 24K on my disk. When BackFax converted it into facsimile format before transmission, it took up 737K. A rather simple cover page for BackFax takes up 54K on the disk.

Some of the CCITT test charts I used for reviewing the fax modems had a lot of information on them; the scanned images took up around 450K per file as PICT files, but expanded to 1.2MB when FAXstf converted them into fax documents. Handling faxes through a fax modem is definitely not meant for floppy-based systems. And, if you're handling a lot of fax traffic, even a 20MB hard disk may be too small.

It's one thing to scan a sheet of fax paper to determine the subject of the document and file it. It's quite another to try the same thing with a fax file on the Mac. All the programs I've seen use some form of a date-time stamp for received faxes; you then have to view them in the fax program to determine the contents. When you translate fax documents to a different file format, you can give the files more meaningful names.

I've already discussed the problems of displaying faxes on the 72-dpi screen of the Mac, so I'll only say a few words here. Programs that don't offer magnification of at least 150 percent for on-screen viewing are worthless. I don't expect to print all of the faxes I receive, so being able to read them on my Mac is a definite requirement. After all, isn't being able to keep everything in electronic form the whole idea of a fax modem?

Fax modems have other financial and logistical disadvantages too. First, they work only for files already on the Mac. If you need to transmit paper documents, you'll need a scanner. That increases the cost of setting up a Mac-fax modem by around \$1500. Second, to create high-quality output from the faxes you receive, you'll need an ImageWriter LQ or a LaserWriter. Finally, should the fax modem be a resource for more than one person, it may become a nuisance for the person who must work on the Mac that the fax modem is connected to.

With the introduction of facsimile modems from Abaton, Apple, Cypress Research and STF Technologies, Mac

With the introduction of facsimile modems from Abaton, Apple, Cypress Research and STF Technologies, Mac

With the introduction of facsimile modems from Abaton, Apple, Cypress Research and STF Technologies, Mac

Hold On to Your Checkbook

When I first thought of using a fax modem, I was intrigued by the idea of being able to receive faxes from clients and then inserting the fax material into other documents, such as page layouts. Unfortunately, the quality of the Group 3 fax standard and the inability of most fax software to represent correctly proportioned graphics keep me from cutting-and-pasting

abcdefghijklmnopqrstuvwxyz
ABCDEFGHIJKLMNOPQRSTUVWXYZ

abcdefghijklmnopqrstuvwxyz
ABCDEFGHIJKLMNOPQRSTUVWXYZ

parts of my fax files into other documents. I'd have to ask my clients to use fonts sizes larger than 12-point to make documents readable (see "Careful Reading"); they'd also have to be warned to provide some dimensional information for drawings if they want me to reproduce the exact size in my documents. Faxing should be relatively painless and these unneeded constraints make it a bother.

Working with the currently available fax modem packages, I've yet to find one package that has it all. The hardware is definitely capably designed and ready to provide the link to the rest of the fax world out there. But the combination of the scaling problems and poor interface design in the software keeps me from actually buying one for my business. No one fax package has all the features I want to make faxing from the Mac easy and useful. If I had to buy some kind of fax unit right now, I'd probably settle for a stand-alone fax machine. Given a few more months, I might change my mind and buy a fax modem. For the time being, I think I'll just hold on to my money. □

See *Where to Buy* for contact information.

What You See Is Not What You Get

You sacrifice document quality and image accuracy when you use a fax modem with a standard fax machine. A fax sent from the AppleFax Modem and received on a Ricoh Rapicom 205 (above) is improperly scaled. Another document (center) sent from the Ricoh Rapicom 205 to the AppleFax modem is improperly scaled and very unclear. Compare them both to the original laser-printed document (bottom).

Careful Reading

Text quality suffers greatly in a fax transmission. Notice the deterioration of this 10-point Helvetica document after fax transmission (above) compared to the original in ReadySetGo (below).



Mac II Utility Kit

by Thom Hogan

If you use a Mac II, you've probably noticed that Apple left some gaps in the utility software that comes with the machine. Those gaps range from the merely exasperating (you can't change the colors on your color computer) to the swear-word-provoking (the bomb appears and the System refuses to acknowledge the Restart button). The solution: fill the gaps by adding several key software utilities. These handy little programs will not only solve some of the Mac II's oversights, but will also make your use of the Mac II more fun and more efficient. You need a utility to fix the following general problems:

- screen size and type incompatibilities
- insufficient coloring resources
- problems with capturing and manipulating color graphics
- inability to organize and optimize high-capacity hard disks
- 68020 instruction cache problems
- HyperCard's dependence on Mac Plus and SE screens
- difficulty getting keys to work as labeled

I haven't tackled all of these problems but I'll address the worst ones. Some solu-

*Utilities that
fill the Mac II's
software gaps*

tions are shareware; the remainder are commercial programs available from dealers or through the mail. All of the shareware products described in this article are available on large online services such as CompuServe, GENie, and the Source. You may freely download and try out these programs at your leisure. The authors of shareware products are taking a gamble on your honesty. They're betting that once you've seen and used their product, you'll send in the product's registration fee.

Crashproofing

The most frustrating problem you're likely to encounter is crashes caused by software written prior to the Mac II's introduction. You've probably heard some of the stories: MacWrite wouldn't run on a Mac II, public domain programs of all kinds were causing frequent crashes, and most communications programs had problems running on a II. Some software would even crash the system so badly that the computer refused to reboot from the hard disk.

Fortunately, most of these problems have been solved. MacWrite and most other programs have been revised, and Apple



Color Menus

BWIIIC works a lot like ResEdit. In this example, the Finder's menu colors are being changed. Select a file, in this case the Finder, and then pick a resource type (top left). Once BWIIIC opens the MENU resources, you have to figure out which ID number corresponds to the resource you want to change. The top right screen shows MENU ID = 1, the Apple menu, chosen. The center screen shows a warning when you create a new resource for the Finder—an mctb (menu color table). Click on the OK button to continue. You choose the exact color from Apple's Color Picker dialog, which appears when you double click on one of the four fields identifying different components in the MENU resource that can be colored.

has finally fixed the Mac II's system software so that the computer should never forget the boot device after a crash. Nevertheless, it is still possible to find programs that need a utility to run on the Macintosh II. To work with these programs you need two utilities: a PRAM protector and an instruction cache toggle.

A PRAM protector allows you to recover more easily from some of the most common crashes, which are caused by software's overwriting the parameter RAM or

PRAM. The PRAM is an area of memory that stores the system date and time, the beep sound, the alarm data, the start-up device, and other such data when the power is off. Disruption of the PRAM can mean that the computer no longer starts up from the hard disk and won't recognize settings for the clock and the desktop pattern. Until System 6.0, the PRAM was unprotected. If you still use System 5.0 or earlier, get an INIT called PRAM Fix and put it in your System Folder. This INIT knows when the PRAM has been corrupted and resets it so that you boot up from your system even if it is corrupted. (System 6.0, or later, users should not use this INIT. Remember to remove it if you upgrade from an earlier system.)

Exorcising Cache Goblins

Nine times out of ten, you can eliminate or recover from repeating crash problems with one of three solutions: turn off MultiFinder, change your monitor configuration in the Control Panel from Color to Black & White/Grays, or install and use an instruction cache toggle. To understand what an instruction cache toggle is, you need to take a closer look at the Mac II's 68020 processor. This processor differs from the 68000 processor in the Plus and the SE in one primary way: it has a small built-in instruction cache. The cache stores the most recently used instructions, which speeds up operations by reducing the number of times the processor must retrieve instructions from memory. Some software programs that predate the Mac II make modifications to stored instructions as the program runs. When you run these programs on a 68020 Macintosh, the processor won't always make the modifications, since it does not always return to memory for instructions already stored in the cache. The likely result is a system crash.

Motorola did provide the ability to turn off the instruction cache in the 68020, but apparently Apple didn't read that page of the manual. So the onus is on the user community to come up with something to turn the cache off for self-modifying programs—an instruction cache toggle. I know of two, CacheKey INIT and Toggle Cache.

CacheKey INIT lets you define an F-key (predefined as \mathbb{A} -Shift-9) that toggles the instruction cache when pressed. It comes in several variations. One example is an INIT that automatically turns the cache off at start-up, another turns it on at start-up.

Since I only use the cache toggle once a month, I use Toggle Cache—a CDEV (control panel device.) After dragging Toggle Cache into the System Folder, open the Control Panel and doubleclick on the ToggleCache II icon to open the toggle checkbox.

Getting Along with Color

Too bad Apple didn't think to provide any color utilities. You see, as delivered, the Mac II has no way to let you color dialog boxes, menus, or icons; no way to change the color lookup table being used by the System; and no way to capture, view, or print color screens. And don't even begin to think of using the Clipboard to handle color graphics. If you paid the extra bucks for color, you're sure as heck going to want to get something for that money. To correct those deficiencies, you'll need a whole diskful of utilities.

To begin with, unless you're able to read between the lines in *Inside Macintosh Volume V* (Addison-Wesley, 1988), juggle ResEdit resources in hexadecimal notation, and keep 32-digit numbers in your head, you won't be able to edit color resources with the tools Apple supplies. The three things you *will* be able to do with color resources are change the desktop pattern to a colored pattern, change the selection inversion to a color, and assign one of seven colors to icon outlines (see "Making Solid Icons" for a twist on this).

Curiously, Russ Wedmore at Apple did write a CDEV named Kolor, which allows you to change resource colors. Apple chose not to distribute it because of anticipated customer-support problems—Kolor is an unfinished work with bugs and incomplete features. But it is available on a number of bulletin board systems.

Kolor can change the color of controls, windows, menus, or selections (see "Kolor"). You can change the colors of controls, including the border, fill, text, and scroll box. Some programs won't recognize certain color assignments made with Kolor, so windows might appear in black and white despite your color selections.

A commercial product called Colorizer includes a CDEV called Colors that is superior to Kolor in two ways: it adds a set of predefined color combinations, and it lets you create color start-up screens. Unfortunately, the predefined color combinations Palomar Software chose to include remind me of the loud and overbearing colors found in trendy cafes. Everyone I know uses the pastel color combination called Miami Vice.

Additional utilities let you color other resources. You can color Apple-supplied alert icons (Stop, Caution, Note) by using ResEdit to paste in the cicon resources available in a shareware file called Color CICNs. You might color the Stop sign red, for example, to reinforce the meaning of the visual cue given by this alert icon. Another shareware resource file called Color Map has a colored map you can paste into the Apple Map CDEV. One last shareware resource file, Color Cursor, changes the usual arrow cursor into one that has the same colored stripes as in the Apple logo. It's not much use, but it's an interesting diversion.

One especially useful shareware utility called BWIIC (stands for black and white to color) works like ResEdit but lets you assign different colors to dialog boxes, controls, menus, menu bars, and windows of individual programs (see "Color Menus"). My favorite use for this utility is coloring the Finder's menu bar and dialog boxes a different color from the standard one (defined by Kolor or Colors). That way, when running under MultiFinder, I can easily tell when I'm in the Finder and when I'm in an application, since the menu bar changes colors when the Finder is active.

Fixing Screen Incompatibilities

Some programs won't run with the color turned on. Examples are programs that deal only with black-and-white bit-

mapped images like FullPaint and early versions of MacPaint. The official Apple fix is time consuming and annoying—click on the Monitors icon, change the Control Panel setting to Black & White/Grays. A quicker way to switch monitor modes is to install an F-key called Switch-a-roo. Switch-a-roo is a shareware product that is also available as part of the commercial Screen Gems package (see "Screen Gems").

Many early Mac programs fixed the location of dialog boxes and alerts. The standard Mac II screen is bigger than the screen on the SE or the Plus (640 by 480 pixels versus 512 by 342). With a 19-inch monitor hooked up to the Mac II, you may find yourself mousing over a lot of territory to get to a dialog box positioned for the Plus and the SE. The shareware INIT Front&Center fixes this problem by positioning dialog boxes near the pointer when called. This can be a little disorienting at first, but once you get used to it you don't have to move the mouse so much.

What if you want your Mac II display to simulate the smaller screen of a Mac Plus or SE? This problem comes up often in an office of mixed Macs—perhaps you're developing a spreadsheet on a Mac II for use by someone with an SE, and you'd like to see it the way he or she will. With Screener, you can reduce the Mac II's resolution down to Plus or SE size and back again (see "Sizing Up the Screen").

HyperCard Reconciliations

HyperCard and the Macintosh II are not friends. HyperCard's most annoying trait rears its head when you use it with MultiFinder. The card window works properly, but the command window can end up floating on top of another program's window. To deal with this problem and to make using HyperCard with MultiFinder easier, Mike Swaine developed a simple script, Hide HyperCard, that creates some interesting buttons on a card. Not only does pressing one of these buttons hide the card and command windows properly, but it hides them where the button is located in the card. For example, a button in the lower right corner would cause the HyperCard window to be hidden in the lower right corner of the desktop—all you see is the top left edge of the hidden win-



Screen Gems

Screen Gems includes five programs: Switch-a-roo, Dimmer, ColorDesk, TN-3, and Globe. Switch-a-roo is an F-key that can turn off color when you don't need it, producing up to a 181 percent speed improvement. Dimmer is a screen saver. ColorDesk substitutes a color picture (in PICT format) for the desktop pattern. TN-3 allows you to change the Color menu in the Finder (foreground).

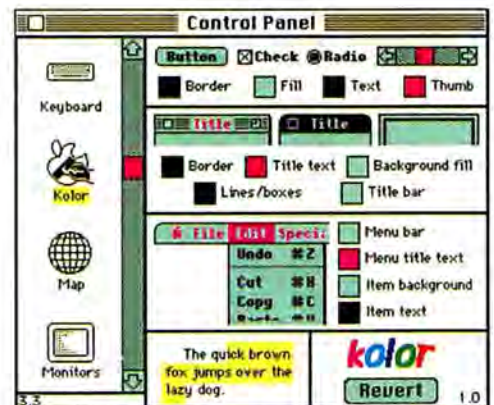

Kolor

The Kolor CDEV was used to assign colors to various resources such as the menu bar at the top of the screen, the window frame, and the controls. Clicking on an interface component in the Kolor window makes the Color Picker dialog box appear. With this dialog you can select a new color for the interface component.

dow. Click on that edge, and HyperCard is restored correctly to where it was. You can order a copy of the script and instructions for using it by sending a stamped, self-

Making Solid Icons

Ever wish you could have solid, colored folders on the desktop? Well, Apple built in a method of making them. You need ResEdit to make the changes, and I suggest that you do this on a separate floppy copy of the System. Then copy the modified System file over onto the hard disk. (Hint: Boot from the hard disk to edit the System file on the floppy; boot from the floppy to copy the System file to the hard disk.)

1. Start ResEdit and open the

Finder file on the floppy disk.

2. Find the resource LAYO = 128, highlight it, and select Open General from the File menu.

3. Select Find Hex from the Search menu; find the number 0000000D (you must do this on an unmodified System file to find this set of bytes).

4. If 0000000D is found, type in the change value 00C8000D and click on the Change button.

5. Select Quit from the File menu and save the changes when prompted.

6. Boot from the floppy to see the differences.

Don't be upset when icons (like the Trash Can) appear as blobs of black when you boot from this disk. Select an icon, select a Color from the Colors menu, and the blobs will change from black to colors (if you didn't select black). Do this for all the blackened icons on the desktop. You'll probably also want to change your desktop pattern, as well.

addressed envelope to HyperCard Script, c/o Macreations, 329 Horizon Way, Pacifica, CA 94044.

Another problem with HyperCard is that it can't use color. Fortunately, HyperCard's ability to read XCMDs has permitted someone to write a "color hook" for HyperCard, which, with a little bit of extra work, lets you add color to cards. ColorCards installs as an XCMD, but to use it, you have to add calls to the XCMD in every script that deals with the information you want colored. Moreover, there is a limitation on how color is used, apparently due to the way Bill Atkinson designed the screen update routines for HyperCard. To wit, no two colors may be used closer than 18 pixels together in the horizontal direction. The authors of ColorCards, Bill and Steve Tuttle, call these color zones (see "In Living Hypercolor"). If all you're interested in doing is coloring backgrounds or adding color text, single-color icons, or buttons, ColorCards does the job reliably and without a lot of extra work.

Capturing Screen Images

A problem that seems to frustrate almost every Mac II user at some point is capturing or printing color screen images.

Forget **⌘-Shift-3** and **⌘-Shift-4**—they don't work unless the display is in monochrome mode (two colors). Even then, these commands behave unexpectedly. For example, **⌘-Shift-3** rotates the image sideways in the resulting MacPaint file.

So how do you get good screen shots with a II? In the commercial realm, you'll find Mainstay's Capture. Capture is an INIT. You save a copy of the display by pressing **⌘-Shift-C**. A cross-hair cursor appears, which lets you drag a selection rectangle over menus, dialog boxes, DAs, and just about anything else that can appear on the display. If you hold the Option key down while dragging the cross-hair cursor, a PICT file is saved in your root directory—the way **⌘-Shift-3** would, if it worked. This saves memory by avoiding the Clipboard: a full screen may take as much as 2MB of storage space on the Clipboard.

Colorizer also comes with screen capture and screen print utilities. These are simply color versions of what Apple supplies, and you can install them as F-keys. On a LaserWriter, the print screen F-key maps light colors to white, dark colors to black. Screens are saved as PICT files in the directory in use.

On the shareware side, one group seems to be doing the most work to alleviate the color screen shot problem. A shareware company called Mark 3 Software has developed, get this, three separate prod-

ucts that can be used to capture screen images on the Mac II: Screen Dump II, ColorSnapShot, and SnapShot. Each has advantages and disadvantages. Screen Dump II, the first of the products, creates replacement F-keys for the ones Apple supplies for print and screen capture. Neither F-key does anything fancy, unless you call swapping light colors for white pixels and dark colors for black pixels fancy. Screen Dump II doesn't rotate images, although it may crop them to fit in a standard MacPaint file. Installation is simple and reasonably idiotproof. Make sure that you have no conflicting F-keys when you create the new ones, or else you'll see the infamous bomb. In other words, if you want to replace Apple's F-keys, get into ResEdit and cut them out of the System file, then install Screen Dump II.

SnapShot and ColorSnapShot are much more elaborate screen-capture routines, for monochrome screens and color displays, respectively. Both allow you to choose the file name and the file format for the saved image. With ColorSnapShot, for example, you can save in Grayview, GIFF, PixelPaint, StartupScreen, PICT, and Clipboard formats. You may also select only a portion of the screen. You can capture an image of the screen with the menus pulled

down by pressing **⌘-Caps Lock-Shift**, and the number you specify. Remember, however, that color displays are memory intensive. In some situations (like 19-inch displays) with lots of color, you won't be able to fit the resulting image on an 800K floppy. Furthermore, if you don't have enough RAM, you may not be able to capture or edit the screen image. ColorSnapshot crashed many times while I was using it. Nevertheless, ColorSnapshot is one of the most useful Mac II utilities I've come across; I know of no other way to do some of the things it does (the figures in this article were captured with ColorSnapshot).

Macro Madness

Next in the list of gaps comes the keyboard. Those of you who've bought a Mac II recently probably have System 6.0.2, which includes MacroMaker. MacroMaker is Apple's belated fix to make the big keyboard—the one with function keys across the top—work properly. Depending on the software you use MacroMaker with, the Print Screen, Scroll Lock, Pause, Help, Home, End, PageUp, and PageDown keys may or may not work. Microsoft Word, for example, can interpret only the last five of these keys. Apple's official position is that these keys are labeled to match their IBM PC counterparts, and the only time you should expect them to work as they are labeled is when you're running IBM PC software on the Mac. MacroMaker lets you disregard Apple's unbecoming preference for allocating function keys to MS-DOS. You can simply assign these keys to any function you want.

You won't have MacroMaker, though, unless you have System 6.0 or later. I know of three commonly available solutions that will put those keys to work for you with an earlier system. The simplest utility, FIF4, is a shareware INIT file that assigns the Undo, Cut, Copy, and Paste functions to keys F1 through F4. It takes little memory, does the job unobtrusively, and requires no maintenance. Put it in your System Folder once and it'll be there every time you start up, unless you hold down the Option key while booting. Don't install FIF4 if you've got MacroMaker installed, however.

Two excellent programs, QuicKeys and Tempo II, go much further than MacroMaker. Most users I know substitute one or the other for MacroMaker.

Unlike MacroMaker, both programs allow you to create an *autoboot* sequence—a set of actions that your computer always performs when you start up. For example, you could create a sequence that automatically logs onto MacNet, downloads your mail, copies all the mail into a single word-processing file, then brings up that file with the day's mail.

Tempo II is an INIT that you invoke with a desk accessory or F-key; QuicKeys is a CDEV. Both programs enable you to assign functions to keys F1 through F12. You can also assign functions to the other labeled keys. Home, for example, could be made to perform the equivalent of moving both scrollbar boxes to their original positions (top or left).

Which of the two is for you? Well, Tempo II is a little easier to learn than QuicKeys, and it has a function called Autopaste that assigns any graphics or text you can cut to the Clipboard to a key. Tempo II also has a CrashCatcher option useful to programmers or program testers. Finally, Tempo II has some nice branching capabilities that enable you to build macros that change in function, depending upon selected text. QuicKeys is a little more Macintosh-like, it handles *sets* of macros better, prints keyboard templates so you can remember the macros you've assigned, and comes with more thorough documentation. Either program is suitable for replacing MacroMaker. Beyond that, you'll probably find Tempo II more interesting if you like programming (building macros for a spreadsheet is a programming action), and you'll like QuicKeys better if you don't. Both programs are worth the extra money.

See *Where to Buy* for contact information.

Thom Hogan is publisher and coeditor of the Macintosh II Report, a monthly newsletter for Mac II owners. He has also written eight computer-oriented books, including the recently published Programmer's Macintosh Sourcebook from Microsoft Press.

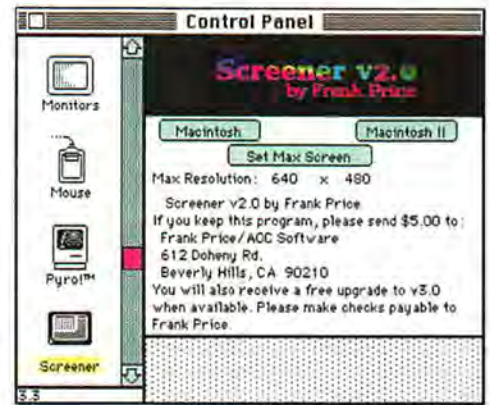

Sizing Up the Screen

The Screener CDEV lets you indicate a screen size different from the Mac II's default size (top). Clicking on the Other Size button produces a dialog box in which you can set the screen's horizontal and vertical dimensions (bottom).



In Living Hypercolor

HyperCard is particular about coloring horizontal regions. Each of the letters in the word color can be assigned a separate color, but close horizontal positioning of colors in the same pixel row is impossible.

BE A WINNER!

ANNOUNCING THE
THIRD ANNUAL

World-Class Macintosh Contest

Macworld is proud to offer you an opportunity to cast your vote for excellence in computing—and perhaps win the ultimate Macintosh hardware and software system. Each year we invite all of our readers to voice their opinions and pick the best Macintosh products in 42 categories.

Usually we give you our opinions on the latest Mac products, but now, with the World-Class Macintosh Contest, we want to hear what you think. Which Mac products do you find significant? Which have served you well during the last year? Which would you recommend to a friend? By voting for the Mac products of your choice on the attached contest-entry form, you can both reward the hard work of your favorite product developers and help keep *Macworld's* editorial coverage on track.

You also earn a chance to win hardware and software worth thousands of dollars. To show you our appreciation for taking the time to participate in this contest, we will pick three winners at random from among the World-Class entry forms. The lucky grand-prize winner will receive most of the top-voted hardware and software products. A copy of each winning software package will go to the runner-up, and the third-place winner will receive a selection of the winning software programs.

Entries must be received no later than **March 15, 1989**; we will announce the results in our September issue. To accurately reflect readers' preferences, we'll publish figures for all significant vote-getters in each category. The following explanations define product categories that are not self-evident, to help you cast your votes appropriately.



CONTEST RULES

Each person may enter the contest only once. Entries must be printed by hand or typed on the form included in *Macworld* or on a reasonable facsimile. Your entry must include at least one product vote, plus your name, address, and daytime phone number. Entries must be received no later than **March 15, 1989**. Employees of PCW Communications are not eligible. Thank you and good luck!

Name _____

Company _____

Address _____

City _____ **State** _____

Zip _____ **Daytime phone** _____

Send Entries to: 1989 World-Class Macintosh Contest, Macworld, 501 Second St., San Francisco, CA 94107.

1989 World-Class Macintosh Entry Form

Please use this entry form to vote for products you are familiar with and would recommend, based on their performance and value. Choose one product per category; you need not vote in all categories. Eligible products must be compatible with the Macintosh computer and commercially available as of February 1, 1989. To ensure accuracy, we will not count a vote unless the following three items are provided: (1) correct product name, (2) manufacturer name, and (3) model number (for hardware only). Version numbers of software products are not required. Please print or type your entry; it must be received by **March 15, 1989**.

HARDWARE

	PRODUCT NAME	MODEL	MANUFACTURER
Alternative Mass Storage	_____	_____	_____
Display—Black-and-White	_____	_____	_____
Display—Color	_____	_____	_____
Communications Board	_____	_____	_____
CPU Upgrade	_____	_____	_____
Digitizer/Scanner	_____	_____	_____
Graphics Board	_____	_____	_____
Hard Disk (80MB or less)	_____	_____	_____
Hard Disk (above 80MB)	_____	_____	_____
Input Device	_____	_____	_____
Modem	_____	_____	_____
Most Promising Newcomer	_____	_____	_____
Plotter	_____	_____	_____
Printer—Dot Matrix	_____	_____	_____
Printer—Laser	_____	_____	_____
Printer—Color	_____	_____	_____

SOFTWARE

	PRODUCT NAME	MANUFACTURER
Black-and-White Paint	_____	_____
Business Accounting	_____	_____
Business Presentation Graphics	_____	_____
Color Paint	_____	_____
Communications—General	_____	_____
Computer-aided Design	_____	_____
Database Management	_____	_____
Desk Accessory	_____	_____
Desktop Publishing	_____	_____
Drawing/Illustration/Animation	_____	_____
Education/Training	_____	_____
File Server	_____	_____
Game	_____	_____
Integrated Package	_____	_____
Micro-to-Mainframe Communications	_____	_____
Most Promising Newcomer	_____	_____
Music	_____	_____
Personal Finance/Taxes	_____	_____
Programming Language	_____	_____
Project Management	_____	_____
Outline Processing	_____	_____
Spreadsheet	_____	_____
Statistics/Math	_____	_____
Utility—Disk and File	_____	_____
Utility—Programming	_____	_____
Word Processor	_____	_____

Hardware

Alternative Mass Storage	All types of mass storage devices except hard disks. Examples include external floppy drives, removable cartridge drives, and tape backup units.
Communications Board	Add-in boards that help the Mac communicate with other Macs and other computers. Examples include Ethernet boards, and 8086 and 80286 coprocessor boards.
CPU Upgrade	Products that increase the Mac's processing capability, either by using faster 68000s, or 68881, 68020, or 68030 devices.
Display—Black-and-White	Monochrome or gray-scale monitors that serve either as a component of the Mac II or as an alternative to the standard display provided by other Macintosh systems.
Graphics Board	Add-in boards that let the Mac II display color or gray scale images.
Input Device	Mice, trackballs, graphics tablets, keyboards, joysticks—everything but digitizers and scanners.
Printer—Color	Any printing device, other than a dot matrix printer or plotter, that produces color output. Examples include thermal printers and ink-jet printers.

Software

Business Accounting	A series or an integrated package rather than a single module (such as a ledger). You can choose a modular package or an all-in-one program as long as it is designed for serious business use.
Business Presentation Graphics	Packages that produce or lay out text; pie, bar, or line charts; or other graphics used by businesspeople to present information.
Computer-aided Design	Computer-aided design includes products that offer two- and three-dimensional capabilities for working with geometry, especially for applications in mechanical, architectural, and electrical engineering.
Desk Accessory	Any programs that install under the Apple menu and that don't fit in any other category. Examples include calculators, notepads, schedulers, calendars, and phone dialers.
Education/Training	Training programs provide tutorials on such subjects as typing or computer applications. Education software includes courseware, examination-preparation programs, and learning aids for children.
File Server	Products that enable multiple network users to share one storage device.
Integrated Package	Products that include several applications—such as word processor, spreadsheet, charting program, and data manager—that share data and a command structure. The applications may be on one disk or in separate modules.
Micro-to-Mainframe Communications	Programs that perform terminal emulation and data conversion for mainframes and minicomputers.
Outline Processing	Stand-alone programs or desk accessories that organize ideas and notes in outline form.
Personal Finance/Taxes	Programs that help you retrieve and handle stock information; that perform portfolio management; that assist in fundamental or technical analysis; and that help you plan or prepare your taxes.
Project Management	Programs that manage resources and scheduling, usually for large, complicated tasks.
Utility	Programs that perform a wide variety of housekeeping chores, such as file conversion, file recovery, disk backup, and keyboard enhancement.

Most Promising Newcomer

Which new products—in both the hardware and software categories—are making an impact? (You may vote for a product you've cited in another classification.) For our purposes, "new" products are those released within the last six months.

Reviews

Studio/8 1.0

Color bitmap painting software. **Pros:** Powerful selection of drawing tools; object-oriented capabilities; useful special effects. **Cons:** Slow response speed with some of the brushes; random printing bugs. **Company:** Electronic Arts. **List price:** \$494.94. **Requires:** 1MB; works only on Mac II; 2MB and 8-bit video card recommended.



Color paint offerings for the Mac are becoming increasingly sophisticated. Take Studio/8, for example. This new bitmap color painting program from Electronic Arts has a multitude of powerful painting tools and special effects that will delight any digital artist currently using programs such as SuperMac's PixelPaint and Computer Friends' Modern Artist. It's rich in features and boasts an excellent user interface and respectable performance.

A Palette of Choices

Studio/8's Tool Palette contains many of the standard drawing devices (rectangles, circles, lines, paint bucket, paintbrush) plus features usually found only in object-oriented graphics programs. The familiar spray can is absent; instead, you get a programmable airbrush with adjustable flow rate and dissipation, which more closely approximates the functionality of its real world counterpart. You get the normal polygon tool as well as a variable-side polygon (triangles, hexagons, and so on); and you can add vertices and reshape the polygon immediately after creating it. The program also incorporates a bezier tool with fully adjustable control points, like the one found in Adobe Illustrator. Besides the standard lasso and marquee selectors, there is a polygonal selector, which works exactly like a polygon drawing tool, except that it selects the region on the screen that falls inside the polygon you draw.

The brush tool is unique in the diversity of operation it offers: besides standard single-color brushes, any selected area can be turned into a brush, and documents stored on disk can be loaded into the program as brushes. Also the brush editing dialog box shows the last eight custom brushes that you created. One of the program's main menus is devoted entirely to special-effects modes for the brushes, including unique goodies such as neon and watercolor brushes. Using some of the special-effects brushes exposed one of the program's principal problems: the brushes respond so slowly that the familiar wrist-watch indicator appears now and then during the process. For artists who depend on a quick and responsive paintbrush, this

could prove to be a major drawback.

Below the main tool icons in the tool palette are nine tool modifiers that change the way many of the drawing and selection tools function. The tool modifiers include controls to toggle the grid, fill/frame, selection, constraining, transparency, and FatBits modes, among others. The tool modifiers, which are linked to the numeric keypad on the Mac II keyboard, allow you to toggle the modes while drawing.

Independent vertical and horizontal line weights, zoom magnifications (1, 2, 4, 6, and 8 times), fill patterns, gradients, and the main color palette are all implemented as tear-off menus that can be placed anywhere on the screen. (And the program can save the positions of the default drawing window, tool palettes, and tear-off palettes for future work sessions.)

Printing images is a straightforward process, but while I had success printing Studio/8 images to a variety of color output devices (including the Tektronix 4693D color thermal-wax printer and Presentation Technologies' Montage film recorder), some of the printouts had vertical white streaks running the entire length of the

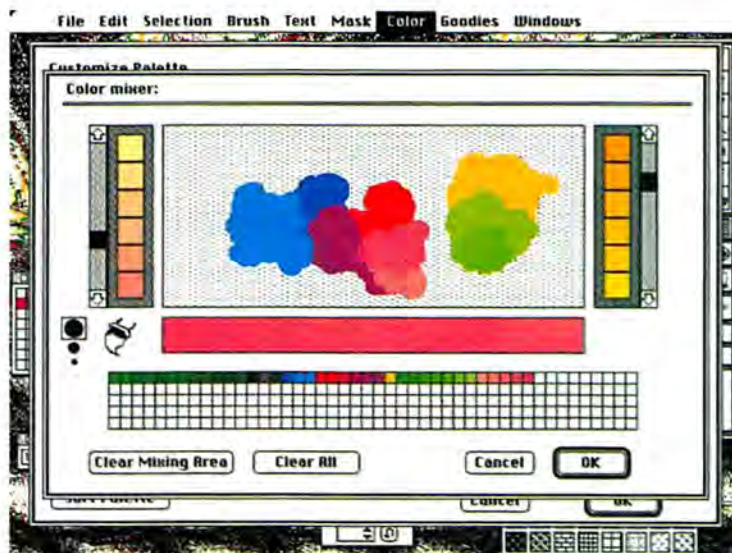

Custom Color

Studio/8 lets you create custom colors by blending and smearing colors in a Color Mixer window, which automatically registers each newly created shade. You select which colors to include in your custom palette.

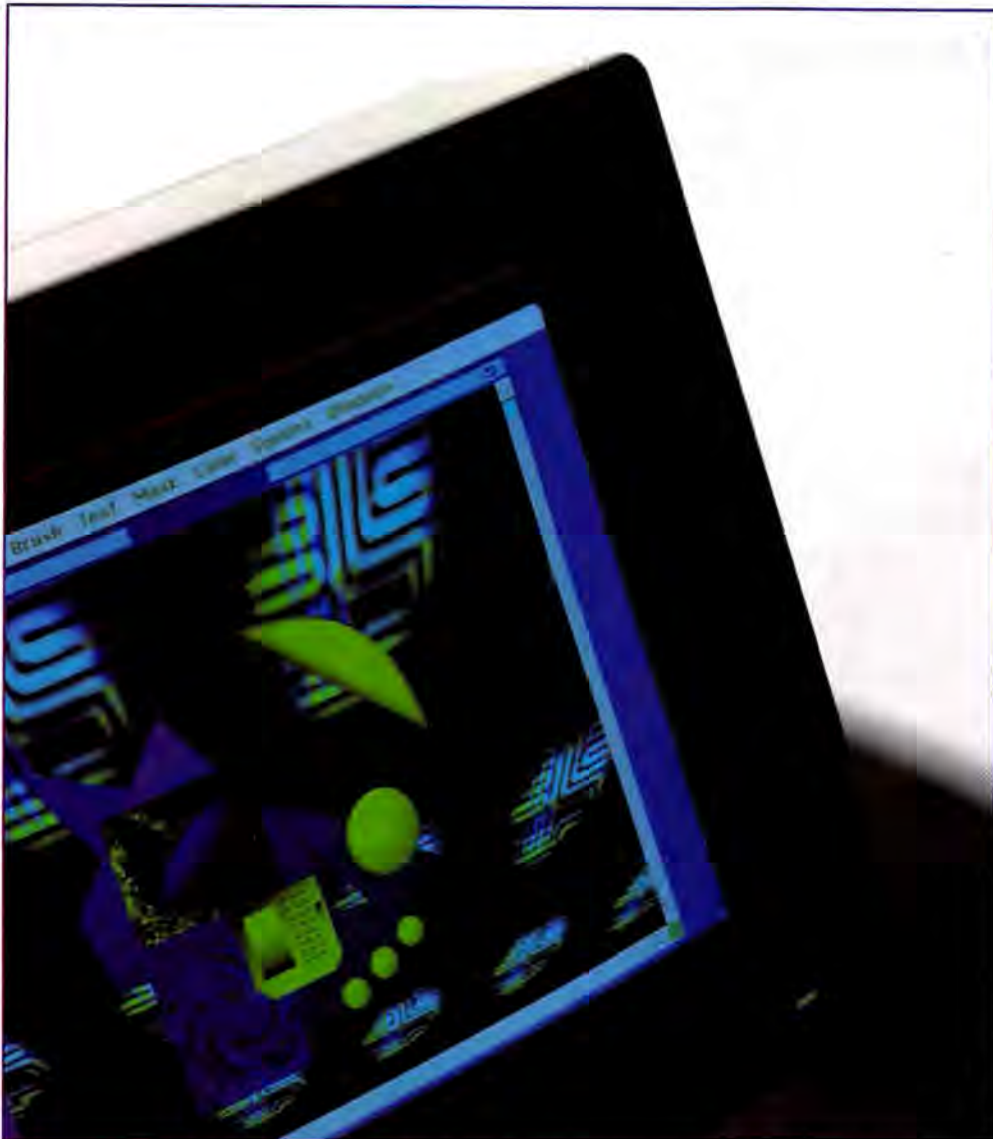

The screen display shows some of the special effects of Studio/8 in the perspective plane of an object (the strange pattern fading off in the background).

printed page. The problem occurred randomly, so I cannot attribute it to any specific sequence of actions or conditions.

Color My World

Studio/8 doesn't skimp in its color-handling capabilities. You can work with either a default Apple system palette, 256 gray shades, or a custom color palette (Studio/8 also works with 4-bit/16-color Mac II video cards). Colors can be created in a number of ways, including a unique Color Mixer window that allows you to smear various colors together to create new shades, and a color table that automatically creates intermediate shades between a number of fixed base colors. Custom color ranges and

gradations can be named and saved in the program's Preferences file (where they are maintained independent of any particular document).

Color gradations are easy to create and edit, and you can use either the existing colors in the current color palette or create new colors, depending on the beginning and ending colors of a gradient range. Each gradient can also have a texture value, which provides a grainy texture to an otherwise banded gradation between colors. There are two gradient modes: shape fitting and uniform, which can be interchanged to achieve a number of 3-D shading effects.

A pickup, or dropper tool, lets you select a color on the screen and make it the current foreground, or painting color.

While most other color painting programs offer a similar tool, Studio/8's dropper adds some special capabilities: by double-clicking on a color on the screen, you bring up a dialog box that allows you to change the selected color to any other while viewing the results on the screen. Also, clicking on a color in the color palette with the dropper tool causes the color to flash anywhere it appears on the screen—a color "find" function not available in any other Mac color painting program.

Very Special Effects

Studio/8 is capable of some stunning visual effects, including some in 3-D. A perspective dialog box allows you to set a three-dimensional vantage point by rotating a grid-plane in any axis. You select any object on the screen, it can either be individually mapped onto the perspective plane, or the perspective plane can be filled with the selected image (with one of three user-selected rendering qualities)—rotation, distortion, and bending tools allow even more manipulation, resulting in some breathtaking visuals.

The masking feature is extensive and well implemented: any color or selected area (or combination of the two) can be set to a mask. When the mask is activated, any drawing tool or special effect will work only within or outside of the mask area. Masks can be saved to disk as permanent stencils and can be loaded into any document. With a separate Slip Color dialog box you can choose a color or range of colors for selection by the lasso, marquee, or polygon. By using the tool modifiers that apply to the mask and slip colors, you can exercise extremely precise control over what portion of an image the drawing and selection tools affect.

Studio/8 pays close attention to small but important details: when selecting a document to open, you can view the image in a small, scaled display (Studio/8 can open PICT II, MacPaint, and color TIFF images; and I was successful in opening a 24-bit scanned TIFF file that Studio/8 converted into 8-bit format, with exceptional color optimization). When creating custom grids, you can select an object on the screen and use the rectangular horizontal and vertical dimensions as a basis for the grid constraint, an immensely useful feature. The FatBits window is movable and resizable, and you can switch the view to

(continues)

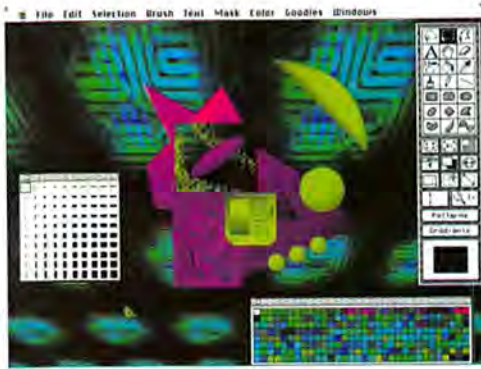

Color and Line-Weight Palettes

The color and line-weight palettes can be torn off and placed anywhere on the screen. The background graphic is an example of Studio/8's perspective-mapping capabilities.

have the actual size of the image appear in the FatBits window, while the magnified view is visible everywhere else in the main drawing window. A Trace With Brush command traces a selected area automatically with the currently selected brush shape and color; by using this command with neon brushes, you can create special type and border effects that would otherwise be difficult to create.

The documentation is well illustrated, with exceptional organization and clarity. There are even some color plates explaining how color tools work. The program itself has a complete, illustrated, online help facility. Also included in the five-disk set are scanned marble and wood textures, a selection of custom brushes, and an excellent slide show program that you can use to easily create slick full-screen presentations with an assortment of fade and dissolve effects.

Pick Up That Brush

Studio/8 is a powerful color painting program that addresses most of the needs of the color artist—anyone interested in producing color bitmapped images on the Mac II should consider it. If you spend a little time learning to use its vast number of capabilities, you will be rewarded by all the colors at the end of the rainbow. —David Biedny

See *Where to Buy* for contact information.

OmniPage

Scanning software package. **Pros:** Easy to use; works with a few different scanners (Apple Scanner; HP ScanJet); adjusts to a variety of fonts, sizes, and layouts. **Cons:** Documentation is thin; software tutorial is inadequate; may not do all you want it to. **Company:** Caere Corporation. **List price:** \$795. **Requires:** 4MB; hard disk; Mac II (or Mac SE with 68020 accelerator board).



The scanner is a neat invention. You plop a document or image on it, select a few options, and presto—the image is in your Macintosh. You can then manipulate, cut and paste, and perform all the usual Macintosh functions on it. If there's text in the scanned image, however, it doesn't get read in as characters—just as indistinguishable bits.

Easy to Use

But suffer no more (or at least not as much), for with OmniPage's automatic text recognition and extraction you can place a document in your scanner and a few minutes later be editing a Mac text file derived from that document. Furthermore, you can extract text from images, whether those images come from a scanner, a paint program, or even another type of computer system. OmniPage doesn't work perfectly, but the amazing thing is that it works at all—especially given the wide variety of fonts, point sizes, and layouts that this software package can handle.

OmniPage is easy to use. You simply put your document in the scanner and select the Scan command in the Text menu. A dialog box appears, letting you set certain options for the document you're scanning: Input Page Layout (Single Column, Multiple Columns, or Financial Form); Single or Multiple Pages; File Format (ASCII, MacWrite, or Excel); Scan Area; Output Page Layout (Auto Pasteup, Manual Galley, Auto Galley); and so on. When ready, you click the OK button. The document is then scanned in. OmniPage searches the image for text, marks off each block of text it finds, and strips out the rest of the image. It then converts each block of text image into an actual text document. OmniPage also

has a QuickScan command that bypasses the dialog box and uses the current settings.

The Settings command in the Text menu lets you set some scanner-specific options: Resolution (200, 240, or 300 dpi); Tone (Line Art, Halftone Fattening, Halftone Bayer); Contrast (Normal, Dark, Light); Data Type (Normal, Mirror, Invert); and Document Size (Letter, Legal, Card).

Since a document may require specific settings, OmniPage lets you save all the current settings as a personalized command set. For example, if you scan in articles from each issue of a given magazine, you can figure out the optimum settings once, then save them to disk. The next time you want to scan an article, you load that file in (using the Load command in the Personalize menu) and proceed with your scan.



OmniPage in Action

OmniPage can scan a document as an image or as text, as this screen shows. It also shows how well OmniPage can pull text out of a less-than-crisp image.

OmniPage adapted automatically and worked just fine with the Apple Scanner and the HP ScanJet. I also tried OmniPage with the Dest PC Scan 1000, but couldn't get the combination to work, although the Dest Publish Pac software worked satisfactorily with the PC Scan 1000.

OmniPage actually handles both text and images. You can scan and save images as either TIFF files—TIFF is the closest thing to an industry standard for graphics

(continues)

The #1 Tool Kit.



Back up your hard disk - fast.

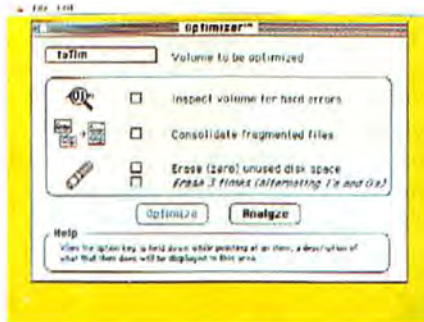

Optimize your hard disk for better performance.



Recover a damaged disk or undelete accidentally erased files.



Locate files on your hard drive.



View and/or change folder organization.



Password protect your sensitive data.

All this for just \$79.* What's more, you don't have to be a technical genius to use it—PC Tools/Mac is easy to use and understand.

See why hundreds of thousands of people have made PC Tools the best-selling utilities for personal computers like the Macintosh. **For the dealer nearest you, or to order direct, call (503) 690-8090 M-F, 8:00 a.m. - 5:00 p.m. (West Coast time). *Plus \$5 s/h.**

Central Point Software
INCORPORATED
15220 N. W. Greenbrier Pkwy. #200
Beaverton, Oregon 97006
(503) 690-8090

PC Tools/Mac.



images—or in Uncompressed format (a normal bitmap). However, OmniPage doesn't have as many options or features for image-manipulation as bundled scanner software like AppleScan or Desk Gallery.

General text recognition is a difficult task, and OmniPage is sensitive to different factors. For example, if the document is slanted more than a little to one side or the other, the recognition rate drops dramatically. Even so, I was impressed at how well the program did with a variety of documents. However, if you're expecting to scan in a complex document and get everything exactly the same, ready to be edited and printed, you're in for a bit of a disappointment. Font type, point size, and general layout is not preserved, and recognition can drop off dramatically if the print is too small or of an unusual type. Even so, OmniPage easily outperformed the Dest PC Scan 1000's Publish Pac.

The OmniPage documentation is not that extensive, given the complexities of the subject. An accompanying HyperCard tutorial stack has a number of problems: it's more of a reference than a tutorial; you can't use it concurrently with OmniPage; the user interface is incomplete and inconsistent; and the stack has some real bugs.

Version 1.0 of OmniPage runs only on a 68020 processor, that is, a Mac II or a Mac SE with a 68020 accelerator board. I experienced some problems running OmniPage under MultiFinder: I got a "This application has unexpectedly quit" message. It's not clear whether lack of memory caused the problem, since OmniPage was set up to use 3MB of RAM and was being run on a Mac II with 5MB.

Should You Buy OmniPage?

OmniPage does its job and does it adequately. However, I would strongly urge you to try it out on someone else's system before buying it. If it can scan the documents you're interested in—and in a form suitable for your purposes—then OmniPage can greatly increase the usefulness of your scanner and save you hours of time as well. —Bruce Webster

See *Where to Buy* for contact information.

G330-70 Color Thermal Transfer Printer

Thermal color printer. *Pros:* Simple, predictable interface. *Cons:* Effective resolution only 75 dpi; prints screen images only; can't print full pages; cursor, menu bar, and all other desktop details on screen appear on printout.

Company: Mitsubishi Electronics America.

List price: \$5900. **Requires:** Macintosh II with Macintosh II Video Card; color monitor and video memory expansion recommended.



Color output devices are here, and they're here in a variety of flavors.

For the person who's trying to get printed copies of colorful Mac II documents, though, more choices doesn't necessarily mean easier choices. There are many interfaces available with the current crop of color printers, and no one interface is capable of printing all types of color screens and documents (see "Printing a Rainbow," *Macworld*, January 1989). A new entry into this fray is the Mitsubishi G330-70 thermal color printer, which doesn't connect to your Macintosh the same way other printers do. Instead it uses the same analog video signals that drive the AppleColor High-Resolution RGB Monitor. In other words, the G330-70 simply reproduces the same image you see on your screen. This unique interface is both the printer's greatest asset and its most severe liability.

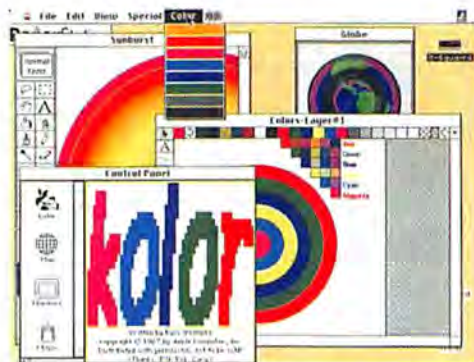

A snapshot of a typical Macintosh desktop printed in dithered mode. The G330-70 even prints pull-down color menus (The color bands in the Globe window are an artifact of the applications, not of the G330-70.)

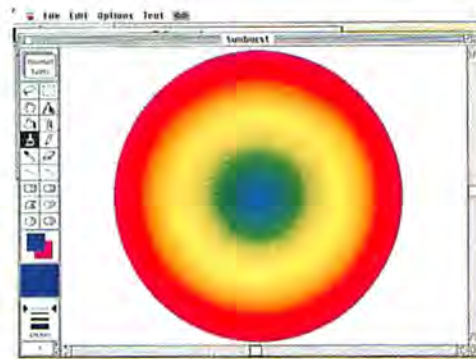

A 256-color PixelPaint sunburst printed in "picture" (4096 colors) mode.

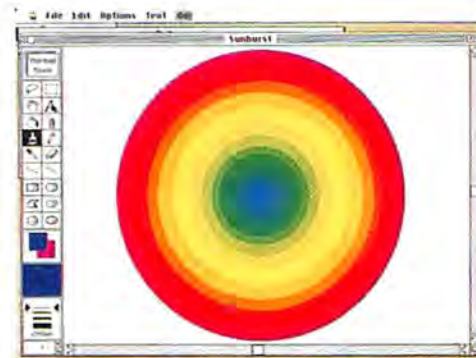

The same sunburst printed in "line" (125 colors) mode. The limited color palette in line mode causes the sunburst to appear banded.

Unique Interface

The G330-70 comes with an adapter cable that connects a Macintosh II Video Card to its color monitor. By interpreting video signals directly, the G330-70 avoids the need for a printer driver. Consequently, you don't have to wonder if the application you're running supports PostScript color, Color QuickDraw, standard QuickDraw color, or PICT II. You don't have to wait a long time for images to be generated when you print. You don't have to have any drivers in the System Folder or select a device with the Chooser. When you push the front panel's Screen button, you get a hard copy replica of your display, in living color. And because the direct video interface requires no drivers, rasterizers, or complex controllers (it's using the hardware and software built in to a Mac II to generate the images), it costs thousands less than other Macintosh-compatible color thermal transfer printers.

The G330-70 uses a three-color ink sheet (ribbon) to print six colors (red,

(continues)

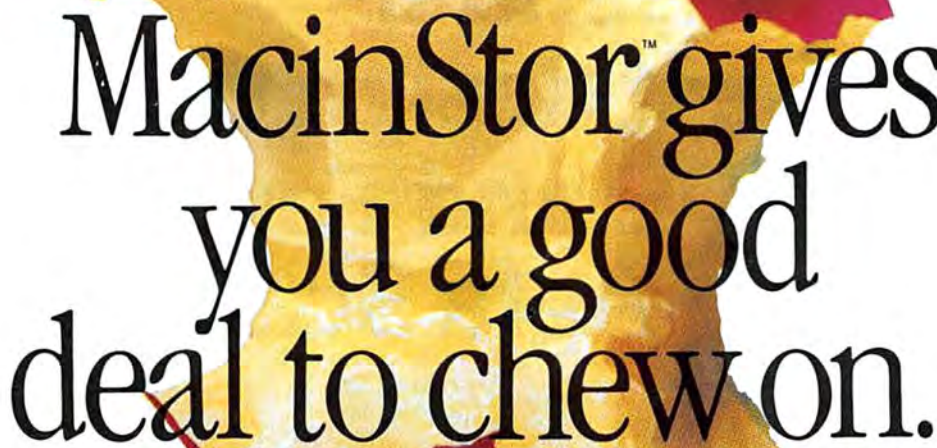

MacinStor™ gives
you a good
deal to chew on.

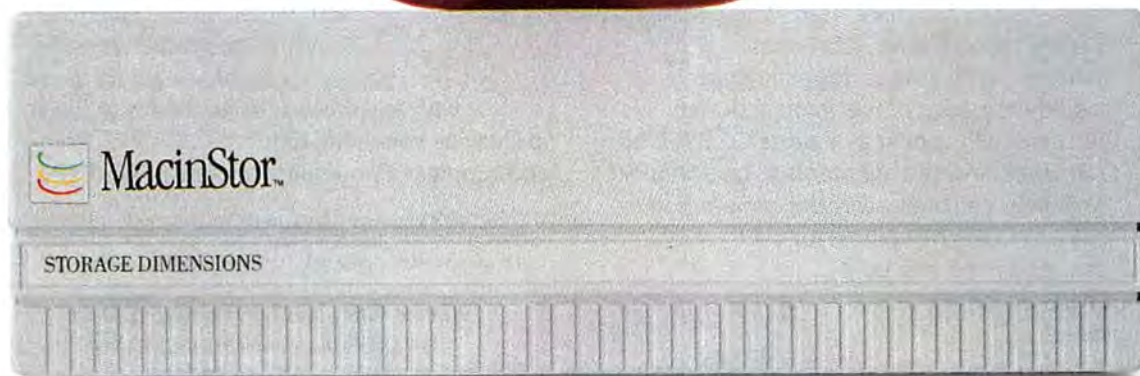

High-Performance Macintosh® storage without the high cost. 45 to 180 megabytes, internal or "zero footprint" external.

Now you can give your Macintosh all the high-performance mass storage you'll ever need. And at a price that won't ruin your appetite.

Storage Dimensions' new MacinStor family of internal and external hard disk subsystems (including great looking "zero footprint" models) delivers the capacity and high performance needed for today's storage-intensive, high-end Mac® applications. Combined with exceptional reliability

at a surprisingly low cost-per-megabyte.

What's more, unlike any other Macintosh storage subsystems, MacinStor comes with a complete, easy-to-use and install package of disk management software that includes a formatter, diagnostics, partitioning, backup and restore, disk optimization, data encryption

and data recovery. Plus comprehensive documentation that's easy to follow.

Any way you look at it, MacinStor represents an outstanding value.

Compare and see for yourself. Call (408) 879-0300, Ext. 606 today for the name of your nearest MacinStor dealer.

He'll show you how to get more bytes out of your Mac. Without taking a bite out of your wallet.



External (including zero footprint) 3.5 or 5.25 inch subsystems.

Internal 3.5 or 5.25 inch subsystems.



STORAGE DIMENSIONS
A MAXTOR COMPANY

Storage Dimensions, 2145 Hamilton Avenue, San Jose, CA 95125.
MacinStor is a trademark of Storage Dimensions. ©1988 Storage Dimensions.

Circle 416 on reader service card

Call for entries

Send us the best design using CG TYPE and FontLiner. Win an Agfa Scanner.

Show off your creativity with CG TYPE and FontLiner.™ Enter the CG TYPE Excellence Contest. Send us your hottest design—logo, ad, headline, newsletter, or brochure. Take first place and win an Agfa Focus 800 Scanner! Get your design in print, too. Photographs of the winning design and artist will appear in a future CG TYPE ad. You don't have the right tools to be a winner? We'll help you blow away the competition. Buy any CG TYPE volume for \$149, and get a FontLiner utility **FREE**. A \$129.95 value!



FontLiner, an exciting new program by Taylored Graphics, lets you convert CG TYPE characters into PostScript® artwork.

Use that artwork instantly with either Adobe Illustrator™ or Aldus FreeHand™. Then let your typographic creativity loose with any project, from memos to logos.

So show us your stuff. Enter the CG TYPE Excellence Contest. For details, call **800-MAC-TYPE**.

CG TYPE, PostScript-compatible type for the Macintosh. In Canada, call 800-533-9795. MasterCard and VISA accepted. Free 48-hour delivery. FontLiner offer good through March 15, 1989.

Win the Agfa Focus 800 Scanner, 800 dpi, 64 gray scale, complete with McView software. **Worth \$5495!**



AGFA 

Compugraphic

To enter the CG TYPE Excellence Contest, send your original design sample with your name, address, and telephone number to Compugraphic Corporation, Type Division, CG TYPE Support Group, 90 Industrial Way, Wilmington, MA 01887. Contest is void where prohibited by law. You must use CG TYPE and FontLiner to create your design. Limit of one entry per person. Entries must be received by March 31, 1989. Prize may not be transferred or substituted. Winner must complete an affidavit of eligibility and release from liability, and consent to use of his/her name/likeness at Compugraphic Corporation's discretion. Entries become the property of Compugraphic Corporation. Winner will be notified by registered mail. The contest is open to CG TYPE users, 18 years or older, except employees of Compugraphic Corporation and its affiliated companies. For the winner's name, send a self-addressed stamped envelope to the address above. Compugraphic is a registered trademark of Compugraphic Corporation. Macintosh is a trademark of Apple Computer, Inc. POSTSCRIPT is a registered trademark of Adobe Systems Inc. Aldus FreeHand is a trademark of Aldus Corporation. Adobe Illustrator is a trademark of Adobe Systems Inc. FontLiner is a trademark of Taylored Graphics. ITC Novarese is a registered trademark of International Typeface Corporation. All copy typeset in ITC Novarese. All type output on a Compugraphic high-resolution output device.

Circle 379 on reader service card

cgType

The Mitsubishi G330-70 color thermal transfer printer uses a three-color ink sheet to print six colors. It also has a dither mode that will display 4096 colors.



green, blue, yellow, magenta, and cyan), plus black, at 150 dpi. Because the resolution of the Macintosh screen is only about 75 pixels per inch, the G330-70 can represent each pixel with four dots that can be combined to reproduce 125 colors. If you want to print graphic images that use a wider range of colors, the G330-70 has a dithered mode that will display 4096 colors, though dithering reduces the effective resolution of the print. It prints on 8½-by-11-inch thermal transfer paper or transparency film suitable for overhead projections.

The Screen, the Whole Screen, and Nothing But the Screen

Though the direct video interface eliminates a number of compatibility questions and makes the G330-70 exceptionally simple to set up and use, the technique carries with it some significant limitations. Output resolution is limited to the screen resolution of 75 dpi, roughly the same as an ImageWriter in Faster mode. The printer always prints the entire screen, including menu bar, cursor, window frames, and so on. There's no way to print just the image you're interested in, and Mitsubishi doesn't supply any utilities for hiding the cursor or menu bar. Perhaps the worst restriction is the fact that you can't ever print more than what's on the screen; to print larger color documents you would have to print them a screenful at a time, then carefully cut and paste them together (with scissors and glue).

Snapshot Approach

The G330-70 is a relatively inexpensive way to get quality color output from a

Macintosh II. With its direct video interface you won't have compatibility problems between your applications and the printer. If you can see it, you can print it (though, like all thermal color printers the G330-70 can't reproduce as many colors as the Macintosh color display). The screen snapshot approach, though, makes the G330-70 a good choice only if you're confident that you'll never want to make color prints larger than the screen or with resolution higher than 75 dpi, and only if you can live with the cursor, menu bar, and other desktop incidentals in your output. Although the G330-70 is well documented and performs without a hitch, most users would probably be better off spending a few thousand more and getting a device with a standard printer driver. —Ron Risley

See *Where to Buy* for contact information.

Findswell 2.0

Utility for locating and opening files, folders, and applications. **Pros:** Extraordinarily easy to use. **Cons:** Incompatible with some applications. **Company:** Working Software. **List price:** \$59.95. **Requires:** 512KE; hard disk.



As efficient as the Hierarchical File System (HFS) is, attempting to find a specific file in the labyrinth of a hard disk's nested folders can be downright frustrating. Apple and third-party developers have attempted to mitigate the problem with desk accessories that search a hard disk for a certain file

name. However, none of these utilities is as convenient and easy to use as Findswell, from Working Software.

Seek and You Shall Find

The concept behind Findswell is simple; it locates and opens files from within standard Macintosh applications. It does this by adding a button to the Open and Save dialog boxes of each application. Clicking on the Findswell button opens Findswell's List and Command Window, which displays a list of the last several files opened, regardless of where they are located on the hard disk. For example, say you save a marketing report in a folder called Marketing. You then open another document in another folder, but you find you need to refer to the marketing report. You don't have to navigate up and down several folders; instead, the List and Command Window displays the file name of the marketing report in its list. To open it, all you do is double-click on its name in the list. You can set up the list so that it always includes documents you use often.

Findswell can also search for a particular file or folder. By clicking on the Find button in the List and Command Window, Findswell takes you to another window that allows you to set a search parameter by entering part or all of a file's name. Findswell then searches the disk and lists every occurrence of the search parameter. The

(continues)

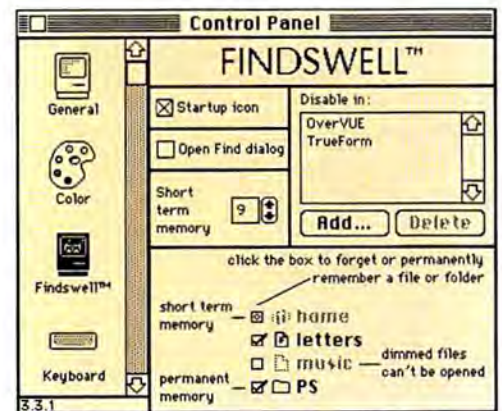

Control Panel

The Macintosh Control Panel permits you to select Findswell's options. You can have Findswell automatically disable itself for particular applications, and you can set the number of previously opened files that you want Findswell to remember.

MacWORM Arrives!

Optical
Elegance

US



Floppy
Chaos

COREL Macintosh WORM Drives

WORM's vs Floppies

- 1000 times capacity
- Hard drive speed
- Rugged cartridges

WORM's vs Tapes

- 12 times capacity
- Hard drive speed
- More reliable
- Withstand airport X-Rays

WORM's vs Bernoullis

- 20 times capacity
- Lower cost/Mbyte
- State of the art technology
- Multiple drive vendors

WORM vs Erasables

- Proven technology
- No accidental erasure
- Lower cost/Mbyte
- Ideal for archiving/audit
- Proven life for media
- Available NOW!

Total MacCompatibility

COREL WORM drives are 100% Macintosh compatible and use the familiar Mac icon interface. Use them just like your floppy or hard drive. COREL software enables the WORM to appear erasable so you can delete files as usual. Files can be saved and retrieved individually or in bulk, and you have the benefit of full recovery at any time.

COREL Leads the Industry

COREL is the World leader in Optical disk interfacing software and uses this vast experience to provide seamless optical subsystems.

Proven Software

COREL has led the way in 5 1/4" WORM drive software with many thousands of installations.

Proven Hardware

COREL uses proven drive mechanisms from the leaders of the industry such as Panasonic, Ricoh and Pioneer.

Dozens of Applications

- Hypercard databases
- Digitized sound
- Multi-media applications
- Virus protection for data
- LAN file servers
- Archiving (Ultra long life)
- Back-up/Multiple copies
- Graphics/CAD libraries
- Image files
- Software libraries
- Full - Text retrieval
- Medical scanned images
- Audit trails
- CD-Rom development
- Data distribution
- Unix applications

Other Systems Available

COREL WORM subsystems available for:

- IBM PC
- Novell LAN fileservers
- 3COM LAN fileservers
- UNIX (Available early 1989)

Plug and Play

Everything you need is included: Drive, Software, Cable, and Manual. Your WORM can be running minutes after opening the box.

Hot Line & Bulletin Board

Just in case you have any problems, COREL provides total support to find the solution quickly and efficiently.

Choice of Drives

- | | |
|--|------------------|
| • COREL 400M
400 Mbyte (2 x 200/side)
Cartridges | \$2,895
\$115 |
| • COREL 600M
600 Mbyte (2 x 300/side)
Cartridges | \$3,795
\$180 |
| • COREL 800M
800 Mbyte (2 x 400/side)
Cartridges | \$3,995
\$160 |

Order Now From COREL

No delays, you will receive your drive within a few days of your order.

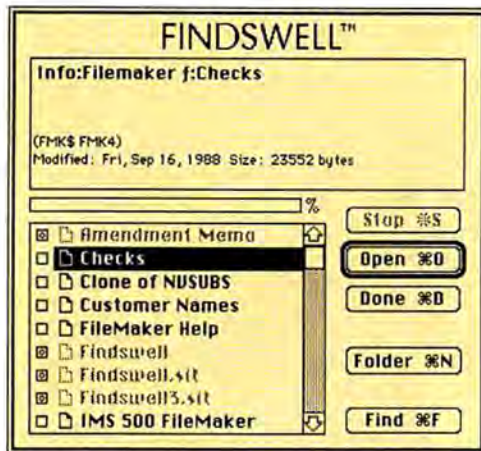

List and Command Window

When you click the Findswell button in the Open or Save dialog box of an application, the List and Command Window appears. Selecting a file in this window permits you to view the file's location on the hard disk, modification date, type, and size.

thermometer displays how much of the hard disk Findswell has already searched. As it finds matching files, Findswell lists the file names in a dialog box. If a file is compatible with the active application, you have the option of opening the file directly from this dialog box. You can also select any file and Findswell will display information about the file—when it was last modified, its size, its creation type.

Just drag Findswell into the System file to install it. The next time you boot up, the program will automatically appear whenever you choose the Open or Save commands. Also included are options for configuring the program for your work style. From the Control Panel you can choose the files you want Findswell to always display in the List and Command Window. (You can also disable Findswell for the few applications it doesn't support, such as OverVue and TrueForm.) Findswell's nine-page documentation is all you need to learn the program. Findswell also includes Program Launcher, which allows you to launch Findswell directly from the Finder, rather than having to use it through an application.

Like Suitcase, Findswell is tremendously practical—an indispensable addition to my hard disk. I wouldn't be without it.—Keith Thompson

See *Where to Buy* for contact information.

Springboard Publisher 1.0

Page-layout program. *Pros:* Easy to use; reliable; automatically flows text; special effects such as word wrap around graphics; can overlay graphics with text; supports a variety of font sizes and paint and draw tools. *Cons:* Sometimes hard to align frames, lines, and boxes. **Company:** Springboard Publisher. **List price:** \$199.95. **Requires:** IMB.

SP The Ferraris of desktop publishing, PageMaker and QuarkXpress, are feature laden, performance oriented, and expensive. Springboard Publisher is more like a Volkswagen—it contains a basic feature set, runs reliably, and comes cheap. The program doesn't offer QuarkXpress's advanced typographic controls or use PageMaker's clever pasteboard metaphor, but Springboard Publisher lets you produce well-designed newsletters, reports, or fliers quickly.

A Frame-Based Publisher

Creating page layouts with Springboard Publisher is easy. The program uses frames for holding text and graphics, much as QuarkXpress does. You draw a frame on the page, and if you aren't happy with its position, you drag it into place or resize it. Each time you draw a frame, a dialog box appears that lets you specify whether it's a text or graphics frame and the style and width of border (if any) that it should have. For text frames, you also specify the number of columns and their width.

Overlapping frames create special effects. For instance, you can place a newsletter's logo in a graphics frame and then place a text frame containing a title over the graphic. If the graphic is dark, you can invert the text so that it is white. Placing text frames on top of one another is handy for adding pull quotes or sidebars because the text in the bottom frame automatically wraps around the top frame.

To create new pages in Springboard Publisher you can copy and paste a formatted page or specify a certain number of unformatted pages to add via an Insert Pages dialog box. Alternately, the program can create the pages for you when you import text. If you place imported text in the bottom frame, or background, Springboard automatically flows the text into the background frames of successive pages. If you

have not created enough pages to hold the text, Springboard Publisher flows text into unformatted pages. However, once you import text, changes to a layout take much longer to redraw, since Springboard must also reformat the text.

If you import text into a nonbackground frame, you can still have it flow from page to page automatically by setting up links. This involves simply selecting the frames and picking the Link Frames command. You can import text in MacWrite, Microsoft Word, or text-only format.

Springboard Publisher provides a solid set of word processing features for entering text directly into a layout. You can choose the margins, justification, line spacing, and indentation for a block of text. Text can be formatted in any font or style, including superscripts and subscripts. Point sizes range from 9 to 72 depending on the font. You can control character spacing somewhat by defining the number of pixels between characters (up to a total of 64) and lines (up to 72).

The program contains a search-and-replace feature (a sorely missed option in PageMaker) and lets you set tab stops that leave spaces blank, or fill them in with dots, dotted lines, or solid lines. Aside from use in creating a table of contents, I also found the filled tab stops handy for tabbed headings and price lists.

(continues)



Graphics Palettes

Springboard Publisher offers many of the same tools as MacDraw and MacPaint. To access the graphics palette, select a graphic frame and double-click on it. You can then edit the graphic or add to it. You can use the freehand tool (the bottom left tool in the side palette) to trace around the edges of a graphic, so that text wraps around the shape.



Why do so many Mac II Owners Choose National?

Because National memory expansion cards give them:

1. Top A/UX performance

Apple + A/UX™ + National adds up to a powerful workstation. One that gives them the highest performance for their memory-hungry A/UX applications.

What applications do you have in mind? Software development, CAD/CAM, high resolution graphics, large databases, or multi-user applications? The NS8/16 memory expansion card has the power to unleash your creativity.

2. Up to 16 Mbytes of memory in a single NuBus slot

1MB RAM chips to save power consumption and card slots.

And they're 100ns chips to give top performance. Your applications will run dramatically faster.

Your Mac II™ can hold up to five NS8/16's, for up to 80 Mbytes of RAM.

3. Full A/UX Compatibility

The device driver is included. A/UX uses the NS8/16 as system memory so all of your A/UX programs will run without any modification.

Also included is software that allows the expanded memory to be used as a RAM disk in the standard Mac operating system.

You get a full five-year warranty and support from the leader in add-in products for the Mac II.

Join the satisfied Mac II users who have chosen National memory expansion cards
Call today 1-800-538-8510
 (in California 1-800-345-4006)



 **National Semiconductor**

Compatible Products Group
 Tel: 408-562-4719

Macintosh, Mac II, and A/UX are trademarks of Apple Computer Inc.

Circle 196 on reader service card

Frames with Flair

Every time you create a frame, Springboard Publisher displays this dialog box. You define the frame as graphic or text, and choose a border style, width, and pattern. You can even crop the graphic to fit in the frame.

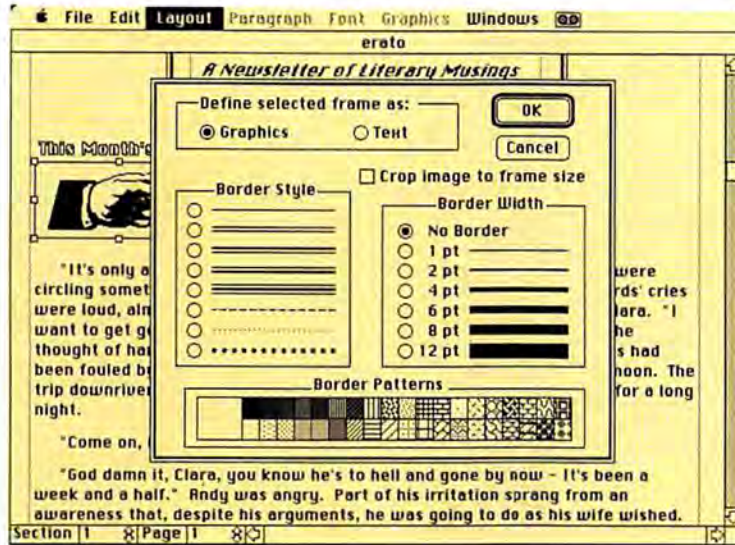

FORTRAN Compilers

Language Systems Fortran Compiler 1.1

Pros: Easy to use; MPW interface; many language extensions; built-in editor; segmentation capability. **Cons:** Large overhead with MPW; no on-screen listing during compile; no symbolic debugger. **Company:** Language Systems.

List price: \$345 with MPW, \$250 without.

Requires: 1MB.

Mactran Plus 3.0 **Pros:** Easy to use, built-in editor; easy Toolbox interface and control of compilation process; many language extensions; on-screen listing during compile; symbolic debugger; batch capability. **Cons:** No MPW compatibility; unnecessary switching between compiler and editor. **Company:** DCM Data Products. **List price:** \$399. **Requires:** 512KE.

MacFortran/MacFortran/020 **Pros:** Many language extensions; symbolic debugger; segmentation capability; batch capability. **Cons:** No built-in editor; no on-screen listing during compile. **Company:** Absoft. **List price:** MacFortran \$295, MacFortran/020 \$495.

Requires: Mac 512K.



FORTRAN is a favorite language among engineers and scientists, primarily because it predates many other programming languages and because large amounts of software have been written in it. Three new FORTRAN compilers are vying for this lucrative market—Language Systems Fortran Compiler 1.1, Mactran Plus 3.0, and MacFortran 2.3 (as well as its Mac II variant, MacFortran/020).

Because the programming process can be long and arduous, it is important to have a compiler that provides more than basic compilation (as all three reviewed here do). A compiler should create a whole programming environment that makes it easy for programmers to do exactly what they want—repeating commands or switching between editing and compiling, for example.

Basic Features and Performance

The three compilers share certain features and offer similar performance. For in-

(continues)

program includes a freehand drawing tool, paintbrush, spray can, paint bucket, pencil, and eraser. A shapes palette contains rounded and straight-edged rectangles, an oval, and a polygon.

Images can be flipped horizontally or vertically. You can also freely rotate an image, although I had a hard time doing so without chopping part of it off. The skew and distort options are a lot of fun, especially when you use them to slant text. (You have to enter the text in a graphic frame to slant or rotate it.)

Fast and Easy Design

In one day, I was able to create several nice layouts using Springboard Publisher. The only thing that bugged me about the program was trying to align frames to the margins of a document or connect two lines. Springboard Publisher is not as accurate as PageMaker, so sometimes I had to redraw a frame or line a few times before I got it perfectly aligned. Still, it's accurate enough that I doubt anyone viewing a printed document would notice the slight misalignment.

Springboard Publisher is a cooperative, straightforward program that excels in creating attractive layouts quickly and easily. And, if you have the time, you can fuss over details, such as creating perfect character spacing or getting words to wrap as tightly as possible around graphics. If desktop publishing isn't the main part of your job, but you need to create snazzier pages than your word processor allows, Springboard Publisher is the package you need. —Cheryl Spencer

See *Where to Buy* for contact information.

Putting Pizzazz on the Page

Although much of Springboard Publisher consists of no-nonsense features for quick and easy publishing, the program does offer a few of the snazzy features found in QuarkXpress or PageMaker—for instance, wrapping text around a frame or an object. You can define boundaries for wrapping text by tracing the outline of a graphic or let the program do it for you. Springboard Publisher was more accurate in tracing than I was, but by tracing an object myself, I could close off areas where I did not want text to appear. For instance, when the program traced a drawing of a horse, the word *the* fit in between the horse's ears. Somehow that just didn't look natural. So I traced the horse's outline with the freeform tool, treating the space between the ears as though it were filled in.

Nonartists will find Springboard Publisher's graphics features sufficient. On the simplest level, the program imports graphics in MacPaint, FullPaint, or PICT format. (For \$5 postage and handling, you can order either a Holiday Series or an Assortment Series of clip art images when you buy Springboard Publisher.) All graphics can be scaled up or down to any percentage from 1 to 200 to fit into a defined area on a layout. You can also crop imported images. While Springboard does import color graphics, once it converts every nonwhite pixel to black, few color images are usable.

Springboard Publisher offers MacDraw and MacPaint-like tools for creating your own graphics within a layout. The



INTRODUCING THE SHORTEST DISTA

Most presentation software seems to be for people with lots of time and a degree in graphic design. But if you're like most business professionals, you probably have neither.

So we borrowed a page from our PageMaker® experience, and developed a new technology for automating the process of creating presentations.

The technology is AutoTemplate™. The program is Aldus® Persuasion.™ And it's the most streamlined way to create great presentations with your Macintosh®. Here's why.

Using the AutoTemplate technology, all you have to do is select a design, type your ideas into the text outliner, and you're done. Aldus

Persuasion automatically formats your outline into professional-looking slides or overheads, using one of the program's pre-formatted designs or one of your own.

You can literally create and change a presentation as fast as you can type your ideas into an outline.

If you want to embellish your presentation, feel free. Persuasion lets you be more creative with text formats, styles, and colors than any other presentation program.

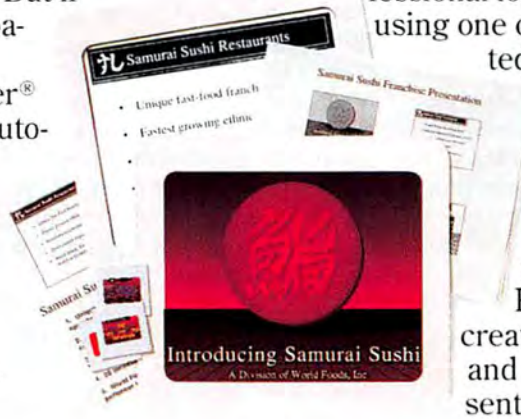

*Offer expires February 28, 1989 and is good in the U.S. and Canada only. Demo disk requires a

Macintosh Plus, SE or II. Aldus, PageMaker and the Aldus logo are registered trademarks and Aldus Persuasion

FREE DEMO DISK

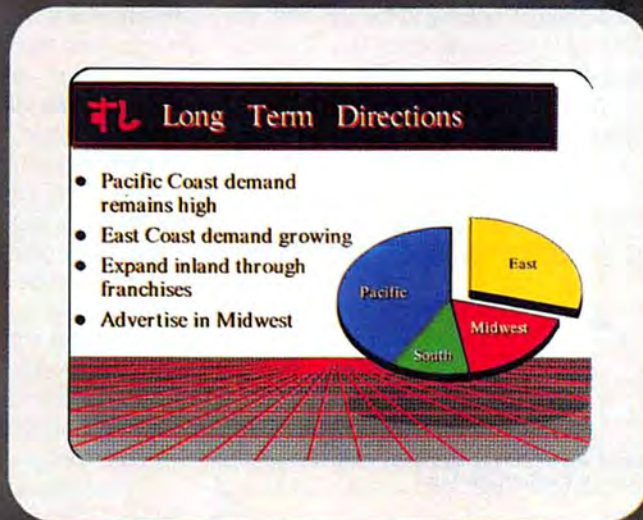

NCE BETWEEN THESE TWO POINTS.

Tables and graphs are easy to add, too. Persuasion automatically generates practically any kind of graph right from the program's data sheet. Or from imported data from spreadsheets such as Microsoft® Excel. And if you want to generate organization charts, Persuasion can do them instantly right from the outliner.

And you can be artistic with Persuasion. It includes powerful drawing tools, special effects, and clip art. So you can easily create flow charts, conceptual diagrams, and logos. Or import art from other graphics programs.

And because Persuasion is the most complete program for presentations, it includes a spelling checker, slide sorter, and an on-screen "slide show" feature. It also generates speaker notes and handouts.

Your output can be color or black-and-white; slides or overhead transparencies.

And film recorders, laser printers, or service bureaus can also be used.

To see just how short the distance can be between your ideas and a professional presentation, call us at 1-800-333-2538, Department D-2 for a free self-running demo disk.* Or visit your authorized Aldus dealer today.



Circle 306 on reader service card

Aldus Persuasion

411 First Avenue South, Seattle, WA 98104, (206) 622-5500

Reviews

stance, all three are full implementations of Fortran-77, the standard for FORTRAN compilers. (I tested this by compiling some standard Fortran-77 programs on each of them, and I did not encounter any problems.) All offer debugging facilities, a linker to merge several modules into a single program, and various language extensions.

On a Mac Plus with 1 megabyte of RAM and an Apple Hard Disk 20, all three compilers were reasonably fast at compiling my programs. Mactran Plus took 18 seconds to launch and compile 28 lines of FORTRAN code. Absoft's MacFortran took just 14 seconds to do the same. The Language Systems compiler, which runs under the Macintosh Programmer's Workshop (MPW), took a minute and a half; but most of the difference is due to the overhead of

Language Systems Fortran

As of this writing, only Language Systems Fortran runs with MPW (version 2.0.2), which gives it a clear advantage over the others. Because Language Systems Fortran does not have its own stand-alone application, you must access its compiler from within MPW. But MPW provides dozens of programming tools, which makes it invaluable.

Language Systems Fortran also uses the MPW editor, which is a standard Mac cut-and-paste editor. It allows both editing and compilation windows to be open on the same desktop, allowing for easy switching. LS Fortran has a standard Mac Toolbox interface, as described in the several volumes of *Inside Macintosh*. Because the program runs under MPW, it allows for

Language Systems has provided clear and complete documentation, which is designed to be used in conjunction with the MPW documentation.

Mactran Plus

Mactran Plus has features that set it apart from the other compilers. First, it automatically lists a program on the screen as it compiles it, so you can see lines containing errors when they are detected. Since you can also suspend, resume, and stop program compilation and execution at any time, you can correct the error immediately. Mactran Plus offers a symbolic debugger that enables you to set breakpoints in a program, step through a program, examine and modify variables, and observe variables as they change. It also shows you statements as they are being executed.

Mactran Plus has a built-in cut-and-paste editor, but using it is a bit cumbersome. After you compile or run a program, you have to select the Edit option from one of the menus in order to return to editing. Mactran Plus removes the editing window from the screen automatically after you have used the editor, regardless of whether or not you wish to close it—so you have to keep reselecting Edit.

Besides supporting the standard FORTRAN-77 language, Mactran Plus offers various language extensions, from the next version of the American National Standards Institute (ANSI) FORTRAN standard and from VAX FORTRAN. It offers several data types, although not as many as Language Systems FORTRAN.

Mactran Plus is the only one of the three compilers to offer a simple toolbox interface, which DCM calls the High Level Toolbox Interface. Using the commands in this interface, I was able to program a simple figure-drawing program, complete with menus, in less than an hour. This interface is fairly complete and is easier to program than the Apple Toolbox (also offered by Mactran Plus).

Mactran Plus offers a batch mode, in which complex sequences of program compilations, module linkages, and program executions can be written in a command (batch) file, which can then be run. This allows the user to avoid repeating complex sequences of commands.

(continues)

Fortran under MPW

Language Systems Fortran enables you to edit your program using the editor within MPW. You type commands for compilation and linking into the worksheet window, and MPW executes them, saving the results in the worksheet for reference. Since all commands are retained in the worksheet, commands never need to be retyped.

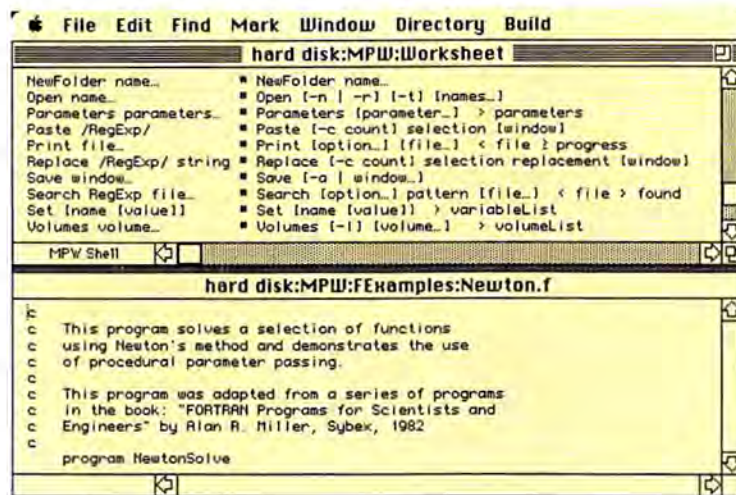

MPW. However, the advantages of using MPW outweigh the increased time.

Using the Sieve of Eratosthenes benchmark, a program that calculates prime numbers, I ran a program to determine all the prime numbers lower than 30,000. Mactran Plus took 6 seconds, MacFortran took 5 seconds, and Language Systems Fortran clocked in at 2 seconds. Thus, run times are likely to be roughly comparable.

Finally, all three compilers can create 68020 code for the Mac II (although from Absoft, you get this support only if you buy the MacFortran/020 compiler); and all three also offer support for the 68881, the Mac II's math coprocessor.

easy linking with program modules written in other languages, such as C and Pascal. One serious disadvantage of LS Fortran is that it lacks a symbolic debugger and relies instead on the low-level debugging facilities offered by the MacsBug debugger under MPW.

Language Systems Fortran offers a number of extensions to the standard Fortran-77 language, many of them based on FORTRAN on the DEC VAX—convenient for the many scientists and engineers who use the VAX. The program also offers a large variety of data types. And for people who write large programs that exceed the available memory in the machine, LS Fortran offers segmentation. This enables you to divide your program into segments that are loaded into memory separately on demand.

Classical.

SuperMac™ has been making Macintosh® classics since 1985.

Like DataFrame™ 20, the first SCSI drive. Spectrum, the first color video card. The first large-screen displays for the Macintosh II. And PixelPaint™, the first color paint program for the Mac® II.

Now there's a new generation of standards. Lasting investments that

help you and your Mac perform brilliantly. In whatever you do. In color or grayscale graphics. In true color. In mass storage. In business. Or in the arts.

Add SuperMac to your repertoire. And create some classics of your own.

Available now at authorized SuperMac dealers nationwide.

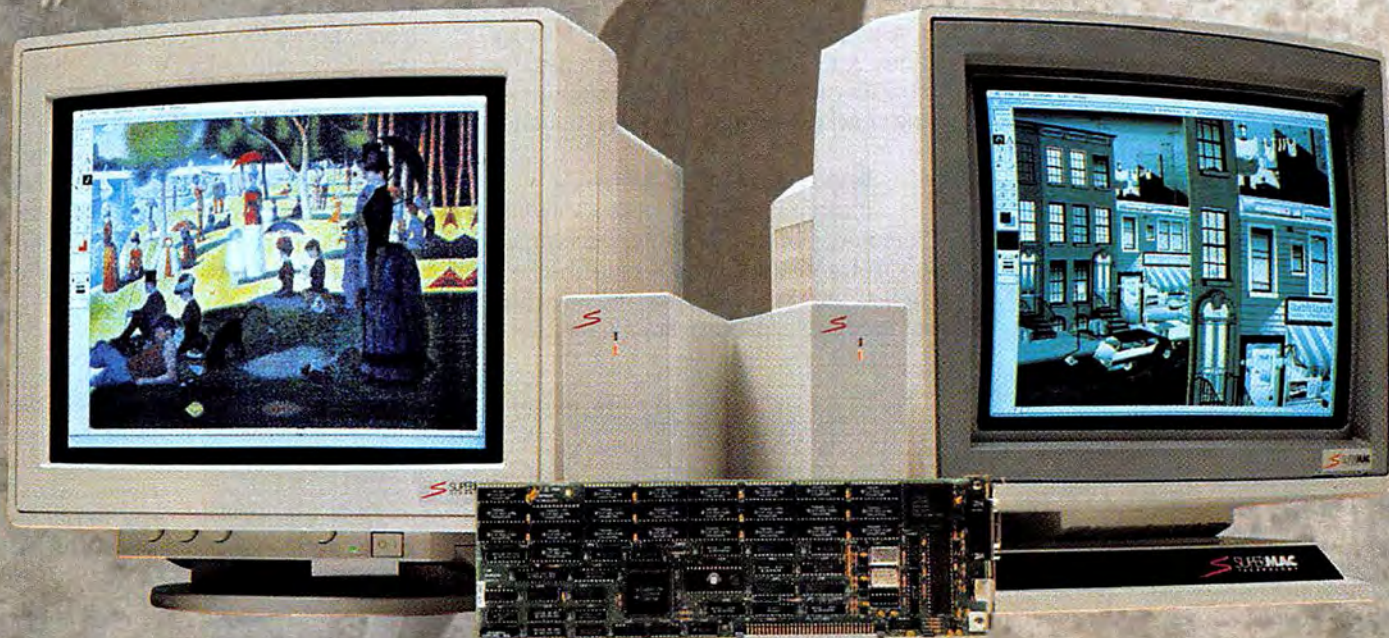

 **SUPERMAC**
TECHNOLOGY

485 Potrero Avenue, Sunnyvale, CA 94086 (408) 245-2202

SuperMac, DataFrame and PixelPaint are trademarks of SuperMac Technology. Macintosh and Mac are registered trademarks of Apple Computer, Inc. *Un dimanche à la Grande-Jatte* (1884-1886) by Georges Seurat. Photograph courtesy of the Bettmann Archive. "Street" copyright © 1988 Bert Monroy.

Copyright © 1989 SuperMac Technology. All Rights Reserved.

Mactran Plus has easy-to-read documentation, divided into a users' guide, describing how to use the system, and a language guide, describing features of the language.

MacFortran

Absoft was involved in Microsoft Fortran's development, so it is not surprising that Absoft's MacFortran is similar to Microsoft Fortran, the first FORTRAN available for the Mac. Microsoft Fortran had several deficiencies, and these have not been remedied in MacFortran.

MacFortran does not have a built-in editor, relying instead on the Apple-supplied Edit program. This means you frequently have to switch between MacFortran and Edit during the program-development process. For efficient use of MacFortran, you need to load both MacFortran and Edit into MultiFinder, and use MultiFinder to switch between them.

MacFortran has the ability to load modules that have not been explicitly linked into a program, as the program executes. Like Mactran Plus, it enables you to execute batch command files, called *scripts*, in MacFortran. Like its two competitors, it can also call the Mac Toolbox.

MacFortran has a symbolic debugger, so you can single-step through a program, set breakpoints, and examine and set program variables.

MacFortran's documentation is generally well-written, but several sections of it seem haphazardly appended.

Comparison

MacFortran has no clear advantages over its two competitors, and its lack of built-in editing is a clear disadvantage. Although it's adequate, it ranks as my third choice.

Mactran Plus, with its ability to create Mac-style applications easily, without a detailed knowledge of the Toolbox, is the best bet for the FORTRAN programmer who wants to explore programming for the Mac without exploring the intricacies of *Inside Macintosh* or learning the MPW environment.

Right now, Language Systems offers the most complete FORTRAN on the market. —Matt Zeidenberg

See *Where to Buy* for contact information.

StandOut 1.0

Desktop presentation program. *Pros:* Includes stylesheets and templates; advanced text features. *Cons:* No readily available way to generate slides. *Company:* Letraset USA. *List price:* \$395. *Requires:* 1MB.



Previously released as ReadySetShow, StandOut is a presentation program that employs the gridwork layout approach of ReadySetGo, the layout program also written by Manhattan Graphics and sold by Letraset. StandOut's design grids enable you to rough out a slide design quickly—before using detailed style sheets, templates, and other convenient design aids—to ensure an accurate, consistent presentation.

From Grids to Style Sheets

You place elements common to all slides on a Master Slide. You can design each slide individually or recall previously saved slide designs from a scrollable template field containing black-and-white design miniatures (see "Design Templates"). Style sheets let you specify font size, style, and alignment; word and paragraph spacing; leading; indents; and color designations. And although slide shows usually contain only a few words, StandOut's spelling checker and glossary come in handy.

Text, Charts, and Pictures

You can fine-tune text blocks with StandOut's precise kerning, tracking, and control over superscripts and subscripts, as well as its text- and format-sensitive find-and-replace capability. StandOut accepts a

variety of formats: imported PICT, PICT2, EPS, TIFF (essential if you are planning to use scanned images), or RIFF graphics can be cropped, rescaled, and superimposed.

Charts and tables are integral to any presentation. StandOut cannot boast the chart-handling capabilities of a dedicated chart designer; however, its pie, scatter, line, column, and bar chart capabilities can probably take care of most of your charting needs. Using the Clipboard, you can import portions of Microsoft Excel spreadsheets as chartable data or as tabular material.

For flow chart diagrams, StandOut adds a triangle, a diamond, and a parallelogram to the standard line, rectangle, and ellipse objects. To facilitate the positioning of text and graphics, StandOut provides automatic text runaround. Drop-shadow effects; customized arrowheads; and automatic frame, leader, and trailer callouts are also included. Other programs can emulate these options, but having them directly available speeds up the design process considerably.

You can attach colors to backgrounds, text, and object outlines and fills. Though StandOut's pull-down color menu is limited to 9 colors, users with full color capability can access a unique StandOut 256-color scroll bar or choose a custom color from Apple's 16-million-plus color palette (see "Style and Color").

From Slide to Show

You can arrange your completed slides by dragging miniature images of them into proper sequence. StandOut will use the slide designs to generate speaker's notes and audience handouts. Each speaker's

(continues)

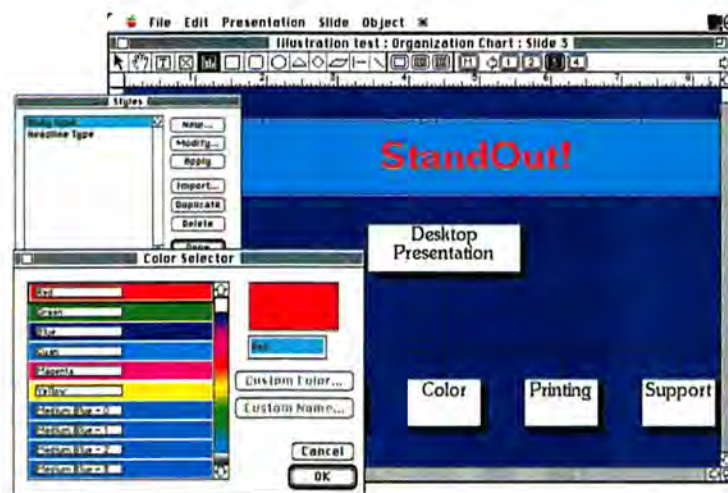

Style and Color

Pictured on top of one of StandOut's slide screens is StandOut's style selector and its unique Color Selector.

Hard rock.

January 1986. Macintosh® Plus takes the stage. But SuperMac™ steals the show. With DataFrame™. The first SCSI hard drive for the Mac®. And we're still the superstar in Macintosh mass storage.

Our new DataFrame drives provide full SCSI partitioning support. Fast seek. Fast access. From 30MB to 100MB internal for the Mac SE. 100MB to to 330MB internal for the Mac II. 20MB to 330MB external for

any Macintosh. And a brand name that stands for rock-hard reliability. In desktop publishing. In color graphics. In whatever you do.

And they include a new manager. Which adds flexible partitioning, greater security and virus control. Plus DiskFit™ backup and restore software, and SuperSpool™ and SuperLaserSpool™ print spoolers.

See them today. At your authorized SuperMac dealer.



 **SUPERMAC**
TECHNOLOGY

485 Potrero Avenue, Sunnyvale, CA 94086 (408) 245-2202

SuperMac, DataFrame, DiskFit, SuperSpool and SuperLaserSpool are trademarks of SuperMac Technology. Macintosh and Mac are registered trademarks of Apple Computer, Inc. Guitars courtesy of Paul Garbon.

Copyright © 1989 SuperMac Technology. All Rights Reserved.

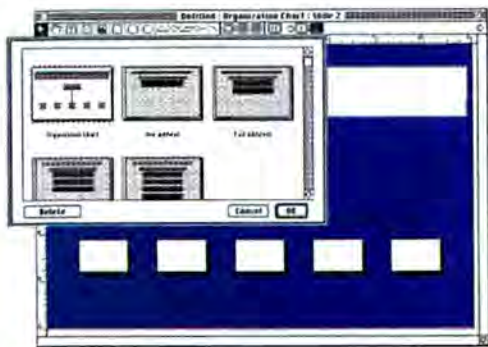

Design Templates

Double-clicking on a design miniature immediately transfers its design elements to the slide. You can add, delete, or reposition text and object blocks. You can also name and add new designs to the template.

note contains a single black-and-white reduced slide image and room to append related text or graphics. All of StandOut's graphics and text tools are available, so pages can be as elaborate as you like.

Audience handouts consisting of only two, four, or eight slide reductions arranged on a page are disappointing. The best way to make handouts is to copy the slide-show file and tailor-make a set of "speaker's notes" for distribution.

A much more serious concern, however, is how to produce slides or transparencies once your presentation has been designed. Rather than limit StandOut's output to a particular slide-generating service center, Manhattan Graphics opted for an output format it believed would work with most graphics applications and desktop film printers—the PICT/PICT2 format.

Does StandOut Stand Out?

StandOut compares favorably with other desktop presentation programs. However, its slightly cumbersome user interface (which requires you to return to the menu and toolbox too frequently) and its disconcerting horizontal top-of-the-screen toolbox slow down operations unnecessarily.

Today's presentations depend on transparencies and slides created at a service center. But desktop presentations of the future will probably choreograph and display presentations entirely from the computer screen. StandOut has not been optimized for stand-alone operation. In Slide Show mode, StandOut limits you to manual (mouse-click) slide-switching or fixed interval autoswitching, in either case employing only one of its fourteen transi-

tional effects (for example, Wipe Right, Venetian Blind, Random).

StandOut comes with a user manual, tutorial, quick-reference guide, and design guide. A user manual supplement elaborates on color options and keyboard slide-show control.

StandOut Outstanding

StandOut brings sophisticated desktop publishing features, such as kerning, tracking, and style sheets, to desktop presentation. Though the program's interface is not cleanly developed, and not enough attention has been given to StandOut's automatic slide-show capability, if you have a good sense of design and a reliable slide-generating source you can count on StandOut for outstanding desktop presentations. —*Joost Romeu*

See *Where to Buy* for contact information.

Desktop Printer and Printer Driver

Brother HL-8 Desktop Laser Printer.

Pros: Fast printing of text-only documents.

Cons: Has only three fonts, in one size each; does not support PostScript, AppleTalk, downloadable fonts; extremely convoluted installation, wiring, and interface; bewildering manual. **Company:** Brother International.

List price: \$2895. **Requires:** 512KE.

Printworks for the Mac/Laser Version.

Pros: Makes otherwise incompatible printers work with the Mac; installs a useful page-preview into all applications. **Cons:** Somewhat confusing installation. **Company:** Phoenix Technologies/Softstyle Products. **List price:** \$145.

Requires: 512K.



You will be amazed by the HL-8 laser printer from Brother International, the veteran printer manufacturer. Amazed, that is, that Brother is marketing it as a Macintosh printer.

When you unpack the HL-8, you will notice that it doesn't have a port to plug in an AppleTalk or Mac printer cable. This discovery is only the first of many unpleasant surprises.

The Brother's Keeper

To plug in the Mac, it turns out, you need a \$100 Macintosh conversion kit, which includes an adapter cable and a software printer driver called the MacDriver.

The MacDriver, however, contains no driver for the HL-8. It includes only drivers for the company's dot matrix and daisy wheel printers. Brother says that one of these drivers—the one for the Brother TwinRiter—works with the HL-8. Using the buttons on the HL-8's front panel, you simply set it to TwinRiter emulation mode.

Now the shock: the HL-8 with the MacDriver provides only three fonts, one of which is inaccessible to the Mac. The HL-8 can't print any normal Macintosh laser fonts, and you can't download any new ones. Of the two usable fonts, one, called Compressed, resembles the Mac's Monaco font, and comes only in one size (8-point). The other, available in a 10-point (Elite) and a 12-point (Pica) size, resembles the Mac's Courier. Neither font is available in any other point size. The third built-in font, Anelia, which looks like the Mac's Times font, has no corresponding screen font, making it theoretically inaccessible to the Mac. The HL-8 fonts do not support Option-key characters such as copyright, trademark, or diacritical marks. These limitations reveal the HL-8's Brother ancestry; even with the MacDriver, it's no more flexible than an electric typewriter.

Since the HL-8 is a non-PostScript printer, it won't print from programs like Illustrator and FreeHand. With the MacDriver, the HL-8 is limited to printing 72-dpi bitmapped graphics, even from object-oriented (MacDraw-type) programs, although the HL-8 is capable of 300 dpi. And the MacDriver software, unlike the LaserWriter driver, has no smoothing routines to soften the jaggies of 72-dpi graphics.

Enter the Hero

Eventually, a technician at Brother admitted to me that the Brother MacDriver kit isn't very useful. He recommended the \$145 Printworks for the Mac/Laser Version instead, a software and cable package from Phoenix/Softstyle.

Printworks is the closest thing to a hero in this story. With this special printer driver, you can trick the HL-8 into thinking that it's a Hewlett-Packard LaserJet printer, eliminating some of the MacDriver's limitations. For example, with Printworks the HL-8 can print MacDraw graphics at full

(continues)

Top 40.

At the Macintosh® II debut, Apple® and third-party companies showcased their products with SuperMac™ Spectrum color graphics cards. And our color monitors.

Today we're still at the top of the Mac® II charts. In 256 colors. Or shades of gray. For business graphics. Presentations. Desktop publishing. And more.

Our latest hits include the Spectrum/8™ (Series II) color graphics cards, with instant hardware panning and

zooming. For popular color and grayscale monitors. Including ours.

And for the standard in color graphics and design software, it's PixelPaint™. With PANTONE® color. Process screen mixes. Color separation. Blending. Dithering. To rival features of programs costing tens of thousands.

Add our hot releases to your playlist. They're available at authorized SuperMac dealers.



 **SUPERMAC**
TECHNOLOGY

485 Potrero Avenue, Sunnyvale, CA 94086 (408) 245-2202

SuperMac, Spectrum/8 and PixelPaint are trademarks of SuperMac Technology. Macintosh and Mac are registered trademarks of Apple Computer, Inc. PANTONE is a registered trademark of Pantone, Inc. *Un dimanche à la Grande-Jatte* (1884-1886) by Georges Seurat. Photograph courtesy of the Bettmann Archive. "Iceworld" by Ron Cobb. Ray tracing © 1987 Apple Computer, Inc., Jim Batson and Mike Potel.

Copyright © 1989 SuperMac Technology. All Rights Reserved.

Reviews

The HL-8 laser printer from Brother International is 17.9 inches wide, 19 inches long, and 9.1 inches tall.



300-dpi resolution. With Printworks you can also print Option-key characters. And Printworks helps to overcome the biggest drawback of the HL-8—its lack of different fonts and sizes—by letting you print bit-mapped (low resolution) versions of any Mac screen fonts, such as the Apple ImageWriter does. Furthermore, Printworks, like the ImageWriter, will search your system for a screen font twice the size of the one you're trying to print; if the double-size font is installed, Printworks will reduce it by 50 percent, doubling the resolution of the printed text.

The Printworks package also gives you access to the HL-8's third built-in font, Anelia. Printworks has a desk accessory called Font Adjustment, which lets you map any Mac screen font to one of the three printer fonts.

Three-Font Monte

The HL-8 is extremely fast if you print text only and use one of its three built-in fonts. In the Pica/Elite style, the capitals are shorter than tall lowercase letters, as you can see in the word Elite. The Palatino example was created by Printworks from the installed 24-point screen font. Printworks also has an option to use a screen font four times larger than the text on the screen—48-point in this case—thus creating even finer resolution.

The Brother HL-8 offers three fonts: Anelia, Pica/Elite, which resembles the Mac's Courier font, and Compressed, an 8-point font.

This example took 17 seconds to print.

With Printworks, the HL-8 can print bitmapped versions of Mac screen fonts. This is Times 12 point.

This is 12-point Palatino, which looks better because Printworks is scaling 24-point Palatino for resolution that's twice as good.

This example took over three minutes to print.

But there's yet another complication: since Printworks treats the HL-8 as an HP LaserJet, the printer fonts listed in the Font Adjustment DA are all LaserJet fonts, not HL-8 fonts. What Mac owners know as Times and HL-8 calls Anelia, Printworks calls Roman-8. You have to use trial and error to figure out which fonts are which, and which Mac screen fonts you should map them to. But even when you've chosen a Mac font to be the screen stand-in for Anelia, you're in for another headache: the printout doesn't match the formatting shown on the screen, since the Mac display shows one font and prints another.

Oh, Brother

If all this sounds confusing, I'll translate: For the \$2895 you'd pay for an HL-8, you could buy a LaserWriter IISC, which

has several attractive fonts (in more than one point size, of course) and the potential for adding more. For \$700 less you could buy a Personal Laser Printer Plus from GCC Technologies, which offers 13 font families and the capacity for more fonts as they become available. Both the LaserWriter SC and the PLP Plus are designed for the Mac and are easy to operate.

If you have an IBM and a Mac that need to share a printer—precisely the market niche the HL-8 purports to fill—here's another idea. Instead of buying an HL-8 and using its HP LaserJet emulation mode, simply buy a LaserJet and pocket the \$200 you'll save. Not only will Printworks still work its magic, but you'll have one less conversion to make on the road to Mac compatibility.

Does the HL-8 have any good features? One: it prints text much faster than PostScript printers. That's because PostScript printers store each character as a hollow outline, so that text can be resized, reshaped, or shaded. The HL-8's fonts aren't outline fonts; instead, it stores each character as a solid shape of fixed size, like a character on a daisy wheel printer. Unlike its Postscript rivals, the HL-8 has no calculating to do to print text; it simply pops each memorized character image onto the page—a very quick process. If the HL-8 weren't so expensive, it might merit consideration as a lightning-fast, text-only business printer.

The HL-8 has one fundamental problem: even with the excellent Printworks driver, it betrays all of the Mac's standards of simplicity and ease of use. Getting the HL-8 to work with the Mac is an inexcusably technical, convoluted process. And you won't get any help from the poorly translated manual. Try, for example, to wade through this grammatical morass: "If the printer have different point size fonts which have the same character pitch, in this case this command may be useful even for fixed pitch font."

Really, though, your understanding of the manual is irrelevant, since the manual doesn't even mention the Macintosh. That's because the HL-8 is not, in fact, a Macintosh printer. It is an IBM printer. It may even be a good IBM printer. But Brother fools nobody—or so I fervently hope—in claiming that the HL-8 is equally at home with the Macintosh. —David Pogue

See *Where to Buy* for contact information.

New wave.

True color. The new wave for the Macintosh® II. See it through the eyes of SuperMac™

The Spectrum/24™ color graphics card lets you display nearly 800,000 colors on screen. From the 16.8 million colors available on the Mac® II. See every shade. Every detail. Everything. For exacting work where true color

is essential. For demanding professionals. In color pre-press. In animation. In video. In Computer Aided Publishing.

For the ultimate in display SuperMac monitors. Color. True color. The future. See it now. At authorized SuperMac dealers.



**SUPERMAC**
TECHNOLOGY

485 Potrero Avenue, Sunnyvale, CA 94086 (408) 245-2202

SuperMac and Spectrum/24 are trademarks of SuperMac Technology. Macintosh and Mac are registered trademarks of Apple Computer, Inc. Guitars courtesy of Paul Gambon.

Copyright © 1989 SuperMac Technology. All Rights Reserved.

Pop Quiz. *Stop. This is a test. For the next 60 seconds, we will be conducting a quiz about Macintosh® II Videographics. Do not turn the page until you have looked at the visual clue and answered all the questions.*

Which Macintosh II graphics card offers the widest range of capture and display resolutions—NTSC, PAL, Apple® Monitor, hi-res, interlaced, non-interlaced and other modes?

- a) NuVista 2M b) NuVista 4M c) All of the above

Name the only videographics card which provides true-color, real-time capture and broadcast-quality display while occupying only a single slot in a Macintosh II.

- a) NuVista 2M b) NuVista 4M c) All of the above

Which videographics card offers full QuickDraw™ compatibility at 1,2,4,8,16 or 32-bits per pixel?

- a) NuVista 2M b) NuVista 4M c) All of the above

Visual clue for Videographics test.

If you chose (c) on all three questions, congratulations! You know that the NuVista series from Truevision is the answer to all your advanced videographics needs. The NuVista is available with either 2Megabytes or 4Megabytes of video memory, and creates professional video effects and computer graphics using any QuickDraw compatible software, now and in the future. No patches, no gimmicks, no hassles.

So whether your application is video production, digital pre-press, presentation graphics or 3D renderings, you'll find the NuVista will pass *your* test with flying colors. Oh, and if you answered (a) or (b) to any question above, give yourself half credit. Then obtain even more NuVista information by requesting a copy of our educational brochure True color? True answers. or visiting your local Authorized Truevision Reseller. Either way, you can find all the answers with a NuVista. Call us at **800-858-TRUE**.

You may now return to your regular reading.

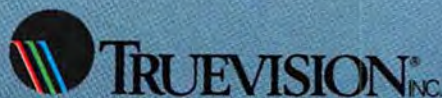
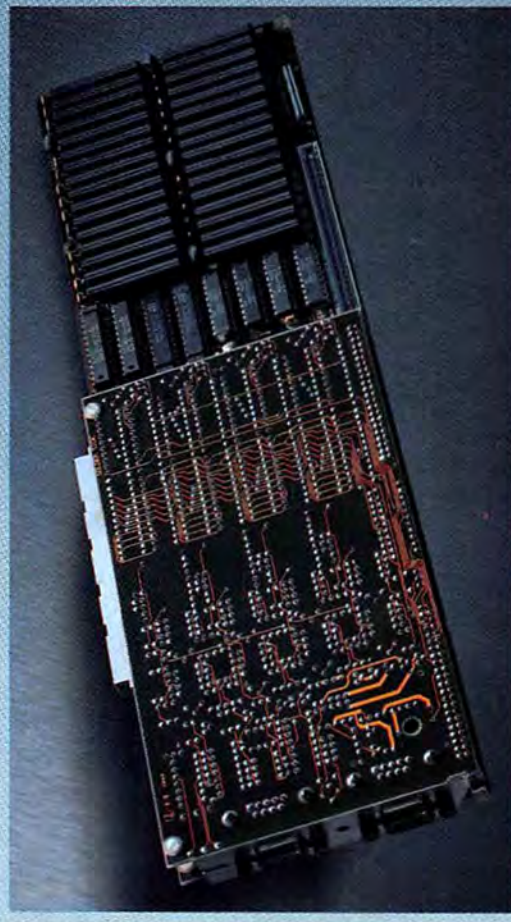

7351 Shadeland Station, Suite 100, Indianapolis, IN 46256

INTERNATIONAL: Canada 416/499-9400 France 33-13-952-6253 Italy 39-2-242-4551 Switzerland 41-1-825-0949 U.K. 44-1-991-0121
West Germany 49-89-612-0010 Other 617-229-6900

Apple and Macintosh are registered trademarks and Quick Draw is a trademark of Apple Computer. Truevision is a registered trademark and NuVista is a trademark of Truevision, Inc. © Truevision Inc. 1989

FastPath 4

Gateway for connecting LocalTalk LANs and Ethernet networks. **Pros:** Autoconfigure option for AppleTalk-only networks; K-Star simplifies TCP/IP configurations; dynamic assignment of IP addresses possible; gateway can be configured from either LocalTalk or Ethernet side. **Cons:** Manual doesn't offer enough examples of IP addressing. **Company:** Kinetics. **List price:** \$2795. **Requires:** Mac 512KE; LocalTalk and Ethernet cabling.

The FastPath gateway for connecting AppleTalk Local Area Networks (LANs) and Ethernet networks was the first product offered by Kinetics. Since then the market has matured, and so has the FastPath line. The latest model, FastPath 4, adds features that make it easier to set up links between AppleTalk LANs and links to networks based on Transmission Control Protocol/Internet Protocols (TCP/IP).

Looks Aren't Deceiving

There are two noticeable hardware differences between FastPath 4 and prior models. First, FastPath 4 now has front-panel lights that show power on/off, data in transmission, and data received. That immediately resolves one problem I had with the older models: I couldn't easily tell if the unit was turned on. The second improvement is built-in support for both thin-wire and thick-wire Ethernet. In the past, you had to buy a different model for each different cabling scheme.

There are many other changes to the internal hardware. The most significant is additional RAM (256K, expandable to 512K), which allows you to take greater advantage of some of the new software that Kinetics provides with the unit.

Simple Links

Accompanying firmware allows you to automatically set up FastPath as a gateway between a LocalTalk net and an Ethernet network without specifying any parameters. Once you make the connection, FastPath dynamically configures itself to the

AppleTalk network, much like other devices that use the AppleTalk protocols. However, you can use the new software, FastPath Manager II, to specify some of FastPath's parameters, such as net names or net numbers, if you wish to reconfigure your existing AppleTalk network layout. Also, you may configure FastPath 4 through either the LocalTalk or the Ethernet connection; you could configure prior models only through LocalTalk.

FastPath Manager II really shines when it comes to configuring FastPath 4 for use with TCP/IP networks. Because IP addresses are static, you usually must select an appropriate IP address for each device. There is a somewhat complex set of rules for assigning IP addresses according to nets and subnets, each of which determines which devices can talk to one another. To simplify the assignment of these addresses, Kinetics includes address-management software called K-Star. With K-Star loaded on FastPath 4, users don't have to worry about assigning an IP address to their Macs; K-Star does it dynamically.

When an AppleTalk device on a LocalTalk network sends information through a FastPath gateway configured for IP, the FastPath can encapsulate the AppleTalk packet in an IP packet. With this kind of support, you can use FastPaths on a complex IP network (one that includes bridges, for example) to connect two or more LocalTalk LANs. In addition, FastPath 4 can route AppleTalk packets and TCP/IP packets simultaneously on the network.

Configurations

The selected FastPath (node 220) was last configured on October 11, 1988, and served as a LocalTalk-Ethernet gateway. The AppleTalk zone name was the local (undefined) zone name, and the net number was 0. Selecting the K-Star Data button leads to another screen that includes information on IP nets and subnets.

Ring Out the Old

The FastPath Manager II software retains the capabilities of its predecessor, but features a redesigned configuration window. A Help area has been added to provide information about any of the options shown in the configuration window. The Help window contents change according to the field or button that you access (see "Configurations").

Kinetics has also done a good job of improving the FastPath manual. It now contains all the information you need to set up FastPath, whether it's for an AppleTalk-only network or a TCP/IP net. The only useful item that's missing from the manual is the IP subnetting worksheet, which used to be included in the FastPath Documentation Addendum that shipped with version 3.0 of FastPath Manager.

FastPath 4 isn't any faster than its predecessors in serving as a gateway between LocalTalk and Ethernet. The major advantages of the new model are its autoconfiguration for AppleTalk-only nets, the innovative K-Star software for dealing with TCP/IP nets, and the combination of both thin-wire and thick-wire connections in one model. Whether you intend to use FastPath 4 with Ethernet to extend and link LocalTalk LANs, or to use it to link Macintoshes to a host computer over a TCP/IP net, FastPath 4 is designed to make your job easier. And it achieves that goal.

—Dave Kosiur

See *Where to Buy* for contact information.

If you're concerned that \$499 is too little to pay for the new Ehman 32 MB Hard Drive, we'll give you 30 days to change your mind.



The Ehman 32 MB Hard Drive is vivid proof that you don't always get what you pay for...*sometimes you get more*. At just \$499 the Ehman drive is actually significantly less than the leading 20 MB drives on the market. But please don't judge us by our price.

True value is based on *performance* and price, and the Ehman drive really hums. Its access speed of 23 milliseconds is almost three times faster than some competitive offerings. And while it includes all the usual utility software and necessary cables, it may be what's not included that you'll appreciate the most... noise. In fact the Ehman drive provides virtually noiseless performance.

You may be wondering how we can provide so much for so little. The simple answer is excellent engineering and an obsession with efficiency. Ehman has been a leading OEM manufacturer of Macintosh peripherals since 1985. We know how to design better Macintosh peripherals. And we keep the overhead low and the margins thin so we can provide our customers with the very best values.

In case you're still not convinced *we'll give you 30 days to return your purchase with no questions asked*. In addition we back our products with a two-year

warranty, compared to as little as 90 days for same manufacturers. Ehman drives are compatible with the Mac Plus™, Mac SE™ and the Mac II™ and come in a variety of sizes. So call

1-800-257-1666 today for the best value in Macintosh peripherals.



Ehman Engineering, Inc.

Peripherals Designed for Value

All product names mentioned are trademarks of their respective holders.

Circle 452 on reader service card

BackFax

Software for sending and receiving facsimiles with the AppleFax Modem.

Pros: Allows background receipt and transmission of facsimile files, even without MultiFinder; converts facsimile files to TIFF, PICT, MacPaint, EPS, and Glue formats; supports user-defined cover pages. **Cons:** No zoom options for viewing facsimile files; cannot automatically assign cover pages. **Company:** Solutions International. **List price:** \$245. **Requires:** 1MB; hard disk recommended.



It seemed only natural that someone would eventually offer software to compensate for the shortcomings of the AppleFax Modem (see *Macworld's* January issue). Solutions International has done just that with its BackFax software. If you have an AppleFax Modem and are dissatisfied with Apple's software, BackFax should relieve most of your discontent.

Boxes, Cabinets, and Books

The main BackFax window includes icons for In and Out boxes, In and Out file cabinets, address books, and cover sheets. Clicking on any icon opens a window that displays the contents of pertinent files; clicking on the Out file cabinet, for example, displays a window containing a list of Sent Messages (see "Central Control").

BackFax lets you maintain multiple address books anywhere on your disk. An ad-

dress book can consist of a single individual's fax phone numbers and distribution lists composed of groups of these numbers. You can create new address books and transfer fax numbers between any of your address books.

Under Cover

BackFax offers the unique ability to make cover pages. You can use any Mac application to design a cover page, bearing in mind that the uppermost five inches of the page will be used for routing information. Then, theoretically, you select BackFax's MailSaver icon from the Chooser and print to BackFax with the Make Cover Page option selected. However, BackFax failed to recognize the cover pages I created until I used ResEdit to change their file type to match that of BackFax's cover page example. Unfortunately, you can't specify particular cover pages for fax numbers in your address book, which would be a real time-saver.

BackFax makes good use of file translations. You can translate any fax file into a MacPaint-, PICT-, TIFF-, EPS-, or Glue-formatted file, or vice versa, within BackFax. This allows you to use fax files as graphics, although you'll always be limited to the maximum 200-dot-per-inch (dpi) resolution of faxes.

Regrettably, BackFax lacks any zoom options for viewing fax documents on the screen. Faxes viewed at the standard Mac's 72-dpi resolution are often illegible; if you simply want to read a fax on your Mac with BackFax, you may be out of luck. I don't want to be forced to print a copy of a fax in

order to read it—after all, electronic storage of faxes is one of the reasons I connected my Mac to a fax modem in the first place.

Although I like dealing with faxes on my Mac's screen, you might want to use BackFax's AutoPrint option in some situations. With it you can automatically print any fax upon receipt. Say you have one Mac acting as the central fax machine, and you have to distribute hard copies of faxes to your coworkers. Since a LaserWriter can take four to five minutes to print a single fax page, you may be better off letting BackFax automatically print the faxes you receive overnight for distribution in the morning.

Solving Apple's Problems

As its name implies, BackFax enables you to use your AppleFax Modem in the background on any Mac with at least 1 megabyte of RAM, whether or not you're running MultiFinder. BackFax will briefly display a dialog box when you're in another application, informing you if you've received a fax or a Mac file; at least you'll no longer need to dedicate a Mac to only sending and receiving faxes.

Just as important, you can use BackFax to set up address books and reschedule fax transmissions without being connected to the AppleFax Modem. I found Apple's insistence that, in order to use its software, the fax modem be powered on and connected to your Mac, to be a nuisance.

Finally, BackFax resolves AppleFax's inability to maintain the proper dimensions of text or graphics objects in a fax. For CAD/CAM drawings, this could be fatal. BackFax includes an Exact Size option for viewing and printing faxes that properly maps the fax's pixels to either the screen or the printer. Be wary of using BackFax's Best Resolution option, which maps each fax pixel to a LaserWriter pixel, since it prints a two-thirds-size image.

BackFax software is a welcome add-on for more efficient use of your AppleFax Modem. However, since the purchase of BackFax brings the cost of a fax modem system (without scanner) to about \$1000, I find it difficult to recommend this software if you're shopping for a fax system for the first time. —*Dave Kosiur*

See *Where to Buy* for contact information.

Central Control

Clicking on the Out file-cabinet icon displays the Sent Messages window, which shows a list of all faxes that have been sent, along with dates and times. Double-clicking the third entry in the Sent Messages window (titled "sample fax doc...") opens a window with an image of the actual document (in this case, the front window, labeled "sample fax doc (fw)-1A").

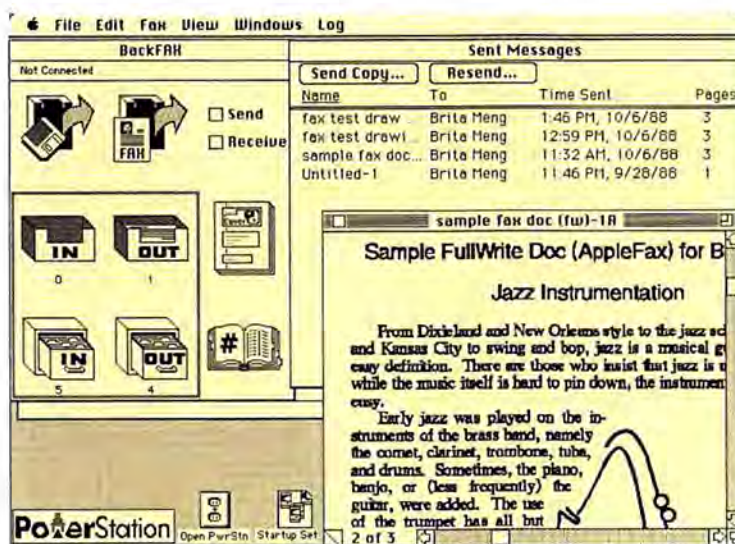

Introducing A Better Display For The Macintosh II[®] ... For About \$300.00 Less Than You'd Expect.



This is not just another display clone. It's the new Magnavox Analog Color (MAC) display, specifically designed and engineered to compliment the Macintosh II system.

When we decided to develop a display exclusively for the Macintosh II, we started with two objectives: Make it work better, and make it cost less.

Our 14" MAC display appeals to even the most discriminating user. It's equipped with our new proprietary 0.29mm dot pitch

CRT for superb resolution, and a glossy CRT face for crystal clear images. Graphics and text on the MAC display shine at their best. The integrated tilt-base provides the ultimate in user comfort.

Additionally we offer a solid, two-year warranty instead of the usual 90 days. And the \$699 retail makes this a great value.

Designing a superior display for the Macintosh II system was smart. Offering it for \$300 less, that's very smart.

MAGNAVOX
Smart. Very smart.

Apple Macintosh II[®] is a registered trademark of Apple Computer, Inc.

©1988 Philips Consumer Electronics Company
A Division of North American Philips Corporation

Animated Adventure Games

Space Quest II: Vohaul's Revenge 1.50.

Pros: Excellent animation directed by player input; cleverly scripted with mature humor.

Cons: Graphics confusing when viewed in black and white. **Company:** Sierra On-Line.

List price: \$49.95. **Requires:** 512K.

Police Quest: In Pursuit of the Death

Angel 1.50. Pros: Excellent animation directed by player input; cleverly scripted with mature humor. **Cons:** Bombed during game.

Company: Sierra On-Line. **List price:** \$49.95. **Requires:** 512K.

✦ Space Quest II: Vohaul's Revenge, and Police Quest: In Pursuit of the Death Angel are virtually guaranteed to please color-crazed Mac II users. But for those who make their quests in black and white on a 512K, Plus, or SE, these animated games may seem less inviting.

Laughing at Danger

Space Quest II continues the adventures of space janitor Roger Wilco, the amusingly animated hero of Space Quest: The Sarien Encounter. Once again, there is much to enjoy in walking hapless Roger through a series of typical adventure-game puzzlements and Mr. Bill-like deaths. With either keyboard or mouse, you direct him through a 3-D cartoon universe—he walks behind rocks and trees, up and down stairs, sometimes completely out of view.

Space Quest

Roger Wilco continues his space adventure in Space Quest II from the space station. The action moves to a jungle planet.



There are several mazes to complicate things—Roger must be guided through a tangle of poisonous roots in one maze and negotiate pitch-dark tunnels and ladders in another—but experienced gamers should encounter minimal difficulty along the way. As in the original game, Space Quest II succeeds with the humor of its animation and scripting.

Law Enforcement by the Book

Police Quest: In Pursuit of the Death Angel utilizes the same interactive animation as Sierra's other games, but represents a departure from fantasy. Your input directs street police officer Sonny Bonds (who moves remarkably like Roger Wilco) through a realistic routine of briefings, duty shifts, and off-duty camaraderie—he even applies for promotion. The goal of the game is to have Sonny be successful as a patrolman, earn promotion to detective, then bring a notorious drug dealer to justice. Codeveloped by a former police officer, Police Quest requires Sonny to follow actual police procedures (from performing a walk-around inspection of his patrol car to reading his arrestees their Miranda rights). You must study an abbreviated but realistic police manual that contains virtually everything you need to know to win the game.

Once Officer Sonny enters his police cruiser, the computer displays an overhead view of the city of Lytton. Cars on the streets stop and go at traffic lights and sometimes break traffic laws. You direct the police car's movement around town, obeying traffic rules, avoiding collisions, and becoming familiar with the city's parks, hangouts, and official buildings, like



Police Quest

A park scene. You must follow real police methods; improper arrest procedures can get you killed.

the courthouse and the jail. You experience the boredom of uneventful patrol time. You catch a speeder and write a ticket (actually, you type "give ticket to driver"). You even arrest a drunk driver and take him to jail for booking. In another case, you have to deal with warrants and court appearances.

If you follow the procedures and perform well on traffic patrol, you'll earn Sonny's promotion to detective and be able to proceed to the next part of the game—a disappointingly straightforward encounter (featuring a bit of poker playing) with a drug-dealing murderer. Unfortunately, Police Quest plays like a long version of a routine TV cop show, and you can't lose if you just follow the manual. The game begs for a challenging mystery with red herrings, multiple suspects, and realistic plot twists.

Haste Makes Waste

Regrettably, there were signs of haste in the creation of these two games. If you selected By Name from Police Quest's View menu (handy if you're storing lots of saved games), the program bombed. As of this writing this bug had been fixed, but another oversight may not have been. In Space Quest II, a yellow rope that stands out on a gray rock in color looks like shadowing or texture in black and white; without color, the accompanying text description is confusing. Attention to details like this one is what I have come to expect from Sierra On-Line's history of innovation and quality. —Keith McCandless

See *Where to Buy* for contact information.

Quit
wasting
time.

File Edit Formula Format Data Options Macro Window						
F500		=D500+E500				
Fill Down						
	A	B	C	D	E	F
1	Base Point	1st Quarter	Q-2 YTD	Q-3 YTD	Foreign	Total YTD
2	11.50	23.50	35.00	58.50	93.50	152.00
3	12.00	24.00	36.00	60.00	96.00	156.00
4	12.50	24.50	37.00	61.50	98.50	160.00
5	13.00	25.00	38.00	63.00	101.00	164.00
6	13.50	25.50	39.00	64.50	103.50	168.00
7	14.00	26.00	40.00	66.00	106.00	172.00
8	14.50	26.50	41.00	67.50	108.50	176.00
9	15.00	27.00	42.00	69.00	111.00	180.00
491	256.00	268.00	524.00	792.00	1,316.00	2,108.00
492	256.50	268.50	525.00	793.50	1,318.50	2,112.00
493	257.00	269.00	526.00	795.00	1,321.00	2,116.00
494	257.50	269.50	527.00	796.50	1,323.50	2,120.00
495	258.00	270.00	528.00	798.00	1,326.00	2,124.00
496	258.50	270.50	529.00	799.50	1,328.50	2,128.00
497	259.00	271.00	530.00	801.00	1,331.00	2,132.00
498	259.50	271.50	531.00	802.50	1,333.50	2,136.00
499	260.00	272.00	532.00	804.00	1,336.00	2,140.00
500	260.50	272.50	533.00	805.50	1,338.50	2,144.00
501						

Excel with Excel. It takes almost 17 seconds to fill this spreadsheet on the Mac SE. Or less than 4 seconds with the Excelerator XL25 board.

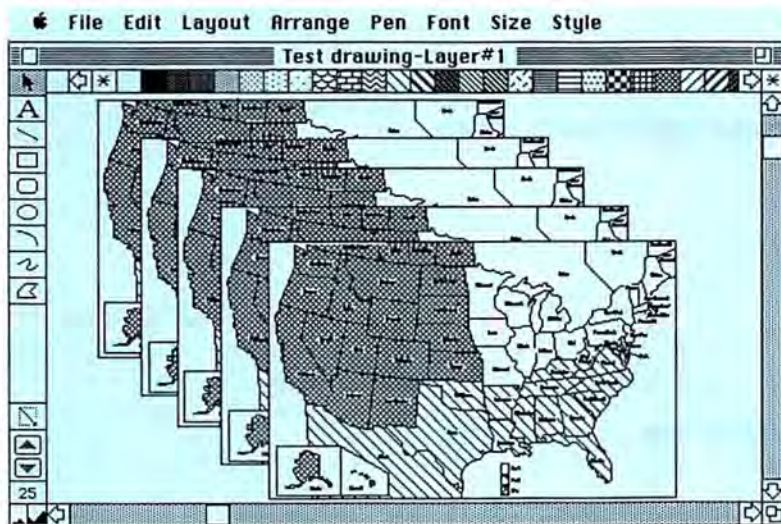

Be quicker on the draw. You can draw this on the Mac SE in about 42 seconds. Or under 6 seconds with the Excelerator XL25 board.

Enough of this dillydallying.

If you're doing business with a Mac, you're spending time you don't have to spend.

Starting now, you can put a new fleet of power products from Irwin to work on your Mac.

And fly through all sorts of productivity tasks like never before.

If that's beginning to sound like blue sky, just take our Excelerator™ XL25 board as hard and fast proof.

It drives a Mac SE up to eight full times faster.

That's right. Faster than a Mac II. Or faster than you can clap your hands.

and no-hassle tape backups.

From the people who already back up more people than anybody.

Any and all of which can make you many times more productive.

To see for yourself, take a walk over to your local computer store.

Or just call 1-800-222-5871 for the name of the dealer nearest you.

So. What are you waiting for?



IRWIN

DTP Advisor

Desktop publishing tutorial and project-management HyperCard stack.

Pros: Excellent resource for beginning electronic publishers; project-management forms useful for more experienced publishers. **Cons:** Some sections of the tutorial—notably audience analysis and creative resource management—reveal a social bias. **Company:** Broderbund Software. **List price:** \$79.95. **Requires:** 1MB.



The dawn of desktop publishing promised us that anyone with access to the appropriate desktop publishing hardware and software could take an initial idea and see it through to the printed page. It soon became apparent, however, that few new electronic publishers have much graphic design experience, and almost none are privy to the finer points of the printing process itself. DTP Advisor, an elegant HyperCard stack from Broderbund Software, attempts to fill those gaps by serving as both a tutorial for design and print production and as a project-management system for graphic arts projects.

From the first control card through the dozens of subsequent tutorial cards and project-management forms, it is obvious that DTP Advisor's designers have a strong aesthetic sense and good familiarity with the subject matter. Unfortunately, invaluable advice for the novice publisher is sometimes offset by an editorial attitude that some may find inappropriate.

Project-Management Forms

The project-management forms that make up the backbone of the program are linked to tutorial cards that illustrate—through text, images, and animation—the planning and design stages of a publishing project. The tutorial cards also give detailed information on typography, art production, and the actual printing process. Advisor includes a full, easily accessible glossary of technical terms as well as a database for storing information on sources, writers, artists, photographers, and printers.

Tutorial cards supplementing the Project Definition Form encourage the new

publisher to examine the objective, target audience, audience features, and strategies behind the proposed project. A section on tactics offers useful hints and tips on brochures and flyers, newsletters, posters, calendars, and a variety of other specific projects.

Logging dates into the Project Schedule Form is only half the battle. As the accompanying tutorial points out, "A schedule is only as good as your ability to meet deadlines." Figuring the costs of even a moderately complicated print project can be a headache, but the Project Estimate Forms and Worksheets make it easier by itemizing and automatically calculating individual costs. Forms for print bids and free-lance assignments are also included.

You may need help when consulting with a printing house: the Typography

Printing Specifications

Novice publishers often find it difficult to communicate their needs to a printing house. The Printing Specifications Form contains enough detailed information to avoid botched jobs and reduce cost overruns.

Specifications Form and the Printing Specifications Form should prove useful. Both are detailed enough to help the publisher and printer avoid costly misunderstandings (see "Printing Specifications"). Linked information on typographical history, characteristics, families, and letterform parts is fascinating. Complex printing techniques—offset lithography, letterpress, silk-screening, and multicolor printing—are also covered in depth. The HyperCard animation of a four-color sheetfed press in action is particularly well done.

Tutor in a Stack

The Program Menu serves as the clearinghouse for information and forms included in the stack. Buttons lead to the

glossary, or project-management forms, or directly to tutorials on initial planning, graphic design, page layout, typesetting particulars, art production, mechanicals, or printing processes. This nesting and interlinking of information illustrates the program's excellent use of the HyperCard interface as an instructional tool.

Nearly all the illustrations on individual cards are actually buttons that trigger animations or sounds, or open windows that contain additional information. Many print terms are technical conundrums to the newcomer, and the program thoughtfully stars each unfamiliar word. Clicking on starred words pops the glossary definition onto the screen.

Many neophytes are intimidated by schematics and mechanicals, prepress representations of final products that are integral elements of the publishing process. DTP Advisor's tutorial on mechanicals is particularly graceful and informative. And anyone putting out a first brochure or newsletter can benefit from the discussion on the advantages of one-, two-, three-, and four-column layouts.

Strong and Weak Points

The sections of the tutorial that focus on the technical aspects of publishing are far more informative and professional than those that deal with planning and personnel management. When exploring a potential audience, for instance, the new publisher is advised, "The male of the species is a rather predictable creature. He still tends to respond to messages that appeal to his ego, his wallet and his car." And, a few paragraphs later, DTP Advisor notes that "When promoting or marketing to a business audience, it is important to know something about that business or about businesses in general."

When hiring illustrators, DTP Advisor grumbles, "Unfortunately, you will have to communicate verbally." And, when hiring photographers, "Experience and ego usually determine the fee."

The authors' opinions were no doubt shaped by personal experience, but there is an editorial pomposity in blanket statements such as these that undermines the real value of the program.

(continues)



Put drafting time on your side.

New Berol RapiDesign Symbols Libraries™ make CAD system drafting faster and easier. For nearly 50 years, Berol® RapiDesign™ templates have made precision manual drafting faster and more economical. Now Berol brings those same benefits to Macintosh-based CAD systems—with RapiDesign Drawing Symbols Libraries.

Four libraries. Each with four times as many symbols. Four comprehensive libraries give you immediate access to the symbols you use most often. Each contains between 900 and 1300 symbols—three to four times as many as other libraries.

Consistently sized for greater accuracy. All symbols are precisely sized to conform exactly to ANSI standards. You get the same accurate, professional results you've always enjoyed with RapiDesign templates.

Electrical/Electronic Design: Over 1200 electrical and electronic symbols consistent with ANSI-Y32.2 specifications.

Mechanical Design: Over 1000 symbols for HVAC systems. Also includes symbols for fluid power design.

Residential Architectural: Over 900 symbols and details for design and floor layout; most are shown in both plan and elevation views. Scale: 1/4" = 1'0".

Commercial Architectural: Over 1000 symbols for architectural design of larger commercial structures. Scale: 1/4" = 1'0".

Apple and Macintosh are registered trademarks of the Apple Computer Corporation. MacDraw and MacDraw II are registered trademarks of Claris Corporation. © 1988 Berol USA, Brentwood, Tennessee 37024-2248

Circle 459 on reader service card

Berol RapiDesign Symbols Libraries

	PICT/MacDraw	MacDraw II
Electrical/Electronic	RM-1	RM-12
Mechanical Design	RM-2	RM-22
Residential Architectural	RM-3	RM-32
Commercial Architectural	RM-4	RM-42

PICT file version supports programs capable of reading PICT-format files. MacDraw II version requires MacDraw II program.

Order now toll-free 1-800-323-2454, ext. 014

Call 8:30 a.m.-5:00 p.m. Pacific Standard Time, or mail the convenient order form.

Send me my RapiDesign Library today!

Payment in U.S. Dollars
 Money Order enclosed
 VISA MasterCard

Item #	Qty.	Price (ea.)	Total
		\$89.95	
		"	
		"	
		"	

Card # _____ Exp. Date _____

Signature _____

Name (Print Name on Card) _____

Address (No P.O. Box) _____

City/State/Zip _____

Daytime Phone # (_____) _____

Subtotal _____
 Please add \$3.00 per order for postage and handling _____
 Add sales tax: CA residents 6% _____
 IL residents 5%, TN residents 5.5% _____
 Total _____

Mail to: Berol USA • P.O. Box BEROL • Carmel Valley, CA 93924
 Alexander & Lord Distribution Center

Press Time

Electronic publishing's great advantage is that individual users have the opportunity to maintain control over their publications and to bypass expensive typesetting and art production costs. But few new publishers are satisfied with the fruits of their desktop labor. They need the kinds of information offered in DTP Advisor.

Priced somewhere between books on self-publishing and a private consultant, DTP Advisor reflects considerable expertise and organizational skill. If fledgling electronic publishers are willing to overlook its rhetoric, the program offers an effective crash course in desktop publishing.—*Suzanne Stefanac*

See *Where to Buy* for contact information.

V.I.P. 2.51

Graphic approach to program development. **Pros:** Easy to use; three user-defined toolbox extensions; point-and-click interface; Hypertext-like flowchart environment. **Cons:** Poor printing interface; documentation weak on extensibility; cannot generate DAs; needs more predefined constants. **Company:** Mainstay. **List price:** \$149.95. **Requires:** 512KE; 1MB recommended.



V.I.P. (Visual Interactive Programming) offers a graphic approach to Macintosh software development. Its goal is to help you interactively develop Macintosh applications, or create and modify prototypes of applications, without an extensive knowledge of *Inside Macintosh*, the Mac programming bible published in five volumes by Addison-Wesley (1985–1988). Mainstay also offers M.I.P. (Macintosh Introductory Programming), a complementary product that is essentially a tutorial introduction to V.I.P. and includes a demo version of V.I.P.; M.I.P. is offered separately for \$49.95.

An Untraditional Approach

Traditional software development on the Macintosh usually involves programming in C, Pascal, BASIC, or Assembler. In V.I.P. you don't learn a traditional programming language; instead you work with a toolbox of icon metaphors for various programming chores. The V.I.P. tools consist of 18 icons each representing a class of pro-

cedures (including 3 user-defined extensions); 6 icons for object types; and 6 for logic forms.

For example, if you want to create a window in your program, you would first click on the Window icon and a list of window-related procedures appears. Selecting New Window from this list brings up a template for specifying the type of window you want to create (see "Procedure Box"). The procedures available create objects, or perform operations on objects, and appear in a flowchart format.

When you want to execute a procedure conditionally, select the logic form if-then-else, fill in the requested information, and place the icon in the appropriate branch of the structure provided.

Defining objects is as easy as clicking on the appropriate Object Type icon and answering the questions in the dialog box that appears.

How Well Does It Fare?

Unfortunately, V.I.P.'s manual is little more than a reference and doesn't adequately explain the underlying concepts of programming or how the tools in V.I.P. tie together. M.I.P.'s manual provides a good introduction and tutorial for V.I.P., but should have included graphic displays of the V.I.P. logic flow in addition to the text program listing.

V.I.P. promotes icon-based, point-and-click programming and does it well. The only time you need the keyboard is to fill in values. But I was disappointed that there are no keyboard alternatives for the point-and-click operations. Constantly moving

between the mouse and the keyboard when you are creating instructions that perform computations can be annoying. Fortunately, I was able to use CE Software's QuickKeys to create keyboard equivalents for frequently performed operations. Another approach is to select the procedure you want to repeat, copy and paste, and then edit the contents. You will also have to cut and paste to reorder any program commands.

V.I.P. lacks predefined constant names for such things as window types, fonts, standard dialog items (like controls), cursors, and patterns. Instead of descriptive names, you need to remember that a standard document window with a zoom box is 7, a check-box control is 3, the New York font is 2, the watch cursor is 4, and so on.

V.I.P. provides source-level debugging with an integrated debugger. You can set breakpoints, step through your program one statement at a time, observe it, and alter variable values. Again, because the debugger did so much so well, I was unhappy not to find watchpoints implemented. (Watchpoints are breakpoints that are only in effect if a specific condition exists—for example, **Break here if the lineLength variable is less than 0.**)

You can add procedures to V.I.P. in one of the three user-defined icons available in the toolbox. This is one of V.I.P.'s strongest features, similar to the XCMD/XFCN capability in HyperCard. Unfortunately, the documentation of this capability is extremely sparse, with no good example—it exists only as a brief appendix. Further, the 2.5 addendum manual states that the format for these procedures has changed, but it doesn't tell in what manner.

V.I.P. performs noticeably better than the BASIC interpreters I've seen, but it runs slower than any of the compiled languages. When you turn off the debugger and save in a compiled form, performance improves.

Online help is provided via a desk accessory based on Mainstay's Think 'n Time. The reasonably useful help system has a treelike approach to topic selection. One annoyance when using the help system is that you must constantly switch between the Help I-beam cursor and the V.I.P. cursor.

An Objective Look

V.I.P. is an excellent alternative to BASIC for anyone interested in learning to program on the Macintosh. It is also an ex-

(continues)

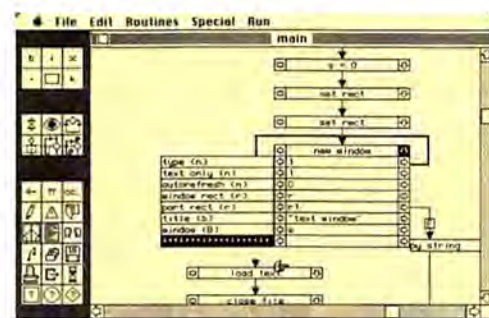

Procedure Box

The V.I.P. screen with the Procedure toolbox open allows you to specify parameters for a new window. The box's bottom line (the asterisk line) is for comments. From top to bottom on the left are the Object toolbox, the logic-form toolbox, and the Procedure toolbox.

Step Up to Color With ProViz™ Video Digitizers

Add the Power of Halftones and Color Images to Your Macintosh™



Gray Scale
\$1,095⁰⁰



Color Images and Gray Scale
\$1,695⁰⁰



If you can focus a video camera, you can add the power of sharp, *real-world* images to your desktop. ProViz video digitizers create a professional look for brochures, newsletters, catalogs or product documentation.

Over The Rainbow Is Just An Upgrade Away

ProViz can color your world with a full spectrum of sharp, clear colors that will bring to life animations, overheads, color proofs or color slides produced on your Macintosh. But, if you don't need the vibrance of *real-world* color now, buy the ProViz Grayscale today, and upgrade to The ProViz Color any time you please.

Plug and Play

ProViz is the only stand-alone video digitizer that is fully compatible with your Mac Plus, SE or Mac II. The ProViz Grayscale digitizes and creates *real-world* images on the Mac Plus and SE. For sharp, brilliant, full color images, attach ProViz Color to any "Scuzzy" port on your Mac II. Either way, there are no compatibility issues to deal with. If it works with a Macintosh and relates to imaging, ProViz supports it.

ProViz Pays For Itself...Fast

ProViz will be the most cost effective device on your desk. The ProViz Grayscale is priced at only \$1,095. List price for the ProViz Color is only \$1,695; That's why scores of our customers have said, "ProViz often pays for itself on the very first project."

To find the ProViz dealer nearest you, call the ProViz information center at 1 (800) 678-1242. Let us show you how ProViz from Pixelogic can make all of your graphic productions look as good as they are. Call Pixelogic today.

 **Pixelogic**
...The Vision of the Future 

800 West Cummings Park, Suite 2900
Woburn, Massachusetts 01801

Circle 356 on reader service card

cellent device for creating functional prototypes of applications, but it's not yet an environment for creating commercial products. In short, it's a great environment for the casual Mac programmer and a useful tool for serious software developers who need to make prototypes before programming in a more traditional development system.

Visual, object-oriented approaches to programming are the coming trend, and V.I.P. is among the first of the breed. In its current state, it could be likened to the 512K Mac. It's useful and capable of doing really nice things, but it still needs some enhancements and polishing to really catch fire. —Dennis Coben

See *Where to Buy* for contact information.

HyperCard Entertainment Stacks

Amanda Stories, Volume I and Volume II.

Pros: Entertaining for young children; stack scripts are easy to examine. **Cons:** Simple stories lack variety; older children may lose interest quickly. **Company:** The Voyager Company.

List price: \$19.95 per volume. **Requires:** 1 MB: hard disk.

The Manhole 1.2. **Pros:** Imaginative, immense fantasy world with nonlinear structure; dazzling visuals and bilarious details; appeals to anyone old enough to use a mouse.

Cons: Very large; requires hard disk; stack scripts are hidden from casual browsing. **Company:** Activision. **List price:** \$49.95. **Requires:** 1 MB: hard disk.

 Personal computers provide youngsters with all kinds of entertainment possibilities, from computerized versions of traditional games to unique entertainment forms that demand active involvement on the part of the player. Interactive fiction is particularly promising in this regard, both as an entertainment medium and as a tool for education.

Until now, most interactive fiction has taken the form of text adventures aimed at older users, with solid reading skills, who enjoy solving complex mental puzzles.

Today, however, a handful of HyperCard stacks suggest a new genre: interactive fiction for nonreaders.

Inigo and Your Faithful Camel

The first of these interactive cartoons was Inigo Gets Out, a delightful picture story by Amanda Goodenough that quickly found its way onto public domain bulletin boards everywhere. Inigo, a puff-ball cat, responds to clicks on the screen by exploring an environment full of the kind of surprises you'd find in a children's storybook. But unlike a storybook, this stack responds to the whims of the explorer: click on the birdbath, and the birds disappear in a flurry of feathers; click on the river, and Inigo falls in with a *splash*. Inigo Gets Out proved to be as popular with adults as with children; Bill Atkinson showed it off to appreciative crowds at HyperCard demonstrations when it came out last year.

With the help of HyperTalk creator Dan Winkler, Goodenough has created several more interactive children's story stacks, sold in inexpensive packages called Amanda Stories, Volumes I and II. Volume I contains four Inigo stories, including a refined version of Inigo Gets Out. Volume II chronicles the explorations of Your Faithful Camel, a silly-looking camel with an offbeat sense of humor (see "One Camel to Go").

Interactive, Not Hyperactive

There's no white-knuckled hypertension in any of these stories; they have the same kind of gentle pacing you find in the simplest children's books. The Amanda stories are especially appealing to very young children who are just developing mouse skills. Each collection comes with a title screen that allows a child to switch from story to story without using the menu bar. Young mousketeers often spend hours exploring these stories over and over. Older children might explore them once or twice and then examine the underlying scripts for HyperTalk tricks.

Enter The Manhole

If the Amanda Stories define a new genre, The Manhole certainly expands the boundaries of it. This five-disk super-stack—the first children's software to require a hard disk—contains a strange and beautiful dreamworld that includes a couch-potato rabbit, a musical roll-top desk, and a jive-talking dragon, for starters.

The Manhole isn't really a story; once you begin the journey by clicking on the

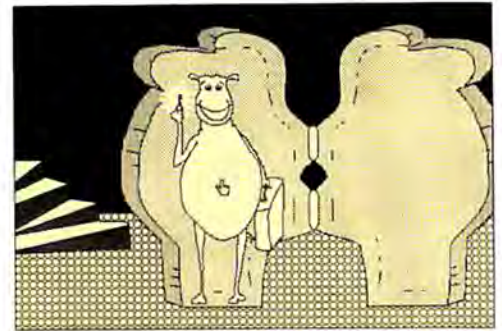

One Camel to Go

Pop-up camel. When you click the mysterious box, it opens, revealing a delighted camel with the key to the next adventure.



A Cup of Good Cheer

A fanciful journey down a river takes you past floating chessboards and through labyrinthian corridors. Suddenly, you see a regal rabbit, who seems to think you've floated into his morning cup of tea.

manhole, you have almost endless choices for exploring the visually dazzling world above and below it. There are all kinds of connections between scenes, some obvious and some surprising. Hop in the boat and you might find yourself in the rabbit's teacup (see "A Cup of Good Cheer"); choose a channel on the dragon's remote-control TV and you teleport to almost anywhere. When you return to the dragon's den (there are several ways to get there), he may or may not be home. The Manhole universe keeps changing, making it fun for kids—and adults with a sense of adventure and a sense of humor—to explore over and over. The realistic sounds, the fantasy-filled graphics, and the stack construction are truly impressive.

Buttoning Up

While exploring these stacks, my young software testers found them to be free of any apparent bugs. But once they

(continues)

On CONNECT, I share
graphics with all
our 24 branches
and swap sweet nothings
with Tony in Tucson.



Sally Nampish, Manager,
Corporate Communications

User Name: MANGA
Routes copy, shares files
and graphics for in-house
PR and desktop publishing.

The CONNECT™ Professional Information Network for Macs and PCs offers a fast, simple, and inexpensive way to share files, graphics, and even scanned images worldwide. It's the first forum for information exchange that is as user-friendly and as easy to use as a Macintosh®.

Unlike typical E-mail systems, CONNECT allows you to share more than just text. With the addition of a scanner, you have the basis of a cost-effective FAX system. You can create messages off-line and send them to many mail systems, FAX, and TELEX machines worldwide. And the user-friendly graphic interface shared by both the PC and Mac versions makes doing all this very simple. Even for computer novices.



\$74.95 for PC/MacNET; \$99.95 including
Microsoft® Windows! run-time.

CONNECT's on-line desktop publishing services can help you operate more efficiently, and without the cost and time of conventional printing methods. You can order business cards and stationery by selecting from a variety of templates and samples. You can even send a file to a typesetting service and receive output from a linotype the same day.

It's the most effective way of swapping information with thousands of PC and Mac users worldwide. Or sweet nothings with one special person. And it's quicker than sending flowers.

Call 1-800-234-3231 or 408-973-0110 today to order your low-priced evaluation package or for the CONNECT dealer nearest you. And get connected.

Get CONNECTed.

1-800-234-3231 or 408-973-0110

→ **CONNECT Inc.** ←

The Professional Information Network

learned that they could hold down the option and ⌘ keys to see outlines of hidden buttons, they started reporting occasional HyperCard alert boxes and frozen screens. It's unclear what caused these surprises, but it appears to be the result of a negative interaction between the sound generators in HyperCard and Apple's System 6.0.2; the problems disappeared when I substituted System 5.0. Hopefully Apple will correct the problem in future releases. It's discouraging when preschoolers uncover System bugs.

Frozen screens notwithstanding, I highly recommend both of these stacks for young children. Older children and adults may or may not be charmed by the simple Amanda Stories; it's a question of taste. But it's hard to imagine a playful soul of any age who wouldn't enjoy exploring the mind-tickling world inside The Manhole.
—George Beekman

See *Where to Buy* for contact information.

Mac II 19-inch Monochrome Displays

Nutmeg 19. *Pros:* Clear, straight image; high (1024-by-786-pixel) resolution. *Cons:* No documentation. *Company:* Nutmeg Systems. *List price:* \$1899.

DualPage Display System. *Pros:* High (1152-by-892-pixel) resolution. *Cons:* Small text; some bowing. *Company:* Cornerstone Technology. *List price:* \$2195.

It's not unusual to find competing color video boards using the same monitor. PCPC and SuperMac both use the Sony 19-inch. The same is true of some monochrome displays. The Nutmeg 19 (from Nutmeg Systems) and the DualPage Display System (from Cornerstone Technology) both use the Sampo BDS-1902, a 19-inch monochrome CRT. Each company just sticks a label on the front and adds its own video board.

The monochrome Sampo 19-inch is attractively designed and a decent performer. It has a 64-KHz refresh rate, with a maximum resolution of 1280 by 960 pixels.

The only controls available to the user are power (on/off) and brightness. A number of other controls—including centering, size, and focus along both the x and y axes—are inside the unit, and can only be accessed with tools.

The monitor itself has a built-in tilt-and-swivel base, with a 12½-by-11½-inch footprint and is larger (19 inches wide by 17 inches deep and 17½ inches high) than some of the early Mac II offerings.

Nutmeg 19

The Nutmeg display uses a small (9-inch) video board and comes with built-in video cable and power cable. As with most such systems, there isn't much to installation: pop the Mac II lid, find an open slot, stick the card in, close the lid, plug the monitor in, and power up.

The Nutmeg display is clear and crisp, with no visible bowing or other distortion along the edges. Some very minor blurring exists along the right edge, and the display is slightly off-center horizontally (toward the right), but these are minor faults. The display is well-proportioned; when I compared a real-life ruler to the one displayed in ReadySetGo3 (Actual Size mode), the horizontal resolution matched reality and there was only a slight stretching along the vertical. Both that stretching and the slightly off-center display can be fixed by opening up the case and using the H-center and V-size controls.

DualPage Display System

The DualPage Display System has a larger board (13 inches), which gives higher resolution than the Nutmeg 19 (1152 by 892) on the same monitor. This one comes with two manuals: a thin 4-page manual for the monitor, and a 24-page installation manual with plenty of step-by-step instruc-

tions. The documentation made reference to a floppy disk with a screen saver INIT on it, but no disk accompanied my display.

The DualPage's resolution is crisp, with no sight of blurring, but there is some slight visible bowing along the left and right edges. Beyond that, the display is fine. The extra resolution really makes a difference: I could view entire pages (top to bottom) in PageMaker and ReadySetGo. A simple graphics benchmark—drawing 200 circles and then 2000 rectangles—showed an actual difference in graphics performance (14.1 seconds on the Nutmeg versus 18.4 seconds on the DualPage).

One unusual problem did show up. I booted up the arcade game Arkanoid on each display (with only that display's video board installed in the Mac II). The game ran fine with the Nutmeg display, with the game centered on the screen. On the DualPage, however, it started out centered (during the boot process), then relocated to the top of the display and stayed there, leaving the old image in the middle. More important, the DualPage somehow slowed the game down dramatically, making it so easy that I finally quit.

Which one to buy? Well, the DualPage gives more room to PageMaker, ReadySetGo, and so on. The higher resolution, especially vertically, really does make a difference in word processing, page layout, and other large-screen applications. On the other hand, the Nutmeg system costs less, graphics run faster on it, and it offers standard (72 dpi) resolution, so that the image size on the screen is the same as that printed. Both monitors are more than acceptable; it's just a case of picking the one that suits your needs and your pocket-book.—Bruce Webster

See *Where to Buy* for contact information.



Macintosh II 19-inch monochrome monitors: the Nutmeg 19 (on the right) from Nutmeg Systems and the DualPage Display System from Cornerstone Technology.

We have an accounting solution for everyone in the world.

And now we have one for the rest of you.

In the past, companies who selected the Macintosh[®] for its power and ease of use have been disappointed when it came to business software. Until now.

Introducing the new Database Accounting Library[™] for the Macintosh from SBT. Complete with Macintosh full-user interface, it's the most flexible and comprehensive accounting software available. Here's why.

More Business Applications Than Anyone.

Designed on the most popular and powerful relational database, SBT's Accounting Library offers you up to fifteen specific business software modules. No other system offers you more. Running alone or integrated, they are the most extensive business programs on the Macintosh today.

Change It To Fit Your Specific Needs.

We provide free source code with every program. So the Library can be adapted to any business as it grows and changes.

Or adapted to any industry. Over three hundred vertical applications across 42 industries make the Library the most widely used accounting solution anywhere.

And because SBT supports the largest network of programming consultants in the world, installation or modification support is just around the corner.

No Business Too Small Or Too Large.

The Database Accounting Library can account for a business with one computer, or for a Fortune 500 with thousands. And because the Library supports AppleShare[™], 3Com[®], and Novell networks, you can share your data with all DOS systems. So even if your office is not entirely on the Macintosh, everyone else can keep up with you.

Five-Year Warranty.

SBT offers an unprecedented five-year warranty and free technical support on all its products. Try and find that anywhere else. And our Educational Products Division offers specialized training for resellers and end-users as well as developers.

For the past eight years, SBT has been providing business solutions for everyone in the world. And now there's one for the rest of you.

Trademarks/owner: Macintosh, AppleShare/Apple Computer, Inc. Database Accounting Library/SBT Corp. 3Com/3Com, Inc.

The screenshot shows a window titled "dInvoice/dStatements MultiNet Rele" with a menu bar (File, Edit, Company, Transactions, Maintain, Print, Exit) and a sidebar menu (Labels, Invoices & CM Forms, Customer Statements, Transaction Reports..., Inventory Reports..., Sales Reports..., Other Reports...). The main area displays a "Business Status Report as of 10/10/88" with the following data:

dInvoice/dStatements		dPurchase	
Current Balance:	106532.63	Current Balance:	23556.44
PTD Billings:	55768.15	PTD Payables:	25978.84
PTD Receipts:	53422.23	PTD Payments:	1285.95
PTD COGS:	22475.84		
Inventory Value:	158412.57		

dOrders		dPurchase	
Open Orders:	8253.76	Open POs:	49703.56
PTD Orders:	54725.43	PTD Orders:	45125.33
PTD Shipments:	55035.12	PTD Receipts:	29874.98
PTD Gross Margin:	29208.50	Net Cash Forecast:	10450.62

Buttons at the bottom: Forecast, Recalculate, Print, Quit.

The Business Status Report on the Database Accounting Library is a complete control panel for your business. A set of instruments that gives you up-to-the-second status on what you're selling and what you're buying. On what you owe and what you're owed. All on the same screen.

Programs start at just \$395. Call now for more information, 800/227-7193 (415/331-9900 inside California). Or write to SBT, One Harbor Dr., Sausalito, CA 94965. If you are an authorized Apple dealer, call now for a free Feature Diskette.

© Copyright SBT Corp. 1988

Circle 456 on reader service card

More than accounting, We stand for better business.

SBT
CORPORATION



SuperSIMM A/UX Memory For The Big Apple



You chose the Macintosh® IIx because you needed more than just a computer, you needed a high-performance UNIX® workstation for the most advanced software applications.

That's why we developed SuperSIMM™ Memory Modules — to provide the ultimate in RAM expansion for Macintosh IIx users.

Micron SuperSIMMs are unlike any other add-in memory product because they plug directly into the processor bus. So you receive 16 to 32 megabytes of memory in a configuration that is more efficient than NuBus™ memory expansion.

SuperSIMMs are perfect for A/UX™ power users. No matter what the application — from sophisticated

multitasking to high-end graphics and desktop publishing — SuperSIMMs deliver the superior speed and performance that matches the sophisticated features of your Mac IIx.

Like all Micron memory products, SuperSIMMs are manufactured and tested under the industry's most stringent quality control standards. Plus they're supported by our service and warranty program.

So choose the "Big Apple" memory solution by calling 1-800-642-7661 for the name of your nearest Micron dealer.

Micron. It's a name worth remembering.

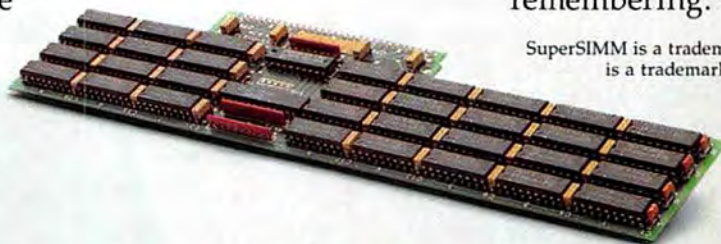

SuperSIMM is a trademark of Micron Technology, Inc. A/UX is a trademark and Apple and Macintosh are registered trademarks of Apple Computer, Inc. UNIX is a registered trademark of AT&T Corporation. NuBus is a trademark of Texas Instruments, Inc.

MICRON

TECHNOLOGY, INC.

2805 E. Columbia Road, Boise, Idaho 83706 (208) 386-3900

Circle 161 on reader service card

Window Shopping

A quick and easy tutorial on HyperCard, typing and word processing, and easy font selection

by Lawrence Stevens

Although I've taken a few courses in programming and even published a children's book on BASIC, I'm not much of a hacker. My writer's mind, which is always looking for three different ways to say the same thing, can't get used to the small subsets of English that make up programming languages. Besides, I'm a sloppy typist and speller, so even when I use the language correctly, I tend to make syntax errors.

Because of all this, it was not until late one Friday afternoon that I finally broke open some packages of HyperCard development tools. I expected to put in a few hours with them and spend the weekend recuperating. But scriptExpert and Icon Factory made HyperCard programming so easy and the Sound Resource Libraries made it so much fun, that I ended up spending most of the weekend working with them. The final result was a bizarre stack in which button commands, special effects, and music combined in a way that was more bewildering than useful. But I now consider myself a junior HyperCard programmer, and that's not bad after only about 15 or 20 hours of work.

scriptExpert

Both a teaching and development tool, scriptExpert provides a menu approach to scripting HyperCard. For example, if you want your Mac to beep twice each time you click on a button, you first go to scriptExpert's list of system messages and select mouseUp (this means the action will occur when the mouse is clicked). You then go to the Command menu, also called the Main Card, and click on Beep. The program asks you how many times, and you type 2. The correct syntax, ready to be pasted into your button's script, appears at the top of the screen.

With more complicated commands, scriptExpert walks you through all the

steps. If you choose Set from the Command menu, the program brings you to a second menu that asks what kind of property you want to set—button, background, field, and so on. If you click on Button, you get a dialog box that asks if this is to be a background button or a card button. Choose Card, and you see a second box that asks what you want to name the button. If you give it a numeric name, scriptExpert asks if it is a name or an ID number. Next you are shown a third menu screen of attributes for style, location, and icon. If you click on Style, a fourth menu screen asks you to choose among the various styles, such as Transparent, Rectangle, or Opaque. After making that choice, you are returned to the Command menu where the syntax **set the style of card button "{NAME}" to rectangle** is displayed, ready for cutting and pasting.

If you select Visual from the Command menu, the program displays a menu card that lists HyperCard's visual effects. After you make the selection and set the

speed, the program demonstrates how the visual effect will look. You can either accept it, in which case the syntax for that effect appears at the top of the Command menu, or try another effect.

This utility is for experienced HyperCard programmers who want to minimize their typing (as well as the danger of what our teachers used to call "foolish errors") and also for new HyperCard programmers who want to learn the language.

If you're a novice programmer you may be able to get started using scriptExpert, but you're going to need other resources to keep going. Explanations of the commands are given in small Help boxes that appear when you Option-click on an item in the Command menu. In some functions, the explanations are clear, but in others, they leave you as confused as when you started. For example, the Click Help box says you can "click... a pair of coordinates separated by a comma." But it doesn't explain how you find the coordinates on the card.

And there is no help for menus other than the Command menu. So at the System Message menu, which has no Help boxes, you are left wondering about the meaning of messages such as Idle and Suspend.

If these problems were fixed, scriptExpert could become a complete HyperCard learning tool. But at \$79.95, even with these problems, it's an excellent start.

HyperTalk Pocket Reference

I had hoped that the *HyperTalk Pocket Reference* (Hyperpress Publishing Corporation, 1988) would clear up some of the questions left unanswered by scriptExpert, but this handbook (I wouldn't call a 4-by-11-inch book "pocket") only helped a little. The book lists commands by cate-

(continues)

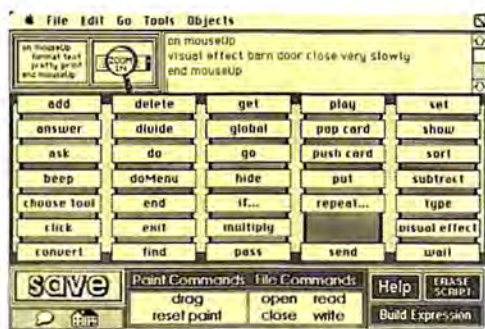

scriptExpert's Main Card

The white area at the top contains HyperTalk script generated by the program. If the script is too long to fit in the window, you can scroll or use the Zoom In button to see all of it. After the script is complete, you click the Save button, which cuts the script from this card and takes it to the last card you were using so you can paste it there.

HARD DRIVES



MiniScribe
Solutions for Data Storage

HARD DRIVES
International
An IDN Company

Three great names, one low price!

The **BIGGEST** name in low priced hard drives comes to **MACINTOSH™**.

HARD DRIVES International . . .

- Our Multi-Million Dollar buying power assures the lowest possible prices.
- Friendly, knowledgeable sales staff will help you choose the drives you need.
- Factory-trained technicians in our Technical Department can assist you with trouble-free installation and setup of your hard drive.
- Helpful Customer Service Representatives provide service after the sale.
- All products include a **One Year Warranty** and our **30-day "Worry-Free" Guarantee**.

HARD DRIVES
International
An IDN Company

1208 E. Broadway Rd., Suite 110
Tempe, Arizona 85282
(602) 829-9187 FAX: (602) 829-9193

1-800-234-DISK

International Orders: (602) 784-1038

Phone Orders: 7am — 7pm Mon. — Fri.
10am — 4pm Sat. (MST)

Customer Service: 1-800-234-5197
TELEX: 405765



**Never A Surcharge
For MC and Visa**

Price and availability subject to change. All items are new with manufacturer's warranty. 5% surcharge for American Express and COD orders. PO's accepted 2% 10 days, NET 20, subject to 9% surcharge. 30-day Guarantee conditions: shipping & handling charges not refundable; product must be in original condition. Add \$20 shipping for Overseas Military APO/FPO EXPRESS Delivery. Hard Drives International is a division of Insight Distribution Network, Inc. MACINTOSH is a registered trademark of Apple Computers, Inc.

MCW 0389

INTERNAL KITS FOR SE & II

20Mb MiniScribe	68ms	\$355
30Mb Seagate	40ms	\$411
45Mb MiniScribe	28ms	\$499
80Mb Quantum	19ms	\$875

INTERNAL KITS FOR MAC II ONLY

65Mb Seagate	40ms	\$ 529
160Mb MiniScribe	17ms	\$1222
340Mb MiniScribe	16ms	\$1955

These complete internal drive kits include the drive, UniMac™ formatting & partitioning software, hardware mounting kit, all necessary cabling, and How-To manual.

EXTERNAL DRIVES FOR MACINTOSH PLUS, SE & II

20Mb MiniScribe	68ms	\$ 426
30Mb Seagate	40ms	\$ 479
45Mb MiniScribe	28ms	\$ 569
60Mb Seagate	40ms	\$ 589
80Mb Seagate	28ms	\$ 799
80Mb Quantum	19ms	\$ 955
160Mb MiniScribe	17ms	\$1275
340Mb MiniScribe	16ms	\$2075

External drives include drive, UniMac™ external case, power supply, cabling, formatting & partitioning software.



**30-day
"Worry-Free"
Guarantee**

If for any reason, you are not completely satisfied with any product, simply return it for a prompt and courteous refund!

gory, and after each command it gives the syntax, a brief description (usually two lines but up to six lines), and sometimes an example of the usage.

If you have a general idea of a command but can't remember the exact syntax, this book will help you. If you're unfamiliar with the commands, only about 70 percent of the explanations offer enough information to help you.

But, after all, this is a reference book, not a primer. Few people could learn a foreign language by scanning a dictionary, but they'd have a hard time progressing in a new language without one. For \$11.95, HyperTalk Pocket Reference is a pretty good dictionary.

Icon Factory

A stack should contain buttons whose icons are good reminders of the buttons' functions. Icon Factory provides a way of creating those buttons. There are two parts to this package. The first is a library of icons that you can simply paste into any of your stacks. The second is the Factory where you can alter or create buttons from scratch using the FatBits mode, as in MacPaint. You can also import icons from any application. After creating a new or altered button, you can save it in the Library as well as paste it into a card. This utility is easy to use, it works well, and the documentation is clear. It costs \$49.95.

Sound Resource Library 1 and 2

What made my lost HyperCard weekend the most fun was playing with the sounds in B & B Soundworks' Sound Resource Libraries. There are human voices (Angry mother: "This room is a pigsty"), office sounds (Mac typing), animal sounds (dog barking), and a wide range of musical instruments.

You install the sounds in your stack using the Resource Mover, an Apple utility that comes with the library and works much like the Font/DA mover. The HyperCard script for playing sound is easy to use: **play (NAME)**.

Sound effects are useful in dressing up presentation stacks such as product demonstrations. Sound becomes old on a stack that you use on a regular basis, like your address book. It's fun to choose and install sounds, so buy these (\$49.95 each) and enjoy.

Mavis Beacon Teaches Typing 1.2B

I've been putting off reviewing this one for a couple of months. I was turned off partly by the stereotyped typing in-

structor (prim, black female) pictured on the cover of the package, and partly because I didn't see why the Mac world needed yet another typing program. Now I'm sorry I waited. Mavis Beacon Teaches Typing is unique. As I said in a past column, I'm not sure that bells and whistles in typing programs really translate into quicker learning. But if you like bells and whistles, Mavis Beacon Teaches Typing gives you more than any other package.

The program is partly an expert system with Mavis Beacon (not a real person) as the expert. She is a tough but understanding instructor. At times she may chide you for asking to quit soon after you start; the Quit dialog box reads: "You'll never learn that way." Other times she'll suggest that you knock off for a while: "You've made a lot of mistakes one after another. Do you want to take a break?" She may play music or a metronome to help pace your typing, or display or hide a digital or analog stopwatch. She may show you the entire paragraph that you will be typing or display only one line at a time. She may allow you to retype a mistyped character or the entire word. She may make you play the instructional video game that comes with the package after every three lessons, or she may stretch it out to every six lessons. Basically, the program experiments with all these choices, calculates the way in which you work best, and customizes Ms. Beacon's lessons to fit.

Before each lesson, you are shown a picture of a blackboard with the goals of the lesson written in neat cursive letters. (What else?) In each lesson you work on a row or a letter combination. The lesson proceeds by displaying characters that you are to type. There is also an animated picture of a keyboard and a pair of hands whose fingers guide you by pointing to the correct key.

After each lesson, you are given a drill in which you practice the lesson and your weak letters and letter combinations. As you type, a gauge displays your speed and accuracy in real time.

Mavis Beacon Teaches Typing uses a wide range of parameters in both creating the lessons and in generating graphs that measure progress. All typing programs look for such things as weak letters, weak letter combinations, a weak hand, weak fingers, and weak rows. But Mavis Beacon Teaches Typing tracks more subtle errors, such as slow transition between two keys,

The image shows a screenshot of the 'Résumé Writer' software interface. It features a yellow background with several form sections:

- PERSONAL INFORMATION:** Fields for Name, Street Address, and Telephone.
- MILITARY INFORMATION:** Fields for From (Year), To (Year), Branch, Rank, and Training.
- JOB OBJECTIVE:** A text area for 'Enter your job objective:'.
- SCHOOL INFORMATION:** Fields for Name, To (Year), From (Year), Address, City, State, Zip, and Description of Studies.
- EMPLOYMENT INFORMATION:** Fields for Name, To (Year), From (Year), Address, City, State, Zip, and Job Description.

 The interface is organized into a grid-like structure with labels and input fields.

Résumé Writer

Mavis Beacon Teaches Typing includes a résumé writer to help you get a new job after you learn to type. You fill out short forms like the ones displayed and the program organizes the information into a professional-looking résumé.

hitting two keys at a time, and hitting in the right row but with the wrong finger.

I'll leave it to educational theorists to decide if this customized approach actually produces better results. But it is certainly unique. For \$49.95, this would be my first choice among typing programs.

MenuFonts 2.01

MenuFonts 2 replaces an application's font menu with a menu that displays font names in their actual font. If you have a lot of fonts, the only reasonable way to remember what they look like is to have a font menu that displays them the way they actually look. MenuFonts 2 can change the size of the fonts in the menu (from 9 to 24 points). And it has a keyscroll feature that can save you scrolling down the menu; with it you can, for example, get to all the fonts that start with the letter *N* by typing an *N*. If you collect fonts and can spare \$49.95 and about 25K of disk space, this program is for you.

Word Processing: the Usable Portable Guide

Word Processing: the Usable Portable Guide (The Writing Resource, 1988), by Jon Haber and Herbert R. Haber, provides basic instructions for 11 word processing programs, including two for the Mac (MacWrite and Microsoft Word 3.0). The instructions are clear, concise, and as far as I could determine, accurate. For \$11.95, this won't make you a power user of any of these programs, but if you find yourself moving from office to office and working on a number of different programs, this book may help get you off to a quick start. □

See *Where to Buy* for contact information.

With CompuServe, you can fax from your computer without a fax board.

Now there's a faster, easier way to send letters, contracts, orders, or any kind of text directly from your computer to any fax machine in the world. Without adding an expensive fax board to your computer and sacrificing an expansion slot.

CompuServe has added the speed and convenience of fax to its long list of business-building services. And the price of faxing on

CompuServe makes good business sense, even before you consider all the other benefits.

For example, when you're away from your office, you can fax from your laptop or another computer. Composing and sending from your keyboard gives your recipient a sharper, cleaner fax. And CompuServe sends you a confirmation of every fax you send.

Circle 319 on reader service card

To fax from your computer, all you need is a personal computer with a modem and a CompuServe membership. To join, call 800 848-8199, or see your local computer dealer. If you're already a CompuServe member, type GO FAX at any ! prompt.

CompuServe®

New Products

Information on the Mac's latest hardware, software, and accessories

Edited by Mary Margaret Lewis

This section covers Macintosh products formally announced but not yet evaluated by *Macworld*. All prices are suggested retail. Please call vendors for information on availability.

HARDWARE

CD-Star Compact disk system for transfer of archival records. Stores digital data and digitized images on one system for search and display. 5 1/4-inch and 12-inch disks available. Expandable database. Price depends on custom configuration. Conversion Dynamics, 404/355-2197.

Color Monitor and Color Multiscan Monitor Mac-compatible 14-inch analog monitor (model RE1475) with nonglare display, 35 kHz scanning frequency, and 640-by-480-pixel resolution at 84 dpi. VGA and Mac II-compatible color multiscan monitor (model RE1520) with 15-inch nonglare display, analog video input, and

unlimited display colors at 1024-by-768-pixel resolution. Model RE1475 \$645; Model RE1520 \$995. Relisys, 408/945-9000.

Datacopy 730GS Desktop scanner with 64-level (6-bit) or 16-level (4-bit) gray tones. Scans at resolutions of 60 to 450



Datacopy 730GS

dpi, with 27 variable settings. Accepts documents in various forms—including single sheets, layouts, and books. \$1995. Xerox Imaging Systems, 415/965-7900.

DayStar 33/030 Accelerator II Accelerator card based on the Motorola 68030 processor that increases speed of the Mac II by two to five times, depending on application. Runs at 33.33 MHz, with zero 68030 wait states. Compatible with all standard Mac II software and Apple's A/UX operating system. \$6000. DayStar Digital, 404/967-2077.

Emac Impact Series External Hard Drives Available in 40MB, 60MB, and 80MB capacities. Feature front-mounted power switch, status lights, automatic head park, external SCSI address selector, and external terminator for daisy-chain-

ing. Shipped with preformatted latest Apple System Folder. Impact-40 \$1295; Impact-40 Plus \$1355; Impact-80 \$1715. Everex, 415/498-1111.

FlashBox Device that enables Macs and IBM PCs to communicate over LocalTalk-compatible networks at 770 kilobits per second. Automatically selects correct speed for FlashTalk or AppleTalk. \$189. TOPS Division, Sun Microsystems, 415/549-5900.

Macintosh Floppy Drive Repair Tool Macintosh adapter board that enables you to align and test 400K or 800K drives with any AVA Floppy Drive Tester products. No specialized software required. \$285. AVA Instrumentation, 408/336-2281.



Macintosh Floppy Drive Repair Tool

Memorybank High Capacity Backup Integrated 2.3 gigabyte tape backup for Memorybank. Compatible with any Mac

(continues)



Color Multiscan Monitor

Mac MAIL

SEs & Mac II Systems

NATIONS LOWEST PRICES

Mac SE-50Dr.-2 Floppy - Ext KEY LIST 4500, NOW 3188.

Mac II -50Dr.-2mb SONY COLOR LIST 8300, NOW 6488.

CALL FOR PERSONALIZED MACINTOSH COMPUTER PACKAGES
HI-PERFORMANCE CONFIGURED PACKAGES... AT LOW PRICES

HARD DRIVES

20mb. EXT. LIST 700, NOW 488.

32mb. EXT. LIST 900, NOW 598.

46mb. EXT. LIST 1100, NOW 788.

42- REMOVABLE LIST 1800, NOW 1198.

FAST QUICKEST DRIVES

40mb. INT. LIST 1100, NOW 848.

80mb. INT. LIST 1600, NOW 1148.

12 MS ACCESS TIME SPEEDS UP OPERATIONS 3 TO 5 TIMES

FASTER THAN "CONVENTIONAL OLD TYPE" HARD DRIVES.

WHY PAY FOR A FAST COMPUTER, THEN INSTALL A SLOW HARD DRIVE... INSTALL THE "QUICKEST" DRIVES AVAILABLE

CALL FOR INFO. ON HARD DRIVES & OTHER SIZES

MAC MONITORS

SE FULL PAGE B/W LIST 1200, NOW 988.

SONY 13 COLOR. LIST 800, NOW 598.

E-MACHINE 16 COLOR NOW 1998.

SUPERMAC 19 COLOR NOW 3488.

CALL FOR INFO. ON MONITORS & OTHER MAKES

PRINTERS

SEIKOSHA DOT LIST 400, NOW 228.

OLYMPIA DOT LIST 500, NOW 388.

NEW "PostScript" LASER PRINTERS

PLP LASER+ LIST 2000, NOW 1698.

BLP LASER LIST 4200, NOW 3198.

ACCESSORIES

DATADesk 101 LIST 200, NOW 148.

2400 Bd. Modem LIST 250, NOW 168.

ACCELERATORS - UPGRADES - BOARDS - MEMORY CALL

CALL FOR... QUOTE ON NEW

Macintosh

FULL SYSTEM PACKAGES

COMPLETE COMPUTER SYSTEMS DESIGNED FOR YOUR

SPECIFIC NEEDS. CONFIGURED WITH THE LATEST...

'State Of The Art' COMPONENTS & PERIPHERALS.

No shipping charges or SalesTax. Call now for prices

The Country's Lowest "Mac" Prices

WE SELL ALL MAJOR BRAND NAMES...

CMS - Mass MICRO - E-MACHINE - SONY- AST

RASTER OPS - Radius - SEAGATE - SUPERMAC

COD's OK - ONE DAY RUSH DELIVERY - No TAX

100
NEW MAC
PRODUCTS

CALL TODAY FOR FAST ORDER LINES
ITEMS NOT LISTED

WE'LL BEAT EVERY PRICE, CALL US LAST!

Mac - Macintosh TM Apple Computer Inc.

Circle 354 on reader service card

New Products

model. Backs up disks unattended. \$15,600-\$17,900. Northern Telecom Memory Systems Division, 800/521-3278.

Nulink Adapter Board Single-slot interface board compatible with NuBus. Provides the interface to the Tecmar QT-Mac150 and the PC, PS/2, and NuBus environments. \$395. Tecmar, 216/349-0600.

One Megabyte Memory Modules One megabyte memory-expansion modules for the Mac Plus and Mac SE. Call company for current price. Clear-point Research Corporation, 617/435-6184.

PCPC Jetstream Tape Backup System Tape backup system for the Mac Plus, SE, and II that archives data from any size storage device, from 20MB to 2.3 gigabytes at up to 14.4MB per minute. Backs up multiple drives on one tape. \$5995. Personal Computer Peripherals Corporation, 813/884-3092.

RGB Color Thermal Printer Produces 240 dpi on paper and overhead transparencies in 72 seconds. Chooser-compatible driver lets you control printer functions via pull-down menu. \$6595. RGB Technology, 703/556-0666.

Sound Accelerator Digital signal processing (DSP) card for the Mac II and SE, based on the Motorola 56001 DSP chip. Provides stereo playback of sounds directly from the computer, and performs most sound processing and synthesis functions in real time. \$1295. Digidesign, 415/327-8811.

Telebit T1000 Multispeed modem that runs at throughput of up to 9600 bps without data compression. Continually analyzes line conditions and adjusts its speed. \$795; optional stand \$15. Telebit, 415/979-3800.

SOFTWARE

Abra 2000 Mac Human resource management system. Base system has more than 50 standard reports for things like salary reviews, telephone directory, and benefit plan enrollment. Optional attendance module. 1MB min. memory. Abra 2000 Mac Base System \$995; Attendance Module \$395. Abra MacDabra, 408/737-9454.

AdaFlow Addition to Iconix PowerTools CASE suite. Supports Buhr diagramming techniques. Groups similar objects with operations, and connects them with alone module \$1995; can be purchased as part of an object-oriented design package. Iconix Software Engineering, 213/458-0092.

Adobe Font Folio Hard disk containing entire Adobe Type Library, totaling more than 300 typefaces. Works with Mac Plus, SE, and Mac II. 1MB min. memory. \$9600. Adobe Systems, 415/961-4400.

Applications and Routines for 4th Dimension Teach nonprogrammers how to write basic business programs in 4th Dimension. You use cut and paste modules to create a library of commonly used procedures. 1MB min. memory. \$129. DucSoft, 419/626-6797.

Arkanoid Arcade-style game that tests your reflexes. Dodge and destroy Konerds, Pyradoks, Tri-Spheres, and the like. Has high-score table and variable skill levels. \$49.95. Discovery Software, 201/268-9877.

Azimuth Mapping program for graphic artists that accurately draws global views of all countries in the world, and all states in the United States, from any distance or angle. 1MB min. memory. \$395. Diehl Graphsoft, 301/461-9488.

Color Session Software that lets the Mac emulate an HP 2397 color graphics terminal. Has up to 16 color palettes, emulates dithered area-fill patterns with

(continues)

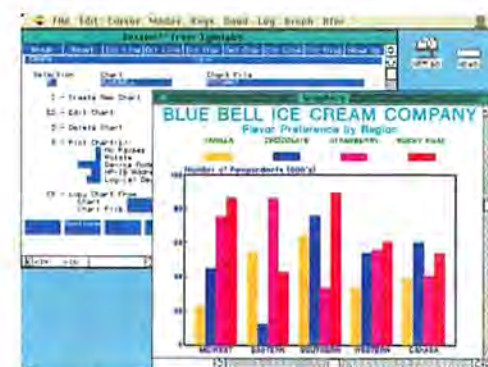

Color Session

AT THE CORE OF EVERY GOOD APPLE



Capacity
The RX™ Series offers the largest internal storage capacity in a half-height hard drive (140 megabytes) you can find for your Macintosh SE™ and Macintosh II™ – along with the largest selection: 200 RX™ (20 MB), 450 RX™ (45 MB), 600 RX™ (60 MB), 1000 RX™ (100 MB) and 1400 RX™ (140 MB).

Speed
Coupling capacity with speed, the RX™ Series of hard disk drives provide you with one of the fastest average seek times (24 milliseconds) available for your Macintosh™!

Reliability
Rodime, a worldwide manufacturer of disk drives and the largest supplier of third party hard disk drives for the Macintosh™ line of computers offers you the level of reliability, innovation and support only an original manufacturer can provide.

Rodime Inc., 851 Broken Sound Blvd., NW
Boca Raton, Florida 33487
407-994-5585
Rodime, PLC, Nasmyth Road
Southfield Industrial Estates
Glenrothes, KY6 2SD, Fife, Scotland
592-774-704
Rodime Paris, Centre d'Affaire de Jouy-en-Josas
5 Bis Rue du Petit-Robinson
78350 Jouy-en-Josas, France
1-34-659798

THE RX SERIES FROM RODIME SYSTEMS

Macintosh is a trademark licensed to Apple Computer, Inc.
© copyright 1988

Circle 149 on reader service card

Moving towards the speed of mind.

AFTER THE DECLARATION OF INDEPENDENCE OUR FOUNDING FATHERS WROTE SOMETHING EVEN MORE IMPORTANT.

Ten years after the signing of the Declaration of Independence our founding fathers created what historians have called the greatest single document struck off by the hand and mind of man.



Our founding fathers created the Constitution of the United States.

For the first time in history, power was granted by the people to the government, and not by the government to the people.

The freedom unleashed by the Constitution allowed Americans to develop their talents and abilities to the fullest. And attain what is now known the world over as the *American Dream*.

As we commemorate the Bicentennial of the Constitution, there is no better way for you as an American to reaffirm the principles for which our country stands than to learn more about the Constitution.

The words we live by.

THE CONSTITUTION

The words we live by

To learn more about the Constitution write: Constitution, Washington, D.C. 20599. The Commission on the Bicentennial of The U.S. Constitution. 

New Products

Mac colors, and contains all HP pens and drawing modes. 512K min. memory. \$399. Tynlabs, 512/478-0611.

CompuFat Kit Computes body fat percentage for people five years old and up. Comes with calipers and HyperCard stack with instructions and graphics. 1MB min. memory. \$34.95. HyperCraft, 505/522-2709.

ComputerEyes Black-and-white image capture from VCR, camera, or any standard video source. Scans images in either 6 or 24 seconds, and saves images in larger-than-screen formats. Compatible with ImageWriter and LaserWriter. 512KE min. memory. \$249.95. Digital Vision, 617/329-5400.



ComputerEyes

Cricket Paint Third-generation monochrome paint program. FreshPaint feature turns any drawn shape into a bitmap image when you deselect it. 1MB min. memory. \$195. Cricket Software, 215/251-9890.

daMath Desk accessory for mathematical-expression evaluation, plotting, and table generation. Evaluates expressions in up to three variables—building on standard algebraic, trigonometric, hyperbolic, gamma, and Bessel functions. Makes two-dimensional line plots and tables of values for any expressions. 512K min. memory. \$50. Spectra Blue, 602/327-4686.

Disk Manager Mac Automatically installs any SCSI drive in Mac SE, II, or Plus. Assigns multiple partitions that may be accessed as if they were separate drives. 1MB min. memory. \$149.95. Ontrack, 800/752-1333 or 612/937-1107.



Disk Manager Mac

Empower Macintosh computer security program. Contains both access control and automatic data encryption. Works for files and programs residing on hard disks or floppies. 1MB min. memory. \$395. Magna, 408/433-5467.

Firepower Arcade-style action game featuring one-to-one playability with the computer, another person, or over a modem. Tank and battle continuous shoot 'em up action. 512K min. memory. \$29.95. MicroIllusions, 800/522-2041.

Flex Expert system toolkit that combines rule-based and object-oriented approaches to expert system development. Uses IF-THEN rule format, backward and forward chaining, and how-and-why explanations. 1MB min. memory. Object code version \$495; limited source code version with run-time licenses \$2000. Logic Programming Associates in London, England, at 011 44 1 871-2016.

Food Processor II Nutrition Analysis System Analyzes nutrients in daily intakes, diet plans, menus, and recipes using American and Canadian nutrient

(continues)



Food Processor II

Now available for
 Word 4.0, Works 2.0 & Excel 1.5!

The slow way to learn software. *The faster way to learn software.*

At last, a faster way to learn Microsoft Word, Works, or Excel.®

Forget about struggling through manuals. Personal Training Systems audio training programs are a fast, effective way to learn the leading Microsoft programs.

With your own personal tutor on cassette tape, you can learn quickly, completely and at your own pace. There are modules for beginning, intermediate and advanced users. You can select the level that's right for you.

Our training systems are so effective, they're unconditionally guaranteed.

Discover the faster way to learn Microsoft software. Return the coupon below or call us at (408) 559-8635 today.

Send me more information about your training series for Microsoft Word, Works, and Excel for the Macintosh.®

Send me information on your other training series for Aldus PageMaker,® Aldus Persuasion,® Adobe Illustrator 88,® HyperCard,™ and using the Macintosh.

Name _____

Company _____

Address _____

City _____ State ____ Zip _____

Daytime Phone (_____) _____

Personal Training Systems

The Smart Way To Learn Macintosh Software

P.O. Box 54240 • San Jose, CA 95154

(408) 559-8635

© 1988 Personal Training Systems. The following are registered and unregistered trademarks of the companies listed: Personal Training Systems - Personal Training Systems, Apple, Macintosh, HyperCard - Apple Computer, Inc.; Aldus PageMaker, Aldus Persuasion, Aldus - Aldus Corporation; Microsoft, Excel - Microsoft Corporation; Adobe Illustrator 88 - Adobe Systems, Inc.

Circle 42 on reader service card

QMS introduces thousands of improvements to PostScript printing.

The new QMS
ColorScript™ 100.
The world's first color
PostScript printer.



PostScript printing is no longer simply a black-and-white issue. Thanks to the QMS ColorScript 100.

Now QMS has opened your projects to a range of new graphic possibilities using Adobe PostScript®, the industry-standard language of the desktop publishing revolution.

Now, your proposals, presentation graphics and publications can go from gray to glorious. Graphic design color schemes can change with

just a single keystroke, not a hundred marker strokes. Even commercial printing proofs and in-house color separations can be produced and color-matched. All this will help save the two things every business needs. Time and money.

QMS worked closely with Adobe Systems, software developers and users to design the

ColorScript 100. All agree it's a breakthrough. That's not surprising since QMS offers more PostScript products than anyone else.

The ColorScript 100 uses a revolutionary thermal transfer process that produces true 300x300-dpi resolution. That means you can generate thousands of brilliant colors with pinpoint registration that can match the color swatches scattered on this page.

The printer is built around an intelligent controller, running a 68020 processor, equivalent to the one in the Macintosh II. That makes it a powerful computer in its own right. A 16 MHz processing speed makes it responsive. Especially to things like deadlines. You can print an 8½"x11" page in just a single minute. An 11"x17" page in under two.

The system's large 8 megabyte memory can handle complex applications. And a 20 megabyte hard disk offers generous space for downloadable typefaces to complement its 35 resident Adobe typefaces.

Compatibility is also built in. The ColorScript 100 connects with Macintosh®, IBM®, Compaq® and other compatible PCs, along with minicomputers, workstations and mainframes.

That means you can work with Aldus FreeHand™, Micrografx Designer™, Quark XPress™, Adobe Illustrator 88™, AutoDesk AutoCAD® and most programs written under Microsoft® Windows. Plus all the new programs that are being developed to join dozens of other color-compatible applications.

The ColorScript 100 is yet another useful solution from QMS. Solutions that have made us a leader in print technology. That's one fact we don't mind giving you in black and white.

For information on the QMS ColorScript 100, including print samples, a complete list of compatible software and information on financing, call 1-800-631-2692, ext. 202.

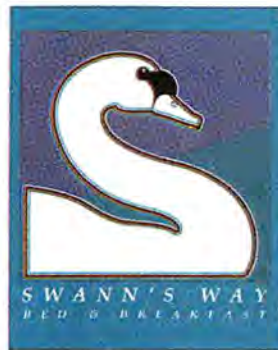

Pictured are just some of the ways designers are using the QMS ColorScript 100. The creative director at one design firm notes: "We're doing comps in minutes that used to take hours. The quality is fantastic."

A computer design system manager in the Midwest says: "Our clients are getting more options, in less time, at lower costs."



SALES FORECAST

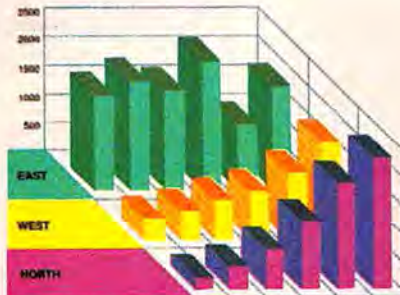

QMS®
More Useful Solutions.

Take The Long View



STEPPING OUT II

"It's *Stepping Out*. It's software. It's the answer to the prayers of Mac owners who need a large screen display, but can't accommodate the bulk or expense of a large monitor."

MacUser, March 1988 *★★★★★



berkeley system design, inc
1700 Shattuck Avenue, Berkeley, CA 94709
415-540-5535

* Reprinted from MacUser, March 1988.
Copyright 1988 Ziff Communications Co.

Circle 187 on reader service card

New Products

standards. Expandable database of 2400-3000 foods and 30 nutrients. 512K min. memory. \$250. Esha Research, 503/585-6242.

For the Record Software/book package that centralizes financial, legal, and personal records. Prompts you to record emergency information, valuable objects, business interests, and credit cards. On-screen notepads and cross-references. 512KE min. memory. \$49.95. Nolo Press, 415/549-1976.

Harmony Grid Real-time musical instrument program that teaches harmony concepts while you play. You control melody, modes, chords, and rhythm with the mouse and keyboard. Metronome keys allow gradual or metrical tempo changes. 128K min. memory. \$99. Hip Software Corporation, 617/661-2447.

J. R. R. Tolkien Adventure Games

Attempt to stop Sauron, keeper of the ring, from achieving ultimate power in *The Fellowship of the Ring*, or quest to destroy the ring in *The Shadows of Mordor*, or take the role of Bilbo Baggins and set out on a magical journey in *The Hobbit*. 512K min. memory. \$39.95. Addison-Wesley, 617/944-3700.



J.R.R. Tolkien Adventure Game

JurisDocket Civil litigation database application that automatically posts data, integrates multiple files, and distributes functions among users. Establish your own system of passwords, attorney codes, and custom form letters. 1MB min.

memory. Basic application plus runtime engine \$675; multiuser version \$1250; demo copy \$15. Seamless Software Systems Corporation, 312/939-6647.

Keymaster Automatically creates screen fonts, supports up to 16 graphic characters per font, and imports art from most drawing programs into PostScript. Has built-in font editor. Supports all filled and stroked figure styles. 1MB min. memory. \$99.95. Altsys Corporation, 214/424-4888.

MacMoney Invoicit Prints invoices and keeps client records for small businesses. Add-on module to MacMoney, personal and small-business financial-management package. 512K min. memory. \$74.95. Survivor Software, 213/410-9527.

Mail Dex Desk accessory rolodex-style database, envelope and label printer, and phone dialer. Searches entries for full or

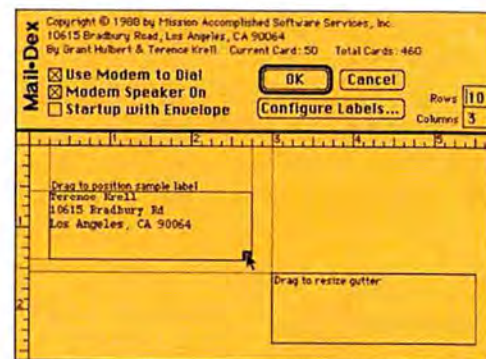

Mail Dex

partial matches to given criteria. Prints three-across mailing labels and envelopes. 512KE min. memory; requires System 5.0 or later version. \$49.95. Mission Accomplished Software Services, 213/870-2441.

MetCom Modula-2 Programming Environment

Extension of Pascal for the Mac. Integrated environment with multiwindow text editor, one-pass Modula-2 compiler, and interactive source-level debugger. 1MB min. memory. \$245. Metropolis Computer Networks, 514/866-4776.

(continues)

LASER QUALITY FOR UNDER \$1000



hp HEWLETT PACKARD DeskJet for the Mac

Affordable Macintosh Publishing

In the past, Macintosh users had to choose between printers they could afford and output that looked good. Laser quality, previously out of reach, is now available to everyone regardless of his budget. The new DeskJet 300 DPI printer from Hewlett Packard provides the solution.

With a retail price of only \$995, the DeskJet offers quality matching that of the Apple LaserWriter IISC, at a cost below that of the ImageWriter LQ. At only 14 lbs., the DeskJet easily follows you to where the work is. Additional features include easy front paper loading, affordable and convenient ink cartridges, and envelope printing. If you need top quality output for the home, school, or small business, the DeskJet delivers.

The DeskJet and the Grappler LS

Until recently, the only problem with the DeskJet was that it didn't work with the Mac. Now the Grappler LS printer interface provides a complete solution, allowing the DeskJet to print from the Macintosh at a professional 300 DPI. Now your letters, homework, proposals, and every document you produce can have that laser quality desktop publishing look.

Quick Draw Printer	Resolution	Price
Apple LaserWriter IISC	300 DPI	\$2,799
Apple ImageWriter LQ	216 DPI	\$1,399
Hewlett Packard DeskJet	300 DPI	\$995
Apple ImageWriter II	144 DPI	\$599

Grappler: Macintosh, ImageWriter, Laserwriter, and pp1e: Hewlett Packard, DeskJet, are trademarks of Orange Micro, Inc., Apple Computer, Inc., and the Hewlett Packard Company, Inc., respectively.

© Orange Micro, Inc. 1988

Grappler LS

Mac Serial Laser/DeskJet

The Grappler LS is the latest Macintosh interface solution from Orange Micro. The Grappler LS connects the HP DeskJet or any HP compatible serial laser printer to the Macintosh Plus, SE, or II and drives it at its full 300 DPI resolution. To achieve this, the Grappler uses a standard Apple printer driver and translates the output for your printer, allowing compatibility with hundreds of popular packages.

The Grappler LS comes complete with cabling, spooling software, and 3 fonts families (Times, Helvetica, and Courier look-alikes). Look for the Grappler LS and other Orange Micro products to bring the best printing solutions to you and your Macintosh.

NEW! Optional Grappler LQ/LS font package!

Make your Grappler output even more effective with three new complete font families and five special headline fonts. Families: ITC Garamond Book, ITC Zapf Chancery Medium Italic, Dutch Italic. Headlines: Blippo Black, Broadway, Cloister Black, Bitstream Cooper Black, and ITC Zapf Chancery Medium Italic.

See your Apple dealer today or contact:

Orange Micro
inc.
1400 N. Lakeview Ave., Anaheim, CA 92807
(800)223-8029 in CA (714)779-2772

Circle 575 on reader service card

Invoicit

Yes, there is a new storm brewing—and you asked for it! It's Invoicit, the new MacMoney invoicing module. And it's from the folks at Survivor Software.



MacMoney

The home and small business financial management program.



Survivor Software Ltd.

We'll send you a bibliography of our reviews and more information about MacMoney. Just call or write. Address written requests to 'Reviews', Survivor Software Ltd., Suite 450, 11222 LaCienega Blvd., Inglewood, CA 90304. Phone (213) 410-9527. List price \$119.95 (MacMoney), \$79.95 (Invoicit). Hardware: Macintosh 512KE, XL, Plus, SE & II.

Circle 112 on reader service card

New Products

Net/One TCP-Mac Standards-based communications package that lets Macs communicate over TCP/IP-based networks. Runs on EtherTalk and LocalTalk networks. 1MB min. memory. \$250 per license. Ungermann-Bass, 408/496-0111.

Nextra Knowledge-acquisition tool for Nexpert Object. Uses illustrations while interviewing an expert on a given subject, and compiles that information into a knowledge base for Nexpert Object. 1MB min. memory. \$4000. Neuron Data, 415/321-4488. West Coast, East Coast, and Gulf Coast. Displays one day or seven consecutive days in standard or daylight saving time, in 12- or 24-hour clocks. 512K min. memory. \$19.95. Zihua, 408/372-0155.

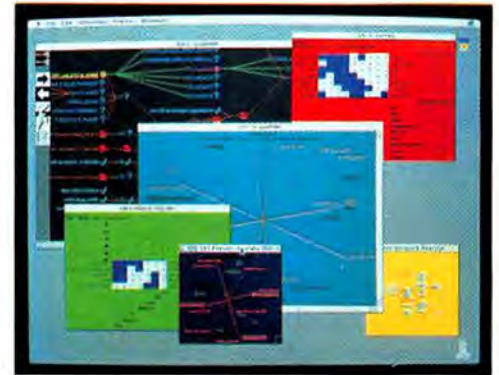

Nextra

Nutrition Stack Keeps a daily log of your meals and calculates daily totals of protein, carbohydrate, fat, fiber, cholesterol, sodium, eight vitamins, and six minerals. 1MB min. memory. \$49.95. Big Byte Software, 617/444-3028.

Order House Business-management software tracks people and services, and inventory items linked with related notes and comments. Includes General Ledger. 1MB min. memory; 2MB recommended. \$995. Elefant Software, 415/843-7725.

Pairs Kerning data for the Mac. Ranges from 250 to 800 kerning pairs per table. Has a volume for each Adobe typeface; works with QuarkXpress, FreeHand, and PageMaker. 1MB min. memory. Prices range from \$25 to \$130 per volume; quantity discount available. Pairs Software, 416/421-9900.

(continues)

Tektronix showmanship for the Mac™ II user.

Now you can create prints and overhead transparencies that rival 35mm slides in brilliance, color, and sharpness. Easily, with a choosers-selectable, Quick-Draw™-based driver. And quickly, at the rate of one page per minute. All with the Tektronix 4693DX Color Image Printer for the Mac II.

For publishing or presenting,

in business, engineering, science, or even graphic arts—the 300 dot-per-inch, 16.7 million-color 4693DX delivers the performance you need. And it's compatible with an impressive range of applications, such as Microsoft® PowerPoint™, Cricket Presents, Aldus PageMaker® and Freehand®, SuperMac® PixelPaint, and others.

For more on what Tek 4693DX showmanship can do for you, or the location of a Tektronix dealer near you, call 1-800-225-5434. In Oregon, call 1-235-7202.



Copyright © 1989 Tektronix, Inc. All rights reserved. ART-112-1
The following are registered trademarks: Freehand and PageMaker of Aldus Corp., Microsoft of Microsoft Corp., and SuperMac of SuperMac Corp. The following are trademarks: Mac and QuickDraw of Apple Corp. and PowerPoint of Microsoft Corp. Screen image courtesy of Visual Information, Inc.

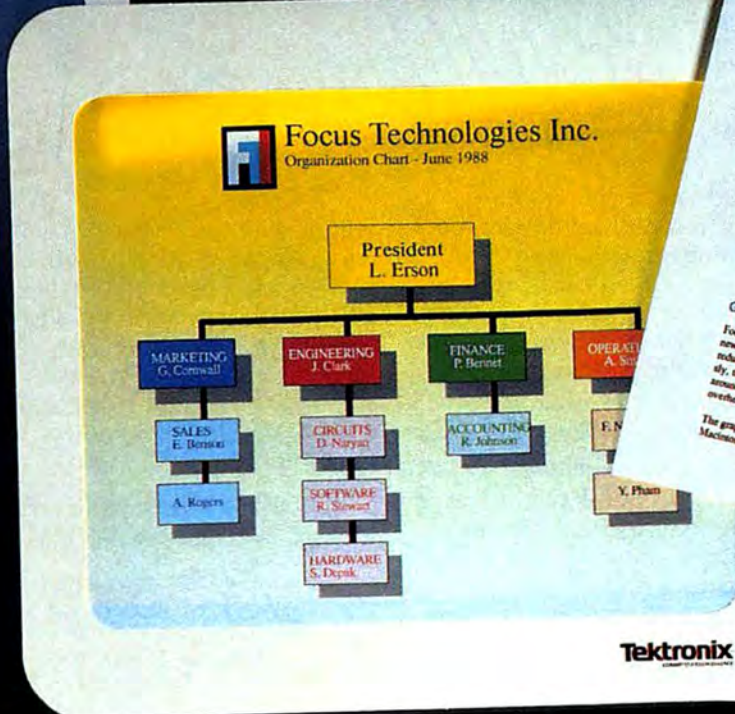
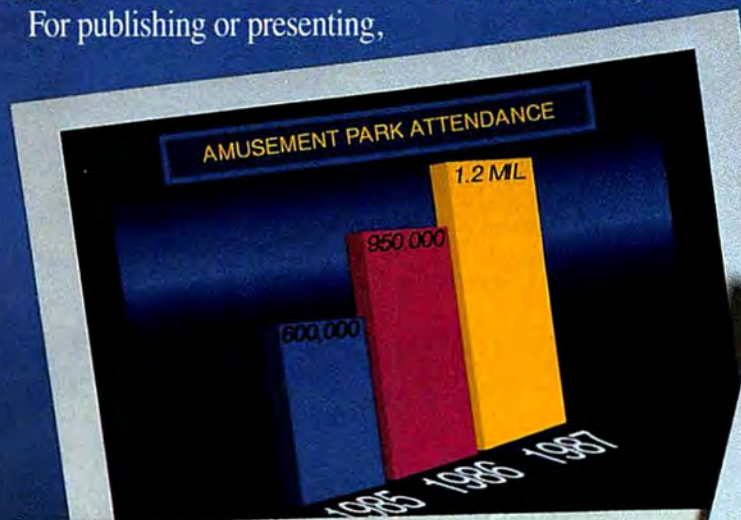

Tektronix

Tektronix
COMMITTED TO EXCELLENCE

FOCAL POINTS NEWS
Focus Technologies Employee Newsletter

1988 BUDGETS RELEASED
Recognizing the need for new product development, the 1988 budget reflects a large increase in engineering expenditures. Marketing Resources are also up from last year. In anticipation of the acquisition of a Tektronix color image printer, Marketing will use the new printer to produce more effective customer presentations and internal communications documents such as this one.

1988 BUDGET ALLOCATIONS
Focus Technologies employees will welcome the new graphics department which was formed to reduce expenditures on outside services. Art Expenditures on most presentations 24 hour overhead transparencies.

NEW LENS MATERIAL TECHNOLOGY LAUNCHED
The advanced research lab introduced LENZE, a new metallic compound which transmits light more efficiently than most glass and plastic based materials. LENZE is based on technology derived from superconductor research. It has been measured at over 99.99999% transmission efficiency.

UNUSUAL MOLECULAR STRUCTURE OF LENZE
The LENZE material is still in the experimental stages, requiring relatively low (sub-freezing) temperatures to remain stable. If this temperature can be raised to about 100 degrees Fahrenheit, LENZE has the potential to become our hottest product!

BE SURE TO RENEW YOUR SUBSCRIPTION!

New Products

Panorama Database structured like a spreadsheet. Sorts, analyzes, categorizes, calculates, and charts records. Opens up to 25 windows at a time. 1MB min. memory. \$395. ProVue Development Corporation, 714/892-8199.

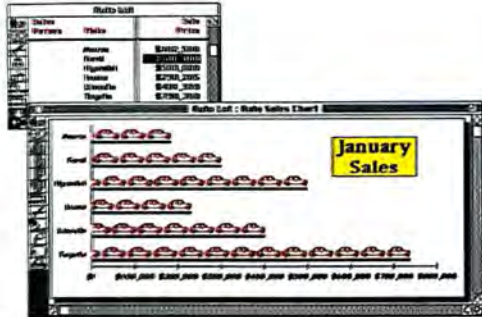

Panorama

Pirates Role-playing game in which you can choose from 6 different time periods; 9 types of ships; and over 50 different islands and nations to visit, trade with, or capture. Graphic depictions of pirates and accurate representations of pirate ships of the day. 512KE min. memory. \$54.95. MicroProse Software, 301/771-1151, ext. 228.

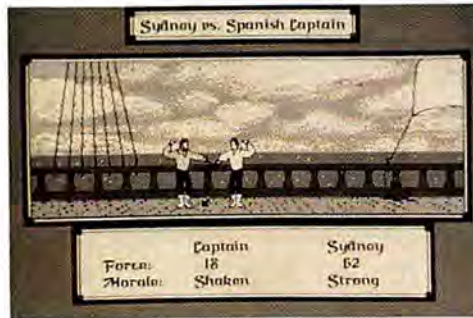

Pirates

P51 Mustang Flight Simulator Fly into enemy-held Northern Europe to tangle with Me109s; seek and destroy ground targets. Replay any maneuver in forward or reverse. Enemy pilot bails out of the plane when hit; parachute opens in air. Digitized sound. 1MB min. memory. \$59.95. Bullseye Software, 702/265-2298.

PrintSpec Printing specifications program for simple and complex jobs. Translates specifications into complete phrases and sentences. Print jobs can be defined in sets of pages, or sets of components, which allow you to work in units appropriate to the specification category within the job. 1MB min. memory. \$595. Straight Edge Software, 215/732-1250.

Real Estate Partners Small-scale real estate and personal investment analysis program. Answers questions about property, cash-flow projections, and investment potential. 512K min. memory; requires external disk drive and printer. \$295. Meta Venture Technology, 818/796-5479.

Sonar Professional Text-retrieval program with automatic hypertext linking. Searches free-form text in multiple files without requiring the user to set up a database. 1MB min. memory; 2.5MB with MultiFinder. \$795. Virginia Systems Software Services, 804/739-3200.

Stack Cleaner HyperCard utility kit. Menu Maker feature modifies or adds menu bar or pop-up menus to HyperCard stacks; Script Cleaner lets you make code changes to selected stacks; other utilities eliminate manual operations for splitting, merging, and cloning stacks. 1MB min. memory. \$49.95. Softworks, 800/874-8662 or 800/535-0900.

(continues)

Make a Key Move

...and create documents with impact using

KeyMaster.

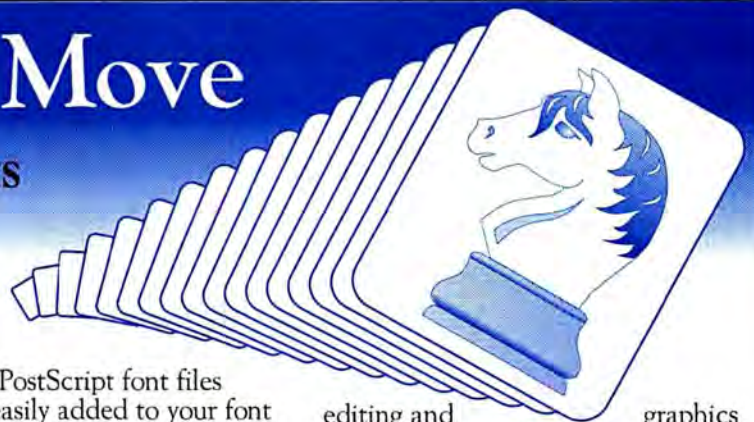

Up till now, adding graphics to a document has required quite a bit of juggling with the clipboard and/or scrapbook. With **KeyMaster**™ you only have to cut and paste or import your artwork *one last time*. KeyMaster, from Altsys Corporation, creates high resolution PostScript® fonts from your artwork.

KeyMaster imports images in EPS format from Aldus® FreeHand™ and Adobe™ Illustrator™, and in PICT format from MacDraw®II, SuperPaint and other popular object oriented Macintosh® drawing programs. Each KeyMaster font supports up to 16 graphic characters.

Once an image has been imported, KeyMaster automatically creates

screen and PostScript font files which are easily added to your font menu. An integrated bitmap font editor allows you to touch up the screen fonts for optimum appearance. Your new KeyMaster font works just like any other font. Drawing and redrawing your artwork is now as easy as selecting a character.

In about five minutes, you can organize a library of drawings into a font ready for use in any Macintosh application. Company logos, symbols, signatures, and graphics can be used in line with regular text. With KeyMaster, access to your art is as close as a keystroke!

KeyMaster is brought to you by Altsys Corporation, the leader in font

editing and graphics design software. Altsys offers a sophisticated selection of fonts and font editing programs that allow you to easily design custom fonts and logos. You know our products: **Fontographer**®, **Fontastic Plus**™, **Faces**™, **Aldus FreeHand**, and now-**KeyMaster**.

Now it's your turn to create an impact - with **KeyMaster**!

ALTSYS
CORPORATION
720 Avenue F, Suite 109
Plano, Texas 75074
(214) 424-4888

KeyMaster suggested retail price \$99.95

Leader of the Mac!



The Experts Agree:

FoxBASE + /Mac's New Version 1.10 is the Ultimate Relational Database Management System for the Macintosh!

Don Crabb, *InfoWorld*, July 11, 1988:

"FoxBASE + /Mac proved to be as easy to use as any Mac relational database we've tested."

Macworld, September, 1988:

"FoxBASE + /Mac deserves serious consideration as both a stand-alone database product and a connectivity solution."

Richard Skrinde, *MacUser*, September, 1988:

"FoxBASE + /Mac is a racehorse that will outrun the other Macintosh databases."

Arthur Fuller, *Computing Canada*, June 9, 1988:

"So phenomenally great that it justifies the purchase of a Macintosh just to run it!"

Michael Masterson, *MacWEEK*, June 7, 1988:

"FoxBASE + /Mac proves beyond a doubt that the Mac is a suitable platform for supporting fast database operations."

BYTE, September, 1988:

"FoxBASE + /Mac combines dBASE compatibility with a strong list of features and a work environment with which Mac users will feel comfortable."

Charles Seiter, *Macworld*, October, 1988:

"It's the fastest general purpose Mac database, often ten to a hundred times faster than its competitors."

FoxBASE + /Mac Version 1.10 includes everything you love about the original FoxBASE + /Mac PLUS a new form generator, an outstanding application generator and a complete template language system — all designed to save you time and effort! Now you can develop complete database applications in just minutes!

And now Fox Software introduces FoxBASE + /Mac Multi-User, leading the industry with the ultimate in data sharing — *concurrent data access!* For the first time, networked Macs and PCs can simultaneously share the same data files!* In addition, FoxBASE + /Mac Multi-User supports an unlimited number of users on your network.

Even with all these enhancements, Version 1.10 doesn't cost any more — it's still only \$395! And our new Multi-User is just \$595!

FoxBASE + /Mac earned an exceptional 7.0 rating on *InfoWorld's* Software Review, and a 4.5 rating on *MacUser's* scale. It's the one Mac database system that has it all!

Join the experts NOW! Contact your local quality software dealer, or order your copy of FoxBASE + /Mac by calling (419) 874-0162, Ext. 650. Free demo package available.

Why be a follower when you can go with the *leader!*

Fox Software

Nothing Runs Like a Fox.

Fox Software (419) 874-0162, Ext. 650
118 W. South Boundary FAX: (419) 874-8678
Perrysburg, OH 43551 TELEX: 6503040827 FOX

Circle 152 on reader service card

* Requires a copy of FoxBASE + /LAN, our PC multi-user software, on the network file server. FoxBASE + /Mac and FoxBASE + /Mac Multi-User are trademarks of Fox Software. dBASE is a trademark of Ashton-Tate. Macintosh is a trademark of Apple Computer, Inc.

The Power to C



In the world of desktop publishing, no personal computer can match the power of a Macintosh®.

It's the only choice. But when it comes to a page printer, you need to choose the one with performance to match. Now you can choose the power of the Qume CrystalPrint Publisher™.

With its ultra-high speed, compact size and PostScript®-compatible page description language, the CrystalPrint Publisher gives you choices no other page printer can.

Choose Productivity

CrystalPrint Publisher maximizes your productivity. Put more simply, it's fast. Faster than any printer with Adobe® PostScript®. Faster than Apple® LaserWriter® II^{NTX}. Even faster than LaserWriter II^{NTX} with a hard disk. The Publisher still wins. And at a price less than LaserWriter II^{NT}. So illustrations and type

that used to take minutes to print are now in your hands in seconds. You spend more time creating and less time waiting to see what you've created. That makes you more productive than ever.

Choose Print Quality

You need top print quality to fully express your creativity. CrystalPrint Publisher delivers. The Publisher's PostScript®-compatible page description

language lets you print detailed drawings with fine lines, solid blacks and smoothly graduated grays.

Mix in text using the wide range of resident authentic typefaces from ITC and Bitstream®.

The result — elegant images with print quality not even the LaserWriter II can match.

Choose Convenience

The Publisher's footprint is more than 43% smaller than the LaserWriter II. That's the smallest of any competitive

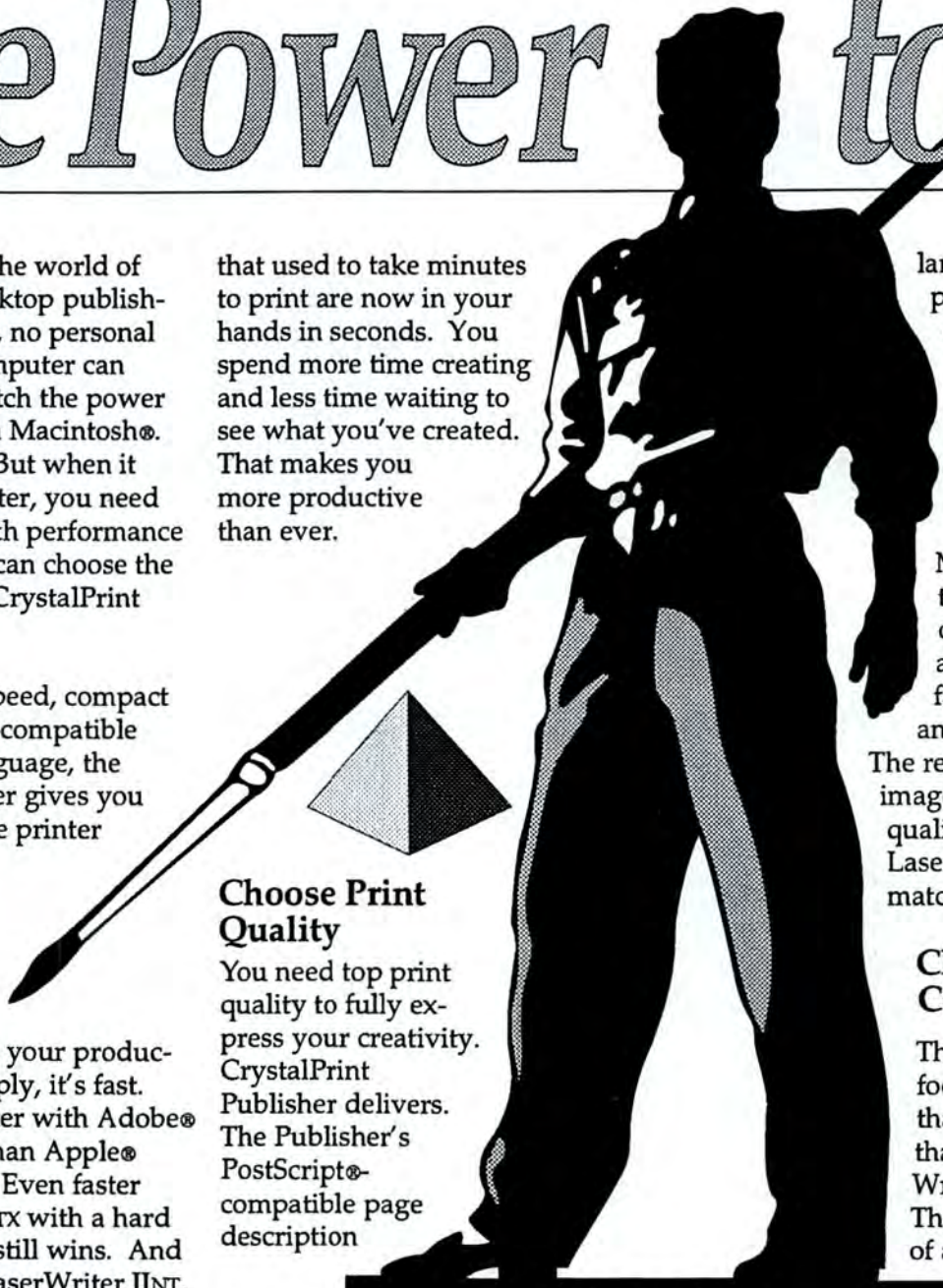

SCHWAB

© Qume Corporation 1988

Choose™

page printer. Which means the Publisher stays close and convenient — where you need it— even in the most space conscious environments.

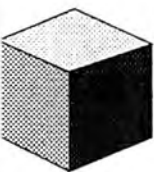

Compare, Then Choose

Let your Qume dealer show you the power of the CrystalPrint

Publisher. Ask them to print this page on the Publisher and then on an Apple LaserWriter II. After that, the choice is yours. Choose the winner and you'll choose CrystalPrint Publisher. With its speed, print quality and convenience, no other page printer can match the power of your Macintosh. CrystalPrint Publisher is the power to choose. For information or a demonstration, contact your nearest Qume dealer or distributor. Or contact Qume at (800) 223-2479.

Qume®

The Company with Peripheral Vision.

CrystalPrint Publisher™

Graphic Proof of Quality and Speed

You know graphic quality when you see it. That's why we used an original printout taken directly from the CrystalPrint Publisher to produce the artwork for the adjacent page. So you can see the fine lines, the well-formed characters and uniform blacks for yourself.

You also know the importance of speed. The LaserWriter IINT takes 172 seconds longer to print the same page. Even the expensive, top-of-the-line LaserWriter IINTX takes longer.



CrystalPrint Publisher



LaserWriter IINTX



LaserWriter IINT

Now, the choice is yours. Choose CrystalPrint Publisher and choose print quality and speed. Then spend more time creating and less time waiting to see what you've created.

CrystalPrint Publisher . . .
The Power to Choose.

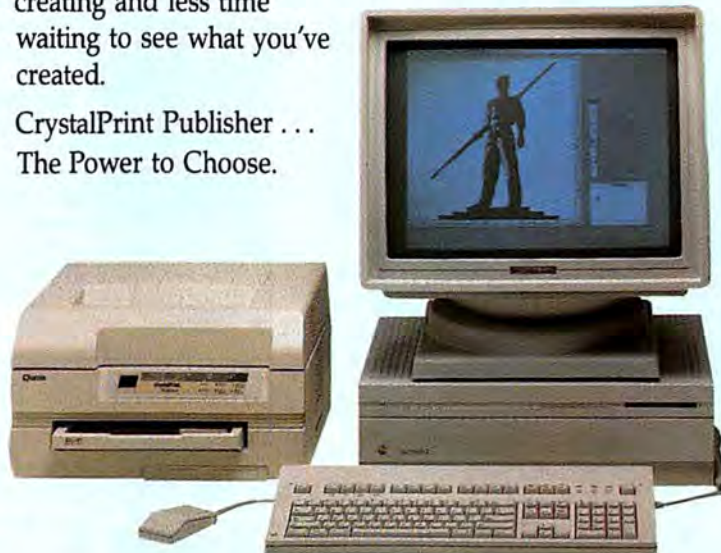

New Products



Tetris for the Mac II

Tetris for the Mac II Color version for the Mac II. The object of this game, designed by two Soviet programmers, is to arrange falling patterns of squares into solid rows. Features 11 original compositions based on Russian folk songs; advanced player and tournament modes. 1MB min. memory. \$39.95. Spectrum HoloByte, 415/552-3584.

Tide Guide 89 Ocean tide predictor that annotates high and low tides on a graph for 200 North American locations on the West Coast, East Coast, and Gulf Coast. Displays one day or seven consecutive days in standard or daylight saving time, in 12- or 24-hour clocks. 512K min. memory. \$19.95. Zihua, 408/372-0155.

To Artemis Leads you dialogue-style through a series of questions designed to probe root psychological blocks that prevent you from achieving and maintaining your goals. 1MB min. memory. \$139. Nicolea, 714/536-2038.

Volume One: Art Nouveau Images

PostScript art based on copyright-free Art Nouveau designs from the end of the nineteenth century and the beginning of the twentieth century. File sizes range from 65K to 225K. Usable by EPS-compatible Mac programs. 1MB min. memory. \$79.95. Silicon Designs, 415/254-1460.



Volume One: Art Nouveau Images

ACCESSORIES

Articulating Keyboard Drawers

Keyboard drawers that raise, lower, and tilt a computer keyboard to suit the user. Release buttons move drawers. Under-

desk articulating model mounts with brackets under desktop or shelf; articulating model rolls out from steel enclosure that supports CPU and monitor. Underdesk Articulating model \$149.95; Articulating model \$159.95. MicroComputer Accessories, 213/301-9400.

(continues)



Articulating Keyboard Drawers

Multimedia, we give you the tools, you give your imagination

Captured at 24 bits with ColorFreeze-24™, color separated with Modern Artist™ 2.0



Call toll free 1-800-547-3303 for complete information on our products and multimedia, animation packages or consult your nearest Apple Dealer

Everybody talks about multimedia, Computer Friends was the first to do something about it. We are still the first to give you a complete, professional and integrated solution for your TV, print, animation and paint production requirements, at a price you can afford.

TV Producer™, Animation



Gen-Lock Overlay Card. Basic tool for multimedia presentations. Send your presentations to video or tape them on VCR. Overlay graphics on live video. Available with animation software.

ColorFreeze-24™, Electronic Color Photography.



Capture high quality color or black and white shots from camera or VCR, modify and

save in your favorite paint program or desk-top publishing program (QuarkXpress™, PageMaker™ etc.).

Modern Artist™ 2.0



Most complete and versatile color paint program. Spectacular special effects. Includes 4 color separation for professional color printing.

PanChroma™ Printer



Finally 300 dpi color printing in a compact, reliable and affordable thermal color printer. Produce beautiful color illustrations or instant color transparencies for your presentations.

Computer Friends, Inc. 14250 NW Science Park Dr. - Portland OR 97229 - tel. (503)626-2291 - fax (503)643-5379

FREE

Seventeen of the best Shareware programs available today including Raymond Lau's sensational StuffIt file compression utility. There's even a powerful word processor that you can install as a desk accessory.

And here's the best part. The Power User's Tool Kit is free with any purchase from MacWarehouse. (You pay only \$1.50 shipping and handling if you want the disk.) The programs are Shareware, so you can try the software free of charge. If you wish to continue, some authors ask that you send them a small fee (\$5 - \$25). All of the details are explained on the disk, which is your's to keep anyway.

from MacWarehouse.....

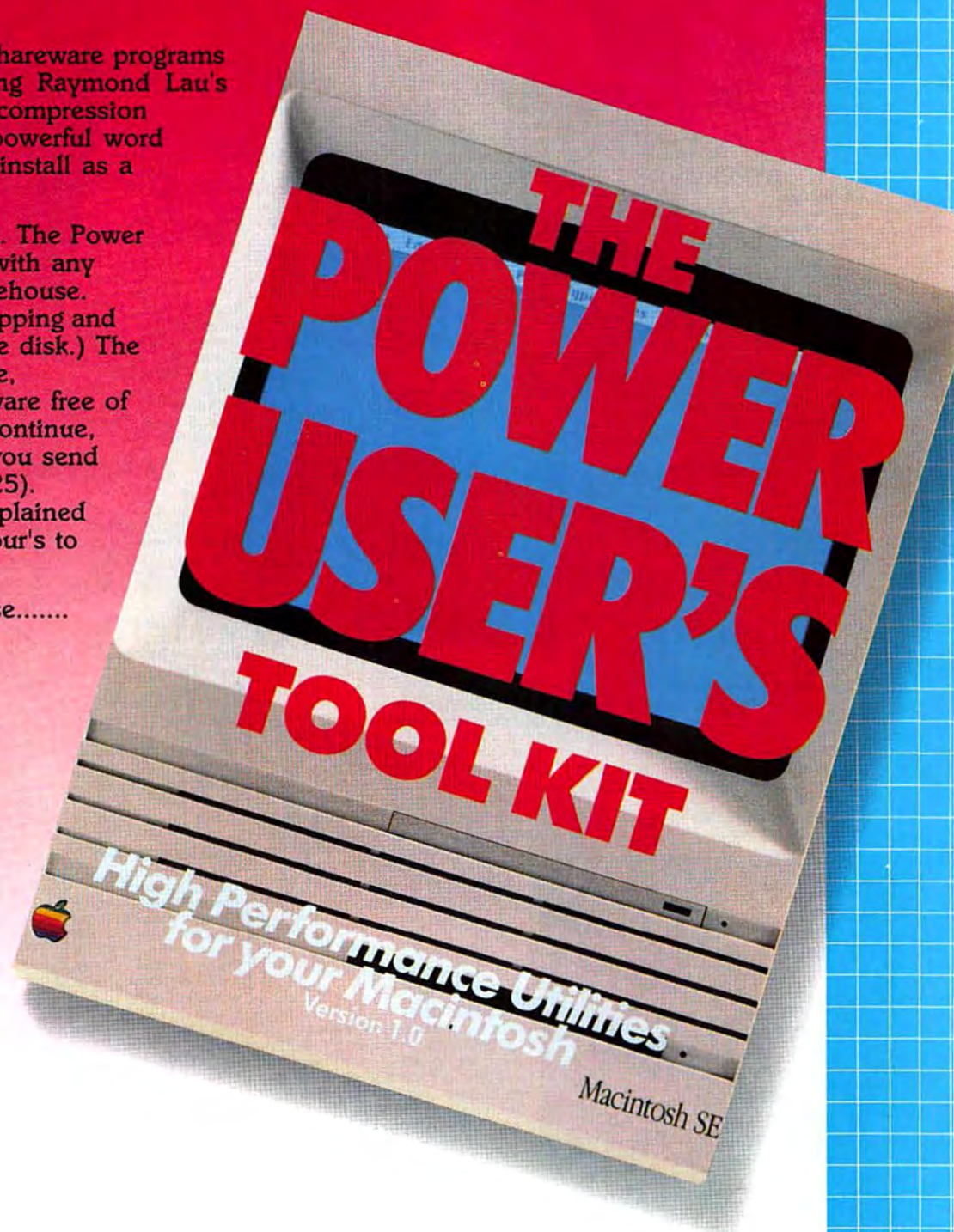

OVERNIGHT DELIVERY

ONLY \$3.00
(see details below)

Wet Paint /Picture Base Bundle (Symmetry)

Wet Paint is a gold mine of images for letters, reports, advertising and business forms. Includes maps, holiday and restaurant graphics. PictureBase is a database manager for graphic files. Buy both and save a bundle! (graphics) \$99.

HYPERWARE

- Activision**
- Business Class & Focal Point 48.
- Focal Point II 89.
- Reports for HyperCard 59.
- Bantam**
- Complete HyperCard Handbook 23.
- Beacon Technologies**
- HyperBible International Version ... 195.
- HyperBible King James Version 159.
- BrainPower**
- ArchiText 182.
- Bright Star Technology**
- HyperAnimator 79.
- HyperPress Publishing**
- Script Expert 49.
- Icon Factory 29.
- MacroMind**
- VideoWorks II HyperCard Driver 60.
- MicroMaps**
- HyperAtlas 64.
- Power Up**
- HyperTutor 29.
- Softworks, Inc.**
- HyperTools #1 or #2 ea 59.
- Stack Cleaner 39.
- Symmetry**
- HyperDA 38.

UTILITIES

- Affinity**
- Tempo II 89.
- Berkeley System Design, Inc.**
- Stepping Out II 52.
- Beyond, Inc.**
- MenuFonts 2 30.
- CE Software**
- DiskTop 3.0.2 27.
- QuickKeys (macro programmer) 53.
- Central Point**
- Copy II Mac (with MacTools) 20.
- PC Tools Deluxe For Mac 40.

Emerald City Software

- Lasertalk 1.0 187.
- Fifth Generation**
- PowerStation 32.
- Suitcase II 45.
- ICOM Simulations**
- On Cue 36.
- Kent Marsh**
- MacSafe or NightWatch ea 89.
- LaCie**
- SilverServer 92.
- Mainstay**
- Capture 42.
- TypeNow 30.
- Microlytics**
- GOfar 44.
- Olduvai**
- ClipShare 109.
- FontShare 149.
- Icon-It! 39.
- MultiClip 36.
- PCPC**
- HFS Backup 3.0 54.
- Simon and Schuster**
- Fully Powered Mac 24.
- Software Power Company**
- PowerOP 1.4 39.
- SuperMac**
- DiskFit or SuperSpool 5.0 ea 54.
- Sentinal 2.0 155.
- SuperLaserSpool 2.0 82.
- Symantec Corporation**
- Symantec Utilities for Macintosh 59.

DESK ACCESSORIES

- Affinity**
- AffiniFile 46.
- Allan Bonadio Associates**
- Expressionist 2.0 (equation edtr) 79.



MultiScreen Video Card (Mobius Technologies)

Increase your screen size almost three times with the NEW MultiScreen Video Card that lets you connect inexpensive 14" monitors to your Macintosh SE. You can choose from three different screen resolutions, including 72 dpi. Displays up to a full page lengthwise and works with your built-in Mac screen for additional workspace. Plugs into SE expansion slot. Its flicker-free screen is ideal for desktop publishing! (disk drives) \$349.

AVAILABLE NOW!

MacSnap 1 Meg surface mount CMOS SIMMS for the Macintosh Plus, SE and Mac II (DOVE) Expand your Plus or SE to 2560K using **MacSnap 2S**. Preserves future expandability. \$750 For Maximum memory in the Plus and SE, or a 4 Meg expansion for the Mac II, the MacSnap 4S utilizes state of the art low profile 1 Meg surface mount CMOS SIMMS. \$1488. The MacSnap 8S expands the Mac II to 8 Megs for the Ultimate in power and memory. \$2975. 256K surface mount MacSnap products are available for the SE and Plus \$439. Included with each MacSnap product is the high-performance Ram Snap software utility. (memory upgrades)

DiskFit 1.5 (SuperMac)

DiskFit makes it easy to backup or restore files on your hard disk drive. DiskFit saves you time because it backs up only the files you have changed since the last backup. DiskFit can verify each floppy after copying files onto it, so you know your files are safe. It discards old version of files, so your backup set doesn't keep growing! Version 1.5 supports for a variety of cartridge tape drives, including the Apple tape backup system. It's the Fastest backup available. (utilities) \$54.

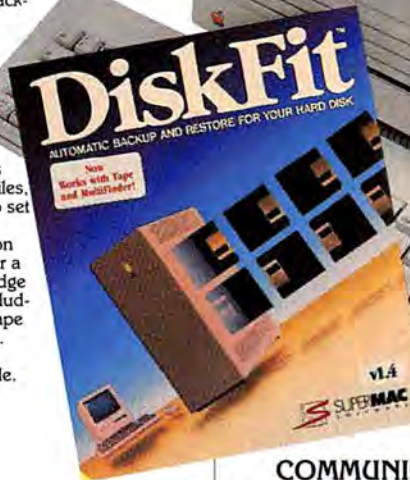

- Borland**
- Sidekick 2.0 65.
- Casady & Greene**
- QuickDEX 32.
- Exodus Software**
- Retriever 59.
- Solutions**
- SmartScrap & The Clipper 35.
- TENpointO**
- Open IT! 49.

LANGUAGES

- Borland**
- Turbo Pascal 65.
- Turbo Database Mac 65.
- Manx Software Systems**
- Aztec C or Unitools ea 65.
- Aztec C+SDB 99.
- Aztec C+MPW 99.
- Microsoft**
- Basic Interpreter 3.0 62.
- QuickBasic 65.
- SmethersBarnes**
- Prototyper 72.
- Symantec**
- CAPP's Lightspeed C or Pascal 49.
- Just Enough Pascal 1.0 44.
- Lightspeed C 3.0 95.
- Lightspeed Pascal 65.
- Zedcor**
- ZBasic 5.0 105.

COMMUNICATIONS

- CE Software**
- QuickMail 165.
- CompuServe**
- CompuServe Navigator 45.
- DataVIZ**
- MacLink Plus w/Cable 145.
- FreeSoft**
- Red Ryder 10.3 54.
- Hayes**
- Smartcom II 88.
- InSignia Solutions**
- Soft PC (Mac II) 479.
- Software Ventures**
- Microphone II 225.
- SuperMac**
- Acknowledge 349.
- Traveling Software**
- Lap-Link 84.

DATABASE SOFTWARE

- Acius**
- 4th Dimension 489.
- Ashton-Tate**
- dBase Mac 295.
- Borland**
- Reflex Plus 165.
- Claris**
- FileMaker II 239.
- Fox Software**
- FoxBASE+Mac 208.

Canvas 2.0 (Deneba)

This revolutionary upgrade sets the standard for drawing programs by blending powerful drawing capabilities with convenient easy-to-use paint features. Features include autotrace, multi-point Bezier curves, unlimited layers, 16.7 million colors for 24-bit Mac II support, hairlines to 1/1,000th of an inch, improved precision to 64,000 dpi, PostScript gray scales in one-degree increments, TIFF and bit-map editing, and zoom capacity ranging from 3% to 3,000%. (graphics) \$169.

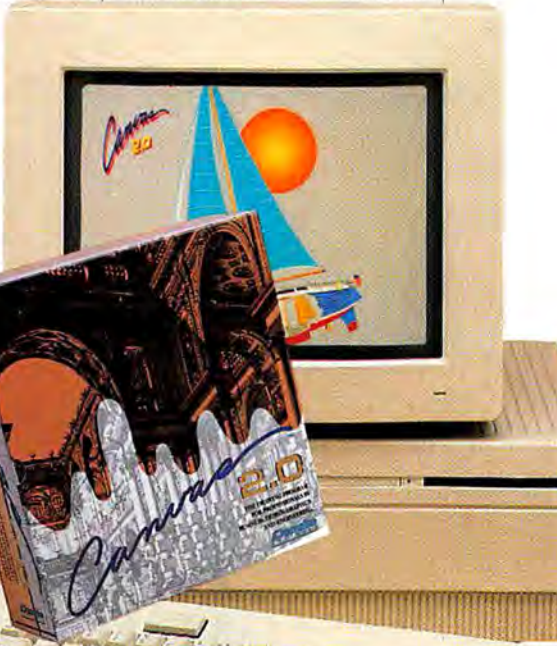

FREE OFFER

The MacWarehouse technical staff and the publishers of the popular Power User's Manual have put together a great new disk of utilities, desk accessories and applications. **THE POWER USER'S TOOL KIT**. Seventeen great programs including Raymond Lau's Stuffit. There's even a powerful word processor you can install as a desk accessory.



And here's the best part. The Power User's Tool Kit is free with any purchase from MacWarehouse. You pay only \$1.50 for shipping and handling (if you want the disk). The programs are shareware, so you can try the software free of charge. If you wish to continue, some authors ask that you send them a small fee (\$5 - \$25). Some of the programs are absolutely free. All of the details are explained on the disk, which is yours to keep anyway.

FREE CATALOG

But that's not all. You'll also receive the brand new MacWarehouse catalog. We've added hundreds of new products and updated all the information from our previous catalogs to bring you the latest answers to your questions about compatibility, copy protection, and features. The catalog will be included with your order, or you can mail us the coupon below for your free copy. Take a look at the MacWarehouse specials and call us with your order to receive your free catalog and **THE POWER USER'S TOOL KIT**.

NEW 800K Drive (Cutting Edge)

The Cutting Edge 800K disk drive's attractive styling, quiet performance, and high-tech reliability make it our most popular floppy drive. The drive uses ASIC technology to reduce the number of parts, increasing reliability and reduce weight. Features an LED light to indicate disk access and a hinged door over the disk insertion slot to keep the mechanism clean. Uses standard Apple formatting routines and supports the Macintosh's standard software eject features. Features manual eject mechanism also. One year warranty. (disk drives) \$175.

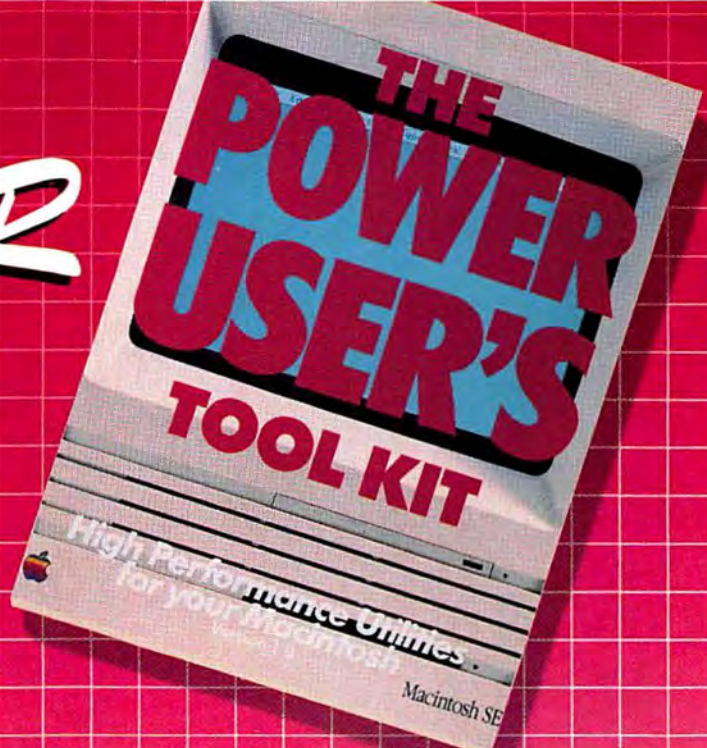

SuperPaint 2.0 (Silicon Beach Software)

Get the freedom of Paint and the precision of Draw in a single program! More than 25 new features including Airbrush, calligraphy brushes and customizable arrows. Mix fonts, styles and sizes. Rotate text and objects. Great for giving clip-art a professional look. (graphics) CALL.



IS/ADB TABLET (Kurta)

A TOTAL INPUT SYSTEM from CAD to Desktop Publishing. Kurta's built in software features a menu strip for access to 11 to 23 programmable function keys. Using a tablet makes it possible to get "absolute positioning" making CAD drawings, desktop publishing and other applications much simpler. Move the screen cursors, draw sketch and trace more precisely than with a mouse. (input/output) \$255. Also available 4 Button Cordless Cursor \$95.



CHOOSE MacWAREHOUSE...

For price, quality and service you won't find a better source for your Mac needs. If you don't see it here, give us a call. Most likely we'll have it in stock. Our sales representatives are here to help!

I'm Kerry, call me at:

MacWAREHOUSE™
1-800-255-6227

(1-800-ALL MACS)

Inquiries: 201-367-0440

Canada: 800-255-6447

FAX # 201-905-9279

MONDAY THRU FRIDAY

8A.M. TO 11 P.M.

(Eastern Time)

SATURDAY 8 A.M. TO

8 P.M. (Eastern Time)

NOW OPEN SUNDAYS!

8 A.M. to 8 P.M.

(Eastern Time)

MacWAREHOUSE CATALOG

1690 Oak Street
P.O. Box 1579
Lakewood, NJ 08701

I don't need to order right now, but please RUSH me my FREE copy of the brand new MacWarehouse Catalog.

NAME _____

ADDRESS _____

APT# _____

CITY _____

STATE _____

ZIP _____

FCC9



FROM MacWAREHOUSE™



Ovaltune
Creates audio-visual performance with a variety of Kaleidoscope graphics. Synchronizes any graphics program with music. Can be played through your MacSpeaker or MIDI synthesizer. (music) \$95.



ThunderScan
Converts your ImageWriter into a scanner with special effects such as rotation, linescreens, captions, and frames of various sizes. It is packaged complete for the Mac 512K, 512KE, Plus and SE (input/output) \$199.



SuperLaserSpool 2.0
SuperLaserSpool lets you use your Mac while printing documents — no more waiting! LaserQueue accessory lets you control when and where your document is printed - even allows you to preview your spooled documents. (utilities) \$82.



MacMoney 3.02
This versatile, powerful and intuitive accounting package from Survivor Software is a full double-entry personal bookkeeping system and financial planning tool. Integrates with MacInTax. (finance) \$62.

Aldus	
PageMaker 3.0	399.
Broderbund	
DTP Advisor	47.
Letraset	
Image Studio or Ready,Set,Go!	279.
Olduvai	
Read-It! 2.0 (OCR)	199.
Quark	
Xpress or QuarkStyle	Call.
Solutions	
SuperGlue 1.05	52.
Springboard	
Springboard Publisher	109.
Target	
Scoop	SPECIAL 189.

NETWORKING PRODUCTS

Connect Inc.	
MacNet	43.
Farallon	
Timbuktu 2.0.1	Call.
Nuvotech	
TurboNET	30.
SuperMac	
Network DiskFit	199.
TOPS	
TOPS 2.0	119.

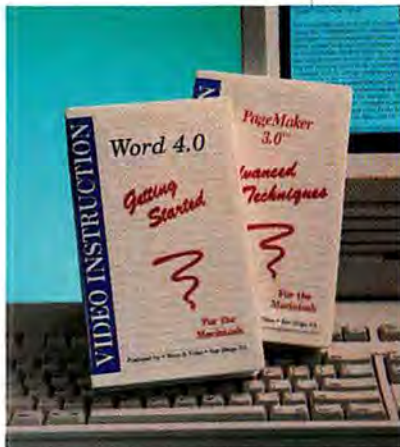

VIDEOS

Adobe	
Fonts	Call.
Altsys	
Fontastic Plus 2.0	54.
Letraset	
LetraStudio	369.
LetraFonts (various)	ea 59.
Olduvai	
ArtFonts	59.

CAD/CAM

Graphsoft	
MiniCad Plus	525.
Innovative Data	
MacDraft 1.2a	155.
Dreams	315.
Micro CAD/CAM	
MGMStation (professional CAD) ...	Call.

FINANCIAL AND ACCOUNTING SOFTWARE

Aatrix	
Payroll 3.5	99.
Payroll PLUS	159.
Bedford	
Simply Accounting	219.
Intuit	
Quicken	33.
MECA	
Managing Your Money	128.
Monogram	
Business Sense	279.
Dollars & Sense	81.
Softview	
MacInTax Federal '88	69.
TaxView Planner	64.

Extended Keyboard Carry Case (Targus)

Pamper your Mac with a Targus carrying case made of Zilicone treated nylon to give you water-proof durability and an impact absorbing high-density foam layer with a soft protective lining for complete protection. Cushioned shoulder pad and handles provide extra comfort and convenience. Plus there's room for everything from your Mac, a hard disk drive and the Extended Keyboard to pockets for your mouse, floppies, cables and pens. (accessories) \$69.



Video Instruction (Voice & Video)

Breeze through Mac software like Pagemaker 3.0, Word 4.0 and Hypercard with the ease of an old pro. You'll have your very own one-to-one trainer on videotape. Each program is simple and easy to use, averaging 90 minutes in length with graphic examples. Titles include "Getting Started" for Word 4.0, Pagemaker 3.0 and Hypercard. "Advanced Techniques" cover new software features for Word 4.0 and Pagemaker 3.0. All the programs are professionally tested and produced. It's an entertaining, easy way to get the most from your programs! (education) \$35. each tape

Survivor	
MacMoney 3.02	62.

STATISTICAL ANALYSIS

Abacus Concepts	
StatView II (req. Mac II, or Plus/SE w/68881 co-processor)	349.
StatView SE+Graphics	229.
BrainPower	
StatView 512+ (requires 512k)	175.
D2 Software	
MacSpin 2.0	189.
Odesta	
Data Desk Professional	289.
Paracomp	
Milo	169.
Select Micro Systems, Inc.	
Exstatix	219.

MacVision 2.0 (Koala)

Turn your video camera into a scanner! MacVision accepts any standard NTSC signal including camcorder, VCRs, videodiscs and DC players. It digitizes an image 640 pixels wide by 480 lines high, with 256 shades of gray. It stores images in TIFF, RIFF, MacPaint, and EPS file formats, so you can export them to Image Studio, Pagemaker, and even to Hypercard! MacVision digitizes 3D objects from any video source! (input/output) \$225.



Software for Recognition Tech

MacEqn	24.
--------------	-----

MUSIC AND SOUND

Coda	
MacDrums	32.
Perceive	52.
Electronic Arts	
Deluxe Music Construction 2.5	84.
Farallon Computing	
MacRecorder (records sound)	139.
Great Wave	
ConcertWare + MIDI 4.0	79.
Impulse	
Audio Digitizer w/SoundWave	149.
Intelligent Music	
OvalTune	95.
Opcode Systems	
Music Mouse	39.
Passport Designs	
Master Tracks Pro	259.
NoteWriter	169.

EDUCATIONAL/PERSONAL

BrightStar	
Alphabet Blocks	32.
Talking Tiles	69.
Bootware Software	
ResumeWriter Pro	75.
Broderbund	
Calculus, Geometry, Physics ea.	59.
Type	20.
Davidson	
Math Blaster	27.
Speed Reader II	39.
Great Wave	
Kids Time	26.
Learning Company	
Reader Rabbit	33.

MORE FOR YOUR MONEY...

Odesta	
Double Helix II	339.
Double Helix II MultiUser Kit	Call.
GeoQuery	199.
Park Row Incorporated	
Publish or Perish	21.
Personal Bibliographic	
Pro-Cite	199.
Software Discoveries	
Record Holder Plus	45.
BUSINESS SOFTWARE	
Access Technology	
Trapeze 2.1	159.
Ashton-Tate	
Full Impact	249.
Bravo	
MacCalc	79.
BreakThrough Productions	
Market Master	185.
Market Master R/A	245.
Claris	
MacProject II	395.
Cognition Technology	
MacSMARTS 3.2	135.
Cricket	
Cricket Graph	119.
Cricket Presents	289.
MicroPlanning International	
MicroPlanner Plus	385.
Microsoft	
Excel 1.5	249.
PowerPoint 2.0	Call.
Works 2.0	189.

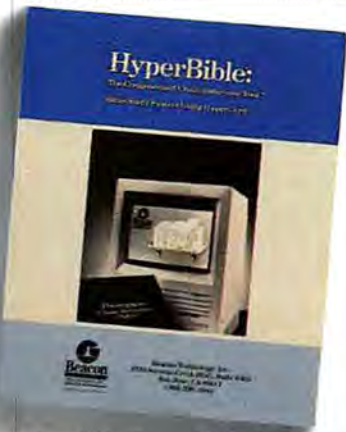

HyperBible (Beacon Technology)
The Computerized Chain Reference Tool puts new life into your study of the Bible, using HyperCard's interface. Over 100,000 notes and cross references, Atlas, 7000 topics and Glossary of Terms. Interface to any word processor. Easy word and phrase search of scripture. Ready made studies for meetings. Available in the New International Version \$195. and the King James Version \$159. Great gift item! (hyperware)

Nolo Press	
For the Record	29.
WillMaker	34.
North Edge Software	
Timeslips III (time/expense tracking)	117.
Satori	
Bulk Mailer 3.2	79.
Shana Enterprises	
FastForms! Construction Kit	89.
Softview	
FormSet	55.
MacInUse	42.
Spectrum Digital	
TrueForm	269.
Symantec	
More II	225.

WORD PROCESSORS AND OUTLINERS

Ashton-Tate	
FullWrite Professional	269.
Claris	
MacWrite 5.0	105.
Microsoft	
Word 4 (updated word processor)	249.
Write 1.0	113.



Cirrus Drive Kits (La Cie Ltd)
With these kits and your choice of a 3 1/2" embedded SCSI drive, you can put together your own internal, or external drive for any SCSI-equipped Mac. Internal kits come with a universal bracket; external kits come with the award-winning Cirrus case and a Cordura Carrying bag. Kits come with SilverLining and SilverServer software. (disk drives) **CALL.**

Niles & Associates	
End Note	82.
Paragon	
Qued/M	109.
Symmetry	
Acta Advantage w/DA	69.
T/Maker	
WriteNow 2.0	109.
WordPerfect Corp.	
WordPerfect	185.
SPELLING CHECKERS	
Aegis	
Doug Clapp's Word Tools	42.
A.L.P.	
MacProof 3.0	115.
Deneba Software	
Bigthesaurus	53.
Spelling Coach Pro	105.
Microlytics	
Word Finder (synonym finder)	33.
Sensible Software	
BookEnds	Call.
Sensible Grammar	54.
Working Software	
Spellswell 2.0	45.

GRAPHICS

3G Graphics	
Images w/Impact	
Graphics & Symbols 1	59.
Business 1	75.
Aba Software	
Draw It Again Sam 2.0	79.
GraphistPaint II	289.
Aldus	
Freehand 2.0	349.
Broderbund	
Drawing Table	79.
PosterMaker Plus	36.
TypeStyler	Call.
VideoWorks II	175.
CE Software	
CalendarMaker	27.

Claris	
MacDraw II 2.0	329.
MacPaint 2.0	105.
Cricket	
Cricket Draw	169.
Cricket Paint	SPECIAL 99.
Pict-O-Graph (color on the Mac II)	99.
Deneba	
Canvas 2.0	169.
Dream Maker	
Cliptures, Business Images	97.
MacGallery	28.
Electronic Arts	
Studio/8	319.
MicroIllusions	
Photon Paint	179.
MicroMaps	
MacAtlas Pro (MacDraw format)	129.
NuEquation	
NuPaint	99.
Olduvai	
Art Clips	69.
Paracomp	
Swivel 3D	265.
Silicon Beach	
Digital Darkroom or Super 3D	Call.
ShadowPaint 2.0	Call.
Solutions	
Curator (graphics management)	79.
SuperMac	
PixelPaint Pro	Call.
Symmetry	
PictureBase & WetPaint	99.
T/Maker	
ClickArt EPS Illustrations	75.
Zedcor	
Deskpaint 2.0	69.

DESKTOP PUBLISHING PRODUCTS

Adobe	
ACE-Textures, Fill, and Patterns ..	168.
Illustrator 88	319.
Streamline	295.

Managing Your Money
A fully integrated software program addressing every aspect of personal and small business finance. Write and print checks, set up a personal budget, estimate your taxes and more. (finance) **\$128.**



Bookends
Save time storing and retrieving information. It's the easy way to search for references and edit them. Rearrange data any way you like. Makes smooth sailing out of sorting and organizing. Great for research papers and articles. (spelling) **CALL.**



SupraModem 2400
More bauds for the buck! The SupraModem gives you 2400 baud performance for less than the cost of 1200 bps units. Offers complete support of the Hayes "AT" command set, auto answer/originate, passthrough phone jack, programmable-volume speaker, and a one year warranty. (modems) **\$149.**



Milo
The math Processor for the Mac! Milo is the first math processor that combines mathematical calculations with graphing and word processing capabilities. Solve problems with a click of the mouse. Milo is an essential tool for scientists, engineers, and math students. (statistics) **\$169.**



- VISA and MASTERCARD accepted. No surcharge.
 - Your credit card will not be charged until your order is shipped.
 - If we must ship a partial order, we pay the freight on the remaining portion.
 - All U.S. shipments are insured at no extra charge.
 - C.O.D. orders accepted (add \$8.00 including shipping) — \$1,000 maximum. Cash, money order, or cashier's check.
 - Corporate purchase orders accepted subject to credit approval.
 - All products are covered by a 120 day limited warranty.
 - CT residents add 7.5% sales tax. NJ residents add 6.0% sales tax.
- SHIPPING**
- All orders add \$3.00 per order. We ship Airborne Express overnight unless UPS ground delivers overnight. (Some rural areas require an extra day.)
 - Orders placed by 5:00 pm Eastern time (weekdays) for "in stock" items ship same day (barring system failure, etc.) for overnight delivery.
 - C.O.D. orders ship via UPS (Blue Label if you are more than 2 days from us via UPS ground). Charge is \$6 including shipping.
 - Alaska, Hawaii, outside continental U.S., APO/FPO call 201-367-0440 for information.

*Defective software replaced immediately. Hardware replaced or repaired at our discretion.

I'm Kerry, call me at:

1-800-255-6227

(1-800-ALL-MACS)

Inquiries: 201-367-0440 Canada: 800-255-6447 FAX # 201-905-9279



MacWAREHOUSE™

1690 Oak Street, P.O. Box 1579,
Lakewood, NJ 08701

MONDAY THRU FRIDAY 8 A.M. TO 11 P.M. (Eastern Time)
SATURDAY 8 A.M. TO 8 P.M. (Eastern Time)
NOW OPEN SUNDAYS! 8 A.M. TO 8 P.M. (Eastern Time)



OVERNIGHT ... ONLY \$3.00

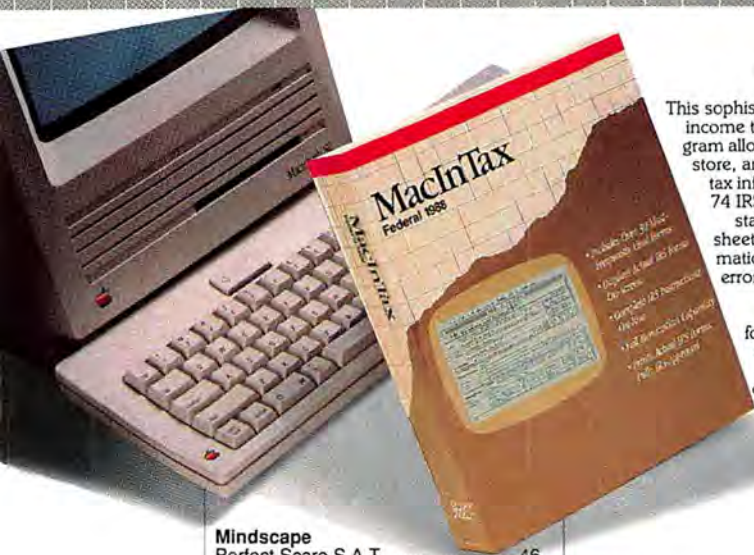

MacInTax Federal 1988 (Softview)

This sophisticated, easy to use income tax preparation program allows you to organize, store, and print out income tax information. Includes 74 IRS forms, schedules, statements and worksheets. Links forms automatically to reduce input errors. Program features the IRS instruction booklet on-line. All forms can be printed, complete with data onto blank paper or preprinted forms, both IRS approved. (finance) \$69.

- Mindscape
Perfect Score S.A.T. 46.
- Simon & Schuster
Typing Tutor IV 35.
- The Software Toolworks
Mavis Beacon Teaches Typing 36.
- Voice & Video
HyperCard Getting Started 35.
- PageMaker 3.0 Video Tape 35.
- Word 4.0 Video Tape 35

GAMES

- Access Software Inc.
World Class Leader Board 34.
- Artworx
BRIDGE 5.0 22.
- GrailQuest 19.
- Broderbund
Ancient Art of War At Sea 27.
- Shufflepuck Cafe 22.

MacTilt (Ergotron)

Neck and back pains disappear like magic when you put your Mac on a MacTilt. You'll be more productive when those aches and pains from improper viewing angles go away. MacTilt raises your screen 4 inches off the desk and gives you a swivel and tilt joint so you can fine-tune your viewing angle and minimize glare. The tilt covers a 30 degree angle and the swivel goes around a full 360. (accessories) \$68.



- Where in the World is
Carmen San Diego 25.
- Bullseye
Ferrari Grand Prix (racing) 32.
- P51 Mustang 32.
- Casady & Greene
Crystal Quest 2.2 w/Critter Editor 42.

Word 4.0 (Microsoft)

Word 4.0 adds new page design capabilities! Create newsletters with multiple columns. Automatically wrap text around graphics. Tables are a breeze. Use Style Sheets to create tables with self-calculating columns. Word 4.0 has a spelling checker, hyphenation, glossary, mail merge, and automatic indexing. Word 4.0 also includes SuperPaint 1.1 at no extra charge. (word processing) \$249.



- Centron Software, Inc.
BlackJack or CrapsMaster ea 27.
- CasinoMaster (5 pack) 55.
- Discovery Software
Arkanoid 27.
- Electronic Arts
Chessmaster 2000 (deluxe chess) .. 28.
- Patton vs. Rommel (strategy) 15.
- Starfleet I: The War Begins 37.
- Chuck Yeager Adv. Flight Trainer 32.
- Epyx
Sub Battle Simulator 29.
- Infocom
Leather Goddess of Phobos 15.
- Micro Sports
MSFL Pro League Football 32.
- Mindscape
Balance of Power, Deja Vu - ea 30.
- Shadowgate, Uninvited - ea 30.
- Nemesis
Go Master 49.
- Joseki Tutor 30.
- PCAI
MacCourses 32.
- MacGolf 2.0 35.
- MacGolf Classic 54.
- Road Racer 45.
- Sierra ON-Line
Leisure Suit Larry 23.
- Silicon Beach
Apache Strike, Dark Castle - ea 27.
- Beyond Dark Castle 27.
- Simon & Schuster
Star Trek:Kobayashi Alternative 24.
- Spectrum HoloByte
Falcon 2.0 32.
- PT109, Gato ea. 26.
- Solitaire Royale or Tetris ea 20.
- The Software Toolworks
The Hunt for Red October 29.

DISK DRIVES/ MEMORY UPGRADES

- 1 MEG SIMMS Call.
- AST
Mac286 Co-Processor (Mac II) 1079.
- CMS
CMS TapeStack 60 Meg Call.
- MacStack 20 Meg 569.
- MacStack 40 Meg 789.
- MacStack 60 Meg 849.
- Cutting Edge
800K Disk Drive "NEW" 175.
- Wedge XL 30 Plus 629.
- Wedge XL 45 Plus 829.
- XL 30 Internal or 45 Internal Call.
- Dayna Communications
DaynaFile single 360K (5 1/4") 529.
- Dove
MacSnap 2S 750.
- MacSnap 2SE 439.
- MacSnap 4S 1488.
- MacSnap 8S 2975.
- MacSnap SCSI Interface Port 109.
- MacSnap 524E (512k to 1 meg) 289.
- MacSnap 524S 379.
- MacSnap 548E (512k to 2 meg) 549.

- MacSnap 548S 599.
- MacSnap Plus 2 439.
- MacSnap 1024 Mem. Exp. Board . Call.
- MaraThon SP 189.
- MaraThon Accelerators Call.
- Everex
EMAC 20D (hard drive) 520.
- EMAC 20D Deluxe (O footprint) 585.
- EMAC 40D Deluxe (O footprint) 995.
- EMAC 60T (tape backup) 895.
- EMAC FS-102 2495.
- Impact Hard Drives Call.
- La Cie Ltd.
3.5 Mounting Kit w/SilverServer & SilverLining 99.
- Cirrus Drive Kits Call.

Casino Master (Centron)

Become a Master of Casino Gambling! Five separate Casino Games Include Blackjack Ace, Crapsmaster, Roulette Master, Pokermaster and Baccarat Master. Learn and practice at your own pace! Exact table simulation, mouse controlled betting, selectable bankroll, stored win/lose statistics and complete manual for rules and strategy included for each game. Recommended and used by professional gamblers! Buy individual games \$27 ea or get the 5-game Casino Master Package \$55. (entertainment)



World Class Leader Board
Play the courses that challenge the greatest golfers or create your own. Digitized sound, practice putting greens and driving range. Choose your club, distance and type of shot. For 1 to 4 players. (entertainment) \$34.



Payroll PLUS

This complete payroll program provides Federal, State, Local, and FICA tables plus 8 user-defined miscellaneous deductions. Calculates hourly wages or salary. Prints paychecks and more. (finance) \$159.



Swivel 3D

Swivel 3D is the ONLY 3D drawing program with color and it's fast. Start with 2D drawings and Swivel's intuitive interface turns them into 3D objects. Use the "Tweening" function for animation. Comes with a library of pre-drawn images and supports PICT and MacPaint files. (graphics) \$265.



FROM MacWAREHOUSE™

The BIG Thesaurus
Contains over 100,000 root words from the Merriam-Webster Collegiate Thesaurus. Inserts replacement words directly into your document. Compatible with Multifinder and Hypercard. (spelling) \$53.



BASF 3.5" Double Sided Double Density
High capacity diskettes with no capacity for error. Every bit, every bite on every track of each BASF 3.5" Diskette is certified 100% error free. Warranted for life. (media) \$17.



MediaMate
Have all your programs at your finger tips! MediaMate holds 10 3 1/2 inch disks in an easy access design. When not in use, it folds up for easy storage. (accessories) \$12.



Spelling Coach Professional
Complete on-line spelling and reference system includes Merriam-Webster's 158,000 word dictionary, 245,000 synonym thesaurus, hyphenation, and a dictionary with 85,000 real definitions! (spelling) \$105.

MiniScribe
20Mb Raw Int. Drive Kit 379.
45Mb Raw Int. Drive Kit 549.
Mobius
MultiScreen Video Card 349.
PCPC
MacBottom HD21 (SCSI) Call for
MacBottom HD32 (SCSI) special
MacBottom HD45 (SCSI) 859.
MacBottom HD21 w/Modem 779.



MAC - 101 Keyboard (Data Desk)
Features 101 keys including a numeric keypad, a separate T-shaped cursor keypad, Cancel Key, Option and Command keys at both ends, definable function keys, plus scrolling, page control, and zooming keys. Comes with free macro software and manufacturer's two year warranty. (input/output) CALL.

MacBottom HD32 w/Modem 829.
MacBottom HD45 w/Modem 979.
WSI (With SCSI Interface) 269.
Peripheral Land, Inc.
Infinity Turbo 40 Meg 1299.
UniMac
3.5 or 5.25 Int. Mounting Kits Call.
Storware 69.

MODEMS

Abaton
InterFax 12/48 Call.
Best Data Products
SmartOne 2400/1200 with cable and software 169.
Everex
EMAC 2400 225.
Hayes
Smartmodem 1200 299.
Smartmodem 2400 449.
Smartmodem 9600 (V series) 985.
Migent
Pocket Modem (ext. 300/1200 baud) 115.
Prometheus
Promodem 2400 309.
Shiva
NetModem 1200 359.
Supra
Supra Modem 2400 149.
US Robotics
Courier 1200 Modem 199.
Courier 2400 Modem 349.

BLANK MEDIA

B.A.S.F.
DS/DD (box of 10) 17.
Sony
DS/DD (box of 10) 19.
SS/DD (box of 10) 13.

INPUT/OUTPUT

Asher Engineering
Turbo Trackball (512/Plus or Se/II) .. 69.
Cutting Edge
CE-105 ADB Keyboard 125.
DataDesk
Mac 101 Keyboard Call.
Kensington
New Turbo Mouse 109.
Koala
MacVision 2.0 225.

More II (Symantec)
From reports to speeches you're a pro with More II. Use the outliner to capture and organize your thoughts. Plan the presentation using the full-function word processing section. Finish with stunning presentation graphics, formatted handouts and a self-running slide show. More II's graphic tools help you create and import charts, graphs, diagrams and illustrations to make your points. It reads PCT, PICT2 and EPS files. (business) \$235.

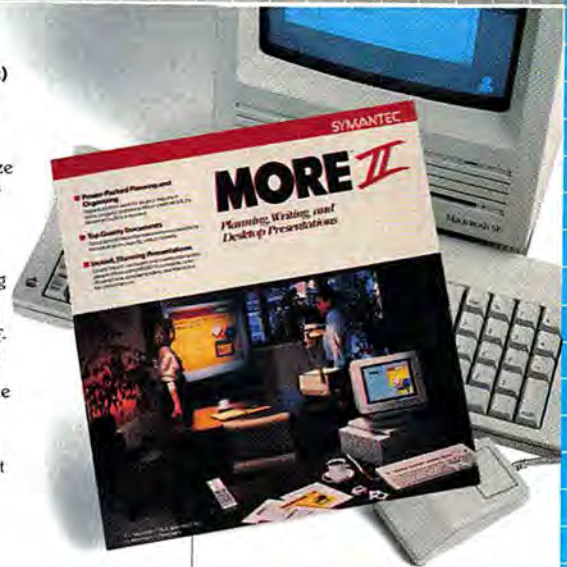

Kurta
IS/ADB Tablet 259.
Cordless 4 Button Cursor 95.
Mouse Systems
A+ Mouse (512/Plus or SE/II) Call.
New Image
MacScan (flatbed) 1749.
Seikosha America
Seikosha Printer (dot-matrix) 235.
Summagraphics
Bit Pad Plus 329.
ThunderWare
LightningScan Call.
ThunderScan 4.0 (incl. Powerport) 199.



Impact Hard Drives (Everex)
The EMAC Impact Hard Drive series features high speed 19 ms performance, external SCSI addressing, external termination, whisper quiet operation and a compact, slim-line chassis 2 1/2 x 6 x 10 1/2 in.. (disk drives) EMAC Impact 60 MB or EMAC Impact 40MB Plus. CALL.

ACCESSORIES

Amaray
MediMate Flex Pac 12.
Computer Friends, Inc.
MacInkr (IW & IW II) 41.
Ergotron
MacTilt or MacTilt SE 68.
Mouse Cleaner 360 15.
I/O Designs
ImageWare II Carrying Case 49.
ImageWriter LQ Ribbon Call.
IW II Ribbons-Black or Color Call.
Macinware Plus Carrying Case 64.
Macinware SE Carrying Case 75.
Kensington
Anti-Glare Filter 33.
Apple Security Kit 34.
Disk Drive Cleaning Kit 20.
Mac II Stand w/Cable Kit 65.
MasterPiece Mac II 105.
Modem/FAX Protector 20 25.
PowerTree SurgeProtectors Call.
System Saver 64.
Mobius Products
Fanny Mac QT 60.
SE Silencer 39.
Omnium Corporation
Mac Desktop Workstation 75.
Orange Micro
Grappler L/Q or LS 92.
Targus, Ltd.
Deluxe Plus/SE-XKB Case (black) .. 69.
ImageWriter II Case (black) 49.
Mac Plus/SE Case (black) 59.

I'm Kerry, call me at:

MacWAREHOUSE™
1-800-255-6227

OVERNIGHT DELIVERY: ONLY \$3.

If you're already a MacWarehouse customer you know that nobody beats our service. Our helpful telephone staff is standing by, seven days a week. Place your order by 5:00 pm Eastern time (weekdays) and it's processed immediately for overnight delivery. Call us toll free right now.



Circle 78 on reader service card

New Products

Cable Sender/Tracer Kit Test kit for LAN system administrators and cable installers. Detects cable runs in floors, walls, and ceilings. \$195. Microtest, 602/971-6464.

Floppiclene Disk drive cleaning kits for 3 1/2-, 5 1/4-, and 8-inch formatted disks. Each kit consists of 50 disposable cleaning disks, cleaning solvent, and reusable disk envelope. \$35 per kit. Tech-Sa-Port, 412/661-2629.

The Inliner Portable, forward-tilting computer cart. Holds any Mac, a small printer, and a variety of peripherals. Makes the computer and equipment accessible from lounge chairs, sofas, and beds. Handcrafted solid oak. \$599. Jenston Manufacturing, 512/653-0414.

Joystick/Keyboard Assembly Metal enclosure for Mac II keyboard, with built-in joystick mouse replacement and removable silicon seal that adheres to the standard Mac II keyboard. \$495; joystick alone \$129. CTI Electronics Corporation, 203/386-9779.



The Inliner

Mach IV Plus Mouse replacement for all mouse-intensive programs. Cursor moves in same direction as stick handle with increasing speeds as you move the stick farther from its center. \$89.95. CH Products, 619/744-8546.

MacLift Lifts the screen of Mac 512K, Plus, or SE at an angle; the front feet of the computer fit into one of the device's five grooves. Raises the front of the Mac

(continues)



Mac IV Plus



THE FINEST NAME IN SIMM (Memory Modules) for MAC PLUS, SE, II

- 1, 2, 4, or 8 Megabytes
- Top Quality
- Surface Mount CMOS
- Easy to Install
- Guaranteed
- Static Protected

Expand your Mac memory by 1 to 8 megabytes economically. Diamond-Pac[®] SIMM's are 100% tested, state-of-the-art CMOS DRAM expansion modules manufactured in the USA by Logitron. Each Diamond-Pac[®] module is shipped with "fail safe" installation instructions, complete testing documentation, full antistatic protection, and a 2 year guarantee. To ensure the best possible price, call for a quote today. Delivery usually within a few working days. Available only from...

AMERICAN MICRO DISTRIBUTORS

16897-D Algonquin, Huntington Beach, CA 92649

714/840-5560

FAX: 714-846-0570

MC VISA AMEX DISCOVERY

© MAC is a trademark of Apple Computers Corp., Diamond Pac is a trademark of Logitron, Inc.

Circle 403 on reader service card

CompuNet has PhoneNet Plus[™] beat.

FlashTalk Compatible !!

Two to one

At half the price of *PhoneNet Plus, The CompuNet System is unbeatable. CompuNet is a local area network (LAN) system that conforms to AppleTalk LAN standards.

It has the convenience of using ordinary telephone wire and RJ 11 modular phone connectors. All of CompuNet's connections are positive locking and make it easy to create custom length cables by using simple materials and crimping tools found at most hardware and telephone accessory stores.

With an unamplified limit of 3000 feet and a signaling speed of 1 megabit per second, the CompuNet System is able to function at three times the rated distance and speed of a comparable AppleTalk Network.

Suggested Retail price: \$29.95

COMPUNET Dealer Inquiries Invited
Trimar USA, Inc. 236 W. 15th Street New York NY 10011 212-645-7008 800-872-4454
FAX 212-645-8786
In Canada call DataSpace Corp. 416-474-0113 800-378-0492
*Based on suggested retail price of \$59.95 effective October 1, 1987

Circle 26 on reader service card

Teach your Mac to perform unnatural acts.

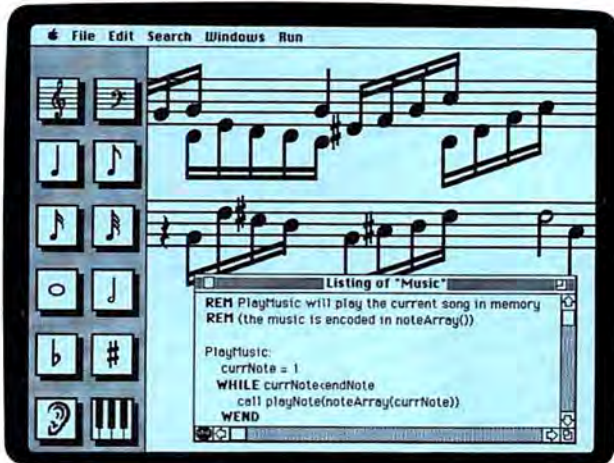

It can sing.

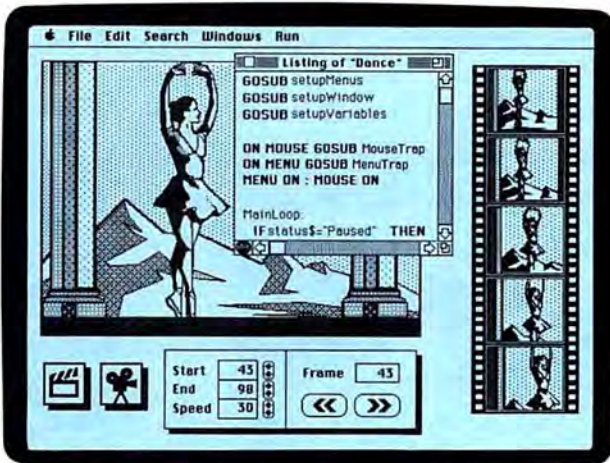

It can dance.



It can even spit nickels.

If you're losing your passion for running the same old programs on your Mac,[®] add a little excitement to the relationship. Start writing your own, with the new Microsoft[®] QuickBASIC for the Macintosh.[®]

BASIC is already the easiest language to learn on the Mac. And now, with new Microsoft QuickBASIC, it's even easier.

We've built the compiler and the interpreter into one program. Which means you can compile and execute whatever your heart desires with a simple double click of the mouse. We've even added a complimentary personal finance program so you can practice. See any Microsoft dealer for a trial run.

You're going to have a lot of fun programming your own Mac, even when you're getting down to serious business. With new Microsoft QuickBASIC, you'll learn how to customize business applications and programs so they meet your specific needs and work with existing applications.

And don't be surprised at some of the ingenious things you can create right off the bat. That's perfectly natural.

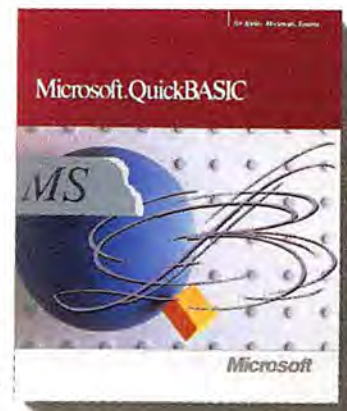

The consummate new Microsoft QuickBASIC for the Macintosh.

Microsoft[®]

© 1988 Microsoft Corporation. All rights reserved. Microsoft and the Microsoft logo are registered trademarks of Microsoft Corporation. Macintosh and Mac are registered trademarks of Apple Computer, Inc.

Portions of Microsoft QuickBASIC for the Macintosh were developed and are copyrighted by Absoft Corporation, Auburn Hills, Michigan, and are based on a version of the Absoft AC/BASIC[™] compiler. All rights reserved.

New Products



MacLift

by up to 2 inches. Platinum or beige. \$12.95. Cordry-Berg Enterprises, 714/361-2557.

Manifesto Executive Desk/Workstation

Handmade oak desk/workstation with motorized platform for the Mac. Press a button or turn a key to lift the computer up to use the Manifesto as a workstation, or place it flush for use as a desktop. Holds Mac, printer, scanner, and storage. \$1995. Sunrise Technologies, 800/446-5991 or 619/466-5991.

PC100+ Power Inverter Produces 100 watts of AC power from any 12-volt battery source. Requires no permanent mounting. Alarm sounds when battery is

getting low; unit shuts off when battery gets down to 10 volts. \$179.95. Statpower Technologies, 604/420-1585.

Surelock Security Kit Steel-cable and brass-lock security system designed to secure Macs and peripherals from theft. \$39.95. Reiko, 206/672-5353.

Textured Papers for Impact Printers

Three new papers: riblaid available in white, ivory, and gray; linen (25 percent cotton) with embossed texture in white, gray, and blue; and brushed cotton (50 percent cotton) with woven finish in white, ivory, and blue. \$24.95 per box of 250 fanfold sheets. James River Corporation, 413/589-7592.



Manifesto Executive Desk

BOOKS & VIDEO

Apple Numerics Manual, Second Edition Updated manual describes SANE on the various processors used in the Apple II and Macintosh family of computers. Includes new information on IEEE-standard arithmetic and the SANE engines for Apple IIGS and Mac II computers. \$29.95. Addison Wesley, 617/944-3700. □

To have your product considered for inclusion in New Products, send an announcement with product name, description, minimum memory, peripherals required, pricing, company name, and phone number to New Products Editor, Macworld, 501 Second St., San Francisco, CA 94107. We reserve the right to edit press releases.

Romancing the Mac



With **JetLink Express™**, It's a remarkable new generation of printer driver for Macintosh® computers and DeskJet, LaserJet, or LaserJet compatible printers. Simplicity, speed, versatility and dependability — without the 'jaggies'.

But that's only part of the story.

JetLink Express employs the same leading-edge outline font technology used by PostScript® laser printers, the standard in desktop publishing.

This allows you the flexibility to create various fonts, sizes and styles with astonishing results.

Where reliability, quality and speed count most, **JetLink Express** achieves first-rank performance. The competition doesn't even come close to delivering 300 dpi in large fonts and sizes *without the 'jaggies'*.

So if you're looking for a printer driver with a heart, we've got your number. Now all you have to do is push ours. You'll get what you need in record time.

Mac Daisy Link™ continues to be the preferred tool for the daisywheel printers and typewriters.

GDT Softworks Inc.

P.O. Box 1865, Point Roberts, Wa. 98281
For Inquiries: 1-800-663-6222

Mac Daisy Link & JetLink Express are trademarks of GDT Softworks, Inc.
DeskJet and LaserJet are trademarks of Hewlett Packard Co., Inc.
Macintosh is a registered trademark of Apple Computer, Inc.
PostScript is a registered trademark of Adobe Systems, Inc.

Circle 439 on reader service card

COMPUTEREYES™



Capture Video Images: \$249.95!

Capture real-world images on your Mac 512E, Mac Plus, SE, or Mac II from any standard video source (video camera, VCR).

On the screen . . .

ComputerEyes includes several options for images display, and edit options such as shrink, expand, scroll, and more.

Behind the scenes . . .

ComputerEyes acquires larger-than-screen images with 256 gray levels for desktop publishing and image processing.

On paper . . .

ComputerEyes saves images on disk in several file formats including TIFF, MacPaint, PICT, RIFF, and EPS for use with PageMaker, Hypercard, MacPaint — virtually all the popular graphics programs.

Think of the possibilities!

ComputerEyes is backed by a one year warranty and the success of over 20,000 systems sold. See your dealer or order direct. For more information, example images, or Demo Disk (\$3), call (617) 329-5400.

To order call 800-346-0090
VISA, M/C, COD accepted.
Digital Vision Inc.
66 Eastern Ave.
Dedham, MA 02026

DIGITAL VISION

Circle 242 on reader service card

Just say **CRATE**



 Seagate

You've known us as AppleCrate. We are now Crate Technology. So, just say Crate!

We offer a great line of external disk drives now known as MacCrate ranging from 20MB to our performance driven 80MB model all using Seagate quality disk drives.

We have expanded our product line to include InnerCrate: our solution for your Mac SE and Mac II internal disk drive needs. InnerCrates range from 30MB to our high performance 300MB model.

Introducing TapeCrate, our high speed quality backup system. TapeCrate's high speed data transfer rate, protects 60MB of your valuable information in just 12 minutes. TapeCrate comes with a 60MB data cartridge and is ready for "Plug and Play" operation.

Inner CRATE

Mac SE 30MB	28ms	\$560
Mac SE 50MB	28ms	\$730
Mac II 40MB	28ms	\$585
Mac II 60MB	28ms	\$655
Mac II 80MB	28ms	\$1085
Mac II 300MB	16.5ms	\$2785

Tape CRATE

60MB tape backup sys. \$739

Mac CRATE

20MB	65ms	\$545
40MB	28ms	\$740
60MB	28ms	\$839
80MB	28ms	\$1149

In California 800-323-9994
Nationwide 800-543-5808
Call for same day orders or technical support.

 **CRATE**
TECHNOLOGY

6850 Vineland Ave. Bldg. M., North Hollywood, CA 91605

Circle 97 on reader service card

How to avoid making backups.

Make Irwin® do it.

An Irwin tape backup system, that is. So go home early. Because an Irwin system will back up your data, your programs, your breakthrough ideas — all automatically.



No complicated commands.
No sloppy floppies.

Our EzTape® software makes it easy to store whatever data you want. Whenever you want.

It doesn't matter whether you're backing up a Mac or a PC.

An Irwin backup system works with them all. Along with all the popular local area networks. Providing up to 80 megabytes of reliable storage.

In fact, with its patented AccuTrak™ precision tracking technology, you can transfer data from a Mac to a PS/2 to a PC and back again. Something that would throw a floppy right off its track.

All in all, that's why more people rely on Irwin mini-cartridge systems to do their backup than all others combined.

Just call 1-800-BACKUP1 for the dealer nearest you. Because the best way to make backups is to avoid it.



© 1989 Irwin Magnetic Systems, Inc., 2101 Commonwealth Blvd., Ann Arbor MI 48105. Irwin and EzTape are registered trademarks and AccuTrak is a trademark of Irwin Magnetic Systems, Inc. All other brand or product names are trademarks or registered trademarks of their respective holders.

Circle 471 on reader service card



Quick Tips

Answers to your questions

by Lon Poole

The down-up commotion an ImageWriter II makes before it prints the first page of a document on pin-feed paper may jam the paper. As reported in last October's *Quick Tips*, you can avoid the jam by starting printing on the second sheet of paper; by choosing the Manual Feed option in the Print dialog box; or by forsaking pin-feed paper and getting a sheet feeder.

On closer inspection of the phenomenon, Ron Zammit of San Luis Obispo, California, observed that the paper doesn't jam if the print head is centered left to right. The clear plastic paper guides on either side of the print head direct the paper beneath the pressure rollers during the down-up movement. A problem occurs only when an application leaves the head off-center after printing a document. You can manually center the print head by lifting the ribbon cover to create an error condition, replacing the cover, and pushing the Select button on the printer. Switching the printer's power off and on also centers the print head.

Don't Ask Me That Again

Have you had enough of the Finder interrupting you with comments like "That item is locked or in use and cannot be removed" and "Are you sure you want to throw away the application——?" You could haul out ResEdit and permanently silence those warnings, as one reader suggested. But you can easily override the Finder's warnings about removing applications, system files, and locked items by pressing Option while you drag the item in question to the Trash. When you press that Option key, you'll hear the Finder clearing its throat as a subtle reminder to proceed with caution.

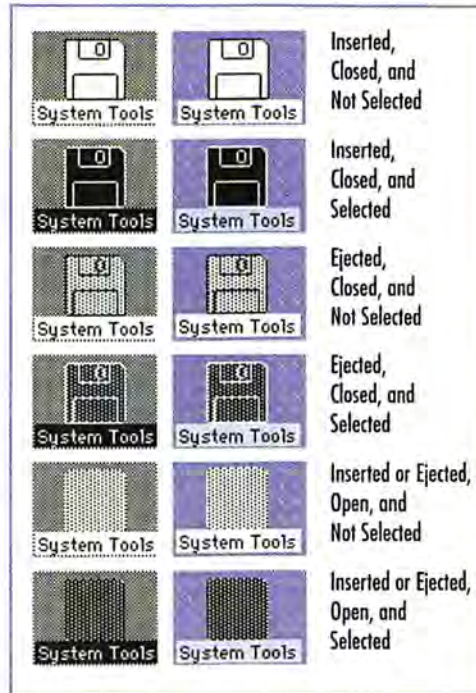

Icon Tell

Glancing at a disk icon tells you whether the disk is selected, whether the icon is open (so you can see the disk directory window), and in some cases whether the disk is inserted or ejected.

Q Icon Disguises

Disk icons have several different looks—white, gray, or black; with or without lines depicting the disk label and shutter. What do they all mean?

Dave Reese
Stoughton, Massachusetts

A We're all graphically oriented here, aren't we? Look at "Icon Tell" for the answer to this question.

Q Violent Reaction

On some occasions when there is software incompatibility, my Mac SE reacts

violently rather than gracefully. Instead of getting the comparatively polite system-error message with its bomb icon and restart button, I hear horrible crackling noises and see flashing lines running across my screen. Is any harm being done? Why is my Mac behaving so violently? Does this behavior come under the heading of *bombs*?

Chris W. Anagnost
Dover, New Jersey

A Video and audio static does signify a bomb, or crash, much like a system error, but less controlled. The rude sights and sounds occur when a damaged application program or damaged System software writes random information in the areas of memory used by the display screen and sound circuit. Usually, the only harm done is a loss of all work completed since you last saved. However, there is a remote danger of corrupting a disk, particularly if the crash occurs while saving to disk. The risk is a bit greater if you are saving to a 400K disk drive. To recover, you must switch the Mac off and on or press the reset button on the programmer's switch (if it is installed).

Q Font Corruption

I have a corrupted screen font (Adobe Garamond) in my System file that causes a system error whenever I try to use it. The same system error occurs when I try to remove the font with Font/DA Mover (version 3.6). The font seems fine on the floppy-disk copy, but causes the error when it's in any file on the hard disk. I'm using a Mac SE with an internal hard disk and System 4.2. Is there any utility software that I can use to remove just the one font?

(continues)

The fastest way to get here.



Claris CAD can't reduce the huge number of two-dimensional drawings it takes to get a plane off the ground. But it makes them a lot easier to do.



Claris CAD supports ANSI Y14.5 and other drawing standards. So those who design parts can share with those who design wholes.



Accurately drawing graceful curves like these becomes a simple matter of point and click.



Claris CAD can help you design everything from electronic schematics to the box they come in.

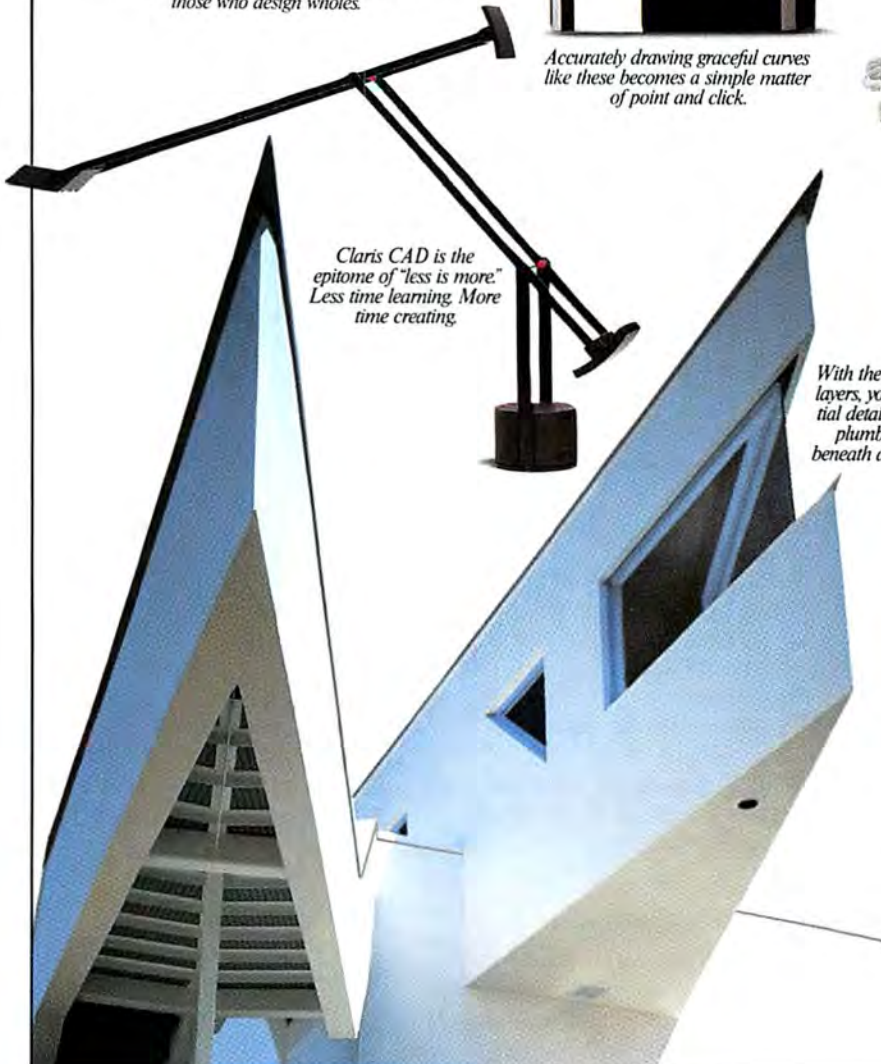

Claris CAD is the epitome of "less is more." Less time learning. More time creating.

With the ability to draw in layers, you can hide essential details like wiring and plumbing just a click beneath an elegant exterior.

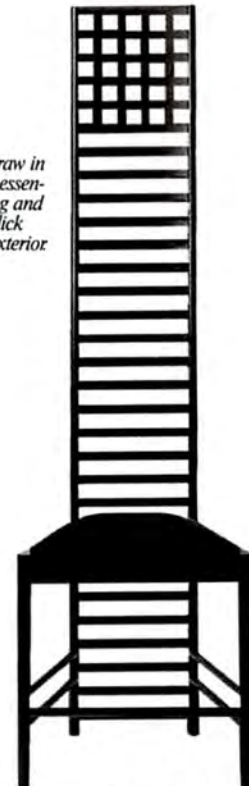

Draw the lines of fine design as finely as you wish: from 1.5 inches to .0001 mm.

Is to start here.

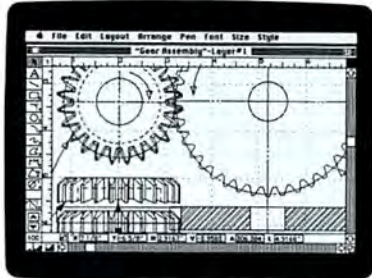

Claris CAD is the first professional 2-D design and drafting tool to fully utilize the intuitive Macintosh way of working. So it takes hours to learn, not days.

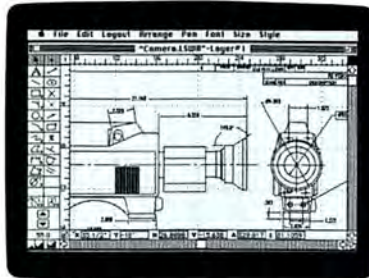

Fillets, tangents, keyboard entry, double lines and automatic dimensioning turn your ideas into realities with exacting precision.

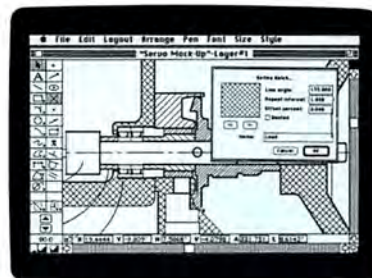

Customizable pens, dashed lines, hatch patterns and dimension appearance give you a new level of versatility.

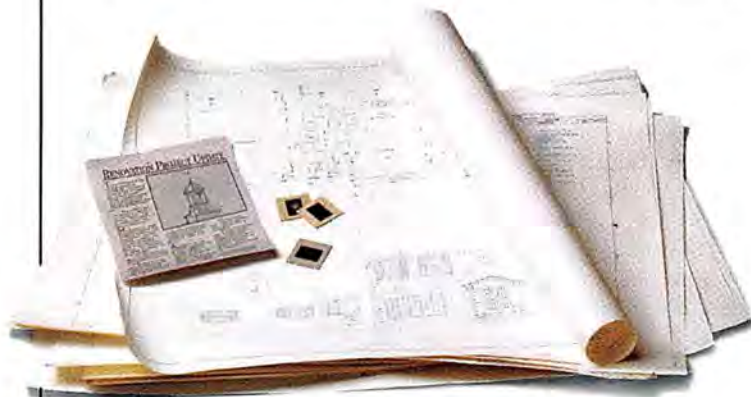

Claris CAD makes it easier to sell your inspirations. Plot your plans, concept sketches, schematics and working drawings exactly as you see them, turn them into slides or overheads, or cut and paste them into proposals and reports.

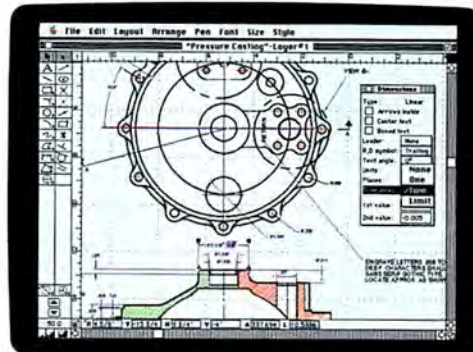

Keeping the vision in your revisions is easy. Because you don't have to redraw from scratch.

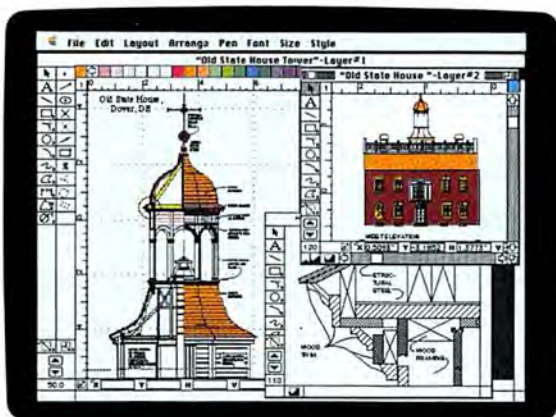

Claris CAD integrates with other CAD software via optional IGES and DXF conversion programs. So you can move them to larger CAD/CAM systems for 3-D modeling and prototyping.



Here's the next step: order the Claris CAD Starter Kit, just \$29.95 (refundable when you buy the complete program). To order call 800-628-2100. And see how intelligent design begets intelligent design.

Introducing Claris CAD.

Mathematics Made Easy!



Milo is the first math processor that combines mathematical calculations with graphing and word-processing capabilities. Milo effortlessly describes a problem, solves it, and graphs your solution. Our WYSIWYG interface allows you to easily manipulate expressions with a click of the mouse. No programming language required! Easily move your results to any word processor or desktop publishing application. Milo is the essential tool for all users of mathematics.

Introductory Retail Price \$249.

Milo™

The Math Processor for the Macintosh®

PARACOMP

123 Townsend Street, Suite 310
San Francisco, CA 94107 (415) 543-3848

Works on all Macintoshes with at least 512K RAM.
©1988 Paracomp, Inc. Milo is a trademark of Paracomp, Inc. Macintosh is a registered trademark of Apple Computer, Inc.

Circle 229 on reader service card

How To/Quick Tips

Any thoughts as to the cause? I use a lot of fonts and this is the only one that has caused a problem. I got the fonts from the Linotronic service bureau where I do business.

*Kirk Wille
Irvine, California*

A If the font works on other disks, something may be wrong with the System file on your hard disk. To eliminate this possibility, replace the System file and other items in the hard disk's System Folder with like-named items from a clean copy of the latest System Tools and Printing Tools disks. System version 6.0.2 was the latest at this writing. Before replacing your current System Folder, be sure to make a copy of it in case something goes wrong.

Fonts are resources, so you can probably remove the troublesome font from your System file using Apple's resource utility, ResEdit. The font will have one FOND resource and many FONT resources, one for each different point size installed and an additional one for an imaginary size 0 font. To see the size 0 resource, you may have to open the FONT resources using the Open General command in ResEdit's File menu. You can get the latest version of ResEdit with documentation from Apple Programmer's and Developer's Association (206/251-6548), or your local user group should have it.

Q Squashed Lines

I've had a problem with my ImageWriter II printer for years. One line of print near the top of the page gets distorted. I'd sure appreciate any direction you could suggest.

*Bob Ricketts
Irvine, California*

A Pin-feed paper may buckle slightly as the perforation goes through the ImageWriter's pinch roller (also called the paper bail), resulting in a flattened line. The glitch occurs about 1 inch from the top of the page on an ImageWriter II. The paper feed path is different on an ImageWriter I, where the glitch occurs about 1/2 inch from the top of the page.

You may be able to alleviate this problem by increasing the tension on the paper coming out of the printer. Try advancing one sheet of paper through and letting it hang there. Try attaching a light weight, such as a clothespin or binder clip, to the exiting paper. Let the exiting paper fall to the floor.

To eliminate the problem, switch to single-sheet paper. I highly recommend using a cut-sheet feeder on an ImageWriter II. It really works well, but be careful removing and reinstalling it so you don't break the plastic hinges that hold the two halves together.

Q Comparing Times and Distances

The Map device in the Control Panel operates properly on our school's office Mac SE, but not on mine at home. The Time Zone/Time Difference feature, which is supposed to calculate the time zone and the time difference between the chosen city and Greenwich Mean Time, always shows the same answer for both.

*Jerry A. Neff
Curtis, Nebraska*

A The Time Zone feature indicates the number of hours and minutes that the location marked by the flashing star is ahead of or behind Greenwich Mean Time. The Time Difference feature (which you access by clicking the words Time Zone) shows the time difference between the location marked by the flashing star and the location marked by a flashing cross, which is called the Current Location. If the Current Location is in the same time zone as Greenwich Mean Time, then the Time Zone and Time Difference will be the same.

You can change the Current Location using Map. First find or add the location you want to designate. Then click the Set button. The flashing cross visibly confirms the setting.

When you change the Current Location, Map automatically adjusts the time and date in the Mac's clock according to the time difference between the new and old Current Location. The Current Location is stored in the Mac's battery-powered memory, along with the time of day and other semipermanent Control Panel set-

(continues)

Our removable hard disk isn't the only thing you'll put in your pocket.



\$1199

Like the best removable hard disk drives on the market, ours gives you 42 megabytes capacity on each disk cartridge. So you get unlimited storage, and unprecedented portability and security, just as you'd expect.

It delivers super-fast 25 ms access speed, for the finest performance money can buy.

It comes with the MacTREE Plus hard disk management system and DS BACKUP software, plus all the cables and terminators you need. Which is more than you get with a lot of the others.

What's the big difference? Simple. Buy ours and you'll save several hundred dollars. Plus you'll get the only two year limited warranty in the high-capacity removable disk drive business. And a full year on our cartridges.



So when you think about it, the real question is not why our removable drive costs so little. But why do theirs cost so much?

Call now to place your order, or for more information.

MICROTECH
INTERNATIONAL, INC.

29 Business Park Drive, Branford, CT 06405

1-800-325-1895
(203-488-7744 in CT)

© 1989 Microtech International, Inc. All product names are trademarks or registered trademarks of their respective owners. The two year limited warranty is offered on the subsystem only. Microtech hard disk cartridges come with a one year warranty. Pricing and specifications are subject to change.

MasterCard and Visa accepted at no extra charge.

Circle 458 on reader service card

ACCOUNTING

for the Macintosh

When you do accounting you'll want something more than database adaptations, spreadsheet templates or converted MS-DOS programs. All three of our fine accounting programs were created especially for the Macintosh!

MultiLedger™

Now you can get General Ledger, Accounts Receivable, Accounts Payable, and Inventory tracking together in one completely integrated program ... at a fraction of the cost of buying individual G/L, A/R, A/P, and Inventory modules.

Payroll

This easy-to-learn, easy-to-use payroll system is ideal for most organizations or businesses with 1 to 1000 employees. Use it as a stand-alone program or integrate it with either of our ledger programs.

Cash Ledger

This is a full-featured accounting system for businesses or organizations using cash-basis reporting. It can also be used by accountants or other professionals who require "write-up" capability.

WE COULDN'T HAVE SAID IT BETTER

"If your preference is for lean, no frills software, you may find that this program wins out over more elaborately packaged rivals."

Macintosh Today
June 20, 1985 / page 28

"This program is so good that if it's the first one you test, I can almost guarantee you it will be the only one you test."

"Computer Output" column
Oshawa Times (Toronto)

"My favorite all-around accounting program is CheckMark Software's MultiLedger Payroll set. It was the simplest and most logical program I examined that provided a reasonably full set of accounting capabilities. Its price/performance ratio represents an excellent value."

Macworld
September 1988 / page 169

MultiLedger - \$395.00
Payroll - \$295.00
Cash Ledger - \$195.00

Full-functioning demo disks available
Dealer inquiries welcome

CHECK MARK
SOFTWARE INC.

1520 E. Mulberry / Suite 200
Ft. Collins, Colorado USA 80524
303-484-3541 In Canada 416-731-0744

800-444-9922 ext 51

How To/Quick Tips

tings. These settings are retained while the Mac is off and when you restart with another startup disk.

Incidentally, Map estimates the time zone for a newly added location from its longitude. Many time-zone boundaries are determined politically, however. For example, let's say Map guesses your hometown of Curtis is in the Mountain time zone, whereas it's actually in the Central time zone. You can manually enter the proper hours and minutes and click Add City to record the new location. If the Add City button is dimmed, click the Remove City button first.

ImageWriter Color

Tip: Does your ImageWriter II print a rainbow where it should print a solid color? My dealer says this is a common problem with many different brands of color ribbons. The ImageWriter II's ribbon-adjustment mechanism (described in *ImageWriter II Technical Reference*, published in 1987 by Addison-Wesley) isn't always adequate. The solution is to make a shim of masking tape or tiny self-adhesive labels.

Build the shim by layering tape or labels on the underside of the ribbon cartridge in a solid flat area that contacts a flat part of the ribbon deck (see "Color Shimmy"). Don't let the shim touch any holes, depressions, or protrusions. If the



Color Shimmy

If your ImageWriter II self-test prints two colors where there should be one, fix it with a shim made of tape or labels applied to the underside of the ribbon cartridge.

print head is hitting low on the ribbon—for example, if yellow text is red at the bottom—apply the shim to the end of the ribbon cartridge nearest the front of the printer. If the print head is hitting high on the ribbon—red text is yellow at the top, for example—apply the shim to the end of the cartridge nearest the print head.

Test your shim using the printer's self-test feature (hold down the Form Feed button as you switch on the printer). Adjust the thickness of the shim by adding or removing layers of masking tape or tiny labels to get the best results. Don't make the shim so thick that you can't snap the cartridge into place easily, though. I used 22 labels (about 3/16-inch thick overall) to correct one of my ribbons, and the cartridge still snapped into place easily. If you have to make the shim so thick the cartridge won't snap into place, give up and get another ribbon.

Greg Pitt
Superior, Wisconsin

Flush Left with Indents

Tip: Here's an easy way to do indented paragraphs and flush-left subheads in MacWrite: Set the automatic first-line indentation, but also set an ordinary tab about two characters from the right margin (see "Flush Indents"). At the end of a regular indented paragraph, press Return and then Tab. The next line appears flush left, ready for a subhead. (If it doesn't, move the tab closer to the right margin.) This method works with any word processor that allows automatic indents.

Shel Horowitz
Northampton, Massachusetts

Pressing Return, as you suggest, places a blank line above the subhead. To suppress the blank line, press Tab without pressing Return. If you have other tabs set, you may have to press Tab more than once to get to the next line. And if the first word of the subhead is short enough that it remains at the end of the previous line, you may have to prefix it with a few blank spaces to make it appear at the left margin.

Moving or Resizing

Tip: In MacDraw and MacDraw II, choosing the Show Size command from the Layout menu makes it easier to tell whether you're moving or resizing an ob-

(continues)

We challenge the competition to match our five year warranty. We'll even give them the plans!

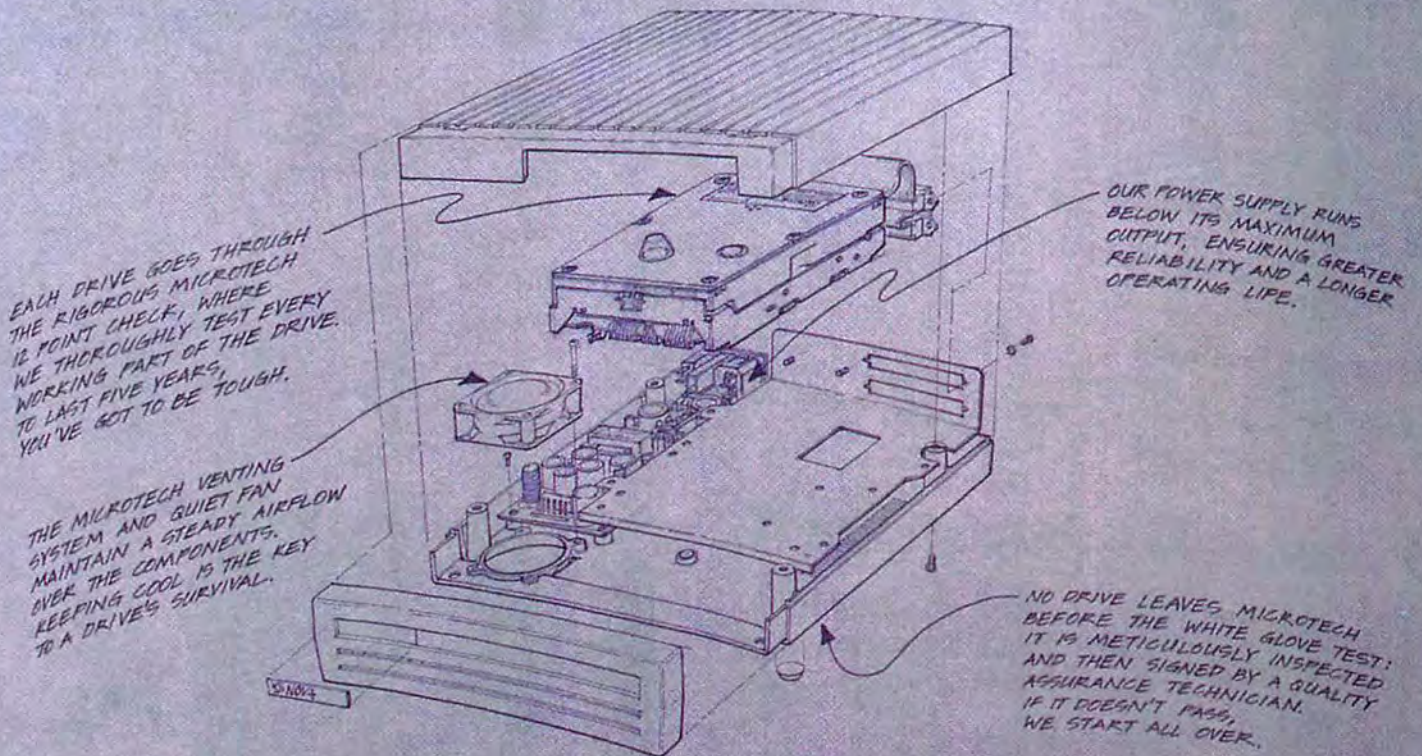

Other manufacturers offer you a one, maybe two year warranty on their hard disk drives. Which probably tells you something about the way they make them.

Only Microtech gives you a five year limited warranty. And that says a lot about the way we make ours.

In fact, when you buy a Microtech internal or external hard disk drive for your Macintosh, you're getting the product of superior design. Top of the line components. Excruciating quality control. And the most dedicated service and support staff in the business.

Size for size, you're also getting the fastest drives available. Each one bundled with MacTREE Plus, the hard disk management system, and DS BACKUP. And all for the most competitive pricing around.

SIZE	ACCESS TIME	INTERNAL	EXTERNAL
20	65	N/A	\$ 532.00
40	19*	\$ 599.00	\$ 679.00
80	19*	\$ 949.00	\$1039.00
100	19*	\$1099.00	\$1199.00
150	16	\$1399.00**	\$1469.00
320	18	\$2699.00**	N/A

* Quantum's DisCache allows access times to drop as low as 12 ms.
 ** Available for the Macintosh II and IIx only.

So for quality, economy, and five full years of unmatched performance, insist on a Microtech hard disk drive.

For the rest of you guys, it's back to the drawing board.

Call now to place your order or for more information.

MICROTECH
INTERNATIONAL, INC.

29 Business Park Drive, Branford, CT 06405

1-800-325-1895
(203-488-7744 in CT)

© 1989 Microtech International, Inc. All product names are trademarks or registered trademarks of their respective owners. The 5 year limited warranty is offered at no extra cost on hard disk drives sold and delivered in the U.S. or Canada. Certain restrictions and exclusions apply. Terms and conditions of the 5 year warranty are available upon request. Prices and specifications subject to change without notice.

MasterCard and Visa accepted at no extra charge.

Circle 243 on reader service card

Flush Indents

This MacWrite formatting ruler gives indented paragraphs when you press Return, but lets you create flush-left headings by pressing Tab once or twice to get to the start of a new line.

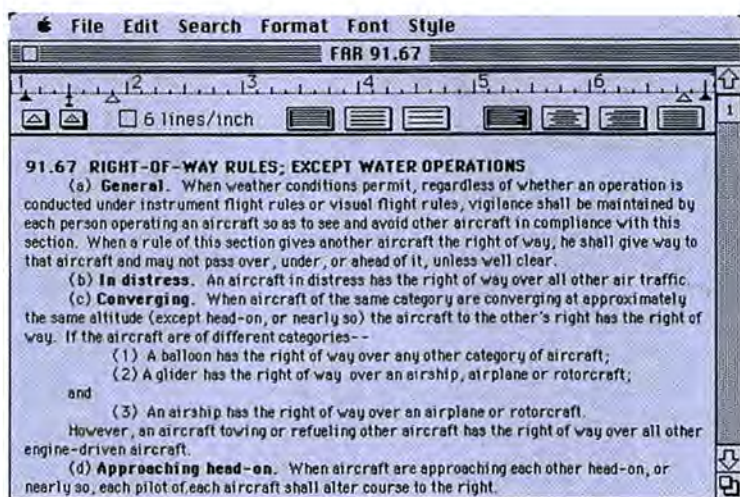

Use a backup application that lets you back up and restore a single file, like HDBackup. Apple includes HDBackup with the Macintosh System Software. Or better yet, use a file-compression utility such as StuffIt, which can reduce file size 40 to 50 percent. It's shareware, available from user groups (BCS Mac at 617/367-8080 or BMUG at 415/549-2684) or from the author (\$18 to Raymond Lau, 100-04 70th Ave., Forest Hills, NY 11375). □

We pay from \$25 to \$100 for tips published here. Send tips or questions (include your address and phone number) to Quick Tips, Macworld, 501 Second St., San Francisco, CA 94107. Send electronic mail to CompuServe (70370, 702) or MCI Mail (addressed to Macworld). All published submissions become the property of Macworld.

ject. If the size changes as you drag, then you're resizing. If the size disappears in MacDraw, or is replaced by offsets in MacDraw II (look for ▲ symbols in the measurements), then you're moving the object.

David L. Chang
Okemos, Michigan

Bagging the Big Ones

Tip: Have you ever scanned an image at a service bureau only to discover that it

wouldn't fit on an 800K disk? You had room for it on your hard disk, but no way to get it there. Next time take a copy of a backup application and several blank floppy disks. Scan your images to the service bureau's hard disk. If an image exceeds 800K, "back up" the file to your blank disks. Back at your Mac, "restore" the file to your hard disk.

Diana Shannon
Princeton, New Jersey

Prevent Macintosh Theft!



MacKablit System

Heavy duty 10' steel cable (7 x 19) secures and locks computer, printer, other equipment, up to 4 components. The unique MacKablit system includes 2 brackets that snap into existing slots on the Macintosh keyboard and computer. Additional hardware included for other Mac peripherals (disk drive, printers). The unique MacKablit system utilizes existing security slots on the keyboard and computer and existing screws in other peripheral equipment. The system includes 2 brackets for the security slots plus unique Kablit fasteners for peripherals. Cable passes through Kablit fasteners, preventing removal of screws

EXCLUSIVE!

Proprietary components (Pat. Pend.) permit only your key to release MacKablit. When ordering multiple units, specify locks to be keyed differently or alike. Specify Mac, Mac Plus SE, or Mac II.

Other Kablit systems for IBM, Apple, others.



\$39.95 + \$3.00 shipping/handling

Quantity pricing also available for multiple purchases from schools, institutions, businesses, industrials, etc. Send P.O.



Money back if returned in 30 days. Phone or send check.

Secure-It, Inc.

18 Maple Court
East Longmeadow, MA 01028
800-451-7592 413-525-7033
Dealer Inquiries Invited

Circle 239 on reader service card

Affordable Large Format Plotting



C-D
\$1695
(Sugg. ret. \$2295)

A-D
\$2295
(Sugg. ret. \$2695)

A-E
\$2695
(Sugg. ret. \$2995)

Features that say value...

Economical: \$1,000 less than other large format plotters.

Compatible: Operates with all popular CAD software supporting DM/PL.™

Multiple Media Sizes as small as 8½" x 11" or as large as 36" x 48" eliminates the need for a second plotter.

Practical speed you can really use: 10" per second assures good drawing throughput while optimizing the speed at which most plotter pens can draw without skipping.

Repeatability and Resolution: .004 assures quality suitable for the most demanding applications including PCB artwork.

Vacuum Paper Hold Down guarantees perfect registration.

CALL NOW AND WE'LL SEND YOU A FREE SAMPLE PLOT.
(415) 490-8380

Dealer inquiries invited.

ZERICON
40491 Encyclopedia Circle, Fremont, Ca 94538

DM/PL is a trademark of Houston Instrument

Circle 267 on reader service card

If finding a lot of memory is turning into a circus, call Microtech.

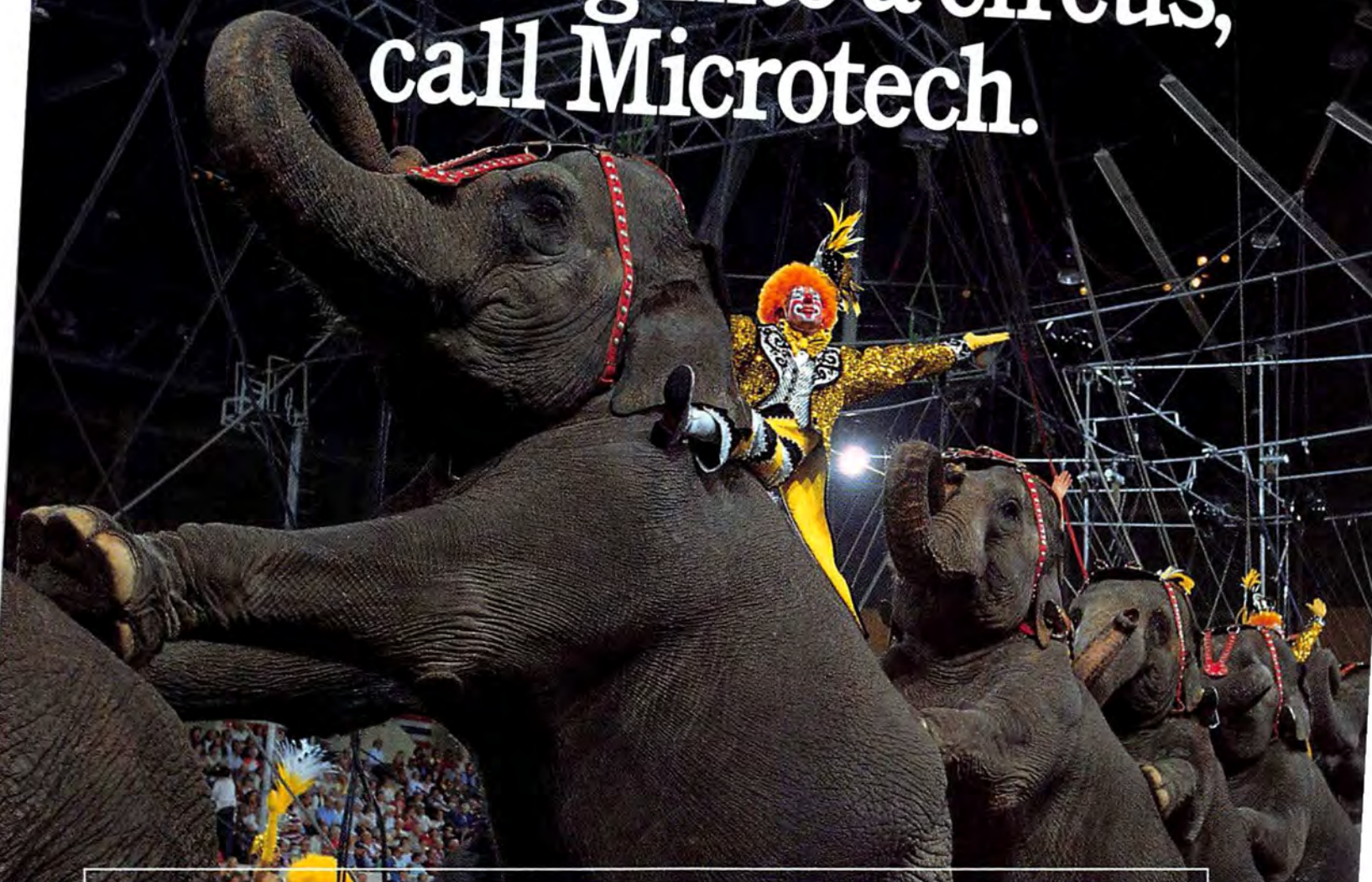

Some companies just take your order for SIMMs, then pack up their tents and move on. Another city, another show.

Next time call Microtech. We're the Macintosh memory experts. In fact, we're the nation's biggest independent supplier of Macintosh memory, serving all kinds of companies, from Westinghouse and WordPerfect, to General Electric and the U.S. Department of Energy. And for some very good reasons.

We maintain a mammoth inventory of 2-8* MB SIMMs for the Macintosh Plus, SE, II, IIx and LaserWriter II, ready to ship today. Each one is tested,



and re-tested before it goes out the door. So they never come back.

Add to that our unbeatable pricing, prompt service and after sales support, and you've got the greatest memory company on earth.

So, the next time you need memory, the choice is clear. Call Microtech.

**MICROTECH**
INTERNATIONAL, INC.

29 Business Park Drive, Branford, CT 06405

1-800-325-1895
(203-488-7744 in CT)

* 8 MB SIMM kits for the Macintosh II, IIx and LaserWriter II. Prices and availability subject to change without notice.
© 1989 Microtech International, Inc. All product names are trademarks or registered trademarks of their respective owners.

MasterCard and Visa accepted at no extra charge.

Circle 62 on reader service card

- Parts Schedule
- Materials List**
- Cost Estimates
- Door Schedule

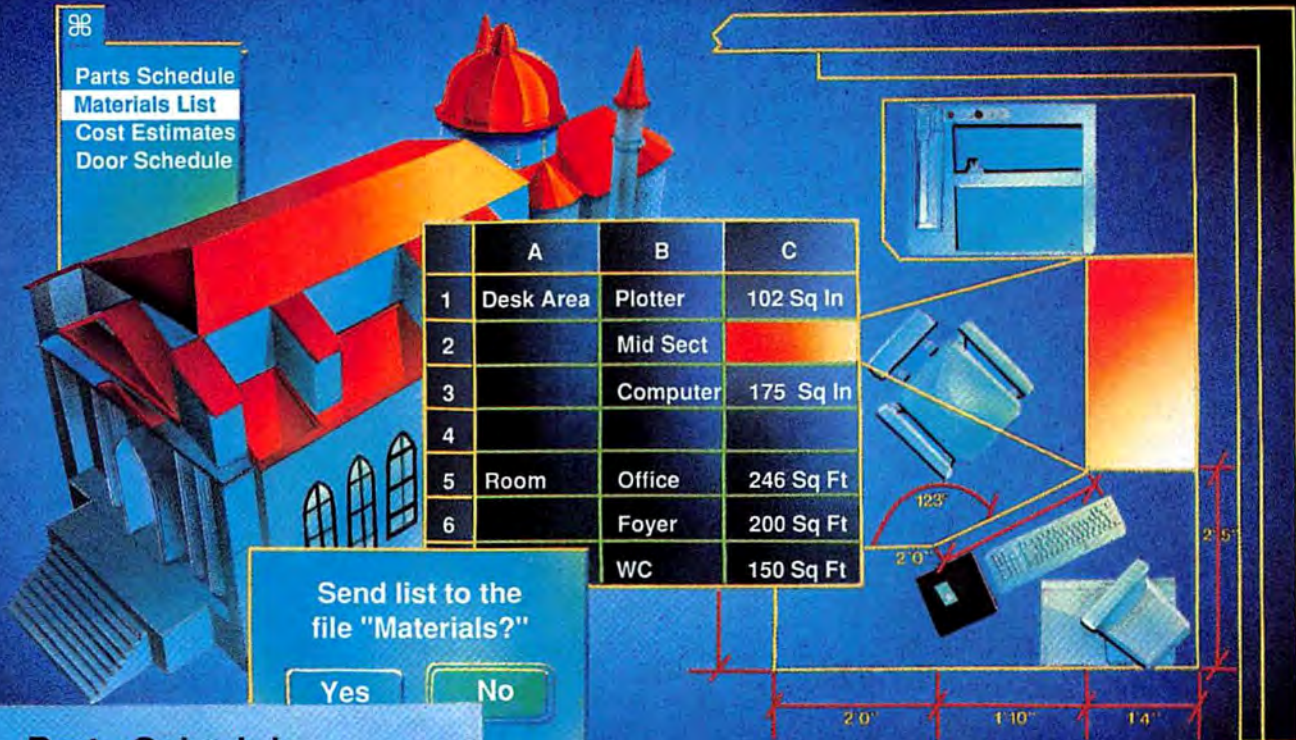

	A	B	C
1	Desk Area	Plotter	102 Sq In
2		Mid Sect	
3		Computer	175 Sq In
4			
5	Room	Office	246 Sq Ft
6		Foyer	200 Sq Ft
		WC	150 Sq Ft

Send list to the file "Materials?"

Yes No

Parts Schedule

Cost Estimates

Materials List

Des	Qty	Description	
		Surface Materials	23.45
337	36	5/8" Wall Board 5' X 10'	14.50
326	142	1/8" Tile - Mosaic	56.95
347	2689	Brick - Chicago	12.00
352	63	Siding Alum (Sky Bl)	78.95
367	12	Paneling (Oak)	12.00
			05.00
			67.45
		Wall Fixtures- Elec:	34.00
645	24	Wall Outlets	78.00
682	18	Single-Pole Switches	62.00
664	4	Modular Phone Jacks	\$5.00
669	3	CTV Plug-In	34.00
628	1	Thermostats	67.89
			45.00
		Plumbing Fixtures:	12.00
285	4	Single Faucets	
224	2	Tub/Shower Enclosure	
249	2	Water Closet	
216	3	Utility Sinks	
037	1	Utility Washer/ Dryer	

MiniCad+™

Computer-Aided Design and Analysis comes of Age

MiniCad+ rises on the foundations of a groundbreaking Macintosh CAD program, MiniCad 2D/3D. Universal in aim, MiniCad Plus is a total design and analysis solution, the answer to time-consuming transfers between applications. This professional CAD system offers the following easy-to-use components:

- High precision 2D drafting environment which includes complex duplication with arrays, hierarchical symbol editing with both external and internal libraries, fillets, bezier & cubic splines, auto-join, auto-dimensioning, continuously variable zoom up to 1000x, double-line tools with auto-clean up, 256 user-definable attributes, 8 line types, unlimited layers, full use of Mac II, and more...
- Active spreadsheet inside drafting area which can be hot linked with objects to perform area calculations, parts schedules, cost estimation and more. As easy-to-use as the spreadsheet you're using now.
- All new integrated 3D that is so powerful and user-friendly we may change your mind about micro 3D.
- MiniPascal, a programmable macro language, will allow advanced users and 3rd party vendors to create reports, macros, and powerful extensions to MiniCad Plus's capabilities.

Graphsoft • 8370 Court Ave. Suite 101 • Ellicott City, MD • 21043

MiniCad+ \$695 • Demo Available for only \$19.00

MiniCad Plotter Drivers: Prof. \$300 Stand. \$150

U.S.: 1 (301) 461-9488 • Canada: 1 (604) 384-2131 • Australia: 61-7-369-1204

Visa & MasterCard Welcome

Circle 77 on reader service card





Getting Started with Tax Software

Will tax-preparation software save you money or waste your time? Read the attached and write your answer on Line 6, Part A.

by Jim Heid

Filing a tax return is more taxing than ever. Orbiting around Form 1040 are more than 30 schedules and forms for reporting everything from business expenses to the income of children under age 14 who have investments. And the Tax Reform Act of 1986 didn't make things any easier. Replacing multiple tax brackets with just two tax brackets sounded as if it would simplify the process, but remember that the bill was drafted by politicians. Behind the tax act lurks one of the most drastic tax-system overhauls in United States history. Dozens of new rules, new interpretations of old rules, and reams of new forms and schedules have made completing a tax return as easy as filling out a checklist—for a space shuttle launch.

Several tax-preparation packages are available for the Mac. Most work along with a spreadsheet program such as Microsoft Excel; one is a stand-alone application; and another runs under Apple's HyperCard. Although they all work differently, they do share a common claim: that using the Mac to prepare tax returns will save time and money.

Don't believe it—at least not without doing some research first. The tax world is

The author wishes to thank Barton Goodeve for sharing his expertise with tax law and tax-preparation software.

Jim Heid is a Macworld contributing editor who focuses each month on a different aspect of Mac fundamentals.

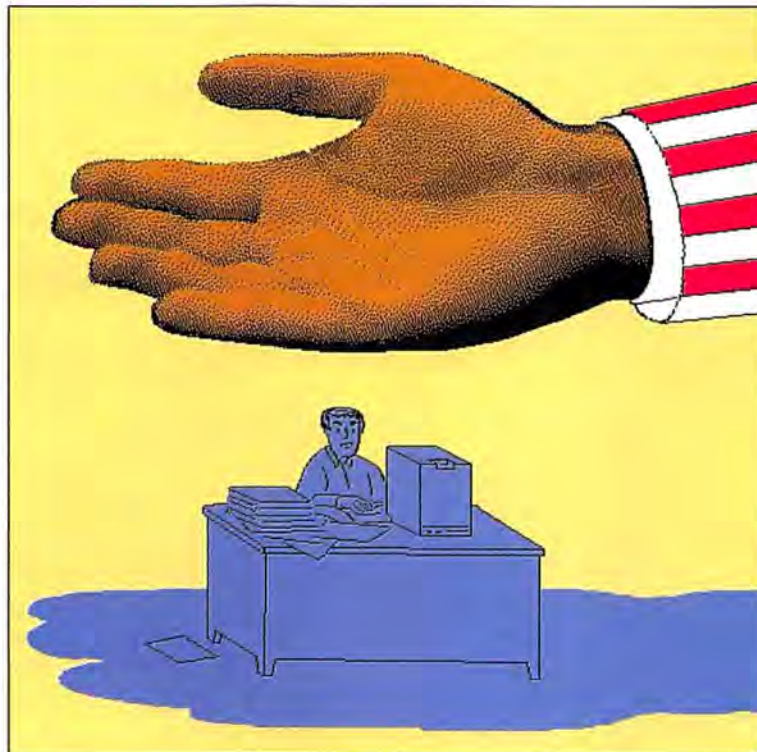

SCOTT BALDWIN

too complex for such claims to apply to everyone. Tax-preparation software works for some people, but it is important to determine whether or not you're in the lucky group. This month, we'll tour the world of Macintosh tax software and look at the factors to consider before you decide whether or not to computerize your return. If you aren't interested in taking chances with tax

software yet, see "Every Little Bit Helps," to learn about other ways the Mac can assist at tax time.

Filling In the Blanks

Given that completing a tax return involves plugging in numbers and calculating sums, it's not surprising that most tax software runs along with a spreadsheet pro-

(continues)

The proven resource for Macintosh systems & support.

1 MB SIMM's



**5 Year Manufacturer's Warranty
Lowest Price Call!**

**Quick Memory 120ns, 100ns, 80ns
Surface & Dip Available**

MAGIC DRIVE INTERNAL

- 300 mb** (For Mac II) **\$1995**
 - 150 mb** (For Mac II) **\$1395**
 - 91 megabyte** (For Mac II, SE) **\$995**
 - 80 megabyte** (For Mac II, SE) **\$749**
 - 60 megabyte** (For Mac II, SE) **\$599**
 - 46 megabyte** (For Mac II, SE) **\$599**
 - 40 megabyte** (For Mac II, SE) **\$559**
 - 30 megabyte** (For Mac II, SE) **\$475**
- external drives available

VIDEO BOARDS

Raster Ops

- Color Board 104** **\$3299**
4-bit True Color, graphics board
- Color Board 108** **\$1149**
8-bit, high-res graphics board
- 19" Trinitron Monitor** **\$2999**
Finest monitor available today!
- Cornerstone FPD** **\$795**
Full page display!
- 19" B/W for Mac II** **\$1499**

MAGIC NET



**100% Flash Box, Local Talk,
Phone Net Compatible
SALE.....19.95**

3 MB LASER PRINTER



- Qume CrystalPrint** **\$3295**
- Jasmine Direct Print** **\$3395**
- Qume ScriptEN** **\$3395**
- General Computer** **call**
- ColorScript 100**.....**call**

MAGIC MODEM 2400



**100% Hayes Compatible
2400 Baud
2-Year Warranty **\$129****

SOFTWARE

We carry over 2000 software products for your Mac, so please call and ask for items not listed in this advertisement.

- Fox Base +** **205.00**
- Mac Link + 139.00
- Mac Recorder 139.00
- Canvas 2.0** **169.00**
- Sum 59.00
- TOPS 119.00
- Managing Your Money 129.00
- LightSPEED C** **95.00**
- Reader Rabbit 33.00
- Typing Tutor 4 38.00
- Early Games 28.00
- WriteNow 2.0** **139.00**
- Adobe Fonts Save 33%
- Quark XPress 2.0 499.00
- Suitcase II 48.00
- Microsoft Products** **call**
- MiniCAD +** **489.00**
- Hyper DA 41.00
- PageMaker 3.0** **395.00**
- Persuasion 355.00
- MS Works 2.0 199.00
- Freehand 355.00
- Illustrator '88 325.00
- MacInTax '88** **69.00**
- SuperPaint 2.0** **108.00**
- MacDraw II 299.00
- QuickKeys 33.00
- Microphone II 225.00

HARDWARE

We will meet or beat any price on CMS, Crate, Everex, Magic, GCC, PCPC, Rodine, Jasmine, Relax.

- | | | |
|-------------------------------|----------------|----------|
| | Internal | External |
| 20meg | 399.00 | 499.00 |
| 40meg | 559.00 | 649.00 |
| 60meg | 599.00 | 749.00 |
| 91meg | 995.00 | 1395.00 |
| 150meg | 1395.00 | 1750.00 |
| 300meg | 1995.00 | 2500.00 |
| 600meg | 3995.00 | 3995.00 |
| Grappler LQ | | 95.00 |
| Cutting Edge 800K | 179.00 | |
| 2 Meg Upgrade (Mac II) | 325.00 | |
| A+ Mouse | | 63.00 |
| Thunderscan | 189.00 | |
| Kraft Quick SE, + | | 35.00 |
| Mac SE, II, ??? | call | |
| Macintosh Plus | 1349.00 | |
| Apple Scanner | 1459.00 | |
| FAX Modem Abaton | 379.00 | |
| TOPS Flash Box | 129.00 | |
| 9600 Baud Modem | | 695.00 |
| Kensington Security Kit | | 35.00 |
| Universal PrinterStand | 12.00 | |
| 105 Keyboard | 129.00 | |
| Fanny Mac QT | | 59.00 |
| Tape Backup 60mb | | 699.00 |
| Mac Recorder | | 139.00 |
| MIDI Interface | | 87.50 |
| Turbomouse 3.0 | 119.00 | |
| Seiksha Printer | | 234.00 |
| Write Move printer | | call |

ACCESSORIES

- | | | |
|---------------------------|-------------------|------------|
| Disks: | DS | SS |
| Sony (10) | 19.00 | 12.90 |
| Sony Bulk (50) | 1.44 | 1.21 |
| MacDisk Bulk (50) | .99 | .98 |
| KA0 Bulk (50) | 1.35 | 1.35 |
| KA0 Boxed | 15.50 | 12.00 |
| Black Ribbons | 2.75 | |
| Colored Ribbons | | 3.50 |
| ImageWriter LQ Ribbons | | 15.00 |
| ImageWriter LQ 4-Color | | 25.00 |
| Mac Plus, SE Bag | 59.00/69.00 | |
| Teak Disk Box 50/100/150 | 16/25/33 | |
| Disk File/30/80 | 7.00/12.00 | |
| MagicNet Connector | 19.95 | |
| MacBible Version II | | 18.00 |
| MacGuard Surge | | 25.00 |

BOARDS/UPGRADES

- 030 Railgun 4995.00
- Daystar 68030 5250.00
- Orion II call
- Novy Mac 20my 16mhz 599.00
- Novy Mac 20my 25 mhz 1099.00
- Orion 16 mhz 699.00
- Epic 2400 Internal 289.00
- 6881, 882 Co-Processors call
- Magic SCSI** **69.00**
- Dove SCSI 99.00
- 512K-1024 Upgrade** **249.00**
- 128K-512K Upgrade 299.00
- 128K-1024K Upgrade 499.00
- 800K Drive & ROMS 299.00
- Dove Upgrades call

ORDERING

Orders ONLY: 1-800-622-3475
Information: 1-512-343-9441
FAX: 1-512-343-6141
Tech: 1-512-343-6133

Hours: 7am - 10pm, M-F, 10am - 6pm Sat-Sun CDT

Minimum Order: \$40.00

Payment:



American Express, Visa, MasterCard (No surcharge), Checks, C.O.D., and Company & Institution P.O.'s. Net 10.

Tax: Texas residents only, add 8% sales tax.

Prices and items are subject to change and availability.

Terms: You are not charged until your order is shipped. Returns may be subject to a restocking fee.

Shipping: Minimum \$4.50 - Airborne, UPS Next Day & 2nd Day Air, US Mail.

FREE UPS Ground on pre-paid orders under 40 lbs.

MacProducts USA carries over 3500 products for the Mac, so call for products not listed. Call for a free catalog.

MacProducts USA

8303 Mopac Expressway • Suite 218 • Austin, Texas 78759 • USA

1-800-MAC-DISK

omniPAGE™

Customer Profile

Regis McKenna

Age: Old enough to remember the day that Intel Corporation was founded.

Profession: Chairman of Regis McKenna Inc., a major marketing company based in "Silicon Valley." A general partner in the venture capital firm of Kleiner Perkins Caufield & Beyers. Author of the *Regis Touch* and most recently, *Who's Afraid of Big Blue?**

Hobbies: Enjoys doing extensive research on innovative new technologies. He recently became involved in building and archiving an extensive database, using state-of-the-art page recognition software.

His Page Recognition Software: *OmniPage* of course. According to Regis: "*OmniPage* represents one of the most complete page recognition software products; providing incredible flexibility to customize data which can be easily accessed later. All of a sudden the cost of archiving and retrieving data has dropped significantly. The 'Information Age' is upon us and we have an exciting new tool!"

Favorite Quote: The New York Times: "*OmniPage* could be the most significant advance in personal computing this year."

Things Disliked Most: "Technology that is not easily accessible or powerful enough to serve the needs of people."

Favorite Scan: "I'm using *OmniPage* to build an extensive electronic library that pertains to the growth and evolution of technology over the past 25 years. Being able to scan literally any article, regardless of layout or column format, has suddenly made this all possible. It's eliminated the labor intensive task of data entry. I'll be able to share this information with employees, customers and colleagues over time. It's an exciting collection of business case studies for future reference."

Future of Page Recognition: "*OmniPage* has provided me with the customizable tool that I need. I can use the Partial Page feature to scan only that text which is relevant to my needs. Having a version that runs in MS-Windows should impress those who are committed to that environment. What we're seeing here is the emergence of a new product category."

omniPAGE

Omni-Page (one of page), Latin from omnis, meaning "all." 1. Any font, computerized. 2. The most advanced page recognition software available in MS-DOS and Macintosh environments. 3. Allows you to scan any page format, including multiple rows and columns of text and graphics. 4. A modern look with extensive online user support applicable for Desktop Publishing (DTP) and designed to eliminate 100% of the error rate. CAERE Key Stroke.

For More Information Write: Caere Corporation 100 Cooper Court
Los Gatos, CA 95030 Or Call: 1-800-535-SCAN

OmniPage is a registered trademark of Caere Corporation. MS-DOS and MS-Windows are trademarks of Microsoft Corporation. ©1988 Caere Corporation.
*Regis McKenna's exciting new book, *Who's Afraid of Big Blue*, is available in hardcover and published by Addison-Wesley Publishing. © Copyright 1988, Caere Corporation. All rights reserved.

CAERE®

Circle 426 on reader service card

Every Little Bit Helps

Lightening the load at tax time doesn't have to mean using a tax-preparation program. The Mac can help in other ways.

■ **Tax planning.** Many tax software firms also offer tax-planning software. With products such as EZWare's Microsoft Excel-based EZTax-Plan and SoftView's TaxView Planner, you enter key figures from last year's return, and the software projects your taxes for this year. From there, you can experiment with different strategies—such as increasing IRA deposits or postponing a major purchase or sale—and see how they would affect your taxes. Using tax-planning software is

also an ideal first step toward computerizing your return, since you'll learn about tax regulations and preparation. And because you don't sign the result and submit it to the IRS, there's no risk.

■ **Organizing deductions.** Instead of handing your tax preparer a shoebox filled with receipts, use a database manager or a spreadsheet program to itemize and total your deductions according to the categories on Schedule C. By doing this groundwork, you'll save money on preparation fees.

■ **Accounting.** A classic problem in tax preparation oc-

curs when figures don't *prove out*—that is, when net profit doesn't equal gross profit minus expenses. At the heart of this problem is a failure to accurately record expenses and income. Accounting software can help you do that, and can also provide an *audit trail*—a report that lets you retrace your accounting steps to verify a calculation or track down a specific piece of information. For details on accounting software, see "Who Keeps the Books?" *Macworld*, September 1988.

gram. EZWare's highly regarded EZTax series, Island Computer's Taxmaster, and Chesapeake Software/MG's Tax Pro each consist of a number of spreadsheet documents that you open and use with Microsoft Excel (which you must buy separately).

Spreadsheet-based tax programs take advantage of a spreadsheet's ability to calculate numbers according to stored formulas. (For spreadsheet basics, see "Getting Started with Spreadsheets," *Macworld*, July 1988.) With most packages, each IRS form and schedule is stored in a separate document that's *linked* to a Form 1040 document. When you complete a given form or schedule—such as Schedule B, for reporting interest and dividend income—the software copies its total to the appropriate line on Form 1040, thus eliminating the error-prone task of manually copying one form's total to a line on another form (see "Spreadsheet Taxes").

Another benefit of spreadsheet-based tax software is that it lets you plug in different numbers to see how they affect your return. What if I stashed more money in my IRA? What if I depreciated the laser printer over a longer period? What if I didn't report my gambling winnings? With tax software, answering such questions is as easy as typing in new values and watching the spreadsheet recalculate. Of

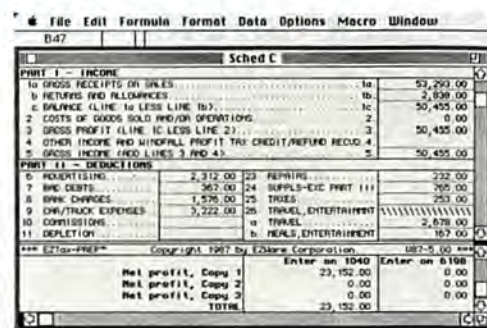
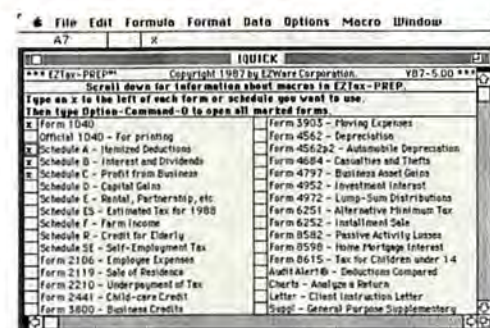

Spreadsheet Taxes

With EZWare's EZTax-Prep, used with Microsoft Excel, the first step in filing a return is to open the forms and schedules you'll need (Part I). In Part II, Schedule C is being completed. In Part III, EZTax-Prep has copied the total from Schedule C to the appropriate line on Form 1040. The bottom of the Form 1040 document displays a running total of taxable income and the taxes owed.

course, you have to know enough about tax ambiguities to ask the questions in the first place.

One tax product that doesn't require Excel but provides the same "what-if" benefits is SoftView's MacInTax, which has

won *Macworld's* World-Class award for tax-preparation software two years in a row. MacInTax takes the Mac's what-you-see-is-what-you-get operating style to its limit by displaying accurate facsimiles of the IRS's own daunting documents. Filling

(continues)

Fast Statistics.

Because you don't have time to waste.

You don't have time to read a 1000 page manual, to play games, to wade through a pile of confusing menus.

You have lots of data.
You need graphs, tables, financial projections, surveys.
The report is due tomorrow and the stat package you thought had everything can't do the job.

Now you can do it.
The company that brought professionals "the best statistics package on the Macintosh"* introduces the *easiest*: FASTAT.
Designed just for the Macintosh, FASTAT makes high-powered, accurate statistics easy.

You can do dependent and independent t-tests, time series analyses, factor analysis, two-way and n-way tables, correlations, nonparametric tests, regressions, analysis of variance and covariance, exploratory data analysis — even if you've never done them before.

You can also create full-featured graphics such as X-Y plots, bubble plots, line plots, histograms, box-plots, stem-and-leaf diagrams, autocorrelation and time series plots, as well as state-of-the-art displays, like scatterplot matrices.

Some of the graphs are only a click away.
Click on a variable name, and you get a histogram or a box plot of the variable. Click on a regression output or a cell in a correlation matrix, and you get a scatterplot of the variables.

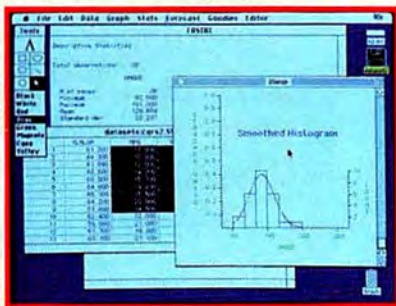

Need to customize a graph?
With FASTAT's MacDraw-like tools you can color, draw, add text, and move things.

Need help understanding a statistic?
FASTAT's "pop-up tutor" tells you what the numbers mean.

Need reports?
FASTAT's built-in text editor lets you scroll through results, cut and paste, change fonts, add explanatory notes, and save your work.

System requirements: 1 megabyte of memory and hard drive.
Mac II version available. Unlimited free technical support.

Dealers circle 492 on reader service card
End users circle 491 on reader service card

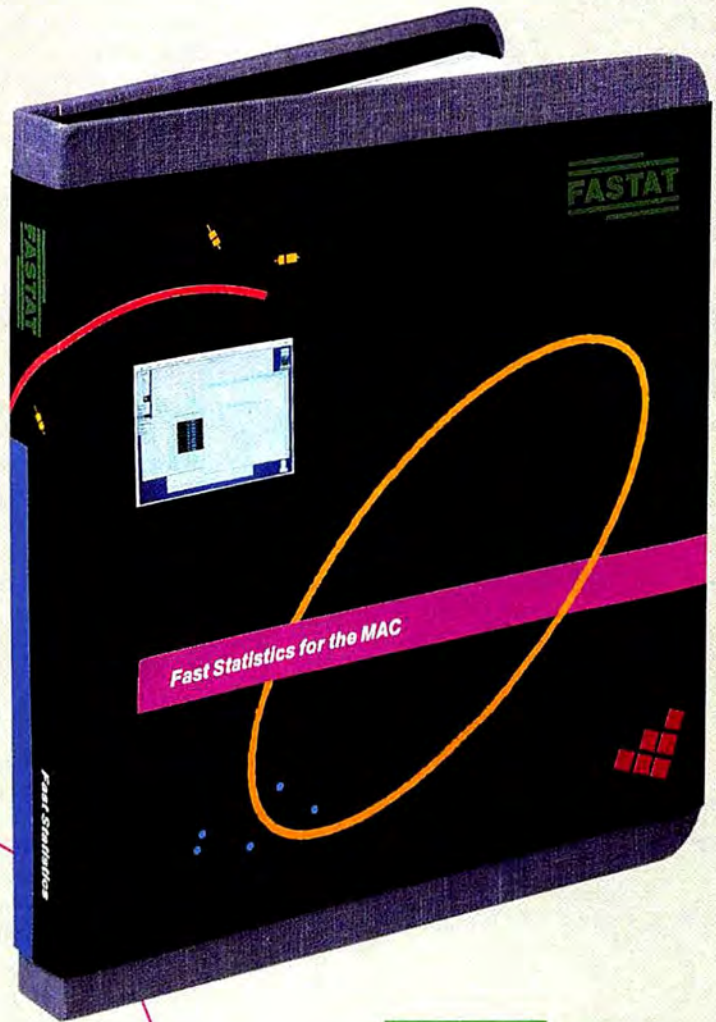

FASTAT

For \$195,** you can stop wasting time.

Systat. Intelligent software.

Call or write for further information:
SYSTAT, Inc.
1800 Sherman Avenue, Evanston, IL 60201
312 864.5670 FAX 312 492.3567

*MacWeek September 13, 1988
**Suggested Retail Price

How To/Getting Started

out a MacInTax form is similar to completing a paper form, except that you don't need an eraser.

Or a calculator. Like a spreadsheet, MacInTax calculates values for you. When you arrive at a line that requires a total from another form or schedule, double-click in the space where that total should appear and the related form appears for you to fill out. MacInTax copies the total from this form to the appropriate line of Form 1040 (see "Filling In the Forms"). MacInTax even includes electronic versions of the IRS's instructions. Double-click on a given line, and a window appears containing the IRS's instructions for that line.

Filling In the Forms

With MacInTax, you complete a return by filling in accurate on-screen facsimiles of IRS forms. In a line that requires figures from a different form or schedule, double-clicking on the space where the numbers should appear brings up the related schedule. Here, in line 8 of Form 1040, MacInTax has copied the total from Schedule B (shown in Part II).

With MacInTax you can enter different values as you work on your return to test different strategies. MacInTax has more smarts—technically speaking, it performs more *error trapping*—than many spreadsheet-based products. For example, if you enter a Social Security number for a spouse, and then specify your filing status as single, MacInTax notifies you of the inconsistency. And because MacInTax is a stand-alone application, you don't have to own Excel in order to use it.

Questions and Answers

If you prefer more hand-holding in your tax software, check out StackWorks' Tax Stacks, which was in development at this writing and scheduled for delivery in January 1989. Tax Stacks runs under Apple's HyperCard and takes a very linear, stepwise approach to completing a tax return. With spreadsheet-based products and with MacInTax, you can move to another form without completing the form you're working on—just as if you were jumping from one paper form to another on your desk. With Tax Stacks, you prepare a return by working through a tax questionnaire that uses yes/no questions and accurate facsimiles of key schedules and forms to gently interrogate you for the necessary information (see "Taxes in HyperCard"). When you've finished, you can preview the return on the screen and correct entries by clicking on them, and you can print IRS-approved hard copy.

If you're a tax novice, Tax Stacks' stepwise approach may be best for you. Because you can't easily jump between forms, you're less likely to forget to enter a key value. If you can't complete a given card, click on the card's flag icon, and Tax Stacks returns to it later. Other icons display IRS instructions, a calculator, and a notepad. And when you get depressed thinking about how your tax dollars are spent, click on the joke icon to read one of Tax Stacks' many built-in tax jokes, which include knee-slappers like "Give a politician a hand, and he'll put it in your pocket."

As you can see, each category of tax-preparation software relies on different data-entry techniques: from navigating spreadsheet cells to shuffling on-screen IRS forms to completing a questionnaire. Which approach is best? At first glance, you might assume that MacInTax's approach is more Mac-like because it accurately repro-

(continues)

Taxes in HyperCard

Tax Stacks runs under HyperCard and turns tax preparation into a question-and-answer session. In Part I, the desired form is being specified. Checking the "I don't know" box displays the IRS instructions telling you which form to consider filing. After a few more questions, you reach the card in Part II, which asks if you have forms W-2 or W-2P. If you answer "Yes," the appropriate form appears so that you can enter its contents (Part III). The interrogation process continues until Tax Stacks has the information it needs to complete your return. Part IV shows a Tax Stacks preview of a completed Form 1040.

Hello, Springboard Publisher.™ Good-bye, word processing.



New Desktop Publisher
Wins Critical Acclaim:

-  Easy To Use
-  Great Features
-  Incredible Price
\$199.95

Springboard Publisher™ makes desktop publishing so easy, you'll choose it over word processing for just about everything you do, every day.



Page Layout Word Processing Graphics Creation

Springboard Publisher™ gives you the best features of MacWrite®, MacPaint® and PageMaker®—all in one program.

New Springboard Publisher™ puts page layout, word processing and graphics creation at your fingertips. All in one program.

So you can "click" your way from layout to text to graphics without ever leaving your page. Or juggling between programs.

It's all so simple. So affordable. So much more fun than plain ol' word processing.

And most important, Springboard Publisher

helps you communicate more effectively, persuasively and dramatically. Every day. In practically everything you do.

Call for your Demo Disk* to preview Springboard Publisher as well as six other new programs.

Say "hello" to Springboard Publisher. And you'll soon have just one word for word processing.

"Good-bye."

Call for Demo Disk 1-800-445-4780, Ext. 4020
\$5 charge (VISA/MC) refundable with purchase.



SPRINGBOARD

Springboard Software, Inc. • 7808 Creekridge Circle • Minneapolis, MN 55435

*HyperCard required. Springboard and Springboard Publisher are trademarks of Springboard Software, Inc. HyperCard is a registered trademark of Apple Computer, Inc. MacWrite and MacPaint are registered trademarks of Claris Corporation. PageMaker is a registered trademark of Aldus Corporation. ©1989 Springboard Software, Inc.

Circle 185 on reader service card

CDA Makes Macintosh® Affordable

Macintosh Plus Entry System

Complete System includes:

- Macintosh Plus Computer w/
 - 1 Megabyte of memory
 - 1 Internal 800 K Drive
 - Keyboard, Mouse & Pad
 - Cutting Edge 800K External Dr.
 - Apple ImageWriter II w/ Cable
 - HyperCard Software
 - Diskettes-Box of 10
 - Computer Paper-Pkg of 500
- Sugg. list \$2760 **CDA \$ 2075**
Specify package #8910

Macintosh Plus 20 System

Same as above system with one internal 800K disk drive and an External Everex 20 Meg. Hard Dr

Sugg. list \$ 3260 **CDA \$ 2399**
Specify package #8911

Macintosh SE Super System

Complete System includes:

- Macintosh SE Computer w/
 - 2 Internal 800K Drives
 - 1 Megabyte of Memory
 - Keyboard and Mouse
 - ImageWriter II Printer
 - ImageWriter cable
 - HyperCard Software
 - Diskettes-Box of 10
 - Computer Paper-Pkg of 500
 - Dust Cover for Macintosh SE
 - Dust Cover for ImageWriter II
 - Mouse Pad
- Sugg. list \$3980 **CDA \$ 3099**
Specify package #8970

Mac SE/20 Super System

Same as the above system except includes one 800K floppy drive and an Apple 20 Megabyte internal hard drive.

Sugg. list \$ 4469 **CDA \$ 3599**
Specify package #8971

Macintosh SE/45 Performance System

Same as the SE/20 Super System except includes two 800K floppy drives and an 45 Meg. (29ms) internal hard drive.

Sugg. list \$5055 **CDA \$ 3799**
Specify package #8945

Write for CDA's Free Catalog

Complete Line of Hardware, Software and Accessories

Shipping Information

Shipping Charges - UPS Ground Shipping, add 3% (\$3.50 min); UPS Blue 2-day service and APO/FPO Shipping, add 8% (\$8.50 min); Alaska, Hawaii, PR, add 6% (\$6.50 min). Foreign Orders - ship via DHL. Please call or fax for rates and more info. Payment Visa, MC, Amex, Discover, Optima welcome. Amex add 2% of order. Cashier Checks and Money orders ship promptly; personal checks are held 10 days for clearing. NO CODs please.

All Prices Subject to change. Apple, Macintosh, HyperCard, LaserWriter and ImageWriter are registered trademarks, & is a trademark of Apple Computer Inc.

CDA

computer sales

CDA Computer Sales P.O. Box 533, Califon, NJ 07830

US/Canada 800-526-5313
NJ/Outside US 201-832-9004

How To/Getting Started

duces on screen what you see on paper. But this approach also assumes that the IRS forms themselves provide the best, most efficient way to enter data—an assumption with which many would disagree. On the other hand, MacInTax checks your entries more carefully than many spreadsheet-based packages—and accurate data entry is more important than fast data entry. As for Tax Stacks, its stepwise approach would slow down experienced tax preparers but may be less intimidating for tax and spreadsheet neophytes.

The Form Factor

Because a tax return's final resting place is on paper, you should also assess a tax program's printing prowess—specifically, its ability to print forms you can sign and submit to the IRS. The IRS accepts computer-printed versions of Form 1040, but the hard copy must accurately mimic the real thing. For most other forms and schedules, you can submit hard copy that differs from the official format, but each line must be visually separated from every other by a horizontal line.

MacInTax and the EZTax series print IRS-accepted Form 1040's. MacInTax prints the other forms and schedules in the IRS format as well. With the EZTax series, you have two ways to produce an official Form 1040. You can print the entire form by using the custom printer driver included with the software, or you can print just the numbers, combine them with a transparent overlay of the form, and then photocopy both to produce the final product. The EZTax series can also print on preprinted, continuous-feed tax forms available from form suppliers such as Nelco Tax Forms of Green Bay, Wisconsin.

Then there's the manual-labor approach taken by Tax Pro and Taxmaster. With these programs, you copy the output to the official Form 1040 by hand. This error-prone approach is unsuitable for a professional tax preparer, but individual taxpayers might find it an acceptable trade-off, given these products' \$50 price tags.

Accuracy Counts

Entering data and printing forms are important, but the trickiest part of preparing a tax return occurs in between those steps. After all, what the tax software does with the numbers you enter is what determines how much tax you pay.

Some programs do little more than turn the Mac into an electronic typewriter and calculator: they calculate the numbers you enter, and then use *lookup tables* to determine your tax. With inexpensive, spreadsheet-based products such as Taxmaster and Tax Pro, the onus is on you to know the tax laws, which forms and schedules to file, and how to file them.

More ambitious programs, including MacInTax, Tax Stacks, and the EZTax series, do more of the work for you. They know how various forms and schedules interrelate, and based on your input, will help you determine which ones to use. Of course, this extra measure of intelligence can't make up for tax ignorance on your part.

Another way good tax software earns its keep is by using error-trapping routines to guard against inaccurate data entry. No tax program can prevent you from typing \$5000 instead of \$500, but a good program should keep you from making inappropriate entries, such as typing a letter where a number belongs.

Why all the fuss about accuracy? The answer is penalties. Tax penalties were originally imposed to assure compliance, but many have evolved into downright punitive laws. You might call forgetting to enter a number from a W-2 or a 1099 form an honest mistake, but the IRS calls it negligence and finds you guilty until you prove yourself innocent. The bottom line: mistakes are going to cost *you*. Developers of tax software—especially of programs that do more than simply calculate values—have a degree of legal accountability similar to that of tax preparers, but the buck always stops with the person whose signature is on the return.

Should You Prepare Yourself?

How do you decide if you can benefit from tax-preparation software? Start by answering a few questions.

Do you prepare your own taxes now? If so, you have a head start over people who don't. You've already struggled with the concepts and the instructions, and you can apply your combat experience to the world of tax software. If you've never prepared your own return, it may be too late to think about buying tax software this year, since you'll have two learning curves to climb: one for the tax laws themselves, and another for the tax software.

How complex is your return? The simpler your return, the less risk of errors

(continues)

GE RENTS APPLES BY THE BUSHEL.



IBM AND COMPAQ, TOO.

When you need an Apple® Macintosh™ computer or peripheral for a short-term project, like a presentation, trade show or training session, shake our tree first. We have bushels of Apple, IBM, Compaq, and compatible PCs, as well as quality peripherals for rent. And, with our extensive inventory and overnight shipment, we make sure the equipment you want is available, gets there fast and works when it arrives. One free phone call is all it takes. Call 1-800-GE-RENTS, Dept. K.

Catch This Special Offer, Too!

Call today and get your FREE catalog of GE Rental/Lease products and services. Ask for your copy when you place your order, or call our special information number—1-800-345-2451.

To Order, Call 1-800-GE-RENTS, Dept. K.
For Information, Call 1-800-345-2451.
Or Mail This Coupon.

- Yes! I need to rent PCs and peripherals ASAP. Please have a representative call me immediately!
- Please send me your FREE catalog of GE Rental/Lease products and services.

Name _____

Title _____

Company _____

Address _____

City _____ State _____ Zip _____

Phone _____ Ext. or Dept. _____



GE Rental/Lease

Send to: GE Rental/Lease, P.O. Box 105625, Atlanta, GA 30348

IBM is a registered trademark of the International Business Machines Corporation. "Macintosh" and "Apple" are registered trademarks of Apple Computer, Inc. Compaq is a registered trademark of Compaq Computer Corp.

Circle 195 on reader service card

—and an audit. But if your last return had the girth of a small novel, proceed with caution. If you're involved in a partnership or an S corporation, or if you own multiple rental properties, you're subject to passive-loss limitations, and that means a fairly complex tax return. You're also a candidate for a complex return if you're subject to the alternative minimum tax or if you have large and varied types of interest expenses. The regulations governing these types of returns are so complicated that many professional tax preparers seek assistance from large tax-preparation bureaus. So if you do anticipate filing a complex return, make sure your program includes the forms and schedules you'll need.

How much are you willing to spend on software? Because regulations and tax rates change yearly, a tax package is good for only one year. Yearly updates are available to registered users, but they aren't free. Depending on the complexity of your return and on what a professional would charge to complete it, it may not be cost-effective for you to update a package every year. And speaking of updates, find out when they'll be available before buying. The IRS often changes its rules or its forms

late in the season, and updates should reflect the latest rules.

Advice for the Determined

If you've read this far and are still determined to computerize your tax return, you're braver than I am. In addition to wishing you luck, I can, thanks to my accountant, offer a few words of advice.

Educate yourself. Tax software won't make you a competent tax preparer any more than a word processor will make you a good writer. Learn about those aspects of tax law that affect you. A good place to start is by reading a tax guide such as *The Price Waterhouse Personal Tax Adviser*, published each year by Bantam Books. This clearly written volume does a good job of demystifying the rules and terminology of taxation. (It's bundled with MacInTax.)

First organize your data manually. Have your W-2's, 1099's, and everything else you need close at hand. Tax software can't cure disorganization, so sort through those shoeboxes and get your paperwork in order before you begin.

Anticipate your results. Don't simply plug numbers into the computer and trust that the tax software will know what to do with them. If you don't have a rough idea of what your return should look like when you're finished, you aren't ready to start.

Know your limits. It's easy to sink so much time and energy into a complex project that you can't let go when the going gets rough. If you get stuck, get help; the time you've invested in the software will enable you to talk more intelligently with a preparer.

If I sound cautious about the world of computerized tax preparation, it's because I am. Tax-preparation software has been a boon to professional tax preparers, but that's because they use the software to automate the mechanical process of completing a return. They don't look at a tax program as a mentor that will tell them what to do, and neither should you. Carelessly using a tax program isn't the only way you can get into trouble with the federal government, after all. You could use a modem to break into the IRS's computers and change your refund.

But who needs the trouble? □

See *Where to Buy* for contact information.

TWO SUPER NEW PRODUCTS! LOW DISK/SOFTWARE PRICES!



1st Great Product



With Cates™ Erasable Labels there's no more marking through existing words to note file changes. Permanent, micro-thin laminated plastic labels allow revisions by simple erasure on-the-spot. Kits with labels (50), pen, erasing materials, and color coding start **\$18.95 + s/h.**

2nd Great Product



Any Apple® Extended Keyboard user knows that remembering function key assignments is a difficult task! F-key Flipbook™ is a helpful tool for both recording and easily referencing meaningful keywords chosen for F-key and other macro keyboard commands. Includes 10 notecards for 5 pages on a durable, laminated template. (Extra notecards available, too.) **\$29.95 + s/h.**

3 Great Buys

1. SONY® Diskettes Bag/10 only \$15.50
Bulk prices without the bulk! Bag of 10, DD/DS. Perfect with Cates™ Erasable labels.

2. Simply Accounting
All-in-one package of 6 modules from Bedford® is ideal for small businesses. GL, AR, AP, PR, INV, DEPT, ORDER ENTRY. Can print invoices/checks/reports. **Only \$219 + s/h.**

3. Strictly Business™
Perfect write-up package for accountants or your business. GL, AR, AP, flexible reports, graphs, print spools. Up to 99 profit centers. Excellent manuals and personal support from the developer. **Only \$299 per module + s/h.**

Multicomp, Inc.
Call toll free 1-800-541-4351. MasterCard/Visa
P.O. Box 2761, Abilene, Texas 79604, 915/676-0844
All trademarks are the property of their respective owners.

Circle 478 on reader service card

HOW DO YOU GET A JOB WITHOUT EXPERIENCE? AND HOW DO YOU GET EXPERIENCE WITHOUT A JOB?

Most young people have one answer to this problem. They avoid it until they're out of college. But they could be getting solid work experience while they're still in college. With your company's help. And ours.

We're Co-op Education. A nationwide program that helps college students get real jobs for real pay, while they're getting an education.

But we can't do it without you. Those real jobs have to

come from real companies. Like yours.

For more information on how you can participate in this valuable program, write Co-op Education, Box 775E, Boston, MA 02115.

Not only will you be giving students a chance to earn money and pick up the most valuable kind of knowledge, you'll be giving yourselves a chance to pick up the most valuable kind of employee.

Co-op Education.
You earn a future when you earn a degree.

The Complete Works of William Shakespeare
Volume 82

TABLE OF CONTENTS

Hamlet II	11
Antidote: Romeo & Juliet II	33
Henry IV: Part XXI	54
The Merchant of Florence	108
Beneath the Merry Wives of Windsor	124
Macbeth IV	155
As You Like More of It	183
Friday, The Thirteenth Night	196
The Merchant of Turin	222
Brutus	256
The Taming of That Damn Cat	300
Bill Shakespeare, My Story	300



If Shakespeare had only had MacWrite II.

Tis a far better MacWrite than you have known before. Upgrade hot line: 800-544-8554.



CLARIS™



Nothing Protects Your Apple Like Tallgrass.

Sooner or later your Macintosh is going to crash. And unless your Mac's been backed up, it'll probably take your data with it. That's why you need the TG-4000 high performance tape backup system from Tallgrass. It features the tape format that Apple endorses, QIC-100. We invented it, and now it's the industry standard.

The Fastest Backup in the Business.

The TG-4000 backs up your data twice as fast as our closest competitor, with over 40 Mb of fully-formatted space. So you won't waste time rotating diskettes in and out of drives.

Backup's Never Been So Easy.

You won't ever have to use the manual. The TG-4000 is icon-interfaced, so you can get the system up and running in no time. From novice to power user, the TG-4000 offers the total flexibility you need and expect from a backup system. Plus, it's compatible with Apple's 40 SC, AppleShare™

and A/UX.™ And since its backup operations are automatic and unattended, you can just set it and forget it.

Nobody Backs Their Backup System Like Tallgrass. Our Exclusive 3-Year Warranty Proves It.



Whether you need a tape only system, tape plus disk, or you want to add an extra 40-100 Megabytes of disk storage at a later date, the TG-4000 fully backs up your Mac Plus, SE, or II.

Check for yourself. Only Tallgrass has enough confidence to offer a three-year exclusive warranty on their backup system.

Tallgrass Protects Your Company's Bottom Line, Too.

The TG-4000 protects your valuable data at a price much lower than you'd expect, and lower than any of our competitors.

Protect Your Apple Before It Falls.

Call 1-800-TAL-GRAS or write to:
11100 West 82nd Street, Overland Park, KS 66214

**Dealers circle 320 on reader service card
End Users circle 6 on reader service card**

 **TALLGRASS
TECHNOLOGIES**

When it's worth saving, it's worth Tallgrass

Updates

This list brings you the highlights of software updates recently received but not yet tested. The first price is the upgrade cost for registered owners; the second is the current list price.

Alchemy version 1.2 has 16-bit stereo sound editing; sound processing; and network support to E-mu Systems Emulator III, Roland S-50, and Roland S-330 digital sampling instruments. SCSI sample dump capacity for Emulator III and Ensoniq EPS (with SCSI serial port option). Blank Software, P.O. Box 6561, San Francisco, CA 94101; 415/863-9224. \$25; \$495 new.

Cue version 2.1 can import and play back MIDI files. Opcode Systems, Inc., 1024 Hamilton Ct., Menlo Park, CA 94025; 415/321-8977. For owners of version 2.0 \$20 plus \$5 s/h; for owners of earlier versions \$75 plus \$5 s/h; \$595 new.

FoxBase+/Mac version 1.10 lets you create data-input-and-editing screens without programming. You can create screens by moving selected objects into place. Pictures may be inserted anywhere on forms. Fox Software, 118 W. South Boundary, Perrysburg, OH 43551; 419/874-0162. Free; \$395 new.

InfoLogic Envelope version 1.1 runs with ImageWriter and LaserWriter printers. InfoLogic, 1937 Regent St., Niskayuna, NY 12309; 518/370-5510. \$5; \$25 new.

Instant-Expert Plus version 1.5 has expanded reference guide. Includes Appendix C—forum for developers to contribute new applications designed with Instant-Expert Plus. Version 2.0 upgrade expected in April 1989. Human Intellect Systems, 1670 S. Amphlett Blvd., #326, San Mateo, CA 94402; 415/571-5939. Free; \$498 new.

Interleaf Publisher for the Apple Macintosh II version 3.5 supports the Apple Font Manager's open font architecture; converts typed-in text to graphic fonts that can be sized, stretched, filled, and rotated; supports a variety of monitors; and runs under Multi-Finder. Interleaf, 6404 Ivy Ln., #408, Greenbelt, MD 20770; 301/982-0991. Free; \$2495 new.

LaserPaint Color II version 1.9 can cut and paste between 8-bit and 24-bit color scanned images. Transparency modes for color-wash effects on gray-scale scans. Imports and saves in most Macintosh file formats. LaserWare, P.O. Box 668, San Rafael, CA 94915; 415/453-9500. Free; \$595 new.

MacArchitron version 4.0 has been designed for builders in United States. User-defined library of primitives allows identification of elements by name, rather than by number. Capacity for unlimited entries in 3-D, Frames, and 2-D symbol libraries. Lets you produce elements in plan and section views. Automatically

converts between U.S. and metric measures at output. Gimeor, 1815 H St. NW, Washington, DC 20006; 202/223-4373. Free; \$1499 new.

MacHerbal version 1.1, database of traditional Chinese herbal medicine, has revised user guide with two new appendixes. Includes alphabetical listing of all therapeutic categories in the database; tells how to change program's default setting for wholesale herb suppliers; adds a list of mail-order herb suppliers. Summerland Press, P.O. Box 77, Summerland, CA 93067; 800/542-5233 in California, 800/543-5233 elsewhere. \$35; \$295 new.

MacVision version 2.0 captures video images from VCR, camcorder, or video camera and turns them into gray-scale digitized images on the Mac II. For Mac Plus and SE systems, the image is translated into a 512-by-342-pixel dithered bitmap. Imports RIFF and TIFF files. Koala Technologies, 269 Mt. Hermon Rd., Scotts Valley, CA 95066-4029; 408/438-0946. \$79.95; \$399.95 new.

Managing Your Money version 2.0 does rapid searches for accounts/budgets when recording a transaction, includes updated tax laws, and sorts transactions by date within accounts. Prints to screen

(continues)

or disk and can print loan amortization schedules. Meca Ventures, Inc., 355 Riverside Ave., Westport, CT 06880; 203/226-2400. \$49.95; \$219.98 new.

Microsoft File version 2.0 comes bundled with SuperPaint 1.1 by Silicon Beach and with AutoMac III 2.0 by Genesis Micro Software. New features include multicolumn label support, horizontal and vertical blank-space compression, and memo field. Includes indexing default, data formulas, editable user preference, custom paper size, and zoom box. Microsoft Corp., 16011 N.E. 36th Way, Box 97017, Redmond, WA 98073-9717; 206/882-8080. Free if purchased after May 1, 1988; \$50 if purchased before then; \$195 new.

Microsoft Works version 2.0 includes new drawing tools, 60,000-word integrated spelling checker with customizable dictionary, and larger spreadsheet with cell notes and date/time functions. Supports color for the Mac II. Print Preview feature lets you view pages of a document before printing. Microsoft Corp., 16011 N.E. 36th Way, Box 97017, Redmond, WA 97017; 206/882-8080. \$75 to registered Microsoft Works users; free if purchased after August 1, 1988; \$295 new.

Music Publisher version 2.0 lets you transpose by modal, chromatic, or diatonic method. Includes automatic measure-numbering. Automatically places odd beat markings, and aligns lyrics to notes. Includes MIDI Playback, MIDI Input, and custom note-spacing features. Graphic Notes,

200 Seventh Ave., Santa Cruz, CA 95062; 408/476-0147. Free; \$595 new.

Nemesis Go Master version 3.0 lets you increase the amount of time the machine takes to contemplate its moves and enables you to watch the machine consider its various possible moves. Has automatic game-replay feature. Rated 15Q by the American Go Association's human tournaments rating system. Toyogo, Inc., 76 Bedford St., #34, Lexington, MA 02173; 617/861-0488. Free; \$79 new.

Parameter Manager Plus version 3.0, data acquisition and analysis software, allows for graph sizes of up to 400 inches by 400 inches. Can handle up to 32,767 graphs from a single data set. Imports data without constructing a template and no longer requires additional time to generate multiple graphs. Rebus Development Corp., 2330B Walsh Ave., Santa Clara, CA 95051; 408/727-0348. For owners of version 2.2 \$25; for owners of version 2.0 \$50; for owners of version 1.0 \$100; \$595 new; if bundled with PM Talk \$100; communications option \$795.

Publish or Perish version 3.0 lets you load references in text-file format, one field per line; redefine field names for uses other than bibliographic reference; and globally define field style. Park Row, 4640 Jewell St., #101, San Diego, CA 92109; 619/581-6778. \$10; \$49.95 new.

QuickMail version 1.0.5 increases run-time speed by approximately 50 percent over original version. CE Software, 1854 Fuller Rd., West Des Moines, IA 50265; 515/224-1995. Free; \$300 per package new (10 users per package).

QuickShare version 2.0 lets you print PostScript-formatted PC files directly on a Mac-compatible printer and redirect Mac files to a PC printer port. Gives you access to up to eight Macintosh virtual disks residing on a PC. Compatible Systems Corp., P.O. Drawer 17220, Boulder, CO 80308-7220; 303/444-9532. \$75; \$465 new.

Sniffer version 2.0 uses a machine-language compiler for complex filters and triggers and can be triggered by an external electronic signal. Automatically recognizes manufacturer IDs. Color-codes protocol layers of the OSI Reference Model, and supports spreadsheet comma-separated value (CSV) formats. Network General Corp., 1945A Charleston Rd., Mountain View, CA 94043; 415/965-1800. If you have a warranty \$50; if you don't have a warranty \$350. Contact vendor for list price. □

To have products listed in this section, send upgraded software, an outline of major changes since the previous release, upgrade price, suggested retail price, company name, mailing address, and phone number to Updates, Macworld, 501 Second St., San Francisco, CA 94107.

XEROX

A 64 GRAY LEVEL SCANNER AT THIS PRICE DOES WONDERS FOR YOUR IMAGE.

FOR THE PRICE OF A 16 GRAY LEVEL SCANNER, GET THE NEW DATACOPY 730GS.

Now get the high quality of a 64 gray level image for a price as low as others pay for 16 gray level scanners. It's a value that will make your published photographs, artwork, and reputation around the workplace look sharper than ever.

The 730GS also gives you greater control over your image's output size, file size, and resolution.



\$1,995⁰⁰

It comes with imaging software, cabling and interface. It's compatible with both Mac and PC. And its small size will fit more conveniently on your desktop.

Let us tell you the other ways it will enhance your image. Call us, at **800-821-2898**.

XEROX IMAGING SYSTEMS

Circle 376 on reader service card

One Drive Fits All.



Only Tecmar Can Back Up All Three With One Tape System.

It's what you told us you need. A single tape backup system to work with your PS/2s,[™] your classic-bus PCs and – here's the clincher – your Macintosh[®] IIs. Three very different architectures supported by one high-speed, high-capacity tape system.

Tecmar's not only done it, we've made it easy! Any external Tecmar QualityTape[™] drive from 60-to-150MB capacity,

including the ones you may already own, can now be shared between PCs, PS/2s and Mac IIs. The QT drives easily connect to a Tecmar host adapter board inside the computer – including the brand-new NuLink[™] Host Adapter for Mac II. If you have more than one architecture, then this is the solution that makes sense! And only Tecmar has it.

More companies choose Tecmar tape systems than any others – for our speed, relia-

bility and support. And now, one drive fits all. For more information, call Tecmar at (216) 349-1009 or (800) 624-8560. Or write Tecmar, Inc., 6225 Cochran Road, Solon, Ohio 44139-3377.

TECMAR
A REXON COMPANY

©Copyright Tecmar, Inc., a subsidiary of Rexon, Inc., 1988. All rights reserved. All Tecmar products are trademarks or registered trademarks of Tecmar, Inc. Other brand and product names are trademarks or registered trademarks of their respective companies.

Circle 321 on reader service card

Special Anniversary Offer

5 YEARS STRONG

We're celebrating our fifth year anniversary. Join us for incredible savings on every issue of Macworld.

Discover Macworld with a Special Anniversary Savings Rate!

12 ISSUES JUST \$24

MACWORLD

POWERFUL

Each issue is packed with powerful techniques, straight-shooting reviews, tips and how-tos.

YES, send me one year (12 issues) for only \$24.00. That's almost 50% off the annual cover price of \$47.40.

Even bigger savings! Send me two years (24 issues) for just \$37.90.

Name _____

Company _____

Address _____

City/State/Zip _____

This rate limited to the USA and its possessions. Basic subscription price is \$30 for 12 issues. The annual cover price is \$3.95 per issue, \$47.40 for 12 issues. Please allow 6 weeks for delivery of the first issue.

Please Bill Me

Payment Enclosed

MACWORLD

4AFE7

INTUITIVE

Develop an understanding of the Macintosh with thought-provoking articles and insightful features.

YES, send me one year (12 issues) for only \$24.00. That's almost 50% off the annual cover price of \$47.40.

Even bigger savings! Send me two years (24 issues) for just \$37.90.

Name _____

Company _____

Address _____

City/State/Zip _____

This rate limited to the USA and its possessions. Basic subscription price is \$30 for 12 issues. The annual cover price is \$3.95 per issue, \$47.40 for 12 issues. Please allow 6 weeks for delivery of the first issue.

Please Bill Me

Payment Enclosed

MACWORLD

4AFF5

FRIENDLY

User-friendly hints and applications to make using the Mac more fun and productive than ever before.

YES, please send a one year subscription (12 issues) to my associate or friend listed below for only \$24.00. That's almost 50% off the annual cover price of \$47.40.

Please Bill Me Later.

Send Gift To:

Send Gift From:

Name _____

Name _____

Company _____

Company _____

Address _____

Address _____

City/State/Zip _____

City/State/Zip _____

This rate limited to the USA and its possessions. Basic subscription price is \$30 for 12 issues. The annual cover price is \$3.95 per issue, \$47.40 for 12 issues. Please allow 6 weeks for delivery of the first issue.

MACWORLD

2AJM7



BUSINESS REPLY MAIL
FIRST CLASS PERMIT NO. 1262 BOULDER, CO

POSTAGE WILL BE PAID BY ADDRESSEE

MACWORLD

Subscription Department
P.O. Box 51666
Boulder, CO 80321-1666



BUSINESS REPLY MAIL
FIRST CLASS PERMIT NO. 1262 BOULDER, CO

POSTAGE WILL BE PAID BY ADDRESSEE

MACWORLD

Subscription Department
P.O. Box 51666
Boulder, CO 80321-1666



BUSINESS REPLY MAIL
FIRST CLASS PERMIT NO. 1262 BOULDER, CO

POSTAGE WILL BE PAID BY ADDRESSEE

MACWORLD

Subscription Department
P.O. Box 51666
Boulder, CO 80321-1666



NO POSTAGE
NECESSARY
IF MAILED
IN THE
UNITED STATES



NO POSTAGE
NECESSARY
IF MAILED
IN THE
UNITED STATES



NO POSTAGE
NECESSARY
IF MAILED
IN THE
UNITED STATES



SAVE NEARLY 50%

When You Subscribe Today!

No other magazine helps you like Macworld. Powerful, Intuitive and Friendly. Macworld is a wealth of information which keeps you up to date on the latest products, news, tips and tactics. Dedicated exclusively to the Mac II, SE and Plus.

We look out for your interests. We tell you what's new for the Mac. What it does. Who it's for. Compare similar products—and name names! Discuss pros and cons. Assess value for money for both hardware and software.

Macworld helps you make the most of your Mac.



MAIL THE ATTACHED CARD TODAY!

Where to Buy

This listing provides company addresses and phone numbers for products mentioned in this issue. Allow several weeks for responses to Reader Service Card inquiries. Asterisks indicate vendors who prefer to be contacted by phone.

Reader
Service

A

- 750 **Adobe Illustrator 88.** Adobe Systems, Inc., P.O. Box 7900, Mountain View, CA 94039-7900; 415/961-4400, 800/833-6687.
- 751 **Aldus FreeHand.** Aldus Corp., 411 First Ave. S, Seattle, WA 98104; 206/622-5500.
- 752 **Amanda Stories, Volume I & Volume II.** The Voyager Company, 1351 Pacific Coast Hwy., Santa Monica, CA 90401; 213/451-1383.
- 753 **AppleFax Modem.** Apple Computer, Inc., 20525 Mariani Ave., Cupertino, CA 95014; 408/996-1010.

B

- 754 **BackFax.** Solutions International, 30 Commerce St., Williston, VT 05495; 802/658-5506.
- 755 **BarneyScan XP.** BarneyScan, Inc., 1198 Tenth St., Berkeley, CA 94710; 415/524-6648.
- 756 **Brother HL-8 Desktop Laser Printer.** Brother International, 8 Corporate Pl., Piscataway, NJ 08854; 201/981-0300, 800/284-4357.
- * **BWIC.** Shareware by Rick Giles, P.O. Box 207, Acadia University, Wolfville, Nova Scotia, Canada BOP 1X0.

C

- * **CacheKey INIT.** Shareware by Chris Demetriou, 859 Woodacres Rd., Santa Monica, CA 90402.
- 757 **Capture.** Mainstay, 5311-B Derry Ave., Agoura Hills, CA 91301; 818/991-6540.
- * **ColorCards.** Shareware by Bill & Steve Tuttle/Imaginetic Neovision.
- * **Color Cursor.** Shareware by Matthias Urlichs.
- 758 **Colorizer.** Palomar Software, Inc., P.O. Box 120, Oceanside, CA 92054; 619/721-7000.
- * **Color Map.** Shareware on CompuServe.
- * **ColorSnapshot.** Shareware by Mark 3 Software, 215 Thayer Pond Rd., Wilton, CT 06897.
- 759 **Color System I.** Knowledge Engineering, 115 Mason St., Greenwich, CT 06830; 203/622-8770.

D

- * **DTP Advisor.** Broderbund Software, Inc., 17 Paul Dr., San Rafael, CA 94903-2101; 415/492-3200, 800/527-6263.
- 760 **DualPage Display System.** Cornerstone Technology, Inc., 1883 Ringwood Ave., San Jose, CA 95131; 408/279-1600.

E

- 761 **Enterprise.** Foundation Publishing, Inc., 5100 Eden Ave., #307, Edina, MN 55436; 612/925-6027.
- * **Excelerator XL 20.** Irwin Magnetics, 2101 Commonwealth Blvd., Ann Arbor, MI 48105; 313/930-9000.
- * **Excelerator XL 25.** Irwin Magnetics, 2101 Commonwealth Blvd., Ann Arbor, MI 48105; 313/930-9000.
- 762 **EZTax-Plan Business Edition.** EZWare Corp., P.O. Box 620, Bala Cynwyd, PA 19004; 215/667-4064, 800/543-1040.
- 763 **EZTax-Plan Personal Edition.** EZWare Corp., P.O. Box 620, Bala Cynwyd, PA 19004; 215/667-4064, 800/543-1040.
- 764 **EZTax-Prep 1040.** EZWare Corp., P.O. Box 620, Bala Cynwyd, PA 19004; 215/667-4064, 800/543-1040.

F

- * **FastPath 4.** Kinetics, Inc., 2500 Camino Diablo, Walnut Creek, CA 94596; 415/947-0998.
- 765 **FaxPlus.** Cypress Research Corp., 296 Elizabeth St., 3rd Floor, New York, NY 10012; 212/475-7782.
- 766 **FAXstf.** FAXstf, 48431 Milmont Dr., Fremont, CA 94538; 816/584-7727, 800/444-5321.
- 767 **Findswell.** Working Software, Inc., P.O. Box 1844, Santa Cruz, CA 95061-1844; 408/423-5696, 800/331-4321.
- * **FIF4.** Shareware on CompuServe.
- * **Front & Center.** Shareware by Pete Helme, 1939 Marshall Ave., #25, St. Paul, MN 55104.

G

- 768 **Gemini 020/030.** Total Systems Integrated, 99 W. Tenth Ave., #333, Eugene, OR 97401; 503/345-7395.
- 769 **Graphics Master 4.** Dean Lem Associates, Inc., 1526 Pontius Ave., Ste. C, Los Angeles, CA 92024; 213/478-0092, 800/562-2562.
- 770 **G330-70 Color Thermal Transfer Printer.** Mitsubishi Electronics America, Inc., 991 Knox St., Torrance, CA 90502; 213/515-3993.

All tax programs should look and print like this one.

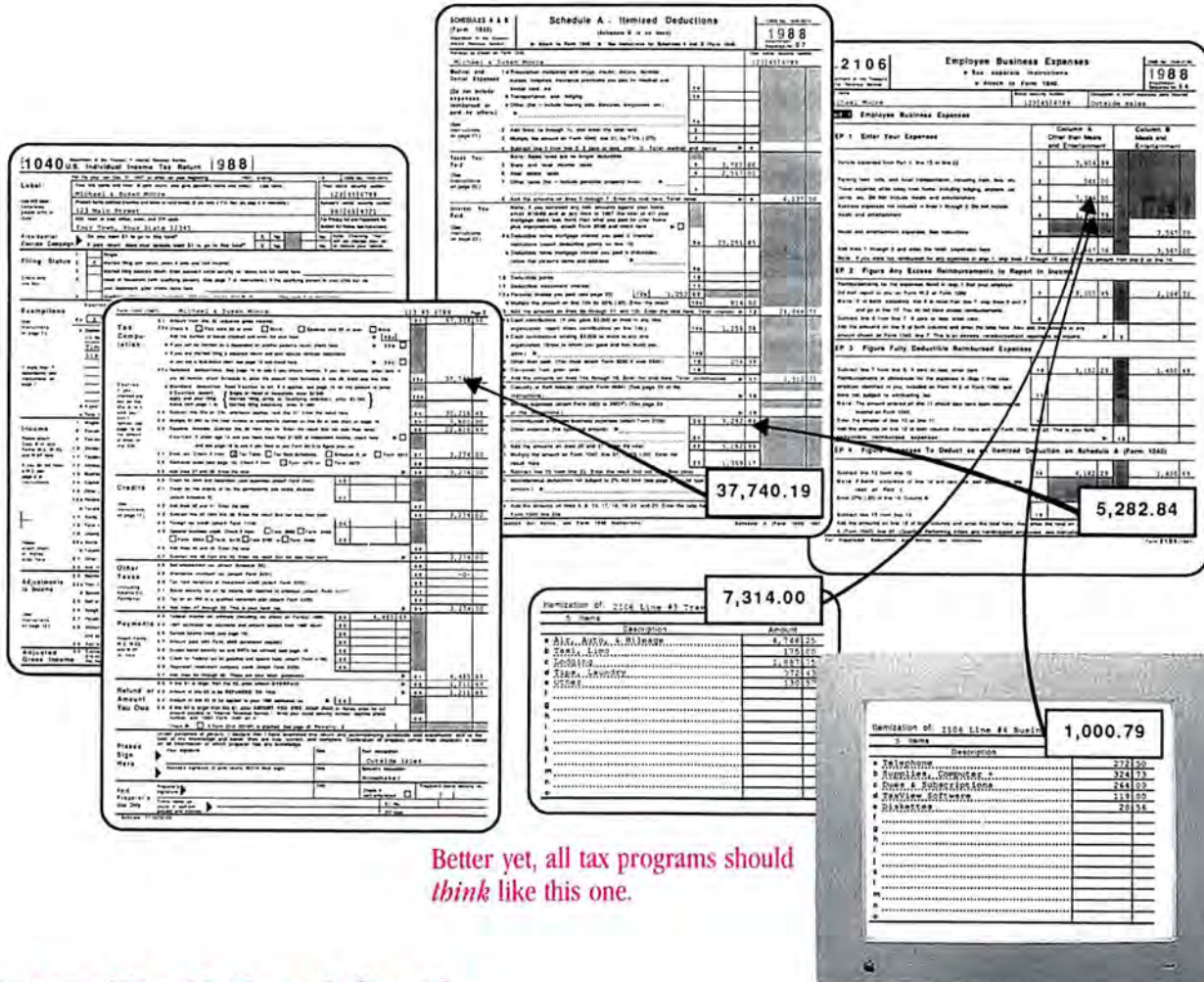

Better yet, all tax programs should think like this one.

MacInTax Federal for the Apple Macintosh.[®]

Simply put, MacInTax whisks you through stacks of receipts and W-2's by allowing you to enter data directly into 72 IRS forms, schedules, worksheets and statements displayed on-screen in identical IRS format. The program totals all entered amounts, automatically makes all tax calculations, and instantly links data to and from individual forms, schedules, worksheets and statements.

It even checks your input and helps you prevent illogical, inconsistent or incomplete entries.

The complete IRS instruction booklet is stored on a line-by-line basis.

What's more MacInTax lets you easily import text files from a variety of outside spreadsheet, database and accounting programs.

When you're ready to sign and send your completed return, the program prints forms and schedules identical to the official IRS versions (complete with your data) onto blank paper using your supported laser or dot-matrix printer. Of course, all printed forms are fully IRS-approved.

One look and it's easy to see why, each year, users give this program their highest rating.

To order your copy publisher-direct, call SoftView at 1-800-622-6829. Or, visit any one of 10,000 retailers offering MacInTax.

MacInTax Federal for the Apple Macintosh.

SoftView,[®] Inc.

4820 Adohr Lane, Suite F
Camarillo, CA 93010
(805) 388-2626

"The Ultimate Macintosh Learning Experience"

When NASA Started Flying Again They Chose the Macintosh and **MacAcademy™**

BY RANDALL D. SMITH

ORLANDO, Fla. - NASA is flying again and many of the flickering screens in the background are Macs! And, just like everyone else, NASA needed valuable, quality, and affordable training on their Macs. On November 30th, NASA sent 58 of their top employees to MacAcademy in Orlando.

In October, Motorola sent 38 employees to MacAcademy in Austin. GTE sent their employees to MacAcademy in Boston. Jet Propulsion Labs, GE, and the University of California attended in Los Angeles. The FBI, the University of Texas, Federal Express, CitiCorp, Polaroid, MIT, the State of California, Mobil Oil, and over 1,000 other companies choose locations throughout the U.S. to send their employees to MacAcademy.

Over 10,000 people, individuals and corporate employees, have attended MacAcademy in the past 12 months!

Why is MacAcademy so popular? The simple answer is that it provides what most Mac owners have been looking for since the day they first used their computer. MacAcademy fills a learning gap that can't be provided by the magazines, trade shows, Apple dealers, user groups, and audio training pro-

grams. It not only provides what the graduates call the *Ultimate Macintosh Learning Experience*, but it accomplishes this task for an unbelievably low price.

MacAcademy is a two-day workshop taught by many of the nation's leading Mac experts. Each instructor is a top business executive who uses the Mac in everyday business operations. Each instructor draws on actual hands-on experience when teaching the operation of the Mac, Excel, Word, FileMaker, PageMaker, HyperCard, and Works.

MacAcademy offers a smorgasbord of workshops allowing each participant the luxury of choosing their own individual class schedule.

Graduates who have attended MacAcademy have given the learning experience an overall rating of 4.5 on a scale of 1 to 5. The entire two days is only \$249 which includes the workshops, class materials, and even lunch.

MacAcademy is designed for Mac owners who are facing the Mac training void and want to slash the learning curve.

To register for MacAcademy or for more information, call 904-677-1918 or write to: MacAcademy 477 S. Nova Rd. Ormond Beach, FL 32074.

Schedule of Upcoming MacAcademy Workshops

Chicago	Feb. 6, 7
Dallas	Feb. 8, 9
Houston	Feb. 10, 11
Seattle	Feb. 13, 14
Portland	Feb. 15, 16
Hartford	Feb. 21, 22
Atlanta	Mar. 2, 3
Boston	Mar. 20, 21
New York	Mar. 22, 23
Philadelphia	Mar. 27, 28
Wash. D.C.	Mar. 29, 30
Detroit	Apr. 6, 7
St. Louis	Apr. 10, 11
Minneapolis	Apr. 14, 15
Chicago	Apr. 17, 18
Milwaukee	Apr. 24, 25
San Diego	May 8, 9
Anaheim	May 11, 12
Los Angeles	May 15, 16
San Jose	May 18, 19
San Francisco	May 22, 23

2 Full Days

9 Mac Business Experts
14 Hrs. Of Instruction
Workshop, Computer Discs,
Workbook, & Lunch

Only

\$249

©1989 Florida Marketing International, Inc.

Circle 406 on reader service card

Where to Buy

Reader
Service

H

* **Hide HyperCard.** Shareware by Maccreations, 329 Horizon Way, Pacifica, CA 94044.

771 **HyperCharger 020.** GCC Technologies, 580 Winter St., Waltham, MA 02154; 617/890-0880, 800/634-9737.

772 **HyperTalk Pocket Reference.** Hyperpress Publishing Corp., P.O. Box 8243, Foster City, CA 94404; 415/345-4620.

I

773 **Icon Factory.** Hyperpress Publishing Corp., P.O. Box 8243, Foster City, CA 94404; 415/345-4620.

774 **ImageStudio.** Letraset USA, 40 Eisenhower Dr., Paramus, NJ 07653; 201/845-6100, 800/526-9703.

775 **InterFax.** Abaton, a division of Everex, 48431 Milmont Dr., Fremont, CA 94538; 415/683-2226, 800/444-5321.

K

* **Kolor.** Shareware by Russ Wetmore, 101 Los Gatos Blvd., #5, Los Gatos, CA 95032.

L

776 **Language Systems Fortran Compiler.** Language Systems, Inc., 441 Carlisle Dr., Herndon, VA 22070; 703/478-0181.

777 **LaserPaint Color II.** LaserWare, Inc., P.O. Box 668, San Rafael, CA 94915; 415/453-9500, 800/367-6898.

M

778 **MacFortran.** Absoft Corp., 2781 Bond St., Rochester Hills, MI 48309; 313/853-0050.

779 **MacFortran/020.** Absoft Corp., 2781 Bond St., Rochester Hills, MI 48309; 313/853-0050.

780 **MacInTax.** SoftView, Inc., 4820 Adohr Ln., Ste. F, Camarillo, CA 93010; 805/388-2626, 800/622-6829.

781 **Mactran Plus.** DCM Data Products, Inc., 1710 Two Tandy Center, Ft. Worth, TX 76102; 817/870-2202.

782 **Mac 20MX-16.** DayStar Digital, Inc., 5556 Atlanta Hwy., Flower Branch, GA 30542; 404/967-2077, 800/962-2077.

783 **Mac 20MX-25.** DayStar Digital, Inc., 5556 Atlanta Hwy., Flower Branch, GA 30542; 404/967-2077, 800/962-2077.

784 **The Manhole.** Activision, 3885 Bohannon Dr., Menlo Park, CA 94025; 415/329-0800.

785 **MaraThon 020.** Dove Computer Corp., 1200 N. 23rd St., Wilmington, NC 28405; 919/763-7918, 800/622-7627.

786 **MaraThon 030.** Dove Computer Corp., 1200 N. 23rd St., Wilmington, NC 28405; 919/763-7918, 800/622-7627.

787 **Mavis Beacon Teaches Typing.** The Software Toolworks, 13557 Ventura Blvd., Sherman Oaks, CA 91423; 818/907-6789.

* **Menu Fonts 2.** Beyond, Inc., Box 31990, Tucson, AZ 85751; 602/290-9790.

788 **Modern Artist.** Computer Friends, Inc., 14250 N.W. Science Park Dr., Portland, OR 97229; 503/626-2291, 800/547-3303.

789 **Musical Instruments Sound Resource Library.** B & B Soundworks, P.O. Box 7828, San Jose, CA 95150; 408/241-7986.

N

790 **Nutmeg 19.** Nutmeg Systems, Inc., 25 South Ave., New Canaan, CT 06840; 203/966-3226.

O

791 **OmniPage.** Caere Corp., 100 Cooper Ct., Los Gatos, CA 95030; 408/395-7000.

792 **Over 030.** Computer System Associates, 7564 Trade St., San Diego, CA 92121; 619/566-3911.

P

793 **PageMaker.** Aldus Corp., 411 First Ave. S, Seattle, WA 98104; 206/622-5500.

794 **PhotoMac.** Data Translation, Inc., 100 Locke Dr., Marlborough, MA 01752; 508/481-3700.

* **PixelPaint Professional.** SuperMac Technology, 295 N. Bernardo Ave., Mountain View, CA 94043; 415/964-8884.

795 **Police Quest.** Sierra On-Line, Inc., P.O. Box 485, Coarsegold, CA 93614; 209/683-6858.

* **Printworks for the Mac/Laser Version.** Phoenix Technologies, Ltd., 846 University St., Norwood, MA 02062; 617/551-4000.

* **Prodigy SE.** Levco, 6160 Lusk Blvd., Ste. C-203, San Diego, CA 92121; 619/457-2011.

Q

796 **QuarkXpress.** Quark, Inc., 300 S. Jackson, #100, Denver, CO 80209; 303/934-2211, 800/356-9363.

797 **QuickKeys.** CE Software, P.O. Box 65580, West Des Moines, IA 50265; 515/224-1995, 800/523-7638.

R

798 **Radius Accelerator 16.** Radius, Inc., 404 E. Plumeria Dr., San Jose, CA 95134; 408/434-1010.

799 **Radius Accelerator 25.** Radius, Inc., 404 E. Plumeria Dr., San Jose, CA 95134; 408/434-1010.

* **Real World PostScript.** Addison-Wesley Publishing Co., Route 128/Jacob Way, Reading, MA 01867; 617/944-3700.

S

* **Screen Dump II.** Shareware by Mark 3 Software, 215 Thayer Pond Rd., Wilton, CT 06897.

* **Screener.** Shareware by Frank Price/AOC Software, 612 Doheny Rd., Beverly Hills, CA 90210.

800 **Screen Gems.** Microseeds, 7030B W. Hillsborough Ave., Tampa, FL 33615; 813/878-2142.

801 **scriptExpert.** Hyperpress Publishing Corp., P.O. Box 8243, Foster City, CA 94404; 415/345-4620.

* **SnapShot.** Shareware by Frank Price/AOC Software, 612 Doheny Rd., Beverly Hills, CA 90210.

802 **Sound Effects Sound Resource Library.** B & B Soundworks, P.O. Box 7828, San Jose, CA 95150; 408/241-7986.

803 **Space Quest II.** Sierra On-Line, Inc., P.O. Box 485, Coarsegold, CA 93614; 209/683-6858.

804 **SpectreMatch.** Prepress Technologies, Inc., 534 Encinitas Blvd., #114, Encinitas, CA 92024; 619/753-0194.

SuperPaint 2.0

Setting the Standard. Again.

1 These faces were created using the freehand Bezier tool, which allows you to create editable Bezier paths quickly and easily. Color preview lets you design on screen and in color.

2 Both painting and drawing features were used to create this scientific illustration.

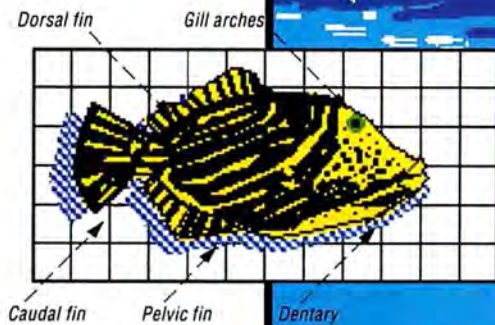

3 Special effects, such as these bubbles on the water, can be easily created with custom-programmed, plug-in paint tools.

4 The freehand Bezier tool provided the precise control necessary to draw this architectural column.



SuperPaint, the best-selling graphics program for the Macintosh®, has always set the standard against which other software is compared. And we just raised that standard.

In Version 2.0, SuperPaint gives you more graphics power than the costly "professional" drawing programs, yet it's easier to use. Draw spontaneously with the freehand Bezier tool, for example. You don't have to get it perfect the first time—the Bezier path is completely editable, so you can progressively refine your work. Or use AutoTrace™ to instantly convert any bitmapped image to an object-oriented line drawing.

Then, with a mouse click, you can further refine your graphic with the most flexible and sophisticated painting tools available on the Mac, including a slick new airbrush that works just like the real thing. Plug-in paint tools can be custom-programmed and will show up in the tool palette.

We've added nearly all the other features you wanted, too. You can set any document size for printing multiple

pages, work in landscape view, or use SuperBits™ to edit bitmaps of any size and resolution—you can even edit a full page at 300 dpi. Plus you can preview your image in color before printing.

More power, more flexibility, and easier to use. That's SuperPaint 2.0—setting the standard for Macintosh graphics...again.

Suggested retail price: \$199. Upgrade from 1.0 or 1.1: \$50.

System requirements:
Macintosh Plus, SE or Macintosh II;
System 6.0 or later

Silicon Beach Software, Inc.
P.O. Box 261430
San Diego, CA 92126 • (619) 695-6956

AutoTrace, SuperBits and the Silicon Beach Software logo are trademarks of Silicon Beach Software, Inc. Macintosh is a registered trademark of Apple Computer, Inc.



SILICON BEACH
SOFTWARE

Circle 266 on reader service card

Where to Buy

Reader Service

- 805 **SpectrePrint.** Prepress Technologies, Inc., 534 Encinitas Blvd., #114, Encinitas, CA 92024; 619/753-0194.
- 806 **Springboard Publisher.** Springboard Software, Inc., 7808 Creekridge Circle, Minneapolis, MN 55435; 612/944-3915.
- 807 **StandOut.** Letraset USA, 40 Eisenhower Dr., Paramus, NJ 07653; 201/845-6100, 800/526-9703.
- 808 **Studio/8.** Electronic Arts, P.O. Box 7530, San Mateo, CA 94403; 415/571-7171, 800/245-4525.
- **Switch-a-roo.** Shareware by Bill Steinberg.
- T**
- 809 **TaxMaster 1988 Preparer.** Island Computer Services, 3501 E. Yacht Dr., Long Beach, NC 28461; 919/278-9483, 800/826-7146.
- 810 **TaxMaster 1989 Planner.** Island Computer Services, 3501 E. Yacht Dr., Long Beach, NC 28461; 919/278-9483, 800/826-7146.
- 811 **Tax Pro.** Chesapeake Software/MG, P.O. Box 1014, Richmond, VA 23208-1014; 804/358-7802.
- 812 **Tax Stacks.** StackWorks, Inc., P.O. Box 426, Urbana, IL 61801; 217/328-5257.
- 813 **TaxView Planner.** SoftView, Inc., 4820 Adohr Ln., Ste. F, Camarillo, CA 93010; 805/388-2626, 800/622-6829.
- 814 **Tempo II.** Affinity Microsystems, Ltd., 1050 Walnut St., #42, Boulder, CO 80302; 303/442-4840, 800/367-6771.
- 815 **33/030 Accelerator II.** DayStar Digital, Inc., 5556 Atlanta Hwy., Flower Branch, GA 30542; 404/967-2077, 800/962-2077.
- **Toggle Cache.** Shareware by Jan Eugenides, P.O. Box 151, Maynard, MA 01754.
- 816 **Turbo SE.** Siclone Sales & Engineering Corp., 1169 Borregas Ave., Sunnyvale, CA 94089; 408/734-9151, 800/862-2636.
- V**
- 817 **V.I.P. (Visual Interactive Programming).** Mainstay, 5311-B Derry Ave., Agoura Hills, CA 91301; 818/991-6540.
- W**
- 818 **Word Processing: the Usable Portable Guide.** Usable Portable Publications, Inc., 5 Woodside Rd., Winchester, MA 01890; 617/729-1943. □

Public domain software and shareware are available through online information services; user groups (call 800/538-9696 ext. 500 for information on a local user group); or mail-order clearinghouses such as Budgetbytes (800/356-3551 for orders, 913/271-6022 in Kansas), Educomp (800/843-9497, 619/259-0255 in California), or the Public Domain Exchange (800/331-8125, 408/496-0624 in California).



Insurance For Fried Apples?

When your surge protector fails will your insurance save you? SAFEWARE™ computer insurance covers power surges, lightning, theft, fire, accidental damage and more! Full replacement of hardware, media and purchased software for as little as \$39 per year.

Total Value, Hardware, Media & Purchased Software	Annual Premium
up to \$2,000	\$ 39
\$ 2,001-\$ 5,000	\$ 69
\$ 5,001-\$ 8,000	\$ 89
\$ 8,001-\$11,000	\$109
\$11,001-\$14,000	\$129

For immediate coverage, information and rates on higher coverages, call

1-800-848-3469

Locally 614-262-0559 On Compuserve, GO SAF

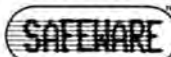

SAFEWARE, The Insurance Agency Inc.
2929 N. High St., P.O. Box 02211, Columbus, OH 43202

Circle 293 on reader service card

Don't Forget!



Send for the latest edition of the free Consumer Information Catalog. □ The Catalog lists over 200 selected federal publications of consumer interest on subjects like health, nutrition, federal benefits, money management. □ The Catalog is free and so are many of the booklets. □ Just send your name and address, no strings attached. Write today:



**Consumer Information Center
Department DF
Pueblo, Colorado 81009**

A public service of this publication and the Consumer Information Center of the U.S. General Services Administration.

Peel this Apple and get Macintosh performance without the Macintosh price.

On the surface, this Apple® appears to be a flawless, shiny Lisa™. But get under its skin and you'll discover Macintosh™ Plus capabilities in all their glory. There's just one way this Apple doesn't measure up to a Macintosh. At \$995*, the Lisa falls impressively short of a Macintosh price tag.

Meet the New Lisa with MacWorks™ Plus

We thought it looked like a perfect match: the highly efficient Lisa and the myriad of Macintosh software solutions. On the one hand, there was the Lisa, a professional business computer with an extra-large 12"



screen, Macintosh graphic interface, familiar mouse, easy-to-reach internal components, space for an internal hard disk drive, three expansion slots, and a numeric keypad on the keyboard. Then there was the popularity of the Macintosh Plus, with its amazing capabilities, functionality and software applications.

What we did to bring the two together was develop a software program called MacWorks Plus. MacWorks Plus brings Macintosh functionality to the Lisa, plus compatibility with every application that runs on the Macintosh Plus. With MacWorks Plus, the Lisa can run HyperCard, MultiFinder, AppleShare, WordPerfect, Adobe Illustrator and Cricket Draw. (To name a few.)



The Apple Lisa with MacWorks Plus runs the latest Macintosh software.



How We Support Lisa and MacWorks Plus

We do a lot more than market the Lisa and MacWorks Plus. We offer a complete line of out-of-production, new and used Apple compatible products. And we are the only company authorized by Apple Computer Inc. to sell and service their out-of-production equipment. Because of this, we have invested sizeable resources in developing improvements for all of the out-of-production and reconditioned products we sell. Plus, every product that comes from us must pass rigorous Apple quality control tests. We also back our products with a 30- to 90-day money-back guarantee.

Call 1-800-821-3221 for your Apple Lisa

If you like the capabilities and compatibility of Macintosh, but don't like the price, pick the Lisa with MacWorks Plus. To order a Lisa, or get a copy of our product catalog, call 1-800-821-3221 and we'll send your order out today. All major credit cards accepted.



Product Index

Reader
Service
Number

■ Software

- Business**
- Acius, 60
 - 401 Advanced Gravis, 180
 - 379 Agfa Compugraphic, 162
 - 329 Aldus Freehand, 10-11
 - 306 Aldus Persuasion, 168-169
 - 220 Ashton-Tate, 38-39
 - 187 Berkeley System Design, 206
 - 383 Brainpower, Inc., 68
 - 365 Ceres Software, 22
 - Checkmark Software, 232
 - Claris, 247
 - Claris, 62-65
 - 165 Design Science, 72
 - 355 Dow Jones Software, 178
 - 155 Dubl-Click, 194
 - 152 Fox Software, 211
 - 360 Infomix, 42-43
 - 472 Lexpertise, 32
 - Microsoft, IFC-1
 - 87 Monogram, 94
 - 213 Paracom, 78
 - 42 Personal Training Systems, 203
 - 456 SBT, 193
 - 297 Shana Corp., 55
 - 419 SoftView, Inc., 254
 - 237 Symantec, 9
 - 215 Symantec, 12
 - 491 Stat, 241
 - 492 Systat, 241
- CAD/CAM**
- 454 Autodesk, 20-21
 - 459 Berol USA, 187
 - Claris, 228-229
 - 77 Graphsoft, 236
- Communication**
- 379 Agfa Compugraphic, 162
 - 319 Compuserve, 198
 - Connect, Inc., 191
 - 281 Dataviz, 33
 - Tops, 74
- Data Management**
- Acius, 60
 - 401 Advanced Gravis, 180
 - 42 Personal Training Systems, 203
 - 317 Preferred Publishers, Inc., 70
 - 451 ProVUE, 196
- Graphics/Desktop Publishing**
- 340 Aba Software, Inc., 82-83
 - Adobe Systems, Inc., 26
 - 401 Advanced Gravis, 180
 - 379 Agfa Compugraphic, 162
 - 329 Aldus Freehand, 10-11
 - 306 Aldus Persuasion, 168-169
 - 35 Altsys, 210
 - 187 Berkeley System Design, 206
 - 426 Caere Corp., 239
 - 365 Ceres Software, 22
 - 61 Computer Friends, 99
 - 400 CTA, 270
 - 217 Deneba, 23
 - 155 Dubl-Click, 194
 - 467 General Parametrics Corp., 80
 - 337 Image Club Graphics, 102
 - 393 NuEquation, 207
 - 213 Paracom, 78
 - 115 Qume, 212-213
 - 353 Qume, 212-213
 - 215 Symantec, 12

Reader
Service
Number

Educational

- 165 Design Science, 72
- 472 Lexpertise, 32
- Microsoft, 223
- 229 Paracom, 230
- 42 Personal Training Systems, 203

Entertainment

- 290 PCAI, 4
- 266 Silicon Beach Software, 257

Networking

- 319 Compuserve, 198
- 150 Farallon, 84
- Tops, 74

Personal Business/Home

- 297 Shana Corp., 55
- 112 Survivor Software, 208

Utilities

- 35 Alsoft, 8
- 187 Berkeley System Design, 206
- 357 Central Point Software, 159
- 346 Deneba, 25
- 180 Deneba, 27
- 439 GDT Softworks, 224
- 478 Multicom, 246
- 284 Olduvai, 34
- 317 Preferred Publishers, Inc., 70
- 237 Symantec, 9
- 470 Xtree, 35

Vertical

- Adobe Systems, Inc., 26
- 426 Caere Corp., 239
- Checkmark Software, 232
- 229 Paracom, 230
- 456 SBT, 193

Word Processing

- 220 Ashton-Tate, 38-39
- Claris, 247
- 180 Deneba, 27
- 165 Design Science, 72
- Microsoft, IFC-1
- Round Lake Publishing, 22
- 215 Symantec, 12
- 332 T/Maker, IBC
- 475 Working Software, 191

Miscellaneous

- 329 Aldus Freehand, 10-11
- 306 Aldus Persuasion, 168-169
- Checkmark Software, 232
- 439 GDT Softworks, 224
- Microsoft, IFC-1
- Microsoft, 223
- 419 SoftView, Inc., 254

Reader
Service
Number

■ Hardware

Boards

- 403 American Micro Distributors, 222
- 127 Clearpoint, 92
- 375 Clearpoint, 92
- 476 DayStar, 79
- 404 DayStar, 81
- 477 DayStar, 77
- 82 Irwin Magnetics, 184-185
- 196 National Semiconductor, 166
- 347 Novell, 16-17
- 445 Truevision, 178

Digitizers/Scanners

- 242 Digital Vision, 224
- 356 Pixelogic, 189
- 327 Sharp, 30
- 176 Thunderware, 24
- 376 Xerox Imaging Systems, 251

Display

- 101 E-Machines, 48-49
- 354 MacMail, 200
- 413 Mobius Technology, 189
- 223 Personal Computer Peripherals Corp., 98
- 117 Sigma Designs, 88

Hard Disks/Storage

- 403 American Micro Distributors, 222
- 233 Corel Systems, 164
- 97 Crate, 225
- 452 Ehman Engineering, Inc., 180
- 440 Hard Drives Int'l, 196
- 337 Image Club Graphics, 102
- 102 Jasmine, 40
- 457 Jasmine, 50-51
- 145 La Cie, 18
- 354 MacMail, 200
- 275 MicroNet, 96
- 398 MicroNet, 96
- 458 Microtech International, 231
- 243 Microtech International, 233
- 62 Microtech International, 235
- 424 Minor Technologies, 66-67
- 449 Multiple Zones Int'l, 90-91
- 223 Personal Computer Peripherals Corp., 98
- 149 Rodime, 201
- Seagate Technology, 37
- 416 Storage Dimensions, 161
- 320 Tallgrass Technologies, 248
- 6 Tallgrass Technologies, 248
- 321 Tecmar, 252

Expansion/Upgrades

- 161 Micron, 194

Modems

- 68 Computer Friends, 214
- 469 Ven-Tel, 44

Printers

- Compugraphic, 76 A-H
- 575 Orange Micro, 207
- 104 QMS/Laserconnection, 204-205
- 115 Qume, 212-213
- 353 Qume, 212-213
- 143 Tektronix, 209
- 93 Vartyper, 28-29

Reader
Service
Number

Video

- 61 Computer Friends, 99
- 467 General Parametrics Corp., 80
- Magnavox, 182

Miscellaneous

- 403 American Micro Distributors, 222
- 150 Farallon, 84
- 337 Image Club Graphics, 102
- 460 Matrix, 53
- 575 Orange Micro, 207
- 296 ScanCo, 71
- 186 Sun Remarketing, 259
- 26 Trimar USA, Inc., 222

■ Accessories

Floppy Disks

- 479 BASF, 86

Furniture

- Anthro Corp., 36
- 296 ScanCo, 71

Services

- 195 GE Rental/Lease, 245
- 406 MacAcademy, 255
- Macworld Expo, 268-269
- 293 Safeware, 258

Miscellaneous

- 68 Computer Friends, 214
- 385 I/O Design, 76
- 30 Kensington Software, 69
- 192 Kensington Software, BC
- 276 Micro Computer Accessories, 100
- 388 Micro Vision, 26
- 239 Secure-It, 234

■ Mail Order

- 5 Beverly Hills Computer, 264-265
- 32 CDA, 244
- 97 Crate, 225
- 562 Diskette Connection, 262
- 368 Dr- Mac, Inc., 263
- 86 Mac Products, 238
- MacConnection, 104-111
- 264 MacLand, 266
- 354 MacMail, 200
- 78 MacWarehouse, 215-221
- 411 Micro Star, 267
- 478 Multicom, 246
- 449 Multiple Zones Int'l, 90-91
- 45 Open Mac, 261
- 44 Programs Plus, 56-59
- 473 Software Library, 46
- 305 USA Flex/Comark, 262

MACWORLD

FREE PRODUCT INFORMATION

Get more information on products you're interested in—simply return one of these cards today. There's no cost. And no obligation.

Please print or type all information.

Name _____ Title _____

Company _____

Address _____ City, State, Zip _____ (zip code needed to ensure delivery)

Phone: Area code/Number _____

(1-200)

1	2	3	4	5	6	7	8	9	10
11	12	13	14	15	16	17	18	19	20
21	22	23	24	25	26	27	28	29	30
31	32	33	34	35	36	37	38	39	40
41	42	43	44	45	46	47	48	49	50
51	52	53	54	55	56	57	58	59	60
61	62	63	64	65	66	67	68	69	70
71	72	73	74	75	76	77	78	79	80
81	82	83	84	85	86	87	88	89	90
91	92	93	94	95	96	97	98	99	100
101	102	103	104	105	106	107	108	109	110
111	112	113	114	115	116	117	118	119	120
121	122	123	124	125	126	127	128	129	130
131	132	133	134	135	136	137	138	139	140
141	142	143	144	145	146	147	148	149	150
151	152	153	154	155	156	157	158	159	160
161	162	163	164	165	166	167	168	169	170
171	172	173	174	175	176	177	178	179	180
181	182	183	184	185	186	187	188	189	190
191	192	193	194	195	196	197	198	199	200

(201-400)

201	202	203	204	205	206	207	208	209	210
211	212	213	214	215	216	217	218	219	220
221	222	223	224	225	226	227	228	229	230
231	232	233	234	235	236	237	238	239	240
241	242	243	244	245	246	247	248	249	250
251	252	253	254	255	256	257	258	259	260
261	262	263	264	265	266	267	268	269	270
271	272	273	274	275	276	277	278	279	280
281	282	283	284	285	286	287	288	289	290
291	292	293	294	295	296	297	298	299	300
301	302	303	304	305	306	307	308	309	310
311	312	313	314	315	316	317	318	319	320
321	322	323	324	325	326	327	328	329	330
331	332	333	334	335	336	337	338	339	340
341	342	343	344	345	346	347	348	349	350
351	352	353	354	355	356	357	358	359	360
361	362	363	364	365	366	367	368	369	370
371	372	373	374	375	376	377	378	379	380
381	382	383	384	385	386	387	388	389	390
391	392	393	394	395	396	397	398	399	400

(401-600)

401	402	403	404	405	406	407	408	409	410
411	412	413	414	415	416	417	418	419	420
421	422	423	424	425	426	427	428	429	430
431	432	433	434	435	436	437	438	439	440
441	442	443	444	445	446	447	448	449	450
451	452	453	454	455	456	457	458	459	460
461	462	463	464	465	466	467	468	469	470
471	472	473	474	475	476	477	478	479	480
481	482	483	484	485	486	487	488	489	490
491	492	493	494	495	496	497	498	499	500
501	502	503	504	505	506	507	508	509	510
511	512	513	514	515	516	517	518	519	520
521	522	523	524	525	526	527	528	529	530
531	532	533	534	535	536	537	538	539	540
541	542	543	544	545	546	547	548	549	550
551	552	553	554	555	556	557	558	559	560
561	562	563	564	565	566	567	568	569	570
571	572	573	574	575	576	577	578	579	580
581	582	583	584	585	586	587	588	589	590
591	592	593	594	595	596	597	598	599	600

CATALOG INFORMATION

601	602	603	604	605	606	607	608	609	610
611	612	613	614	615	616	617	618	619	620
621	622	623	624	625	626	627	628	629	630
631	632	633	634	635	636	637	638	639	640
641	642	643	644	645	646	647	648	649	650
651	652	653	654	655	656	657	658	659	660
661	662	663	664	665	666	667	668	669	670
671	672	673	674	675	676	677	678	679	680
681	682	683	684	685	686	687	688	689	690
691	692	693	694	695	696	697	698	699	700
701	702	703	704	705	706	707	708	709	710
711	712	713	714	715	716	717	718	719	720
721	722	723	724	725	726	727	728	729	730
731	732	733	734	735	736	737	738	739	740
741	742	743	744	745	746	747	748	749	750

WHERE TO BUY

751	752	753	754	755	756	757	758	759	760
761	762	763	764	765	766	767	768	769	770
771	772	773	774	775	776	777	778	779	780
781	782	783	784	785	786	787	788	789	790
791	792	793	794	795	796	797	798	799	800
801	802	803	804	805	806	807	808	809	810
811	812	813	814	815	816	817	818	819	820
821	822	823	824	825	826	827	828	829	830
831	832	833	834	835	836	837	838	839	840
841	842	843	844	845	846	847	848	849	850
851	852	853	854	855	856	857	858	859	860
861	862	863	864	865	866	867	868	869	870
871	872	873	874	875	876	877	878	879	880
881	882	883	884	885	886	887	888	889	890
891	892	893	894	895	896	897	898	899	900
901	902	903	904	905	906	907	908	909	910
911	912	913	914	915	916	917	918	919	920
921	922	923	924	925	926	927	928	929	930
931	932	933	934	935	936	937	938	939	940
941	942	943	944	945	946	947	948	949	950

MARCH 1989

MACWORLD

FREE PRODUCT INFORMATION

Get more information on products you're interested in—simply return one of these cards today. There's no cost. And no obligation.

Please print or type all information.

Name _____ Title _____

Company _____

Address _____ City, State, Zip _____ (zip code needed to ensure delivery)

Phone: Area code/Number _____

(1-200)

1	2	3	4	5	6	7	8	9	10
11	12	13	14	15	16	17	18	19	20
21	22	23	24	25	26	27	28	29	30
31	32	33	34	35	36	37	38	39	40
41	42	43	44	45	46	47	48	49	50
51	52	53	54	55	56	57	58	59	60
61	62	63	64	65	66	67	68	69	70
71	72	73	74	75	76	77	78	79	80
81	82	83	84	85	86	87	88	89	90
91	92	93	94	95	96	97	98	99	100
101	102	103	104	105	106	107	108	109	110
111	112	113	114	115	116	117	118	119	120
121	122	123	124	125	126	127	128	129	130
131	132	133	134	135	136	137	138	139	140
141	142	143	144	145	146	147	148	149	150
151	152	153	154	155	156	157	158	159	160
161	162	163	164	165	166	167	168	169	170
171	172	173	174	175	176	177	178	179	180
181	182	183	184	185	186	187	188	189	190
191	192	193	194	195	196	197	198	199	200

(201-400)

201	202	203	204	205	206	207	208	209	210
211	212	213	214	215	216	217	218	219	220
221	222	223	224	225	226	227	228	229	230
231	232	233	234	235	236	237	238	239	240
241	242	243	244	245	246	247	248	249	250
251	252	253	254	255	256	257	258	259	260
261	262	263	264	265	266	267	268	269	270
271	272	273	274	275	276	277	278	279	280
281	282	283	284	285	286	287	288	289	290
291	292	293	294	295	296	297	298	299	300
301	302	303	304	305	306	307	308	309	310
311	312	313	314	315	316	317	318	319	320
321	322	323	324	325	326	327	328	329	330
331	332	333	334	335	336	337	338	339	340
341	342	343	344	345	346	347	348	349	350
351	352	353	354	355	356	357	358	359	360
361	362	363	364	365	366	367	368	369	370
371	372	373	374	375	376	377	378	379	380
381	382	383	384	385	386	387	388	389	390
391	392	393	394	395	396	397	398	399	400

(401-600)

401	402	403	404	405	406	407	408	409	410
411	412	413	414	415	416	417	418	419	420
421									



NO POSTAGE
NECESSARY
IF MAILED
IN THE
UNITED STATES



BUSINESS REPLY MAIL
FIRST CLASS PERMIT NO. 215 PITTSFIELD, MA

POSTAGE WILL BE PAID BY ADDRESSEE

MACWORLD

Reader Service Department
P.O. Box 5299
Pittsfield, MA 01203-9906



NO POSTAGE
NECESSARY
IF MAILED
IN THE
UNITED STATES



BUSINESS REPLY MAIL
FIRST CLASS PERMIT NO. 215 PITTSFIELD, MA

POSTAGE WILL BE PAID BY ADDRESSEE

MACWORLD

Reader Service Department
P.O. Box 5299
Pittsfield, MA 01203-9906



NO POSTAGE
NECESSARY
IF MAILED
IN THE
UNITED STATES



BUSINESS REPLY MAIL
FIRST CLASS PERMIT NO. 215 PITTSFIELD, MA

POSTAGE WILL BE PAID BY ADDRESSEE

MACWORLD

Reader Service Department
P.O. Box 5299
Pittsfield, MA 01203-9906



Advertiser Index

Reader Service Number

Reader Service Number

- | | | | |
|-----|----------------------------------|-----|---------------------------------|
| 340 | Aba Software, Inc., 82-83 | — | Magnavox, 182 |
| — | Acus, 60 | 460 | Matrix, 53 |
| — | Adobe Systems, Inc., 26 | 276 | Micro Computer Accessories, 100 |
| 401 | Advanced Gravis, 180 | 411 | Micro Star, 267 |
| 379 | Agfa Compugraphic, 162 | 161 | Micron, 194 |
| 329 | Aldus Freehand, 10-11 | 398 | MicroNet, 96 |
| 306 | Aldus Persuasion, 168-169 | 275 | MicroNet, 96 |
| 35 | Alsoft, 8 | — | Microsoft, IFC-1 |
| 35 | Alsys, 210 | — | Microsoft, 223 |
| 403 | American Micro Distributors, 222 | 458 | Microtech International, 231 |
| — | Anthro Corp., 36 | 243 | Microtech International, 233 |
| 220 | Ashton-Tate, 38-39 | 62 | Microtech International, 235 |
| 454 | Autodesk, 20-21 | 388 | Micro Vision, 26 |
| 479 | BASF, 86 | 424 | Mirror Technologies, 66-67 |
| 187 | Berkeley System Design, 206 | 413 | Mobius Technology, 189 |
| 459 | Berol USA, 187 | 87 | Monogram, 94 |
| 5 | Beverly Hills Computer, 264-265 | 478 | Multicomp, 246 |
| 383 | Brainpower, Inc., 68 | 449 | Multiple Zones Int'l, 90-91 |
| — | Buick, 47 | 196 | National Semiconductor, 166 |
| 426 | Caere Corp., 239 | 347 | Novell, 16-17 |
| 32 | CDA, 244 | 393 | NuEquation, 207 |
| 357 | Central Point Software, 159 | 284 | Olduvai, 34 |
| 365 | Ceres Software, 22 | 45 | Open Mac, 261 |
| — | Checkmark Software, 232 | 575 | Orange Micro, 207 |
| — | Claris, 62-65 | 213 | Paracomp, 78 |
| — | Claris, 247 | 229 | Paracomp, 230 |
| — | Claris, 228-229 | 290 | PCAI, 4 |
| 127 | Clearpoint, 92 | 223 | Personal Computer |
| 375 | Clearpoint, 92 | — | Peripherals Corp., 98 |
| — | Compugraphic, 76 A-H | 42 | Personal Training Systems, 203 |
| 319 | CompuServe, 198 | 356 | Pixelogic, 189 |
| 61 | Computer Friends, 99 | 317 | Preferred Publishers, Inc., 70 |
| 68 | Computer Friends, 214 | 44 | Programs Plus, 56-59 |
| — | Connect, Inc., 191 | 451 | ProVUE, 196 |
| 233 | Corel Systems, 164 | 104 | QMS/Laserconnection, 204-205 |
| 97 | Crate, 225 | 353 | Qume, 212-213 |
| 400 | CTA, 270 | 115 | Qume, 212-213 |
| 281 | Dataviz, 33 | 46 | Radius, 6-7 |
| 404 | DayStar, 81 | 149 | Rodime, 201 |
| 476 | DayStar, 79 | — | Round Lake Publishing, 22 |
| 477 | DayStar, 77 | 293 | Safeware, 258 |
| 217 | Deneba, 23 | 456 | SBT, 193 |
| 346 | Deneba, 25 | 296 | ScanCo, 71 |
| 180 | Deneba, 27 | — | Seagate Technology, 37 |
| 165 | Design Science, 72 | 239 | Secure-It, 234 |
| 242 | Digital Vision, 224 | 297 | Shana Corp., 55 |
| 562 | Diskette Connection, 262 | 327 | Sharp, 30 |
| 355 | Dow Jones Software, 178 | 421 | Shiva, 5 |
| 368 | Dr.,Mac, Inc., 263 | 117 | Sigma Designs, 88 |
| 155 | Dubl-Click, 194 | 266 | Silicon Beach Software, 257 |
| 452 | Ehman Engineering, Inc., 180 | 419 | SoftView, Inc., 254 |
| 101 | E-Machines, 48-49 | 473 | Software Library, 46 |
| 150 | Farallon, 84 | 185 | Springboard Software, 243 |
| 152 | Fox Software, 211 | 416 | Storage Dimensions, 161 |
| 177 | GCC Technologies, 15 | 186 | Sun Remarketing, 259 |
| 439 | GDT Softworks, 224 | — | Supernac |
| 195 | GE Rental/Lease, 245 | — | Technology, 171, 173, 175, 177 |
| 467 | General Parametrics Corp., 80 | 112 | Survivor Software, 208 |
| 77 | Graphsoft, 236 | 237 | Symantec, 9 |
| 440 | Hard Drives Int'l, 196 | 215 | Symantec, 12 |
| 337 | Image Club Graphics, 102 | 491 | Systat, 241 |
| 360 | Informix, 42-43 | 492 | Systat, 241 |
| — | Intuit, 73 | 320 | Tallgrass Technologies, 248 |
| 471 | Irwin Magnetics, 226 | 6 | Tallgrass Technologies, 248 |
| 82 | Irwin Magnetics, 184-185 | 321 | Tecmar, 252 |
| 385 | I/O Design, 76 | 143 | Tektronix, 209 |
| 102 | Jasmine, 40 | 176 | Thunderware, 24 |
| 457 | Jasmine, 50-51 | — | Tops, 74 |
| 192 | Kensington Software, BC | 26 | Trimar USA, Inc., 222 |
| 30 | Kensington Software, 69 | 445 | Truevision, 178 |
| 145 | La Cie, 18 | 332 | T/Maker, IBC |
| 472 | Lexpertise, 32 | 305 | USA Flex/Comark, 262 |
| 406 | MacAcademy, 255 | 93 | Varityper, 28-29 |
| — | MacConnection, 104-111 | 469 | Yen-Tel, 44 |
| 264 | MacLand, 266 | 475 | Working Software, 191 |
| 354 | MacMail, 200 | 376 | Xerox Imaging Systems, 251 |
| 86 | Mac Products, 238 | 470 | Xtree, 35 |
| 78 | MacWarehouse, 215-221 | 267 | Zericon, 234 |
| — | Macworld Expo, 268-269 | | |

GET MORE FROM YOUR MACINTOSH™

MEMORY

48 Hour Shipment
Guaranteed!

For Macintosh Plus, SE, II
Ram II+II - Cost Effective **\$CALL**
 4 Megabytes RAM, 120ns, CMOS.
Ram II- Cost Effective (No Mac II)
 Two 1 Megabyte SIMMs **\$CALL**



For Macintosh Plus
RamPlus 2- Cost Effective **\$CALL**
 Expands to 2 Megabytes RAM. Plus Only
RamPlus 4- **\$CALL**
 Expands to 4 Megabytes RAM. Plus Only
Reliable delivery for over 4 years!

We've reduced prices!
Call now to get your RAM upgraded.

VIDEO

NOW WITH GENLOCK!

Mac II to NTSC (Television) Converter

Connect your Mac II to NTSC video.

Record your Macintosh images to video tape, or use for live presentations. Compatible with Apple & SuperMac Video Cards. The NEW GENLOCK Converter allows you to overlay Macintosh graphics onto video from a camera or VCR.

STANDARD \$599. GENLOCK \$999.



Ask about our special Videoworks II offer!

Digitization

NEW!

RGB Converter™

Converts standard video to RGB for your frame grabber or digitizer. Saves you \$1000's since RGB camera is no longer required.



The RGB Decoder eliminates the need for special camera equipment

Call for more information!

All OPEN MAC products are Guaranteed:

- Are Manufactured by OPEN MAC Enterprise - Are User Installable - Preserve Manufacturer's Warranty - Carry a minimum 1 Year Warranty - Are stocked for rapid shipment -
- Are listed at a Cash Discount Price - Credit Cards not charged until shipment - Prices may vary

VISA/MC/AMEX/Discover Accepted

OPEN MAC Enterprises

415/682-0440- FAX: 415-686-4244

FORTUNE 1000 PURCHASE ORDERS ENCOURAGED

2280 Bates Avenue, Suite J, Concord, CA 94520

© 1989 OPEN MAC Enterprises. VideoEx, RamPlus, Ram II, Ram II+II, VA Plus, VA SE are trademarks of Open Mac Enterprises. Microsoft is a registered trademark of Microsoft Corporation. Macintosh is a trademark of Apple Computer Incorporated. RGB Decoder, NTSC Converter, and GENLOCK Converter are trademarks of Julian Systems, Inc. Videoworks II is a registered trademark of Macromind Inc.

Circle 45 on reader service card

Macworld 261

KAO

Media from the Surface Scientists

100 years of leadership in surface science technology goes into every **KAO** diskette — from raw materials to final packaging. You can be assured that every **KAO** diskette exceeds all world-wide industry standards

Boxed in Tens 100+

3 1/2" SS  **1.16** ea.
1K36A12

3 1/2" DS **1.37** ea.
1K38A12

Rainbow Pack
5 colors per clear plastic box
Boxed in Tens

3 1/2" DS **1.65 1.54** ea.
1K38A11-RB

Mac • Pac
Bulk packaged in 50's

100+ 400+
3 1/2" DS **1.14 1.09** ea.
1K38A13

Diskette labels **5¢** each. Minimum 50

EXTERNAL HARD DRIVES

Preference

WESTERN DIGITAL

20 Meg MAC **\$539**

40 Meg MAC **\$699**

SONY

Boxed in Tens

3 1/2" SS  **\$1.09** ea., 100+
1G36A12

3 1/2" DS **\$1.53** ea., 100+
1G38A12

MAC • PAC
Bulk Packaged in 50's

3 1/2" DS **1.20** ea., 100+
1H38A13
1.17 ea., 400+

Diskette Labels **5¢** each
Minimum 50

7 TO 7 CENTRAL M-F • 9 TO 2 SATURDAY •

USA FLEX

1-800-872-3539

FAX/ 312-351-7204

Minimum order \$100. No surcharge for MasterCard and Visa. Shipping and handling additional

135 N. Brandon Drive, Glendale Heights, IL 60138

SONY

	2-4 box	5-9 box	10+ box
3 1/2" DS	15⁹⁵	15⁸⁰	15⁵⁵

2 ME. HD	37⁹⁵	37⁵⁰	36⁹⁵
-----------------	------------------------	------------------------	------------------------

	MAC-PAC-50 (50)	"NO LABEL" (100)	(400)
3 1/2" SINGLE	1.15 ea.	1.12 ea.	1.09 ea.
DOUBLE	1.27 ea.	1.22 ea.	1.19 ea.

Old Phone: Delaware 1-800-451-1849
P.O. BOX 10247, WILMINGTON, DE 19850
Oklahoma 1-800-654-4058
P.O. BOX 1674, BETHANY, OK 73008
Nevada 1-800-621-6221
P.O. BOX 12396, LAS VEGAS, NV 89112
TELEX-4933362 FAX 405-495-4598

IBM

RIBBONS & DISKS

3.5" DS 1.0 MB #6404107		
23⁹⁵	23⁵⁰	22⁹⁵
1bx	5bx	10bx

3.5" HD 2.0 MB #6404078		
45⁹⁵	45⁵⁰	44⁹⁵
1bx	5bx	10bx

PROPRINTER **\$799**
XL 4202 #1040150 EA

Old Phone: Delaware 1-800-451-1849
P.O. BOX 10247, WILMINGTON, DE 19850
Oklahoma 1-800-654-4058
P.O. BOX 1674, BETHANY, OK 73008
Nevada 1-800-621-6221
P.O. BOX 12396, LAS VEGAS, NV 89112
TELEX-4933362 FAX-405-495-4598

 **3M**
Authorized Distributor
Magnetic Media Division Products

Packaged 10 per Box

	2-4 box	5-9 box	10+ box
3 1/2" S-Side	11²⁰	10⁹⁵	10⁸⁰
3 1/2" D-Side	15⁵⁰	15³⁰	15¹⁰
HIGH DENSITY	40⁵⁰	39⁹⁵	39⁵⁰

Old Phone: Delaware 1-800-451-1849
P.O. BOX 10247, WILMINGTON, DE 19850
Oklahoma 1-800-654-4058
P.O. BOX 1674, BETHANY, OK 73008
Nevada 1-800-621-6221
P.O. BOX 12396, LAS VEGAS, NV 89112
TELEX(4933362) FAX(405-495-4598)

Minimum order \$200. No Surcharge on Visa MasterCard. COD orders add \$30. Surface Shipping UPS add \$30 per 100 for 3 1/2" or 5 1/4", add \$40 per 100 for 8". U.S. Mail delivery add 9%. Prices subject to change without Notice.

Circle 562 on reader service card

MAIL-ORDER CONSUMERS DO HAVE RIGHTS.

The vendors and developers who advertise in the pages of Macworld share with you a common goal—to serve you, the consumer. And as a mail-order consumer, you have certain rights you should know and understand.

Mail-order sales must comply with the rules of the Federal Trade Commission (FTC) and various state laws. Here are some guidelines to alert you to your rights and help you shop by mail more effectively.

THE FTC MAIL ORDER RULES STATE:

1. The Seller must ship your order within 30 days of receiving it, unless clearly stated otherwise in the advertisement.
2. If the Seller cannot ship your order when promised, you must be notified in writing prior to the promised date. The notice must specify a new date if available, and must give you the opportunity to (a) cancel with a refund; (b) agree to a specified delayed shipping date; or (c) agree to an indefinite delay.
3. The Seller's notice must include a postage-paid reply envelope or card so that you may indicate your preference. If you do not respond, the Seller may assume you agree to the delay.
4. Even if you agree to an indefinite delay, you retain the right to cancel at any time before the merchandise has been shipped.
5. If you cancel an order that has been paid by check or money order, the Seller is obligated to mail your refund within seven business days. If you paid by credit card, the Seller must credit your account within one billing cycle following receipt of your cancellation. Store credits or vouchers are not acceptable in place of a refund.
6. If the item you order is unavailable, the Seller may not send you substitute merchandise without your consent.

DO'S AND DON'TS

By mail:

- Compare prices, including sales tax and shipping fees, before you order. Your purchase may be exempt from sales tax—check your state laws on collection regulations. Handling, packing, and shipping fees are legal and most states tax these services.
- State the precise specifications of the merchandise, such as model, make, size, component parts, etc.
- Confirm the price and expected delivery date as advertised.
- State on your order whether you will accept substitute merchandise if the item you specified is unavailable. If you won't accept a substitute, state that your payment should be returned.
- Record of payment is essential if a problem arises, so do not send cash.
- Keep copies of your order and all associated correspondence. Your records should include the company's name, address, and phone number, a description of the merchandise, your canceled check or money-order carbon, the date you mailed the order, and any sales slips and shipping receipts.
- Do not insure your order. It is the Seller's responsibility to make sure you receive your merchandise.

By phone:

- Note the name of the person who takes your order, and the time and date of your conversation.
- Make a record of your order, the price, promised availability, and the expected components.
- Save all correspondence, including your canceled check or money-order carbon and any written confirmation sent by the Seller.

Questions to ask:

- Does the advertised merchandise include all necessary parts and accessories? Are they made by the same manufacturer? Is the version number or model number the same? Is the product compatible with the hardware/software you intend to use it with?
- Can your order be shipped immediately? If not, when will it be available for shipping?
- Has the advertised price increased?
- What warranties does the merchandise carry? Who provides the service?
- What is the Seller's return policy? Exchange or repair? The refund policy?
- If a problem arises, with whom should you correspond?

PROBLEMS? SOLUTIONS:

1. If you do not receive your order as promised or if the merchandise is defective, write to the Seller immediately. Include a description of your order, the price, date, and account number or order number if available. Keep a copy of your letter.
2. If you register your complaint by phone, send a follow-up letter to confirm and keep a copy of it.
3. If you think the merchandise is defective, review your product instructions and warranty carefully. Make sure you expect only those features and abilities that the product is supposed to have. Then contact the Seller for procedures. Do not return the merchandise until you have been instructed to do so.
4. If you return the merchandise, keep the shipper's receipt or packing slip. Your right to reimbursement of postal costs is determined by store policy.
5. If you have discussed your problem thoroughly with the Seller and remain dissatisfied, write to the consumer complaint agency in the Seller's state. If you paid for the merchandise by credit card, you may have the right to withhold payment under the Federal Trade Commission's Fair Credit Billing Act.

Macworld believes that the customer has a right to product and service satisfaction. If you continue to experience problems with mail-order purchasing, the President of Macworld Communications and the Editor-in-Chief of Macworld want to know about it. Please take a moment to write to: Jim Martin, President, Macworld Communications, or Letters to the Editor, Macworld, 501 Second Street, San Francisco, CA 94107. You may also phone the President at 415-243-0505 to discuss your situation. Our goal is to help you become a satisfied mail-order consumer.

MACWORLD

The Macintosh Magazine

MACWORLD Communications, Inc. An IBC Communications Publication

Circle 305 on reader service card

DR MAC



Call now for
orders and
free catalog

1-800-825-MACS
FAX • 1-818-501-3760

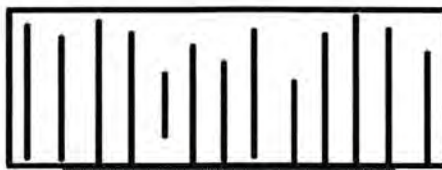

CALL
1-800-825-6227

Examine Us!

Dr. Mac provides superior service.



Check this symbol for
Dr. Mac's special
prescriptions.

Your Prescription For Success

SOFTWARE

3G GRAPHICS	
Images with Impact	52
Images with Impact Business	65
ABA SOFTWARE	
Draw it Again Sam	74
ADOBE SYSTEMS	
Adobe Illustrator '88	315
Fonts - Please Call	
AEC MANAGEMENT SYSTEM	
AEC Info Manager	399
ALDUS	
Pagemaker 3.0	395
Freehand 2.0	344
ALSOFT	
Disk Express	33
Font/DA Juggler Plus	40
ASHTON-TATE	
FullPaint	69
FullWrite	275
dBase Mac	299
BEDFORD SOFTWARE	
Simply Accounting	199
BERKELEY SYSTEMS	
Stepping Out II	49
BRAVO TECHNOLOGIES	
Mac Calc	72
BRIGHTSTAR	
Talking Tiles	71
Hyper Animator	79
BRODERUND	
Drawing Table	81
Printshop	37
CENTRAL POINT	
Copy II Mac	19
PC Tools Deluxe / Mac	38
CENTRON SOFTWARE	
Casino Games	24
CE SOFTWARE	
QuickKeys	50
Calendar Maker	26
Disktop	26
Quickmail	153
CHANG LABS	
C.A.T. 2.0	225
CLARIS	
MacDraw II	319
FileMaker II	235
MacProject II	388
COMPUSERVE	
Compuserve Navigator	40
CRICKET SOFTWARE	
Pict-o-Graph	105
Cricknet Graph	119
Cricknet Draw	169
Cricknet Presents	285
DATA VIZ	
Mac Link Plus	103
DBFAST	
dBFast Mac	115
DENEBA	
Canvas 2.0	150
Coach	51
Comment 2.0	51
Coach Thesaurus	31
Coach Professional	99
DUBL CLICK SOFTWARE	
Wet Paint Vol. 1 & 2	43



World Class Fonts	44
E.K.D.	
MacTerm	73
FIFTH GENERATION	
Fastback	59
Suitcase	43
Power Station	36
FOX SOFTWARE	
FoxBASE + / Mac	200
FoxBASE + Runtime / Mac	160
GENERIC	
CADD Level I	53
ICOM SIMULATIONS	
Tmon	89
On Cue	35
IMAGINE SOFTWARE	
Smart Alarms & Appt. Diary	32
Smart Alarms Multi-User	79
INNOVATIVE DATA DESIGN	
Mac Draft	149
Paste-Ease	28
Dreams	265
INTUIT	
Quicken	33
LACIE	
Silver Server	89
LETRASET	
Ready, Set, Go 4.0	275
Image Studio	275
MACROPAC INTERNATIONAL	
101 Macros for Excel	39
MARK OF THE UNICORN	
Performer	316
Professional Composer	396
MECA	
Managing Your Money	125
MICROSOFT	
MS Word	248
Chart	92
Excel	250
File 2.0	137
Works	195
Flight Simulator	34
Power Point	259
Quick Basic	73
NOLO PRESS	
Will Maker	33
NORTHEGE SOFTWARE	
Timeslips III	115
PRO PLUS	
Wall Street Investor	319
QUARK	
XPress	475
Style	175
SILICON BEACH SOFTWARE	
Super Paint 2.0	123
Dark Castle	26
Silicon Press	40
Beyond Dark Castle	26
Super 3D	152
Digital Darkroom	152
SOFTVIEW, INC.	
TaxView Planner	63
Form Set Business Forms	50
Macintax	63
SOFTWARE VENTURES	
Microphone II	219

SOLUTIONS INTERNATIONAL

SmartScrap & The Clipper	48
SuperGlue	46
The Curator	72

SUPERMAC SOFTWARE

SuperSpool 5.0	52
SuperLaserSpool 2.0	79
Multi-User SuperLaserSpool	195
Diskfit	52
Network Diskfit	195
Sentinel	149
PixelPaint	249

SYMANTEC

Mac SQZ	46
In-Box Starter	199
Symantec Utilities	57
Lightspeed C	105
Lightspeed P	75
More II	224

SYMMETRY CORPORATION

Acta 2.0	39
HyperDA	38

TRAVELING SOFTWARE

Lap Link Mac	82
--------------------	----

T-MAKER

Write Now 2.0	109
---------------------	-----

TOPS

TOPS for Mac	116
TOPS Flashcard	165



WORDPERFECT CORP.

Wordperfect	195
-------------------	-----

HARDWARE

ABATON

Interlax Fax-modem	314
--------------------------	-----

CUTTING EDGE

CE 800K Disk Drive	172
Wedge XL 20+	475
Wedge XL 30+	625
Wedge XL 45+	825

DATADESK

Mac - 101	156
-----------------	-----

DOVE COMPUTER CORP.

68020 Accelerator Boards for Mac	
MSE 1	550
MSE 2 1MB	975
MSE 3 Math Co-processor	734
MSE 4 1MB and Math Co-pro 1155	
Acc. or MacII Memory Exp.	459
Macsnap 1024	446
Macsnap 2H	685
Macsnap 2S	734
Macsnap 4H	1357
Macsnap 4S	1455
MacSnap Plus 2	446

FARALLON COMPUTING

PhoneNET-AppleTalk 120	9
PhoneNET PLUS	33
PhoneNET Star Controller	1225
PhoneNET Punch Down Block Wire	
Kit	68
Timbuktu	78
TrafficWatch	155

GENERAL COMPUTER

Write Move	519
------------------	-----

GIGA CELL

Data Cell 20	499
Data Cell 30S	624
Data Cell 65	828

Data Cell 90	1320
Data Cell 150	1740
Internals - Please Call	

KENSINGTON

Disk Drive Cleaning Kit	20
Macintosh II Stand	20
MasterPiece Mac II	103
System Saver Mac	63
System Saver SE	51
Turbo Mouse	113

MASS MICRO

Data Pak	1519
Data Pak Duet	2525
Data Pak Hard Drive 40	2259

PRACTICAL PERIPHERALS

1200 Baud External Modem	105
2400 Baud External Modem	185
Mac Comm. Pac 2400	228

SAMSUNG

15 in. Monitor Mac II	907
15 in. Monitor Mac SE	842

SHARP

JX-450 Color Scanner	5295
----------------------------	------

SIGMA DESIGNS

Color Max II	3760
LaserView 19 in. SE	1599
LaserView 19 in. II	1679
SilverView SE/II	1419

SOFTSTYLE

MacEnhancer	155
-------------------	-----

SUMMAGRAPHICS

Bit Pad Plus ADB	325
------------------------	-----

SUPRA

2400 Baud External Modem	140
--------------------------------	-----



SYSTEMGATE

800K Floppy Drive	159
-------------------------	-----



TARGUS

Mac Plus/SE Carry Case	56
Mac SE Ext. Keyboard Case	66
Imagewriter II Carry Case	46



TECMAR

QT Mac 40 Tape Backup	975
-----------------------------	-----



THUNDERWARE

ThunderScan 4.0 with Pwr Port ..	193
Mac II Power Accessory	41

Policies

- Corporate Accounts Welcome. Please send Purchase Orders
- Visa, Mastercard, and AMEX accepted.
- Credit card is not charged until order is shipped
- California residents add 6.5% sales tax
- To order call anytime Mon - Fri, 10 - 9 EST
- Enquiries call (818) 501-6581. FAX# (818) 501-3760
- All prices subject to change without notice.

Shipping

- All orders add \$5. Shipped Federal Express Standard Air
- Same day shipping on orders placed by 5pm EST

Returns

- Defective software will be replaced immediately by the same item. Call customer service at (818) 501-0861 for R.A. number before returning defective product.

Dr. Mac Inc.
14542 Ventura Blvd., Suite 200
Sherman Oaks, CA 91403

DR. MAC WELCOMES CORPORATE AND EDUCATIONAL ACCOUNTS

20 Megabyte External

Hard Drives

AST

20 mg/20 mg Tape Back-up...\$749

CMS

(Mac Plus, SE, II)

SD 20 Megabyte\$499

SD 30 Megabyte\$599

SD 60 Megabyte\$799

SD 80 Megabyte\$1249

CMS Pro Series Internal Mac SE/II

30 Megabyte SE rear\$499

45 Megabyte SE rear\$649

65 Megabyte SE rear\$899

80 Megabyte SE rear\$1199

100 Megabyte SE rear\$1489

40 Megabyte Mac II\$549

60 Megabyte Mac II\$699

80 Megabyte Mac II\$1145

150 Megabyte Mac II1879

300 Megabyte Mac II\$2749

Cutting Edge

800K External Drive\$175

Wedge XL30\$625

Wedge XL45\$825

Everex/EMAC

External 20D\$499

External 20 Zero Footprint\$549

Impact 40\$549

Impact 40 plus\$849

Impact 60\$989

Impact 80\$1349

Internal Mac II 20 Megabyte ..\$445

Internal Mac II 91 Megabyte \$1395

Micro Net Technology

External 300 Megabyte\$2995

External 620 Megabyte\$3995

Epson Printers

FX-850, FX-1050, LQ-500



Epson LX-800
9 pin, 180 cps\$199
Grappler C/Mac\$79

Epson LQ-500

24 pin, 180 cps\$369

Grappler LQ\$89

Hewlett Packard

DeskJet\$698

Grappler LS\$89

Seikosa

SP 1000 AP\$215

Imagewriter Compatible



General Computer
PLP Laser\$1598

PLP Plus\$1698

Business Laser Plus\$3298

GCC Write Move

Portable ink-jet printer\$529

Monitors

E-Machines

Big Picture 17" Monochrome \$1298

Big Picture T-16 Color\$2698

Big Picture T-19 Color\$4498

Magnovox

14" Color\$538

Moniterm

Viking 1 19"\$1498

Viking 2400 24"\$1898

Viking GS 19"\$2498

Viking 10 Color 19"\$3898

Sigma Design

Pageview Plus/SE 15"\$988

Silverview 21"\$1528

Siverview 256 Gray Shades . \$2398

Colormax 19"\$3898



Magnovox 14" Mac Display
640 x 480 Resolution\$538
Fine Dot Pitch, Tilt & Swivel Base

Scanners

Hewlett Packard ScanJet ... \$1395

Microtek

300C 16 gray levels\$1349

300QS 64 gray levels\$1949

300G 256 gray levels\$2749

400G 256 graylevels 400 dpi \$3349

All Scanners bundled w/Software.

Please call for competitive system pricing.



Computer professionals since 1975.

1-800-426-8166

From Beverly Hills
(213)273-3710

Fax Machine
(213)675-2522



279 South Beverly Drive, Suite 1200, Beverly Hills, California 90212

Hard Drive \$449



AST
20 mg/20 mg Tape Back-up...\$749
Limited quantity

Modems

- Abaton InterFax\$389
- Beverly Hills**
- External 1200 Baud\$99
- External 2400 Baud\$149
- Internal 2400 Mac II\$199
- Epic Technology**
- Internal 2400 Mac II\$319
- Everex**
- Emac External 2400\$219

Accessories

- Abaton**
- Propoint\$98
- CH Products**
- Flightstick\$48
- Mach IV Joystick\$48
- Mirage\$38
- Cutting Edge**
- Mac 105 ADB Keyboard\$129
- Datadesk Keyboard**
- Mac 101 or ADB version\$129
- Hyperdialer\$25
- Dust Covers/Carrying Cases**
- Mac/Plus/Se\$15
- Keyboard (specify type)\$9
- Mac II CPU only\$12
- Mac II with Mono Monitor.....\$19
- Mac II with Color Monitor.....\$19
- Imagewriter II Printer\$9
- Imagewriter LQ Printer\$14
- Laserwriter Printer.....\$24

Generic Computer Supply

- Disks Box of 10 DS/DD\$17
- Mouse Pad\$7
- Monitor Stand.....\$18
- Printer Stand 80 column\$14
- Printer Stand 132 column\$19
- Surge Protector 6 outlet\$18

Kenningson

- Superbase\$33
- System Saver\$63
- System Saver SE\$52
- Security System\$34
- Mac II System Stand\$19
- Masterpiece Mac II\$105
- Keyboard Cable ADB\$25
- Monitor Extension Kit.....\$33
- MacTilt & Swivel\$22
- Turbo Mouse.....\$118
- Turbo Mouse ADB\$118

Microspeed

- MacTrac Trackball\$78

Low prices, great service!

Practical Peripherals

- Mac Pack 2400\$239

U.S. Robotics

- External 2400\$169

DCA

- Mac Irma-Mac II or SE.....\$795

Dove Computer

- MacSnap Tool Kit\$15
- MacSnap Plus 2Call
- MacSnap 2 SECall
- MacSnap 524SCall
- MacSnap 548SCall
- MaraThon 020 Accelerator\$549
- Co-Processor 68881\$249

Call for SIMM prices

GCC Technologies

- Hypercharger 020 Accelerator . \$679

Tape Back-up Systems

- CMS 60 Megabyte External**
- TS-60.....\$729

Micro Net Technology

- 150 Megabyte External \$1499

Software

- Aldus Pagemaker\$389
- Microsoft Excel.....\$239
- Microsoft Word\$239
- Microsoft Works.....\$189

- Imagewriter II Carrying Case...\$59
- Mac Plus/SE Carrying Case...\$59
- Mac SE w/Ext. Keyboard\$69

Ergotron

- MacTilt\$68
- Muzzle.....\$58

Farallon

- MacRecorder Sound System ..\$129

OUR POLICY

- Plain and simple. Hardware; your satisfaction guaranteed or your money back.
- Software; defective software will be replaced immediately. Manufacturers policies prohibit us from offering refunds on opened software.
- We accept most major credit cards with no surcharge added.
- Your credit card is not charged until we ship.
- Please allow 10 days for personal and company checks to clear.
- C.O.D. orders accepted.
- We gladly accept purchase orders from most major institutions.
- International orders accepted.
- California, Texas, Georgia and Arizona residents please add the appropriate local sales tax.
- To Place orders call Monday thru Friday 7AM to 6PM P.S.T.
- Prices and availability subject to change.

Circle 5 on reader service card



SE Silencer

- Ultra quiet
- Internal Fan
- Keeps it cool & quiet \$39⁹⁵

Mobius

- Fanny Mac QT\$58
- SE Silencer\$39

Mouse System

- A+ Mouse\$65
- A+ ADB Mouse.....\$79

SHIPPING

All items in stock will ship in 24 hours. We offer daily service from Federal Express, UPS, U.S. Postal Service. UPS ground shipments, please add 50¢ per pound. UPS Air Shipments, please add \$1 per pound. Minimum shipping charge \$4.00.

MacLand ^{T.M.}

The Lowest Prices with Technical Support, Too!

WARNING: Beware of money-back offers on hardware! MacLand sells only NEW, NEVER USED merchandise. We will not send you re-packaged, slightly-used hard disks.

External Hard Drives

20 Megabyte	
Giga Cell 20	\$499.
Crate 20	\$539.
30 Megabyte	
CMS Enhancements 30	\$589.
MicroNet 30	\$579.
40 Megabyte	
Conner 40	\$669.
Crate 40	\$649.
MicroNet 46	\$699.
Quantum 40*	\$749.
60 Megabyte	
CMS Enhancements 60	\$749.
Crate 60	\$699.
MicroNet 62	\$739.
80 Megabyte	
CMS Enhancements 81	\$1,099.
Crate 80	\$1,149.
MicroNet 80	\$979.
Quantum 80*	\$979.
90 Megabyte	
CDC 90	\$999.
MicroNet 91	\$999.
140 Megabyte	
Rodime 140	\$1,299.
150 Megabyte	
CDC 150	\$1,949.
MicroNet 150	\$1,949.
173 Megabyte	
CDC 173	\$1,649.
MicroNet 173	\$1,649.

Drives over 173 Meg Call for Price

Internal Hard Drives for the SE

30 Megabyte	
CMS Enhancements 30	\$469.
Crate 30	\$499.
40 Megabyte	
Conner 40	\$549.
Quantum 40*	\$625.
45 Megabyte	
CMS Enhancements 45	\$659.
MicroNet 46	\$649.
50 Megabyte	
Crate 50	\$639.

*All Quantum Drives carry a manufacturers Two Year Warranty.

80 Megabyte	
CMS Enhancements 80	\$1,099.
MicroNet 80	\$889.
Quantum 80*	\$889.
100 Megabyte	
Conner 100	\$899.

Mac II Internal Hard Drives

40 Megabyte	
Conner 40	\$549.
Crate 40	\$549.
Quantum 40*	\$625.
60 Megabyte	
CMS Enhancements 60	\$659.
Crate 60	\$599.
MicroNet 62	\$629.
80 Megabyte	
CMS Enhancements 81	\$999.
Crate 80	\$1,079.
MicroNet 80	\$889.
Quantum 80*	\$889.
90 Megabyte	
CDC 90	\$899.
MicroNet 91	\$899.
100 Megabyte	
CMS Enhancements 102	\$999.
Conner 100	\$899.
140 Megabyte	
CMS Enhancements 140	\$1,149.
Rodime 144	\$1,199.
150 Megabyte	
CMS Enhancements 150	\$1,749.
CDC 150	\$1,699.
MicroNet 150	\$1,699.
173 Megabyte	
CDC 173	\$1,549.
MicroNet 173	\$1,549.
300 Megabyte	
CDC 300	\$2,349.
CMS Enhancements 300	\$2,679.
Crate 300	\$2,295.
MicroNet 300	\$2,349.
Priam 327	\$2,295.

Removables

MicroNet 45	\$1,199.
(includes one cartridge).	
45 Cartridge	\$119.



45 Cartridge Drive

Tape Back-Ups

CMS Enhancements 60	\$699.
Crate 60	\$669.
Irwin 40	\$899.
Irwin 80	\$1,099.
MicroNet 150	\$1,349.

Hardware Accessories

Anchor-5 year warranty (includes Cable & Software)	
2400 Baud Modem	\$149.
Everex	
2400 Baud Modem & Cable	\$209.
Farrallon	
Mac Recorder	\$135.
Phone Net Connector	\$34.
General Computer	
Business Laser Printer	\$3,199.
Personal Laser Printer	\$1,499.
Gume	
Script 10 Laser Printer	\$3,299.
Radius	
Radius 16+ Accelerator	\$739.
Radius 25 Accelerator	\$1,249.
Full Page Display +, SE	\$1,299.
Full Page Display II	\$1,375.
Two Page Display SE, II	\$1,849.
Radius Color Monitor	Call.

Memory

SIMMS IN STOCK

All hard disk drives carry a manufacturers one year warranty except for the **Crate & Quantum** drives which have a manufacturers **Two Year Warranty**.



For Ordering and Technical Support Call 1-800-333-3353

Visa, MasterCard, and American Express accepted NO surcharge. Your Credit Card will not be charged until your order is shipped. We accept COD orders, additional \$5.00 charge. AZ residents add 6.5%. All shipments made by Federal Express

Standard Air which is 1 to 2 day service. COD's Shipped by UPS 2 day air. Call for shipping costs. Products purchased in error are subject to a 20% restocking fee. All prices subject to change without notice. All products subject to availability.

5006 South Ash Avenue, Suite 101 Tempe AZ 85282 (602) 820-5802

Circle 264 on reader service card

Take The Guesswork Out Of Choosing The Best Shareware And Public Domain Software

Selecting the best programs from the thousands available is overwhelming. Our librarians have done the work for you while eliminating the risk. Each collection of 5 double-sided disks contains the very best of the Micro Star/Macintosh collection for only \$23.95 per set!

- ★ **GAMES** Monopoly - Air Traffic Controller - Aliens - Billiards - Klondike - Orion - Lunar Lander - MacMissiles - Golf - MacFootball - Radical Castle, etc.
- ★ **EDUCATION** Animals - 3D Moles - Life Hack - Orbit - Math Min - Full Moon - Hangman - Word Search - Math Mud - Pattern Block - etc.
- ★ **CLIP ART** Famous Faces - Cartoons - Borders - Cars - Sports Clips - Logos - Shadowettes - and more!
- ★ **AUDIO** Sound Effects - Pop Tunes - Sound Mover - Max Headroom - Monty Python - Cheap Beep - plus many more!
- ★ **UTILITIES** Red Ryder 9.4 - Big Screen INIT - Font Utilities - Disk Librarian - Servant - Disk Utilities - Resource Editor - and many more!
- ★ **APPLICATIONS** Typing Helper - BiPlane - MacAuto - Camera - MaxWrite - MacRoots - Dot-to-Dot - Memory - CK - etc.
- ★ **STACKS NO. 1** Your Faithful Camel - Sound Mover - Mac Tips - Hyper Slots - Guitar Tutor - Family Tree - The Aids Stack - etc.
- ★ **STACKS NO. 2** Jungle Adventure - Sound Manager - The Guide - Hyper Zap - Away From Home - Rez Mover - Home Desk - etc.
- ★ **STACKS NO. 3** Till - Restaurants - Hyper Jotto - Indigo Wine Man - Hyper-quackey - and more!
- ★ **STACKS NO. 4** Laura's Letters - Astro Stack - Hyper BBS - Star Trek Adventure Script Printer - Indigo Gets Out

Each series has five double-sided disks for only \$23.95 per set!

**Choose Micro Star's Econo-Packs for the BEST Values
in Shareware and Public Domain Software!
Only \$18.95 per set! Any 3 for \$54.95! Any 6 for \$99.95!**

150 UTILITIES



250 ART PICTURES



150 SOUNDS



100 LAZER PACKS

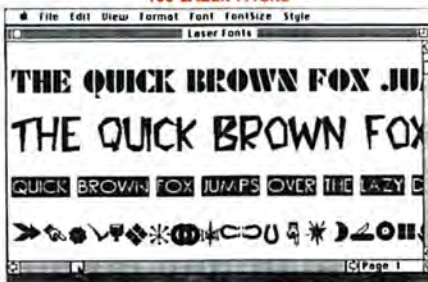

150 GAMES



225 FONTS



100 KID PACK



250 DESK ACCESSORIES



125 STACKS FOR HYPERCARD



Join the Micro Star Software of the Month Club and receive the best and most up-to-date software available. For only \$5.95 per month you will be shipped one double-sided disk containing software you can use: home financial programs, graphics, education, desk top accessories, games, and other featured programs.

Call today and order toll free. If for any reason you are not completely satisfied, return your first issue for a complete refund, no questions asked.

MICRO STAR
1105 Second Street
Encinitas, CA 92024
Info: (619) 436-0130

ORDER TODAY TOLL FREE! Orders shipped out same or next day. We accept MasterCard, Visa, checks and C.O.D. orders (add \$4). We offer FREE technical support for our customers. Econo-packs contain four double-sided disks. Add \$5/set for single-sided. Add \$4 per order for shipping and handling. Call today for free catalog!

**ORDER TOLL FREE
(800) 444-1343**
7 am to 5 pm Pacific Time
Monday through Saturday



1

Register early for
MACWORLD Expo/
Washington.
And save fifteen
Washingtons.

1



WASHINGTON

Register for MACWORLD Expo/Washington conference sessions by March 24. And save \$15, by George.

This is your chance to pre-register for MACWORLD Expo/Washington, D.C., April 26-28, 1989, at the Washington, D.C. Convention Center. Please choose your package and fill out this form completely. Incomplete forms will be returned. **Use one form per person.** And make photocopies to register additional people. Then send the completed form(s) along with your payment to: MACWORLD Expo, P.O. Box 67, Westwood, MA 02090. Registration coupons must be received by March 24. And registration fees are non-refundable. For further information, call Mitch Hall Associates at 617-326-9955. U.S. and Canadian attendees will be mailed their badges on or around April 5. All other badges will be held at the Pre-registration Counter at the Washington, D.C. Convention Center for pick up beginning Tuesday, April 25, 1989. Registration coupons received after March 24 will be returned to you.

Please register me for:

- Package One \$65** Conference sessions* and exhibits. Pre-register by March 24. \$80 at door.
- Package Two \$20** Admission to exhibits only. Pre-register by March 24.
- Please rush me detailed information (including pricing) about the Mac Masters Series.**

Please send my badge and further information to:

Please check one: **Home Address** **Company Address**

Last Name First Name

Mailing Address

City, State, Zip

Telephone

If mailing to company address:

Title

Company

- Check enclosed (make payable to MACWORLD Exposition) Amount \$ _____
- MasterCard Visa American Express Amount: \$ _____

Account Number (Include all numbers) Expiration Date

Cardholder Signature _____ (Signature necessary to be valid.)

If cardholder is other than registrant, please print name below:

Last Name First Name

Cash only at the door. After March 24, you must register at the show.

Please check the appropriate boxes:

- | | | | |
|---|--|--|--|
| <p>Your industry or profession</p> <p>a. <input type="checkbox"/> Manufacturer (noncomputer)</p> <p>b. <input type="checkbox"/> Manufacturer (computer industry)</p> <p>c. <input type="checkbox"/> Distributor/dealer/retailer/service</p> <p>d. <input type="checkbox"/> Finance/insurance/real estate</p> <p>e. <input type="checkbox"/> Professional (law/medicine)</p> <p>f. <input type="checkbox"/> Communications/publishing</p> <p>g. <input type="checkbox"/> Education</p> <p>h. <input type="checkbox"/> Government</p> <p>i. <input type="checkbox"/> Consultant</p> <p>j. <input type="checkbox"/> Other (specify) _____</p> | <p>Your title</p> <p>k. <input type="checkbox"/> CEO/president/vice president</p> <p>l. <input type="checkbox"/> Comptroller</p> <p>m. <input type="checkbox"/> DP/MIS manager</p> <p>n. <input type="checkbox"/> Owner/Partner</p> <p>o. <input type="checkbox"/> Engineer</p> <p>p. <input type="checkbox"/> Doctor/lawyer/dentist/CPA</p> <p>q. <input type="checkbox"/> Educator</p> <p>r. <input type="checkbox"/> Consultant</p> <p>s. <input type="checkbox"/> Marketing</p> <p>t. <input type="checkbox"/> Sales</p> <p>u. <input type="checkbox"/> Other (Specify) _____</p> | <p>Size of your organization (number of employees national/international)</p> <p>v. <input type="checkbox"/> Under 50</p> <p>w. <input type="checkbox"/> 50-99</p> <p>x. <input type="checkbox"/> 100-499</p> <p>y. <input type="checkbox"/> 500-999</p> <p>z. <input type="checkbox"/> 1,000-5,000</p> <p>aa. <input type="checkbox"/> Over 5,000</p> <p>Which personal computer(s) do you own/or use?</p> <p>bb. <input type="checkbox"/> Macintosh</p> <p>cc. <input type="checkbox"/> Macintosh Plus</p> <p>dd. <input type="checkbox"/> Macintosh SE</p> <p>ee. <input type="checkbox"/> Macintosh II</p> | <p>ff. <input type="checkbox"/> Apple II +</p> <p>gg. <input type="checkbox"/> Apple IIe</p> <p>hh. <input type="checkbox"/> Apple IIc</p> <p>ii. <input type="checkbox"/> Apple III</p> <p>jj. <input type="checkbox"/> Apple II GS</p> <p>kk. <input type="checkbox"/> None</p> <p>ll. <input type="checkbox"/> Other (specify) _____</p> <p>Where will you be staying while at MACWORLD Expo/Washington, D.C.?</p> <p>mm. <input type="checkbox"/> Home</p> <p>nn. <input type="checkbox"/> With friends</p> <p>oo. <input type="checkbox"/> Hotel (specify) _____</p> <p>pp. <input type="checkbox"/> Other (specify) _____</p> |
|---|--|--|--|

* All conference sessions are on a first-come, first-served basis with no guaranteed seating. Please fill out this form completely and send it, along with your check or money order to: MACWORLD Expo, P.O. Box 67, Westwood, MA 02090.

Here's a sound business deal for anyone who

appreciates the value of a dollar.

Register by March 24 for the first-ever MACWORLD Expo/Washington D.C.—April 26, 27, and 28—and save \$15.

That means you pay just \$65, instead of \$80 at the door, for three-day admission to the original Macintosh computer show at the Washington, D.C. Convention Center. This one low fee allows you to attend all conference sessions* and visit all exhibits.

Meet and talk with more than 300 exhibitors spread over

200,000 square feet of space. And take part in dynamic seminars and workshops run by the biggest names in the Macintosh industry, people like John Sculley, Bill Atkinson, and Jerry Borrell. Plus you'll hear from the gurus of the Macintosh in the federal government, C. Lloyd Mahaffey, Dave Lavery, and Steven Woit.

There's something for everyone in business or government.

It doesn't matter whether you

use a Mac to run a private business or manage an agency of the federal government. In three days, under one roof, you'll gather more useful information than you could in weeks of running around to computer stores.

MACWORLD Expo/Washington is a hands-on, do-it-yourself show.

You can create professional-quality presentation visuals—on

the spot. Compose newsletters, reports, brochures, and ads. Send or receive messages from Mac to Mac, or Mac to PC, or Mac to DEC. Witness the power of HyperCard. Try your hand at animation or graphics. And much more.

There's literally something for every Macintosh user—from novice to aficionado—including special sessions for educators, engineers, attorneys, health-care professionals, real estate agents, bankers and financial managers,

home office, corporate and government users.

New to MACWORLD Expo: The Mac Masters

Series of Private Executive Seminars.

MACWORLD Expo/Washington will feature a series of private, limited-attendance, no-nonsense seminars on the subjects executive users want to hear about most—networking, spread-

HyperCard, telecommunications and more.

Each practical, in-depth seminar gives you the rare opportunity to learn directly from Macintosh masters. Pick up pointers and shortcuts you can put to work right away. And get the straight story on major applications and vendors in your subject area.

If you would like to know

more about the Mac Masters Series, please check the appropriate box on the attached reply form. Or call 214-554-0111. We'll send you an information package, including pricing, immediately.

Save on airfare and hotels.

American Airlines is offering special airfares to attendees

of MACWORLD Expo/Washington. Simply call 1-800-433-1790 and ask for STAR File # S16676. You'll automatically receive a discount.

MACWORLD Expo/Washington has also arranged for special rates at a variety of hotels in area code 202: Comfort Inn Downtown, 289-5959; JW

Marriott, 393-2000; Grand Hyatt Washington, 582-1234;

Hyatt Regency, 737-1234; Quality Inn, 638-1616; Ritz Carlton, 293-2100; The Bellevue Hotel, 1-800-327-6667; Holiday Inn-The Governor's HS., 296-2100; The Mayflower, 347-3000; Hotel Washington, 638-5900; Holiday Inn-Thomas Circle, 737-1200; One Washington

Circle, 872-1680; Vista International, 429-1700; Embassy Square

Hotel, 659-9000; Washington Marriott, 872-1500; Washington Plaza Hotel, 842-1300; The Henley Park Hotel, 638-5200; Days Inn Downtown, 842-1020. Call soon to ensure reservations.

Avoid long lines and save.

Register for MACWORLD Expo/Washington conference sessions*

before March 24 and save \$15. Simply fill out the attached

registration form and mail it with your check or money order for \$65 (or supply credit card information) to the address on the form. After March 24, the cost is \$80 and you must register on-site. Registrations received after March 24 will be returned.

If you want to attend the exhibits only, admission is \$20. And if you're a student, the pre-registration cost is just

\$15. But you must send us a copy of your student I.D. with

your registration form to qualify. We encourage you to register now and avoid long lines at the door.

If the registration form is missing from this ad, please call Mitch Hall Associates at 617-326-9955. We'll be happy to send you one.

Don't miss this opportunity to attend the first-ever MACWORLD

Expo/Washington.

And save fifteen Washingtons.

MACWORLD EXPOSITION®

WASHINGTON, D.C.
April 26-28, 1989

*All conference sessions are on a first-come, first-served basis with no guaranteed seating. MACWORLD Exposition is produced by World Expo Corp., and managed by Mitch Hall Associates. MACWORLD Exposition is a registered trademark of World Expo Corp., Inc. MACWORLD Exposition is the original Macintosh computer show. It's sponsored by MACWORLD, the Macintosh™ Magazine, a member of the IDG Communications/Inc. family. MACWORLD Exposition is an independent trade show not affiliated with Apple Computer, Inc. APPLE and the APPLE LOGO are registered trademarks and MAC, MACINTOSH, and MACWORLD are trademarks of Apple Computer, Inc.



TextPert™ Reader.

We've got a new concept in Optical Character Recognition for the Mac. It's called TextPert.

We'll show you five good reasons that make TextPert the most intelligent OCR purchase you can make.

1 Flexibility

Flexibility in the type of document you want to read – (TextPert can read documents as simple as mono-spaced, typewritten pages or as complex as newspapers and telephone directories). Flexibility to read any text - bold, italic, written in a foreign language with special characters, or written in an unusual font. Flexibility in choosing the scanner you want to use or turning the scanner you already have into an Expert TextReader – (we work with all Macintosh compatible scanners on the market).



2 Ability

Ability to read columns of kerned text from 4 to 36 points in size printed on poor quality paper. Ability to read columns or tables of information, maintain their format, and import them into databases. Ability to read text even if it has up to a 25% rotation.

3 Compatibility

TextPert is compatible with you. It is intuitively written to modify the reading parameters automatically according to the document it is reading. And it is compatible with all of the major word-processing and page layout programs available on the Macintosh.

4 Affordability

TextPert gives you the power and functionality of large OCR systems at a fraction of the price.

5 It Works

Unlike other programs which claim to give you large system functionality at a fraction of the price, TextPert works... with an error rate of less than 1/2% on high quality originals.



TextPert™

Expert Text Reader

TextPert reads quickly and accurately, with maximum flexibility, and at an affordable price. Call us at 1-800-592-2209 for more information, or 212-759-6201 in New York State. In Canada, call 1-800-668-8986

CTA

c/o Trans-National Trade
Development Corporation
866 Second Avenue
New York, NY 10017
(212) 759-6201
Fax (212) 644-9867

In Canada,
c/o Uppercase Technology Inc.
PO Box 3280
Markham Industrial Park
Markham, Ontario L3R 3L0

Circle 400 on reader service card

The Macworld Catalog

Now *Macworld* connects you with the world of Macintosh products instantly. And cost-effectively.

The Macworld Catalog is your immediate access to hundreds of Macintosh products, manufacturers, and services. Each month, this special direct response section brings you detailed product information arranged by category—so you can quickly compare prices and capabilities. Then pick up the phone and order!

For the best Macintosh buys, scroll through *The Macworld Catalog*.



The Macworld Catalog

Accessories

- Furniture273
- Hardware273
- Mouse Pads273
- Supplies273

Hardware

- Bar Code274
- Computer Systems . . .274
- Data Acquisition275
- Emulators275
- Expansion Chassis . . .275
- Memory Upgrade275
- Miscellaneous277
- Networking278
- Peripherals278
- Printers278

Hypercard Stacks

278

Services

- Computer Insurance . . .279
- Data Conversion279
- Desktop Output279
- Desktop Publishing . . .279
- Disk Duplication280
- Laser Recharge280
- Training280

Software

- Architecture280
- Astrology281
- Bar Code281
- Business281
- Business Mgmt.281
- Clip Art282
- Communications282
- Data Base282
- Desktop Publishing . . .282
- Document Mgmt.283
- Educational283
- Engineering284
- Entertainment284

- Financial285
- Fonts285
- Fund Raising286
- Genealogy286
- Graphics286
- Health286
- Investment286
- Languages286
- Medical287
- Music/MIDI287
- Politics287
- Programming Tools . . .288
- Public Domain288
- Real Estate288
- Recreational288

- Reference Mgmt.288
- Religion289
- Rental289
- Retail290
- Sales/Marketing290
- Scientific290
- Statistics290
- Utilities290
- Word Processors291

Miscellaneous

- Business Opportunities 291
- Mailing Lists291

Categories are subject to change

Advertising Rates & Information *The Macworld Catalog*

The *Macworld Catalog* section is a monthly link-up for advertisers and volume purchasers of Macintosh-related products and services. The *Catalog* offers advertisers a low-cost marketing opportunity and provides readers with a timely, easy-to-use menu for product buying.

Display ads are sold by column inches (2" minimum). Standard red is available as a second color. Text-only listings are available for a minimum of three issues at \$322 per issue (\$965 total).

For more information, space closings, and material deadlines, please call toll-free 800/888-8622.

**Instant Link:
Macintosh Products,
Manufacturers,
Services**

**The Macworld
Catalog**
501 Second Street
San Francisco,
CA 94107
800/888-8622

Account Managers
Niki Stranz,
Western U.S.
Carol Felde,
Eastern U.S.

The Biggest Small Investment You Can Make.



Take advantage of the direct link with your buyers that maximizes exposure at a low cost.

The *Macworld Catalog* reflects the expanding corporate Macintosh audience whose purchasing activities increasingly include mail order. The cost-effective direct response advertising available monthly in *The Macworld Catalog* links you instantly with nearly 500,000 qualified buyers.

Get into the link. Call 800.888.8622 and place your ad now!

800.888.8622

The Macworld Catalog

Accessories Furniture

Furniture for the Macintosh

Nationally advertised fine oak furniture

Save up to
40%
factory direct!



- CAD-CAM WORKSTATIONS
- LASERWRITER CARTS
- PRINTER STANDS
- AND MORE...

Call Now
For Free Catalog

1-800-333-8095

The Walker Company Petaluma, CA

CIRCLE 706 ON READER SERVICE CARD

Hardware

TURBO MOUSE*

Now you can own the *Winner of the 1988 Turbo Mouse Race*, for less than half the retail price!! Our Turbo Mouse has been named Top Input Device for '87 & '88 by the readers of *Macworld*. The '88 *Macworld* standings for Hardware-Top Input Device: • TURBO MOUSE*

• Abaton Mouse Trackball-Pro-point • Apple Expanded Keyboard • Mac-101 Enhanced Keyboard • Mouse Systems A+ Mouse. Also Turbo Mouse ADB at low, low prices!

Cambridge Automation, Inc., 3260 Industry Dr., Signal Hill, CA 90806, 213/597-1626, 800-345-8666, 800/826-9214 (in CA)

Security Kits/Cust Cables

For Mac+, SE, II, Image II, LW, & Apple II, IBM, clones & terminals. Since 1984. Largest security line available. MacLock secures Mac, Keyboard, mouse & most peripherals with 8' red coated aircraft cable. MacGuard prevents unauthorized use or power up. Lock incl. No tools req. Also custom data cable for any computer need. Competitive prices. Vol. discounts & dealer pricing avail.

MacProducts, 20231 San Gabriel Valley Dr., Walnut, CA 91789, 714/595-4838

Mouse Pads

Mouse Pads

Custom Printing Available Cloth: Blue, Gray, Burgundy, Red, Brown, Green, Black, Navy & Platinum

Size: 8 x 7½, 8 x 9½, 8½ x 11

12 Pads	3.25	3.50	3.75
72	3.00	3.25	3.50
144	2.85	3.10	3.35

PLASTIC: Blue, Platinum, Gray & Red

Size: 8½ x 11

12 Pads	6.50	36-6.00
72-5.75	144-5.25	

CALL AND ASK US ABOUT OUR VIEW PAD AND PICTURE PAD.
Precision Line Inc., 14100 23rd Ave N., Minneapolis, MN 55441 1-800/328-0077, 612/557-1917

Company Logo Specialist

Grey, Green & Red Pads

Size: 9¼" x 8" x ¾"

- 12 pads \$9.50 w/logo
- 36 pads \$8.50 w/logo
- 72 pads \$6.90 w/logo
- 144 pads \$4.70 w/logo
- 500 pads \$4.14 w/logo
- 1000 pads \$4.02 w/logo

ENTIRE pad imprintable.

Guaranteed to last. Multi-color jobs OK. SAMPLES w/your company logo \$12.50.

Computer Expressions, 3833 Chestnut Street, Philadelphia, PA 19104, 800/443-8278

Supplies

MacHarness™ Carrier

Only \$29.95

Mac portability for less!

Not bulky to carry & folds small for storage

Nylon webbing, padded leather shoulder strap, quick-release buckles
Keyboard, mouse, & cables attach with straps (included)



Bitbags P. O. Box 834
Clairton, PA 15025
(800) 635-5482
(ORDERS ONLY PLEASE)
OR
(412) 653-1082

CIRCLE 703 ON READER SERVICE CARD

NYBILS™ SOFT-WEAR MOUSE

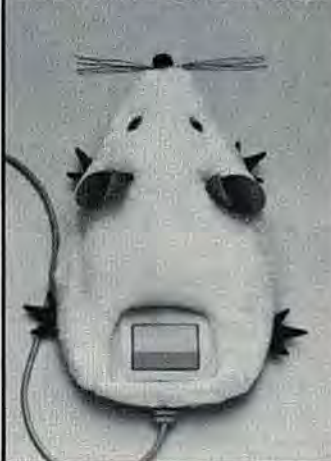

CIRCLE 668 ON READER SERVICE CARD

MacDisks for less.

3.5 DS/DD

Blue, Gray, Blk
5 Color Labels
White Box
Shrink Wrapped

\$1.12

50 or more.
\$1.16 each,
less than 50.

(In 5 colors \$1.33, 50 or more)

3.5 DS/DD

Blue, Gray, Blk
5 Color Labels
Shrink Wrapped

\$1.07

50 or more.
\$1.11 each,
less than 50.
(In 5 colors \$1.28, 50 or more)

Continuous form labels!

2¼" x 2¾" - 1 across - 2500... \$12.00/M



"The Quality Disk & Label Specialist Since 1982"
1040 Broadway, Westville, NJ 08093

1-800-426-3303

609-456-6996 • FAX #609-456-7172
All orders F.O.B. Westville, NJ, Fresno, CA.
C.O.D. orders add \$2.20. Purchase orders,
Visa & MasterCard accepted.

CIRCLE 692 ON READER SERVICE CARD

LASEREDGE® Paper/Film

Get high resolution from plain paper laser printers and color plotters. LASEREDGE® high resolution Papers/Films are waxable for paste-up. The bright white background, denser image, and finer edge of line will allow enhanced capability for 300 dpi to reproduce on camera. Call or write for samples today. MC/VISA accepted.

CG Graphic Art Supply, Inc., 481 Washington St., NY 10013, 800/342-5858 FAX# 212/941-9765

LEATHER PAD

8" x 10" black top-grain leather, neoprene backed.

Great gifts, 5 year warranty.

Send only \$9. for either (includes S/H) to:

Foresight Designs, Box 70,
Southeastern, PA 19399

VISA/MC (215) 647-8534

MacDesk Organizer

Harwell Services
386 Freeman St. 3
Long Beach
CA 90814

Call Now
213-433-3807

Printer Stand
Now Available
\$25



- Affordable, sturdy, functional, handsome
- 100% wood finished in cherry, oak or walnut
- 2 models, extended or standard
- Holds both external and hard disk drives
- Keyboard and peripherals fit underneath
- Cost only \$30

CIRCLE 672 ON READER SERVICE CARD

TIZIO LAMP SALE

The Museum of Modern Art design classic.

Mac users love it for its bright, halogen light, glare control and great looks next to the Mac.

Special Price
40-50% Off

1 800 962-6789
CT: 866-4321

AmEx
Visa
MC
primo

114 Washington St., South Norwalk, CT 06854

CIRCLE 620 ON READER SERVICE CARD

The Macworld Catalog

Supplies



Pack your Mac in seconds!

Cordera has internal padded pockets for mouse, keyboard and drive. Available in six colors. Extended Keyboard version also available. For a dealer near you call toll free **1-800-548-0053** West Ridge Designs 1236 N.W. Flanders Portland, OR 97203

CIRCLE 681 ON READER SERVICE CARD

ComputerWear

100% COTTON CANVAS
DUST COVERS!



FOR
MAC, II, ImageWriters, & Lasers
Beige w/ Gray Trim. Breathable, Static-Free!
Available Individually or Special Set Price
Call For Prices or Free Catalog. Dealers Welcome!

OrderToll-Free
1-(800)826-5761

Contemporary ComputerWear
1320-36th Ave San Francisco 94122

CIRCLE 709 ON READER SERVICE CARD

Cates ERASABLE LABELS

are new type permanent disk labels of micro-thin plastic. Two styles: with organizational categories or blank, both protected by durable lamination. Write with the non-smear pen, revise by erasing. Make spot revisions or erase entire surface. Erds label tug-of-war. **Kits w/labels/all erasing materials** start \$16.95 (50). Orders/info call Cates & Co. 800/541-4351, P.O. Box 2761, Abilene, TX 79604, V/M/C.

REMOVE THE LINK, NOT THE LABEL!

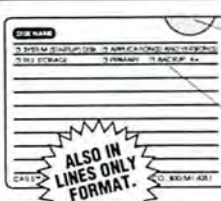

Handy, removable, color code stickers wrap around disk, allows you to color code your labels as needed - on the spot. No more too many or not enough of a certain color label. Printed categories provide easier way to record data names. Lamination protects printing from eraser.

CIRCLE 720 ON READER SERVICE CARD

MACINTOSH DUST COVERS

Mac, keyboard & mouse.
Reg. \$32 **NOW \$25**
Mac II, monitor atop CPU, keyboard & mouse.
Reg. \$42 **NOW \$33**
*Free 8"x9 1/2" Mousepad valued at \$10 with cover set purchase. Satisfaction Guaranteed.

Computer Cover Company
23352 Peralta, #14, Laguna Hills, CA 92653

TOLL-FREE: 800/235-5330

VISA In CA: 800/237-5376 MC

CIRCLE 727 ON READER SERVICE CARD

PRINTER PROBLEMS?

Misfeeds? Smudges? Envelopes Jam? Slip?

- Retro-fix Mac Laser SC, NT, NTX
- Fix Image & Laser I Feed Drivers

Laser-Fix

Laser Writer II \$39.95 + 3.00
All others \$29.95 + \$3.00

Visa or M/C Call or Write

1-800-228-1383

J.B. Marketing Co. 10712 N. Elma Dr. Spokane, Wa. 99218

CIRCLE 645 ON READER SERVICE CARD

SECURITY

PADLOCK™ physically secures your computer from theft without cables or bolts. Two interlocking steel pads use high-bond acrylic adhesive technology to protect your equipment with 10,000 lbs. of strength. Easy to install. Order keyed different or alike. \$ 79.95 + \$5.00 shipping

CONTROL POWER™ gives you control over the use of your computer with a key. No unauthorized access. Control Power attaches to any electronic device with a removable, 3 prong power cord. Order keyed different or alike. \$69.95+\$3.00 s/h
(415) 861-2223

DOSS INDUSTRIES

1224 Mangrove St. SF. CA 94107

CIRCLE 669 ON READER SERVICE CARD

OPTIMAC™

Eye Saving Optical Magic SpaceLight™
Mounts on the top front edge of your MAC... Eliminates desk top clutter, glare, visual discomfort and fatigue... Precise optical mirror control of tungsten halogen light properly illuminates paper information to the left and right of the computer... OPTIMAC does the work of two desk lamps... Please tell us type of MAC and/or monitor \$155

Includes shipping within continental U.S. by UPS... Add 6% sales tax in California... Check Visa or MasterCard

SPACE LIGHTING INC.
37 Commercial Boulevard
Novato, California 94949
(415) 382-7816

CIRCLE 645 ON READER SERVICE CARD

QUALITY DISKETTES

3 1/2" DS-DD
100% Certified Lifetime Warranty Major Mfg.
99¢ EA. MIN 50
Color 3 1/2" DS DD (5 Colors)
Orange-Red- \$129 ea.
Yellow-Green-Gray
DD80 Holds 80 3 1/2" Holder w/Lock \$1195 ea.
5 1/4" DS DD \$.29 ea.
5 1/4" DS HD \$.69 ea.
3 1/2" DS HD (2MB) Call for best price

Shipping \$4 per 100 diskettes
Order by phone or send your check to:

AMERICAL GROUP
(800) 288-8025
12132 Sherman Way,
N. Hollywood, CA 91605

CIRCLE 686 ON READER SERVICE CARD

Dust Covers

for a Clean Machine

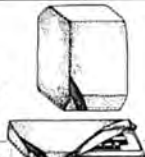

Protect your equipment from dust, spills, and aggravating downtime with **ABCOM DUST COVERS** for personal computers.
Attractive, water resistant packcloth in NAVY, SILVER, or BROWN

- ▶ Custom-fitted, stylish, and durable.
- ▶ With the original rainbow ribbon accent.
- ▶ Extensive selection of dust covers for over 400 models, including:
 - IBM
 - APPLE II SERIES
 - MACINTOSH
 and numerous printers.



MC & VISA ACCEPTED. PLEASE WRITE OR CALL FOR COMPLETE PRICE LIST AND BROCHURE
2333A N. SIERRA HWY, BISHOP, CA 93514
619/872-1946

CIRCLE 683 ON READER SERVICE CARD

Hardware

Bar Code

BAR CODE & MAGNETIC STRIPE READERS FOR MACINTOSH PLUS, SE & II

Connects on keyboard or ADB
Requires no additional program or port
Does not affect keyboard or mouse
Industrial quality, heavy-duty units
Also available
Magnetic encoder
Code 39 Bar Code Printing Program
Portable Bar Code Reader

TPS Electronics
4047 Transport Street
Palo Alto, CA 94303
415-856-6833
Telex: (Graphnet) 371 9097
FAX: 415-856-3843

CIRCLE 613 ON READER SERVICE CARD

Computer Systems



Macintosh COMPUTER PACKAGES™
SEs - Mac IIs - Laser Printers
Hard Drives - Monitors - Scanners
CALL FOR FULL...
SYSTEM PACKAGE PRICING TODAY!
800 622-8804

CIRCLE 606 ON READER SERVICE CARD

DATA (213) 470-9555
Computers Fax 470-9457
2253 Westwood Blvd. L.A. CA 90064

LaserWtr.SC/NT/NTX In Stock
Mac+ /20Mb 1345./1895.
MacSE2Dr/20Mb* 2275./2595.
MacSE30/45Mb* 2685./2895.
MacII/40Mb* 3565./3995.
MacII60/80Mb* 4145./4535.
CMS Hard Drives CALL
MonitorMono/Color 325./725.
*Keyboard Reg./Ext. 99./175.

Apple logo COD & Next Day Delivery Available
No Tax Outside California

CIRCLE 650 ON READER SERVICE CARD

The Macworld Catalog

DISCOUNT MACINTOSH

Macintosh Plus.....	\$Call
Macintosh SE 2 800k drive.....	\$Call
Macintosh SE 30mb internal.....	\$2695
Macintosh SE 40mb internal.....	\$2895
Macintosh II 40mb internal.....	\$3995
Macintosh II 60mb internal.....	\$4150
Apple keyboard for SE or II.....	\$100
Datadesk 101 keyboard.....	\$140
Apple 13" color monitor.....	\$750
Mac II 8 bit video card.....	\$495
Imagewriter II w/cable.....	\$450
Imagewriter LQ w/cable.....	\$995
Apple laserwriter II NT.....	\$3695
General Computer P.L.P. Plus....	\$1595
C.M.S. external hard drives.....	\$Call
SIMM chips in stock.....	\$Call

KIWI COMPUTERS
P.O. BOX 67381
Los Angeles, CA 90067
(213) 553-4643

Orders must be prepaid by cashiers check or money order. Ground or air shipping charges extra. Call for rates. Foreign orders welcome. We ship to most countries. California residents add sales tax. All items new with warranty. 90 days on Apple products. Prices subject to change without notice. All sales final. Apple and Macintosh trademarks of Apple Computer Inc.

Mon-Fri 7A.M.-5 P.M. Pacific Time

CIRCLE 734 ON READER SERVICE CARD

Data Acquisition

MacPacq

The MacPacq transforms the Macintosh into a digital oscilloscope, chart recorder & waveform generator. A complete data acquisition & control system. 8 channel A/D, 8 digital I/O, programmable gain, 64K RAM. Optically isolated, line or nicad powered. Runs remote and/or connected to Mac. Comprehensive software interface provides for powerful & flexible system. \$1195 complete.

Biopac Systems, 5960 Mandarin Dr., #D5, Goleta, CA 93117, 805/967-6615

Emulators

II in a Mac

An Apple II/e computer
...all in software!

Run Apple II software on your Macintosh.
Convert Apple II files to Macintosh files.

\$149.95 Add \$3 for P&H

COMPUTER:applications, Inc.
12813 Lindley Drive Raleigh, NC 27614
(919) 846-1411

CIRCLE 640 ON READER SERVICE CARD

Expansion Chassis

Expansion Chassis for the MACINTOSH

Open up your Macintosh Plus, SE or II with an expansion chassis system from Second Wave, Inc. *ExpanSE Plus*, *ExpanSE*, and *Expanse II* allow you to custom configure your Macintosh with a variety of option boards:

Accelerators • Monitors • MS-DOS Communications • Data Acquisition Industrial Control • Transputers

SECOND WAVE, INC.

9430 Research Blvd., Bldg. II, #260
Austin, TX 78759
(512) 343-9661

CIRCLE 687 ON READER SERVICE CARD

Memory Upgrade

MAC SIMMS

Add memory to your Mac Plus, SE or Mac II. One megabyte SIMM modules available in 2 MB sets. We offer the lowest price you'll find anywhere—any quantity. Call for quote. MC/VISA. Immediate delivery. Product satisfaction guaranteed. We've been in the RAM business since 1982.

Palo Alto RAM, P.O. Box 50690, Palo Alto, CA 94303, 415/858-0125

HARD DRIVES

LIFETIME WARRANTY

20 MEG INTERNAL	\$349
31 MEG INTERNAL	\$415
46 MEG INTERNAL	\$489
20 MEG EXTERNAL	\$465
31 MEG EXTERNAL	\$510
41 MEG EXTERNAL	\$565
46 MEG EXTERNAL	\$629
61 MEG EXTERNAL	\$659
80 MEG EXTERNAL	\$804
100 MEG UP - Call	

Fits in SE+Mac II with 2 drives
Include PD+Backup Software
External fits under Mac
Seagate—Miniscribe—Quantum
WESTCOM COMPUTER
P.O. Box 154-Ayden, NC 28513
800-422-8591-919-746-4961

CIRCLE 694 ON READER SERVICE CARD

D SIMS MODULE

100% MAC II
COMPATIBLE
1 MG X 8 - 100NS

\$360.00 PER UNIT

QUANTITY DISCOUNTS AVAILABLE!
1 YEAR WARRANTY

WJL PRODUCTS INC.
COMPUTER NETWORKING & TECHNOLOGY

8755 N.W. 57th Street
Tamarac, FL 33351
1-800-635-6366 At Tone 726

CIRCLE 639 ON READER SERVICE CARD

MEMORY ACCELERATORS HARD DRIVES MODEMS



Your first choice for quality...

MAC II

1 Meg Increase \$ 495 ~~\$ 359~~

4 Meg Increase \$2,896 ~~\$ 1430~~

SE or Plus

2 Meg Increase \$1,298 ~~\$ 720~~

2400 Baud INTERNAL MODEM for Mac II/SE!

Mac II & SE \$ 329! Auto Dial • Redial on busy • Data/Voice Mini-External 2400 for Mac II, SE & Plus \$ 179!

Internal & External Hard Drives for Mac II/SE

Intern: 30mb \$479! • 40mb \$589! • 80mb \$899! • 120mb \$ 1199!
External: 40mb \$699 • 50mb \$769 • 80mb \$949 • 120mb \$1199!

Increase your SE to Mac II Speed!

Easy installation • 16Mhz microprocessor • 100% compatible with all software and external hardware! \$ 329!

Second Source (602) 966-0357

2011 E. 5th Street, Suite 6 • Tempe, AZ 85281

MEMORY \$S SALE !!

*100% compatible with all internal hardware! • While supplies last • All prices subject to change without notice

CIRCLE 742 ON READER SERVICE CARD



The Macworld Catalog

Memory Upgrade

Ask about our 5-YEAR WARRANTY! **Exclusive!**

Memory Expansion SIMM Kits for Macintosh™ Plus, SE and Macintosh™ II

Easy to install, plug-in modules that let you add 2 to 8MB of memory. Ideal for "memory-gobbling" software applications and the new Multi-Finder multitasking environment.

Guaranteed Same Day Shipment

Orders received by 3:00 p.m. (CST) for 1MB SIMMs are shipped same day, or we pay freight.

We manufacture these high and low profile SIMMs in volume for immediate shipment.

	85ns	100ns	120ns
1MBx8	High Profile	High & Low Profile	High & Low Profile
1MBx9	High Profile	High & Low Profile	High & Low Profile

We buy and sell 256K SIMMs.



CALL FOR PRICES AND DISCOUNTS
1-800-678-DRAM
(678-3726)

Newer™
TECHNOLOGY

Newer Technology
Phone (316) 685-4904
FAX (316) 685-9368
1117 S. Rock Rd., Suite 4
Wichita, KS 67207

Designers and manufacturers of the newest technology in memory

- DartCard™ • attention!™ • Concentration™
- LIMfile™ • ADDITION™

CIRCLE 631 ON READER SERVICE CARD

APPLE CABLES & ACCESSORIES

... an economical source

Are you looking for a easy & low cost way to network all your Apple computers & peripherals? ...

Try our

NETWORK ADAPTERS



APPLE is a trademark of Apple Computers, Inc.

Give us a CALL!
(408) 294-6800

We offer printer & modem cables for the following computers: Mac+, Mac SE, Mac II, Mac, Apple IIc, and Apple IIe. We also offer a selection of Apple SCSI cables and a terminator.

Dealer and Distributor inquiries are always welcome.

HVMCO
TECHNOLOGIES, INC.
270 Cimino Street • San Jose, CA 95125

CIRCLE 746 ON READER SERVICE CARD



The application "HyperCard" could not be opened (1,000K needed, 509K available). Try quitting from another application to increase unused memory.

Okay

PSI

Look familiar?

Call **PSI** so you will never see this on your screen again!

PSI has the one megabyte SIMMS that will give you the extra memory you need to get the maximum performance out of your Macintosh Plus, Macintosh SE, or Macintosh II. Call now!

(800) 622-1722
(408) 942-8188



PINNACLE
SALES
INTERNATIONAL

1609-A South Main Street
Milpitas, CA 95035

Macintosh Plus, SE and II are registered trademarks of Apple Computer, Inc.

CIRCLE 617 ON READER SERVICE CARD

The Macworld Catalog

SOFTSTEP

SOFTSTEP MEMORY UPGRADES

For the Mac Plus/SE and Mac II / Ix

SOFTSTEP IV
New!

SOFTSTEP IV is a module with no onboard memory. The user supplies 256K SIMMs to build a 2 meg upgrade for a Mac Plus.

SOFTSTEP I

Upgrade your Mac Plus/SE from 1 Meg to 2 Megs by using your existing 256K SIMMs.

SOFTSTEP II

Upgrade your Mac II from 1 Meg to 4 Megs or from 2 Megs to 5 or 8 Megs using your existing 256K SIMMs

SOFTSTEP III

SOFTSTEP III is a module with no onboard memory. The user supplies 4-256K SIMMs to make 1 meg SIMMs. SOFTSTEP III is for the Mac II / Ix and is placed in the SIMM socket.

ORDERS & INFO

1-800-950-CARE

In MN (612) 920-CARE (2273)
Dealer inquiries welcome

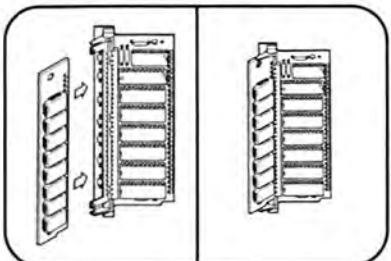

SOFTSTEP II installation Illustrated



SIMMS

- 1 MEG SOJ
- 1 MEG DIPS
- 256K SIMMS

All Computer Care products carry a 1 year warranty.

Visa/MC Accepted

5124 Russell Ave S
Minneapolis, MN 55410
FAX: (612) 925-2720

CIRCLE 662 ON READER SERVICE CARD

DON'T LET THIS HAPPEN TO YOU!

COLOR? MULTIFINDER?

MEMORY UPGRADES FOR THE MAC PLUS, SE, II

SINGLE IN-LINE MEMORY MODULES



CDC ENTERPRISE (714) 630-4633
2970-F E. LA PALMA, ANAHEIM, CA 92806

CIRCLE 736 ON READER SERVICE CARD

Upgrade w/Accu-Simms

Upgrade your Mac Plus, SE or Mac II with our surface mounted one MEG SIMM modules. We assemble, test, and have strict quality control, and can give a lifetime warranty. \$275.00 per meg. (Qty. discounts.) Full instructions come with order. (All SIMMS are 120NS or faster.) Prices may be lower by the time this ad comes out. Call for quote & info 1-800/662-SIMM
Data Memory Systems Co.,
15 Union St., Lawrence, MA 01840
Tel: 508/683-2325
Fax: 508/975-5232

Miscellaneous

Macintosh System Enhancements/New Macintosh Systems

RAM/ROM Upgrades

128K to 512K
128K to 512Ke
128K to MacPlus
128K to 2MB Plus
512K to MacPlus
512Ke to MacPlus
SCSI Interface

Used Mac Systems

512K\$ 679
512Ke\$ 889
MacPlus.....\$1149
Mac SE\$1900

Same Day Turn-Around on Macintosh Upgrades and Computer Repairs!!!



New Macintosh Computers in stock for immediate delivery!!!

Simmons Consulting
5526 Pemberton Street
Philadelphia, Pa. 19143
(215)471-9242-Ext. 30

New Mac Systems

Mac SE w/kybd
MacII w/kybd
ImageWriter II
LaserWriter NTX
Hardware/Acc.
CMS 20-300MB
800K Drive
12-2400 Modem
Seikosha Printer
Repairs/Parts
Internal Drives
Keyboards
Repl. Mouse
Logic Boards
Power Supplies

CIRCLE 655 ON READER SERVICE CARD

We Manufacture

ONE MEG SIMMS

Mac II Mac Plus Mac SE

Don't settle for long lead times from other suppliers.

- Competitive Price
- Full Service
- 1 Year Factory Warranty

Order Today: 800-227-4637 or 303-449-6400

Mac-cessory™

EVEREX
EMAC DIVISION

EMAC-20D \$509
EMAC-40+IMP 12MS Access \$835

We carry the entire Everex Line!

NO SURCHARGE FOR VISA & MC

Giga Cell Systems - Nu-DATA

20 MB DATA CELL 20 \$489

Data Cell 60 \$759

Toll Free **800-634-1497**
or call 216-543-1952
MC Valley Computers Visa

16744 W. Park Circle, Chagrin Falls, OH 44022
We DO NOT charge credit cards until order ships

CIRCLE 619 ON READER SERVICE CARD

MEMORY UPGRADE!

- 1 Meg SIMMs - low profile
- "No worry" lifetime warranty
- 30 day money back guarantee
- Corporate POs accepted
- Macintosh Plus/SE/II
- 256k trade-in
- Credit cards
- Call for pricing

TechnologyWORKS

2111 Dickson Dr. #30 Austin TX 78704

(512) 448-4133

Guaranteed same day shipping

CIRCLE 656 ON READER SERVICE CARD



The Macworld Catalog

Networking

PhoneNET® System

The PhoneNET System is a network solution incl. hardware & software to build networks, manage & use them to their full potential. Components incl. PhoneNET Connectors, PhoneNET Repeater, PhoneNET StarController™ w/StarCommand™ network mgmt. software, TrafficWatch™ network analysis software, PhoneNET™, CheckNET™, Timbuku™ & Timbuku/Remote™ to operate other computers on local AppleTalk network or remote sites, & ScreenRecorder™ to record screen sessions for later viewing.
Farallon Computing, 2150 Kitredge St., Berkeley, CA 94704, 415/849-2331

Ethernet for the Mac

Kinetics provides Ethernet hardware & software for all Macintosh® computers. Products include:

- FastPath: AppleTalk Ethernet gateway
- EtherSC: SCSI-Ethernet controller
- EtherPort SE: Internal Ethernet card for the Mac SE.
- EtherPort II: Internal Ethernet card for Mac II. AppleTalk, TCP/IP & DECnet supported.

Kinetics, Inc. 2500 Camino Diablo, Walnut Creek, CA 94596 415/947-0998

Printer

Apple Daisywheel Printer

TRUE letter quality on all Mac's & Apple II's. Proport, spacing, bold-face, 198 columns. Fast 40cps speed and full 130 character printwheel. NEW \$449, RECONDITIONED \$349 includes easy MAC point & click driver software & cable. New bi-di tractor \$99, sheetfeeder \$49. All heavy duty with 90-day guarantee.
Quality Discount Computers, Inc., 135 Artist View Dr., Wellington, NV 89444, 702/465-2473, 415/487-8148

Peripherals

9-Track Tape Subsystem For the Macintosh™



Exchange data files between your Macintosh and any mainframe or mini-computer using IBM compatible 1600 or 6250 BPI 9-track tape.

Unit can also be used for disk backup. Transfer rate is up to 1 megabyte per minute via your SCSI interface. Subsystem includes, tape drive, software, and complete documentation. For more information, call us today!

QUALSTAR®

9621 Irondale Avenue
Chatsworth, CA 91311
Telephone: (818) 882-5822

Macintosh is a trademark of Apple Computer, Inc.

CIRCLE 733 ON READER SERVICE CARD

Hypercard Stacks

HyperCONTROL™

Report Generator...

- print selected cards
- manipulate data field layouts
- print faster than H-Card reports
- save data in text files

Perfect for mailing labels.
Just \$59.95, P&H included.

Works within HyperCard. Installation included.
 800-228-0417
NORDIC SOFTWARE
3939 North 48th
Lincoln, NE 68504
402-466-6502

CIRCLE 659 ON READER SERVICE CARD

HyperBook™ Maker • \$59.95

• Prints your HyperCard stack as a collated, ready-to-staple book.



• Your book can show the cards full size, half size, or 1/4 size.

- Another print option: both sides, 8-1/2" X 11" notebook format.
 - Create new stacks automatically from cards in any other stacks.
 - Review: Oct. 88 Macworld, p. 192
- Ideaform Inc. (515) 472-7256
P.O. Box 1540, Fairfield, IA 52556

CIRCLE 705 ON READER SERVICE CARD

HC ORGANISER

Personal Information Management Stack

- ◆ Rolodex ◆ To-Do Lists ◆
 - ◆ Mail Merge ◆ Action Items ◆
- Stands alone or interfaces with Focal Point & downloads to the Z88 laptop, PSION Organiser, and the WristMac.

◆ FREE ◆

Free (\$50 value) with purchase of Focal Point II, WristMac, PSION Organiser II, or Z88 from MAX Solutions. Call for prices.

MAX SOLUTIONS™

241 12th St. Del Mar, CA 92014
Visa (619) 481-0479 MC

CIRCLE 643 ON READER SERVICE CARD

CLIENT means Business!

Client™, a user customizable client & sales management system, maintains customers, business & financial information, contract history & more. Specs Features: Pop-up choice lists for fields, redefine field names & formats, search by any combination of fields, mail labels. Includes latest HyperCard®. \$195.
Softworks, Inc., P.O. Box 2285, Huntington, CT 06484, 203/926-1116

MacRecorder™ Sound Sys.

When graphic & text are not enough, give presentations a dramatic dimension—narration & sound. MacRecorder Sound System is an audio workshop. Record, edit, play back live or pre-recorded sound. Includes: Digitizer & Sound-Edit™ allows you to add voice, music & sound effects to HyperCard™, Video Works™, StudioSession™, JamSession™, & more; & Hypersound™ lets you record & work w/sound within HyperCard. Combine MacRecorder w/our ScreenRecorder™ (avail. separately) to create multi-media presentations.
Farallon Computing, 2150 Kitredge St., Berkeley, CA 94704, 415/849-2331

ADD POWER TO YOUR STACKS



HyperTools™ #1: Icon Editor, Alignment & Array Creation Tools, Scan Cards, Script & Font Tools, XCMD tools, Button Tools and more. 16 Tools in all for stack design! \$99.95

HyperTools™ #2: Multiple Choice Lists for Fields, Field Sorting, Formatting & Data Validation, Sound Tools, Group Tools, Font Tools and more. 16 tools for visual presentation of data! \$99.95

Stack Cleaner™: Complete menu creation & editing facility for stacks. A script cleaner to reduce the size of scripts by using standard abbreviations. Plus utilities to merge, split, and clone stacks. \$49.95

Softworks Inc PO Box 2285 Huntington, CT 06484 (203)926-1116

CIRCLE 612 ON READER SERVICE CARD

The Macworld Catalog

Uncle Max has excellent stax for taxing times.



Extract your refund with Tax Stack™ and MH Accountant®. Escape the pressure with What's His/Her Face...?® and Angus MacFly®.

Write now for your free Rax of Stax™ catalog.



P.O. Box 2719, Dept. 4
Oakland, CA 94602

CIRCLE 745 ON READER SERVICE CARD

Hyperworks Tools

Need to make global changes in scripts? Draw or move groups of objects? Make help cards? Let Tools from Hyperworks make your work easier. Work on single scripts or groups. Put any script or text onto the Tools Workdesk™ and use the editing Tools to make global changes, count, sort, number, find, add soft returns, offset groups of numbers, and more! Introductory price \$59.95

Call 1-800-544-0339 for orders only.

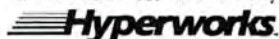

PO Box 5201, Mission Hills, CA 91345
818/891-0066

CIRCLE 737 ON READER SERVICE CARD

2 Great Business Stacks

Copyrights, Trademark & Patents
A comprehensive government information stack with "fill-out-on-screen" forms. Complete How-To guidelines. Suggested Retail \$49.95.
Business LetterBase

An expandable letterbase stack of 200 plus business letters in 12 categories. Includes letter writing guide & much more!
Suggested Retail \$99.95.

Aardvark Software, 14400 Ella Blvd. #150, Houston, TX 77014,
713/872-8085

Services

Computer Insurance

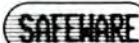

INSURES YOUR COMPUTER. Safeware provides full replacement of hardware, media, and purchased software. As little as \$39 a year provides comprehensive coverage. No lists of equipment needed. One call does it all! Call 8 a.m. to 10 p.m. ET (Sat. 9 to 5). SAFEWARE, The Insurance Agency Inc. 2922 N. High St., PO Box 02211, Columbus, OH 43202

800-848-3469
(Local - 614-262-0559)

CIRCLE 635 ON READER SERVICE CARD

Data Security Insurance offers two policies for computers, each with essential coverages not available elsewhere. As low as \$35/year.

INSURE YOUR COMPUTER AGAINST ACCIDENTAL BREAKAGE
1-800-822-0901

CIRCLE 624 ON READER SERVICE CARD

Data Conversion

TAPE/DISK CONVERSIONS



Conversion services to or from over 1250 computer systems:
• Magtapes • Mini Computers
• Micro Computers • Typesetters
• Word Processors

CALL THE INDUSTRY LEADERS

PIVAR
COMPUTER SERVICES, Inc.

(312) 459-6010

165 Arlington Heights Rd #MC
Buffalo Grove, IL 60080

CIRCLE 641 ON READER SERVICE CARD

WE CAN CONVERT DATAFILES TO/FROM OVER 1,500+ SYSTEMS IN VIRTUALLY ANY FORMAT! — ON DISKS OR TAPES!

Systems like:

- Mainframes
- Minis
- Microcomputers

- Dedicated Word Processors
- Typesetters, etc.

Formats like:

- MacWrite*
- Microsoft Word*/Works*
- WordPerfect*
- Omnis*
- 4th Dimension*

- FileMaker*
- Jazz*
- Excel*
- Tab-delimited ASCII, etc.

*Trademarks of their respective companies

CompuData Translators, Inc.

3325 Wilshire Blvd. Ste. 1202
Los Angeles, CA 90010

800/825-8251 • 213/387-4477

CIRCLE 605 ON READER SERVICE CARD

Desktop Publishing

Laser Printing Services

LaserWriter (300-dpi)/Linotype L100 (1270-dpi) output of your Mac/IBM files. Disk or modem. 24 hr. service. Linotype \$7 per page (\$3.50 volume discount). LaserWriter \$50 per pg. Desktop publishing specialists in consulting & design services. Hardware/software sales. Offset printing & bindery services available. Rent IBM/Mac \$5 hr. Adobe font dealer. Check our low price.

Laser Printing Services, 26058 W. 12-Mile Rd., Southfield, MI 48034,
313/356-1004 (MI),
800/722-3475 (Nat'l.),
Modem: 313/356-3186

Type/Imagesetting

Island Color Productions has so many advantages:

- High-resolution typesetting
- Linotronic imagesetting
- Laser printing
- Computer graphics & design
- Speedy turnaround time
- From MAC, IBM or any ASCII file
- Whether keyboard, disk, or modem

Why not take advantage of us?

Island Color Productions,
11 Stony Brook Ave., Stony Brook,
NY 11790, 516/751-0485 (voice),
516/751-0430 (24-hr. modem
on line)

Desktop Output

Looking for great desktop output? Authorized Linotype Imaging Center available by 24 hr. BBS. Film acetate as low as \$7.50/pg and RC paper as low as \$5.00/pg. Choose from more than 300 PostScript® fonts for Mac and IBM — also available for purchase. High Resolution 2540 dpi, OCR, image scanning and disk conversions output to L300. 24-hour turnaround in most cases. Your disk or by modem.

Your ship has come in. 103 E. FRONT ST., RED BANK, NJ 07701

Call Toll Free 1-800-USS-TYPE **Riverside**

CIRCLE 701 ON READER SERVICE CARD

From your disk, to our Linotronic 300's, to the printing press fast!

3 Linotronic 300's to Serve You
24 Hour Turn Around
1,400 Type Fonts
PC, Macintosh or
Postscript Files

LAZER GRAPHIX

3250 S. Pollux—Las Vegas, NV 89102
1-800-873-8736

CIRCLE 647 ON READER SERVICE CARD



The Macworld Catalog

Waldman *graphics* Printers + Typographers

NYC / NJ / Phila DESIGNERS

We help top-notch designers achieve high resolution type & graphics using desktop tools. Keep your standards while lowering your costs. Original electronic art and PostScript special effects our specialty.

- 1270 & 2540 dpi pages from Linotype L300s
- Repro, Pos. & Neg. film • Disk or modem • Color separations • Scitex system • Award-winning prepress, printing, binding & mailing
- 18 messengers! • Adobe dealer

We are the most knowledgeable people you will talk to. Call Mary Ann Ostberg for more information about our superb services.
212 925-2420 / 201 522-8778 / 215 627-7200 / 609 662-9111

CIRCLE 637 ON READER SERVICE CARD

TONER RECHARGES

LOW AS ~~US~~ \$34.95

- 24 HOUR TURN AROUND
- 100% GUARANTEE
- BETTER THAN NEW
- COLORS AVAILABLE

Ribbon Land

THE BEST FOR LESS
TOLL FREE 1-800-221-4892 IN PA 215-524-9750
PO BOX 506-EXTON-PA-19341

CIRCLE 691 ON READER SERVICE CARD

P.C. Copier & Laser Printer Owners



TONER Service Company

UPS to:
2128 Dolman
St. Louis, MO
63104

We buy empties - \$10.00

314-776-1155
800-88-TONER

CIRCLE 604 ON READER SERVICE CARD

Training

CBT Development Stacks

CBT

Create Computer-Based Training in HYPERCARD

Four disks, 32 stacks, almost 3 megs of routines, templates and scripts—a roadmap for developing CBT in HyperCard. 100-page User Manual with documentation, instructions and authoring ideas. Price: \$135.

No licensing fees or royalties. VISA or MasterCard. First Reference, Inc. 516 Fifth Ave. #706 New York, NY 10036

New: Version 1.1 (212) 730-8211

CIRCLE 644 ON READER SERVICE CARD

Disk Duplication

SOFTWARE DUPLICATION

- All Formats
- Copy Protection
- Custom Packaging
- 48 Hour Turn Around
- Labels/Sleeves
- 100% Guaranteed
- Highly Competitive Pricing

1-800-331-4055

In WA (206) 633-0524

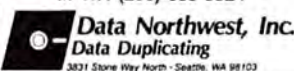

CIRCLE 682 ON READER SERVICE CARD

TONER 2 DAY AIR Prepaid Return

- Remanufacturing Services
- Laser cartridges in Black \$44.50
- Laser cartridges in Colors \$64.50
- PC cartridges in Black \$34.50
- Microfiche cartridges \$44.50
- Remanufactured cartridge \$54.50

- Get back your cartridge! Every cartridge pretested! Color test prints available!
- We support over 200 printers!
- Bulk toner • Quantity Discounts • Jumbo's
- We buy empties in quantities, please call.



9723 Mill Creek Drive Eden Prairie MN 55344

\$44.50 for laser cartridges

100% Satisfaction

24 Hour Turnaround

800-777-8444

CIRCLE 696 ON READER SERVICE CARD

Long Life Laser Cartridge Recharge

LASTS 30-50% LONGER!

FACTORY LIKE METHOD—NO HOLES CUT!

For Apple, H.P. & 25 more using Canon EP Engines.

100% Money Back Guarantee in writing!

24 hr Turn-Around

SEND \$38.50 + \$3.00 S/H
With Each Cartridge To:

Texas Toner Cartridge Co.
11408 Audella Rd. #4740, Dallas, TX 75243
214/475-5006 Business Opportunities Available

CIRCLE 546 ON READER SERVICE CARD

Laser Recharge

National Laser Recharge

Save your money! Let us recharge your toner cartridges for HP Series I & II, Apple, Canon, QMS & others. All Canon, PC models 100% Guaranteed Factory-Like recharge method. No drill & fill!

Long Life method for only \$49 incl. s/h. Up to 7 charges per cartridge Color avail. We buy empties -\$10. Send cartridge w/check or Money Order To:

National Laser Recharge
1413 W. Loop 281, Ste. 101
Longview, TX 75604
214/297-0200

CIRCLE 726 ON READER SERVICE CARD

reconditioned **TONER** for laser printers & Canon PC Copiers

BETTER THAN NEW!
• 20% MORE TONER
• DARKER PRINT
• 100% GUARANTEED

From \$44.95

We buy empties
call for brochure
800-426-8196

Willow Products Corp.
3857 Willow Ave, Pgh, PA 15234

WILLOW

CIRCLE 638 ON READER SERVICE CARD

Software

Architecture

Desktop Architect

Professional detailing system by architects. Pre-drawn components to assemble custom details with minor editing. Parts kits combine bitmapped and object-oriented graphics. Includes wall and cross sections, details and interior elevations. 8" x 10" format for working drawings. \$189.00 Super Paint required.

Desktop Architect Co.
634 N. High St.,
Columbus, OH 43215
614/469-9906

Time Saver Payroll™ V.5.0

- NEW FEATURES FOR 1989
- Full Featured Payroll system.
- Salaried, hourly, comm. & tip wages
- 11 deductions, incl. fed., state & local taxes
- 401k deductions
- Tax tables easily edited by user
- Monthly & quarterly reports, incl. 941, FUTA/940, SUTA
- Prints checks and W-2 forms
- Flexible—easy to use! Requires Microsoft Excel \$99.50 + \$3 s/h.
- MC/VISA/Chk. Demo \$15 + \$3 s/h (applied to purchase).

Western Software Associates,
110 El Dorado Rd., Walnut Creek,
CA 94595, 415/932-3999

The Macworld Catalog

Astrology



Graphic Astrology

The Gamma Series . . .
 The Perfect Gift!
 The Gamma Edition \$199.50
 Chart Interpreter \$199.50
 Gamma & Interpreter \$325.00
 Gamma Basic \$ 59.50

Astrology for Everyone!

Time Cycles Research
 27 Dimmock Road
 Waterford, CT 06385
 (203) 444-6641

Supports Laser & Mac II
 Write or Call for brochure
 MC/Visa OK

CIRCLE 731 ON READER SERVICE CARD

Bar Code



PrintBar Mac™

- BAR CODE FONTS FOR THE MAC
- Code 39 and UPC symbologies.
 - PostScript fonts for the LaserWriter.
 - Bit-mapped fonts for screen and ImageWriter.
 - Use PrintBar Mac™ with any software.
 - CodeScan™ bar code reader works as second keyboard.
- (916) 622-4640 / FAX 916 622 4775

Bear Rock
 SOFTWARE COMPANY, Inc.

6069 Enterprise Dr., Placerville CA 95667

CIRCLE 684 ON READER SERVICE CARD

Business

HOW TO MAKE YOUR CREATIVE BUSINESS CLICK!

COLLEAGUE 1.1 introduces powerful, intuitive, integrated business management software for creative professionals, featuring:

- interactive client files • automated pricing, time billing, and invoicing • job traffic • general ledger
- account aging • income/expense report graphs • activities calendar & message center • multiple check-books • mail merge & direct mail promotions • multi-user early 1989

\$695. Demo \$30. VISA or MasterCard accepted.



COLLEAGUE™
 YOUR PARTNER IN CREATIVE BUSINESS
 10000 RESEARCH BLVD, SUITE 208 • AUSTIN, TX 78759
 512/836-4389

CIRCLE 621 ON READER SERVICE CARD

50 Resumé Designs

MacResumé™ Professional Resumé Templates

Produce perfect Resumés with these preformatted designs in Microsoft, WORKS OR WORD please specify

\$39 MacResumé™
 P.O. Box 713
 Cambridge, MA 02140
 2 Disk Set with CATALOG
 1-800-422-9010 ext. 4091

CIRCLE 666 ON READER SERVICE CARD

50 TEMPLATES - \$ 79.95

FOR MICROSOFT EXCEL™ and WORKS™

PRE-BUILT • READY TO USE • JUST ADD VALUES

- Monthly payments
- Loan Amortizations
- Depreciations
- Full Cash flows
- Break-Even analysis
- Present Values
- Future Values
- Rates of Return
- Financial Ratios
- and much more!

REAL ESTATE • ACCOUNTING • FINANCIAL PLANNING

MICROTEMP™ 1.800.284.8367
 FINANCIAL CALCULATORS
 318 MENDOCINO AVENUE, SUITE 22, SANTA ROSA, CALIFORNIA 95404

CIRCLE 735 ON READER SERVICE CARD

Strategic Business & Marketing Plans

BizPlanBuilder™ Quickly and easily complete an effective business / marketing plan for presentation to senior management, investors or clients. A comprehensive and proven framework — Over 85 pages of outlines, headlines, structured sentences & paragraphs, lists, suggestions... already typed & formatted in 29 MacWrite™ & MS WORD™ files. Includes spreadsheet financials in Excel™.

Marketing & Sales Oriented
 Everything you will need to organize, describe, promote & support your venture. (Similar to reverse engineering where the best elements of good plans are cut & pasted together.) No blank pages. Follow

the tutorials & edit into a finished plan. Includes manual. Preferred by investment capital experts, corporate managers & experienced consultants.

- Also available:
- Investment Capital Sources
 - Domestic & International Marketing
 - Employee Handbook Template

Tools For Sales™

Roadmaps to Better Mousetraps
 13335 Wildcrest Drive • Los Altos Hills, CA 94022
 800/ 442-7373 • 415/ 941-9191

\$99⁰⁰ + \$3 Shipping & 7% Tax (CA)
 30-day acceptance / return.
 Site licenses available.

Visa
 MC
 Amex

CIRCLE 636 ON READER SERVICE CARD

Business Mgmt.

Do-it-Yourself Business Plans and Forecasts

Over 10,000 sold since 1985. The only ones with fully linked spreadsheets, step-by-step manuals, real analysis. Look at these reviews: "... a powerful and practical tool for solving real-world problems... clear and concise... an excellent example of the power and beauty contained in simplicity." (MacGuide v 1, no.4). "Complete a professional business plan in a few hours without expensive consultants." (Micro Times 12/88)

- Tim Berry's Business Plan Toolkit™:** Complete linked spreadsheets for forecasts, financials, ratios, charts. Includes text-builder HyperCard stack, sample plan on disk, 150-page manual.\$99.95
Financial Forecasting Toolkit™: Complete linked income, cash flow, and balance statements, macros, charts, 200-page manual\$69.95
Sales and Market Forecasting Toolkit™: Step-by-step guide with sample models, macros, charts, 200-page manual\$69.95

Order today with Visa, MC, COD. 30-day guarantee.

\$5 Shipping & handling per order. CA residents add 7% tax. Toolkits work with any SYLK-compatible spreadsheet, but Excel is recommended.



Palo Alto Software

(800) 336-5544
 In CA, **(415) 325-3190**
 260 Sheridan Ave., Suite 219
 Palo Alto, CA 94306

CIRCLE 628 ON READER SERVICE CARD

Your Ad Gets More For Less.

Call *The Macworld Catalog* and see why.



800.888.8622



The Macworld Catalog

Business Mgmt.

Clients & Profits.[™] Advertising Agency Management



Designed by advertising professionals for ad agencies: job management; traffic; job costing; payables; time sheets; estimates; receivables; POs; flexible billing; exporting; Customizable! \$2495. Trial-Size \$40.

Working Computer
San Diego CA
619 721-0501

CIRCLE 675 ON READER SERVICE CARD

Clip Art

Professional Quality

Color PostScript Art

Totem Graphics

5109-A Capitol Blvd.
Tumwater, WA 98501-4415
(206)352-1851

CIRCLE 713 ON READER SERVICE CARD



MacAtlas[™]

Professionally drawn maps of the USA by state, world regions by country, and all 50 states by county!

Paint \$79 • Draw (PICT) \$199 • EPSF \$199

To order or request information please call:

800-334-4291

MicroMaps Software, Inc., Box 757, Lambertville, NJ 08530

CIRCLE 708 ON READER SERVICE CARD

ADD THAT DAZZLING TOUCH...with PostScript MASTERWORKS[™]



CIRCLE 721 ON READER SERVICE CARD

NEW!

ART NOUVEAU IMAGES

Volume 1 • EPS Format
\$79.95 + \$3 SEH (U.S.)
Check/Visa/MC • Contact:
SILICON DESIGNS
P. O. Box 2234, Orinda, CA
94563 (415) 254-1460



Cathay Europa Designs 2-disk set
P.O. Drawer B \$79 postpaid
Newmarket, NH 03857 Call Toll Free
800-533-5504 Visa, MC, AX

CIRCLE 607 ON READER SERVICE CARD



CIRCLE 662 ON READER SERVICE CARD

- Business & Commercial \$69.95
- Borders \$129.95 (4 disk set)
- Christmas \$89.95 (2 disk set)
- Equestrian \$89.95 (2 disk set)
- US Maps w/Counties \$229.95 (4 disk set)

Artware Systems, Inc. • 4332 Bland Rd. • Raleigh, NC 27609
For inquiries (919) 872-6511

To Order 1-800-426-3858



WE'VE GOT THE LOOK YOU NEED!
From fun & sassy, to cool & classy.
•Cartoons•Hands•Special Occasions•Education
•Borders & Designs•And lots more!
• Originals by top commercial artists. • Many formats.
\$54.95/disk, plus \$5 Shpg. TX Res. add 8% tax.
ORDER NOW!

(512)388-7099

P.O. BOX 2142, ROUND ROCK, TX 78680
©COPYRIGHT 1988, EYCON COMPUTER GRAPHICS

CIRCLE 716 ON READER SERVICE CARD

Communications

PacerLink (was pCLINK)

Connects Macs to VAX (VMS and ULTRIX), Stratus and UNIX systems. Supports serial line, remote modem, direct Ethernet, and AppleTalk bridged to Ethernet communications media. Provides terminal emulation (VT220, VT100, VT240/241), file transfer, virtual disk, and print services. PacerShare extension enables the VAX/VMS system to act as an AppleShare compatible file server.
Pacer Software, Inc.,
7911 Herschel Ave. #402, La Jolla, CA 92037, 619/454-0565

Data Base

Bookends Mac

Bookends[™] is a specialized database for managing your references. You can quickly put your finger on any article from books, journals, or newspapers. When it comes time to print your bibliography, Bookends outputs your bibliography in almost any style without reentering references. \$99.95.

Sensible Software, Inc., 335 E. Big Beaver, Ste. 207, Troy, MI 48083, 313/528-1950

Desktop Publishing

MacPalette

By Microspot prints multicolored graphics & text from most Macintosh[®] software using the ImageWriter II. MacPalette will colorprint documents from MacDraw, MacDraft, MiniCad, MacProject, MacWrite, JAZZ, Microsoft Chart, Word, Excel etc. (not MacPaint.)

It prints black as a true black instead of mixing a black. \$69.
CompServCo, 800 Freedom, Slidell, LA 70458, 800/272-5533 or 504/649-0484



OCR SCANNERS

- Leading OCR software developer
 - Support MAC & PC/XT/AT/PS2
 - Read text from documents, form, books and magazines using "SPOT" OCR program
 - Trainable for English and foreign language characters
 - Works with most scanners
 - FAX and networking capability
 - Customized software available
 - Large inventory of Canon, Panasonic and HP scanners
 - Free "SPOT" demo program
- Avoid the middleman—Go direct!**

FLAGSTAFF ENGINEERING 602-779-3341 FAX 779-5998

CIRCLE 719 ON READER SERVICE CARD

The Macworld Catalog

Japanese Desktop Publishing

Kanji PageMaker™



- * Supports varied multi-column formats
- * Supports Kanji JIS level I and II
- * Compatible with Kanji Talk 2.0
- * Compatible with EGWord 3.0

コラム幅変更機能、トリミング機能、マスターページ、ペーストボードなど高度な編集機能を満載。本格的なDTP環境を強力にサポート。

List Price \$995.
Req. 2MB RAM

Dealer inquiries welcome.

Qualitas Trading Co. Order: 415-848-8080
6907 Norfolk Rd., Berkeley, CA 94705 Info: 415-848-5815
Fax: 415-848-8009

Developed by Aldus Corporation

CIRCLE 743 ON READER SERVICE CARD

Document Mgmt.

MacDocument™

New Document Management System powerful enough to index an entire public library. Manage journals, articles, mail, office correspondence—any written information. Locate documents with only a mouse click. Isn't it time you finally got organized? \$295.00 or \$15.00 for a Demo disk. Call now! MC/VISA 800/888-5368.

Kentrex, Inc., Suite 85, 806 Broad Street, Chattanooga, TN 37402

MacKids™

Call or write for your free catalog of Macintosh™ educational programs. Written especially for pre-school to elementary students. \$39.95 each, VISA/MC accepted.



800-228-0417
NORDIC SOFTWARE
3939 North 48th
Lincoln, NE 68504
402-466-6502

CIRCLE 657 ON READER SERVICE CARD

Educational

MacAnatomy

A complete electronic atlas of human anatomy in MacPaint document form. The drawings may be modified and merged into MacWrite documents using the Clipboard. Comprised of four volumes, available singly or as a collection. MacMedic Publications Inc., 7530 Harwin Dr., Houston, TX 77036, 713/977-2655

Make Learning Fun!

- * MacRobots
- * Read-A-Rama
- * Animal Kingdom
- * Math Wizard
- * Fraction Action
- * Decimal Dungeon

To order programs or to receive a free brochure call or write:



UNICORN™
EDUCATIONAL SOFTWARE
Dept MW
2950 E. Flamingo #B
Las Vegas, NV 89121
702-737-8862
FAX 702-737-9085

CIRCLE 738 ON READER SERVICE CARD



MacBaby™ Math

Teach children, 6 months and up, number quantity recognition (1-100) and math concepts (+, -, x, +). Call (408) 739-9517 or send \$39.95 (plus tax) to: Babyware, 730 Bantry Court, Sunnyvale, CA 94087
FREE book—Teach Your Baby Math

CIRCLE 633 ON READER SERVICE CARD

Teacher's Rollbook

Teachers: The first program that handles all your record keeping needs. Grade averaging and reporting. • Full attendance records and totals • Records disciplinary actions • Class size reports • Up to 315 students per file • Remembers birthdays & checked out items • Requires Mac 512K, +, SE, II, 2 drives • \$149 • Demo \$10

Current Class Productions,
22824 Berendo Ave., Torrance,
CA 90502, 213/326-4246

Kieran

Integrated learning program for children 2-6 yrs. Uses child's name in speech and pictures. Totally mouse driven interactive program with iconic interface. Covers alphabet training, time telling, counting skills, upper-lower case, and mystery door! 4-mice rating in Mac-User. Great gift! MC/VISA \$39.95. Obm Software, 163 Richard Dr., Tiverton, RI 02878, 401/253-9354, 800/346-9034

TEST GENERATION AND SCORING!

LXR•TEST™—the only complete testing system for the Mac! Rated "best testing tool on the market."

Logic eXtension Resources
9651-C Business Center Drive
Rancho Cucamonga, CA 91730
(714) 980-0046 AppleLink: D0626

CIRCLE 649 ON READER SERVICE CARD

An all new edition of the Macintosh Educational Software Collection

- Hard-to-Find & Best Sellers
 - HyperCard / Shareware
 - Over 150 Titles
 - All Subject Areas
 - Teachers, Students, Parents
- Send for Free Catalog!

CHARIOT • 3659 India St. • San Diego, CA 92103 (619)298-0202

NOW Available!! MicroTest III

Reasonably priced full featured Test Generation

Large database • Auto Question Select • Easy to Use • DA Graphics Editor
GUARANTEED!!

Ask for our Special Buy on MicroTest III & MicroGrade.

CIRCLE 685 ON READER SERVICE CARD

The Macworld Catalog

Engineering

Cross Assemblers

µASM™

NEW-8085 & 8086

- 400 COP400 family
- 1802 1802 family
- 6502 6502/6502C/02
- 6801 6801/6800/6301 families
- 6804 6804/HCD4
- 6805 6805/HCD5/6305
- 6809 6809/6309
- HC11 68HC11/6800/6801 families
- 8048 8048 family
- 8051 8051 family
- 8085 8085/8080 family
- 8096 8096/80C196 family
- Z8 Z8 family
- Z80 Z80/64180 family

Fast. Full Macintosh interface. Output downloads to most EPROM programmers. Features macros, conditional assy, local and automatic labels, symbol table cross-ref, module sectioning. Editor included, MC/V.

Micro Dialects, Inc. Dept W
PO Box 3001 J
Cincinnati, OH 45230
US \$129.95 ea plus s/h*

Micro Dialects, Inc. Dept W
PO Box 3001 J
Cincinnati, OH 45230
\$4 cont. USA
\$8 50 Can. AK, HI
\$15 overseas
(513) 271-9100
MCI Mail MICRODIALECTS

CIRCLE 608 ON READER SERVICE CARD

Schematic Entry/Digital Simulation

DesignWorks™

Fully integrated and fully functional schematic and simulation on the Macintosh, featuring:

- fully interactive digital simulation with logic-analyzer style timing display
- fully compatible with Douglas CAD/CAM™ PCB layout
- full 7400, 4000, LSI, analog libraries
- full high level language PLD support when used with LPLC logic compiler
- dot-matrix, laser, pen plotter output
- user-definable device symbols with full simulation

DesignWorks: \$685 LPLC: \$535
Low-cost educational versions also available

Capilano Computing
545 108th NE, Suite F
Bellevue WA 98004
(604) 669-6343

CIRCLE 602 ON READER SERVICE CARD

STRUCTURAL-SURVEYING

NEW VERSION!! LANDesign... for surveying & land & road layout.

- Import/Export data: radial stakeout, lot, sideshots
- All information is displayed graphically at all times.
- Points, lines, curves, boundaries and traverses can be added, changed, copied, pasted, and duplicated
- FRAME mac. BEAM mac 2, BEAM mac: for structural analysis of 2-D frames, trusses, and beams.
- MacShapes for calculating structural properties.

All programs have full Macintosh interfaces. Money-back guarantee, free support. From \$145-\$595. Visa or MC.

Compuneering Inc. - (416) 738-4601
113 McCabe Crescent
Thornhill, Ontario L4J 2S6 CANADA

CIRCLE 660 ON READER SERVICE CARD

IEEE 488 Interfaces

MacII488 • NuBus IEEE board for MacII
MacSCSI488 • SCSI/IEEE controller
Mac488B • Serial/IEEE controller
MacSerial488 • IEEE plotter interface
MacDA488 • IEEE desk accessory
MacDriver488 • IEEE language driver

Call or send for your
FREE Technical Guide

(216) 439-4091

IOtech
IOtech, Inc.
25971 Cannon Road
Cleveland, Ohio 44146
Telex 6502820864
Fax (216) 439-4093

London (0734) 86-12-87 • Paris (1) 34810178 • Zurich (01) 821 944
Milan (02) 41203601 • Linköping (033) 11 01 40 • Götterchem 01830-3333
Sydney (2) 452 3831 • Seoul 784-9942 • Munich and other European,
North African and Middle East countries not listed (089) 7190201

CIRCLE 702 ON READER SERVICE CARD

Scientific Plotting Package

SoftWear Plot produces publication-quality plots using multi-column ASCII file (e.g., program outputs, text editors, spreadsheets). Linear or logarithmic formats in either axis, overlays, zoom, on-line measurements, custom labels and tokens. Number of points limited only by disk space. Laser-Writer and big-screen compatible, \$99.95 + \$5 s/h.

SoftWear Products, 7230 Oliver St., Lanham, MD 20706, 301/577-9207

Electronic CAD

The powerful, easy-to-use Douglas CAD/CAM Professional System takes you from the schematic drawing to the final routed board with:

- Color support on Mac II
- Unlimited multilayers
- SMT capability
- 1 mil resolution
- Layout w/ parts-placement facility
- Schematic w/ digital simulation
- Flexible, multi-pass router

Take your first step into the new age of electronic CAD by ordering a full-feature demo with all 3 programs included. Call or write to us today.

Douglas Electronics, Inc.

Pro. Layout: \$1500
Schematic: \$700
AutoRouter: \$700
Demo: \$25

718 Marina Blvd.
San Leandro, CA 94577
(415) 483-8770

CIRCLE 680 ON READER SERVICE CARD

Road Design

MacRoad is a fully interactive road design program that allows you to:

- Design cross sections using a palette of edge & surface types
- Design vertical gradings graphically
- Produce a schedule of quantities
- Adjust the grading & immediately see the effect on the cross sections & quantities
- Produce drawings on a range of printers or pen plotters

Creative Engineering, 6 Antill St., Wilston Queensland 4051, Australia, +61 73566271

Circuit Maker 2.0

- Professional digital logic design with full on screen simulation
- Trace mode-see the state of every node in the circuit as the simulation runs!
- Real-time logic simulator style waveform display
- Define your own working macro devices and save them in a library (requires option 1)
- The circuit and waveforms can be copied to the clipboard
- Includes a library of 45 commonly used TTL devices plus LEDs, switches, RAMs, PROMs, pulse generators, and more
- High quality laser or dot matrix printout of circuit and waveforms
- Optional TTL library provides 65 additional devices

CircuitMaker - \$100
Option 1 - Macro Devices \$65
Option 2 - Additional TTL devices library \$40

MicroCode Engineering
1943 N. 205 W. Suite 1
Channahon, IL 61607
801-226-4470

CIRCLE 744 ON READER SERVICE CARD

E(E)PROM, MICRO & MEMORY CARD PROGRAMMERS WITH INTEGRATED MAC USER INTERFACE

- Connects to modem port. Pull-down commands menus.
- No personality modules for E(E)PROMs & Intel Micros.
- All 24/28/32 pin EPROMs to 1 Mbit (upgradable to 32 Mb).
- 8741, 2, 4, 8, 8H, 9, 9H, 51, CS1, S2, 55, 9761; EEPROMs.
- Memory Cards (Seiko/Epson/G1) Flash EPROMs; On Board Programming capability; Modular design; Easy F/W upgrades.
- Stand alone E(E)PROM and Memory Card duplication/verify.
- Offset/split Hex, Binary, Intel & Motorola 8, 16, 32 bit.
- Built-in Eraser/Timer option (\$50); Gang Module ready.
- Direct technical support; Full 1 year warranty.

VISA MC AMEX Call today for datasheets!

B&C MICROSYSTEMS
355 WEST OLIVE AVE, SUNNYVALE CA 94086
PH: (408) 730-5511 FAX: (408) 730-5521 TELEX: 984185

\$345 - 595

CIRCLE 725 ON READER SERVICE CARD

Entertainment

NEMESIS™ Go Master®

Go, a game of strategic elegance, has been a way of life in the Orient for over four thousand years. Many consider Go to be the secret of the Japanese businessman's success. "While chess is a game of war, Go is a game of market share" (President of Nikko Hotels).

"If you are interested in Go, buy this program." J. Pournelle
Game of the Month BYTE 7/87

Toyogo, Inc. (617) 861-0488
76 Bedford Street, #34-C, Lexington, MA 02173
579 Go Master®. \$49 Joseki Tutor™.
\$59 Tactical Wizard™ Add \$6 U.S. S&H

CIRCLE 693 ON READER SERVICE CARD

Pardon me, boys, is this the MacInooga Choo-Choo?

Yes, it's a super true-to-life electronic train set! You can build elaborate model railroad systems on your Macintosh and bring them to life with the click of a switch. You simply place desired images of tracks, engines, cars, and terrain on a grid in any configuration. Build layouts of one screen or more. Run your train at night. Use MacPaint to create more scenery.

Abacadata \$49.95 + 3.55 Shipping
Box 2440, Dept M VISA/MC/AMEX
Eugene, OR 97402 (503) 342-3030

CIRCLE 676 ON READER SERVICE CARD

The Macworld Catalog

Tired of Arcade Games?
 Nine real simulations: Rommel's DESERT WAR • MIDWAY or SOLOMONS (carrier actions) • Rome's glory in BARBARIAN or EAGLES IN THE SAND • WESTERN CAMPAIGNS or THE ARMY OF NORTHERN VIRGINIA (Civil War) • NORWEGIAN SEA or U.S. Invasion in RED STARS (U.S./Soviet clashes) \$34.95 each game or \$64.95 for two. 512K Minimum. VISA and MC Accepted. Allow 4-6 wks.
SJP Enterprises PO Box 246 MCHenry IL 60050

CIRCLE 710 ON READER SERVICE CARD

MacScuba™

Have you ever dreamed of scuba diving in some exotic port in search of sunken pirate treasure?

The Ultimate Mac Simulator

MacScuba simulates the underwater world using Mac's 3D graphics and digitized sound. You control all aspects of scuba diving from filling your tank to doing decompression dives using the U.S. Navy dive tables. Fight off killer tiger and hammerhead sharks while you explore a sunken pirate wreck in search of treasure. Fun for the experienced diver or if you have never been in the ocean before.

\$49.95
 +3.50 S&H
Paradise Software Corp.
 P.O. Box 50996
 Phoenix, AZ 85076

To Order Call:
(602) 893-8324

CIRCLE 732 ON READER SERVICE CARD

Custom Laser Typography
 Complete line of LaserPerfect™ Fonts. Distinctive, downloadable fonts features legibility, good fit, kerning, *Fine type*: adaptations of Bembo, Gill Sans, Granjon, many others. *Foreign*: Hebrew, Ancient & Modern Greek, Hindi, Cyrillic. *Also*: Fractions, Bar code, Phonetic, OCR-A, LCD. \$55-125. Logo conversions, custom fonts. Free samples and estimates.
Neoscribe International, P.O. Box 633, East Haven, CT 06512, 203/467-9880

BirdSongs!

Improve your office environment — play bird songs in the background while you work with your Macintosh.

BirdSong Player: \$40.
 700k of American bird songs included.
 Additional specialty bird songs: \$15 per disk.

Mac 512ke or better required.
 MultiFinder & Network friendly.
 DA & HyperCard versions also available.

CIRCLE 664 ON READER SERVICE CARD

Fonts

DOWNLOADABLE LASER WRITER FONTS
 FOR SCIENCE

— ä å ã Ä Å ∇ α β γ φ ψ η ζ τ ι ι

FOR FOREIGN LANGUAGE TEXTS
 Μήνιν άειδε θεά. Πηληϊόδεω 'Αχιλλῆος
 α ε ζ ε ι ς ι ς Α Ε Ζ Ξ Ζ Λ Σ Ξ

ALLOTYPE TYPOGRAPHICS
 1600 PACKARD ROAD SUITE 5
 ANN ARBOR, MICHIGAN 48104
 (313) 663-1989
 Compatible with all Macintosh systems

CIRCLE 615 ON READER SERVICE CARD

Beverly Hills 2.0
"Best Imagewriter™ font available!"

- "Typeset" look, better photocopies
- 11 sizes: 6-12, 14, 18, 24 & 36 pt.
- Multi-digit fractions; horiz. lines
- 2-/1-pixel leading/space adjustment
- Additional math & musical symbols
- Includes disc, 70-p. printed manual
- Save new printer cost; only \$29.95!
- See your dealer! Direct orders, add \$3.00 S/H (or \$4.80 in CA, incl. tax)
- Site licenses; dealer inquiries invited

ADH Software
 P.O. Box 67129
 Los Angeles, CA 90067-0129

CIRCLE 648 ON READER SERVICE CARD

Financial

LOAN AMORTIZATION

AmPack \$49.95
 Variable Rates & Flexible Payments
 BiWeekly, Monthly, & Annual Loans
 What If Analysis & Balloons
 Negative Amortization
 Customized Professional Reports

AmPack Plus \$89.95
 365 or 360 Day Interest
 Skipped & Principal Only Payments
 Constant Principal Reduction
 Interest Only & Odd Day Interest
 Quarterly, SemiMonthly/Annual & Weekly
 And many more features
(414) 797-4490
 Add \$5 S/H

Soffflair, Inc.
 8753 Parkview
 Milwaukee, WI 53226

30 Day Guarantee
Demo Disk Available
 MC/VISA

CIRCLE 618 ON READER SERVICE CARD

Alphabits® fonts for the Mac

Bitmap fonts to broaden the output options of any ImageWriter II, LQ or Laser-Writer IISC, as well as any printer connected with an Orange Micro Grappler® LS or LQ. Only \$99 for all 7 fonts!

Cooper Cloister Blippo Broadway
Garamond Dutch Italic Zapf Chancery

(800) 223-8029 In CA: (714) 779-2772
 Orange Micro, Inc., Anaheim CA

CIRCLE 634 ON READER SERVICE CARD



The Macworld Catalog

Fund Raising

Community Contact Sys.

A unique approach and solution for nonprofits to more effectively communicate to the public they serve. The system enables organizations to increase fund-raising, public relations and marketing activities. Macintosh and the Community Contact System. Set yourself apart! Call today.

*Campagne Associates, Ltd.,
9 Goldfinch Lane, Nashua,
NH 03062, 603/891-2129*

Genealogy

MacGene™ new (ver. 3.10)

80% faster & 100% complete. Designed specifically for the Mac. One program for data entry, find, list & charting. Features: History, Hints, Mail-List, Family Tree, Pedigree, Statistics, Biography, etc.

- LDS compatible • Mac's & Mac-XL
- MORE NOTES • User Fields
- Custom Reports • Import/Export
- No copy protect • 80-pg. manual
- 3-back guarantee \$145. Demo \$25.

*Applied Ideas, Inc., P.O. Box 3225,
Manhattan Beach, CA 90266,
Free info: 213/545-2996*

HyperFamily-Tree™

The HyperCard stack that lets you easily record and graphically display genealogy information including digitized photos of your relatives. Auto-link lets you click-to-navigate through generations of your family. Creates, prints and exports pedigree charts, family group sheets, family lines, mailing labels, birthday calendars & person sheets. \$59.95 plus \$3 s&h. VISA/MC orders welcome.

*Leister Productions, 14 Hill Blvd.,
Mechanicsburg, PA 17055,
717/697-1378*

Family Heritage File

Most powerful genealogy program on the Mac. Rated "Best" by *Macworld*. Licensed vers. of *Personal Ancestral File*,™ produced by the LDS Church.

- Mac user interface • Supports all Macs & hard disks except 128K
- Exports data to word processors/databases/modems
- Reports: Pedigree, Family Group, Individuals, Marriages, Surnames, Documentation, etc., \$149 + \$3 s/h (Utah res. +6%. Demo \$7.

*StarCom Software Systems,
Windsor Park East, 25 West 1480
North, Orem, UT 84057,
801/225-1480*

Family Roots™

Do it YOUR way! Huge variety and capacity for your family history. Make pedigree charts, descendants charts, person sheets, group sheets, indices and much more. Customize to your own preferences. Standard Mac interface. Call for FREE information. Satisfaction guaranteed. MC/VISA/AE.

*Quinsept, Box 216, Lexington, MA
02173, 617/641-2930,
800/637-ROOT*

Graphics

MacPlot & MacCAD

MacPlot by Microspot is a powerful plotter driver that will plot any object-oriented graphics produced on the Mac in up to 30 colors/pens. MacPlot supports over 50 plots. MacCAD is a series of 12 separate architectural & engineering template symbol libraries for use with *MacDraw*, *MacDraft*, *MiniCAD*, etc.

*CompServCo, 800 Freedom,
Slidell, LA 70458, 800/272-5533
or 504/649-0484*

MiniCAD 3.0

By Diehl Graphsoft boasts 1000+ power zoom, symbol library, 40 layers, auto-dimensioning, double-line tool, clip/add/intersect polygons tools, object snap, fillet & trim-lines tools, object sizer & locator, 9 decimals accuracy, full 2-D & 3-D modes, etc. It reads *MacDraw* & *MacDraft* files. \$495. Demo avail. *CompServCo., 800 Freedom,
Slidell, LA 70458, 800/272-5533
or 504/649-0484*

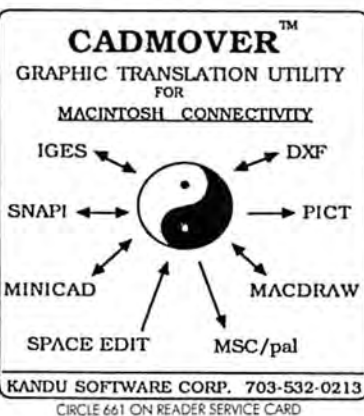

Health

Analyze Diets, Menus...

so much more with the FOOD PROCESSOR II!

- This TOP-rated software has the best database of any system on the market today! Acclaimed by schools-colleges-hospitals-homes-fitness centers & businesses.
- 2400-3000 foods - 30 nutrients. \$250
- CALL OR WRITE TODAY FOR FREE DEMO DISK!

*ESHA Research, P.O. Box 13028,
Dept. D, Salem, OR 97309,
503/585-6242 or 585-7755*

Investment

The Right Time System

The Stock, Index & Futures programs generate accurate Buy/Sell signals for individual stocks, indexes and commodities. The software was developed by an expert portfolio manager for his own personal use & are now available for any smart trader who wants to make quick profits. Call or write for free info.

*T.B.S.P. Inc., 2265 Westwood Blvd.
#793, Los Angeles, CA 90065,
213/312-0154*

Languages

FORTRAN in MPW

Language Systems FORTRAN is a full featured FORTRAN 77 compiler integrated w/MPW. Full ANSI FORTRAN 77 plus VAX-type extensions. SANE numerical calculations & data types incl. COMPLEX*16. 68000, 68020 and 68881 object code. Arrays greater than 32K. Link with Pascal, C, MacApp. \$304 w/MPW via air. Mac+, SE, MacII. *Language Systems Corp.
441 Carlisle Drive, Herndon,
VA 22070, 703/478-0181*

Fortran on Your Desktop

No need to wait for time on the "big" computer any longer. Language Systems Fortran lets you run the same high performance Fortran programs at your desk. VAX-compatible extensions, high precision IEEE floating point data types, complete access to Toolbox, direct code generation for the Mac II, and the MPW programming environment make this compiler the most powerful Fortran for the Mac. *Language Systems Corp., 441 Carlisle Drive, Herndon, VA 22070,
703/478-0181*



The Macworld Catalog

MACTRAN PLUS

The versatile Integrated Made-for-Mac Development System

- Includes: Editor, Optimizing Compiler, Source Level Debugger, Linker, Library Manager
- Supports: 68020/68882 in-line code generation. Significant VAX FORTRAN & ANSI 8X extensions. Comprehensive MAC Tool Box Interface. Unlimited code segment size.

DCM DATA Products, 1710 Two Tandy Center, Fort Worth, TX 76102, 817/870-2202

Medical Office Mgmt.

Tess System™ software for insurance and billing. Expandable line to grow with your needs. Our \$650 package outperforms software selling at three times that price. Multi-user & electronic claims available. Call for Demo software, VHS tape, or documentation. System prices from \$650 to \$5000.
Wabash Medical Resources, Inc., 4727 Shireton Court, Indianapolis, IN 46254, 317/299-7800

Call 1/800/FOR MIDI

MIDI for everyone! Start your computer/MIDI system today with discount prices & expert help from FUTURE MUSIC. You don't have to be a PRO—most of our customers are just "plain folks" with a home computer and a love of music. Call for FREE CATALOG of Hardware, Software, Synthesizers, 4-tracks and more. All major brands avail.

Future Music Inc., 489 E. Plumb Lane, Reno, NV 89502, 702/826-6434

Politics

Constituent Manager

The Ideal Political Software for the Apple Macintosh®



Peripheral Visions, Inc. (800) 882-8889 In Maine 877-9554.

CIRCLE 653 ON READER SERVICE CARD

Medical

CMAMedical CMADental CMA

CMA Micro Computer
5888 Yucca Trail, Suite 5
Yucca Valley, CA 92284

Solo and multi-practitioner office management systems for the Macintosh 512KE, Plus, SE and II. Compare these features:

Paper Claims	Appointments with Recall	Multi User
Electronic Claim Files	Management Reports	Multi Tasking Networks
SuperBill	Production Analysis	AppleShare, Conus, TOPS, MacServe
Patient Ledgers	Responsible Party Billing	File Interchange with other programs
Financial Histories	Audit & Backup	
Diagnostic Data Base	Patient Labels	

Please Call (619) 365-9718



CIRCLE 673 ON READER SERVICE CARD

Music/Midi

version 2.0

PRACTICA MUSICA

Ear Training & Music Theory for Everyone

"Best New Education Program, 1987" —MacUser Magazine

- Teaches intervals, chords, melody, rhythm
- Interactive staff notation • Saves scores
- High quality sound • MIDI compatible
- Historical & computer-generated melodies
- Custom ear training melodies

\$125 • Call Toll Free 800-445-4866, In CA: 800-445-8749

ARS NOVA
BOX 40629, SANTA BARBARA, CA 93140

CIRCLE 699 ON READER SERVICE CARD

Good Sound Advice!

Beginner, professional, solo or ensemble—Soundware carries the best MIDI products for your musical needs. Our commitment is providing you with the best product information, values and support available. Complete MIDI starter packages from under \$250! Call today for our FREE CATALOG and latest prices.

(800) 333-4554
Good Anywhere in the U.S.

soundware®

200 Menlo Oaks Dr. Menlo Pk CA 94925
(415) 328-5773

CIRCLE 747 ON READER SERVICE CARD

Public Domain

You Pick It!

Tired of getting what they want to send you? Choose an 800K disk of what YOU want from our library of over 300 meg of high quality shareware & public domain software, graphics, games, DA's, fonts, utilities & stacks. ONLY \$15. Prices reduced for multiple disks. Send \$5 (refundable) for a catalog.
HK Distribution, P.O. Box 201432, Austin, TX 78720-1432

Mac to MIDI Made Easy!

Make the Right Choices

We have designed MAC based system for headline superstars and 1st time users. We offer: • Expert advice • Complete systems design. We sell: • All MIDI interfaces, software, accessories • All major synths & samplers • At discount prices. Why settle for less than the best?

TekCom Corporation, 1020 N. Delaware Ave., Philadelphia, PA 19125, 215/426-6700

Free Custom Software!

Don't buy public domain software you don't want! Pick the programs you want from our catalog of thousands P.D.-S.W. programs to create a custom disk. We do not charge for programs, pay only a small fee for producing a custom disk. No club fees. Prices as low as \$2.90 per disk. Call now for a free catalog!
Software Supermarket, 5101 Addison Dr., Charlotte, N.C. 28211, 800/438-1242 Ext. 515, in N.C. 800/534-0476 Ext. 515

MedQuest™

Our program handles all the routine medical office tasks: e.g., patient & third party billing, DX & procedure tracking with recall, appointments and practice analysis. MedQuest is running in over 180 medical offices, support & training available. Single or multi-user version \$2,495 & demo \$50 (+, SE, MacII).

The Program Workshop, Inc., 159 Marine Street, Suite 6, Anderson Gibbs Bldg., St. Augustine, FL 32084, 904/829-6500

The Macworld Catalog

Public Domain

125 Stacks for HyperCard™



150 Games



250 DAs



225 Fonts

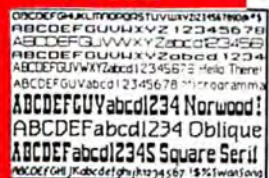

250 Pictures



VISA

MC

For a limited time only!
\$19.95 per set!

All five sets: Only \$89.95!

All sets on double-sided disks. Add \$5/set for single-sided

Call 800-843-9497 Add \$4 pb per order.

Send \$2 (refundable w/order)
for our 288 page catalog!



Educorp
531 Stevens Ave. Suite B
Solana Beach, CA 92075

CIRCLE 740 ON READER SERVICE CARD

FREE PUBLIC DOMAIN & SHAREWARE CATALOG

Lowest Price
Best Quality
Fast Service

Over 1000 Macintosh
Software

Write to:
SOFTSHOPPE
POB 709, Ann Arbor, MI 48105
(313) 763-8721

CIRCLE 749 ON READER SERVICE CARD

Real Estate Software

Ten Minute

Property Manager

Accounting system for multiple properties.
Ideal for investors who manage their own
properties.

ProAnalysis

A Sophisticated investment analysis
program designed for the investor who
demands professional quality analysis.

Demos Now Available!

Metropolis 499 Hamilton Ave., Suite. 202
Palo Alto, CA 94301
Software (415) 322-2001

CIRCLE 689 ON READER SERVICE CARD

REMS Investor Series

CCIM recommended. Multi-year
cash flow projections and analysis,
amortization, depreciation, tax
calculations, and export to Excel.
REMS Investor 3000 imports from
Excel, handles partnerships, ground
leases, participation loans and more.
Not a template.

REMS Investor 2000 **\$395**

REMS Investor 3000 **\$795**

GOOD Good Software Corp.

13601 Preston Rd. Suite 500W, Dallas, Texas 75240
1-800-272-GOOD

CIRCLE 679 ON READER SERVICE CARD

Programming Tools

POWER DEVELOPMENT TOOLS

• Programmer's EXTENDER
Vol 1: Macintosh User interface
Vol 2: lists, printing, graphics,
blinking, popups

• EXTENDER GRAFFPAK
high quality color graphs - bar,
line, log; customizable symbols,
grid patterns

Invention Software
313-996-8108

CIRCLE 629 ON READER SERVICE CARD

New from RealData —

Real Estate Investment Analysis, Version 6.0

Real Estate Investment Analysis has been our best-selling product since it
was introduced in 1982. Many software products have come and gone
over the years, but RealData and our *Investment Analysis* have stood the
test of time. Now Version 6.0 adds new power to this popular program.

What can it do? *Real Estate Investment* allows you to make ten-year
projections of the income, expenses, cash flows, re-sale and tax implica-
tions of your property. It performs virtually all of the complex Tax
Reform, financing and rate-of-return calculations for you in just seconds.
It also includes a lease analysis and annual operating statement

*Real Estate Investment Analysis, Version 6.0 runs with Microsoft
Excel™ or Works™ on the Mac 512 or greater — just \$250.*

To order, call or write today. MC, VISA, AMEX Welcome
or send \$2 for our catalog of real estate software for the Mac and PC.



78 North Main St.
South Norwalk, CT 06854
(203) 255-2732

CIRCLE 610 ON READER SERVICE CARD

Real Estate

Property Management

Comprehensive program for man-
aging residential and commercial
properties. Many management re-
ports, including operating state-
ment, delinquent rent, lease expira-
tion, and transaction register.

Provides check writing, check rec-
onciliation, posting late fees, recur-
ring expenses—\$395. Investment
analysis—\$245.

*Yardi Systems, 813 Reddick St.,
Santa Barbara, CA 93103,
805/966-3666*

Recreational

Tidal Predictions

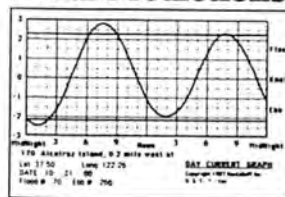

MacTides: Current & tide height
plots, tables & more: 5400 stations
on 5 discs: valid 'til 2010: \$99/disc
+ \$3 sh. MC/Visa. Info: (800)
441-0360 Ext 1009. Nautasoft Inc.,
Box 282, Rockland, DE 19732

CIRCLE 744 ON READER SERVICE CARD

Reference Mgmt.

RefMaker 2.0

Works with Microsoft® Word and
HyperCard™ or Reflex™. Incorpor-
ates references downloaded from
BRS (MESH & BIOZ), MEDLARS, &
CAS Online. Creates bibliographies
automatically from manuscript cita-
tions. 20+ customizable bibliogra-
phy styles. Stores 10,000 references.
Easy to use! \$75 postage pd.
*Cat's Cradle Software, P.O. Box
684, Ann Arbor, MI 48106,
313/665-6152*

For your ad to appear on *The Macworld Catalog* screen, call 800/888-8622.



The Macworld Catalog

New dimensions in Bible study



THE WORD processor
A comprehensive Bible study program. Instant access to any verse in the Bible. You can search for any word or phrase and build indexes to record your study. Separate windows for comparing various verses and translations. Only \$199.95

Our family of products
Choose from NIV, RSV, KJV or NKJV text. Add Greek or Hebrew transliterators or topical cross references, personal commentary, a chronological Bible and chain references. Our memory resident **VERSE TYPIST** transfers verses to your word processor.

Bible Research Systems
(512)251-7541

2013 Wells Branch Parkway #304
Austin, Texas 78728

Postage extra. For IBM, MSDOS, Macintosh. Some products for Apple II.

CIRCLE 665 ON READER SERVICE CARD

The Macworld Catalog is the direct response section for the Macintosh marketplace. It's action-oriented advertising that reaches the experienced users who know what they want, want it fast, and look for it here—each and every month.

The most readers. The least cost. Immediate access. Just call *The Macworld Catalog* at 800.888.8622 and place your ad—today!



800.888.8622

Rental

Mac Software Rentals

Try before you buy...We have a complete inventory of Macintosh software, including hard to find programs, ready for your evaluation. Of course your rental fee is applied to the regular low price, should you decide to purchase.

In addition to software, we stock a full line of Mac peripherals, such as hard drives, full-page monitors, and modems at **low discount prices.**

Call for our free catalogue.

From California:
800 426-2777

Outside California:
800 622-4774

FAX:
714 879-7422



SoftCore
Software

CIRCLE 728 ON READER SERVICE CARD

For your ad to appear on *The Macworld Catalog* screen, call 800/888-8622.

The Macworld Catalog

Retail

Retail Engine



Retail Engine™, the complete point of sale software system for apparel stores with up to 10 locations. Sales, Cash, Inventory, A/R, A/P and General Ledger. Decisive and timely information for the apparel retailer who has a passion for success.

Houlberg Development
PO Box 151501
San Diego, CA 92115
(619) 287-7444

CIRCLE 714 ON READER SERVICE CARD

Sales/Marketing

MarketMaster for Mac
MacGuide calls it "the best sales lead follow-up you can buy..." Enter leads whenever you get them and MarketMaster™ contacts the right people the right way at the right time. Prints letters & envelopes, phone lists, scripts, and NEVER FORGETS! Easy to learn and use. Frees salespeople to SELL and supports them to SELL MORE! Breakthrough Productions, 10659 Caminito, Cascara, San Diego, CA 92108, 619/281-6174

Your Ad Gets More For Less.

Call *The Macworld Catalog* and see why.



800.888.8622

Scientific

typeset quality

Equations Made Easy

Expressionist™ 2.0 2-WAY FAX Interface

An excellent toolkit that all technical people should have... - Jean Louis Gassée, VP, Apple Computer, Inc.

$$B = \frac{\mu_0}{4\pi} \int \frac{J \times r}{r^2} dt$$

A powerful application and desk accessory that generates equations for word processing and Desktop Publishing.

allan bonadio associates 814 Castro #56, SF, CA 94114, (415) 282-5864 \$129.95

CIRCLE 690 ON READER SERVICE CARD

Geological Software

Great graphics, low prices!

- Lithologic log plotting
- Gridding • Contouring
- Piper/Stiff plots • Oil & Gas economics • Stereonet plots
- Plate tectonics • Geophysical modelling, + much more for the Macintosh & PC \$50-\$1500. Call or write for FREE catalog of easy-to-use software products.

RockWare Inc., 4251 Kipling, Suite 595, Wheat Ridge, CO 80033, 303/423-6171, Telex: 9102504964

Statistics

MINITAB'S a PC of cake!

MINITAB features intuitive commands for comprehensive data analysis. Includes basic statistics • regression • time series • tabulation • ANOVA • plots • histograms • LOTUS interface • hi-res graphics • no copy protection. Now available for MAC+, MAC SE, and MACII's. For free brochure call 814/238-3280.



Minitab, Inc.
3081 Enterprise Dr., State College, PA 16801

CIRCLE 630 ON READER SERVICE CARD

CLR ANOVA

Analysis of variance program that can compute up to a 10-way design with repeated measures and unequal *n*. Marginal means, plots of interactions, simple effects, range tests, contrasts, and more. Full Mac interface. Can read text files w/entries separated by spaces, commas, or tabs. \$100 + \$3 s/h.

Clear Lake Research, 5615 Morningside #127, Houston, TX 77005, 713/523-7842

Biotech Software

OF scientists, teachers, students

Use Bioscript™ on your Mac to instantly draw chemical structure of a 400 amino acid protein!!! Easily display, manipulate, search, & edit protein, RNA, & DNA sequences & structures from within WORD®. Bioscript™ includes chemical structure drawings, hydrophobicity, hydrogen bonding, & more. Font-based, >100 protein & DNA sequences, DS disk, requires any version of Microsoft WORD®.

TEMM Software \$129.95 MC/Visa
10320 Fontainebleau (Wis res add tax)
Mequon, WI 53092 414-242-4048, 4312
option: 3/88 PIR (>7,000 protein sequences) on 4 disks for \$70 add.

CIRCLE 707 ON READER SERVICE CARD

RATS! Version 2.1

Best-selling econometrics software program. Now available on the Mac. Multiple regression, including stepwise, 2SLS, logit, probit, and much more! Forecasting with AR-IMA, VAR. Exponential smoothing, model simulations, support for daily/weekly data. \$300. VISA/MC. 512K + external drive.

VAR Econometrics, Inc., P.O. Box 1818, Evanston, IL 60204-1818, 312/864-8772, 800/822-8038

Utilities

Hot! Hot! Hot!

MacLabeler® Plus Label Construction Set™

The ultimate disk labeler
\$79.95

- It's easy...Label your disks automatically with a click of a button.
- It's flexible...Design and save your own Label Templates.
- It's powerful...Put 10 kinds of fields anywhere you want:

Disk name
File / Folder names
Desktop icons
DA's & System fonts
Space and HFS/MFS
Date & Serial #
Imported graphics
Custom text



- Give each field a font, style, color, custom width, etc.
- Fill these fields by inserting disk.
- Set to manual or automatic modes.
- Bordered or borderless labels.
- Built-in print queue.
- For MacPlus, SE, or Mac II.
- For LaserWriters or ImageWriters.
- 60 pin-feed QuickLabels® included.

DiskQuick™ \$49.95

- Catalogs hard disks and floppies.
- Powerful "Subset" file locator.
- Shows info box comments.
- Exports catalog to database.
- 512k to Mac II.
- IW or LaserWriter
- MacGuide rates it a 96... "Essential for anyone who uses a hard drive or owns more than two floppy disks."



Ideaform Inc. (515) 472-7256
PO Box 1540, Fairfield, IA 52556

MacLabeler, Label Construction Set, QuickLabels, and DiskQuick are trademarks of Ideaform Inc.

CIRCLE 658 ON READER SERVICE CARD

The Macworld Catalog

Plotter Utility...with professional fonts for Apple, HP, Houston; A-E sizes.
\$125

Terminal Utility...
fast VT100, Tektronix, file transfer, color, large screens.
\$195

Mesa Graphics, Inc
P.O. Box 600
Los Alamos, NM 87544
(505) 672-1998

CIRCLE 632 ON READER SERVICE CARD

Miscellaneous Business Opportunities

Mac Underground



THE MAC UNDERGROUND WANTS YOU !!!!
The demand for our on-line electronic magazine for the Mac is more than we can handle! Distribute our magazine & software products in the US, Can., U.K., Australia, Far East or Europe. We offer:

- EXCLUSIVE TERRITORIES •
- PROVEN MARKET •
- SMALL INVESTMENT - BIG RETURNS •
- TECHNICAL and SALES SUPPORT •

Have fun and make \$\$ with your Mac! You can launch this business from your home or existing business, and expand from there. For further information...

CALL
MAC UNDERGROUND, 1180 South 1300 East, Salt Lake City, Utah 84105 USA (801)-582-1676

CIRCLE 670 ON READER SERVICE CARD

Word Processors

QUEM

...Quality Editor w/Macros™

The Most Powerful Text Editor with Macros

- Unlimited Undos • Find Files with Key Words • Find/Replace with Wildcards • Write or Record Macros • Count Lines, Sentences, Words • Extract any Data from Text Files • Text Folding • File Compare • Many More Features! ONLY \$119

4954 Sun Valley Road
Del Mar, CA 92014

To Order: (800) 922-2993; in CA: (619) 481-1477; S&H \$3.50, CA res. + sales tax; VISA, MC O.K.

CIRCLE 609 ON READER SERVICE CARD

Japanese Software

- New *Kanji Pagemaker 2.0*: Japanese DTP. Int'l. standard w/ professional quality. \$995.
- New *EGBook 1.2*: Japanese DTP. Supports vertical format. \$599.
- New *EGWord 3.0*: Japanese WP. Auto kana-kanji conversion. \$499.
- *EGWord & EGBook* Bundle. \$799
- New *MacVJE 1.0*: Japanese FEP. \$249.
- *MacKanji 2.0*: Japanese FEP. \$99.95. All Req. 2MB RAM.
- New *SweetJAM v.3.51*: Japanese FEP. \$249. Req. 1MB RAM.

Distributed by
Qualitas Trading Co.,
6907 Norfolk Rd., Berkeley, CA
94705, 415/848-8080 or
415/848-5815

Mailing Lists

MAILING LIST of Mac Users

On labels, tapes, diskettes... or by modem.



Choose from hundreds of thousands of users!
Only 5c per name, with no charge for selecting, sorting, media, or delivery.

Semaphore Corporation, 207 Granada Dr., Aptos, CA 95003
(408) 688-9200 (voice) 662-2717 (modem)

CIRCLE 611 ON READER SERVICE CARD

If you have a small workbench or table, you can start your own toner cartridge recharging business — full or part-time.

The demand for recharged toner cartridges for laser printers and copiers is just beginning to explode. You can cash in on this demand by starting your own high profit, low overhead recharging business. The LaserCharge process enables you to offer companies in your area a way to reuse toner cartridges instead of having to buy more expensive new ones. Your customers save money, and you make money.

LaserCharge provides dealership training, tools, supplies, trade secrets, marketing strategies and technical support. Choice of two dealership plans: \$4,900 or \$6,900. Master Distributorship Plan also available.

 **LaserCharge**

Call for a free cassette and brochure about this new field!
800-223-8134 512-335-8191

CIRCLE 730 ON READER SERVICE CARD

The Biggest Small Investment You Can Make.



Take advantage of the direct link with your buyers that maximizes exposure at a low cost.

The *Macworld Catalog* reflects the expanding corporate Macintosh audience whose purchasing activities increasingly include mail order. The cost-effective direct response advertising available monthly in *The Macworld Catalog* links you instantly with nearly 500,000 qualified buyers.

Get into the link. Call 800.888.8622 and place your ad now!

800.888.8622



Macworld Best-Sellers

Months on chart	Last month	This month	
Business Software			
46	1	1	Microsoft Word <i>Microsoft</i>
25	3	2	Microsoft Works <i>Microsoft</i>
37	2	3	Microsoft Excel <i>Microsoft</i>
33	4	4	PageMaker <i>Aldus</i>
22	5	5	MacWrite <i>Claris</i>
6	6	6	WordPerfect for the Macintosh <i>WordPerfect</i>
6	7	7	Adobe Illustrator/Illustrator 88 <i>Adobe Systems</i>
1	-	8	FreeHand <i>Aldus</i>
21	-	9	SuperPaint <i>Silicon Beach Software</i>
5	-	10	QuarkXpress <i>Quark</i>

Education Software

13	2	1	Reader Rabbit <i>The Learning Company</i>
29	1	2	Math Blaster <i>Davidson & Associates</i>
26	3	3	Typing Tutor <i>Simon & Schuster Computer Software</i>
26	4	4	KidsTime <i>Great Wave Software</i>
1	-	5	Geometry Sensei <i>Software</i>

Entertainment Software

29	2	1	MacGolf <i>PCAI</i>
28	1	2	Flight Simulator <i>Microsoft</i>
25	3	3	Dark Castle <i>Silicon Beach Software</i>
11	4	4	Falcon <i>Spectrum HoloByte</i>
9	5	5	Beyond Dark Castle <i>Silicon Beach Software</i>

Networking/Data Communications

25	1	1	TOPS <i>TOPS</i>
29	3	2	LocalTalk <i>Apple Computer</i>
16	4	3	PhoneNet <i>Farallon Computing</i>
21	2	4	AppleShare <i>Apple Computer</i>
1	-	5	MacLink Plus <i>DataViz</i>

Months on chart	Last month	This month	
Hard Disks*			
4	-	1	Rodime 45 Plus External <i>Rodime Systems</i>
7	-	2	SD Macstack 20 MB <i>CMS Enhancements</i>
14	-	3	Rodime 20 Plus External <i>Rodime Systems</i>
13	3	4	FX20 General Computer
2	2	5	Pro Series 30-SE Internal <i>CMS Enhancements</i>

Add-In Boards

16	1	1	Radius Accelerator <i>Radius</i>
15	-	2	Apple 2MB Memory Expansion Kit <i>Apple Computer</i>
3	2	3	Radius Interface Display <i>Radius</i>
3	-	4	Mac286 <i>AST Research</i>
2	4	5	Micro Snap Memory Expansion Kit <i>Microtech International</i>

Product Watch

Editors' choice of other recent or forthcoming products of particular interest.

Aldus FreeHand 2.0 *Aldus* color drawing package

More II *Symantec* presentation graphics

Wingz *Informix* spreadsheet

Source: exclusive InfoCorp survey of more than 125 Macintosh retailers and selected mail-order suppliers. Covers sales during November 1988.

*Does not include hard disks installed at the factory.

The WriteNow difference: Ease, Performance, and...



	WriteNow 2.0	MacWrite 5.0	MS Write	MS Word 3.01
Spelling checker size	100,000 words	100,000 words	80,000 words	80,000 words
Font size range	4-127 pts.	7-24 pts.	7-72 pts.	2-127 pts.
Maximum recommended document size (in pages)	Over 2,000	240	50	500
Number of open documents	Unlimited*	1	30	30
Mail merge	Yes	No	No	Yes
Number of editable, on-screen columns (WYSIWYG)	4	1	1	1
On-screen auto-numbering footnotes	Yes	No	No	No
Automatic repagination	Yes	Yes	No	No
Graphics in same line as text	Yes	No	Yes	Yes
Multiple headers and footers	Yes	No	No	Yes
Extensive Undo	Yes	No	No	No
Variable line spacing (in points)	Yes	No	No	Yes
Selective font, size, style, and ruler changes	Yes	No	No	Yes
MacUser Magazine's Best New Word Processor	Yes	No	No	No
Search for a word	2.4 sec	7.6 sec	9.5 sec	9.7 sec
Spell Check document	6.3 sec	2 min 34.0 sec	2 min 2.3 sec	1 min 48.0 sec
Copy & Paste large area	6.8 sec	1 min 0.9 sec	12.4 sec	12.3 sec
Change font size of document	10.7 sec	50.2 sec	17.6 sec	16.2 sec
Change font of document	10.8 sec	37.1 sec	14.1 sec	15.2 sec
'Save As' a 12-page document	3.6 sec	9.4 sec	20.3 sec	19.6 sec
Retail Price	\$195	\$125	\$175	\$395
Happy Users	Yes	?	?	?



* Number determined by Macintosh system constraints.

...Happy Users!

Our users love WriteNow—a claim our competition can't easily make for their products.

How do we know? Because our users tell us—on registration cards, on the telephone, on bulletin boards, and in letters.

We've heard dramatic stories about how WriteNow has significantly reduced training and support costs. And how clean, fast, and enjoyable it is to use. And how WriteNow got the job done when our competition sputtered.

You see, at T/Maker we feel a great word processor is more than just a stockpile of features. It's the *usability* of those features—how easy they are to learn and use, and how they *feel* under your fingertips when doing real work.

And from their overwhelmingly terrific response, it's clear our users agree.

WriteNow 2.0 is the user's choice for best Macintosh word processor—and we'll show anyone our customer registration cards to prove it!

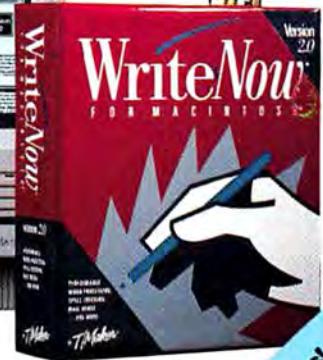

T/Maker

T/Maker Company
1390 Villa Drive
Mountain View, CA 94041
(415) 962-0195

What's new with WriteNow 2.0?
Over 50 New Features And Improvements!

Mail Merge • 100,000-Word Dictionary • Character and Word Count
Direct Opening and Saving of Text, MacWrite, and RTF (Word Option)
Cursor Key Support • Windows Menu • Decimal Tabs
Case Change • Hide Pictures Option • "Smart Quotes"
Fixed Line Spacing • MultiFinder/Network Compatibility • and More!

© 1988 T/Maker Company. All rights reserved. WriteNow is a trademark licensed to T/Maker Co.

Attention WriteNow 1.0 Owners!
WriteNow 2.0 is shipping —
Order your upgrade —
today!
Call or write T/Maker
for details.

Circle 332 on reader service card

10 reasons why you should switch to New Turbo Mouse.



1 Fly across even the biggest screen with automatic acceleration. Turbo Mouse® senses the speed at which you're working and moves the cursor further when you move faster.

2 No rolling room required. With the Turbo mouse ball on top, you move only the ball, not the whole mouse.

3 Three times as precise as a mouse. New patented "optical levering" technology offers 200 CPI pin-point precision.

4 One button is for regular clicking, the other is a click lock. You choose which is which.

5 Advanced two-button design allows for either right or left-handed use!

6 Only 4" by 6", Turbo Mouse fits neatly beside any Macintosh® or Apple IIgs® keyboard.

7 Turbo Mouse offers a second mouse port. Turbo Mouse ADB offers a second ADB port.

8 Perform one of seven functions—Save, Print, Open, Close, New, Quit, or Undo when you click both buttons at once. (Only in Turbo Mouse ADB.)

9 Turbo Mouse ADB, #62360, works with Mac SE, Mac II, or Apple IIgs. Turbo Mouse, #62358, works with Mac or Mac Plus. Both have a suggested retail of \$169.95.

10 It's easy to find. For a Turbo Mouse dealer near you, just call **1-800-535-4242**, or **212-475-5200**.

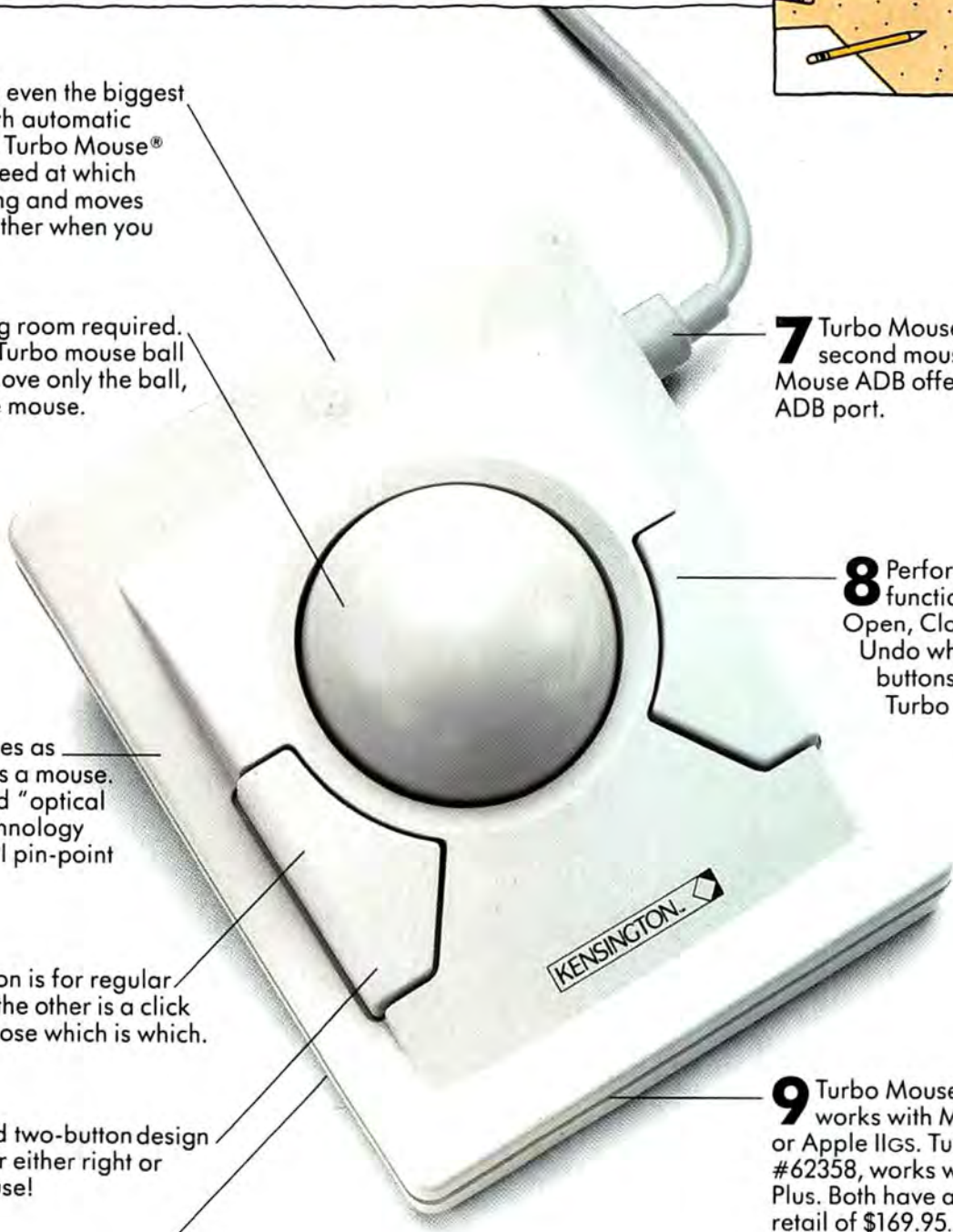

KENSINGTON 

Circle 192 on reader service card