



MASERATI

Ghibli

Owner's manual



WARNING:

Operating, servicing and maintaining a passenger vehicle or off-road vehicle can expose you to chemicals including engine exhaust, carbon monoxide, phthalates, and lead, which are known to the State of California to cause cancer and birth defects or other reproductive harm. To minimize exposure, avoid breathing exhaust, do not idle the engine except as necessary, service your vehicle in a well-ventilated area and wear gloves or wash your hands frequently when servicing your vehicle. For more information go to: www.P65Warnings.ca.gov/passenger-vehicle.



MASERATI

Ghibli

Owner's Manual



Dear Customer,

thank you for choosing a Maserati.

This vehicle represents the result of Maserati's great experience in the design and production of sports, touring and racing vehicles.

The purpose of this manual and of the other documents in the two on-board documentation kits is to provide you with an understanding of the equipment, systems and controls of the vehicle and to explain how they work.

The description of all the on-board safety systems and devices and the car's technical data are given in the main guide.

Before driving your vehicle for the first time, we suggest reading this manual carefully in order to quickly acquaint with commands and functions of your vehicle.

In a dedicated section of this manual you will also find instructions for basic maintenance procedures, in order to ensure steady levels of performance, quality and safe driving.

In addition, keep in mind that proper maintenance is an essential factor to help preserve the value of the vehicle over time and protect the environment.

For "Scheduled Maintenance" or any other operation, contact your **Authorized Maserati Dealer**: you can trust our trained technical staff, who is constantly updated and provided with the required equipment in order to ensure that all service operations are performed properly and reliably.

All the documents contained in on-board documentation kits are integral part of the vehicle and should always be kept on board.



| | |
|---|----------|
| Introduction | 1 |
| Understanding the Vehicle | 2 |
| Before Starting | 3 |
| Dashboard Instruments and Controls | 4 |
| Starting and Driving | 5 |
| Driver Assistance Systems | 6 |
| In an Emergency | 7 |
| Maintenance and Care | 8 |
| Index | 9 |





1 - Introduction

| | |
|-----------------------------------|---|
| On-board Documentation Kits | 6 |
| Owner's Information Online | 6 |
| Consulting the Manual | 7 |
| Abbreviations | 8 |
| Updating | 9 |



On-board Documentation Kits

On board there are various documents to provide the User with all the necessary information regarding the manufacturer's warranty, assistance request and to know all the devices supplied with the car and their functions, in order to be able to operate the vehicle using all of its potential.

These documents are contained in two kits, one placed in the dashboard glove box and the other inside the luggage compartment.

The kit inside the dashboard glove box contains the Warranty Card and Owner's Main Guide.

The kit inside the luggage compartment, in addition to this Owner's Manual, also contains the Maserati Intelligent Assistant (MIA) information booklet.

Depending on the equipment chosen, the market, etc., the kits may contain other additional documents.

NOTE:

After reviewing the manual, always put the document in its case to avoid losing it.

All specifications and illustrations contained in these documents refer to the manual publishing date.

Updated versions of the on-board documentation and the "Regulatory Information" are always available and can be consulted by accessing the section "Services" on the website **www.maserati.com**.

In case of loss, excluding the Warranty Card, it is possible to purchase a copy of these documents by requesting it from your **Authorized Maserati Dealer**.

Owner's Information Online

Most of the on-board documents can also be consulted online in PDF format by accessing the website **www.ownerdocumentation.maserati.com**. The website is available for most markets.

The online documents may be more up to date than those supplied with the car.

By accessing the website **www.maserati.com** it is possible to watch videos and find other useful information regarding your Maserati and all available services.



Consulting the Manual

This manual illustrates maintenance and use information related to 3.8 V8 and 3.0 V6 motorization models. If not otherwise specified, the information is valid for all models.

For an easy identification of the topics, this Manual is divided into sections and chapters: each chapter can have more paragraphs.

Meaning of Warning and Note Symbols

Within the text, important warnings and notes are also easily identifiable through icons.



WARNING!

Describe operating procedures that could result in a collision, bodily injury and/or death.



ENVIRONMENTAL!

This note indicates the correct behavior when using the vehicle to protect the environment.



CAUTION!

Describe procedures that could result in damage to your vehicle.

NOTE:

Additional information regarding the subject and/or the operation described.



In addition to these, this symbol in the text indicates a reference to the Owner's Main Guide.

Optional Equipment and Versions/Markets Validity



In addition to the standard equipment, this manual also describes optional parts and accessories which are identified in the title and /or text by this symbol alongside in brackets.



Optional equipment and also some functions or systems are not available in all vehicle versions and may only be available in certain markets. In these cases, the equipment or the function/system will be identified in the title and/or text by this symbol alongside in brackets.

Other General Indications

- In the images the vehicle is represented in the base version. On other versions, some part or equipment may differ from those shown in the images.
- "Left" and "right" in this manual, always refer to the driving direction.
- All indications and images in this Manual refer to a vehicle with left-hand drive. On right-hand drive vehicles, some controls are ordered differently than shown in the illustrations.
- If not otherwise specified, the instrument cluster shown in the images is the version with the speedometer in MPH of the 3.0 V6 motorization model – however the indications given are also valid for the version in km/h and for all the other motorization models.



Abbreviations

| | | | | | |
|-------------|--------------------------------------|---------------|--|--------------|--|
| A/C | Air-Conditioning system. | EDR | Event Data Recorder. | SABIC | Supplemental Side Air Bag Inflatable Curtains. |
| ABA | Advanced Brake Assist. | EPB | Electric Parking Brake. | SBR | Seat Belt Reminder. |
| ABS | Anti-Lock Braking System. | EPS | Electric Power Steering. | SRS | Supplemental Restraint System. |
| ABSA | Active Blind Spot Assist. | ESC | Electronic Stability Control. | TCS | Traction Control System. |
| ACC | Adaptive Cruise Control. | ETC | Electronic Throttle Control. | TFT | Thin Film Transistor. |
| ADA | Active Driving Assist. | FCW | Forward Collision Warning. | TPMS | Tire Pressure Monitoring System. |
| ADAS | Advanced Driver Assistance Systems. | HBA | Hydraulic Brake Assistance. | TSA | Traffic Sign Assist. |
| AEB | Autonomous Emergency Braking | HSA | Hill Start Assist. | VIN | Vehicle Identification Number. |
| ALR | Automatic Locking Retractor. | I.C.E. | Increased Control and Efficiency. | | |
| AQS | Air Quality Sensor. | LATCH | Lower Anchors and Tether for Children. | | |
| ATC | Automatic Temperature Control. | LDW | Lane Departure Warning (LaneSense). | | |
| AWD | All-Wheel Drive. | LKA | Lane Keeping Assist. | | |
| BAS | Brake Assist System. | MIL | Malfunction Indicator Light. | | |
| BSA | Blind Spot Assist. | MIA | Maserati Intelligent Assistant. | | |
| BTO | Brake Throttle Override. | OBD | On-Board Diagnostics. | | |
| CAN | Controller Area Network. | ORC | Occupant Restraint Controller. | | |
| CC | Cruise Control. | ORS | Occupants Restraint Systems. | | |
| CRS | Child Restraint Systems. | PEB | Pedestrian Emergency Braking. | | |
| DRL | Daytime Running Lights. | RAB | Ready Alert Braking. | | |
| EBD | Electronic Brake-force Distribution. | RCP | Rear Cross Path. | | |
| ECU | Electronic Control Unit. | RKE | Remote Keyless Entry. | | |
| | | SAB | Side Air Bag. | | |



Updating

Constant improvements are being performed to maintain this vehicle's high level of quality. Therefore, there may be differences between this manual and your vehicle.

Maserati reserves the right to carry out design and functional changes and to provide updates or improvements.

This manual illustrates and describes all versions of the current vehicle model. Therefore, some of the equipment and accessories in this publication may not appear on your vehicle; please only consider the information related to your vehicle.

All specifications and illustrations contained in this manual are as of the Manual publishing date.

NOTE:

The updated version of the on-board documentation can be consulted by accessing the section "Services" on the website www.maserati.com.





2 - Understanding the Vehicle

| | |
|---|----|
| Main Controls Overview | 12 |
| Front Power Seats | 15 |
| Memorize the Driver's Seat Position | 18 |
| Rear Seats | 20 |
| Power Steering Wheel Adjustment | 22 |
| Adjustable Pedals (OPT) | 23 |
| Rear-View Mirrors | 24 |
| External Lighting | 27 |
| Interior Lighting | 30 |
| Internal Equipment | 32 |
| Audio System | 39 |
| Cargo Area | 41 |
| HomeLink® (OPT) | 44 |
| Air Conditioning Distribution | 48 |



Main Controls Overview

On Dashboard

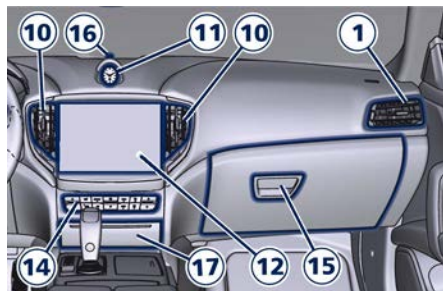
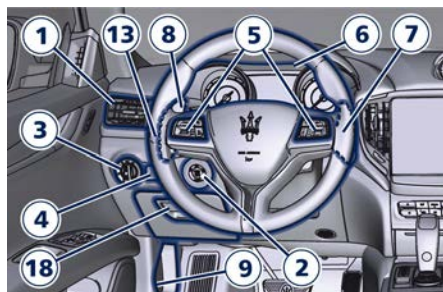

- 1 Adjustable side air outlets (page 49)
- 2 Engine **START/STOP** button (page 52) and (page 146)
- 3 Light switch (page 120)
- 4 Light dimmer controls (page 126)
- 5 Steering wheel controls (page 116)

- 6 Instrument cluster (page 78)
- 7 Right shift paddle +, if foreseen (page 160)
- 8 Left shift paddle -, if foreseen (page 160)
- 9 Hood release (page 74)
- 10 Adjustable central air outlets (page 49)
- 11 Analog clock (page 131)
- 12 MIA display (page 101)
- 13 Multifunction lever (windshield wipers, headlight selection and turn signals) (page 127)
- 14 Climate controls (page 135)
- 15 Passenger side glove box handle (page 132)
- 16 Vehicle security alarm light ( : chapter "Vehicle Security Alarm" in section "Safety")
- 17 Cover for compartment with multimedia ports and slide phone drawer with Wireless Charger (OPT) (page 35)
- 18 Driver side glove box handle (page 132)

On Central Console

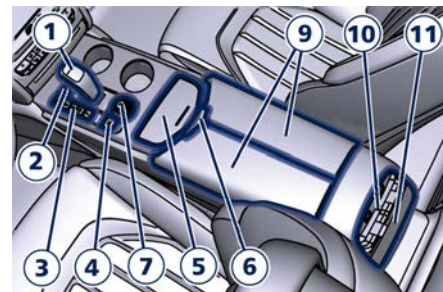
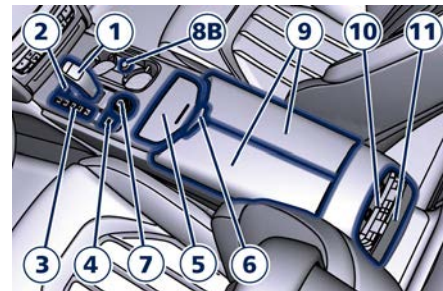
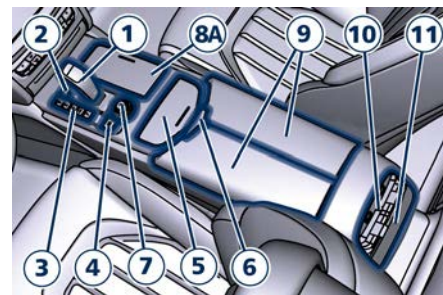



- 1 Automatic transmission shift lever (page 154)
- 2 Hazard lights switch (page 240)
- 3 Drive mode switches (page 163)
- 4 Electric Parking Brake lever (page 177)
- 5 Glove compartment access cover
- 6 Unlock button for central console with cup holder and power outlet (page 33)
- 7 Rotary selectors and buttons for the multimedia navigation (page 101)
- 8 A - Cup holder and power outlet compartment access cover (page 33)
B - Power outlet (page 32)
- 9 Central console covers with armrest function (page 33)
- 10 Air outlets (adjustable) (page 49)
- 11 Rear power sunshade (page 67) and rear seats comfort controls panel (page 20)

On Front Dome Console

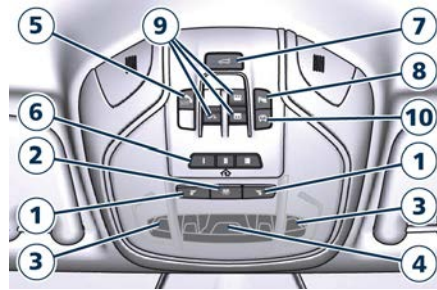

- 1 Reading lights control button (page 30)
- 2 Central light control button (page 30)
- 3 Reading lights (page 30)
- 4 Central light (page 30)
- 5 Button to activate the SOS call (📞) (page 242)
- 6 HomeLink controls (OPT) (page 44)
- 7 Button to release the manual trunk lid or to open fully/partially the power trunk lid (🔓) (page 68)
- 8 Button to enable/disable front sensors of the Park Assist system (if equipped) (page 197)
- 9 Sunroof controls (page 65)
- 10 Button to switch off passenger compartment lights (page 31)

On Front Doors

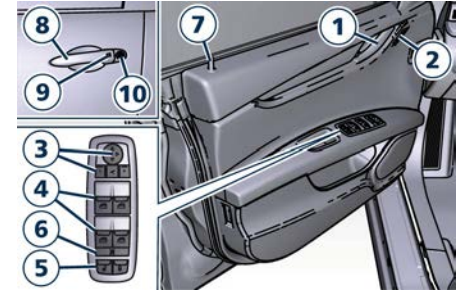

Driver door

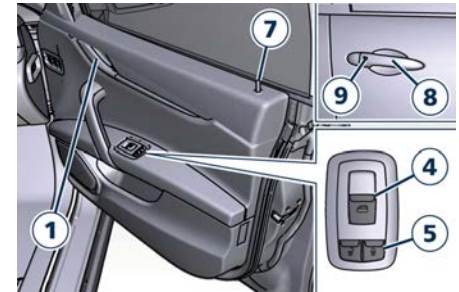



Passenger door

- 1 Internal door handle (🔓 : chapter "Doors Security Locking" of section "Safety")
- 2 Driver's seat, steering wheel, adjustable pedals and rear mirrors memory switch (OPT) (page 18)
- 3 Rear view mirrors switches (page 24)





Understanding the Vehicle

2

- 4 Power window switch (page 63)
- 5 Power door unlocks/locks ( : chapter "Doors Security Locking" of section "Safety")
- 6 Rear windows and sunshade lockout button (page 65)
- 7 Internal door lock/unlock knob ( : chapter "Doors Security Locking" of section "Safety")
- 8 External door handle ( : chapter "Doors Security Locking" of section "Safety")
- 9 Door lock button with "Passive Entry" function (page 60)
- 10 Door outboard manual opening lock (page 52)

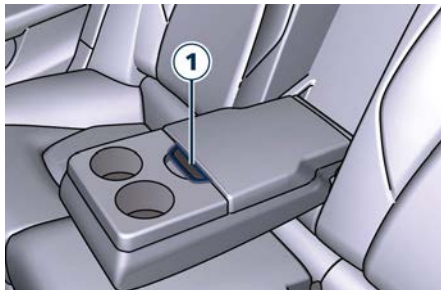
Between the Rear Seats



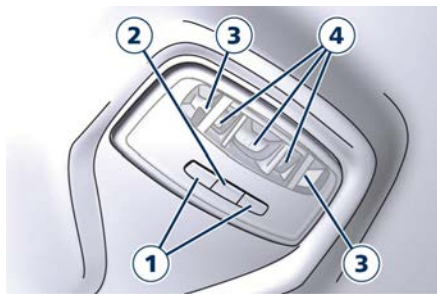

- 1 Unlock button to access the armrest compartment with power outlet and USB port () (page 32)

On Rear Dome Console



- 1 Reading lights control button (page 30)
- 2 Central light control button (page 30)
- 3 Reading light LED (page 30)
- 4 Central light LEDs (page 30)

- 2 Power window switch (page 63)
- 3 Power doors lock/unlock buttons ( : chapter "Doors Security Locking" of section "Safety")
- 4 "Child protection" door lock system ( : chapter "Doors Security Locking" of section "Safety")
- 5 Inside door lock/unlock knob ( : chapter "Doors Security Locking" of section "Safety")
- 6 External door handle (page 60)

On Rear Doors

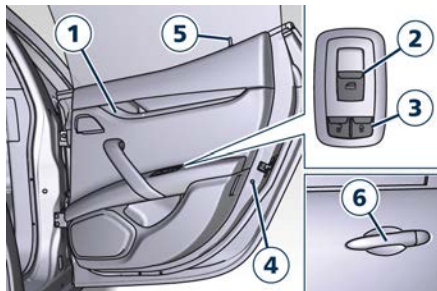

- 1 Internal rear door handle ( : chapter "Doors Security Locking" of section "Safety")



Front Power Seats

Seats, head restraints and seat belts are part of the Occupant Restraint System of the vehicle. For further information, : chapter "Occupant Restraint System (ORS)" and "Head Restraints" in section "Safety".



WARNING!

Be sure everyone in your vehicle is in a seat and using a seat belt properly.

Front Power Seat Controls

The power seats switches are located on the outboard side of the seat cushion.

Use the front switch **1** to move the seat up or down, forward or rearward or to recline the seat cushion. Use the switch **2** to recline the seatback.

Use the rear switch **3** to adjust the lumbar support.

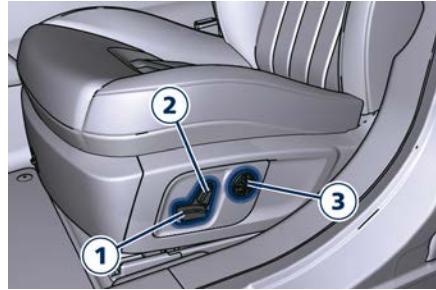

Seat Forward/Rearward Adjustment

The seat can be adjusted both forward and rearward.

Push the seat switch **1** forward or rearward, the seat will move in the direction of the switch.

Release the switch **1** when the desired position is reached.

Seat Up/Down Adjustment

The height of the seat can be adjusted up- or downward.

Grip switch **1** from the back side and push it down or up.

Release the switch **1** when the desired position is reached.



CAUTION!

If the seat's movement does not work, make sure that the corresponding fuse is not tripped (see chapter "If a Fuse Blows" in section "In an Emergency").

Seat Tilt Control (Up/Down)

The angle of the seat cushion can be adjusted in four directions.

Pull upward or push the front of the switch **1**, to move the front cushion seat in the direction of the switch.

Release the switch **1** when the desired position is reached.

Seat Back Tilt Control

The angle of the seatback can be adjusted forward or rearward.

Push the seatback switch **2** forward or rearward, the upper seatback will move in the direction of the switch.

Release the switch **2** when the desired position is reached.

Power Lumbar

Push the switch **3** forward or rearward to increase or decrease the lumbar support.



Understanding the Vehicle

2

Push the switch **3** upward or downward to raise or lower the lumbar support.

WARNING!

- **Never adjust the seat while driving. You could lose control of the vehicle. Moving the seat could distract you or make you press a pedal unintentionally.**
- **Seats should be adjusted before fastening the seat belts and while the vehicle is parked.**
- **Do not ride with the seatback reclined so that the shoulder belt is no longer resting against your chest. In a collision you could slide under the seat belt, which could result in serious injury or death.**

CAUTION!

Do not place any object under a power seat or obstruct its movement as it may cause damage to the seat controls. Seat movement may become limited if there is an obstruction in the way.

Front Heated Seats

The front seats are equipped with heaters in both seat cushions and seatbacks.

Front seat heating is operated by the MIA system.

The seat comfort icons are in the upper status bar in any MIA screen configuration.

Touch the heated/vented seat icon near the temperature value to open the pop up that will allow you to activate and set the function on the driver's seat and/or on the passenger seat.



To activate and set the heating/ventilation functions of the front seats and the heating of the steering wheel (if available), in addition to what is indicated, it is possible to access the "Seats and Wheel" submenu of the "Comfort" page in which there are the seats and wheel icon.



WARNING!

- **Persons with low skin sensitivity because of advanced age, chronic illness, diabetes, spinal cord injury, medication, alcohol use, exhaustion or other physical conditions must be careful when using the seat heater. It may cause irritation even at low temperatures, especially if used for long periods of time.**
- **Do not place anything on the seat that insulates against heat, such as a blanket or cushion. This may cause the seat heater to overheat.**

Front Seats Heat Function

NOTE:

The engine must be running for the heated seats to operate.

If the function is not active (state "OFF"), the dynamic parts of the icon



are grey: to activate the function operate in the following mode:

- Starting from the state "OFF", within 15 seconds touch the driver or passenger seat soft-key once to select HI-level heating displayed by the seat icon with 2 arrows and 2 red lines.
- Within 15 seconds, touch the driver or passenger seat soft-key a second time to select LO-level heating displayed by the seat icon with 1 arrow and 1 red line.
- Within 15 seconds, touch the same soft-key a third time to shut off the seat heating.

NOTE:

Once a heat setting is selected, heat will be felt within 2 to 5 minutes.

When the HI-level setting is selected, the heater will provide a boosted heat level during the first 4 minutes of operation.

Then, the heat output will drop to the normal HI-level.

If the HI-level setting is selected, the system will automatically switch to LO-level after a maximum of 60 minutes of continuous operation.

At that time, the display will indicate the change from HI to LO.

The LO-level setting will turn OFF automatically after a maximum of approximately 45 minutes.

Front Ventilated Seats (if equipped)

To enhance occupants comfort by high external temperatures, both the driver and passenger seats, on request, can be ventilated.

Small fans are located in the seat cushion and seatback, they draw air from the seat surface through fine perforations in the seat cover to help keep the driver and front passenger cooler when the temperature is high. The ventilated seats are operated with the MIA system.

The seat comfort icons are in the upper status bar in any MIA screen configuration.

Touch the heated/vented seat icon near the temperature value to open the pop up that will allow you to activate and set the function on the driver's seat and/or on the passenger seat.



Front Ventilated Seats Function

NOTE:

The engine must be running for the ventilated seats to operate.

If the function is not active (state "OFF"), the dynamic parts of the icon are grey: to activate the function operate in the following mode:

- Starting from the state "OFF", within 15 seconds touch the driver or passenger seat soft-key once to select HI-level ventilation displayed by the seat icon with the fan and 2 blue lines.
- Within 15 seconds, touch the driver or passenger seat soft-key a second time to select LO-level ventilation displayed by the seat icon with the fan and 1 blue line.



- Within 15 seconds, touch the same soft-key a third time to shut off the seat ventilation.

Memorize the Driver's Seat Position

This function allows the driver to store up to two different memory profiles for easy recall through a memory switch. Each memory profile contains desired position settings for the driver seat, external side mirrors, adjustable pedals (OPT), power tilt and telescopic steering column and a set of programmed radio stations.

Your key fob can also be set to recall the same positions by pressing the  button.

NOTE:

- Only one key fob can be linked to each of the memory positions.
- "Passive Entry" door handles cannot be linked to the memory function. Use either the memory recall switch or the key fob (if linked to the memory function) to recall memory positions 1 or 2.

The memory seat switch is located on the driver's door trim panel. The switch consists of three buttons:

- The "S" (SET) button, which is used to activate the memory save function.
- The "1" and "2" buttons which are used to recall either of two programmed memory profiles.

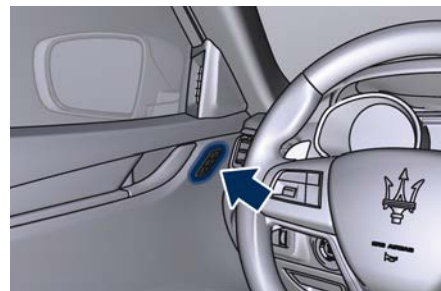

Memory Profiles Setting

NOTE:

Saving a new memory profile will erase an existing profile from memory.

To create a new memory profile, perform the following:

- Cycle the ignition device to the ACC or RUN position.
- Adjust all memory profile settings to desired preferences (i.e., seat, side mirrors, adjustable pedals (OPT), power tilt and telescopic steering column, and radio station presets).
- Press and release the "S" button on the memory switch.
- Within 5 seconds, press and release the memory button "1" or "2".
- Check on the instrument cluster for the positive response of the actions "Memory 1 (or 2) profile set".



After these steps, the profile set will be memorized in the selected position.

NOTE:

Memory profiles can be set without the vehicle in P (Park), but the vehicle must be in P (Park) to recall a memory profile.

Pairing Remote Keyless Entry Transmitter to Seats Memory



Your key fob can be programmed to recall one of two programmed memory profiles by pressing the  button on the key fob.

NOTE:

This function can be enabled or disabled using the MIA system, refer to "Functions of Settings Menu on MIA" in section "Dashboard Instruments and Controls" for further information.

To program your key fobs, perform the following actions:

- Cycle the ignition device to the **RUN** position.
- Move the seat and/or the other adjustable devices in the position that you wish to memorize, or recall a previously memorized profile, pressing the corresponding memory button "1" or "2".
- Cycle the ignition device to the **OFF** position.

- Press and release the "S" button.
- Within 5 seconds, press and release the memory button "1" or "2".
- Press and release the  button on key fob.
- Within 3 seconds, press and release the  button on the key fob.

To check if the system has memorized the correct profile, you can move the seat and press the  button: the seat will move to the memorized position.

NOTE:

Your key fobs can be unlinked to your memory settings by pressing the "S" button followed by the  button on the key fob.

Memory Position Recall

NOTE:

The vehicle must be in P (Park) to recall memory positions. If a recall is attempted when the vehicle is not in P (Park), a message will display in the instrument cluster.

To recall the memory settings for driver, press memory button number "1" or "2" on the driver's door trim panel or the  button on the key fob linked to memory position "1" or "2" with ignition device in the **RUN** position.

A recall can be canceled by pressing any of the buttons ("S", "1", or "2") during a recall. When a recall is canceled, the driver seat, external side mirrors, adjustable pedals () and power tilt and telescopic steering column stop moving.

A delay of at least one second will occur before selecting a new recall.

Easy Entry/Exit Driver Seat

This function provides automatic driver seat positioning to enhance driver mobility when entering and exiting the vehicle.

The distance the driver seat moves depends on where you have the driver seat positioned when you place the ignition device to the **OFF** position.

- When you cycle the ignition to the **OFF** position the driver seat:
 - will move about 2.36 in (60 mm) rearward if the driver seat position is greater than or equal to ca. 5.51 in (140 mm) forward of the rear stop;
 - will move to a position of ca. 3.15 in (80 mm) rearward of the rear stop if the driver seat position is between 5.51 in (140 mm) and 3.15 in (80 mm) forward of the rear stop.
- The seat will return to its previously set position when you place the



ignition into the ACC or RUN position.

- The easy entry/easy exit function is disabled when the driver seat position is less than 3.15 in (80 mm) forward of the rear stop. In this position, there would be no benefit to the driver by moving the seat for Easy Exit or Easy Entry.

Each stored memory setting will have an associated easy entry/ exit position.

NOTE:

The "Easy Entry/Easy Exit" function can be enabled or disabled using the MIA system, refer to "Functions of Settings Menu on MIA" in section "Dashboard Instruments and Controls" for further information.

Rear Seats

Rear seats can fit three passengers. Seats, head restraints and seat belts are parts of the occupant restraint system of the vehicle.



WARNING!
Be sure everyone in your vehicle is in a seat and using a seat belt properly.

NOTE:

For further information,  : chapter "Occupants Restraint Systems (ORS)" and "Head Restraints" in section "Safety".

Rear Armrest

The rear armrest is mobile and can be folded up into the seat back.

- To lower it, pull the stripe as indicated.



- To close it, pull it upwards then push it back into its seat.

On the front part of the armrest there are two cupholders (see "Internal Equipment" in this section).

Inside the armrest there is a glove or document compartment. To access this illuminated compartment press the opening button and lifting the cover.



WARNING!
The armrest is not designed to support the weight of an adult or a child: please use it only to store beverages, small objects or documents.

Rear Side Heated Seats (OHT)

The side rear seats can be equipped with heaters both in seat cushion and seatback.

Rear seats heating can be adjusted by operating control devices on the panel



located on the rear side of the central console. The panel also includes command for the rear window sunshade (see “Rear Windows” in section “Before Starting”).



WARNING!

- Persons with low skin sensitivity because of advanced age, chronic illness, diabetes, spinal cord injury, medication, alcohol use, exhaustion or other physical conditions must be careful when using the seat heater. It may cause irritation even at low temperatures, especially if used for long periods of time.
- Do not place anything on the seat that insulates against heat, such as a blanket or cushion. This may cause the seat heater to overheat. Sitting in a seat that has been overheated could cause irritation due to the increased surface temperature of the seat.

The buttons on the panel with the resistance icon activate the heating on one or both seats.

- Push the button once to select the highest heating level. The two LED beside of the icon will illuminate.

- Push the same button a second time to select the lowest level. Only the lower LED remains illuminate.
- Push the same button a third time to shut the heating elements OFF. The LED will turn off.



NOTE:

- Once a heat setting is selected, heat will be felt within two to five minutes.
- The engine must be running for the heated seats to operate.

By selecting the HI-level setting, the heater will provide a boosted heat level during the first four minutes of operation. Then, the heat output will drop to the normal HI-level.

By setting the HI-level, the system will automatically switch to LO-level after a maximum of 60 minutes of continuous operation. The LO-level setting will turn off automatically

after a maximum of approximately 45 minutes.



Power Steering Wheel Adjustment

2

This function allows you to tilt the steering column upward or downward or to lengthen or shorten it in order to adjust the steering wheel to an optimized position.

The power tilt/telescoping steering column/wheel switch is located on the lower left side of the steering column. To adjust the tilt of the steering column/wheel, move the switch up or down as desired.



To lengthen or shorten the steering column/wheel, pull the switch toward you or push the switch away from you as desired.

NOTE:

You can use your key fob or the memory buttons on the driver's door

trim panel to return the tilt/telescopic steering column/wheel to programmed positions. See "Memorize the Driver's Seat Position" in this section.



WARNING!

- Do not adjust the steering column/wheel while driving.
- Adjusting the steering column/wheel while driving could cause the driver to lose control of the vehicle. Be sure the steering column/wheel is adjusted before driving your vehicle. Failure to follow this warning may result in serious injury or death.

Heated Steering Wheel

The steering wheel may contain a heating element inside the rim that helps warm driver's hands by cold weather.

The heated steering wheel has only one temperature setting. Once turned on, this function will operate for approximately 58 to 70 minutes before automatically shutting off.

The heated steering wheel can shut off early or may not turn on when the steering wheel is already warm.

The heated steering wheel can be turned on and off using the MIA system.

The heated steering wheel icon is in the upper status bar in any MIA screen configuration.

Touch the steering wheel icon near the temperature value of driver's side to open the pop up that will allow you to activate the heating function.

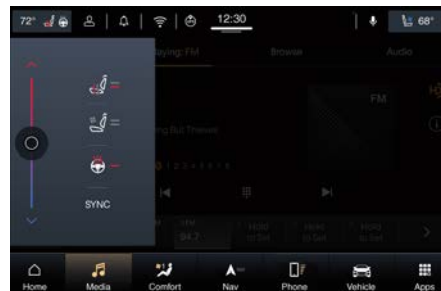

To activate the heating function, in addition to what is indicated, it is possible to access the "Seats and Wheel" submenu of the "Comfort" page in which there is the wheel icon.



NOTE:

The engine must be running for the heated steering wheel to operate.

If the function is not active (state "OFF"), the dynamic parts of the icon are grey: to activate the function operate in the following mode:

- Within 15 seconds, touch the heated steering wheel soft-key to turn on the function displayed by the steering wheel icon with the arrows and red line.
- Within 15 seconds, touch the heated steering wheel soft-key a second time to shut off the function: the dynamic parts of the icon turns grey.

WARNING!

- Persons with low skin sensitivity because of advanced age, chronic illness, diabetes, spinal cord injury, medication, alcohol use, exhaustion or other physical conditions must be careful when using the seat heater. It may cause irritation even at low temperatures, especially if used for long periods of time.
- Do not place anything on the steering wheel that insulates against heat, such as a blanket or steering wheel covers of any type and material. This may cause the steering wheel heater to overheat.

Adjustable Pedals (OPT)

The adjustable pedals system is designed to allow greater range of pedals positions enabling driver comfort with regard to the steering wheel tilt and the seat position.

This function allows the brake and accelerator pedals to move toward or away from the driver's feet.

The switch is located on the front side of the driver's seat cushion shield.



Press the switch downward to move the pedals forward (toward the front of the vehicle).

Lift the switch upward to move the pedals rearward (toward the driver).



WARNING!

Do not adjust the pedals position while the vehicle is moving. You could lose control and have an accident. Always adjust the pedals position while the vehicle is parked.

The following messages will be displayed if the driver is attempting to adjust the pedals when the system is locked out:

- "Adjustable Pedals Unavailable While Reversing";
- or "Adjustable Pedals Unavailable While Cruise Engaged".

NOTE:

For vehicles equipped with driver memory seat, use your key fob or the memory buttons on the driver's door trim panel to return the adjustable pedals to programmed positions. See "Memorize the Driver's Seat Position" in this section for further information.



CAUTION!

Do not place any object under the adjustable pedals or obstruct their movements as it may cause damage to the pedal controls. Pedal movement may become limited if there is an

obstruction in the adjustable pedal's path.

Rear-View Mirrors

External Mirrors

External mirrors can be adjusted electrically and are equipped with anti-mist resistors operated by the air conditioning system (see "Air Conditioning Controls" in section "Dashboard Instruments and Controls").

The mirrors can be closed electrically and will yield in both directions in case of a collision.

The external mirrors are electrochromic, which means, they automatically operate an anti-glare function by gradually shading as the light hitting the mirrors increases.

The external rear-view electrochromic mirrors work in conjunction with the internal rear-view electrochromic mirror.

NOTE:

- The mirrors can be adjusted electrically only with the ignition device in **ACC** and **RUN** position.
- When the vehicle is started, the indicator light shown in the picture will momentarily illuminate in both outside rear-view mirrors to let the driver know that the BSA system is



operational. For more details see chapter "Blind Spot Assist - BSA" or "Active Blind Spot Assist - ABSA" in section "Driver Assistance Systems".

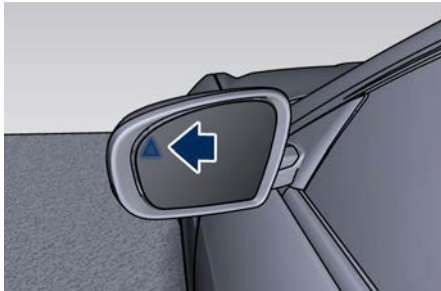

The external of the rear-view mirror support is equipped with LEDs, lighting up when the turn signals and vehicle entry/exit lights are activated.

When the surround view camera system is installed, at the external bottom side of the rear-view mirror is the side view camera (refer to "Surround View Camera System" in section "Driver Assistance Systems").

Mirrors Positioning

The power mirror controls are located on the driver's door trim panel.

The power mirror controls consist of mirror select buttons and a four-way mirror control switch.

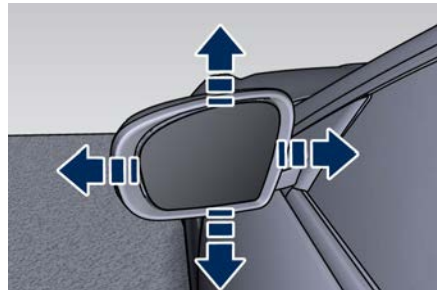

To adjust a rearview mirror, press either the L (left) or R (right) button to select the mirror that you want to adjust. The spin button will illuminate indicating the rearview mirror is activated and can be adjusted. Press the mirror control switch corresponding to the arrow indicating the direction of the desired movement.

For optimal vision orientate the outside(s) mirror(s) in order to frame

the adjacent lane and get a partial overlap with the visible image on the inside rearview mirror.

Power mirror preselected positions can be reset by operating the Memory Driver Seat device. Check "Memorize the Driver's Seat Position" in this section for further information.



WARNING!
Vehicles and other objects seen in the external side convex mirror will look smaller and farther away than they really are. Relying too much on your passenger side convex mirror could cause you to collide with another vehicle or object. Use the inside mirror to judge the size or distance of a vehicle seen in the external side convex mirror.

Tilt Side Mirrors In Reverse

This function provides automatic external rearview mirrors positioning, allowing the driver to view the ground area behind the front doors. The external mirrors will move slightly downward from the current position when the shift lever is shifted into reverse. The external mirrors will then return to the original position when the lever is shifted out of the reverse position. Each memory set of



Understanding the Vehicle

2

the driver's seat (see "Memorize the Driver's Seat Position" chapter in this section) corresponds to a mirror tilt position in reverse.

NOTE:

The mirrors tilt in reverse can be turned on and off using the MIA system, refer to "Functions of Settings Menu on MIA" in section "Dashboard Instruments and Controls".

Folding Mirrors

By selecting this function on MIA the rear-view mirrors automatically fold when the vehicle is locked by the key fob and when the power trunk lid (if equipped) is closed and locked by pressing the  button on the right lower parts of the lid.

When the vehicle and the trunk lid will be unlocked and the ignition device is set in **RUN** position, the rear-view mirrors will automatically open in the position they had before the lock. The switch for the power folding mirrors is located between the power mirror switches.



Press the switch once and the mirrors will fold in; press the switch a second time to reset the mirrors to the standard position.

There is a way to make external mirrors automatically fold/unfold.

- If the function is available, it needs to be activated by MIA (refer to "Functions of Settings Menu on MIA" in section "Dashboard Instruments and Controls").

- If the mirrors are automatically folded after the last lock action, then they will automatically unfold when the ignition device is set on **ACC** or **RUN** position.
- If the mirrors were manually folded by the switch on the driver's door panel, before a lock action, they will need to be manually unfolded to reactivate the automatic function.



CAUTION!

Never retract or open the mirrors manually: it could damage the power mechanism.

Internal Rear-View Mirror

The position of internal rearview mirror can be manually adjusted, and is endowed with an accident prevention release system operating in the event of a collision.

Internal rearview mirror is electrochromic: this glare function is automatically deactivated in reverse to ensure maximum visibility of obstacles.

**WARNING!**

To avoid damage to the mirror during cleaning, never spray any cleaning solution directly onto the mirror. Apply the solution onto a clean cloth and wipe the mirror clean.

"Mirror Dimmer" Function

The auto-dimming function can be disabled or re-enabled by pressing the on/off button on the mirror base.

Disabling this function will increase the reflectance of the internal mirror, increasing visibility at night.



External Lighting

External Lights Equipment

The vehicle is equipped with lighting systems and functions that depend on the type of equipment and the target market. Some of these are completely automatic, other can be switched on and off via the light switch and the multifunction lever on the dashboard, or via "Controls" and "Settings" menu of "Vehicle" page on MIA.

This chapter only describes systems that may or may not be installed because of the various options available.

For switching the external lights on and off via the light switch and the multifunction lever behind the steering wheel, refer to the chapter "Light Controls" in section "Dashboard Instruments and Controls".

External Lights Cluster

The lights of the front clusters are arranged as follows:

Bi-Xenon Version

- 1 Low-beam/high-beam light: Bi-Xenon bulb 25W.
- 2 Position and DRL light LED.
- 3 Turn signal LED.
- 4 Side-marker light LED.
- 5 Side reflex-reflector.

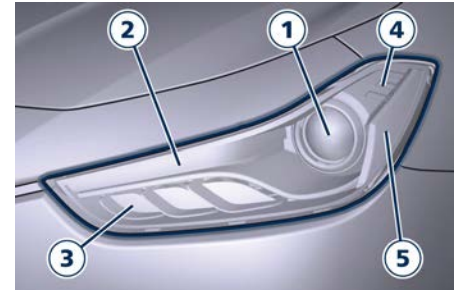
**Bi-Xenon Version**

Full-LED Version

- 1 Low-beam light LED.
- 2 Position and DRL light LED.
- 3 Turn signal LED
- 4 Side-marker LED.
- 5 Side reflex-reflector.
- 6 Bending light LED.
- 7 Matrix high-beam light LED.

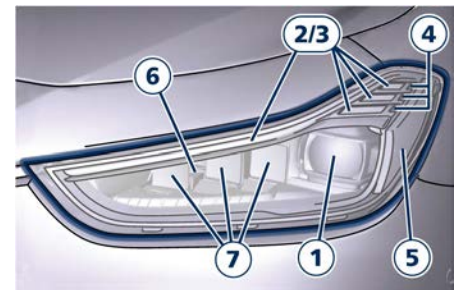
**Full-LED Version**



Understanding the Vehicle

2

The lights of the rear clusters are arranged as follows:

- 1 Position light guide LED.
- 2 Stop and turn signal light LEDs.
- 3 Side-marker LED.
- 4 Reverse light LED.
- 5 Rear fog light LED.
- 6 Side reflex reflector LED

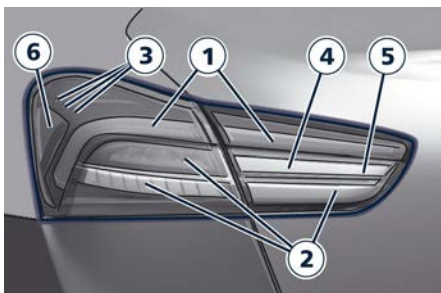

Integrated External Rearview Mirror Lights

LED turn signals are integrated on the support of the external mirrors.



The LED turn signal indicators flash simultaneously with the corresponding turn signal lights in the front and rear of the vehicle. Turning on the hazard warning lights will also activate these LEDs.

On the vehicles with "Surround View Camera System", the external mirrors are equipped also with approach and courtesy LEDs, lighting up when the vehicle entry/exit lights are activated. See "Illuminated Entry/Exit" in section "Before Starting"

Bi-Xenon Headlight

The gas-discharge (xenon) headlights operate with an electric arc saturated with Xenon gas under pressure, instead of the incandescent filament. The light produced is assuredly higher compared to traditional light bulbs, in terms of quality (brighter light) as well

as of the span and positioning of the illuminated area.



WARNING!

- If xenon headlamp replacement is necessary, contact the Authorized Maserati Dealer only: **DANGER - RISK OF ELECTRICAL SHOCK.**

Full-LED Headlight with Cornering Function

These headlamps combine the cornering function to the "Full-LED" technology consisting of an additional LED module which turns on when two conditions occurs: the driver turns the steering wheel or the driver activates the turn signal. The cornering function will illuminate the corner to enhance the visibility to the driver as long as speed will be lower than 25 MPH (40 km/h).

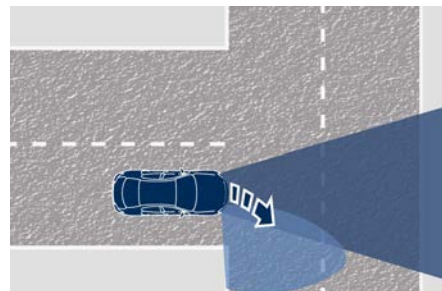



"Full-LED" Technology

This technology creates headlights with a simpler construction and a more compact size compared to those equipped with traditional or Xenon light bulbs.

Other advantages are:

- a clearer light beam, with a cool white tone that allows a better perception of the contrasts thus making the night vision more efficient and less tiring;
- a longer duration equivalent at least to that of the vehicle;
- a reduced current consumption.

These features positively affect some vehicle management economy aspects by eliminating/reducing the light bulb replacements and help limit fuel consumption.

Automatic High Beam

The Automatic High Beam headlight control system provides increased forward lighting at night by automating high beam control through the use of the forward-facing digital camera located behind the rear-view mirror, which is the same one used for example by the Lane Keeping Assist - LKA system on vehicles with ADAS systems.

This camera detects the environmental luminosity, the headlamps of oncoming vehicles and the tail lamps of preceding vehicles in the front area. In these cases, the system automatically switches from high beams to low beams until the approaching vehicle is out of view.

Furthermore, the digital camera is able to detect the urban areas and the inhabited centers and to turn off the high beams when driving near of one of them.

The properly working for this function (if all the other conditions are met) is ensured between 21.7 MPH (35 km/h) and 155 MPH (250 km/h).

Activation Mode

To activate Automatic High Beam function:

- Shift the multifunction lever onward .
- Put the light switch in "AUTO" position.
- Touch the "Vehicle" soft-key on the main category bar of the MIA display and open the "Settings" menu.
- Choose the "Auto Dim High Beams" function in the "Lights" submenu and insert the check mark in the box to turn on the function.

- To turn off the function delete the check mark in the box.

After these steps, the green indicator on the upper right side of the TFT display comes on.



NOTE:

- The function is enabled only if the brightness sensor detects the right lighting conditions and then switch to low beam on.
- Broken, muddy, or obstructed headlights and taillights of vehicles in the field of view will cause headlights to remain on longer (closer to the vehicle). Also, dirt, film, and other obstructions on the windshield or camera lens will cause the system to function improperly.

Automatic High Beam Failure

In the event of a failure of the high beam system, the related amber



warning light will illuminate on the TFT display.

Take your vehicle to the nearest **Authorized Maserati Dealer** as soon as possible avoiding to use this system.

2

Interior Lighting

The interior and exterior approach lights turn on and off when entering/exiting the vehicle (see "Illuminated Entry/Exit" in section "Before Starting" for further information).

The brightness of the ambient lights, controls and instruments can be manually adjusted with the regulator positioned beside the light switch as described in the chapter "Light Controls" in section "Dashboard Instruments and Controls".

For backlight operation, see paragraph "Ambient Lights and Backlight Adjustment" of chapter "Illuminated Entry/Exit" in section "Before Starting"

Dome Lights

The front and rear part of the dome, include each a central and two reading lights.

The central light automatically turns on when one of the doors is opened and turns off when the door is closed (timed switching off). The light may be switched on manually by pressing the central button.

The reading lights are controlled by the respective side buttons.

If they are turned on by pressing the button, both central and reading lights will stay on for about 10 minutes after turning the engine off, and will then turn off gradually.

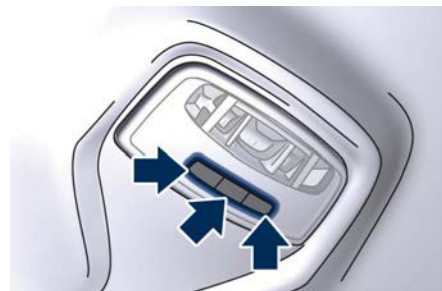

When the exterior lights are switched on, the two night LEDs fitted on the side of the power buttons on the overhead console will light up to facilitate the use of the transmission lever and the central console.





If one or more doors are opened, the front and rear dome lights will turn on for 27 seconds. If the door is closed before this time, the lights will dim and subsequently switch off after about 3 seconds.

NOTE:

The dome lights will also turn on by pressing the  or  button for centralized doors unlock and lock on the key fob. See "Illuminated Entry/Exit" section "Before Starting" for further information.

In the event of a collision causing automatic interruption of fuel supply, the dome lights switch on automatically and remain lit for approx. 15 minutes.

Button to Switch off Passenger Compartment Lights

In addition to specific switches to turn on and off the front and rear side dome lights as previously described, on the front console there is a button that allows to turn off all these lights.



Interior Lights Operation

To protect the battery, the interior lights will turn off automatically 10 minutes after the ignition device has been shifted to **OFF**. This occurs if the interior lights were turned on manually or by opening of a door. The glove box light, share the same characteristics excepting the trunk light.

To adjust interior lights, either turn the ignition device out of **OFF** or rotate the multifunction lever out of "0" position.

Courtesy Dimmable Lights

The following dimmable courtesy lights, can be set with the regulation device (see "Light Controls" in section "Dashboard Instruments and Controls"):

- instrument cluster dials and display;
- dome light (front/rear);

- inside door handle LED;
- doors and steering wheel backlight controls LED;
- front footrest light;
- front seats night lighting.

Cargo Lights

To illuminate the cargo area there are two lights inside the trunk compartment, one on each side.

These lights turn on when trunk lid is opened and turn off when it is closed.

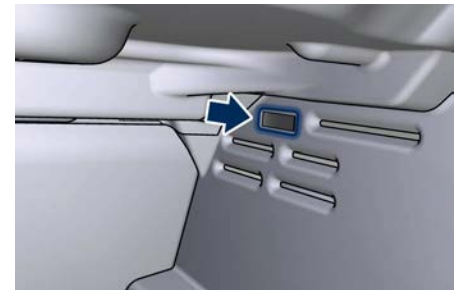

If trunk lid is left open for a long time, lights will turn off after 30 minutes to save battery charge.



Internal Equipment

Electric Power Outlets

The vehicle is equipped with four 12 Volt (13 Amp) electric power outlets, two available for the front seat passengers, one for rear seat passengers and one fitted in the trunk compartment.

In vehicles equipped with "Smoking Kit" the electric power outlet inside the cupholder is replaced with a cigarette lighter.

All power outlets are supplied only when the engine is started or the ignition device set to **ACC** or **RUN**. Power outlets are protected by a fuse. Insert a cigar lighter or accessory plug into the power outlets to ensure proper operation.

Otherwise, check the matching fuse integrity, see "If a Fuse Blows" in section "In an Emergency" for further information.



CAUTION!

- Do not plug in accessories that exceed the maximum power of 160 Watts (13 Amps) at 12 Volts.
- Power outlets are designed for accessory plugs only. Do not insert

any other object in the power outlets as this will damage the outlet and blow the fuse. Damages caused by improper use of the power outlet are not covered by the New Vehicle Limited Warranty.



WARNING!

To avoid serious injury or death:

- Only devices designed for use in this type of outlet should be inserted into any 12 Volt outlet.
- Replacing the fuses that protect power outlets with others of higher amperage, there is the risk of fire.
- Do not touch with wet hands.
- Close the lids when the plug is not used and while driving the vehicle.
- If this outlet is mishandled, it may cause an electric shock and failure.

Power Outlet for Cigarette Lighter inside the Cupholder

To access the power outlet is inside the cupholder beside the transmission lever, press the cover as indicated to open it completely. This operation is not necessary on version without access cover.

NOTE:

This outlet is specifically dedicated to power the cigarette lighter. It is not recommended to use it as an outlet to charge devices: use the other power outlets for this function.



WARNING!

High power consumption items plugged into this outlet for long periods may discharge the battery and/or prevent the engine from starting.



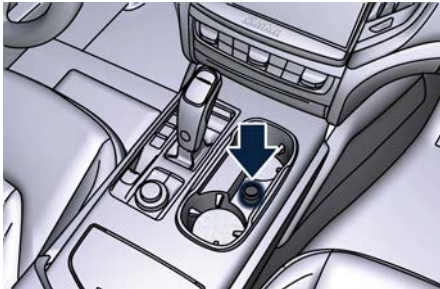
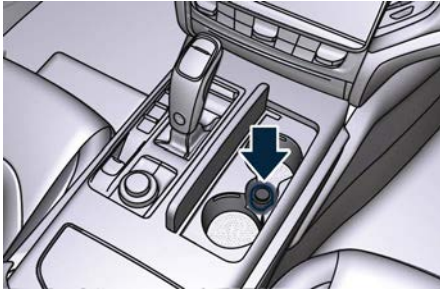

Power Outlets inside the Central Console

To access the power outlet located inside the glove box of the central console you need to open the half-lids as indicated in the following paragraph.

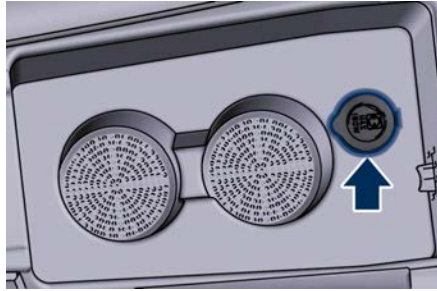

Rear Power Outlets

A 12 V power outlet inside the armrest between the rear seats is available upon request for rear seat passengers (see "Rear Seats" in this section).

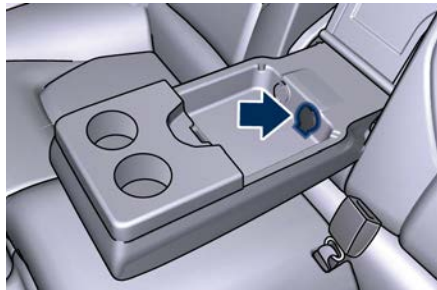

Power Outlet inside the Trunk

The power outlet is positioned on the right side of the trunk compartment.

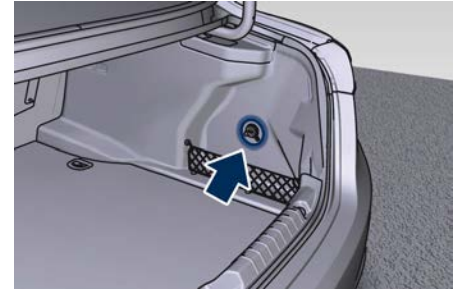

Cupholders

The vehicle is equipped with several cupholders.



- Use light and shatterproof containers.
- Do not forcefully push unsuitable containers into the cupholders to prevent damage to the containers.
- Do not store hot drinks.

Cupholders for Front Passengers

The front cupholders are located beside the transmission lever and may be at sight or with access cover.



2

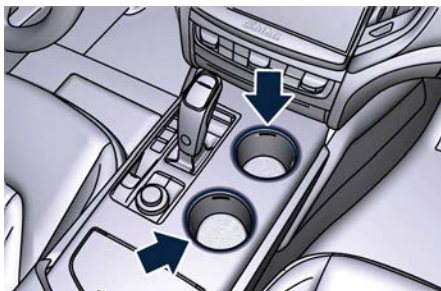

At Sight Version without Power Outlet



Version with Cover



At Sight Version with Power Socket

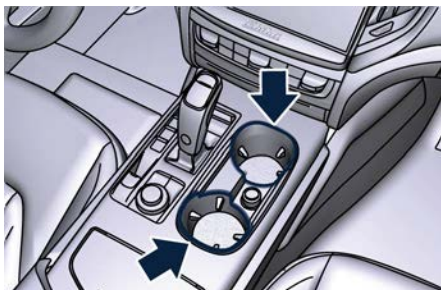

At Sight Version with Power Outlet

To access the cupholder, push the cover as shown in the picture and it will open completely.

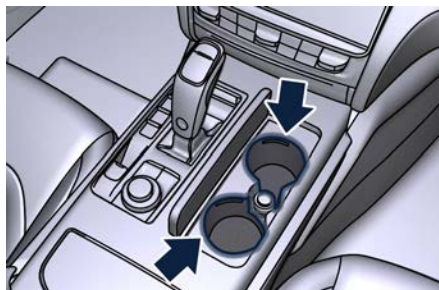

Version with Cover

Pressing the indicated button on the central console, the half-lids will rise completely enabling access to the inner compartment where the two cupholders are located.

The storage and passenger compartment share the same air conditioning even though you may exclude the air conditioning of the cupholder compartment by moving the indicated button.



To close one or both of the half-lids, push them down to the locking position.



Cupholders for Rear Passengers

Two cupholders are available in the front side of the rear seats central armrest.

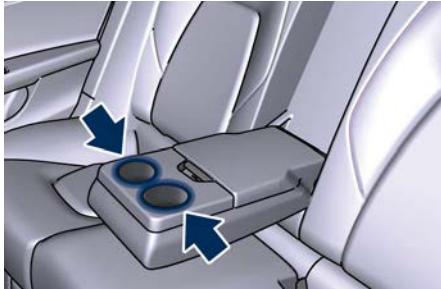

Multimedia Port and Wireless Charger Compartment

Multimedia ports and the sliding drawer for the mobile phone are located inside the dashboard compartment below the climate control panel.

This compartment, in addition to the components indicates, can be equipped with Wireless Charger that allow you to recharge your mobile phone (if it support this technology) without have to connect it to the charging port through a cable.

Wireless Charger Operation

The Wireless Charger system is designed to wirelessly charge mobile phones (maximum power available 15

W) compatible with the Qi® standard. The system is activated in automatic mode when the mobile phone is placed in its compartment. If the mobile phone is removed from the Wireless Charger compartment during the wireless charging phase, this will automatically be interrupted. The Wireless Charger system enables charging when all doors are closed properly and the ignition device is in ACC or RUN position.



CAUTION!

- Key fob must not be placed on the Wireless Charger compartment. This could cause excessive overheating and damage to the key fob. Placing the key fob near the Wireless Charger may prevent the engine from starting. In this case, a dedicated message will be shown on the MIA display to alert the driver of the need to remove the key fob from this compartment.
- Do not place any other type of metal or magnetized object (e.g. credit cards, coins, etc.) inside the Wireless Charger compartment.
- Make sure that you place the mobile phone correctly (display facing

- downwards) in the phone drawer: charging may not be enabled if it is in the wrong position.
- To avoid interference with the key fob search, the Wireless Charger system stops charging when any door is opened.
- Make sure that there are no metal objects between the mobile phone and the wireless charger system during charging. Any such objects could overheat.

The charge status icon of the mobile phone housed in the Wireless Charger compartment is always visible in the MIA display on the "Home" and "Phone" screen.

This icon becomes blue if the mobile phone is charging, green if it is fully charged and blinking red for system fail or foreign object in the compartment. The blink ends after a timeout of 5 seconds and the icon becomes solid until the fail is solved.



Understanding the Vehicle

2

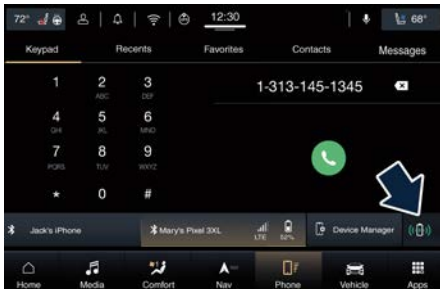

You can also drag and drop the Wireless Charger icon from the shortcut page to insert it in the upper status bar.



The Wireless Charger also offers the possibility to share the mobile phone apps information with the MIA via the "mirroring", allowing even to use Android Auto, Apple CarPlay and Baidu CarLife, where available. For further information, consult the "Maserati Intelligent Assistant (MIA)" guide.

To access the multimedia ports and Wireless Charger compartment, check that cupholder cover is closed, then push the door as indicated in picture: it will open completely. Gently push and release the drawer which will come out automatically of its housing and stop in the first position. In case of necessity, pull out the drawer completely.

NOTE:

- To prevent damage to the sliding mechanism, do not force the drawer into the extracted position.
- Before closing the compartment door, ensure that the drawer is fully back in its seat.

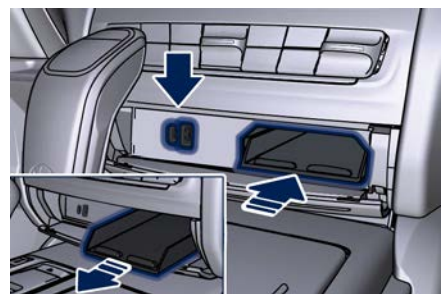
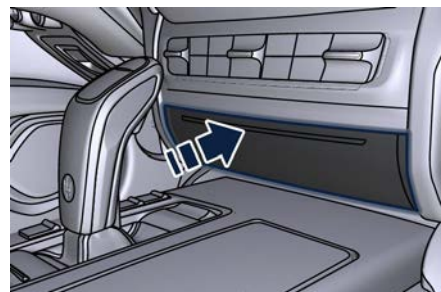

Multimedia Ports Operation

This USB port  inside the Wireless Charger compartment can be used for data exchange and charge of



the connected source (refer to the "Maserati Intelligent Assistant (MIA)" guide for further details).

Through this USB input is possible to recharge the connected device for about an hour when the ignition device is turned **OFF** ("Active Charging" function). When this function is enabled, the USB port will be backlight.

In the Wireless Charger compartment of the central console there is also a SD memory card port. Once inserted into the slot, to extract it press lightly on the card.

Another USB port is present for rear seat passengers, inside the armrest between the rear seats.

To access the USB port, open the outside cover (see "Rear Seats" in this section).

This USB port allow charging the connected source.

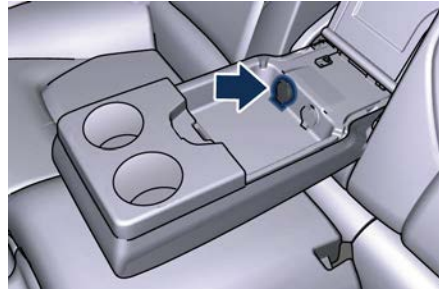

iPod® Connection

An iPod® can be connected to the system via USB port by means of a special cable (OPT). The MIA will then control the following functions: play, pause, fast forward, rewind, next track, previous track, random or repeat mode, selection and navigation of playlist/genre/singer/album/Podcast.



CAUTION!

Do not leave your USB device, iPod® or an external audio source in the vehicle for extended periods of time: extreme temperatures and humidity can occur in the vehicle.

Sun Visors

Sun visors can be folded to the front and to the side of the vehicle. To move the visor laterally, lower and release it from its catch as indicated.

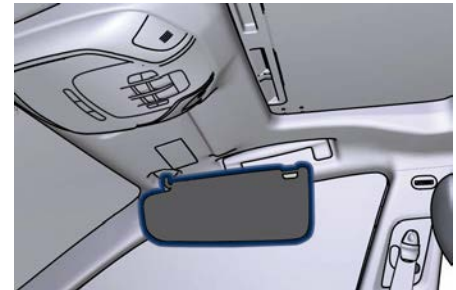
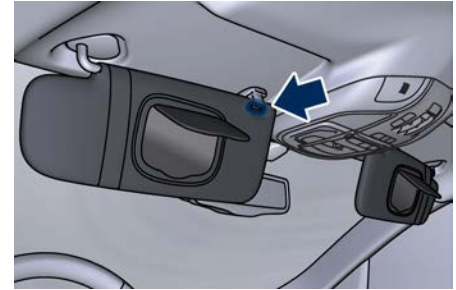

By lowering the visor you can access the courtesy mirror with incorporated light illuminating automatically (with the ignition device in **RUN**) by raising the mirror protective cover.

A business card holder is fitted inside each sun visor.

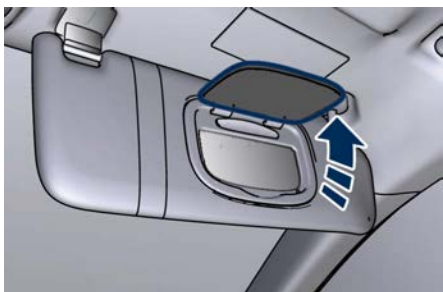

Removable Ashtray and Lighter

The removable ashtray with cover for front seats passengers can be inserted inside the front cupholder.

The rear seat passengers can use the removable ashtray by inserting it into the rear door pocket.

Cigarette Lighter Use

Pressing the central button activates the cigarette lighter. After about 20 seconds the button returns automatically to the initial position and stops the heating; now the cigarette lighter is ready for use.



CAUTION!

After use, always make sure that the cigarette lighter is switched off.



WARNING!

- The cigarette lighter reaches high temperatures. Handle it carefully and do not allow children to use it.
- The cigarette lighter may not be used as a power outlet.

Handholds and Cloth Hooks

Handholds are fitted above the passenger doors. Once grabbed, they will lower until the block position. When released, a return spring will bring them back to the original position.

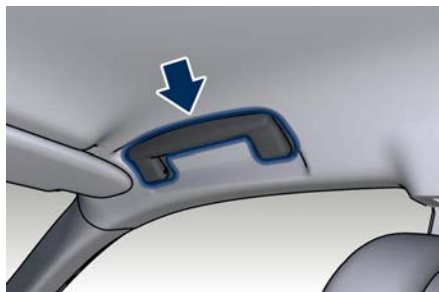

Rear handholds also include a cloth hook.



Map Pockets

Front seats are fitted with map pockets, on the rear of the seatbacks, and accessible by rear passengers.



The mesh pockets can hold small items, maps and magazines.

**CAUTION!**

Do not put heavy or sharp objects in the mesh pockets.

Wi-Fi Hotspot 

The user can activate a Wi-Fi Hotspot in the car which allows them to connect up to 8 mobile devices.

To take advantage of this service, the user needs to subscribe directly with the Maserati Mobile Network Operator Partner. This can be done through the user web portal, directing him/her to a dedicated page on the partner's website.

In order to use the Wi-Fi please select the field at the soft-key of the "Apps" screen.



For further information about this service, see the "Maserati Intelligent Assistant (MIA)" guide.

iPad Holder (Genuine Accessories)

The **Authorized Maserati Dealer** can provide you with all information about the "Maserati iPad Holder" mounted on the rear of the front seatbacks, available in the "Genuine Accessories" range.

**Audio System**

The vehicle is equipped with an audio system that offers superior sound quality, higher sound pressure levels and reduced energy consumption.

The system maximises the amplifier and speaker technology delivering substantially higher components and system efficiency.

Basic System

The basic sound system features 8 speakers and can develop a sound output of 80 W.

The basic system includes:

- Four 6.5 in (165 mm) diameter Woofers, one on each door.
- Four 1 in (25 mm) diameter Tweeters, two on the upper edges of the dashboard and one on each rear door.



Basic System

Premium System

The vehicle can be equipped with a "Premium" sound system which features 10 speakers and can develop a sound output of 900 W.

This system includes:

- Four 6.5 in (165 mm) diameter Woofers, one on each door.

- One 3.5 in 90 mm diameter Midrange diameter, on the top of the dashboard.
- Four 1 in (25 mm) diameter Tweeters, two on the upper edges of the dashboard and one on each rear door.
- One 12.4 x 7.9 in (315 x 200 mm) Subwoofer on the rear panel below the rear window.
- 8-channel amplifier in the trunk.



Premium System

High Premium System

The vehicle can be equipped with a "High Premium" audio system including 15 speakers and 1280 W of sound power, available upon request.

The "High Premium" system includes:

- Four 6.5 in (165 mm) Woofers: one on each door.
- Five 4 in (100 mm) Midranges: one on center dashboard, one on each front door and two on the rear parcel shelf.
- Five 1 in (25 mm) Tweeters: one on center dashboard, two on the upper edges of the dashboard and one on each rear door.
- 12.4 x 7.9 in (315 x 200 mm) Racetrack Sub Dual VC on the rear parcel shelf.
- 16 channel 1280 Watts Class-D amplifier in the trunk.



High Premium System

Cargo Area



WARNING!

To help protect against personal injury, passengers must not be seated in the rear cargo area. The rear cargo space is intended for load carrying purposes only, not for passengers, who should sit in seats and use seat belts.

Vehicle Load Carrying Capacity

The load carrying capacity of your vehicle is shown on the loading label positioned on the driver's side rear door pillar.



The information indicated on the label concerns passengers and luggage loading operations.

Do not exceed the specified Gross Vehicle Weight Rating (GVWR) or the

Gross Axle Weight Rating (GAWR), both front and rear.

The GVWR is the total allowable weight of your vehicle. This includes driver, passengers, and cargo.

The total load must be limited so that you do not exceed the GVWR indicated on the label.

Vehicle Loading



WARNING!

- After loading the vehicle, before driving, adjust the headlight beam leveling using the specific regulator (if available) as described in chapter "External Lighting" in this section.
- Improper weight distribution can have an adverse effect on the way the vehicle steers, handles and the way the brakes operate.
- Never drive with the trunk lid open. Exhaust gases can enter the passenger compartment.
- Do not pile luggage or cargo higher than the top of the seatback. This could impair visibility or become dangerous in a sudden stop or collision.

The trunk is the most suitable place to load bulky and heavy objects onboard the vehicle. The maximum allowable



Understanding the Vehicle

2

load on the floor of the trunk is 440 lb (200 kg).

To load your vehicle properly, store heavier items below and be sure you distribute their weight as evenly as possible.

Stow all loose items securely before start driving as they could move during the trip.

Light objects can be stored in the net pocket on the right side of the trunk.

To fasten heavy and bulky luggage inside the compartment a luggage net with hooks anchored to the floor is available upon request. The hooking eyelets of the net are positioned on the floor and on the rear wall of the trunk.



NOTE:

The Authorized Maserati Dealer can provide you with information about the available "Genuine Accessories" for the trunk.

Loading with Rear Seatbacks Folded Down

The 60/40 split-folding seatback of the rear seat provides cargo-carrying versatility.

The seatback folded down provides a continuous nearly-flat extension of the load floor able to accommodate large sized equipment and objects (such as the "Maserati Ski and Snowboard Bag") that may not fit within the normal dimensions of the trunk.

NOTE:

Both seat backs can be reclined independently.

Folding the Short (40) Seatback Side

The short (40) seatback side fold down easily by pulling tab between the seatback and the lateral support structure.

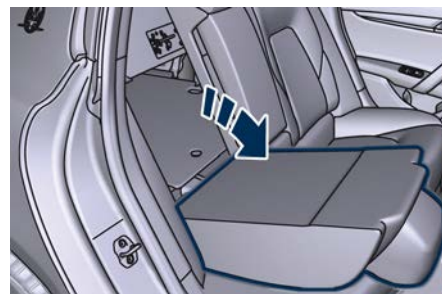

Ski and Snowboard Bag Housing

To safely store the Ski and Snowboard Bag:

- Tilt forward the short seatback side.



- Secure the rear hook of the bag to the eyelet located on the rear wall of the trunk.
- Wrap the belt around the seat back of the folded seat and fasten the belt buckle.
- Tighten the belt as much as necessary to prevent the bag from moving.

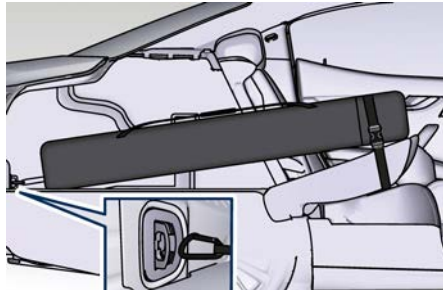

Folding the Long (60) Seatback Side

- Press the red button located on the front of the buckle using the free latch plate (step 1) and unlatch the plate from the left-side buckle.

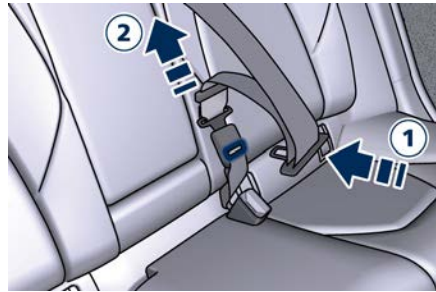

- Allow the belt to retract completely into the retractor seat behind the seatback.
- Unlatch the long (60) seatback side by pulling tab between the seatback and the lateral support structure.



- Partially fold down the long seatback side and remove the head restraint of the center seat ( : chapter "Head Restraints" in section "Safety"). In this way it is avoided that the fully

- reclined seat back touches the edge of the central console.
- Fully fold down the long seatback.

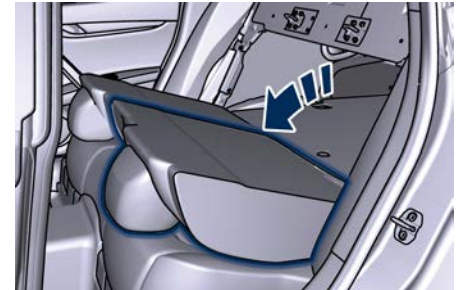

When the short or both seatbacks are tilted to the upright position, make sure they are latched by strongly pulling on the top of the seatback above the seat strap.

NOTE:

When the seatback is tilted to the upright position, reassemble the head restraint of the center seat ( : chapter "Head Restraints" in section "Safety") make sure the seatbelt of the rear central position is in the proper condition for use.



WARNING!

- Make sure that the seatback is securely locked into position. If the seatback is not securely locked into position, the seat will not provide the proper stability for child seats and/or passengers. An improperly latched seat could cause serious injury.
- The cargo area in the rear of the vehicle with the rear seatbacks in the folded down position should not be used as a play area by children when the vehicle is in motion. They could be seriously injured in a collision. Children should be seated and use proper restraint system.

HomeLink®

HomeLink® replaces up to three hand-held transmitters operating the automatic devices that open garage doors and gates, enable/disable the lighting or security systems. The HomeLink® unit is powered by your vehicle's 12 Volt battery. The HomeLink® buttons that are located in the overhead console designate the three different HomeLink® channels. The HomeLink® indicator light is located behind the buttons.



NOTE:

HomeLink® is disabled when the vehicle security alarm is active (: chapter "Vehicle Security Alarm" in section "Safety").

WARNING!

- Your motorized door or gate will open and close while you are programming the universal transceiver. Do not program the transceiver if people, pets or other objects are in the path of the door or gate. Only use this transceiver with a garage door opener that has a "stop and reverse" function as required by Federal safety standards. This includes most garage door opener models manufactured after 1982. Do not use a garage door opener without these safety functions. Call toll-free 1-800-355-3515 or, on the Internet at www.HomeLink.com for safety information or assistance.
- Vehicle exhaust contains carbon monoxide, a dangerous gas. Do not run your vehicle in the garage while programming the transceiver. Exhaust gas can cause serious injury or death.

Before You Start Programming HomeLink®

Be sure that your vehicle is parked outside of the garage before you begin programming.

For more efficient programming and accurate transmission of the radio-



frequency signal it is recommended that a new battery be placed in the hand-held transmitter of the device that is being programmed to the HomeLink® system.

Before starting programming it is necessary to erase the standard codes memorized on the HomeLink® device during the production phase. To erase such codes:

- place the ignition device in the **RUN** position without starting the engine;
- press and hold the two outside HomeLink® buttons (I and III) until the indicator light starts flashing (after approximately 20 seconds);
- release the buttons.

NOTE:

- *Erasing the standard codes should only be performed when programming HomeLink® for the first time. Do not perform this operation to program additional buttons.*
- *If you have any problems, or require assistance, please call toll-free 1-800-355-3515 or, on the Internet at www.HomeLink.com for information or assistance.*



System with Devices Provided with Rolling Codes

Programming the Hand-held Transmitters Manufactured after 1995

These devices can be identified by the "LEARN" or "TRAIN" setting button located where the hanging antenna is attached to the garage door/gate opener. It is NOT the button that is normally used to open and close the door.

The name and color of the button may vary by manufacturer.

- Place the ignition device to the **RUN** position without starting the engine.
- Place the hand-held transmitter 1 to 3 inches (5 - 30 cm) away from the HomeLink® button you wish to program.
- Simultaneously press the HomeLink® button you want to program and the hand-held transmitter button.

- Release immediately the HomeLink® button you want to program.
- Continue holding the hand-held transmitter button until the indicator light starts flashing quickly; then release the button.

The quick flashing light indicates that the channel with the new frequency has been acquired and programmed correctly by the HomeLink® system.

NOTE:

The distance necessary between the portable hand-held transmitter and the HomeLink® in the vehicle depends on the system you wish to program. Probably it will be necessary to try several times. Upon every attempt, keep the setting position for at least 15 seconds before trying again.

Synchronizing the Rolling Codes

At the end of the previously-described programming, if the HomeLink® has been programmed for a rolling code system, it will be necessary to synchronize it to ensure its correct operation.

- Locate the "LEARN" or "TRAINING" setting button of the opening motor. Firmly press it and then release it. On some garage door openers/devices there may be a light that blinks when



Understanding the Vehicle

2

the garage door opener/device is in the LEARN/TRAIN mode.

NOTE:

You have 30 seconds to initiate the next step after the setting button has been pressed.

- Return to the vehicle and press the programmed HomeLink® button for two seconds and then release it.
- Repeat this operation a second time.

If the garage door opening device activates, the programming/synchronization phase is complete.

NOTE:

If the garage door opening device does not activate, press the button a third time for two seconds and then release it to complete the programming/synchronization phase.

- To program the remaining two HomeLink® buttons, repeat each step for each remaining button. **DO NOT erase the channels.**

Reprogramming a Single HomeLink® Button

To reprogram a channel that has been previously trained, follow these steps:

- Place the ignition device to the **RUN** position without starting the engine.
- Press and hold the desired HomeLink® button.

- **Without releasing the button** proceed with “Programming the hand-held transmitters” from second step and follow all remaining steps.

System with Devices Without Rolling Code

Programming the Hand-held Transmitters Manufactured before 1995

- Turn the ignition device to the **RUN** position without starting the engine.
- Place the hand-held transmitter 1 to 3 inches (5 to 30 cm) away from the HomeLink® button you wish to program.
- Simultaneously press and hold both buttons until the indicator light starts flashing quickly; then release both buttons.

The quick flashing light indicates that the channel with the new frequency has been acquired and programmed correctly by the HomeLink® system.

NOTE:

The distance necessary between the portable hand-held transmitter and the HomeLink® in the vehicle depends on the system you wish to program. Probably it will be necessary to try several times. Upon every attempt,

keep the setting position for at least 15 seconds before trying again.

- Press and hold the programmed HomeLink® button.

If the garage door opener/device activates, programming is complete. To program the remaining two HomeLink® buttons, repeat each step for each remaining button. **Do not erase the channels.**

Reprogramming a Single HomeLink® Button

To reprogram a channel that has been previously trained, follow these steps:

- Place the ignition device to the **RUN** position without starting the engine.
- Press and hold the desired HomeLink® button.
- **Without releasing the button** proceed with “Programming the hand-held transmitters” from second step and follow all remaining steps.

Using HomeLink®

To operate, press and release the programmed HomeLink® button. Activation will now occur for the programmed device (i.e., garage door opener, gate operator, security system, entry door lock, home/office lighting,



etc.). The hand-held transmitter of the device may also be used at any time.

Security

It is advisable to erase all channels before you sell or turn in your vehicle. To erase the channels press and hold the two outside HomeLink® buttons (I and III) until the indicator light starts flashing (after approximately 20 seconds).

The HomeLink® Universal Transceiver is disabled when the vehicle security alarm is active ( : chapter "Vehicle security alarm" in section "Safety").

Troubleshooting Tips

If you are having trouble while programming HomeLink®, here are some of the most common solutions:

- Replace the battery in the original hand-held transmitter.
- Press the LEARN button on the garage door opener to complete the training for a rolling code.
- Did you unplug the device for programming and forgot to plug it back in?

If you have any problems, or require assistance, please call toll-free 1-800-355-3515 or, on the Internet at www.HomeLink.com for information or assistance.

Radio Frequency Transmitter - Regulatory Information

The "Regulatory Information" for all the radio and radar frequency devices can be consulted by accessing the "Services" section on the website www.maserati.com.



Air Conditioning Distribution

2

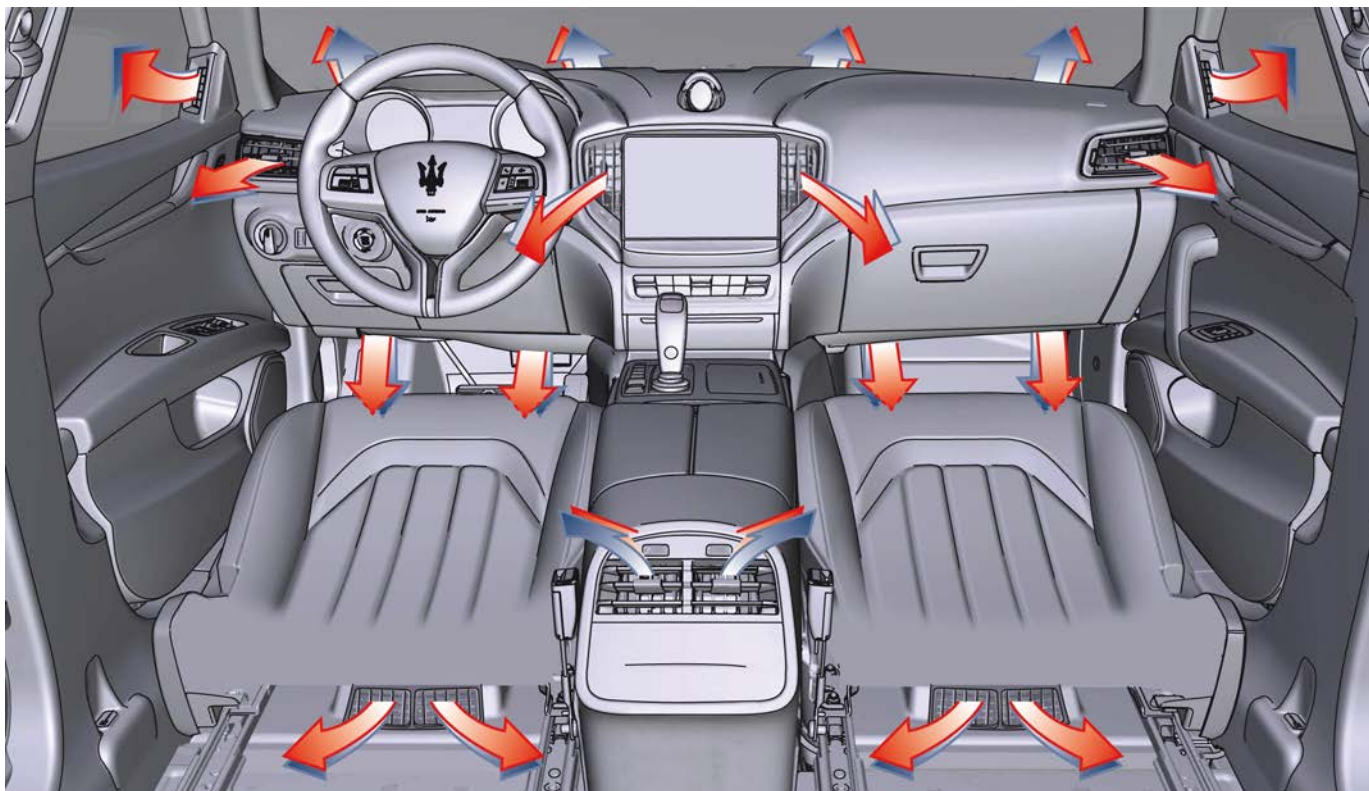



Adjustable and fixed air vents allow passengers to achieve the optimal comfort conditions.

Fixed Air Vents

- The fixed vents, positioned on the upper part of the dashboard, beneath the windshield and above the front part of the front door panels are meant to guarantee the demisting and defrosting of the windshield and the side windows.

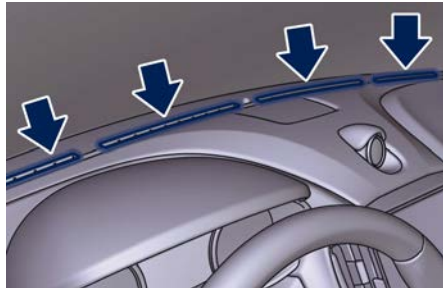

- The fixed vents under the dashboard are aimed at ventilating the lower part of the front passenger compartment.



- The ventilation of the lower part of the rear passengers compartment is made by means of fixed vents positioned under the front seats.

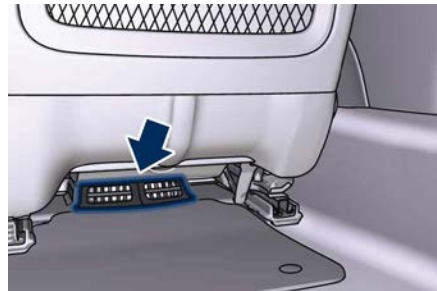

Adjustable Air Vents

- The adjustable vents are located at the center of the dashboard, to

both sides of the MIA display, and at the side ends of the dashboard. They have the purpose of ventilating the upper part of the passenger compartment. There are also adjustable vents placed at the rear end of the central console. These vents can be adjusted in vertical and horizontal direction, by operating on the central handle 1, indicated in the following pictures. The rotor 2, located near each vent, allows to control the air flow.

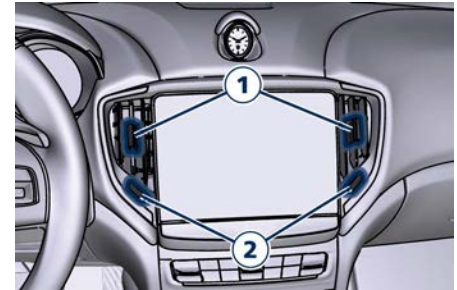



2

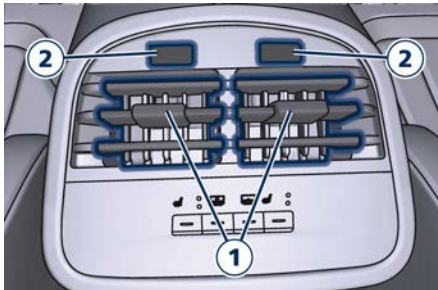
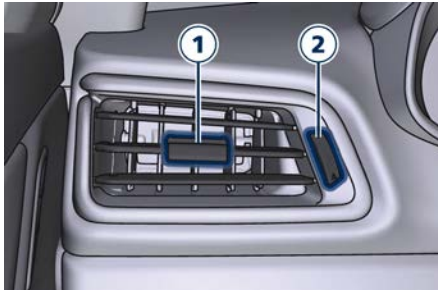

NOTE:

In order not to obstruct the air conditioning inlet, the defrosting or the demisting function of the glass surfaces, avoid covering vents with clothing or other items.



3 - Before Starting

| | |
|---|----|
| Keys | 52 |
| Illuminated Entry/Exit | 54 |
| Unlock the Vehicle with Key fob | 57 |
| Requiring and Setting Additional Key fobs | 58 |
| Passive Entry System | 60 |
| Power Windows | 63 |
| Power Sunroof with Sunshade | 65 |
| Rear Window | 67 |
| Trunk Lid Operation | 68 |
| Hood Operation | 74 |



Keys

The vehicle is equipped with a Remote Keyless Entry (RKE) transmitter and a Keyless Ignition Node (KIN), to enter, start and protect the vehicle.



Keyless Ignition Device

This KIN allows the driver to operate the ignition device with the push of a button, as long as the RKE transmitter is inside the vehicle.

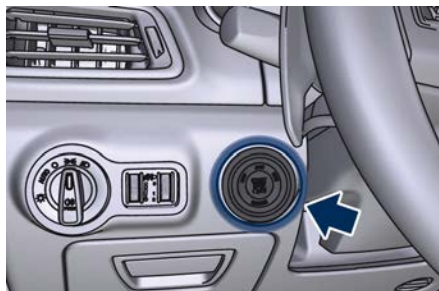

The ignition device has three operating setups indicated on the outer ring. Pressing and releasing the middle button, you can switch from one setup to the next without starting the engine, the switched on indication will turn amber.

The engine will start by pushing the center button **START/STOP** with the brake pedal pressed and the device set in any of the three operating setups. In case the ignition device does not change by pushing a button, the RKE transmitter, also called the "key fob", may have a low or discharged battery. If this occurs it is necessary to replace the battery in order to operate the ignition device (see "Requiring and Setting Additional Key fobs" in this section).

It is still possible to operate the ignition device using the key fob with discharged battery by pressing

the nose side (side opposite of the emergency key) of the key fob on the **START/STOP** button.

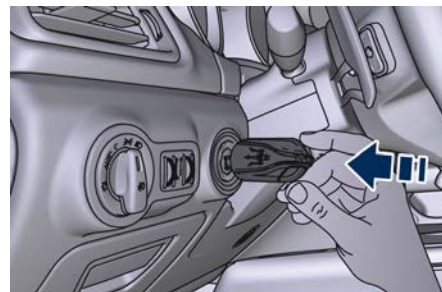

Ignition Device Positions

The ignition device has three operating modes and is activated by pressing the central button only.

- Press and release the central button, to switch from one mode to the next without starting the engine: the active mode indication will light up on the outer ring.
- Push the central **START/STOP** button with brake pedal pressed and ignition device in any of the three operating modes, to start the engine (for more information, see the chapter "Normal Starting of the Engine" in section "Starting and Driving").

OFF: is the starting mode that enables centralised door locking from inside



the vehicle, provided that all doors are closed.

ACC: puts power to accessories.



CAUTION!

Do not leave the ignition device on the **ACC** position for a long time before a long period of inactivity to avoid further discharging of the battery.

RUN: enables all devices and controls of the vehicle.

After 30 minutes of inactivity with the ignition device in the **RUN** or **ACC** position, the transmission lever in P (Park) position and the engine off, the system turns **OFF** automatically in order to preserve battery life.

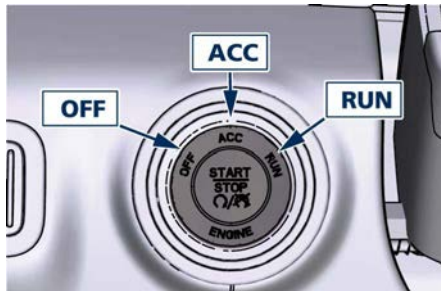

Key fob

This vehicle is provided with two programmed key fobs.

In addition to the RKE transmitter the key fob also contains an emergency key.

The emergency key allows you to open the vehicle by inserting into the lock of the opening handle on the driver's door, in case the battery of the vehicle or the key fob go dead.



You can keep the emergency key with you when using valet parking. To remove the emergency key:

- hold the mechanical latch on the back of the key fob sideways;
- simultaneously remove the emergency key by sliding laterally towards the end of the key fob.



NOTE:

You can insert either side of the emergency key into the lock cylinder.

Shift Ignition Device to OFF Alert

Opening the driver's door to exit the vehicle when the ignition device is set in **ACC** or **RUN** (engine not running), a beep will remind you to cycle the ignition to **OFF**.

In addition to the acoustic signal a dedicated message is displayed on the instrument cluster.

If the ignition device is left in the **ACC** or **RUN** position, when vehicle is locked the system will turn off the instrument cluster and automatically set ignition device to **OFF**.

With the MIA system, the power window switches, radio, power sunroof, and power outlets will remain



Before Starting

active for up to 10 minutes after the ignition device is cycled to the OFF position. Opening either front door will cancel this function, it is possible to set the timing of this function.

NOTE:

Refer to "Functions of Settings Menu on MIA" in Section "Dashboard Instruments and Controls" for further information.

3



WARNING!

- When leaving the vehicle, always remove the key fob and lock your vehicle.
- Do not allow children to be in a vehicle unattended or with access to an unlocked vehicle. A child or others could be seriously or fatally injured. Children should be warned not to touch the parking brake trigger, brake pedal or the shift lever.
- Do not leave the key fob in or near the vehicle, and do not leave the ignition device in the ACC or RUN mode. A child could operate power windows, other controls, or move the vehicle.
- Do not leave children or animals inside parked vehicles in hot

weather. Interior heat build-up may cause serious injury or death.

- An unlocked car is an invitation to thieves. Always remove the key fob from vehicle, cycle the ignition switch to OFF and lock all doors when leaving the vehicle unattended.
-  **WARNING!**
- Do not ingest battery, chemical burn hazard. This product contains a coin/button cell battery. If the coin/button is swallowed, it can cause severe internal burns in just 2 hours and can lead to death.
 - Keep new and used batteries away from children. If the battery compartment does not close securely, stop using the product and keep it away from children. If you think batteries might have been swallowed or placed inside any part of the body, seek immediate medical attention.

Illuminated Entry/Exit

Lights will turn on and off when you enter/exit the vehicle and operate the buttons on the key fob and/or on the "Passive Entry" system as follows:

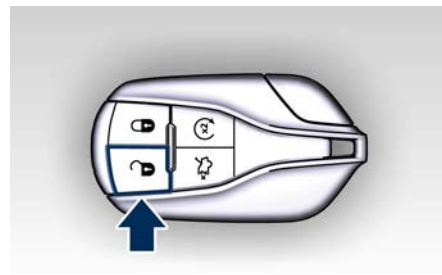

- If the unlock command is enabled by pressing the specific  button on the key fob or by the "Passive Entry" system, the "illuminated entry" mode will activate. Courtesy & dimmable internal lighting, night front seats



lighting, and approach lighting will stay on for 27 seconds.

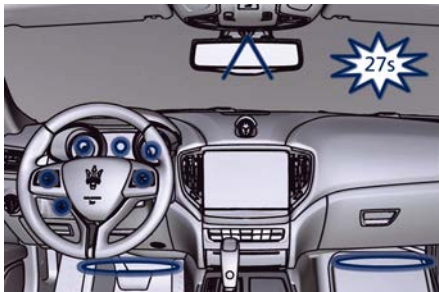

- If the lock command of the car is enabled by pressing the specific  button on the key fob or by the "Passive Entry" system, when the key fob is moved out of range, all the lights will turn off within 3 seconds, if they were previously on.

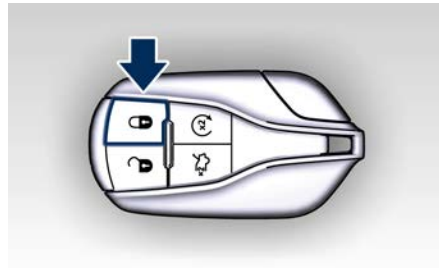

minutes before turning off. The light will immediately turn off if you lock the trunk lid before 10 minutes.

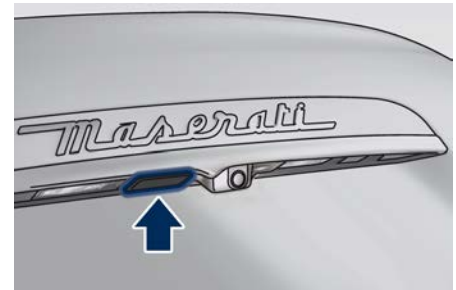
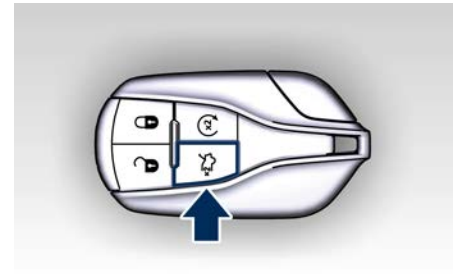

- After activating the trunk lid opening command in the possible modes (see "Trunk Lid Operation" in this section), the inner trunk light will turn on and will stay on for 10



3

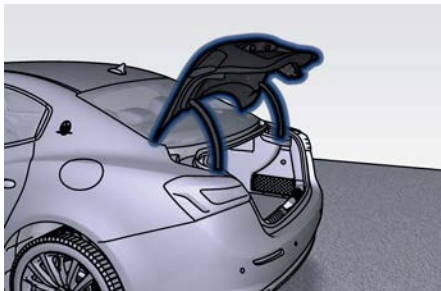

Vehicle Lighting with Open/Closed Doors

- If one or more doors are open, the central light, front/rear domelights (main and spot light), the instrument cluster, the MIA display, the night front seats lighting and the ignition device backlight will turn on and will light up for 27 seconds.
- If the doors are closed, all lights will turn off (within 3 seconds) with the exception of the console display and the ignition device backlight, which will turn off after 27 seconds.

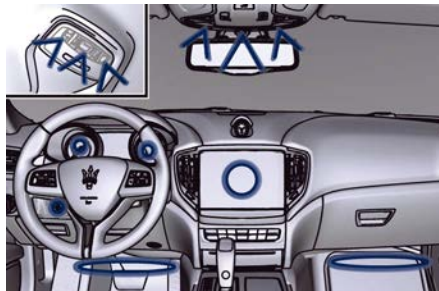

Use of Light Switch for Vehicle Lighting

Vehicle lighting can be operated from the key fob, the "Passive Entry" system and from the light switch on the left side of the dashboard. Refer to "Light Controls" in section "Dashboard Instruments and Controls" where it is indicated which external lights turn on according to light switch positions.



United States Market



Canadian Market

Ambient Lights and Backlight Adjustment

The ambient light and the backlight of the controls and instruments does not depend on the position of the light switch but on the detection of the ambient brightness made by the RLS solar sensor.

In "DAY" mode the backlighting of the instruments will be at 100% intensity while the backlighting of the switches will be at minimum. In "NIGHT" mode backlighting will be adjust via the left dimmer next to the light switch.

The ambient light are adjustable in the same condition which it is possible to adjust the backlight (in "NIGHT" mode only) via the left dimmer.

In all other conditions, you can activate the ambient lighting only



in mode "all turned on" (Parade), turning the left dimmer upward to the second detent.

Light Dimmer Controls

The light dimmer controls are complementary to the light switch and are positioned next to the switch (see "Light Controls" in section "Dashboard Instruments and Controls" for further information).



Unlock the Vehicle with Key fob

The Remote Keyless Entry (RKE) system allows you to unlock the doors and the fuel filler door, open the trunk and turn the approach and courtesy lights on from a distance up to approximately 33 ft (10 m). The key fob does not need to be pointed at the vehicle to activate the system. See "Illuminated Entry/Exit" in this section for further information.

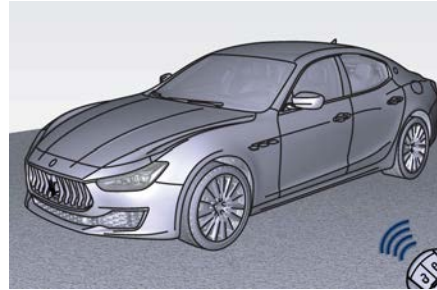

NOTE:

Driving at speeds of 5 MPH (8 km/h) and above disables the system from responding to all key fob buttons.

Unlock the Doors, Fuel Filler Door and Trunk

Press and release the unlock button  on the key fob once to unlock the

driver's door or twice within five seconds to unlock all doors, the fuel filler door and the trunk lid. The turn signal lights will flash for the unlock signal recognition. The illuminated entry/exit system will also turn on. See "Passive Entry System" in this section for further information.

Unlock Driver Door/All Doors with Remote Key 1st Press

This function allows you to program the system to unlock either the driver's door or all doors, the fuel filler door and the trunk lid, by the first press of the unlock button  on the key fob. To change the current setting, see "Functions of Settings Menu on MIA" in section "Dashboard Instruments and Controls".

Lock/Unlock Doors Flash Lights

This function will cause the flash of the turn signal lights when the doors are locked or unlocked with the key fob. This function can be turned on or turned off. To change the current setting, see "Functions of Settings Menu on MIA" in section "Dashboard Instruments and Controls".

Turn Headlights On with Key fob

This function activates the headlights for up to 90 seconds when the doors are unlocked with the key fob.



Before Starting

The duration can be set as desired. To change the current setting, see "Functions of Settings Menu on MIA" in section "Dashboard Instruments and Controls".

Sound Horn when Locking the Doors with Key fob

With this function activate the horn will sound when the doors are locked with the key fob. This function can be enabled or disabled. To change the current setting, see "Functions of Settings Menu on MIA" in section "Dashboard Instruments and Controls".

Unlatch the Trunk Lid

Press the button  on the key fob two times within five seconds to unlatch the trunk lid.

If the vehicle is equipped with power trunk lid, besides unlocking the trunk lid, the control will fully open it. See chapters "Passive Entry System" and "Trunk Lid Operation" in this section for further information.

Requiring and Setting Additional Key fobs

Provide your **Authorized Maserati Dealer** the following when ordering additional key fob RKE transmitters:

- all key fobs RKE transmitters in your possession;
- a personal ID;
- the identification and registration documents proving ownership of the vehicle.

Setting new key fobs or re-setting the original ones can only be performed at an **Authorized Maserati Dealer**.

NOTE:

Codes of any key fob RKE transmitters that are not present when the new setting procedure is done will be deleted from the memory to prevent lost or stolen key fobs transmitters being used to disarm the electronic alarm system.

Key fob Battery Replacement

NOTE:

A low charge level of the key fob battery will be indicated on the instrument cluster display.

The recommended replacement battery type is: CR2032. To replace the battery proceed as follows:

- Remove the emergency key as indicated in "Keys" chapter of the current section.
- Loosen the lateral screw that connects the two side covers with a torx T6 screwdriver.



- Separate the two lateral covers from the key fob case.





- Separate both parts of the key fob case.



- Remove the card with PCB (Printed Circuit Board).



- Remove the battery from its seat and replace with a new recommended type of battery.

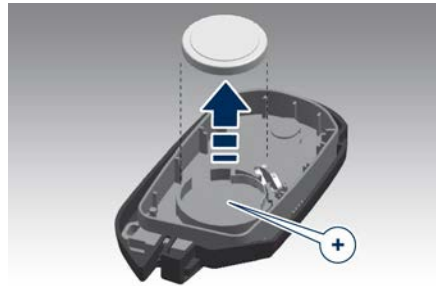

ENVIRONMENTAL!

Batteries contain dangerous materials that could harm the environment. Please dispose of them according to local regulations or at an Authorized Maserati Dealer.

NOTE:

Avoid touching the new battery with your fingers. Skin oils may cause battery deterioration. If you touch a battery, clean with alcohol.

- Match the + sign on the battery to the + sign on the inside of the battery clip, located on the back cover.
- Replace the printed circuit board by using the indicated pin for the sealing of the two covers.
- Assemble the key fob case and reassemble the two lateral covers: a click will indicate successful sealing.
- Combine the disassembled parts with clamping screw and reassemble the emergency key.

Radio Frequency RKE Transmitter - Regulatory Information

The "Regulatory Information" for all the radio and radar frequency devices can be consulted by accessing the "Services" section on the website www.maserati.com.



Passive Entry System

The "Passive Entry" system is an enhancement to the vehicle's Remote Keyless Entry (RKE) system. This function allows you to lock and unlock the vehicle's door(s) without having to press the key fob lock or unlock buttons.

NOTE:

- "Passive Entry" may be programmed to on/off; see "Functions of Settings Menu on MIA" in section "Dashboard Instruments and Controls" for further information.
- If wearing gloves, or if it has been raining on the "Passive Entry" door handle, the unlock sensitivity can be affected, resulting in a slower response time.
- Access to the vehicle using "Passive Entry" system may not work properly in case of interference caused by external sources such as metal objects, mobile phones, overhead power lines, antennas, etc. In these cases, use the buttons of the key fob to open and close the vehicle or the emergency key, inserting it into the driver side door lock.
- The "Passive Entry" system does not lock and unlock the doors directly

and immediately but with a slight delay (about 2 seconds).

Unlock Door from the Driver Side

With a valid key fob within 1 m (3.3 ft) of the driver's door handle, grip the driver's door outside handle to unlock the door automatically. The interior door panel lock knob will rise when the door is unlocked.



NOTE:

If "1st Press of Key Fob Unlocks" is selected, all doors will unlock when you grip the front driver's door handle. To select between "Driver Door" and "All Doors", see "Functions of Settings Menu on MIA" in section "Dashboard Instruments and Controls".

Unlock Door from the Passenger Side

With a valid key fob within 3.3 ft (1 m) of the passenger door handle, grip the front passenger outside door handle to unlock all four doors automatically. The interior door panel lock knob will rise when the door is unlocked.

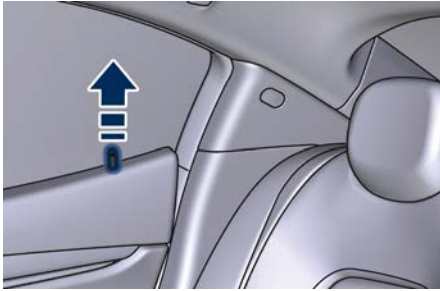

**NOTE:**

All doors will unlock when you grip the front passenger door handle regardless of the driver's door unlock preference setting ("Driver Door" or "All Doors").

Preventing Inadvertent Locking of the Key fob Inside the Vehicle

To minimize the possibility of unintentionally locking a key fob inside your vehicle, the "Passive Entry" system is equipped with an automatic door unlock function which will function if the ignition device is in the OFF position.

If one of the vehicle doors is open and the door panel switch  is used to lock the vehicle, once all open doors have been closed, the system checks

the inside and outside of the vehicle for any valid key fobs.

If one of the vehicle's key fobs is detected inside the vehicle, and no other valid key fobs are detected outside the vehicle, the "Passive Entry" system automatically unlocks all vehicle doors and chirps the horn fourteen times (on the fifteenth attempt ALL doors will lock and the key fob will be locked in the vehicle). This will happen even on vehicles equipped with power trunk lid pressing RH button  on its right lower part to close and lock the trunk lid.

NOTE:

The vehicle automatically unlocks the doors under any of the following conditions:

- the doors are manually locked using the door lock knob positioned on the door panel;
- there is a valid key fob inside the vehicle;
- there is not a valid key fob outside the vehicle.

**NOTE:**

The vehicle will not automatically unlock the doors under any of the following conditions:

- the doors are locked using the key fob;
- the doors are locked using the button on the "Passive Entry" door handles;
- there is a valid key fob outside the vehicle and within 3.3 ft (1 m) of either "Passive Entry" door handle;
- fifteen attempts are made to lock the doors using the door panel switch and/or the RH button  (on the right lower part of the trunk lid) and then close the doors.



Before Starting

3



If the key fob is inside the passenger compartment and one of the doors locked only to the first detent of lock pawl (hence it is not fully closed), when the vehicle lock function with alarm system for trunk lid and doors is being activated by means of RH button  at the bottom of the trunk lid, said function will be activated all the same. In this condition, any attempt to duly close the door that is partially open will cancel vehicle lock and alarm system arming thus leaving vehicle unlocked.

Since when the doors are locked, the "Passive Entry" system waits for about 16 seconds before verifying if a key fob is present inside the vehicle.

Release the Lid and Enter the Trunk

For vehicles equipped with manual trunk lid: with the key fob within 3.3

ft (1 m) of the lid, press the button located between the license plate lights and lift it manually.

For vehicles equipped with power trunk lid, the key fob within 3.3 ft (1 m) of the lid, press the button located between the license plate lights, the power trunk lid will automatically open until it has reached its maximum height; if the same button is not pressed again to stop it (for more information, see chapter "Trunk Lid Operation" in this section).

If the vehicle had already been unlocked through key fob or "Passive Entry", the presence of the key fob is not required; simply use the button located between the license plate lights to open the trunk lid manually or automatically.

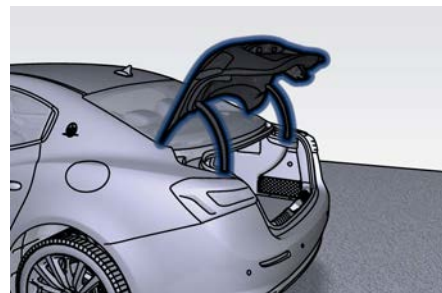

Manual Door Lock from Outside

With one of the vehicle's key fobs within 3.3 ft (1 m) of the driver or passenger front door handles, press the external door handle button to lock all four doors.



NOTE:

- After pressing the outside door handle button, you must wait two seconds before you can lock or unlock the doors using this door handle. By pulling the external door handle, you can check if the car remains locked, without "Passive Entry" system reacting and unlocking the doors.
- The "Passive Entry" system will not operate if the key fob battery is dead.



- If power trunk lid (if equipped) has been left open, it will stay open when you press the button on door external handle, and the locking function will only occur after the closing of the power trunk lid.



The vehicle doors can also be locked by using the key fob lock button  or the lock button  located on the vehicle's inner door panel.

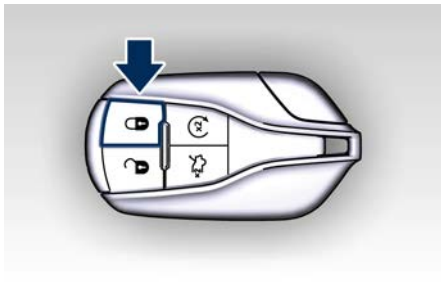

Radio Frequency RKE Transmitter - Regulatory Information

The "Regulatory Information" for all the radio and radar frequency devices can be consulted by accessing the "Services" section on the website www.maserati.com.

Power Windows

The window controls on the driver's door panel govern all the door windows.

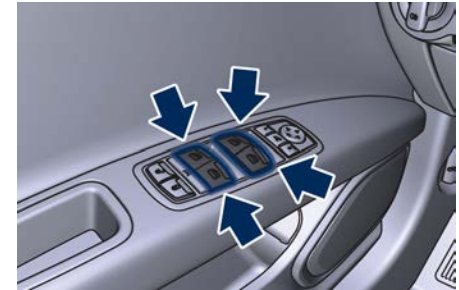

There are single window controls on each passenger door trim panel, which operate the corresponding window. The window controls will operate only when the ignition device is in the **ACC** or **RUN** position.



NOTE:

- The power window switches will remain active for up to 10 minutes after the ignition device is turned to the **OFF** position. Opening either front door will cancel this function. The time lapse can be set. See "Functions of Settings Menu on MIA" in section "Dashboard Instruments and Controls" for further information.
- Frequent activations of the power windows could result in a temporary lock out of the motors. In this case, wait a moment before a new activation.



WARNING!

Improper use of the power windows and the sunroof (if equipped) can however be dangerous, even with the anti-pinch prevention system. Before and during activation of the power window, always check that the passengers are not exposed to the risk of injury both by the moving window and by personal objects that could be dragged or hit by it. Do not leave unattended children in a vehicle with a key fob inside. When getting out the vehicle, always remove the key fob to prevent the windows being

accidentally activated, posing a risk to passengers remaining onboard.

Auto-Down Function

The driver door power window switch and some model passenger door power window switches have an auto-down function.

Press the window switch to the second detent, release, and the window will go completely down automatically.

To open the window part way, press the window switch to the first detent and release it when you want the window to stop.

To stop the window from going all the way down during the auto-down operation, pull up on the switch briefly.

Auto-Up Function with Anti-Pinch Protection

Lift the window switch to the second detent, release, and the window will go all the way up automatically.

To stop the window from going all the way up during the auto-up operation, push down on the switch briefly.

To close the window part way, lift the window switch to the first detent and release it when you want the window to stop.

NOTE:

- If the window runs into any obstacle during auto-closure, it will reverse direction and then go back down. Remove the obstacle and use the window switch again to close the window.
- Any impact due to rough road conditions may trigger the auto reverse function unexpectedly during auto-closure. If this happens, pull the switch lightly to the first detent and hold to close the window manually.
- Frequent activations of the anti-pinch function could disable the auto-down and auto-up function of the windows. In order to re-activate this function proceed with a reset cycle as described in the next paragraph.



WARNING!

There is no anti-pinch protection when the window is almost closed. Be sure to clear all objects from the area before closing the window.

Reset Auto-Up/Down

Should the auto-up/down function stop working, the window probably needs to be reset.



To reset auto-up/down, pull the window switch up to close the window completely and push the window



switch down to open the window completely.

Open the Windows with Key fob and Ignition Off

When the ignition device is in **OFF** position, windows can be opened by pressing the  button on the key fob.

- Press the  button and release it;
- Press a second time the  button and keep it pressed until complete opening of the windows, if they were closed.

Rear Window and Sunshade Lockout Button

The window lockout button on the driver's door trim panel allows to disable the window and sunshade control on the rear doors by pressing the window lockout button (setting it in the down position).

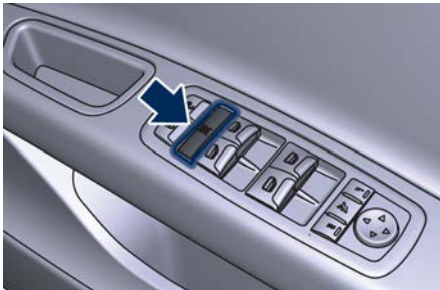

To enable the controls previously described, press the window lockout button again (setting it in the up position).

Wind Buffeting

Wind buffeting can be described as the perception of pressure or a helicopter-type sound. Your vehicle may exhibit wind buffeting with the windows down, or the sunroof in open or partially open positions. This is a normal occurrence and can be minimized. If the buffeting occurs with the rear windows open, open the front and rear windows together to minimize the buffeting. If the buffeting occurs with the sunroof open, then adjust the sunroof opening to minimize the buffeting.

Power Sunroof with Sunshade

The sunroof is power controlled and can only be operated with the ignition device in **RUN** position.

It can slide lengthways and be raised at the rear (tilting).

By opening the sunroof a front flap rises automatically in order to deviate the air flow.



The power sunroof controls are located between the sun visors on the overhead console.

The right two buttons controls the sunroof movement, whereas the left button controls the lifting of the sunroof for venting.



The sunshade can be opened manually. However, the sunshade will open automatically as the sunroof opens.

The sunshade cannot be closed if the sunroof is open.

WARNING!

- **Improper use of the sunroof can be dangerous, even if it features a finger-trap prevention system. Before and during the sunroof operation, always make sure that passengers are not exposed to the risk of injuries caused by the moving sunroof or by personal objects dragged or hit by the moving sunroof.**
- **Never leave children in a vehicle with the key fob in the passenger compartment.**

- **In a collision, there is a greater risk of being thrown from the vehicle if the sunroof is open. Always fasten your seat belt properly and make sure all passengers are properly secured too.**
- **Do not allow small children to operate the sunroof. Never insert fingers, other body parts, or any object through the opening sunroof.**

CAUTION!

- **In the event of rain, always close the sunroof to prevent water infiltrations from staining the fabric/leather upholstery.**
- **Do not open the sunroof if there is ice on it: risk of damage.**

Slide Opening Sunroof

• **Full automatic express opening**

Press the right rear button for more than half second and the sunroof will open automatically regardless of any previous position. The sunroof will open fully and stop automatically. During this operation, if any sunroof button is pressed, the sunroof will stop.

• **Full or partial manual opening**

To open the sunroof manually press the right rear button for less than

half second to move step by step the sunroof panel.

Venting Sunroof

Press and release the left button, and the sunroof will open to the vent position. This is called "Express Vent", and will occur regardless of sunroof position. During this opening operation, any movement of the button will stop the sunroof.

Pinch Protect Function

This function will detect an obstruction in the opening of the sunroof during express close operation. If an obstruction is detected, the sunroof will automatically retract. If this occurs, remove the obstruction then press the right front button and release to express close.

NOTE:

If three consecutive attempts to close in express mode the sunroof result in pinch protect reversals, the fourth attempt will be manual, with pinch protect function disabled.

Pinch Protect Override

If any obstruction (ice, debris, etc.) prevents closing the sunroof, press the right front button and hold for two seconds after the reversal occurs. This



allows the sunroof to move toward the closed position.

NOTE:

Pinch protection is disabled while pressing the right front button.

Wind Buffeting

Wind buffeting can be described as the perception of pressure or a helicopter-type sound. Your vehicle may exhibit wind buffeting with the windows down, or the sunroof in certain open or partially open positions. This is a normal occurrence and can be minimised. If the buffeting occurs with the rear windows open, then open the front and rear windows together to minimise the buffeting. If the buffeting occurs with the sunroof open, then adjust the sunroof opening to minimise the buffeting.

Ignition Off Operation

The power sunroof controls will remain active for up to approximately ten minutes after the ignition device is in **OFF** position. Opening either front door will cancel this function. The ignition system timing can be set using the MIA system (see "Functions of Settings Menu on MIA" in section "Dashboard Instruments and Controls").

Sunroof Maintenance

Use only a nonabrasive cleaner and a soft cloth to clean the glass panel.

Rear Window

Rear Window Defroster

The rear window defroster button is located on the climate control panel. See "Air Conditioning Controls" in section "Dashboard Instruments and Controls".

Power Sunshade (OPT)

Your vehicle can be equipped on request with a power sunshade that will reduce the amount of sunlight that will enter through the rear window.

The sunshade is rolled in and stored inside the cover behind the rear seats; when activated, it rolls out upwards. The power sunshade can be operated using the MIA system.

- Touch the "Vehicle" soft-key on the main category bar of the MIA display and choose the "Controls" menu.
- Within 15 seconds, touch the "Rear Sunshade" soft-key to raise the power sunshade.
- Within 15 seconds, touch the "Rear Sunshade" soft-key a second time to lower the sunshade.



Before Starting



3

If the sunshade is in the raised position and the transmission lever is positioned in R (Reverse), the sunshade will automatically fully lower.

When the transmission lever is shifted out of R (Reverse) the sunshade will automatically return to the fully raised position after approximately five seconds.

On versions equipped with heated rear seats are available the curtain buttons of the rear sunshade, positioned at the rear of the central console, which can be operated from the rear passengers.

- Press the left button to fully raise the sunshade.
- Press the right button to fully lower the sunshade.



NOTE:

The rear sunshade control and rear power windows switches, can be locked by pressing the window lockout button on the driver side door panel.

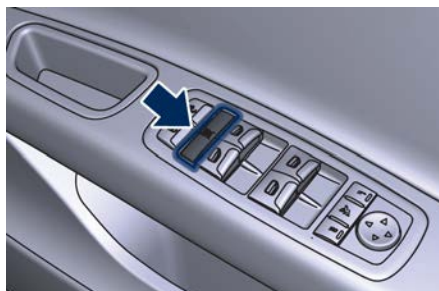

Trunk Lid Operation

Manual Trunk Lid Operation (for TROFEO version only)

The manual trunk lid can be unlocked from inside the vehicle by pressing the button on the front dome console.

NOTE:

The shift lever must be in P (Park) before the button on front dome console can operate.

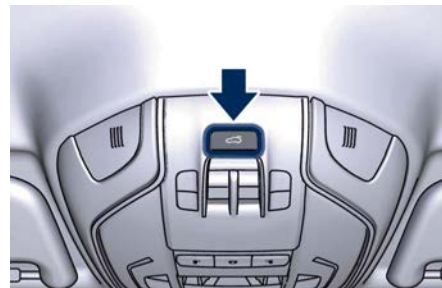

The manual trunk lid can be released from outside the vehicle by pressing the  button on the key fob with twice within five seconds or by using the external release button located on the lower side of the trunk lid ledge, between the license plate lights, when the vehicle has been unlocked using the key fob or the "Passive Entry" system.

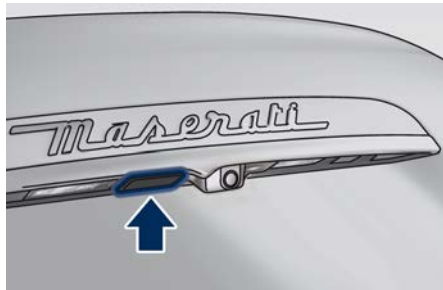
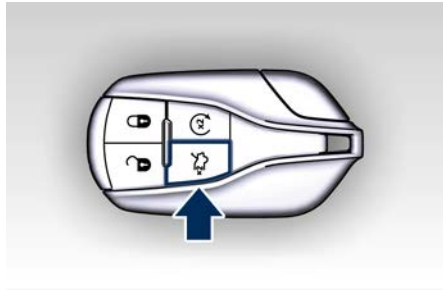

When the button  on the key fob is pressed twice within five seconds, the turn signals flash twice to indicate the unlocking of the trunk lid. To manually close the trunk lid use the handle as indicated beside the closing device.



With the ignition device in **RUN** position, the red symbol  will display on the instrument cluster with the message indicating that the trunk lid is open. Once the trunk is closed both symbol and message will disappear from the display.



With the ignition device in the **OFF** position, the trunk open symbol and message will display until closure. See "Passive Entry System" in this section for more information on trunk lid

operation with the "Passive Entry" function.

Power Trunk Lid with "Hands Free" Function

Automatic opening and closing movement of the power trunk lid/Hands Free is driven by electric actuators and a motorized latch ensuring lid locking upon closing. Power trunk lid can be opened using button  on the key fob and the button on the front dome console.

NOTE:

The shift lever must be in P (Park) before the button on front dome console can operate.

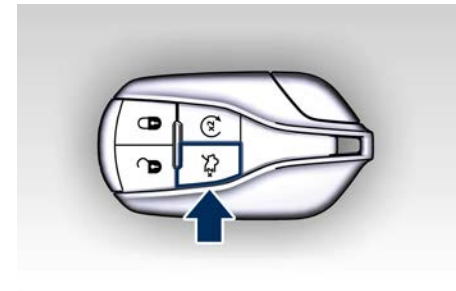



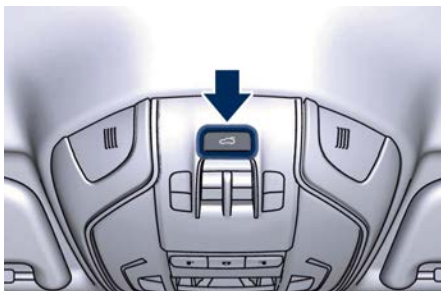

Before Starting

3



The  button on key fob and button on dome console not only allows user to completely open the power trunk lid, but also to stop it at any intermediate position by pressing the button again at anytime you wish to stop the opening process.

When the button  on the key fob is pressed twice within five seconds, the turn signals flash twice to indicate the opening of the power trunk lid, if the light flashing function at closing is activated on MIA (for more information, see the chapter "Functions of Settings Menu on MIA" in section "Dashboard Instruments and Controls").

With the ignition device in **RUN** position, the red symbol  will display on the instrument cluster with the message indicating that the trunk lid is open. Once the trunk is closed both

symbol and message will disappear from the display.



With the ignition device in the **OFF** position, the trunk open symbol and message will display until closure. See "Passive Entry System" in this section for more information on trunk lid operation with the "Passive Entry" function.

In addition to these commands, it is possible open and close the power trunk lid by simply moving your foot under the rear bumper, if the vehicle is so equipped with the "Hands Free" function, as specified in the paragraph "Hands Free Power Trunk Release and Closing". In this latter case, the lid will be opened and closed only if the "Passive Entry" system acknowledges the presence of the key fob within 3.3 ft (1 m) of the trunk lid.

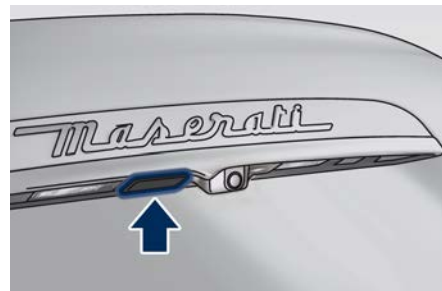

Power trunk lid uses the button in between the license plate lights, indicated in figure, to activate the opening once the car has been unlocked by the key fob or by the "Passive Entry" function.



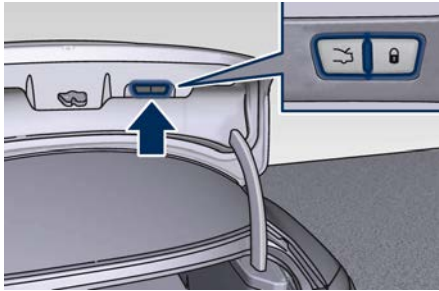

By pressing this button when the power trunk lid is closed you can open it completely or by pressing the button again stop the opening process. When the power trunk lid is open, to move it there are two buttons positioned on its right lower part as indicated in figure.





When the power trunk lid is completely open if you press and release the LH button , the power trunk lid will be completely closed unless it is stopped;

- if instead the power trunk lid is in an intermediate position and you press and release the LH button  during the closing or opening stroke, it will be stopped;
- if instead the power trunk lid is stopped in an intermediate position and you press and release the LH button , it will reverse its previous movement and it will be completely opened or closed unless it is stopped again.

In any case, when you press the LH button , the doors will not be locked and the alarm system will not be armed.

When the power trunk lid is completely open if you press and release the RH button , the power trunk lid will be completely closed unless it is stopped;

- if instead the power trunk lid is in an intermediate position and you press and release the RH button  during the closing or opening stroke, it will be stopped;
- if instead the power trunk lid is stopped in an intermediate position and you press and release the RH button , it will reverse its previous movement and it will be completely opened or closed unless it is stopped again.

In any case, when you press the RH button , the doors will not be locked and the alarm system will not be armed immediately, but only when the power trunk lid will have reached the totally closed position as effect of every movement commands received from every other available inputs.

NOTE:

- *The order of the functions shown does not represent the sequence in which they can be performed.*
- *The buttons of the power trunk lid do not work if a gear is engaged or*

if the vehicle speed is higher than 0 MPH or km/h.

- *The power trunk lid does not work with temperatures lower than -22°F (-30°C) or higher than 150°F (65°C).*
- *If the opening buttons or the handles are operated while the power trunk lid is closing, the stroke of lid stops. Pressing another time the same command it reverses movement and fully open.*
- *If the opening buttons or the handle are operated while the power trunk lid is opening, the motor of the lid is disabled to allow manual operation.*
- *If the power trunk lid finds several obstacles during the same operating cycle, it will stop automatically and must be opened or closed manually.*
- *If the power trunk lid is closing and a gear is engaged, the lid will continue closing. In this condition, it is possible that, during the closing stroke, it may find an obstacle and stop.*

Set the Position of Maximum Power Trunk Lid Opening



The maximum opening position of the trunk lid can be modified using the previously described buttons on its right lower side.

1. Activate the trunk lid and stop it in the new maximum opening



Before Starting

position to be set, by pressing the LH button .

2. Press the LH  and RH  buttons at the same time and keep them pressed for 3 seconds.
3. Release both buttons. Upon the following opening controls, the trunk lid will stop in the stored position.

3

If you want to reset the maximum possible opening position of the power trunk lid, proceed as described below starting from the previously set opening position.

1. Manually push the trunk lid to the maximum possible opening position.
2. Repeat the previously performed steps 2 and 3.

Power Trunk Lid Automatic Safe Movement

Power trunk lid safe opening and closing is ensured by a protection system able to stop its movement when an obstacle is detected along the path: when opening or closing, it stops automatically and then slightly moves back.

After the closing command, when power trunk lid starts closing, all the indicators will blink to warn anyone within range. Apart from activating indicators blinking when power trunk

lid is operated, it is also possible to activate a sound warning by selecting the relevant function within MIA user settings (see "Functions of Settings Menu on MIA" in section "Dashboard Instruments and Controls"). When power trunk lid edge reaches the car body, the motor locking the latch is activated automatically.

If necessary, the power trunk lid can also be opened or closed manually. This operation could be required when the trunk lid remains open for a long period of time.



WARNING!

- **Activate power trunk lid only when vehicle is at a standstill.**
- **Always pay utmost attention when opening and closing power trunk lid.**
- **After the closing command, always make sure that power trunk lid is completely closed.**



CAUTION!

- **Under extreme weather conditions, trunk lid seal could freeze and compromise power trunk lid automatic opening and closing.**
- **Before opening power trunk lid, make sure that no objects or snow**

are set on trunk lid or might jam or prevent its opening.

Hands Free Power Trunk Release and Closing (OPT)

"Hands Free" mode is controlled by the "Passive Entry" system (see paragraph "Passive Entry System" in this section), which automatically releases and closes the power trunk lid when you place your foot in the area under the rear bumper.

The system will only operate if the system acknowledges the presence of the key fob within 3.3 ft (1 m) of the power trunk lid.

The range of the sensors that detect your foot movement extends along and underneath the central portion of the rear bumper.

To activate the power trunk lid, stand behind the vehicle, near the trunk lid, and move your foot under the bumper as if to kick something. Do not place your foot too close to the bumper or touch the underbody.

**WARNING!**

- Pay careful attention to the exhaust tailpipes as they can reach high temperatures and, in case of contact, they can cause severe burns.
- When it is not necessary to open the power trunk lid with the "Hands Free" mode, make sure the key fob results outside the range of use (3.3 ft/1 m). Otherwise, the power trunk lid/Hand Free can be opened accidentally by an unintentional movement of the foot.

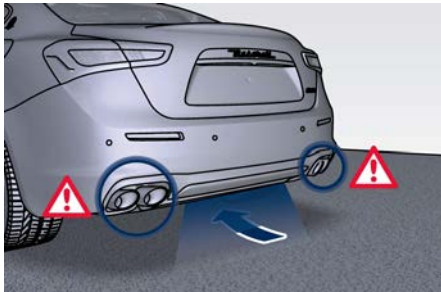

In order for the sensors to detect your foot movement, move your foot towards the vehicle rather than sideways and immediately pull it back: from this moment, the power trunk lid will activate within two seconds. If closed, with the foot movement the power trunk lid will:

- unlock and completely open;
- after another kick, will stop;
- after another kick, will reverse its movement and completely close unless stopped again.

If open, with the foot movement the power trunk lid will:

- completely close but not lock;
- another kick before the completed closing can stop the movement;
- if the movement was stopped another kick operation will invert a complete opening.

NOTE:

- If your foot movement fails to activate the power trunk lid movement, wiggling your foot under the bumper will not help. Repeat the whole kick movement.
- In particular situations, external factors affecting the sensor area may trigger the "Hands Free" power trunk lid release function. For example, when washing the vehicle, a water jet aimed at the sensor area may trigger the "Hands Free" power trunk release function. Keep the key fob away from the sensing range of the sensors (10 ft/3 m) or disable the "Hands Free" function from the MIA menu (see "Functions of Settings Menu on MIA" in section "Dashboard

Instruments and Controls"). A key fob located in the front seat passenger area is considered out of range of the "Hand Free" trunk release sensor

- If somebody or something knocks against the power trunk lid while it is moving, the safety system might stop lid opening or closing movement.

Trunk Lid Emergency Release

To access the trunk compartment from the rear seats, operate the emergency release lever pulling tab between the seatback and the bolster in order to lower the rear seat backrest (see "Cargo Area" in section "Understanding the Vehicle"). Release the trunk lid from inside by pulling on the phosphorescent handle ( : chapter "Trunk Safety" in section "Safety").

If the power release control fails to operate by either the key fob or by pressing the button on the dome console, the vehicle battery could be depleted or disconnected. If the doors are still locked, use the emergency mechanical key inserted in the driver's door lock to enter the vehicle and open the hood.

In this condition, it is possible to temporarily power the system by using



Before Starting

the battery remote poles located inside the engine compartment (see “Auxiliary Jump-Start Procedure” in section “In an Emergency”). Then it is possible to normally unlock and open the trunk lid by using the key fob or the button on the dome console. Have the vehicle checked by an **Authorized Maserati Dealer** in order to solve the failure.

3

Hood Operation

Opening

Two latches must be released to open the hood.

- From inside the vehicle, pull the hood release lever located under the left lower side of the dashboard.

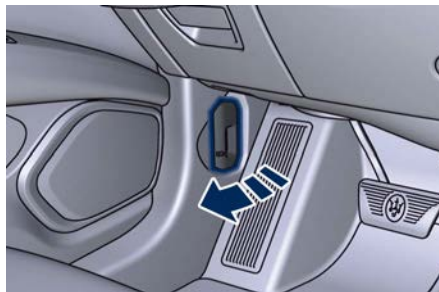

- Move to the outside and stand in front of the vehicle front grille.

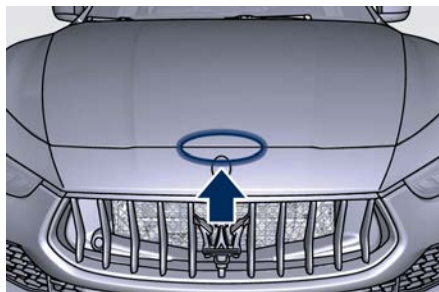

- Slightly lift the hood and push the safety catch as indicated by the arrow. The safety catch is located in the center of the hood.

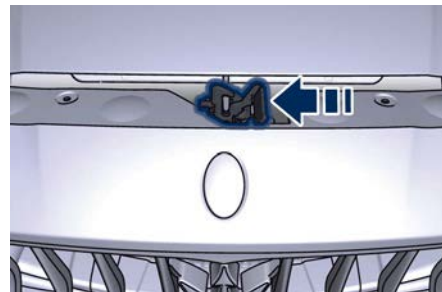

- Lift the hood completely: this operation is facilitated by two gas struts keeping the hood in the fully open position.

With the ignition switch in **RUN** position, the red symbol  will display on the instrument cluster with the message indicating that the hood is open.

Closing

Lower the hood, and then drop it. This should secure the inclusion of both latches.

**CAUTION!**

To prevent possible damage, do not slam the hood to close it.

**WARNING!**

- Be sure the hood is fully latched before driving your vehicle. If the lid is not fully latched, it could open when the vehicle is in motion and block your vision. Failure to follow this warning could result in serious injury or death.
- Gear shifting is always active and may be performed even when one or more doors, the hood or the trunk lid are open. Therefore, in these conditions, take great care to avoid moving the transmission shift lever and so accidentally engage gears.





4 - Dashboard Instruments and Controls

| | |
|--|-----|
| Instrument Cluster Overview | 78 |
| TFT Display: Menus and Settings | 79 |
| TFT Display Pop up Messages | 80 |
| TFT Display Setting and Menu Overview | 81 |
| TFT Display: Menu and Submenu Content | 85 |
| Warning and Indicator Lights | 90 |
| Maserati Intelligent Assistant Operation | 101 |
| Functions of Controls Menu on MIA | 105 |
| Functions of Settings Menu on MIA | 106 |
| Controls on Steering Wheel | 116 |
| Light Controls | 120 |
| Wiper and Washer Control | 128 |
| Analog Clock | 131 |
| Glove Box Compartment | 132 |
| Air Conditioning Controls | 135 |



Instrument Cluster Overview

The instrument cluster is divided into three main areas.

A - Analogue speedometer. It indicates the vehicle speed and displays in its interior some of the main warning lights (see "Warning and Indicator Lights" in this section).

B - Analogue tachometer. It indicates the engine revolutions and displays in its interior some of the main warning lights (see "Warning and Indicator Lights" in this section).

C - TFT display. In this area are displayed all the other warning and indicator lights (see "Warning and Indicator Lights" in this section), information, signs and text and/or icon messages.

NOTE

The image shows the instrument cluster before starting the engine.

U.S. Federal Regulations requires that upon transfer of vehicle ownership, the seller certify to the purchaser the correct mileage that the vehicle has been driven.

If your odometer needs to be repaired or serviced, the repair technician should leave the odometer reading the same as it was before the repair or service. This repair should be performed by an **Authorized Maserati Dealer**.

The odometer setting should be maintained following the repair or service.

Keep a record of the odometer mileage before any repair or service to ensure that the odometer is properly reset.



V8 Engine



V6 Engines



TFT Display: Menus and Settings

When operating, the TFT Display is divided into sectors including menus and sub-menus, running data, warning lights and messages represented in the example of picture.

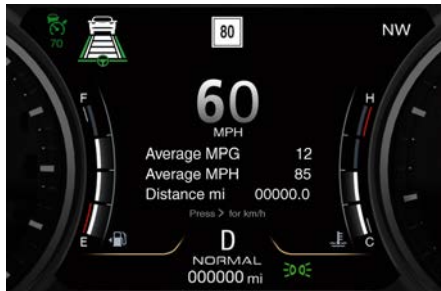

The presence of some areas depends on the type of equipment and the target market.

The different sectors of the display layout are rendered in the following picture.

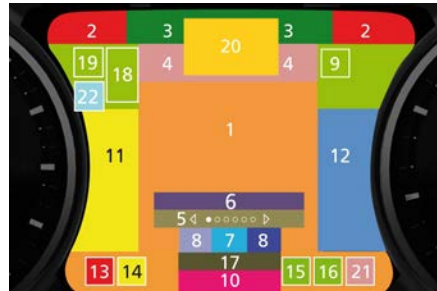

- 1 Main area.
- 2 Selectable information (data, time, outside temperature, compass, etc.). When setting the "Auto Dim High Beams" function, in the right portion of this area is displayed the respective indicator.
- 3 Main menu number and titles with scroll arrows (the number and the main menu title is always visible while scrolling the menu, and for the next five seconds).
- 4 Submenu titles.
- 5 Position within the submenus and scroll arrows (example: 1 of 5). There can be maximum 9 displayable submenu positions. When the number of submenu points exceeds 9, the points are replaced by a numerical value within the scroll arrows.
- 6 Menu Instruction (hideable).
- 7 Shift lever position (P, R, N, D, M, 1, 2, 3...) and driving modes.
- 8 Gear shift indicator light and paddle (if equipped).
- 9 Hard or soft suspension and Launch Control (TROFEO version only) indicator light.
- 10 Complete odometer (total distance covered by the vehicle).
- 11 Fuel gauge.
- 12 Engine temperature gauge.
- 13 Reconfigurable quadrant for red telltales.
- 14 Reconfigurable quadrant for amber telltales.
- 15 Low beam headlights/position lights.
- 16 Speed Warning indicator (dynamic text).
- 17 NORMAL, I.C.E., SPORT and CORSA (TROFEO version only) modes indicator light.
- 18 Combined telltale of ACC, LKA and ADA status. They are displayed in the cluster when one (or more) of these systems is enabled and a different menu from "Drive Assist" is displayed in the main area.
- 19 CC and ACC status function.
- 20 Traffic Sign Assist icons: conditioned and unconditioned



speed limit and/or supplementary signs (time restriction, etc.). See "Traffic Sign Assist - TSA" in section "Driver Assistance Systems" for further details.

- 21 Electric Parking Brake (EPB) failure warning light.
- 22 BSA and ABSA status.

TFT Display Pop up Messages

The central area of the TFT displays is the one dedicated to "pop up" messages. These pop up messages fall into several categories.

The display background may change according to the type of message displayed.



- No color: normal conditions.
- Yellow color: low-critical warning.
- Red color: high-critical warning.

Five-Second Stored Messages

When the appropriate conditions occur, this type of message appears on the main display area for five seconds and then returns to the previous screen. Most of the messages of this type are then stored (as long as the condition that activated them remains

active) and can be reviewed from the "Stored Messages" main menu item. Example of this message type is the one shown in the picture.



Unstored Messages

This message type is displayed until the condition that activated the message is cleared (see example in picture).





Unstored Messages with Ignition Switch in RUN

This message type is displayed until the ignition device is in **RUN** position. An example of this message type is the one shown in picture.



Five-Second Unstored Messages

When appropriate conditions occur, this type of message appears on the main display area for five seconds then returns to the previous screen.

Five-Second-displayed Navigation Messages

When the navigation menu is enabled on the MIA, information pop-ups will be displayed for 5 seconds while changing direction or approaching a turning point.

On highway, the first pop up will be displayed at 2 miles (3.2 km) from the turn, on roadway, at 1 mile (1.6 km). While approaching the turn, further pop ups will be displayed starting at 437 yd (400 m) from the turning point and the countdown to 0 miles.



While getting closer to a turn, the sections referred to the distance already traveled will switch off while the ones referred to the distance yet to be traveled will remain on.

NOTE:

- *Popup boxes might take up the space normally used to display main menu items and relevant submenus.*
- *The distance indicated under the road name is expressed in the unit of measure set by the user.*

TFT Display Setting and Menu Overview

Setting Controls

Operate the controls on the right side of the steering wheel to scroll, modify and program the main and submenu.

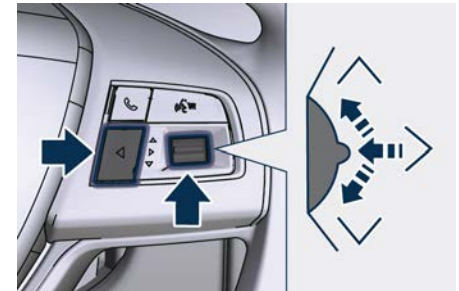

Press and release the multifunction switch in the \wedge and \vee arrow directions, corresponding to the same symbols on the TFT display, to scroll upwards and downwards the main menu titles.

The screen area in sector 1 (Main Area) will be updated and the selected title will be shown in sector 3 (main menu number and title).

Press and release the multifunction switch \triangleright , corresponding to the same symbol and the indication "SELECT" on the TFT display, to enter the information screens or a submenu.



Dashboard Instruments and Controls

Keep the switch > for 2 seconds to restore the selected/visualized functions.

The selected sub-menu title selected will be displayed in sector 4 (submenu title).

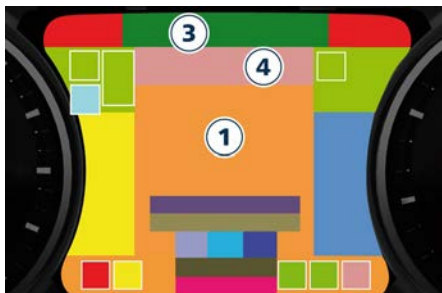

Within a submenu, press and release the multifunction switch in the ^ and v arrow directions to scroll the menu.

Press the < button, corresponding to the same symbol and the indication "EXIT" on the TFT display, to return to the main menu from an item of interest or from an information screen.

When the driver selects a main menu page and the Traffic Sign Assist (TSA) function on "Vehicle" page of MIA is set off (see "Functions of Settings Menu on MIA" in this section), main menu title, its number and the scroll

arrows will disappear after two seconds.

When driver selects a main menu, if the TSA function is set on and a sign and/or a speed limit icon is displayed in sector 20, only the main menu number and the scroll arrows remain displayed in sector 3, left side.



Menu Overview

1. MAIN MENU

- View speed in MPH or km/h

2. VEHICLE INFO

- Drive Mode
- Tire Pressure
- Gauges: Transmission Temperature, Oil Temperature and Oil Pressure
- Battery Voltage
- Maintenance

3. DRIVER ASSIST

- Shows a specific feedback referred only to ACC, LKA and ADA drive

assist systems (for each of these systems, see section " Driver Assistance Systems")

- LKA (LaneSense) status

4. TRIP & FUEL ECONOMY

- Trip A: Distance, Average (fuel economy), Average (speed), Elapsed time
- Trip B: Distance, Average (fuel economy), Average (speed), Elapsed time
- Fuel Economy: Current fuel economy bar graph, Range, Average (fuel economy)

5. VEHICLE SETTINGS

- Speed Warning: enables, disables or sets the speed limit represented in the dynamic icon on the TFT display
- Auto apply Off/On of the Electric Parking Brake
- Screen Setup
 - Upper Left
 - Upper Right
 - Main Menu: Line 1
 - Main Menu: Line 2
 - Main Menu: Line 3
 - MPH km/h Display On/Off
 - Main Menu Navigation
 - Audio: Radio, Media and Projection Mode
 - Key-On Display
 - Key-Off Display
 - Defaults



6. STORED MESSAGES

How to Set TFT Display

To set the TFT display it is necessary to select the "Screen Setup" submenu from the "Vehicle Settings" menu, proceeding as follows.

After having entered the "Vehicle Settings" menu, press and release the switch in the \wedge or \vee arrow directions until this menu item is displayed.

Press and release the multifunction switch \triangleright to access the available items for this submenu.

If the vehicle exceeds 5 MPH (8 km/h), this function is unavailable and the main screen shows possible options in grey (not activable).

Operate this function with the vehicle stopped and transmission in P (Park) position.

In order to enter a function, press the multifunction switch \triangleright .

The following directory shows the items available in this submenu:

Upper Left

- None
- Compass (only with navigation system)
- Outside Temperature (default: Upper Right)

- Date
- Time
- Time/Date (default: Upper Left)
- Range to Empty
- Average MPG (or L/100km or km/L)
- Current MPG (or L/100km or km/L)
- Trip A Distance
- Trip B Distance

Upper Right (example in picture)

- None
- Compass (only with navigation system)
- Outside Temperature (default: Upper Right)
- Date
- Time
- Time/Date (default: Upper Left)
- Range to Empty
- Average MPG (or L/100km or km/L)
- Current MPG (or L/100km or km/L)
- Trip A Distance
- Trip B Distance



Main Menu: Line 1 (only displays in Main Menu)

- None (default status)
- Compass (only with navigation system)
- Outside Temperature
- Date
- Time
- Time/Date
- Range to Empty
- Average MPG (or L/100km or km/L)
- Current MPG (or L/100km or km/L)
- Trip A Distance
- Trip B Distance
- Audio

Main Menu: Line 2 (only displays in Main Menu)

- Same configurable options as Line 1

Main Menu: Line 3 (only displays in Main Menu)

- Same configurable options as Line 1

MPH km/h Display (instruction line)

- On
- Off

Main Menu Navigation

- On
- Off

Audio

- Radio frequency
- Media: USB and Bluetooth® (text label only)



Dashboard Instruments and Controls

- Projection Mode: Apple CarPlay and Android Auto (text label only)

Key-On Display

- On
- Off

Key-Off Display

- On: Trip summary
- Off: screen with Maserati logo and trident

Defaults

- Restore
- Cancel

4

Scroll with the switch in the \wedge or \vee arrow directions to view the selectable items (in the example "Time" is selected). A check mark will remain next to the previously-selected item until a new selection is made.



Press and release the multifunction switch \triangleright to select an item. The notification of setting saved appears as a pop-up for 2 seconds, then the

display will show the last-modified item.

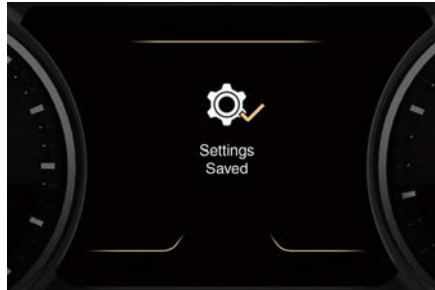

Press and release the \triangleleft button to return to the "Screen Setup" submenu. "Screen Setup" submenu parameters set by the user as the ones to be displayed are also indicated in the top part of the MIA (see example in the figures).

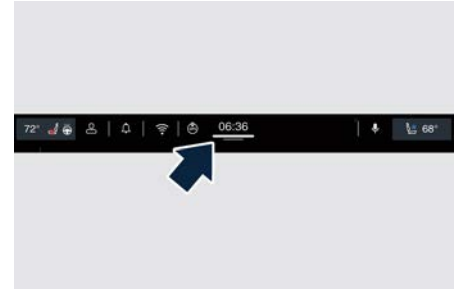

As for the instruction line "MPH km/h Display", you can either select to display it in sector 6 or not ("Off" option). In the latter case, the function of changing units remains in any case active.

If the "Main Menu Navigation" is set to "On", navigation information will be displayed in the main area of the display only if a destination has been set on the navigator of the MIA. If function is set to "Off", the navigation information will not be displayed.

"Key-On Display" and "Key-Off Display" items allow user to set display during vehicle key-on and off.

"Key-On Display" is normally set to "On". When entering the vehicle, after the welcome screen, the display will show the information concerning engine starting sequence. While if it is set to "Off" (example shown in figure), the display will show the



information displayed before last vehicle key-off.

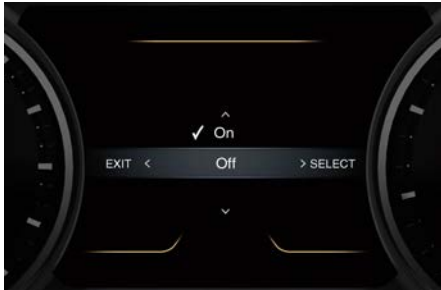

When engine is started and ignition device is pressed to stop it, it is possible to set "Key-Off Display" to obtain the following display settings:

- On: Trip Summary screen (Trip B is reset after each key-on/key-off cycle);
- Off: screen with Maserati logo and trident.

The "Defaults" item of "Screen Setup" submenu allows restoring Maserati factory settings.

TFT Display: Menu and Submenu Content

1. MAIN MENU

Press and release the multifunction switch in the \wedge or \vee arrow directions until this menu item is displayed.

Pressing and releasing the multifunction switch \triangleright will toggle the unit of measure between MPH or km/h.



Further to speed, the main area can indicate three lines that can be set to the same options and in the top right or top left area. When these three lines are present and turn-by-turn navigation is on, main menu area will automatically show navigation information. For further details, please refer to "Maserati Intelligent Assistant (MIA)" guide.

Press and release the \triangleleft button to return to the main menu.

2. VEHICLE INFO

Press and release the multifunction switch in the \wedge or \vee arrow directions until this menu item is displayed.

Press and release the multifunction switch \triangleright to access the submenus.

Press and release the multifunction switch in the \wedge or \vee arrow directions to scroll through the following information displays pressing and releasing the multifunction switch \triangleright to display the selected information.

Drive mode

Press and release the multifunction switch in the \wedge or \vee arrow directions until this menu item is displayed. The screen graphically shows the Drive Mode: I.C.E., NORMAL, SPORT, CORSA (TROFEO version only) and ⚡ (Suspension) set by the user through the relevant controls .

The display main area will show vehicle image with parameters and color-coded components affected by the selected drive mode.

The image will show the following parameters:



Dashboard Instruments and Controls

4

- torque distribution percentage indicated under the arrow in front of the wheels (on AWD version only).
- selected drive mode (in the example shown: SPORT).

For any color-coded components, color depends on settings of:

- ESC: identified by wheel color.
- PowerTrain: identified by engine + transmission unit color.
- Suspension  : identified by the color of the four shock absorbers.



For every drive mode, function (ESC, PowerTrain and Suspension) and color of the components shown are matched as follows:

| Drive Mode | ESC | PT |  |
|--------------------------|-----|----|---|
| I.C.E. | | | |
| NORMAL | | | |
| SPORT | | | S |
| CORSA (*) | | | |
| (*) TROFEO version only. | | | |

NOTE:

To set drive parameters according to own needs and path, refer to chapter "Drive Mode" in section "Starting and Driving".

Press and release the < button to return to the main menu.

Tire Pressure

Indicates the pressure of each single tire (see example below). For further information,  : chapter "Tire Pressure Monitoring System (TPMS)" in section "Safety".



Gauges

This screen shows the following parameters in bar graph form.

• Oil Pressure

Displays the current motor oil pressure level.

• Oil Temperature

Displays the current engine oil temperature level.

The gauge fill and telltale (if applicable) are highlighted in red to emphasise that the parameter is at a critical level.

NOTE:

This strategy is also applicable in the "Transmission Temperature" and "Oil Pressure" information screen.

• Transmission Temperature

Displays the current transmission temperature level.



Battery Voltage

Displays the current battery voltage.



Maintenance

(service)

Displays mileage and days remaining to next frequency scheduled maintenance service.



Press and release the < button to return to the main menu.

3. DRIVER ASSIST (if equipped)

Press and release the multifunction switch in the ^ or v arrow directions until this menu item is displayed.

The screen graphically shows current status of driver assist systems: the figure shows an example with ACC and ADA ready and LKA engaged.



NOTE:

To set these systems, see chapters "Adaptive Cruise Control - ACC", "Active Driving Assist - ADA" and "Lane Keeping Assist - LKA" in section "Driver Assistance Systems".

Press and release the < button to return to the main menu.

4. TRIP & FUEL ECONOMY

Press and release the multifunction switch in the ^ or v arrow directions until this menu item is displayed.

For each of the "Trip A" and "Trip B" sub-menus the screen will display the following:

- **"Distance"** traveled in miles or km. Shows the total covered distance since the last reset.
- **"Average"** consumption in MPG (US), MPG (UK) or l/100km. Shows the average fuel consumption since the last reset.
- **"Average"** speed in MPH or km/h. Shows the average speed since the last reset.
- **"Elapsed Time"** Shows the total time of travel since the last reset in "hours:minutes: seconds." Elapsed Time will increment when the



ignition device is in the **RUN** or **START** position.

Press the multifunction switch \triangleright for 1 second and release to reset "Trip A" or "Trip B".

"Trip B" is reset after each key on/key off cycle.



The "Fuel Economy" screen will display the following:

Current Fuel Economy in MPG (US), MPG (UK) or L/100km

Shows the instantaneous fuel economy. During AutoStop stage performed by the Start&Stop system (see "Normal Starting of the Engine" in section "Starting and Driving"), a dash will be displayed instead of the value.

Range in miles or km

Shows the range since the last fuel average reset.

When the fuel economy is reset, the display will read "Reset" or show dashes for two seconds.

Then, the history information will be erased, and the averaging will continue from the last fuel average reading before the reset.

Fuel Economy Average in MPG (US), MPG (UK) or L/100km

Shows the average fuel economy since the last reset.

Press the multifunction switch \triangleright for 1 second and release it to reset the fuel economy average.

When the fuel economy is reset, the display will read "Reset" or show dashes for two seconds.

Then, the history information will be erased, and the averaging will continue from the last fuel average reading before the reset.



Press and release the \triangleleft button to return to the main menu.

5. VEHICLE SETTINGS

With ignition device in **RUN** position and vehicle stopped, press and release the switch in the \wedge or \vee arrow directions until this menu item is displayed.

Press and release the multifunction switch \triangleright to access the submenus.

Scroll with the multifunction switch in the \wedge or \vee arrow directions to view the selectable items:

- Speed Warning: in order to set this function see example below.
- Electric Parking Brake: in order to modify the status of electric parking brake, see chapter "Parking Brake" in section "Starting and Driving".
- Screen Setup: see chapter "TFT Display Setting and Menu Overview" in this section.

Example to modify the "Speed Warning" status

NOTE:

- Minimum set speed: 20 MPH (30 km/h).
- Maximum set speed: 175 MPH (280 km/h).



When the vehicle is in motion (above 5 MPH– 8 km/h) this function is available and displayed in the list of "Vehicle Settings" menu.

Scroll with the multifunction switch in the \wedge or \vee arrow directions to view the selectable items.

Press and release the multifunction switch \triangleright to select "Speed Warning".

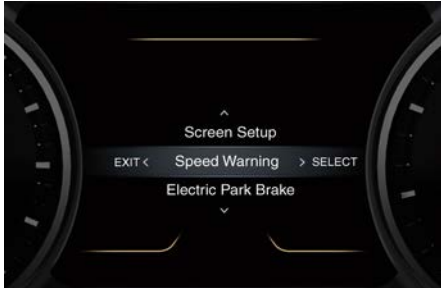

Press and release the multifunction switch \triangleright once again to view the related options: "Off" is the default status.



Scroll with the multifunction switch in the \wedge or \vee arrow directions to view the selectable options.

Speed values are in loop, keeping the multifunction switch pressed in the \wedge or \vee arrow directions will increase scroll speed.

Press and release the multifunction switch \triangleright to select the option. A check mark will remain next to the previously-selected item until a new selection is made.



A setting saved notification appears as a popup for 2 seconds and a white telltale indicating the set speed limit will appear on display.

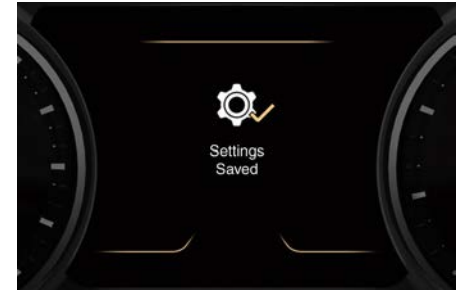

Then the display will show the last modified item.

When the set speed is exceeded, the driver is alerted by an acoustic signal and the telltale indicating the speed limit becomes amber.

A pop-up message indicating that the limit has been exceeded will appear on display.



The pop-up message and the telltale will be displayed for 5 seconds then system will return to the previous screen.

4

6. STORED MESSAGES

Press and release the multifunction switch in the \wedge or \vee arrow directions until this menu item is displayed.

The system will either display the number of the stored messages (if any available) or "No Stored Messages" if there are no stored messages.

Press and release the multifunction switch in the \wedge or \vee arrow directions to scroll the stored messages.

When the number of messages exceeds 9, the submenu points will be replaced by a numerical value indicating the message number. Press and release the multifunction switch

> to view the selected message (see example in the picture).



Press and release the < button to return to the main menu.

Warning and Indicator Lights

Warning and Indicator Lights on Speedometer

The following telltales are displayed on the speedometer, and related messages are visible for 5 seconds on the central sector of the display, unless otherwise indicated (see "TFT Display" paragraph in this chapter).



Malfunction Indicator Light (MIL)



The Malfunction Indicator Light (MIL) is part of an onboard diagnostic system that monitors engine and automatic transmission control systems.

Under normal conditions, this indicator light should switch on when the ignition device is in **RUN** position and switch off soon after the engine is



started (the MIL does not shut off immediately).

This is a sign of the indicator light working properly. If the indicator remains lit or switches on while driving, there is a failure in the fuel supply/ignition and emission control systems.

The failure could cause high exhaust emissions, loss of performance, poor vehicle handling and high consumption levels.

Should this occur, proceed with caution to your **Authorized Maserati Dealer** without heavy throttle application or driving at high speeds. Obey all applicable local traffic regulations.

The indicator light will go out if the problem is no longer present. The error will be registered by the system in any case.



CAUTION!

- When the ignition device is in the **RUN** position and if the indicator light does not switch on or if it switches on while driving, contact an **Authorized Maserati Dealer** as soon as possible.

- Prolonged driving with the MIL on could cause damage to the engine control system. It also could affect fuel economy and drivability. If the MIL is flashing, severe catalytic converter damage and power loss may occur. Immediate service is required. In addition, the On-Board Diagnostics (OBDII) system incorporates a diagnostic connector that can be interfaced using diagnostic equipment. This makes it possible to read the error codes stored in the control unit, together with a set of specific parameters for the engine operation diagnostic cycle, for compliance with CARB & EPA OBDII regulations.

Left Turn Signal Indicator Light



This indicator lights up when the left turn signals or the hazard flashers are turned on.

The indicator light will flash at the same frequency of the turn signals and is controlled by the stalk switch lever.

If the vehicle electronics sense that the vehicle drives for more than 1 mile (1.6 km) with either turn signal on, a continuous sound will alert the driver to turn the signal off.

If the indicator flashes at a fast rate, check for a defective exterior light LED.

Tire Pressure Monitoring Light



This warning light is connected to the Tire Pressure Monitoring System (TPMS).

Under normal conditions, the warning light should illuminate when the ignition device is in **RUN** and should go off once the engine is started.

If the warning light remains lit or illuminates while driving, the pressure of one or more tires is too low and a message will be displayed.

The TPMS malfunction indicator is connected to the low tire pressure monitoring light.

When the system detects a malfunction, the monitoring light and the related message will flash for approximately one minute and then remain lit.

This sequence will continue upon subsequent vehicle startups as long as the malfunction lasts.

When the malfunction warning lights up, the system may not be able to detect or signal low tire pressure correctly.



For further information,  chapter "Tire Pressure Monitoring System (TPMS)" in section "Safety".

Anti-Lock Braking System (ABS) Malfunction Warning Light



This warning light, and its related message, indicate possible malfunctions of the Anti-Lock Brake System (ABS). The warning light will turn on when the ignition device is in **RUN** position and may stay on for 4 seconds. If the ABS warning light remains lit or turns on while driving, the Anti-Lock portion of the brake system is not functioning and requires service. However, the conventional brake system will continue to operate normally if the **BRAKE** (US market) or  (CDN market) warning light is switched off. If the ABS warning light turns on while driving, or if it does not switch on when the ignition device is in **RUN** position, please visit an **Authorized Maserati Dealer** as soon as possible to restore the Anti-Lock brake function.

Electronic Stability Control (ESC) Activation/Malfunction Indicator Light



The ESC activation/malfunction indicator light on the instrument cluster will display

when the ignition device is in **RUN** position.

It should switch off by starting the engine.

If the light stays on with the engine running, there is a malfunction in the ESC system.

If the light still stays on after several ignition cycles, and the vehicle has been driven for several miles at more than 30 MPH (48 km/h) speed, visit an **Authorized Maserati Dealer** as soon as possible to have the problem diagnosed and serviced.

NOTE:

*Each time the ignition device is in **RUN**:*

- *The ESC OFF indicator light  and the ESC activation/malfunction indicator light illuminates temporarily.*
- *When the ESC is functioning, the system will make buzzing or clicking sounds. This is normal. The sounds will stop once ESC becomes inactive and the road conditions that caused the ESC activation no longer persist.*

Electronic Stability Control (ESC) OFF Indicator Light



This indicator notifies that the Electronic Stability Control (ESC) is disabled; the linked message will be displayed.

Warning and Indicator Lights on Tachometer

The following telltales are displayed on the tachometer and related messages are visible for 5 seconds on the central sector of the display, unless otherwise indicated.



US Market



CDN Market



Start&Stop Active Indicator Light



This indicator light indicates that the engine has been switched off automatically by the Start&Stop system.

When the engine starts again, the telltale will switch off.

If the indicator light during an automatic engine shutdown (AutoStop) phase starts flashing, it will be necessary to restart the engine normally with the ignition device while holding down the brake pedal. See chapter "Normal Starting of the Engine" in section "Starting and Driving" for further information.

Rear Fog Light Indicator Light



This indicator lights up when the rear fog lights are switched on.

High Beam Indicator Light



This indicator lights up when the high beams are switched on or when blinking.

Brake Warning Light



US



CDN

This warning light monitors various brake functions, including brake fluid level, brake pads wear (on US market only) and parking brake engagement.

If the brake warning light illuminates the parking brake may be engaged, the brake pads have reached wear limit (on US market only), the brake fluid level may be low or a problem with the anti-lock brake system (ABS) reservoir may have occurred.

In all the above situations, a related message will be displayed.

If the warning light still illuminates when the parking brake has been disengaged, and the fluid level is at the full mark on the master cylinder reservoir, there could be a brake hydraulic system malfunction or a problem with the brake booster detected by the ABS/ESC system. If this occurs, the warning light will remain lit until the problem has been solved. If the problem concerns the brake booster, the ABS master cylinder will run when engaging the brake and a brake pedal pulsation may be felt during each stop of the vehicle.

Inefficiency of one of the dual brake system cycles is indicated by the brake indicator light, which will turn on when the brake fluid level in the master cylinder has dropped below a certain level.

The warning light will remain lit until the problem has been solved. If a brake failure occurs, visit an **Authorized Maserati Dealer** as soon as possible in order to check up the brake system.

In the event of an Electronic Brake Force Distribution (EBD) failure, both the brake warning light and the ABS light illuminate.

Immediate repair of the ABS system is required.

Functioning of the brake indicator light can be checked by turning the ignition device from **OFF** to **RUN** position.

The warning light should illuminate for approximately 2 seconds. The warning light should switch off unless the parking brake is engaged or a brake fault is detected. If the warning light does not illuminate, have the light system repaired by an **Authorized Maserati Dealer**.

The warning light will also switch on when the parking brake is engaged



with the ignition device in **RUN** position.

This warning light only indicates the brake is engaged but not the clamping force of the parking brake to the wheels.



WARNING!

Driving a vehicle with the red brake light on can be very dangerous and is not recommended. Part of the brake system may have failed, resulting in increased braking distances and the risk of an accident. Have the vehicle checked as soon as possible at an Authorized Maserati Dealer.

Air Bag Warning Light



This warning light will illuminate for a few seconds for a bulb check when the ignition device is in **RUN**. If the light does not illuminate while starting the engine, stays lit, or switches on while driving, have the system checked at an **Authorized Maserati Dealer** as soon as possible.

In the latter case, the message will remain displayed: to hide it, press the button  on the steering wheel right side.

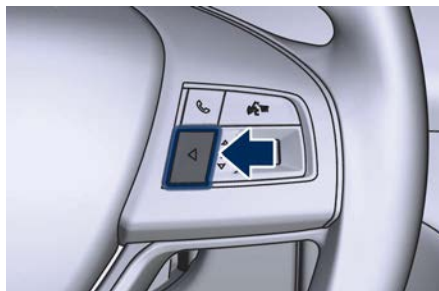

For further information,  : chapter "Supplemental Restraint System (SRS) – Air bags" in section "Safety".



WARNING!

If the warning light remains ON or if it does not illuminate or illuminates while driving, contact your Authorized Maserati Dealer as soon as possible.

Right Turn Signal Indicator Light



This indicator lights up when the right turn signals or the hazard flashers are switched on.

The indicator light will flash at the same frequency of the turn indicators and is controlled by the multifunction lever behind the steering wheel.

If the vehicle electronics sense that the vehicle drives for more than 1 mile (1.6 km) with either turn signal on,

a continuous sound will advise the driver to turn the signal off. If the indicator flashes at a fast rate, check for a defective exterior light LED.

Seat Belt Reminder Indicator Light



When the ignition device is in **RUN**, the seat belt reminder indicator light will light up for a few seconds as a bulb check.

During the bulb check, you will hear an acoustic signal if one or both front seat belts are unbuckled.

After the bulb check or while driving, if a seat belt is unbuckled, together with the acoustic signal the seat belt reminder light will light up and a message will indicate which belt is not fastened.

The SBR system monitors the condition of the seat belt buckled and unbuckled for all the passengers in the vehicle.

The system visualizes this indicator light inside the tachometer and the state of each rear seat belt represented by the same symbol in red or green color on the upper part of the TFT.

**WARNING!**

Maserati urges you to use the seat belts correctly fastened and adjusted at all times. Correct use of the seat belts can help reduce the risk of serious injury in the event of an accident. Do not pass seat belts over sharp edges. They could tear. Do not pin anything to the seat belts. This could reduce their initial strength and cause them to tear in the event of a crash.

For further information,  : chapter "Occupants Restraint Systems (ORS)" in section "Safety".

Warning and Indicator Lights on TFT Display

The relevant messages will be indicated within the main area for 5 seconds, unless otherwise specified. Fault messages will be stored under "Stored Messages".

Charging System Warning Light



This warning light shows the status of the electrical charging system.

If the light stays on or comes on while driving, turn off some of the vehicle's non-essential electrical devices or increase engine speed (if at

idle). If the charging system warning light remains on, it means that the vehicle is experiencing a problem with the charging system. **IMMEDIATELY** contact an **Authorized Maserati Dealer** to have the vehicle serviced. If jump starting is required, refer to "Auxiliary Jump Start Procedure" in section "In an Emergency".

Transmission Temperature Warning Light



This warning light and the related message indicate that the transmission fluid temperature is rising.

If this warning light turns on, safely pull over and stop the vehicle. Then, shift the transmission into P (Park) and run the engine at idle until the temperature drops and the light switches off. If the problem persists, contact an **Authorized Maserati Dealer**.

**CAUTION!**

Continuous driving with the transmission temperature warning light illuminated will eventually cause severe transmission damage or failure.

Engine Temperature Warning Light



This warning light notifies when the engine is overheated. If the temperature reaches critical levels and the gauge displayed in sector 12, on the left side of the tachometer, turns red, this warning light under the engine temperature gauge indicator will illuminate in red color combined with the related message on display. When the temperature is reaching the set threshold an acoustic signal will be heard.

If the warning light switches on while driving, safely pull over and stop the vehicle. If the A/C system is on, turn it off. Also, shift the transmission into N (Neutral) and idle the vehicle. If the temperature does not return to normal, immediately turn the engine off and contact an **Authorized Maserati Dealer**.

Check "Engine Overheating" in section "In an Emergency" for more information.

Low Oil Pressure Warning Light



Under normal conditions, the warning light illuminates when the ignition device is turned to **RUN** and goes off as soon as the engine is started.



If the warning light stays or turns on while driving, the engine oil pressure is too low. The warning light is combined with a displayed message and an acoustic signal that will last 4 minutes. In this case, turn the engine off immediately and carry out the necessary checks.

Do not operate the vehicle until the problem has been corrected. This warning light does not indicate the oil level. The engine oil level must be checked with the dipstick located under the hood (see "Maintenance Procedures" in section "Maintenance and Care"). If the problem persists, contact an **Authorized Maserati Dealer**.

Engine Oil Temperature Warning Light



This warning light indicates that the engine oil is overheated. The warning light is combined with the related displayed message. In this case, drive carefully until the temperature drops back to normal level and the light warning light turns off.

If the problem persists, contact an **Authorized Maserati Dealer**.

Low Engine Oil Level Warning Light



This warning light and the related displayed message, indicate a low engine oil level.

The engine oil level must be checked with the dipstick fitted under the hood (see "Maintenance Procedures" in section "Maintenance and Care").

Electric Power Steering Failure Warning Light



This warning light, and the related message, illuminate when the electric power steering is not operating and needs service.

If the warning light is on, steering assistance may be not available.



WARNING!

After battery disconnection event, the warning light may be on. In this case, start the engine and perform a steering wheel stroke end to end.

If the problem persists, contact an **Authorized Maserati Dealer**.

Catalyst Over Temperature Warning Light



This warning light, and the related message, light up if the engine runs irregularly with

consequent high temperature in the exhaust system.



WARNING!

- **If the warning light is accompanied by the message "Catalyst Temp Getting Hot Reduce Speed": the temperature of the catalytic converters is too high. The driver must slow down immediately until the warning light turns off.**
- **If the message "Catalyst Temp Hot Stop Safely Wait To Cool" appears after decelerating: the temperature in the catalytic converters has reached a dangerous level and the catalytic converters could be damaged. Drive slowly to the nearest Authorized Maserati Dealer.**
- **Maserati declines all responsibility for whatever damage deriving from non-compliance with the above mentioned warnings.**

Door Ajar Indicator



This indicator illuminates when one or more doors are ajar.

The indicator will show which door is ajar. When one or more doors are open, a related message will be displayed if the vehicle is running at a speed of 5 MPH (8 km/h) or faster.



Trunk Lid and Hood Ajar Indicator Lights



These indicator lights will illuminate to indicate that the trunk lid and/or the hood are ajar.



When the trunk lid or the hood is open, a related message will be displayed besides the light if the vehicle is running at a speed of 5 MPH (8 km/h) or faster.

Traffic Sign Assist (TSA) Indicator Lights



Speed limit unconditioned signs (in example: 80 MPH), limiting condition



acknowledged (in example: snow) and conditioned speed limit signs are displayed when the TSA function is active.

For further information, see "Traffic Sign Assist - TSA" in section "Driver Assistance Systems".

Electronic Throttle Control (ETC) Indicator Light



This indicator light indicates a failure of the Electronic Throttle Control (ETC) system.

If the indicator turns on while driving (a torque decrease is possible), have the system checked by an **Authorized Maserati Dealer**.

When detecting a failure, the light indicator will illuminate while the engine is running.

If the indicator remains lit with the engine running, you can still drive your vehicle. However, contact an **Authorized Maserati Dealer** as soon as possible.

If the indicator is flashing while the engine is running, immediate service is required. You may experience reduced performance, an elevated/rough idle or engine stall and your vehicle may require towing.

Low Fuel Indicator Light



When the fuel level reaches approximately 4.2 Gallons (16 litres) this indicator light under the fuel gauge indicator will turn on, and remain on until fuel is added together with the related message. In this condition the color indicating the quantity of fuel in the tank, inside the indicator on display, will go from white to amber.

Refer to "Refuelling" in section "Starting and Driving" for fuel filling.

Windshield Washer Low Fluid Indicator Light



This indicator light will illuminate for 5 seconds to indicate a low level of the

windshield washer fluid. A related message will be displayed. See "Maintenance Procedures" in section "Maintenance and Care" for fluid filling.

Headlight Aiming System Failure Warning Light



This warning light and the related message indicate a failure of the automatic headlight aiming system.

Please contact an **Authorized Maserati Dealer** to check the system.

Automatic High Beam Failure Warning Light



This warning light and the related message illuminate to report a failure of the automatic high beam headlights. Contact an **Authorized Maserati Dealer** as soon as possible.

Suspensions Failure Warning Light



This warning light and the related message turn on while driving if there is a failure of the Skyhook suspension system. Please contact an **Authorized Maserati Dealer** to check the system (only with  Skyhook active suspension).



Ice Hazard Indicator Light



When the external temperature falls below 38 °F (3 °C), the temperature value blinks for a few seconds, the warning light turns on, a message is displayed and an acoustic signal is triggered to warn the driver of the risk of icy roadbed.

Under such conditions, we recommend using the I.C.E. drive mode (see "Automatic Transmission" in section "Starting and Driving") drive carefully and slow down as the grip of the tires may be significantly reduced. The warning light flashes for 5 seconds and switches off when the temperature reaches 43 °F (6 °C) or higher.

Brake Pads Wear Warning Light (CDN market only)



This warning light and the related message indicate that the brake pads have reached their wear limit.

Please contact the **Authorized Maserati Dealer** to have them replaced.

Electric Parking Brake Failure Warning Light



This warning light and related message illuminate when there is an EPB system failure.

The failure could also completely or partially block the vehicle because the parking brake could remain on even after it has been automatically or manually disengaged though its controls.

If it is still possible to use the vehicle (parking brake not engaged) drive to the nearest **Authorized Maserati Dealer** and remember to performing each operation/command that the electric parking brake is not functioning.

Start&Stop Disable Indicator Light



This indicator light illuminates when Start&Stop system is not available in the conditions described in "Start&Stop Not Active" of the "Automatic Start&Stop System" chapter, or the system is turned off through the hard button on the central console or through the controls on the right side of the steering wheel or the relevant soft-key on MIA. See chapter "Automatic Start&Stop System" of section "Starting and Driving" for further information.

Start&Stop Failure Warning Light



This warning light illuminates when there is a failure in the Start&Stop system.

Switch the engine on or off using the normal procedure with the ignition device **START/STOP** and have the vehicle checked at an **Authorized Maserati Dealer**.

Scheduled Maintenance (Service) Indicator Light



This indicator light illuminates and a message flashes on the display for approximately 5 seconds after an acoustic signal to indicate that the next scheduled maintenance is due or is already overdue.

Unless reset, the message will continue to display each time you cycle the ignition device to the **RUN** position. To turn off the message temporarily, press and release the < button on the steering wheel. To reset the service indicator system, please visit an **Authorized Maserati Dealer**.



ADAS Status Indicators Lights



When you are not viewing the "Drive Assist" page, the indicator lights at the top left-hand side of the display indicate status of individual ADAS system or the combination of them (see examples). For further details, refer to "Adaptive Cruise Control - ACC", "Lane Keeping Assist - LKA" and "Active Driving Assist - ADA" in section "Driver Assistance Systems".

Forward Collision Warning (FCW) Off (if equipped)



This warning light informs the driver that Forward Collision Warning (FCW) is disabled.

This might occur when front sensor and/or the ACC/FCW system sensors are malfunctioning and need cleaning or servicing and when ACC/FCW system is not available due to a system error (for further details, refer to "Adaptive Cruise Control – ACC" in section "Driver Assistance Systems"). This warning light will light even when the activation of another driver assistance function or drive mode (such as "ESC OFF") disables the FCW.

Forward Collision Warning (FCW) and Pedestrian Emergency Braking (PEB) Fault (if equipped)



This warning light informs that FCW and/or PEB is in fault state and the autonomous braking may not be available. If this light occurs together with other specific messages, take your vehicle to an **Authorized Maserati Dealer** for service.

It is nevertheless possible to drive the vehicle without using this function (for further details, refer to "Forward Collision Warning - FCW" in section "Driving").

AWD Failure Warning Light (on AWD version only)



This warning light turns on to indicate a fault of the AWD system otherwise a fault or overheating due to excessive wheel spin.

Contact an **Authorized Maserati Dealer** as soon as possible, and avoid using the vehicle in heavy duty conditions.

Passive Speed Limit Set



This indicator light indicates the passive speed limit set via the controls on the RH side of the steering wheel (for further details,

refer to "TFT Display Setting and Menu Overview" in this section).

Passive Speed Limit Exceeded



This indicator light informs the driver that the speed limit that was set has been exceeded.

Suspension Setting Indicator Light



This indicator light displays which suspensions setting (soft "S" or hard "H") is on. For further details, refer to "Drive Mode" in section "Starting and Driving".

Drive Mode Indicator Light



Drive mode set by the driver through the controls on central console is displayed above the transmission lever indicator (example in picture: NORMAL).

For further details, refer to "Drive Mode" in section "Starting and Driving".

Cruise Control (CC) Ready or Canceled



This white indicator light will illuminate when the CC is ready to be set (with 3 dashes below) and, once it sets, when it is temporarily canceled (set speed in white below).

For further information, check "Cruise Control - CC" in section "Driver Assistance Systems".



Cruise Control (CC) Set



This green indicator light will illuminate with the set speed when the CC is set and in driver override. For further information, check "Cruise Control - CC" in section "Driver Assistance Systems".

Blind Spot Assist (BSA) or Active Blind Spot Assist (ABSA) Ready and Active



This white indicator light indicates that the BSA is in stand-by (ready): the same indicator light in green color indicates that the system is active.

Active Blind Spot Assist (ABSA) Intervention



This amber indicator light indicates the intervention of the system on the steering to avoid a potentially dangerous lane change.

For further information, see "Active Blind Spot Assistance - ABSA" in section "Driving Assistance systems".

Lane Keeping Assist (LKA) Fault



This warning light on indicates that the LKA system is in fault. If the warning light and the relevant message do not go off after a few manoeuvres and eventually an

ignition cycle, contact an **Authorized Maserati Dealer**.

Active Driving Assist (ADA) Fail



This warning light will turn on to indicate a failure of the ADA system.

Contact an **Authorized Maserati Dealer** as soon as possible avoiding using this system.

Adaptive Cruise Control (ACC) Ready or Canceled



This white indicator light indicates that the ACC is ready to be set (with 3 dashes below) and, once it sets, when it is temporarily canceled (set speed in white below).

For further details, refer to "Adaptive Cruise Control - ACC" in section "Driver Assistance Systems".

Adaptive Cruise Control (ACC) Set



This green indicator light with below the set speed turns on when the ACC is set (for further details, refer to "Adaptive Cruise Control - ACC" in section "Driver Assistance Systems") and vehicle will keep set speed.

Adaptive Cruise Control (ACC) Fault



This warning light turns on when ACC is not operating or needs servicing. For further

details, refer to "Adaptive Cruise Control - ACC" in section "Driver Assistance Systems".

Blind Spot Assist (BSA) and Active Blind Spot Assist (ABSA) Failure



This warning light and related message light on to report a failure of the BSA system.

As consequence, on vehicles equipped with ABSA also this latter will be not working or malfunctioning. Contact an **Authorized Maserati Dealer** as soon as possible avoiding to use this system.

Low Beams On Indicator Light



This indicator light will illuminate when the low beams headlights are turned on.

For further details, see "External Lighting" in section "Understanding the Vehicle".

Headlight On Indicator Light



This indicator light will illuminate when the position lights or headlights are turned on.

For further details, see "External Lighting" in section "Understanding the Vehicle".



Automatic High Beam On Indicator



This indicator turns on when the "Auto Dim High Beams" function is set on MIA (see "Functions of Settings Menu on MIA" in this section).

Gear Shift Indicator Light



This indicator lights up to indicate gear shift change in order to optimize fuel consumption.



See "Drive Mode" in section "Starting and Driving" for further information.

Electronic Differential (e-DIFF) Fault



This warning light indicates a fault on the electronic differential.

Contact an **Authorized Maserati Dealer** as soon as possible.

Performance "Launch Control" Indicator Light (TROFEO version only)



This indicator lights up when the car is engaged in the "Launch Control" performance start procedure.

See chapter "Launch Control Mode" in section "Starting and Driving" for the activation procedure.

Maserati Intelligent Assistant Operation

General Notes

The vehicle is equipped with the infotainment Maserati Intelligent Assistant (MIA) system, an advanced user interface which combines innovative and exclusive technical functions integrating entertainment, user settings, air conditioning, navigation, communication functions within a single system. The MIA system features an audio system which is acoustically optimised for this specific vehicle.

Only the MIA functions related to driving and on-board comfort that the User can set are described in this manual; all other entertainment and communication functions are described in a specific guide called "Maserati Intelligent Assistant (MIA)". This guide also includes all warnings and precautions, which are essential for a safe use of the MIA system. Maserati advises you to read this guide carefully and thoroughly.

Manual Controls and Devices

The MIA display is positioned in the central part of the dashboard and the manual controls and devices for

multimedia navigation and to connect external sources are positioned on the central console.

This manual controls are a further interface for the driver and nearby passenger, that adds to the MIA display soft-keys. Using the manual controls, the MIA display will work as a graphic display of the inputs from the controls.

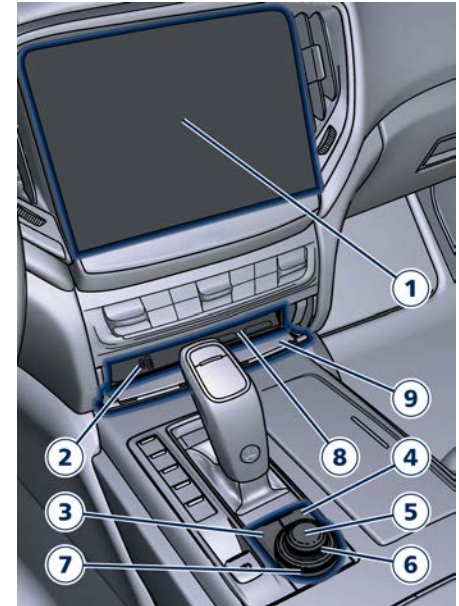



4

1 MIA touch display

The touch screen soft-keys allows to access to all available functions.

When you touch an active area of the screen a visual feedback of active area's is linked to the touch event. It is valid for all active areas with or without long touch functionality. This feedback associated to the touching state highlight the icon or text label and apply an additional graphic shape. This strategy is valid for all the active areas of the display (soft-keys, main category bar, etc...) except the lists, the status bar and the draggable areas.

To select a list item touch and release the screen or press the "BROWSE-ENTER" button in the central console.

2 Multimedia Ports

For further details, refer to "Internal Equipment" in section "Understanding the Vehicle".

3 "BROWSE/ENTER" button

In Radio/Media screen, after selecting a function using the tune/scroll knob or soft-keys on MIA display, press this button to see the detail of the items/options of the selected function. When in "Phone" page, open phonebook browse.

4 "MUTE" button

Press this button to mute the volume of the active sources.

5 "ON/OFF" button

Press this button to turn the MIA system on or off.

6 "VOLUME" control

Independently from currently shown MIA screen, turn this knob clockwise to increase the volume, counter-clockwise to decrease it.

When the volume control is adjusted through the "VOLUME" knob or the steering wheel control, a volume alert pop up will appear at the top of MIA screen. Volume alert shows the icon of the active source, the volume level bar with numerical value and the - and + soft-keys. Touch this soft-keys or press anywhere or drag the scrubber bar to decrease/increase the volume of the source highlighted.

Touching the drop down arrow on the right side of the volume alert to view and possibly change the volume level of the other sources (Media, Phone, Navigation and Voice Recognition).

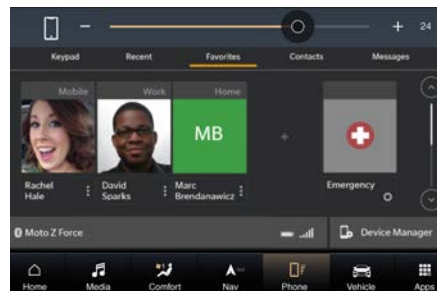

The volume control pop up will automatically time out 5 seconds after last touch, touching anywhere outside of the pop up or touch the "X" soft-key on the upper right side.

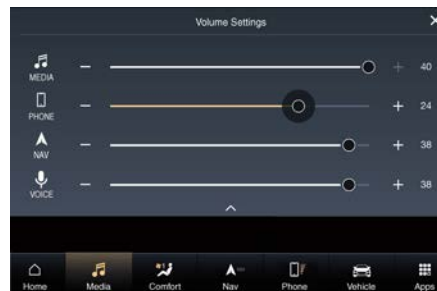

7 "TUNE-SCROLL" control

When navigating a list, turn this knob clockwise to move the cursor downwards, or counter-clockwise to move it upwards. In any main screen, turn this knob to tune a Radio stations



up or down and to skip the previous or next track of Media source.

NOTE:

For more information on the other functions, see "Maserati Intelligent Assistant (MIA)" guide included in the onboard documentation.

8 Phone drawer

Slide phone drawer.

9 Multimedia ports and phone housing door

Door for access to multimedia ports and phone housing with Wireless Charger.

Main Status Bar on MIA Display

Main status bar is set up by Maserati: some of soft-keys that make up the bar can be customised according to personal requirements, as explained in "Customising Main Status and Category Bar" in this chapter.

The composition of the main status bar is briefly indicated below. For further information, refer to the "Maserati Intelligent Assistant (MIA)" guide included in the on board documentation.



- 1 Driver temperature and seat and steering wheel comfort functions (if equipped).
- 2 Profiles (customisable).
- 3 Notifications (customisable).
- 4 Wi-fi connection (customisable).
- 5 Geolocation.
- 6 Clock.
- 7 Status alert box.
- 8 Passenger Voice Recognition - VR (customisable).
- 9 Passenger temperature and seat comfort function (if equipped).

NOTE:

The images may represent a main status bar other than the one on your MIA.

Main Category Bar on MIA Display

The softkeys located on the lower part of the MIA display represent the main menu modes/functions, which are briefly indicated below.



Main menu bar is set up by Maserati: it can be customised according to personal requirements, as explained in "Customizing the Main Status and Category Bar" in this chapter.

To view the label of the soft-keys in the main category bar it is necessary to activate the "Show Main Category Labels" function in the "Display" submenu of the "Settings" screen of the "Vehicle" page.

(Continued)



NOTE:

The images may represent a main category bar other than the one on your MIA.

For further information on the "Home", "Media", "Nav", "Phone" and " Apps", refer to the "Maserati Intelligent Assistant (MIA)" guide included in the onboard documentation.

Touch one of these soft-key to access the list of functions that users can set.

- 1 **"Home"** soft-key
Touch this soft-key to enter the home page from which you can choose among all the available widgets the one to display the desired function.
- 2 **"Media"** soft-key
Touch this soft-key to access media sources such as: Radio, USB device, Bluetooth and SD card as long as the requested media is present.
- 3 **"Comfort"** soft-key
Touch this soft-key to access the air conditioning settings and the other comfort controls available: Heated Seats, Heated Steering Wheel and Ventilated Seats. See

"Air Conditioning Controls" in this section for further details.

- 4 **"Nav"** soft-key (if equipped)
Touch this soft-key to access the Navigation function.
- 5 **"Phone"** soft-key
Touch this soft-key to access the MIA Phone function that can be set or monitored via MIA.
- 6 **"Vehicle"** soft-key
Touch this soft-key to access the "Controls" and "Settings" menu from which to choose which the customer programmable functions of some driver assistance system (ADAS) to set up. Functions can be selected and adjusted or turned on/off by touching the related soft-key (see "Functions of Controls Menu on MIA" in this section).
- 7 **"Apps"** soft-key
Touch this soft-key to have access to the Apps page from which you can choose which app you want to display between "Favorites", "Recent", "Categories" and "All".

Switch OFF Touchscreen Backlight

If the screen backlight becomes annoying when driving, it is possible to switch it off pressing ON/OFF

button described in the "Manual Controls and Devices" of this chapter. The MIA touch screen can be turned off by touching the "Screen Off" soft-key in the "Controls" menu of the "Vehicle" page.

Touchscreen Display Warnings



WARNING!

- Do NOT attach any object to the touchscreen, doing so can result in damage to the touchscreen.
- Do not press the screen with any hard or sharp objects (pen, USB stick, jewelry, etc.) which could scratch the touchscreen surface.
- Do not spray any liquid or caustic chemicals directly on the screen. Use a clean and dry micro fiber lens cleaning cloth in order to clean the touchscreen.
- If necessary, use a lint-free cloth dampened with a cleaning solution, such as isopropyl alcohol, or an isopropyl alcohol and water solution ratio of 50:50. Be sure to follow the solvent manufacturer's precautions and directions.

Customizing the Main Status and Category Bar

The soft-keys for the main functions of the MIA system, indicated at the



bottom of the MIA display and some of those on the main status bar can be easily customised to suit user's requirements, as follows:

- drag and drop the soft-key to move it inside the bar;
- touch the "Apps" soft-key to open applications/settings screen or access the screen with the function symbol to be inserted in the bar;
- drag and drop the icon corresponding to the selected function until it overlaps the one to be replaced on the top of the bottom bar.

Once it is set in the category bar, the new connection will be immediately operational.

Functions of Controls Menu on MIA

The MIA system uses a combination of keys able to access and change the customer programmable functions present in the "Controls" or "Settings" menu of the "Vehicle" screen page.

A shortcut to set the customer programmable functions is available in the "Apps" screen page.

Once you enter the "Controls" screen, using the touch soft-keys or turn the "TUNE-SCROLL" knob to scroll and change settings of the customer programmable functions.

Touch the function soft-key or press the "BROWSE-ENTER" button to confirm the selection.

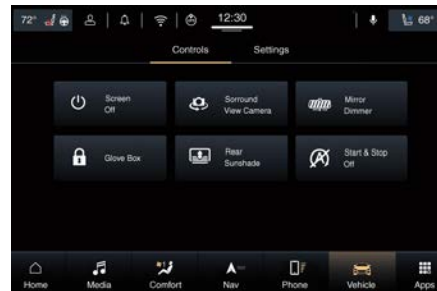

Some functions can be set only on or off touching the corresponding soft-key which will be highlighted with the

yellow outline (example: "Start&Stop Off").

Other functions can have one or more instruction/setting pages that are accessed by touching the corresponding soft-key (example: "Glove Box").

NOTE:

- All settings must be edited with ignition device set to **RUN** position.
- Some of the customer programmable functions are optional or for a specific model/version and may not be available on your vehicle.
- Only one touch screen area/soft-key may be selected at a time.

• Screen Off

This function allows you to switch off the MIA screen backlight if it becomes annoying when driving.

• Surround View Camera

Activating this function the system uses four cameras to monitor the area around the vehicle when transmission lever is shifted to P (Park), N (Neutral) or D (Drive) position.

When activation occurs by touching the "Surround View Camera" soft-key in the "Controls" screen or moving the shift lever in R (Reverse) position, the initial view will be the



default view (associated with current gear state).

See "Surround View Camera System" in section "Driver Assistance Systems" for further details.

• Mirror Dimmer

The auto-dimming function can be disabled or re-enabled by touching this soft-key. See "Rear-View Mirrors" in section "Understanding the Vehicle" for further details.

• Glove Box

This function allows you to enter a 4-digit PIN code to lock and unlock the glove box in the passenger side of the dashboard.

See "Glove Box Compartment" in this section for further details.

• Rear Sunshade

This function allows you to open and close the sunshade on the rear window.

See "Rear Window" in section "Before Starting" for further details.

• Start&Stop Off

This function allows you to disable the Start&Stop when frequent stops and restarts of the engine may become annoying.

See "Automatic Start&Stop System" in section "Starting and Driving" for further details.

Functions of Settings Menu on MIA

The MIA system uses a combination of keys able to access and change the customer programmable functions present in the "Controls" or "Settings" menu of the "Vehicle" screen page.

A shortcut to set the customer programmable functions is available in the "Apps" screen page.

Once you enter the "Settings" screen, using the touch soft-keys or turn the "TUNE-SCROLL" knob to scroll and change settings of the customer programmable functions.

NOTE:

- All settings must be edited with ignition device set to **RUN** position.
- Some of the customer programmable functions are optional or for a specific model/version and may not be available on your vehicle.
- Only one touch screen area/soft-key may be selected at a time.

Modes for Setting a Function

To enter the desired function, touch the corresponding soft-key on the lateral list (the picture shown is "Display").

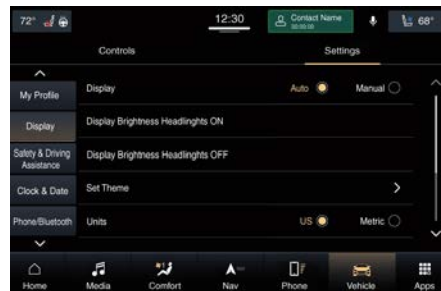

To scroll through the functions of the list, move the cursor up or down, or touch the arrow ∇ or \blacktriangle until the function to be set is displayed. Touching the \blacktriangle or ∇ soft keys and the cursor on the right side of the screen will allow you to scroll up or down through the available setting options. In this screen one or more boxes may indicate status or possible variants of the function. A check mark in a box indicates the current status of the function.

When in a setting line with many options:

- touching on the option currently not selected (no check mark in option) move the selector and change the option accordingly;
- touching on the option already selected (with selection) do not



perform action (maintain the option selection).

When in a setting line with one option only:

- if on/off setting (example: "Touchscreen Beep") touching on the option select/deselected the option (check mark appear/disappear). The same behavior is performed touching on the entire row area;
- if one-of-many option setting (example: "English" under "Language" function) touching on the option do not perform action (maintain the check mark). Also in this case, the same behavior is performed touching on the entire row area.

When in a function with +/- soft-key:

- if touch on the +/- soft-key, increase or decrease the value. Touching outside the +/- soft-key do not perform action;
- when the maximum value +/- is reached, +/- the soft-key turn grey.

Once the procedure is completed touch the < back arrow to return to the previous menu or touch the upper right "X" soft-key, to close the settings screen.

In this mode the MIA system allows you to access the following programmable functions: Display,

Safety & Driving Assistant, Clock & Date, Phone/Bluetooth, Voice, Navigation, Camera, Mirrors & Wipers, Lights, Doors & Locks, Seats & Comfort, Key Off Options, Audio, Notifications, SiriusXM Setup, Geolocation, Software Updates, System Information and Reset.

Display

Touch this soft-key to set the following modes.

• Language

When in this display, you can select one language for all display descriptions, including the trip functions and the navigation system (if equipped). The available languages are specific to the target markets.

• Display Mode

When in this display, you can select "Auto" or "Manual" mode.

• Display Brightness with Headlights On

When "Display Mode" function is in "Manual" mode, you can select the brightness with the headlights on (night condition). Adjust the brightness from level 0 to 10 with the "+" and "-" setting soft-keys or by selecting any point on the scale between the "+" and "-" soft-keys.

• Display Brightness with Headlights Off

When "Display Mode" is in "Manual" mode, you can select the brightness with the headlights off (day condition). Adjust the brightness as previously explained for "Headlights On" setting.

• Units

After pressing the "Units" and then "Custom" soft-key on the touchscreen you may select between "US" units and "Metric" of measure. Each unit of measure can be independently displayed in the TFT Display and in the navigation system. The following selectable units of measure are listed below:

- **Speed** unit:

select from: "MPH" or "km/h".

- **Distance** unit:

select from: "mi" or "km".

- **Fuel Consumption** unit:

select from: "MPG (US)", "MPG (UK)", "L/100km" or "km/L".

- **Pressure** unit:

select from: "psi", "kPa" or "bar".

- **Temperature** unit:

select from: "°F" or "°C".

- **Power** unit:

select from: "kW", "HP (US)" or "HP (UK)".



- **Torque** unit:

select from: "lb-ft" or "Nm".

• Touchscreen Beep

When in this display, you can turn on or shut off the sound activated by pressure of a touchscreen soft-key.

• Show Main Category Bar Labels

By selecting this function, the system shows the labels on the soft-keys of the main category bar.

• Navigation Turn-by-Turn Displayed in Cluster

By selecting this function, the next turn direction will appear on the instrument cluster along a programmed route until the desired destination is reached (see picture).

• Phone Pop-ups Displayed in Cluster

When this mode is selected a pop up message will appear in case of incoming call. Information associated to call in progress are available by entering to the "Audio" menu using the buttons on the steering wheel RH side.



Safety & Driving Assistant

Touch this soft-key to set the following modes.

• Forward Collision Warning / Pedestrian Emergency Braking

The FCW function primary use the front radar and the forward looking camera for sensing vehicle and pedestrian (if the car is equipped with Pedestrian Emergency Braking - PEB function) ahead, provide warnings to the driver and may perform brakings and brake jerks (if set).

FCW is always active: it is possible to set the warnings, the sensitivity and the aid of the active braking.

FCW warnings can be set in "Off", "Only Warning" and "Warning + Active Braking".

FCW sensitivity can be set to "Near", to "Med (Medium)" or to "Far".

The default status of FCW sensitivity is the "Med" setting.

FCW with active braking can be set to "On" or "Off".

See "Forward Collision Warning - FCW" in section "Driver Assistance Systems" for more details.

• Traffic Sign Assist

Activating this function the forward-facing digital camera, with the aid of maps on the navigation system, is able to detect signs (no overtaking, etc.) and speed limits. Those are displayed by the TSA system on the instrument cluster display together with a possible alert when the vehicle exceeds the speed limit.

See "Traffic Sign Assist - TSA" in section "Driver Assistance Systems" for further details.

• Lane Keeping Assist

Activating this function the LKA system will attempt to keep the vehicle in lane and can apply direct input to electric power steering system to change direction of vehicle. Driver warnings can be only "Visual" or "Visual & Haptic" (default mode). System response can be set to "Early", "Medium" (default mode) and "Late".



System reaction force can be set to "Low", "Medium" (default mode) and "High".

See "Lane Keeping Assist - LKA" in section "Driver Assistance Systems" for more details.

- **Active Blind Spot Assist**

Activating this function the system will try to prevent collision between host vehicle and potential blind spot collision hazard. System applies direct input to electric power steering system to change direction of vehicle to avoid collision.

Driver warnings can be only "Visual", "Visual & Acoustic" (default mode) or "Visual & Haptic".

System response can be set to "Early", "Medium" (default mode) and "Late".

System reaction force can be set to "Low", "Medium" (default mode) and "High".

See "Active Blind Spot Assist - ABSA" in section "Driver Assistance Systems" for more details.

- **Park Assist**

The park assist system will scan for objects behind and in front of the vehicle when the transmission shift lever is in R (Reverse) and the vehicle speed is less than 7.5 MPH (12 km/h).

The system can be enabled with "Sound Only", "Sound+Display", or turned "Off". See "Park Assist (Ⓟ)" in section "Driver Assistance Systems" for further information.

- **ParkSense Front Sensors Active in Drive**

If this function is active, when driver takes shift lever from P (Park) or N (Neutral) to D (Drive), front parking sensors are activated. If this function is not active, when driver takes shift lever from P (Park) or N (Neutral) to D (Drive), front parking sensors are NOT activated.

- **Front ParkAssist Volume**

When this function is selected, the chime volume of front park assist sensors can be set to "Low", "Medium" or "High" level. "Medium" is the default setting.

The system will retain its last known configuration state through ignition cycles.

- **Rear ParkAssist Volume**

When this function is selected, the chime volume of rear park assist sensors can be set to "Low", "Medium" or "High" level. "Medium" is the default setting.

The system will retain its last known configuration state through ignition cycles.

- **Hill Start Assist**

By selecting and check-mark this function, this system provides start assistance when the vehicle is on an incline.

Clock & Date

Time is always visible on the dashboard analog clock (see "Analog Clock" in this section) and in digital format on the instrument cluster and on the MIA display.





With this function it is possible to view and set the following modes.

4 • Sync with GPS Time

Time is normally automatically synchronised with the radio signal. It is also possible to set automatic synchronisation mode using GPS signal instead.

• Set Time Hours

With "Sync with GPS Time" function unchecked and this mode selected, you can set the hours manually from 1 to 24. To select, touch the "+" or "-" soft-keys to adjust the hours.

• Set Time Minutes

With "Sync with GPS Time" function unchecked and this mode selected, you can set the minutes manually from 0 to 59. To select, touch the "+" or "-" soft-keys as done for the hours.

• Time Format

When in this mode, you can select the time format display. To change the current setting, touch and release the "12 Hrs" or "24 Hrs" soft-key.

• Show Time In Status Bar

This function will allow you to turn on or shut off the digital clock in the status bar.

• Set Date (in Cluster)

When in this mode, you can set the date manually in the upper status bar of the MIA and on the instrument cluster display. Touch the "+" or "-" soft-keys to adjust day, month and year.

Phone/Bluetooth

Touch this soft-key to select the function related to the connect phones.

• Device Manager

By selecting this function, when touch the "Phone" soft-key in the main category bar the system open the "Device Manager" page to manage the connected devices.

• Do Not Disturb All

By selecting this function will block incoming texts, calls or both.

• Enable Two Active Phones

By selecting this function the MIA system enable two phones connected via Bluetooth.

NOTE:

On the Maserati website, at www.maserati.com, or through an **Authorized Maserati Dealer** you may consult the list of telephones that are compatible with the MIA, and their level of compatibility.

• Phone Pop-ups Displayed in Cluster

When this mode is selected a pop-up message will appear in case of incoming call. Information associated to call in progress are available by entering to the "Audio" menu using the buttons on the steering wheel RH side.

Voice

After touching this soft-key the following modes to give voice commands will be available.

• Voice Options

It is possible choose between "Female" or "Male" voice commands.

• Wake Up Word

With the microphones in the listening mode, this function allows you to select the wake up word from the available options.

• Voice Barge-in



By selecting this function it is possible to respond to a voice response before the statement is completed.

- **Show Command List**

When this function is selected, it is possible to select suggested options during a voice control session.

Navigation

Touch this soft-key to set the following modes.

- **Show**
- **Map View**
- **Routing**
- **Sound & Alerts**
- **Other**

Camera

Touch this soft-key to set the following modes.

- **Surround View Camera Delay**
By selecting this function the image of surround camera.
- **Surround View Camera Guidelines**
By selecting this function on the screen of the surround camera are displayed guidelines.
- **ParkView Backup Camera Delay**
By selecting this function, when the shift lever is moved out of R (Reverse), the rear view image will be displayed for up to 10 seconds after

shifting unless the forward vehicle speed exceeds 8 MPH (12 km/h).

Mirrors & Wipers

Touch this soft-key to set the following modes.

- **Tilt Side Mirrors In Reverse**

By selecting this function the outside side-view mirrors will tilt downward when the ignition device is in **RUN** position and the transmission shift lever is in R (Reverse) position. The mirrors will move back to their previous position when the transmission is shifted out of R (Reverse).

- **Auto Folding Side Mirrors**

By selecting this function the rear-view mirrors automatically fold when the vehicle is locked by the key fob and when the power trunk lid (if equipped) is closed and locked by pressing the  button on the right lower parts of the lid.

When the vehicle and the trunk lid will be unlocked and the ignition device is set in **RUN** position, the rear-view mirrors will automatically open in the position they had before the lock.

If the mirrors were manually folded by the switch on the driver's door panel, before a lock action, they

will need to be manually unfold to reactivate the automatic behave.

- **Rain Sensing Auto Wipers**

By selecting this function, the system will automatically activate the windshield wipers if the rain sensor senses moisture on the windshield.

- **Headlights with Wipers**

By selecting this function, while the headlight lever is in "AUTO" position, the headlight will turn on approximately 10 seconds after the wipers are activated. The headlight will also turn off when the wipers deactivate if they were activated in the current mode.

Lights

Press the "Lights" soft-key to set the following modes.

- **Headlight Off Delay**

By selecting this function, the driver can choose to have the headlight off or lit for 30, 60, or 90 seconds when the engine is shut off. To change the current headlight off delay status, touch and release the "0", "30", "60" or "90" soft-key to select the desired time range.

- **Headlight Illumination on Approach**

By selecting this function, the driver can choose to have the headlight off or lit for 30, 60, or 90 seconds when



the doors are unlocked with the key fob.

• **Headlights with Wipers**

By selecting this function, while the headlight lever is in "AUTO" position, the headlight will turn on approximately 10 seconds after the wipers are activated. The headlight will also turn off when the wipers deactivate if they were activated in the current mode.

• **Auto Dim High Beams**

By selecting this function, the high beam headlight will deactivate automatically under certain conditions. See "External Lighting" in section "Understanding the Vehicle" for further information.

• **Daytime Running Lights (DRL)**

By selecting and check-mark this function, the DRL lights will turn on whenever the engine running.

• **Headlight Dip (right/left-hand drive) (if equipped)**

By selecting this function, the headlights will change their light distribution when a left-hand-drive vehicle enter a Country with right-hand-drive system and vice versa.

• **Flash Lights with Lock**

By selecting this function, the headlights will flash when the doors

are locked or unlocked with the key fob or when using the "Passive Entry" function.

Doors & Locks

Touch this soft-key to set the following modes.

• **Auto Door Locks**

When this function is selected, all doors will automatically lock when the vehicle is in motion.



• **Auto Unlock on Exit**

By selecting this function, all doors will unlock when the vehicle is stopped, the transmission is in P (Park) or N (Neutral) position and the driver's door is open.

• **Flash Lights with Lock**

By selecting this function, the headlights will flash when the doors are locked or unlocked with the key fob or when using the "Passive Entry" function.



• **Sound Horn with Lock**

When this function is selected, the horn will sound when the doors are locked with the key fob. You can choose from the following options: "Off" (no sound), "1st Press" (sound on the first press of the  button) and "2nd Press" (sound on the second press of the  button).



• **Sound Horn with Remote Start**

When this function is selected, the horn will sound when you use the key fob to start the engine. See "Remote Start System" in section "Starting and Driving" for further details.

• **1st Press of Key Fob Unlock**

By selecting this function you may set up only the driver's door or all doors mode will unlock on the first press of the key fob  button. When "Driver Door" is selected, you must press the key fob  button twice to unlock also the passenger's doors. When unlocking "All Doors" by first press selection mode, all doors will unlock on the first press of the key fob  button.

• **Passive Entry**

This function allows you to lock and unlock the vehicle door(s) without having to push the key fob  or  buttons. By selecting this function, "Passive Entry" may be set to "On" or "Off".

The default status is "On". With "Passive Entry" deactivated, also the "Pre-Short Drop" function is disabled (for further information, refer to "Bodywork Maintenance and Care" in section "Maintenance and Care").



- **Personal Settings Linked to Key Fob**

This selected mode enables to combine the key fob to personal driver's position settings. These settings will be implemented when pressing the  button on the key fob with ignition device in **RUN** position.

- **Hands Free Power Liftgate**

To prevent the accidental opening of the power trunk lid with Hands Free (HFP) with the movement of the foot, it is possible to disable this function. This operation is recommended when you have to wash the car (for further information, refer to "Trunk Lid Operation" in section "Before Starting").

Seat & Comfort

Press this soft-key to set the following modes.

- **Easy Exit Seats**

When this function is selected, the driver's seat will automatically move rearward once the engine is shut off for easy exit of the vehicle.

- **Auto-on Driver Heated/Vented Seat & Steering**

This function allows to activate the comfort of the driving seat when starting the engine.

If equipped, the driver's heated/vented seat and/or heated steering wheel will automatically activate by temperatures below 40 °F (4 °C). When temperatures are above 80 °F (26 °C) the driver vented seat will turn on.

- **With Vehicle Start**

You can choose from the following options: "Off", "Remote Start" (activation of this function when you use the key fob to start the engine) and "All Starts" (activation of this function when you start the engine in all modes).

Key Off Options

This function allows you to set some functions after turning off the engine.

- **Easy Exit Seats**

When this function is selected, the driver's seat will automatically move rearward once the engine is shut off for easy exit of the vehicle.

- **Key Off Power Delay** (power duration after engine shutdown)
By selecting this function, the power window switches, radio, MIA Phone System, power sunroof (if equipped), and power outlets will remain active for up to 10 minutes after turning off the engine.

Opening of one front doors will cancel this function.

The switch-off delay can be cancelled (0 seconds) you can choose from 45 seconds, 5 minutes or 10 minutes.

- **Headlight Off Delay**

By selecting this function the headlight will stay lit for up to 90 seconds after turning off the engine. The switch-off delay can be cancelled (0 seconds) or reduced to 60 or 30 seconds.

Audio

This function enables to view and set the available audio modes depending on the type of audio system supplied on the car.

- **Audio Settings**

Touch this function to open the subscreen with all the audio settings items.

The following settings refer to the "High Premium" audio system.

- **Balance/Fade**

Use this screen to adjust the balance and fade settings. Touch and drag the speaker icon, use the arrows to adjust, or tap the "C" icon to readjust to the centre.



4

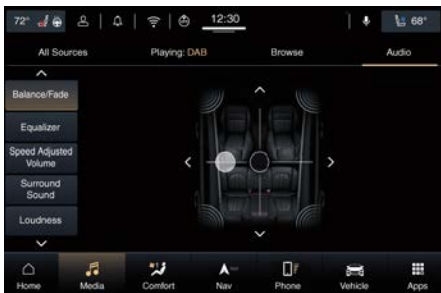

• Equalizer

Use this screen is used to adjust the "Bass", "Mid" and "Treb" settings. Adjust the settings with the "+" and "-" setting soft-keys or scroll and touch the slider in any point on the scale between the "+" and "-" soft-keys.



• Speed Adjusted Volume

This function increases or decreases volume combined to vehicle speed. To change the speed adjusted volume

touch the "Off", "1", "2" or "3" soft-key.

• Surround Sound

This function provides simulated surround sound mode. Available settings: "On" and "Off".

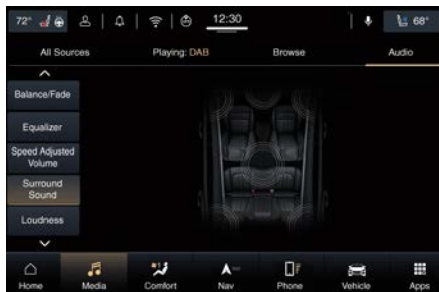

• Auto Play

When a portable device is connected via Wireless Charger or USB port to MIA system, it plays automatically the songs if this function is set to "On".

• Clari-Fi

This function improves the audio quality by enhancing digitally compressed source files such as MP3 and AAC files and certain music tracks played by radio stations. In case of high-definition source files, Clari-Fi shall apply no enhancement. Clari-Fi intervention is completely automatic.

Notification

Touch this soft-key to set the following modes.

• App Drawer Favoriting Popups

By selecting this function is possible turns on and off popup for "App Favored".

• App Drawer Unfavoriting Popups

By selecting this function is possible turns on and off popup for "App Unfavorited".

• New Text Message Popups

By selecting this function is possible turns on and off receiving/storing a popup for new text messages of any connected phone.

• Missed Calls Message

By selecting this function is possible turns on and off receiving/storing a popup for missed calls of any connected phone.

• Navigation Popups

By selecting this function is possible turns on and off receiving/storing predictive Navigation popups and any other Navigation popups that can be turned off.

• Wireless Charger Status Pop-ups

Display Wireless Charger status pop-ups on the MIA screen.

• Drive Mode Transition Popups



SiriusXM Setup

After pressing the "SiriusXM Setup" soft-key the following settings will be available.

• Tune Start

"Tune Start" begins playing the current song from the beginning when you tune to a music channel, so you can enjoy the complete song.

"Tune Start" works in the background, so you will not even realize it's on, except that you will miss the experience of joining your favorite song with only a few seconds left to play.

• Channel Skip

SiriusXM can be programmed to designate a group of channels that are the most desirable to listen to or to exclude undesirable channels while scanning. To make your selection, touch the Channel Skip soft-key, select the channels you would like to skip followed by pressing the arrow < soft-key.

• Subscription Information

SiriusXM Satellite Radio requires a user-paid subscription to access these stations.

It will be necessary to access the information on the Subscription

Information Screen in order to subscribe.

Touch the Subscription Info soft key to access your receiver ID number. Write down the SiriusXM ID numbers for your radio. To activate SiriusXM service, either call the number listed on the screen or visit SiriusXM online at www.siriusxm.com/subscriptions or call the number listed.

Geolocation

Touch this soft-key to set the following modes.

• Geolocation

By selecting this function is possible disables or re-enables the GPS tracking in the vehicle.

Software Updates

Touch this soft-key to set the following modes.

• Software Downloads over Wi-Fi

By selecting this function you can download the MIA software via Wi-Fi.

System Information

Touch this soft-key to set the following modes.

• Version Information

By selecting this function you can access the data page relating to the software version installed on MIA.

• License Information

Reset

Touch this soft-key to set the functions which allow you to reset data, Apps and password used by MIA system.

• Restart Radio

• Reset App Drawer to Default Order

By selecting this function a popup will appear asking user to confirm App Drawer resetting. Select "Yes" to restore, or "Cancel" and "X" to close the popup without reset the App Drawer.

• Restore Setting to Default

When this function is selected, it will reset the "Clock", "Audio", and "Radio" settings to their default settings.

Run this function and a pop up will appear asking user to confirm default settings resetting. Select "Yes" to restore, or "Cancel" and "X" to exit. Once the settings are restored, a pop up appears confirming that settings have been reset to default and then the MIA will restart.

• Clear Personal Data

When this function is selected, it will remove personal data concerning



settings and/or options that have been modified compared to factory settings and will also remove from system memory Bluetooth devices, Apps and presets.

To remove personal information, select this function and a pop up will appear asking confirmation to delete all personal data. Select "Yes" to clear, or "Cancel" and "X" to exit. Once the data have been cleared, a pop up appears confirming that personal data have been cleared and then the MIA will restart.

• Reset Wi-Fi Password for Projection

By selecting this function a popup will appear with the request to confirm the intention to change the Wi-Fi password. Select "Yes" and then "OK" to reset the password, or "Cancel" and "X" to close the popup without reset the Wi-Fi password.

• Factory Reset

Selecting this function a popup will appear with the request to confirm the intention to reset the MIA to the factory defaults. The "Yes" choice will cause the MIA to restart and the backup camera, the radio, SOS Call and several driving assistance functions will not be available. This could take several minutes. Select

"Cancel" or "X" to close the popup without reset the factory defaults.

Controls on Steering Wheel

ADAS Controls

The controls on the left side of the steering wheel are dedicated to ADAS systems and their presence and layout depend on the car's options.

The "Standard Configuration", in addition to the multifunction switch 1, includes the control of the Cruise Control (CC) 2 system.

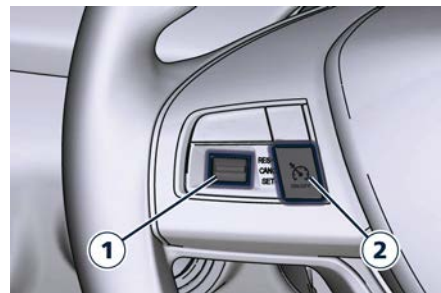

Standard Configuration

The "Optional Configuration", in addition to the multifunction switch 1, includes the ON/OFF Adaptive Cruise Control (ACC) button 3, the button 4 to set the ACC time gap to the sensed vehicle ahead and can include the Active Driving Assist (ADA) ON/OFF button 5. The two ACC controls also



allow the switching on and off of the CC.

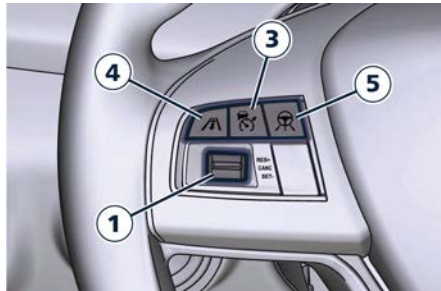

Optional Configuration

For all information on the use of these commands, see the chapters on the individual ADAS systems in the section "Driver Assistance Systems".

Phone and Voice Controls

The controls on the right side of the steering wheel activate/deactivate the phone mode (☎) and the Voice Recognition (VR) controls functions.



These functions are only available when one or more Bluetooth® compatible mobile phones are paired with the MIA system connection. To pair a phone and to learn all available functions refer to the "Maserati Intelligent Assistant (MIA)" guide.

NOTE:

On the Maserati website, at www.maserati.com, or through an **Authorized Maserati Dealer** you may consult the list of telephones that are compatible with the MIA, and their level of compatibility.

The voice command communication system is fully integrated with the vehicle's audio system.

The volume can be adjusted from the "VOLUME" upper knob on the central console (see "Maserati Intelligent Assistant Operation" in this section or

from the steering wheel radio controls described in this chapter.

The system will automatically mute the radio when using the phone mode.

When activating the phone mode using voice commands with speakerphone, you should talk quietly in a normal conversational tone by keeping the driving position and turning to the microphone of the voice command system located inside of the internal rear-view mirror.

The ability of the system voice control to recognize the user's voice commands can be invalidated when speaking too quickly or too loudly.



WARNING!
Any voice-controlled system should be used only in safe driving conditions following all applicable regulations. Full attention should be kept on driving.

Phone Mode Button

By using the phone button ☎ on the steering wheel it is possible to: activate the phone mode, start a call, show recent incoming and outgoing calls, show contacts list, etc.



4



Phone call status information during an active call will be shown in the main area of the TFT display. Touching the active call soft-key on the main category bar, the "Phone" page will open (see example in picture).



When pressing the phone button  an audible sound will invite you to impart a command.

Information on incoming call is indicated in a pop-up on instrument cluster display main area if this function is checkmarked on MIA (see "Functions of Settings Menu on MIA" in this section). Said information will stay displayed until a control is executed (e.g.: answer, reject, etc.) for the incoming call.

The screen will only display the phone number or name of caller (if available) as long as this complies with system specifications in terms of font and number of characters.

Call details can be displayed at any time through "Audio" submenu item. "Phone: call details" using the buttons on steering wheel RH side. On display,

said details shall temporarily replace the ones on media source in use.

Voice Recognition Button

The short pressure of the VR  button on the steering wheel allows you to give voice commands dedicated to all the native functions of the MIA (radio, media, navigator, climate, etc.). Excluded are all functions that interact with the Apps: "Apple CarPlay" and "Android Auto" or those of the voice assistants: Siri, Google Voice, etc..., supported on the mobile connected via Bluetooth® to the MIA.

The voice assistant of Baidu is not available with mobile paired via Bluetooth® to the MIA because Baidu CarLife is a projection mode application.

A long pressure of the VR  button, in addition to the native ones of the MIA, allows to give voice commands dedicated to the above mentioned Apps and voice assistants.

NOTE:



The pressure difference of the VR  button (short or long) is effective only when the mobile is paired via Bluetooth® to the MIA.

On the markets where it is available, once voice recognition is activated via the VR  button on the steering



wheel, a "teleprompter" screen is displayed on the MIA with a list of commands specific to each active function key shown on the vertical menu bar in the left side of the screen. The teleprompter screen shall always open at the "Suggested" menu (see example in picture). Selecting a different menu will bring up commands within that menu.

The key words to activate the dialog are white, the variable ones gray between the symbols "< >" and the alternative ones after the slash "/".

Touching voice help  soft-key the help response will be reproduced. It will have the same function as saying help. If the dialogue is paused, at the end of the help  prompt the teleprompter will return to the listening status.

Touching setting  soft-key the voice session will be canceled and will open the voice settings page.

At the top center of the teleprompter screen is displayed an animation representing the listening, processing and speaking state. While in the listening state, the animation will react to the microphone input: when in speaking state, will react to the prompt.

Touch the "Cancel" soft-key to end the voice dialog and close the teleprompter screen. Touching one of the soft-key on the main category bar, the session is cancelled and displays the selected category screen.

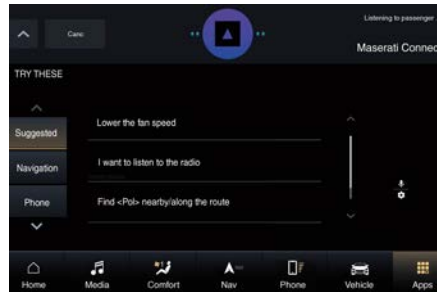

When pressing the VR  button an acoustic signal will invite to give a voice command.

NOTE:

For further details refer to the "Maserati Intelligent Assistant (MIA)" guide.

Siri Smart Personal Assistant

When a compatible iPhone or iPad that supports Siri voice recognition is paired to the vehicle via Bluetooth®, a long press of the VR  button activates the Siri Smart Personal Assistant.

Siri requires mobile internet access and its functionality might change depending on the geographical area. Through simple voice commands, without taking your eyes off the road, it may be possible to send messages, make phone calls, create notes and reminders, etc.

Audio System Controls

The vehicle is equipped with audio controls which allows the driver to operate the audio system. These controls can be used to adjust audio volume, change radio station or mode. These audio controls are rocker-type switches with a button in the center and are located on the rear side of the steering wheel, right behind the front switches.



Press any button to display information on the radio station or



track being listened to inside a pop-up for 2 seconds on instrument cluster.

The right-hand control manages the volume.

By pressing the top of the rocker switch you can increase the volume and by pressing the bottom of the rocker switch you can lower it. Press the center button to mute the volume.

The left-hand control functions depend on the current source. To change source, press the center button.

4

When in "Radio" mode, pressing the top of the switch will "Seek" up for the previous listenable station and pressing the bottom of the switch will "Seek" down for the previous listenable station.

When an external source is connected to MIA, a light press on the top of the switch will play the next track on the device connected.

Press the bottom of the switch once to go to the beginning of the current track, or to the beginning of the previous track if it is within one second after the current track begins to play.

If you press the switch up or down twice, it plays the second track; three times, it will play the third one, etc.

Light Controls

Light Switch

The headlight switch located on the left side of the dashboard can be used to turn on and off the position/DRL lights, headlights, side marker, license plate lights and front and rear fog lights.

The light switch on vehicles of United States (US) market can take the following positions:

0 All lights off;

☰☑☒ Position/DRL lights, side marker and license plate light;

AUTO Automatic headlights;

☰☑☒ Manual headlights.

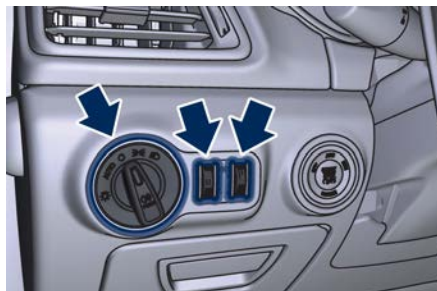

US Market

The light switch on vehicles of Canadian (CDN) market can take the following positions:

☰☑☒☒ Position/DRL lights, side marker and license plate light;

AUTO Automatic headlights;

☰☑☒ Manual headlights.

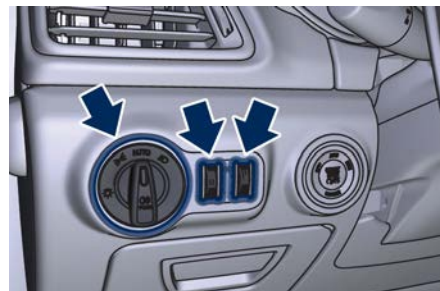

CDN Market

The light switch can also be pressed (☑☒) to turn the rear fog lights on and off.

By turning the light switch in the ☰☑☒ or to the ☰☑☒ position: the instrument cluster will display the related telltale (in example: position/DRL lights).



When the engine is not started and the lights are switched on automatically by the twilight sensor or manually via the light switch, after about 30 minutes the lighting system turns off the lights that would otherwise remain lit and could discharge the battery.

The following tables show the on/off condition of external lights, according to the ignition device position, to the engine status, to the twilight sensor mode and to the light switch position.



Table Valid for United States Market Only

| Ignition Device Position | Engine Status | Twilight Sensor Mode | Lights Switch Position | | | |
|--------------------------|---------------|----------------------|---|--------------------------------|---|---|
| | | | AUTO | 0 | | |
| OFF | – | – | All lights off. | All lights off. | Position lights (1), side marker and license plate lights on (3). | Low beams, position (1), side marker and license plate lights on. |
| ACC | Off | – | All lights off. | All lights off. | Position lights (1), side marker and license plate lights on (2). | Low beams, position (1), side marker and license plate lights on (2). |
| RUN | Off | – | All lights off. | All lights off. | Position lights (1), side marker and license plate lights on (2). | Low beams, position (1), side marker and license plate lights on (2). |
| RUN | On | DAY | DRL (1) on (if enable by MIA). | DRL (1) on (if enable by MIA). | DRL (1), rear position lights, side marker and license plate lights on. | Low beams, position (1), side marker and license plate lights on. |
| RUN | On | NIGHT | Low beams, position (1), side marker and license plate lights on. | DRL (1) on (if enable by MIA). | DRL (1), rear position lights, side marker and license plate lights on. | Low beams, position (1), side marker and license plate lights on. |

(1) The lighting system uses the same LED for DRL and front position lights with two different levels of intensity: high for DRL and low for position lights.

(2) The lights are powered up for 30 minutes to preserve the charge of the battery.

(3) To preserve the charge of the battery, do not leave these lights on for a long time.

4



Table Valid for Canadian Market Only

| Ignition Device Position | Engine Status | Twilight Sensor Mode | Light Switch Position | | |
|--------------------------|---------------|----------------------|---|---|---|
| | | | | AUTO | |
| OFF | – | – | Position lights (1), side marker and license plate lights on (3). | All lights off. | Low beams, position (1), side marker and license plate lights on. |
| ACC | Off | – | Position lights (1), side marker and license plate lights on (2). | All lights off. | Low beams, position (1), side marker and license plate lights on (2). |
| RUN | Off | – | Position lights (1), side marker and license plate lights on (2). | All lights off. | Low beams, position (1), side marker and license plate lights on (2). |
| RUN | On | DAY | DRL (1) on. | DRL (1) on. | Low beams, position (1), side marker and license plate lights on. |
| RUN | On | NIGHT | Low beams, position (1), side marker and license plate lights on. | Low beams, position (1), side marker and license plate lights on. | Low beams, position (1), side marker and license plate lights on. |

(1) The lighting system uses the same LED for DRL and front position lights with two different levels of intensity: high for DRL and low for position lights.
 (2) The lights are powered up for 30 minutes to preserve the charge of the battery.
 (3) To preserve the charge of the battery, do not leave these lights on for a long time.



Position Lights and Daytime Running Lights (DRL)

The lighting system uses the same high or low intensity headlamps LED, respectively, for the DRL lights and front position lights.

With the light switch turned in , the position lights will turn on when the ignition device is in any position and the engine is stopped or when the engine is running and the twilight sensor is in "NIGHT" mode.

The position lights are always on when the light switch is set in the  position.

DRL lights will turn on when the twilight sensor is in "DAY" mode, the engine is running and the light switch is in  or "AUTO" position.

NOTE:

If the headlights or position/DRL lights are on after the ignition device is placed in OFF position, a buzzer will alert the driver while opening the driver's door.

If a turn signal is activated, the DRL LED on the same side of the vehicle switches in position light function for the duration of the turn signal activation. Once the turn signal is deactivated, the DRL LED will light up again.

NOTE:

On Canadian vehicles DRL are always on. On United States vehicles, the DRL lights can be turned on and off using the MIA system, see "Functions of Settings Menu on MIA" in section "Dashboard Instruments and Controls" for further information.

Automatic Headlights

This system automatically turns the headlights on or off according to ambient light intensity detected by the twilight sensor positioned on the inner surface of the windshield, over the rear view mirror. To turn the system on, rotate the lights switch clockwise to "AUTO" position.

When the automatic system is activated, the headlight time delay function is activated as well. This means the headlights will stay on for up to 90 seconds after you place the ignition device into OFF position.

To turn the automatic system off, move the lights switch out of "AUTO" position.

NOTE:

The engine must be running before the headlights turn on in automatic mode.



WARNING!

The responsibility for turning on the lights, depending on the daylight and regulations in force in the country of use, always lies with the driver. The automatic system for switching on and off the external lights is to be considered as an aid for the driver. If necessary, switch the lights including the rear fog lights on and off manually.

Headlights On with Wipers

When this function is active, the headlights will turn on approximately 10 seconds after activation of the wipers, if the lights switch is placed in the "AUTO" position. The headlights will additionally turn off by deactivation of the wipers if previously activated with this function.

NOTE:

The Headlights with wipers function may be turned on and off using the MIA system, refer to "Functions of Settings Menu on MIA" in section "Dashboard Instruments and Controls".

Headlights Time Delay

This safety function provides headlight illumination for up to 90 seconds



(programmable) when leaving your vehicle in an unlit area. To activate the delay function with the light switch in "AUTO" position, place the ignition device in the **OFF** or **ACC** position while the headlights are still on.

The delay interval begins when the lights switch is turned off (position "0"), on the vehicles of United States market, and/or when the ignition device is placed in the **OFF** or **ACC** position on vehicles of Canadian market. If you turn the headlights or position lights on, or place the ignition device in **RUN**, the system will cancel the delay.

If you turn the headlights off ("0" position) before the ignition, they will turn off in the normal mode.

To activate manually the delay function the headlights must be on before place the ignition device in the **OFF** or **ACC** position and the light switch in "AUTO" position.

NOTE:

- To activate this function the lights must be turned off ("0" position), on vehicles of united States market only, and/or the light switch must be turned in "AUTO" position within 45

seconds of placing the ignition device in the **OFF** or **ACC** position.

- Once the delay function is active, any additional shifting of the light switch will cancel the function.
- The headlight delay time is programmable using the MIA system, see "Functions of Settings Menu on MIA" in section "Dashboard Instruments and Controls".
- If the low beam LEDs are active due to "Headlights with Wipers", then the headlamps delay function will not be activated when the ignition device is set in **OFF** position.



Manual Headlights

Turning the light switch in position  turns on the low beam together with the position lights, the side markers and the license plate lights regardless of the ignition device state and the "DAY" or "NIGHT" mode detected by the twilight sensor (see table in "Light Switch" paragraph of this chapter).

The related telltale  will display on the instrument cluster.

Fog Lights

The rear fog lights switch is built into the lights switch.

To activate the rear fog lights, turn the light switch to the low beam light  or "AUTO" position (the picture shows that of United States market). Press the lights switch  to turn on the rear fog lights.

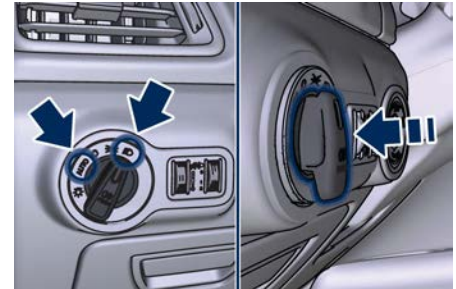

Pressing again the lights switch  will deactivate the rear fog lights. Turning the lights switch off (position "0") will also deactivate the rear fog lights on vehicles of United States market.

A dedicated telltale in the instrument cluster illuminates when the rear fog lights are turned on.



4



NOTE:

After a key-off/key-on cycle, the rear fog lights will NOT activate automatically when turning on the low beam or "AUTO" headlights. The rear fog lights will only turn on by operating the switch as previously described.

Light Dimmer Controls

The regulation devices beside the light switch may have a different configuration according to type of headlights installed. It can adjust respectively:

- the left one: brightness of the instrument cluster lights, doors controls rear lighting, interior and night lighting.
- the right one: headlights leveling or brightness tuning of night lighting .

Interior Lights Regulator (only with Bi-Xenon Headlights)

The regulation device rotates from position "0" upward and back downward performing stable and dimmable positions.

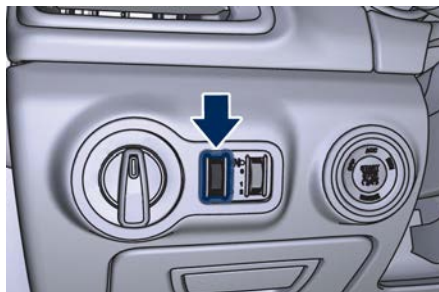

This regulator switch has 4 different positions:

- 0 Stable position: lower level of (OFF) the internal and night lighting.
- 1st Dimmable position: allows minimum to maximum brightness tuning of the instrument cluster dials, display, control switches and MIA's backlight, including all displayed messages and night lighting.
- 2nd Stable position: allows maximum brightness set.

- 3rd Stable position: allows to switch on the main and reading lights of the front dome light.

NOTE:

On the cars with bi-Xenon headlights, with the right regulation device you can adjust the headlights leveling (: chapter "Manual Headlights Leveling" in section "Safety").

Interior Lights Regulators (only with Full-LED Headlights)

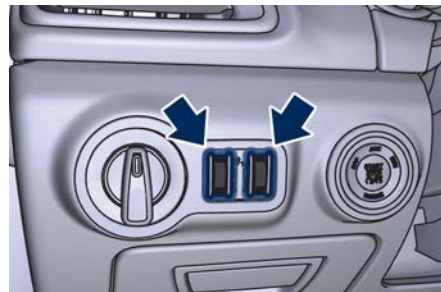

The regulation devices rotate from position "0" upward and back downward performing stable and dimmable positions.

The left regulator switch has 4 different positions:

- 0 Stable position: lower level of (OFF) the internal and night lighting.



- 1st Dimmable position: allows minimum to maximum brightness tuning of the instrument cluster dials, display, control switches and MIA's backlight, including all displayed messages and night lighting.
- 2nd Stable position: allows maximum brightness set.
- 3rd Stable position: allows to switch on the main and reading lights of the front dome light.

The right regulator has 2 different positions:

- 0 Stable position: night lighting (OFF) off.
- 1st Dimmable position: allows minimum to maximum brightness tuning of the front dome light LED and the night lighting.

Multifunction Lever

The multifunction lever is fitted on the left side of the steering column. The multifunction lever controls the operation of the turn signals, headlight beam selection, overtaking lights and windshield wiper and washer (for this content see the

chapter "Wiper and Washer Control" of this section).

Turn Signals

Move the multifunction lever all the way up or down until the stop triggers.

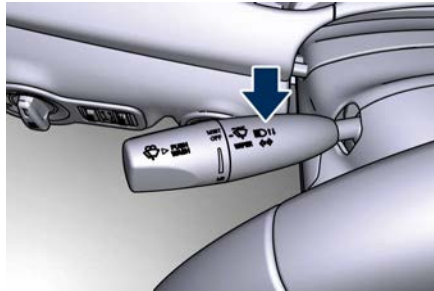

The left or right arrow on the speedometer and tachometer instrument cluster respectively, flashes to show proper operation of the front and rear turn signal lights.



To activate lane change function, tap the lever up or down once, without moving beyond the detent. The turn signals (right or left) will flash three times then automatically turn off. This function is useful when overtaking or changing lanes.

NOTE:

- If either light remains on and does not flash, or flashes at a fast rate, check for a defective outside light. If an indicator on the instrument cluster fails while moving the lever, then the turn indicator could be defective.
- The message that a turn signal is on will appear in the instrument cluster and a continuous chime will sound if the vehicle is driven more than 1 mile (1.6 km) with either turn signal on.

High Beams and Flashing

To switch on the high beams with the light switch in headlamp 



Dashboard Instruments and Controls

or "AUTO" position, shift the multifunction lever onward.

A related telltale  will illuminate on the tachometer.

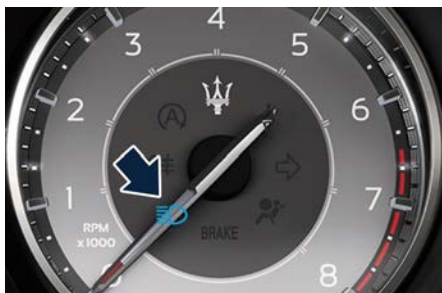

By pulling the lever backward (toward the steering wheel) you switch off the high beams and switch on the low beams.

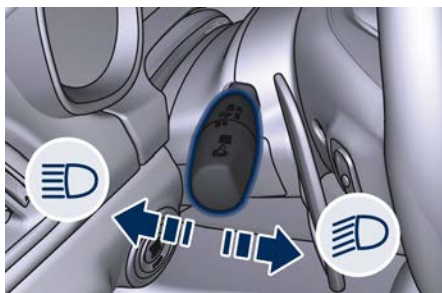

You can signal another vehicle with your headlights by lightly pulling the multifunction lever toward you. This

will turn on the high beams headlights until the lever is released.

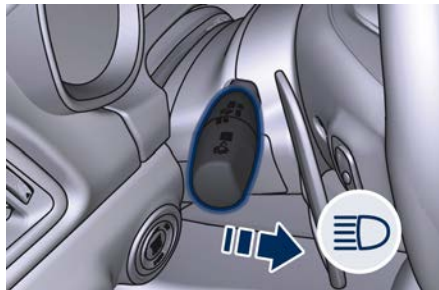

Flashing occurs also with lights off (lights switch in position "0") if the ignition device is **RUN** position.



CAUTION!

The high beams can only be switched on manually by pushing the multifunction lever forward.



WARNING!

If the high beams are activated, they will turn on automatically every time the low beams are switched on either manually or automatically. We recommend therefore that you switch them off when they are no longer necessary and every time the twilight sensor deactivates the external lights.

Wiper and Washer Control

The multifunction lever is located on the left side of the steering column. The multifunction lever operates the wipers and washers acting on the windshield when the ignition device is placed in **RUN** or **ACC** position. A low fluid level of windshield washers is indicated by the warning light  and by the message on the instrument cluster.



To refill the fluid, see "Maintenance Procedures" in section "Maintenance and Care".

Windshield Wipers

- Rotate the end of the multifunction lever to one of the four settings to activate the automatic intermittent setting (see "Rain Sensing Wipers" paragraph in this chapter).



- For low speed wiper operation (stable position "LO"): rotate the end of the multifunction control lever forward to the first trigger after the intermittent setting.
- Rotate to the second trigger after the intermittent setting for high-speed (stable position HI) wiper operation.
- Rotate the end of the lever downward to the "MIST" position to activate a single wipe cycle. The wipers will continue to operate until you release the multifunction lever.
- The wipers will continue to operate until you release the multifunction lever.
- To turn the wipers off rotate the lever to "OFF".

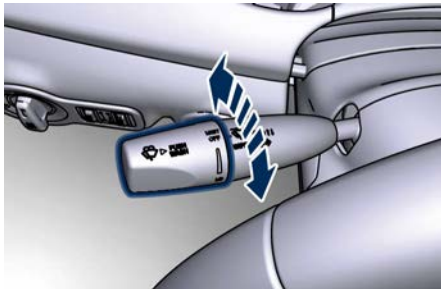

CAUTION!

- Turn the windshield wipers off when driving through an automatic car wash. The windshield wipers may be damaged if the wiper control is left in any position other than "OFF".
- In cold weather, always turn off the wiper switch and allow the wipers to return to the park position before turning off the engine. If the wiper switch is left on and the wipers freeze to the windshield, the wiper motor may be damaged when the vehicle is restarted.
- Always remove any buildup of snow that prevents the windshield wiper blades from returning to the off position. If the windshield wiper control is turned off and the blades cannot return to the off position, the wiper motor may be damaged.

Rain Sensing Wipers

This function detects moisture on the windshield through an internal rearview mirror integrated sensor, which automatically activates the relative wipers.

Rotate forward the end of the multifunction lever to one of four settings to adjust the detection system. First wiper delay position is the least

sensitive, and fourth wiper delay position is the most sensitive. Third position should be used for normal rain conditions.

The rain sense wipers will automatically change between an intermittent wipe, slow wipe and a fast wipe depending on the amount of detected moisture sensed by a particular area of the windshield. Place the wiper switch in the "OFF" position when you do not want to use the automatic intermittent system. The rain sensing function can be turned on and off using the MIA system, see "Functions of Settings Menu on MIA" in section "Dashboard Instruments and Controls" for further information.



CAUTION!

- The rain sensing function may not function properly by ice or dried salt water on the windshield.
- Use on the windshield of RainX® or products containing wax or silicone may reduce rain sensor performance.

The rain sensing system has protective functions for the wiper blades and arms. It will not operate under the following conditions:

- **Low temperature wipe inhibit:** the rain sensing function will not operate



when the ignition device is in **RUN** position, the vehicle is stationary and the outside temperature is below 32 °F (0 °C). To resume, set the automatic function on the multifunction lever, start the engine and drive or wait until the outside temperature rises above freezing.

- **Wipe inhibit with transmission in N (Neutral) position:** the rain sensing function will not operate when the ignition device is placed in the **RUN** position, the transmission shift lever is in the N (Neutral) position and the vehicle speed is less than 5 MPH (8 km/h). To resume, set the multifunction lever to the automatic function or move the shift lever out of N (Neutral).

Headlights On with Wipers

When activating this function, the headlights will light up approximately 10 seconds after the wipers acting on the windshield are turned on if the light switch is placed in "AUTO" position. In addition, the headlights switch off when the wipers are turned off (position "OFF") if they were previously turned by using this function. Powering on Headlights with wipers can be activated and deactivated with the MIA system, see "Functions of Settings Menu on MIA"

in section "Dashboard Instruments and Controls" for further information.

Wiper Blade Maintenance

When the wiper arms are in the rest position it is not possible to check or replace the blades (Service position) as they are folded under the hood. To service the blades (see paragraph "Wiper Maintenance and Blades Replacement" in chapter "Maintenance Procedures" of section "Maintenance and Care") it is necessary to shift the multifunction lever to "OFF" and the ignition device to **OFF** position.

Shift the control lever within 15 seconds to the "MIST" position (forward rotation of the end of the multifunction control lever) and release. The blades are brought in a position enabling to open the wiper arms and change the blades.

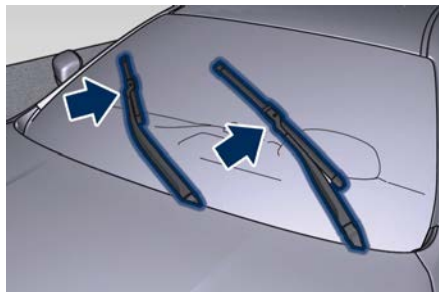

It is possible to use the "MIST" position for a maximum of 3 times within two minutes, corresponding to different three blades positions on the windshield. When completed, bring the ignition device in **RUN**: the arms will reposition. If necessary move the multifunction lever to other required operating positions.



WARNING!

Operate or service the windshield wiper blades without deactivating the wipers ("OFF" position), leaving the ignition device in RUN can be dangerous for the operator since the rain sensor may suddenly activate the wipers. Always use "Service" position for any intervention on the windshield wiper blades.

Windshield Washers

To use the washer, push the end of the multifunction lever inward (toward the steering column) and hold it as long as washer spray is desired.

If you activate the washer while the windshield wiper control is in the automatic intermittent range, the wipers will operate for two wipe cycles after releasing the lever and then resume the previously selected intermittent interval.



If you activate the washer while the windshield wiper is turned off ("OFF" position) the wipers will operate for three wipe cycles and then turn off.

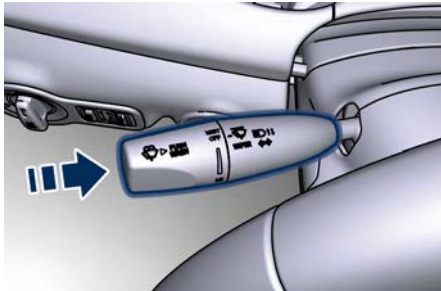

WARNING!

- Do not start the windshield washer during the cold months until the windshield has warmed up. If it has not warmed up, the liquid could freeze on the glass and block your view.
- Sudden loss of visibility through the windshield could lead to a collision. You might not see other vehicles or other obstacles. To avoid sudden icing of the windshield during freezing weather, warm the windshield with the defroster before and during windshield washer use.

Heated Windshield Washer Nozzles (OPT)

To avoid fluid freezing inside at low external temperatures, the fluid supply nozzles can be heated by internal resistors.

Analog Clock

To adjust the analog clock located on the center of the dashboard between the air outlets, use the MIA system (see "Functions of Settings Menu on MIA" in this section).



The time can be visualized also on the MIA upper status bar and on the instrument cluster display (see "Functions of Settings Menu on MIA" in this section).

Clock lighting works in the same way as instrument and controls backlighting (refer to "Interior Lighting" in section "Understanding the Vehicle").



Glove Box Compartment

There are two glove box compartments on the dashboard sides to store devices, small items or documents.



WARNING!

Do not operate the vehicle with a lid glove box compartment in the open position. Cellular phones, music players, and other handheld electronic devices should be stowed while driving. Use of these devices while driving could cause an accident due to distraction.



CAUTION!

Do not place objects weighing over 22 lb (10 kg) in the glove box compartment.

Glove Box Driver Side

To open the glove box on the driver side, pull the handle as indicated.



The compartment is ca. 6 in (15 cm) deep and is lit by two courtesy lights when open (the light automatically switches off when the compartment is closed).



Glove Box Passenger Side

To open the glove box on the passenger side, pull the handle as shown in the picture.



The compartment is divided into two parts: in the lower part you can find one of the two on-board documentation kits, while in the upper part you can fit small items.



The compartment is illuminated by a courtesy light when open (the light will automatically switch off when the compartment is closed).

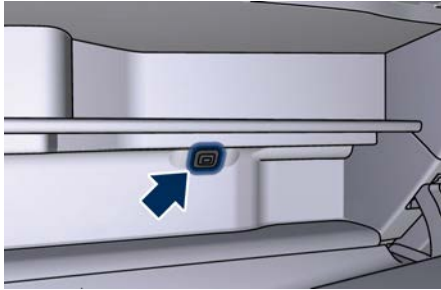

Privacy Lock Functions

The glove box compartment in the passenger side can be equipped with an opening/closing electric actuator that can be locked and unlocked via the MIA, by entering a 4-digit PIN code. These functions are useful for example when you have to leave the vehicle to another driver (for example, valet parking).

"Glove Box" function allow you to only lock the glove box and is available in the "Controls" menu of the "Vehicle" page and in the "Apps" page.

"Valet Mode" function is only available in the "Profiles" page and, in addition to lock the glove box, allows you to lock all the driver profiles for listening and guidance.

It is important to memorise and take note of the PIN since if it is lost, you

must contact the **Maserati Service Network** that will reset this function.

NOTE:

- "Glove Box Mode" and "Valet Mode" can not be activated at the same time.
- "Glove Box Mode" and "Valet Mode" lock functions must be activated when the glove box is already closed. If you activated one of these lock functions when the glove box is opened, the glove box will not close properly and will not lock.

Glove Box Activation Procedure

- Open "Controls" screen and touch "Glove Box" soft-key.

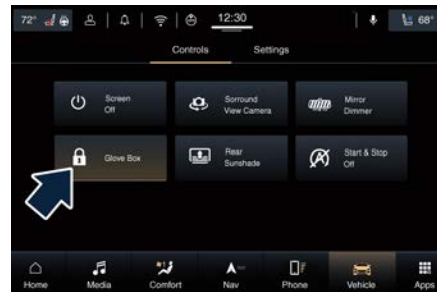

- Touch "Yes" soft-key in the function described screen to activate the function.



- Using the keypad, enter the four digits of the PIN and touch "OK". The system prompts you re-enter the PIN code to confirm it.



NOTE:

- To activate and deactivate the function, the user has 10 attempts to type a 4 digit PIN before system cancels the deactivation. The user can try again in 30 minutes.

(Continued)



(Continued)

- If you do not enter all PIN digits, a prompt will indicate that you should do so.
- In case of an incoming call while entering the PIN, the MIA system will temporarily stop the release function. As soon as the call is over, the keypad screen will be displayed again so that you can enter the PIN.
- When the next page shown in figure appears, touch "OK".



Glove box is now locked and the MIA will go back to "Controls" page. In this condition, system operation is reduced and only "Climate", "Controls" and "Settings" functions are active.

Glove Box Deactivation Procedure

To unlock the glove box which has been locked with PIN code, touch "Vehicle" category soft-key and open the "Controls" menu.

- Touch the "Glove Box" soft-key to enter this page.
- Unlock glove box by entered the lock code as previously specified.
- Touch "OK" to deactivate the function.



Glove Box Manual Unlock

If battery is dead, it is necessary to manually unlock the actuator on the LH side of the glove box in order to open the glove box that has been locked using the PIN code.

To perform this operation you need to remove the lower dashboard moulding to access the actuator unlocking cable. Considering the complexity of this operation, we recommend you to contact an **Authorized Maserati Dealer**.

Valet Mode Activation Procedure

- Open "Profiles" screen and touch "Valet mode" soft-key.



- Touch "Yes" soft-key in the function described screen to activate the function.



- Using the keypad, enter the four digits of the PIN and touch "GO".



NOTE:

- To activate and deactivate the function, the user has 10 attempts to type a 4 digit PIN before the system cancels the deactivation. The user can try again in 30 minutes.
- If you do not enter all PIN digits, a prompt will indicate that you should do so.
- In case of an incoming call while entering the PIN, the MIA system will temporarily stop the release function. As soon as the call is over, the keypad screen will be displayed again so that you can enter the PIN.

"Valet Mode" activated will be indicated in the main status bar with a  lock symbol combined with the Profile icon. In this condition if the user touches the Profile icon in the main status bar a pop-up will indicate that

the function is not available in Valet Mode.

To Exit Valet Mode Function

To exit Valet Mode function touch the "Exit Valet Mode" soft-key in the "Welcome" pop-up at key on.

Deactivate the function by entering the lock PIN code as previously specified.

NOTE:

Valet Mode function cannot be deactivated while the vehicle is in motion.

Air Conditioning Controls

The vehicle is equipped with an automatic dual-zone air conditioning system that allows to adjust separately the temperature and the airflow distribution in the left and in the right zone of the passenger compartment, according to the requests of the driver and the front passenger.

A humidity sensor, positioned on the inner surface of the windshield, over the rear view mirror, allows the A/C system to prevent/eliminate fogging of the windshield and side windows.

The best efficacy in preventing fogging is obtained by selecting the "AUTO" function, described later.

A dual zone solar sensor helps to achieve the best comfort in presence of solar radiation.

Climate Controls

This system can be operated by using the controls of the climate control panel on the dashboard, or the soft-keys on the MIA display when "Comfort" mode is selected.

To monitor the comfort parameters on board, you can also access the widget page from the "Home" screen and choose the "Climate" widget (see example in picture).



4



To navigate the MIA screen, it is possible to use the "TUNE-SCROLL" lower rotary knob on the central console to scroll through the soft-key of each function: the cursor will appear in grey outline on the first available function. Press "BROWSE/ENTER" button to enter the selected function and to adjust it through the "BROWSE/ENTER" knob.

In the "Climate" screen of the MIA, the front seats and steering wheel comfort setting soft-keys may be present (optional equipments). The "OFF" state of the front seats comfort setting is shown on their soft-key.

The front seats and steering wheel comfort setting soft-keys may be present in the upper status bar if the car is equipped with these devices. When these are active, the related icon is colored red or blue: when they are not active, it is grey (see "Front Seats"

and/or "Steering Wheel Adjustment" in section "Understanding the Vehicle" for further details).

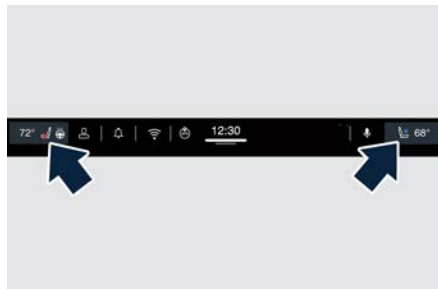

Front seats and steering wheel comfort setting soft-keys are present even when the A/C is off.

When the MIA system is in any category other than "Comfort" ("Home", "Media", "Phone", etc.) the driver and passenger temperature is always visible on the upper status bar together with the front seats and steering wheel comfort functions (if equipped).

Description of Controls

All described functions can be set and modified using the controls on the climate control panel or the soft-keys on the MIA display.

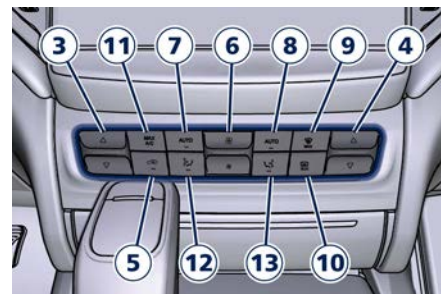

Press any of controls on the climate control panel to display "Comfort" screen.

To adjust driver and passenger side temperature and fan speed, climate control panel features rocker switches that can be pushed up to increase temperature/speed, or down to decrease them.

When MIA is in any category other than "Comfort", pressing an air distribution or blower hard control on



the climate control panel a small pop up will appear for 3 seconds above the "Comfort" icon on the main category bar (see example in picture).



1. Climate control on/off

Once you enter the screen "Climate", touch the "ON" soft-key to switch the climate control on/off.



The "OFF" soft-key will appear in place of "ON" when the A/C is on. If the A/C system has been turned off,

temperature values in the upper status bar will be obscured in all MIA modes.

NOTE:

For the vehicles equipped with Remote Start, the Air Conditioning System will not function during Remote Start operation if the climate control is left in "OFF".

2. A/C

Touch the A/C soft-key to change the current air conditioning setting; the soft-key illuminates when the A/C is on. Operating this function will cause the automatic function to switch into manual mode and the "AUTO" LED on the buttons and MIA soft-key will turn off.

3. Driver temperature control

Provides the driver with independent temperature control. Touch the blue √ soft-key for cooler temperature.

Touch the red ^ soft-key for warmer temperature. The driver's temperature setting will be displayed on the upper status bar, left side.

The temperature can also be adjusted by pressing and sliding the bar towards soft-key ^, to increase temperature, or towards soft-key √ to decrease it.

During this phase, the corresponding temperature will be displayed on the upper status bar.

It is possible to adjust the temperature on the driver and passenger side even when you are outside the "Comfort" screen by simply touching the temperature indication on the upper status bar. A pop up will appear below with the bar and √/^ arrows to change the temperature and the "SYNC" soft-key to synchronise the driver's side temperature with which of the passenger side (see example in picture).



You can also increase or decrease the temperature using the rocker switch on the climate control panel.

(Continued)







NOTE:

In "SYNC" mode, this control will also automatically and simultaneously adjust the passenger temperature.

4. Passenger temperature control

Provides the passenger with independent temperature control.

Touch the  soft-key for cooler temperature. Touch the  soft-key for warmer temperature. The passenger's temperature setting will be displayed on the upper status bar. The temperature can also be adjusted by touching and sliding the bar towards soft-key ,  increase temperature, or towards soft-key  to decrease it.

During this phase, the corresponding temperature will be displayed on the upper status bar as for the driver's side.

You can increase or decrease the temperature using the rocker switch on the climate control panel.

NOTE:

Pressing the **4** button/soft-key while in "SYNC" mode will automatically exit "SYNC".

5. Recirculation

Press to change the current setting, the LED indicator on the button and the relevant soft-key illuminates to indicate which recirculation function is activated. For further details, see paragraph "Climate Control Functions" in this chapter.

6. Blower control

Blower control is used to adjust the amount of air forced through the climate system. Eight levels of blower speed can be selected. Adjusting the blower will cause automatic mode to switch to manual.

On the climate control panel, push the rocker switch up to increase blower speed. Push the rocker switch down to decrease blower speed. Pushing down the rocker switch when set blower is at the first speed, causes the A/C system shutdown (OFF condition).

On the MIA display, touch the number corresponding to the blower speed you want to set.

When the MIA is displayed in any mode other than "Climate", the blower speed is indicated by the bright segments in the climate icon.

7 - 8. AUTO

This function automatically controls the interior temperature by adjusting the air flow rate and the air

distribution respectively on the driver and on the passenger zone. Press "AUTO" to switch the ATC between manual and automatic mode. The LED on the button and the "AUTO" soft-key illuminates when the automatic function is activated. See "Automatic Temperature Control (ATC)" in this chapter for more information.

9. MAX defrosting/demisting

Press the  button or the MIA soft-key to switch the airflow setting to the windshield and the front side windows to get quick defrosting/defogging. The LED on the button and the MIA soft-key illuminates when this function is activated. Operating this function will cause the ATC to switch into manual mode: so the "AUTO" LED on the button and the MIA soft-key will turn off. With engine off, the blower will run at minimum speed (level 1) and can be increased manually: with engine on, the blower speed will gradually increase to the higher speed (level 8). MAX defrosting/demisting shall also involve REAR defrosting/demisting function. If this function is turned off the climate system will return to the previous setting, switching on the A/C ("A/C" LED on the button and the MIA soft-key illuminated).



10. REAR defrosting/demisting

Press the  button or the MIA soft-key to turn on the rear window defroster and the heated outside mirrors. The LED on the button and the MIA soft-key will illuminate when the rear window defroster and the heated external mirrors are on. The rear window defroster and the heated external mirrors automatically turn off after 15 minutes.

For any subsequent request after the first one (in the current ignition cycle), the system activates the function for 5 minutes. The timing described above is automatically reset and the defrost/demisting function is deactivated at each key-off.



CAUTION!

Failure to observe the following cautions may cause damage to the rear windows defroster:

- Use care when washing the inside of the rear window. Do not use abrasive window cleaners on the interior surface of the window. Use a soft cloth and a mild washing solution, wiping parallel to the heating elements. Labels can be peeled off after soaking with warm water.

- Do not use scrapers, sharp instruments, or abrasive window cleaners on the interior surface of the window.
- Keep all objects inside the vehicle at a safe distance from the window.

11. MAX A/C

By pressing the "MAX A/C" button or the MIA soft-key, the system automatically switches to get the maximum cold air flow in both zones.

12-13 Air flow distribution modes

The airflow distribution mode, respectively on the driver and on the passenger zone, can be adjusted so air comes from the dashboard vents, vents under the dashboard in direction of the floor, demist/defrost vents and vents under the front seats and adjustable vents at the rear end of the central console for the rear passengers only.

The climate control panel features a single button for each zone: press it several times to select and set the required airflow distribution mode. The airflow mode combinations will cycle in this order: "Dashboard" → "Bi-Level" → "Floor" → "Mix" → "Defrost" → "Hi-Level" → "Tri-Level". When MIA are out of the "Comfort" page, each time the button is pressed, a pop up

will appear with the airflow mode activated.

When in the "Comfort" category, the MIA displays the relevant soft-keys to set these modes individually for each zone.

The arrow on the  symbol soft-key in white indicates active status, in grey indicates inactive status.

Available settings are as follows:

- "Dashboard" mode 

Air for each zone flows from four adjustable vents of the dashboard and two positioned at the rear end of the central console. Each of these vents can be singly adjusted. The air grids or vanes of the vents can be moved to adjust air flow direction. A setting wheel, placed near each vent, allows to regulate or close the airflow.

- "Bi-Level" mode 

Air for each zone flows from the dashboard and central console adjustable vents and from the fixed floor vents described in "Floor" mode. A small portion of the airflow is directed through the defrost/demist vents to prevent windows fogging.

(Continued)



NOTE:

Bi-Level mode is designed to let cooler air come in the dashboard and rear part of the central floor vents and warmer air from the floor vents.

• **"Floor" mode**

Air for each zone flows from the fixed front vents, located under the dashboard, and under the front seats for the rear passengers. A small portion of the airflow is directed through the defrost/demist vents to prevent windows fogging.

• **"Mix" mode**

Air for each zone flows from the defrost/demist vent, the fixed vent under the dashboard and which from floor vent described in "Floor" mode. This mode is recommended for cold climates, to improve comfort and prevent windows fogging.

• **"Defrost" mode**

Air for each zone flows from the dashboard defrost/demist vents to prevent windows fogging.

• **"Hi-Level" mode**

Air for each zone flows from the dashboard defrost/demist vents, from the dashboard and central console adjustable vents and from the fixed

floor vents described in "Floor" mode.

• **"Tri-Level" mode**

Air for each zone flows from all the adjustable/fixed and defrost/demist vents.

14. "SYNC" mode

Touch the "SYNC" soft-key on the MIA to switch the Sync function on/off. The "SYNC" soft-key illuminates when this function is selected. This function is used to synchronise the passenger temperature setting with the driver temperature setting.

It is possible to activate this function even when MIA is in any category other than "Comfort" through the pop up window that opens when you touch the driver's temperature soft-key on the upper status bar.

Changing the passenger temperature setting while in "SYNC" will automatically exit this function.

Climate Control Functions

Air Conditioning (A/C)

The "A/C" soft-key allows to manually activate or deactivate the air conditioning system. When the air conditioning system is turned on, cool dehumidified air will flow through the vents into the cabin. For improved fuel economy, touch the "A/C" soft-key

to turn off the air conditioning and manually adjust the blower and airflow mode settings.

When the A/C and automatic functions are switched off it is not possible to have air at a lower temperature than the outside.

Recirculation and Air Quality Sensor (AQS)

When outside air contains smoke, odours, or high humidity, or if rapid cooling is desired, you may wish to recirculate interior air by pressing the recirculation control button or the relevant soft-key button to activate the two different functionalities.

The recirculation function, that allows to open/close the A/C air inlet by operating the button on the climate control panel or the MIA soft key, is integrated with the Air Quality Sensor.

This sensor, positioned upstream of the A/C filter, in front of the air intake of the A/C system, detects the presence of polluting substances and submits an electric signal to the A/C control unit, that closes the intake of the external air by activating the air recirculation.

The button or the MIA soft-key can therefore enable 3 operating



modes, switchable in sequence: "Auto", "Manual" and "Open".

Starting from the outside air condition ("Open" mode) with LED on the button off and MIA soft-key not highlighted, in which the external air is aspirated by the A/C system and treated to be introduced into the passenger compartment, subsequent actuations of the button or the MIA soft-key change the state as follows.

- First press - "Auto" mode : the A/C system activates the automatic recirculation control by using the signal transmitted from the AQS. The symbol "A" on the button lights up and the MIA soft-key with the symbol "A" in white lights up.
- Second press - "Manual" mode: the A/C system activates the recirculation, the LED on the button light up and the MIA soft-key with the symbol "A" in white lights up. The A/C system will stay this way up to a new actuation, or until the increased humidity could lead to windshield fogging: in this case the recirculation automatically switches to external air.
- Third press - "Open" mode: the A/C system switches back to external air (default operating mode).

The next press of the button or the MIA soft-key restarts the operating cycle just described.

NOTE:

To avoid the risk of fogging, the AQS is disabled when the external temperature falls below 2°C (35°F) or rises above 26°C (79°F).

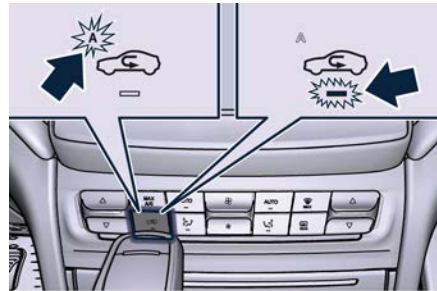

NOTE:

In cold weather, use of recirculation mode may lead to window fogging. Select the MIX mode and increase the blower speed to prevent fogging.

MAX A/C

Activating this function, the system switches to exit "AUTO", enter "A/C" and recirculation. The minimum temperature (LO) in both zones, the maximum blower speed and the "Dashboard" air distribution mode are also selected.

The blower speed can be adjusted and the air distribution can be modified without exiting "MAX A/C". To exit "MAX A/C" touch the relevant MIA soft-key or exit A/C or recirculation. Selecting , "AUTO", or "OFF", will also exit "MAX A/C".

Automatic Temperature Control (ATC)

Automatic operation

The system activates automatic mode in the following ways:

- Press the "AUTO" soft-key of driver and/or passenger zone on the climate control panel or the relevant soft-key button on the MIA screen. The text "Auto" and the fan in white



will appear inside the area usually occupied by the blower speeds.



4

- Set the desired temperature adjusting the driver and/or passenger temperature control buttons or soft-keys. The system automatically work to maintain the best comfort level inside the passengers compartment.
- When the system is set up for your comfort level, it is not necessary to change the settings anymore, simply allow the system to function automatically.

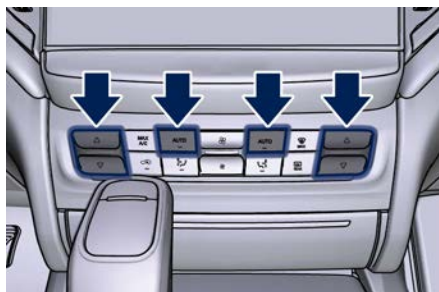

- To provide you with maximum comfort in the automatic mode, during cold start-ups the blower speed will remain low until the engine warms up.
- AUTO mode can be deactivated by operating any airflow or blower controls and by pressing "AUTO", "A/C", "MAX AC", "MAX" or "OFF" button or the same MIA soft-key.

Manual operation

The system allows manual selection of blower speed, air distribution mode, A/C status and recirculation control. The blower fan speed can be set to any fixed speed by using the blower control. In this case the blower will operate at a fixed speed until a different speed is selected. This allows the front occupants to control the volume of air circulated in the vehicle exiting the "AUTO" mode.

The user can also choose the direction of the airflow by selecting one of the available mode settings. A/C operation, recirculation control and "SYNC" mode can also be manually selected.

Operating Tips

- Continuous use of the air recirculation in winter, in rainy weather or humid climate is not recommended because it may cause window fogging.
- Interior fogging on the windshield can be quickly removed by fast defrosting/defogging. The "Mix" mode can be used to maintain a clear windshield and provide sufficient heating. If side window fogging becomes a problem increase blower speed.

NOTE:

- *Recirculation mode without A/C should not be used for long periods of time, as fogging may occur.*
- *If inside the passenger compartment there are conditions of high temperature and humidity, when the A/C compressor is switched on (A/C softkey illuminated on MIA display or LED on climate control panel A/C button ON) there may be some cold*



steam at ventilation port outlet: this situation is normal and does not indicate air conditioning system malfunction.

- *Automatic Temperature Controls (ATC) will automatically adjust the climate control settings to prevent or eliminate window fogging on the front windshield.*
- Make sure the A/C system air intake grille, located under the bonnet directly in front of the windshield, is free of obstructions such as leaves or other objects. Leaves collected in the air intake may reduce airflow, and if they enter the plenum, they could plug the water drains. In winter make sure the air intake is clear of ice, slush, and snow.
- The temperature can be displayed in US or Metric. units by selecting the "Units" customer programmable function. See "Functions of Settings Menu on MIA" in this section.
- Any time you store your vehicle or keep it stationary (i.e., during vacation) for two weeks or more, run the air conditioning system at idle for about five minutes in the fresh air by high blower setting. This will ensure adequate system lubrication and minimize the possibility of

compressor damage when the system is started again.

A/C Filter

The climate control system filters outside air containing dust, pollen and some odors. Strong odors cannot be totally removed by A/C filter at the entrance of the air climate system. See "Maintenance Procedures" in section "Maintenance and Care" for filter replacement instructions.





5 - Starting and Driving

| | |
|---|-----|
| Normal Starting of the Engine | 146 |
| Remote Start System | 148 |
| Automatic Start&Stop System | 150 |
| Automatic Transmission | 153 |
| All-Wheel Drive (AWD version only) | 162 |
| Drive Mode | 163 |
| Launch Control Mode (TROFEO version only) | 176 |
| Parking Brake | 177 |
| Parking | 181 |
| Using the Brakes | 183 |
| Use of the Engine | 184 |
| Refueling | 186 |
| Driving Conditions | 188 |



Normal Starting of the Engine



WARNING!

It is dangerous to run the engine in an enclosed area. The engine consumes oxygen and discharges carbon dioxide, carbon monoxide and other toxic gases in the atmosphere.

When doors are opened, the instrument cluster displays the model logo in the center and the complete odometer plus the open doors indicator  in the lower part of the cluster.



Before starting the engine, close the doors, adjust your seat, the inside and outside mirrors, fasten your seat belt and instruct all other occupants to buckle their seat belts.

The shift lever must be in P (Park) or N (Neutral) position before you can start the engine. Apply the brakes before shifting into any driving gear (see "Automatic Transmission" in this section).



CAUTION!

- Before starting the engine, switch off the electrical devices with a high power consumption (air-conditioning and heating system, heated rear window, headlights, etc.).
- Do not start the engine if the fuel level in the tank is low.

The keyless ignition allows the driver to operate the ignition device by pushing the center button, as long as the key fob is within the passenger compartment (check "Keys" in section "Before Starting" for further information).

By pressing the brake pedal and pushing the **START/STOP** button the engine starts. Instrument cluster displays the initial sequence with warning light and analog instruments test routine and switch-on of the engine temperature indicators and fuel level. This happens if option "Key-On Display" was set in "Screen Setup" submenu for display switch-on (see

chapter "TFT Display Setting and Menu Overview" in section "Dashboard Instruments and Controls").



The current display subsequently sets up with the latest screenshot.

If the engine fails to start, the starter will disengage automatically after 10 seconds. If you wish to stop the cranking of the engine prior to starting it, press the button again.

NOTE:

Normal starting of either a cold or a warm engine is obtained without pumping or pressing the accelerator pedal.

If the driver only pushes the **START/STOP** button but does not press the brake pedal, the ignition device cycles to the **ACC** position (see "Keys" in section "Before Starting") and the



instrument cluster displays the latest screenshot.

At the third press of the **START/STOP** button the ignition device returns to **OFF** position and the display powers down.

At the fourth press of the **START/STOP** button the screen will display the message that invites you to press the brake pedal and push the **START/STOP** button to start the engine.

NOTE:

*If the ignition device is left in the **ACC** or **RUN** (engine not running) position and the transmission is in P (Park), the system will automatically time out after 30 minutes of inactivity and the ignition device will switch to the **OFF** position.*

After starting the engine, the idle speed is controlled automatically and will decrease as the engine warms up.

Engine Start Failure



CAUTION!

- Do not attempt to push or tow your vehicle to get it started. Vehicles equipped with an automatic transmission cannot be started this way. Moreover, unburned fuel could

enter the catalytic converter and once the engine has started, ignite and damage the converter and vehicle.

- If the vehicle has a discharged battery, booster cables may be used to obtain a start from a booster battery or the battery in another vehicle. This type of start can be dangerous if done improperly. See "Auxiliary Jump Start Procedure" in section "In an Emergency" for further information.

Flooded Engine Clearing

If the engine fails to start after you have followed the described procedures, it may be flooded. To clear any excess fuel, move the shift lever in P (Park) position. Press and hold the brake pedal, push the accelerator all the way to the floor and hold it, then press and release the **START/STOP** button once. The starter will engage automatically, run for 10 seconds, and then disengage. Once this occurs, release the accelerator pedal and the brake pedal, wait 10 to 15 seconds, then repeat the normal starting of the engine procedure.

Starting and Driving with a Cold Engine

Start-off slowly, avoiding sudden acceleration and rev the engine up at low medium speeds. High performance driving should be avoided until the engine temperature reaches 65-70°C (149-158°F).

Engine Turn-Off

- With the shift lever in P (Park), D (Drive) or R (Reverse) positions (see "Automatic Transmission" in this section) and vehicle standstill, press and release the **START/STOP** button to switch off the engine. A burst on the accelerator pedal before turning off the engine has no purpose and increases fuel consumption.
- If the shift lever is in N (Neutral) and the **START/STOP** button is pressed once, the instrument cluster will display a "Vehicle Not in Park" message and the engine will remain running.



WARNING!

Never leave a vehicle out of the P (Park) position, as it could move.

(Continued)



NOTE:

If the ignition device is left in the **ACC** or **RUN** (engine not running) position and the transmission is in P (Park), the system will automatically time out after 30 minutes of inactivity and the ignition device will switch to **OFF** position.

Engine Turn Off when in Automatic Start&Stop

When the engine has been turned off by the Start&Stop system, press and release the **START/STOP** button. The ignition device will return to the **OFF** position and the vehicle is off.

"Panic Stop" Strategy

In panic conditions, if driver stops engine in any non-standard manner while driving at a speed over 5 MPH (8 km/h), the "Panic Stop" strategy can manage the situation by checking gearchange condition upon engine cutting, driver's action on brakes, road condition (flat or slope) so as to set gearchange to the most suitable condition.

Remote Start System

This system enables the key fob to start the engine conveniently from outside the vehicle while still maintaining security. The system has a range of approximately 300 ft (91 m). Obstructions between the vehicle and the key fob may reduce this range.

NOTE:

Changes or modifications not expressly approved by the party responsible for compliance could void the user's authority to operate the equipment.

If your key fob fails to operate from a normal distance, check for these conditions:

- A weak battery in the key fob. The expected life of the battery is a minimum of three years.
- Closeness to a radio transmitter such as a radio station tower, airport transmitter, and some mobile or CB radio.
- Obstructions between the vehicle and the key fob.

How to use Remote Start

All of the following conditions must be met before the engine will remote start:

- System not disabled from previous remote start event.

- Vehicle theft alarm not active.
- Doors closed.
- Hood closed.
- Trunk lid closed.
- Hazard lights switched off.
- Brake pedal not pressed by any passenger remained in the vehicle.
- Battery at an acceptable charge level.
- The shift lever is in P (Park) position.
- The vehicle transmission is in automatic mode.
- The remote start has not been activated yet two consecutive times.

If EPB (Electric Parking Brake) is not inserted, at key-off in some conditions the remote start system may not allow engine to start. We suggest to set "Auto Apply On" function through the switch on the right-side of the steering wheel (refer to "Parking Brake" in this section).



WARNING!

- Do not start or run an engine in a closed garage or confined area. Exhaust gas contains Carbon Monoxide (CO) which is odorless and colorless.
- Keep key fobs away from children. Operation of the Remote Start System, windows, door locks or



other controls could cause serious injury or death.

Engine Remote Start Abort Message on Instrument Cluster

The following messages will display on the instrument cluster if the vehicle fails to remote start or exits remote start prematurely:

- "Remote Start Cancelled Door Open".
- "Remote Start Cancelled Trunk Open".
- "Remote Start Cancelled Fuel Low".
- "Remote Start Cancelled Time Expired".
- "Remote Start Disabled Start Vehicle to Reset".

The message on the instrument cluster stays active as long as the ignition device is in **RUN** position.

To enter Remote Start Mode

NOTE:

On some versions, the remote start button (x2) on key fob is replaced by the **PANIC** button.

Press and release the button (x2) on the key fob twice within five seconds. The vehicle doors will lock, position lights will flash and the horn will ring twice (if the "Sound Horn with Remote

Start" function of the "Doors & Locks" submenu is activate using the MIA system, refer to "Functions of Settings Menu on MIA" in section "Dashboard Instruments and Controls"). Then, the engine will start and the vehicle will remain in the "Remote Start" mode for a 15-minute cycle.



NOTE:

- In case of an engine fault or low fuel level, the vehicle will start and then shut down in 10 seconds.
- The position lights will turn on and remain lit during "Remote Start" mode.
- For security reasons, power window and power sunroof operation (if equipped) are disabled when the vehicle is in the "Remote Start" mode.

- The engine can be started two consecutive times (two 15-minute cycles) with the key fob. However, the ignition device must be cycled to the **RUN** position before you can repeat the start sequence for a third cycle.

To exit Remote Start Mode without Driving the Vehicle

Press and release the button (x2) one time or allow the engine to run for the entire 15-minute cycle.

NOTE:

To avoid unintentional shutdowns, the system will disable the one time press of the button (x2) for two seconds after receiving a valid "Remote Start" request.

To exit Remote Start Mode and Drive the Vehicle

Before the end of 15-minute cycle, press and release the button (lock) on the key fob to unlock the doors and disarm the vehicle security alarm. Then, prior to the end of the 15-minute cycle, press and release the **START/STOP** button.

(Continued)



NOTE:

The message "Remote Start Active Push Start Button" will display in the instrument cluster until you push the **START/STOP** button.

Driver's Seat Comfort with Remote Start

The driver's heated and ventilated seat and the heated steering wheel (if foreseen) can be programmed to come on during a remote start. Refer to "With Vehicle Start" function of the "Seats & Comfort" submenu in the "Settings" page (see chapter "Functions of Settings Menu on MIA" of section "Dashboard Instruments and Controls" for further information).

Radio Frequency RKE Transmitter - Regulatory Information

The "Regulatory Information" for all the radio frequency and radar devices can be consulted by accessing the section "Services" section on the website www.maserati.com.

Automatic Start&Stop System

The Maserati Start&Stop system allows the engine to automatically switch off when the vehicle stops and to restart when the driver intends to drive. This function helps reduce fuel consumption. During the "Stop (AutoStop)" phase the ignition is still on and all security functions are available.

In order for the Start&Stop to activate, the vehicle must be stationary and the brake pedal adequately pressed.

NOTE:

If the brake pedal is not sufficiently pressed the Start&Stop may not function even if the vehicle is stopped.

When the Start&Stop switches off the engine, the related light **(A)** illuminates on the instrument cluster.

As soon as the brake pedal is released, the engine turns on.

While the vehicle is stopped, the transmission can be placed in P (Park) pressing the "P" button on the shift lever.

In this case it is possible to release the brake pedal and the vehicle will remain in "AutoStop" with engine off.

Pressing the brake pedal and shifting transmission into D (Drive) or R (Reverse) will deactivate the "AutoStop" condition and restart the engine.



Start&Stop Deactivated

Start&Stop function is deactivated under the following conditions:

- When SPORT drive mode is activated.
- When  (ESC Off) drive mode is activated.
- If it has been disabled through the main menu item "Start&Stop", via the controls located on the right side of the steering wheel, or through the Start & Stop hard button on the central console (see chapter "Drive Mode" in this section) or via the MIA in the "Controls" page (see "Functions of Controls Menu on MIA" in section "Dashboard Instruments and Controls").



Start&Stop Not Active

For keeping driving safety, interior comfort and a correct functioning of engine and vehicle, the Start&Stop function does not activate ( warning light on) under the following conditions:

- When the driver's seat belt is unbuckled (see example).



- When the driver door is open.
- When the fuel level is too low.
- When the vehicle is stopped on a very steep road.
- When the vehicle is stopped with steered wheels (over 135° of steering wheel angle for each part).
- When the vehicle is maneuvering: shift lever in R (Reverse).
- When the temperature conditions inside the vehicle do not correspond to the air conditioning setting.

- When the front and rear "defroster" function is activated.
- When the engine coolant and the engine oil temperature are not on proper functioning level.
- When the external temperature is too cold.
- When the battery charge is below safety value.
- When the previous stop had just happened (few seconds) and the minimum speed has not yet been achieved.
- Shortly after R (Reverse) has been set or when driving under a certain speed level.
- When the hood is open.
- The sensors managing the Start&Stop have been damaged.
- Start&Stop system faults are present.
- When Adaptive Cruise Control (ACC) and/or Active Driving Assist (ADA) system are engaged.

Automatic Restarting of the Engine

The engine may automatically restart, before the brake pedal has been released, when one of the following conditions occurs:

- The SPORT drive mode or  (ESC Off) drive mode is being activated.

- If the Start&Stop function has been disabled through the Start&Stop hard button on the central console (see chapter "Drive Mode" in this section) or via MIA in the "Control" page (see "Functions of Controls Menu on MIA" in section "Dashboard Instruments and Controls").
- If shift lever is moved to R (Reverse).
- If the steering wheel is moved to steer the wheels.
- When the temperature conditions inside the vehicle do not correspond to the air conditioning setting.
- When changing the temperature setting on the air conditioning.
- When the defroster function is being activated.
- When the battery charge is below safety value.
- When the accelerator pedal is being pressed (together with the brake pedal).
- If a long time has passed since the last automatic stop of the engine.

Occupants Safety Function

To enhance occupants safety, the Start&Stop system monitors if the driver is present and does not allow automatic restarting of the engine if one of the following manoeuvres is



being performed while in "AutoStop" condition:

- The driver unbuckles his/her seat belt and releases the brake pedal.
- The driver opens the door and releases the brake pedal.
- The driver unbuckles the seat belt and opens the door.
- The driver opens the hood.

All the above-mentioned conditions deactivate the Start&Stop function (the "AutoStart" is deactivated and the engine remains off) and the transmission shifts automatically in P (Park).

The  telltale will flash to indicate the Start&Stop function disabling. To restart the engine it is necessary to press the brake pedal and push the **START/STOP** button.

Move the shift lever to D (Drive) to drive away.



WARNING!

- **Even when the vehicle is stopped in the "Stop (AutoStop)" phase, the driver is responsible for the vehicle and the occupants and shall take care of what happens inside and outside the vehicle.**

- **Even when the vehicle is stopped within the "Stop (AutoStop)" phase, the vehicle driver is responsible for the vehicle, the vehicle's occupants and the vehicle's surrounding area. Never leave the vehicle unattended with the engine running; doing so poses a risk of danger. It is a good practice to always ensure to set the parking brake and place the transmission gear selector lever into the P (Park) position, thereby ensuring the vehicle will not move, when performing any vehicle checks, maintenance and/or service procedures on the vehicle.**

Start & Stop Function Disabling

Start & Stop enabled is the default status.

Under certain driving conditions, when frequent stops and restarts of the engine may become annoying, it is possible to disable the Start & Stop function in different ways.

- Press the Start&Stop hard button on the central console to the disable the function (see instructions in chapter "Drive Mode" in this section).
- Use the controls located on the right side of the steering wheel (see instructions in chapter "TFT Display Setting and Menu Overview" in

section "Dashboard Instruments and Controls") and hold the multifunction switch  to change the status of the function.

When the Start & Stop function is disabled, in addition to the related message the amber indicator  on the TFT display indicated in the picture and the same symbol on MIA upper status bar will turn on.



Other ways to disable the Start & Stop are via the MIA entering the "Vehicle" or  "Apps" menu.

- Entering the "Vehicle" page and touch the "Controls" soft-key.
- Touch the "Start & Stop Off" soft-key to disable the function.
- Touch a second time the same soft-key to re-enable the function.



NOTE:

The highlighted and yellow soft-key indicates the disabled status of Start & Stop system and vice versa.

- Touch the "Apps" soft-key on the main category bar or open the shortcuts page (shown in picture).
- Touch the "Start & Stop Off" soft-key to disable the function.

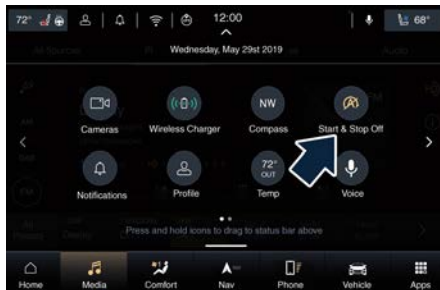

To quickly disable the Start&Stop function, you can insert it in the main status or category bar of

the MIA display (see "Maserati Intelligent Assistant Operation" in section "Dashboard Instruments and Controls"). Once it is set in the bar, the new menu will be immediately operational.

If the driving conditions allow it, the user can re-enable the Start&Stop function at any time using one of previous ways.

NOTE:

After user intervention, the Start&Stop system will automatically update the status of the function in all contexts where it can be modified.

Start&Stop System Failure

When the (A)! warning light and the related message illuminate on the TFT display (see chapter "Warning and Indicator Lights" in section "Dashboard Instruments and Controls") there is a malfunction in the Start&Stop system and the engine cannot be switched off and restarted automatically. To switch off or restart the engine it is necessary to push the **START/STOP**. Have the vehicle checked at an **Authorized Maserati Dealer**.

Automatic Transmission

The vehicle is equipped with an electronically controlled 8-speed automatic transmission, which automatically changes gear according to the vehicle's instantaneous usage parameters (vehicle speed, road gradient and accelerator pedal position).

It is possible to change gear manually thanks to the "M +/-" (Manual) position for the shift lever.

The electronic shift lever replaces the conventional mechanical lever and has no mechanical connection to the transmission. The transmission is operated by electrical actuators on the hydraulic system and all commands to the control system are transmitted by the CAN network. The lever itself represents a mere user interface. Gear positions are simulated by solenoids inside the lever body, which are computer-controlled and enable or disable certain positions of the lever. The solenoids inside the shift lever prevent the movement of the lever towards invalid positions.

The electronically-controlled transmission provides a precise shift schedule. The transmission electronics are self-calibrating, therefore the



gearshift behaviour could become perfect as expected after few hundreds of miles.



CAUTION!

In order to properly use the automatic transmission, it is essential that you read through the whole chapter, so that you can understand right from the start what the correct and granted operations are.

Damage to the transmission may occur if the following precautions are not observed:

- Shift into P (Park) only after the vehicle has come to a complete stop: this is the default position of the lever. After engaged P (Park) it is possible set the ignition device to OFF.
- Shift into or out of R (Reverse) only after the vehicle has come to a complete stop and the engine is at idle speed.
- Do not shift between P (Park), R (Reverse), N (Neutral) or D (Drive) when the engine is above idle speed.
- To effect any change from vehicle stop to R (Reverse), D (Drive), 1st or 2nd gear, it is necessary to keep the brake pedal fully depressed.



WARNING!

- It is dangerous to move the shift lever out of P (Park) or N (Neutral) if the engine speed is higher than idle speed. If your foot is not firmly pressing on the brake pedal, the vehicle could accelerate quickly forward or in reverse. You could lose control of the vehicle and hit someone or something. Only shift into gear when the engine is idling normally and when your foot is firmly pressing on the brake pedal.
- Unintended movement of a vehicle could injure those in or near the vehicle. As with all vehicles, you should never exit a vehicle while the engine is running. Before exiting a vehicle, always apply the electronic parking brake, shift the transmission into P (Park), and turn the engine off.
- Never leave children alone in a vehicle, or with access to an unlocked vehicle. Allowing children to be in a vehicle unattended is dangerous for a number of reasons. A child or others could be seriously or fatally injured. Children should be warned not to touch the parking brake, brake pedal or the shift lever.

- When leaving the vehicle, always remove the key fob and lock your vehicle.
- Do not leave the key fob in or near the vehicle. A child could operate power windows, other controls, or move the vehicle.

This vehicle is equipped with a function which requires the transmission to be placed in P (Park) before the engine can be turned off. This prevents the driver from inadvertently leaving the vehicle without having placed the transmission in P (Park). This system also locks the transmission in P (Park) whenever the ignition device is in the OFF position.

Automatic Transmission Lever

Automatic transmission is operated by a shift lever with unlock button, located on the central console, which can have the following operating positions:

- P (Park): button control;
- R (Reverse);
- N (Neutral);
- D (Drive) automatic forward speed;
- M +/- (Manual): "+" shifting to higher gear or "-" shifting to lower gear in manual mode (see "Drive Mode" in this section).

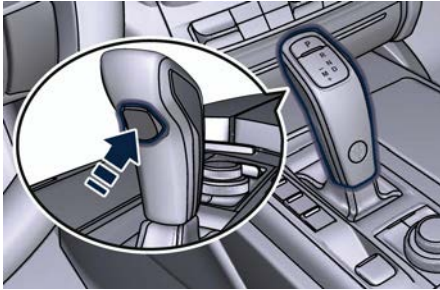

Transmission status is visible on the lever and on the lower part of the instrument cluster display.



Shift Lever Movements

Shift lever has two main positions with a single step selection (backward/forward): two unstable position (2) and (3) and two stable position (1) and (4).

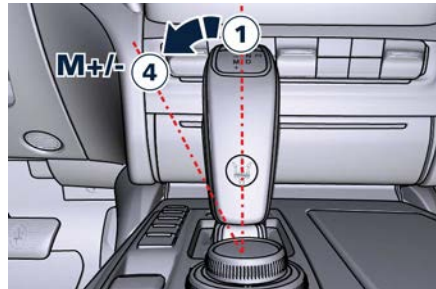
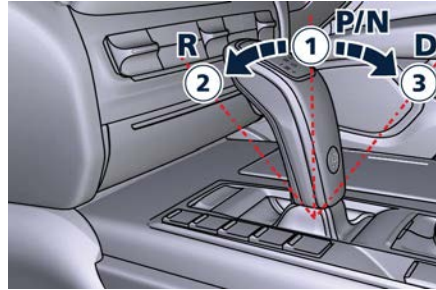

- Automatic lane ("R", "N", "D") as main central position.
- Manual lane ("M +/-") on left position: move forward for "-" and backward for "+".
- "P" is a button on the top of the lever.

Shift Lever Backlit

- White backlit for "P", "R", "N", "D" and "M +/-": brighter when selected and dimmer when not selected.

- When P (Park) mode is selected, the letter "P" becomes brighter and "P⁺" appears brighter near "N".

Backlit on the shift lever depends on the status of the ignition device.

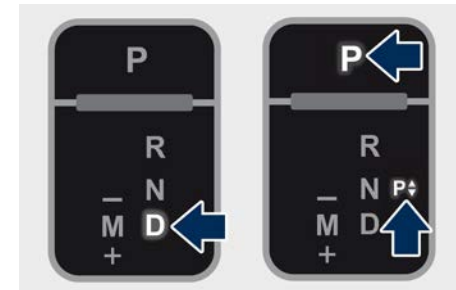

To Engage a Mode (briefly)

To select one of the operating modes, move the lever as previously indicated and press the brake pedal at the same time.

To engage "P" mode, driver must press the "P" button.

In order to engage "R" or "D" mode, driver have to move the shift lever by pressing the unlock button. If the unlock button is not pressed, the instrument cluster shows the popup message shows in picture.



The lever functions like a joystick, so releasing it after giving the command, it automatically returns to the two stable positions (vertical in line with "R", "N" and "D" or in line with "-" and "+" when in "M +/-" mode).

- To engage the N (Neutral) mode from R (Reverse) or D (Drive) mode, the driver has to move the shift lever while pressing the brake pedal.
- Normally, to engage R (Reverse) mode, press the brake pedal and the unlock button together.
- To pass from P (Park) mode directly to D (Drive) mode, in addition to pressing the brake pedal, it is also necessary to press the unlock button.
- Normally, to pass from R (Reverse) mode directly to D (Drive) mode and vice versa, in addition to pressing the brake pedal, it is necessary to press the unlock button.

- The P (Park) mode can be automatically enabled by pressing the "P" button: if the shift lever was in "M +/-" position, will go to central stable position automatically.
- To exit P (Park) mode, or to pass from N (Neutral) to D (Drive) or R (Reverse) position when the car is stopped or is moving at a low speed, press the brake pedal and the unlock button.
- If using the shift lever in M +/- (Manual) mode, you can activate it by moving the lever from D (Drive) to the left and then forward towards the "-" symbol or back towards the "+" symbol and the gear is shifted.



CAUTION!

- **DO NOT accelerate while shifting from P (Park) or N (Neutral) to another mode.**
- **After selecting a transmission mode, wait a few seconds before accelerating. This precaution is particularly important with a cold engine.**

Transmission Status on the Instrument Cluster Display

By pressing the unlock button on the lever, the gear change positions field is displayed: if you release the button without moving the lever, the

field disappears after 2 seconds. By operating instead the lever, the new range will be indicated in the field and in the lower part of the display.



If the vehicle is in D (Drive) status, in M +/- (Manual) or temporarily in manual drive mode, the gear position is indicated beside the lever status ("D" or "M"), on the lower part of the display.



The Instrument cluster will display the related indicator light **BRAKE** (United States market) or  (Canadian market) and the message for 5 seconds.



United States Market

Service Shift Lever

In the event of a shift lever malfunction, a message on the instrument cluster will invite to stop the car safely and turn off the engine. In this way the system moves the transmission in P (Park) position.

Automatic Transmission Range P (Park)

Use this position to park the vehicle. The transmission can be shifted from "P" position only with the brake pedal and the unlock button pressed: then move the shift lever. To move the shift lever from "P" position to any other position, the engine must be switched on. The engine can be regularly started in P (Park) range. Never attempt to use P (Park) while the vehicle is in motion. When parking on a level surface, you may press the "P" button first, and then apply the electronic parking brake by pulling the trigger upwards.



Canadian Market

When parking on a hill, apply the parking brake before pressing the "P" button.

For enhanced security, turn the front wheels toward the kerb on a downhill and away from the kerb on an uphill grade.



WARNING!

- **Never use the P (Park) mode as a substitute for the electric parking brake. Always apply the parking brake fully when parked to prevent vehicle movement and possible injury or damage.**
- **Make sure the transmission is in P (Park) before leaving the vehicle.**



CAUTION!

DO NOT race the engine when shifting from P (Park) or N (Neutral) into another gear range, as this can damage the drivetrain.

The following indicators should be used to ensure that you have engaged the shift lever into the "P" position:

- when shifting into P (Park), push the "P" button on the shift lever.
- with the brake pedal released, verify that "P" position is illuminated on the shift lever and in the instrument cluster display.

R (Reverse)

This range is used to move the vehicle backward.

Switching to R (Reverse) starting from N (Neutral) is only possible if the vehicle is moving backwards. We recommend to shift into R (Reverse) only after the vehicle has come to a complete stop.

- Vehicle stationary: switching between R (Reverse) and D (Drive), passing from N (Neutral), in addition to the action on the shift lever this requires applying the brake pedal and the unlock button being pressed.
- Vehicle moving: the driver can switch from R (Reverse) to N (Neutral) acting

on the shift lever without pressing the unlock button and the brake pedal.

N (Neutral)

- Vehicle stationary and engine started: switching from N (Neutral) to P (Park) requires "P" button pressed only. Switching from N (Neutral) to R (Reverse) and/or D (Drive) requires brake pedal and unlock button pressed and the action on the shift lever.
- Vehicle moving: switching from N (Neutral) to R (Reverse) and/or D (Drive) requires pressing the unlock button and the action on the shift lever. Switching to R (Reverse) starting from N (Neutral) is only possible if the vehicle is moving backwards, while switching to D (Drive) starting from N (Neutral) is only possible if the vehicle is moving forwards.

Set the parking brake and shift the transmission into P (Park) if you must leave the vehicle.

**WARNING!**

Do not switch to N (Neutral) and/or never turn off the ignition to coast downhill. These are unsafe practices that limit driver's response to changing traffic or road conditions. It is possible to lose control of the vehicle and have a collision.

**CAUTION!**

Towing the vehicle, coasting, or driving for any other reason with the transmission in N (Neutral) can result in transmission damage. See "Towing a Disabled Vehicle" in section "In an Emergency" for further information.

D (Drive)

This range should be used for most city and highway driving. It provides the smoothest upshifts and downshifts and the best fuel economy. The transmission automatically shifts up and down through all gears. The D (Drive) mode provides optimum driving characteristics under all normal operating conditions of the vehicle.

- Vehicle stationary: to switch from D (Drive) to R (Reverse) requires brake pedal and unlock button pressed and the action on the shift lever: to reach

N (Neutral) starting from D (Drive) is possible by only acting on the shift lever.

- To enable special operations while the car is moving at a low speed, such as getting out of marsh or snow, it is possible to run quickly from D (Drive) to R (Reverse), and vice versa, by pressing the unlock button and acting on the shift lever passing from N (Neutral).
- Vehicle moving: switching to N (Neutral) from D (Drive) it is not necessary to press brake pedal.
- From D (Drive) selected mode it is always possible to switch to M +/- (Manual) mode, by move the shift lever to the left (see following paragraph); to return to "D" position, move the shift lever to the right. It is possible to shift from D (Drive) mode to M +/- (Manual) mode regardless of car speed.
- When in D (Drive) mode, using the paddles behind the steering wheel (if equipped), will cause the system to enter a temporary function and enable the manual shift mode. This range is indicated with the symbols "+/-" above and below "D" letter on the gear range field of the display. The system will then switch back to automatic mode according to time

elapsed in "temporary" mode and driving conditions.

At extremely cold temperatures (-23 °F / -30 °C or below), transmission may be affected by the low temperature of the engine and transmission. Normal operation will resume once the transmission temperature has risen to a normal level.

M +/- (Manual)

This mode is obtained by moving the shift lever to the left in "M +/-" position.

In this mode, the transmission interacts with the driver in order to allow manual shift and ensure increased control of the vehicle. The current mode allows the transmission system to optimise the engine brake action, remove undesired shifting into higher and lower gears and improve the overall performance of the vehicle.

This mode allows you to move the shift lever step by step forward "-" or backward "+" without pressing the unlock button. The current transmission gear is displayed on the instrument cluster beside "M".



Manual mode can be activated at any time, with no need to release the brake pedal.

In M +/- (Manual) mode, the transmission will shift up or down (+/-) if manually selected by the driver by using the shift lever, or shift paddles on the steering wheel (if foreseen). The transmission remains in the engaged gear until the driver shifts into another higher or lower gear, except in the following cases.

- Lack of accelerator pedal activity will cause the transmission to revert to automatic operation. The transmission will also upshift automatically once maximum engine speed is reached.
- If in SPORT mode, the transmission will remain in the selected gear even when maximum engine speed is reached. The transmission will upshift only if enabled by the driver.

Manual upshift or downshift will be maintained as long as SPORT mode is selected, even by full stroke pedal press.

- If in "M +/-" or in SPORT mode, the transmission will automatically downshift as the vehicle slows to halt (to prevent engine lugging) and the current gear will display on the instrument cluster. Shifting the shift lever backward "+" or moving the right shift paddle "+" towards the steering wheel when stationary, will cause the vehicle to start in second gear. If the vehicle speed is too low, the system will ignore further upshifts. Avoid using speed control when the M +/- (Manual) mode is engaged.

When the car stops in M +/- (Manual) mode, the transmission automatically moves the shift lever and inserts P (Park).

If you enter the I.C.E. drive mode when the gearshift is in "M +/-" position, the system activates the automatic return of the shift lever in D (Drive) mode.

Shift Paddles (if equipped)

The driver can change gears with the shift paddles behind the steering wheel when in D (Drive) and M +/- (Manual) mode.

Using the shift paddles, the corresponding icon will display on the instrument cluster beside the "M" indication and current shifted gear.

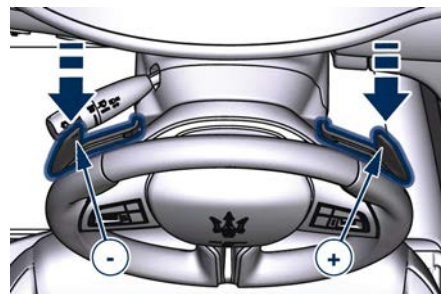

Pull the right shift paddle "+" towards the steering wheel and release it to enter the higher gear; do the same operation with the left shift paddle "-" to enter the lower gear.

- When in D (Drive) mode, by pressing "-" paddle the transmission shifts to "D1 - D2" temporary mode (or the



"Launch Control" on the TROFEO version).

- Pull simultaneously both paddles to deactivate the D (Drive) temporary mode (or the "Launch Control" on the TROFEO version).

Gear Shift Indicator (GSI)

In order to improve fuel economy, we recommend that you shift gears when the GSI system prompts you to do so. This will help reduce fuel consumption without significantly affecting vehicle performance.

When in "M +/-" (Manual) mode, GSI indicates when a gear shift is needed in two different ways, depending on whether you use the paddles or the transmission lever to change gear.

- When using the paddles, GSI indicates when a gear shift is needed by coloring the correspondent paddle in white: up (right side) or down (left side) and displaying "SHIFT" reinforced by an up/down arrow according to the side.

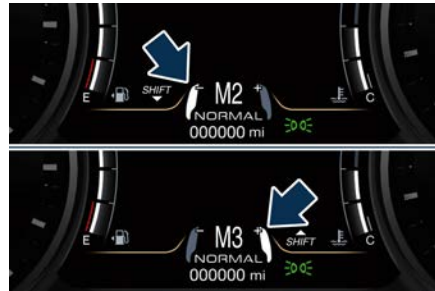

- When using the transmission lever to shift, GSI indicates when a gear shift is needed by displaying just "SHIFT" on the corresponding side reinforced by an up/down arrow according to the side.



When the new gear is engaged, the GSI turns off. If the shift runs late or is not performed at all, the GSI remains lit for a few seconds then turns off. As soon as new conditions requiring

further gear change occur, the GSI light will illuminate again.

NOTE:

The GSI system will only work when the transmission is set in M +/- (Manual) mode.

Transmission Malfunction and Overheating Conditions

Transmission Emergency Control

Transmission function is electronically monitored to detect abnormal conditions. If a condition that could result in transmission damage is detected, "Transmission Limp Home Mode" will be activated. In this situation, the transmission may operate only in certain gears, or may not shift at all. Vehicle performance may be severely degraded and the engine may stall. In some situations, the transmission system may not re-engage if the engine is turned off and restarted.

A message in the instrument cluster will inform the driver about the more serious transmission conditions, and indicate what actions may be necessary.

Transmission Oil Overtemperature



If the transmission oil temperature exceeds the operating limit, the 



red warning light illuminates on the instrument cluster.



In this case, slow down until temperature returns to normal level (the light will turn off).

If this is not sufficient, we recommend to stop the vehicle, shift the lever to position P (Park) or N (Neutral) and keep the engine idle until the red temperature warning light  turns off and the message disappears from the display. Resume driving without demanding high engine performance. If the red warning light  and the related message turns on again, it is advisable to stop the vehicle, turn off the engine and wait for the engine/transmission assembly to fully cool down.

If the instrument cluster message indicates that the transmission may not re-engage after engine shutdown,

perform the following procedure preferably at an **Authorized Maserati Dealer**.

In the event of a momentary problem, the transmission can be reset to regain all forward gears by performing the following steps.

- Stop the vehicle.
- Shift the transmission into P (Park), if possible.
- Turn the engine off.
- Wait approximately 30 seconds.
- Restart the engine.
- Shift the transmission into D (Drive) and then into the desired gear range. If the problem is no longer detected, the transmission will return to normal operation.

NOTE:

*Even if the transmission can be reset, we recommend that you visit an **Authorized Maserati Dealer** at your earliest possible convenience, which has diagnostic equipment to determine if the problem could recur.*

Transmission Manual Release of P (Park) Position

See chapter "Transmission Manual Release of P (Park) Position" in section "In an Emergency".

All-Wheel Drive (AWD version only)

The active on-demand All-Wheel Drive (AWD) system provides available optimum traction for a wide variety of road surface and driving conditions. The system minimizes wheel slip by automatically redirecting torque to the front and rear wheels as necessary.

To maximise fuel economy, the AWD system automatically disengages torque distribution on front axle when road and environmental conditions are such that wheel slip is unlikely to occur. When specific road and environmental conditions require increased levels of road traction, the AWD system automatically distributes the torque between front and rear axle in order to grant the best driving experience. Torque distribution is displayed on the TFT in the "Drive Mode" main menu. Refer to "TFT Display: Menu and Submenu Content" in section "Dashboard Instruments and Controls" for further information.

**WARNING!**

There may be a slight delay for AWD engagement after a wheel slip condition occurs.

**NOTE:**

If the AWD system service warning message appears after engine start up, or during driving, it means that the AWD system is not functioning properly or is in recovery mode due to overheating caused by the excessive wheel spin. In this condition the vehicle can continue driving but only rear wheel drive is working. If the warning message is often activated, it is recommended to have the vehicle serviced at an **Authorized Maserati Dealer**.

**Drive Mode****Controls Preview**

Drive modes can be set using the buttons on central console.

**CAUTION!**

"NORMAL" is the default drive mode, optimized for the best balance between performances, fuel consumption and emissions in the standard conditions use of the car.

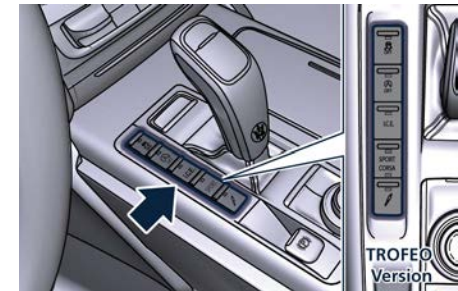

Buttons on the central console have the following functions:

- (ESC Off): to exclude/reactivate the ESC system.
- (Start&Stop Off): to deactivate/reactivate the Start&Stop system.
- I.C.E: to activate/deactivate the drive mode to ensure increased control on slippery surfaces as well as higher



energy efficiency (see "Monitoring Settings on Display" in this chapter).

- **SPORT (NOT for TROFEO version):** to activate/deactivate a sportier drive mode. In this mode, the vehicle has a faster throttle response and ESC sport calibration (not recommended on wet/slippery surfaces). Activating this drive mode, will also change the EPS setting.
- **SPORT and CORSA (TROFEO version only):** to activate/deactivate the sportier and the race drive mode. When in "SPORT" drive mode, the vehicle has a faster throttle response and ESC sport calibration (not recommended on wet/slippery surfaces). Activating this drive mode, will also change the EPS setting. When in "CORSA" drive mode, in addition to what indicated for the sports mode, the transmission use a specific gear shift pattern and the traction is shifted more on the rear wheels with increased oversteering behavior. Traction control with dedicated calibration to maximize traction vs stability and "Launch Control" start mode.
-  (Suspension): to switch between the two suspensions setting modes: soft (LED light off and "S" in the telltale on the TFT display) and hard

(LED light on and "H" in the telltale on the TFT display). Activating this drive mode, will also change the EPS setting.

By selecting one of these drive modes, the yellow or white LED on the button illuminates and, for some of these, the vehicle configuration obtained is graphically displayed on instrument cluster. The same screen is also obtained when selecting the "Drive mode" menu using the buttons on steering wheel.



Refer to chapter "TFT Display Setting and Menu Overview" in section "Dashboard Instruments and Controls" for further information.

Setting the Drive Mode

Drive modes can be set using the buttons on central console.

Keys (buttons) only have two statuses: OFF and ON. The OFF status (button released) is the standard function mode. The ON status is activated by pressing the button, the dedicated LED will illuminate. It is necessary to press the  (ESC Off) button for at least 3 seconds.



At each key on the car starts always in NORMAL drive mode (all LEDs are OFF) and driver can select different drive mode according to following table.

| Button | ON – Button pressed (LED ON) |
|---|---|
|  | Electronic Stability Control ESC partially deactivated. |
|  | Start&Stop function deactivated. |
| I.C.E. | Increased Control and Efficiency mode ON (*). |
| SPORT | Sportier drive mode (SPORT) ON. |
| SPORT CORSA (TROFEO version only) | <ul style="list-style-type: none"> • Button pressed the first time (upper LED ON): sportier drive mode (SPORT) ON. • Button pressed the second time (upper and lower LED ON): race drive mode (CORSA) ON, ESC partially deactivated (ON) and hard/stiff suspension setting ("S"). • When button is pressed third time, it returns to OFF-button release. |





























| Button | ON – Button pressed (LED ON) |
|---|---------------------------------|
|  (**) | Soft/Hard suspension setting. |
| <p>(*) I.C.E. (Increased Control and Efficiency) operates on engine supply in order to reduce fuel consumption, exhausts, noisiness (efficiency) by dampening vehicle reactions (control). The current mode is also useful for low-grip surfaces.</p> <p>(**) Only with Skyhook active suspensions.</p> | |

The tables below summarise the adjustment of transmission and engine parameters according to set drive mode/s.  (ESC Off) is the only mode that does not depend on the activation or deactivation of the other modes. The tables show the two configurations with:

-  (ESC Off) button NOT pressed;
-  (ESC Off) button pressed.



(ESC Off) Button NOT pressed (NOT for TROFEO Version)

|  Button pressed: LED ON  Button not pressed: LED OFF |  OFF  OFF  I.C.E.  SPORT  |  OFF  I.C.E.  SPORT  |  OFF  OFF  I.C.E.  SPORT  |  OFF  OFF  I.C.E.  SPORT  |  OFF  OFF  I.C.E.  SPORT  |
|---|--|---|--|--|--|
| <i>Setup</i> | NORMAL + Auto + S&S enabled + Soft suspensions | NORMAL + Auto + S&S disabled + Soft suspensions | I.C.E. + Auto + S&S enabled + Soft suspensions | SPORT + Auto + S&S disabled + Soft suspensions | NORMAL + Auto + S&S disabled + Hard suspensions |
| Stability control | Active | Active | Active | Active-Sport (*) | Active-Sport (*) |
| Electric Power Steering (EPS) | Normal | Normal | Normal | Sport | Sport |
| Suspensions setup | Normal | Normal | Normal | Normal | Hard |
| Engine control | Normal | Normal | Comfort | Performance | Performance |
| Engine boost | Normal boost | Overboost | Low boost | Overboost | Overboost |
| Exhaust sound | Low (Rev. Threshold) | Low (Rev. Threshold) | Low | Always High | Always High |
| Gear shifting point | Normal | – | Comfort | Performance | Performance |
| Kick down | Yes | Yes | Yes - Soft | Yes - Strong | Yes - Strong |
| Upshift rev. limiter | Yes | Yes | Yes | Yes (No, when in M+/-) | Yes (No, when in M+/-) |
| Automatic downshift | Normal | Anti - Stall | Comfort | Performance (Anti - Stall, when in M+/-) | Performance (Anti - Stall, when in M+/-) |



| | | | | | |
|--|--|--|--|--|--|
| <p> Button pressed: LED ON</p> <p> Button not pressed: LED OFF</p> | <p> OFF</p> <p> I.C.E.</p> <p> SPORT</p> <p></p> | <p> OFF</p> <p> I.C.E.</p> <p> SPORT</p> <p></p> | <p> OFF</p> <p> I.C.E.</p> <p> SPORT</p> <p></p> | <p> OFF</p> <p> I.C.E.</p> <p> SPORT</p> <p></p> | <p> OFF</p> <p> I.C.E.</p> <p> SPORT</p> <p></p> |
| Shifting timing | Normal | Rapid - Normal | Comfort | Sport (Rapid - Sport, when in M +/-) | Sport (Rapid - Sport, when in M +/-) |

(* In low- and medium-grip conditions (e.g., rain, snow, ice, sand, etc.) it is advisable not to activate SPORT mode, even with the ESC system active (button (ESC OFF) not pressed).

(ESC Off) Button pressed (NOT for TROFEO Version)

| | | | | | |
|--|--|--|--|--|--|
| <p> Button pressed: LED ON</p> <p> Button not pressed: LED OFF</p> | <p> OFF</p> <p> I.C.E.</p> <p> SPORT</p> <p></p> | <p> OFF</p> <p> I.C.E.</p> <p> SPORT</p> <p></p> | <p> OFF</p> <p> I.C.E.</p> <p> SPORT</p> <p></p> | <p> OFF</p> <p> I.C.E.</p> <p> SPORT</p> <p></p> | <p> OFF</p> <p> I.C.E.</p> <p> SPORT</p> <p></p> |
| <i>Setup</i> | NORMAL + Auto + S&S disabled + Soft suspensions | NORMAL + Auto + S&S disabled + Soft suspensions | I.C.E. + Auto + S&S disabled + Soft suspensions | SPORT + Auto + S&S disabled + Soft suspensions | NORMAL + Auto + S&S disabled + Hard suspensions |
| Stability control | OFF | OFF | OFF | OFF | OFF |
| Electric Power Steering (EPS) | Normal | Normal | Normal | Sport | Sport |
| Suspensions setup | Normal | Normal | Normal | Normal | Hard |
| Engine control | Normal | Normal | Comfort | Performance | Performance |
| Engine boost | Normal boost | Overboost | Low boost | Overboost | Overboost |



Starting and Driving

| <div style="display: flex; align-items: center;"> <div style="width: 20px; height: 10px; background-color: black; margin-right: 5px;"></div> Button pressed: LED ON <div style="width: 20px; height: 10px; border: 1px solid black; margin-right: 5px;"></div> Button not pressed: LED OFF </div> <th> <div style="display: flex; align-items: center;"> <div style="width: 20px; height: 10px; background-color: black; margin-right: 5px;"></div> OFF <div style="width: 20px; height: 10px; background-color: black; margin-right: 5px;"></div> OFF <div style="width: 20px; height: 10px; border: 1px solid black; margin-right: 5px;"></div> I.C.E. <div style="width: 20px; height: 10px; border: 1px solid black; margin-right: 5px;"></div> SPORT <div style="width: 20px; height: 10px; border: 1px solid black; margin-right: 5px;"></div> </div> <th> <div style="display: flex; align-items: center;"> <div style="width: 20px; height: 10px; background-color: black; margin-right: 5px;"></div> OFF <div style="width: 20px; height: 10px; background-color: black; margin-right: 5px;"></div> OFF <div style="width: 20px; height: 10px; border: 1px solid black; margin-right: 5px;"></div> I.C.E. <div style="width: 20px; height: 10px; border: 1px solid black; margin-right: 5px;"></div> SPORT <div style="width: 20px; height: 10px; border: 1px solid black; margin-right: 5px;"></div> </div> <th> <div style="display: flex; align-items: center;"> <div style="width: 20px; height: 10px; background-color: black; margin-right: 5px;"></div> OFF <div style="width: 20px; height: 10px; background-color: black; margin-right: 5px;"></div> OFF <div style="width: 20px; height: 10px; background-color: black; margin-right: 5px;"></div> I.C.E. <div style="width: 20px; height: 10px; border: 1px solid black; margin-right: 5px;"></div> SPORT <div style="width: 20px; height: 10px; border: 1px solid black; margin-right: 5px;"></div> </div> <th> <div style="display: flex; align-items: center;"> <div style="width: 20px; height: 10px; background-color: black; margin-right: 5px;"></div> OFF <div style="width: 20px; height: 10px; border: 1px solid black; margin-right: 5px;"></div> OFF <div style="width: 20px; height: 10px; border: 1px solid black; margin-right: 5px;"></div> I.C.E. <div style="width: 20px; height: 10px; background-color: black; margin-right: 5px;"></div> SPORT <div style="width: 20px; height: 10px; border: 1px solid black; margin-right: 5px;"></div> </div> <th> <div style="display: flex; align-items: center;"> <div style="width: 20px; height: 10px; background-color: black; margin-right: 5px;"></div> OFF <div style="width: 20px; height: 10px; border: 1px solid black; margin-right: 5px;"></div> OFF <div style="width: 20px; height: 10px; border: 1px solid black; margin-right: 5px;"></div> I.C.E. <div style="width: 20px; height: 10px; border: 1px solid black; margin-right: 5px;"></div> SPORT <div style="width: 20px; height: 10px; background-color: black; margin-right: 5px;"></div> </div> </th> </th></th></th></th> | <div style="display: flex; align-items: center;"> <div style="width: 20px; height: 10px; background-color: black; margin-right: 5px;"></div> OFF <div style="width: 20px; height: 10px; background-color: black; margin-right: 5px;"></div> OFF <div style="width: 20px; height: 10px; border: 1px solid black; margin-right: 5px;"></div> I.C.E. <div style="width: 20px; height: 10px; border: 1px solid black; margin-right: 5px;"></div> SPORT <div style="width: 20px; height: 10px; border: 1px solid black; margin-right: 5px;"></div> </div> <th> <div style="display: flex; align-items: center;"> <div style="width: 20px; height: 10px; background-color: black; margin-right: 5px;"></div> OFF <div style="width: 20px; height: 10px; background-color: black; margin-right: 5px;"></div> OFF <div style="width: 20px; height: 10px; border: 1px solid black; margin-right: 5px;"></div> I.C.E. <div style="width: 20px; height: 10px; border: 1px solid black; margin-right: 5px;"></div> SPORT <div style="width: 20px; height: 10px; border: 1px solid black; margin-right: 5px;"></div> </div> <th> <div style="display: flex; align-items: center;"> <div style="width: 20px; height: 10px; background-color: black; margin-right: 5px;"></div> OFF <div style="width: 20px; height: 10px; background-color: black; margin-right: 5px;"></div> OFF <div style="width: 20px; height: 10px; background-color: black; margin-right: 5px;"></div> I.C.E. <div style="width: 20px; height: 10px; border: 1px solid black; margin-right: 5px;"></div> SPORT <div style="width: 20px; height: 10px; border: 1px solid black; margin-right: 5px;"></div> </div> <th> <div style="display: flex; align-items: center;"> <div style="width: 20px; height: 10px; background-color: black; margin-right: 5px;"></div> OFF <div style="width: 20px; height: 10px; border: 1px solid black; margin-right: 5px;"></div> OFF <div style="width: 20px; height: 10px; border: 1px solid black; margin-right: 5px;"></div> I.C.E. <div style="width: 20px; height: 10px; background-color: black; margin-right: 5px;"></div> SPORT <div style="width: 20px; height: 10px; border: 1px solid black; margin-right: 5px;"></div> </div> <th> <div style="display: flex; align-items: center;"> <div style="width: 20px; height: 10px; background-color: black; margin-right: 5px;"></div> OFF <div style="width: 20px; height: 10px; border: 1px solid black; margin-right: 5px;"></div> OFF <div style="width: 20px; height: 10px; border: 1px solid black; margin-right: 5px;"></div> I.C.E. <div style="width: 20px; height: 10px; border: 1px solid black; margin-right: 5px;"></div> SPORT <div style="width: 20px; height: 10px; background-color: black; margin-right: 5px;"></div> </div> </th> </th></th></th> | <div style="display: flex; align-items: center;"> <div style="width: 20px; height: 10px; background-color: black; margin-right: 5px;"></div> OFF <div style="width: 20px; height: 10px; background-color: black; margin-right: 5px;"></div> OFF <div style="width: 20px; height: 10px; border: 1px solid black; margin-right: 5px;"></div> I.C.E. <div style="width: 20px; height: 10px; border: 1px solid black; margin-right: 5px;"></div> SPORT <div style="width: 20px; height: 10px; border: 1px solid black; margin-right: 5px;"></div> </div> <th> <div style="display: flex; align-items: center;"> <div style="width: 20px; height: 10px; background-color: black; margin-right: 5px;"></div> OFF <div style="width: 20px; height: 10px; background-color: black; margin-right: 5px;"></div> OFF <div style="width: 20px; height: 10px; background-color: black; margin-right: 5px;"></div> I.C.E. <div style="width: 20px; height: 10px; border: 1px solid black; margin-right: 5px;"></div> SPORT <div style="width: 20px; height: 10px; border: 1px solid black; margin-right: 5px;"></div> </div> <th> <div style="display: flex; align-items: center;"> <div style="width: 20px; height: 10px; background-color: black; margin-right: 5px;"></div> OFF <div style="width: 20px; height: 10px; border: 1px solid black; margin-right: 5px;"></div> OFF <div style="width: 20px; height: 10px; border: 1px solid black; margin-right: 5px;"></div> I.C.E. <div style="width: 20px; height: 10px; background-color: black; margin-right: 5px;"></div> SPORT <div style="width: 20px; height: 10px; border: 1px solid black; margin-right: 5px;"></div> </div> <th> <div style="display: flex; align-items: center;"> <div style="width: 20px; height: 10px; background-color: black; margin-right: 5px;"></div> OFF <div style="width: 20px; height: 10px; border: 1px solid black; margin-right: 5px;"></div> OFF <div style="width: 20px; height: 10px; border: 1px solid black; margin-right: 5px;"></div> I.C.E. <div style="width: 20px; height: 10px; border: 1px solid black; margin-right: 5px;"></div> SPORT <div style="width: 20px; height: 10px; background-color: black; margin-right: 5px;"></div> </div> </th> </th></th> | <div style="display: flex; align-items: center;"> <div style="width: 20px; height: 10px; background-color: black; margin-right: 5px;"></div> OFF <div style="width: 20px; height: 10px; background-color: black; margin-right: 5px;"></div> OFF <div style="width: 20px; height: 10px; background-color: black; margin-right: 5px;"></div> I.C.E. <div style="width: 20px; height: 10px; border: 1px solid black; margin-right: 5px;"></div> SPORT <div style="width: 20px; height: 10px; border: 1px solid black; margin-right: 5px;"></div> </div> <th> <div style="display: flex; align-items: center;"> <div style="width: 20px; height: 10px; background-color: black; margin-right: 5px;"></div> OFF <div style="width: 20px; height: 10px; border: 1px solid black; margin-right: 5px;"></div> OFF <div style="width: 20px; height: 10px; border: 1px solid black; margin-right: 5px;"></div> I.C.E. <div style="width: 20px; height: 10px; background-color: black; margin-right: 5px;"></div> SPORT <div style="width: 20px; height: 10px; border: 1px solid black; margin-right: 5px;"></div> </div> <th> <div style="display: flex; align-items: center;"> <div style="width: 20px; height: 10px; background-color: black; margin-right: 5px;"></div> OFF <div style="width: 20px; height: 10px; border: 1px solid black; margin-right: 5px;"></div> OFF <div style="width: 20px; height: 10px; border: 1px solid black; margin-right: 5px;"></div> I.C.E. <div style="width: 20px; height: 10px; border: 1px solid black; margin-right: 5px;"></div> SPORT <div style="width: 20px; height: 10px; background-color: black; margin-right: 5px;"></div> </div> </th> </th> | <div style="display: flex; align-items: center;"> <div style="width: 20px; height: 10px; background-color: black; margin-right: 5px;"></div> OFF <div style="width: 20px; height: 10px; border: 1px solid black; margin-right: 5px;"></div> OFF <div style="width: 20px; height: 10px; border: 1px solid black; margin-right: 5px;"></div> I.C.E. <div style="width: 20px; height: 10px; background-color: black; margin-right: 5px;"></div> SPORT <div style="width: 20px; height: 10px; border: 1px solid black; margin-right: 5px;"></div> </div> <th> <div style="display: flex; align-items: center;"> <div style="width: 20px; height: 10px; background-color: black; margin-right: 5px;"></div> OFF <div style="width: 20px; height: 10px; border: 1px solid black; margin-right: 5px;"></div> OFF <div style="width: 20px; height: 10px; border: 1px solid black; margin-right: 5px;"></div> I.C.E. <div style="width: 20px; height: 10px; border: 1px solid black; margin-right: 5px;"></div> SPORT <div style="width: 20px; height: 10px; background-color: black; margin-right: 5px;"></div> </div> </th> | <div style="display: flex; align-items: center;"> <div style="width: 20px; height: 10px; background-color: black; margin-right: 5px;"></div> OFF <div style="width: 20px; height: 10px; border: 1px solid black; margin-right: 5px;"></div> OFF <div style="width: 20px; height: 10px; border: 1px solid black; margin-right: 5px;"></div> I.C.E. <div style="width: 20px; height: 10px; border: 1px solid black; margin-right: 5px;"></div> SPORT <div style="width: 20px; height: 10px; background-color: black; margin-right: 5px;"></div> </div> |
|---|--|---|--|--|--|
| Exhaust sound | Low (Rev. Threshold) | Low (Rev. Threshold) | Low | Always High | Always High |
| Gear shifting point | Normal | – | Comfort | Performance | Performance |
| Kick down | Yes | Yes | Yes - Soft | Yes - Strong | Yes - Strong |
| Upshift rev. limiter | Yes | Yes | Yes | Yes (No, when in M+/-) | Yes (No, when in M+/-) |
| Automatic down-shift | Normal | Anti - Stall | Comfort | Performance (Anti - Stall, when in M+/-) | Performance (Anti - Stall, when in M+/-) |
| Shifting timing | Normal | Rapid - Normal | Comfort | Sport (Rapid - Sport, when in M +/-) | Sport (Rapid - Sport, when in M +/-) |

5

WARNING!

On TROFEO version, when CORSA drive mode is activated, the (ESC OFF) indicator light on the instrument cluster is on because the intervention of the Electronic Stability Control (ESC) system is lower than the other modes, but still present to allow a more sporty drive.

You can always press (ESC OFF) button to fully deactivate ESC system. Due to high power output of the engine can be potentially dangerous to drive the car on wet or slippery roads with ESC off and CORSA drive mode set.



(ESC OFF) Button NOT pressed (TROFEO Version only)

| Button pressed: LED ON Button not pressed: LED OFF | OFF I.C.E. SPORT CORSA | OFF I.C.E. SPORT CORSA | OFF I.C.E. SPORT CORSA | OFF I.C.E. SPORT CORSA | OFF I.C.E. SPORT CORSA | OFF I.C.E. SPORT CORSA |
|---|--|---|--|--|--|--|
| Setup | NORMAL + Auto + S&S enabled + Soft suspensions | NORMAL + Auto + S&S disabled + Soft suspensions | I.C.E. + Auto + S&S enabled + Soft suspensions | SPORT + Auto + S&S disabled + Soft suspensions | CORSA + Auto + S&S disabled + Manual + Corsa suspensions | NORMAL + Auto + S&S disabled + Corsa suspensions |
| Stability control | Active | Active | Active | Active-Sport (*) | Active-Corsa (*) | Active-Sport (*) |
| Electric Power Steering (EPS) | Normal | Normal | Normal | Sport | Corsa | Sport |
| Suspensions setup | Normal | Normal | Normal | Normal | Hard | Hard |
| Engine control | Normal | Normal | Comfort | Performance | Performance | Performance |
| Engine boost | Normal boost | Overboost | Low boost | Overboost | Overboost | Overboost |
| Exhaust sound | Low (Rev. Threshold) | Low (Rev. Threshold) | Low | Always High | Always High | Always High |
| Gear shifting point | Normal | - | Comfort | - | Performance | Performance |
| Kick down | Yes | Yes | Yes - Soft | Yes - Strong | Not | Yes - Strong |
| Upshift rev. limiter | Yes | Yes | Yes | Yes (No, when in M+/-) | Not | Yes (No, when in M+/-) |



Starting and Driving

































| | | | | | | |
|---|---|--|--|--|--|--|
| <p>Button pressed: LED ON</p> <p>Button not pressed: LED OFF</p> | <input type="checkbox"/> I.C.E. <input type="checkbox"/> SPORT <input type="checkbox"/> CORSA <input type="checkbox"/> | <input checked="" type="checkbox"/> I.C.E. <input type="checkbox"/> SPORT <input type="checkbox"/> CORSA <input type="checkbox"/> | <input type="checkbox"/> I.C.E. <input checked="" type="checkbox"/> SPORT <input type="checkbox"/> CORSA <input type="checkbox"/> | <input type="checkbox"/> I.C.E. <input checked="" type="checkbox"/> SPORT <input type="checkbox"/> CORSA <input type="checkbox"/> | <input type="checkbox"/> I.C.E. <input type="checkbox"/> SPORT <input checked="" type="checkbox"/> CORSA <input type="checkbox"/> | <input type="checkbox"/> I.C.E. <input type="checkbox"/> SPORT <input type="checkbox"/> CORSA <input checked="" type="checkbox"/> |
| Automatic downshift | Normal | Anti - Stall | Comfort | Performance (Anti - Stall, when in M+/-) | Anti - Stall | Performance (Anti - Stall, when in M+/-) |
| Shifting timing | Normal | Rapid - Normal | Comfort | Sport (Rapid - Sport, when in M+/-) | Quick - Corsa | Sport (Rapid - Sport, when in M+/-) |
| <p>(*) In low- and medium-grip conditions (e.g., rain, snow, ice, sand, etc.) it is advisable not to activate SPORT or CORSA mode, even with the ESC system active (button (ESC OFF) not pressed).</p> | | | | | | |

5

(ESC OFF) Button pressed (TROFEO version only)

| | | | | | | |
|--|---|--|--|--|--|--|
| <p>Button pressed: LED ON</p> <p>Button pressed: LED OFF</p> | <input type="checkbox"/> I.C.E. <input type="checkbox"/> SPORT <input type="checkbox"/> CORSA <input type="checkbox"/> | <input checked="" type="checkbox"/> I.C.E. <input type="checkbox"/> SPORT <input type="checkbox"/> CORSA <input type="checkbox"/> | <input type="checkbox"/> I.C.E. <input checked="" type="checkbox"/> SPORT <input type="checkbox"/> CORSA <input type="checkbox"/> | <input type="checkbox"/> I.C.E. <input checked="" type="checkbox"/> SPORT <input type="checkbox"/> CORSA <input type="checkbox"/> | <input type="checkbox"/> I.C.E. <input type="checkbox"/> SPORT <input checked="" type="checkbox"/> CORSA <input type="checkbox"/> | <input type="checkbox"/> I.C.E. <input type="checkbox"/> SPORT <input type="checkbox"/> CORSA <input checked="" type="checkbox"/> |
| Setup | NORMAL + Auto + S&S disabled + Soft suspensions | NORMAL + Auto + S&S disabled + Soft suspensions | I.C.E. + Auto + S&S disabled + Soft suspensions | SPORT + Auto + S&S disabled + Soft suspensions | CORSA + Auto + S&S disabled + Manual + Corsa suspensions | NORMAL + Auto + S&S disabled + Corsa suspensions |



|  Button pressed: LED ON  Button pressed: LED OFF |  OFF  I.C.E.  SPORT  CORSA  |  OFF  I.C.E.  SPORT  CORSA  |  OFF  I.C.E.  SPORT  CORSA  |  OFF  I.C.E.  SPORT  CORSA  |  OFF  I.C.E.  SPORT  CORSA  |  OFF  I.C.E.  SPORT  CORSA  |
|---|--|--|--|--|--|--|
| Stability control | OFF | OFF | OFF | OFF | OFF | OFF |
| Electric Power Steering (EPS) | Normal | Normal | Normal | Sport | Corsa | Sport |
| Suspensions setup | Normal | Normal | Normal | Normal | Hard | Hard |
| Engine control | Normal | Normal | Comfort | Performance | Performance | Performance |
| Engine boost | Normal boost | Overboost | Low boost | Overboost | Overboost | Overboost |
| Exhaust sound | Low (Rev. Threshold) | Low (Rev. Threshold) | Low | Always High | Always High | Always High |
| Gear shifting point | Normal | – | Comfort | Performance | Performance | Performance |
| Kick down | Yes | Yes | Yes - Soft | Yes - Strong | Not | Yes - Strong |
| Upshift rev. limiter | Yes | Yes | Yes | Yes (No, when in M+/-) | Not | Yes (No, when in M+/-) |
| Automatic downshift | Normal | Anti - Stall | Comfort | Performance (Anti - Stall, when in M+/-) | Anti - Stall | Performance (Anti - Stall, when in M+/-) |
| Shifting timing | Normal | Rapid - Normal | Comfort | Sport (Rapid - Sport, when in M+/-) | Quick - Corsa | Sport (Rapid - Sport, when in M+/-) |



NOTE:

A different drive mode can be set even with engine running and vehicle in motion.

To activate a drive mode, press the corresponding button as indicated below. The LED on the button will light up and set drive mode screen will be displayed (example in the figure: NORMAL) for 5 seconds.



Activate/Deactivate (ESC OFF) Drive Mode

To activate (ESC OFF) drive mode press the corresponding button for at least 3 seconds: the yellow LED on the button will turn on.



To deactivate the drive mode, briefly press the same button again: the LED will turn off and the display will show the message indicating that (ESC OFF) drive mode is off and ESC system is active.

Deactivate/Reactivate (Start&Stop Off) Drive Mode

To deactivate the Start&Stop function normally active, briefly press the corresponding button once: the yellow LED on the button will turn on.

To reactivate the Start&Stop function, briefly press the same button again: the LED will turn off.

Activate/Deactivate I.C.E., SPORT Drive Mode

To activate one of these drive mode, briefly press the corresponding button once: the white LED on the button will turn on.



To disable the drive mode activated, briefly press the same button again: the LED will turn off.

If you deactivate the SPORT mode by briefly pressing the related button when is activate (LED lit) it also deactivates the (Suspension) mode if it was activate (LED lit).

Activate/Deactivate SPORT and CORSA Drive Mode (TROFEO Version only)

To activate SPORT drive mode, briefly press the corresponding button once: the upper white LED on the button will turn on. CORSA drive mode can be active by pressing again the same button for more than a second (about 1.2 seconds): also the lower LED on the button will turn on. To return in SPORT drive mode, briefly press the SPORT/CORSA button again.

When in CORSA drive mode, (Suspension) hard drive mode can not





be set and you can run the "Launch Control" start procedure (see "Launch Control Mode" in this section).



To disable the SPORT mode without activating the CORSA mode, briefly press the same button once again: the two LED will turn off.

Activate/Deactivate Hard Suspension Drive Mode

Briefly press "  " (Suspension) button on the central console to activate the hard suspension setting recognizable by the green color of the 4 shock absorbers, when in NORMAL, I.C.E. or SPORT drive mode. When exiting the drive mode screen, the setting is always visible through the icon  with "S" (Soft) or "H" (Hard) beside on the upper right side of the TFT display (area 9).



Monitoring Settings on Display

By gaining access to "Drive mode" menu through the buttons on steering wheel right-hand side, it is possible to monitor the settings for driving.

The list and figure show vehicle parameters referred to each drive mode. Driving mode and its parameters are identified by a different color (example in the figure: SPORT).

A Powertrain.

B Drive Mode/ESC.

C Torque distribution (AWD version only).







D Suspension stiffness.





SPORT



The table below specifies the default settings for each drive mode.

| Drive Mode | Default Condition | |
|---|---|--------|
|  <p>I.C.E.</p> | ESC | I.C.E. |
| |  | Normal |
|  <p>NORMAL</p> | ESC | Normal |
| |  | Normal |
|  <p>SPORT</p> | ESC | Sport |
| |  | Normal |



| Drive Mode | Default Condition | |
|---|---|-------|
| <p data-bbox="391 162 454 176">CORSA</p>  | ESC | Corsa |
| |  | Corsa |
| <p data-bbox="300 395 507 415">Suspension (in Sport Mode)</p>  | ESC | Sport |
| |  | Firm |



I.C.E. Mode excluding ESC

To release the vehicle in low grip conditions (e.g.: heaps of snow, mud, sand, etc), it is possible to shift the transmission function in the specific driving mode as required for these situations, by pressing the I.C.E. button and to exclude completely the yaw and spinning control system, by pressing the button for at last three seconds  (ESC Off).

Launch Control Mode (TROFEO version only)

"Launch Control" mode is a performance start procedure. By activating this procedure you get the best possible acceleration from standstill of the car.

This mode allows you to ground the torque necessary to prevent the wheels from slipping during acceleration performance.

To make a performance start in "Launch Control" mode, the following conditions must be met:

- Water and transmission temperature in proper range.
- No engine and on board systems faults.
- The vehicle mileage must be higher than 440 mi (700 km).
- "CORSA" drive mode on.
- Shift lever in "D" or "M +/-" position.
- The vehicle must be stationary on a level road surface.
- The driver door closed and the safety belt fastened.

Launch Control Sequence

NOTE:

- All the above mentioned conditions must be verified in order to activate

"Launch Control" performance start procedure.

- During "Launch Control" ACC, FCW and ADA (if equipped) are temporarily disabled.
- Each step displayed on the instrument cluster has a time out approximately of 5 seconds.
- "Launch Control" maneuver requires to use both foot, left foot to brake and right foot to accelerate at the same time.
- With engine on, parking brake disengaged, brake pedal pressed and steering wheel straight, pull "-" left paddle. The instrument cluster shows the "Launch Control" engaged page.

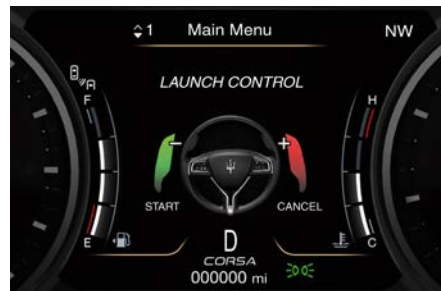

- To confirm the procedure, pull again the "-" paddle. To abort the procedure, pull "+" right paddle.



- To confirm the "Launch Control" sequence, press full the brake pedal as indicated in the message on the instrument cluster.



- With brake pedal pressed full with left foot, fully press the accelerator pedal (with right foot) as indicated in the message on the instrument cluster.



- Release brake pedal. The launch of the vehicle starts with ESC that manages the maximum performance

and engine torque calibrated to maximize performance. Maximum performance is achieved if driver let the engine rpm stall above 2300 rpm before releasing brake pedal.



During the acceleration phase the "Launch Control" symbol appears at the top right of the TFT display.



Parking Brake

The vehicle is equipped with an electric automatic parking brake, also called EPB (Electric Parking Brake). The EPB braking action on model with "Base" braking system (equipped with rear floating caliper) is ensured by a power actuator directly working on the brake pad inside each caliper of the rear brake system.

All other modes with "Dual Cast" braking system are equipped with a dedicated caliper which acts on each rear brake disc.

It can be automatically engaged when the engine is turned off and disengaged with engine running, driver seatbelt latched and driver door closed, while pressing the brake pedal and operating the shift lever.

Furthermore, EPB can be automatically engaged above a slope threshold with transmission in parking to avoid damage to the vehicle. EPB can be disengaged before turning off the vehicle.

When the parking brake is applied, the warning light **BRAKE** (United States market) or  (Canadian market) lights up on the tachometer display and the related message is displayed on the instrument cluster for 5 seconds



(see "Warning and Indication Lights" in section "Dashboard Instruments and Controls").



United States Market



Canadian Market

During engagement and disengagement procedures, the warning light **BRAKE** (United States market) or **(!)** (Canadian market) flashes until the parking brake has reached its maximum activation force and is respectively fully released.

In the above-mentioned conditions, the automatic engagement function can be deactivated/activated by selecting the menu item "Vehicle settings" on the main menu (refer to paragraph "Deactivating Automatic Operation" in this chapter).

Manual Engagement/Disengagement

The parking brake can also be manually engaged or disengaged when the engine is running or the ignition device is in the **RUN** position, by pressing the brake pedal and raising the lever located behind the shift lever.

When the parking brake is applied, the warning light **BRAKE** (United States market) or **(!)** (Canadian market) lights up on the tachometer and the related message will be displayed for 5 seconds on the instrument cluster.

If you attempt to engage/disengage the parking brake without having pressed the brake pedal, a message will be displayed, warning you to proceed.

If the engine was turned off when the automatic engagement device was deactivated (see "Deactivating Automatic Operation" in this chapter) it is possible to shift the parking brake

simply by pulling the lever upward within 3 minutes after turning off.

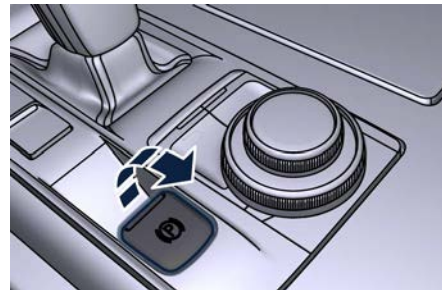

CAUTION!

The main function of the EPB is to allow safe parking of the vehicle, therefore it must only be applied when the vehicle is already stationary. If the EPB is used while the vehicle is moving and decelerating until a speed lower of 3 MPH (5 km/h) and, in particular, until complete stop (typically in a sudden brake), it is necessary to have the EPB system checked by an **Authorized Maserati Dealer**.

**WARNING!**

- Always hold the brake pedal pressed during engagement or disengagement of the parking brake.
- The EPB command activation while running generates a deceleration of the vehicle with strong deceleration (Dynamic Braking). It is therefore recommended to use this function only in case of emergency. The stability of the car is guaranteed by the action of the activated ESC system.
- It is advisable to keep the "Auto Apply" function always active (On) so that the vehicle is properly secured with electric parking brake.

Deactivating Automatic Operation

The automatic engagement function can be deactivated/reactivated by selecting the menu item "Vehicle settings" through the switch on the right-side of the steering wheel (refer to "TFT Display Setting and Menu Overview" in section "Dashboard Instruments and Controls".)

Press and release the multifunction switch toward the arrow \triangleright to select "Electric Park Brake".



Press and release the switch once again toward the arrow \triangleright to visualize the options connected to this function.

- Auto Apply On (recommended setting);
- Auto Apply Off.

**WARNING!**

It is advisable to keep the "Auto Apply" function always active (On) so that the vehicle is properly secured with electric parking brake.



Scroll with the multifunction switch toward the arrow \wedge or \vee through the programmable options.

Press and release the multifunction switch toward the arrow \triangleright to set the selected option. A check mark will remain next to the previously-selected item until a new selection is made.



"Setting Saved" Selection notification appears as a popup for 2 seconds then the display will show again the modified function.

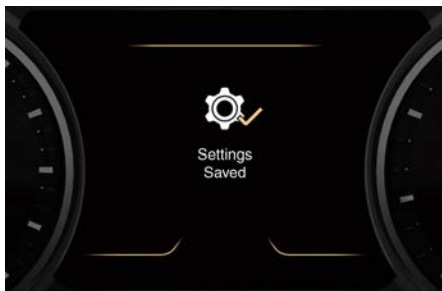

In order to disable the automatic operation follow the same procedures and select the other option.



CAUTION!

- Under certain conditions when the battery voltage is low, the electric automatic parking brake system may temporarily be deactivated for safety reasons. Therefore, typically upon starting the engine, when the battery voltage drops, a message may temporarily be displayed, indicating that automatic operation is temporarily disabled.
- In case of repetitive requests to reset the EPB through the messages shown on the TFT display, please contact an **Authorized Maserati Dealer**.

Failure Indication

In the event of electric parking brake system failure, the warning light (P)! on the display will flash for 10 seconds and the related message will show until the failure is present.



WARNING!

In the event of an EPB failure, take your vehicle to the nearest Authorized Maserati Dealer as soon as possible.



Initialize the EPB System after Re-connecting the vehicle battery

After the detachment and the subsequent connection of the battery, on the instrument cluster display the warning light (P)! will be illuminated. To initialize the EPB system, lift, release and lift again the lever located behind the shift lever.

Emergency Disengagement

In case of brake lock with complete electrical system failure, is necessary to act on the electric actuator to undo the pressure on the pads of rear brake calipers (see "Emergency Release of the Parking Brake" chapter in section "In an Emergency").

EPB Operation with Overheated Brakes

Driving on mountain roads with steep slopes or a sports use of the vehicle could overheat the brake system components. In these conditions, parking brake must not be used since the push of the power actuator might not be sufficient to ensure vehicle braking, especially on a slope. Drive normally without braking to allow the brakes to cool down a few minutes before stopping. In this way, the automatic or manual activation of the parking brake will ensure vehicle braking.



Parking

Before leaving the vehicle, **make sure that the parking brake is fully applied** in automatic or manual and place the transmission lever in the P (Park) position by pressing the "P" button.



WARNING!

- **Always check that the vehicle is locked before leaving it.**
- **Never leave children unattended in the vehicle.**
- **Do not park the vehicle on paper, grass, dry leaves or other flammable materials. They could catch fire if they come into contact with hot parts of the exhaust system.**
- **Do not leave the engine running while the vehicle is unattended.**



CAUTION!

When you need to park the vehicle on a steep slope, both with the engine on and off, it is recommended not only to engage the parking brake, but also to shift the transmission lever to P (Park) before leaving the vehicle. A warning message on the instrument cluster could appear when parking on a steep slope to remember that

only the parking brake could be not sufficient to stop the vehicle.

When parking on hill roads, it is important to turn the front wheels toward the curb on a downhill grade and away from the curb on an uphill grade.

Apply the parking brake before placing the shift lever in P (Park), otherwise the load on the transmission locking mechanism may make it difficult to move the shift lever out of P (Park).

In certain conditions, it is however advisable to disengage the parking brake manually and slightly apply the service brake for starting off. This is advisable when there are obstacles very close to the vehicle in the direction in which you intend to move.



"Drive Away Inhibit" strategy

In order to avoid a dangerous condition resulting from leaving the vehicle "not braked" with running engine and without driver on board, "Drive Away Inhibit" strategy alerts the driver with messages on the instrument cluster display and sounding chimes, then puts the transmission in P (Park).

The table shows the vehicle condition and the action that the system runs to exit the dangerous condition.

| Vehicle condition | ▶ | Action of the driver | ▶ | The system puts the transmission in P (Park) position. |
|--|---|--|---|--|
| <ul style="list-style-type: none"> • Engine running and speed lower than 1.8 MPH (3 km/h). • Transmission in any position other P (Park). • Driver safety belt unlocked. • Driver door opened. • Brake pedal pressed. | | The driver releases the brake pedal to get out of the vehicle. | | |
| Warnings | | Warnings | | |
| <ul style="list-style-type: none"> • Slow continuous chime. • The condition of the vehicle not in P (Park) position will be signaled by a message on the display. | | <ul style="list-style-type: none"> • Fast chime. • A message which invites to engage the parking brake to prevent vehicle movement will be displayed on the display. | | |



Using the Brakes



CAUTION!

To obtain a good performance by brake pads and discs, avoid sudden braking during the first 190 mi (300 km).

The pad wear limit is indicated by the illumination of the warning light **BRAKE** on vehicles of United States market or of the specific warning light  on vehicles of Canadian market and by a message on the instrument cluster.

In this event, please contact an **Authorized Maserati Dealer**.



United States Market



Canadian Market



WARNING!

Riding the brakes can lead to brake failure and possibly an accident. Driving with your foot resting or riding on the brake pedal can result in abnormally high brake temperatures, excessive lining wear, and possible brake damage. In an emergency full braking capacity may be impaired.

Brake Pads and Brake Discs

Wear on the brake pads and brake discs depends to a great extent on the driving style and the conditions of use and therefore cannot be expressed in actual miles driven on the road.

The brake system is designed for optimal braking effect at all speeds and temperatures.

Certain speeds, braking forces and ambient conditions (e.g. temperature, humidity and long outdoor stopping periods) can therefore cause the brakes to "squeal". This is normal and will cease after a few brakings.

New Brake Pads and/or Brake Discs

New brake pads have to be "bed in", and therefore only attain optimal friction to the brake disc when the vehicle has covered several hundreds of miles.

During this first period, the slightly reduced braking ability must be compensated for by pressing the brake pedal harder. This applies whenever the brake pads and/or brake discs are replaced.

Brake Overheating

Driving on mountain roads with steep slopes or a sports use of the vehicle could overheat the brake system components. In these conditions, the parking brake must not be used since the push of the power actuator might not be sufficient to ensure vehicle braking, especially on a slope.

Drive normally without braking to allow the brakes to cool down a few minutes before stopping. In this way,



the automatic or manual activation of the parking brake will ensure vehicle braking.

Brake overheating could also cause "squeals" and "vibration".

Use of the Engine

Breaking-In

Today's most modern production methods are designed to provide extremely precise construction and assembly of components. However, moving parts do undergo a settling process, basically in the first hours of vehicle operation.

Do not drive keeping at a constant high speed rate for a prolonged time.

While cruising, brief full-throttle acceleration within the limits of local traffic laws contributes to a good break-in. Wide-open throttle acceleration in low gear can be detrimental and should be avoided.

The engine oil installed in the engine at the factory is a high-quality energy conserving type lubricant. Oil changes should be consistent with anticipated climate conditions under which vehicle operations will occur. For the recommended viscosity and quality grades, see "Refillings Table" in section "Maintenance and Care".

A new engine may consume some oil during its first few thousand miles of operation. This should be considered as a normal part of the break-in and not interpreted as an indication of malfunction.

Specific Requirements

Avoid exceeding 5000 rpm for the first 620 mi trip (1000 km).

After starting the vehicle, do not exceed 4000 rpm until the engine has warmed up sufficiently (coolant temperature: 149-158 °F /65 70 °C).

While Driving

Never travel with the tachometer indicator approaching the peak rpm, not even downhill. When the tachometer indicator is approaching the peak rpm (red colored zone), take precautions to avoid exceeding that limit.



Ensure proper operation of different devices checking their respective control telltales.

**CAUTION!**



- Under normal conditions, all red warning lights on the instrument cluster display should be off. When they come on, this indicates a malfunction. Refer to "Warning and Indicator Lights" in section "Dashboard Instruments and Controls".
- Continuing to drive when a red warning light is on could cause serious damage to the vehicle and affect its performance.

On-Board Diagnostics (OBD)

Your vehicle is equipped with a sophisticated on-board diagnostic system. This system monitors the performance of the emissions, engine, and automatic transmission control systems. When these systems are operating properly, your vehicle will provide excellent performance and fuel economy, as well as engine emissions well within current local regulations of various countries. If any of these systems require service, the system will turn on the  Malfunction Indicator Light (MIL). It will also store diagnostic codes and other information to assist which your **Authorized Maserati Dealer** will use

to service your vehicle. Although the vehicle will still be driveable and not need towing, contact an **Authorized Maserati Dealer** for service as soon as possible.

**CAUTION!**

- Prolonged driving with the  Malfunction Indicator Light (MIL) on could cause further damage to the emissions control system. It could also affect fuel economy and drivability. The vehicle must be serviced before any emissions tests can be performed.
- If the  Malfunction Indicator Light (MIL) is flashing while the engine is running, severe catalytic converter damage and power loss will soon occur. Immediate service is required at an **Authorized Maserati Dealer**.

- After the problem has been solved, the **Authorized Maserati Dealer** personnel will perform specific tests on the test bench for a complete check of the system and, if necessary, also road tests, even on long distances.

Spare Parts



Use of genuine parts for normal or scheduled maintenance and repairs is highly recommended to ensure excellent performance.

Damage or failures caused by non-genuine spare parts used for maintenance and repairs will not be covered by the manufacturer's warranty.



Refueling

Fuel Filler Neck Access

To access the fuel filler neck, the filler door must be unlocked. From outside the vehicle, this can only be done by pressing the unlock  or the lock  button on the key fob, in the same way as if opening or closing the doors. If any of the door lock controls is pressed from inside the vehicle, the filler door will still remain open to allow refueling.

- Press the indicated area on the filler door, which is located on the rear left side of the vehicle: the filler door will open completely.



Refill the Tank

The fuel filler is sealed by an internal closing tab, which is opened by the fuel nozzle of the service station when refueling.

Only a nozzle of the suitable size can open the closing tab.

- Insert the fuel nozzle fully into the filler.

NOTE:

Only with a correct size nozzle you can refuel.



- **To avoid the risk of fire, do not approach the filler with open flames or cigarettes!**
- **To avoid the risk of inhaling noxious fumes, do not breathe close to the fuel filler door, when opened.**

- **Never have any smoking materials lit in or near the vehicle when the fuel filler door is open or the tank is being filled.**
- **Never add fuel when the engine is running. This violates most fire-prevention regulations and may cause the Malfunction Indicator Light (MIL)  to turn on (see "Warning and Indicator Lights" in section "Dashboard Instruments and Controls").**
- Fill the vehicle with fuel. Fuel tank capacity is indicated in the "Refillings Table" in section "Maintenance and Care". When the fuel nozzle "clicks" or shuts off, the fuel tank is basically full: it is possible to further ensure refueling by enabling the fuel nozzle additional fuel supply until twofold clicks. After the two additional clicks, the amount of fuel allowed by the system is very low, we recommend therefore not to persist further.
- Wait approximately 10 seconds before removing the fuel nozzle in order to ensure completed supply of residual fuel and restrict the risk of fouling the fuel filler door area.
- Remove the fuel nozzle.
- Close the fuel filler door.

**CAUTION!**

To avoid fuel spillage and overfilling, do not “top off” the fuel tank after filling.

Emergency Refueling Funnel

A funnel is provided in the tool box container (represented in the picture a tool kit of a Gasoline model with compact spare wheel) for emergency refuelling with a gas can (see chapter “Tool Kit” in section “In a Emergency”).

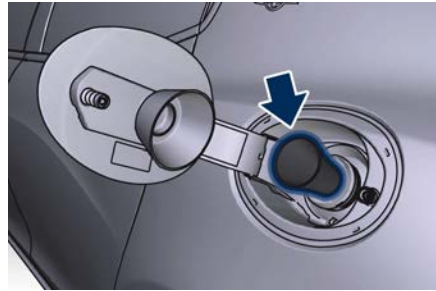
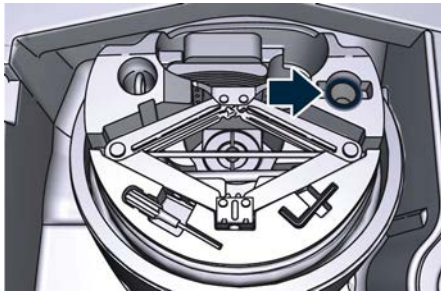
**WARNING!**

A fire may result if fuel is pumped into a portable container that is inside of a vehicle. You could be burned. Always place gas containers outside the vehicle while filling.

Emergency Fuel Filler Door Release

If you are unable to unlock the fuel filler door using the key fob, use the fuel filler door emergency release fitted in the trunk.

- Open the trunk lid (see “Trunk Lid Operation” in section “Before Starting”).
- Lift the access cover on the left side of the trunk.

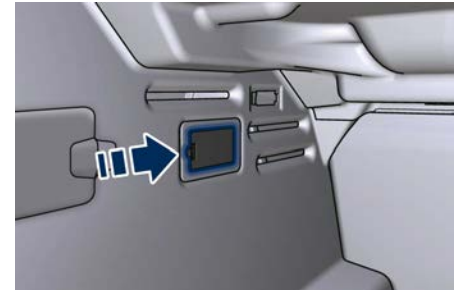

- Pull the release cable moderately to avoid its possible break. It's not possible to feel or hear the unlocking of the fuel filler door actuator.

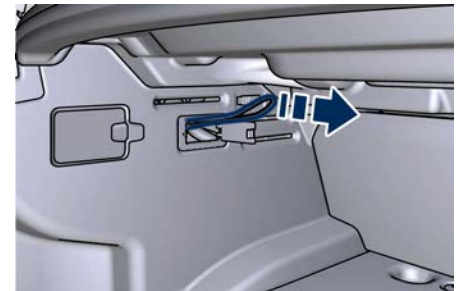

- Then open normally the fuel filler door.



Driving Conditions

Before the Trip

Check the following at regular intervals and always before long trips:

- tire pressure and condition;
- levels of fluids and lubricants;
- conditions of the windshield wiper blades;
- clean the glass on the external light and all other glass surfaces;
- proper operation of the indicator lights and of the external lights.



CAUTION!

It is however advisable to perform these checks at least every 600 mi (1000 km) and always following the maintenance schedule reported in section "Maintenance and Care".

Before you drive:

- adjust seat position, steering wheel, adjustable pedals (if equipped with) and rearview mirrors in order to have the best driving position;
- ensure that nothing (mat covers, etc.) is obstructing the pedals movement;
- carefully arrange and secure any objects in the trunk, to prevent them from moving forward in case of sudden stops;

- avoid heavy meals before a trip. A light snack helps keep your reflexes sharp. In particular, avoid drinking alcohol.



WARNING!

Passengers must only travel seated in the vehicle seats, with the seat belts fastened. Always check that the driver and all passengers have the seat belts correctly fastened.

Safe Driving

Although the vehicle is equipped with active and passive safety devices, the driver's conduct is always a decisive factor for road safety.

Some simple rules for traveling safely in different conditions are listed below. Some of them will probably already sound familiar but, in any case, it would be useful to read them carefully.

Driving at Night

The main guidelines to follow when driving at night are set out below.

- Drive carefully. Night conditions demand more focus and attention.
- Reduce your speed, especially on roads with no streetlights.
- Stop at early signs of drowsiness. Continuing to drive would be a risk

for yourself and for others. Have a rest before continuing your trip.

- Keep the vehicle at a greater distance from vehicles in front of you than you would during the day: it is difficult to assess the speed of other vehicles when you only see the lights.
- Use the high beams only outside of densely-populated areas and when you are sure that they will not disturb other drivers.
- When another vehicle is approaching, switch from high beams (if on) to low beams.
- Keep lights and headlights clean.
- Outside of densely-populated areas, beware of animals crossing the road.

Driving in the Rain

Rain and wet roads are dangerous. On a wet road all maneuvers are more difficult since wheel grip on the road is significantly reduced. This means that braking distances increase considerably and road grip decreases.

Some advices for driving in the rain are listed below.

- Reduce your speed and keep a greater safety distance from the vehicles in front of you. High speed may result in a loss of vehicle control.
- When driving on wet or slushy roads, it is possible for a wedge of water to build up between the tire and road



surface. This is known as aquaplaning and may cause partial or complete loss of vehicle control and stopping ability. To reduce this possibility: slow down if the road has standing water or puddles.

- Heavy rain substantially reduces visibility. In these circumstances, even during the day, turn on the low beams, to be more visible to other drivers.
- Set the air conditioning and heating system controls on the defogging function, in order to avoid any visibility problem.
- Periodically check the conditions of the windshield wiper blades.
- In low grip conditions use "I.C.E." driving mode (see chapters "Drive Mode" in this section).
- Avoid driving with ESC OFF as this will likely cause a loss of control of the vehicle.

Driving in Fog

If the fog is dense, avoid traveling if possible.

When driving in mist, blanket fog or when there is the possibility of banks of fog, please consider some advices listed below.

- Keep a moderate speed.

- Even in daytime, turn on the low beams and rear fog lights. Do not use the high beams.
- Remember that fog creates dampness on the asphalt and thus any type of maneuver is more difficult and braking distances are extended.
- Keep a safe distance from the vehicle in front of you.
- Avoid sudden changes in speed as much as possible.
- Whenever possible, avoid overtaking.
- If you are forced to stop the vehicle (breakdowns, impossibility of proceeding due to poor visibility, etc.), first of all, try to stop off of the travel lane. Then turn on the hazard warning lights and, if possible, the low beams.
- Sound the horn rhythmically if you hear another vehicle approaching.



CAUTION!

Be aware that rear fog lights can bother the drivers following your vehicle: when visibility is back to normal, turn off these lights.

Driving in the Mountains

Mountain roads usually have many narrow turns and curves, tunnels and steep uphill or downhill slopes: please consider some advices listed below.

- Drive at a moderate speed, avoid "cutting" corners.
- When driving inside a tunnel in daylight turn on the low beams in advance; avoid high beams and be aware of the rapid brightness change. Avoid abrupt maneuvers that could be dangerous for the following vehicle.
- Never coast downhill with the engine off or in neutral.
- Remember that passing other vehicles when driving uphill is slower and thus requires more free distance on the road. If you are being overtaken on a hill, slow down and allow the other vehicle to pass.

Driving on Snow or Ice

Please consider some general advice for driving in these conditions, listed below.

- Maintain a very moderate speed.
- Fit snow chains or specific tires if the road is covered with snow,  chapter "Tires Information" in section "Safety".
- We recommend you to activate the "I.C.E." mode (see chapters "Drive Mode" in this section).
- During the winter season, even apparently dry roads can have icy sections. Be careful when crossing bridges, viaducts and roads that have



little exposure to the sun and are bordered by trees and rocks. They may be icy.

- Keep an ample safe distance from the vehicles in front of you.
- Avoid sharp braking, sharp changes in direction and rapid acceleration.

Rapid acceleration on snow covered or icy surfaces may cause the driving wheels to pull erratically to the right or left. This phenomenon occurs when there is a difference in the surface traction under the rear (driving) wheels.



WARNING!

Rapid acceleration on slippery surfaces is dangerous. Unequal traction can cause sudden pulling of the driving wheels. You could lose control of the vehicle and possibly have a collision. Accelerate slowly and carefully whenever there is likely to be poor traction (ice, snow, wet mud, loose sand, etc.).

Driving through Flooded Sections

Driving through more than a centimeters deep shallow standing water section will require extra

caution to ensure passenger safety and prevent damage to your vehicle.



WARNING!

Do not drive on or across a road or path where water is flowing and/or rising (as in storm run-off). Flowing water can wear away the road or path surface and cause your vehicle to sink into deeper water. Furthermore, flowing and/or rising water can carry your vehicle away swiftly. Failure to follow this warning may result in injuries that are serious or fatal to you, your passengers, and others around you.

Although your vehicle is capable of driving through shallow standing water, consider the following Caution and Warning before doing so.



CAUTION!

- Always check the depth of the standing water before driving through it. Never drive through standing water that is deeper than 6 in (150 mm).
- Determine the condition of the road or the path that is under water and if there are any obstacles in the way

before driving through the standing water.

- Do not exceed 5 MPH (8 km/h) when driving through standing water. This will minimize wave effects.
- Driving through standing water may cause damage to your vehicle drivetrain components. After driving through standing water, do not drive if you are not sure about drivetrain condition. Such damage is not covered by the New Vehicle Warranty.
- Getting water inside your vehicle engine can cause it to lock up and stall out, and cause serious internal damage to the engine. Such damage is not covered by the New Vehicle Warranty.
- After driving through standing water always have the fluids (engine oil, transmission oil, etc) checked for contaminations at an **Authorized Maserati Dealer**.



WARNING!

- **Driving through standing water limits your vehicle traction capabilities. Do not exceed 5 mph (8 km/h) when driving through standing water.**



- Driving through standing water limits your vehicle braking capabilities, which increases stopping distances. Therefore, after driving through standing water, drive slowly and lightly press on the brake pedal several times to progressively dry the brakes discs and pads.
- Getting water inside your vehicle engine can cause it to lock up and stall out.
- Failure to follow these warnings may result in injuries that are serious or fatal to you, your passengers, and others around you.





6 - Driver Assistance Systems

| | |
|--|-----|
| General Notes | 194 |
| Park Assist (P) | 194 |
| Rear Parking Camera | 199 |
| Surround View Camera System (OPT) | 200 |
| Cruise Control - CC | 203 |
| Adaptive Cruise Control -ACC (OPT, with FCW only) | 206 |
| Forward Collision Warning - FCW (OPT) | 215 |
| Lane Keeping Assist - LKA (OPT, with ACC only) | 219 |
| Blind Spot Assist (BSA, without ACC) | 223 |
| Active Blind Spot Assist - ABSA (OPT, with ACC only) | 228 |
| Active Driving Assist - ADA (OPT, with ACC only) | 232 |
| Traffic Sign Assist - TSA (OPT) | 236 |



General Notes

This section lists all the parking assistance systems and all the Advanced Driver Assistance Systems, sintetically called ADAS, available for this car.

Some ADAS are standard, others are optional and may vary depending on the equipment of the car and the target market.

Some of these systems activate or deactivate automatically, others can be activated or deactivated and set using the buttons on the steering wheel L/H side or via the "Controls" and "Settings" menu on the "Vehicle" page or the "Apps" page of MIA display. For further information see "Functions of Controls Menu on MIA" and "Functions of Settings Menu on MIA" in section "Dashboard Instruments and Controls".

6

Park Assist (P)

The Park Assist (also called "ParkSense") system provides visual and audible indications of the distance between the rear and/or front bumper and a detected obstacle when backing up or moving forward, e.g. during a parking maneuver.

Besides the use of the sensors available on the bumpers and of the rear parking camera, the vehicle may be equipped with surround view cameras (OPV) to assist the driver during maneuvers on dead-ends/roads and on intersections. For more details on this option, see chapter "Surround View Camera System" in this section.

Refer to "Park Assist System Usage Precautions" in this chapter for limitations of this system and recommendations. Park Assist system will retain the last system state (enabled or disabled) from the last ignition cycle when the ignition device is changed to the **RUN** position.

Park Assist system can be active only when the shift lever is in R (Reverse) or D (Drive).

If Park Assist is enabled at one of these shift lever positions, the system will remain active until the vehicle speed is increased to approximately 7.5 MPH

(12 km/h) or above. The system will become active again if the vehicle speed is decreased to speeds less than approximately 6.2 MPH (10 km/h).

Park Assist Sensors

The four Park Assist sensors, located in the rear bumper, monitor the area behind the vehicle that is within the sensors' field of view. The sensors can detect obstacles up to approximately 78 in (200 cm) from the rear bumper in the horizontal direction, depending on the location, type and orientation of the obstacle.

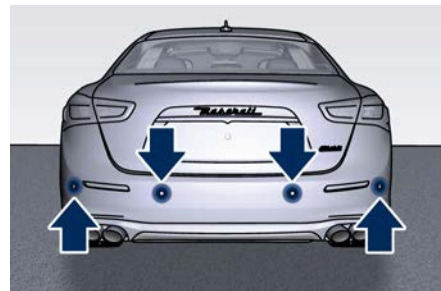

The six Park Assist sensors, located in the front bumper, monitor the area in front of the vehicle that is within the sensors' field of view.

The sensors can detect obstacles up to a distance of approximately 50 in (120 cm) from the front bumper in the horizontal direction, depending on the



location, type and orientation of the obstacle.

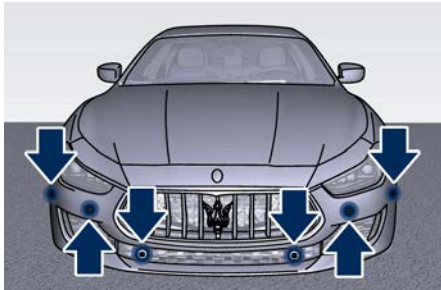

Park Assist Warning Messages Display

The Park Assist Warning screen will only be displayed if "Sound + Display" is selected from the MIA system.

Refer to "Functions of Settings Menu on MIA" in section "Dashboard Instruments and Controls" for further information.

The Park Assist Warning screen is located on the instrument cluster display.

It provides visual warnings to indicate the distance between the rear bumper and/or front bumper and the detected obstacle.

The warning display will turn on indicating the system status (ready or off) when the vehicle is in R (Reverse)

or in D (Drive) and an obstacle has been detected.

The detection area in front of the vehicle is divided into two parts with four arcs while the two detection areas behind the car into five arcs.

The system will indicate a detected obstacle by displaying arcs with fixed or flashing light and a characteristic sound according to the obstacle distance. The color indicates the distance and the arc indicates the position of the detected obstacle. The green color of the outer arc indicates the maximum distance, the amber color of the middle arcs indicates the medium distance, while the red color of the nearest arc indicates the minimum distance.



As the vehicle moves closer to the object, the instrument cluster will display the arc moving towards the vehicle and the sound tone will change from single to slow, to fast and to continuous.

The vehicle is close to the obstacle when the instrument cluster displays one flashing red arc only, combined with a continuous sound.



The following charts show the warning alert visualization when the system is detecting an obstacle.

| Front Sensors - Warning Alerts | | | | | |
|--------------------------------|-----------------------------|--------------------------|-------------------------|----------------------------|------------------------------|
| Front distance | More than 50 in (120 cm) | 50-40 in (120-101 cm) | 40-24 in (100-61 cm) | 23.6-12.2 in (60-31 cm) | Less than 12 in (30 cm) |
| Audible Alert | None | None | Slow (5 Hz) | Fast (8 Hz) | Continuous |
| Arc in left and right areas | None | 4 th | 3 rd | 2 nd | 1 st (inner most) |
| Light type | None | Solid | Solid | Flash | Flash |
| Arc color | — | Green | Amber | Amber | Red |
| Radio sound | Active | Active | Mute | Mute | Mute |

| Rear Sensors - Warning Alerts | | | | | | |
|-------------------------------|-----------------------------|----------------------------|--------------------------|-------------------------|----------------------------|------------------------------|
| Rear distance | More than 78 in (200 cm) | 78-59.4 in (200-151 cm) | 60-40 in (150-101 cm) | 40-24 in (100-61 cm) | 23.6-12.2 in (60-31 cm) | Less than 12 in (30 cm) |
| Audible Alert | None | None | Slow (2 Hz) | Slow (5 Hz) | Fast (8 Hz) | Continuous |
| Arc in left and right areas | None | 5 th | 4 th | 3 rd | 2 nd | 1 st (inner most) |
| Light type | None | Solid | Solid | Solid | Flash | Flash |
| Arc color | — | Green | Amber | Amber | Amber | Red |
| Radio sound | Active | Active | Mute | Mute | Mute | Mute |

**NOTE:**

Park Assist will turn off the front park assist audible alert (chime) after approximately 4 seconds when an obstacle has been detected, the vehicle is stationary, and brake pedal is applied.

Enabling and Disabling Park Assist

By accessing the submenu "Safety & Driving Assistant" from MIA system, the "Park Assist" can be disabled (option "Off"). The available options regarding the warning alerts are: "Sound" or "Sound + Display". Refer to "Functions of Settings Menu on MIA" in section "Dashboard Instruments and Controls" for further information.

The front sensors can be enabled or disabled at any time by pressing the button on the front dome console.



After pressing the button the instrument cluster will display the state of front parking sensors for approximately five seconds. The button LED will be on when the front sensors are disabled. The button LED will be off when the front sensors are enabled. If the button is pressed and the system requires service, the LED will blink momentarily, and then the LED will be on.

When the shift lever is moved to R (Reverse) or to D (Drive) at a speed of 7 MPH (11 km/h) or below and the system is disabled, the instrument cluster will display the "PARK ASSIST Off" message for 5 seconds until the shift lever remains in R (Reverse) or when the shift lever is moved in D (Drive).

Service the Park Assist System

In case of malfunction of the Park Assist system, the instrument cluster will actuate a single sound, once per ignition cycle. The instrument cluster will display a message when any of the rear or front sensor(s) are blocked by snow, mud, or ice and the vehicle is shifted into R (Reverse) or D (Drive).

The instrument cluster will display a message when any of the rear or front sensors are damaged and require service.

When the shift lever is moved to R (Reverse) or D (Drive) and the system has detected a faulted condition, the instrument cluster will display the corresponding message for the time lapse the vehicle is in R (Reverse) or D (Drive) at speeds less than 7 MPH (11 km/h). Under this condition Park Assist will not operate. See "Warning and Indicator Lights" in section "Dashboard Instruments and Controls" for further information.

If the instrument cluster displays a message prompting you to clean the sensors, make sure the outer surface and the underside of the rear bumper and/or front bumper is clean and clear of snow, ice, mud, dirt or other obstruction and then cycle the ignition device. If the message continues



to appear contact the **Authorized Maserati Dealer**.

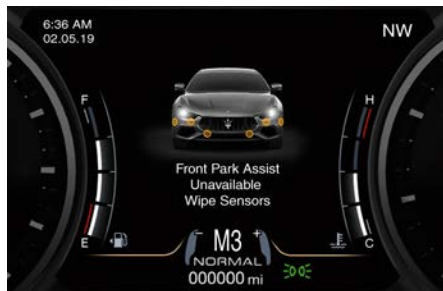

If a failure message is displayed on the instrument cluster, contact the **Authorized Maserati Dealer**.

Cleaning the Park Assist Sensors

When cleaning the sensors, take special care not to scratch or damage them; therefore, do not use dry, rough or hard cloths.

The sensors must be washed with clean water, possibly adding car shampoo. Should you need to repaint the bumper or in case of paint touch-ups in the sensor area, please contact exclusively the **Authorized Maserati Dealer**. Incorrect paint application could affect the parking sensors operation.

Park Assist System Usage Precautions

NOTE:

- Jackhammers, large trucks, and other vibrations could affect the performance of Park Assist.
- Objects such as bicycle carriers, trailer hitches, etc., must not be placed within 12 in (30 cm) from the rear bumper while driving the vehicle. Failure to do so can result in the system misinterpreting a close object as a sensor problem, causing the service Park Assist message to be displayed in the instrument cluster.



CAUTION!

- Park Assist is only a parking aid and it is unable to recognize every obstacle, including small obstacles. Parking curbs might only be temporarily detected or not detected at all. Obstacles located above or below the sensors will not be detected when they are in close proximity.
- The vehicle must be driven slowly when using Park Assist in order to be able to stop in time when an obstacle is detected. When backing up, it is recommended that the driver looks

over his/her shoulder when using Park Assist.



WARNING!

Drivers must be careful when backing up even when using the Park Assist system. Always check carefully behind your vehicle, look behind you, and be sure to check for pedestrians, animals, other vehicles, obstructions, and blind spots before backing up. You are responsible for safety and must continue to pay attention to your surroundings. Failure to do so can result in serious injury or death.

Park Assist Volume

The volume of the acoustic signal emitted by the front and rear parking sensors is set to the medium level. Three different levels of volume can be selected via the submenu "Safety & Driving Assistant" of the "Settings" page on MIA.

Low level is useful in certain conditions when the parking sensor acoustic signal keeps coming on although there is no actual collision hazard. This may typically occur when driving in a queue or when the vehicle is overtaken by motorcycles or other vehicles on one or both sides in a queue of traffic.



When you set the volume, only the parking sensor acoustic signal will be affected. The radio or any other devices connected to the vehicle sound system will not be affected. Refer to chapter "Functions of Settings Menu on MIA" in section "Dashboard Instruments and Controls" for further information.

Rear Parking Camera

Your vehicle can be equipped with a rear parking camera that allows you to see an image on the MIA screen of the rear surroundings of your vehicle whenever the shift lever is put into R (Reverse).

When "Parkview Backup Camera Delay" mode is enabled, the rear view image shall be displayed for up to 10 seconds after shifting out of R (Reverse).

To assist the driver during maneuvers on dead-ends/roads and on intersections, the vehicle may be equipped with an optional surround view camera system. In this case, the rear parking camera is integrated into the surround view camera system. In both configurations (rear parking camera only or surround view camera system), you can always monitor the rear view. For more details on this option, see chapter "Surround View Camera System" in this section.

The image will be displayed along with a caution note to "Check Entire Surroundings" across the top of the screen. After five seconds this note will disappear.

The rear parking camera is located on the rear of the vehicle above the rear license plate.



When the shift lever is shifted out of R (Reverse), the rear camera mode is exited and the navigation or audio screen appears again.

When displayed, dynamic grid lines (if the function is set to MIA through the "Settings" menu of the "Vehicle" page) will illustrate the width of the vehicle to assist with parking or aligning to a hitch/receiver. The dynamic grid lines will show separate zones in different color that will help indicate the distance to the rear of the vehicle.

The following table shows the approximate distances for each zone and color:



| Zone | Distance to the rear of the vehicle |
|--------|-------------------------------------|
| Red | 11 - 12 in (28 - 30 cm) |
| Yellow | 12 - 78 in (30 cm - 2 m) |
| Green | 78-157 in (2 - 4 m) or greater |

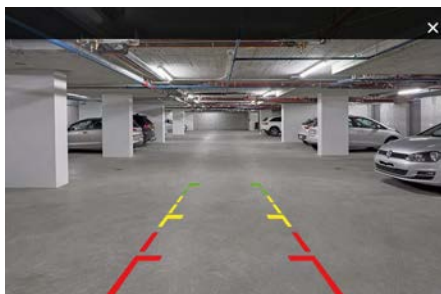

6

WARNING!

Drivers must be careful when reversing even when using the rear view camera. Always check carefully behind your vehicle, and be sure to check for pedestrians, animals, other vehicles, obstructions, or blind spots before reversing. You are responsible for the safety of your surroundings and must continue to be careful while reversing. Failure to do so can result in serious injury or death.

CAUTION!

- To avoid vehicle damage, the rear camera should only be used as a parking aid, as the rear camera is unable to view every obstacle or object in your drive path.
- To avoid vehicle damage, the vehicle must be driven slowly when using the rear camera to be able to stop in time when an obstacle is seen. It is recommended that the driver looks frequently over his/her shoulder when using the rear camera.

NOTE:

If snow, ice, mud, or any other substance builds up on the camera lens, clean the lens, rinse with water, and dry with a soft cloth. Do not cover the lens.

Surround View Camera System

System components

The system uses four cameras to monitor the area around the vehicle, placed on the front grid, under the side rearview mirrors and on the trunk lid, between the number plate lights.

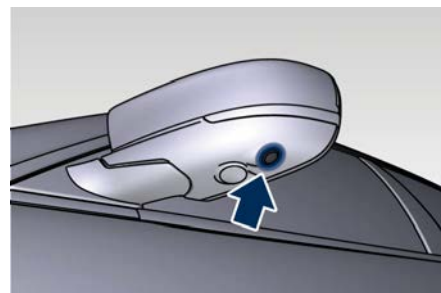



When the shift lever is shifted to R (Reverse) position, the top view and the rear view of the surrounding area will be automatically displayed on MIA display.

Image will be displayed with active guidelines while in that gear as long as vehicle speed remains lower than 8 MPH (12 km/h).





When vehicle is shifted into a different gear, the image will remain displayed for 10 seconds, or vehicle is shifted in P (Park), or until vehicle speed exceeds 8 MPH (12 km/h), at which point it will immediately cancel and return to the last-viewed screen.

Instead, when the shift lever is shifted to P (Park), N (Neutral) or D (Drive) position, it is possible to activate/deactivate the system by touching "Surround View Camera" soft-key in

"Controls" menu of the "Vehicle" page.



Once the "Surround View Camera" screen is displayed, it is possible to choose which images to display according to 4 possible settings.

-  Rear view and top view
-  Rear cross path view
-  Front cross path view
-  Front view and top view

In any shift lever condition, when "Surround View Camera" screen is displayed, a pop-up message will appear in the upper part for 5 seconds to advise the driver to check the surrounding scenario before any maneuver.

With transmission in P (Park), N (Neutral) or D (Drive), the upper right corner of the screen will show the "X" key: touch it to go back to the previous screen of MIA display, before entering in "Controls".

The deactivation of the rear visualization via "X" soft-key is not possible when the transmission is in R (Reverse) position.

Choose the most suitable setting for the situation and the maneuver you are performing or going to perform, by touching the relevant button present under the images: the edges of the pressed button will highlight. The button will highlight and the type of setting will appear on each image.

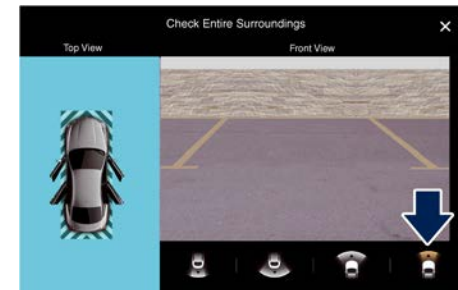

In the top view, the vehicle is represented as it is during the maneuver (see example in the figure),



therefore any open doors will be visible in the image.

To display also the dynamic lines of the trajectory you are setting, it is necessary to set this function by accessing the "Settings" menu on "Vehicle" page of MIA, at "Safety & Driving Assistant" item, by using the dynamic gridlines action menu. Once this menu is displayed, it is also possible to set the function that delays the exit from this screen in special situations when the transmission lever is in D (Drive), N (Neutral) and P (Park) position by using the surround view camera delay menu. For further information, see "Functions of Settings Menu on MIA" in section "Dashboard Instruments and Controls".

6

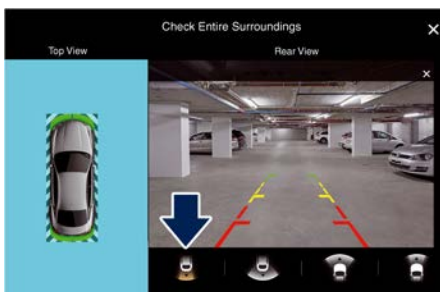

WARNING!

Failure to follow the precautions below might result in serious injury or even death.

- Drivers must be careful during maneuvers also when using the camera system with surround view.
- Always check carefully the areas around your vehicle, before proceeding forward or backward.
- Be sure to always check for any pedestrians, animals, other vehicles, obstructions, or blind spots.
- The driver must use the utmost caution while using the system to avoid damage to property or personal injury.
- The camera system with surround view is designed for use during the day or under good lighting conditions. Do not use and rely on the system under poor lighting conditions.
- Distance lines and directional lines must be used only as a reference and only when vehicle is on a flat ground. The distance shown on MIA display must be interpreted as a reference and might be different from the distance actually present

between the vehicle and any displayed objects.

- Any obstacles present above the cameras cannot be detected.



CAUTION!

- To avoid vehicle damage, the camera system with surround view should only be used as a parking aid, as the cameras are unable to view every obstacle or object in your drive path.
- To avoid vehicle damage, the vehicle must be driven slowly when using the camera system with surround view, to be able to stop in time when an obstacle is seen. It is recommended that the driver looks frequently over his/her shoulder when using this system.

NOTE:

If snow, ice, mud, or any other substance builds up on the camera lens, clean the lens, rinse with water, and dry with a soft cloth. Do not cover the lens.



Cruise Control - CC

The electronic Cruise Control (CC) enables the driver to maintain the desired vehicle speed without pressing the accelerator pedal, reducing driving fatigue on highways, especially long trips, as the set speed is automatically maintained. A firm press on the accelerator pedal or the braking pedal will temporarily deactivate the cruise control function.



CAUTION!

The device can only be switched on at speeds exceeding 18 MPH (30 km/h) and it switches off automatically when the brake pedal or the accelerator pedal is pressed.



WARNING!

The Cruise Control function must only be activated when traffic and the route permit a constant speed to be maintained safely for a sufficiently long distance.

Controls

The controls are located on the left side of the steering wheel.

Control configuration depends on which driver assist systems are installed to the vehicle.

In the standard configuration there is a specific button to enable and disable the CC.

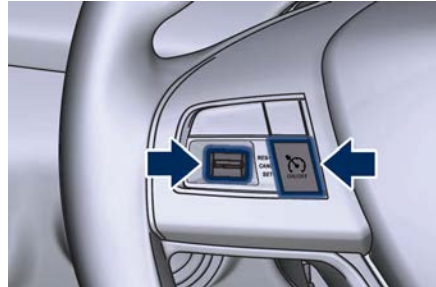

Standard Configuration

In the optional configuration, there is no specific button to enable and disable the CC, since the driver uses the ACC control buttons.

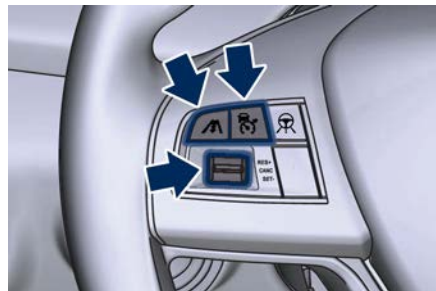

Optional Configuration

Control buttons have the following functions:

Standard Configuration



ON/OFF button to engage/disengage CC system.

Optional Configuration



Press ACC time gap button and hold it down for 2 seconds to enable the CC system.



Press ACC button to disable the CC system.

Shared by All Configurations



Multifunction switch:

- Press up (indication RES +): increase speed, set current speed or resume previously set speed when system is in "cancelled" status;
- Pushed (indication CANC): deletes the set speed;
- Press down (indication SET -): set speed/decrease speed.

NOTE:

- The figures only show the Standard Configuration.
- In order to ensure proper operation, the CC system has been designed to shut down if multiple systems

(Continued)



(Continued)

are operated at the same time (example: ACC and FCW). When conditions so allow, the CC system can be reactivated by pushing the CC "ON/OFF" button or the ACC time gap button (in the Optional Configuration) and resetting the desired vehicle set speed.

Displayed Information

Apart from the pop-up messages at the center of the display, CC system status is represented by icons at the top left of the TFT display, in the dedicated area. See "TFT Display Areas" in section "Dashboard Instruments and Controls".

Displayed information depends on system status: ready, set, temporarily cancelled or override.

6

Activation

To turn the system on, push the ON/OFF button or the ACC time gap button for 2 seconds (in the Optional Configuration). The white light with below 3 dashes on the TFT display will illuminate.



To turn the system off, push the ON/OFF button a second time or the ACC button (in the Optional Configuration). The white light will turn off.

NOTE:

The CC system must be turned off when not in use.



WARNING!
Never leave the Cruise Control system on when not in use. You could accidentally set the system or cause it to go faster than you want. Always leave the system off when you are not using it.

Speed Range of Use

| Speed | MPH (km/h) |
|---------|------------|
| Minimum | 20 (30) |

| Speed | MPH (km/h) |
|-------------------|------------|
| Engaged/activated | 20 (30) |
| Maximum | 130 (210) |

Setting Desired Speed

Turn on the CC function. When the vehicle has reached the desired speed (in the example: 60 MPH), push downward the multifunction switch (SET -) and release.

The green light below the desired speed will illuminate on the TFT display.



Release the accelerator and the vehicle will operate at the selected speed.

NOTE:

The vehicle should be traveling at a steady speed and on level ground before pushing the switch downward.



Pressing the  "ON/OFF" button or the ACC time gap button for 2 seconds (in the Optional Configuration) or moving the ignition device in **OFF** position erases the set speed memory.

Changing Speed Setting

Pushing the multifunction switch upward (RES +) or downward (SET -) once, or by holding it down, will enable to increase or decrease the set speed by one unit (1 MPH or 1 km/h). If the car is equipped with ADAS Systems, the single press of the multifunction switch will increase or decrease the set speed of 1 MPH or 1 km/h; a continuous pressure of the same will increase or decrease the set speed of 5 MPH or 10 km/h.

Release the switch when the desired speed is reached, and the new set speed will be visualized below the green light.

Each subsequent tap of the multifunction switch will increase or decrease the speed by 1 MPH or 1 km/h.

Temporary Deactivation

A soft tap on the brake pedal, pressing the multifunction switch (CANC), or normal brake pressure while slowing the vehicle will temporarily deactivate the CC without erasing the set speed

memory. The  white light with below the set speed will appear on the display.



Driver Override

If the driver presses the accelerator pedal while the CC is on, such as to overtake another vehicle, and exceeds the set speed limit, the system will temporarily deactivate the CC. During the event, the speed indication below the  green light will be blinking.



When the accelerator pedal is released, the  vehicle will return to the set speed and the green light with below the set speed with steady light will be displayed.

Resume Speed

To resume a previously set speed, push upward the multifunction switch (RES +) and release. The  green light with below the set speed will illuminate on the TFT display. Resume can be used at any speed above 18 MPH (30 km/h).

Using Cruise Control on Hills

The transmission may be downshifted on hills to maintain the vehicle set speed. The CC system maintains set speed up and down hills. A slight speed change on moderate hills is normal. On steep slopes it is recommended to drive without CC.



WARNING!
Cruise Control (CC) can be dangerous where the system cannot maintain a constant speed. Do not use CC in heavy traffic or on winding, icy, snow-covered or slippery roads.



Adaptive Cruise Control -ACC (OPT, with FCW only)

The Adaptive Cruise Control (ACC) is part of ADAS equipments and can only be present on cars equipped with Front Collision Warning (FCW).

NOTE:

LKA and ABSA and all the other ADAS systems are described in the relevant chapters of this section.

Warning and Cautions

The ACC further increases the drive comfort ensured by the Cruise Control (CC). Acc can work in any type of road: however, its use it is not recommended for urban driving.

Always consider that ACC is not a safety system and is not designed to prevent accidents.

The ACC allows driver to keep CC active in limited or moderate traffic conditions with no need to constantly restore the CC.

The ACC uses a radar sensor, located on the front grille behind the trident, and the forward-facing camera behind the internal rear-view mirror to detect the presence of a vehicle ahead at a close distance and moving in the same direction.



This vehicle, in this chapter, will be indicated as "target vehicle" or "vehicle ahead".

NOTE:

- If the sensor detects no vehicle ahead, the ACC system will maintain set steady speed.
- When the ACC sensors detect a target vehicle, the system keeps the time gap selected by the driver. In the same way, the ACC adapts the vehicle speed according to both distance gap and set speed selected by the driver.



- WARNING!**
- The Adaptive Cruise Control (ACC) is designed to increase vehicle driving comfort. It must not be considered as a means of replacing the required attention of the driver. The driver is always required to drive carefully.

The driver is always required to pay utmost attention to driving conditions (road, traffic, weather) and style (speed, distance from sensed vehicle ahead, brake use). Driver has the full responsibility of the vehicle therefore his attention is crucial to keeping vehicle control, in particular when approaching curves and situations with heavy traffic. Failure to follow these warnings can result in a collision and death or serious personal injury.

- In some driving scenarios, the ACC could have detection problems. In such cases, the ACC could kick in late or unexpectedly. The driver must be careful since his/her intervention could be necessary.
- It is always the driver's responsibility to obey speed limits and to keep minimum legal distance to the preceding vehicle.
- ACC system can decelerate only with limited braking, it cannot execute emergency braking.

The ACC system:

- Does not activate/react in the presence of pedestrians, bicycles, incoming traffic from the opposite direction and steady objects such as a vehicle stuck in a traffic jam.



- Is meant for the use on highways and well-built roads, not for city traffic or mountain roads.
- May not have enough time to react and/or decelerate sufficiently on vehicles when lane is changed too quickly or the relative speed is too high. In such cases the driver has to react appropriately and without any acoustic/visual and warning.
- Cannot consider road, traffic and weather conditions and might prove limited when visibility is poor.
- Does not always fully recognize complex driving conditions and this could cause an incorrect assessment of the required safety distance.

It is recommended to disable the ACC system in the following instances:

- When driving in the fog, heavy rain, heavy snow, slush, heavy traffic and similar complex situations such as highway construction zones.
- When entering a junction lane or a slip road to leave the highway; when driving on narrow, icy, snowy, slippery roads, or on steep uphill and downhill roads.
- When circumstances do not allow to drive safely at constant speed.

Displayed Information

ACC condition, as well as the LKA and ADA status, is displayed on TFT Display after selecting "Driver Assist" menu (see paragraph "TFT Display: Menu and Submenu Content" in section "Dashboard Instruments and Controls").

Displayed information depends on system status: ready, set, temporarily cancelled or override.

Apart from the image at the centre of the display, ADAS systems status is represented by icons at the top left and right of the TFT display. These icons remain displayed even when you exiting the "Driver Assist" screen.

The vehicle(s) and horizontal bars represent the ACC status as ready (white) or with sensed vehicle ahead (green); the white, grey or yellow lines represent the LKA and ADA systems.

The ACC screen can be displayed any time driver changes system status or settings. After 5 seconds of ACC inactivity, the display goes back to last screen.

System Controls and Activation Conditions

The buttons on the LH side of the steering wheel control the ACC operations and the other

functions/driver assist systems installed to this vehicle.

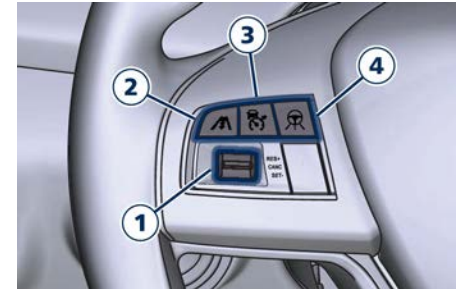

1. Multifunction control shared by all driver assist functions/systems:
 - Press up (indication "RES +"): increase speed, set current speed or resume previously set speed when system is in "cancelled" status.
 - Pushed (indication "CANC"): cancel the function if it was in "set" status, going in a ready condition but remembering the previous set speed.
 - Press down (indication "SET -"): set speed/decrease speed.
2. Two functions button with ACC activated:
 - ACC time gap: pressed and released; set the distance to sensed vehicle ahead as



- horizontal bars (setting cycle starts to 3 bars).
 - CC On: pressed for 2 seconds activates the CC system. See chapter "Cruise Control - CC" in this section for further details.
 - Press it to switch from CC to ACC.
3. ACC ON/OFF button. If enabled, pressing this button will disable CC.
 4. ADA ON/OFF button **with ACC set** only. See "Active Driving Assist - ADA" in this section for further details.

NOTE:

Any change made to tire dimensions affects performance of Adaptive Cruise Control and Front Collision Warning, if equipped.

6

The ACC is not activated in the following conditions:

- When braking.
- When parking brake is activated.
- When automatic transmission is in P (Park), R (Reverse) or N (Neutral).
- When vehicle speed is out of preset speed range.
- When brakes are overheated.
- When driver door is open.
- When the driver's seat belt is unbuckled.

- When the road is particularly steep (both uphill and downhill) at low speed.
- When drive mode  (ESC OFF) is selected.
- When the door is opened at low speed.
- When there has been an ESC event in the last 5 seconds, or is still active.
- When there is an object too close in front of the vehicle.

It is possible that more than one system is active at the same time such as ACC and ABSA just to mention some.

While activation of ACC and CC at the same time is impossible.

Speed Range of Use

| Speed | MPH (km/h) |
|-------------------|------------|
| Minimum | 0 |
| Engaged/activated | 20 (30) |
| Maximum | 130 (210) |

Activation/Deactivation

NOTE:

Pictures show status of ACC and LKA systems.

Press and release  ON/OFF button to activate the ACC and enter the "Driver Assist" page. The display will

show in the top left corner the  white symbol with below 3 dashes will illuminate indicating that system is ready to be set.

In the main area the symbology of the other ADAS system set will be displayed.

When exiting the "Drive Assist" page, only the ADAS symbology will remain on the top left corner.



If a vehicle is detected as being too close, the display will show a message for 5 seconds and trigger a buzzer to warn the driver that current conditions do not allow enabling of the ACC. At any rate, system will remain in the ready status.



Push the ON/OFF button a second time and release to turn the system off. A pop-up message is displayed for 2 seconds to indicate that ACC was disabled.



WARNING!

Leaving the Adaptive Cruise Control (ACC) system on when not in use is dangerous. You could accidentally activate the system or cause it to go faster than you want. Always leave the system off when you are not using it.

Setting the Speed

When vehicle reaches required speed, press down and release the multifunction control (SET -). The display will show set speed corresponding to vehicle current one. Speed value will be indicated below the green symbol and above the distance bars, in the center of the display.



Remove foot from accelerator pedal and vehicle will continue at set speed.

Driver Override

If the driver accelerates beyond the set speed or faster than the car would do with ACC engaged, the set speed below the green light will blink and the time gap bars will vanish to indicate that in this condition the system cannot control the distance between vehicle and sensed vehicle ahead. Vehicle speed will be determined only by the accelerator pedal position.

Changing Speed Setting

Once speed is set, driver can increase or decrease it by respectively pressing multifunction control up (RES +) or down (SET -). Speed can be increased or decreased in two ways:

- Pressing control once, set speed will increase or decrease by one unit corresponding to 1 MPH (1 km/h).
- Hold the control to increase or decrease set speed by 5 MPH (10 km/h) at a time.

NOTE:

- When pressing the multifunction control up (RES +) or down (SET -), the new set speed will be the current speed of the vehicle.
- When using (SET -) control to decelerate, if the engine braking

(Continued)



(Continued)

power does not slow down the vehicle sufficiently to reach the set speed, the brake system will automatically slow down the vehicle.

- The ACC system applies the brake down to a full stop when following a target vehicle. If an ACC host vehicle follows a target vehicle to a standstill, after a two second delay, the system will not be able to resume driving the car autonomously. At this point it is necessary the intervention of the driver on the multifunction control (press SET- or RES+) or press the accelerator pedal (see "ACC Operation Before and During Stop" in this chapter).
- The ACC system maintains set speed when driving up hill and down hill. However, a slight speed change on moderate hills is normal. In addition, downshifting may occur while climbing uphill or descending downhill. This is normal operation and necessary to maintain set speed. When driving uphill and downhill, the ACC system will cancel if the braking temperature exceeds normal range.

6

Temporary Deactivation

A soft tap on the brake pedal, pushing the multifunction control (CANC), or normal brake pressure while slowing the vehicle will temporarily deactivate the ACC without erasing the set speed memory. The  white light will appear on the TFT display with below the set speed.

Conditions for Disabling and Deactivation

Besides the cases specified in the previous paragraph, the following conditions will disable the system:

- Anti-Lock Brake (ABS) kicks in.
- Transmission lever is not in D (Drive).
- The Electronic Stability Control and the Traction Control System (ESC/TCS) activate.
- Vehicle parking brake is operated.
- The driver safety belt is unbuckled at low speed.
- The driver door is ajar at low speed.
- The driver disabled the ESC using the  (ESC Off) button on central console.
- The road is too steep both uphill and downhill at low speed.

The system is deactivated and set speed is deleted from system memory, if the ACC ON/OFF button is pressed or if ignition device is turned to **OFF**.

Resuming Speed

If a speed setting is stored in system memory, press the multifunction control (RES +) up and take foot off the accelerator pedal. The last set speed will be displayed.



WARNING!

The resume function should be used only when road and traffic conditions allow it. Resuming a too high or too low speed for current traffic and road conditions could cause a harsh vehicle acceleration or deceleration which could increase the risk of collisions and death or serious injury.

Setting the Time Gap

The specified time gap has four different settings, identified by 4 horizontal bars that represent 4 different distance gaps:

- Maximum (longest) time: 4 bars.
- Long time: 3 bars (default time).
- Medium time: 2 bars.
- Short time: 1 bar.

Based on both time gap, selected by the driver, and the actual vehicle speed, ACC calculates the distance to keep from the vehicle ahead.

If another information covering ADAS visualization in the main area (textual



pop ups, NAVI information, phone call, etc...) are displayed, the ACC time gap symbol shall be displayed in the top left corner for the time the ADAS in the main area is covered (see detail in picture).

If system does not detect the presence of any vehicles ahead, only the bars referred to set time gap will be displayed.

When system detects the presence of a vehicle ahead, it is displayed in front of the bars (see example in the figure).



To increase or decrease the number of bars, corresponding to the time gap from vehicle ahead, press and release the related setting button.

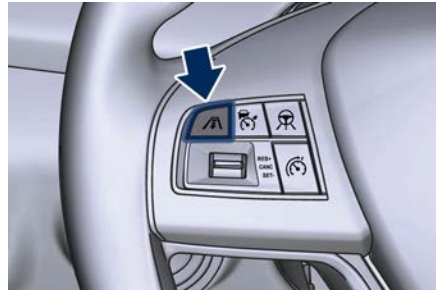

Each press and release of the button changes the time gap starting from 3 bars (default time) and moving in a sequential way towards the minimum time: 3→2→1→4→3→2→1→4 and so on.

If there is no vehicle ahead, the vehicle will maintain the set speed. If a slower moving vehicle is detected in the same lane, the system displays the target vehicle icon before the bars.

From that moment, the system adjusts vehicle speed automatically to maintain the time gap setting, regardless of the set speed.

The vehicle will then maintain the set time gap until:

- The vehicle ahead accelerates to a speed above the set speed.
- The vehicle ahead moves out of your lane or view of the sensor.
- The time gap setting is changed.
- The driver disables the system.

The maximum braking applied by ACC is limited; however, the driver can always apply the brakes manually, if necessary. Any time the ACC system automatically operates the brakes, the stop lights will turn on as if the driver was braking.

A Proximity Warning on display will alert the driver if ACC predicts that its maximum braking level is not sufficient to maintain the set time gap. If this occurs, a visual alert will flash on the display and a chime will sound while ACC continues to apply its maximum braking capacity.

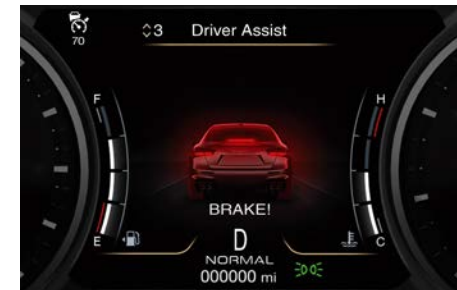

NOTE:

The displayed warning is a warning for the driver to take action and does not necessarily mean that the Forward Collision Warning system is applying the brakes autonomously.



Overtake Aid

When driving with ACC engaged and following a target vehicle, the system will provide an additional acceleration to assist in passing vehicles in front.

This additional acceleration is triggered when the driver utilizes the left turn signal to start overtaking. In locations with left hand drive traffic, overtake aid is active only when passing on the left hand side of the target vehicle.

When a vehicle goes from a location with left hand drive traffic to a location with right hand drive traffic, the ACC system will automatically detect traffic direction. In this condition, overtake aid is active only when passing on the right side of the target vehicle. This additional acceleration is triggered when the driver utilizes the right turn signal to start overtaking. In this condition the ACC system will no longer provide Overtake Aid on the left side until it determines that the vehicle has moved back to a location with left hand drive.

System Operation Before and During Stop

If an ACC host vehicle follows a target vehicle to a standstill, after two

seconds the system will not be able to resume.

In this condition, TFT displays an instruction message pop up for 5 seconds and the driver has to press the accelerator pedal or resume the ACC speed by acting on the multifunction control (RES + or SET -).

While ACC with Stop is holding your vehicle at a standstill, if the driver unbuckles the seatbelt or opens the door, the ESC system will activate the EPB. During standstill, ACC system monitors the occupant detection signals: if the driver's seatbelt becomes unbuckled, the ACC system shall be cancelled when the EPB is applied.



WARNING!

- **When the Adaptive Cruise Control (ACC) system is resumed, the driver must ensure that there are no pedestrians, vehicles or objects in the path of the vehicle. Failure to follow these warnings can result in a collision and death or serious personal injury.**
- **During the automatic stopping behind a vehicle in some rare cases it may happen that the system does not recognize the rearmost point of**

the vehicle ahead but a target under the vehicle ahead (e.g. the back axle of a truck with a high loading edge or a bumper of a vehicle although overhanging load is hanging over the vehicle's rear). In these cases the system cannot guarantee the appropriate stopping distance leading to collision in the worst case. For this reason the driver has to be attentive and ready to brake during automatic stops.

Display Warnings and Maintenance of ACC and FCW Systems

Wipe Front Radar Sensor Warning

This warning will display and also a chime will indicate when conditions temporarily limit system performance due to sensor poor or failed signal reception. This most often occurs at times of poor visibility, such as in snow or heavy rain. The ACC and FCW systems may also become temporarily blinded due to obstructions, such as mud, dirt or ice on the radar sensor. In these cases, the system will be disabled.

This message can sometimes be displayed while driving in highly reflective areas (i.e. tunnels with reflective tiles, or ice and snow). The



ACC and FCW systems will recover operation after the vehicle has left these areas. Under rare conditions, when the radar is not tracking any vehicles or objects in its path this warning may temporarily occur.

If weather conditions are not a factor, the driver should examine the sensor. It may require cleaning or removal of an obstruction. The sensor is located in the center of the front grille, behind the Maserati trident.

To keep the ACC System operating properly, it is important to note the following maintenance items:

- Always keep the sensor clean. Carefully wipe the sensor lens with a soft cloth. Be cautious not to damage it.
- Do not remove any screws from the sensor. Doing so could cause an ACC system malfunction or failure and require a sensor realignment.
- If the sensor or front end of the vehicle is damaged due to a collision, see your authorized dealer for service.
- Do not attach or install any accessories near the sensor, including transparent material or aftermarket grilles. Doing so could cause an ACC system failure or malfunction. When the condition that deactivated the

system is no longer present, the system will return to the “Adaptive Cruise Control Off” state and will resume function by simply reactivating it.

NOTE:

If the radar sensor wipe warning message occurs frequently (e.g. more than once on every trip) without any snow, rain, mud, or other obstruction, have the radar sensor realigned at an Authorized Maserati Dealer.

Clean Front Windshield Warning

This warning will display and a signal will indicate when conditions temporarily limit system performance due to failed signal reception. This most often occurs at times of poor visibility, such as in snow or heavy rain and fog. The ACC and FCW systems may also become temporarily blinded due to obstructions, such as mud, dirt, or ice on the windshield and fog on the inside of glass or when driving in bad weather. In these cases, the system will have degraded performance. The ACC and FCW systems will recover operation after the vehicle has left these areas. Under rare conditions, when the camera is not tracking any vehicles or objects in its path this warning may temporarily occur.

If weather conditions are not a factor, the driver should examine the windshield and the camera. They may require cleaning or removal of an obstruction.

When the condition that created limited functionality is no longer present, the ACC and FCW systems will return to full functionality.

NOTE:

If the windshield wiper warning message occurs frequently (e.g. more than once on every trip) without any snow, rain, mud, or other obstruction, have the windshield and forward-facing camera inspected at an Authorized Maserati Dealer.

Service ACC/FCW Warning

If the ACC and FCW systems turn off, and the system displays a service warning, there may be an internal system fault or a temporary malfunction that limits functionality. Although the vehicle is still driveable under normal conditions, ACC and FCW will be temporarily unavailable. If this occurs, try activating ACC and FCW again later, following an ignition cycle. If the problem persists, contact an Authorized Maserati Dealer.



Precautions while Driving with ACC

Offset Driving

ACC may not detect a vehicle in the same lane that is offset from your direct line of travel, or a vehicle merging in from a side lane. There may not be sufficient distance to the vehicle ahead. The offset vehicle may move in and out of the line of travel, which can cause your vehicle to brake or accelerate unexpectedly.

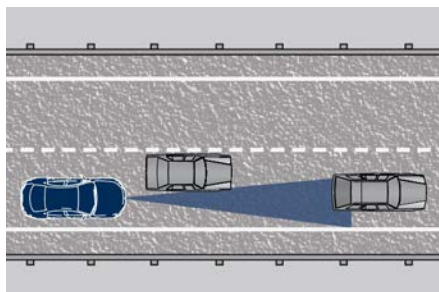

Turns and Bends

When driving on a curve with ACC engaged, the system may decrease the vehicle speed and acceleration for stability reasons, with no target vehicle detected. Once the vehicle is out of the curve the system will resume your original Set Speed. This is a part of normal ACC system functionality. Moreover, the radar sensor might detect a vehicle on a nearby lane or no longer detect the target vehicle.

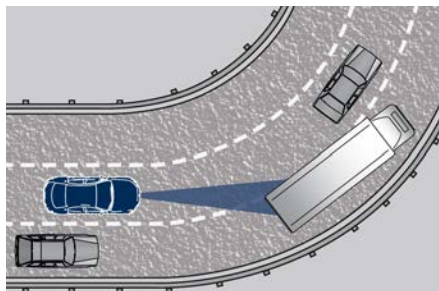

Using ACC on Hills

When driving on steep hills, ACC may not detect a vehicle in your lane when vehicle reaches the crest. Depending on the speed, vehicle load, traffic conditions, and the steepness of the hills, ACC performance may be limited.

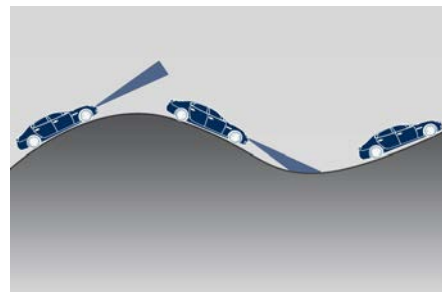

Lane Changing

ACC may not detect a vehicle until it is completely in the lane in which you are travelling.

In the illustration shown, ACC has not yet detected the vehicle changing lane and it may not detect the vehicle until it is too late for the driver to take action. ACC may not detect a vehicle until it is completely in the lane. There may not be sufficient distance to the lane changing vehicle.

Always be attentive and ready to apply the brakes if necessary.

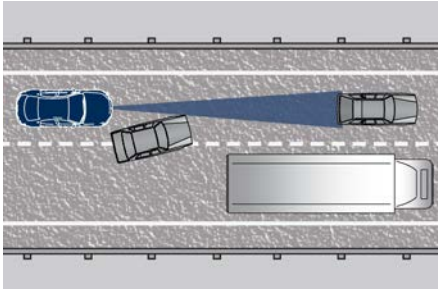

Narrow Vehicles

Some narrow vehicles (like motorcycles) travelling near the outer edges of the lane or edging into the lane are not detected until they have moved fully into the lane. There may not be sufficient distance to the vehicle ahead.

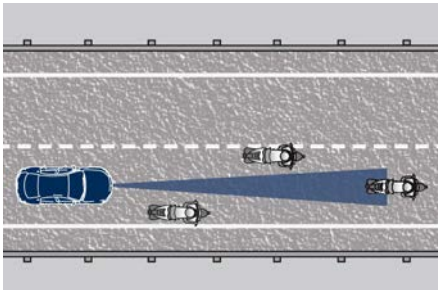

Stationary Objects and Vehicles

ACC does not react to stationary objects and stationary vehicles. For example, ACC will not react in

situations where the vehicle you are following exits your lane and the vehicle ahead is stopped in your lane. Always be attentive and ready to apply the brakes if necessary.

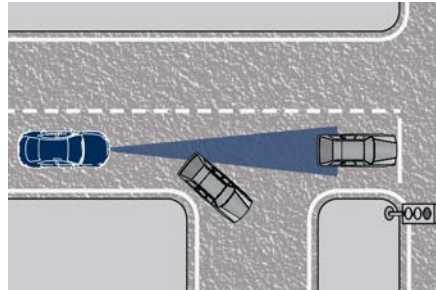

Radar Device - Regulatory Information

The "Regulatory Information" for all the radio frequency and radar devices can be consulted by accessing the "Services" section on the website www.maserati.com.

Forward Collision Warning - FCW (DPT)

The Forward Collision Warning (FCW) system with braking action uses the same parts already described for Adaptive Cruise Control (ACC) for sensing vehicle ahead (hereinafter "target vehicle") as well as part of the warnings/messages on system condition and activation status. Full performance can be reached only when both the sensing parts have detected a vehicle or, if the car is equipped with Pedestrian Emergency Braking (PEB) system, also a pedestrian.

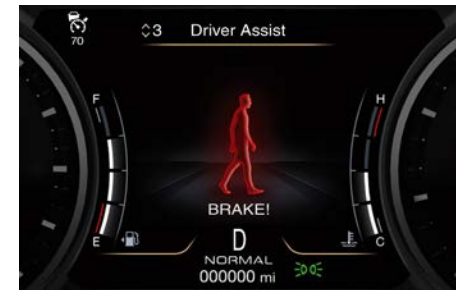



The difference between full and reduced performance is not visible for the driver.

Pedestrian Emergency Braking (PEB) System (if equipped)

PEB is a sub-system of FCW and it provides the driver with audible warnings, visual warnings on the instrument cluster display, and may apply automatic braking when it detect a potential frontal collision with a pedestrian.

NOTE:

The PEB function is only active up to 37 MPH (60 km/h).



Pedestrian Emergency Braking (PEB) is not intended to avoid a collision on its own, nor can PEB detect every type of potential collision with pedestrian. The driver has the responsibility to avoid a collision by controlling the vehicle via braking and steering. Failure to follow this warning could lead to serious injury or death.

PEB System Limitations

PEB may be impaired or may not function in the following situations:

- If there is poor visibility, e.g. due to insufficient illumination of the road, if there are highly variable shade conditions or in rain, snow or fog.
- If there is glare, e.g. from oncoming traffic, direct sunlight or reflections from other vehicles.
- If the windshield in the area of the camera is dirty, or if the camera is fogged up, damaged or covered.

System Operation

The FCW provides audible and visual warnings when a potential collision is detected. Brake jerk and limited braking may also be applied depending on the specific scenario. FCW monitors the information from the forward looking radar sensor as

well as the Electronic Brake Controller (EBC), to calculate the probability of a forward collision. When the system determines that a forward collision is probable, the driver will be provided with audible and visual warnings and may provide a warning brake jerk. If the driver does not take actuation based upon these progressive warnings, then the system will provide a limited level of active braking to help slow down the vehicle and mitigate the potential forward collision. If the driver reacts to the warnings by braking and the system determines that the driver intends to avoid the collision by braking but has not applied sufficient brake force, the system will compensate and provide additional brake force as required. When the system determines a collision with the vehicle in front of you is no longer probable, the warning messages will be deactivated.

NOTE:

- *Bad weather conditions, like strong rain, snow, etc., can lead to reduced system performance. Under these conditions relevant objects will not be detected or detected late by the system.*



- FCW is designed to react in specific situations in typical traffic scenarios with objects in the same lane driving in the same direction, but under certain conditions it can also react on stationary objects in the same lane. It is not designed to react to oncoming traffic or crossing traffic.
- The FCW alerts may be triggered on objects other than vehicles such as guard rails or sign posts based on the course prediction. This can occur but it is not a part of normal FCW activation and functionality.
- It is unsafe to test the FCW system. To prevent such misuse of the system, after four Active Braking events within an ignition cycle, the Active Braking portion of FCW will be deactivated until the next ignition cycle. The limit of four events applies to the brake jerk too.
- FCW will automatically deactivate when  (ESC OFF) button is pressed (LED light up).

**WARNING!**

- **Forward Collision Warning (FCW) is not intended to avoid a collision on its own, nor can FCW detect every type of potential collision. The driver has the responsibility to avoid a collision by controlling the vehicle via braking and steering. Failure to follow this warning could lead to serious injury or death. The driver is always in charge to safely drive and to avoid critical situations not relying on the support of the system. Driver has to keep in mind that the system and therefore its intervention is always subject to the prevailing physical limits.**
- **FCW is not intended either to warn or to apply any brake aid/brake intervention in case of collisions with pedestrians (if not equipped with Pedestrian Emergency Braking - PEB sub-system), bicycles and smaller vehicles in general.**

Speed Range of Use

| Speed | MPH (km/h) |
|-------------------|------------|
| Minimum | 0 |
| Engaged/activated | 1.24 (2) |
| Maximum | 155 (250) |

When the speed is outside the specified limits, the system automatically disables without turning on the corresponding warning light on the instrument cluster.

System Status

The driver can adjust FCW sensitivity or enable/disable the brake jerk with the other emergency brakings by touching "Forward Collision Warning" soft-key on the "Apps" page or in the "Settings" list of the "Vehicle" page. Setting options are described in the following paragraph.

When FCW status for some reason changes in off, the corresponding amber warning light on instrument cluster will light on.

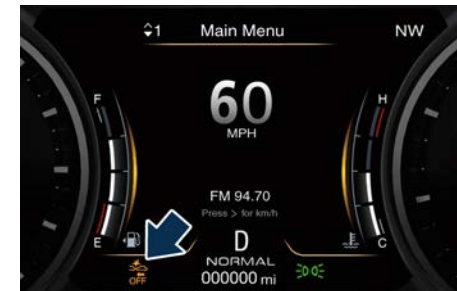

This warning light informs the driver that FCW is disabled. This warning light will light even when the activation of another driver assistance



function or drive mode (example:  (ESC Off)) disables the FCW.

NOTE:

The FCW system setting chosen by the User is kept in memory only for the current ignition cycle.

System Configuration

FCW warning can be set in "Active Braking" (default mode), "Warning" or "Warning & Active Braking".

The default status of FCW sensitivity is the "Med (Medium)" setting. When also the active braking function ("Forward Collision Warning Active Braking") setting is on, the system warns you of a possible collision with the vehicle in front of you when you are farther away and it applies limited braking. This gives you the most reaction time to avoid a possible collision.

Changing the sensitivity status to the "Near" setting, allows the system to warn you of a possible collision with the vehicle in front of you when you are much closer. This setting provides less reaction time than the "Warning & Active Braking" sensitivity setting, which allows for a more dynamic driving experience.

"Med" is the intermediate status between the two described above.

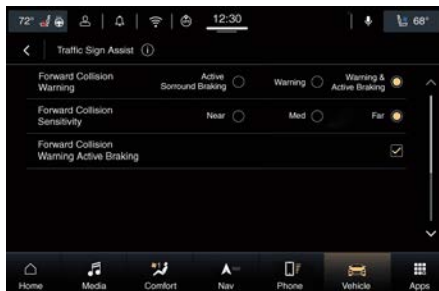

NOTE:

- The default values shall appear at every new ignition cycle: Sensitivity = "Med" and "Active Braking" = on.
- FCW may not react to irrelevant objects such as objects not in the path of the car, stationary objects that are far away, oncoming traffic, on cross traffic vehicles, or leading vehicles with the same or higher rate of speed.
- The active braking (autonomous braking/braking aid) will not engage in case of potential collision with static object such as guard rails, walls, etc..
- FCW will be disabled like ACC (refer to chapter "Adaptive Cruise Control - ACC" in this section).

Changing the active braking status to "Off" prevents the system from providing limited autonomous braking

or additional brake support if the driver is not braking adequately in the event of a potential frontal collision. In this state the system disables the brake jerk.

Limited Operation and Service Warning

The messages indicating on display the limited functionality or service at an **Authorized Maserati Dealer** required are the same as for the ACC system. For further details, refer to "Adaptive Cruise Control- ACC" in this section.

NOTE:

- The adjustment of the sensor could be affected by strong shocks or light collisions. This could affect the system by reducing the systems performance or could increase the false positive rate. The adjustment of the radar system has to be proved or a new adjustment has to be performed by an **Authorized Maserati Dealer**.
- The radar system requires specific function to detect objects. The detection could be disturbed/ reduced by environment influences, for example by electrical field or the object itself. Object with small radar reflection properties could not be detected or detected late.



Radar Device - Regulatory Information

The "Regulatory Information" for all the radio frequency and radar devices can be consulted by accessing the "Services" section on the website www.maserati.com.

Lane Keeping Assist - LKA (OPT, with ACC only)

This system was designed especially for highway or freeway driving, to reduce the risk that the vehicle, under particular circumstances, accidentally departs from the lane in use. When this happens, graphic instructions on instrument cluster display together with steering torque application and steering wheel vibration (depending on the distance to the line and the setting that the driver has chosen from the "Settings" menu on MIA as described in "Customized Settings" of this chapter) warn the driver that the vehicle is going out of the lane initiates a steering manoeuvre to try to prevent the lane exit.

To detect lane lines, the system uses the forward-facing camera behind of the rear-view mirror, which is the same one used also by the lighting system to manage automatic high beam. The logic core is in the front radar.

LKA system remembers the condition it was in before turning off the vehicle. Refer to "Functions of Controls Menu on MIA" in section "Dashboard Instruments and Controls" for further information.

NOTE:

In case of wet road or raining conditions the function could be disabled by the system in order to minimize the risks.

Speed Range of Use

| Speed | MPH (km/h) |
|-------------------|------------|
| Minimum | 37 (60) |
| Engaged/activated | 37 (60) |
| Maximum | 112 (180) |

Customized Settings

LKA is configurable by the driver in order to maximize its efficiency based on the driver driving style and the expectation of the system, reducing at the same time the possible invasiveness.

Entering "Settings" menu of the "Vehicle" page on MIA display the driver can see the current setting beside the "Lane Keeping Assist" soft-key.

Touching "Lane Keeping Assist" soft-key to enter the setting page. Driver warnings can be only "Visual" or "Visual & Haptic" (default mode). System response can be set to "Early", "Medium" (default mode) or "Late".



System reaction force can be set to "Low", "Medium" (default mode) or "High".

Meanings of Settings

- "Visual" only: the system will not request any steering torque/vibration to correct the car trajectory. The system will only show on the TFT display with yellow/yellow flashing indication respectively when the driver is approaching or already touching the line lane with at least one tire.
- "Visual & Haptic": the system will apply steering torque when lane departure is detected showing at the same time the proper cluster indication, adding to this steering vibration when the departure is very imminent.

When "Visual & Haptic" is selected and of course LKA is enabled then two following menu will be used by the system.

- "LKA Sensitivity": it tunes the distance to the lane boundary interested where the system will start to apply steering torque.
- "LKA Strength": it tunes the steering torque and speed value increasing or decreasing it to have

a stronger or weaker trajectory correction/deviation.



WARNING!
In rare cases, Lane Keeping Assist (LKA) may make an inappropriate steering torque application. LKA may be interrupted at any time counter steering. Lack of attention may lead to serious injury or death.

System Availability

The ADAS systems help the driver while driving. These systems can be set and monitored simultaneously on the display, after opening "Driver Assist" menu (see "TFT Display: Menu and Submenu Content" in section "Dashboard Instruments and Controls").

When you are not in the "Driver Assist" page, the system status is indicated by a notification at the top left of the TFT display.

LKA is designed for an attentive driver therefore the system is available only when his/her hands are on the steering wheel or with hands off for a very limited amount of time. When the system is enabled it will trigger cluster warning in case at least one hand is not detected on the steering wheel.

The torque application as well as the vibration are suppressed/inhibited in case of: high driver torque in the steering wheel, high lateral acceleration, trailer connected to the proper control module, hands not on the steering wheel detected for more than a certain time.

High dynamic behaviours, driving on the lane boundary, off course will prevent the function from working. FCW braking and stability system interventions (ESC, ABS) will also prevent the system from operating.

Changing lane results in system inhibition for a certain time. In addition, the road must respect some characteristics such as minimum maximum width, lane clearly defined by two lane boundaries and only in limited cases for a limited time at least one.

The LKA system is active both in the case of both lines visible and available for the system, and in case of the only line available on the road.

Each LKA intervention is notified to the driver with the relative graphics which is shown for the entire duration of the system intervention and for a minimum time of 1 second.



Multiple interventions are allowed both in terms of visual and acoustic signals and in terms of steering torque. If more than three consecutive interventions are required within a period of 180 seconds, starting from the second intervention the acoustic signal will last 10 seconds longer than the previous one.

Starting from the third acoustic signal the system will emit a continuous sound and a message on TFT display will indicate to keep the center line.

NOTE:

- *In case of wet road or raining conditions the function could be disabled by the system in order to minimize the risks.*
- *The system is developed to work only on the lines painted on the road surfaces, but it may happen that shadows, traces of old lines, road edges, etc. are also interpreted as such.*

Being this function used to prevent unintentional lane change/lane drift, it will be temporarily suppressed/inhibited by a turn indicator activation, therefore, graphic warning, steering torque application and vibration will be terminated. In these conditions the graphics turn gray.

Function Description and Operating Mode

The function intent is to prevent the lane departure by warning the driver through indication on the cluster and if set applying steering torque and vibration. The graphic intent is to represent at the glance the system knowledge of the lane in front of the car, the system suppression status and warning.

For this a simple colour code has been adopted for each line (of the two presented):

- Both grey lines means system enable, not able to operate (suppression condition present or lane detection system not able to estimate properly the lane);
- Left/right grey line: the lane detection system is not able to detect that specific lane boundary;
- Yellow line: there is a steering torque intervention in progress that tries to prevent a departure on that side, in this situation the warning should increase the driver attention requiring him to properly handle the situation;
- Yellow flashing line: the graphic is shown whenever the system detects a very imminent lane departure, at this can be added torque and

steering vibration if configured by the customer.

The white lines (one or both) indicates that the corresponding lane boundary is detected and the system is capable to intervene on it.

Whenever the system is enabled there will be graphic on the dedicated screen of the "Driver Assist" page. This graphic will be available in the form of symbols (see detail in figure) in the top left corner of the cluster screen.

An example of this screen, with only LKA system activated and with LKA and ACC systems activated, can be found in the following figures.

In the first, only LKA system is activated, steering torque in progress to correct the trajectory towards the lane center.

In the second LKA and ACC systems are activated, car is crossing the lane boundary, steering torque and vibration if configured are in progress when this graphic is shown.



The icons that represent the status of the ADAS systems remain displayed even when you exit the "Driver Assist" screen.

System Limitations

Because of physical limits, in order to properly operate, the system needs good visibility (it might not work or not properly operate in case of heavy rain, snow, wet roads, fog, direct sun on the camera, etc.).

NOTE:

The sensors are not able to detect the presence of the hands on the steering wheel areas covered in wood, plastic bezels or carbon inserts (where present).

Sharp turns, slopes and change in slopes, poor lane boundaries, as well as construction areas and all the scenario described in this paragraph may challenge the system, therefore be always ready to prevent any unexpected behaviour of the car. Damaged front bumper, windshield replaced without proper technical intervention may also lead to system malfunction or system unavailability. Other conditions such as fault, but not explicitly indicated here may also prevent/interrupt the system intervention.



WARNING!
If the driver fails to adapt his/her driving style, Lane Keeping Assist (LKA) can neither reduce the risk of an accident nor override the laws of physics. It cannot take into account road, weather or traffic conditions. Active LKA is only an aid. Driver is always responsible for the distance

to the vehicle in front, for vehicle speed, for braking in good time and for staying in lane.

System in Fault

When the LKA cannot properly operate due to a fault of its components or because the windshield in front of the forward facing camera is dirty, the amber light and/or the corresponding message will be displayed.



If message suggestion does not allow fixing the fault, do not use the system and have the vehicle inspected at an Authorized Maserati Dealer.

Radar Device - Regulatory Information

The "Regulatory Information" for all the radio frequency and radar devices can be consulted by accessing



the "Services" section on the website www.maserati.com.

Blind Spot Assist (BSA, without ACC)

System Operation

The Blind Spot Assist (BSA) system uses two radar-based sensors, located inside the rear bumper fascia, to detect highway licensable vehicles (cars, lorries, motorbikes, etc.) that enter the blind spot zones from the rear/front/side of the vehicle in adjacent lanes.

The example shown in the figure highlights the blind spots on either side of the vehicle when overtaking traffic is approaching from behind.

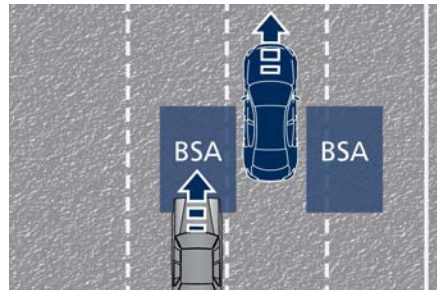

When the vehicle is started, the BSA warning light will momentarily illuminate in both outside rear view mirrors to let the driver know that the system is operational and on. The BSA system sensors operate when

the vehicle is in any forward gear and enters standby mode when the transmission is in (P) Park.

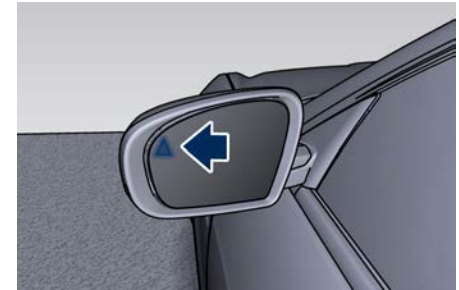

The BSA detection zone shown in figure covers approximately one lane on both sides of the vehicle (approximately 11 ft or 3.3 m). The blind spot area extends from immediately behind the exterior rear-view mirrors up to about 23 ft (7 m) behind the rear bumper.

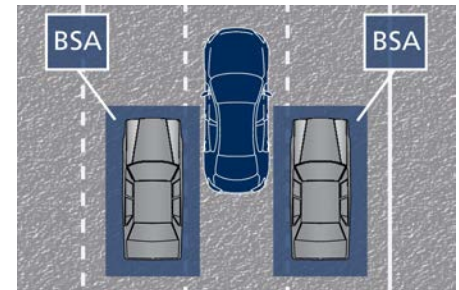



Driver Assistance Systems

The BSA system monitors the detection zones on both sides of the vehicle to detect the presence of vehicles and begins to warn the driver by flashing the warning light in the side mirror when the vehicle speed reaches approximately 4 MPH (6 km/h) or higher.



WARNING!

- The Blind Spot Assist (BSA) system does NOT alert the driver about rapidly approaching vehicles that are outside the detection zones.
- The BSA might alert the driver too late especially in case of rapidly approaching vehicles.



WARNING!

Risk of accident despite Blind Spot Assist (BSA). BSA does not detect/react to the following:

- Overtaking vehicles close on the side, placing them in the blind spot area. As a result, BSA may neither give warnings nor intervene in such situations.
- Always pay attention to the traffic situation and maintain a safe distance at the side of the vehicle.

NOTE:

If your vehicle has experienced any damage in the area where the sensor is located, even if the fascia is not damaged, the sensor may have become misaligned. Take your vehicle at an Authorized Maserati Dealer to verify sensor alignment. Having a sensor that is misaligned will result in the BSA not operating to specification.

The area on the rear bumper fascia where the radar sensors are located must remain free of snow, ice, and dirt/road contamination so that the BSA system can function properly. Do not cover or block the area of the rear bumper fascia where the radar sensors are located with foreign objects (bumper stickers, spoilers, bicycle racks, etc.).

The BSA system notifies the driver of vehicles or objects in the detection zones by illuminating the BSA warning light located in the outside mirrors in addition to sounding an audible (chime) alert and reducing the radio volume (if the radio is on). Refer to "BSA and RCP Setting" in this chapter for further information.

The BSA system monitors the detection zone from three different entry points (side, rear, overtaking traffic) while

driving to see if an alert is necessary. The BSA system will issue an alert whenever a vehicle enters any one detection zone as outlined below.

Speed Range of Use

| Speed | MPH (km/h) |
|-------------------|------------|
| Minimum | 6 (10) |
| Engaged/activated | 6 (10) |
| Maximum | – |

Entering from the Side

Vehicles that move into your adjacent lanes from either side of the vehicle.

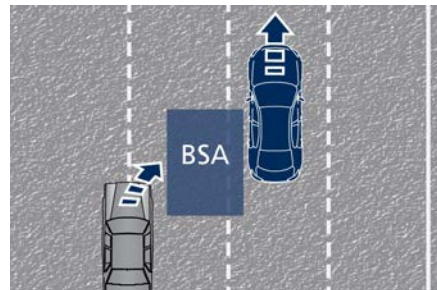

Entering from the Rear

The alert will turn on when the vehicles that come up from behind your vehicle on either side and enter the rear detection zone with a relative speed of more than 27 MPH (43 km/h).

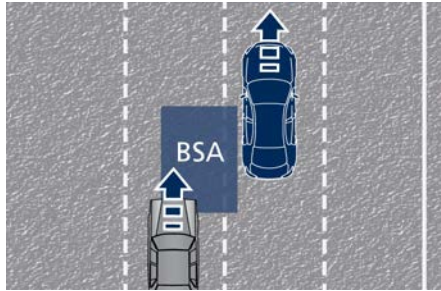

Overtaking Traffic

The figures show the vehicle approaching (A) and passing (O) another vehicle in the overtaking lane. If you pass another vehicle slowly, the vehicle remains in the blind spot for approximately 2 seconds, the BSA warning light in the outside mirror will illuminate after 1.5 seconds. If the difference in speed between the two vehicles is greater, the warning light will not illuminate.

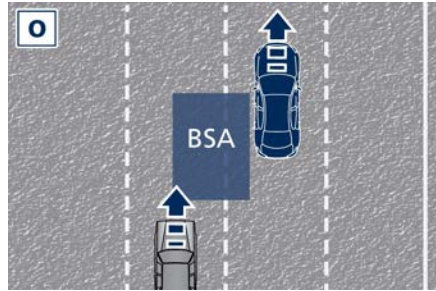
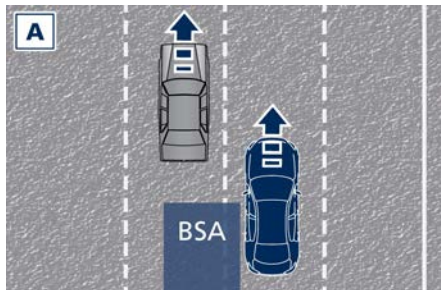

Other Cases

The BSA system is not designed to issue an alert on stationary objects such as guardrails, posts, walls, foliage heaps, berms, etc. However, occasionally the system may alert on such objects. This is normal operation and your vehicle does not require service.

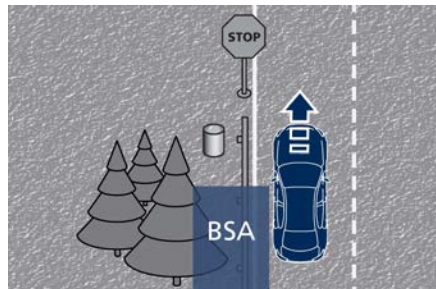

The BSA system will not alert you of objects that are travelling in the

opposite direction of the vehicle in adjacent lanes.

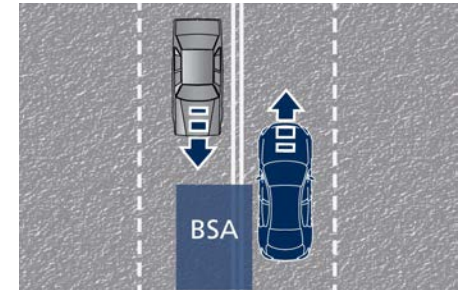

WARNING!

- The Blind Spot Assist (BSA) system is only an aid to help detect vehicles in the blind spot zones.
- The BSA system is not designed to detect pedestrians, cyclists, or animals.
- Even if your vehicle is equipped with the BSA system, always check your vehicle's outside and rearview mirrors for any vehicles approaching from behind or overtaking.
- Use your turn signal before changing lanes.

System Monitoring on TFT Display

Whenever the BSA system is enabled by the user, an specific indicator is



displayed in the left upper corner of the TFT display (area 22). This indicator can take on different colors depending on the system status:



stand by status (white icon);



active status (green icon).

RCP - Rear Cross Path

The Rear Cross Path (RCP) function is intended to aid the drivers when gear in reverse of parking spaces where their vision of oncoming vehicles may be blocked.

The RCP system monitors the rear detection zones on both sides of the vehicle. Using sensors located on either side of the rear bumper, it detects any vehicles or objects that are moving toward the side of the vehicle with a minimum speed of approximately 1 to 2 MPH (1 km/h to 3 km/h) to a maximum of approximately 10 MPH (16 km/h), such as in parking lot situations.

NOTE:

In a parking lot situation, oncoming vehicles can be obscured by vehicles parked on either side. If the sensors are blocked by other structures or

vehicles, the system will not be able to alert the driver.

Proceed slowly and cautiously out of the parking space until the rear end of the vehicle is moderately exposed.

The RCP system will then have a clear view of the cross traffic. If an oncoming vehicle is detected, the RCP system will alert the driver using both the visual and audible alarms. If the radio is on, it will also reduce the radio volume.

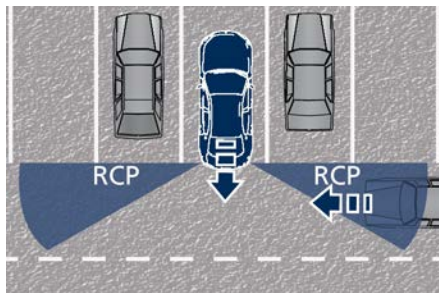

WARNING!

Rear Cross Path (RCP) is not a Back Up Aid system. More specifically, it is intended to be used to help a driver detect an oncoming vehicle in a parking lot situation. Drivers must be careful when backing up, even when

using RCP. Always check carefully behind your vehicle, look behind you, and be sure to check for pedestrians, animals, other vehicles, obstructions, and blind spots before backing up. Failure to do so can result in serious injury or death.

BSA and RCP Setting

Setting modes can be selected from the MIA system.

Touch "Settings" soft-key on "Vehicle" page and then select "Blind Spot Assist" soft-key to enter the setting page.

Refer to chapter "Functions of Controls Menu on MIA" in section "Dashboard Instruments and Controls" for further information.

BSA in Visual Mode

When operating in "Visual" mode, the BSA system will provide a visual alert in the appropriate side view mirror when it detects a vehicle or an object in the detection areas monitored by its sensors: depending on the status of the relative turn indicator, the warning light can be fixed or flashing. However, when the system is operating in RCP mode, it will respond with both visual and audible alerts when an oncoming vehicle or an



object approaching the rear end side of the vehicle is detected.

Whenever an audible alert is requested, the radio is muted (if the radio is on).

BSA in Visual and Acoustic Mode

When operating in "Visual & Acoustic" mode, the BSA system will provide a visual alert in the appropriate side view mirror based on a detected vehicle or object.

If the turn signal is then activated, and it corresponds to an alert present on that side of the vehicle, an audible chime will also be sounded: in the same moment the warning light will start flashing.

Whenever a turn signal and detected vehicle or object are present on the same side at the same time, both the visual and audio alerts will be issued. In addition to the audible alert, the radio volume will be reduced (if the radio is on).

NOTE:

If the hazard flashers are on, the BSA system will issue the appropriate visual alert only.

When the system is in RCP mode, the system shall respond with both visual and audible alerts when a detected vehicle or object is present. Whenever

an audible alert is requested, the radio (if on) is also muted.

Right/left turn/hazard signal status is ignored; the RCP status always requests the chime when needed.

Blind Spot Alert Off

When this function is turned off from the MIA, there will be no visual or audible alerts from either the BSA or RCP subsystems.

NOTE:

The BSA system will store the current operating mode when the vehicle is shut off. Each time the vehicle is started, the previously-stored mode will be recalled and used.

System Temporarily Unavailable

The blind spot system will become temporarily unavailable and the instrument cluster display will show the message "Blind Spot Alert Temporarily Unavailable" when the vehicle enters a radio quiet zone (example the areas around radio telescopes).

The warning light on the outside rear-view mirrors will be lit up and stay lit until the vehicle exits the zone.

System is Faulty

The BSA system cannot properly operate due to a fault of its

components, or because the area on the rear bumper fascia where the radar sensors are located is dirty. In these cases the amber warning light and the related message will be displayed on the instrument cluster.



In these cases do not use the system and have the vehicle inspected at an **Authorized Maserati Dealer**.

Radar Device - Regulatory Information

The "Regulatory Information" for all the radio frequency and radar devices can be consulted by accessing the "Services" section on the website www.maserati.com.



Active Blind Spot Assist - ABSA (Ⓢ, with ACC only)

ABSA system represents an addition to the BSA previously described (see chapter "Blind Spot Assist - BSA" of this section).

ABSA adds to the BSA the possibility in certain circumstances to avoid and or mitigate side collisions with vehicles proceeding in the adjacent lanes by changing the car trajectory in order to try to keep it inside the detected/estimated lane. A steering wheel vibration is used as further feedback to warn the driver that the lane change is not safe.

The main logic core is the front radar, whereas the sense inputs are the radars on the rear bumper fascia used for sensing the presence of vehicle in the blind spot areas and the forward facing camera placed behind the internal rear-view mirror that instead is used for lane detection and estimation.

ABSA is designed to avoid and/or mitigate a collision. Torque and vibration application is however available in the 37 - 112 MPH (60 - 180 km/h) speed interval. All the speed thresholds related to the BSA remain

still valid, since ABSA as mentioned is BSA extension.

ABSA is intended as a "hands-on" function meaning that the driver is required to stay engaged in the driving all the time with his/her hands on the steering wheel, in case hands are not on the steering wheel for a certain time there cannot be any steering torque application vibration included (see "System Monitoring on TFT Display" in this chapter).

System Availability

ABSA is designed for an attentive driver therefore the system is available only when his/her hands are on the steering wheel or with hands off for a very limited amount of time. When the system is enabled, it will trigger cluster warning in case at least one hand is not detected on the steering wheel.

The torque application as well as the vibration are suppressed/inhibited in case of: high driver torque in the steering wheel, high lateral acceleration, trailer connected to the proper control module, hands not on the steering wheel detected for more than a certain time.

Highly dynamic behaviours, driving on the lane boundary, off course will prevent the function from working.

FCW braking and stability system interventions (ESC, ABS) will also prevent the system from operating. Changing lane results in system inhibition for a certain time.

In addition the road must respect some characteristics such as minimum-maximum width, lane clearly defined by two lane boundaries and only in limited case for a limited time at least one.

Each steering of the ABSA system is always notified to the driver with acoustic and visual feedback and each signaling has the same duration as the steering intervention, with a minimum of 1 seconds.

Multiple steering interventions are only allowed if both line lines are available for the system.

Multiple interventions are allowed both in terms of visual and acoustic signals and in terms of steering torque. If more than three consecutive interventions are required within a period of 180 seconds, starting from the second intervention the acoustic signal will last 10 seconds longer the previous one.

Starting from the third acoustic signal the system will emit a continuous



sound and a message on TFT display will indicate to keep the center line. If there is only one line on the road, when it is correctly detected by the ABSA system, only one trajectory correction with relative acoustic signal will be possible. Until two lines are displayed again, there will be no trajectory correction but only acoustic and visual signals.

Furthermore in case of a single and very wide lane line, if the system intervenes by steering in the opposite direction to the line, this could force the car to remain slightly misaligned from the center of the lane, towards the only available line. This behavior serves to prevent the intervention that has just taken place the car off the road from the side where the lane is not available.

NOTE:

- *In case of wet road or raining conditions the function could be disabled by the system in order to minimize the risks.*
- *The system is developed to work only on the lines painted on the road surfaces, but it may happen that shadows, traces of old lines, road edges, etc. are also interpreted as such.*

Speed Range of Use

| Speed | MPH (km/h) |
|-------------------|------------|
| Minimum | 37 (60) |
| Engaged/activated | 37 (60) |
| Maximum | 112 (180) |

System Limitation

Because of physical limits the system to properly operate needs good visibility (it might not work or not properly operate in case of heavy rain, snow, wet roads, fog, direct sun on the camera, dirty windshield, low illumination etc.)

Sharp turns, slopes and change in slopes, poor lane boundaries, as well as construction areas and all the scenarios described in this paragraph may challenge the system, therefore be always ready to prevent any unexpected behaviour of the car.

Damaged front bumper, windshield replaced without proper technical intervention may also lead to system malfunction or system unavailability.

Other conditions such as faults, but not explicitly indicated here may also prevent/interrupt the system intervention.

ABSA Setting

ABSA is configurable by the customer in order to maximize its efficiency based on the driver driving style and his/her expectation of the system, reducing at the same time the possible invasiveness.

Setting modes can be selected from the MIA system (see "Functions of Controls Menu on MIA" in section "Dashboard Instruments and Controls" for further information).

Touch "Settings" soft-key on "Vehicle" page and select "Active Blind Spot Assist" function to enter the setting page.

Driver warnings can be only "Visual", "Visual & Acoustic" (default mode) or "Visual & Haptic". When "haptic" feedback is selected, every time a steering force is applied there will always also an acoustic signal to the driver.

System sensitivity can be set to "Early", "Medium" (default mode) or "Late". System strength can be set to "Low", "Medium" (default mode) or "High".

NOTE:

The ABSA system will store the current operating mode when the vehicle is shut off. Each time the vehicle is

(Continued)



(Continued)

started, the previously-stored mode will be recalled and used.

Meanings of Settings

When "Visual & Haptic" is selected and of course ABSA is enabled, then two following menus will be used by the system.

- ABSA "Sensitivity": it tunes the distance to the lane boundary where the system will start to apply steering torque.
- ABSA "Strength": it tunes the steering torque value to have a stronger or weaker trajectory correction/deviation.

System in "Visual & Haptic" Mode

When the system is on and configured "Visual & Haptic" then the ABSA is enabled and to the conventional visual warnings is added the steering torque and vibration.

When operating in this mode, the system will provide a visual alert in the appropriate outside rear-view mirror when it detects a vehicle or an object in the detection areas monitored by its sensors. In case of turn indicator activation on the appropriate side, the system will react with a torque on the steering wheel to try to prevent the lane change

and therefore to avoid/mitigate the collision. The torque on the steering is applied when the car is very close to the lane boundary as a further feedback to warn the driver of the unsafe maneuver.

NOTE:

The steering torque is not supplied if the system is not able to estimate a lane and if the turn indicator from the appropriate side is not inserted.



WARNING!

- Risk of accident despite steering torque application of Active Blind Spot Assist (ABSA).
- A course-correcting steering torque application cannot always prevent a collision.
- The driver is always required to steer, brake or accelerate themselves, especially if ABSA warns or makes a course correcting steer intervention.
- Always maintain a safe distance at the sides.
- Steering torque application may be interrupted at any time by counter steering by the driver.

System Monitoring on TFT Display

Whenever the ABSA system is enabled by the user, a specific indicator is displayed in the left upper corner of the TFT display (area 24). This indicator can take on different colors depending on the system status:



stand by status (white icon);



active status (green icon);



intervention (amber icon).

In Case of Intervention

ABAS shall apply a torque on the steering wheel when a vehicle is detected in blind spot. If driver's hands are off the steering wheel, a graphic pop-up shall appear on TFT display to invite you to keep your hands on the steering wheel. In this case, a single audible chime is repeated until he/she will take the control of the vehicle again.



RCP - Rear Cross Path Operation

RCP operation is the same as described in chapter "Blind Spot Assist - BSA".

The visual or audible alerts from RCP subsystem will also be present when ABSA is turned off from MIA "Settings" menu of the "Vehicle" page.

When ABSA is turned on with any setting, RCP subsystem shall respond with both visual and audible alerts when a detected vehicle or object is present. Whenever an audible alert is requested, the radio (if on) is also muted.

Right/left turn/hazard signal status is ignored; the RCP status always requests the chime.

System Temporarily Unavailable

The blind spot system will become temporarily unavailable and the instrument cluster display will show the message "Blind Spot Alert Temporarily Unavailable" when the vehicle enters a radio quiet zone (example the areas around radio telescopes).

The warning light on the outside rear-view mirrors will be lit up and stay lit until the vehicle exits the zone.

System Fault

The ABSA system cannot properly operate either due to a fault of its components, or because the area on windshield where the forward-facing camera is located or on the rear bumper fascia where the radar sensors are located is dirty. In these cases the amber warning light and the related message will be displayed on the instrument cluster.



In these cases do not use the system and have the vehicle inspected at an **Authorized Maserati Dealer**.

Radar Device - Regulatory Information

The "Regulatory Information" for all the radio frequency and radar devices can be consulted by accessing the "Services" section on the website www.maserati.com.



Active Driving Assist - ADA (ⓈPT, with ACC only)

The Active Driving Assist (ADA) is not an autonomy system (in reference to NHTSA standards) and is designed to aid the driver in the steering, acceleration, and braking functions of the vehicle.

ADA can work in any type of road. However, its use it is not recommended in urban scenarios. ADA centres the vehicle by controlling the EPS system based off of lane line information from the forward-facing camera and data from the front radar sensor.

6

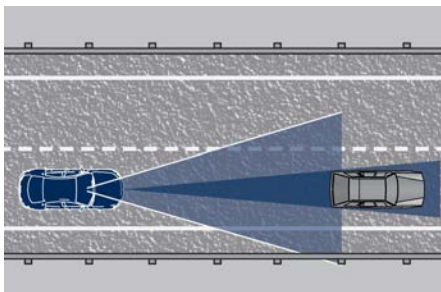

ADA combines ACC and LKA to manage the steering and speed of the vehicle under specific conditions. The conditions to engage ADA are listed in the next paragraph. If a lane line cross

is imminent, the steering wheel will vibrate and a graphic will display on the instrument cluster.



WARNING!

- In case the vehicle approaches a curve that is too tight in relation to the current speed the system will disengage, therefore the driver must be prepared to take over control of the vehicle immediately at any time. To avoid this situation it is important that the vehicle speed is not set higher than the current speed limit of the road.
- Active Driving Assist (ADA) is a hands-on function! You must keep your hands on the steering wheel at all times. The ADA system will disengage and ACC will cancel if your hands are removed from the steering wheels for a set amount of time.
- ADA is intended for use only on highways or limited access freeways, freeways, etc. with a fully attentive driver. When using ADA, hold the steering wheel and be aware of surrounding traffic and road conditions. Always be prepared to immediately take over control of the

vehicle from the ADA system. Failure to follow these instructions could result in serious injury or death.

- The following list does not fully represent all situations in which ADA may not function as intended. Do NOT solely rely on the ADA system to control the vehicle. It is the driver's responsibility to stay alert and safely control the vehicle at all times.
- If the windshield is replaced, you must have the forward-facing camera remounted and aligned by an Authorized Maserati Dealer.

Many factors can impact the performance of ADA causing the system to be unable to function as intended. These include (but are not limited to):

- Narrow, winding or curvy roads.
- Poor visibility (due to heavy rain, snow, fog, etc.).
- Bright light (oncoming headlights or direct sunlight) or shadows.
- Damage or obstruction caused by mud, ice, snow, etc.
- A damaged or misaligned bumper.
- Interference from other equipment that generates electromagnetic waves.



- Wet roads, roads covered or partially covered by snow.
- Construction zones.

System Operation

With ACC set (see "Adaptive Cruise Control – ACC" in this section), ADA system activates by simply pressing the  button on the steering wheel. Once the conditions are met, ADA will engage.



CAUTION!

The Active Driving Assist (ADA) system may take up to 5 seconds to engage once all conditions are met.

The conditions for ADA to engage are as follows:

- ADA must be turned on or enabled.

NOTE:

In case of wet road or raining conditions the function could be disabled by the system in order to minimize the risks.

- The vehicle must be on the highway or limited access freeway, or on extra urban roads.
- ACC must be engaged.
- Left and right visible lane lines.
- Vehicle speed must be between 0 to 90 MPH (0 and 145 km/h).

- No faults in the forward facing camera, radar, EPS, or MIA.
- Lane width between 3 to 4.6 yd (2.8 and 4.2 m).
- Turn signal not activated.
- No faults related to this system.

Speed Range of Use

| Speed | MPH (km/h) |
|--|------------|
| Minimum | 0 |
| Engaged/activated (with ACC engaged) | 0 |
| Engaged/activated (with ACC not engaged) | 20 (30) |
| Maximum | 90 (145) |

- If set above the maximum speed, ADA will not function after the vehicle speed will reach the maximum speed.
- If set below the maximum speed and the ACC target speed is increased, ADA will function up to the maximum speed and then the system will turn off automatically.
- When the ACC target speed is reduce and speed is lower than the maximum speed, the system will start automatically.
- If the ACC target speed is set under the maximum speed, ADA is active

and vehicle speed increases above the maximum speed due to slope, ADA will continue to function.

Monitoring on TFT Display

ADA and the other ADAS systems conditions can be monitored on TFT display by accessing the "Driver Assist" page with the buttons on the steering wheel (see "TFT Display Setting and Menu Overview" in section "Dashboard Instruments and Controls").

The  symbol in grey indicates that the ADA system is active, but not engaged and is shown at the centre of the TFT display when the "Driver Assist" page is displayed.

The ACC and ADA information are shown with a telltale on the left top corner of the TFT display when other information (textual pop ups, NAVI information, phone call, etc...) cover the ADA's ones (see detail in picture). In telltale ADA uses steering wheel icon and corner lines to indicated its status.

When exiting the "Driver Assist" page, on TFT display top left corner, the  grey symbol will appear in the multiple light of active ADAS systems.



In addition to these symbols, on the TFT top and bottom edge a coloured glow may appear (further referred to as "attention level colour"). Attention level colour together with the outline of the symbol  represent a further indication of the system status.



When exiting the "Driver Assist" page, the attention level colour will always be displayed until the system is disabled by pressing the button on the steering wheel.

The ADA system uses sensors in the steering wheel outer crown to detect if the driver's hands are on the steering wheel. If the driver's hands are not detected on the steering wheel, the instrument cluster will display a series of warnings to alert the driver to return their hands to the steering wheel. There will also be audible chimes. After a set amount of time, ADA will cancel if the driver's hands are not returned to the steering wheel.

When the system does not sense the hands on the steering wheel for a few seconds (3 – 5 seconds) or more (up to 10 seconds), it tries to draw the attention of the driver by showing, even when the display is not in the "Driver Assist" page, the  symbol with the figure of the hands in the centre of the display. According to such time frames, the system will change the attention level colour, silence the audio in the vehicle (if it is active) and emit audible chimes to invite the driver to take the control of the vehicle again. This is the only way to reengage the system.

Hands Detection on Steering Wheel

The sensors in the steering wheel outer crown are able to detect the presence of the hands on the steering wheel.

In order to be able to use the ADA system, place your hands around the steering wheel outer crown.

NOTE:

The sensors are not able to detect the presence of the hands on the steering wheel areas covered in wood, plastic bezels or carbon inserts (where present).

ADA is deactivated if the steering wheel is no longer being touched.

System Statuses

The active status of the ADA system is indicated by the green attention level colour which is maintained even if the driver releases his/her grip from the steering wheel up to 3 seconds.

The graphic information changes as soon as (max 1 second) the driver releases the steering wheel:

- glow color: green;
- lines: green;
- car: centered;
- steering wheel: yellow small in the center (see picture).



The yellow attention level colour appears when the driver removes his/her hands from the steering wheel for 3 to 5 seconds and the  symbol will occupy the whole central area of the TFT display.



The red attention level colour appears when the driver releases his/her grip from the steering wheel for 5 and up to 10 seconds: in this case a single audible chime is repeated until he/she

will take the control of the vehicle again.

The red attention level colour and the chime remains even when the steering wheel is released for more than 8 to 10 seconds.



When the system disengage the ADA, a sequences of 3 audible chimes will be emitted and a message invites him/her to grip the steering wheel again. Then the  symbol on TFT display will become grey.



If the driver keeps his/her hands away from the steering wheel (for more than 8 to 10 seconds), also the ACC system is deactivated ( white ACC symbol on the display) and will have to be reset. The aid of LKA system will be disabled as well. In these cases the display will not show the attention level colour anymore and the vehicle will be controlled by the driver only.

System Disengage

To disengage ADA you can do any of the following actions:

- Press the  ADA enable button on the steering wheel.
- Begin steering manually.
- Press brake pedal.
- Turn off ACC.
- Unbuckle the driver's seat belt.
- Press ACC time gap button for two seconds to enable CC system.
- Shift out of the (D) Drive gear.
- Enter an Autonomous Emergency Braking (AEB) event (See chapter "Forward Collision Warning - FCW" in this section).
- Turn signal activated.

System Cancellation

The ADA system will cancel (without driver intervention) if either of the following actions occur:



- Curve that is too tight.
- When removing the hands from the steering wheel.
- Lane line markers are not detected by the forward facing camera.
- The lane intersection or roundabout (traffic circle).
- Any ADAS system faults.
- ACC cancellation.
- Vehicle speed exceeds the maximum limit.
- Lateral accelerations exceeds the limits.

NOTE:

When ADA cancels, the  symbol will turn red then grey.

System Limitations

ADA is unable to guide the vehicle when the following conditions occur.

- Lane markings are not clear or visibility is poor (i.e. heavy rain, snow, fog, etc.).
- Obstructed, covered or damaged forward-facing camera or sensor.
- When driving on hills or sharp curves.
- When approaching toll booths.
- When the highway entrance or exit is wider than 20 ft (6 meters).
- Bright light (ex. direct sunlight or glare) facing the forward camera.



WARNING!

Many unforeseen conditions can occur that can affect the performance of Active Driving Assist (ADA). Always keep this in mind and drive attentively. It is the drivers responsibility to keep control of the vehicle at all times.

System in Faulty

The ADA system cannot properly operate due to a fault of its components, or because the components themselves or their detection area is obstructed.

In these cases the amber warning light and the related message will be displayed on the instrument cluster.

In this condition avoid using the system and have the vehicle inspected at the **Authorized Maserati Dealer**.

Radar Device - Regulatory Information

The "Regulatory Information" for all the radio frequency and radar devices can be consulted by accessing the "Services" section on the website www.maserati.com.

Traffic Sign Assist - TSA



TSA detects traffic signs through the use of a forward-facing digital camera mounted on windshield, behind the rear-view mirror. TSA assists the driver by displaying on the instrument cluster detected speed limits and traffic signs with a restriction indicated by an additional sign (e.g. in snow conditions). TSA also uses the data of the navigation system, in order to provide information to the driver in all cases in which the camera is not able to detect the traffic signs that are present on the road where the car is travelling.

Some examples of these are: due to low visibility, light reflection, damaged traffic signs, traffic signs in wrong position like rotated or fallen poles.

NOTE:

- Overtaking restriction sign are not displayed by the TSA system.
- TSA provides a visual warning to the driver when he/she unintentionally reaches the maximum speed limit allowed or when it exceeds the set "Sensitivity" value.



- The performance of TSA depends on the update degree of navigation system's maps.

Customised Settings

TSA is configurable by the customer regarding the display mode on the instrument cluster and the warning sensitivity.

Entering "Vehicle" page on MIA display and select the "Traffic Sign Assist" soft-key of the "Settings" menu to enter the setting page.

The check mark on the "Warning Mode" box indicates that the warning function is active.

The display of the traffic signs can be blinking or static.

The system can be set to display the traffic signs when the speed of the vehicle is equal to the speed limit allowed, or when it is higher than 5 or 10 MPH (5 or 10 km/h).

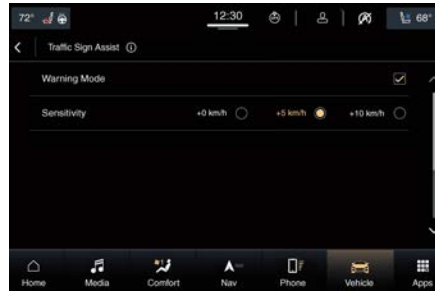

Signs Monitoring on Instrument Cluster

If TSA function is set and a sign or a speed limit is detected, the related icons are displayed in the upper area of the instrument cluster beside of the main menu number and scroll arrows.

The display area is divided in two different sectors:

1. Conditioned speed limit area.
2. Unconditioned speed limit area.



NOTE:

Overtaking restriction signs are not displayed by the system.

If "Blinking On" warning mode is set, when the visual warning is provided only the unconditioned speed limit (in sector 2) will start blinking when the vehicle speed exceeds to the detected unconditioned speed limit (" +0 MPH" or " +0 km/h" option) or when it exceeds the set sensitivity value (" +5 MPH" - " +5 km/h" or " +10 MPH" - " +10 km/h" options). If the vehicle speed stays above the unconditioned speed limit for several seconds the unconditioned speed limit sign will stop blinking because the manoeuvre is evaluated as intentional. If the TSA is not able to determine any kind of valid speed limit neither from camera nor from digital maps the following image will be shown in sector 2.





Since TSA also uses the data provided by the navigation system, it can update the sector 2 of the display in the following situations without detecting traffic signs:

- When the vehicle changes road.
- Highway enter/exit.
- Urban area stored in the digital map enter/exit.

System Limitations

TSA may be impaired or may not function in the following situations:

- If there is poor visibility, e.g. due to insufficient illumination of the road, if there are highly variable shade conditions or in rain, snow or fog.
- If there is glare, e.g. from oncoming traffic, direct sunlight or reflections from other vehicles.
- If the windshield in the area of the camera is dirty, or if the camera is fogged up, damaged or covered.
- If the traffic signs are hard to detect, e.g. due to dirt or snow, or because they are covered or because of insufficient lighting.
- If the information in the navigation system's digital map is incorrect or out-of-date.
- If the signs are ambiguous, e.g. traffic signs on construction sites or in adjacent lanes.

- When passing buses or trucks with a speed sticker.



7 - In an Emergency

| | |
|--|-----|
| Tool Kit | 240 |
| Hazard Warning Flashers | 240 |
| In the Event of an Accident | 241 |
| SOS and Assist Call (OPT) | 242 |
| In case of a Punctured Tire | 244 |
| If a Fuse Blows | 249 |
| In Case of External Lights Fault Signal | 255 |
| Emergency Release of the Parking Brake | 255 |
| Transmission Manual Release of P (Park) Position | 256 |
| Auxiliary Jump-Start Procedure | 257 |
| Towing a Disabled Vehicle | 259 |



Tool Kit

The tools are located in the trunk inside a preformed container and are available by lifting the ground coverage.

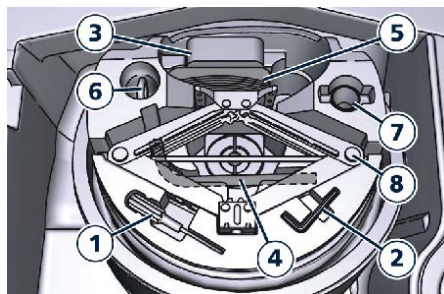

The tools inserted in the container above the compact spare wheel are the following:

| Ref. | Description |
|------|--|
| 1 | Double torx + cross-head screwdriver |
| 2 | 8 mm Allen wrench for unscrewing/tightening the fastening nut of the reverse light cluster |
| 3 | Electric compressor complete with pressure gauge for inflating the compact spare wheel |

| Ref. | Description |
|------|--|
| 4 | Wrench for unscrewing/tightening the wheel nuts and for operating the jack |
| 5 | Chock to be positioned in front of or behind the wheel |
| 6 | Tow hook |
| 7 | Funnel for emergency supply |
| 8 | Jack |

Hazard Warning Flashers

The hazard warning flashers switch is located in the central console in front of the transmission lever.



Press the switch to turn on the hazard warning flashers to warn oncoming traffic of an emergency. When these lights illuminate, the turn signals, the related warning lights on the instrument cluster and the button start flashing.

Press the switch a second time to turn off the hazard warning flashers.

This is an emergency warning system and it should not be used when the vehicle is in motion. Use it when your vehicle is disabled and it is creating a safety hazard for other motorists.

When you must leave the vehicle to seek assistance, the hazard warning flashers will continue to operate even



though the ignition is placed in the OFF position.



CAUTION!

- When the hazard warning flashers are activated, the turn signals control is disabled.
- With extended use the hazard warning flashers may wear down your battery.

In the Event of an Accident

It is important always to keep calm.

- If not directly involved, stop at a safe distance of at least ten yards (meters) away from the accident area.
- If on a highway, stop without obstructing the emergency lane and be especially careful if you need to exit the vehicle.
- Turn off the engine and switch on the hazard warning flashers.
- At night, illuminate the accident area with the headlights.
- Always act with caution to avoid the risk of being crashed into by other drivers.
- Indicate that an accident has occurred by placing the emergency triangle (if equipped) in a well visible position and at the prescribed distance.
- Call the emergency services, providing as much information as possible. On the highway, use the special call boxes.
- Remove the ignition key (if present) from the vehicles involved.
- If fuel or other chemical products can be smelled, do not smoke and ask people around you to put their cigarettes out.

- To extinguish fires, even small ones, use a fire extinguisher, blankets, sand or earth. Never use water.
- In multiple accidents occurred on highways, particularly where visibility is poor, there is a high risk of being involved in other collisions. Leave the vehicle immediately and move away from the area.

In case of Injured Persons

- Never leave the injured person alone. Persons not directly involved in the accident are also required to give assistance.
- Do not crowd around injured persons.
- Reassure the injured person that help is on the way.



SOS and Assist Call (OPT)

The car is equipped with on-board assistance functions designed to provide support in the event of an accident and/or emergency (SOS Call) or vehicle malfunction (Assist Call).

NOTE:

For SOS and Assist Call functions, location (GPS) must always be active: any deactivation would make these services unavailable.

SOS Call

The SOS Call is sent to a private response center (this service is not equivalent to the e-call service envisaged by the applicable legislation for new type-approved vehicles). The call is powered by its own battery to ensure operation even when the vehicle battery is low or disconnected.

When the call system battery goes low, the instrument cluster display will show a message and send a notification via mobile App.

NOTE:

Failure to replace the call system battery or to ignore system warnings may impair or completely exclude the operation of the services.

In an Emergency

Regardless of the state of charge, the call system battery must be replaced every 5 years at the **Service Network**.

The SOS Call is only to be used when there is a concern for the health of individuals. In this case, the operator of the emergency center verifies the status of the vehicle's safety systems and defines with the driver the type of emergency support needed (ambulance, fire brigade, etc..). The SOS Call is automatically forwarded in the event of an accident with air bag deployment providing that the ignition device is in **RUN** position and air bags are working (malfunction warning light  off).

The SOS Call can be activated manually by the user in 3 different ways:

- via the button on the dome console;
- via "SOS call" soft-key on the "Apps" page of the MIA screen;
- using the MIA smartphone application (applicable only in European countries).

Via the Button on the Dome Console

Press and hold for a few seconds the SOS Call button on the dome console; the green LED on the button will blink and then become a fixed light indicating that a call has been placed.



The manual SOS Call is possible when the ignition device is in the **RUN** or **ACC** position and in **OFF** position until its backlight stays on, which is a convenient way to get in contact with an operator to request help. When the connection between the vehicle and a safety operator is made, your vehicle will automatically transmit location and vehicle information to the service operator.

NOTE:

- In case the SOS Call button is accidentally pushed, there is a 10 second delay before the call is placed. The system will verbally alert you that a call is about to be made. To cancel the call connection, press the button on the dome console again.



- The SOS Call function may not be available in the first minute after starting the car.

The SOS Call has priority over other audio sources, which will be muted. If you have a phone connected via Bluetooth®, it will be disconnected and reconnected again at the end of the call. Voice prompts will guide you during the SOS Call.

If a connection is made between a service operator and your vehicle, you understand and agree that operators may, like any other SOS Call, record conversations and sounds in and near your vehicle upon connection.

Only a safety operator can remotely end the SOS Call and, if necessary, call back the vehicle eCall system. After the call, you can still call the emergency service operator to indicate additional information by pressing the button again.

In an Emergency, the connection and the call to the operator of the SOS center will immediately be activated and the following screen will be displayed on the MIA App.

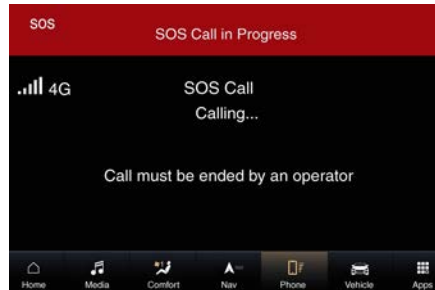

During the SOS Call, if the user opens another page and exits the screen, the SOS Call status bar will be shown on all the other screens too, displaying "SOS Call in Progress" in writing and the call time, if available.

For further information, see the "Maserati Intelligent Assistant (MIA)" guide.

SOS Call Not Available Messages

The SOS Call is not available in the following cases:

- during a system update process;
- system error (generic fault, sim fault, antenna, USB connection, etc.);
- the subscription to the service is not active or has expired. In these cases, the SOS Call can be temporarily unavailable.

NOTE:

If a customer has not subscribed to Maserati Connected Services, the SOS Call will not be available. For more details, see the official Maserati website.

Assist Call

The Assist Call service is available only where the user has an active assistance coverage.

Assist Call requires the ignition device to be in **RUN** or **ACC** position with a properly functioning electrical system. Owners have the ability to activate to types of Assist Call:

• Roadside Assistance Call

Road Assistance provides 24 hours / 7 days of assistance in case of vehicle-related problems (towing, flat tire, etc..) and dispatches roadside assistance to the vehicle's location. Enter the "Assist Call" menu of the "Apps" and touch the "Road Assistance" soft-key.



NOTE:

When the user selects the "Road Assistance" soft-key, the vehicle location will be sent through to the call center.

• Customer Service Call

Customer Service provides assistance and support on general enquiries. Enter the "Assist Call" menu of the "Apps" and touch the "Customer Service" soft-key.

NOTE:

- When the user selects the "Customer Service" soft-key, the vehicle location will be sent through to them.
- If a customer has not subscribed to Maserati Connected Services, the Assist Call will not be available. For more details, see the official Maserati website.

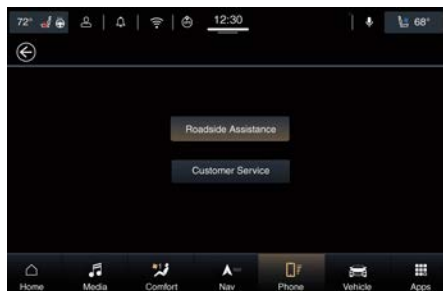

In an Emergency

NOTE:

- Roadside Assistance Call or Customer Service Call may not be available in the first minute after starting the car.
- In case the Roadside Assistance Call or Customer Service Call soft-key are inadvertently touched on the MIA screen, the call can be interrupted by touching the end call soft-key.
- If there is an active SOS Call, neither a Roadside Assistance or Customer Service Call can be triggered. For further information, see the "Maserati Intelligent Assistant (MIA)" guide.

Assist Call Not Available Messages

The Assist calls are not available in the following cases:

- the subscription to the service is not active or has expired;
- there are problems connecting to the network. In these cases, the user will be warned that the call cannot be made on the TFT display.

In case of a Punctured Tire

If the vehicle is equipped with a compact spare wheel.

Using the Compact Spare Wheel

NOTE:

The compact spare wheel is supplied in aluminium or steel: the pictures show the one in aluminium.

The compact spare wheel is stored in the trunk and is supplied deflated in order to limit the amount of space occupied. An electric compressor is also provided for inflating.

In the event of a tire puncture, proceed as follows.

- Stop the vehicle in a place that does not constitute a danger to traffic and where the wheel can be changed safely.
- Select the P (Park) mode and then engage manually the electric parking brake and move the ignition switch to **OFF** position.
- If necessary, turn the hazard warning flashers on and place the warning triangle (if equipped) at the required distance.

**WARNING!**

- The vehicle must be level and on firm ground during the vehicle lifting operations. The use of chock contained in the tool kit is always mandatory. In case of slight slope (less than 10%), place the chock in front of (downhill) or behind (uphill) the wheel diagonally opposite the one to be replaced. In case of higher slope (more than 10%), call the Assistance Service and avoid any operation.
- The jack should be used on level firm ground wherever possible.
- It is recommended that the wheels of the vehicle be chocked, and that no person should remain in a vehicle that is being jacked.
- Never start or run the engine with the vehicle on a jack.
- No person should place any portion of their body under a vehicle that is supported by a jack.

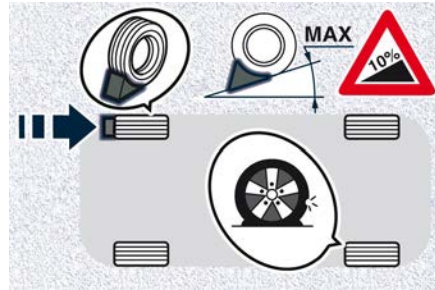

- Before placing the chock, it is necessary to open it like a book as shown in the picture.

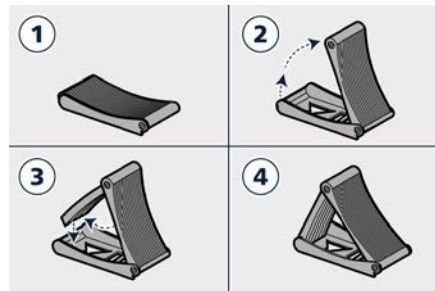

- Lift the ground coverage of the trunk.
- Take the tools indicated in picture for changing the wheel from the container.

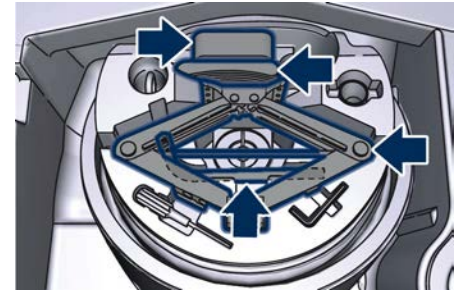

- Loosen and remove the spare wheel locking knob.
- Take the tool box container and the compact spare wheel out of the trunk.

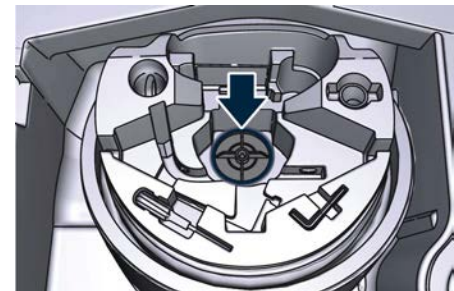
**Compact Spare Wheel Installation**

- Using the kit wrench, loosen counterclockwise by approximately one turn the five bolts on the wheel to be changed. In case a "Wheel Security Stud Bolt" is installed, it can only be loosened and removed



In an Emergency

by using the specific fitting wrench insert provided with the "Wheel Security Stud Bolt Kit", available in the "Genuine Accessories" range. In this case, the insert must be installed on the kit wrench.



Place the jack near the wheel to be changed as illustrated. Make sure that the head of the jack is correctly inserted in one of the slots 1 or 2 under the longitudinal member.

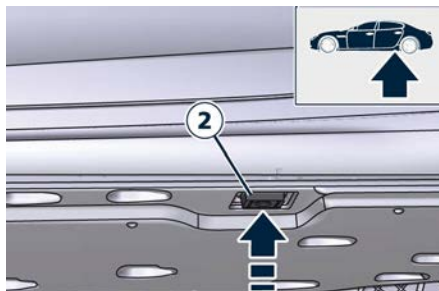

WARNING!

- **Never position yourself under a jacked vehicle.**
- **A jack in the wrong position could cause the vehicle to fall. Severe risk to the operator's safety and damage to the vehicle could occur.**
- **Never use the jack to carry out maintenance or repairs under the vehicle.**
- Insert the kit wrench on the hexagonal end of the jack and turn it clockwise until the jack bracket is firmly inserted in the slot under the longitudinal member.



- Turn the jack lever until the wheel is raised a few inches off the ground.
- Completely unscrew the five bolts and remove the wheel.
- Make sure that the contact surfaces between spare wheel and hub are clean and free of impurities.
- Fit the compact spare wheel with the valve stem side out and secure it with the five bolts previously removed, without tightening them.
- Remove from the compressor case the inflation hose and the cable with a plug for the power outlet.
- Unscrew the valve cap of the compact spare wheel and screw the fitting of the inflation hose onto the valve.
- Insert the plug inside one of the available power outlets fitted in the trunk or passenger compartment.
- Set the ignition device on **ACC** or **RUN** position.

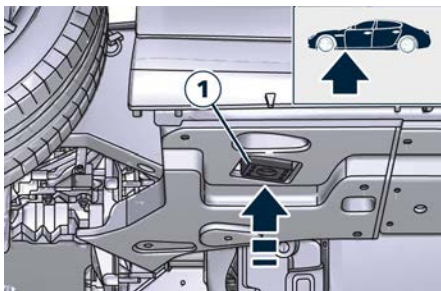



- Turn the compressor on by pressing the switch.
- When the pressure indicated by the gauge reaches the recommended level of 350 kPa - 51 PSI - 3.5 bar ( : chapter "Tire Inflation Pressure" in section "Technical Specifications"), stop the compressor by pressing the switch again and screw the cap on the spare wheel valve.

**CAUTION!**

- In order to obtain a more accurate reading, the compressor should be switched off when checking the tire pressure of the compact spare wheel on the pressure gauge.
- Do not run the compressor for more than 20 minutes: there is a risk it could overheat. Also, prolonged

power absorption may discharge the battery, subsequently preventing the engine from starting.

- The compressor has been designed exclusively to inflate compact spare wheels; do not use it to inflate air mattresses, floatation devices, etc.
- With the kit wrench, turn counterclockwise the hexagonal end of the jack to lower the vehicle and remove the jack.
- Fully tighten clockwise the bolts, alternately tightening diametrically opposite.

**WARNING!**

- **FOR ALUMINIUM SPARE WHEEL** Observe the tightening torque for the bolts securing the spare wheel (72 ± 7 lbf-ft/ 98 ± 10 Nm).
- **FOR STEEL SPARE WHEEL** Observe the tightening torque for the bolts securing the spare wheel (63 ± 7 lbf-ft/ 86 ± 10 Nm).
- To avoid the risk of forcing the vehicle off the jack, do not tighten the wheel bolts fully until the vehicle has been lowered. Failure to follow this warning may result in personal injury.

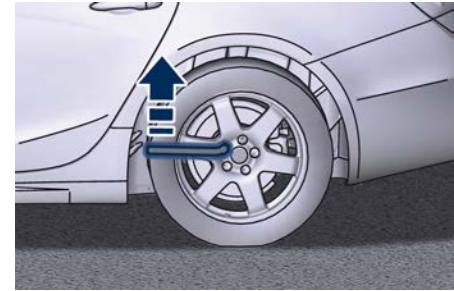
**WARNING!**

- The compact spare wheel is narrower than standard wheels and must only be used to travel the distance required to reach a service station, where the punctured tire can be repaired or replaced.
- Do not exceed a maximum speed of 50 mph (80 km/h) when using the compact spare wheel; when this limit is exceeded, the stability, road holding and braking of the vehicle will be compromised. Avoid accelerating to full speed, heavy braking and fast cornering.
- The compact spare wheel must be inflated to the recommended tire pressure ( : chapter "Tire Inflation Pressure" in section "Technical Specifications").



- For safety reasons, it is absolutely forbidden to drive with more than one compact spare wheel fitted on the vehicle.
- Snow chains cannot be fitted on the compact spare wheel.
- The compact spare wheel can travel a maximum of 1,800 mi (3,000 km).
- For Trofeo Version, in case of tire/rim/valve replacement, it is necessary to use a new valve and sensor with same technical features.

To Refit the Standard Wheel with Repaired or Replaced Tire

- Following the procedure and the caution described above, raise the vehicle and remove the compact spare wheel reusing the supplied wrench.
- Fit the standard wheel with repaired or replaced tire.
- Tighten the original bolts on the wheel.
- Lower the vehicle and remove the jack.
- Fully tighten the bolts, alternately tightening diametrically opposite.

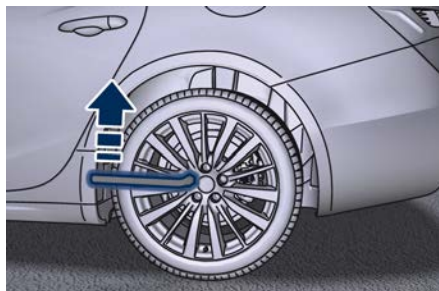

WARNING!
Observe the tightening torque for the bolts securing the wheels (72 ± 7 lbf-ft / 98 ± 10 Nm).

Once finished:

- completely deflate the compact spare wheel by pressing on the valve with the overhang of the valve cap;
- place the compact spare wheel and tool container in the boot;
- fix everything in place with the locking knob;

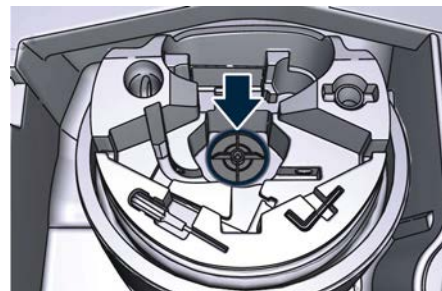

- wrap the power cable and the inflation hose inside the compressor case.
- place the compressor, the jack, the wrench and the adapter in the container inside the compact spare wheel;
- remove the chock located in front of or behind the wheel and place it inside the container.

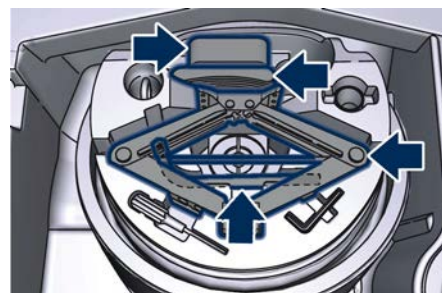

- lower the ground coverage at the bottom of the trunk.



If a Fuse Blows

Used Fuses Characteristics

When an electrical device is not functioning, check that the corresponding fuse is in proper working order (intact).

A Fuse intact

B Fuse blown



The vehicle mainly uses mini-and maxi-fuses with blade engagement. Besides these there are other types of fuses provided with holes for attaching to the cable connection terminals. For the replacement of these fuses contact an **Authorized Maserati Dealer**.

Replace the faulty fuse with a new one featuring the same rating, by using appropriate forceps added in the integrated power module and

inside the cover of the rear power distribution center.

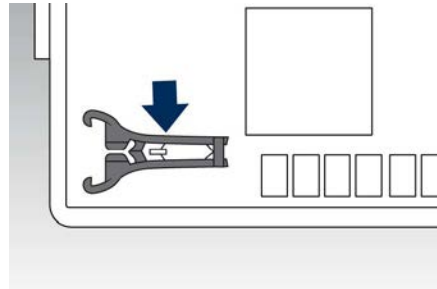

The color identifies the value of the fuses in amperes which is also reported on them.

The table shows the match between color and amperage of mini and maxi fuses.

| Type | |
|-------------|-------------|
| Mini Fuse | Maxi Fuse |
| Beige - 5 | Yellow - 20 |
| Brown - 7,5 | Green - 30 |
| Red - 10 | Orange - 40 |
| Blue - 15 | Red - 50 |
| Yellow - 20 | Blue - 60 |
| White - 25 | |
| Green - 30 | |



CAUTION!

- Never replace a blown fuse with anything other than a new and suitable fuse (same rating).
- After replacing a fuse, if the fault recurs, contact an **Authorized Maserati Dealer**.

Position of Fuses

The fuses are located in three parts of the vehicle, namely:

- inside the integrated power module, on the right hand side of the engine compartment;

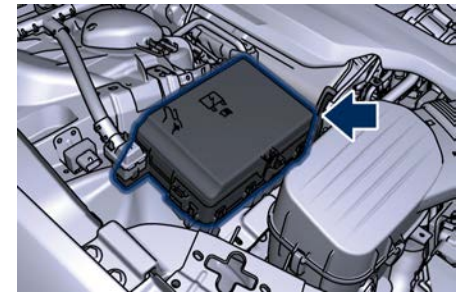

- inside the rear power distribution center, behind the battery, on the right hand side of the trunk compartment;



- on the fuse and relay box located in a covered area, behind the glove compartment on the dashboard left side.

Integrated Power Module

- To access the module it is necessary to lift the hood (see "Hood Operation" in section "Before Starting").
- To access the fuses remove the module cover unhooking the lateral locks as shown in the picture. To recognize the reference number of the fuses in the table below, see the diagram inside the cover just removed.

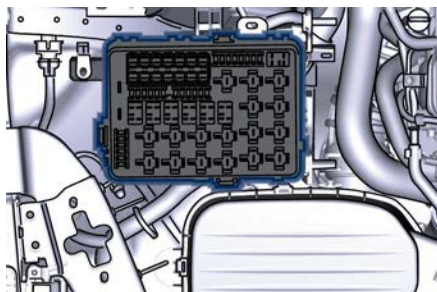
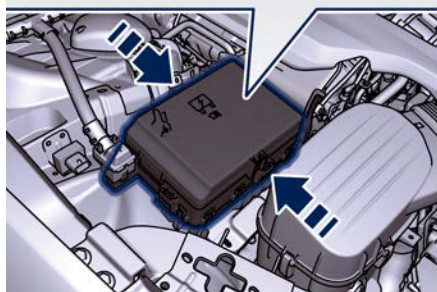
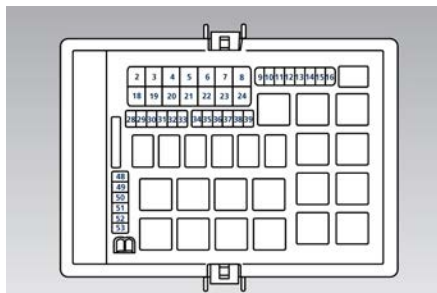

The table points out the position as featured in the cover, the type and function of the fuses included in the integrated power module.



CAUTION!

- After replacement, refit the protective cover of the module.
- If you need to wash the engine compartment, do not direct the water for too long directly on the module.

| Ref. | Type | Function |
|------|------------|---|
| 2 | Maxi - 50A | Secondary air pump relay input (3.8 V8 engine only) |
| 4 | Maxi - 30A | Starter motor relay input and starter solenoid supply |
| 5 | Maxi - 40A | ABS-ESP pump feed |
| 6 | Maxi - 30A | AWD module (AWD version only) |
| 8 | Maxi - 40A | ABS-ESP valve feed |



| Ref. | Type | Function |
|------|-------------|--|
| 11 | Mini – 20A | Horn relay input |
| 12 | Mini – 10A | AC compressor feed relay input |
| 14 | Mini – 7,5A | Alarm siren |
| 15 | Mini – 10A | Washer heated nozzles relay input |
| 16 | Mini – 10A | Enable cooling fan relay input and enable cooling oil pump relay input |
| 19 | Maxi – 30A | HDLP washer relay input |
| 20 | Maxi – 30A | Wiper motor relay output and wiper LOW/HI |
| 21 | Maxi – 20A | LH low beam relay input |
| 22 | Maxi – 20A | RH low beam relay input |
| 28 | Mini – 7,5A | Drive Assist System Module (DASM) |

| Ref. | Type | Function |
|------|------------|--|
| 29 | Mini – 10A | PCM module-Starter solenoid relay coil - Voltage Body & Dash, PTC relay coil |
| 30 | Mini – 5A | ORC- Air bag module |
| 31 | Mini – 5A | ABS-ESP module |
| 32 | Mini – 5A | AWD module (AWD version only), EPS and AQS |
| 33 | Mini – 20A | HDLP LED/All Xenon Headlights - AFLS |
| 34 | Mini – 15A | Primary load to engine harness LH side |
| 35 | Mini – 15A | Primary load to engine harness RH side |
| 36 | Mini – 30A | PCM module primary load |
| 37 | Mini – 15A | Engine secondary load |
| 38 | Mini – 15A | Lambda sensor |

| Ref. | Type | Function |
|------|-------------|--|
| 39 | Mini – 7,5A | Tank lackage, canister, exhaust by-pass valve relay coil and air shutter |
| 49 | Mini – 10A | Pedal brake switch - TCM module |
| 50 | Mini – 15A | +30 PCM module |
| 51 | Mini – 30A | Fuel pump high speed relay input |
| 52 | Mini – 5A | Starter solenoid signal for PCM and voltage stabilizer |
| 53 | Mini – 10A | AWD module (AWD version only) |

Rear Power Distribution Center

- To access the center it is necessary to lift the ground coverage of the trunk compartment and remove the access cover (refer "Battery Status and Maintenance" in section "Maintenance and Care").



In an Emergency

- To access the fuses, unhooking the cover lock shown in picture.

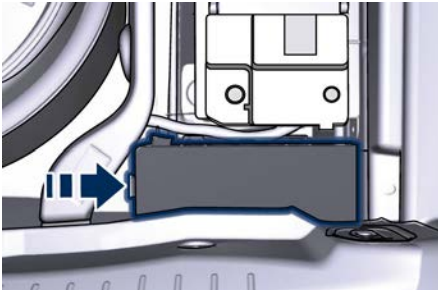

- Press the release latch and lift the lid from this side.
- Push the lid toward the right side to release the indicated latches on the unit. To recognize the reference number of the fuses in the table below, see the diagram inside the cover just removed.

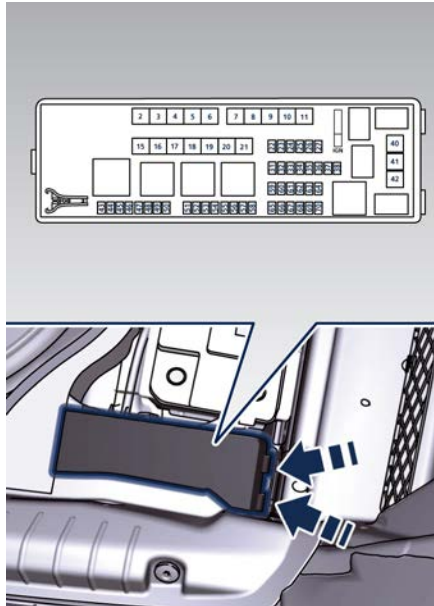

The table points out the position as featured in the cover, the type and function of the fuses on the rear area distribution control unit.

| Ref. | Type | Function |
|------|------------|------------|
| 2 | Maxi – 40A | BCM module |
| 3 | Maxi – 40A | BCM module |
| 4 | Maxi – 30A | BCM module |
| 5 | Maxi – 30A | BCM module |

| Ref. | Type | Function |
|------|------------|--|
| 6 | Maxi – 20A | Sunroof module |
| 7 | Maxi – 30A | Driver door module |
| 8 | Maxi – 30A | Passenger door module |
| 9 | Maxi – 40A | Start&Stop: voltage stabilizer, dashboard |
| 10 | Maxi – 40A | Start&Stop: voltage stabilizer, body |
| 11 | Maxi – 40A | "High Premium" stereo amplifier unit |
| | Maxi – 20A | "Premium" stereo amplifier unit (1) |
| 15 | Maxi – 40A | HVAC front blower relay coil |
| 16 | Maxi – 40A | Rear window defrost relay coil (HVAC module) |
| 17 | Maxi – 30A | Rear LH door module |



| Ref. | Type | Function |
|------|------------|---|
| 18 | Maxi – 30A | Rear RH door module |
| 20 | Maxi – 20A | "Premium" stereo amplifier unit (2) |
| 21 | Maxi – 40A | Eldor - fuel pump |
| 23 | Mini – 10A | Fuel door relay and RF Hub module |
| 24 | Mini – 10A | ITM module, ceiling light unit (front and rear), rain/lights sensor |
| 31 | Mini – 25A | LH front seat movement |
| 34 | Mini – 20A | Soft Door Close latch |
| 36 | Mini – 10A | Transmission lever, Navtrak, Hands Free access module |
| 37 | Mini – 25A | Power lift-gate/boot lid module |

| Ref. | Type | Function |
|------|-------------|---|
| 38 | Mini – 25A | RH front seat movement |
| 40 | Maxi – 20A | Trunk power outlet |
| 43 | Mini – 20A | Seat passenger heater module |
| 46 | Mini – 5A | Rear camera |
| 47 | Mini – 5A | Navtrak |
| 48 | Mini – 5A | Surround view |
| 49 | Mini – 10A | Internal temperature sensor, umidity sensor, internal mirror and HALF |
| 51 | Mini – 25A | Rear seat and steering wheel heater module |
| 54 | Mini – 7,5A | Blind Spot module |
| 56 | Mini – 7,5A | Blower front HVAC coil relay |

| Ref. | Type | Function |
|------|-------------|--|
| 59 | Mini – 10A | SDC module, transmission lever, Eldor fuel pump ASBM, rear tunnel stack switch |
| 60 | Mini – 10A | SDC module |
| 61 | Mini – 25A | Front console power outlet and cigar lighter |
| 62 | Mini – 7,5A | Front HVAC module |
| 64 | Mini – 10A | Wi-fi |
| 65 | Mini – 10A | Intelligent battery sensor |
| 66 | Mini – 10A | Wi-fi |
| 67 | Mini – 7,5A | USB charge outlet, sunroof |
| 68 | Mini – 20A | Rear sunshade module |
| 69 | Mini – 25A | Rear console power outlet and cigar lighter |



| Ref. | Type | Function |
|------|------------|--|
| 70 | Mini – 10A | Front HVAC module and Parking Aid Module (PAM) |

Fuse Box under the Dashboard

This box is located in an internal area that can be accessed only by removing the glove compartment on the dashboard left side. Considering the complexity of this operation, we recommend having the fuses replaced by an **Authorized Maserati Dealer**.

The table points out the position as featured in the figure, the type and function of the fuses in the box under the dashboard.

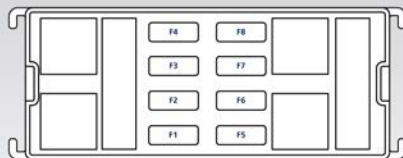
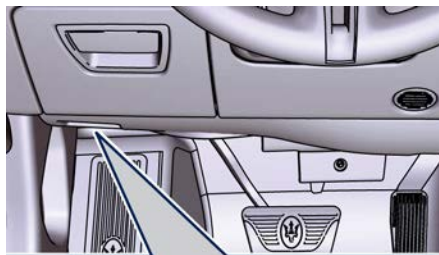

| Ref. | Type | Function |
|------|-------------|---|
| 3 | Mini – 10A | DSRC and DTV system (Japan version only) |
| 4 | Mini – 5A | E-call |
| 5 | Mini – 7,5A | Security Gateway |
| 6 | Mini – 25A | Radio |
| 7 | Mini – 10A | Column software module, CSS, USB auxiliary port |
| 8 | Mini – 10A | Start & Stop switch, diagnostic outlet |

| Ref. | Type | Function |
|------|-------------|--|
| 1 | Mini – 7,5A | Cluster module, CSS, SGW and DSRC (Japan version only) |
| 2 | Mini – 15A | Cluster module, clock |



In Case of External Lights Fault Signal

The signal failure of an external light is communicated to the instrument cluster that displays on the TFT screen in a graphical form and with a text message which light is faulty (see example in the figure).



Replacement of LED Lights



CAUTION!

Due to the complexity of the operation, for the replacement of the headlight clusters light bulbs/LEDs, we recommend that you contact an **Authorized Maserati Dealer**.



WARNING!

The vehicle can be equipped with **Bi-Xenon bulbs: this bulbs are a type of high voltage discharge tube. High voltage can remain in the circuit even with the headlamp switch and the ignition device off. Because of this, you should not attempt to replace a Bi-Xenon bulb yourself, but take the vehicle to an Authorized Maserati Dealer for service.**

Most of the bulbs are LED powered and cannot be replaced individually. Contact an **Authorized Maserati Dealer** to locate the correct parts and replace them.

Emergency Release of the Parking Brake

In the event the electric parking brake locks due to a system failure (see "Parking Brake" in section "Starting and Driving"), it is not possible to move the vehicle, since the power actuator that operates on the brake pad inside each rear caliper will lock the rear wheels.

After verifying that the battery is sufficiently charged (otherwise use an external power source connected to the vehicle electric system to operate the EPB control lever and try to unlock the parking brake), for moving the vehicle it is necessary to address the electric actuator or caliper to undo the locked brake calipers. Contact the **Authorized Maserati Dealer** to carry out this operation.



WARNING!

If the parking brake has been activated in manual or automatic mode and it is not possible to release it by operating on the lever of the central console, do not move the vehicle since rear brake calipers might be damaged. For more information on



vehicle towing see "Towing a Disabled Vehicle" chapter in this section.

Transmission Manual Release of P (Park) Position

The manual disengagement of the shift from P (Park) has the purpose to allow towing the vehicle if not normally possible using the shift lever (such as inability to start the engine). This procedure is exclusively intended for emergency situations, only!



WARNING!

Always secure your vehicle by fully applying the parking brake, before activating the manual park release. Activating the manual park release could allow your vehicle to roll away if it is not secured by the parking brake. Activating the manual park release on an unsecured vehicle could lead to serious injury or death for those in or around the vehicle.

The cover that allows the emergency manual park release is located on the left part of the driver's foot well.

- Lift the mat on the driver side to access the cover.
- Slip the cover from its seat.

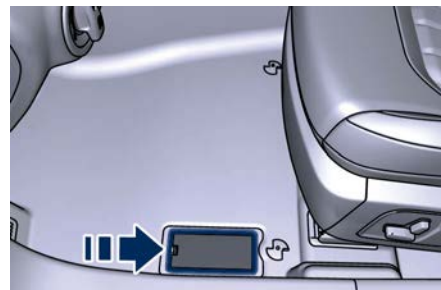

- Take strap out of its seat.
- With the tip of a screwdriver press the clip shown in the picture box and lift the strap up to release the transmission from the P (Park) position. The new position will allow vehicle moving and towing.
- Release the parking brake only when the vehicle is securely connected to a tow vehicle.

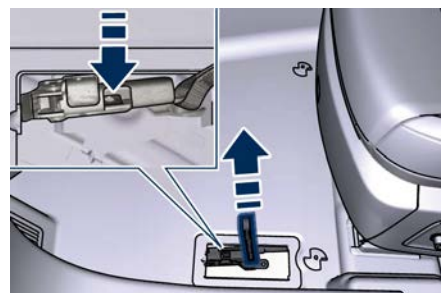



Auxiliary Jump-Start Procedure

If your vehicle has a discharged battery it can be jump-started using a set of jumper cables and a battery of another vehicle or by using a portable battery booster. It is necessary to have proper jumper cables in order to connect the booster battery to the remote posts of the discharged battery. Booster cables have positive and negative terminal clamps and are identified by the sheath color (red = positive, black = negative).

NOTE:

An **Authorized Maserati Dealer** can provide you with information about the "Maserati Jumper Cables Kit", available in the "Genuine Accessories" range.

Jump-starting can be dangerous if done improperly so please follow the procedures in this section carefully.

NOTE:

When using a portable battery booster pack, follow the battery manufacturer's operating instructions and precautions.



CAUTION!

- To jump start a vehicle do not use a portable battery, a booster pack or any other booster source with a system voltage greater than 14 Volts or damage to the battery, starter motor, alternator or electrical system of the vehicle with the discharged battery may occur.
- Do not use a battery charger for emergency starting under any circumstances. You could damage the electronic systems, particularly the control units managing the ignition and fuel supply functions.
- If the battery is completely discharged when the windows are fully raised, open the door with the utmost care; do not close the door again until it is possible to lower the window.



WARNING!

- Always perform jump-starting operations with appropriate tools and environmental conditions, taking all necessary precautions.
- Do not attempt jump-starting if the discharged battery is frozen.

- To avoid the risk of explosion or fire, do not approach the battery with open flames or cigarettes that could generate sparks.

NOTE:

If you need to disconnect the battery from the vehicle electrical system, see "Battery Status and Maintenance" in section "Maintenance and Care".

Battery Remote Posts Position

For easier operation, remote battery posts for jumpstarting are located in the engine compartment while the battery is stored in the trunk. Open the engine hood (see "Hood Operation" in section "Before Starting") the positive remote post (+) and the negative remote post (-) are easily recognizable by the icons labeled on the integrated power module.

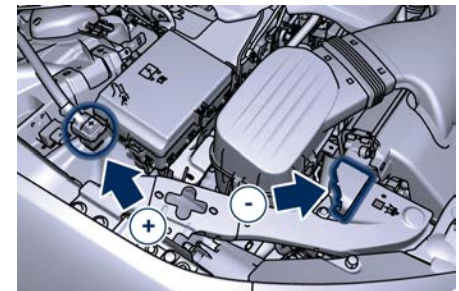



Jump-Start Procedure



WARNING!

- Stay clear of the radiator cooling fan whenever the engine hood is raised. It can start anytime the ignition device is on. You could be injured by the moving fan blades.
- Remove any metal jewelry such as watch bands or bracelets that might make an inadvertent electrical contact. You could be seriously injured.
- Do not allow the vehicles involved in the jumpstarting operation to touch each other as this could establish a ground connection and cause personal injury.
- Turn off the heater, radio, and all unnecessary electrical accessories.
- Set the parking brake, shift the automatic transmission into P (Park) and turn the ignition device to **OFF**.
- If using another vehicle to jumpstart the battery, park the vehicle within the jumper cables reach and set the parking brake and make sure the ignition is off.
- Connect one terminal clamp of the positive jumper cable to the positive (+) remote post of the vehicle with the discharged battery after lifting

the protection cap of the cable indicated on the external side of the integrated power module.

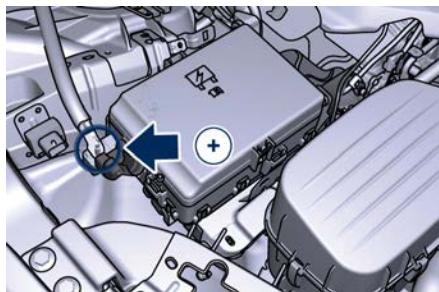

- Connect the opposite terminal clamp of the positive (+) jumper cable to the positive (+) post of the booster battery.
- Connect one terminal clamp of the negative jumper cable to the negative (-) post of the booster battery.
- Connect the opposite terminal clamp of the negative (-) jumper cable to the remote negative (-) post of the vehicle with the discharged battery as rendered.

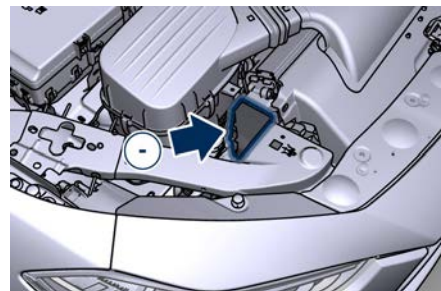

- Start the engine in the vehicle that has the booster battery, let the engine idle a few minutes, and then start the engine in the vehicle with the discharged battery. If using a portable battery booster, wait a few seconds after connecting the cables, before starting the booster vehicle. Once the engine is started, remove the jumper cables in the reverse sequence.
- Disconnect the terminal clamp of the negative (-) jumper cable from the remote negative (-) post of the vehicle with the discharged battery.
- Disconnect the opposite terminal clamp of the negative jumper cable from the negative (-) post of the booster battery.
- Disconnect the terminal clamp of the positive (+) jumper cable from the positive (+) post of the booster battery.



- Disconnect the terminal clamp of the positive jumper cable from the remote positive (+) post of the discharged vehicle.

NOTE:

*If frequent jump-starting is required to start your vehicle you should have the battery and charging system inspected at an **Authorized Maserati Dealer** center.*

Towing a Disabled Vehicle

Proper towing or lifting equipment is required to prevent damage to your vehicle.



WARNING!

Any improper maneuver and use of unsuitable equipment for recovering vehicle in an emergency from off road location could seriously damage the vehicle. Contact an Authorized Maserati Dealer.

Manual Release of Transmission with Low Battery

In order to push or tow the vehicle if unable to shift the transmission out of P (Park) (such as a discharged battery), a manual park release is available. In this case it is necessary to manually release the shift lever and release the parking brake if inserted (see "Emergency Release of the Parking Brake" in this section).

Follow the steps as indicated in "Transmission Manual Release of P (Park) Position" in this section to manually disengage the transmission.

Vehicle Towing Conditions

Maserati only allows vehicle towing either on a flatbed or with all four wheels off the ground.

Towing an RWD Vehicle

If flatbed equipment is not available, and the transmission is still operable, a RWD vehicle may be flat towed (with all four wheels on the ground) under the following conditions.

- The shift lever must be in N (Neutral).
- The distance to be traveled must not exceed 30 mi (50 km).
- The towing speed must not exceed 30 MPH (50 km/h).

If the transmission is not operable, or the RWD vehicle must be towed faster than 30 MPH (50 km/h) or farther than 30 mi (50 km) (for example on a highway), tow with the rear driving wheels off the ground and on a platform of a rescue vehicle, or with the rear wheels raised using a wheel lift.



CAUTION!

If you have to tow the RWD vehicle with 2 wheels raised, ensure that the ignition device is in the OFF position. If this is not observed,



when the ESC is active, the ECU will store a malfunction and the relative warning light  will illuminate on the instrument cluster display. This requires the intervention of an **Authorized Maserati Dealer** to reset the system.

Towing an AWD Vehicle



WARNING!

Single axle towing or use of a tow dolly is not allowed since it will severely damage components of an AWD vehicle.



WARNING!

Use of a tow dolly on front wheels is strictly forbidden since front wheels may still receive a residual amount of torque and disengage the vehicle from the tow dolly and affect safety of both rescuers and other road users.

Use the Tow Hook Included in the Tool Kit



CAUTION!

The tow hook should only be used for towing the car on flat roads. Do not use the tow hook to remove the car that is stuck on off road stretches.

The tow hook can also be used to tow the vehicle on the platform of a tow truck.

It is necessary to inform the operators of the rescue vehicle about the vehicle minimum height to avoid, during its loading, any contact of the lower ends of the front or rear bumper with the tow truck loading ramp.

The tow hook is contained in the tool kit (see "Tool Kit" in this section) and must be screwed in its seat accessible behind the front grille, right-hand side, after removing the protective cap.

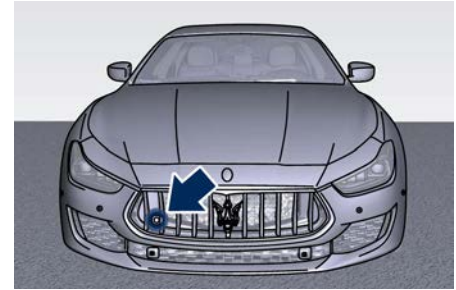

- Carefully clean the threaded seat before screwing the hook.
- Screw the tow hook into its seat for at least 11 turns.

NOTE:

Maximum work angle of towing cable or bar: 15°.

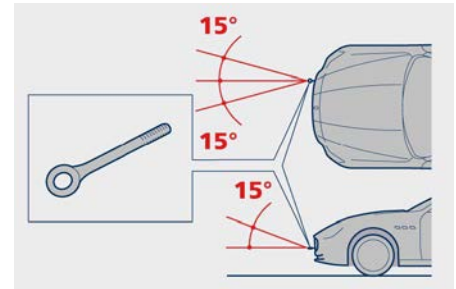



8 - Maintenance and Care

| | |
|--|-----|
| Scheduled Maintenance Service | 262 |
| Scheduled Service Plan | 263 |
| Maintenance Service Components | 269 |
| Maintenance Procedures | 271 |
| Battery Status and Maintenance | 277 |
| A/C System Maintenance | 282 |
| Wheels Maintenance | 283 |
| Bodywork Maintenance and Care | 285 |
| Interior Maintenance and Care | 288 |
| Vehicle Stored for Long Periods | 289 |
| Restarting the Vehicle after a Long Inactivity | 290 |
| Refillings Table | 291 |



Scheduled Maintenance Service

Correct maintenance is clearly the best way to guarantee vehicle performance and safety functions, ensure respect for the environment and low operating costs.

NOTE:

Also remember that the observance of the maintenance procedures is essential for keeping your vehicle operating properly. Not adhering to the "Scheduled Service Plan" can impact your vehicle's warranty.

Interval Running Coupons

Maserati has therefore provided for a series of checks and maintenance operations involving the 1st service and subsequent when the vehicle reaches mileage/years reported on the "Scheduled Service Plan" in this section.

After the last service, maintenance must be restarted with the operations scheduled for the 1st, 2nd and 3rd service.



CAUTION!

The Scheduled Maintenance services are prescribed by the Manufacturer. Failure to have the services carried out can affect your warranty.

The Scheduled Maintenance service is provided by an **Authorized Maserati Dealer**. In the event that, when a service is performed, further replacements or repairs are found to be necessary in addition to the scheduled operations, these can be carried out only with the specific consent of the Customer.



CAUTION!

You are advised to notify the **Authorized Maserati Dealer** of any minor operating problem, without waiting for the next scheduled service.

NOTE:

• *Change your engine oil more often if you drive your vehicle off-road for an extended period of time or short trips without reaching operation temperature. Even the use of the vehicle with extremely hot or cold ambient temperature may make*

necessary change engine oil more often.

- *Under no circumstances should oil change intervals exceed mileage/years reported on the "Scheduled Service Plan" in this section.*



CAUTION!

Failure to perform the required maintenance items may result in damage to the vehicle.

Scheduled Maintenance (Service) Indicator

The service indicator system will remind you the deadline for the maintenance program.

The indicator light  on the instrument cluster flashes for approx. 5 seconds displaying the message backed by a beeping sound, indicating that the next scheduled maintenance is due or has already overdue.



When the scheduled maintenance has overdue, the indicator light and message will be displayed on the instrument cluster.



The service indicator and message will illuminate approximately from 620 mi (1000 km) or 30 days to the next scheduled maintenance.

Have your vehicle serviced as soon as possible.

NOTE:

The service indicator will not monitor the time elapsed from the last scheduled maintenance.

To check the km/mi and the days that remain at the inspiration of the next scheduled maintenance, consult the "Maintenance" submenu of "Vehicle Info" main menu (see "TFT Display Menu and Submenu Content" in section "Dashboard Instruments and Controls" for more details).

An **Authorized Maserati Dealer** will reset the service indicator message after completing the scheduled maintenance operations.

Scheduled Service Plan

The Scheduled Maintenance services listed in this manual must be done at the times or mileages specified to protect your vehicle warranty and ensure the best vehicle performance and reliability.

More frequent maintenance may be needed for vehicles in severe operating conditions, such as dusty areas and very short trip driving.

Inspection and service should also be done anytime a malfunction is suspected.

Maserati recommends that these maintenance intervals be performed at an **Authorized Maserati Dealer**. The technicians at your dealership know your vehicle best, and have access to factory-approved information, genuine Maserati parts, and specially designed electronic and mechanical tools that can help prevent future costly repairs.



Main Operations/Service Coupons

| | Interval running coupons: every 12500 mi (20000 km) or 1 year (whichever occurs first) | | | | | |
|---|--|----|----|----|----|----|
| Service coupons | 1° | 2° | 3° | 4° | 5° | 6° |
| Main operations | Available Pre-Paid Maintenance Program | | | | | |
| Vehicle road test | | I | | I | | I |
| Check with Maserati Diagnosi | I | I | I | I | I | I |
| Engine oil and filter | R | R | R | R | R | R |
| Engine coolant level | I | I | I | I | I | I |
| | Replace every 10 years or 150000 mi (240000 km) | | | | | |
| Engine check for leaks | I | I | I | I | I | I |
| Cooling system connections and lines (check for leaks) | | I | | I | | I |
| Air filter | | | | R | | |
| Belt for alternator, water pump and air conditioning compressor (3.8 V8 Engine) | I | I | I | R | I | I |
| | Replace every time the part is removed | | | | | |
| Belt for alternator and belt for water pump and air conditioning compressor (3.0 V6 Engines) | I | I | I | R | I | I |
| | Replace every time the part is removed | | | | | |
| Spark plugs | | | R | | | R |
| Intercooler check for leaks | I | I | I | I | I | I |
| Brake fluid | I | I | I | I | I | I |
| | Replace every 2 years | | | | | |
| Brake system (lines, calipers, connections) - Instrument cluster warning light efficiency - Parking brake operation | I | I | I | I | I | I |
| Tire wear, tire and spare tire (if equipped) pressure check | I | I | I | I | I | I |



| | Interval running coupons: every 12500 mi (20000 km) or 1 year (whichever occurs first) | | | | | |
|---|--|----|----|----|----|----|
| Service coupons | 1° | 2° | 3° | 4° | 5° | 6° |
| Main operations | Available Pre-Paid Maintenance Program | | | | | |
| Joints, rods for front and rear suspensions, front and rear under-chassis | I | I | I | I | I | I |
| Correct operation and reliability of the seats and seat belts | I | I | I | I | I | I |
| Pollen filter | | R | | R | | R |
| Windshield fluid level - Windshield washer cleaner | I | I | I | I | I | I |
| Headlight leveling | I | I | I | I | I | I |
| E-Call module: battery change | (1) | | | | | |
| Controls and adjustment systems in general, hinges, doors, engine compartment lid and luggage compartment | I | | I | | I | |
| Condition of the leather interiors | I | | I | | I | |
| I = Inspect and carry out any other necessary operation. R = Replace. (1) The E-Call module's battery must be replaced every 5 years. | | | | | | |



Periodic Maintenance

Every 600 mi (1000 km) or before long journeys

Check:

- engine coolant;
- brake fluid;
- windshield washer fluid level;
- tire inflation pressure and condition;
- operation of lighting system (headlights, turn signals, hazard warning flashers, etc.);
- operation of windshield washer/wiper system and wear of windshield wiper blades.

Every 1900 mi (3000 km)

Check and top up, if required, the engine oil level.

Heavy-Duty Vehicle Use

If the car is mainly used under one of the following conditions:

- off-road;
- short, repeated journeys (less than 4-5 mi/7-8 km) at sub-zero outside temperatures;
- engine often idling or driving long distances at low speeds or long periods of idleness;

you should perform the following inspections more frequently than recommended on the "Scheduled Service Plan":

- check front disc brake pad conditions and wear;
- check cleanliness of hood and trunk locks, cleanliness and lubrication of linkage;
- visually inspect conditions of: engine, transmission, pipes and hoses (exhaust - fuel system - brakes) and rubber elements (boots - sleeves - bushes - etc.);
- check battery charge;
- visually inspect condition of the accessory drive belts;
- check and, if necessary, change engine oil and replace oil filter;
- check and, if necessary, replace pollen filter of the A/C system;
- check and, if necessary, replace air cleaner filter.



CAUTION!

All maintenance operations for the vehicle must be carried out by an **Authorized Maserati Dealer**. For routine and minor maintenance operations which you can carry out yourself, make sure that you have the necessary experience and always use suitable equipment, original **Maserati spare parts and the prescribed fluids**. Shall this not be the case, do not



carry any operation on your own and contact an **Authorized Maserati Dealer**.

On-Board Diagnostics (OBD)

Your vehicle is equipped with a sophisticated on-board diagnostic system called OBD II. This system monitors the performance of the emissions, engine, and automatic transmission control systems. When these systems are operating properly, your vehicle will provide excellent performance and fuel economy, as well as engine emissions suited to current government regulations. If any of these systems require service, the OBD II system will turn on the Malfunction Indicator Light  on the instrument cluster display (refer to "Warning and Indicator Lights" in section "Dashboard Instruments and Controls"). The system stores as well diagnostic codes and other information to assist your service technician by performing repairs. Although the vehicle will be driveable and will not need towing, contact an **Authorized Maserati Dealer** for service as soon as possible.



CAUTION!

- Prolonged driving with the MIL  on could cause further damage to the emissions control system. It could also affect fuel economy and driveability. The vehicle must be serviced before any emissions tests can be performed.
- If the MIL  is flashing while the engine is running, severe catalytic converter damage and power loss will soon occur. Immediate service at an **Authorized Maserati Dealer** is required.



Emissions Inspection and Maintenance Programs

In some localities, it may be a legal requirement to pass an inspection of your vehicle's emissions control system. Failure to pass could prevent vehicle registration. For states that require an Inspection and Maintenance (I/M), this check verifies the "Malfunction Indicator Light  " is functioning and is not on when the engine is running, and that the OBD II system is ready for testing.

Normally, the OBD II system will be ready. The OBD II system may not be ready if your vehicle was recently serviced, recently had a dead battery



or a battery replacement. If the OBD II system should be determined not ready for the I/M test, your vehicle may fail the test.

To check if your vehicle's OBD II system is ready, you must do the following:

- Press the ignition device to the **RUN** position, but do not crank or start the engine.
- As soon as you press the ignition device to turn the engine On, you will see the MIL remain illuminated for 15 seconds, this is a normal bulb check.
- Approximately 15 seconds later, one of two things will happen:
 - The MIL  will remain illuminated and a message error will appear on your instrument cluster. This means that your vehicle's OBD II system is not ready and you should not proceed to the I/M station.
 - The MIL  will turn Off. This means that your vehicle's OBD II system is ready and you can proceed to the I/M station.

If your OBD II system is not ready, you should see an **Authorized Maserati Dealer** or repair facility. If your vehicle was recently serviced or had a battery failure or replacement, you may need to do nothing more than drive your vehicle as you normally would in order

for your OBD II system to update. A recheck with the above test routine may then indicate that the system is now ready.

Regardless of whether your vehicle's OBD II system is ready or not, if the MIL  is illuminated during normal vehicle operation you should have your vehicle serviced before going to the I/M station. The I/M station can fail your vehicle because the MIL  is on with the engine running.

Spare Parts

Use of genuine Maserati parts for normal or scheduled maintenance and repairs is highly recommended to ensure excellent performance.

Damage or failures caused by non-genuine spare parts used for maintenance and repairs will not be covered by the manufacturer's warranty.

Dealer Service

An **Authorized Maserati Dealer** has the qualified service personnel, special tools, and equipment to perform all service operations in an expert manner. Service Manuals are available which include detailed service information for your vehicle.



Maintenance and Care

Refer to these Service Manuals before attempting any procedure yourself.

Intentional tampering with emissions control systems may void your warranty and could result in civil penalties.



WARNING!

You can be badly injured working on or around a motor vehicle. Take your vehicle to an Authorized Maserati Dealer.



Maintenance Service Components

The following images show the position of all components involved in the maintenance service.

3.8 V8 Engine

1. Engine oil level dipstick.
2. Engine oil filler neck.
3. Air cleaner filters.
4. Engine coolant expansion reservoir cap.
5. Coolant reservoir cap for transmission cooling system.
6. Windshield washer fluid reservoir cap.
7. Brake fluid reservoir access cover.
8. A/C pollen filter access cover.
9. Integrated power module (fuses).

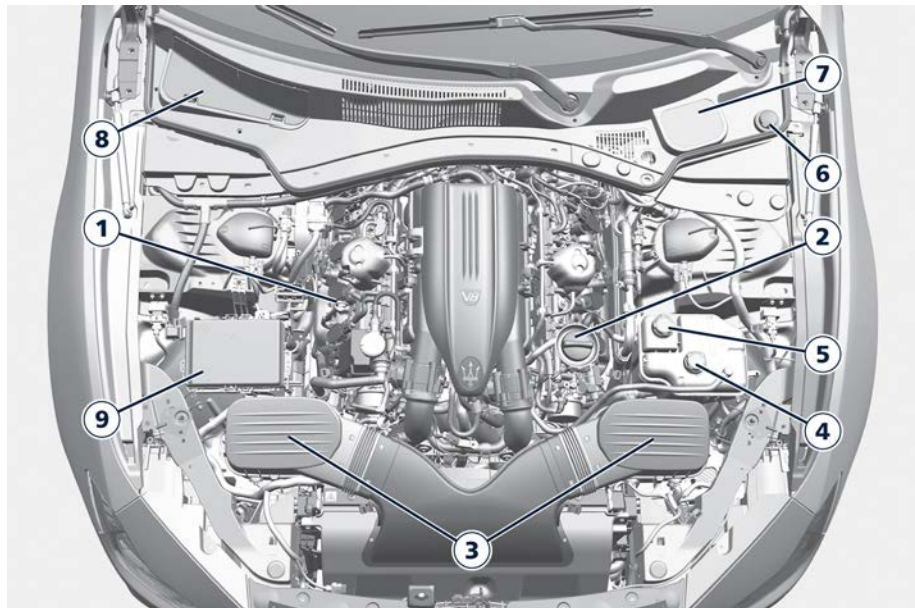

3.8 V8 Engine



3.0 V6 Engines

1. Engine oil dipstick.
2. Engine oil filler neck.
3. Air cleaner filters.
4. Engine coolant expansion reservoir cap.
5. Coolant reservoir cap for transmission cooling system.
6. Washer fluid reservoir cap.
7. Brake fluid reservoir access cover.
8. A/C pollen filter access cover.
9. Integrated power module (fuses).

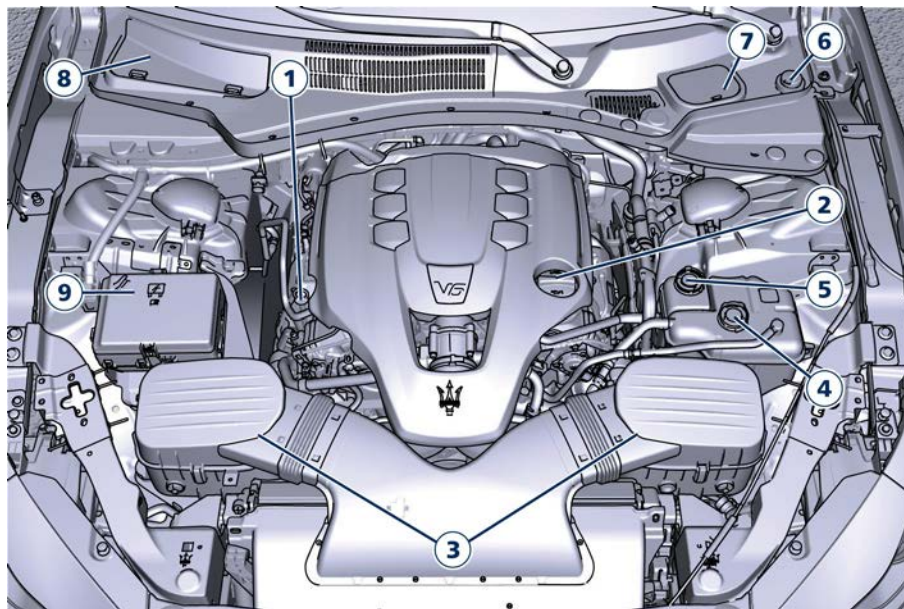

3.0 V6 Engines



Maintenance Procedures

The following pages contain the "required" maintenance standards determined by Maserati engineers.

Besides those maintenance items specified in the "Scheduled Service Plan", there are other components which may require service or replacement in the future.

To perform most of the services, it is necessary to open the hood (see "Hood Operation" in section "Before Starting").



CAUTION!

- Failure to properly maintain your vehicle or perform repairs and service when necessary could result in more costly repairs, damage to other components or negatively impact vehicle performance. Immediately have potential malfunctions examined by an **Authorized Maserati Dealer** or a qualified repair center.
- Your vehicle has been equipped with improved fluids that protect the performance and durability of your vehicle and also allow extended maintenance intervals. Do not use chemical flushes for washing as the

chemicals can damage your engine, transmission, power steering or air conditioning. Such damages are not covered by the New Vehicle Limited Warranty. If a flush is needed because of component malfunction, use only the specified fluid for the flushing procedure.

Level Checks



ENVIRONMENTAL!

- The engine oils and fluids used contain substances that are dangerous to the environment. For replacement you are advised to contact the Authorized Maserati Dealer, where all the necessary equipment is available to dispose of the used oil and fluids in compliance with the regulations in force and in an environment-friendly manner.
- All equipment used for fluids replacement (gloves, cloths, containers, etc) must be disposed of in compliance with the regulations in force.

Engine Coolant Level Check

Your vehicle has been equipped with an improved engine coolant (antifreeze) that offers high protection against corrosion, freezing and allows

extended maintenance intervals.

To prevent reducing extended maintenance periods, it is important to use original engine coolant (antifreeze) when adding coolant throughout the life of your vehicle.

When adding engine coolant (antifreeze) use pure water only, such as distilled or deionized water when mixing the water/engine coolant (antifreeze) solution. The use of impure water will reduce the amount of corrosion protection in the engine cooling system.

- Mix a minimum solution of 50% engine coolant (antifreeze) and distilled water. Use higher concentrations (do not exceed 70%) if temperatures below -35°F (-37°C) are forecast.

Please note that it is the owner's responsibility to maintain the proper level of protection against freezing according to the temperatures occurring in the circulation area of the vehicle.

The coolant reservoir provides a quick visual method to determine that the coolant level is adequate. As long as the engine operating temperature is satisfactory, the coolant reservoir only needs to be checked once a month.



Maintenance and Care

With the engine off and cold, the level of the coolant in the reservoir on the left side of the engine compartment should be between the ranges indicated on the reservoir and inside the filler neck.

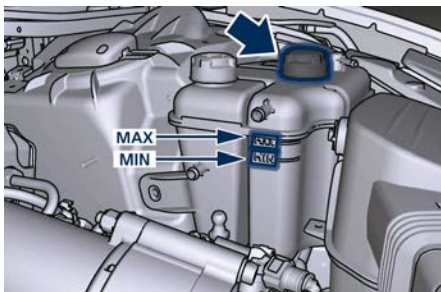

- When additional engine coolant (antifreeze) is needed to maintain the proper level, it should be added to the coolant reservoir after removing the cap. Do not overfill.

- Once the desired level is reached, reassemble and firmly close cap of the reservoir.
- If frequent engine coolant (antifreeze) additions are required, or if the level in the coolant recovery reservoir does not drop when the engine cools, the cooling system should be tested by an **Authorized Maserati Dealer**.
- Keep the front of the radiator and the condenser clean.



WARNING!

- **Never add engine coolant (antifreeze) when the engine is hot. Do not loosen or remove the cap of the engine coolant reservoir to cool a hot engine. Heat causes pressure to build up in the cooling system. To prevent scalding or injury, do not remove the pressure cap while the system is hot or under pressure.**
- **When adding coolant do not use a pressure cap other than the one specified for your vehicle. Personal injury or engine damage may result.**

Brake Fluid Level Check

Check the fluid level immediately if the brake system warning light **BRAKE** (on vehicles of United States market) or  (on vehicles of

Canadian market) and the related message turn on indicating a low level of brake fluid.

- Remove the brake fluid reservoir access cover.

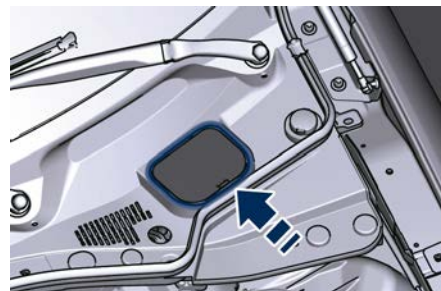

- Clean the top of the master cylinder reservoir before removing the cap.
- Add fluid to bring the level up to the "MAX" mark on the side of the master cylinder reservoir. Use only manufacturer's recommended brake fluid (see "Refillings Table" in this section).
- Once the correct level is reached, firmly close the cap.

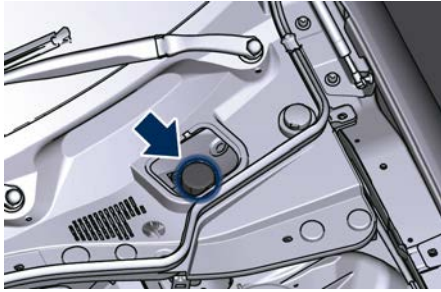

Normal brake pad wear could cause the fluid level to fall. However, low fluid level may be caused by a leak too, and requires accurate checkup of the braking system.



CAUTION!

The symbol  on the tank cap identifies the synthetic type of brake fluid, distinguishing it from the mineral type. Using mineral fluids damages the special rubber linings of the brake system irreparably.



WARNING!

- To avoid contamination from foreign materials or moisture, use only new brake fluid or fluid that has been in a tightly closed container. Keep the

master cylinder reservoir cap secured at all times.

- Overfilling the brake fluid reservoir can result in spilling brake fluid. Brake fluid can also damage painted and vinyl surfaces, make sure it does not spill over these surfaces.
- Do not allow petroleum based fluid to contaminate the brake fluid. Brake seal components could be damaged.

Adding Windshield Washer Fluid

The reservoir on the left side of the engine compartment contains the fluid to wash the windshield.

During scheduled services or when the message of low level of the washer fluid appears together with the related telltale  add more fluid as soon as possible.

The fluid reservoir may contain nearly 3.7 Quarts (3.5 litres) of washer fluid.

- Remove the reservoir cap in the engine compartment and lift the filler neck.

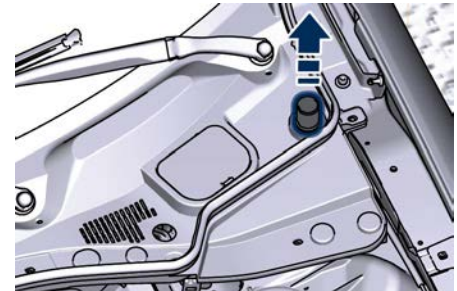
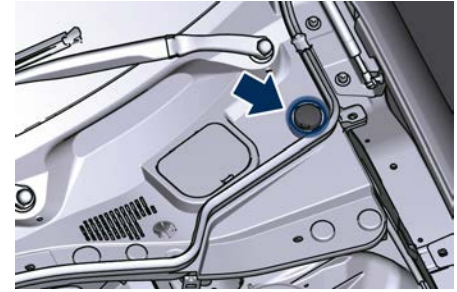

- Fill the reservoir with windshield washer solvent (refer to “Refillings Table” in this section) and operate the system for a few seconds to flush out the residual water.
- When refilling the washer fluid reservoir, apply some washer fluid to a cloth or towel and wipe the wiper blades clean. This will help blade performance.

To prevent freeze-up of your windshield washer system in cold



Maintenance and Care

weather, select a solution or mixture that meets or exceeds the temperature range of your climate.

This rating information can be found on most washer fluid containers.

NOTE:

The **Authorized Maserati Dealer** can provide you with information about the Maserati recommended "Windshield Washer Fluid" with antifreeze, available in the "Genuine Accessories" catalog.



WARNING!

- Commercially available windshield washer solvents are flammable. They could ignite and burn you. Care must be exercised when filling or when working around the windshield washer system.
- Do not drive with the windshield washer reservoir empty: the action of the washer is essential for improving visibility when driving.

Engine Oil Level Check

To assure proper lubrication of your vehicle's engine, the engine oil must be maintained at the correct level.

If the  warning light illuminates and the related message of low oil level displays, or during scheduled

services (see "Scheduled Maintenance Service" in this section) it is necessary to check the engine oil level.

The best time to check the engine oil level is about five minutes after a fully warmed up engine is shut off or before starting the engine after it has sat overnight. In both cases the vehicle should be parked on level ground to improve the accuracy of the oil level readings.



CAUTION!

- Do not top up with oil with different characteristics than the engine one (refer to "Refillings Table" in this section).
- Overfilling or underfilling the oil pan will cause aeration or loss of oil pressure. This could damage your engine.
- Do not add any supplemental materials to the engine oil. Engine oil is an engineered product, and its performance may be impaired by supplemental additives.
- Remove the dipstick and clean it with a dry and clean cloth (the figure represent a 3.0 V6 engine).

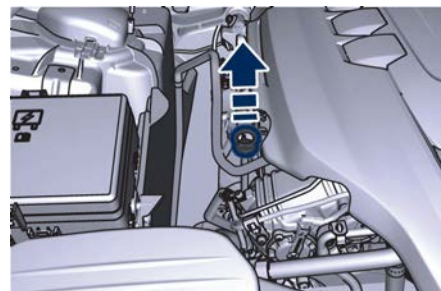

- Re-insert the dipstick completely and remove: the oil level should maintain between the MIN and MAX reference ranges (SAFE range).

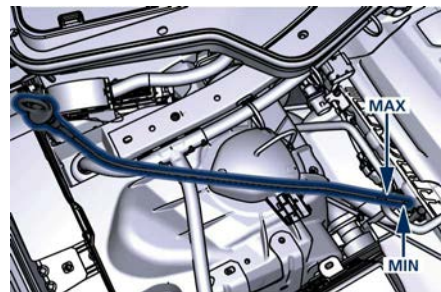

- If a refilling is necessary: unscrew the filler neck cap.

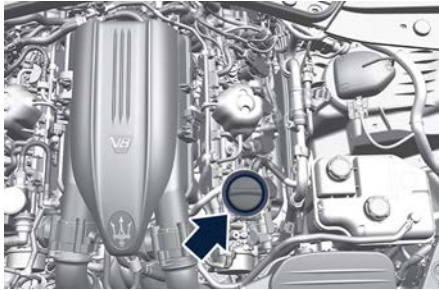

3.8 V8 Engine

Engine Oil Filter Replacement

The engine oil filter should be replaced with a new filter at every oil change.

Contact the **Authorized Maserati Dealer** to perform this service.

Automatic Transmission Oil Check

Contact the **Authorized Maserati Dealer** for the oil level check.

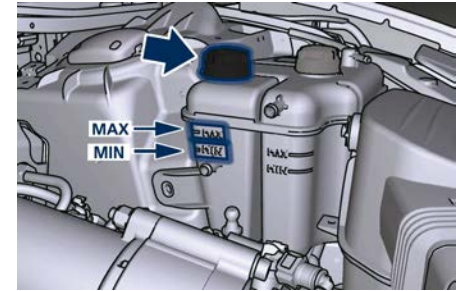

Engine Air Filters Replacement

Contact an **Authorized Maserati Dealer** to have the air filters replaced.

A/C Air Filter Replacement

This filter performs mechanic/ electrostatic air filtering, provided that windows and doors are closed.

The filter is located under the hood in the external A/C system air inlet, on the passenger side of the vehicle, next to the windshield wipers.

To replace the filter during the scheduled maintenance services or after the vehicle has been heavily used on dusty roads, proceed as follows:

- Remove the access door in the cowl screen by pressing the retaining clips indicated.

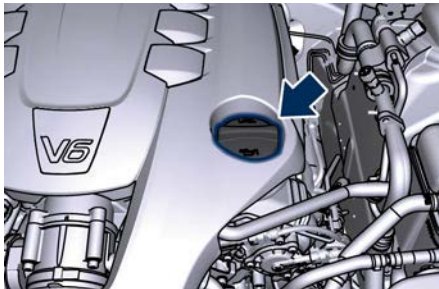

3.0 V6 Engines

Fluid Level Check for Coolant Transmission System

The coolant contained in the reservoir of this system is the same as the one used for the cooling system of the engine.

For the preparation of the mixture of water and antifreeze and for the control of the level, proceed as shown in the "Engine Coolant Level Check" of this chapter.

- Adding 1.6 Quart / 1.4 liters (3.8 V8 engine) or 1.1 Quart / 1 liter (3.0 V6 engines) of oil when it is at the minimum level.
- Return the cap and dipstick to their position and wait for a few minutes to allow the oil to reach the oil pan.
- Check the level again.

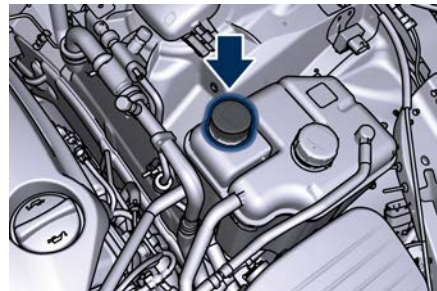

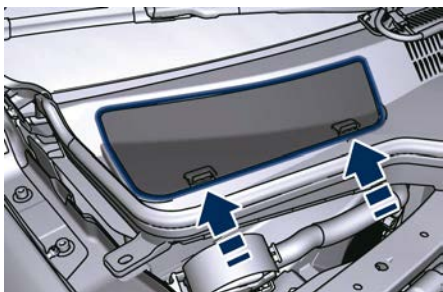

- Unsnap both ends and lift the filter retaining cover.

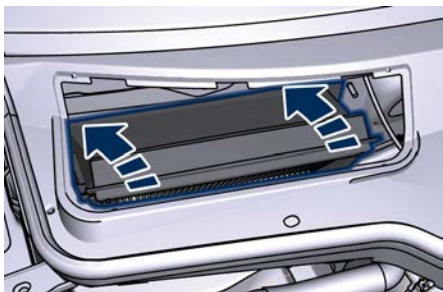

- Remove the used filter slipping it off from within the air intake.
- Install the new filter with arrows pointing in the direction of airflow, which is toward the rear of the vehicle (text and arrows on the filter will indicate this).



- Close the filter retaining cover and reinstall the access door.



CAUTION!
Failure to replace the filter may considerably reduce the air conditioning and heating system efficiency.

Wiper Maintenance and Blades Replacement

Windshield Wiper Arms Lifting

When the windshield wiper arms are in rest position it is not possible to check or replace the blades as they remain under the engine hood. To service the blades it is necessary to move the wiper arms in "Service" position (see chapter "Wiper and Washer Control" in section "Dashboard Instrument and Controls"). In this way it is possible to

lift the arms for cleaning or replacing the wiper blades.



WARNING!
It is dangerous to operate or service the wiper blades with the windshield wipers in an active position (any position different from "OFF") and with the ignition device in the RUN position. The rain sensors may suddenly activate the wipers. Always use the "Service" position for any intervention on the windshield wiper blades.

Windshield Wiper Maintenance

Life expectancy of wiper blades varies depending on the geographical area's weather conditions where the car is used and frequency of use. Poor performance of blades may be present with chattering, marks on the glass, water lines or wet spots. If any of these conditions are present, clean the wiper blades or replace if necessary. Clean the rubber edges of the wiper blades and the windshield/rear window glasses periodically with a sponge or soft cloth and a mild nonabrasive cleaner. This will remove accumulations of salt or road film. Operation of the wipers on dry



glass for long periods may cause deterioration of the wiper blades.

Always use washer fluid when using the wipers to remove salt or dirt from a dry windshield.

Avoid using the wiper blades to remove frost or ice from the windshield. Keep the blade rubber out of contact with petroleum products such as engine oil, gasoline, etc.

Spray nozzles

If the jet does not work, first check that there is fluid in the tank (see paragraph "Level checks" in this section) then check that the nozzles are not clogged.

Blades Replacement

- Move the wiper arms into "Service" position, (see chapter "Wiper and Washer Control" in section "Dashboard Instruments and Controls") and lift them.
- Press the indicated button, slip off the blade support from the arm and replace it.

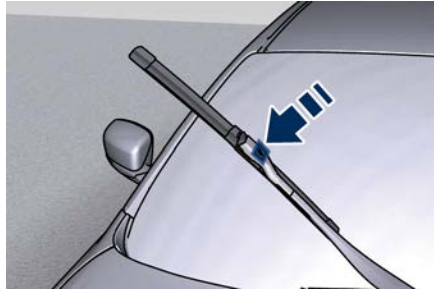

- Return the blade to its original position on the windshield.
- Turn the multifunction lever to one of the automatic settings (see chapter "Wiper and Washer Control" in section "Dashboard Instruments and Controls") and move the ignition device to the **RUN** position: the wiper arms will return to the resting position.

NOTE:

*Due to the difficulty of this operation, we recommend that you contact an **Authorized Maserati Dealer** for replacement of the blades.*

Battery Status and Maintenance

This vehicle is equipped with a sealed type maintenance-free battery. You will never have to add water, nor is periodic maintenance required.



- **Battery fluid is a corrosive acid solution and can burn or damage the eyes. Do not allow battery fluid to contact your eyes, skin, or clothing. If acid splashes in eyes or on skin, flush the area immediately with large amounts of water.**
- **Battery gas is flammable and explosive. Keep flame or sparks away from the battery. Do not use a booster battery or any other booster source with an output greater than 12 Volts. Do not allow cable clamps to touch each other.**
- **Battery posts, terminals, and related accessories contain lead and lead compounds. Wash hands after handling the battery.**
- **The battery in this vehicle has a vent hose that should not be disconnected and should only be**



replaced with a component of the same type (vented).

NOTE:

Remote battery terminals for starting are located in the engine compartment for jump-starting to be used with an auxiliary battery or a battery from another vehicle (see "Auxiliary Jump-Start Procedure" chapter in section "In an Emergency").

Battery State of Charge

To avoid problems with ignition and/or the electrical system in general when you are driving, the battery charge status is constantly maintained and guaranteed by the vehicle's recharge circuit; the main component of which is the alternator. This circuit is only able to supply voltage to the battery when the vehicle is traveling.

The warning light  on the instrument cluster, will indicate any malfunctions in the recharge circuit or an insufficient battery charge status (example in figure).



The vehicle contains advanced electronic systems, such as, for example, the alarm system and various electronic control modules, which consume power even when the ignition device is in the OFF position and the vehicle is not being used.

Therefore, it is fundamental that the battery is properly charged to ensure that the engine starts properly and that all the electrical/electronic systems in the vehicle work efficiently.

To Disconnect the Battery

The battery is located on the inner right side of the trunk compartment. To access the battery it is necessary to lift the ground coverage of the trunk compartment and remove the access cover turning the release latch shown.

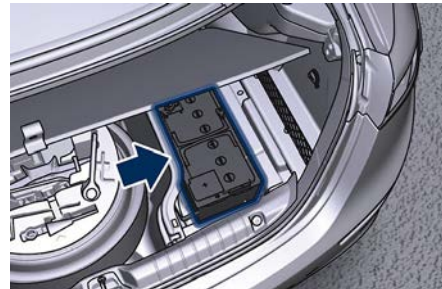
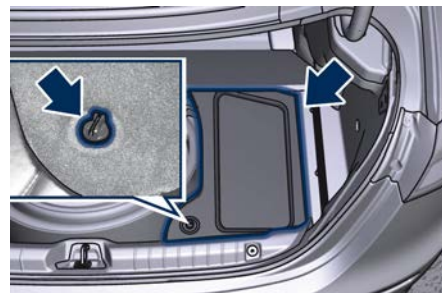

CAUTION!

- Before disconnecting the battery, open the trunk and lower the windows a few centimeters, to avoid damaging the seal and the glass when opening and closing the door. When the battery is connected, the lowering of the window is performed automatically when the door is opened and closed. The trunk lid



must remain open and the windows lowered until the charged battery is reconnected.

- Never disconnect the battery from the electrical system when the engine is running.
- To temporarily disconnect the vehicle electrical system from the battery, simply remove the cable end with quick coupling from the negative post (-) of the battery.
- If the battery needs to be removed from its compartment, you must first detach the terminal clamp to the negative post (-) and then the other terminal clamp to the positive post (+), after removing the protective cover. Battery posts are marked positive (+) and negative (-) and are identified on the battery case.

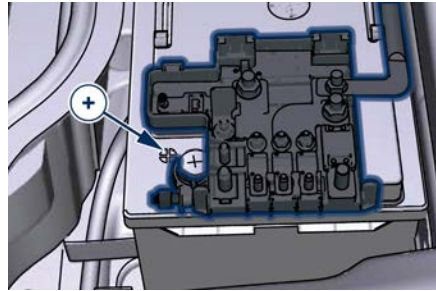
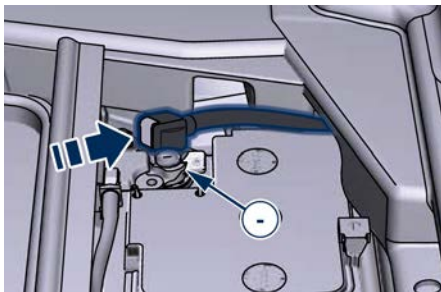

To Reconnect the Battery

NOTE:

When the battery cables have been disconnected and the trunk lid has been locked, it is necessary to pull the emergency release lever in order to re-open it. To access the trunk and operate the emergency release fold the rear seatback (see "Cargo Area" chapter in section "Understanding the Vehicle").



CAUTION!

- It is essential when replacing the cables on the battery that the positive cable is attached to the positive post (+) and the negative cable is attached to the negative post (-).

- Cable clamps should be tight on the terminal posts and free of corrosion.

After the battery has been disconnected and re-connected and before starting the engine it is necessary to proceed as follows:

- Unlock and lock the doors using one more time the Key fob.
- Close manually the liftgate unlock it lid with the key fob and then lock it manually on more time. If the vehicle is equipped with power liftgate, manually perform the complete closure. Then move the lid automatically, using the buttons on the outer edge of the left trunk, performing a complete cycle of opening and closing. If the limit of the power liftgate opening has been set, it is necessary to reset it (see "Trunk Lid Operation" in section "Before Starting").
- Initialize the climate control system by activating the system and pressing the "AUTO" control as described in chapter "Air Conditioning Controls" in section "Dashboard Instruments and Controls".
- Turn on the MIA and set the date and time (see "TFT Display Setting and Menu Overview" in section



"Dashboard Instruments and Controls").

- Lift, release and lift again the lever on the central console to initialize the electric parking brake. Following this operation the (P)! warning light on the instrument cluster will turn off.
- For correct activation of the approach lights on the external mirrors, press at least once the tilt button on the driver's door panel so that the door mode recognizes the mirrors position.
- Start the engine and re-calibrate the EPS by steering fully to the left and then to the right; the EPS failure warning light and message should disappear on the TFT display.



CAUTION!

- Every time the battery is reconnected, wait at least 30 seconds with the ignition device turned to **RUN** before starting the engine, in order to allow the electronic system that manages the motor-driven throttles to run a self-learning cycle. At the same time, you can run the date and time set up procedure for the MIA.

- Every time the battery is reconnected the warning light **BRAKE** (on vehicles of United States market) or (P)! (on vehicles of Canadian market) and (P)! flash for about 10 seconds and then go off.

Useful Advice to Extend Battery Life

When parking the vehicle, make sure that the doors, front, rear lids and flaps are properly closed. All interior lights should be off.

When the engine is turned off, do not keep the connected devices switched on for a long time (such as radio, hazard warning flashers, fan, etc.).



CAUTION!

If the battery charge remains below 50% for a long period of time, it will be damaged due to sulfation; its performance and starting power will be reduced and it will be more subject to freezing.

We recommend you to have the battery charge condition checked, preferably at the beginning of the cold season, to prevent the electrolyte from freezing.

This check should be carried out more frequently if the vehicle is used mainly

for short trips or if it is equipped with power-absorbing devices that remain permanently on even when the ignition switch is off. This applies above all if these devices have been retrofitted ("Aftermarket" services). If the vehicle is not used for long periods of time, please see "Vehicle Stored for Long Periods" in this section.

Battery Recharge



WARNING!

The process of charging or recharging the battery produces hydrogen, a flammable gas that can explode and cause serious injuries. When charging or recharging the battery, follow the recommended precautions at all times.

- Before using a charger device always check that this tool is suitable for the installed battery, with constant voltage (lower than 14.0 V) and low amperage (maximum limit 15 A).
- Recharge the battery in a well-ventilated environment.
- Never charge or recharge a frozen battery.
- Ensure that any sparks or open flames are kept well away from the battery while it is charging.



- Before using a charger to charge or maintain the battery charge status, carefully follow the instructions provided to ensure the charger is connected to the battery safely and correctly.

It is possible to recharge the battery without disconnecting the cables of the vehicle electrical system.

- To access the battery lift the ground coverage of the boot compartment and remove the battery access cover (see paragraph "To Disconnect the Battery" in this chapter).
- Remove the protection cover and connect the terminal clamp of the charger positive cable (typically in red) to the positive post (+) of the battery.
- Connect the terminal clamp of the charger negative cable (typically in black) to the nut located by the negative post (-) on the battery, indicated in the picture.

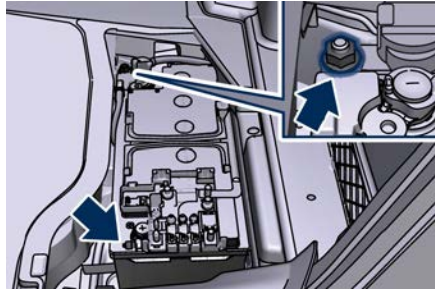

The vehicle is equipped with an IBS (Intelligent Battery Sensor) sensor able to measure charging and discharging currents and to calculate the state of charge and state of health of the battery. This sensor is located at the negative post (-) of the battery.

For a successful charge/recharge operation, the charging current must flow through the IBS sensor as shown in the picture.

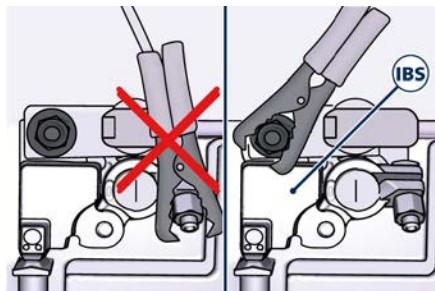

- Turn the charger on and follow the instructions on its user manual to completely recharge the battery.
- When the battery is recharged, turn off the battery charger before disconnecting it from the battery.
- Disconnect first the terminal clamp of the charger black cable from the battery and then the terminal clamp of the red cable.
- Reassemble the protection cover on the battery positive post and the other parts removed for this operation.

Maintaining Battery Charge

If you perform short daily trips (approximately 10 miles/16 km), which correspond to an annual total of 4000 miles/6000 km, or when the vehicle is not going to be used for one week or more, Maserati recommends connecting the vehicle to a battery charger, to save you the trouble of having to recharge the battery. The battery charger will keep the battery charged properly and at the correct voltage levels required by the systems and devices in the vehicle.

Before using and/or connecting the battery charger, carefully follow the instructions provided.



If you do not use a battery charger to prevent the battery from going dead when you are not going to use the vehicle for long periods of time, you need to check and recharge the battery at least once every three weeks. Make this check if you perform short daily trips (approximately 10 miles/16 km) which correspond to an annual total of 4000 miles/6000 km. Please note that allowing the battery to go dead repeatedly can cause premature wear on the internal cells and greatly reduce their life, leading to problems with the ignition system and other electrical/electronic systems. The **Authorized Maserati Dealer** is available to advise you on how to recharge your battery correctly and give you useful information on battery care and maintenance.

NOTE:

*The **Authorized Maserati Dealer** can provide you with any information about the Maserati approved "Battery Charger and Conditioner", available in the "Genuine Accessories" range.*



WARNING!

The process of charging or recharging the battery produces hydrogen, a dangerous gas that can explode and cause serious injuries. When charging or recharging the battery, follow the recommended precautions at all times:

- **always charge or recharge the battery in a well-ventilated environment;**
- **never charge or recharge a battery that has frozen;**
- **ensure that any sparks or open flames are nowhere near the battery while it is charging;**
- **before using a charger to charge or maintain the battery charge status, carefully follow the instructions provided to ensure the charger is connected to the battery safely and correctly.**

A/C System Maintenance

For the best performance, the air conditioning system should be checked and serviced by an **Authorized Maserati Dealer** at the beginning of the warm season.

This service should include cleaning of the condenser, check of the drive belt tension and a performance test.

During the winter, the air conditioning system should be operated at least once a month for about 10 minutes.



CAUTION!

Do not use chemical flushes in your air conditioning system as the chemicals can damage your air conditioning components. Such damage is not covered by the New Vehicle Limited Warranty.



WARNING!

- **Use only refrigerants and compressor lubricants approved by the manufacturer for your air conditioning system. Some unapproved refrigerants are flammable and can explode, causing injuries. Other unapproved refrigerants or lubricants can cause**



the system to fail, requiring costly repairs.

- The air conditioning system contains refrigerant under high pressure. To avoid risk of personal injury or damage to the system, adding refrigerant or any repair requiring lines to be disconnected should be done by an Authorized Maserati Dealer.

Periodically remove any leaves and insects that may build up and obstruct the inlet of external air in the air conditioning system through the grille present underneath the rear part of the hood.

To access the grille, lift the hood as described in "Hood Operation" in section "Before Starting".

Wheels Maintenance

Tires Maintenance



CAUTION!

- To obtain the best performances and the longest mileage from the tires, take the following precautions during the first 310 mi (500 km):
- do not drive at the vehicle's maximum speed;
- drive at low speed on curves;
- avoid sudden steering;
- avoid sudden braking;
- avoid sudden acceleration;
- do not drive at high speeds for too long.

The tires inflation pressure must correspond to the prescribed values ( : chapter: "Tire Inflation Pressure" in section "Technical Specifications") and should be checked only when the tires have cooled down. In fact, the pressure increases as the tire temperature progressively increases.

Never reduce the pressure if tires are hot ( : "Tires Information" chapter in section "Safety").

Insufficient tire inflating pressure can cause tire overheating and possible internal damage.



CAUTION!

After inspecting or adjusting the tire pressure, always reinstall the valve stem cap. This will prevent moisture and dirt from entering the valve stem, which could damage it.

Impacts with curbs, holes, and obstacles in the road, and prolonged trips on rough roads can cause tire damage which may not be visible to the naked eye.

Check your tires regularly for any signs of damage (e.g. scratches, cuts, cracks, bulges, etc.). If sharp objects penetrate the tires, they can cause structural damage which is only visible when the tire is removed.

In any case, any possible damage must be inspected by an experienced technician, as it may seriously reduce the tire life.

Remember that tires deteriorate with time, even if used little or not at all. Cracks in the tire tread and sides, alongside possible bulging, are a sign of deterioration.



WARNING!

- Check the inflating pressure of the tires when cold, at least every two weeks and before long trips.
- Have old tires inspected by an experienced technician, to make sure they can still be used safely. If the same tire has been on your vehicle for 4 or 5 years, have it inspected anyway by an experienced technician.
- Never fit tires of uncertain origin.
- “Directional” tires have an arrow on their side showing the rolling direction. To keep the best performance when replacing a tire, make sure that the rolling direction corresponds to the one shown by the arrow.
- During the tire life, the rolling direction used for the first fitting should always be observed, also in case of “nondirectional” tires.
- Check the depth of the tire tread at regular intervals. The minimum allowed value is 0.06 in (1.6 mm) or 0.6 in (4 mm) for winter, all-season and snow tires, at that point the wear indicators on the tire will be visible ( : chapter “Tires

Information” in section “Safety”). The thinner is the tread, the greater is the risk of skidding.

- Drive carefully on wet roads to decrease the risk of aquaplaning.

Winter Tires

These tires are specially designed for driving on snow and ice and are fitted to replace the ones supplied with the vehicle.

The specific functions of the winter tires lead to lower performance under normal environmental conditions or on long highway trips, compared to the standard tires.

Therefore, their use should be limited to the situations and performance for which they have been type-approved. The **Authorized Maserati Dealer** can provide all necessary information about fitting winter tires on the vehicle.

NOTE:

- *We recommend fitting winter tires on the vehicle at temperatures below 45 °F (7 °C) since the driving performance of summer tires is reduced at low temperatures. Summer tires may be permanently damaged at extremely low temperatures.*

- *Comply with all state and local laws governing snow tire and tread depth requirements.*

Wheel Rims Maintenance

All wheel trims should be cleaned regularly with a mild soap and water.

To remove heavy soil and/or excessive brake dust, use a nonabrasive, non-acidic cleaner.

Do not use scouring pads, steel wool, a bristle brush, or metal polishes.

Do not use oven cleaner that may affect and damage the brake calipers. Avoid automatic car washes that use acidic solutions or harsh brushes that may damage the wheel rim protective finish.



Bodywork Maintenance and Care

Protection from Atmospheric Agents

The main causes of corrosion are:

- atmospheric pollution;
- salinity and humidity in the atmosphere (marine areas or a damp climate);
- seasonal environmental conditions;
- salt scattered on the roadbed to melt ice and snow.

The abrasive action of wind-carried atmospheric dust and sand, mud and stones should not be underestimated.

On this vehicle, Maserati has adopted the best technological solutions to protect the bodywork from corrosion.

The main measures are:

- paint products and systems that give the vehicle particular resistance to corrosion and abrasion;
- use of galvanized (or pre-treated) metal sheets which are highly resistant to corrosion in the most exposed parts;
- spraying of the underbody, engine compartment, insides of wheel housings, and other structures with wax products having high protective power;

- spraying of plastic materials, with a protective function, in the most exposed points: underneath the doors, inside part of the mud guards, edges, etc.;
- use of ventilated box sections, coated with protective wax products, to avoid condensation and trapped water which could encourage the formation of internal rust.

Useful Advice to Keep the Bodywork in Good Condition Paint

The paintwork does not only have an aesthetic function but also protects the underlying metal sheets. In the event of abrasions or deep scratches, we recommend to have the necessary touch-ups made immediately, to avoid any rust formation. Touch-ups do not feature particular difficulties, even on metallic and matte finishes.

For all paint touch-ups, use only original products indicated on the plate applied on the lower left side of the hood.

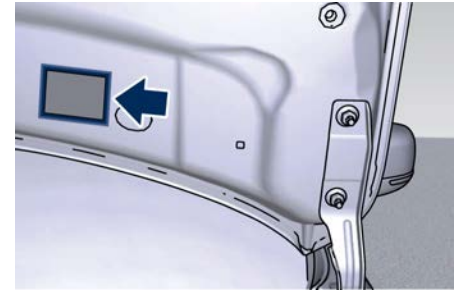

Normal paint maintenance consists in washing, the frequency of which depends on the conditions of use and of the environment. For example, if driving the vehicle in areas where there is high atmospheric pollution or the roads are spread with anti-freeze salt, it is advisable to wash the vehicle more frequently.



ENVIRONMENTAL!

Detergents pollute water. Therefore the vehicle should be washed in areas equipped for the collection and purification of the fluids used for washing.

NOTE:

The use of alcohol-based products for cleaning the metal surfaces in the engine compartment and/or the trunk may deteriorate the protective paint.

(Continued)



(Continued)

It is recommended to use water-based products.

Car Wash

For correct washing:

- wet the bodywork with a low pressure water jet;
- pass a sponge with a light detergent solution over the bodywork, frequently rinsing the sponge;
- rinse well with water and dry with an air jet or chamois leather.

When drying, take particular care with the parts that are less visible, such as the door and lids bays, headlight edges, in which water can be trapped more easily.

You are recommended not to take the vehicle immediately into an enclosed environment, but leave it in the open air so as to allow the water to evaporate.

Do not wash the vehicle after it has been left in the sun or when the hood is hot: the paint gloss could be affected.

External plastic parts must be cleaned with the same procedure followed for the normal washing of the bodywork. Avoid, as far as possible, parking the vehicle under trees; the resinous substances that very often drop

from the trees give the paint a dull appearance and increase the possibility of originating corrosive processes.

It is important that the drain holes in the lower sides of the doors, rocker panels, and trunk bottom be kept clear and open.



CAUTION!

- **Bird droppings must be washed off immediately and thoroughly, since their acidity is particularly corrosive.**
- **To provide better protection for the paint, polish the vehicle at intervals with a suitable product leaving a protective film on the paint.**
- **If the vehicle is washed using high-pressure water jets or cleaners, it is important that the nozzle of the jet be kept at a distance of at least 16 in (40 cm) from the bodywork to avoid damaging it.**

Washing Vehicles with Matte Finish Paint

- It is recommended to hand wash vehicles with matte-finish paint.
- Before washing, first remove from the bodywork dust and other particles that could damage the paint. Preferably use an air pressure jet.

- When grease spots and fingerprints are present, it is recommended using a special cleaner for matte finish paint. Apply the product using a microfiber cloth. To avoid damaging the paint surface, do not use too much pressure.
- Wet the bodywork with plenty of water and clean it using a soft sponge and a neutral wax-free shampoo, starting from the top and working down. Dry the bodywork using an air pressure jet.
- Rinse all the parts of the vehicle thoroughly with plenty of water. Keep the sponge or the washing mitt in use always wet and clean.
- At last, using a different sponge or washing mitt, clean the wheels, the door sill plates and the other parts that are less visible.



CAUTION!

- **It is recommended not to wash the vehicle in direct sunlight. The little drops of water, acting as small focal lenses, could damage the paint.**
- **Always and only wash the vehicle by hand. Avoid using abrasive sponges or mitts that could damage the matte finish paint.**



- Never polish and never use polishing agents on the vehicle with matte finish paint or on parts of it.
- Hard water (over 30 °f) could leave limestone residues.

Glass Surfaces

All glass surfaces should be cleaned on a regular basis with any commercial household-type glass cleaner.

Never use an abrasive type cleaner.

Use caution when cleaning the inside rear window equipped with electric defrosters. Do not use scrapers or other sharp instrument that may scratch the elements.

When cleaning the rearview mirror, spray cleaner on the towel or rag that you are using. Do not spray cleaner directly on the mirror.

Labels can be peeled off after soaking with warm water.

When cleaning is performed, keep all metal objects at a safe distance from the window.

Cleaning Headlights

Your vehicle has plastic headlights that are lighter and less susceptible to stone breakage than glass headlights.

Plastic is not as scratch-resistant as glass and therefore different lens cleaning procedures must be followed.

To minimize the possibility of scratching the lenses and reducing light output, avoid wiping with a dry cloth. To remove road dirt, wash with a mild soap solution followed by rinsing.

Do not use abrasive cleaning components, solvents, steel wool or other aggressive material to clean the lenses.

Condensation and Fogging on the Light Clusters

With cold or humid climates, after a driving rain or after cleaning the car, the surface of the front and rear light clusters could fog and/or form condensate drops on the inside. This is a natural phenomenon due to the temperature and humidity differences between the lens internal and external surface, which nevertheless does not indicate a fault and does not compromise the regular operation of the lights. The fogging/condensate disappears when switching on the lights, starting from the centre of the diffuser and gradually going to the edges.

Moldings and Aluminum Trims

- For cleaning moldings and aluminum trims, avoid the use of acidic or alkaline cleaning agents that can

destroy the protecting surface treatment.

- After washing aluminum trim with warm water, apply the cleaning agent with a clean tissue or a soft sponge on the surface. Do not use any other equipment such as brushes, steel wool, abrasives or any other equipment for cleaning.
- After cleaning, please rinse the aluminum trim with a lot of clear water.
- While cleaning in the car, please make sure that the moldings and aluminum trims only get in contact with soft brushes or textiles.

Engine Compartment

At the end of each winter season, carefully wash the engine compartment, remembering to avoid directing the jet of water for too long on the electric parts.

To perform this operation, you must contact an **Authorized Maserati Dealer**.

Pre-Short Drop Function

When in a car wash, if the driver keeps the key fob in his/her pocket, or in any place outside the vehicle within 3.3 ft (1 m) distance, the front windows will perform a pre-short drop. This is a shorter drop compared to the normal



short drop performed by the "Passive Entry" function when you grab the door handle to enter the vehicle.

In order to prevent water from entering the vehicle between the upper edge of the glass window and the door outline on the bodywork, while the car is being washed, it is advisable to disable the "Passive Entry" from the MIA system, for further information refer to chapter "Functions of Settings Menu on MIA" in section "Dashboard Instruments and controls". When deactivating the "Passive Entry", also the "Pre-Short Drop" function will be disabled.

Interior Maintenance and Care

Interior trim should be cleaned starting with a damp cloth. Do not use harsh cleaners.

The leather upholstery can be best preserved by regular cleaning with a damp soft cloth. Small particles of dirt can act as an abrasive and damage the leather upholstery and should be removed promptly with a damp cloth. Stubborn soils stains can be removed easily with a soft cloth and appropriate products. Avoid soaking the leather upholstery with any liquid.

Please do not use polishes, oils, cleaning fluids, solvents, detergents, or ammonia-based cleaners to clean your leather upholstery.

Application of a leather conditioner is not required to maintain the original condition.

Check at regular intervals that there is no water trapped under the mats (due to drips off shoes, umbrellas etc.) which may cause the metal parts to oxidize.



CAUTION!

Do not use alcohol, petrol or solvents to clean the instrument cluster's transparent dome, the MIA display, the analogue clock and the leather upholstery. We recommended the use of "Car Care" products approved by Maserati for the maintenance and care of the interior.

Leather Upholstery Treatment

Have the leather upholstery only treated, as provided in the Scheduled Service Plan, by an **Authorized Maserati Dealer** which has the required specific products.

Parts in Premium Quality Wood

Remove any dirt with a damp cloth.

NOTE:

*The **Authorized Maserati Dealer** can provide you with any information about the Maserati approved "Car Care" products, available in the "Genuine Accessories" range.*

Maserati Intelligent Assistant Touch Screen

- Do NOT attach any object to the touch screen, doing so can result in damage to the touch screen.



- Do not touch the screen with any hard or sharp objects (pen, USB stick, jewelry, etc.) which could scratch the touch screen surface.
- Do not spray any liquid or caustic chemicals directly on the screen! Use a clean and dry micro fiber lens cleaning cloth in order to clean the touch screen. If necessary, use a lint-free cloth dampened with a cleaning solution, such as isopropyl alcohol, or an isopropyl alcohol and water solution ratio of 50:50. Be sure to follow the solvent manufacturer's precautions and directions.

Car Cleaning and Sanitizing

According to what is prescribed by the health authorities in each country, after using the car it is necessary to clean all surfaces that may have been touched by other people (example: steering wheel, transmission lever, air vents, seat belts, keys, handles, etc.).

To carry out this operation safely and correctly, trying to avoid possible damage to the internal surfaces of the car, here are some useful tips:

- perform the operation if possible outdoors or in any case in a sufficiently ventilated area;

- wear all personal safety devices: gloves, mask and goggles using new or sanitized devices;
- clean the surfaces with a microfibre cloth moistened with an alcoholic sanitizing solution, avoiding to apply or spray said solution directly on the surface. The use of hydrogen peroxide, bleach and amuchin is not recommended as they can develop too aggressive action on leather and plastic;
- check the air conditioning filter and sanitize the vents that circulate the air in the passenger compartment;
- vacuum the dust from the upholstery and the mats, or wash them with the appropriate detergent products.

A good habit to take, is to always have clean hands, both before and after driving, as it will help to keep the steering wheel and other surfaces more frequently touched inside cleaner car.

Vehicle Stored for Long Periods

If the vehicle is going to be stored for long periods of time, follow the below precautions:

- Wash and dry the vehicle thoroughly.
- Store the vehicle on a level surface in a covered, dry and, if possible, ventilated area.
- Select P (Park) and turn off the engine.
- Disconnect the battery or connect a battery charger (refer to paragraph "Maintaining Battery Charge" of chapter "Battery Status and Maintenance" in this section).
- Check the battery charge status. During parking, this check must be carried out every three weeks. Recharge the battery if the open circuit voltage is lower than 12.2 V.
- Check that the parking brake is NOT engaged.
- Do not empty the engine cooling system.
- Clean and protect the painted parts applying protective wax.
- Clean and protect polished metal parts with special products available on the market.
- Cover the vehicle with a long cloth in breathable fabric (available from



an **Authorized Maserati Dealer**). Do not use thick plastic sheets, which do not allow the humidity on the vehicle surface to evaporate.

- Inflate the tires up to a pressure which must be 14.5 psi (1 bar) higher than the normally prescribed one, and check it at regular intervals.

NOTE:

*The **Authorized Maserati Dealer** can provide you with any information about the available "Indoor and Outdoor Car Covers", available in the "Genuine Accessories" range.*



WARNING!

The tire pressure must be brought back to the prescribed value before reusing the vehicle ( : chapter "Tire Inflation Pressure" in section "Technical Specifications").

Restarting the Vehicle after a Long Inactivity

Before restarting the vehicle after a long period of inactivity, we recommend that you carry out the following operations.

- Check the tires for pressure and for any damages, cuts or cracks. If this is the case, have them replaced.
- Do not dry-rub the external surface of the vehicle: use a damp cloth.
- Visually inspect if there are any fluid leaks (oil, brake and clutch fluid, engine coolant etc.).
- Have the engine oil and filter replaced.
- Check the fluid levels in the brake system, as well as the engine coolant level.
- Check the air filters and have them replaced if necessary.
- Reconnect the battery after checking the charge status (refer to "Battery Status and Maintenance" in this section) and perform the initializing procedure if applicable.
- With the transmission in N (Neutral), let the engine idle for several minutes.



WARNING!

The engine idle must be performed outdoors. Exhaust gases contain carbon monoxide which is strongly toxic and potentially lethal.



Refillings Table

NOTE:

Maserati reserves the right to change or revise specifications without prior notification.



CAUTION!

To guarantee vehicle's integrity and maintain performance level always use genuine parts approved and recommended by Maserati.

Refillings and Recommended Products

| Parts to be refilled | Quantity | Product Specifications |
|--|--|---|
| Fuel tank | 21 Gallons/80 litres (including 4.2 Gallons/16 litres of reserve) | Premium unleaded fuel with no less than 91 CLC or AKI (95 RON/85 MON). |
| Engine (3.8 V8): oil capacity including filter cartridge | 8.8 Quarts/8.3 litres (max) (MIN and MAX difference: 1.5 Quarts/1.4 litre) | Synthetic multigrade lubricants SAE 5W-40 that meet API SL/CF and ACEA A3, B3, B4 specifications. Recommended oil: PENNZOIL Platinum Maserati 5W-40 (1) . |
| Engine (3.0 V6): oil capacity including filter cartridge | 7.7 Quarts/7.3 litres (max) (MIN and MAX difference: 1.1 Quarts/1 litre) | Synthetic multigrade lubricants SAE 10W-60 that meet API SN/CF and ACEA A3, B3, B4 specifications. Recommended oil: PENNZOIL Platinum Maserati 10W-60 (2) . |
| Engine (3.0 V6 - AWD version): oil capacity including filter cartridge | 8.8 Quarts/8.3 litres (max) (MIN and MAX difference: 1.1 Quarts/1 litre) | |
| Windshield washer fluid tank | 3.7 Quarts/3.5 litres | Mix of water and detergent fluid, in the proportions indicated on the product package. If the temperature is below -4°F (-20°C), use pure detergent fluid. Detergent fluid: Mix of CUNA NC 956-II surfactants and alcohols. Recommended fluid: WUERTH Windshield Washer Fluid with antifreeze or AREXONS DP1. |



| Parts to be refilled | Quantity | Product Specifications |
|--|------------------------------------|---|
| Engine cooling circuit (3.8 V8) | 15.11 Quarts/14.3 litres | Mixture of water and coolant, proportionally 50/50%. Coolant: protective, antifreeze action and ethylene glycol-based with organic inhibitors compatible with regulations: <ul style="list-style-type: none"> • ASTM D 3306, ASTM D 2570 • ASTM D 4340, ASTM D 2809 • SAE J 1034 • CUNA NC 956/16. Recommended fluid: PETRONAS Paraflu UP (1681). |
| Engine cooling circuit (3.0 V6) | 9.7 Quarts/9.2 litres | |
| Automatic transmission cooling circuit | 2.64 Quarts/2.5 litres | |
| (3) Automatic transmission | 8 Quarts/7.6 litres | First equipment oil: SHELL ATF L- 12108 or ZF Lifeguard 8 |
| (3) Differential | 1.4 Quarts/1.3 litres | Synthetic Axle Lubricant SAE 75W-90 – FE Hypoid Gear Lubricant. |
| (3) Front differential (3.0 V6 - AWD version) | 0.47 Quarts/0.45 litres | First equipment oil: SHELL TF 0951B. |
| (3) Transfer case (3.0 V6 - AWD version) | 0.65 Quarts/0.62 litres | First equipment oil: SHELL TF 0870. |
| Braking system | 0.93 Quarts/0.88 litres +/- 4% | Synthetic fluid: FMVSS 116 DOT 4, ISO 4925 Class 4, ENSAYOS INTA-UNE 26-109-88, SAE J1703, SAE J1704, CUNA NC 956-01. Recommended fluid: PETRONAS Tutela TOP 4/S.  CAUTION! To guarantee vehicle's integrity and maintain performance level always use genuine parts approved and recommended by Maserati. |
| Air conditioning system | 21.9 oz +/-0.7 oz 620 g +/-20 g | Coolant: r1234yf. |
| | 6.08 oz / 180 ml | First equipment oil: Daphne Hermetic Oil PS-D1 (3) . |



| Parts to be refilled | Quantity | Product Specifications |
|--|----------|------------------------|
| <p>(1) In countries where it is not available, recommended oil "PENNZOIL Platinum 5W-40".</p> <p>(2) In countries where it is not available, recommended oil "PENNZOIL Platinum 10W-60".</p> <p>(3) No change and/or topping up expected in scheduled maintenance.</p> | | |

Engine Oil Identification Symbol



This symbol means that the oil has been certified by the American Petroleum Institute (API). Maserati only recommends API Certified engine oils.



CAUTION!

Do not use chemical flushes in your engine oil as the chemicals can damage your engine. Damage caused by use of non-approved chemicals is not covered by the new Vehicle Limited Warranty.

Engine Oil Viscosity (SAE Grade)

SAE 5W-40 (for V8 engine) and SAE 10W-60 (for V6 engine) engine oil is recommended for all operating temperatures. The engine oil filler cap also shows the recommended engine oil viscosity for your engine. For information on engine oil filler cap location, see chapter "Maintenance Procedures" in section "Maintenance and Care".

Lubricants that do not have both the engine oil certification mark and the correct SAE viscosity grade number should not be used.





Index

| | | | | | |
|---|-----|--|-----|--|-----|
| A bbreviations | 8 | Changing Speed Setting | 209 | Air Conditioning Distribution | 48 |
| Active Blind Spot Assist - ABSA | 228 | Conditions for Disabling and | | Adjustable Air Vents | 49 |
| ABSA Setting | 229 | Deactivation | 210 | Fixed Air Vents | 49 |
| Radar Device - Regulatory | | Display Warnings and | | Air Conditioning System | |
| Information | 231 | Maintenance of ACC and FCW | | Maintenance | 282 |
| RCP - Rear Cross Path | | Systems | 212 | All-Wheel Drive | 162 |
| Operation | 231 | Displayed information | 207 | Analog Clock | 131 |
| Speed Range of Use | 229 | Driver Override | 209 | Audio System | 39 |
| System Availability | 228 | Overtake Aid | 212 | Basic System | 39 |
| System Fault | 231 | Precautions while Driving with | | High Premium System | 40 |
| System Limitation | 229 | ACC | 214 | Premium System | 40 |
| System Monitoring on TFT | | Radar Device - Regulatory | | Automatic Start&Stop System | 150 |
| Display | 230 | Information | 215 | Automatic Restarting of the | |
| System Temporarily | | Resuming Speed | 210 | Engine | 151 |
| Unavailable | 231 | Setting the Speed | 209 | Occupant Safety Function | 151 |
| Active Driving Assist - ADA | 232 | Setting the Time Gap | 210 | Start&Stop Deactivated | 150 |
| Hands Detection on Steering | | Speed Range of Use | 208 | Start&Stop Function Disabling | |
| Wheel | 234 | System Controls and Activation | | Indicator | 152 |
| Monitoring on TFT Display | 233 | Conditions | 207 | Start&Stop Not Active | 151 |
| Radar Device - Regulatory | | System Operation Before and | | Start&Stop System Failure | 153 |
| Information | 236 | During Stop | 212 | Automatic Transmission | 153 |
| Speed Range of Use | 233 | Temporary Deactivation | 210 | Automatic Transmission | |
| System Cancellation | 235 | Warning and Cautions | 206 | Lever | 154 |
| System Disengage | 235 | Adaptive Cruise Control -ACC | 206 | Automatic Transmission | |
| System Limitations | 236 | Adjustable Pedals (OPT) | 23 | Range | 157 |
| System Operation | 233 | Air Conditioning Controls | 135 | Service Shift Lever | 157 |
| System Statuses | 234 | A/C Filter | 143 | Transmission Malfunction and | |
| Active Driving Assist – ADA | | Automatic Temperature | | Overheating Conditions | 161 |
| System in Faulty | 236 | Control (ATC) | 141 | Auxiliary Jump-Start Procedure | 257 |
| Adaptive Cruise Control – ACC | | Climate Control Functions | 140 | Battery Remote Posts | |
| Activation/Deactivation | 208 | Climate Controls | 135 | Position | 257 |
| | | Operating Tips | 142 | Jump-Start Procedure | 258 |



| | | | | | |
|--|-----|----------------------------------|-----|---|-----|
| B attery Status and Maintenance | 277 | Vehicle Loading | 41 | Bi-Xenon Headlight | 28 |
| Battery Recharge | 280 | Consulting the Manual | 7 | External Lights Equipment | 27 |
| Battery State of Charge | 278 | Controls on Steering Wheel | 116 | Full-LED Headlight with | |
| Maintaining Battery | | Audio System Controls | 119 | Cornering Function | 28 |
| Charge | 281 | Phone and Voice Controls | 117 | F orward Collision Warning - FCW | 215 |
| To Disconnect the Battery | 278 | Cruise Control - CC | 203 | Pedestrian Emergency Braking | |
| To Reconnect the Battery | 279 | Activation | 204 | (PEB) System | 216 |
| Useful Advice to Extend | | Changing Speed Setting | 205 | System Configuration | 218 |
| Battery Life | 280 | Controls | 203 | Forward Collision Warning – FCW | |
| Blind Spot Assist - BSA | | Displayed Information | 204 | Limited Operation and Service | |
| System Monitoring on TFT | | Driver Override | 205 | Warning | 218 |
| Display | 225 | Resume Speed | 205 | Radar Device - Regulatory | |
| Blind Spot Assist (BSA, without | | Setting Desired Speed | 204 | Information | 219 |
| ACC) | 223 | Speed Range of Use | 204 | Speed Range of Use | 217 |
| Blind Spot Assist (without ACC) | | Temporary Deactivation | 205 | System Operation | 216 |
| BSA and RCP Setting | 226 | Using Cruise Control on | | System Status | 217 |
| Radar Device - Regulatory | | Hills | 205 | Front Power Seats | |
| Information | 227 | D rive Mode | 163 | Front Heated Seats | 16 |
| RCP - Rear Cross Path | 226 | Controls Preview | 163 | Front Power Seat Controls | 15 |
| System Operation | 223 | Setting the Drive Mode | 164 | Front Power Seats | 15 |
| Bodywork Maintenance and Care | 285 | Driving Conditions | 188 | Front Ventilated Seats | 17 |
| Pre-Short Drop Function | 287 | Before the Trip | 188 | Functions of Controls Menu on | |
| Protection from Atmospheric | | Safe Driving | 188 | MIA | 105 |
| Agents | 285 | Sections | 190 | Functions of Settings Menu on | |
| Useful Advice to Keep | | E mergency Release of the | | MIA | 106 |
| the Bodywork in Good | | Parking Brake | 255 | Audio | 113 |
| Condition | 285 | Entry/Exit, lights on | 54 | Camera | 111 |
| C argo Area | 41 | Example to modify the "Speed | | Clock & Date | 109 |
| Loading with Rear Seatbacks | | Warning" status | 88 | Display | 107 |
| Folded Down | 42 | External Lighting | 27 | Doors & Locks | 112 |
| Vehicle Load Carrying | | Automatic High Beam | 29 | Geolocation | 115 |
| Capacity | 41 | | | Key Off Options | 113 |



| | | | | | |
|---|----------|---|-----|--------------------------------------|-----|
| Lights | 111 | I f a Fuse Blows | 249 | Parts in Premium Quality | |
| Mirrors & Wipers | 111 | Fuse Box under the | | Wood | 288 |
| Notification | 114 | Dashboard | 254 | Internal Equipment | 32 |
| Phone/Bluetooth | 110 | Integrated Power Module | 250 | Cupholders | 33 |
| Reset | 115 | Position of Fuses | 249 | Electric Power Outlets | 32 |
| Safety & Driving Assistant | 108 | Rear Power Distribution | | Handholds and Cloth Hooks | 38 |
| Seat & Comfort | 113 | Center | 251 | iPad Holder | 39 |
| SiriusXM Setup | 115 | Used Fuses Characteristics | 249 | iPod® Connection | 37 |
| Software Updates | 115 | Illuminated Entry/Exit | 54 | Map Pockets | 38 |
| System Information | 115 | Light Dimmer Controls | 57 | Multimedia Port and Wireless | |
| Voice | 110 | Vehicle Lighting with | | Charger Compartment | 35 |
| Functions of Settings on MIA | | Open/Closed Doors | 56 | Removable Ashtray and | |
| Navigation | 111 | In case of a Punctured Tire | 244 | Lighter | 38 |
| G love Box Compartment | 132 | Using the Compact Spare | | Sun Visors | 37 |
| Glove Box Driver Side | 132 | Wheel | 244 | Wi-Fi Hotspot (📶) | 39 |
| Glove Box Passenger Side | 132 | In Case of External Lights Fault | | Key Fob Requiring and setting | |
| Privacy Lock Functions | 133 | Signal | 255 | Additional Key Fobs | 58 |
| H azard Warning Flashers | 240 | In the Event of an Accident | 241 | Keys | 52 |
| HomeLink® | 44 to 45 | In case of Injured Persons | 241 | Key fob | 53 |
| Before You Start Programming | | Instrument Cluster | | Keyless Ignition Device | 52 |
| HomeLink® | 44 | TFT Display: Menus and | | Shift Ignition Device to OFF | |
| Radio Frequency Transmitter - | | Settings | 79 | Alert | 53 |
| Regulatory Information | 47 | Instrument Cluster Overview | 78 | L ane Keeping Assist - LKA | |
| Security | 47 | Interior Lighting | 30 | Customized Settings | 219 |
| System with Devices Without | | Cargo Lights | 31 | Function Description and | |
| Rolling Code | 46 | Dome Lights | 30 | Operating Mode | 221 |
| Troubleshooting Tips | 47 | Interior Maintenance and Care | 288 | Radar Device - Regulatory | |
| Using HomeLink® | 46 | Car Cleaning and | | Information | 222 |
| Hood Operation | 74 | Sanitizing | 289 | Speed Range of Use | 219 |
| Closing | 74 | Leather Upholstery | | System Availability | 220 |
| Opening | 74 | Treatment | 288 | System in Fault | 222 |
| | | Maserati Intelligent Assistant | | | |
| | | Touch Screen | 288 | | |



| | | | | | |
|---|-----|--|-----|--|-----|
| System Limitations | 222 | Main Category Bar on MIA Display | 103 | Park Assist Warning Messages Display | 195 |
| Lane Keeping Assist-LKA | 219 | Main Status Bar on MIA Display | 103 | Service the Park Assist System | 197 |
| Launch Control Mode (TROFEO version only) | 176 | Manual Controls and Devices | 101 | Parking | 181 |
| Light Controls Multifunction Lever | 127 | Memorize the Driver's Seat Position Easy Entry/Exit Seats | 18 | Drive Away Inhibit strategy . . | 182 |
| Lights Position Lights and Daytime Running Lights (DRL) | 124 | Memory Position Recall | 19 | Parking Brake | 177 |
| Lights Controls | 120 | Memory Profiles Setting | 18 | Deactivating Automatic Operation | 179 |
| Light Switch | 120 | Pairing Remote Keyless Entry Transmitter to Seats Memory | 19 | Failure Indication | 180 |
| M ain Controls Overview | 12 | Menu Overview | 82 | Manual Engagement/ Disengagement | 178 |
| Between the Rear Seats | 14 | N ormal Starting of the Engine . . | 146 | Passive Entry System | 60 |
| On Central Console | 12 | "Panic Stop" Strategy | 148 | Manual Door Lock from Outside | 62 |
| On Dashboard | 12 | Engine Start Failure | 147 | Preventing Inadvertent Locking of the Key fob Inside the Vehicle | 61 |
| On Front Dome Console | 13 | Engine Turn Off | 147 | Radio Frequency RKE Transmitter - Regulatory Information | 63 |
| On Front Doors | 13 | O n-board Documentation Kits | 6 | Release the Lid and Enter the Trunk | 62 |
| On Rear Dome Console | 14 | O wner's Information Online | 6 | Unlock Door from the Driver Side | 60 |
| On Rear Doors | 14 | P ark Assist | 194 | Unlock Door from the Passenger Side | 60 |
| Maintenance Procedures | 271 | Cleaning the Park Assist Sensors | 198 | Power Steering Wheel Adjustment Heated Steering Wheel | 22 |
| A/C Air Filter Replacement . . . | 275 | Enabling and Disabling Park Assist | 197 | Power Sunroof with Sunshade . . | 65 |
| Engine Air Filters Replacement | 275 | Park Assist Sensors | 194 | Pinch Protect Function | 66 |
| Level Checks | 271 | Park Assist System Usage Precautions | 198 | Slide Opening Sunroof | 66 |
| Wiper Maintenance and Blades Replacement | 276 | Park Assist Volume | 198 | Sunroof Maintenance | 67 |
| Maintenance Service Components | 269 | | | | |
| Maserati Intelligent Assistant Operation | 101 | | | | |
| Customizing the Main Status and Category Bar | 104 | | | | |



| | | | | | |
|---------------------------------------|-----|--------------------------------------|-----|---|-----|
| Venting Sunroof | 66 | Refueling | 186 | S cheduled Maintenance Service | 262 |
| Power Windows | 63 | Emergency Fuel Filler Door | | Interval Running Coupons | 262 |
| Auto Down/Auto Up | | Release | 187 | Scheduled Maintenance | |
| Function | 64 | Fuel Filler Neck Access | 186 | (Service) Indicator | 262 |
| Auto-Up Function with Anti- | | Refill the Tank | 186 | Scheduled Service Plan | 263 |
| Pinch Protection | 64 | Remote Start System | 148 | Dealer Service | 267 |
| Open the Windows with Key fob | | Driver's Seat Comfort with | | Emissions Inspection and | |
| and Ignition Off | 65 | Remote Start | 150 | Maintenance Programs | 267 |
| Reset Auto-Up/Down | 64 | Engine Remote Start Abort | | Heavy-Duty Vehicle Use | 266 |
| Wind Buffeting | 65 | Message on Instrument | | Main Operations/Service | |
| Window and Sunshade Lockout | | Cluster | 149 | Coupons | 264 |
| Button | 65 | How to use Remote Start | 148 | On-Board Diagnostics | |
| R ear Parking Camera | 199 | Radio Frequency RKE | | (OBD) | 266 |
| Rear Seats | 20 | Transmitter - Regulatory | | Periodic Maintenance | 266 |
| Rear Armrest | 20 | Information | 150 | Spare Parts | 267 |
| Rear Side Heated Seats | 20 | To enter Remote Start | | SOS and Assist Call | 242 |
| Rear Window | 67 | Mode | 149 | Spare Parts | 185 |
| Power Sunshade | 67 | To exit Remote Start Mode and | | Surround View Camera System | 200 |
| Rear Window Defroster | 67 | Drive the Vehicle | 149 | System components | 200 |
| Rear-View Mirrors | 24 | To exit Remote Start | | T FT Display Pop up Messages | 80 |
| External Mirrors | 24 | Mode without Driving the | | TFT Display Setting and Menu | |
| Internal Rear-View Mirror | 26 | Vehicle | 149 | Overview | 81 |
| Refillings | | Requiring and Setting Additional Key | | TFT Display: Menu and Submenu | |
| Engine Oil Identification | | fobs | | Content | 85 |
| Symbol | 293 | Key Fob Battery | | Tool Kit | 240 |
| Engine Oil Viscosity (SAE | | Replacement | 58 | Towing a Disabled Vehicle | 259 |
| Grade) | 293 | Radio Frequency RKE | | Manual Release of | |
| Refillings Table | 291 | Transmitter - Regulatory | | Transmission with Low | |
| Refillings and Recommended | | Information | 59 | Battery | 259 |
| Products | 291 | Restarting the Vehicle after a | | Use the Tow Hook of the Tool | |
| | | Long Inactivity | 290 | Kit | 260 |
| | | | | Vehicle Towing Conditions | 259 |



| | | | |
|---|-----|--|-----|
| Traffic Sign Assist - TSA | 236 | W arning and Indicator Lights . . . | 90 |
| Traffic Sign Assist – TSA | | Warning and Indicator Lights on | |
| Customised Settings | 237 | Speedometer | 90 |
| Signs Monitoring on | | Warning and Indicator Lights on | |
| Instrument Cluster | 237 | Tachometer | 92 |
| System Limitations | 238 | Warning and Indicator Lights on | |
| Transmission Manual Release of P | | TFT Display | 95 |
| (Park) Position | 256 | Wheels Maintenance | 283 |
| Trunk Lid Operation | 68 | Tires Maintenance | 283 |
| Trunk Lid Emergency | | Wheel Rims Maintenance | 284 |
| Release | 73 | Wiper and Washer Control | 128 |
| U nlock the Vehicle with Key Fob . . . | 57 | Headlight On with Wipers . . . | 130 |
| Sound Horn when Locking the | | Rain Sensing Windshield | |
| Doors with Key fob | 58 | Wipers | 129 |
| Unlatch the Trunk Lid | 58 | Windshield Washers and | |
| Unlock the Doors, Fuel Filler | | Headlight Washer | 130 |
| Door and Trunk | 57 | Windshield Wipers | 128 |
| Updating | 9 | Wipers Blades | |
| Use of the Engine | 184 | Maintenance | 130 |
| Breaking-In | 184 | | |
| On-Board Diagnostics | | | |
| (OBD) | 185 | | |
| While Driving | 184 | | |
| Using the Brakes | 183 | | |
| Brake Overheating | 183 | | |
| Brake Pads and Brake Discs . . . | 183 | | |
| New Brake Pads and/or Brake | | | |
| Discs | 183 | | |
| V ehicle Stored for Long | | | |
| Periods | 289 | | |



Maserati S.p.A. & Maserati North America, Inc. reserve the right to make changes and/or modifications to the content and all technical information and specifications without prior notification.

Therefore, the user is not entitled to any claims based on the contents (texts, data, illustrations, explanations and regulations) in this manual, which are based on the data known at the time of going to print.

© 2020. Maserati S.p.A. All rights reserved.

Publication no. 910043011 - 2nd Edition - 06/2020

This document may not be reproduced, printed or translated, even partially, without the written consent of MASERATI S.p.A.

910043011



WWW.MASERATI.COM
MASERATI SPA · VIALE CIRO MENOTTI, 322 · I-41121 MODENA