

MAC/VAX

AppleTalk

DEC

PROFESSIONAL

SPANNING DIGITAL'S WORLD

- Graphics Terminals on The Shop Floor
- Special Anniversary Section
- Choosing A Digital Multimeter

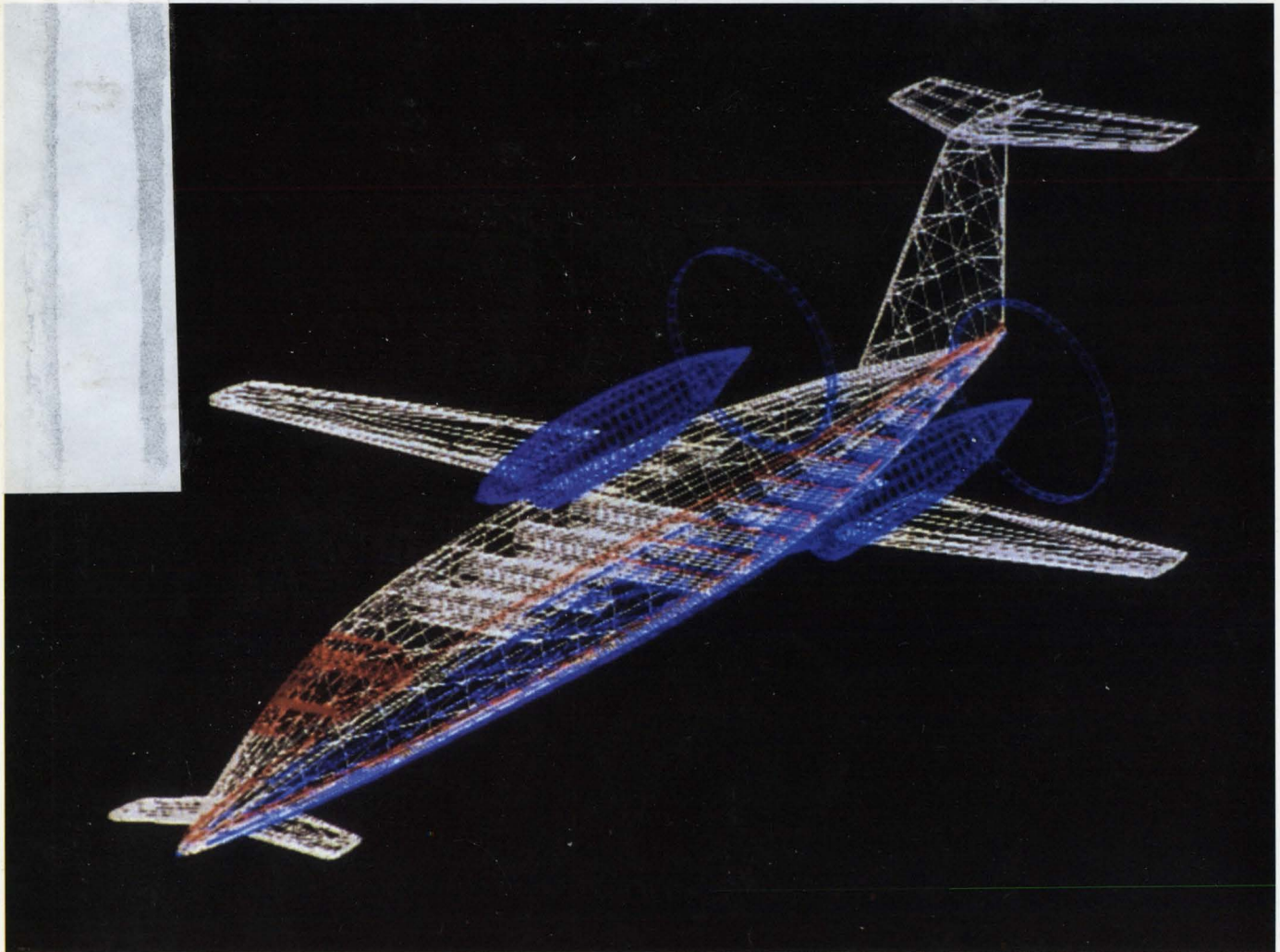

CIM: Integrating Man and Machine

This magazine is not sponsored or approved by or connected in any way with Digital Equipment Corporation. "DEC" is a registered trademark of Digital Equipment Corporation. Digital Equipment Corporation is the owner of the trademark "DEC" and is the source of all "DEC" products.

Guaranteed
to outperform any
disk in the market . . .
or your money back.

TurboDisk™ VMS

THE ULTIMATE IN DISK PERFORMANCE

Unleash the processing
power of your VAX.

Go from millisecond to
microsecond response time.

▶ Call Now 617-443-5106



EEC SYSTEMS INC., Sudbury MA 01776

VMS and VAX are registered trademarks
of Digital Equipment Corporation.

Readers Endorse Clearpoint's Designer's Guide

"A good refresher text for highly technical professionals, as well as an excellent introduction for the broader requirements of technicians and purchasing departments."

R.B. Guppy
Senior Electrical Engineer
KALUM CHEMICAL
A Division of PPG Canada Inc.

"The Designer's Guide is perfect for someone who understands the basics but needs essential information to make decisions. Congratulations on a very objective presentation."

Christopher M. Kreager
Systems Specialist
UNITED DATA SYSTEMS

"We have made a lot of use of the Designer's Guide at Logicon. As software developers, we were most interested in the sections on reliability. I absolutely recommend it."

Robert N. Mellott
Technical Staff Member
LOGICON

"Tremendously interesting... I understood everything. The section on the VAXBI clearly explained why it is different from the other buses, without unnecessary or boring detail. Next time send 6 or 8 copies."

Steve Waddell
Software Training Consultant
SOUTH CENTRAL BELL
Advanced Systems, Inc.

"I especially recommend it for software technical people who have a need for information on hardware options. I learned a lot, not only regarding memory, but also about the various bus structures available in the market. Clearpoint did an excellent job presenting the material clearly..."

Carl F. Billhardt
Principal Research Scientist
BATTELLE

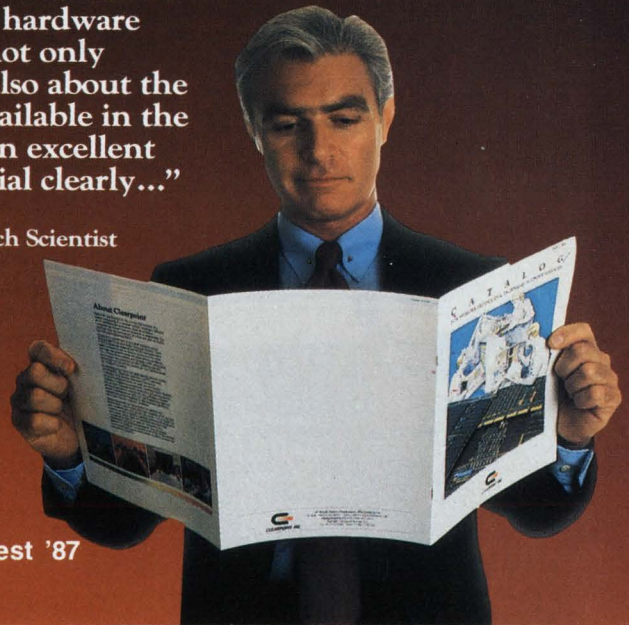
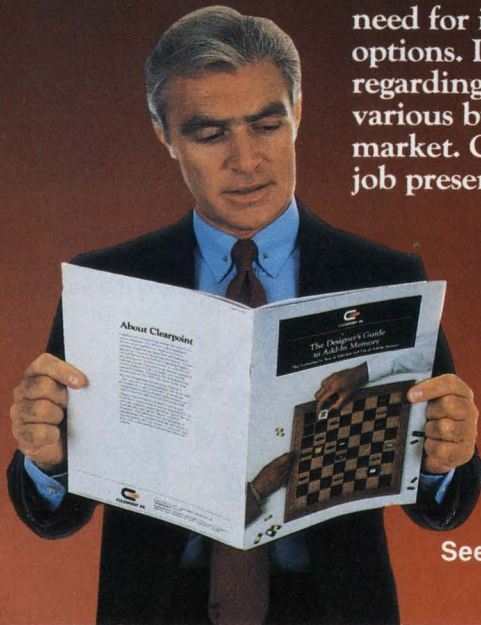

See us at DEXPO West '87
Booth #1315.

FREE: The 1987-88 Edition of Clearpoint's Designer's Guide to Add-in Memory and Product/Service Catalog

The New Designer's Guide to Add-in Memory

is the authoritative reference for buyers with a need to know. It is clearly written for a broad range of reader requirements, from the very technical to the purely management-oriented. Find out why readers everywhere rave about the Designer's Guide—an objective source book that tells you how to find the best in performance, reliability and value.

The updated 1987-88 edition includes important new information on the buses appearing today: ■ the proliferation of new DEC machines ■ where to find the best price/performance for memory ■ an expanded survey of the performance and memory options available in the IBM line, from the PS/2 Micro Channel to the 9370 ■ What the H P 9000 offers users ■ MIPS and megabytes for the new Sun 4/2XX and Apollo DN 4000 ■ and much, much more.



CLEARPOINT INC.

99 South Street • Hopkinton, MA 01748-2204
U.S.A. 1-800-CLEARPT Telex: 298281 CLEARPOINT UR
Massachusetts 617-435-5395/435-2301
Europe: Clearpoint Europe b.v.
Tel: 31-23-273744 Telex: 71080 CLPT NL
Canada: Clearpoint Canada Tel: 416-620-7242
Japan: Clearpoint Asia
Tel: 03-221-9726 Telex: 32384

The New Clearpoint Catalog of Memory Products & Technical Support Services

is a colorful and comprehensive technical brochure presenting the full spectrum of Clearpoint products, manufacturing procedures, customer support services, and specifications.

- The DEC-compatible products include: MicroVAX II, the complete VAX 8000 Series, VAX 780 and 750, Unibus, PMI-Bus, and Q-Bus.
- Other high performance memory: VMEbus, IBM PC/RT, VERSAbus, Sun, and Apollo.
- Non-Memory products: Liberty Board, TurboDisk, and TurboDisk-Plus.

Write or Call for Your Free Copies

DEC, MicroVAX II, VAX, PMI-Bus, Q-Bus, are all registered trademarks of Digital Equipment Corporation.
IBM PC/RT and PS/2 Micro Channel are registered trademarks of International Business Machine Corporation.
Sun is a trademark of Sun Microsystems.
Apollo is a trademark of Apollo Computer.
Liberty is a trademark of Trimarchi, Inc.
TurboDisk and TurboDisk-Plus are trademarks of EEC Systems.
VERSAbus is a trademark of Motorola.
HP is a trademark of Hewlett Packard.

ENTER 107 ON READER CARD

Introducing Equinox's New Data PBXs. More for Less.

Since 1984 our first generation Data PBXs have provided reliable data switching and connectivity solutions. After shipping over 1000 systems we learned what was good and what could be made even better. Then we set about designing our second generation. Here's what we came up with:



Less \$

Reduced manufacturing costs, due to VLSI technology allowed us to lower prices on our second generation Data PBXs. More features for less money means maximum value for your data switching dollar.

More of the Same

We kept the Equinox hallmarks of reliability, easy installation, comprehensive wiring solutions and user friendly operation.

We based our second generation on the same architecture as our first generation DS-5 and DS-15 Data PBXs.

They look the same, configure the same, even the names have stayed the same.

More Throughput

Our new Data PBXs each provide 25 Mbps throughput for 660 simultaneous full duplex connections at 19.2 kbps. With double the throughput of our first generation, and more than any other comparable Data PBX; that's enough for all the terminals, PCs, computer ports and peripherals you can throw at them.

19,200 bps

T 1 N e t w o r k i n g

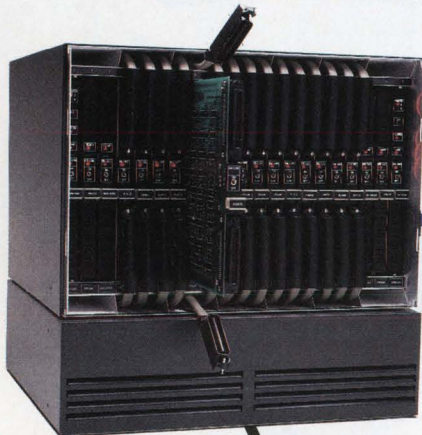

More Connectivity

T1 links join individual Data PBXs to form large multi-node Local or Wide Area Networks supporting many thousands of lines. You can use twisted-pair, telco, microwave or fiber optic links to solve virtually any connectivity problem.

So if you already own an Equinox Data PBX, all the features of our new generation can easily be added to your network.

If you need the most advanced Data PBX available, don't wait a minute more.



More Network Security

Dialback Security available as an option shields your network from unauthorized access by dial-in users. This feature lets you restrict dial-up access to designated users at pre-defined locations during specified time periods.

Call 1-800-DATA-PBX

In Florida: (305) 255-3500
Equinox Systems Inc.
14260 S.W. 119th Avenue
Miami, FL 33186



EQUINOX

Smart Connections For Dumb Terminals

ENTER 119 ON READER CARD

DEC PROFESSIONAL NOVEMBER 1987



DEC

PROFESSIONAL

C CONTENTS

NOVEMBER 1987

VOL. 6, NO. 11

CIM

44 TYING ISLANDS OF AUTOMATION INTO CIM SYSTEMS

by Donald E. Stern Jr.

Schick razor developed its CIM program with top-down commitment and bottom-up design and implementation.

54 GRAPHICS TERMINALS

by Gary Conner

A critical link in automating the shop floor.

ARTICLES

60 CONNECTIVITY: THE BLURRING OF DEC NETWORKS

by David Langlais

A bulwark to the continued effectiveness of DEC systems, or a threat?

70 TERMINALS: THE CIT-224 TERMINAL

by Bruce Feldman

An ANSI-compatible entry that's worth a look.

74 VAX: GETTING THE MOST FROM VAX/VMS MAIL

by Cynthia Hartman

To: You, From: Me, Subject: State-of-the-art delivery for MAIL.

82 COMMUNICATIONS: RESPOND/QUICK

by Michael G. Gonzales

A fast, easy-to-install DEC emulator for an IBM PC-compatible terminal.

90 MASS STORAGE: DISK I/O: PART 1

by Moses Sun

Challenge of the disk storage system integrator.



The lab seal indicates that the product reviewed has been tested by one of our experts in our Laboratory and Testing Center.

ON THE COVER:

This wireframe model of the Piaggio Avanti was designed by Dick Rutan (of Voyager fame) for Piaggio of Italy. The model was created with GEOMOD (SDRC, Cincinnati) on an Evans & Sutherland PS 390 running on a VAX 11/780. Cover courtesy of Evans & Sutherland, Salt Lake City.

Continued on page 6.



CONTENTS

Continued from page 5

98 RSTS: CACHING IN ON RSTS/E

by *Laurence F. Koolkin*

Make the most of your system by allowing mass enabling of caching for selected sets of files.

DEPARTMENTS & COLUMNS

Special Anniversary Feature

by *DEC PRO Staff*

Professional Press Looks Back.....32

Let's C Now

by *Rex Jaeschke*

DEC's VAX C Compiler, Part 2102

Field Service

by *Ron Levine*

Looking For A Digital Multimeter?110

Managing Your MicroVAX

by *David W. Bynon*

MVII Configuration—Back To The Basics..116

DCL Dialogue

by *Kevin G. Barks*

The Joys Of Captivity126

DEC Watch

by *Charles Connell*

DECWORLD: Digital Scores

The Big Win134

From the Lab

by *Carl B. Marbach*

Keyword's KEYPAK.....138

From the Lab

by *David W. Bynon*

TRIMM Industries' DA 123 Cabinet.....148

From the Lab

by *Dave Mallery*

The Emulex QD33 Controller Upgrade...154

MAC/VAX

by *Al Cini*

A Tale of Two Protocols160

Back End

by *John C. Dvorak*

The Great American Trade Show Quiz.....194

Letters.....12

ARISTALK.....18

Product Watch22

Products164

Used Equipment186

New Equipment188

Product Showcase.....189

Classified.....190

Advertisers Index.....192



The ARIS symbol on an article indicates that the program segments are available electronically on our Automated Reader Information Service. Dial (215) 542-9458.

We will consider for publication all submitted manuscripts and photographs, and welcome your articles, photographs and suggestions. We cannot be responsible for loss or damage. This magazine is not sponsored or approved by or connected in any way with Digital Equipment Corporation. "DEC" is a registered trademark of Digital Equipment Corporation. Digital Equipment Corporation is the owner of the trademark "DEC" and is the source of all "DEC" products. All materials presented are believed accurate, but we cannot assume responsibility for their accuracy or application. DEC PROFESSIONAL Magazine ISSN 0744-9216 is published monthly, plus two issues in the spring and fall, by Professional Press, Inc., 921 Bethlehem Pike, Spring House, PA 19477. Printing and binding by R. R. Donnelley & Sons Company. Subscriptions are complimentary for qualified U.S. and Canadian sites. Single copy price, including postage, \$4. One year subscription rate \$30 in the U.S. and Canada; and \$60 foreign. All orders must be prepaid. Second Class postage paid at North Wales, PA, and additional mailing offices. POSTMASTER: Send all correspondence and address changes to: DEC PROFESSIONAL, P.O. Box 503, Spring House, PA 19477-0503. COPYRIGHT © 1987 by Professional Press, Inc. All rights reserved. No part of this publication may be reproduced in any form without written permission from the publisher.



HDS offers a better choice

Why pay more or settle for less?



Introducing the HDS3200 Image Leader Terminals

Now you don't have to settle for a terminal with less capability than you need. And you won't pay high prices to get the features you want. Because now you can buy an HDS3200 Image Leader terminal from Human Designed Systems, the company that ships more integrated text and graphics terminals than any other independent manufacturer.

With prices starting at just \$699 list, the HDS3200 Image Leaders offer full DEC compatibility, and much more. Feature for feature, you'd pay over a thousand dollars more to get less from DEC.

Start with integrated text and graphics. Every HDS3200 Image Leader includes DEC SIXEL and Tektronix 4014 compatible graphics. So now you can run DEC and third-party graphics applications on all your terminals. And graphics looks even better since our high-resolution 15 inch monitor is easier to read, with higher resolution and much better focus.

We've also included HDS Windows—an easy-to-use system that lets you create six independent windows on the HDS3200's screen. You can talk to different computers in

separate windows at the same time and even pass files from computer to computer through the terminal.

For hundreds of dollars less than DEC charges, the HDS3200 Image Leaders have numerous standard and optional features that DEC doesn't even offer. Including 1056 x 800 resolution, 38.4K baud communication, a built-in calculator, a 50 line screen mode, LaserJet support, true re-draw pan and zoom graphics, and an HDS Mouse that controls these functions easily.

So what are you waiting for? Now that HDS offers a better choice of text and graphics terminals, at better prices than DEC, why settle for less? Call toll free today for a free trial.

For a free trial of an HDS3200 Image Leader,
Call 1-800-HDS-1551 x 133

HDS
human designed systems

the leading independent graphics terminal vendor

ENTER 127 ON READER CARD



On Line Disk
Compression & Optimization
SQUEEZPAK®

55	22	0001
3311	337	
555	155	4
941117	7	
33	4	4 999
6	4	777 11
1	22	6

Find the seven 5s.
Find room for ten 8s.

1111111112222
33333344444
5555556677
77779999000

Now it's easy to find the seven 5s.
Now find room for ten 8s.

With SQUEEZPAK, the time you invest in compressing and optimizing your disk will be less than the time it takes to read this ad.

1. Optimizes Disk Performance!

Performance-enhancing features resulting from SQUEEZPAK include unfragmented files, contiguous free space and packed files.

2. Single Disk Operation!

SQUEEZPAK performs compression and optimization on a single disk, avoiding slow, awkward tape transfers.

3. On-Line Transparent Operation!

The disk is completely available for other uses during SQUEEZPAK's entire compression and optimization process.

4. VMS and RSX Operating Systems!

SQUEEZPAK is the Better Way.
Call Now For Your 30 Day Evaluation.

1-800-267-3862
(in Canada, call 613-748-0209)
West Coast, call 714-553-8683

DEMATIC
SOFTWARE LTD.

1260 Old Innes Road, Ottawa, Ontario, K1B 3V3

DEC
PROFESSIONAL

Publisher: Carl B. Marbach
Editorial Director: R. D. Mallery

Editorial

- MANAGING EDITOR** Linda DiBasio
ASSOCIATE EDITOR Bruce Feldman
SENIOR TECHNICAL EDITOR Al Cini
EAST COAST EDITOR Charles Connell
WEST COAST EDITOR Philip Naecker
TECHNICAL EDITOR Ron Levine
BACK END EDITOR John C. Dvorak
C EDITOR Rex Jaeschke
DCL EDITOR Kevin G. Barks
MICROVAX EDITOR David W. Bynon
NETWORKING EDITOR Bill Hancock
SPECIAL EDITOR Victor J. Chorney
UNIX EDITOR Lori A. Snyder
STAFF EDITOR Suzanne Garr
CHIEF COPY EDITOR Pamela F. Fullerton
COPY EDITOR Karen Detwiler
EDITORIAL ASSISTANT Anne Schrauger
CONTRIBUTORS Gary Conner, Michael G. Gonzales, Cynthia Hartman, Laurence F. Koolkin, David Langlais, Donald E. Stern, Jr., Moses Sun

Design

- DESIGN/PRODUCTION DIRECTOR** Leslie A. Caruso
DESIGN/PRODUCTION ASSOC. Ruth Ann Leiby
ART/PRODUCTION ASSOC. Timothy M. Kraft
ART ASSISTANT Sue Ann Rainey
PRODUCTION ARTIST Richard G. Kortz
TRAFFIC/PRODUCTION ASST. Joann Corvino
TYPESETTING (EDITORIAL) MaryEllen Springer
TYPESETTING (MARKETING) Diana Pohl

Circulation & Administration

- VICE PRESIDENT** Peg Leiby
CIRCULATION DIRECTOR Mary Wardlaw
CIRCULATION MANAGER Margie F. Pitrone
CIRCULATION FULFILLMENT Patricia Dunkerley, Ruth Henderson, Claire Hollister, Karol Hughes, Donna Schmidt
ACCOUNTING Andrea Beneke
COMPUTER SYSTEMS Kevin Kennelly, Ruth Mermelstein, Rory Mulvey
ARIS MANAGER Bonnie Auclair
MAILING LIST COORDINATOR Cathy Dodies
MARKETING SERVICES (215) 542-7008
Mary Ann Browarek, Kim Slackway
ASSISTANT TO THE PUBLISHER Jan Krusen

PROFESSIONAL PRESS, INC.

For information on how to contact your sales representative, see page 192. Editorial, Advertising Sales, and Executive Offices at 921 Bethlehem Pike, Spring House, PA 19477. (215) 542-7008. TWX 910 333 9522. FAX (215) 628-2845. Easylink 62805174. ARIS (Automated Reader Information Service) (215) 542-9458. Additional Editorial Offices: East Coast Office at 238 Bedford St., Suite 3, Lexington, MA 02173. (617) 861-1994. West Coast Office at 3011 N. Mount Curve Ave., Altadena, CA 91001. (818) 791-0945.

CPU-Bound VAX Systems Rescued by Avalon

Attached processors are oriented towards number-crunching programs written in DEC Fortran.

Hardware and Software systems run C, Fortran, and Pascal programs with full access to VAX files, terminals, and system services.

Avalon Computer Systems recently released its second generation of attached processor systems. Founded in 1982, the company has been quietly delivering attached processor systems for UNIBUS and Q-bus VAX systems for 4 years.

Avalon's customer base has been drawn largely from the aerospace, government, and university ranks. These users were attracted by Avalon's transparent system software which executes programs (under VMS or UNIX) directly off of the VAX disk, with full access to all files, terminals, and system services. The announcement last summer of an updated Fortran compiler with VMS extensions and two new, faster attached processors has widened the user spectrum substantially. Recently, chemical, genetics, and AI companies have joined Avalon's growing customer base.

Named the AP/20 (Q-Bus) and the AP/24 (Unibus), the new coprocessors are based on the Intel 80386 microprocessor operating in the 32-bit protected mode. Both systems contain a 64K byte cache memory and an optional high-speed floating point accelerator which can multiply two single precision numbers in 437 nanoseconds. The AP/20 has 4 million bytes of real memory while the AP/24 has 4, 8, or 12 million bytes of real memory.

Either AP with an FPA is 2 times faster than a completely unloaded VAX 11/780 on floating point programs and is 3 times faster on integer programs. More important than the increased speed, however, is that the AP provides additional, *parallel* computing power.

By adding one or more AP Systems to the VAX, CPU cycles can be incrementally expanded for "power users" with compute-bound programs. The end result is the transformation of VAX Systems into parallel computers which still run the VAX/VMS operating system.

The AP software optionally includes C, Fortran, and Pascal compilers, with support for VMS, Ultrix, Berkeley UNIX and AT&T System V UNIX. Under VMS, the Avalon software automatically executes system services and I/O operations by passing messages between the coprocessor and an interface program that runs under VMS. An Avalon official explained: "The Avalon compilers put a VMS executable image in front of the Avalon program. This starts the coprocessor interface under VMS, and the Avalon image on the AP. This way, operation under the coprocessor is transparent to the program and the user after it has been recompiled." The recompiled program can then access all VMS files, terminals, and most system services, just as it did in its original form. However, the program runs entirely on the AP when not performing I/O and neither affects, nor is affected by, the computational load on the VAX.

It is believed that Avalon is the only company supplying "Blue Fortran" compatibility in its Fortran compiler. The Avalon Fortran implements virtually all of the DEC Fortran extensions and provides complete access to VMS system facilities.

Avalon provides VAX compatible, high performance systems to end users who need more power, without requiring any modifications to the original source code.

Both the AP/20 and the AP/24 are single circuit boards that range in price between \$10,000 and \$18,000, depending on selected options.

For more information call or write:

Sales
Avalon Computer Systems
425 E. Colorado Blvd. #710
Glendale, CA 91205
(818) 247-2216

SmarTerm 240. DEC terminal emulation. True connectivity.

Mainframe-PC links are the current vogue. One terminal emulator is ahead of the connectivity trend.

SmarTerm[®] 240 affords users exact four-color emulation of a DEC[®] VT241 terminal on an IBM[®] or compatible PC. Along with delivering full-screen ReGIS[®] and Tektronix[®] 4010/4014 graphics, SmarTerm 240 offers precise VT220, VT102, VT100, and VT52 text emulation.

Three error-free file transfer protocols, including Kermit and Xmodem, are provided. If judged as a communications stand-alone, SmarTerm 240 could well be the premier PC-to-the-rest-of-the-World connectivity package.

SmarTerm 240's user-interface is state-of-the-industry. Its user-support is without peer.

This program's full collection of features add up to more power for connecting people to mainframes. Which helped earn it *Digital Review's* 1987 Target Award for the Best Connectivity Software Product.

Contact your dealer or call us at 608-273-6000 for more reasons why your choice for DEC terminal emulation should be SmarTerm. Period.

See us at Fall Comdex Booth H8706. Or use inquiry code 500.

© 1987 Persoft, Inc. All rights reserved. Persoft and SmarTerm are registered trademarks of Persoft, Inc. IBM is a registered trademark of International Business Machines. DEC, VT and ReGIS are trademarks of Digital Equipment Corporation. Tektronix is a registered trademark of Tektronix, Inc.

See us at DEXPO West Booth 1024.

smarterm **240**

DEC® VT240 / VT241 Color Graphics Terminal Emulator
with ASCII and Binary File Transfer and
DEC ReGIS and Tektronix® 4014 Emulation

persoft

persoft®

LETTERS

PACK CLUSTER SIZES

I enjoyed Dave Mallery's editorial, "Billions of Little 'Fasters,'" in the September issue. However, I would like to amplify a point: Using a cluster size other than one for a VMS disk volume is, for most sites, not a good idea. The appropriate way to avoid file fragmentation is to use a reasonably large value for the volume extension size, and/or the system default RMS extend quantity. (Values in the range of 80-200 are typical.)

Raising, or defaulting, the cluster size from one block to three or more, still will result in unreasonably fragmented files if adjustments are not made in one of these other parameters. Conversely, if the volume or RMS parameters are set reasonably, a cluster size other than one only serves to waste disk space, as Mallery correctly noted. This same point has been made by others at DECUS over the years. (None of these strategies, incidentally, is a substitute for periodic volume compression or the use of a commercial disk defragmenter.)

File fragmentation, especially within image files, can impact VMS system performance seriously. As Mallery noted, this aphorism becomes truer as disk transfer rates increase disproportionately to seek and rotational latencies.

Steve Duff
Ergodic Systems Inc.
Newport Beach, California

Dave Mallery: My goal in raising the pack cluster size was not to escape fragmen-

Address letters to the editor to *DEC PROFESSIONAL* magazine, P.O. Box 503, Spring House, PA 19477-0503. Letters should include the writer's full name, address and daytime telephone number. Letters may be edited for purposes of clarity or space.

tation, but rather to increase the I/O data rate. I noticed in my benchmarks that far fewer physical I/Os were needed and the data rate was much higher when the only change was to the pack cluster size. I think that you should posit the use of a good defragmentation program (if only image backup/restore) and ask what is the best cluster size for a regularly reorganized volume.

I grant your RMS parameter argument. Thanks very much.

CHEERS FOR THE LITTLE GUYS

Charles Connell's otherwise comprehensive article, "September Means School" (September 1987), overlooked one very important source for computer training: the independent consultant (IC).

ICs can provide high-quality custom training at a fraction of the cost of large specialized vendors. Most large metropolitan areas contain scores of qualified consultants who are able to service a wide range of educational needs. Because of their nature, ICs are

more flexible than large vendors and quite often have more extensive practical experience. An IC can do more than explain a concept; he can develop a practical application and demonstrate its use.

ICs can be located in a number of ways: through the Yellow Pages, by contacting trade groups such as the Independent Computer Consultants Association, and by making inquiries with other sites using similar systems.

As you do with formal educational services, secure and verify the IC's references and obtain a complete written agreement and course outline.

The firms described in Connell's article are all top-flight operations. But don't forget the capabilities of the little guys.

Jim Christopher
DB Enterprises
Buckingham, Pennsylvania

AN APPLE FOR TEACHER

The article, "September Means School" by Charles Connell (September 1987), didn't include what we consider to be a critical ingredient in learning: the teacher. Today's more sophisticated student can spot an instructor who simply has book knowledge. We found it critical that all our instructors have real-world experience and have performed all the tasks they're teaching. The students get an instructor who can relate to very real, daily operational issues. All of our instructors have these credentials.

In looking for trainers, you should

Continued on page 16.



The Silent 700™ Data Terminal Series from Texas Instruments.

Next time you take off, take the DEC™ connection.

Talk about convenience for the DEC user. TI's TravelMate™ 1200 is display, printer and communications all rolled into one lightweight, go-anywhere package that emulates a VT-100™ video terminal. With it, you can access DEC computers from just about any remote location as long as there's a phone handy.* Perfect for on-the-go DEC communications.

The TravelMate 1200 VT-100 emulation cartridge also includes auto access features such as stored phone numbers and log-on sequences. This actually makes your TravelMate-to-DEC communications easier than using a phone. And the VT-100 emulation cartridge can be programmed to fit individual applications within your DEC operating environment.

The TravelMate 1200 with VT-100 emulation capability also carries an impeccable pedigree — a 15-year heritage of reliable, rugged design and dependable operation. After all, it's a



member of the Silent 700 Series of Portable Data Terminals family from Texas Instruments. It's definitely a terminal you can trust.

So next time you have to take off, take the DEC connection.

For more information on the Silent 700 Series, TravelMate and VT-100 emulation, call toll-free 1-800-527-3500.

**TEXAS
INSTRUMENTS**

ENTER 159 ON READER CARD

*In locations where a phone jack is not accessible, the optional acoustic coupler may be required.
Silent 700 and TravelMate are trademarks of Texas Instruments Incorporated.
DEC and VT-100 are trademarks of Digital Equipment Corporation.
Products described above are in compliance with applicable FCC rules for Class B computing devices and peripherals.
© 1987 TI 31685



SAS/GRAPH® from SAS® Institute



DCF® from IBM®

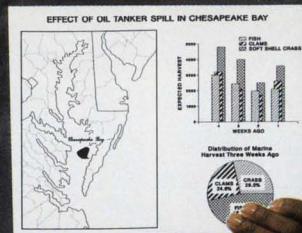

CA-DISSPLA™ from Computer Associates®

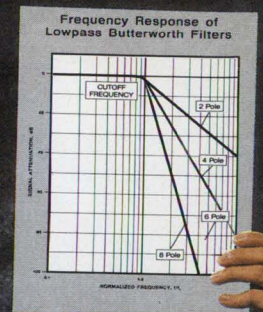

Picture™ from Precision Visuals®

QMS Lasergrafix more image problems

Unable to merge highly sophisticated, presentation-quality graphics with text? Can't print complicated statistical analyses? Frustrated that all your PC's, minis and mainframes, running dozens of different software packages, can't share one printer? To face these and other tough image problems, rely on the QMS Lasergrafix® family of laser printers, including our new Lasergrafix 1510.

The Lasergrafix 1510 speaks volumes

The new Lasergrafix 1510 is ideal for producing high volumes of complex graphics. Its six-megabyte memory and high-speed controller let you process two fully bit-mapped legal- or A4-size pages at the same time. Plus its 16 resident fonts, 15-page-per-minute output and 15,000-print-per-month duty cycle give you flexibility and reliability.

High-profile compatibility

The new Lasergrafix 1510, like all of our Lasergrafix printers, runs in a wide range of host environments with the most popular software. You can use Computer Associates, SAS and Precision Visuals software to produce some of the finest graphics possible. Using Tektronix™, Calcomp™ and Versatec™ software you create sophisticated vector graphics in minutes, not hours. Typesetting packages such as MASS-11™, TEX™, troff, and ditroff™ allow output with math equations, chemical formulas, arcs, circles, as well as other graphics and character sets unique to the scientific and engineering worlds. And for composing straight text documents there's DCF from IBM.

QUIC study

Further text and graphics support comes from QUIC™, the proprietary print system language developed by QMS. QUIC is simple for nonprogrammers to use and provides you with a versatile array of print options. With a few simple commands you can draw lines, boxes, shaded bar charts, pie charts, and other kinds of presentation graphics that you can combine with text on your final printout. What's more, QUIC is supported by all the popular high-level graphics software.

Flexible partners

Lasergrafix laser printers support multiple emulations and interface options to match IBM, DEC®/VAX®, Apollo®, Sun®, UNIX™ and many other systems. It's this kind of printer technology exper-

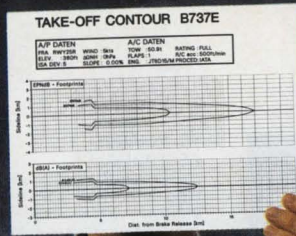
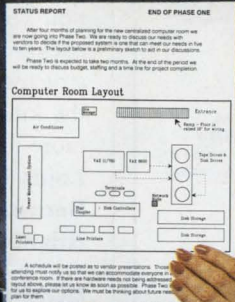
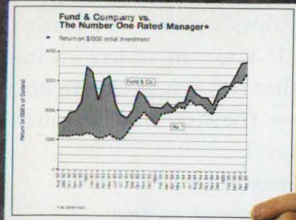

TRUFF
 FROM: ...
 TO: ...
 SUBJECT: ...
 ...

SPSS Graphics™ from SPSS Inc.*

MASS-11™ from
 Microsystems Engineering Corp.*

QTEK PLOT® from QMS

troff™ from AT&T Bell Labs

printers have solved than Madison Avenue

tise that sets QMS apart as a leader in all these environments.

Proven performance

The Lasergrafix family of 8-, 15- and 24-page-per-minute laser printers incorporates the proven graphics processing

technology and dependability common to all QMS products, along with different levels of functionality to match many different needs. For single users or even for high-volume, multiuser sup-

port, there's no other laser printer family in this class that has more versatility. Which is what users have come to expect from the laser printer company that continues to set the standard for all the rest.

Find out what a QMS Lasergrafix laser printer can do for your image by calling **1-800-631-2692** for product literature or to arrange a demonstration.

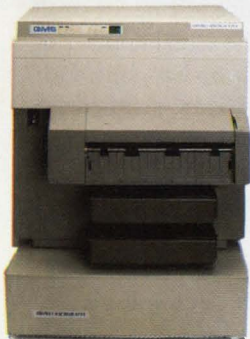

QMS Lasergrafix 800 II
 8-page-per-minute output
 up to legal or A4 size



QMS Lasergrafix 1510—new
 15-page-per-minute output
 up to legal or A4 size



QMS Lasergrafix 2400
 24-page-per-minute output
 up to 11" x 17" or A3 size

The following are trademarks of their respective companies: DEC and VAX of Digital Equipment Corporation; T_EX of the American Mathematical Society; UNIX, troff and ditroff of AT&T Bell Labs; Tektronix of Tektronix, Inc.; Calcomp of California Computer Products, Inc.; Versatec of Versatec, Inc.; SAS/GRAPH and SAS of SAS Institute, Inc.; IBM and DCF of International Business Machines Corp.; MASS-11 of Microsystems Engineering Corp.; Precision Visuals and Picture of Precision Visuals; Apollo of Apollo Computer Inc.; Sun of Sun Microsystems Inc.; and SPSS Graphics of SPSS, Inc.



ENTER 204 ON READER CARD

GRAF^{KIT}

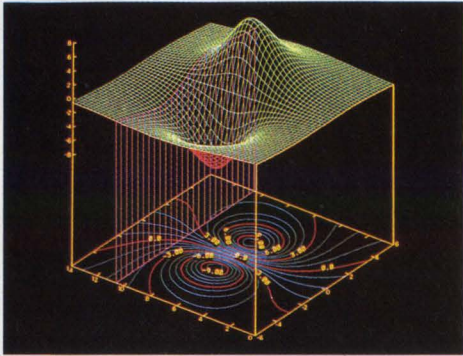

3D Surface Over a Contour
Quantitative results displayed through contours can be combined with qualitative presentations of the same data using a surfacing routine. Contours can be used for displaying scientific distributions or representing geophysical data.

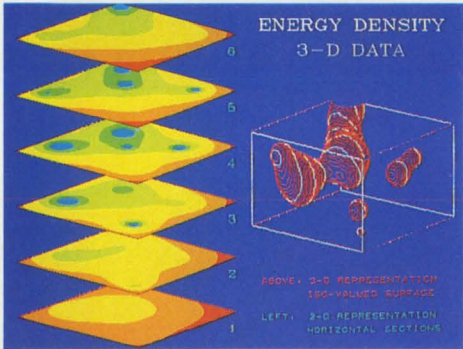

3D Solids and Contours
Presentation flexibility of 3D data is greatly enhanced by offering variable perspectives on 3D surfaces and solids. Contours and halftones may be added to clarify results.

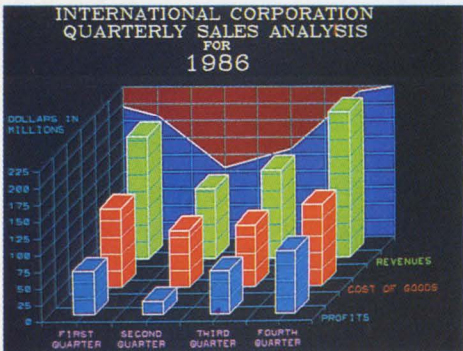

Histograms and Graphs
2D and 3D histograms are available with color fill or shading capabilities. Choose from a complete set of characters and multiple fonts to enhance your graphs. A wide range of 2D and 3D graphs are also available.

ENTER 231 ON READER CARD

A COMPLETE TECHNICAL GRAPHICS PACKAGE

TO EXPAND: PERFORMANCE

GRAFkit™ provides serious technical graphics capability for VAX computers in a VMS or ULTRIX environment. It allows the user to organize, store and output complex graphs on a wide range of devices by using simple calls to the GRAFkit™ library of routines.

VERSATILITY

GRAFkit™ is based on and includes a Graphical Kernel System (GKS) foundation which organizes graphic data in an ANSI/ISO approved format. It offers better integration with other software programs by using the national and international standards for graphic data. GRAFkit™ also includes an ANSI/ISO approved Computer Graphics Metafile (CGM) which allows data to be stored device independently. Over 100 popular devices are currently supported including: DEC, HP, Tektronix, Calcomp, Apple, Graphon, NDS, Versatec, IBM, BBC, etc.

TO SAVE: TIME

GRAFkit™ allows the user to concentrate on the application programs and pass the results through GRAFkit™ routines to automatically organize, interpolate, smooth, label, color/shade, translate, and produce a finished visual presentation.

EFFORT

In most cases, only a single call is used to access the GRAFkit™ library of routines, and all remaining functions are automatic. GRAFkit™ routines can be accessed from application programs written in C, Pascal, BASIC, COBOL, FORTRAN, PL/I, and ADA.

EXPENSE

Although GRAFkit™ is a complete technical graphics package, the initial cost is usually the same or less than the price of a GKS package alone from another vendor. At \$3,995, GRAFkit™ is an ideal graphics solution for a work station. It can also be purchased for a variety of departmental VAX computers for under \$10,000.

Our commitment to continuous support of the package at a nominal fee makes GRAFkit™ a fine investment for years of high quality service.

Call Today:
1-800-222-4239
ext. 714



740C South Pierce Avenue
Louisville, CO 80027-9989
303/666-5400
Telex: 292682
FAX: 666 7054

SCO, Inc. is a wholly owned subsidiary of International Computer Exchange, Inc.

Continued from page 12.

poll your vendors on the instructor's background. If you can secure an instructor who has real-world experience, the knowledge transfer will be much more meaningful.

Louis H. Bernstein
Bernstein & Associates Inc.
Atlanta, Georgia

PRICING-PER-USER PROBLEMS

I read with interest Al Sutherland's letter, "Licensing Per User" (August 1987), proposing pricing on a limited-user basis for software systems. While his idea sounds like a good one at first glance, there are some inherent problems with this approach. The most obvious has to do with user satisfaction.

When a user is able to access a particular software package, he typically uses it, even when he isn't the designated user. When the designated user is unable to operate the software because someone else already is using it, internal conflicts arise. Of course, the greater the number of users on a machine, the higher the probability for internal user/DP manager conflict.

You might suggest that the solution is easy: just upgrade the license. But this presents problems for system managers who need to budget their software purchases in advance.

Specifying designated users within the software is another option, but this turns out to be an unmanageable alternative for the software company and the VAX administrator as well.

While our company provides a limited use license for sophisticated 4GL/DBMS software (*System 1032*), which includes very attractive pricing for small numbers of users, the actual number of customers (to date) who have opted for this approach have hardly justified the internal software enhancement effort required to facilitate this capability. I would love, however, to be proved wrong.

Ken D. Chism
CompuServe Data Technologies
Fullerton, California

The following are trademarks of Digital Equipment Corporation:

A-to-Z	DECnet	IAS	PDP	VAX
ALL-IN-1	DECsystem-10	IVIS	PDT	VAXBI
CDD	DECSYSTEM-20	LAN Bridge	P/OS	VAXcluster
DATATRIEVE	DEC/Test	LA50	Q-bus	VAX DIBOL
DDCMP	DECUS	LA100	Rainbow	VAXELN
DEC	DELNI	LQP02	RALLY	VAXFMS
DECcalc	DIBOL	LSI-11	Rdb/VMS	VAXlab
DECconnect	DNA	MASSBUS	RSTS/E	VAX LISP
DECgraph	Eve	MicroPDP-11	RSX	VAXstation
DECmail	FMS	MicroPower/Pascal	RT-11	VMS
DECmate	GIGI	MicroVAX	TEAMDATA	VT
			TOPS	Work Processor
			ULTRIX	WPS
			UNIBUS	

UNIX is a trademark of Bell Laboratories.
MS-DOS is a trademark of Microsoft.
Macintosh is a trademark of Apple Computer Inc.

Would You Read The Whole Dictionary To Find The Definition Of One Word?

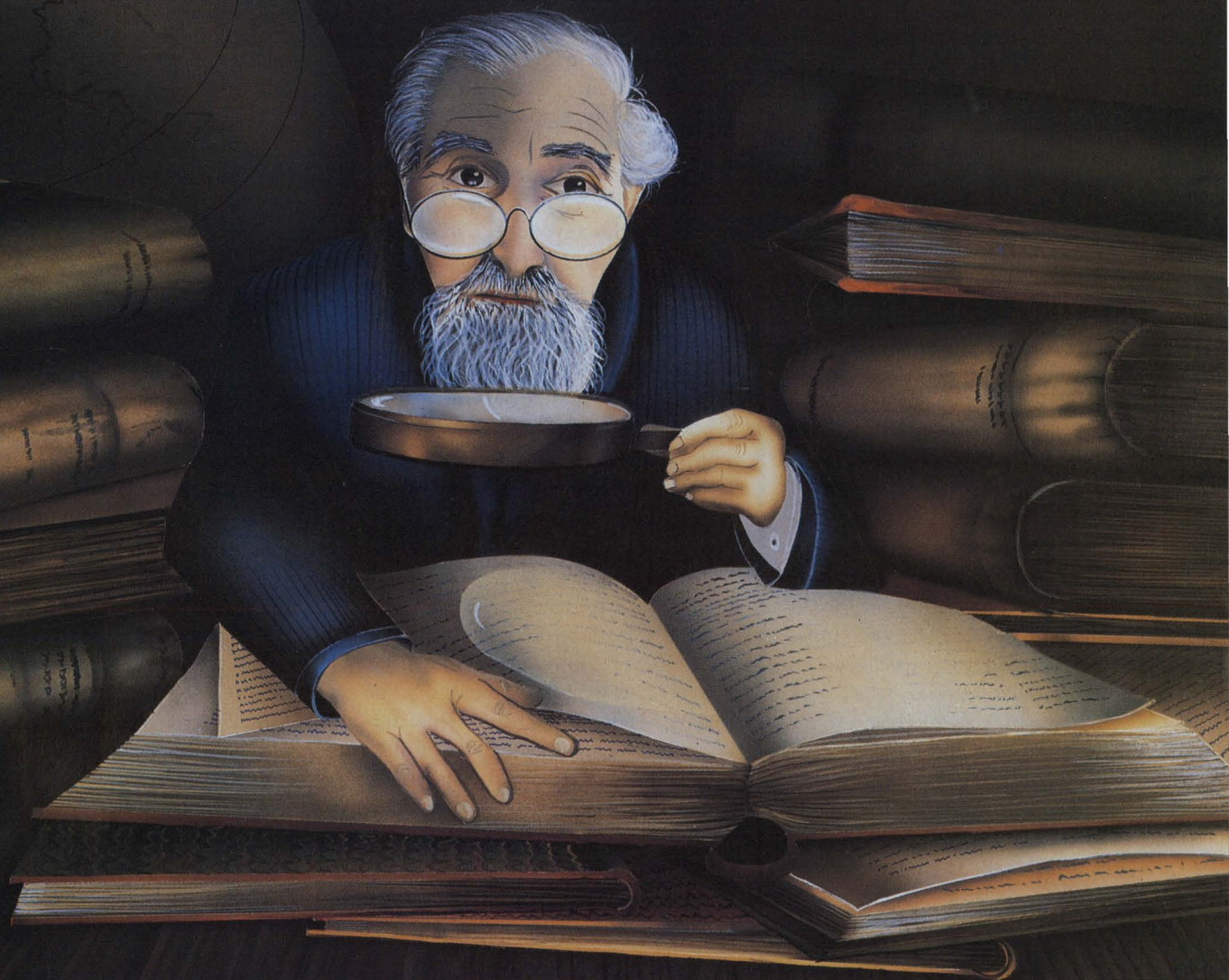

You wouldn't read the whole dictionary to find the definition of one word . . . So why waste countless man hours going through page after page of large documents and other text format files searching for specific references? STATUS, the world's most advanced text storage and retrieval system from CP International allows you to search, cite, and display references, no matter how specific, in seconds.

STATUS provides you with immediate access to any information in your files, both structured and unstructured. Contracts, product reports, catalogs, service manuals, large volumes of legislation, government regulations and patent summaries can be searched and referenced in almost any way imaginable . . . right down to specific words or phrases. It's little wonder that STATUS software has received rave reviews from so many of the world's largest oil companies, banks, pharmaceutical companies, power companies, federal agencies, and state and local governments.

Best of all, STATUS is backed and supported by CP, a leader in data processing technology for nearly 20 years. Our staff of text-based systems experts are specially trained to conduct complete analysis, installation and support, whenever required.

For more information and a free product brochure, call or write CP International at 210 South Street, New York, NY 10002. (212) 815-8691.

ENTER 230 ON READER CARD



International, inc.

STATUS

You Have It Or You Don't

How To Use ARIS

If you're a subscriber to *DEC PROFESSIONAL*, you can call up our VAX and log into ARIS, our Automated Reader Information Service. In ARIS, you can download programs from our publications, communicate with our editors, request a change of address, find additional information about advertisers, order books and back issues, check the guidelines for submitting articles, access our cumulative index, take a peek at our editorial calendar for the year, and communicate with other DEC users.

To log in, you'll need your subscriber number (it's on your mailing label). Then, just set your terminal to seven data bits, one stop bit and space parity, or eight data bits, one stop bit and no parity, and dial (215) 542-9458. Baud rates: 300, 1200 or 2400.

APPLE II AS VT100?

QUERY:

Steve Peterson (SIG 25/MESS 101) HELP: A customer insists on using his Apple IIe as a terminal, with *ALL-IN-1* on his MICROVAX. He's running the communications package, *ACCESS*. At the *WPS* menu, E to edit and C to create cause the

Apple to display the previous screen (next higher menu?).

Questions: Can *ACCESS* be configured to work properly? What other emulators for Apple will work? *SOFTERM II* was suggested. *CROSSTALK* was said not to emulate VT100 completely. Has anyone seen or produced a table of VT100 versus ANSI x3.64 terminal characteristics? I'd appreciate any help.

REPLY:

Edward Finneran (SIG 25/MESS 129): I noticed you said *ACCESS*, not *ACCESS II*. *ACCESS II* appears to work properly, because one of our teachers uses it all the time to work in *WPS+VMS*.

The other day we used it to upload for the first time, and there was no problem. Perhaps *ACCESS II* is close enough to *ACCESS* for your customer to go for it. We're doing a demo now of *SOFTERM II* on an Apple IIgs. While it's a more powerful terminal emulator (including emulations of lots of different terminals), the manual is horrible. You can use it to customize a lot of what you normally do to make it easier.

I'm still waiting for an Apple emulator that will use the keypad correctly with various keypad software, like *WPS*, *EDT*, etc.

HEWLETT-PACKARD PLOTTER ON MICROVAX II

QUERY:

Bryan Coleman (SIG 25/MESS 113): I'm trying to connect an HP 7550A plotter to our MICROVAX II, and have had strange problems. I'd ultimately like to set up a print queue to spool plots to, but for now I've just been trying to copy a plot file (generated with *SAS/GRAPH*) to a terminal port.

It never seems to work the first time, and several of the SET TERMINAL parameters seem to have no effect. I'm able to get plots off successfully by

copying them a second time. I have the plotter connected to a DHV-11 port on our MICROVAX that's set: Baud = 9600, Parity = Even, Interactive, Ttsync, Passthru, and NO for just about everything else. I've tried various device types, but none seem any better than "UNKNOWN."

I welcome any suggestions; I've yet to set up a queue. So far I've only tried to copy the file of plotter commands to a terminal port. When I tried setting up a queue, I'd get a "STALLED" job, and would have to DELETE the entry. I'll look into the truncation question, although there still seems to be a problem with the port (either handshaking, or proper settings in VMS). I'll try to use the following to set up the QUEUE:

```
$ SET DEVICE/SPOOLED =
(SYS$PLOT,SYS$SYSDEVICE)
$PLOTTER
```

```
$ INIT/QUEUE/NOSEPARATE/DEFAULT=
(NOBURST,NOFEED,NOFLAG,
NOTRAILER)/ON=$PLOTTER
SYS$PLOT
```

This hopefully would allow multiple files to be queued using a print command.

REPLY:

Kitty George (SIG 25/MESS 124): After buying the Precision Visuals *PICTURE* software, I had the pleasure of trying to get an HP 7550A plotter to work as well. From your description of the problem, it sounds like the truncation bugaboo gotcha. Here are the commands to set it up:

1. Define a form HP7550. I used form number 6 here.

```
$ DEFINE/FORM HP7550 6
/NOSETUP/STOCK=DEFAULT
```

For Digital users in search of high-performance systems software, Software AG comes through.

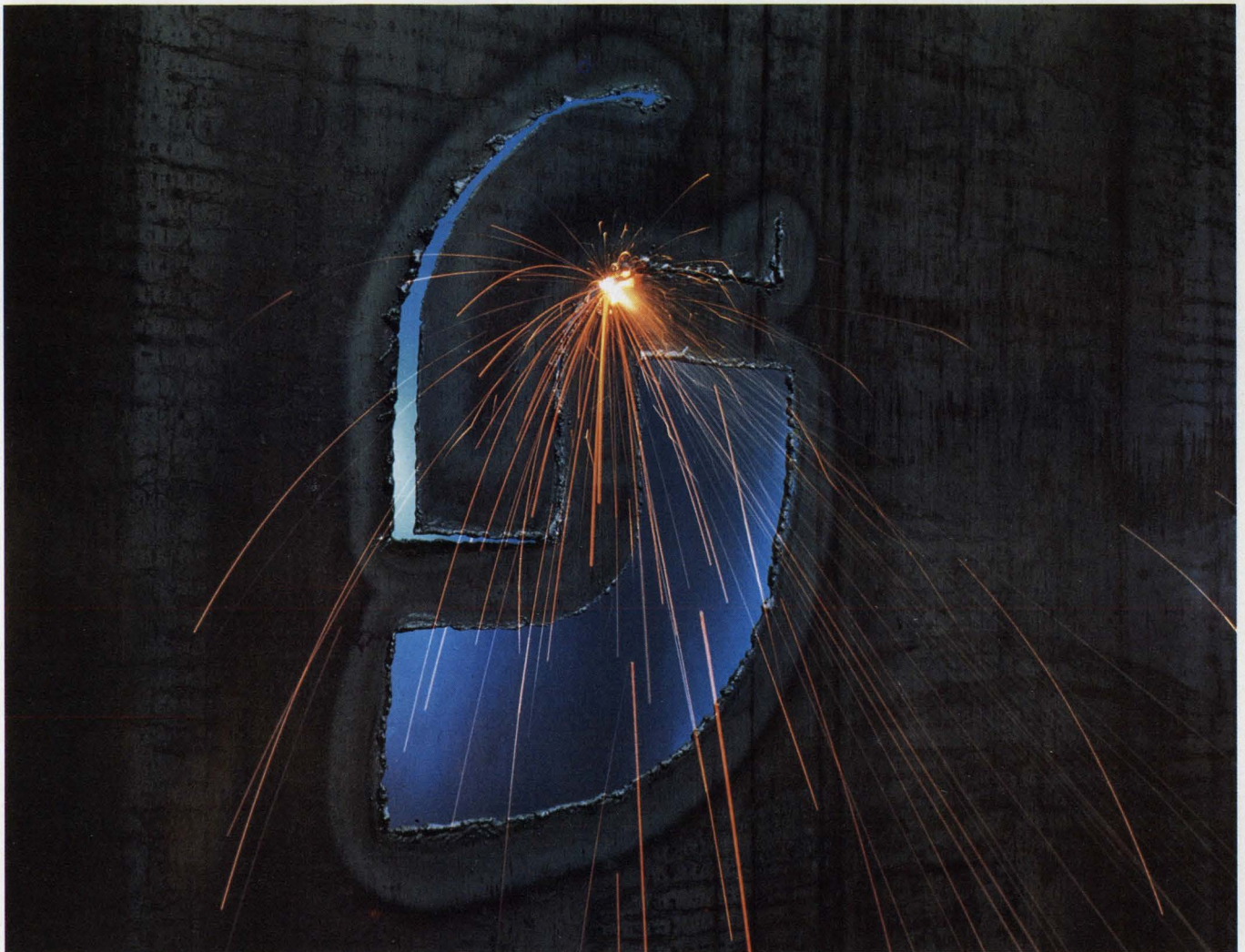

It's becoming clear: for more and more users of Digital's VAX computers, Software AG delivers the advantage in systems software that only fully integrated technologies can provide.

The Software AG VMS product family provides comprehensive solutions for the information management needs of today's high-volume VAX production environments, with proven, high-performance technologies:

- * **ADABAS**—flexible, high-performance data base management;
- * **NATURAL**—advanced 4th Generation applications development;
- * **PREDICT**—integrated, active dictionary for data and applications;
- * **SUPER NATURAL**—interactive applications generation for end users;
- * **NET-WORK**—powerful communications for distributed processing.

Like all Software AG technologies, these tools feature open architectures for easy integration with other environments and systems.

So take a closer look at the technologies that Digital users have come to demand. Software AG. The Digital Advantage.

For a free color brochure on the Software AG VMS product family, call toll-free:

1-800-843-9534

(In Virginia and Canada call: 703-860-5050)

ENTER 154 ON READER CARD

SOFTWARE AG
PROGRAMMING BUSINESS SUCCESS

WHY DO FORTUNE 500 COMPANIES SPEND ONLY \$900 FOR PRESENTATION GRAPHICS?

To get RENDER — an immensely flexible package for the DEC environment. RENDER brings powerful technical and business graphs to a wide range of hardware configurations. RENDER is highly portable across DEC operating systems, and supports over 100 popular output devices, including Tektronix, HP, DEC, and many laser printers. Additional modules in the Multiware Graphics System provide a menu interface, 3D, contouring and high-level subroutines. Call Maria Ruiz today for a full information package or to order a FREE trial copy of RENDER, at 1/800/522-0202.



MULTIWARE
INCORPORATED

2121 Second Street, Building B, Suite 107
Davis, California 95616 916/756-3291

DEC, Tektronix, HP, and RENDER are trademarks of Digital Equipment Corporation, Tektronix Inc., Hewlett-Packard Corp., and Multiware, Inc., respectively.

INNOVATION AT WORK

See us at DEXPO West, Booth #2040.

ENTER 222 ON READER CARD

CORRECTION

In "The Invisible VAX" by Al Cini (October 1987, page 31 A), we inadvertently indicated that AlisaTalk was from Apple Computer Inc. AlisaTalk is a product of:

Alisa Systems Inc.
221 E. Walnut Ave., Ste. 230
Pasadena, CA 91101
(818) 792-9474

ENTER 371 ON READER CARD

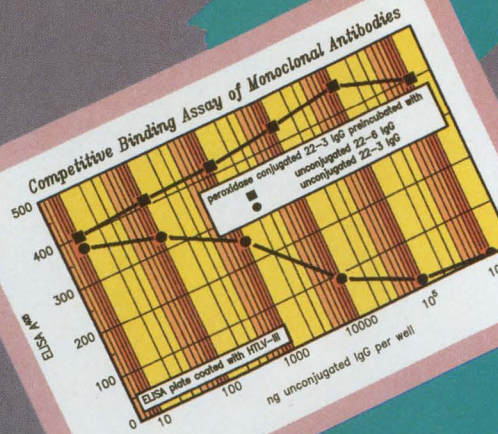

```
/WID = 65535/LEN = 255/MARGIN =
(BOTTOM = 0)/NOTRUNCATE
/DESCRIPTION = "HP7550 PRINTER"
```

2. Set up the terminal characteristics.
3. Assume that you're setting up a queue on LTA2:, which is a port on a DECSERVER 100. The commands are:

```
$ SET TERM LTA2:/PERM
/DEV = LA120/WID = 511/PAGE = 255
/NOBROAD/SPEED = 9600/NOWRAP
! HP7550 plotter.
```

```
$ SET PROT = (S:RLWP,O,G,W)
/DEVICE LTA2:
! Only symbiont accesses LTA2.
```

```
$ SET DEVICE LTA2:/SPOOLED =
(PLOTQ1,SYSSYSDEVICE)
! Set device spooled for Q named
PLOTQ1.
```

4. Now start up the queue PLOTQ1 on LTA2: using form HP7550:

```
$INIT/QUEUE/START/PROCESSOR =
LATSVM/RETAIN = ERROR/DEFAULT =
(FORM = HP7550,NOFEED,NOBURST,NO
FLAG,NOTRAILER) /RECORD___
BLOCKING/ON = LTA2: /SCHED =
NOSIZE PLOTQ1
```

! If you are using a hard-wired port, leave off the /PROCESSOR=LATSVM.

5. Test print a file with:

```
$ PRINT/QUEUE = PLOTQ1 foo.file
! foo.file is my PLAYGIRL pin-up plot.
```

As for the HP7550, I didn't use any non-standard setup settings other than those to ensure that the baud rate is correct and the XOFF/XON protocol is enabled. The only other gotcha I can think of is an error in setting up the DECSERVER port. Again, it should be the same as for any other printer hooked up to a DECSERVER. Hope this helps. ■

Uncommon Screens

Annotations:

- MULTI-LEVEL MENU SYSTEM
- NESTED POP-UP FORMS
- SCROLLABLE REGION
- CHOICE LIST
- CLOCK
- POP-UP WINDOW
- RUNNING TOTALS
- MESSAGE WINDOW

Invoice Screen Content:

Invoices: Create Review Print Exit

INVOICE

Invoice No.: 008784 Date: 09/10/87 Time: 17:37:23

Customer: William Jones
Innovative Software
351 Bulletin Avenue
Needham, MA 02194
(617) 394-5512

No.	PRODUCT	DESCRIPTION	QUANTITY	PRICE	AMOUNT
5	WDXE	Windows for Data XENIX	2	1295.00	2590.00
6	WDUM3	Windows for Data MicroVax	1	2900.00	2900.00
7	WDUM5	Windows for Data Vax 785	1	4900.00	4900.00
8	WD3B2	Windows for Data 3B2 Unix	2	1995.00	3990.00
9			0	0.00	0.00

Subtotal: 14380.00
Shipping: 0.00
TOTAL: 14380.00
Payment: 0.00

Cursor keys scroll, ENTER selects and ESC exits choice menu

If you program in C, take a few moments to learn how Windows for Data can help you build a state-of-the-art user interface.

- ✓ Create and manage menus, data-entry forms, context-sensitive help, and text displays — all within windows.
- ✓ Provide a common user interface for programs that must run on different machines and operating systems.
- ✓ Build a better front end for any DBMS that has a C-language interface (most popular ones do).



FROM END TO BEGINNING

Windows for Data begins where other screen packages end, with special features like nested pop-up forms and menus, field entry from lists of choices, scrollable regions for the entry of variable numbers of line items, and an exclusive built-in debugging system.

NO WALLS

If you've been frustrated by the limitations of other screen utilities, don't be discouraged. You won't run into walls with Windows for Data. Our customers repeatedly tell us how they've used our system in ways we never imagined — but which we anticipated by designing Windows for Data for unprecedented adaptability. You will be amazed at what you can do with Windows for Data.

YOU ARE ALWAYS IN CHARGE

Control functions that you write and attach to fields and/or keys can read, compare, validate, and change the data values in all fields of the form. Upon entry or exit from any field, control functions can call up subsidiary forms and menus, change the active field, exit or abort the form, perform almost any task you can imagine.



OUR WINDOWS WILL OPEN DOORS

Our windows will open doors to new markets for your software. High-performance, source-code-compatible versions of Windows for Data are available for PC DOS (OS/2 soon), XENIX, UNIX, and VMS. PC DOS

versions are fully compatible with Microsoft Windows, TopView, and DESQview. **No royalties.**

You owe it to yourself and your programs to try Windows for Data. If not satisfied, return for a full refund. Call for **DEMO.**



**Vermont
Creative
Software**

21 Elm Ave.
Richford, VT
05476

Phone: (802) 848-7731 ext. 71

Telex: 510-601-4160 VCISOFT FAX 802-848-3502

ENTER 164 ON READER CARD

AP/20 Is Compatible With Q-bus VAX Systems

386-Based Attached Processor Increases VAX Speed Threefold

Avalon Computer Systems has developed the Intel 80386 that significantly improves overall CPU performance when added to a VAX system. Although the new AP/20 attached processor is compatible with all Q-bus VAX systems, it's expected to be used primarily by VARs who are developing systems using the MICROVAX.

By using the new 386 chip, the AP/20 attached processor increases the processing speed of the system by running CPU-bound programs on the attached processor instead of the host CPU. This results in a threefold increase in the VAX system's processing speed. According to Ross Harvey, a founder of Avalon, and its marketing manager, "In essence, the AP/20 is an asymmetrical multiprocessor that turns a VAX into a parallel computer system."

Off-loading computationally intense programs from the VAX to the AP/20 board is the product's major

advantage. Harvey explained, "Large FORTRAN programs and applications, such as computer graphics, CAD/CAM and simulations, are system killers. They significantly degrade system performance. With the AP/20, the VAX CPU is relieved of these number-crunching operations and its performance is improved substantially. In tests we conducted, VAX performance was improved by a factor of three."

The AP/20 runs at 3.5 to 4 mips and isn't affected by the load on the VAX. The floating point multiply time is 437 nanoseconds. It's compatible with any Q-bus VAX. Several AP/20 boards can be added to a single VAX. When multiple boards are used, performance is increased by a factor of 10 to 20, with as many programs being able to run concurrently.

No specialized programming is required to use the AP/20. It's available with C, FORTRAN and PASCAL compilers. Source code

changes aren't required and it's only necessary to recompile the source code using one of the Avalon compilers. The result is an image file that's accessed like any other VAX program, yet runs on the attached processor. Many VMS FORTRAN extensions are supported with programs running on the AP/20 without modification. AP/20 programs are written and executed in the same manner as host VAX programs.

The AP/20 has its own memory and operating system kernel. All user mode instructions, and many of the operating system functions, execute completely on the AP/20 with no transfers over the bus or loads on the VAX. The VAX interface is used only for program loading, I/O, and for system call pro-

cessing. Because all I/O is executed through the VAX operating software, changes in files, shared peripherals, and all other system features are extended transparently to the AP/20.

A one gigabyte protected virtual address space is provided. Four million bytes of real memory are standard. High-speed floating point is available as an option.

The AP/20 is designed simply to plug into an existing slot of the VAX using the same procedure that's used for peripheral devices. The price for the AP/20 is \$10,000.

For more information, contact Avalon Computer Systems, 425 East Colorado Blvd., #710, Glendale, CA 91205; (818) 247-2216.

Enter 432 on reader card

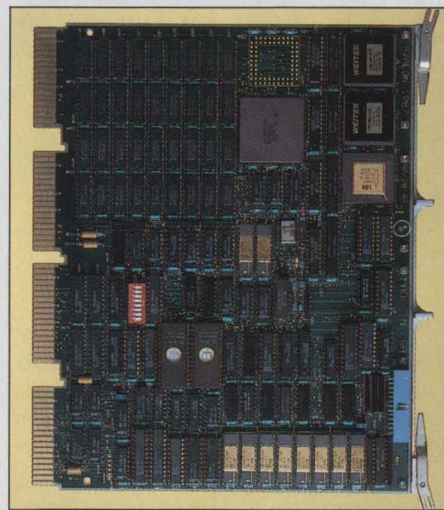

With the AP/20, from Avalon Computer Systems, the VAX CPU is relieved of number-crunching operations, and performance is improved substantially.

lab.
 on a
 are
 cause that's exactly what they've done.
VTERM/220 is, in our opinion, a master
 emulator of DEC's VT220/100 series terminals
 on the IBM PC and compatibles.
 Installation is a snap. Simply mail-

REPRINTED FROM
 DEC PROFESSIONAL MAGAZINE, MAY 1987

(WITH REVIEWS LIKE THESE, WHO NEEDS CLEVER HEADLINES?)

Find out why magazines like DEC Professional and PC Week and over 60,000 PC users appreciate the convenient yet powerful features of VTERM/220, VTERM III and VTERM/4010. Send in this coupon and see for yourself.

VTERM/220: Precise VT220, VT100 and VT52 emulation with full KERMIT and XMODEM file transfer and automatic reformatting of host files for insertion into spreadsheets and data bases.

VTERM III: VT100 and VT52 emulation with many of the convenient features of VTERM/220.

VTERM/4010: VT100 and Tektronix 4010 emulation for graphics applications. **VTERM***

ENTER 108 ON READER CARD

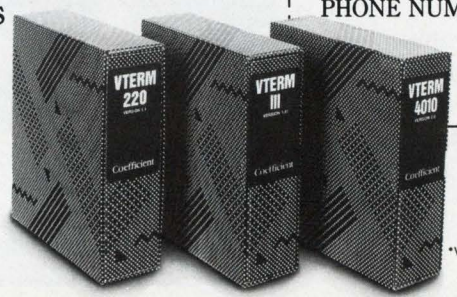

I would like to find out why magazines like DEC Professional, PC Week and others rate VTERM/220 so highly.

- Please send me the DEC Professional and PC Week reviews.
- Please send me information on your free 30-day evaluation of VTERM/220, VTERM III and VTERM/4010.

NAME _____ TITLE _____
 COMPANY _____
 ADDRESS _____
 CITY _____ STATE _____ ZIP _____
 PHONE NUMBER _____

Write: Coefficient Systems Corporation
 611 Broadway, New York, N.Y. 10012

or call **(212) 777-6707** ext **611**
 FAX: (212) 228-3137 TELEX: 6503156498

*VTERM refers to VTERM/220, VTERM III and VTERM/4010 from Coefficient Systems Corporation.

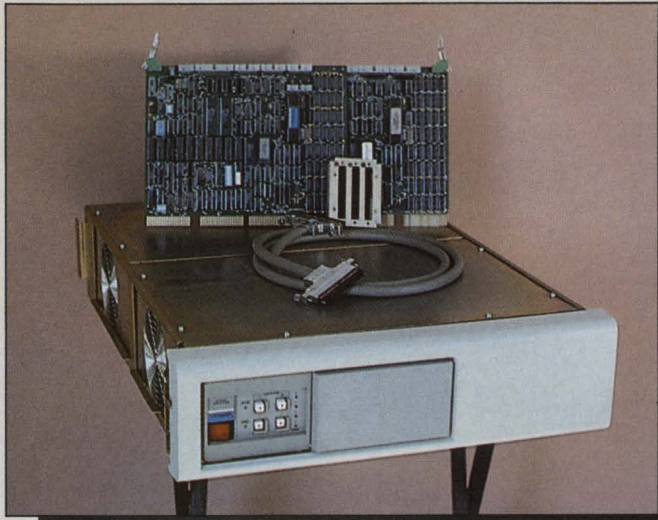

Users Gain High Capacity In Limited Space

UNIBUS Disk Storage System Joins The MasterDisk Line With Speed, Performance, Flexibility And A Two-Year Warranty

American Digital Systems has made the next move by adding a UNIBUS disk storage system to its MasterDisk line of high-performance disk storage systems.

According to Alan Kivnik, president of American Digital Systems, "For the last year, MasterDisk storage systems have offered the highest speed available in a disk system for Q-bus computers. Now we can offer UNIBUS users the same high-performance we've been providing to the Q-bus user."

Kivnik adds, "Our current customers are seeing dramatic performance improvements over their DEC drives. Many who have added MasterDisk have found they could add additional users to their system with no reduction in performance; all are finding disk

speed increases of 200 to 450 percent over their old drives."

MasterDisk is available in configurations ranging from 152 to 607 MB. It boasts an effective average access time of 7.26 milliseconds and a data transfer rate of 24 MB/second. This high performance is achieved by the use of Winchester disk drives (16 millisecond average seek) coupled to the controller that incorporates 1 MB of cache.

For those users who need high capacity in a limited space, MasterDisk's ADD-ON system comes with its own housing in a DEC BA23 floor stand, table top cabinet, or rack-mount package. The rack-mount package can be included in an existing UNIBUS VAX or PDP-11 system cabinet. For MICROVAX and MICRO/PDP users who need high capacity built into their micro cabinet, MasterDisk's ADD-

ON system comes with each disk drive mounted to a DEC skid plate for easy installation into a BA23 or BA123.

All MasterDisk products now come with a two-year warranty. With this new warranty, American Digital Systems leaps forward to be the first company to offer this in the DEC disk storage subsystem industry.

According to Kivnik, "I know our present and future customers will be pleased to hear this news. I always tell people that quality was the top priority when we designed MasterDisk, and that will continue to be true for the products we will be announcing in the next few months. We intend to offer the same warranty for all

future MasterDisk products."

All MasterDisk products are supported by Control Data Corporation's nationwide network of field service offices. American Digital Systems supplies all of the necessary diagnostics, formatting and verification utilities, and even a test cable. In addition, the company provides you with a complete installation tool kit.

The price range for the UNIBUS disk storage system is \$8,950 to \$20,950. A Q-bus version is available ranging from \$6,450 to \$19,950. For more information, contact American Digital Systems Inc., 75 Union Ave., Sudbury, MA 01776; (617) 443-7711.

Enter 481 on reader card

Datamedia Brings Good Things To Color

Colorscan/2 Allows Users To Switch Between Terminal And PC Sessions

The buzz word these days is workstations, and Datamedia Corporation is on the cutting edge with its Colorscan/2. This two-in-one workstation combines the capabilities of an IBM

Personal System/2-, PC/XT- or PC/AT-compatible computer with the communications and graphics capabilities of DEC's VT240 terminal.

Colorscan/2 features parallel operation in the DEC



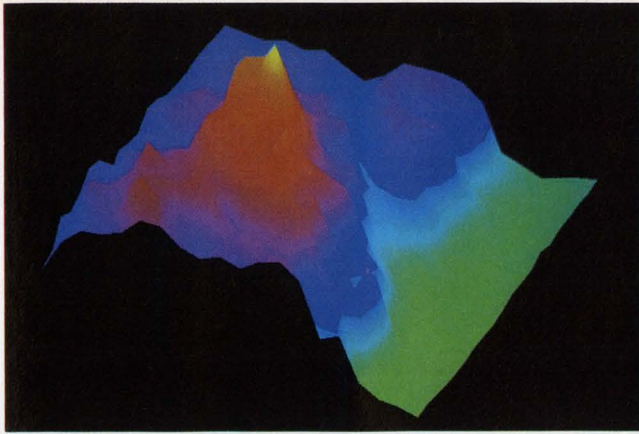

Local, interactive 3D manipulation of mapping data captured on a Tektronix 4129.

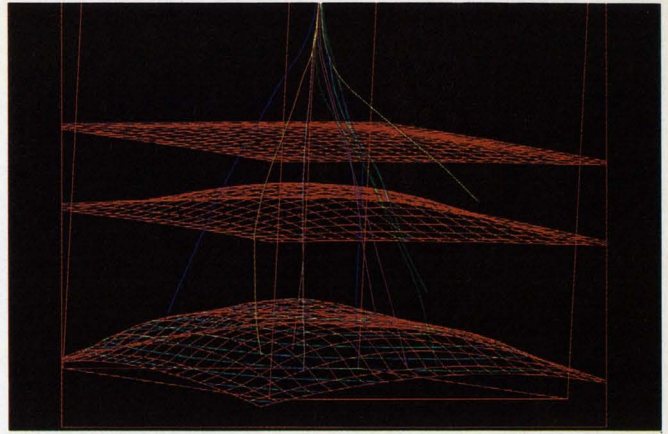

The 3D modeling capabilities of DI-3000 XPM are shown in this interactive drilling application.

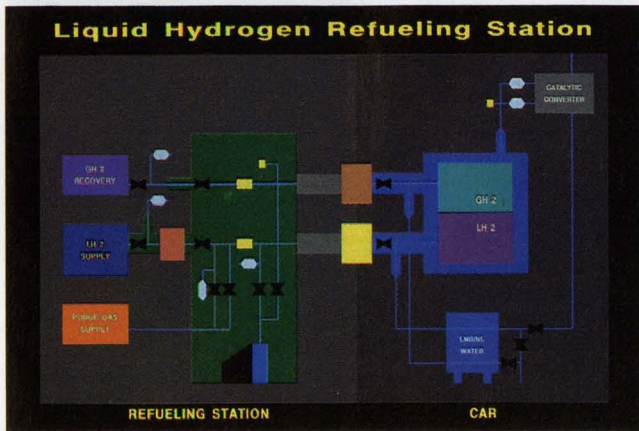

The DI-3000 XPM graphics database excels at process modeling applications.

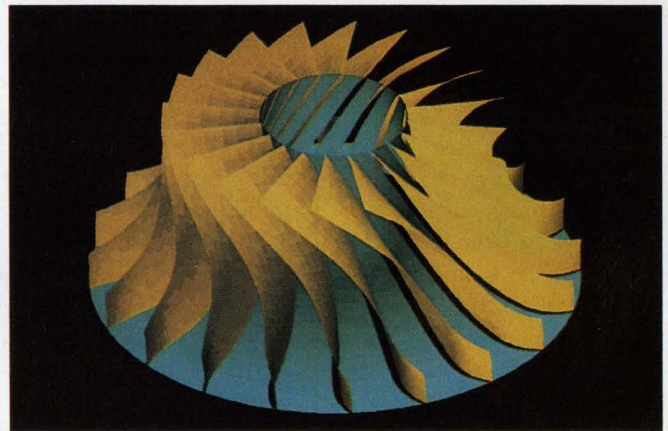

Using DI-3000 XPM, a turbine impeller is realistically rendered with local light source modeling.

Precision Visuals' DI-3000 XPM™

Graphics Modeling and Simulation Tools for Your VAX

The Product

DI-3000 XPM™ is Precision Visuals' flagship graphics tools product for creating 2D and 3D graphics application programs ranging from simple data display up to hierarchical graphics data management, and hidden line removal. DI-3000 XPM, which includes the powerful DI-3000® package proven by use at over 2000 sites, provides complete FORTRAN-callable subroutine tools for modeling and viewing. Industry-acclaimed documentation, product training, a HelpLine, and a team of Sales and Technical Support Engineers help speed your application development.

The User

DI-3000 and DI-3000 XPM are widely used subroutine libraries for developing engineering and scientific applications. DI-3000 XPM programmers have 2D or 3D applications that require: definition and repetitive use of graphics objects; updating of these objects and changing their relationships; changing spatial positioning, and manipulating selected subcomponents.

The Environment

DI-3000 XPM is machine and device independent, with initial support for the VAX/VMS environments. In the DEC environment,

Precision Visuals' products install automatically as run-time shareable libraries, allowing run-time selection of device drivers and efficient use of machine resources. Over 100 graphics devices are supported, including graphics terminals and hardcopy devices from Tektronix, DEC, and HP, as well as PostScript-supported laser printers. Prices for DI-3000 XPM start at \$5,500 on the DEC MicroVAX GPX; license fees scale up and down depending on CPU power.

The Features

DI-3000 XPM includes the entire DI-3000 2D/3D graphics subroutine library. For sophisticated development tasks, the XPM extension includes graphics data management based on the PHIGS output model, hidden line processing, and many extended primitives such as rectangles, ellipses, arcs, spheres, extruded polylines, extruded fill area sets, and solids of revolution. Graphics structures can be built, edited, and archived with or without images appearing on a graphics device. Output can also be displayed and rendered locally on Tektronix 41xx/42xx terminals by combining DI-3000 XPM with Precision Visuals' AddSys-3000™ software. DI-3000 XPM also supports a powerful name set filtering option for controlling the display and detectability of graphics picture components.

The Applications

DI-3000 XPM is a tool for programmers building design, simulation, process monitoring, and other applications including: Transportation or Communication Networks Simulation of Flow Phenomena Manufacturing Simulation Molecular Modeling 2D Layout Architectural Modeling Any Simulation Where 2D or 3D Objects Change Based on Events. Less complex applications can be fully addressed with the basic DI-3000 package.

The Story

To get the full story on DI-3000 XPM, including technical information and a complete list of supported systems and users,

Call Chris Logan at:
303/530-9000.



Precision Visuals®

Precision Visuals, Inc.
6260 Lookout Road
Boulder, Colorado 80301 USA
303/530-9000
Telex (RCA) 296428

Precision Visuals International
West Germany
Telephone: 49-69/6666 597 Telex: 17-6997150
United Kingdom
Telephone: 04427-76171 Telex: 826715

ENTER 147 ON READER CARD

VAX and MS-DOS environments, which allows the user to switch between them with a single keystroke. Colorscan/2 has incorporated IBM and DEC compatibility and functionality into a powerful and compact diskless workstation. It's designed as a platform for online information access and desktop business computing where timely access to several sources of information is essential. The Colorscan/2 also features color graphics capabilities.

According to Guy Daniello, president and chief executive officer of Datamedia, "The Colorscan/2 is more than a terminal or personal computer. It actually is two products in one, combining the features and applications of graphics terminals with the independence and large software library of personal computers, making it the multi-purpose workstation of the future."

Custom development of application-specific integrated circuits (ASICs) enables the company to combine several functions in one desktop unit. A proprietary hardware-supported mapping technique allows the Colorscan/2's microprocessor to be switched between tasks stored in different memory partitions. This enables the user to switch rapidly between applications without restarting the Colorscan/2.

It offers several features that allow the user to access and process information such as:

1. **Connectivity**—The Colorscan/2 features two RS-

232 ports for simultaneous communications with two hosts, and a parallel printer port. Two additional IBM PC/XT compatible expansion slots enable connection to local area networks (LANs) and external peripherals.

2. **Graphics**—The workstation supports IBM Enhanced Graphics Adaptor, (EGA) and has enhancements that enable the screen to be updated twice as fast as IBM's EGA and provide sharper characters. The workstation supports numerous operating modes and screen resolutions.

3. **Storage**—Colorscan/2 is available with several storage and memory options, including a RAMfile with up to 2 MB of internal battery-backed auxiliary storage; a credit card-sized non-volatile storage device, called a CARDfile; and an external 3.5-inch floppy/hard disk peripheral, called a DISKfile. All storage devices are MS-DOS disks and can be used to store and share a variety of data, such as spreadsheets, applications software and complex engineering diagrams. MS-DOS can be booted from any of these devices. The Colorscan/2's connectivity allows users to access and store data in corporate hosts, minicomputers and LAN file servers.

The Colorscan/2 lists for \$2,000. For more information, contact Datamedia Corporation, 11 Trafalgar Sq., Nashua, NH 03063; (603) 886-1570.

Enter 435 on reader card



Pan, Zoom, Draw And Erase With GP-220

Graphics Terminal Can Store Four Different Terminal Configurations

GP-220, a high-resolution graphics terminal from Northwest Digital Systems, features enhanced emulation of the Tektronix 4014 and DEC VT220. It offers two separate 200 KB display banks, each of which allows high-resolution gray-scale graphics or 75 pages of off-screen text memory. The terminal also features a completely programmable DEC VT220-style keyboard.

In graphics mode, the GP-220 boasts fast and accurate emulation of the Tektronix 4010 and 4014 and is compatible with graphing software packages written for Tektronix terminals. It offers 1024 x 780 resolution and includes functions such as pan, zoom, gray scale, animation, arc draw, seed fill, windowing, fill patterns, area erase, area move and more.

In text mode, the GP-220 offers emulation of the DEC VT220, VT100 and VT52 terminals. Additionally, the terminal allows convenient dis-

play formats of 80 or 132 columns by 24, 50 or 66 lines. The Off-screen Text Memory feature automatically stores 75 pages of text that may be scrolled back onto the screen at the user's command.

The GP-220 is designed for applications flexibility. Full-screen set-up menus allow extensive terminal configuration via quick and easy commands. A feature unique to the GP-220 is the ability to store four different terminal configurations in non-volatile memory making them available for instant recall. Other features include an 8 x 15 character cell, built-in print buffer, built-in mouse and digitizer support, local Find and editing functions.

The GP-220 terminal lists for \$2,195. Contact Northwest Digital Systems, P.O. Box 15288, Seattle, WA; (206) 524-0014.

Enter 482 on reader card
—Suzanne Garr

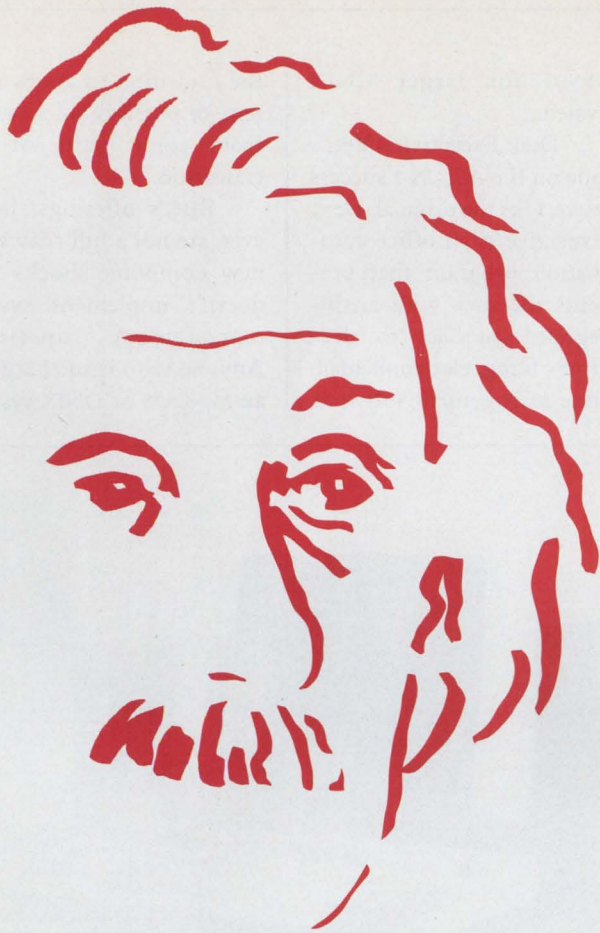

THE RELATIONAL PROBLEM JUST GOT SOLVED

PowerHouse[®] brings solutions
to typical relational
DBMS problems

Integrate new applications with existing data

New applications built in a third party relational DBMS won't necessarily integrate with your existing data. Because the PowerHouse development language supports both Digital's relational database and dominant file system, you're free to build new applications using Rdb/VMS and integrate them with existing ones built on VAX RMS. That means you're not 'locked-in' to a proprietary relational DBMS and 'locked-out' of your existing data.

PowerHouse provides compatibility and performance

Implementing relational technology can present compatibility and performance problems. Not with PowerHouse — it's tightly integrated with Digital's databases and operating system to guarantee you exceptional 4GL/DBMS performance. You can enjoy the combination of a fast-execution language and Digital-optimized databases, now and in the future. Your applications are completely compatible with all standard Digital software. And wherever Digital takes its hardware and software — your applications and data will go, too.

Development power for 'production' applications

PowerHouse gives you total development capability in one language, and not a collection of weak DBMS utilities and interfaces. Regardless of which Digital database you're using, PowerHouse gives you advanced, dictionary-driven development power. The power you need to prototype and build 'production' commercial applications, such as order entry, inventory tracking, and manufacturing — the backbone of your company.

And Cognos has a full service organization to back you up. For more information, call toll-free 1-800-4-COGNOS. In Canada, call 1-613-738-1440. In Europe, call +44 344 486668. Or call on any of our 38 Cognos offices around the world and find out why over 7,800 customer sites use PowerHouse.

COGNOS[®]

Cognos Corporation, 2 Corporate Place, 1-95, Peabody, Massachusetts 01960.
Cognos and PowerHouse are registered trademarks of Cognos Incorporated.
Rdb, RMS, VAX and VMS are registered trademarks of Digital Equipment Corporation.

Company Banks On Popularity Of VMS

Computer Shock And Change Are Eased With BBC's New Philosophy

Boston Business Computing (BBC) believes that VMS has become a comfortable, familiar computing interface for many people. BBC has implemented this philosophy by selling a line of software products for MS-DOS and UNIX computers that emulates some of VMS's functions.

VCL is BBC's emulation of the VMS command interface. It executes many of the verbs and features of DCL on non-DEC computers. At the simplest level, VCL translates a DCL command into the equivalent MS-DOS or UNIX command. An example is the DIRECTORY command. When VCL is running on a UNIX system, and the user types DIRECTORY, VCL executes an "ls" in UNIX.

A stronger feature of VCL, however, is that it goes beyond simple command translation. It also implements many of the user-helpful features of DCL that make it a powerful operating system interface. VCL includes symbols and logical names, command line recall and editing, user-definable keys, command files, lexical expressions, the DIFFERENCES and SEARCH utilities, and VMS-like help screens. VCL also allows you to type native commands (MS-DOS or UNIX), and pass them through to the operating system, for direct execution without translation.

VCL sells for \$195 in its

MS-DOS version, \$300 for UNIX workstations, \$1,000 for small multiuser UNIX systems and \$2,000 for larger UNIX systems. At this writing, VCL has been ported to many UNIX machines.

It's well known that people can become attached to an editing program and thus will resist change. There are even people who still use TECO, even though it's approximately four generations old. BBC hopes that its text editor, PC/EDT, can capitalize on this fact. PC/EDT is an EDT-like editor, allowing users to move from a VAX to an MS-DOS or UNIX machine while retaining their editor.

I used PC/EDT under MS-DOS and found it to be as advertised. While I didn't try every function of EDT, everything I did try worked as it should. PC/EDT also includes session journaling and recovery, user-definable keys, line and screen modes, and EDT-like help screens. It sells for \$250 on MS-DOS computers, \$995 for small multiuser UNIX systems and

\$1,995 for larger UNIX systems.

Desk Executive is BBC's ride on the *ALL-IN-1* success wave. Like the original, Desk Executive is an office automation program that presents the user with an integrated interface to electronic filing, electronic mail, time management software,

the transition to a new system, or possibly shield a user from some parts of the transition.

BBC's offerings, however, are not a full answer to new computer shock. VCL doesn't implement system management functions. Anyone who is in charge of an MS-DOS or UNIX system



BBC eases transition from the familiar to the new.

word processing, and other functions.

As with *ALL-IN-1*, one of the nicest features of Desk Executive is its ability to be customized by the user. If you have an application program that you use frequently, it can be merged into Desk Executive. You can modify the menu so that it presents the application as one of the menu options. It then will call the application when that choice is selected. Desk Executive sells for \$495 and only runs on MS-DOS computers.

These products should appeal to users who are uncomfortable with a complete change in their computing environment. They can ease

must learn the native commands. It's also likely that users at every level will find themselves having some interaction with the native operating system. A set of emulators can go only so far at hiding what is underneath.

BBC's products do offer an opportunity for people who would like to retain some old friends when they move to an unknown system. For more information, contact Boston Business Computing, Riverwalk Center, 360 Merrimack St., Lawrence, MA 01843; (617) 683-7920.

Enter 434 on reader card
— Charles Connell



With some databases writing a complex application can be a punishing experience.

VAX programmers can take it on the chin if they try to create applications using a database without a complete fourth-generation language.

You'll find them working in cumbersome, time-consuming third-generation ways.

The alternative is FOCUS—a complete fourth-generation language with its own powerful database manager.

FOCUS includes all the productivity tools your programmers need. They can write any application completely in FOCUS, without lapsing into any other language.

You can expect FOCUS to improve programmer productivity by a factor of ten or more.

Easy on the Mind

From the first day, programmers can learn as they

earn using a window-driven interface. Even old hands find this technique useful for super-quick prototypes.

Then, as knowledge of FOCUS grows, so does the

Applied FOCUS

Thousands of FOCUS applications run in all of these categories:

- Financial
- Accounting
- Tracking Systems (e.g., Inventory, Assets, Equipment)
- Marketing Analysis
- Sales Reports
- Personnel
- Payroll
- Strategic Planning and Analysis
- Research Studies and Surveys
- Order Entry
- Production Control

depth and richness of the language. You'll never out-grow FOCUS.

Big on Support

FOCUS presents a common language in the DEC VAX, IBM 370, Wang VS, UNIX and PC/PS environments. Applications are fully portable, and so are programmers' skills.

FOCUS has a large and independent user group. And we back FOCUS with local help lines in 12 regional offices, a central hotline, and a national network of technical support and training centers.

Protect yourself. Ask for more information on FOCUS. Call 1-212-736-4433, Ext. 3700. Or write Information Builders, Inc., Dept. I9, 1250 Broadway, New York, NY 10001. Without sticking your chin out.

digital
Cooperative Marketing
Program

ENTER 129 ON READER CARD

 **FOCUS**
Information Builders, Inc.

TEK 4200 SERIES TERMINALS

**HOW TEK CONNECTS
YOU TO BOTH HOSTS,
EVEN THOUGH THEY'RE
POLES APART.**

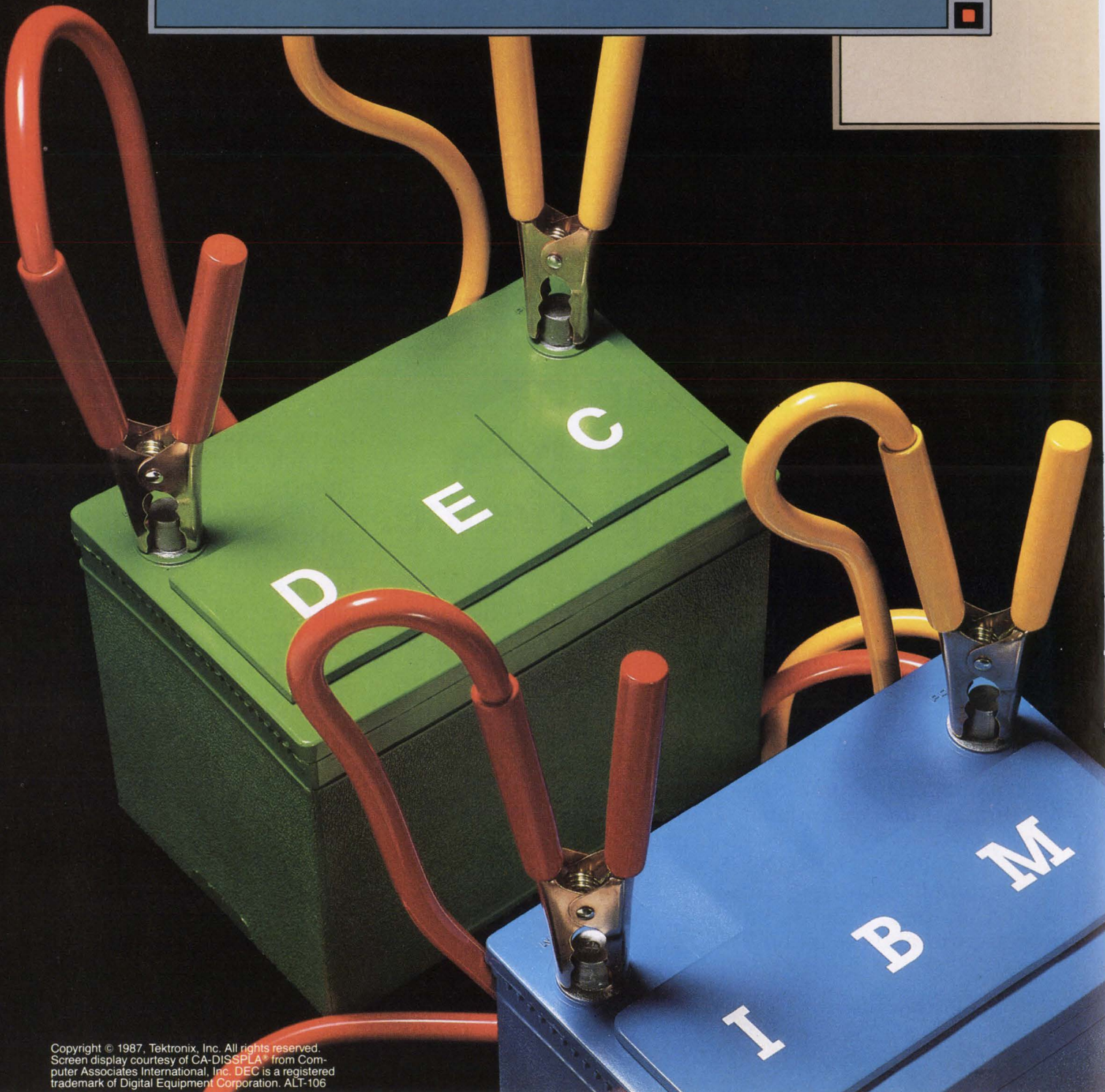

Typically, one host serves your business applications while another serves your engineering and database needs. Now Tek's 4200 Series gives you one window to them all.

Tek 4200 Series terminals let you switch between IBM and DEC hosts at will, and work with up to six databases at once.

You can work independently of the host, too: Among Tek's superb graphics capabilities is

extensive local intelligence that lets you go off-line to better utilize host resources. Local zoom and pan, for example, lets you view data well beyond display addressability.

Compatibility with over 175 leading software packages puts the 4200 Series in the mainstream of CAD/CAM, CAE, technical data analysis and business graphics. Bring your report, presentation and documenta-

tion hard copy to life with the 4200-compatible 4690 Family of color printers.

Available in 13-inch or 19-inch versions, as well as a super-tough industrial version, Tek 4200 terminals add the ideal graphic and alphanumeric solution to every station.

To learn more about the 4200 Series, contact your local Tek representative.

Or call 1-800-225-5434.

In Oregon, 1-235-7202.



Tektronix
COMMITTED TO EXCELLENCE

ENTER 157 ON READER CARD

Aniversaries are a good time to look back on what has happened and what you've accomplished, as well as a time to look ahead at what you might be able to do in the future.

Looking far back to 1967 when I first used a DEC computer, it was fun and still is fun. I liked the PDP-6 that taught me timesharing and Digital-style computing. DEC was a small company then, less than 1,000 employees and under \$100 million in sales. In 1987, just 20 years later, they are approximately 100 times larger. In 1972, I bought a DECLAB 11/40 for a scientific gait study center, complete with 16K of memory, an A-D converter and a VT40 graphics display — is anyone surprised that it's still running?

What is it that made DEC what it is today? What it will be in the next eight years? First, it's the style of computing that DEC pioneered back in the early 1960s. Minicomputers meant Digital computers, and interactive was how they worked. They were a success. The word leaked out slowly, then gained momentum through the 70s leading to an explosion in the 80s. The key to DEC computing was how it felt; no cards were fed to an operator, which delivered output hours (days?) later. DEC computing was hands-on and interactive, if you made a mistake, you knew it immediately. It was fun. It was productive.

No doubt about it, DEC got it right. That's number one. Getting it right once can give you an edge, but only for a while. But, Digital didn't sit still; the company built its current architecture, the VAX, to be compatible with each other and above all the computers were made to be connected together. Networking and connectivity became the watchwords of the 80s. Most companies only said the words while DEC produced computers that "have it now."

Clusters, Local Area VAXCLUSTERS, DECNET, Ethernet and gateways all are meaningful terms for DEC computers; they do it all. This is DEC's second coup; they have it right again. First minicomputers and now networking.

Staying number one in small computers has been difficult, but DEC is slowly closing in on the giant IBM. While they are still far apart, the gap is narrowing for IBM with alarming speed. While it used to be unthinkable that DEC could overtake IBM, now industry experts (besides us) are starting to see that possibility.

What will the next eight years bring? We foresee no major change in DEC, an evolutionary migration of the sales force into a more professional, customer oriented group is important for DEC's complete transition to be a key player in corporate computing. The VAX family will grow and its capabilities will expand. Networking will continue as a fundamental in connecting

all of a corporation together. IBM will be forced into a technology and architecture that will be new to it and its customers; it may or may not be successful. DEC's path for these years, however, is assured, made that way by clever planning and excellent execution.

When Digital started as a company it had less than five people and \$75,000 in capital. Today it is are a \$10 billion company with more than 100,000 employees and over \$1 billion net income. From this powerful base it can grow much faster and support that growth from a strong financial base. Ken Olsen recently re-

marked, "If our message ever gets across, we'll need all of our cash to support the demand." We think that the message is getting across, and that even more spectacular growth is in store for the future.

In eight years it won't be, "Can DEC be Number 1?" It will be DEC *is* Number 1.

8 t h A N N I V E R S A R Y

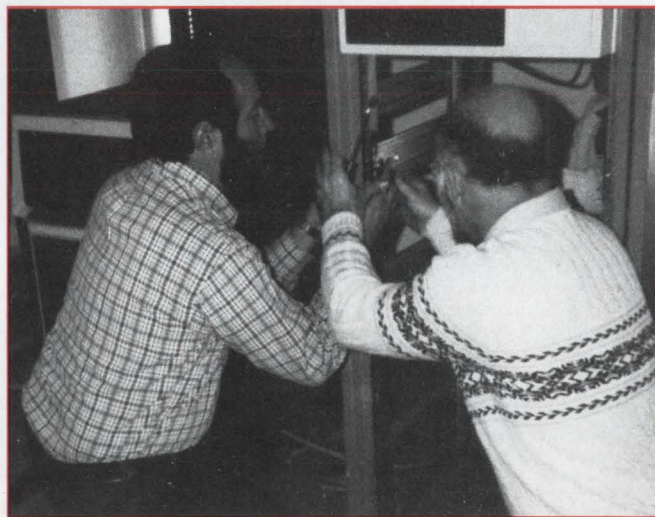

A Look Back...

by Carl B. Marbach

My first 11/70 came with the snow in December 1975. It cost approximately \$150,000 largely uninflated dollars, had 96K of memory (core, of course) and a gigantic 88MB RP04! Its serial was 5104 (Number 104) and its original backplane is hanging on the wall next to me as I write this. (It, of course, is still in operation 24/7, running the code I wrote for it in the fall of that year.)

When I attended my first DECUS the entire RSTS SIG fit into a small room. There was the usual assortment of gurus, each with a specialty in some arcane 16-bit type problem. Carl and I made our mark early on because we figured out how to optimize a disk structure. We used to give cook-book style lessons on how to do it by hand (there was no other way).

Time passed, and the RSTS SIG grew until it was filling a room meant for 600. Then, it began to contract again, as the 32-bit message sank in. Gurus went away as did the problems they addressed. Today, most of them actually are working on useful new things, rather than work-arounds to circumvent 16-bit restrictions.

We all, some more reluctantly than others, took the plunge into the icy waters of VMS. Icy they are, compared to the warm fuzzy world of RSTS. Each in turn has railed against the seemingly endless complexity of the operating system, and each in turn has overcome.

The beauty of VMS is that with each seeming complexity comes another level of freedom. I notice that the applications our programmers are churning out have a level of finesse and class that you never could have achieved in the old days, no matter how clever you were.

The restraints on RSTS were so great that either you traded programming ease for performance, or you spent loads of time re-inventing the wheel to buy a little more performance.

I was always re-inventing the wheel. I spent at least 40 percent of my time inventing things that come free with VMS. Programmers today spend no time on wheels, and all their time producing code.

Today's world has slightly different hardware constraints. When 88 MB was a very big disk, you designed your files differently from the procedures used today, when 1.3 GB is a fairly big disk, but another one costs only about \$15K (88MB cost \$30K in 1975). When all your programs had to fit into 32

KB, no matter what, and you had to pay the premium of overlays and endless linking, you tended to write in a certain style. Today, with free memory (\$600/MB versus \$100K/MB), that problem is gone.

My first 11/70 was as far ahead of my first computer (an RCA 501) as my MICROVAX is of my 11/70. The only thing that is changing now is the dt/dx (the rate of change). A generation now spans about 18 months. The MICROVAX III that we applaud today will be junk in mid 1989. (How's your new 8200?)

8th ANNIVERSARY



...And Ahead

by Dave Mallery

Our publications have grown and contracted with the DEC market. Our *RSTS PROFESSIONAL* was the guru's delight. It served that community in its hour of need, then went away... or should I say, followed its readers into VMS. Our late lamented *Personal and Professional* chronicled a brief and unhappy experiment in mass marketing, and died with the idea.

Today, *VAX PROFESSIONAL*, *The Software Journal For VMS* serves the VMS professional with today's mission: software excellence. *DEC PROFESSIONAL* continues to be the magazine that professionals keep around because reading it makes them better at their respective jobs.

We are growing. We use our DEC computers in new ways to create these publications for you. We will continue to grow technically as the community grows. Every article that passes my desk in the review process must pass a single test: I must learn something from it.

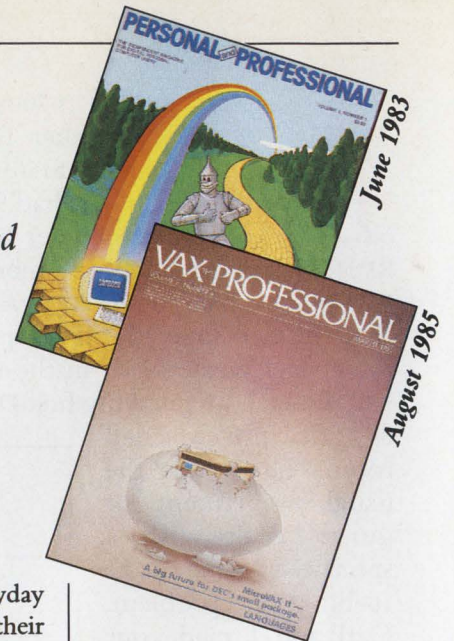

It Started One Day With An Idea And Soon Grew Into A Celebrated Eight Years Of Publishing.

PROFESSIONAL *press*

“A forum is a meeting place, a place for politics and speeches, a place for intelligence gathering and a place to do business; a place to learn and a place to teach. A forum that’s not crowded with people and full of noise and activity is a useless empty space. The *RSTS PROFESSIONAL* will be a forum only if you, the professionals, flock to it, use it, trade in it, and learn from it.” These words, written by Dave Mallery, appeared in Volume 1, Number 1 of *RSTS PROFESSIONAL* which was in print by the Fall DECUS in San Diego. That November/December 1979 issue became the first computer-specific magazine in history. *RSTS PROFESSIONAL* was the seed that sprouted into what Professional Press is today — publisher of *DEC PROFESSIONAL*; *VAX PROFESSIONAL*, *The Software Journal For VMS*; *HP PROFESSIONAL* and a series of technical books.

But where did that seed originate? In the winter of 1975, Carl Marbach, then with Jacob Stern and Sons in Jenkintown, Pennsylvania, braved a snowstorm to borrow a SYSGEN tape from Dave Mallery, then installing his first 11/70 computer system at his company, Nationwide Data Dialogue (NDD) in nearby Southampton. Carl’s computer was ready to roll when he discovered he had the wrong tape and DEC Field Service suggested he plow over to NDD and borrow the tape from Dave.

From this first meeting, Carl and Dave discovered a realm of common interests that brought them together at DECUS meetings. As both were “authors by inclination,” they were soon prominent contributors to DEC’s *RSTS SIG Newsletter* and frequent presenters at DECUS meetings.

At the time, DEC computer systems were growing rapidly, but their performance didn’t always keep up with the demand. Performance became a major issue. Because Carl and Dave were involved in corporate computing, both confronted per-

formance in their everyday jobs. Bringing together their experience from various resources and their own ideas, they presented a session at DECUS on performance.

This quickly became known as the “Carl and Dave Show.” The session included approximately 600 attendees and started at 8 p.m. It regaled the multitudes on every facet of RSTS performance until the wee hours. The session went on from there to be a full day and was presented both at the Australian DECUS and the U.K. DECUS in London.

Time marched on and fortune, lurking around the corner, presented itself in the spring of 1979 when Dave and Carl attended the New Orleans DECUS. The idea for their first magazine was born during a RSTS SIG meeting at which DECUS announced its plan to charge for the newsletter. The suggestion was met with an uproar: “Why not take advertising?” the throngs shouted! Why not?

In one of the great moments of publishing

history, Carl turned to Dave and said, “We need to make a magazine!” At that time, there were no DEC-specific publications. The only conduit of information was the DECUS SIG publications, and they were small and infrequent offset newsletters. The major source of information was at the DECUS Symposia.

Carl foresaw the need for a DEC-specific magazine to serve advertisers and readers. At the time, DEC’s market was relatively small, VAX was beginning to take off, and there was no cost-effective place for third-party vendors to advertise. DEC buyers were looking for a source of information and analysis. Thus the seedling took root and *RSTS PROFESSIONAL* began publishing.

When *RSTS PROFESSIONAL* was introduced at the San Diego DECUS meeting in November 1979, DEC management was shocked. “You can’t publish this,” was their first reaction to an article about operating system internals that advo-

DEC-Size Power, PC-Size Price.



The QUBE, Unbound's New Desktop Computer ... a powerful, compact and affordable entry-level system, compatible with LSI 11/23, 11/73 and MicroVAX II.

BREAKTHROUGH FOR INTEGRATORS! Now you can offer a DEC solution, priced like a PC but with more capability and expandability. In fact, this Q-Bus compatible is the most compact and affordable DEC-type computer available. It actually takes up less space than an AT—with far superior price/performance advantages. And UNBOUND's deep discounts mean better margins for you!

TRUE CONFIGURATION FLEXIBILITY. Modular design lets you start with the exact system you need, then grow anytime. A choice of powerful, reliable high-capacity peripherals includes fast ESDI storage to 760 MB and floppy disk, ¼" or ½" DEC TK-50 backup.

OPENS UP NEW APPLICATIONS. The QUBE's unique features, low cost, small size and big power are the keys. Dimensions: 6" x 14" x 14"—and weigh just 22 lbs. Even with disk, tape and optional carrying case the QUBE tucks under an airline seat. So you can take it with you to those important demos.

The QUBE is compact for business users, powerful enough for departmental computing. Ruggedized and transportable for lab, industrial and field duty. And perfect for custom data acquisition, with its high-speed performance.

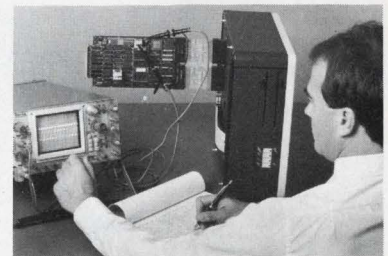

GETTING THE SQUEEZE FROM PCs? The QUBE gets you around it! Also, our high-powered/low-cost solution is well supported and highly reliable, thanks to time tested components. Find out more with a toll-free call. That's 1-800-UNBOUND. (In Calif. 714/895-6205.) Or write: UNBOUND, 15239 Springdale St., Huntington Beach, CA 92649.

UNBOUND

DEC, LSI 11, MicroVAX, TK-50 and Q-Bus are registered trademarks of Digital Equipment Corporation.

cated certain patches to increase performance. But by realizing that information distribution is good for everyone, DEC changed its attitude. And, many of the highest level DEC executives subscribed, even Ken Olsen, president and founder of Digital Equipment Corporation.

The magazine started out as a quarterly, supported by paid subscriptions. Pressure began to mount as

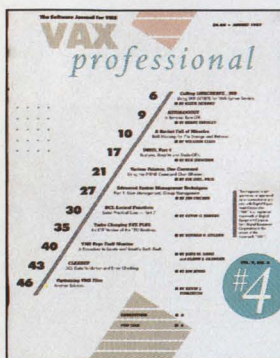

August 1987

readers demanded more and in 1980, RSTS PROFESSIONAL became a bimonthly publication. Between 1979 and 1981, growth was steady. Dave and Carl increased their activities in DECUS; gave seminars

throughout the country and overseas; founded the RSTS Rescue Squad, a service that saved logically corrupted disks; consulted in Australia, Canada and throughout the United States including solving a major problem with the four DEC computers installed in the Office of the President of the United States — one that DEC itself had been unable to solve.

According to Mallery, "During the '79 to '81 period, RSTS was maturing as an operating system, but was plagued with all the classic 16-bit address space problems. As people demanded more and more from their systems, they ran up against limitations. Anyone with experience in enhancing performance on a RSTS system became well known rather quickly."

By 1982, RSTS PROFESSIONAL had 10,000 readers and provided a media and advertising outlet that was responsible for the birth of a whole generation of DEC-specific companies. All the 16-bit problems had been fixed in the VAX, but it was still too early for the mass

migration. People were holding out and stretching their investments in RSTS and RSX.

As other computer-specific magazines followed RSTS PROFESSIONAL's lead, the time had come to pull even farther ahead. According to Mallery, "The writing was on the wall: Digital was going to make it big, and to be there when it arrived, we had to have a free magazine that dealt with every aspect of the corporation and served all the constituencies." The tough got going and in July 1982, Volume 1, Number 1 of DEC PROFESSIONAL made its debut.

Changes, developments and innovations continue to be trademarks of the computer industry. So Professional Press, to keep up with the times, changed RSTS PROFESSIONAL to VAX/RSTS PROFESSIONAL and then again to VAX PROFESSIONAL, The Software Journal For VMS.

That seedling that Carl and Dave planted in 1979 sprouted again in June of 1983 with Personal and Professional. The magazine focused

on choosing, using and adapting Digital Equipment Corporation's personal computer line. Personal and Professional delivered up-to-date news on current topics from

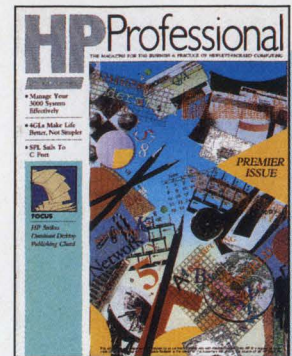

May 1987

hardware insights to software reviews. Unfortunately, as the DEC Rainbow market faded, so did Personal and Professional magazine.

As DEC PROFESSIONAL became implanted in the computer publishing field and known throughout computer circles for its technical excellence, the publishers of Professional Press planted yet another seedling. May 1987 marked the debut of HP PROFESSIONAL, serving the Hewlett-Packard market.

Understanding and anticipating the needs of the reader have made Professional Press Inc. the leading publisher in the DEC market, setting the pace and the standard for the industry. Publisher Carl Marbach and Editorial Director Dave Mallery see their mission as one to publish material that will help professionals grow in their everyday jobs. Professional Press celebrates its eight years of publishing with you our loyal readers.



All the Tools You Need For Motorola 680X0 From Whitesmiths

Whitesmiths, Ltd. now offers a complete set of 68K Cross Development Tools — specifically designed to work together — for the Motorola 68000 family of microprocessors. You get:

A C CROSS COMPILER

Whitesmiths' C Compilers offer the closest conformance currently available to the draft ANSI C Standard. We've added 68020 and 68881 support, and dramatically optimized code generation, so you can get the code quality you need today with the language you'll need tomorrow.

SUPPORT TOOLS

We have all the extras you need to develop embedded programs. Our powerful object utilities help you link multi-segment programs, build direct and sequential libraries, create load maps and interspersed listings, and talk to dozens of downloaders, emulators, and PROM programmers.

C SOURCE LEVEL DEBUGGING

We have the support you need to debug in terms of C functions, data types, and source lines. You debug what you write, not a lower level language.

A MICSIM SIMULATOR

You can debug your embedded programs right on your development host — our MICSIM Simulator needs no extra hardware. It's like debugging on your favorite emulator, but with no contention for dedicated resources, no download time, and with the symbolic breakpoint and trace control you've always dreamed of having.

AN XA8 CROSS ASSEMBLER

Our macro assembler is both fast and powerful, with support for 68020, 68881, and 68551.

A PASCAL COMPILER

You can program as much as you want in ISO Standard Pascal, or use the powerful extensions we've added to this production quality compiler. And you get complete integration with C and assembly language as well.

Working together, the 68K Cross Development Tools deliver both optimized performance and improved programmer productivity. Best of all, Whitesmiths offers everything you need at a very competitive price. We've been delivering and supporting high quality software development tools since 1978, and we're committed to continually enhancing our product line.

If you develop 68000 programs on a DEC VAX, an IBM PC, or a UNIX workstation, chances are we can save you time and money. For more technical details, call our toll-free number today. We also offer attractive packages for OEMs.



Whitesmiths, Ltd.

59 Power Road
Westford, MA 01886
617/692-7800

ENTER 168 ON READER CARD

TOLL-FREE
NUMBER
1-800-225-1030

DEC Milestones

1979-1987

1979

PDP-11/44 ■ LSI-11/23 ■ SBC-11/21

1980

VAX-11/750

1981

DECMATE 1

1982

DECMATE II ■ Professional 300
 ■ Professional 325 ■ Professional
 350 ■ VAX-11/730 ■ Rainbow
 100 ■ VT180 Robin ■
 VAX-11/782 ■ MICRO PDP-11

1983

LSI-11/73 (MICRO PDP-11/73)
 ■ VAXCLUSTER ■ DEC informs
 DECSYSTEM-10 and DECSYSTEM-20
 users that it's no longer developing
 these systems. DEC continues sup-
 port, but actively converts DEC-
 SYSTEM 10 and 20 users to VAX
 solutions ■ MICROVAX I
 ■ VAX-11/725 ■ DEC breaks into
 top Fortune 100 industrial
 companies list.

1984

PDP-11/84 ■ Professional
 380 ■ DECMATE III
 ■ VAX-11/785 ■ VT200
 ■ VAX 8600

1985

MICROVAX II ■ MICRO
 PDP-11/83 ■ DEC ceases development
 of its PC product line and begins
 R & D on an IBM PC AT-compatible/
 VAX-compatible low-end machine
 ■ VAX 8650 ■ DEC'S DNA protocols
 already are well matched with OSI,
 and its protocols are largely peer in
 nature. This process began in June
 1985 and is expected to be complete
 in June 1988 ■ By the end of 1985,

Charter Subscribers Look Back

■ Michael Mayfield, vice president of Research and Development at Northwest Digital, Seattle, Washington, received his first copy of RSTS PROFESSIONAL in 1979 at DECUS in San Diego. Eight years later, Mayfield is still a subscriber. He recently shared his views with Staff Editor Suzanne Garr. ■ ■

When did you first start reading RSTS PROFESSIONAL? How did you become aware of the magazine?

Dave Mallery and Carl Marbach introduced me to the magazine at DECUS in 1979. I found the magazine impressive as well as the fact that they started a whole new industry. There really was no place to go for information about your system. The entire RSTS community has Dave and Carl to thank for giving us the knowledge to do a better job.

What is your view of the change of RSTS PROFESSIONAL to VAX RSTS PROFESSIONAL and then to VAX PROFESSIONAL, The Software Journal For VMS?

At the time, the RSTS market as well as the DEC market was changing. More and more interest was in the VAX market. VAX/VMS is the vehicle for active involvement of new custom applications. RSTS PROFESSIONAL started out as a user-supported magazine and VAX PROFESSIONAL continues the tradition.

Can you provide me with an anecdote about your early days with DEC equipment?

When DEC came out with WPS-8, I told them that they could put it on RSTS. They commented that it couldn't be done; there wasn't a market for it. Then DPD and I designed the WPS-8 compatible, WORD-11.

How did you get involved in RSTS?

In 1973, I was attending the University of California-Irvine and worked on V4.A.

What type of hardware were you working on in 1979?

I was working on the PDP-11/45.

What system are you currently working on?

At Northwest Digital, we work on the PDP-11/73 and VAX.

Is there anything you miss about the old system of RSTS?

My feelings are: "The answer is VAX, now what's the question?" DEC's general philosophy is that the VAX is the answer.

Where do you see the direction of DEC and the third party going in the next eight years?

I see DEC concentrating more on Fortune 500 companies than on the traditional market.

■ David N. Witham, MIS director at A.H. Harris & Sons Inc., New Britain, Connecticut, started reading RSTS PROFESSIONAL in 1979 with the November/December premier issue. ■ ■

Can you provide me with an anecdote about your early days with DEC equipment?

We thought we were training DEC support people at the company's expense.

... Continued on page 40.

**Data Shuttle™ Family for use with
all computer systems**

Integral power supply
for all disk
configurations

MDB canister design
protects disk drives
from 100-G shocks

Compact 5¼" rack
height

Proprietary DC power-down
feature assures head retraction
and park when removing
drives, without elaborate
relays or solenoids

Canisters with or without drives
(Up to 760 MBytes per canister)

With or without
high-performance
MDB controllers

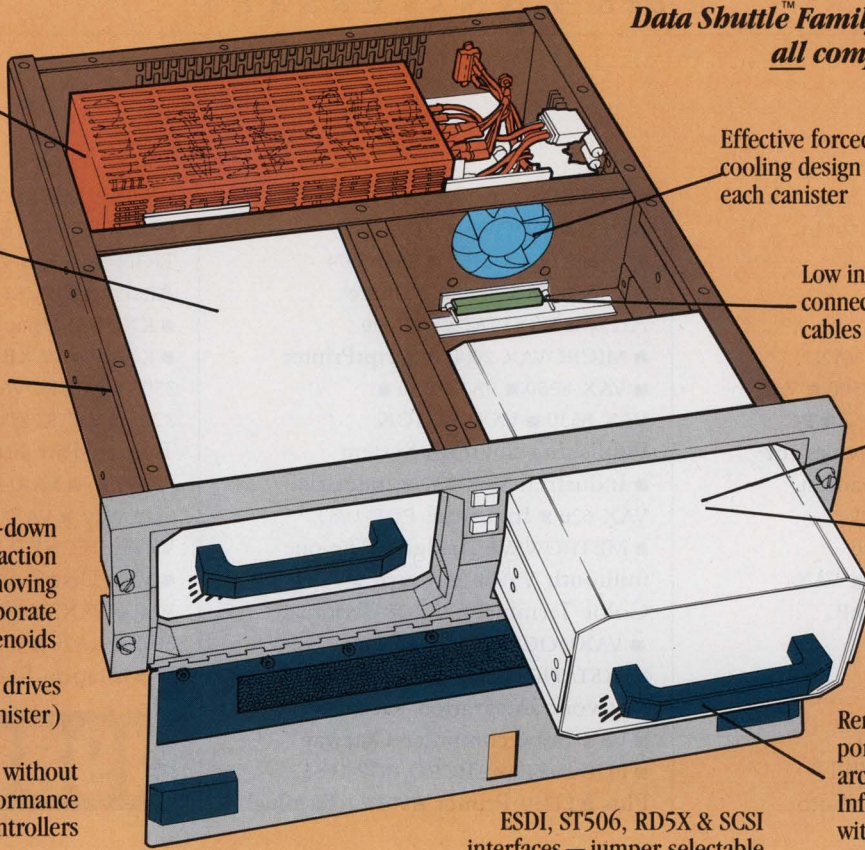

Effective forced-air
cooling design for
each canister

Low insertion force
connectors — no
cables to disconnect

Mounts any 5¼" device — Winchester
or optical

Unique shock
isolation of drives
for safe removal,
transport and
storage

Removability for
portability, security,
archiving, maintenance.
Infinite storage capacity —
with Winchester reliability

ESDI, ST506, RD5X & SCSI
interfaces — jumper selectable

The only commercial removable-drive subsystem with shock isolation, superior design.

See us at Dexpo West
Booth #269

**With quick-release
failure-proof
power-down feature**

DATA SHUTTLE 2000™ is the latest in MDB's removable-disk subsystems. Drawing upon real experience in airborne and shipboard ruggedized, militarized installations, MDB is able to offer proprietary shock protection in this affordable and functional package.

You'll get the new freedom of removability: large-capacity data portability, the ultimate in data security, easy software updating, file duplication, and maximum system up-time during disk replacement. It has a failure-proof power-down scheme that is automatically implemented when removing the canister.

Plus you get something else: ease of mind, knowing that MDB's unique drive mounts will protect your drives during transport.

That's why MDB will warranty the disk drives for shock-related failures for one-year — even if the manufacturer doesn't!

Call us about the configuration that's right for you.



DATA SHUTTLE 2000™

The only shock-isolated, low-cost design for commercial, lab and industrial applications.

DATA SHUTTLE 3000™

Rock-solid ruggedized for harsh environments, when you need durability, but not the added cost of Mil-spec.

DATA SHUTTLE 4000™

The peripheral subsystem of our Rugged Computer System (RCS-P).
The most ruggedized, Mil-spec, Tempest-certifiable unit today.

**MDB
SYSTEMS INC.**

— We put the State of the Art to work —

Corporate Headquarters 1995 N. Batavia Street, Box 5508, Orange, CA 92613-5508
TEL: (800) 556-0222 • IN CA: (800) 637-2028 • TWX: 910-593-1339 • FAX: 714-637-4060

FOR UNITED KINGDOM MDB Systems U.K., Ltd. Unit 13, Intec 2, Wade Road, Basingstoke,
Hants. RG24 0NE • TEL: 0256 464767 • TELEX: 858389 MDBSYS G • FAX: 0256 59748

FOR WESTERN EUROPE MDB Systems IRL., Ltd. Portumna Co. Galway, Republic of Ireland
• TEL: (0509) 41163/41413 • TELEX: 50918 MDBEI • FAX: (0509) 41447

ENTER 224 ON READER CARD

DEC had installed 3,700 networks with 206,000 devices on them.

■ 1986 ■

VAXMATE ■ VAX 8800 ■ VAX 8700 ■ VAX 8550 ■ VAX 8500 ■ VAX 8200/8300 Configuration 2 ■ PC ALL-IN-1 ■ VAX/VMS services for MS-DOS ■ LA75 Companion Printer ■ MUXSERVER 100/DECMUX II ■ RD54 Hard Disk Drive ■ Local Area VAX-CLUSTER ■ VAX DEC/MAP ■ DECMATE III Plus

■ 1987 ■

DEC is the darling of Wall Street. ■ VAX Data Distributor

■ VAX SQL Software
 ■ DECWINDOWS ■ RTVAX 8550 ■ RTVAX 8700 ■ VAX 8974
 ■ VAX 8978 ■ SA482 Storage Array ■ VAXSTATION 2000
 ■ MICROVAX 2000 ■ ScriptPrinter
 ■ VAX 8250 ■ VAX 8350 ■ VAX 8530 ■ VAXSTATION Publishing Solution System
 ■ Industrial VAX 630 ■ Industrial VAX 620 ■ Industrial PDP-11/83
 ■ METROWAVE Bridge ■ The one millionth VT220 terminal ■ VT340 Color Terminal ■ VT330 Terminal
 ■ VAXDOCUMENT ■ Color VAXSTATION 2000 ■ IBM PC Network Integration Package
 ■ VAX Supercomputer Gateway
 ■ PDP-11/84E ■ MICRO PDP-11/53 Plus ■ LJ250 Printer ■ VT320 Terminal

■ Three MICROVAX IIs ■ Two new VAXSTATION configurations: VAXSTATION II/GPX ■ VAX Source Code Analyzer ■ TU81-Plus Based System
 ■ KXJ11-C Peripheral Processor
 ■ KA620 ■ VAXBI 8750 ■ MICROVAX 3500 ■ MICROVAX 3600 ■ VAXSTATION 3200 ■ VAXSTATION 3500 ■ Unshielded Twisted-Pair Ethernet Adapter (UTPEA) ■ VAX Message Router/S Gateway ■ VAX Message Router V3.0 ■ DECNET System Services
 ■ VAX Distributed Name Service V1.0 ■ VAXSERVER 3500, 3600 and 3602 ■ RA70 ■ RA82 ■ TK70 ■ ULTRIX Workstation Software

1988 ...

Continued from page 38.

How did you get involved in RSTS?

We needed an on-line environment. DEC had a better approach and price. They handled communications more effectively. We were working on the PDP-11/45 in 1976.

What type of hardware were you working on in 1979?

We were working on the PDP-11/45.

What system are you currently working on?

We're currently working on the VAX 785, but converting over to the VAX 8530.

Is there anything you miss about the old system or RSTS?

Not at all. VAX is far superior.

Where do you see the direction of DEC going in the next eight years?

I think DEC is going to get more horsepower for less buck.

When did you first start reading RSTS PROFESSIONAL?

With the November/December premier issue in 1979. I still have the first issue on my shelf. I kept them all because they are great references. I continue to read DEC PROFESSIONAL today.

What was the intellectual environment like then and now?

In the beginning, the advancements were slower. The 11 line was around for a long time and the VAX was slow to take over. Now the changes happen every month and the support people are great.

■ ■ Carol Teague, director of academic computing at Eastern Kentucky University, Richmond, Kentucky, received her first copy of RSTS PROFESSIONAL in 1979 with the November/December premier issue and continues to read DEC PROFESSIONAL today eight years later. ■ ■

Can you provide me with an anecdote about your early days with DEC equipment?

I remember my first computer installation. It was a PDP-11/70 with 16 terminals and ordered by a University committee. We didn't know that you needed cables and cords and a room with proper air conditioning. This was my first initiation to add-ons and extras.

How did you get involved in RSTS?

In 1976 we had to choose between two systems, IAS and RSTS. We chose RSTS because it was great. It was very user-friendly.

What system are you currently working on?

We are still using the PDP-11/70; it just sits there and hums. But we also work on the VAX 785.

What was the physical environment like then?

The difference between now and then? There really is no difference. Our PDP-11/70 doesn't take up that much more room than the VAX 785. We thought back in 1976 that we could put our PDP-11/70 in a classroom, plug it in and let it rip. Not so; we had to get special plugs, cables and a properly air conditioned room.

Is there anything you miss about the old RSTS system?

The lights on the front CPU; they use to blink.

When did you start reading RSTS PROFESSIONAL?

Back in 1979 with the premier issue. I must comment RSTS PROFESSIONAL helped to keep RSTS alive when DEC was considering making the system obsolete. The editors did a great job.

What was the intellectual environment like then and now?

People's knowledge and attitude toward what they can do has certainly changed in the last eight years. Back then the computer was considered an interesting diversion. Today computers are necessary to life. Almost everyone will be exposed to computers and eventually use them in his job or everyday life.

Now with MNP™
Class 5 Error
Correction...

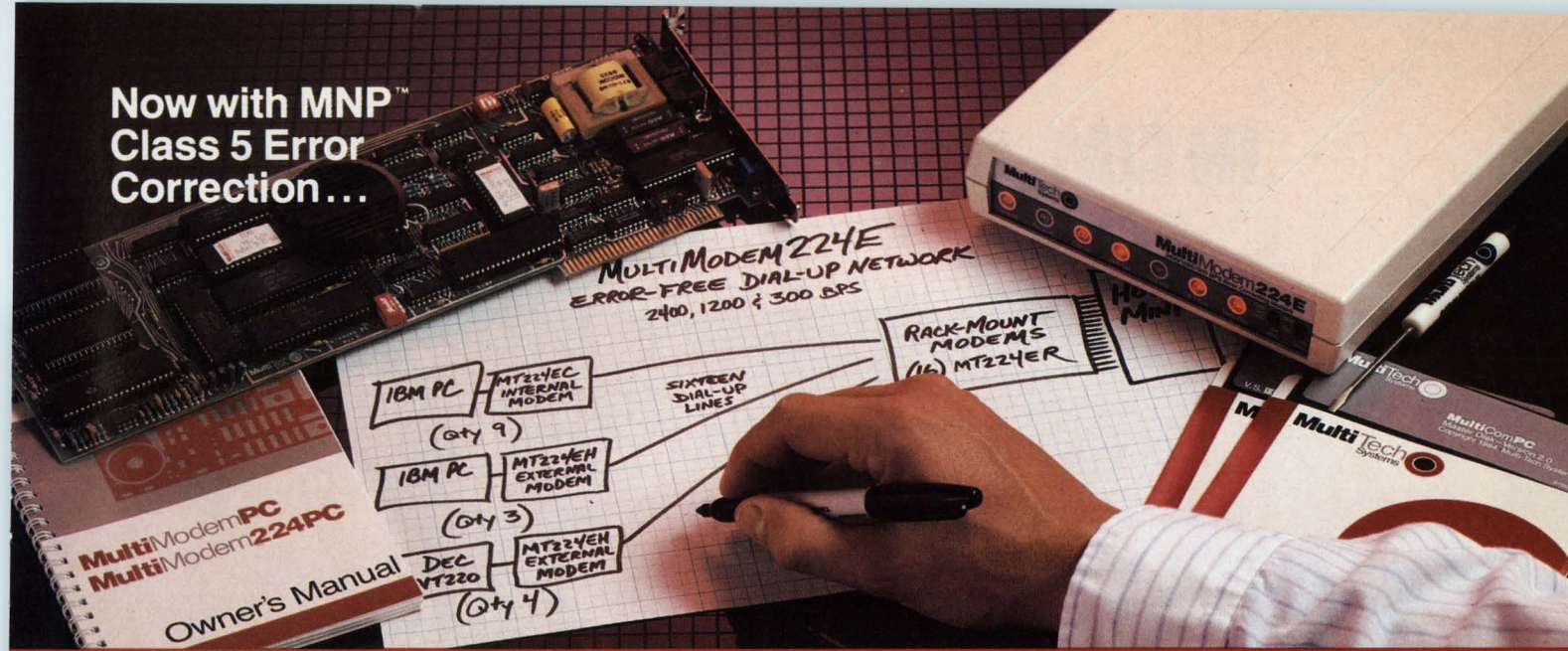

Error-Correcting 2400 bps Modems from Multi-Tech Systems: When it has to be as good as it is fast

- Dial-up 2400 bps modems have arrived. More datacomm users are upgrading from 1200 to 2400 than ever before. But there can be a flip side to increased speed: more transmission errors.
- That's why our MultiModem224E™ offers MNP™ error correction. Available in our 2400 bps desktop, internal and rack-mounted modems, MNP gives you 100% error-free transmissions, no matter how bad the phone line. MNP does it without the speed degradation of less efficient, software-based protocols.
- Another important point: MNP Class 3 has emerged as an industry standard. It's now in the public domain, and has been implemented in virtually all 2400 bps modems that offer error-correction.

● So, why buy error-correcting modems from Multi-Tech? There are many good reasons, including:

1. Multi-Tech modems are 100% Hayes-compatible (more so than Hayes' own 2400 bps modems*), and our MultiModem224E with error-correction costs less than a Hayes Smartmodem 2400™ without this feature.
2. Bonus features, like speed conversion, both synch and asynch operation, battery-backed option settings and phone number memory.
3. Versatility: the auto-dial/auto-answer MultiModem224E runs at 2400, 1200 or 300 bps, with or without error-correction, automatically!
4. Our two year warranty means something. Since Multi-Tech modems are designed and manufactured at our Minnesota headquarters (as they have been for the last sixteen years), you can be sure we'll be here when you need us.

● Please call us toll-free at **1-800-531-0019**, for additional information... get a modem that's as good as it is fast!

**InfoWorld-8/5/85-reprints available*

ENTER 233 ON READER CARD

Trademarks: MultiModem and the Multi-Tech Systems logo:
Multi-Tech Systems Inc. • MNP: Microcom Inc.
Smartmodem: Hayes Microcomputer Products, Inc.

Networx™

DATA PRODUCTS COMPANY, Inc.

Networx Data Products Company, Inc. • 188 Main Street • Northport, NY 11768
1-800-531-0019 • 1-516-754-2798 • FAX 516-754-2474 • Telex 6004981



IN CIM, OUR PROGRAM MANAGEMENT



SYSTEM LETS YOU DEC YOUR COMPETITION.



Companies like Alcoa, Ford Australia, Xerox and Volvo who are successfully implementing Computer-Integrated-Manufacturing are solving the problems commonly associated with CIM by using the MAPPS program management system.

They're using MAPPS because they've focused on the origins of these problems:



getting the right data to the right person at the right time from every man-

agement function involved from finance to MIS to engineering, manufacturing, marketing, and production planning and control.

A unique characteristic of MAPPS is that MAPPS is truly a management system rather than just a software program. Part of this system involves a built-in training and education program that successfully breaks down the traditional barriers between manufacturing, MIS, finance, and top management. MAPPS integrates the business objectives of CIM with manufacturing applications needs and MIS disciplines from the first day of training. As a result, functional relationships are strengthened. MIS comes to understand the problems of shop floor applications, while manufacturing comes to appreciate the software maintenance and documentation skills that MIS can provide. The result: much quicker implementation of your CIM program.

MAPPS program management software is modular to let you take full advantage of DEC's superior connectivity.

You can begin on DEC workstations for single projects and migrate upward into multiple projects and company-wide programs on DEC minis and mainframes. MAPPS' combination of flexibility and power, along with Mitchell Management Systems' unique training program, are two of the reasons why MAPPS received the 1987 Target Award as the best DEC-compatible project management software system from the 80,000 subscribers of Digital Review.

MAPPS power allows you to freeze the complex interface dynamics of CIM to reallocate resources, time, and costs, so your CIM system becomes operational more quickly and then delivers faster, more profitable production cycles.

If you're implementing—or thinking of implementing—CIM on DEC hardware, join the other Fortune 500 companies who are ensuring the success of that implementation with the MAPPS software system. For more information, call 1-800-336-3661. Or write Mitchell Management Systems, Westborough Office Park, 2000 West Park Drive, Westborough, MA 01581.

MITCHELL MANAGEMENT SYSTEMS

A subsidiary of URS Corporation.
Making Technology Work.™

ENTER 140 ON READER CARD

Tying Islands Of Automation Into CIM Systems

SCHICK RAZOR developed its CIM program with top-down commitment and bottom-up design and implementation.

BY DONALD E. STERN JR.

COMPUTER INTEGRATED MANUFACTURING (CIM) is the use of computers to streamline the flow of materials and information within a manufacturing organization. The goal of CIM is to increase productivity, product quality and manufacturing flexibility while decreasing cost and time-to-market. It's important to keep in mind that CIM itself isn't the goal, but instead a strategy to ensure the long-term survivability of the manufacturing organization.

CIM is the strategy by which manufacturers organize the various hardware and software components, such as robotics, machine vision, CAD, CAM and Manufacturing Resource Planning (MRP-II), into a unified system working toward the same goals. There is, however, no scientific formula for CIM. You can't expect to purchase a generalized CIM solution, only CIM tools.

Each organization must build its

own CIM system to fit its personality and organizational requirements. CIM implies more than getting the various pieces of hardware in the manufacturing process communicating with each other. Organizational and procedural flexibility is necessary in the CIM implementation process. Just as a CIM program is molded to the organization, the organization must be willing to change in order to realize the full benefit of a CIM implementation.

Just In Time

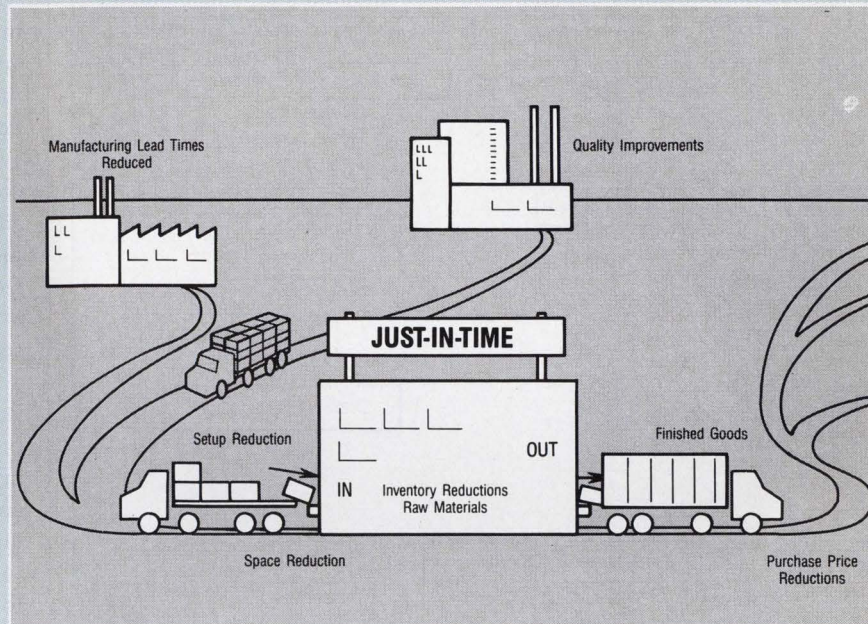

The acronym JIT is used for the phrase just in time. It refers to a methodology for operating a plant such that the materials needed to complete a manufacturing operation are delivered to that operation at the time they're to be used or "just

in time." The result of JIT manufacturing is a minimization of a company's investment in inventory and, therefore, the associated costs of carrying the excess inventory.

Companies usually have excess work in process (WIP) inventory to ensure that the manufacturing operation will flow smoothly and not be interrupted by material shortages. To achieve JIT a company must gain control of the entire manufacturing process from the raw material vendors to shipment of finished goods. A company must work with carefully selected suppliers so that the necessary level of quality can be assumed, eliminating or minimizing the need for receiving inspection. JIT delivery schedules must also be worked out with vendors to ensure on-time deliveries. Within the plant, each of the various manufacturing operations must be synchronized with subsequent steps in the process. Close coordination between the manufacturing operations is necessary. Quality must be monitored during the process rather than at the end.

To achieve JIT, a manufacturer must ensure that each step in the manufacturing process supplies the correct parts in the correct quantity to the next step. Too few, or the wrong parts, can shut down the operation, while too many parts will result in excess inventory. In either case, the costs can be enormous.

Over the past several years, CIM has been evolving at the Schick Razor and Blade manufacturing facility in Milford, Connecticut, an operating unit of the Warner-Lambert Company, a worldwide health-care and consumer-products company. Schick razors and blades are manufactured in Milford for the domestic market.

Schick has been developing its CIM program with top-down commitment and bottom-up design and implemen-

tation. Local experts in manufacturing, engineering, quality and information systems technology have driven the CIM effort. Major systems have been developed or purchased that touch, in some way, all functional areas of the facility. While some systems started as islands of automation, the goal has been to implement all systems with integration in mind.

The first commercial application of digital computers for many companies

is in the accounting and financial areas. A substantial portion of the total DP budget of several organizations still deals with the task of counting the money. In many large organizations, this is accomplished with centralized systems that run on mainframe computer systems.

During the '70s and '80s, as low-cost computers became available, digital computers found a place within the manufacturing environment. Now a

Figure 1.

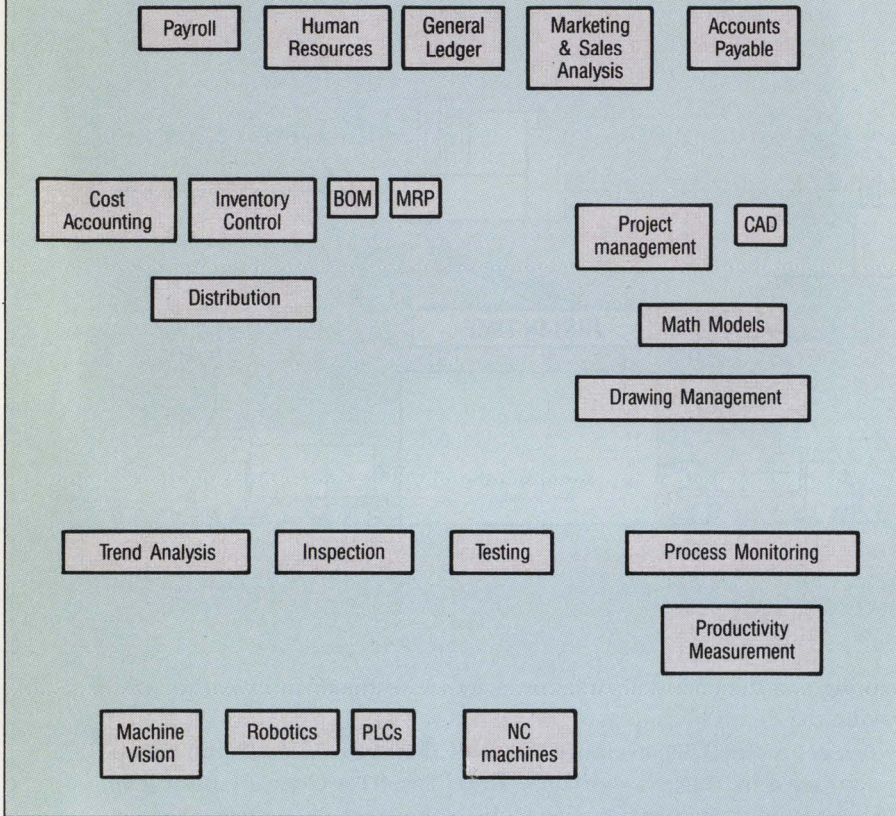

Typical islands of automation.

Figure 2.

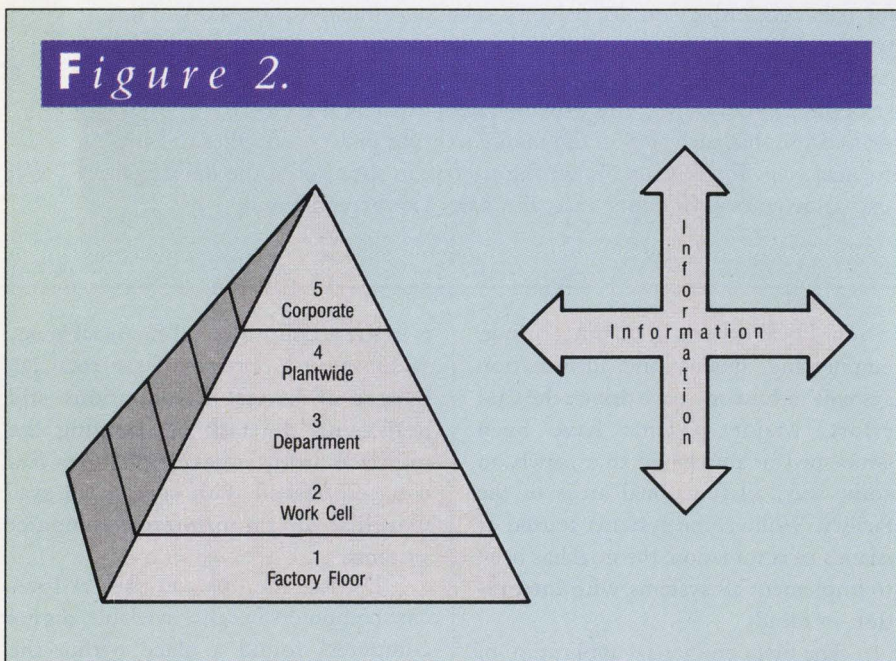

CIM pyramid.

viable option, specialized systems have been implemented to collect and analyze quality data, assist in the planning process, aid in the engineering design process, track productivity data, control machinery, track material movements, and more. The phrase "islands of automation" has become popularized and describes these disconnected, standalone systems (see Figure 1). Although low-cost computing has contributed to advances in planning, implementing, monitoring and controlling the manufacturing process, more is possible with a coherent plan for integrating these standalone systems.

The manufacturing environment isn't a set of disconnected, unrelated processes. Communication between individuals and functional units such as engineering, production, planning, quality and accounting, is a prerequisite to a well-managed organization. Information must flow freely and in a timely fashion; it must be accurate and available to decision makers when they need it. CIM addresses this key premise.

Analogous to the hierarchical structure of many organizations, the CIM Pyramid has been used to model the architecture of a generalized CIM environment. The pyramid is divided into five levels (see Figure 2). At the foundation, level one is the factory floor. Automated production equipment, robots and numerically controlled machinery populate this level.

Regulatory systems reside on level two. Using feedback data from level one, as well as setup and control data from the upper levels, the real-time control of the manufacturing process occurs here. Automatic gauging, microprocessors, programmable logic controllers (PLCs) and bar code devices are some of the hardware tools used at this level.

Level three represents the work center or department. Supervisory control is the function of systems at this level. Departmental computers and personal workstations are the hardware tools found here.

The fourth level contains systems involved with resource management.

Gray, Judy Krieter, Raedel Schrage, Tony Ha, Gene Taylor, Charles Thompson Jr., N...
 Wayne Garusey, Judy Skidham, Ron Paley, Pamela Gr... Philip Sa...
 H. Dean Huber, John Whalen, Eric Weinstein, Kari... James Dan...
 sh, Terry Anderson, Jeffery Lampos, Thomas D... am Engl... Patricia Borden, St...
 achman, Robert Lefeburk, Patricia... nicolo, Jeff Ru... ba Hocek, Al Me...
 tz, Wayne Nicholls, Ruth Ing... s, Bart Triesh, C... heppard, Tom F...
 vid Grimaud, William Stevens, G... ker, Beverly Peter... so, Ruben L...
 orah Kent, Keith Tolond, Michael S. M... n, Tom Meyer, Craig... n, Brenda...
 Lynn Shackelford, Geoffrey S. Perlma... ng-Ning Huang, Jan G... Miller, C...
 Donald Morin, Darlene Lindholm, Paul... ohn F. Sherman, Rich Will... J. Ec...
 y Black, Vince Currier, Wayne Smith, I... efebvre, Celeb Coleman, C... I. C...
 Lupton, Steve Schrammel, Edwin G... Robert L. Goetze, John P. Do...
 tevan R. Bronnier, Ginger Kaiser, Anne... Mike Hamill, Richard Harding, An...
 hultes, Jean-Francois Cloutier, Nadean... sen, Bud Aaron, R. J. Spencer, Beth...
 Jones, Joe Hobbs, Wayne Brubaker, S... Putz, Charles Cullier, Gerald L. Feldma...
 ane Pleier, Lynne Avery, Len Anderson... Lomoro, Bill Dengs, Robert Millanovich...
 ra, Steve Forrester, Brian Trethewey, D... ; David Zizza, Steve Harris, Mark Owens, D...
 ulekat, Ray McCarthy, Randy Treadway... torff, Ron Romberger, Scott Mones, Venu Rac...
 J. Gabbert, Michael Kantz, David Harm... Holt, Sheila Bre... ire Desormeaux, Vince...
 David Dowe, Peter Scaggs, Paul B. Codis... ow, Dave Cur... Crowley, L. Friedman...
 ek, Chris Scott, Dr. H. McCubbin, Peter... kwell, Ann R... Riedl, Barrie D. Brev...
 l, Violet R. Day, Gale Williams, Ed Coy... Robert De... hoefler, Ron Marks...
 ohn Chickering, Garth Oldham, Kathy... erg, Charle... benthaler, Denise Se...
 sen, Les David, Tom Ulrich, Steve Bell... osman, N... ser, Rip O'Neil, Richa...
 alho, Steve Steinfelt, Bob Rub... d Mc... R. Pemrick, Shawn Sp...
 Burch, Mark D. Sticht, Sue Ke... McMan... ary Hudson, Robert Lefe...
 Darice W. Lewis, Bryan Lanman, Steve Madden, Paul Klotman, M. D., Carl Bonaventupa, M. C. Clark, E. Aurand...
 James Johnson, Paul B. Godfrey, Marilyn Marchiono, T.A. Miller, Chuck Spoon, Al Doorfee, Anthony Garlin, B...

**RECOMMENDED BY DEC
 FOR THE VIP SYSTEM,
 AS SEEN AT DECWORLD '87****



OVER 15,000 DESKTOP PUBLISHERS MADE MICROTEK #1.

More sophisticated desktop publishers are using Microtek desktop scanners with their IBM-PCs and Macintoshes than any other. This was true in 1985, 1986, and is still true in 1987! Several independent surveys have verified this*: Over 15,000 have chosen Microtek manufactured scanners.

Why do more people choose Microtek? One reason is Microtek's product "family." You can choose from four different image scanners; plus Optical Character Readers; plus Fax communication tools; plus Raster to Vector conversion software.

*International Data Corp. and Dataquest reports.
 Macintosh is a registered trademark of Apple Computers, Inc.
 IBM is a registered trademark of International Business Machines Corporation.

Our family gives you room to grow with the confidence that all members will work together.

Another reason why over 15,000 desktop publishers have made us #1 is that Microtek products are more reliable, and more feature-rich than others. You can count on receiving more capability for your money with

Microtek. We are the choice of the serious user! Contact your local Microtek Dealer or call us to see why.



MICROTEK

16901 South Western Ave.
 Gardena, California 90247
 213-321-2121 800-654-4160

ENTER 239 ON READER CARD
 **MICROTEK is the CMP choice of DEC.

Figure 3.

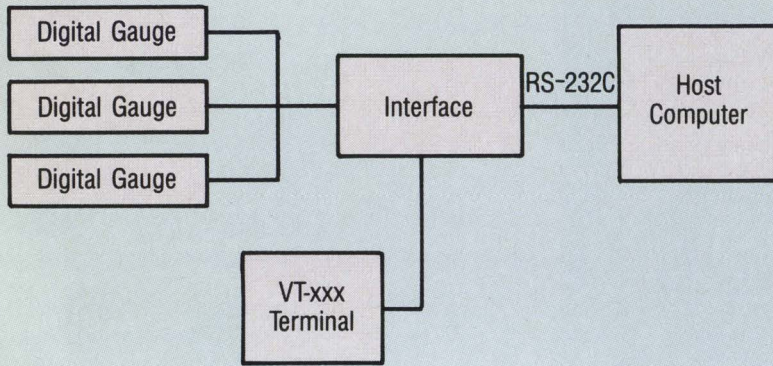

Concept for automatic quality data collection.

Figure 4.

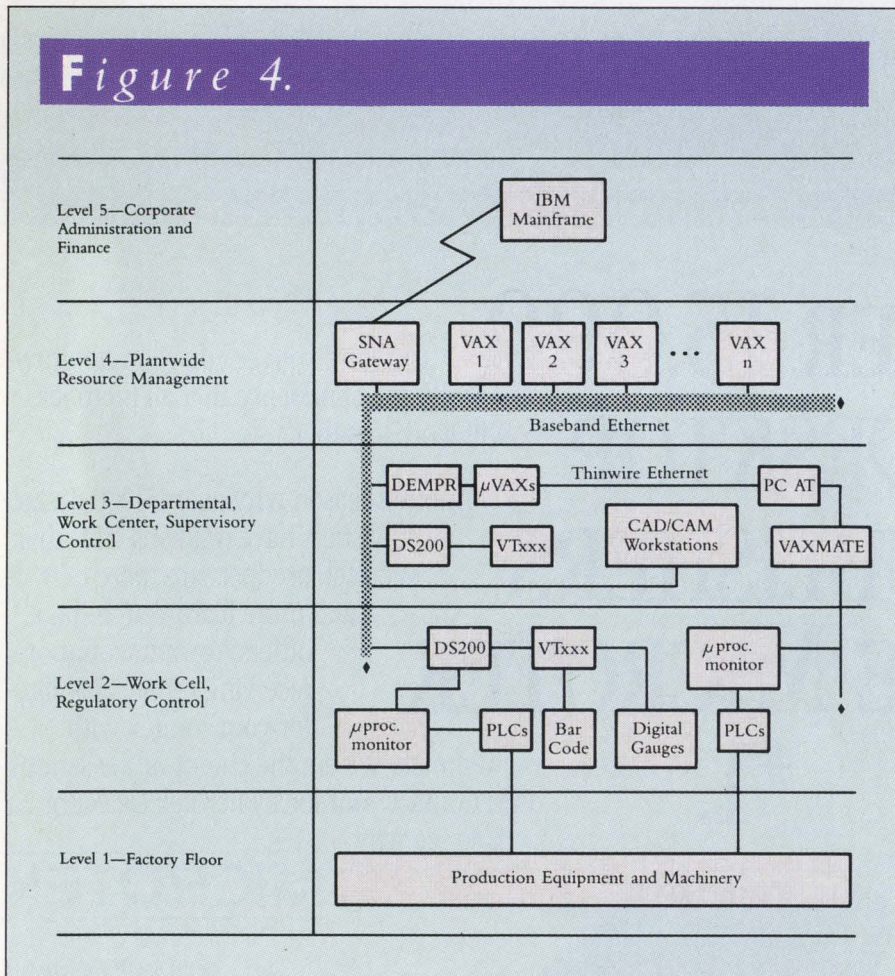

Simplified diagram of a CIM topology.

MRP-II and CAD are among the computerized systems that populate this level.

At the top level are the corporate systems. Inputs to systems at this level, together with external stimuli, provide information to top management for strategic decision making and communication back down to the plants.

Just as departmental responsibilities sometimes aren't delineated, the distinction between the levels isn't always clear; computerized systems can fill the continuum of organizational requirements for information. The pyramid is shown as an aid to understanding the requirements of a successful CIM implementation. A primary purpose of CIM is to facilitate the omnidirectional flow of information within an organization so that more timely decisions can be made.

Evolution Of A CIM Environment

Among the first of the islands of automation to be developed was in the area of automating the inspection process. Several years ago, the company made a commitment to a program of Total Quality Control (TQC). Early in our CIM implementation, the need for automation in quality assurance was recognized. Before implementing automated systems for the collection and analysis of quality data, quantities of data representing quantitative gauge measurements were recorded on paper by inspectors. This data was used in real-time to spot gross drifts in the manufacturing process, and primarily in hindsight to verify and diagnose a problem that already had occurred.

Gauges were modified so that their output could be electronically captured, and interfaces were developed to convert the gauge data into an ASCII data stream that could be transmitted to the host PDP-11 computer via a standard RS-232 line. An ASCII terminal also was connected to the interface providing keyboard access for the inspector (see Figure 3).

The PDP-11 also was introduced into the research environment at approximately the same time. Initially used for

real-time laboratory data collection and for machine vision inspection systems, the PDP-11 quickly became a general-purpose departmental computer.

As the number of applications and the subsequent demand for computing power grew, these PDP-11s were replaced with VAX systems and supplemented with personal computer systems. The diagram in Figure 4 illustrates

A PRIMARY
purpose of
CIM is to
facilitate the
omnidirectional
flow of
information . . .

how a Local Area Network (LAN) topology evolved and how this topology fits the CIM model.

We've found that centralizing data while distributing the data processing is a key feature to a successful CIM system. The hardware glue that binds our information systems together is an Ethernet LAN and a number of VAX systems. VT240/241 and VT330/340 terminals are connected to DECSERVER 200s and DECSA terminal servers that in turn are connected to the Ethernet. All of the VAX systems use the VMS operating system and are running DECNET.

The baseband network provides sufficient bandwidth to accommodate present and anticipated future data rates. One feature of this arrangement is that growth is managed because of the commonality of the VMS operating system across the VAX line and the ability to loosely couple the system in both high-end and local-area cluster configurations.

We've found that bridges and gateways are available that provide access to non-Digital equipment and to other

networks. An SNA Gateway, for example, provides a bridge between the LAN and the corporate mainframe computer.

With the availability of PC-based DECNET, personal computers have been added to the network. This promotes

data sharing and, through the use of virtual disks, enhances the security of data files. Because these data files reside on VAX systems, backup of the files becomes part of the daily routine.

It's widely recognized that CIM

CIM Architecture Terms

CIM — Computer integrated manufacturing includes the management of required resources; people, organization, material, energy, data, computer technology and automation equipment.

Architecture — A set of principles, rules and standards and other supporting data, classified and presented in a form to illustrate the arrangement and connectivity of parts of a system.

CIM Architecture — A set of principles and rules for selecting and developing products and standards that can participate in a CIM system.

Enterprise — A set of functions that carry a product through its entire lifespan from concept through manufacture, distribution, sales and service.

System — Describes something that has numerous interrelated components.

CIM System — Refers to an implementation of the CIM architecture to integrate an enterprise.

Subsystem — A collection of logically connected functions that implement a particular function in the system.

Task — The lowest level of functional decomposition of an enterprise that corresponds to the function of a single person or machine at a point in time.

Model — A synthetic abstraction of reality.

Application — A user- or machine-oriented function supported by automation technology.

Architectural Resources — The integrating elements used to build a CIM system. Resources can be categorized as interfaces, protocols or handlers and management tools.

Protocol — A formal definition that describes how data is to be formatted for communication between a data source and a data sink.

Function — A group of tasks that can be classified as having a common objective within a company.

Conceptual Model — An abstract representation of an object or phenomenon that provides a common understanding.

Human Interface — A tool able to intercept, interpret and guide the interaction of the end user with the system.

Message — A collection of one or more sentences and/or command statements to be used as an information exchange between applications or users.

Application Process — An element within a system that performs the information/data processing for a particular application.

Open System — A system that obeys public standards in its communication with other systems and/or between layers.

MAP Or Ethernet?

By providing a standard communications language and a shared medium, Manufacturing Automation Protocol (MAP) networks allow dissimilar computers and devices in factories to communicate with each other. With computers and devices able to communicate, manufacturing efficiency and flexibility is increased, helping companies reap higher returns from their investments in CIM systems.

MAP specifies a 10 megabits-per-second (Mbps) token-passing bus network operating on broadband cable. Its origins date back to 1980, when General Motors (GM) began investigating alternatives after determining that its point-to-point wiring system was expensive, inflexible and inefficient relative to performance. GM determined that linking all devices with a single, contiguous cable and allowing them to communicate with a common set of protocols was the best solution.

MAP on broadband satisfies manufacturers' most important factory communications needs: multivendor connectivity, predictable network access and response time, wide area coverage and multiple data channels.

Why MAP? The answer lies in the multivendor nature of most factories. Unlike proprietary networks, which interconnect devices from a single manufacturer, MAP's standards-based architecture allows a diversity of computers and production devices to communicate through a common set of protocols over a single cable.

With the worldwide, standards-based protocol system provided by MAP, manufacturers are free to select the best computer or tool for each production task, and not compromise the choice by having to accept whatever will run on the proprietary system.

Why not use Ethernet, an existing standard, as a factory floor network? The primary reason is found in the different network access methods used by Ethernet and MAP. Ethernet's carrier-sense multiple-access/collision detection (CSMA/CD) allows any station to send a data packet any time, creating the potential for packet collisions. While CSMA/CD is well suited for offices and laboratories, which have less real-time network traffic than factories, it's inappropriate for the task-dependent, time-critical environments found in production areas.

MAP's token-passing method provides predictable network access and response times because the token is passed in turn to all workstations. Because only the station with the token can send data, the possibility of collisions is eliminated.

Predictable access and assured response times help satisfy the wide area coverage requirement of factory networks. Many plants are hundreds of thousands, and sometimes millions, of square feet, and have hundreds of networked workstations. The performance of such a large system would be severely limited without assured access and response times.

Why broadband? With multiple channels, broadband is suitable for use as an enterprise-wide cable because it can support multiple types of transmissions, such as data, voice, video and utility. A typical configuration is to run MAP in factory areas over several of the broadband channels, Ethernet and token ring in offices and laboratories, and video and utilities throughout the company.

—Michael A. Gardner, Ungermann-Bass Inc., Santa Clara, California.

can't be mandated or managed by a large central MIS department, particularly if the manufacturing plant is at a remote facility. The end users must be involved in the development process. They must own and embrace the system; if it's forced onto an organization, it won't be accepted and successful. The active participation of the individuals responsible for manufacturing the product is necessary. Responsibility for identifying, justifying, acquiring and managing CIM systems within the plant has remained in the plant. As a result, local expertise in information systems technology gradually has been built up over several years.

Many CIM applications have been developed internally. At the start of the program, commercially available software didn't fit the applications. Additionally, because this was the first exposure to a computer system for many of the individuals involved, it was felt that a customized user interface would minimize anxiety.

With local computing experts coming from engineering and other technical backgrounds, it's not surprising that FORTRAN became the standard language used. *DECFORMS* products, FMS and TDMS, enjoy wide use in many applications. Extensive use is made of the VAX Information Architecture family of software products. While many older systems use RMS files for data storage, the newer internally developed systems use VAX Rdb/VMS or VAX-11 DBMS for data management. The Common Data Dictionary is part of virtually every system that we created. VAX *DATATRIEVE* is used extensively by programmers and end users for both standard reports and ad hoc inquiries.

To conserve prime-time resources, reports that aren't time critical are created during off-peak hours by automatic procedures that reschedule and resubmit themselves. In many cases, the reports generated are graphical; in these instances, either *DATATRIEVE* or *DECGRAPH* plots are generated. One internally developed application manages these reports and provides menu-

"It's easy looking at you, kid."



This is the screen that dreams are made of—the DEC-compatible ADDS 3220. Its unique 70Hz refresh display gives you a stunning flicker-free performance. Along with a presentation so brilliant your operators will be happy to work with it all day.

And you'll appreciate our supporting cast of bigger-than-life characters. Presented on a 14" flat green, amber or white screen, our easy-to-read double wide and double high/wide characters can be viewed in your choice of 80 or 132 column format. With operator selectable settings for brightness and contrast.

Brains and beauty.

But more than just a terminal that's great to look at, the ADDS 3220 gives you brains behind the beauty. Our DEC-style keyboard enhances the performance of your software. With value-added features like 22 fully program-

The person pictured above is a celebrity look-alike. The estate has not authorized or approved the use of look-alikes.

See us at Comdex/Fall - #2746, & DEXPO West - #1448

mable function keys and 256 bytes of non-volatile memory that help distinguish your product from the competition.

Naturally the ADDS 3220 is fully compatible with the DEC VT220, VT100, VT52, and ANSI X3.64. What's more, it won Digital Review's 1987 "Best Alphanumeric Terminal of the Year" award.

Screen test an ADDS 3220 today. It could be the start of a beautiful relationship. For more information, call 1-800-231-5445. In N.Y. 516-231-5400. Ask for Displays Marketing.

ADDS
Applied Digital Data Systems Inc.
A Subsidiary of NCR Corporation

100 Marcus Blvd., Hauppauge, N.Y. 11788

ENTER 102 ON READER CARD



driven user interface for uniform access to text, ReGIS, and SIXEL documents.

While several applications have been developed, we've found that the decision to develop software internally must be evaluated. With local programming expertise, it becomes tempting to create applications that are customized and precisely fit the organization. Even if the development costs can be justified, managers can't afford to ignore the long-term operating and maintenance costs associated with these systems.

Programming standards and structured methodologies can help control program development and maintenance costs. Strict enforcement of documentation standards becomes necessary to preserve the value of the application and to avoid unnecessary future maintenance costs. In short, managers with responsibility for plant-wide computing must apply many of the same principles that managers of large central MIS organizations have learned over the past 40 years.

Purchased Systems

In many cases it's not feasible to invest the resources necessary to develop and maintain some applications. At our facility, this was the situation for two systems, CAD and MRP-II.

After surveying the market, an Intergraph CAD system was selected by

the Engineering Department. Like the first internally developed systems, the CAD system was PDP-11 based initially, and later was upgraded to a VAX-based system. A VAX 11/780 supports 12 shared design workstations. Connected to the Ethernet, asynchronous terminal access is provided via the various terminal

CIM isn't and can't be just another computer system layered on the existing business . . .

servers on the network. A program called *Pseudostation* from Bentley Systems provides access to design files through VT240/241, VT330 and VT340 terminals. Similarly, a standard RS-232 line provides the link between the CAD system and a CNC system.

The most recent CIM application to be purchased is an MRP-II system. MRP-II, or big MRP, systems are relatively new and were preceded by little MRP systems. Materials Requirements Planning systems were designed to track current and future inventory requirements based on forecasted demands, known product structures and projected manufacturing output. MRP-II systems build on the shop floor control achieved with MRP, incorporating it with financial databases and routing information, to form a manufacturing planning system.

ASK Computer Systems Inc.'s MANMAN software was acquired because it provided the best fit to our manufacturing operation. The production of razors and blades is a defined set of processes. Unlike a work order-driven operation where the necessary

components are kitted prior to assembly, our products are manufactured according to a build schedule with work in process (WIP) flowing continuously among manufacturing departments. The plant operates on a just-in-time (JIT) system; a philosophy that components and supplies should be delivered to the shop floor at the time they are to be used. The MANMAN/REPETITIVE software permitted us to maintain this mode of operation. Key features of this software include the ability to develop and maintain build schedules and a utility that provides automatic component material consumption or backflushing when a production completion is reported.

From the local DP perspective, the product was attractive for a number of reasons. It ran on VAX hardware using a standard VMS system; it was coded in VAX FORTRAN; and it used VAX-11 DBMS and the CDD for data management. These features made it compatible with existing and planned systems. The vanilla MANMAN system has been supplemented with a number of custom reports. Because standard DEC VIA products were used, DATATRIEVE has been able to provide the primary mechanism for generating these custom reports. A decision has been made not to modify the actual code or database structure in order to avoid future maintenance overhead.

CIM isn't and can't be just another computer system layered on the existing business; it's a fundamental change in the way business is conducted. Top management, therefore, must have an understanding of the technology and how it relates to the overall business plan. Clear goals and reasonable expectations must be set if commitment to and support for CIM is to be sustained in the face of increasing global competition and cost of goods pressures. — Donald E. Stern Jr. is a manager of computer services at Warner-Lambert Company in Milford, Connecticut.

MANMAN

ASK Computer Systems Inc.
730 Distel Dr.
Los Altos, CA 94022
(415) 969-4442

ENTER 406 ON READER CARD

Pseudostation

Bentley Systems
180 Gordon Dr.
Lionville, PA 19353
(215) 524-9800

ENTER 407 ON READER CARD

CAD System

Intergraph Corporation
One Madison Industrial Park
Huntsville, AL 35807
(205) 772-2000

ENTER 408 ON READER CARD

ARTICLE INTEREST QUOTIENT
Enter On Reader Card
High 403 Medium 404 Low 405

Too many people
have been led to believe
only DEC[™] is experienced
enough to service
their computers.



For years, you've believed that only DEC has the expertise to service your computer. But that's just not true.

Because at Control Data, we've been in the computer maintenance business for over 25 years. And we fix everything from PCs to mainframes, even mixed peripherals.

So before you're led into signing another one of their service contracts, call us instead. 1-800-828-8001, ext. 58A. In Minnesota, 612-921-4400, ext. 58A.

 CONTROL DATA

Graphics Terminals

A CRITICAL link in automating the shop floor.

BY GARY CONNER

COMPUTER INTEGRATED MANUFACTURING (CIM) maximizes the efficiency of the production process from design through machining and beyond. CIM's power lies in the recognition of the information processing aspects of manufacturing. Overall efficiency depends on more than spindle speeds. New approaches help translate ideas into products. The computer plays a central role, aided by communication networks and protocols, and specialized software for planning, documentation, control and tracking.

The human-machine interface remains a critical link in the CIM process. The communication at the shop floor is

more than sending instructions to a machine; the machine operator is linked to engineering, quality, and scheduling data, allowing more flexible and accurate decision-making at the point of production.

The optimum human-machine interface is the graphics terminal. Instead of burying the machine operator with tabulated data, charts and graphs can be displayed quickly. Instead of paper drawings that are difficult to keep clean, let alone current, online computer file access and graphics display give the operator instant access to any engineering data required. Any conceivable format for instructions, data display or

advisory information can be programmed to appear on a graphics terminal. This flexible approach allows the same interface device to serve multiple applications and to support any improvements made to the system software.

The Graphics Connection

The integration of production systems depends on meaningful, comprehensive and reliable communication within and among key production tools and processes. Experts agree that CIM is most effective as a function of timely and task-specific information exchange between a company's design, production,

scheduling and manufacturing departments.

Numerous obstacles, however, prevent its immediate attainment. One problem has been the burden of too much information taxing both design and manufacturing capabilities. Too little information between design and manufacturing functions is unacceptable. Too much information also is problematic; it can overload the system and limit the ability to deal with the very data necessary to bring about a more productive relationship between the design and manufacturing processes.

The solution is the increased use of computer graphics terminals and graphics software to focus only on the pertinent and relevant job-specific information for the immediate shop floor task at hand. When used properly, graphics terminals act as selective optical filters, offering the shop floor targeted access to specifically desired information within the engineering database. Timely and precise information in a compre-

hensible format is immediately available to operators on the production floor.

Instructions generated from the design database and graphically portrayed on a graphics terminal screen are the optimal way to communicate this essential information. The result is improved accuracy with a reduction in waste, scrap and rework, and decreased paperwork and handling.

Computer graphics terminals linking the shop floor with design, engineering, marketing and other corporate functions decrease product development time and expense. The graphics terminal is *the* emerging critical component moving us closer to the factory of the future.

Why More Automation?

Numerous obstacles and problems need to be overcome before CIM is realized fully. It's useful to review some basic assumptions concerning increased shop floor productivity.

The motivation for increased manufacturing automation is the same as

for the original industrial revolution.

Automation is the way to increase productivity and improve manufacturing accuracy. It thus enhances product quality, eliminates dangerous and boring work, and reduces labor, material and operational costs. Particularly noteworthy is the need to bring the efficiencies of mass production to small batch production. Competition with automated foreign manufacturers has increased U.S. acceptance of the need for more shop floor automation.

Automation is production in which certain operations are carried on automatically under direction of programmed controls. Automatic control systems on the shop floor began in the late 1940s with transfer machines for moving and positioning large objects on a production line.

In the 1950s, control systems were primarily analog-type instruments providing feedback from a single point within the scope of a machine's task, and providing correction of any opera-

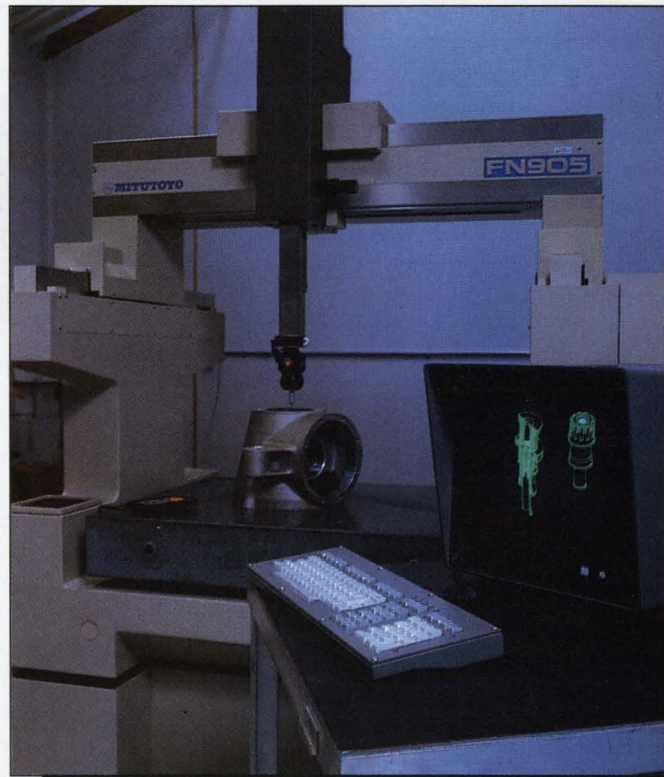
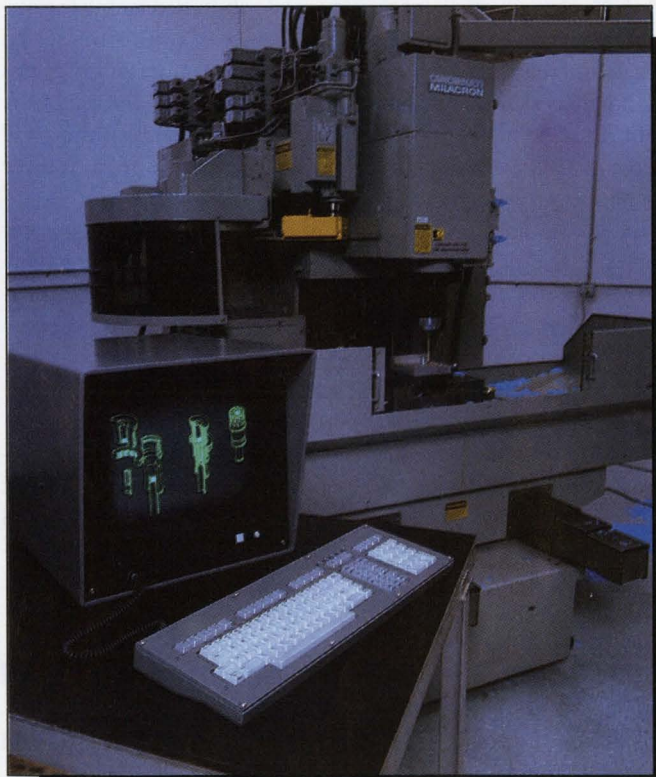

Photo A (left) shows a terminal from Graph-On Corporation, Campbell, California, in use with a flexible manufacturing cell (FMC). In Photo B the terminal is in use with a computerized part measuring station.

tional deviance to a single point. The "total" control system was simply a collection of such devices. Analog control systems provided information about plant production conditions, but required manual operation and adjustments to correct problems.

Automation of the factory environment progressed with the increasing use of numerical control (NC) systems, a process controlling the action of machines through direct insertion of numerical data on punched cards or tape into the shop floor production tool. The machine then automatically interprets at least some portions of this data, receiving instruction in the proper sequence, kind of operation, feed rate and other tasks. Most NC-controlled shop floor machines are semiautomatic, requiring an operator to, at the very least, load, unload and supervise the operation of the device.

Computer Numerical Control

To be fully automatic, a machine tool must be capable of producing parts repetitively without operator assistance in loading, starting the machine and unloading. The addition of digital computers to computer numerical control (CNC) brought the shop floor a step closer to full automation.

The advent of CNC made clear the computer's actual and potential role in controlling the production process. Computers could supervise the production task by changing set parameters externally, depending on conditions. Digital computers could provide direct control of specific operations by replacing a group of analog controllers. Ideally, computers could exercise both supervisory and direct control, resulting in complete hierarchical control of all operations of any particular shop floor device.

Flexible Manufacturing Systems

Flexible manufacturing systems (FMS) operations follow a predetermined sequence of steps in making a product. Flexible manufacturing systems are a step closer to true factory automation

because they're designed to be programmed and reprogrammed easily and cost effectively in order to produce different parts or products. The FMS operation is less labor intensive, has lower setup costs, shorter lead times and requires lower inventory levels than less efficient production modes.

While components of any batch

FLEXIBLE
manufacturing
systems (FMS)
operations follow
a predetermined
sequence of
steps in making
a product.

processing system spend 90 percent of the time queuing for time on a tool, FMS allows automated manufacturing of components on a random basis. Aggregate production volumes can be high enough to justify the cost of FMS even though individual part volumes are low.

An integral part of FMS is computer-controlled materials handling systems, which include robots, towline and wire-guided self-propelled carts, overhead cranes, and variable speed conveyers. These allow items to be moved between production stations. By enabling the automation of low-volume production, FMS holds the key to the workerless factories of the future.

Arthur D. Little Co., a research firm, claims that by 1992 CIM will be a \$100 billion market with 35 percent of all U.S. manufacturing production suitable for some kind of CIM support. Major CAD/CAM vendors have committed substantial investment in developing turnkey CIM systems. Major end users like General Motors, General Electric and IBM currently have fully automated

plants with more to come. Competition, especially from Japan, whose 36,000 industrial robots outnumber the estimated 6,300 currently at work in the U.S., intensifies the pressure on American manufacturers to increase their commitment to CIM.

The Graphic Terminal's Role

Some information about a production process still may be missing from the manufacturing database. In many cases, however, the problem is finding a way to communicate the existing information within flexible manufacturing cells (FMCs) and among larger work centers within the production process. Computer graphics offers an ideal method of abstracting extensive quantitative information into readily understood pictographs.

There are numerous examples of computer graphics facilitating communication among and within FMS and FMC operations. At General Motors, a technician at a graphics terminal soon will be able to call up a moving image of an industrial robot, determine the optimal path of its work task on the screen and download any number of programs to the robot on the assembly line. Off-line graphics aided programming will cut the time to train a robot from three days to 30 minutes.

At a General Electric dishwasher plant, a DEC PDP-11/44 computer supervises assembly. Custom software provides a color graphics display of every machine on the floor and locates parts, subassemblies and other components.

In order to make possible a just-in-time (JIT) inventory schedule, eliminating the need to have large quantities of materials on hand, comprehensive and timely inventory data must be consistently available and comprehensible. Graphics aids in that function.

The Shop Floor Graphics Terminal

While graphics terminals allow production personnel to comprehend data and act on it quickly, on the shop floor, graphics terminals must have performance capabilities exceeding those re-



VAX 8500 VAX 8800

EMC²

EMC CORP NATICK MA 01940

EMC's New 8000 Series Memory Upgrades Are A Lot Like Digital's. Except They're More Advanced, Better Serviced And More Reliable.

At last, you have an alternative when it comes to memory upgrades for 8500 up to 8800 VAXes. From EMC, the company that's been everyone's favorite all along.

In addition to saving you about 20-30 percent, even more if you've earned EMC trade-up credits, they'll impress you in ways you've come to expect.

For starters, our modules use the latest 1Mbit chips instead of older 256K RAMs. Which means our boards are inherently more reliable, since they use about 1/4 the number of connections.

And while we're on the subject of reliability, consider our stringent testing procedures. After burn-in, each board spends at least 24 hours running test patterns and diagnostics in one of our own VAX™ 8000 Series computers. Which is more quality control than even Digital provides.

What's more you'll get some pretty comforting guarantees from EMC.

We guarantee delivery to meet your demands. And we guarantee our boards for the life of your system. If you even suspect a problem, just give us a call. You'll have a replacement in your hands overnight. Or, you can select one of our priority

service plans. In either case, you can return the suspect board after the replacement arrives.

And finally, we can just about guarantee, you'll like working with us. You get the commitment of an industry leader. The financial resources of a \$100+ million corporation to back that commitment up. And the comfort of knowing we have the best track record in the business.

So when your VAX 8000 Series,* or any other VAX for that matter, is ready for an upgrade, move up with EMC. For more information contact EMC Corporation, Hopkinton, MA 01748-9103.

For More Information Or To Order, Call

1-800-222-EMC2

(In MA, call 617-435-2541)

In Canada: 416-922-0419; European Headquarters: In London (01668) 5511; In Germany: (0619648) 1885.

International Number: +441668 551; U.S. TELEX 948615 EMC CORP NTK.

Digital and VAX are trademarks of Digital Equipment Corporation.

*EMC 8000 memory includes: 16MB, 32MB, and 64MB arrays for VAX 8500, 8530, 8550, 8700, 8800 computers.

EMC²

The System Enhancement
Company

ENTER 118 ON READER CARD

quired for the typical office environment.

Terminals on the shop floor must be hardened to withstand heat, dust, vapors, dripping caustic and acidic liquids and repeated impact. They must be highly reliable. A \$4,000 terminal can't be responsible for shutting down a \$1 million FMS operation. The ideal shop floor graphics terminal basically should be maintenance free and possess off-the-shelf, plug-in reliability.

The following should be areas of concern to prospective purchasers of shop floor graphics terminals:

1. **Size and Weight** — Space is at a premium on the shop floor, so graphics terminals must demonstrate a sensitivity to size limitations. A small footprint, as well as small volume, is a must.

Terminal weight isn't necessarily a protection against a tough nuts and bolts environment. It's really a burden to end users who may have to physically move a shop floor graphics terminal as production machine configurations change. The heavier the terminal, the heavier the

hardware required to fix and mount the terminal enclosure at the production site.

2. **Mounting the Shop Floor Terminal** — The ideal shop floor graphics terminal should adapt to many potential mounting styles in order to accommodate the varied conditions encountered in a shop floor environment. The flexible graphics terminal is one that can be mounted easily and inexpensively on a pedestal by means of bolts, hung from an inverted U bracket, or mounted on a tilt and swivel mechanism which is optionally bolted to a horizontal or vertical surface. In each case, there must be a logical method for attaching the terminal keyboard to the front of the display enclosure. The simplest arrangement would be not to mount the terminal at all, but to place it on rubber feet on a convenient horizontal surface.

3. **Enclosure Strength** — Shop floor graphics terminals must possess industrial strength but not at a penalty of increased weight or complexity. The shop floor graphics terminal enclosure must be able to withstand the rough

treatment of users accustomed to working with heavy tools and materials that require no finesse in handling. The terminal enclosure must be strong enough to withstand a hammer dropped from above or a heavy chuck placed on the unit for temporary storage. Certainly, if leaned on, the enclosure should not flex.

4. **Resistance to Liquids** — The ideal shop floor graphics terminal will be impervious to dripping or puddling liquids that could penetrate the enclosure and harm the electronics. A shop floor graphics terminal should possess no seams to permit dripping or sprayed liquid access to the interior. Connectors should be splash proof, and may require additional protection to deflect sprayed liquids.

5. **Keyboard Enclosure** — Especially important is the keyboard's ability to function free of jamming caused by flying chips, foreign substances, oils and liquids common to the shop floor environment. However, the keyboard and keyswitches are protected; the keyswitch must allow full travel for operator comfort and ease of use. The keyboard cable and connector should be strong enough to support a dropped keyboard dangling from the connector.

Inexpensive, composite graphics terminals will become increasingly cost effective as a reliable and efficient means to enhance computer control over the manufacturing and production process. While emerging as the key in effectively coordinating the movements of the shop floor and the corporate office, graphics terminals will be most productive as part of a well-designed and integrated production automation system. Optimum system building continues to require planning. For manufacturers, the best advice is to work closely with CIM vendors in designing a system tailored to specific production needs — not today, but as those production needs will be 10 years from now. —Gary Conner is vice president of Operations at GraphOn Corporation, Campbell, California.

Glossary Of Automation Terminology

CAM — (Computer Aided Manufacturing) Reference to production process using some form of computer control.

CAD — (Computer Aided Design) Creation of product or part design using computer graphics.

CAE — (Computer Aided Engineering) Software that predicts how a product or part will perform.

NC — (Numerical Controls) The use of tape or punch cards to control the operation of a machine tool.

CNC — (Computer Numerical Control) The use of a digital computer to control the operation of a machine tool.

FMC — (Flexible Manufacturing Cell) An interconnected group of machine tools controlled by NC units connected by computer, minus materials handling systems.

FMS — (Flexible Manufacturing Systems) Robot-control transport of work from one machine to another. Control of NC units connected by computer via data transmission network.

MAP — (Manufacturing Automation Protocol) General Motors, standard for linking incompatible devices in a network.

ARTICLE INTEREST QUOTIENT
Enter On Reader Card
High 452 Medium 453 Low 454



ASCII



COM.FILE



CPT



Convergent/DEF



DEC/dx



DCA (RFT)



NBI



Xerox 860



XeroxWriter



WPS-PLUS (dx)



WordStar



WordPerfect



WordMARC



Wang VS



Wang OIS



Wang PC



SAMNA



Q-ONE



Office Writer

HOW TO ACHIEVE PERFECT VAX-BASED DOCUMENT INTERCHANGE BETWEEN 26 DIFFERENT SYSTEMS (INCLUDING AN APPLE).

The simple answer is Keyword's KEYpak™

KEYpak is the only VAX-based Editable Document Exchange (EDE) software that provides you with perfect document interchange between so many different systems. So comparing interchanged documents is always comparing oranges to oranges. Even if they originate on an Apple.

The document you create on your PC using MultiMate Advantage appears with every tab, indent, underline and boldface perfectly reproduced on a Macintosh using Word.

Or DisplayWrite 4, Wordstar, Xerox 860 — or any of 26 different systems.

KEYpak provides total document interchange between any or all of these systems regardless of where the document originates.

Use it between your PCs, dedicated word processors, VAXs, VTs, IBM mainframes or all of them combined. Your documents will always appear letter perfect instantly.

When you invest in the KEYpak system you're in the company of such innovators as

DuPont, US West, Boeing, Martin Marietta and British Gas. Keyword pioneered the technology of document interchange and continues to lead the industry.

For example, our KEYpak+1 Seamless User Interface allows you to integrate KEYpak

with DEC ALL-IN-1. Your electronic mail can then be extended into document mail, offering transparent operation to the end user.

Or KEYpak can function as a stand-alone VMS application.

However you choose to employ KEYpak you'll never outgrow it. It's designed to be truly modular. As your needs grow, so will your KEYpak system.

And as productivity improves, your investment pays off.

With one phone call you can begin to maximize the potential of PC-VAX integration. Call Keyword, the Connectivity catalyst, today and ask for more information and trial software on KEYpak™ EDE and KEYpak+1 User Interface products.

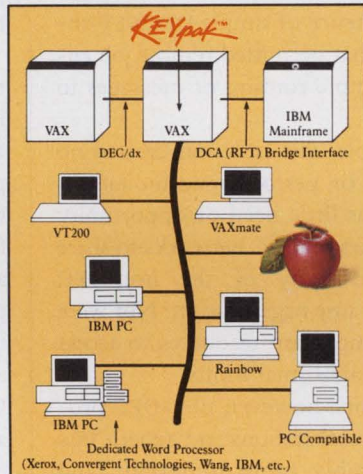

DisplayWrite 3/4



MASS-11



MS Word (MAC)



MS Word (PC)



MultiMate



MultiMate Advantage

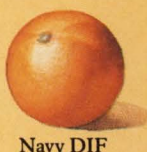

Navy DIF

KEYpak™ by **KEYWORD**

1-(800) 661-8161

ENTER 216 ON READER CARD

DEC, VAX, VT and ALL-IN-1 are all registered trademarks of Digital Equipment Corporation. All other products are the registered trademarks of their respective manufacturers.



CONNECTIVITY

T HE BLURRING OF DEC NETWORKS

By David Langlais

A Bulwark To The Continued Effectiveness Of DEC Systems, Or A Threat?

In the past, DEC networks have existed behind a solid line of demarcation, consisting almost entirely of DEC hardware and networking software. The only notable exception has been the existence of simple DECNET-to-SNA converters that permitted remote job entry and some simple routing of messages to SNA networks.

On the whole, this isolation created no major problems or performance limitations because there was little need or opportunity for DEC processors on DEC networks to share information with any of the non-DEC resources in the same organization. Nor were there critically important resources to access outside the organizational limits.

In recent years, however, non-DEC processors like Sun workstations and generic PCs became considerably more important, and users on systems supporting only DECNET began to feel hemmed in. Many VMS users clamored to cross the DECNET line and access powerful UNIX utilities and applications. Organizations began to see the cost-effectiveness of having PCs and workstations break through the line to use available VAXs as file servers and supplementary processors, and to access laser printers, pen plotters and other peripherals.

Approximately three years ago, the first sign of blurring in the line between DEC and non-DEC networks appeared. The occasion was the installation of a non-proprietary pro-

ocol called Transmission Control Protocol/Internet Protocol (TCP/IP) on a VAX for the first time. The new capability allowed DEC users to add equipment and access resources that previously had been outside the limits of their DEC network.

Since then, a variety of new communications technologies and products have decisively and permanently blurred the line between DEC and non-DEC networks. Users on primarily DEC-based networks now are able to access a variety of processors and resources from other vendors. The blurring centers around the addition of well-established non-proprietary protocols to VMS. It also involves the use of link-level media normally not available to DECNET, the sharing of existing DEC Ethernet controllers with other protocols and even the capability to support third-party file transfers among incompatible resources across DECNET.

Once the DECNET communications barrier to other operating systems was broken, more organizations began to perceive the advantages of linking DEC networks to other resources. Over the years, a vigorous market has sparked development of a range of TCP/IP-based products that allow DEC computers to share information and resources with virtually every other major vendor's offerings.

The basic TCP/IP suite of protocols that allow diverse hosts to communicate freely and

FIGURE 1.

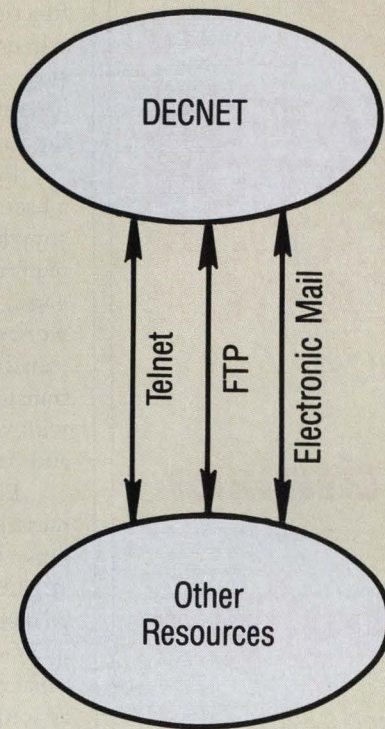

The three main TCP/IP facilities for all processors using the protocol to communicate.

transparently were developed more than a decade ago and almost immediately incorporated into all UNIX BSD versions, 4.2 and later. Berkeley 4.2 BSD, and later 4.3, quickly became the most popular UNIX system for VAXs and for almost every significant CAD/CAM workstation on the market. This wasn't because of the powerful new networking capabilities they offered, but because they supported the virtual memory and demand paging required for processing large jobs. TCP/IP also has become the dominant method for networking with UNIX System V.

Fundamentally, DECNET was and still is far richer in functionality than TCP/IP. However, DECNET never has been able to provide VAXs the degree of unfettered and

transparent communications with UNIX and other non-DEC resources that have become routine under TCP/IP. The addition of TCP/IP capabilities to VMS is one of the most significant forces blurring the line between DEC and non-DEC resources.

Three Main Facilities

Although over 60 vendors support the TCP/IP suite of protocols, they all provide the same basic functionality through either the Department of Defense protocol suite or the very similar Berkeley "r" utilities. This tends to make the use of TCP/IP extremely consistent and simple for the vast majority of users. All versions of TCP/IP provide three main facilities for all processors using it to communicate: virtual terminal, in the forms of Telnet and rlogin; file transfer, in the forms of FTP and rcp; and electronic mail (see Figure 1).

Telnet allows any user on the network to



**DISK FRAGMENTATION
DISK FRAGMENTATION
DISK FRAGMENTATION
DISK FRAGMENTATION
DISK FRAGMENTATION**

**WITH
RABBIT-7 Disk Optimizer
AND
Increase VMS throughput**

FEATURES:

- Eliminates file fragmentation
- Consolidates free space
- Users position files, directories & free space
- Extensive "before & after" disk statistics
- Runs on-line or off-line
- Runs *FAST & SAFE!!!*

BENEFITS:

Studies show 40-55% throughput gains when files are contiguous. Data base, CAD/CAM, word processing, and back up applications show significant improvement after fragmented files are "fixed" with *RABBIT-7 Disk Optimizer*.

**Run RABBIT-7 and
Go Home Early!**

Just Contact:

RAXCO USA 1370 Piccard Dr. Rockville, MD 20850 (301)258-2620	RAXCO CANADA 899 3rd Ave. East Owen Sound, Ontario N4K 2K6 (519)371-5020
---	---

RAXCO NETHERLANDS

Meenthof 18
1241 CP Kortenhoef
Netherlands, (3135) 62444

RAXCO European Distributor:

Software Intelligence Ltd.,
Portland House, 21 Narborough,
Cosby, Leicester LE9 5TA
United Kingdom, (0533) 866613



address any equipment on the network or connected networks simply by typing TELNET followed by the host's network name. In practice, any terminal or PC can connect to any processor and function as though it were a locally wired-in terminal. The data transmission is extremely efficient, and any necessary translations are transparent to the user.

File Transfer Protocol (FTP) allows a user to move files to and from hosts anywhere in the network. The transfer requires a one line command giving file-name, source, and destination. The network does all required conversions and translations, allowing files to be transferred smoothly between hosts with very different internal architectures and data storage formats.

Electronic mail provides the usual message routing services, but does it between DEC and non-DEC hosts. TCP/IP electronic mail has even been implemented using the standard VMS MAIL interface. The network calculates the optimal routing from one user to another, as well as automatic return routing for replies or undeliverable messages. TCP/IP electronic mail can also use established distribution lists.

Powerful Internets

One of the most important reasons TCP/IP-based products are helping to blur the line between DECNET and other resources is their built-in internet capabilities. The continuing push toward open networking is fueled largely by users' needs and desires to connect to a variety of data, peripherals and processors. The internet concept facilitates this process efficiently and transparently to the user.

As you probably recognize, a network is considered to be a single type of physical link connecting multiple processors. By extension, an internet is made up of several physical links connecting multiple processors, in effect a network of several networks (see Figure 2).

To successfully make possible the efficient and transparent data transfer

from one physical network to another, an internet protocol must support the different physical links in all of the interconnected networks. These differences usually are quite considerable. For example, Ethernet is capable of 10 megabits per second. HYPERCHANNEL links support transfer rates of up to 50 megabits per second. The X.25, however, in use on many telephone lines, may operate at any rate from 4800 bits per second to 56 kilobits per second.

It's also necessary to combine both wide area and local area networks (LANs), which use vastly different technology. LANs normally provide high bandwidth (1 to 100 megabits per second) over a short distance using fiber optic lines or coaxial cables. A wide area network, by contrast, operates at 4800 to 1.5 megabits per second over much longer distances using X.25, DMR-11, or point-to-point communications, like a satellite channel.

TCP/IP has been successful in blurring DEC data networks because it doesn't hamper users with any of these technological considerations. All users on the internet operate as if all hosts are connected to a single physical link, creating a virtual network. LANs can be mixed with host-to-host leased lines, microwave channels and satellite links in any conceivable order or combination. In addition, the number and placement of the hosts or the topology of the blurred DEC network becomes totally irrelevant to the user.

For example, at one situation within Boeing Aerospace Company, Sun workstations are communicating with some VAX computers running VMS, with other VAXs running 4.2 BSD UNIX, and with IBM PCs and Apollo workstations (see Figure 3). The established limits of DECNET have been blurred by means of TCP/IP so that a user on any of the VAXs has access to processing power anywhere on the full Boeing computer network. Files can be transferred between hosts and PCs or workstations with ease and speed.

In corporations and research organizations across the country, DEC net-

RABBIT-5

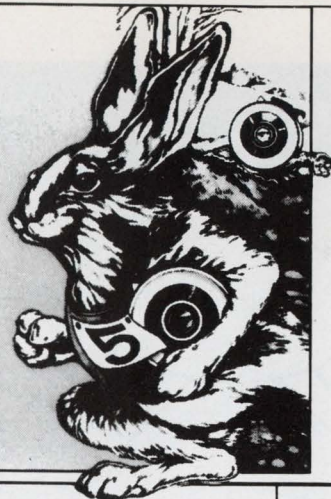

**HIGH
SPEED VMS
ARCHIVING
BACKUP**

*RAXCO's RABBIT-5 Backup
Management System...the safest,
fastest backup restore system
in the world.*

RABBIT-5 isn't "just a replacement" for your present backup program. It's a completely new approach that combines administrative, operational and programmed solutions for the modern data center.

Replace your old backup problems with *new RABBIT-5* solutions:

- Run **RABBIT-5** during first shift and go home early. It's so frugal with VMS® system resources, users won't even know (or care) when you run it.
- **RABBIT-5's** librarian tape management feature prompts operator for the correct backup tape and checks the label, *safeguarding* backup data.
- **RABBIT-5** Archiver locates lost files by tape number for fast data restores.
- Run concurrent **RABBIT-5** backups and utilize 100% of all tape drives while increasing throughput up to five times.

Good Investment:

RABBIT-5 is efficient — it gets the job done quickly. **R-5** is safe — it gets the job done right. **R-5** eliminates many backup headaches and saves countless hours of operator and CPU time.

Try **R-5**. It pays for itself in real dollars — *fast*.

Just Contact:

RAXCO USA	RAXCO CANADA
1370 Piccard Dr.	899 3rd Ave. East
Rockville, MD	Owen Sound,
20850	Ontario N4K 2K6
(301)258-2620	(519)371-5020

RAXCO NETHERLANDS

Meenthof 18
1241 CP Kortenhoef
Netherlands, (3135) 62444

RAXCO European Distributor:

Software Intelligence Ltd.,
Portland House, 21 Narborough,
Cosby, Leicester LE9 5TA
United Kingdom, (0533) 866613



ENTER 187 ON READER CARD

F I G U R E 2 .

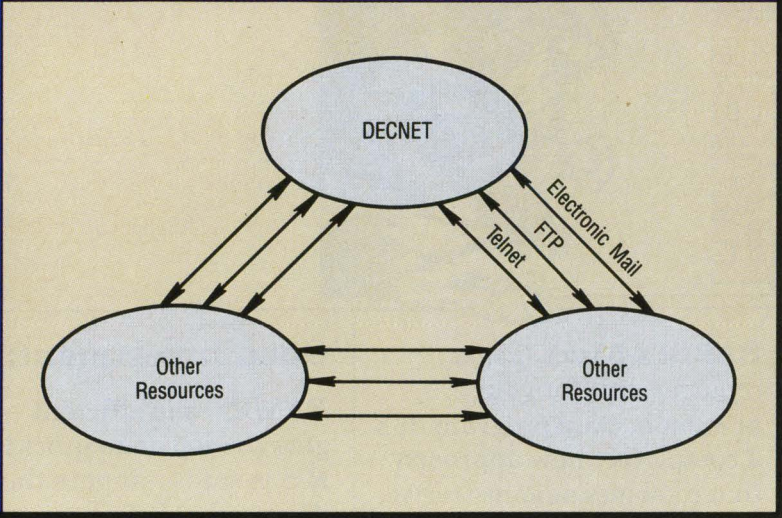

An internet is made up of several physical links connecting multiple processors.

F I G U R E 3 .

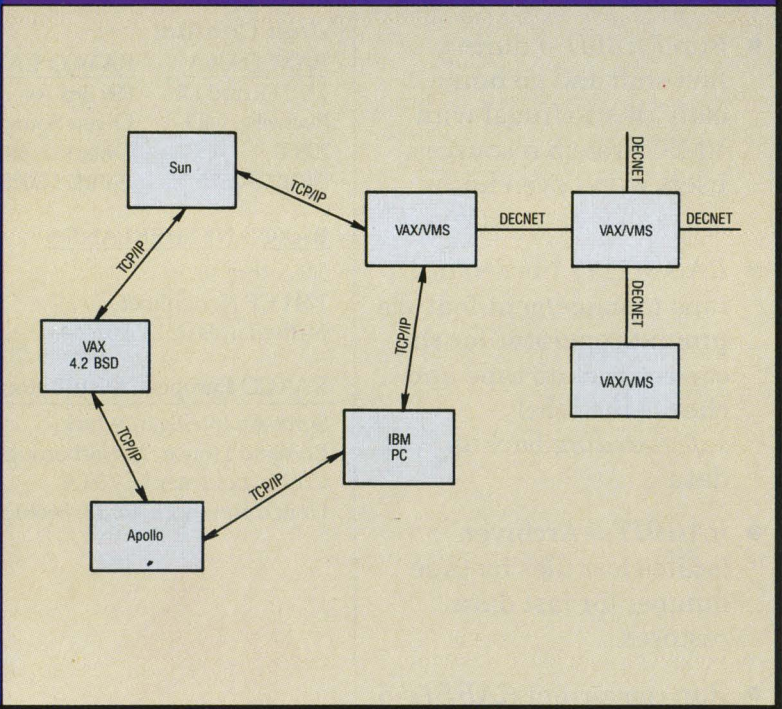

A sample configuration, from the Boeing Aerospace Company.

works using TCP/IP internet capabilities to support a functionally transparent network across virtually every combination of local area networks, dedicated lines, satellite links, fiber optic channels, clusters and hosts. Workstations, minicomputers, mainframes, and even supercomputers with incompatible operating systems now are linked in endlessly different topologies. Yet they still function efficiently. No matter what the network or multinet network configuration, the same simple TELNET or FTP command operates almost identically across all these networks and internets.

The new breed of blurred DECNETs also copes easily with the addition or subtraction of hosts, and non-DEC processors can be added to the internet in a variety of configurations. This means a DEC-based network can support complex and rapidly changing network topologies much more easily than before.

For example, consider an organization running two DECNETs in separate cities, each consisting of a VAX supporting its own Ethernet local area network with several local workstations (see Figure 4). By putting TCP/IP networking software on, say, an IBM mainframe in one city and a PC in another, and by also installing TCP/IP software on designated DECNET gateway processors controlling a link between the two networks, the organization creates an internet allowing simple, direct communications between the mainframe and the PC.

Adding TCP/IP to other non-DEC processors on either one of the Ethernet links allows them to join the internet and operate as if also linked directly together. None of the end users on the internet need be aware of or concerned about the various levels and links it contains.

The advantages of TCP/IP's superior performance and adaptability to unusual network topologies is important for large organizations, which rarely can exist today with just a single DECNET. Instead, large organizations typically use several distinct networks that support

the organizational structure and conform to geographical dispersion and data traffic patterns. With internetting, all of these networks can be linked into one.

A true non-proprietary internet, supported by dozens of independent vendors, TCP/IP is used in products able to accommodate a variety of physical links and many different data transfer rates. Because the vendors continually are competing for market share and new markets, TCP/IP remains a lively and viable protocol that regularly grows to meet new technologies and to bridge more gaps between DECNET and non-DEC resources.

In addition, Wollongong's TCP/IP-based products implement the protocol kernel essentially as a device driver that's connected like any other device into the VMS operating system, providing high throughput for network operations with no alterations to the VMS kernel.

Shared Resources For Networking

Normally, both DECNET and TCP/IP use dedicated controllers, but modern implementations of TCP/IP in software have become highly adept at cutting the cost of blurring DEC networks by sharing the DECNET communications lines and controllers already installed. The ability to use DECNET resources for non-DECNET protocols means user organizations need not incur any additional hardware costs to put up a supplementary TCP/IP network.

While sharing these important resources, however, the piggy-back protocols are careful to allow DECNET to function normally. Of course, network administrators in these organizations find themselves with the added responsibility of supporting the second protocol, but users get connectivity benefits not otherwise available.

One example of the blurring technology is the sharing of the DEUNA, which connects a VAX to an Ethernet. By having the already installed DEUNA used simultaneously by both DECNET and TCP/IP, users connected to the DEC host gain access to non-DEC processors

FIGURE 4.

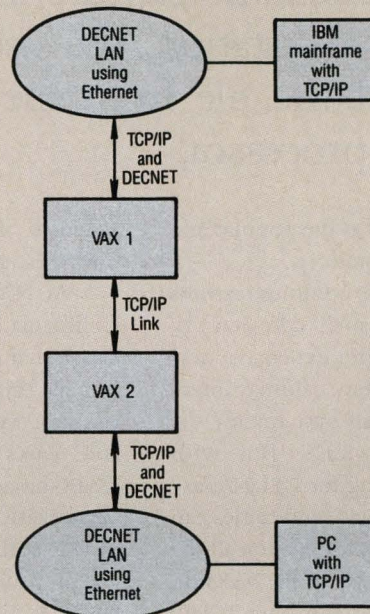

An organization running two DECNETs in separate cities, each with a VAX supporting its own Ethernet LAN, with several local workstations.

FIGURE 5.

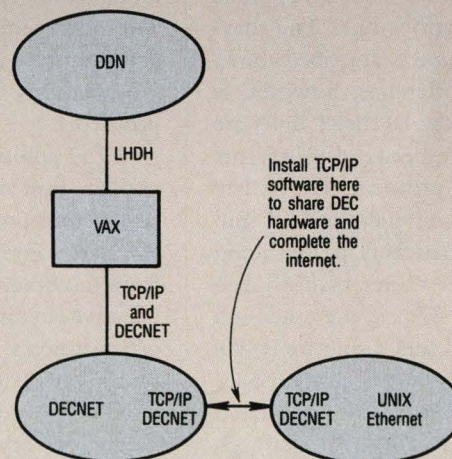

NASA Ames' direct access to the Defense Data Network.

Once schematic capture is completed at the workstation, the user easily can shift the file from the VAX to a third processor,

on the Ethernet, such as the popular and powerful Sun workstations.

Normally, a full communications link to accomplish such connectivity would require a second expensive network, including all new cabling, interfaces and management systems for the duplicate, non-DEC links. But with TCP/IP software sharing the DEUNA, existing Ethernet hardware and cables can be used to communicate between all the TCP/IP machines and any of the VAXs on the DECNET running the proper TCP/IP software. Meanwhile, DECNET operations are unaffected.

The same type of sharing is available for wide area communications links. TCP/IP software with a DBRIDGE option for the VAX and MICROVAX make shared resources possible for a large number of installed DECNETs regardless of whether they use synchronous, RS232, X.25, DMR-11, or some other communications link. The sharing is much the same as described above.

The main difference, however, is that in this case the DECNET links are acting as a bridge between processors using the TCP/IP protocol. The TCP/IP packets actually are encapsulated into standard DECNET packets, passed along any of the DECNET routes, then stripped of their DECNET skins at the other end of the bridge and sent along to TCP/IP processors as though the DECNET bridge didn't exist. Like the shared Ethernet option, the DBRIDGE option is another way to use existing DECNET communications lines and routing instructions to put up a low-cost TCP/IP

network that can communicate with non-DEC systems.

At NASA Ames, Mountain View, California, TCP/IP is the network protocol that now links Amdahl mainframes running UTS with DEC VAXs running System V and UNIX 4.2 BSD, DEC VAXs running VMS, and various UNIX-based workstations. The research organization is using sophisticated TCP/IP software products to transport TCP/IP packets over DECNET lines and DEUNA communications controllers.

Until recently, the organization's only direct access to the Defense Data Network (DDN) was a VAX running TCP/IP using an LHDH interface (an older DDN protocol (see Figure 5). But that VAX was connected only to DECNET networks, while the UNIX workstations needing DDN access were linked through an Ethernet with no direct connection to the LHDH VAX. The intervening DECNETs couldn't communicate via TCP/IP, and the UNIX workstations couldn't use DECNET protocols.

The solution involved a complex combination of a shared DEUNA and co-existing protocol software. But the software solution to a lack of one cable from the Ethernet to the DDN was cost effective because this integrated the organization's entire computing environment. TCP/IP was and remains the only viable networking solution here because no other networking protocol could match its performance on this many interconnected and heterogeneous processors.

Each shared process essentially is independent, so a single VAX can have a variety of DECNET and DECNET-

sharing operations under way at the same time. Ordinarily, such multiple networks working through a single processor would seriously degrade overall performance. But because TCP/IP does most of its own context switching and internal packetizing as independent VMS processes, TCP/IP shared throughput can remain as high as 85 percent of the VAX's pure DECNET communications capability.

Although shared communications methods are slightly slower than dedicated methods, bear in mind that simple speed comparisons are of little value because the shared techniques represent the only way in which a particular VAX is able to communicate with a non-DEC processor.

Of course, sharing isn't necessary to blur a DEC network. TCP/IP can take full control of any DECNET physical interface, such as a DEUNA, DMR-11, X.25, or HYPERCHANNEL. TCP/IP functionality can be point-to-point, as with a DMR-11, or point-to-many-points, as with a typical Ethernet.

It's usually faster and more responsive than DECNET over the same facilities.

DEC Connects To UNIX

As the line between DECNET and other resources eroded, DEC began to support a basic implementation of UNIX and its TCP/IP protocol in its own offerings. The company's initial product was ULTRIX, which was developed by adding some enhancements to the Berkeley 4.2 version of UNIX and TCP/IP.

Approximately two years ago, DEC began to offer The Wollongong Group's version of TCP/IP (called WIN/TCP) for VAXs running the VMS operating system. Trying to cover all bases, the company also implemented a version of DECNET to run under ULTRIX.

With these and other products, users on VMS have gained new

capabilities for building DEC-based networks that can communicate with both DEC and non-DEC processors. Workhorse VAXs now can use DECNET to share data with both UNIX and VMS systems. They also can employ the TCP/IP suite of protocols to share files, mail and data with other UNIX and non-UNIX systems running TCP/IP.

The blurring of the line between DEC and UNIX networks is satisfying. The openness helps connect the vast installed base of the VAX, with its enviable processing power and resources, to the efficient development environment of UNIX and to the specialized capabilities of workstations developed within the UNIX environment.

Pure DECNETs currently are adequate only within narrowly defined applications, and they continue to offer only limited ability to cross-connect to other resources. Even when gateways and other links are operable, a user needs considerable operational training and experience to communicate with diverse hosts. But with newer non-proprietary software-based protocols like TCP/IP, the line between DECNETs and other resources is becoming blurred almost to invisibility.

In the CAD/CAM world, for example, a link to VAX/VMS systems often is important because much of the early CAD/CAM work was accomplished in VAX environments, and because the VAX offers a significant installed base of processing power. TCP/IP makes possible a link between the newest high-performance graphics CAD/CAM units, across existing DECNET facilities or other transmission media, to under-used VAX installations.

Today, it's not uncommon for engineering users to do their CAD work on Sun workstations communicating over a network to a remote VAX and its available online disk capacity. Once schematic capture is completed at the workstation, the user easily can shift the file from the VAX to a third processor, perhaps a Sequent parallel-architecture computer, to accomplish the massive computational work involved in per-

forming circuit simulation, board layout and other complex simulations and design analyses.

One of the most recent advances that's blurring the distinctions between DECNETs and other facilities is the capability of performing third-party file transfers (see Figure 6). Visualize an

organization with a VAX that's a gateway between a pure DECNET system and an Ethernet using TCP/IP. The gateway VAX now can smoothly and easily oversee the movement of a file from any host on the Ethernet to any host on the DECNET.

Another relatively new feature

How Much Faster Will Your Computer Be With MASTERDISK?



As Fast As It Can Get.

Add one of MasterDisk's disk storage systems to your DEC computer and discover what you can do with significantly increased speed and storage:

- Make a MicroVAX II outperform a VAX 8600*
- Double the number of users on the system and get a better performance for each user*
- Improve disk system throughput by as much as 450%*

MasterDisk is the most convenient and cost effective means available to attain the maximum throughput from your existing DEC system.

Storage Capacities - 152 megabytes to 2.93 gigabytes

Compatibility - All Q-Bus and Unibus systems including MicroVAX II, & 3000s; PDP-11s, and VAXs

Warranty - Exclusive TWO YEAR WARRANTY with Nationwide service and support

Mounting/Packaging - Rack mount, floor stand, table top or internal mounting

Delivery - Within 30 days, complete and ready for simple customer installation

* Actual field application data reported by some of our enthusiastic customers

MasterDisk®

Call Department D1 for information.

(617) 443-7711



American Digital Systems Inc.

75 Union Avenue, Sudbury, MA 01776-9990

See Us At
DEXPO West 87
Booth #1747

ENTER 192 ON READER CARD

F I G U R E 6 .

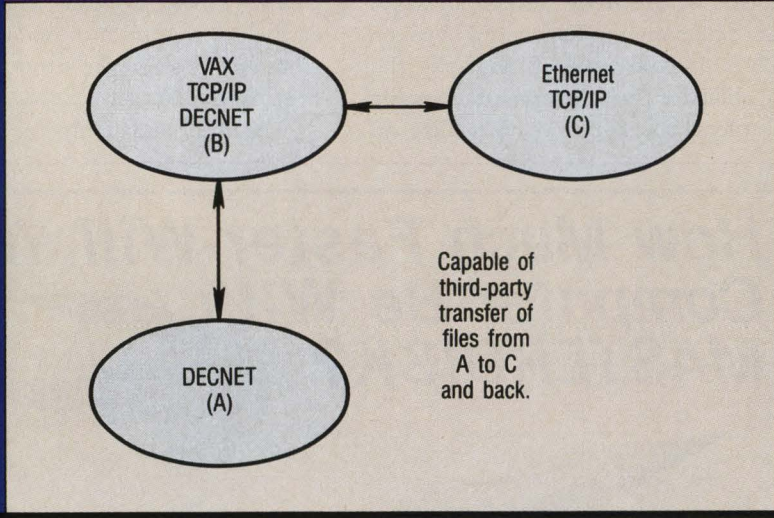

A third-party file transfer.

F I G U R E 7 .

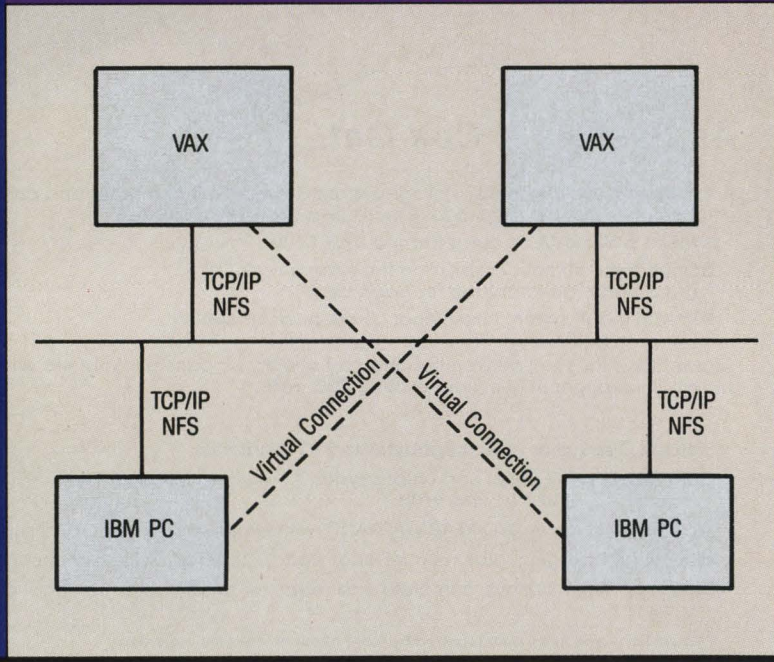

The Network File System permits local resources to be made transparently available to remote hosts on the network.

that's helping to blur the line surrounding DECNET is the Network File System, (NFS). This facility essentially permits local resources to be made transparently available to remote hosts on the network. For example, once all or part of a local disk storage device is exported out to the network and then mounted to a remote host, files on the exported portion of the disk can be accessed by the remote host as though the disk were their local resource (see Figure 7).

In practical terms, this means a PC user in one building can access the disk subsystem of a VAX in another building as though the disk were locally controlled and in the same room. NFS probably will blur DECNETs even more because it obliterates most of the remaining discontinuities among DEC and other resources. NFS creates exciting new opportunities for untrained users and local applications to use file sharing and distributed data.

Benefits To The Users

In the broad view, the blurring of DEC networks significantly benefits users because it allows each organization maximum latitude in choosing the best hardware and software to fit its needs, in many instances regardless of whether or not the preferred solution happens to be offered by DEC.

A major benefit to the user stems from TCP/IP not being a proprietary protocol. All vendors of TCP/IP products want the protocol as flexible, useful and compatible with other products as possible. As a result, no other protocol crosses so many proprietary boundaries and works so effectively with so many proprietary systems for both wide and local area networks.

TCP/IP networks running on DEC systems provide all the advantages of standardization, too, because TCP/IP is the official standard promulgated by the U.S. Department of Defense, the National Science Foundation, many research organizations, the majority of supercomputer centers and other large centers of processing power. This

ensures that the protocol will remain compatible with mainstream products introduced in years to come. Once installed, TCP/IP also is fairly simple to learn and use because it provides a consistent user interface across all the processors, terminals and peripherals on the network.

Even before reliable OSI-based products reach the market in great numbers, DEC networks using TCP/IP are proving their ability to communicate and share data with a variety of important subsystems, including offerings from Sun, Data General, Cray, Control Data, Apollo, Pyramid, and more than 50 other vendors. Given their present level of connectivity and the likelihood of continued development in the same direction, DEC networks should be able to follow along smoothly as the dominant vendor independent protocol migrates from TCP/IP toward OSI.

Once the line between DECNET and non-DEC resources was impenetrable; today it's heavily blurred, broken and erased. Although it may never disappear, the connectivity between DEC and non-DEC resources continues to increase at a regular rate.

Today, the growing popularity of vendor independent networking protocols leads user organizations to exercise their shopping rights to an unprecedented degree. The line between DEC networks and other resources is blurring close to invisibility. The typical network, once constructed homogeneously from DEC hosts and components, now tends to incorporate a variety of third-party offerings. Users who once were blocked from reaching non-DEC resources, now routinely tap into a range of external networks and vendor independent facilities.

Although a few die-hard DEC enthusiasts still lament the blurring of DEC networks and the concomitant shift in networking strategies, most network specialists view the trend as a bulwark, rather than a threat, to the continued effectiveness of DEC systems. As a practical matter, DECNET offerings remain very strong, and their popularity

is undiminished. If anything, the blurring of the line between DEC and other networks makes DECNET more viable than ever. The increased connectivity made possible by the blurring allows the strengths of DEC systems to flow beyond the boundaries of what once

was a vendor-specific network.
— David Langlais is director of major accounts for The Wollongong Group Inc., Palo Alto, California.

ARTICLE INTEREST QUOTIENT
Enter On Reader Card
High 465 Medium 466 Low 467

AVERAGE DISK ACCESS TIME... 6.39 msec.

What can this kind of performance do for you?
Add one of **MasterDisk's** disk storage systems to your DEC computer and discover what you can do with significantly increased speed and storage:

- Make a MicroVAX II outperform a VAX 8600*
- Double the number of users on the system and get a better performance for each user*
- Improve disk system throughput by as much as 450%*

MasterDisk is the most convenient and cost effective means available to attain the maximum throughput from your existing DEC system.

Storage Capacities - 152 megabytes to 2.93 gigabytes

Compatibility - All Q-Bus and Unibus systems including MicroVAX II, & 3000s; PDP-11s, and VAXs

Warranty - Exclusive TWO YEAR WARRANTY with Nationwide service and support

Mounting/Packaging - Rack mount, floor stand, table top or internal mounting

Delivery - Within 30 days, complete and ready for simple customer installation

* Actual field application data reported by some of our enthusiastic customers

MasterDisk®

Call Department D2 for information.

(617) 443-7711

See Us At
DEXPO West 87
Booth #1747



American Digital Systems Inc.

75 Union Avenue, Sudbury, MA 01776-9990

ENTER 229 ON READER CARD



THE CIT-224 TERMINAL

By Bruce Feldman

An ANSI-Compatible Entry That's Worth A Look.

At first glance, there's not much that distinguishes the CIT-224 from the pack. It's rather plain with amber eyes and its keyboard is distinguished only by a slate-gray flip panel that sits across the head like a bandana and, OK, it has nice, small feet.

But when you take it to your desk and turn it on, the CIT-224 terminal, from CIE Terminals Inc., is a pretty fair performer; a versatile VDT that's compatible with its DEC VT220, VT100 and VT52 predecessors and operates in either ANSI or VT52 mode.

Standard features include a multimode bidirectional auxiliary port and two- and three-key compose sequences. The display is a 14-inch diagonal, non-glare CRT with light on dark characters or the reverse, in cells of 10 x 6 dots, and screen formatting of 24 x 80 or 132 characters. Cursor types are block, underline or invisible, in blinking or non-blinking modes. A host addressable 25th status line enables the host to send system messages to this line, without otherwise disturbing the current screen display.

Looks Aren't Everything

The display is one of the nicest aspects of this terminal. The character dot patterns are tight, well formed and pleasing to the eye, with full descenders. The separate controls for contrast and brightness provide a more-than-adequate range of intensities to explore. The characters are displayed without the common haziness around the edges that appears on some low-end terminals, often on different parts of the screen.

Attributes include blinking, underline and bold. The CIT-224 stocks several character sets, including ASCII, special graphics, supplemental graphics, national replacement sets and "soft" downline loadable character sets.

Vital Statistics

The monitor sits on a petite, rectangular pedestal that's only 11½ inches wide, 10 inches deep and less than one-inch high. The complete unit requires 13 inches of desk space from front to rear, however, to accommodate the depth of the monitor. The monitor easily rotates 45 degrees left or right and tilts up or down 30 degrees on its base. All of the hardware is housed upstairs.

There are three molded plastic cut-outs just below the screen at the far left and right. One contains the block-like power ON/OFF switch, with a power indicator LED right next door. The third is the (replaceable) model number panel, indicating that the identical housing probably is used for other CIE terminals.

The screen of the 224 is bordered in off white at the top and bottom, with offsetting slate-gray borders to accent the top keyboard strip. Separate brightness and contrast controls are hidden at the rear of the monitor unit, underneath and to the right. Adjacent is the keyboard jack.

At the rear of the unit is a 115V/230V AC voltage selection switch, a fuse holder, the AC power input and two RS-232C ports — the



main communications port connector and an auxiliary port.

For a terminal that features such a clean, crisp display, it's unfortunate that not enough attention was paid to the keyboard. The features are there, but the ergonomics are not.

The keyboard emulates the standard DEC VT220 keyboard, with separate editing and cursor keypads and a strip of function keys at the top. A gray flip panel covers six LEDs, one each for Online, Hold Screen, Caps Lock, Compose, Wait and Shift Lock. Below the LEDs is a row of programmable and non-programmable function keys. At the far right are the Hold Screen, Print Screen, Setup, Data/Talk and Break keys. Function keys 6 through 14 and 17 through 20 are programmable and separated by the Help and Do keys.

The Escape key sits at the top left-most position. The Back Space key is next to the Delete key at the upper-right corner, not a good spot because most VT220 clones have the Delete key there alone. With the Back Space key so close, annoying errors can easily occur within applications that define specific func-

CIT-224 Terminal
CIE Terminals Inc.
2505 McCabe Way
Irvine, California 92714
(714) 660-1421
Price: \$699
ENTER 412 ON READER CARD

tions for each key.

The feel of the keys, on a scale from precise to unsteady, is forgiving of wandering fingers, but is a bit like walking on loose sand. In the middle 50- to 75-words-per-minute range that most typists inhabit, however, it's probably minimally adequate.

One nice touch on the keyboard is the top flip panel. The lower portion of the panel is transparent plastic so that programmed function key identifications can be slipped underneath for quick reference.

The coiled keyboard cord stems from a jack located well underneath the keyboard unit toward the left side. The cord is wrapped



The CIT-224 terminal emulates a DEC VT220, VT100 or a VT52.

MICROTEK, WE MEAN BUSINESS!



Your company's **DEC** and compatible computer needs are as important to us as they are to you. We take those needs very seriously because we want your business, and we want you to get the right equipment, at the right price, at the right time. With our large inventory and staff of skilled professionals, Microtek can assist you in your computer purchasing decisions with speed and skill, unmatched in the industry.

Additionally, with each purchase from Microtek you receive our three-way guarantee:

1. We do not sell equipment which has not been maintained by the manufacturer.
2. All equipment is checked out in our Cleveland Plant by factory trained technicians for fool proof operation to anticipate and completely eliminate all delays to immediate usefulness.
3. All equipment is guaranteed for 30 days, and is guaranteed for maintenance by the manufacturer.

MICROTEK, WE MEAN BUSINESS

800-828-0303
IN OHIO 216-234-8040
FAX 216-234-0784
TELEX 4944465



8370 Dow Circle, Cleve., OH 44136

ENTER 178 ON READER CARD

through a subterranean groove, so that the unit lies flat, to the right-most end, where it then stretches to the jack in the monitor housing, also on the same side. Unfortunately, plastic prongs on the underside of the keyboard base are insufficient to keep the cord fully tucked underneath the unit. As a result, the cord springs loose and annoyingly must be tucked in by hand whenever the keyboard is moved aside to make room for other desk work.

The base of the keyboard sprouts two small, plastic feet with rubber soles to prevent marring the desktop. The feet can tuck under, stand flat or stretch on tippytoes.

Health Check

At power ON, a self test is run and the message "CIT-224 OK" appears if everything checks out. Error messages are displayed in reverse video on the screen and echoed by the LEDs; i.e., the Hold Screen light blinks if there's a ROM error, Caps Lock blinks for a RAM error as does the Compose key for an NVR error.

The Setup key plants you in an 11-screen environment, where NVR memory permanently stores your settings. Factory default settings otherwise are displayed.

Special Skills

The CIT-224 includes a Compose key for creating special characters not available on the keyboard. There are both two- and three-key sequences for many of these. The library of special characters is extensive, but remember that to use them in a document, your printer must support them.

The programming of the function keys isn't completely menu driven and requires reading the documentation. Pressing a Shift-Function key returns the current definition of the row of unshifted function keys. Pressing a CTRL-Function key displays the unshifted key definitions. Finally, you can display an additional row of function keys by pressing CTRL-Shift.

Each of these commands accesses

the Function Key Editor menu that displays the function of the key being programmed, the identities of other programmed keys on the board, and the programmable key space remaining. There are a total of 60 function keys, 45 of which are programmable locally in non-volatile memory.

This menu is not accessed directly through the setup directory, which can be confusing. Replacing the current definition merely requires deleting the old and typing in the new, then saving it by pressing the Enter key.

The manual that comes with the CIT-224 is a concisely written, dot matrix-printed guide with sections on installation, keyboard description and configuration, operation of the terminal and programmer data, control codes and the like.

Appendices are included for code tables, control sequences and codes, and sample setup screens. Illustrations and tables abound and are referenced in the Table of Contents. A CIT-224 maintenance manual is available from C. Itoh Inc., but isn't included with the terminal.

The manual is comprehensive without being hyperbolic. Subheads abound, as do lists and charts to present information in the most accessible manner. The section on the compose character sequences is presented especially well, by providing a bulleted, step-by-step keystroke progression that also is accompanied by a table of characters and the sequences that elicit them.

When all is said and done, this terminal is worth a look.

Editor's note: At press time, DEC announced the settlement of a dispute with C.Itoh & Co. Ltd., the parent company of CIE Terminals Inc. As part of the agreement, C.Itoh agreed to alter the setup screens on the CIE-224 terminal.

ARTICLE INTEREST QUOTIENT
Enter On Reader Card
High 438 Medium 439 Low 440



Discover a light beyond conventional computing.

For years thousands of businesses and computer specialists have relied on **mdbs** products and services to reach plateaus far beyond the capabilities of other software packages. No matter what the size or scope of your data processing needs, **mdbs** can help you create unique, powerful applications quickly and efficiently.

GURU combines an expert system development tool and familiar information management tools in one software environment. **GURU** applications provide expert advice or embed reasoning in everyday computing.

MDBS III, the extended-network data base management system, provides solutions for easy and efficient development of applications involving massive data bases and complex relationships.

KnowledgeMan/2 fuses a powerful relational data base management system with business computing essentials such as spreadsheet, graphics, text processing, report generation, communications and more.

MDBS III, GURU, and KnowledgeMan/2 are offered for single-user micros, popular PC-based LANs, and the DEC VAX.

mdbs also supplies specialized application development, consulting, training and other services to corporations, government agencies and VARs.

For more information on how **mdbs** software and services will help you discover the real potential of your computer, call or write us.

mdbs, Inc.

P.O. Box 248
Lafayette, IN 47902
800/344-5832 or 317/463-2581
TLX: 5106017487 (MDBS LAF UQ)



mdbs
THE KNOWLEDGE MANAGEMENT COMPANY

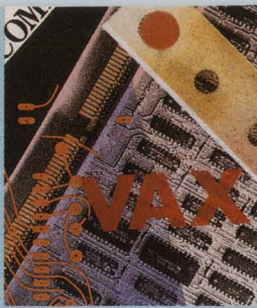

VAX

GETTING THE MOST FROM VAX/VMS MAIL

By Cynthia Hartman

To: You
From: Me
Subject: State-Of-The-Art Delivery For MAIL

One major advantage of networking is the ability electronically to transfer information worldwide with a few keystrokes. A common way to transfer information across the network is by using the VAX/VMS operating system's mail utility, referred to as MAIL. This utility provides you with the means to communicate with anyone on the network.

Like other VAX/VMS users, I begin my morning by pouring a cup of coffee, logging in, and reading my mail. In the process I've learned some useful MAIL features.

A Copy For Your Records

It's convenient to send yourself a copy of the messages you send to others. When you announce that you're scheduling a meeting for 9 a.m., on the day of the meeting you can refer back to the message to make sure you're on time. To automatically receive a copy of each message you send or reply to, enter the following command at the MAIL> prompt:

```
MAIL>SET COPY_SELF SEND,REPLY
```

You only have to type this command

once. From now on, MAIL will send you a copy of all your messages.

On the other hand, if you want to choose which messages you receive a copy of, specify the /SELF qualifier each time you send or reply to mail:

```
MAIL>SEND/SELF  
MAIL>REPLY/SELF
```

This method is useful if you don't want a copy of everything you send to others.

Using Your Editor

You can invoke MAIL so that when you send messages, you automatically call up an editor to enter the text of the message. When you exit from the editor, your mail message is sent. This is helpful when you have to send an error-free message.

To enter the editor, invoke MAIL with the following command:

```
$ MAIL/EDIT=(SEND,FORWARD,REPLY)
```

I prefer to edit messages only before I SEND or FORWARD them, so I put the following symbol in my LOGIN.COM:

```
$ M*AIL := = MAIL/EDIT=(FORWARD,SEND)
```



digital

IBM
Personal
Computer
Color Display

It's Not That Easy.

PC-to-DEC Communications, The Right Way.

Some companies think it's easy to make your IBM PCs act like a DEC terminal. But before you settle for some patch job, consider these facts.

Only Polygon has consistently offered true emulation through the years. In fact, when Digital Equipment Corporation went looking for terminal emulation software to license, they didn't choose just anyone. They chose Polygon. Today Polygon continues to be used in more DEC installations than any other competitive product.

Polygon is ahead in other ways, too. We were first to ship VT220 emulation. First with VT240 emulation. First with full-color VT241 support. And now we provide Ethernet (LAT) communications as well.

You'll find our dedication shows in a whole range of products, featuring error-free file transfers, and sharing PC files in a VAX library. Our poly-STAR, poly-SHARE and the famous poly-COM series of products have set the standards for DEC communications software.

So if you want it done right, talk to Polygon.

**Call 1-(314)-576-7709
For Free Demo.**

We'll send a free demo package to any qualified company. Just call or write us. Polygon, Inc., 1024 Executive Parkway, Saint Louis, MO 63141 (314) 576-7709, Telefax: (314) 275-9185. Telex 883245.



Terminal Emulation, The Right Way.

ENTER 146 ON READER CARD

Polygon, the Polygon logo, and poly are registered trademarks of Polygon, Inc.

DEC, VT, and the Digital logo are trademarks of Digital Equipment Corporation. The IBM logo is a registered trademark of International Business Machines Corp.

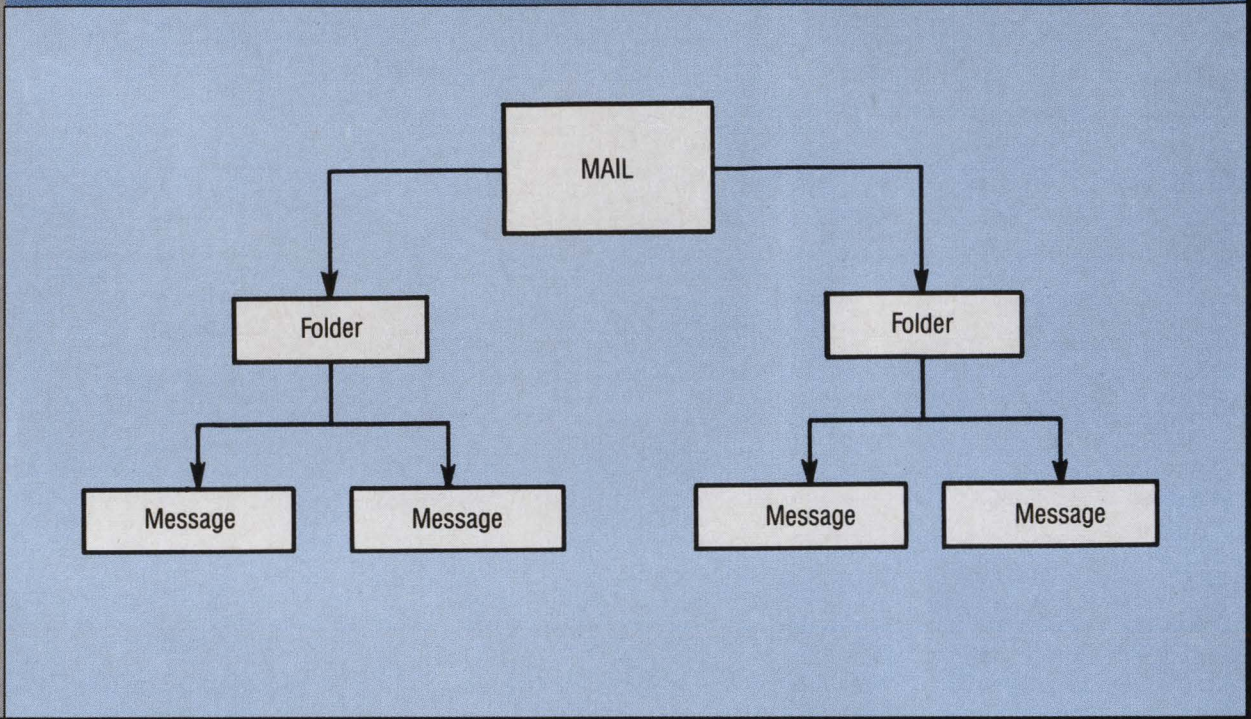
F**FIGURE 1.****MAIL Folders.**

If you want to edit particular messages, you can use the /EDIT qualifier with individual SEND, REPLY, and FORWARD commands.

By default, MAIL invokes the EDT editor. If you wish, you can tell MAIL to use TPU instead. To do this, put the following logical definition in your LOGIN.COM file:

```
$ DEFINE MAIL$EDIT CALLABLE_TPU
```

Organizing Messages

Frequently, you receive messages that you want to save for future reference. It's difficult to locate specific messages if you keep all of them in the same place. Fortunately, MAIL provides you with the ability to organize your messages into folders (see Figure 1).

Your MAIL file automatically contains three folders: MAIL, NEWMAIL and WASTEBASKET. The title of the folder you're in is displayed in the upper right-hand corner of your screen.

Your MAIL folder contains messages that you've read already, but didn't delete. The NEWMAIL folder contains new messages that you haven't read. The WASTEBASKET folder contains all of the messages that you delete before you enter PURGE at the MAIL > prompt or exit from MAIL.

You can create additional folders to store your messages. For instance, let's say you're working on three different projects: apples, peaches and plums. You can put messages about

these projects in their own folders so that they are easy to find for future reference.

You create folders by moving a message to a folder that currently doesn't exist. To move the message you're currently reading to another folder and delete it from its current folder, enter one of the following commands:

```
MAIL>MOVE folder__name
```

or

```
MAIL>FILE folder__name
```

Use the COPY command to move a message to a folder without deleting it from its current folder:

```
MAIL>COPY folder__name
```

If the folder currently doesn't exist, MAIL asks if you want to create that folder. For example, if you try to copy a message to a new folder called REQUEST, MAIL issues the following response:

```
Folder REQUEST doesn't exist.
Do you want to create it (Y/N, default is N)?
```

Look what a pioneer in miniaturized data communications can pack into a modem. Our short range models feature data rates of up to 19,200 bps, distributing data locally over unconditioned 4-wire telephone lines. What's more, they're transformer-isolated from the telephone line for uninterrupted transmission and protection of your equipment. Operating without AC power, these mini modems are the ideal



solution for every environment, async or sync. A variety of models are available, including modems conforming to Bell Specs 43401.

For more big reasons why you should look into small Rads contact us today for your nearest distributor. We have a whole range of miniaturized products into which we pack more, including a mini price.

Rad miniature products communicate in a big way.

NOW A LITTLE MODEM CAN PACK A BIG PUNCH

*From the growing
Rad family.*

RAD

data communications ltd.



Rad Data Communications

U.S. Headquarters:

151 West Passaic Street
Rochelle Park, NJ 07662
Tel: (201) 587-8822
Telex: 6502403647 MCI
Fax: 201-368-2102

International Headquarters:

8 Hanechoshet Street
Tel Aviv 69710, Israel
Tel: 972-3-483331
Telex: 371263 RADCO IL
Fax: 972-3-498250

ENTER 209 ON READER CARD

You can send mail easily to various people by creating a distribution list.

Once you start creating folders, you need to keep track of the names of all of them. To recall the names of the folders, enter DIRECTORY/FOLDERS at the MAIL > prompt. MAIL lists the names of all your folders:

```
MAIL>DIRECTORY/FOLDERS
```

Listing of folders in DISK__NAME:[USERNAME]MAIL.MAI;
Press CTRL/C to cancel listing

```
APPLES      MAIL
NEWMAIL     PEACHES
PLUMS       WASTEBASKET
```

Select a folder by typing SELECT folder__name at the MAIL > prompt:

```
MAIL>SELECT folder__name
```

Selecting a folder allows you to move among folders. To display a directory of all of the messages in a folder, you have two choices. If you've selected that folder already, simply type DIRECTORY at the MAIL > prompt. If you're not yet in that folder, type "DIRECTORY folder__name" at the MAIL > prompt. The latter method also selects that folder for you.

One final note: Every folder vanishes when there are no messages in it.

Mail And VMS Files

Another command that invokes your specified editor is the REPLY/EXTRACT command. I find this command useful when I want to include text from the original message in my reply. When the message you want to reply to is on your screen, enter the following command at the MAIL > prompt:

```
MAIL> REPLY/EXTRACT
```

MAIL invokes the editor in an editing session that contains the text of the message to which you are replying. You then can add to the message and send it.

Sometimes, you receive messages that you need to ex-

tract into a file to edit or use at a later time. Type the following command while the message is on your screen:

```
MAIL> EXTRACT filename.extension
```

When I extract files, I like to store them without the MAIL header information by typing:

```
MAIL> EXTRACT/NOHEADER filename.extension
```

You also can send files from the DCL prompt without entering MAIL. To do this, use the DCL command MAIL from the DCL prompt:

```
$ MAIL /SUBJECT="subject" filename.ext username
```

The subject qualifier is optional. If you don't specify a subject, the subject line of your message will be blank.

Personalizing Your Mail

You may define a text string, called a personal name, to be associated with your MAIL account. Your personal name appears when the new MAIL message broadcasts on the receiver's terminal and also in the MAIL header information.

You can identify your messages with your name and phone number or perhaps a quote. Set your personal name by typing:

```
MAIL>SET PERSONAL__NAME "Zippy the Pin-Head"
```

Once you set your personal name, you may want to remind yourself of it before you send your monthly status report to your boss. View your personal name by typing:

```
MAIL>SHOW PERSONAL__NAME
```

Defining Logical Usernames

A logical name is a string that VMS automatically translates into another string. You may define short logicals to refer to users to whom you frequently send messages. Define the logicals in your LOGIN.COM file in the following manner:

```
$ DEFINE GEORGE GEORGES__NODE::GEORGES__NAME
```

When in MAIL, enter GEORGE at the TO: prompt to send a message to George. You no longer have to type George's node followed by George's username:

```
TO: GEORGE
```

Sending Mail To Many People

You can send mail easily to various people by creating a distribution list. For instance, one of my distribution lists is

MRI *COMPUTERS*

PEP - 70!

**PEP
TALK**

**JOIN THE NEW GENERATION
OF PDP 11/70 USERS**

IMAGINE!

- **5X MEMORY SPEED**
- **STATE-OF-THE-ART DISK CAPACITY**
- **FASTER USER RESPONSE TIMES**
- **SMALLER FOOTPRINT AND MAINTENANCE \$**
- **A SIMPLE "PLUG AND PLAY" UPGRADE**

NOW PINCH YOURSELF — IT'S REAL!

THE PDP 11/70 PERFORMANCE ENHANCEMENT PACKAGE

The **PEP-70** will **renew** your well-founded belief in the **PDP 11/70**. You always knew that it was the finest communications system ever produced by DEC. Its **horsepower** was **harnessed** only by its **memory speed**.

Now you can **throw away the harness** and **un-bridle** its **raw power**. Your **software** applications are **secured** and you can be assured of applause from your users. Shine in the glow of the **PEP-70 generation**.

Call or Write

MRI *COMPUTERS*

1520 N.W. 65th Avenue, Suite 2
Ft. Lauderdale, FL 33313

800-992-6340

In Fla.: 305/587-7464

800-992-6340

ENTER 223 ON READER CARD

DEC, PDP, UNIBUS are trademarks of
Digital Equipment Corporation.

By defining keys you can move between your main process and your MAIL subprocess with a single keystroke.

titled "WRITERS.DIS" and contains the nodes and names of all of the writers in my group. When I have information that I'm sure they all would be interested in, I send the message to my Writers distribution list.

Sending messages to a distribution list is a three-step process.

1. Create a logical name in your LOGIN.COM that points to the directory that will hold all your distribution lists. For example, define the logical \$LISTS to be your home directory.
2. Create each distribution list in the directory you've chosen above. The list simply contains each username on a separate line with its nodename if you're on a network. The file should have a .DIS extension. Don't use leading dollar signs.
3. When you want to send mail to that list, reference it at the TO: prompt in MAIL. Begin with an @ sign, then include the logical directory name and the distribution list filename:

```
TO: @$LISTS:WRITERS
```

Sending Your Mail Elsewhere

With the proliferation of MICROVAX II and VAXSTATION II systems, it's not uncommon for today's VAX/VMS user to have an account on more than one node.

If you plan to be working on another node and still want to receive your mail, you can forward your messages from any other node on which you have an account, to your current node:

```
MAIL> SET FORWARD node::username
```

If you set your forwarding address and want to make sure your messages will be forwarded to the right place, type:

```
MAIL> SHOW FORWARD
```

To cancel the forwarding command, type:

```
SET NOFORWARD
```

at the MAIL> prompt.

Running MAIL In A Subprocess

For those of you who often enter and exit MAIL, you may prefer to run MAIL in a subprocess. You'll find attaching to

a subprocess takes less time than invoking MAIL. Furthermore, by defining keys you can move between your main process and your MAIL subprocess with a single keystroke.

The first step is to define the keys used to spawn and to attach to the subprocess. Add the following lines to your LOGIN.COM file:

```
$ DEFINE/KEY/NOLOG F17 "ATTACH ""sub__mail"" ""  
/TERMINATE  
$ DEFINE/KEY/NOLOG F18 "SPAWN /PROCESS=  
""sub__mail"" ""/TERMINATE
```

You don't have to define the same function keys as in the example above. However, I've found these two keys to be convenient for this purpose. Also, choose your own name for the subprocess (sub__mail) because this name must be unique within each user group on your system.

You have to create a MAIL initialization file to define the key. This allows you to attach back to your main process. Create a file that contains the following line:

```
DEFINE/KEY F17 "ATTACH/PARENT" /TERMINATE
```

Define the following logical in your LOGIN.COM to point to this file. This causes MAIL to define that key during initialization:

```
$ DEFINE MAIL$INIT  
disk__name:[username]MAIL$KEYDEF.INI
```

Before any of this works, run your LOGIN.COM file; type @LOGIN or log out and back in again. To set up your MAIL subprocess at the beginning of the day:

1. Press F18 to spawn your MAIL subprocess
2. Type MAIL to invoke MAIL
3. Press F17 to return to your main process.

Now use the F17 key to toggle between your MAIL subprocess and your main process.

I'VE ONLY SKIMMED the capabilities of VAX/VMS MAIL. For additional documentation on MAIL, see DEC's *VAX/VMS Introduction to VAX/VMS Manual* and *VAX/VMS MAIL Utility Reference Manual*. You also can enter HELP at the MAIL> prompt for the syntax or meaning of any MAIL command, as well as see examples of these commands. —Cynthia Hartman is a free-lance writer in Marlboro, Massachusetts.

ARTICLE INTEREST QUOTIENT
Enter On Reader Card
High 413 Medium 414 Low 415

Terminal Emulation That Works For Everyone.

How can VAX managers and PC users agree on VT220 emulation software? You might call it a small miracle, but all you need is one look at Reflection 2.

Reflection 2 works for managers.

When you standardize on Reflection, two good things happen. Confusion disappears. And productivity takes over. That's because our powerful command language lets you create command scripts for custom user interfaces or perform complex and unattended tasks. It lets you configure your video for 132-column display. Or remap PC keyboards to conform to the terminal layout you prefer.

If you're linked by a LAN, Reflection supports you here too. With Reflection you also receive host-based file transfer software, a costly option with some other emulation packages. And our optional PLUS software automatically backs up PC-user files on the host.

Reflection 2 works for PC users.

Getting started is a snap. An on-screen question and answer session helps new users connect to the host in minutes.

Only Reflection lets you do two things at once. Bounce from the VAX to a PC application quick as you can say "hot key." And at the same time, Reflection can be running in the background. A VAX file might be streaming out of your printer. Or a PC file could be beaming up to your VAX.



VAX managers and PC Users both like what they see in Reflection 2.

And if you ever get stuck, there's immediate telephone support at no extra cost.

Reflection 2 works for everyone.

Now, for the price of ordinary emulation software, you can put Reflection 2 to work. Because Reflection performs every task you could want and offers choices no other package can match. Reflection 2 costs just \$199. Or, get automatic backup capability with Reflection 2 PLUS at \$249.

Ask about our aggressive quantity discounts. Try Reflection 2 for 30 days. If you're not completely satisfied, return it for a full refund. For all the details and to order, call 800-8PC2VAX (800-872-2829).

Walker Richer & Quinn, Inc. 

2825 Eastlake Avenue East, Seattle, Washington 98102, (206) 324-0350, Telex 311743 WRQR

ENTER 220 ON READER CARD

RESPOND/ QUICK

By Michael G. Gonzales

A Fast, Easy-To-Install DEC Emulator For An IBM PC-Compatible Terminal.

RESPOND/QUICK from Software Synergy Inc. enables an IBM PC (or compatible) to emulate a DEC VT102 in a manner that justifies its name — you can install and begin emulation quickly and easily.

RESPOND/QUICK comes on a single disk, and is inserted into the A or B drive after booting with PC-DOS. The first screen is the *RESPOND/QUICK* logo. Next, the *RESPOND* Main Menu appears (see Screen 1). The novice user should select the Quick Start screen (see Screen 2).

After creating a profile with Quick Start, you can enter terminal emulation mode and begin communications, or return to the Main Menu and save the new profile.

The Select a Profile option permits you to choose a communications profile previously created with Quick Start. The Enter Terminal Emulation option enables the PC to emulate a VT102 and initiates a communications session using the current communications profile.

To exit *RESPOND* and display the DOS prompt, choose Quit *RESPOND*. To access DOS without exiting DOS, choose the Enter DOS Command option.

The Main Menu also allows Save a Profile and Erase a Profile options, along with the Help Mode option (see Screen 3).

Documentation

RESPOND/QUICK comes with a user manual that's well illustrated and easy to follow. The manual doesn't have an index but has a rather

comprehensive Table of Contents.

Chapter 1 introduces *RESPOND/QUICK* and its capabilities. The second chapter, "Installation," discusses hardware requirements and setup notes, along with installation procedures for single, dual, and hard-disk systems. Accessing Quick Start, the topic of Chapter 3, discusses the mechanics of creating profiles and entering terminal emulation mode. The fourth chapter describes the *RESPOND* Main Menu, while Chapter 5, "Guide to Emulation," discusses sending and receiving text files. An Appendix details modem requirements.

Operation And Evaluation

RESPOND/QUICK is easy to learn, easy to use and fun to work with. Setting up profiles in Quick Start is so simple that you can do most of it without reading the documentation.

The online Help Mode is quite useful, providing fingertip information that's clear and readily understood. In fact, topics detailed in Help allow you to find things without doing a lot of reading.

Quick Start allows you to create communications profiles. You can enter some of the parameter values necessary for a communications session, while others are set automatically. The Quick Start parameters are:

1. Service/Network — This specifies the service name and network type used to make the connection. In many cases, choosing a service



Complex document production. Simple method to get there. This is WORD-11. The ultimate in VAX word processing.

This is a WORD-11 document, and this is how we did it.

Set up newspaper columns format—
2 to 16 columns :10
Type document and check spelling 3:15
Transfer graphics :16
Print document 1:00
Total time: 4 min., 41 sec.

Calculated on a per page basis of columned documents and graphics.

That's it, WORD-11—simple operations, great results, and business documents that have character. For over ten years we have been perfecting WORD-11—refining it, making it faster, easier to use, and expanding the features.

Now with release 4.1 we have achieved a long sought after level in VAX/VMS word processing.

WORD-11 is now the unquestionable leader in ease of operation. With optional menus, on-line help, and a color coded keyboard, a new user can be writing simple pieces in 30 minutes. The majority of editing functions require only 1 or 2 key strokes, making all operational skills come very quickly. In addition, the transition from other word processing programs is more forgetting a lot of operations you don't need rather than learning new skills.

WORD-11 delivers even more cost effectiveness to word processing with efficient resource

usage—which translates to more users on your system.

Some features may seem like just subtle differences, but sometimes subtle differences produce more than just subtle results in speed and clarity. The bottom line is that WORD-11 delivers the highest level of speed, simplicity, and cost saving efficiency, plus the fullest functionality of any word processing package in the DEC market today.

All this and total system application—from VAX 8978 to Micro VAX 2000—WORD-11 performs brilliantly on all VAX systems.

For more information about WORD-11 call, or mail the attached reply card.

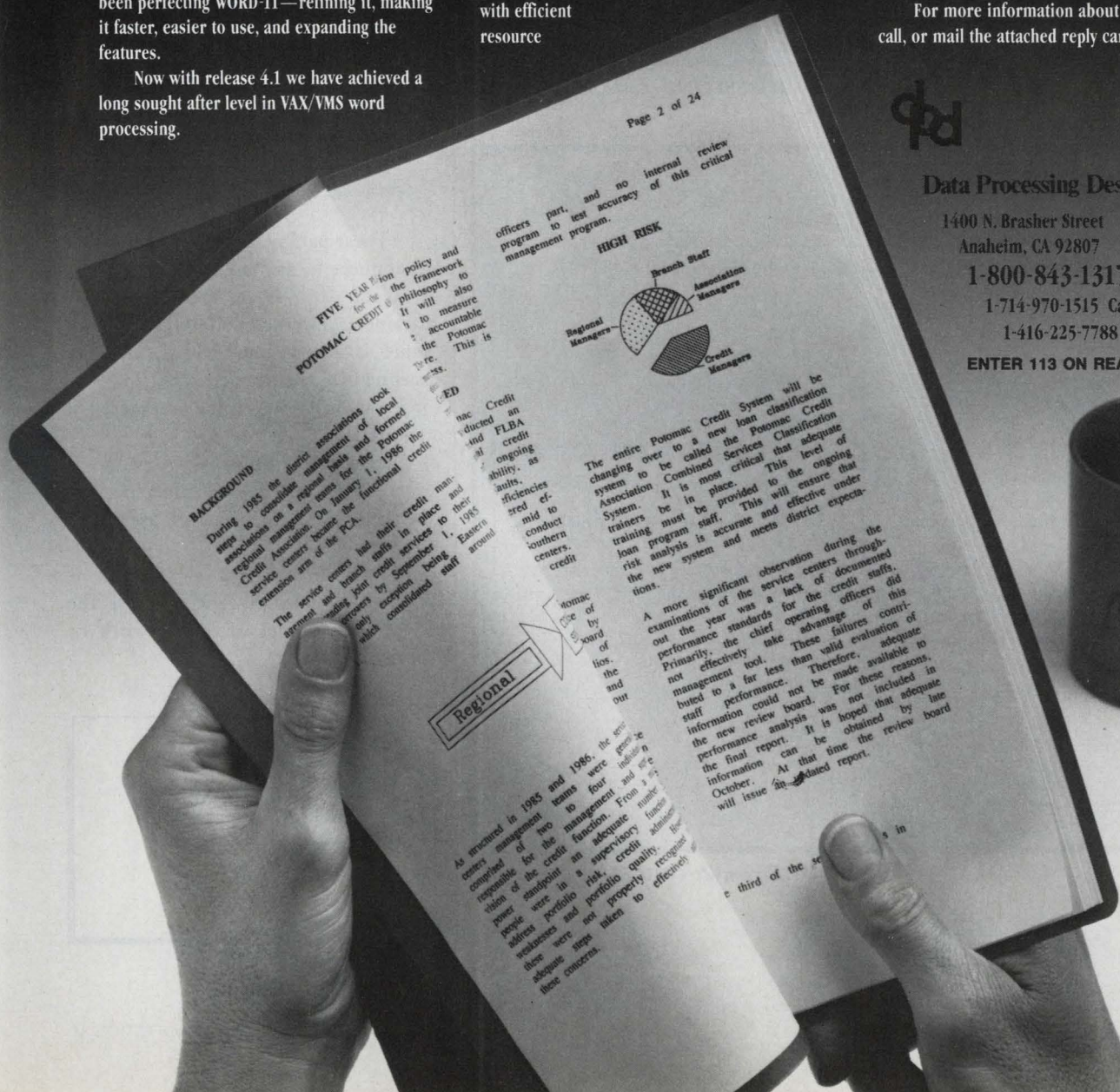

Data Processing Design, Inc.

1400 N. Brasher Street
Anaheim, CA 92807

1-800-843-1317 USA

1-714-970-1515 California

1-416-225-7788 Canada

ENTER 113 ON READER CARD



RESPOND Main Menu

A) Select a Profile
 B)
 C) Enter Terminal Emulation Mode
 D)
 E)
 F)
 G) Quick Start
 H) Save a Profile
 I) Erase a Profile
 J)
 K) Quit RESPOND
 L) Enter DOS Command Mode
 M) Enter Help Mode

INSTRUCTIONS

Welcome to RESPOND, the Standard for Integrated PC Communications!
 To Quick Start Asynchronous Communications, Press the "G" Key.
 To Select a Different Function, Use the Space Bar or Arrow Keys to Move the Cursor and Then Press the Enter Key.

MESSAGES

Current Profile: < none >

Screen 1: RESPOND main menu screen.

Quick Start Screen

PARAMETERS	VALUES
A) Service/Network	CompuServe/Direct Dial
B)	<?>
C) User ID	<?>
D) Password	<?>
E)	<not required>
F) Network Address	<?>
G) Telephone Number	TONE
H) Dialing Method	Hayes Compatible 300 or 300/1200
I) Modem	COM1
J) Communications Adapter	1200
K) Baud Rate	7 Data—Ignore Parity—1 Stop
L) Character Bits (Set for Service)	
M)	

INSTRUCTIONS

Use the Plus and Minus Keys to Change the Value of This Parameter
 Use the Space Bar or Arrow Keys to Move Cursor
 Press the Esc Key to Return to the Main Menu
 Press Ctrl/Home When All Values Are Correct to Start Communications

MESSAGES

Note: Identifies the Service and the Way You Wish to Connect to it

Screen 2: QUICK START screen.

will select values simultaneously for other parameters.

Possible values for the Service/Network parameter include direct dialed, hard wired, Telenet and Tymnet choices from CompuServe and The

RESPOND allows you to send and receive data while in emulation mode.

Source, Dow Jones Newsnet, OAG, RCA Mail and MCI.

In addition, you may select the following parameter values for Service/Network:

<other>/Direct Dial
 <other>/Hard Wired
 <other>/Telenet
 <other>/Tymnet

These parameter values can be used to connect to any host or service.

2. User ID — A value for this parameter is entered if required. The value is the account of ID number assigned by the service.
3. Password — A value is entered if required.
4. Network Address — A value is entered if required. The value specifies the address that the network assigns to the service.
5. Telephone Number — A value is entered if required. The value is the telephone number of the network or service.

RESPOND/QUICK

Software Synergy Inc.
 641 Avenue of the Americas
 New York, NY 10011
 (212) 645-9663

Price: \$39

ENTER 367 ON READER CARD

Now there's a new UNIX® System video training program, from the people who wrote the book.

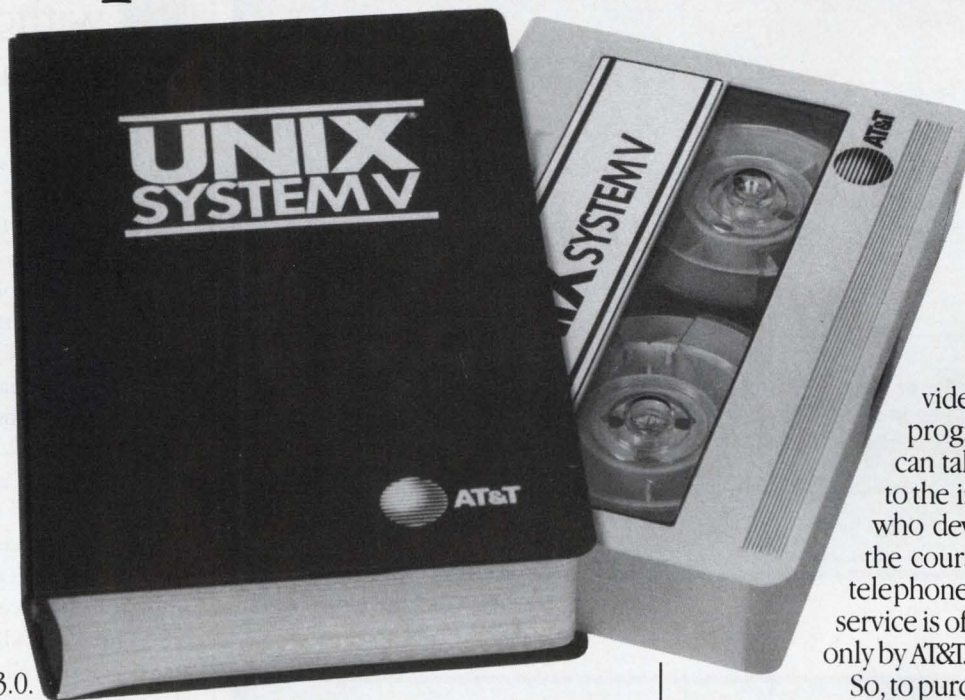

AT&T, the inventor of the UNIX System, now offers the most comprehensive and most current UNIX System training, even including UNIX System V Release 3.0.

A complete curriculum, on videotape, through the new AT&T Videotape Library.

Modular Courses.

- Fundamentals of the UNIX System:
 - Basic
 - Intermediate
 - Advanced
 - Shell Command Language for Programmers
 - 'C' Language for Programmers
- Our courses are created by AT&T instructors with 10 years of experience in grooming AT&T's own UNIX System professionals. Courses are modular and can be used in entirety or in sections.

More than a 'taped lecture.'

Each course blends professionally developed graphics and text into a

high-interest, easy-to-follow learning experience. And each course is self-contained, including sample programs and workbook exercises for thorough retention of skills.

Questions? Call us.

If you have any technical questions after you have reviewed your

videotape program, you can talk directly to the instructors who developed the courses. This telephone support service is offered only by AT&T.

So, to purchase or lease a video training program that is authoritative, current, and complete, call or write now for more information on the AT&T Videotape Library. A demonstration video is available.

© 1987 AT&T

Call 1 800 247-1212, Ext. 1001, or mail this coupon.



AT&T Videotape Library,

PO. Box 2160, Jacksonville, FL 32232-9912

DP1187

- Please rush me your course catalog on the AT&T Videotape Library for Computer Systems Training.
- Please send me information on your classroom training programs.
 - UNIX System training
 - Business applications training
 - Data communications and networking training

Name _____

Title _____

Company _____

Address _____

City _____ State _____ Zip _____

Phone () _____

Visit AT&T at COMDEX

Nov. 2-6

Las Vegas Convention Center
North Hall, Booth #2530.

ENTER 104 ON READER CARD



AT&T

The right choice.

The data transfer modes functioned without glitches.

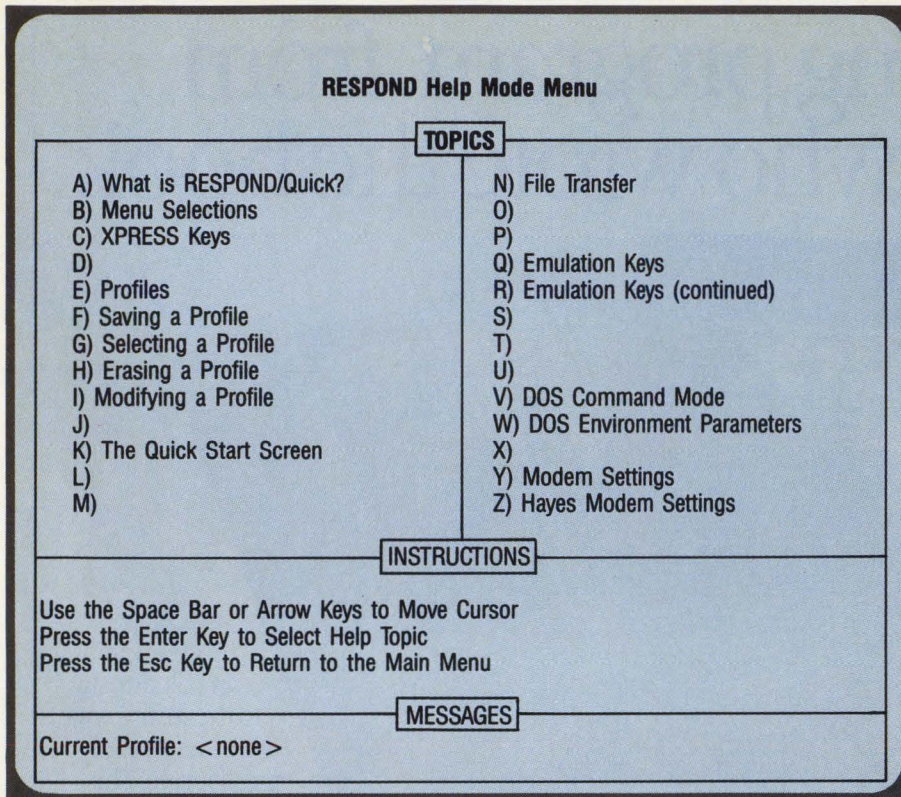

Screen 3: RESPOND help mode menu.

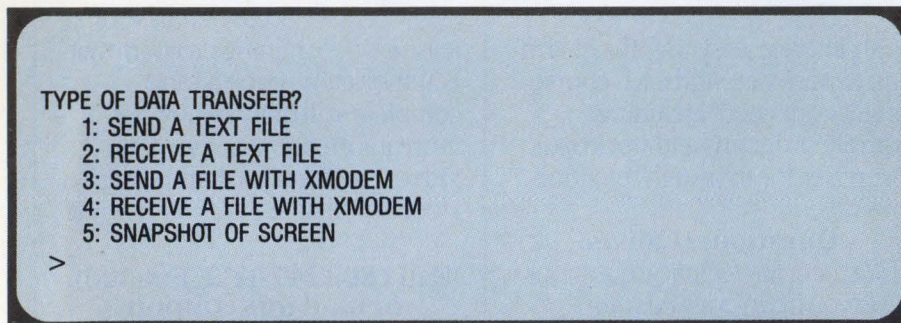

Screen 4: Data transfer menu.

number of bits representing each character.

RESPOND/QUICK allows you to send and receive data while in emulation mode. Upon pressing the ALT-F keys, you're prompted for the type of data transfer (see Screen 4). After typing the appropriate data transfer code, you enter the name of the file to be sent or received.

The Send a Text File and the Receive a Text File options operate without any special error-checking protocol. The XMODEM error-checking protocol, however, is available.

The Snapshot of Screen data transfer option allows you to store snapshots of the screen on disk. After typing a 5 for the desired data transfer option, you enter the name of the file to hold the snapshots. Subsequently, the current screen is saved in the specified file each time CTRL-PrtScrn is entered.

The data transfer modes functioned without glitches. And, as is typical of this package, data transfer was accomplished easily.

If you want to add a friendly communications package to your software library, RESPOND/QUICK is a worthwhile choice. —Michael G. Gonzales is assistant professor of computer and information science at Gwynedd Mercy College, Gwynedd, Pennsylvania.

ARTICLE INTEREST QUOTIENT
 Enter On Reader Card
 High 368 Medium 369 Low 370

6. Dialing Method — A value is entered if required. Two values are possible: tone or pulse.

7. Modem — A value is entered if required. Possible values are: Hayes Compatible 300 or 300/1200, Hayes Smartmodem 2400 or Manual Dial.

8. Communications Adapter — This

specifies the communications adapter on the PC to be used for communications. Possible values are COM1 and COM2.

9. Baud Rate — Possible values are 110, 150, 300, 600, 1200, 2400, 4800, 9600, 19200, 1200/300 autobaud and 1200/2400 autobaud.

10. Character Bits — This specifies the

WHY 40 OF DEC'S TOP 50 CUSTOMERS DEPEND ON INGRES.



In a word...*performance*. Today's most respected information managers and MIS professionals are investing in Digital VAXclusters as part of their information management solutions. And when they do, they're turning to INGRES to maximize return on investment. They know that INGRES is the only relational DBMS designed to optimize VAXcluster performance. Here's how:

Superior processing power and versatility.

INGRES harnesses the power in VAXcluster architecture, turning it into a multi-processing database server for hundreds of concurrent users. Through the use of advanced caching, query optimization, and distributed lock management, INGRES gives DEC's top customers the peak cluster performance they need to drive a range of high powered applications as diverse as realtime shop floor control or the daily clearing of billions of dollars in financial transactions. Only INGRES fully leverages their VAXcluster investment by supporting system expansion for years to come. Whenever additional capacity is required, they can simply plug another INGRES node into their cluster.

Production systems tolerant to a fault.

When it comes to reliability, the DEC Top 40 count on INGRES for data/transaction integrity and fault-tolerant DBMS operation. Even if a node goes down, other cluster users go right on processing; INGRES automatically keeps the database consistent. INGRES takes full advantage of DEC features like disk shadowing to guarantee production systems are up and running when they're needed.

Award-winning 4GL development tools.

Now you can achieve the order-of-magnitude increases in development productivity enjoyed by DEC's top customers. INGRES makes it easy to prototype applications, then implement across the desired operating environments. INGRES even protects investments in earlier generation language programs. A rich set of host language interfaces makes it possible to tie existing programs to INGRES applications as you build them.

With so much going for it, plus support and service that sets an industry standard all by itself, it's no wonder so many top DEC customers like GE, Kodak, and Citicorp depend on INGRES. To find out how to put INGRES solutions to work in your VAXcluster, just send in the coupon and we'll mail you a free information-packed report entitled "Maximizing Vaxcluster Productivity with INGRES." Or for even faster action, call 1-800-4-INGRES.

ENTER 150 ON READER CARD

Yes I'd like more details on INGRES performance. Please:

- | | |
|---|--|
| <input type="checkbox"/> Send me my free report. | <input type="checkbox"/> Have a salesperson call me. |
| <input type="checkbox"/> I'd like to attend a free INGRES seminar in my area. | <input type="checkbox"/> I'd like to know more about the INGRES sampler. |

Name _____

Company _____

Title _____

Mailing address _____

City _____ State _____ Zip _____

Telephone _____

Mail to: INGRES
Relational Technology
1080 Marina Village Parkway
Alameda, CA 94501-9891
Or call: 1-800-4-INGRES

113

INGRES
Relational Technology

To design our new through the eyes of



Though it's priced like an alphanumeric terminal, our 600 Series can display both bit-mapped graphics and full-featured text.

It has been said that the video quality on most alphanumeric terminals doesn't even deserve a second look. Much less a fixed gaze. Unfortunately, we have to agree.

We know what poor video quality can do to an operator's productivity. And we also know that lost productivity can cost you more than any investment you make in terminals.

But until now, it was almost impossible to find good video at a good price. You had to choose between high-performance,

high-priced graphics terminals, and lower-priced, lackluster alphanumeric terminals.

Introducing the Visual 600 Series Integrated Image Display Station.* A new kind of terminal that combines text with graphics for an image so superior that your users will forget all about things like poor resolution, flicker and edge distortion.

For about the same price as a regular alphanumeric terminal, it will emulate ASCII, ANSI or VT220™ terminals, while displaying powerful bit-mapped graphics you would



One of the best things about the 600 Series is that it is designed for plug-and-play operation.

terminal, we looked the terminal operator.

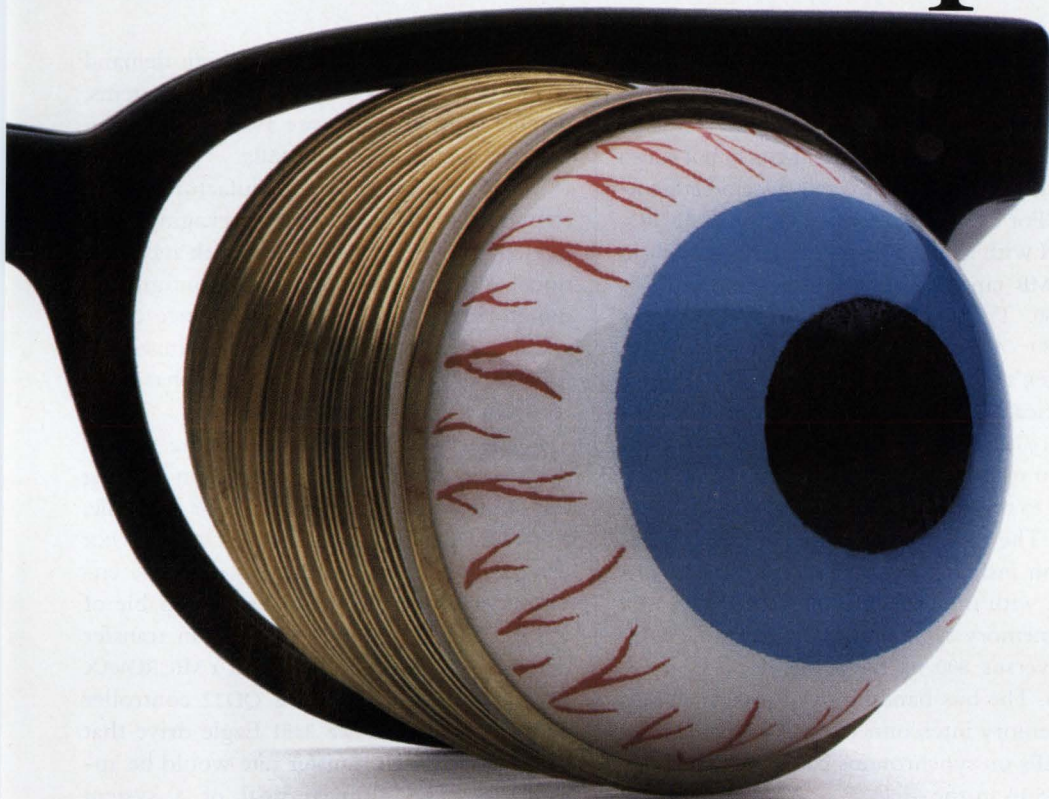

only expect from a dedicated graphics terminal. And we think its integration of text and graphics will soon become the standard for business computing.

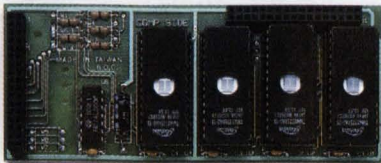

A plug-in "personality module" tells the 600 Series whether to emulate a DEC, Wyse, Televideo or you-name-it.

The trick is something we call a plug-in personality module that can change our basic terminal into a VT220, a Wyse 50+ or almost anything. And VARs get an open architecture so they can customize to their hearts' delight.

But don't settle for mere words. Look at our new 600 Series Integrated Image Display Station. Because nobody should look at a terminal through eyes like these.

For more information or to arrange a demonstration, call 1-800-433-0880 or write Visual Technology, P.O. Box 5505, Peoria, IL 61601.

VISUAL

DISPLAYS OF INTELLIGENCE

Corporate Headquarters: Visual Technology, Inc., 1703 Middlesex Street, Lowell, MA 01851
*Patent pending. VT220™ is a registered trademark of Digital Equipment Corp.

ENTER 167 ON READER CARD

Disk I/O: Part 1

By Moses Sun

Challenge Of The Disk Storage System Integrator.

The role of the disk storage subsystem in a modern computing facility should never be underestimated. Not only is it costly but it also has a great impact on overall system performance. For example, the price tag on a MICROVAX II with 5 MB memory, a 71 MB hard disk, a 95 MB tape drive, and four serial ports is \$21,280. The price tag on an RA81 drive is \$13,280. A MICROVAX II equipped with Emulex's QD32 controller and a Fujitsu America 2351 Eagle drive competes with the VAX 11/780 equipped with an RA81 drive.

In recent years, improvements have been made to the performance of the VAX architectures. The VAX 8800 is capable of executing 12 million instructions per second (MIPS) compared with one MIPS on the 11/780. The VAX 8800 memory cycle time is 495 ns for a 256-bit read versus 800 ns for a 64-bit read on the 11/780. The bus bandwidth of 8800 is 30 MBs on memory interconnect (MI) compared with 13.3 MBs on synchronous backplane interconnect (SBI) in the 11/780.

According to DEC, seek time and rotational delay use 78% of the total transfer time on the 11/780 to complete a disk transfer of four to eight blocks. Therefore, a responsive system requires minimizing the disk transfer time, a challenge not only to the disk drive and controller manufacturers but also to the system configurator, the system manager and the application programmer.

Disk drive manufacturers have responded to the need by producing faster, higher-capacity and more cost-effective drives. The CDC 9772, for example, has a 1330 MB (unformatted) storage capacity, 16 ms access time,

and a 3.0 MB transfer rate. For high demand applications such as image processing systems, parallel transfer drives are available that can transfer data as fast as 12 MBs.

The disk controller manufacturers have responded to the challenge by packaging more intelligence (i.e., advanced disk seek and rotational optimization algorithm, configuring, monitoring, tuning, and maintenance tools) and larger cache memory into the controller. As a result, the effective seek time has been reduced.

The challenge presented to the system designer is to build a balanced system meeting the application requirements. For example, a MICROVAX II equipped with a Digital RDxx drive isn't adequate for an I/O intensive environment. Because the Q-bus is capable of transferring 1-3 MBs, the RDxx can transfer only 625 KBs. On the other hand, a MICROVAX II equipped with Emulex's QD32 controller and a Fujitsu America 2351 Eagle drive that supports a 2.5-MB transfer rate would be appropriate. The ultimate goal of a system designer is a cost-effective computer system in which each component can perform to its potential.

The system manager must develop a better understanding of the disk I/O mechanism and the on-disk information structure (i.e., Files-11 disk structure) so that adequate memory caching is provided and an optimal disk structure is maintained. The application programmer must understand the mechanism of the file system, and design well-structured files so that the end users can enjoy good system performance. By understanding the disk storage system, the system integrator will be able to configure a balanced system. In a future article, we'll take a look at how the

GET MORE OUT OF YOUR VAX

Control your space

VDM catches the "disk demons" who are gobbling up your blocks. You get daily reports showing the blocks allocated to each user. Rapidly growing accounts are highlighted. If you're using quotas, VDM also shows you what percentage of quota each user has used up.

\$495

Never run out

MINUTEMAN guards your free space. Once a minute, it checks how many blocks are free on each disk drive. If any drive has less than the minimum you've set, it recovers space by purging multiple file versions and deleting temporary files according to rules you've specified. If space continues to decrease, it warns you and asks for help. With MINUTEMAN, you'll never run out of free space again.

\$395

Twice as fast

GO moves you up, down and around VMS directories twice as fast as SET DEFAULT. It's simple, powerful and FAST. This is what the SET DEFAULT command should have been.

\$195

FREE TRIAL

Try any of our products on your system for 30 full days without cost or obligation.

GUARANTEE

If, within the first 90 days, you're not completely satisfied, simply return the distribution and we will refund all your money.

Pinpoint bottlenecks

WATCH helps you manage your VAX. Minute by minute, it shows how your system is handling its load and where the performance bottlenecks are. WATCH screens are packed with key performance indicators. A potent VMS performance monitor.

\$495

Eliminate waste

HITMAN frees up resources and plugs security leaks by killing idle processes. If a process remains idle longer than the time you selected, HITMAN eliminates it with or without warning. All "hits" are logged to the system console.

\$395

What's going on?

SNITCH tells you when a particular user logs on, when a specific terminal is used, when a DIALUP login occurs, when a particular image runs and lots more. You can define your own "events" as well. A good SNITCH is invaluable. You'll wonder how you ever got along without one.

\$395

VAX to VAX

VtV moves executables and data files from one VAX to another over normal telephone lines. You can transfer your data interactively during the day or by batch at night when the rates are low.

\$495

Call Alan Clifford at:
Jager Computer Systems
(403) 259-0700

VAX, VMS are trademarks of Digital Equipment Corporation

F

FIGURE 1.

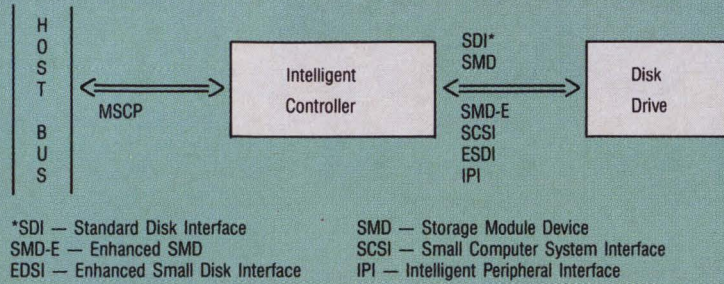

Disk storage system architecture.

F

FIGURE 2.

Controller Type	MAX I/O Bandwidth	Connected Drives	Drive Type	Connecting Bus	Command Buffer	Data Buffer (Sectors)
UDA50	3 MBs	4	RAxx,SA482	UNIBUS	20	52
KDA50	3 MBs	4	RAxx,SA482	Q-BUS	20	41
KDB50	3 MBs	4	RAxx,SA482	BI	20	42
HSC50	4 MBs	24	RAxx,SA482	BI,SBI,CMI via CI	1000	256
HSC70	4 MBs	32	RAxx,SA482	BI,SBI,CMI via CI	2000	512
RQDXx	NA	4	RDxx,RXxx	Q-Bus	NA	NA

DEC DSA disk controller characteristics.

F

FIGURE 3.

BUS	I/O Bandwidth	CPU
Q-Bus	3 MBs	MicroVAX
UNIBUS	1.2 MBs	11/7xx,8xxx
CMI	5 MBs	11/750
SBI	13.3 MBs	11/78x,86xx
BI	13.3 MBs	8(2,3,5,7,8)xx
CI	8.8 MBs	VAXcluster

CMI — CPU Memory Interconnect
 SBI — Synchronous Backplane Interconnect
 BI — Bus Interconnect
 CI — Computer Interconnect

Host bus characteristics.

system manager maintains it and the programmer develops more efficient applications.

Disk Storage System Architecture

The most advanced disk storage system implemented by DEC is called Digital Storage Architecture (DSA). In DSA, an intelligent controller is used to interconnect the host internal bus and the disk drive (see Figure 1). This architecture does more than add another smart controller to offload drive control from the CPU. DSA specifies the functionalities of the host computer software (device driver), the disk controller, and the disk drive and how they relate to each other. It also defines the interface standards and message format between these components.

The functions of the disk controller defined by DSA include:

1. Seek and rotational optimization
2. Data error checking and correction
3. Command buffering and prioritization
4. Data buffering
5. Self-testing
6. Bad block replacement and mapping
7. Logical to physical data mapping.

The command and data buffering capabilities enable the controller to balance the I/O bandwidth differences between the host bus, the controller, and the disk drive to sustain the continuity of the dataflow. The bad block replacement and mapping feature conceals any disk flaws from the host computer by remapping the bad block with a good replacement block. The data error checking and correction capability guarantees that error-free data will be provided to the host computer.

Several techniques are employed in the seek and rotational optimization:

1. The seek ordering technique minimizes the disk head movement by ordering the I/O requests so the closest seek request will be satisfied first.
2. Overlapped seeking technique, applicable to a single-controller-with-multiple-drives configuration, enables one drive to perform a data transfer

POWERFUL TEAMMATES

SYSTEM ENCLOSURES

DA 23 & DA 523

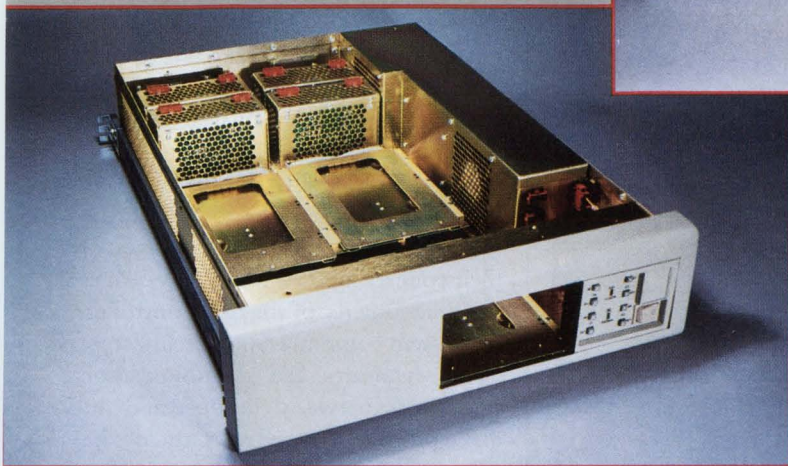
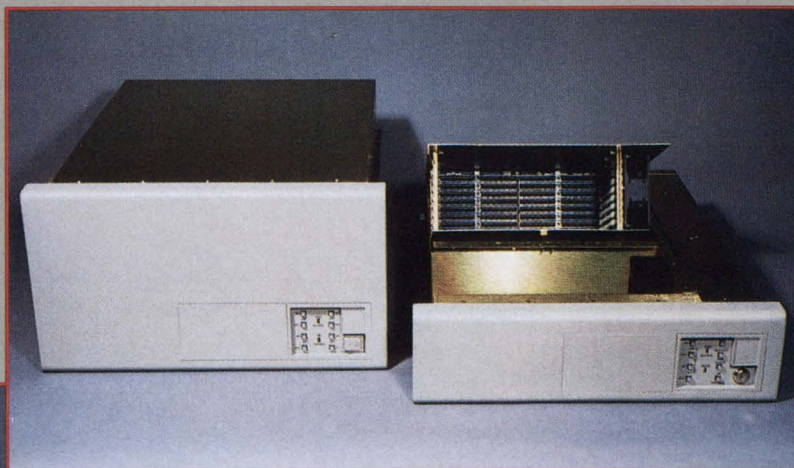

5.25" DISK STORAGE ENCLOSURE

DA 50

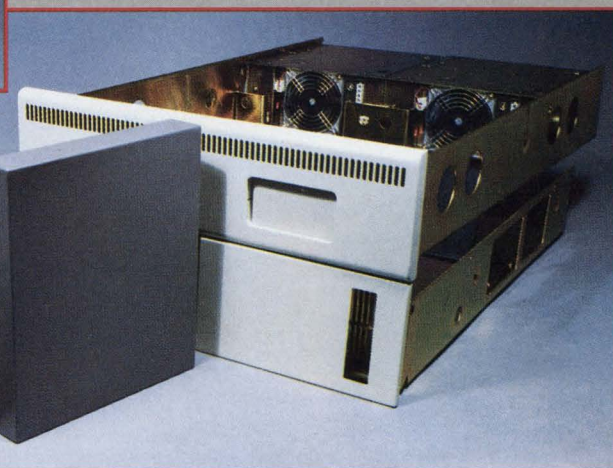

8" & 9" DISK STORAGE ENCLOSURES

DA 80 & DA 90

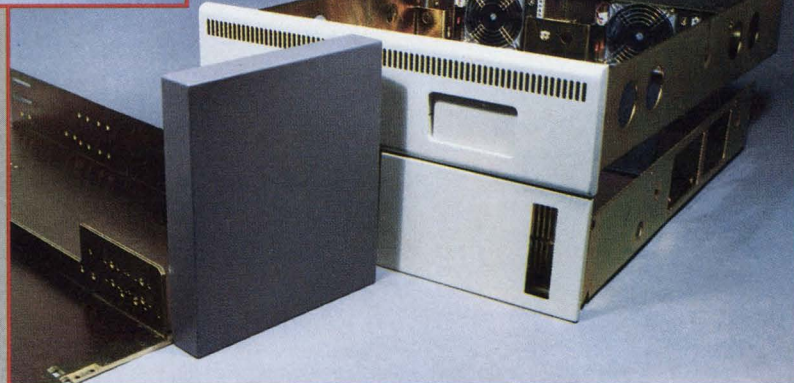

DA 23

- Cardage with 8 Slot "CD" or "Q22" Backplane
- Mounting for two 5.25" Peripherals
- 350 Watt Continuous Power Supply
- Control Console with Write Protect/Ready functions and Audible and Visual Thermal Protection Alarm

DA 523

- Cardage with 12 Slot "CD" Q-Bus Backplane
- Mounting for five 5.25" Peripherals
- 500 Watt Power Supply
- Control Console with Write Protect/Ready functions and Audible and Visual Thermal Protection Alarm

DA 50

- Mounting for four 5.25" Peripherals
- 50 Watt Power Supply for each drive
- Control Console with Write Protect/Ready functions
- Cooling System with Audible and Visual Thermal Protection Alarm

DA 80 and DA 90

- Mounting for 2 Peripherals side by side
 - Standard Square Edged or DEC styled front bezel
 - Optional 270 Watt Continuous Power Supply for 8" Drives
- ENTER 226 ON READER CARD

TRIM INDUSTRIES



11949 Sherman Road, North Hollywood, CA 91605
Phone: 818-983-1833, 800-272-3557 in CA, 800-423-2024 outside CA
FAX: 818-503-0438 TWX: 910 499 4745

TRIM INDUSTRIES LIMITED



2-6 Giltway, Giltbrook
Nottingham, NG16 2GN, England
Phone: (0602) 385485 FAX: (0602) 389973 Telex: 378317

while the other drives are seeking.

3. When multiple drives are on cylinder, the rotational position sensing technique enables the controller to service the drive whose heads are closest to the requested data sectors.

4. Segmented data transfer, another rotational optimization technique, allows a data transfer to start at any disk sector within the target sectors without requiring the head to rotate to the beginning of the target sectors. For example,

if the current head position is at sector three, a request for the data sectors zero to seven will be transferred in two segments, four to seven and zero to three.

Perhaps the most important function performed by the controller is the logical-to-physical data mapping. When the host driver requests a data block, only the logical block number (LBN) is given to the controller. The controller translates the given LBN to the physical location; that is, cylinder, track and sector, on the drive. With this feature, the host disk driver is freed from knowing the details of the drive geometry cylinders, tracks and sectors; is able to control drives with different characteristics capacity and speed; and is easier to maintain.

The characteristics of the DEC DSA controllers are summarized in Figure 2. Figure 3 shows the characteristics of their connecting bus. While DSA defines the functionality of the disk controller, the system communication architecture (SCA) delineates the communication framework between the host and the disk controller. Under SCA, the device driver is divided into two layers: a class driver (DUDRIVER) and a port driver (PUDRIVER, PADRIVER). DUDRIVER is a generic disk driver that can communicate with any DSA drives through a port driver. PUDRIVER controls the UDA50 controller. PADRIVER controls the CI750/780 controller.

DUDRIVER uses message packets to communicate with the disk controller. The format of the message packet is defined by the Mass Storage Control Protocol (MSCP). Two types of message are defined by MSCP: the command packet specifying the command that needs to be executed by the controller, and the response packet which sends the completion status of the command execution to the host.

The disk interface standard specifies the physical connection, data channel, and handshaking signals between the controller and disk drive. These specifications enable a disk controller to control any drive that complies with the same standard, regardless of its speed,

F **FIGURE 4.**

Interface Standard	I/O Bandwidth
ST506	625 KBs
ESDI	1.2 — 2.5 MBs
SCSI	1.5 MBs
IPI	4 — 4.5 MBs
SMD	1.2 MBs
ESMD	1.8 MBs
HSMD	2.4 MBs
SMD-E	3 MBs

Disk interface standard characteristics.

F **FIGURE 5.**

Drive	Access Time(ms)*	Transfer Rate(MBs)	Capacity
RA80	33.3	1.2	121
RA81	36.3	2.2	456
RA60	50	1.98	205
SA482	32.3	2.4MB/spindle	3.4 GB
RD53	38	625 KBs	71
RD54	38.3	625 KBs	159

* access time = seek time + rotational delay

DEC disk drive characteristics.

F **FIGURE 6.**

Configuration	Capacity	Size	Access Time	Throughput	Price
2 RA81 + cabinet	912 MB	10.5"	36.3 ms	2.2 MBs	\$28,635
SI93C + SDI/SMD controller	844 MB	9"	23 ms	2.4 MBs	\$28,000

Comparison of two configurations.

**FULL TEKTRONIX™
CAPABILITY ON PCs**

Introducing a New Image for DECnet DOS™

Mainframe Graphics Through Your PC.

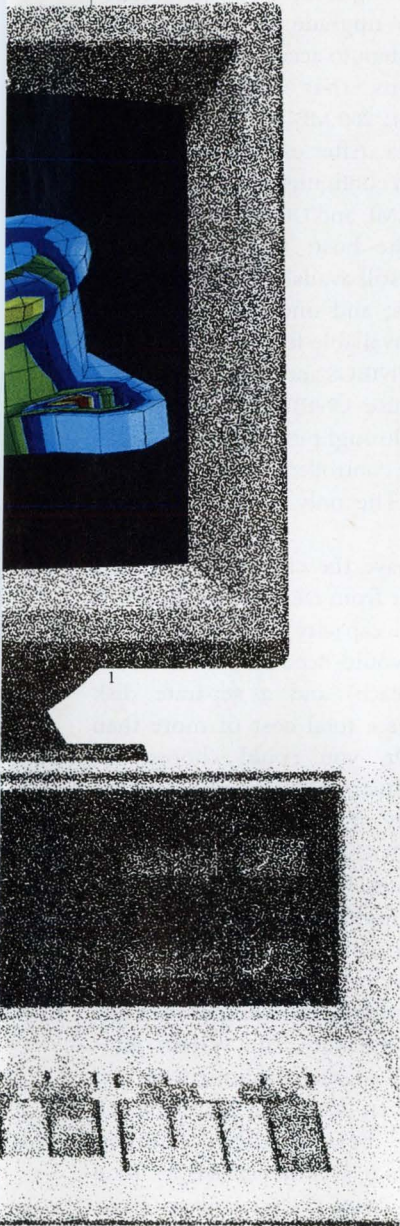

Grafpoint™, the leader in Tektronix terminal emulation software, announces support for DECnet DOS. With Grafpoint's TNET™ your PC can now be networked with host-based graphics programs.

Look To Grafpoint For The Widest Selection In Terminal Emulation Software

Grafpoint has a wide range of high-performance graphics terminal emulators, giving you a choice of Tektronix's 4105, 4107, 4109, or 4115 Terminals in asynchronous or local area network environments. Grafpoint's software transforms your PC and graphics card combination into a powerful graphics terminal, capable of supporting hundreds of mainframe graphics applications.

Discover The Latent Graphics Terminal In Every PC

With TNET, your networked PC will provide full Tektronix compatibility, plus the advantage of network communications speeds. PCs become powerful and versatile workstations for both stand-alone and host-dependant applications. Grafpoint's TNET offers graphics terminal emulation capability over networks such as Ungermann-Bass Net One™, Bridge EtherTerm™, and now, DECnet.

You Can't Afford To Use Less Than The Best

Grafpoint's commitment to quality in products and customer support is second to none. Free updates and technical support for one year are just part of Grafpoint's comprehensive effort in providing support to you the customer, making Grafpoint the industry leader in high-performance terminal emulation.

Free 30-day Trial

To learn more about TNET, or to arrange for a no-risk 30-day trial, call **1-800-426-2230**, (408-446-1919 in CA).

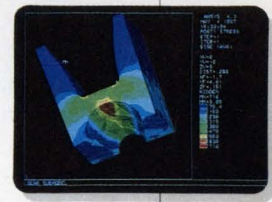
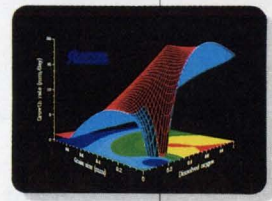

- 1 Courtesy of PDA Engineering
- 2 Courtesy of SDRC
- 3 Courtesy of TEMPLATE
- 4 Courtesy of Computer Associates International, Inc.
- 5 Courtesy of Swanson Analysis Systems, Inc.

Yes, please send me your free terminal emulation guide on Grafpoint's high-performance Tektronix graphics terminal emulation software for PCs.

Name _____
 Title _____ Company _____
 Address _____
 City _____ State _____ Zip _____
 Telephone _____



GRAFPOINT

1485 Saratoga Avenue, San Jose, California 95129
 (800) 426-2230 In CA (408) 446-1919

ENTER 123 ON READER CARD

DECnet DOS is a registered trademark of Digital Equipment Corporation.
 etherTerm is a registered trademark of Bridge Communications.
 Grafpoint & TNET are registered trademarks of Grafpoint. NET-1 is a
 registered trademark of Ungermann-Bass, Inc. Tektronix is a registered
 trademark of Tektronix, Inc.

Control Data Corporation
MPI Division
12701 White Water Dr.
Minneapolis, MN 55343
(800) 232-1985
ENTER 460 ON READER CARD

Digital Equipment Corporation
146 Main St.
Maynard, MA 01754-2571
(617) 897-5111
ENTER 461 ON READER CARD

Emulex Corporation
3545 Harbor Blvd.
P.O. Box 6725
Costa Mesa, CA 92626
(714) 662-5600
ENTER 462 ON READER CARD

Fujitsu America Inc.
3055 Orchard Dr.
San Jose, CA 95134-2017
(408) 946-8777
ENTER 463 ON READER CARD

System Industries
560 Cotton Wood Dr.
Milpitas, CA 95035
(408) 942-1212
ENTER 464 ON READER CARD

capacity, and physical size. Unfortunately, no single standard exists. DEC employs its own standard disk interface (SDI) but doesn't support the widely used storage module device (SMD) standard, an ANSI standard. Figure 4 shows the performance characteristics of current industry disk interface standards.

This presents a problem to the system designer when selecting the disk storage system, because he can't buy a SMD drive and expect it to work with the UDA50 controller or the HSC50. A separate SMD controller or an SMD/SDI converter has to be installed to use the drive.

DEC's intention is to grab a major share of the peripheral market. If the cost/performance ratio is not a concern in your establishment, DEC can save you the time of shopping around (see Figure 5). But if cost performance/ratio

is an issue, check into some other options offered by the third-party vendors.

The other types of disk storage architectures implemented by Digital and third-party vendors are UNIBUS and MASSBUS disk storage systems. In both architectures, the host processor plays a major role in controlling the disk drives. In fact, the details of a disk drive are built into the operating system disk driver. Consequently, to upgrade and maintain a disk storage system is costly.

To keep up with the evolving disk controller and drive technologies without incurring massive costs in rewriting the disk driver, DEC invented DSA. In DSA, all the MSCP compatible controllers can communicate with the host generic disk driver. This feature enables the peripheral manufacturers to concentrate on producing better controllers and drives without worrying about which operating system they'll be connected to. Currently, the MSCP compatible products occupy 65 percent of the peripheral market.

Disk Storage System Integration

A system integrator must apply his understanding of disk storage system architecture to configure a cost-effective disk storage system. To do so, he needs two pieces of information about the host system: the I/O bandwidth that's required by the application, and the connecting host bus performance characteristics.

Defining the I/O requirements of an application is a non-trivial task. This information may be obtained from the software vendor who furnishes the software, the programmer who developed the application or the VMS monitor utility.

The next step is to find controllers compatible with the system bus and performance characteristics. Because a variety of controllers is available, you must evaluate optimization techniques, error checking and recovery capabilities, the size of the cache buffer, the MSCP compatibility, the drive interface standard, the board size, the I/O bandwidth and the number of supporting drives.

The third step is to find drives that are compatible with the controllers you selected. The choice of selecting a drive is dependent on its capacity, I/O bandwidth, interface standard, mean time between failure, access time and physical size. The final step is to determine the cost/performance ratio of the potential configurations.

For example, suppose you were requested to upgrade an existing disk storage system to accommodate several applications that require 2 MBs throughput, 200 MB for code, and 500 MB for data. After examining the current system configuration, you find that UNIBUS, CMI, and CI (HSC50) are available on the host; two channels on HSC50 are still available for connecting disk drives; and one slot in an RA81 cabinet is available for mounting. Rule out both UNIBUS and CMI bus connections because UNIBUS supports only 1.2 MBs throughput and no MSCP-compatible controller is available for the CMI bus. The only possibility is the HSC50.

You have the choice of buying a drive either from DEC or a third party. Because the capacity requirement is 700 MB, you would need two RA81 drives (456 MB each) and a separate disk cabinet, for a total cost of more than \$28,000. Or, you could choose the System Industry's SI93C drive with 844 MB capacity or the Emulex SMDI with the large CDC drives, and use the existing cabinet. Figure 6 compares these two configurations. In this example, the third-party equipment would provide superior performance at lower price.

With an understanding of the basic system architecture, the system integrator can recognize the limitations and options when designing a system and make the best possible choices. —Moses Sun is a system manager for Texas A & M University, College Station, Texas.

ARTICLE INTEREST QUOTIENT
Enter On Reader Card
High 457 Medium 458 Low 459

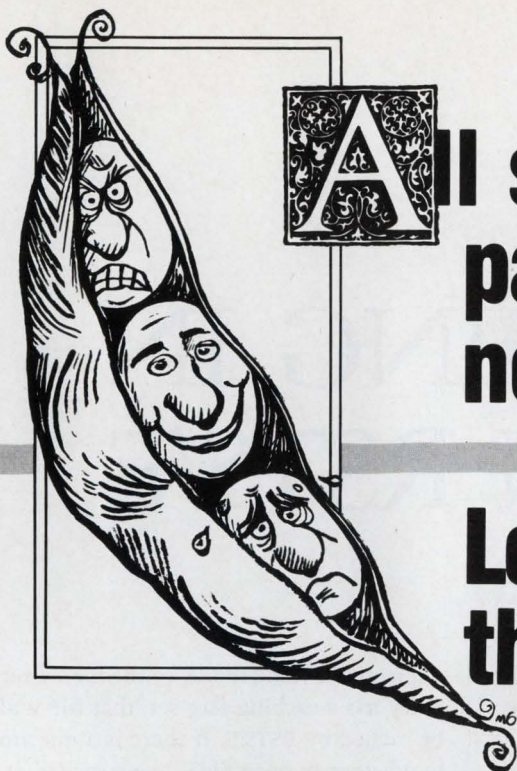

All system accounting packages are not created equal.

Let GEJAC show you the difference.

Some system accounting packages look fine on the outside . . . but their actual performance just doesn't measure up to VMS standards. And with others, their numbers just don't add up—they're flashy but not functional.

Then there's ARSAP—the one complete resource management tool that lets you do everything from overseeing your chargeback operation to capacity planning and performance analysis. And, you get the critical level of efficiency, reliability, and accuracy you require from a systems product.

How can you tell the difference before you buy? For starters, here are three questions to ask yourself about any system accounting package:

- What language is it programmed in? (We programmed ARSAP in MACRO-32 and FORTRAN—the most efficient, optimized higher level language available on VMS.)
- What kind of user interface does it have? (With ARSAP, we give you familiar, powerful DCL-style commands with online help and wild card support.)
- Will the company be around to support you? (We will! We have a proven ten-year support track record and we'll be here to support you in the future.)

We approach your system accounting problems from a systems orientation. That means you benefit from a soft-

ware design that looks like it came from DEC. And, whether you have a standalone CPU, network, or VAXcluster, ARSAP's the answer to your system accounting needs.

Get in touch with GEJAC today—because system accounting packages are not like peas in a pod. And you need to find out the difference *before* you buy.

Yes! Show me the difference.

Name _____ Title _____

Company _____

Address _____

City _____ State _____ Zip _____

Phone _____

DP Manager _____

These are the areas I'm most interested in:

- Chargeback Performance Evaluation
 Capacity Planning Project Accounting
 Resource Management
 Other _____

I have the following VAX/VMS systems:

of Systems _____ Model Nos. _____

Mail to: GEJAC
 8643 Cherry Lane
 Laurel, MD 20707
 Or call: 301-725-2500



RSTS

CACHING IN ON RSTS/E

By Laurence F. Koolkin

Make The Most Of Your System By Allowing Mass Enabling Of Caching For Selected Sets Of Files.

The ability to cache both directory and data information has been available under the RSTS/E operating system for quite some time. By now, most RSTS/E sites with a technical understanding of their operations probably are making as much use of caching as the dropping cost of memory allows, but are they *really*? Often, a site's system startup command file (START.COM) will use the "SET CACHE/ALL" command, and the system manager assumes that this will cause all opened files to be cached by RSTS/E V9.3. Unfortunately, this is not necessarily true!

A CAREFUL READING of the description of the "/ALL" switch indicates that it "... caches all read requests ... for a particular file depending on the file's UFD entry or the OPEN MODE specification." Unless application software is specifically coded to open a file in random or

sequential caching mode, or the file's directory entry has a caching flag set, that file will not be cached by RSTS/E. If there is a question as to whether an open file is being cached or not, simply check the characteristics of the open files for the job in question from another terminal (while the file is opened), using the SYSTAT utility and "/W" switch. Unfortunately, the DCL command "SHOW FILES/OPEN" does not show the required information. By using the "/W" switch, the open mode specifications are shown (see Figure 1).

To see if the UFD entry for a file is flagged to perform caching upon open, use the DIR/FULL command. If you are coding in BASIC under RSTS/E, you can open (either for INPUT or OUTPUT) a file with "MODE 256." for random caching, or "MODE 256.+2048." for sequential caching, on a program by program basis.

Often, a system has many data files (or

FIGURE 1.

Open Files and jobs accessing them:

DRO: -- File	Op/RR	Size	Clu	Status
DRO:[125,1]ABCDE .DAT<60>	1/0	534	8	
Job 4 Block 383	Rd, Wr, Rnd			<-- Cached/Random shown by 'Rnd'
DRO:[0,1]LOGIN .COM<104>	2/1	4	8	
Job 2 Block 2	Rd, Seq,			
Job 8 Block 2	Rd, Seq,			
Job 4 Block 2	Rd, Seq, RR			<-- Cached/Seq shown by 'Seq'

A

All clone-priced terminals
are not created equal.

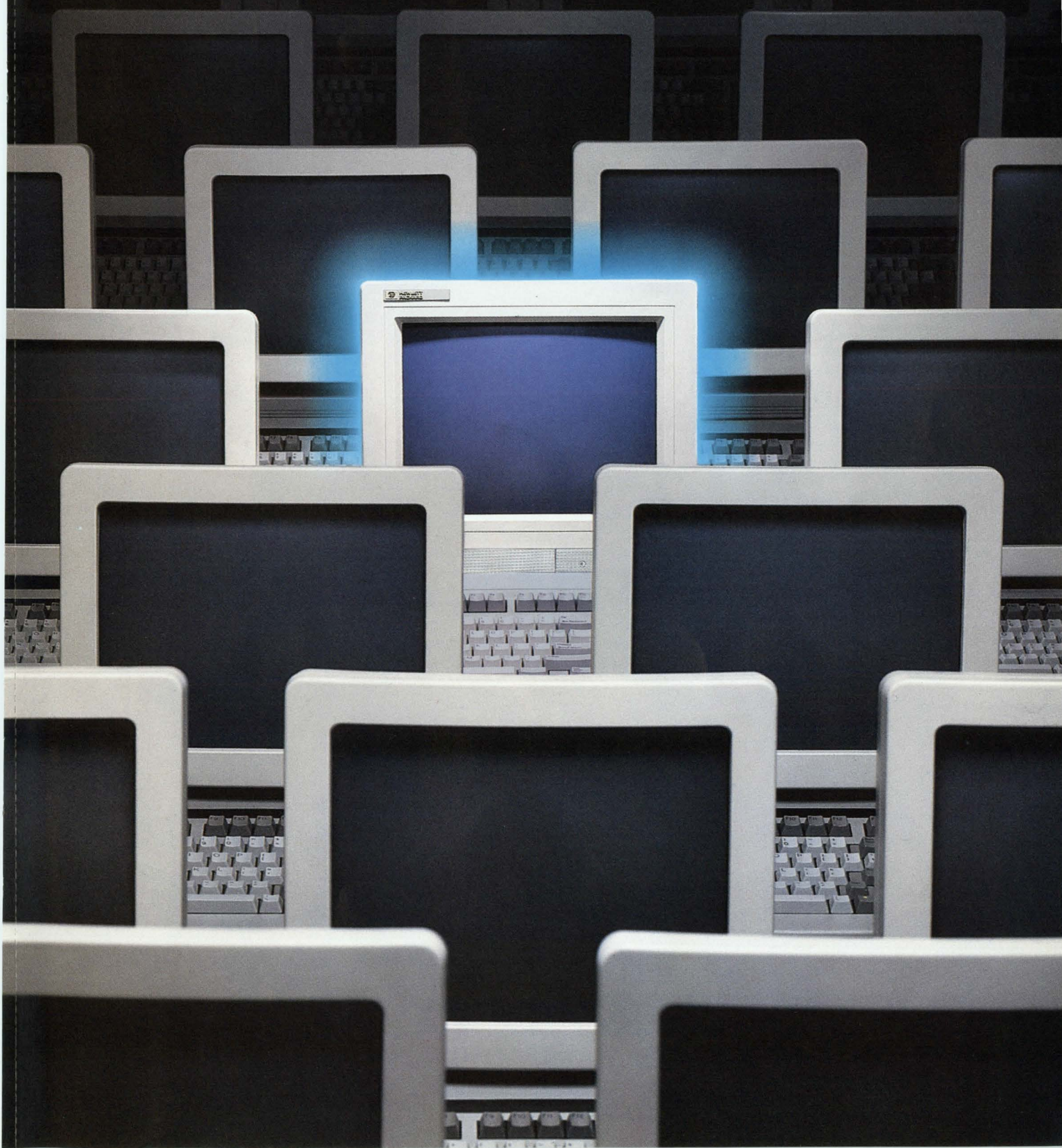

Introducing HP terminals for your DEC, IBM or ASCII system.



Into a world of sameness comes a world of difference.

Until now you could pick a terminal on price alone. Now you can pick a name. A name that stands for design and engineering excellence.

And still get a clone price.

With all the reassurance of knowing that in consecutive Datapro surveys from 1982 through 1986, Hewlett-Packard users gave us top ratings in overall display terminal performance.

That's the difference we make.

HP 700/22 for your DEC/ANSI system.

VT220 compatible with VT220 keyboard layout; 4 pages of memory; choice of screen color including soft-white.

(See next page for more.)

\$575*

HP 700/71 for your IBM system.

3191 compatible with 3191 keyboard layouts; 14" diagonal display with easier-to-read characters; choice of screen color.

(See next page for more.)

\$695*

HP 700/41 for your ASCII system.

9 emulation modes; 14" diagonal display with easier-to-read characters; full-function keyboard; choice of screen color.

(See next page for more.)

\$375*

Call 1 800 752-0900, Dept. 304A

Call us toll-free for more information about the new HP 700 family of terminals. And for details of our introductory **half-price offer** on your first evaluation unit, call before December 31, 1987.



*we never
stop
asking* "What if..."

*All prices U.S. list.

**HP 700/22
DEC VT220 Compatible Terminal**

Compatibility Modes
VT220 mode, 7-bit controls
VT220 mode, 8-bit controls
VT100 mode
VT52 mode

Keyboard
VT220 style 106-key layout
Tactile feedback

Ergonomics
14-inch anti-glare screen
Green, amber or soft-white display
Tilt and swivel
Selectable 50, 60 or 72 HZ refresh rates
Front panel controls
Detached adjustable keyboard

Additional Features
4 pages of display memory
80 or 132 column display
30 programmable function keys
Easy setup menus
RS232C and 20m current loop interfaces
9-pin RS232C printer port

Other
1 year warranty
Jump or smooth scroll
Compose character capability
Nonvolatile memory for saving setup
National language layouts available

DEC VT220, VT100 and VT52 products of Digital Equipment Corporation
DEC is a registered trademark of Digital Equipment Corp.

**HP 700/71
IBM 3191 Compatible Terminal**

Compatibility Modes
IBM 3191 Models A and B, Display Station
IBM 3270 Information Display System, coax connection

Keyboards
IBM style 102 and 122 key layouts
24 programmable function keys for application use
Tactile feedback

Ergonomics
14-inch anti-glare screen
Green or amber display
Tilt and swivel
Front panel controls
Detached adjustable keyboard

Additional Features
Security lock and keys
Automatic screen saver
Easy setup menu

Other
1 year warranty
Nonvolatile memory for saving setup information
National language layouts available

IBM 3191 Display Station and IBM 3270 Information Display products of International Business Machines Corp.
IBM is a registered trademark of International Business Machines Corp.

**HP 700/41
Entry Level ASCII Terminal**

Compatibility Modes
Wyse WY-30
TeleVideo 905, 910+, 925E
Lear Siegler ADM 3A, ADM 5
Hazeltine 1500
ADDS Viewpoint A2
Qume QVT-101

Keyboard
Enhanced 106 key layout
16 function keys (32 shiftable)
58 programmable keys
Tactile feedback

Ergonomics
14-inch anti-glare screen
Green or amber display
Tilt and swivel
Front panel controls
Detached adjustable keyboard

Additional Features
2 standard RS232C ports
Split screen capability
Easy setup menus

Other
1 year warranty
Variable smooth scrolling
Copy and transparent print modes
Nonvolatile memory saves setup, programmed key info
National language layouts available

WY-30 product of Wyse Technologies Systems.
TeleVideo 905, 910+ and 925E products of TeleVideo Systems, Inc.
ADM 3A and ADM5 products of Lear Siegler Corp.
Hazeltine 1500 product of Esprit Systems, Inc.
ADDS Viewpoint AZ product of Applied Digital Data Systems, Inc.
QUME QVT-101 product of Qume Corp.

**For more information, call
1 800 752-0900, Dept. 304A.**



The SAS[®] System

The Quality Control Tool You Won't Outgrow.

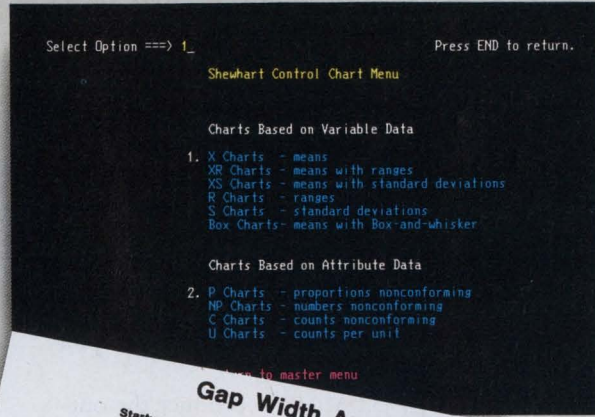

histograms, scatter plots, and more.

In fact, you'll find the SAS System a key decision support tool at every stage of production. Analyze manufacturing data using everything from simple descriptive statistics to advanced methods such as nonlinear regression. Produce reports for line workers, process engineers, and managers. Plan optimal production schedules. Manage inventories.

It's easy to combine tools in the SAS System to meet your changing information needs. We've even created a prototype menu system to get you started.

Novice users can run complete applications with just a few keystrokes, and your programmers can tailor the sample applications.

See for yourself how the SAS System brings you higher productivity, lower production costs, and greater customer satisfaction. Just send us your name and address. Or call a Software Sales Representative today.

Better Quality Products Begin with the SAS System.

SAS SAS Institute Inc.
 Box 8000 □ SAS Circle
 Cary, NC 27511-8000
 (919) 467-8000
 Fax (919) 469-3737

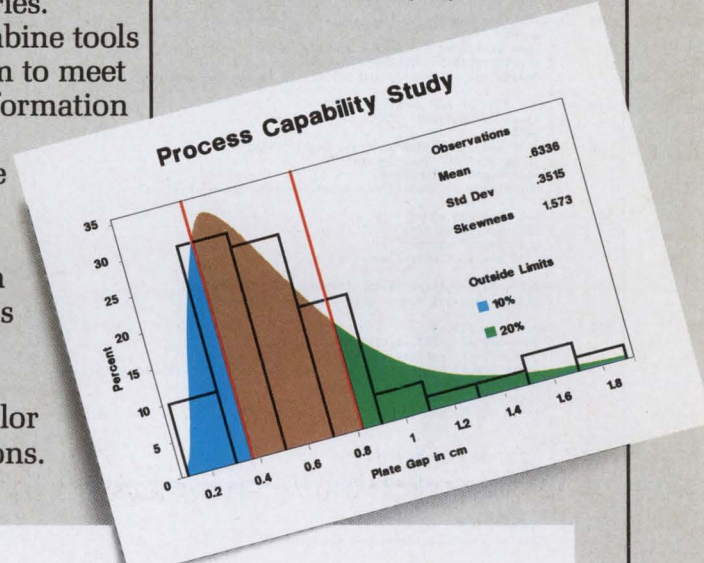
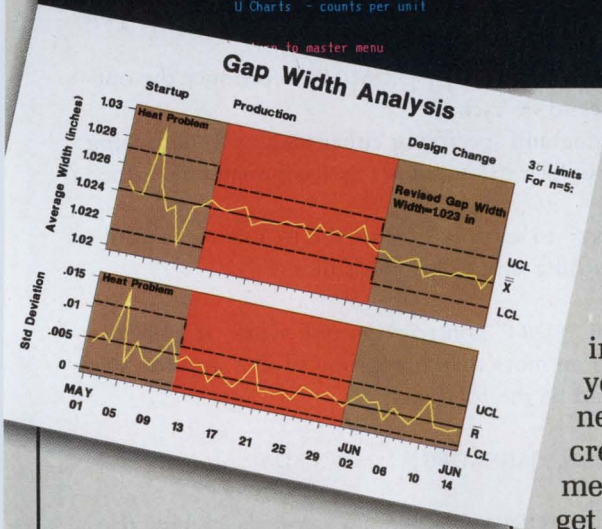

When quality counts, you can count on the SAS[®] System...software that keeps you in control.

The SAS System gives you a faster, easier way to put statistical quality control in action. And you don't have to be a programmer to use it! Easy-to-use procedures let you turn production data into powerful graphic presentations. You can generate all basic types of Shewhart control charts, as well as cumulative sum and moving average control charts,

- Send me more about the quality control tools in the SAS[®] System.
- Include details about training.
- Tell me other ways the SAS System can work in my company.
- Call me to discuss a 30-day trial.

Please complete or attach your business card.

Name _____
 Title _____
 Organization _____
 Address _____
 City _____ State _____ ZIP _____
 Phone () _____
 Machine _____ Operating System _____

Mail to: SAS Institute Inc., Attn: CC
 Box 8000, SAS Circle, Cary, NC 27511-8000

The SAS System runs on IBM 370/30xx/43xx and compatible machines, Digital Equipment Corporation's VAX™ and MicroVAX II™ Data General Corporation's ECLIPSE® MV series, Prime Computer, Inc.'s Prime 50 series, and the IBM PC XT and PC AT. Not all products are available for all operating systems.

SAS is the registered trademark of SAS Institute Inc., Cary, NC, USA. Copyright © 1986 by SAS Institute Inc. Printed in the USA.

large overlaid task images) that should be cached, but won't be unless their UFD entries are flagged. By using the BASIC program given (see Program 1), any group (or groups) of files that can be identified with the "PIP" utility and "/LI" switch can have their UFD caching flag set — in a mass update fashion! The program takes an output file created by using "PIP/LI", and creates a DCL command file. For each entry appearing in the "PIP/LI" output file (including specific disk and

UFD designators), the DCL command file will have an entry of the form:

```
$ SET FILE {disk:acct:filename}/CACHE
```

or

```
$ SET FILE {disk:acct:filename}
/CACHE = SEQUENTIAL
```

For instance, if your system would benefit from random caching on all files with the extension "*.DAT" only on disk "DRI:", this can be accomplished quickly and easily using these four steps:

1. Log onto an account with this program available, and the appropriate privileges to perform a "PIP/LI" of the files to be cached and to execute the DCL "SET FILE . . ." command upon those files.
2. Enter "PIP xx.yy = DRI:[*]*.DAT/LI" to produce the output list of files to be cached.
3. Run this program, specifying either SEQ or RAN caching for the group of files; its output is a DCL command file named "xx.COM".
4. Enter "@xx" to actually execute the DCL command file, and enable caching on the group of files.

Any legal "PIP/LI" construction will work. If you need to set caching on more than one group of files at once, step #2 above could be the following:

```
PIP xx.yy = SY:[*]*.IDX,DB0:[99*]ABC???.DAT, . . .
```

Some of the RSTS/E V9.x utilities preserve the caching flags in a UFD entry; be aware that "PIP" does not. Once the caching flag has been turned on in the UFD, it will remain in effect for file opens until it is reset, or the file somehow is moved or copied by a utility that does not preserve this flag. The DIR and SYS commands described above may be used to check a file's status, if a question arises.

This article is not meant to be a treatise on the intricacies of caching's effects on system performance, or system tuning. Questions such as the optimal cache "/KEEP" time for a given site, disk versus cache cluster sizes, or ensuring that sufficient cache clusters are always available for directory caching (as opposed to data caching) are beyond the scope of this article. Instead, I hope it presents a few easily used tips on how to ensure that your system is at least "Caching in on RSTS/E." —*Laurence F. Koolkin is president of Systems Alternatives, Inc., Montpelier, Vermont.*

PROGRAM 1.

```
1 !CACHE.BAS - USE TO TURN ON CACHING ON A GROUP OF SELECTED FILES; RSTS/E V9.x
!
! FOR USE ON A PRIVILEGED ACCOUNT THAT CAN EXECUTE DCL 'SET FILE' COMMAND
!
! To Use: PIP xxx.DAT=[aaa,bbb]*.???/LI
! RUN CACHE
! It will ask for the .DAT file name, and create xxx.COM
! and ask whether to use RAN or SEQ caching switch. When its done,
! simply enter 'Qxxx' to execute the command file.
!
! You can do multiple accts by PIP xxx.DAT=(aaa,*)*.???/LI,
! or PIP xxx.DAT=(aaa,bbb)*.???/LI,(ccc,ddd)*.???/LI,
! or specific disks only by PIP xxx.DAT=DUn:(aaa,bbb)*.???/LI, etc.
!
100 extend
110 on error goto 1000
120 input "xxx.DAT filename from Directory";DAT$
! goto 32767 if cvt$(dat$,-1%)=""
! x%=instr(1%,dat$,".")
! dat$=dat$*.DAT" if x%=0%
! x%=instr(1%,dat$,".") if x%=0%
! x$=left(dat$,x%-1%)
! open dat$ for input as file 1%
! Open the *.DAT file with PIP/LI information
!
130 print "Command file being created is "x$.COM"
! print
! open x$.COM" for output as file 2%
! print #2%, "% SET VERIFY"
! Create the *.COM file and SET VERIFY to monitor execution of *.COM File
!
140 input "SEQ or RAN caching";type$
! type$=cvt$(type$,-1%)
! cnt%=0%
! goto 140 if type$<"SEQ" and type$<"RAN"
! if type$="RAN" then type$="RAN"
! else type$="SEQUENTIAL"
! Which type of Caching requested for this group of files?
!
150 input line #1%,a$
! x%=instr(1%,a$,"[")
! goto 150 if x%=0%
! Find start of PIP/LI entries
!
160 acct$=cvt$(right(a$,x%-4%),1%-2%-4%-8%-16%-32%-128%)
! Extract account number with disk specification
!
170 input line #1%,a$
! goto 150 if cvt$(a$,-1%)=""
! goto 170 if instr(1%,a$,"<")=0%
! print #2%, "% SET FILE "+acct$+cvt$(left(a$,10%),-1%)+"/CACHE"+type$
! cnt%=cnt%+1%
! goto 170
! Write out a 'SET FILE...' entry to the *.COM file, go back for more
!
1000 !
! ----- error handling -----
!
1010 if erl=120 then print chr$(7%)*" Invalid Name or Cannot Find File"
!
! print
! resume 120
! Invalid input filename specification
!
1020 if erl=150 or erl=170
then resume 32767
! Bail out when done with input file
!
1100 on error goto 0
! resume 32767
! Trap any unexpected errors
!
32767 print
! print cnt%," entries written to "x$.COM"
! print #2%, "% SET NOVERIFY"
! close 1%,2%
! end
! Finish up, SET NOVERIFY, then announce number of entries to be CACHED
```

ARTICLE INTEREST QUOTIENT
Enter On Reader Card
High 486 Medium 487 Low 488

The SAS[®] System

The Data Analysis Tool You Won't Outgrow.

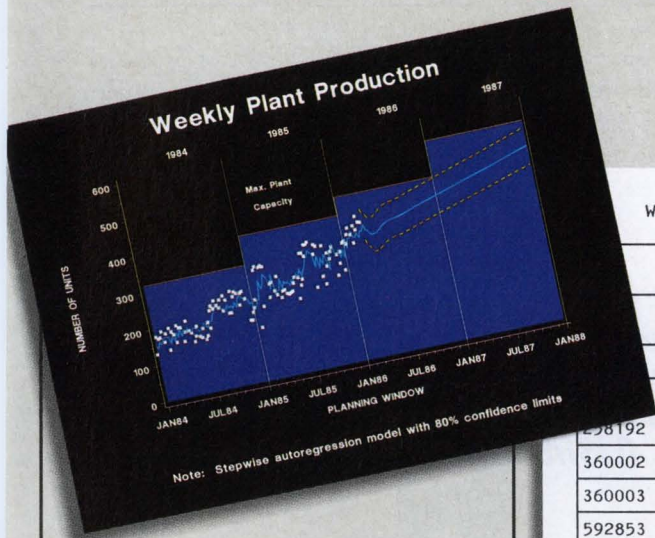

Warehouse Inventory Report - 16JAN87

	Quantity on Hand	Quantity on Order	Projected Reorder Date
	123980	10000	THU, FEB 12, 87
	89450	5000	FRI, FEB 20, 87
298192	20110	1000	MON, MAR 30, 87
360002	8585	0	TUE, FEB 10, 87
360003	15985	500	TUE, FEB 10, 87
592853	469120	20000	WED, FEB 18, 87

For details, send us your name and address. Or call a Software Sales Representative today.

The SAS System. It's the most widely installed tool for data analysis among VMS users*... And more.

If your job demands a powerful data analysis tool, the SAS[®] System is your solution. The SAS System gives you ready-to-use procedures for performing every kind of analysis—from simple descriptive statistics to advanced regression, analysis of variance, discriminant analysis, clustering, scoring, and more.

The SAS System reads data in any structure from any kind of file. You can create new variables, modify old ones, combine files, detect errors, and accumulate totals. Once your analysis is complete, you can report your results in lists, tables, charts, or plots.

And as your needs grow, the SAS System grows with you. All the tools you need for color graphics, forecasting, modeling, "what if" analysis, project management, optimization, and quality control are available in the SAS System. You choose the products you need, and enjoy the same easy-to-use language and syntax in each. Plus, you can use the same software on your personal computer.



SAS Institute Inc.
SAS Circle □ Box 8000
Cary, NC 27512-8000
(919) 467-8000
Fax (919) 469-3737



Production Rate

Rate	Lots Tested	Lowest	Highest	Mean	Percent
30	4	1	4	2.5	0
40	6	1	6	3.5	33
50	6	3	8	5.5	66
60	6	4	9	6.5	83
70	7	4	10	7.0	

* Computer Intelligence, January 1986.

The SAS System runs on Digital Equipment Corp.'s VAX[™] series minicomputers and workstations under VMS[™] as well as other mainframes, minicomputers, and personal computers.

SAS is the registered trademark of SAS Institute Inc., Cary, NC, USA. Copyright © 1987 by SAS Institute Inc. Printed in the USA.

digital [™] Cooperative Marketing Program

LET'S C NOW

Rex Jaeschke

DEC's VAX C Compiler, Part 2

Editor's note: This month Mr. Jaeschke continues his series on DEC's VAX C compiler. The topics he addresses include the preprocessor and the ways in which VAX

C violates the VAX Standard Calling Sequence.

In my opinion, V2.2 had a serious deficiency: The preprocessor directives were required to begin in column 1 of a source line. For a free-format language, not only is that contradictory, but also it's arbitrarily restrictive. Surely it's not that hard to ignore leading white space. What we need is the ability to indent nested sets of directives as in:

```
#ifdef VAXC
  #ifdef DEBUG
    ...
  #endif
#else
  ...
#endif
```

V2.3 carries on that tradition. Strangely though, it is permissible (in UNIX and ANSI tradition) to have white space between the # and the directive name — something that provides no utility and can lead to bad programming practices, since eventually someone is going to write something like:

```
# define PI 3.1415926
# define MAX 23
# define MIN 34
```

which is not easy to read. Give 10 programmers some room to move and they will find 10 different ways to represent the same data. Even the compiler-supplied headers are formatted inconsistently; some use one space, others none.

The #define Directive

If you write complex macros, particularly those that reference other macros (which in turn reference other macros, etc.), you will appreciate the ability to display the macro expansion at each level using the compile-time switches `/LIST/SHOW=INTERMEDIATE`. This is essential when debugging macros since compiler error messages that result, or symbolic references from `DEBUG`, all relate to the preprocessed output, not the source as written.

For simple cases, defining macros in the compilation command-line is straightforward. However, macros with arguments or definitions containing literal strings usually require some head scratching. The main problem is DCL; it gets in the way. DCL insists on being case-insensitive for the most

part and since C treats macro names as case sensitive (as it does for all identifiers), this can be a problem. For example, `/DEFINE = debug` causes the macro `DEBUG` (not `debug`) to be equated to the value 1. DCL converts `debug` to uppercase and

“
**If you write complex macros, . . .
you will appreciate the ability to display
the macro expansion at each level
using the compile-time switches
`/LIST/SHOW=INTERMEDIATE`.**

passes it to the compiler. So if you really want a macro of the name `debug`, you must use `/DEFINE = "debug"`.

If you need to define a macro as being a literal string, you need to specify and preserve extra sets of quotes. For example, `/DEFINE = "VERSION = ""V2.3"""` has the same effect as `#define VERSION "V2.3"`.

Again, we have to fool DCL. At a glance, it seems that it's impossible to have more than one `/DEFINE` switch on a command line, and that is the case. How then can we define more than one macro? That is done by extending the syntax of the `/DEFINE` such that it can handle multiple declarations. For example:

```
/DEFINE=( "DEBUG=1", "CHAR='a'" )
```

is equivalent to:

```
#define DEBUG 1
#define CHAR 'a'
```

The VAX Standard Calling Sequence

Prior to the introduction of the VAX, DEC had a variety of operating systems and languages, each one invented by some group or other that seemed to go out of their way not to talk to each other. With the VAX, DEC decided to design the hardware and the operating system so that they complemented each other. They also intended that there be only one operating system for the VAX and that any language would be able to call any other language provided that the languages complied with the VAX Standard Calling model. They even added ex-

Announcing - the database development system that you designed.

Now For VAX

db_Vista III™

C PROGRAMMERS-

We asked what you wanted in a database development system and we built it!

db_VISTA III™ is the database development system for programmers who want powerful, high performance DBMS capabilities ... and in any environment. Based on the network database model and the B-tree indexing method, db_VISTA III gives you the most powerful and efficient system for data organization and access. From simple file management to complex database structures with millions of records. db_VISTA III runs on most computers and operating systems like MS-DOS, UNIX, VAX/VMS and OS/2. It's written in C and the complete source code is available, so your application performance and portability are guaranteed! With db_VISTA III you can build applications for single-user microcomputers to multi-user LANs, up to minis and even mainframes.

RAIMA'S COMMITMENT TO YOU: No Royalties, Source Code Availability, 60 days FREE Technical Support and our 30-day Money-Back Guarantee. Extended services available include: Application Development, Product Development, Professional Consulting, Training Classes and Extended Application Development Support.

HOW TO ORDER: Purchase only those components you need. Start out with Single-user for MS-DOS then add components, upgrade ... or purchase Multi-user with Source for the entire db_VISTA III System. It's easy... call toll-free today!

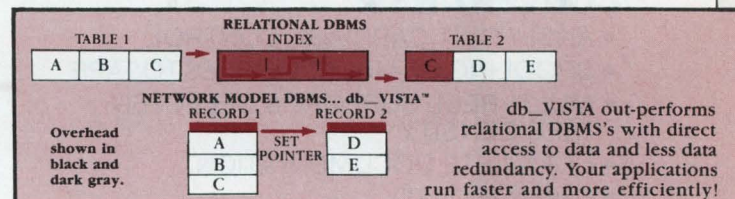

The db_VISTA III™ Database Development System

1 db_VISTA™: The High Performance DBMS

The major features include:

- Multi-user support for LANs and multi-user computers.
- Multiple database access.
- File and record locking.
- Automatic database recovery.
- Transaction processing and logging.
- Timestamping.
- Database consistency check utility.
- Fast access methods based on the network database model and B-tree indexing. Uses both direct "set" relations and B-tree indexing independently for design flexibility and performance.
- An easy-to-use interactive database access utility.
- File transfer utilities for importing/exporting ASCII text and dBASE II/III files.
- A Database Definition Language patterned after C.
- Virtual memory disk caching for fast database access.
- A runtime library of over 100 functions.
- **Operating systems:** MS-DOS, UNIX V, XENIX, VMS, OS/2.
- **C Compilers:** Lattice, Microsoft, IBM, Aztec, Computer Innovations, Turbo C, XENIX, and UNIX.
- **LAN systems:** LifeNet, NetWare, PC Network, 3Com, SCO XENIX-NET, other NET-BIOS compatible MS-DOS networks.

2 db_QUERY™: The SQL-based Query.

- Provides relational view of db_VISTA applications.
- Structured Query Language
- C linkable.
- Predefine query procedures or run ad-hoc queries "on the fly".

3 db_REVISE™: The Database Restructure Program.

- Redesign your database easily.
- Converts all existing data to revised design.

All components feature royalty-free run-time distribution, source code availability and our commitment to customer service. That's why corporations like ARCO, AT&T, Hewlett-Packard, IBM, Northwestern Mutual Life, UNISYS and others use our products.

db_VISTA III™ Database Development System

db_VISTA III™ \$595 - 3960
 db_QUERY™ \$595 - 3960
 db_REVISE™ \$595 - 3960

db_VISTA™ File Manager Starts at \$195

We'll answer your questions, help determine your needs and get you started.

CALL TODAY!

1-800-db-RAIMA

(that's 1-800-327-2462)



RAIMA™
CORPORATION

3055 112th Avenue N.E., Bellevue, WA 98004 (206)828-4636
 Telex: 6503018237MCIUW FAX: (206)828-3131

DP1187

Convert[©] YOUR VAX TAPE AREA

THE CONVERT
TAPE UTILITY
IS THE
SOLUTION
TO THE
EXCHANGE OF TAPES
BETWEEN
DEC & IBM

CONVERT CAN:

- CREATE & PROCESS STANDARD IBM LABELED TAPES
- PROCESS FILES FROM EBCDIC TO ASCII & ASCII TO EBCDIC
- TRANSFER PACKED & BINARY FIELDS
- READ OR WRITE VARIABLE & FIXED LENGTH RECORDS

CONVERT HAS:

- ANSI-PRINT CARRIAGE CONTROL
- SPOOLING OF MULTIPLE FILES TO TAPE
- MULTI-REEL SUPPORT & SELECTED TAPE DENSITY
- COMPLETE DOCUMENTATION
- DUMP FACILITY

CONVERT IS:

- RELIABLE
- ACCURATE AND FULLY SUPPORTED BY:

EDISON SOFTWARE SYSTEMS

Call Today
(201) 906-1321
OR WRITE
P.O. BOX 211
METUCHEN, NEW JERSEY 08840

*DEC & VAX are trademarks of Digital Equipment Corp. IBM, DOS, OS are trademarks of International Business Machines, Inc. Convert Tape Utility is a copyright of Edison Software Systems 1982 ALL RIGHTS Reserved.

ENTER 214 ON READER CARD

tensions to all their languages so that you can pass arguments by value, address and descriptor, as necessary. And, of course, the complete system services library immediately became accessible to every application program without requiring you to resort to assembler.

Before we take a look at how VAX C fits into that model, it's worth doing a quick refresher course on the VAX calling model. When control is passed to a subroutine, the argument list is pushed onto the stack along with the argument count in the form:

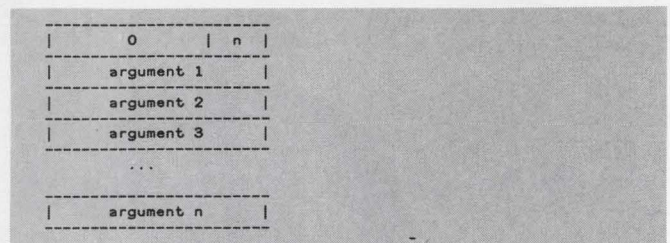

The argument count **n** is an unsigned byte in the first byte of the argument list. The maximum number of arguments, therefore, is 255. The high-order three bytes in that first longword are reserved by DEC for future use. Each argument on the stack takes up a longword and may represent either a value, the address of a data object or piece of executable code, or the address of a descriptor.

If **n** is 10, the stack frame contains the count longword and 10 longword arguments. If **n** is zero, the frame contains only one longword, that for the count. Therefore, the maximum size of the call stack is 255 longwords, which one might think is big enough, and it is. Since every argument passed by the VAX languages fits nicely into a longword, the number of arguments actually passed in the program matches **n**, and hence, the number of longwords on the stack.

Now to the C specifics. VAX C violates the VAX Calling Sequence in two ways: one involving double-precision arguments, the other, structures. What exactly does violating the calling sequence mean, and why do we care? After all, DEC broke its own rule since it implemented VAX C so one presumes it isn't too serious. Serious? No. Restrictive? Maybe.

First, the floating-point case:

```
#include <math.h>
f()
{
    double d;
    g(&d);
    d = sqrt(1.2);
}
```

The function **g** is called with one argument: the address of the **double** variable **d**. Because all object addresses are 32 bits, this fits nicely in one longword; **n** is 1 and the argument list has two longwords. The call to **sqrt** is a different matter. Because all floating-point constants have type **double**, and scalars are passed by value, the constant 1.2 is passed to **sqrt** by value as a **double**. A **double** normally is stored using the D floating-point representation, which is eight bytes long.

(When the /G_FLOAT compile-time switch is specified, a **double** object is represented using the G floating-point type. However, this type is still only eight bytes long — it just uses a different number of bits for the exponent and mantissa.)

How is this eight-byte value represented on the stack because the VAX calling sequence requires that each argument fit into a four-byte longword? The value is represented as two longwords. It violates the VAX calling sequence. The other interesting thing is that now the argument count is two (one

“

In recent years, the C language has been extended to allow the passing of structures (and unions) by value. That is, f(str); and f(&str); are different.

”

for each longword in the **double** value) and the stack frame contains three longwords. While **n** is two, only one argument was passed in the C code. Now we see that **n** is actually the number of physical arguments (longwords) on the call stack, not the number of actual (logical) arguments used in the programming language. For C, these two values may be different. (FORTRAN always passes REAL*8 arguments by address and a pointer always fits in a longword.)

Now to the second case, that involving structures; specifically, the passing of structures by value:

```

struct big {
    int table[255];
};

main()
{
    struct big st;

    printf("Calling test1 with stack of 255 longwords\n");
    test1(st);
}

test1(arg)
struct big arg;
{
}

$ CC PRDG
$ LINK PRDG
$ RUN PRDG
Calling test1 with stack of 255 longwords

```

In recent years, the C language has been extended to allow the passing of structures (and unions) by value. That is, **f(str);** and **f(&str);** are different. Because a structure has no theoretical limit on its size, this can cause problems. How is the stack set up in the above program? Let's look at a fragment of the code generated by using the compile-time switches /LIST/MACHINE:

```

test1(st);

subl2 #1020,sp /* allocate auto st */
movc3 #1020,-1024(fp),(sp) /* push st onto stack */
calls #255,TEST1 /* call test1 */
movl #1,r0 /* setup return value */
ret /* return from main */

```

Q-BUS MASS STORAGE: UP YOURS!

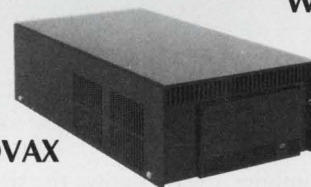

11/23
11/53
11/73
11/83
MICROVAX

WINCHESTER
FLOPPY
TAPE
INTERNAL
EXTERNAL

CUSTOM OR STANDARD ZOLTECH DELIVERS

Zoltech offers the latest controller and drive technology, combined with our modular chassis design, to bring you the most versatile and cost effective Q-Bus mass storage subsystems. Use one of our standard packages or let us build your special system. We can provide the exact configuration you need — at a standard cost and with fast delivery. We offer all the standard DEC emulations (MSCP, TSV, TMSCP, RL, RX) with the highest storage capacities (to 1200mb) and data transfer rates (>500kb/s). Configurations range from bare drives and controllers to completely assembled and tested turnkey subsystems.

**Call or write today
for our latest catalog and price list.**

ZOLTECH CORPORATION®

7023 Valjean Avenue, Van Nuys, California 91406 USA
(818) 780-1800 Telex 755451

Representative and dealer inquiries are invited.

11/23, 11/53, 11/73, 11/83 and MICROVAX are trademarks of the Digital Equipment Corporation.

ENTER 225 ON READER CARD

The structure contains an integer array of 255 elements; each four bytes long. Therefore, the size of the structure is 255 longwords, or 1,020 bytes. As we can see, code is generated to move 1,020 bytes from the automatic variable `st` to the stack. Then the function `test1` is called with the argument count set to 255. That is, `n`, the argument count, is set to 255 to indicate that the stack frame contains the 255 longwords of arguments. So even though only one argument is passed in C, 255 (longword) arguments are on the stack. In short, the stack is filled completely with only one argument.

Let's prove that the stack really is filled:

```

struct big {
    int table[255];
};
main()
{
    struct big st;

    printf("Calling test1 with stack of 255 longwords\n");
    test1(st);
    printf("Calling test2 with stack of 256 longwords\n");
    test2(st, 100);
}
test1(arg)
struct big arg;
{
}
test2(arg1, arg2)
struct big arg1;
int arg2;
{
}
%CC-E-ARGLISTOOLONG, Function reference specifies an argument list
whose length exceeds the VAX architecture limit.
At line number 12 in DUB6:[INTR09]STACK.C;2.

```

Because the compiler always knows the size of an object at compile time, it detects that the argument list we are passing to `test2` is 256 longwords (255 for `st` and 1 for the `int` constant 100) and as we have seen, the stack can only hold 255 longwords of arguments besides the count longword. Therefore, the compiler informs us that we can't do what we want. We have violated the VAX calling sequence; however, this time it's fatal.

The limitation is that we can't pass structures or unions by value if their size is more than 1,020 bytes. More generally stated, the restriction is that the sum of the sizes of all of the arguments AFTER WIDENING can't exceed 1,020 bytes. The number of arguments actually present in the function call has little bearing except that it obviously can't exceed 255.

Apart from these (minor) restrictions, what's so bad about violating the VAX calling sequence? Doing so means that you can't call most other languages and pass them **doubles** or structures by value; they simply have no syntax to allow you to map into them on the stack frame. You must pass them by address. Of course, you can handle just about anything in MACRO (and possibly in BLISS as well) but for the high-level languages, it's not possible using native data types. For this reason, C has to have its own math library because most of the math functions expect to receive double arguments to be passed by value.

I stated "the total size after widening" for two reasons. As you know, certain types in C always are widened when passed to a function by value. The rules are that **char** and **short**

are widened to **int**, and **float** is widened to **double**. For **char** and **short** arguments, this means that they always occupy a longword on the call stack, just as an **int** does. The upper bytes in **char** and **short** arguments are wasted. When a **float** is widened to a **double**, four bytes of zero bits are added to the mantissa.

The second reason has to do with the other way that you can pass an argument with a size other than a multiple of four

“

It's obviously cheaper to copy n bytes to the stack than it is to copy n + 1; so the smaller the object to be copied, the cheaper the copy.

”

bytes: structures and unions by value. Consider the case where we pass two five-byte structures by value, one after the other. How much stack space is used and what is the argument count stored in `n`?

Another reality of the VAX calling sequence is that each argument on the call stack must begin on a longword boundary. Therefore, the first five-byte structure is copied to the stack where it occupies two longwords. The upper three bytes in the second longword are unused. The second five-byte structure then is pushed on to the stack in the same manner. The result is that four longwords are used and `n` is set to 4.

So while the maximum size of the call stack is 1,020 bytes, it really should be thought of as 255 longwords because we could not fit 204 five-byte structures there. (This would require $204 * 8 = 1,632$ bytes.) Nor could we fit four 255-byte structures because each would be aligned on the next longword boundary and would require 1,024 bytes in all, four bytes more than are available.

Just what is the cost of passing by value anyway? If it's too expensive, then the whole problem might go away. It's obviously cheaper to copy `n` bytes to the stack than it is to copy `n + 1`; so the smaller the object to be copied, the cheaper the copy. Whether the cost is appreciable depends on the speed criteria of your program, but for most applications it probably won't matter. The only restriction then is that you can't pass a structure or union larger than 1,020 bytes, by value and that's probably a restriction we can live with. After all, all the other VAX languages do. And you always can pass these large objects by address, allowing even the largest structures to be accessed.

The only impact this has on the proposed ANSI Standard

Whose MRP II manufacturing system is easy to install?

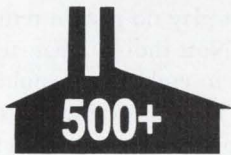

MCBA's.

MCBA makes the transition to computerized operations easy. With MCBA's modular manufacturing software system, you can install just what you need when you need it. Handle key areas first, add more of MCBA's 18 integrated manufacturing, distribution, and accounting software modules* when you're ready. One step at a time. Without disrupting your whole operation.

A leader in the business for over a decade, MCBA has software that's field-proven. MCBA's full MRP II system is at work in over 500 job shops and repetitive manufacturing environments. And MCBA's accounting and distribution packages boast close to 25,000 users worldwide.

Put it all together, and you have a powerful, integrated system that can give you increased visibility and control of your operations. With comprehensive reports and easy data access.

MCBA's Manufacturing System is available for PDP*-11s and the full VAX* line. And MCBA provides source code,

so customization to your special needs is simple.

Why not make computerization easy on yourself? For FREE information, mail us the coupon, or call the MCBA office nearest you.** Reseller inquiries are invited.

Please send me FREE information on MCBA's manufacturing software for VAX COBOL; DIBOL*.

Name _____

Title _____

Company _____

Address _____

City _____ State _____ ZIP _____

Phone (_____) _____ Best time to call _____

End User; Software Reseller; OEM; Consultant.

Hardware in use _____ Number of DP staff _____

Mail to: MCBA, Inc., Dept. A

425 W. Broadway

Glendale, CA 91204-1269

DP1187

**Software
Solutions
that Mean
Business™**

MCBA®

**Headquarters: 425 W. Broadway, Glendale, CA 91204-1269. (818) 242-9600

**Branch Office: 120 Wood Ave. S., Suite 300, Iselin, NJ 08830-2709. (201) 548-6600

(Currently serving MS, TN, AL, SC, GA, FL, NC, VA, NY, NJ, DE, MD, DC)

*MCBA's Manufacturing System Modules: Accounts Payable, Accounts Receivable, Bill of Material Processor, Capacity Requirements Planning, Customer Order Processing, Fixed Assets and Depreciation, General Ledger, Inventory Management, Job Costing, Labor Performance, Master Scheduling, Material Requirements Planning, Payroll, Purchase Order and Receiving, Report Writer, Sales History, Shop Floor Control, Standard Product Costing, and Standard Product Routing. (Call for package availability.)

Copyright © 1987 by MCBA, Inc. All rights reserved. MCBA® is a registered trademark and Software Solutions that Mean Business™ is a trademark of MCBA, Inc. VAX™ is a trademark and PDP® and DIBOL® are registered trademarks of Digital Equipment Corp.

ENTER 136 ON READER CARD

is that it must say that the maximum size of a structure or union that may be passed by value is implementation-defined. The VAX is allowed to live on.

Returning Structures And Unions By Value

Another recent addition to the C language is the ability to have functions with structure and union return types as well as pointer to structure and pointer to union types. While support for these places some burden on the implementer, it's nowhere near that of passing them by value.

As well as having a standard calling sequence on the VAX, we also have a standard value returning sequence. If a function's return value fits in 32-bits, it is returned in register R0. If it is representable in 64-bits, the register pair R0 and R1 are used. If only eight bytes are available how then can we return a structure of 48 bytes, for example, by value? Let's look at a program that returns a 48-byte structure by value:

```

struct tag {
    int i[10];
    double d;
};

void f()
{
    struct tag str1, str2;
    struct tag g();

    str2 = g(str1);
}

struct tag g(arg)
struct tag arg;
{
    return (arg);
}

```

Now let's look at a fragment of the code generated by using the compile-time switches /LIST/MACHINE.

```

str2 = g(str1);

    sub12    #48,sp
    movc3   #48,-100(fp),(sp)
    pushab  -148(fp)
    call5   #13,G
    movc3   #48,-148(fp),-52(fp)

struct tag g(arg)
struct tag arg;
    .entry  g,"m<r2,r3,r4,r5>
    sub12   #4,sp
{
return (arg);
    movc3   #48,8(ap),04(ap)
    ret
}

```

The key to the question lies in the instruction "calls #13,G". The size of the object being passed into **g** is 12 longwords (an array of 10 longwords and a **double** of two longwords.) Why then is the argument count on the stack set to 13? What is this extra longword being used for? As to what is being pushed, it's the address of a data area by using the instruction "pushab -148(fp)". Specifically, it's the address of a temporary 48-byte structure the compiler created on the stack. This is not one of the two auto 48-byte structures we declared.

Then when the **return** statement is encountered in function **g**, the 48-byte structure to be returned is copied to the location on the stack whose address was passed as the extra argument. When control returns to the calling function **f** that

48-byte temporary is copied to the structure **str2**. The reason it has to be done as a two-step process is that C functions are not obliged to use the value returned to them by a function. Therefore, **g** could not copy directly into **str2**, because **str2** need not exist and if **f** and **g** were compiled separately, **g** would have no way of knowing whether its return value was being used or not. By copying the return value on the stack that

“
**Another recent addition to the C language
is the ability to have functions with
structure and union return types
as well as pointer to structure
and pointer to union types.**
”

value can be accessed easily by the caller if it needs it, and if it doesn't, then the temporary copy will be deleted when the caller returns to its caller.

In short, the registers R0 and R1 play no part in returning structures and unions by value. (Note though, that structures and unions less than or equal to eight bytes could be passed back in these two registers.) The return value is passed back via the extra argument the compiler added to the call list. Because of this, the VAX architecture places no limit on the size of a structure or union that can be returned by value.

Having deduced this, let's refer to the VAX architecture documentation regarding what it says happens when a return value is larger than 64 bits. "If the function value cannot be represented in 64 bits, the source language list of arguments and formals is shifted by one and the first formal in the argument list is reserved for the function value." And that's exactly what C does.

There is one subtle impact of this extra argument. When it's created by the compiler, it limits the actual user-supplied calling argument list to 254 longwords instead of 255. Therefore, the following program will not compile:

```

struct big {
    int table[255];
};

main()
{
    struct big str1, str2;
    struct big g();

    str2 = g(str1);
}

```

The reason the compiler would complain is that it needs a stack with 256 longwords for arguments, 255 for the structure and one for the address of the temporary return value that the compiler itself generates. The program would compile if the size of the structure were reduced to 254 entries.

Readers are encouraged to submit any C-related comments and suggestions to Rex Jaeschke, 2051 Swans Neck Way, Reston, Virginia 22091. ■



IT'S 2:00 A.M. DO YOU KNOW WHAT YOUR VAX COULD BE DOING ?

Sooner or later, even your VAX has to grow up. With the new BLAST II and its superscript, your VAX could start taking responsibility for its own actions . . . like calling up remote computers of almost any kind and collecting daily orders, or other data. Automatically! Then processing and transferring results to another computer. Unattended! Even at 2:00 in the morning while you, and everyone else, are sound asleep.

BLAST's superscript is a powerful programming language designed especially for communications applications. With its user-friendly menus, you can *quickly* create totally automatic operations that allow your VAX to actively manage each session — dialing out (and re-dialing until the connection is made), logging on, executing commands, accessing, manipulating and transferring files error-free.

Get the new BLAST II with superscript — the safest, fastest, *smartest*, most reliable, most powerful, and connectible communications software available today — and sleep well tonight.

For more information call . . . 1-800-242-5278

BLAST[®]

Communications Research Group

5615 Corporate Boulevard, Baton Rouge, Louisiana 70808 (504) 923-0888

ENTER 105 ON READER CARD

Ron Levine

Looking For A Digital Multimeter?

You have been making decisions all of your life: *The light is yellow.* ■ *"Don't Walk" is flashing.* ■ *Should I stand here or risk running across?* ■ *If I drink a diet soda instead of a malt, can I get away with eating the burger and fries?* ■ *If I don't understand the joke, should I laugh anyway?*

In the case of buying the right tools, the decision isn't easier. The digital multimeter dilemma is a prime example. Besides the oscilloscope, the digital multimeter (DMM) is one of the most often used pieces of electronic test equipment. This fact has drawn a large number of manufacturers into the marketplace, each with its own combination of features, quality, and price. And each year the cost per feature in DMM units goes down.

The design of the DMM is evolving continually to reduce operator errors, increase accuracy and improve resolution. And some DMMs now can measure the surface or ambient temperature of ICs, transistors or mechanical components. Many are even able to measure capacitance and frequency, and test continuity and diodes. This, of course, is in addition to measuring AC/DC voltage, current, and resistance — the main purpose of these versatile instruments.

Unfortunately, because none of the devices on the market excels in all areas, you must evaluate your particular situation and needs in order to find the DMM best suited to your applications. Not only do the features vary, but so also does the ruggedness, ease of use, ac-

curacy, and over-all quality (and also the manufacturer's reputation and warranty).

We'll be looking at the "standard" units; i.e., those suitable for normal field service use, the heavy-duty ones built to last under grueling conditions, and the lower priced models. A lower price doesn't necessarily mean less service. Because some of the higher priced units emphasize durability or a few specialized features, the lower priced ones may provide more functions and features that an FE uses on a daily basis.

Selecting The Right DMM

Knowing the right questions to ask when choosing a DMM is important. Ask yourself how the DMM will be used, how often, to measure what, and where. Only then can you select the one that's best for you. The following is a

summary of the various categories of DMMs from which to choose:

1. Standard Units — Though not as rugged as the heavy-duty models, the standard units are made to withstand normal daily field service use. They usually are bench type or hand held and have more functions than the heavy-duty DMMs. Even without ideal lighting conditions, these units are easy to read. Standard units are accurate and sell for \$40 to \$360.

Is a standard DMM right for you? Ask yourself, "Am I going to be using my DMM frequently, but not in a situation dangerous to the equipment, such as near moisture or dust?" You can depend on the standard model to provide years of service while withstanding occasional bumping, jarring and quite a bit of handling. An FE who services office-

The Fluke 77 multimeter is a convenient size for carrying in the field. Lead connections also are configured for ease of use.

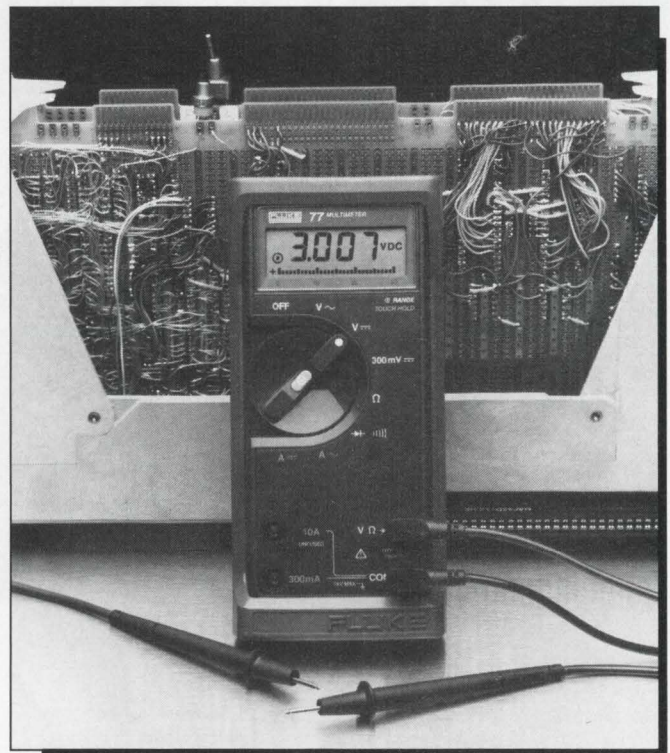

type accounts will do well with a standard unit.

2. Heavy-Duty Units — A rugged, water-tight casing makes these models ideal for coping with situations where you'll encounter liquid spills, dirt,

“

Knowing the right questions to ask when choosing a DMM is important.

”

smoke or where it might be dropped off a desk or counter, or slammed around in a toolbox or briefcase. They are in the same price range as the standard units because “survivability” is traded for other options, though most have higher overload protection and are more easily serviced than their standard counterparts.

How do you know if this type is for you? Consider your situation: Will you be travelling frequently, subjecting the unit to airport baggage carousels, the hot and bumpy trunk of a car, or the jamming of subway crowds? Is this DMM going to be used in an environment involving moisture, like in a boiler room or factory where there might be steam? Will it be used where water and other liquids might be spilled, like in an office, near hanging plants, or even outside? If the answer is yes to any of these, you might seriously consider buying a heavy-duty model.

3. Lower Priced Units — Most units priced below \$80 are not made in the United States, but may be sold by foreign or American companies. They are typified by their small, compact size (pocket sized), and may contain specialized functions. Note, however, that they're usually less accurate than the two categories of DMMs above, and many buy the lower priced models as throw aways to discard after having been ex-

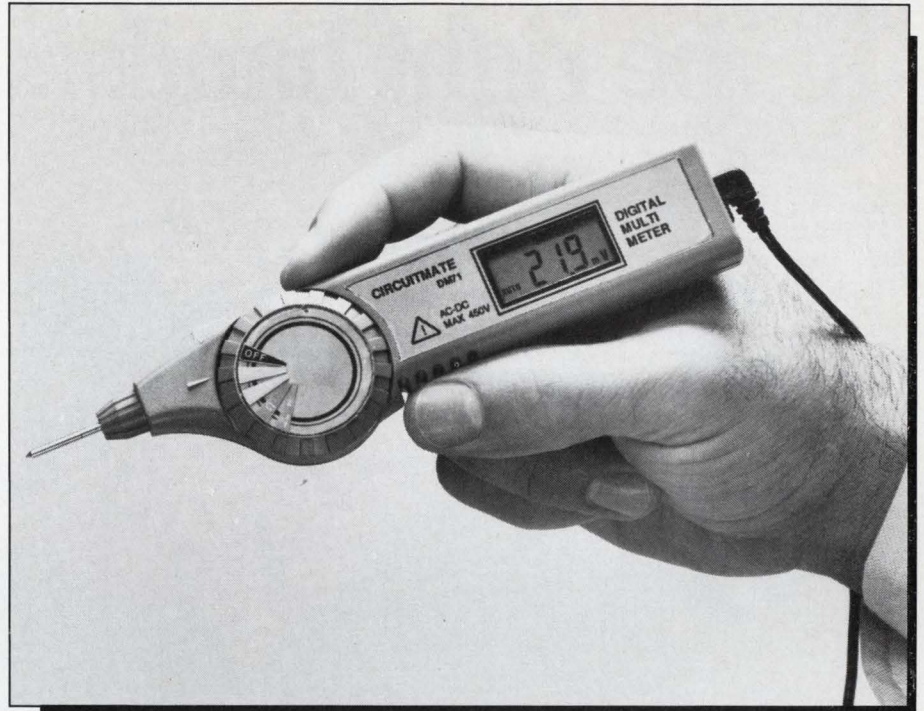

The Circuitmate DM71 multimeter is a hand-held pen-type multimeter from Beckman Industrial Corporation.



The size and features of the Simpson Model 462 multimeter offer maximum versatility for work on the bench, in the field or on the line.



In the right hands...

ENTER 242 ON READER CARD

posed to an electrical overload or after being dropped.

These units are largely unrepairable. "Will I be using my DMM infrequently or am I buying one especially for a feature that's needed only occasionally? Am I going to be using the unit carefully in an environment where it's unlikely to be damaged?" If so, a low-cost unit should serve your needs.

Desirable Features

Most DMMs can handle the basics — measuring AC and DC current, AC and DC voltage, resistance (ohms), and checking continuity. Special features include the ability to measure frequency and capacitance, monitor temperature on a logic or mechanical circuit or component (surface) or in the air (ambient), and test diodes. Also, some include functions

like data hold (allowing the freezing of measurements) and peak hold (allowing the freezing of high-point readings) in which the probe can be removed and the results maintained for later recording. Most DMMs offer only two or three of these special features. The following is a detailed description of the more desirable ones:

1. Display — The most common is called the $3\frac{1}{2}$ digit display, actually showing four digit readings (because the first digit can be only a 0 or a 1, it's considered " $\frac{1}{2}$ "). On some models a $4\frac{1}{2}$ -digit display (again 0 or 1 only as the first digit) is provided. When buying a DMM, check for easy readability. We recommend that you tilt the unit to see if it's readable at an angle and ask about the availability of a high-contrast display that many find easier on the eyes. You also might look for a DMM with a recessed display to better protect against scraping and scratching of the surface.

If buying a lower priced model, check for last digit bounce — when the last digit doesn't settle but fluctuates around its true value. We found it very annoying. Note that the display's resolution factor, determined by the combination of the number of display digits and the number of ranges of each function, is the smallest number that will appear on the display.

2. Switches — Push button and rotary switches are the two main types on the market. Both have advantages and disadvantages. Push buttons (or the slide type) usually require more complex DMM setup and can be hard to use until you're familiar with the unit. They can make life easier when your hands are full, however, because they're easier to use than the dial type (wouldn't you rather have a push-button phone?).

Rotary switches, however, can be

easier to use in the beginning because they need fewer decisions and steps to set the meter. We found both the type that uses a single switch to select the range, function and turn the meter on/off, and those that use a dual rotary setup. The disadvantage of the rotary switch DMMs is that conductive "filings" tend to build up between contacts (due to the rotary contact method), thus creating a path for high-voltage current. Another drawback is that rotary switches tend to wear out faster than the push-button or slide types.

3. Outside Case — The heavy-duty types are made of impact resistant plastic and, as mentioned before, are made to withstand most "reasonable" wear and tear and spills. I wouldn't throw one over Niagara Falls and expect it to live, but I wouldn't worry if it fell from the top of my car on a misty day. It also might be wise to buy a DMM with a casing made from self-extinguishing plastic in case of fire.

4. Safety — Accidental contact with electrical components (even when

working with low voltages) is to be avoided. Make sure that the meter you buy has protective sleeves around the banana plug and that the jacks are recessed. Also, it's preferable that the test leads have finger guards. Some also have a serrated surface to help guard against forward finger slippage.

5. Location Of Fuses — Don't wait until a fuse blows to find out how hard or easy it is to change. Look for a DMM with fuses located in plain view when the meter is opened, one that uses a size that's easy to find (and preferably not ceramic because these can't be visually checked), and if possible, buy a unit containing a place to store a spare.

6. Arrangement Of Lead Connections — The grouping of the connections can make troubleshooting easier if it's done in a logical way. Avoid having to switch leads often when taking measurements. It's easier to use if the volts and ohms (the two most common measurements) are measured from the same socket instead of the amps and ohms.

7. Location Of Battery — As with fuse

location, this isn't one of the most important features, but one of convenience. We recommend a DMM with a battery compartment rather than one in which you have to open the back of the DMM and expose the working components to reach the battery. This may not be available on some heavy-duty models, however, because of the concern for water tightness.

8. Stand Or Tilt Bail — This device is attached to the casing and is used to stand the DMM on the desk, bench or wherever you're working. This helps position the meter for easy reading and frees both hands.

9. How Correct Is The Measurement? — There's a wide range of accuracy between models; what you need depends on your particular application. For AC measurements, there are two methods used: RMS and average.

If exceptionally accurate measurements of the various types of waveforms (e.g., square waves, sine waves, etc.) commonly encountered when working with triac, SCR, and digital circuits are

EUNICE™

A masterpiece in UNIX/VMS harmony.

EUNICE BSD. Our latest technology to blend UNIX™ 4.3 BSD and VMS™ on a single system. Imagine: a transparent, fully integrated,

fully supported environment for all VMS systems. A pretty picture indeed. For more information, call 800-872-8649 (in California

800-962-8649) or send us this ad with your business card. The Wollongong Group, Inc., 1129 San Antonio Road, Palo Alto, Ca. 94303.

WOLLONGONG

We are the standard.™

© 1987, The Wollongong Group, Inc. EUNICE is a trademark of The Wollongong Group, Inc. All other product names are registered trademarks of their respective manufacturers.

ENTER 243 ON READER CARD

Companies Mentioned In This Article

AW Sperry Instruments
245 Marcus Blvd.
Hauppauge, NY 11788
(516) 231-7050
ENTER 418 ON READER CARD

B&K Precision
6460 W. Cortland St.
Chicago, IL 60635
(312) 889-8870
ENTER 419 ON READER CARD

Ballentine Labs
P.O. Box 97
Boonton, NJ 07005
(201) 335-0900
ENTER 420 ON READER CARD

Beckman Industrial Corp.
630 Puente St.
Brea, CA 92621
(714) 671-4800
ENTER 421 ON READER CARD

Black Box Corp.
P.O. Box 12800
Pittsburgh, PA 15241
(412) 746-5500
ENTER 422 ON READER CARD

Heath Zenith Co.
Hilltop Rd.
Saint Joseph, MI 49085
(616) 982-3200
ENTER 423 ON READER CARD

Hewlett-Packard
1820 Embarcadero
Palo Alto, CA 94303
(915) 857-4161
ENTER 424 ON READER CARD

John Fluke Mfg.
P.O. Box C
9090/MS 250C
Everett, WA 98206
(206) 347-6100
ENTER 425 ON READER CARD

Misco Inc., Computer Supplies
1 Misco Plaza
Holmdel, NJ 07733
(201) 946-3500
(800) 631-2227
ENTER 426 ON READER CARD

Pioneer Instrument
4800 E. 131st St.
Cleveland, OH 44105
(216) 587-3600
ENTER 427 ON READER CARD

Simpson Electric Co.
853 Dundee Ave.
Elgin, IL 60120
(312) 697-2260
ENTER 428 ON READER CARD

Time Motion Tools
410 S. Douglas St.
El Segundo, CA 90245
(213) 772-8170
ENTER 429 ON READER CARD

Tool Kit Specialists Inc.
1366 Borregas Ave.
Sunnyvale, CA 94089
(408) 745-6020
ENTER 430 ON READER CARD

Triplet Corp.
One Triplet Dr.
Bluflon, OH 45817
(419) 358-5015
ENTER 431 ON READER CARD

pendent on your application, however, we're not making any bandwidth recommendations.

12. Protecting Against Overload — This is an important feature, especially if using the DMM for power supply measurements. The amount of overload protection governs the amount of voltage capacity to which the meter can be exposed. Some DMMs provide overload protection for all ranges and functions, while others only warn of an overload condition.

13. RFI Shielding — This is useful in keeping readings accurate in a high RFI-generating situation.

14. Size — The smallest units we found are the probe type, shaped like a pencil (or tire gauge). These are carried easily and are helpful when taking measurements in out-of-the-way or hard-to-reach spots. The pocket-calculator size also is portable and convenient. This size is more durable and provides a higher resolution than the "tire-gauge" sized DMMs.

These are small tools and aren't made for rugged use. The larger meters (pocket-calculator size) have internal supports and sturdier cases for extra protection. Unless you'll use your DMM infrequently or have a need for one that only can be used to probe in hard-to-reach spaces, one of the larger units may be preferable. These are designed for everyday field service situations.

Of course, if you need a DMM that can withstand a particularly hazardous or rough environment, you can be fairly safe with a heavy-duty unit. This type still can be hand-held and convenient.

15. Manufacturer's Warranty — Look for a warranty covering more than just defective parts and workmanship. We found that there are warranties that cover accidental exposure to high voltages and accidental misuse, such as being dropped. Of course, any compo-

required, an RMS meter is a must.

Though some standard models use the average method, it's mostly found in the lower priced units. This method is accurate only for pure sine waves because the analog-to-digital conversion is done by sampling at predetermined intervals.

10. Continuity Check Indicators — LEDs and audible beeps are the two types of continuity check indicators that we found. In the case of beeps, a tone is heard when the test is positive (useful for circuit checking without having to

continually look at the DMM). We recommend this type beeper over the type that leaves the tone on continually while continuity is maintained. Besides draining the battery, we vote it the DMM most likely to be thrown out the window. Try one in the store and see if you don't agree.

The LED type of indicator, of course, only helps if you're looking at the meter. A positive continuity test is indicated by a light, or sometimes a special symbol.

11. Bandwidth — We found that you can choose anywhere between 10 Hz and 40 KHz. Because this is so de-

nent problem, other than those caused by outright abuse, should be covered by the manufacturer.

16. Service — Even the most rugged units need service sometimes. Before

“

We found that there are warranties that cover accidental exposure to high voltages and accidental misuse, such as being dropped.

”

buying a DMM, ask these questions:

- a. Who can service it and where?
- b. Is there someone local or must it be mailed halfway across the country?
- c. How long will repairs take?
- d. Is it more expensive to repair the unit or replace it? And remember, consider the reputation of the manufacturer when checking out the warranty and service.

17. The Buying Decision — Now that we've discussed most of the different options available, let's answer the original questions: How and where will I be using it? How often? Exactly what do I need to measure?

Add the following questions: How high are the voltages normally encountered? Would it be better to buy one DMM that can do everything or a few specialized ones? How will I transport my unit — in my trunk, in a toolbox, in my pocket? Will I be lending it to my clumsy partner? And, of course, the biggest question — How much can I afford to spend for this tool?

When these questions are answered, you're ready to buy. There are many DMM manufacturers out there and we don't pretend to have seen all the units available. But we did see enough different types and combinations of options to say with confidence that the perfect digital multimeter for you is surely out there. ■

OUR OAS™ OPTICAL ARCHIVING SYSTEM WILL WORK WITH YOUR COMPUTER.

WE GUARANTEE IT!

If your computer uses an industry standard tape drive, Aquidneck will put optical archiving to work for you now.

Aquidneck's OAS Optical Archiving Systems provide 1-280 Gigabytes of on-line storage. Our systems require no host software and modifications. In fact, installation is incredibly simple. Just plug it in! If it doesn't perform to your satisfaction, we'll take it back.

See for yourself. Call or write today for information. On-site demonstrations are available for qualified customers. Aquidneck Systems International, 650 Ten Rod Road, North Kingstown, RI 02852. Telephone: (401) 295-2691. FAX: (401) 295-1851. Telex: 6716233.

ENTER 103 ON READER CARD

AQUIDNECK
systems international, inc

MANAGING YOUR MICROVAX

David W. Bynon

MVII Configuration — Back To The Basics

With all of its virtues, the MICROVAX can still be a thoroughly aggravating piece of equipment. Take, for example, the simple chore of adding a new disk controller. What slot does it go in? What should the CSR and vector be? Why does it work in one slot and not the other? Why won't the other disk drives show up now? It's back to basics for the answers.

The MICROVAX II bus (common communication path for address, data and control information transferred between CPU, memory and controllers) is called a Q22 bus. It's an extended design based on Digital's LSI Q-bus computer systems. It's important to understand a little about this animal before you can install new options.

The Q22 bus, also called the extended Q-bus, gets its name from its addressing capability: it has a 22-bit address range. The Q22 consists of two unidirectional and 42 bidirectional signal lines incorporated into a backplane. The backplane, which houses the signal lines

and physical connectors for each module, is divided into four rows (A to D) and eight or 12 slots (columns).

As a special design for the MICROVAX, the Q22 bus is wired so that some of the C and D backplane rows

the CD slots. However, any quad-size module (four rows) may be installed in a CD slot. Dual-width modules (two rows) may only be installed in the AB rows of a CD slot.

The CPU must always be the first

“
The Q22 bus, also called the extended Q-bus, gets its name from its addressing capability: it has a 22-bit address range.
”

are interconnected. This CD interconnection is known as the MICROVAX Memory Interconnect or CD. In a BA23 system, the first three slots are CD, and in a BA123 system, the first four slots are CD.

MICROVAX Add-Ons

As a rule, only a MICROVAX CPU or MICROVAX memory should be put in

device on the bus, and it must never be installed in a non-CD slot — it would be the death of the little workaholic.

Next, MICROVAX memory always should follow the processor in subsequent CD slots. It is interesting to note that while Digital only allows two memory boards to be installed in a MICROVAX II system (because of the CPU-to-memory jumper [PMI]), it's possible to install more. I made a cable with four connectors and successfully installed two 4-MB memory boards and one 8-MB memory board in a BA123 system.

The MICROVAX II CPU and memory are the easy parts; there are no configuration switches or jumpers to worry about on the MICROVAX II processor or memory boards, and the order of these boards is clearly defined. Other devices, however, require a little research.

Each device on the Q22 bus is required to have a unique address, referred

```
$
$ RUN SYS$SYSTEM:SYSGEN
SYSGEN > CONFIGURE
DEVICE > UDA,2
DEVICE > DHV11
DEVICE > QNA
DEVICE > TU81
DEVICE > Exit
Device:TU81      Name:PTA      CSR:774500    Vector:260    Support:yes
Device:QNA       Name:XQA      CSR:774440    Vector:120    Support:yes
Device:UDA       Name:PUB      CSR:760354    Vector:310    Support:yes
Device:DHV11    Name:TXA      CSR:760500    Vector:320    Support:yes
SYSGEN > EXIT
$
```

Screen 1: SYSGEN configuration example.

Introducing A High-Performance Graphics Engine With A Low Sticker Price.

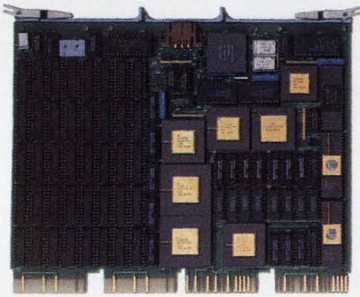

Now the DEC MicroVAX II® can be equipped with "four-on-the-floor."

Here's a high-performance champion that's graphically superior.

It's CalComp's new Formula 1™ Series. The hot little graphics engine that uses new, custom VLSI

gate-array technology to give you as many as four workstations from a single MicroVAX II. Without excess power drain. Before CalComp got in the race, a MicroVAX II could gain graphics capability only by using multiple slots. Or with the addition of separate, bulky and expensive controller hardware. Now, there's no contest.

With CalComp's Formula 1 Series your MicroVAX II gains a graphics capability that will set the designing mind free. Zoom, pan and update with turbocharged speed and a high-visibility 1280 x 1024 resolution. All in 256 souped up colors on a flicker-free screen. Plus get 32-bit floating point CGI standard functionality as standard equipment.

And don't worry about sticker shock. You can drive away with the entire Formula 1 Series subsystem—graphics engine, high-resolution color monitor, keyboard and mouse—for only \$6995. Or, try-out the Formula 1 Series engine alone for just \$3995. It's your option.

Naturally, our smooth-running Formula 1 Series graphics engine is **CalCompatible** with other peripherals and software. For information and specifications call 1-800-CALCOMP. Or write CalComp, P.O. Box 3250, Anaheim, CA 92803.

Drop the Formula 1 Series graphics engine into your MicroVAX II and see what it'll do. Because there's no other way to get high performance and four-on-the-floor at a price like this.



We draw on
your imagination.™

 **CalComp**
A Lockheed Company

ENTER 193 ON READER CARD

DEC and MICROVAX II are registered trademarks of Digital Equipment Corporation.
Formula 1 is a trademark of CalComp. ©1987 CALCOMP

T

TABLE 1.

Device	Module	Current +5v	(amps) +12v	Power (watts)
KA630-AA	M7606	6.2	0.14	32.70
MS630-AA	M7607	1.0	0.0	5.00
MS630-BA	M7608	1.3	0.0	6.50
MS630-BB	M7609	1.8	0.0	9.00
MS630-CA	M7610			
DHV11	M3104	4.5	0.55	29.10
DZV11	M7957	1.2	0.39	10.70
DZQ11	M3106	1.0	0.36	9.32
DEQNA	M7504	3.5	0.5	23.50
RQDX2	M8639-YB	6.4	0.1	33.20
RQDX3	M7555	2.48	0.06	13.20
KDA50-Q	M7164/5	13.5	0.03	67.90
TKQ50	M7546	2.9	0.0	14.50
LPV11	M8027	0.8	0.0	4.00
KLES1	M7740	3.0	0.0	15.00
TSV05	M7196	6.5	0.0	32.50
RD52		1.0	2.5	35.00
RD53		0.9	2.5	34.50
RD54		1.0	2.5	35.00
TK50		1.35	2.4	33.55

Device load information.

T

TABLE 2.

KA630	DEQNA
MS630-XX (or other manufacturer's memory)	KMV11
TSV05	DHV11 (or emulating devices)
MRV11	TKQ50
AAV11	RQDX3 (or emulating device)
ADV11	KDA50 (or emulating device)
IEQ11	KLES1
DRV11-J	RQDX2
LPV11	DRV11-WA
DZV11/DZQ11 (or emulating devices)	

Recommended device order.

T

TABLE 3.

Device	SYSGEN name	Device	SYSGEN name
DPV11	DPV11	RQDX-*	UDA
DRV11-*	DR11W	KDA50	UDA
LPV11	LP11	TQK50	TU81
DZV11	DZ11	TSV05	TS11
DZQ11	DZ11	DEQNA	QNA
DHV11	DHV11	IEQ11	IEQ11

SYSGEN device names.

to as a CSR (command/status register), and an interrupt vector. The CSR is a register, residing in the processor's I/O, that's used to pass commands and data to and from the device's software driver. The vector is a storage location, known to the system, which contains the memory address of the device driver. When a device interrupts the CPU, current program execution is suspended and control is passed to the software driver via the address contained at the device vector.

An easy way to think of the purpose of the CSR and vector is by looking at the operation of UPS or the post office. In order to deliver a package (data), it must have an address (CSR). When the delivery man (device) rings your door bell (interrupt vector), you (software driver) answer the door and accept the package.

The CSR address and interrupt vector are either fixed or floating. Fixed means that there's an address location reserved in memory for the address or vector of that device. Floating means that the device is assigned an address or vector within a range of octal numbers. A floating CSR is in the range of 17760010 to 17763776. A floating vector is in the range of 300 to 774.

Because the four most significant digits of the CSR are always the same, and the magnitude of the last digit is limited to six, the only bits that must be adjusted in the 22-bit word are bits 12 to two. For this reason, the most jumpers or dip switches you'll ever see for the CSR is 10.

CSR and vector information are provided with the option you have purchased or, in most cases (if it's a Digital product), in the MICROVAX II *Hardware Information Manual* provided with the system.

System Considerations

A major concern when configuring a new module or storage peripheral into

a MICROVAX system is power. The MICROVAX power supply is very conservative and can be overloaded easily. Table 1 provides the information you need to compute the load you want to put on it. If you're installing a non-Digital option, look at the manufacturer's specifications for this information.

Remember that each MICROVAX configuration has a different power supply. For example, a BA23 system has a single power supply with a rating of 230 watts, which supplies +5 volts dc at 36.0 amps and +12 volts dc at 7.0 amps. The BA123 system has a 460-watt supply split between two regulators. Each regulator supplies +5 volts dc at 36.0 amps and +12 volts dc at 7.0 amps. H9642-J systems are simply multiple BA23 chassis installed in the rack mount cabinet. Use these values when figuring a new system load.

If you approach or exceed the limits of the power supply, two problems arise. First, as the load increases in the system, so does the heat and the chance that a component will fail. Even MICROVAX fans are thermostatically regulated; they're limited in the amount of cooling they can provide. Second, if you overload the power supply, the circuit breaker will blow and bring down your system. This often will happen only after the system has had sufficient time to get warm.

Before planning to add a new option that uses backplane space, you first must ensure that you have slots free. The owners of the BA123 with its 12-slot backplane don't have to worry about slot space. BA23 owners, on the other hand, find it very easy to fill the backplane.

When it's full and you still want more devices, consider one of several options. The first is to use an alternate bus (other than the Q22). For example, if you must expand your storage system, rather than using the standard ST506, ESDI, SMD, TSV05 or TKQ50 device controllers, use a bus host adapter, such as an SCSI. An SCSI host adapter consumes one backplane slot but allows you to in-

terface multiple disk and tape drive systems. There also are performance benefits with this method.

Another option is to do it the Digital way and start using Ethernet as your second bus. Instead of using serial port controllers like the DHV11, DZV11

or DZQ11, start using terminal servers. In this way, only one dual-width board, the DEQNA, is required in the backplane.

Finally, be aware that some devices are position dependent; i.e., they won't work, or won't be recognized unless

Repairs & Spares For DEC?



DSN For Less!

DSN announces NEW competitive prices on ALL...DEC repairs! Add to this our Buy/Sell Parts Program and Full Exchange Program and you have the best DEC Repairs & Spares one-stop DEPOT support available anywhere. You can eliminate multi-vendor problems.

DynService Network, formerly Dynalectron Service Network, has spent over a decade specializing in DEPOT repair and service of DEC assemblies and their subassemblies. From LSI to VAX and beyond, DSN provides prompt and reliable quality service at the most competitive prices. Call today and ask for our new low prices.

Call NOW for New Competitive Prices On DEPOT Repairs & Spares & Exchanges For DEC:

HSC50, CI750/780, RPO7, RM80, RA80/81, VAX750/780/785, MicroVAX II...AND MORE!

Repairs & Exchanges
...Call Carolyn Czaikoski
Buy/Sell Parts
...Call Al Lewis
Call (408)432-6100



See us at DEXPO West Booth #1726.

DynService Network
National Depots for Repairs and Spares

ENTER 116 ON READER CARD

they fall into the correct order relative to other devices. For this reason, Table 2 lists a recommended device (option) order. Additionally, there may be performance reasons for the device order you choose. Because the MICROVAX operates on an interrupt priority

scheme, if two devices interrupt at the same time, the device that's electrically closest to the CPU will get control.

Configuring Controller Options

Warning: All MICROVAX circuit boards are sensitive to static electricity.

Therefore, you should always use an antistatic kit when handling circuit boards or storage devices. You can find these at your local electronics supply store.

The first step in configuring a new MICROVAX option is to use the running MICROVAX as a configuration tool. This is done with the SYSGEN utility, through the use of the CONFIGURE command.

After telling SYSGEN what devices you want in your new configuration, it will make the necessary calculations to figure out where it expects those devices to be (CSR and vector). SYSGEN provides you with a list of device names, CSRs and vectors. This information then can be used to configure your new option. Table 3 shows a list of device names that SYSGEN accepts. Screen 1 shows a sample configuration.

As soon as you have the CSR and vector for your new device, you can set the dip switches or jumpers according to the information provided with the option. The CSR and vector settings are always listed as a series of ones (1s) and zeros (0s). A one corresponds to the switch being on or the jumper in. A zero means that the switch should be off or the jumper out. A pen or paper clip can be used to flip the dip switches.

When the option has been configured, it's ready to be installed. For all hardware installations, the MICROVAX must be shut off. Removing or installing an option with the power on will cause serious damage to the computer. After the power has been turned off, the panels providing access to the card cage can be removed. On BA23 systems, this includes the rear cabinet cover and the I/O panel; on BA123 systems, it encompasses the right side panel and the card cage cover.

In most cases, installing a new controller option requires moving options already installed in the card cage. Decide first where your new option should go by using the device order table (see Table 2). If your new option must be installed between existing options, start by moving down the last and subsequent boards

MAKE YOUR PDP-11 PERFORM LIKE A VAX!

SOLVE YOUR SYSTEM MIGRATION PUZZLE!

You can double your system's speed and triple peripheral capacity.

If you own a PDP-11/24, 11/34 or 11/44 you've probably experienced one or more of the following problems with your system:

- UNIBUS bandwidth topped-out
- System is at maximum configuration
- High data rates choke the UNIBUS
- Insufficient Device/DC load capability
- Real-Time increases out of control
- Unidentified errors

A new system would be ideal, but the cost can be prohibitive.

A UNIBUS Enhancement Package is available that will add years of life to your current data processing investment, solve phantom problems and allow for planned migration to new CPU and bus technology.

The heart of the Enhancement Package is an Ultra Fast UNIBUS Memory (UFUM) and a UNIBUS Segment Isolator/High Speed Repeater (USI/HSR).

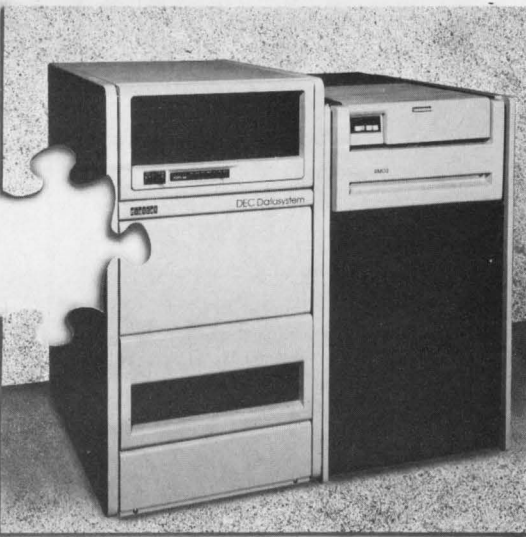

Since 1976, Digital Data Systems Inc., has provided design, service and unique manufactured products for End-User's and OEMs. Our design engineers have developed custom memory products for many Fortune 500 Companies and the U.S. Government.

At DDS, over a decade of experience in memory design and manufacturing has contributed to a product line of unfailing reliability. Standard products are manufactured to the same stringent specifications as required for Government contracts. Our state-of-the art design and manufacturing capabilities enable us to offer superior products at the lowest possible cost, with a lifetime warranty and 24-hour replacement guarantee.

THE INTELLIGENT SOLUTION



WORLD'S FASTEST UNIBUS MEMORY

MEMORY FEATURES

- Effective memory cycle time less than 5NS compared to the industry standard of 500NS.
- System bandwidth increase of at least a factor of 2, with certain applications realizing further improvements.
- Plug and play, requires no software or hardware changes.
- On board battery backup.
- Up to 1MB of storage on a single board.
- Designed with Static Rams.
- CSR standard.

ISOLATOR/REPEATER FEATURES

- Allows UNIBUS bandwidth to be driven up to 6MB.
- Automatically tunes the UNIBUS eliminating the need to reconfigure as the system grows.
- Plug and play, requires no software or hardware changes.
- Upgrades to UDA-50 technology with existing UNIBUS configuration.
- Allows the addition of up to 60 DC unit loads on a single UNIBUS.
- Allows the addition of two UDA controllers on one UNIBUS or UBA.
- Improves data integrity as proven under UNIX.

Note: DEC, PDP-11 and UNIBUS are registered trademarks of Digital Equipment Corp. UNIX is a trademark of AT&T Bell Laboratories. USI/HSR is a trademark of SETASI Research & Development.

DIGITAL DATA SYSTEMS INC.
1551 N.W. 65TH AVENUE • PLANTATION, FL 33313 (305) 792-3290
©1987 DIGITAL DATA SYSTEMS, INC. TWX: 910-997-4751 (DIGITAL)

ENTER 200 ON READER CARD

Reaching Beyond superPDL™

superPDL™

superCASE™

The Quintessential*
Life-Cycle
Development Tool
for your Software Projects

For detailed
information
about VAX/VMS
oriented superCASE™
please contact:



Advanced Technology
International, Inc.
350 Fifth Ave., Suite 2420
New York, N.Y. 10118

Tel: (212) 947-4755
Telex: 263057
ATI UR

Ada® is a registered trademark of the U.S. Government
VAX and VMS are trademarks of Digital Equipment Corp.

Finally, a complete Life-Cycle Development Tool reaching
from High-Level Design through Detailed Design and Code
Generation, to Code Completion and Maintenance Activities.

- An elegant Ada® Design Environment supporting the full Ada® syntax.
- Full DoD-Std-2167 compliance.
- Powerful facilities for C, Fortran, Pascal & PL/M.
- Code Generation in all above Languages.
- Automatic Retrofitting of Design and Design Documentation based on changes in Code.
- Automatic Extraction of Design from Existing Source Code.

*Quintessence: the essence of a thing in its
purest and most concentrated form.

ENTER 249 ON READER CARD

Connectivity

Teltone, the creator of
data over voice,
introduces:

over voice.



► TelLAN: The 1-Mbps
switched data network
on your phone lines.

Now you can link terminals, PCs, minis, mainframes, printers, modems and other data devices to a powerful data-over-voice local area network. TelLAN combines PC/LAN and data switch functions that let you:

- share printers and other resources
- perform high-speed file transfer between PCs
- handle multiple calls with one login
- communicate with devices that operate at different speeds up to 19.2 kbps

It's all implemented on the phone lines, without affecting telephone service. Cable installation costs are eliminated. Modular components let you start small, and grow as needed up to 250 nodes.

TelLAN is friendly, password protected, and easy to install. Ask for a free copy of our connectivity solutions guide:

1-800-426-3926

(In Washington State: 206-827-9626)

TEL TONE®

Teltone Corporation, 10801-120th Avenue NE, Kirkland, Washington 98033, 206-827-9626
Teltone Limited, 183 Amber Street, Markham, Ontario L3R 3B4, 416-475-0837

ENTER 245 ON READER CARD

Attention
Oracle Users!

Report writing just got easier.

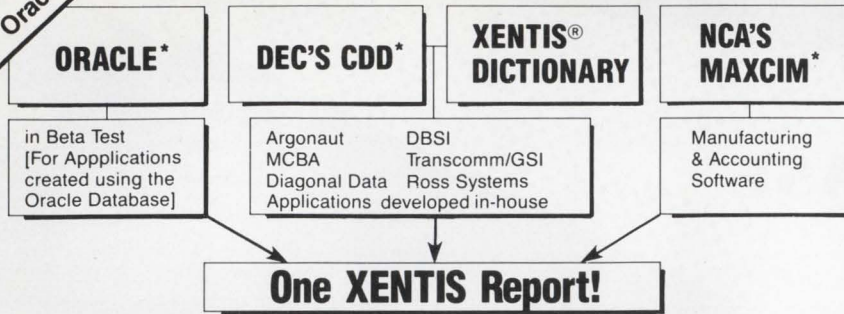

XENTIS—the premier report generator for DEC VAX/VMS computers—will soon be able to interface with the Oracle 4th GL. For programmers and nonprogrammers alike, XENTIS is fast and easy to use.

Proven in more than 500 installations, the Park Software report writer can combine information across several data bases. . . for example, your accounting staff can pull information from Ross Systems accounting software and combine it with data from Argonaut's Human Resources package in one report. And soon you'll be able to add data from applications created with the Oracle system.

To learn more about XENTIS and our fully functional evaluation kit, call (206) 343-0447 today!

ENTER 143 ON READER CARD



PARK SOFTWARE, INC.

P.O. Box 31529
Seattle, WA 98103-1529 (206) 343-0447

*Oracle is a registered trademark of the Oracle Corp. DEC and CDD are registered trademarks of Digital Equipment Corp. XENTIS and XENTIS/Dictionary are registered trademarks of Park Software, Inc. MAXCIM is a registered trademark of the NCA Corp. MCBA is a registered trademark of MCBA, Inc.

Network DEC to UNIX?

What You Didn't Know--Will Help You!

TCP/IP Networking Software...

Did you know that most UNIX computers already support industry-standard TCP/IP networking protocols? And that Process Software Corporation gives you TCP/IP networking solutions for more DEC operating systems than anybody?

For VMS, RSX, RT-11, IAS, And TSX-Plus...

Network to UNIX using just our TCP/IP software and your standard DEC Ethernet hardware on the UNIBUS, Q-bus, VAXBI, or the new MicroVAX 2000. And run concurrently with DECnet, LAT, or LAVC.

Designed To Benefit You...

Say goodbye to special hardware, messy installation, and unneeded layers of software. Our TCP/IP products are modular, efficient, and designed for the operating system they run on. You benefit from ease of use, simple installation and virtually no maintenance.

For Every Application...

And we support the full range of popular TCP/IP applications, including FTP (File Transfer), TELNET (Virtual Terminal), TCP, IP, and UDP programming interfaces, and others.

You won't find a better lower-cost way to connect DEC to UNIX anywhere!

Interested? Call Process Software Corporation today.

PROCESS SOFTWARE 413-549-6994

35 Montague Road • PO Box 746 • Amherst, Massachusetts 01004

DEC, IAS, RSX, RT-11, UNIBUS, VAX, and VMS are Digital Equipment Corporation trademarks. Unix is an AT&T trademark. Ethernet is a Xerox Corporation trademark. TSX-Plus is a S&H Computers trademark.

ENTER 148 ON READER CARD

one slot at a time. Finally, install your new option.

If your new option is on a dual-height board, and the installation leaves two rows empty, you must install a continuity grant card in the empty rows. This is because the Q22 backplane pro-

“

Digital's RDxx drives are controlled by an RQDX-type controller, which has a single connector output.

”

vides continuity in a serpentine fashion, like ABCD-DCBA-ABCD... .

After the board is installed, you must connect any cables that will carry data from the controller to a cabinet kit or directly to an internal device. Be sure to push the cables in straight so as not to bend the pins.

Installing New Disk Drives

Perhaps the most common MICROVAX option is an additional RDxx disk drive or an OEM disk subsystem. If you're adding this option to a BA23 system, the disk drive will be in an external cabinet, while the BA123 most likely will be internal.

Installing an external RDxx drive is a clumsy proposition at best. Digital's RDxx drives are controlled by an RQDX-type controller, which has a single connector output. This output is sent to a signal distribution board which provides connectors for an RX50 floppy drive and two RDxx-type drives. To extend the controller signals to an external drive, you must purchase an RQDX-E expansion board, which brings all signals, not only the ones you want, out to the I/O panel. These signals, again, must be run into an RQDX signal distribution board.

For immediate relief of disk backup headaches, just press here.



Only MegaTape makes disk backup totally painless, with up to 630 MB per cartridge (formatted). *Enough to hold the entire contents of any popular disk drive.*

Think what that means: No media changes. No waiting. Just pop in a cartridge, fire up your regular backup utility—and go home.

MegaTape has already cured backup headaches at thousands of sites. And we're developing even higher capacity for the future. So no matter how big your disks get, your backup job doesn't have to get any bigger. Just push the button and go home.

Try MegaTape once. You'll agree that anything else is just a big pain.



Available in tabletop, rackmount, and "half-wide" configurations

**See Us At DEXPO West
Booth #457**

ENTER 138 ON READER CARD

 **egaTape**

MEGATAPE CORPORATION 1041 Hamilton Road, Duarte, CA 91010-0317
(818) 357-9921/TELEX 510 600 7131

For all who are upgrading to an external (and internal) system, I suggest using an OEM solution, preferably going to the ESDI disk format. Many solutions are available from companies like U.S. Design, DILOG, and Emulex. Most ESDI disk controllers handle from two to four physical drives, and the con-

trollers have individual connectors for each drive; therefore, no signal distribution board is required.

Adding internal drives to a BA123 system is simple. Each RQDX controller comes with a signal distribution board that plugs into the last slots in the backplane. Connection, then, is only a

DILOG
1555 S. Sinclair St.
P.O. Box 6270
Anaheim, CA 92806
(714) 937-5700
ENTER 478 ON READER CARD

Emulex Corporation
3545 Harbor Blvd.
P.O. Box 6725
Costa Mesa, CA 92626
(714) 662-5600
ENTER 479 ON READER CARD

U.S. Design Corporation
4311 Forbes Blvd.
Lanham, MD 20706
(800) 368-2811
ENTER 480 ON READER CARD



We've got the connections NOW!

Whether your need is user-proof separation of data from voice or future RS232/RS423 compatibility, MOD-TAP has the Modified Modular Jack (MMJ) products NOW!

Compatible with DECconnect, IBM, HP, Wang, and many others, MOD-TAP meets your communication needs for today **and** tomorrow with a wide range of MMJ products that include:

- Patching
- Wallplates
- Harmonicas
- Octopuses
- Adapters

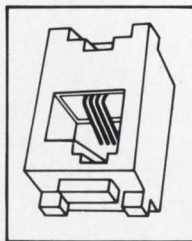

At MOD-TAP, communications wiring is our **only** business, so make the right connection with our MMJ products.

**See Us At DEXPO West '87
Booth #354**

DEC and DECconnect are trademarks of Digital Equipment Corporation.
HP is a trademark of Hewlett Packard.
IBM is a registered trademark of International Business Machines Corporation.
MOD-TAP is a trademark of MOD-TAP System.
Wang is a trademark of Wang Laboratories, Inc.

MOD-TAP MOD-TAP System • P.O. Box 706 • Harvard, MA 01451 • (617) 456-3500

ENTER 215 ON READER CARD

matter of routing cables from the distribution board to the new drive, and plugging in the drive's power supply cable.

Before any new drive is installed, from Digital or an OEM, a minor configuration must be made. All 5 1/4-inch Winchester disk drives have jumpers or switches to control drive select. The drive select is, in essence, the drive address for the controller. For example, if four drive-select jumper positions are provided on the drive, and the drive you're installing is the second on the controller, then you'd move the jumper to the second position. When using an RQDX controller, drive selects one and two are reserved for an RD50 drive. Follow the manufacturer's directions for this procedure.

If you're like me, you do something first and read the directions later or as a last resort. After all, you're just as smart as the guy who built the thing. Right?

Take it from me: Read the manual before you start reconfiguring your system or adding an option. In most cases the directions will tell you if changes must be made to the system, what the power requirements are, how to set the dip switches and jumpers, and where the cables go. Just because things fit doesn't mean they go there. ■

Any disk backup system can save your data. This one can save your life.

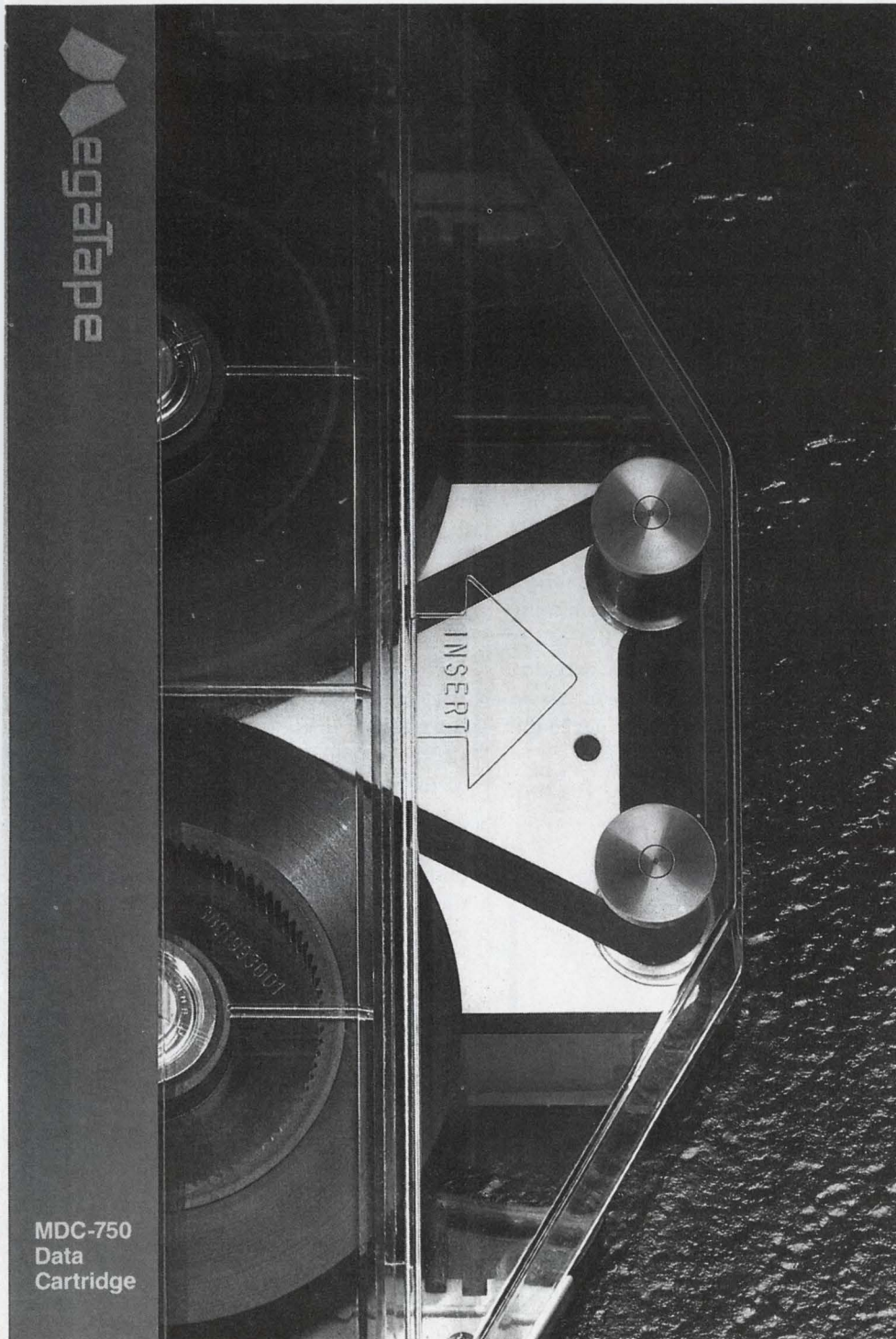

Most people would agree that life is too short to spend sitting in front of a tape drive, swapping reels or cartridges while disk backup grinds on and on.

It's boring, error-prone, and expensive.

It's also unnecessary.

Just get an inexpensive MegaTape drive. Plug it in right where your 9-track was (your system won't know the difference). Pop in a cartridge. Push the button.

Then turn out the lights and go home.

When you come back in the morning, all your data—up to an amazing *630 megabytes*—will be safe and sound on a single book-size cartridge. That's an entire RA-81 or Fujitsu Eagle, with room to spare. *Room enough even for the next generation of ultra-high capacity drives.*

No other tape backup system—existing, rumored or announced—offers anything close to this kind of convenience. And we've been delivering it for over two years.

So why waste your life babysitting a backup, when with MegaTape you can save it for more important things?

 **egaTape**

**BECAUSE ONE IS ENOUGH
AND TWO IS TOO MANY.**

ENTER 234 ON READER CARD

**See Us At DEXPO West
Booth #457**

© 1986 MEGATAPE CORPORATION 1041 Hamilton Road, Duarte, CA 91010-0317
(818) 357-9921/TELEX 510 600 7131

A

DCL DIALOGUE

Kevin G. Barkes

The Joys Of Captivity

VAX system sites are often the victims of a double-edged sword. Small- to moderate-sized systems require little in the way of day-to-day management. If extensive magnetic tape handling isn't required, the need for full-time operators is eliminated. A one-person operation and the economies it provides are one of the major pluses of running VAXs.

On the downside, a VAX is a VAX, from MICROVAX to 8800, and there are certain semicomplex functions, such as incremental backup, that must be performed by someone with a relative degree of competence.

The following is a "case study" of such a site, which offers one way of handling the problem.

The installation ran in a commercial environment on a 24-hour-a-day, 7-day-per-week basis. Data constantly was entered by users into a database management system. All data was maintained online; operators weren't required. Key operations personnel were

trained to perform printer-related duties, such as fixing jams and changing paper and ribbons. The necessary queue-management functions were contained in a small suite of DCL command procedures.

Because of the volatility of the database, incremental backups were required every eight hours. This was the source of the problem. No systems personnel were on duty after business hours; only production workers. Management didn't like the idea of leaving privileged accounts open to members of the staff.

The system manager had a problem with scheduling the backups to be executed from batch queues. Instead, he opted to run the jobs from a captive account. A captive account severely limits the user. Among other restrictions, captive users can't change their passwords, use the /DISK or /COMMAND qualifiers at login to bypass the default login command procedure, or CTRL-Y out of the procedure. The command file executed by the captive account at login can be set up so that the user never gets to the

Your comments, criticisms and suggestions are encouraged. You'll get the fastest response by leaving a message on ARIS (215) 542-9458. You also can write my office at 4107 Overlook Street, Library, PA 15129; DEC PROFESSIONAL, P.O. Box 503, Spring House, PA 19477; via CompuServe EasyPlex, user I.D. 72067,341 (check out the VAXSIG while you're there); or, by calling or sending a message to my DCL BBS, SYS\$OUTPUT (412) 854-0511. If your local FidoNet BBS isn't carrying the national VAX echomail conference, ask the SYSOP to contact me at FidoNet 129/38.

DCL level. This permits the manager to give the account high-level privileges without having to worry about the person logging in gaining free access to the system.

The Table shows the user-authorization record of the captive account used in this application. Note the login flags entry, which ensures that the user can't escape to the system. The "Diswelcome" entry eliminates the display of the welcome message at login.

Although not visible on the UAF record, the account is set up with no password; all that's required is to enter the account name BACKUP. The actual incremental backup is performed by the command file SYS\$MANAGER:INCBACK.COM, the procedure executed at login. Added security is provided here by performing several checks.

The procedure looks at the terminal where the process is logged in. If it's not the operator's console, the procedure

TABLE 1.

```

Username: BACKUP                               Owner: SYSTEM MANAGER
Account: SYSTEM                               UIC: [1,5] ([SYSTEM,BACKUP])
CLI: DCL                                       Tables:
Default: SYS$SYSROOT:[SYSMGR]
LGICMD: SYS$MANAGER:INCBACKUP.COM
Login Flags: Disctly Captive Diswelcome
Primary days: Mon Tue Wed Thu Fri
Secondary days:                               Sat Sun
No access restrictions
Expiration: (none)                            Pwdminimum: 8      Login Fails: 0
Pwdlifetime: (none)                          Pwdchange: (none)
Last Login: 2-SEP-1987 17:08 (interactive),   (none) (non-interactive)
Maxjobs: 0  Fillm: 20  Bytlim: 20480
Maxacctjobs: 0  Shrfilm: 0  Pbytlim: 0
Maxdetach: 0  BIDlim: 18  JTquota: 1024
Prclm: 10  DIDlim: 18  WSdef: 512
Prlo: 4  ASTlim: 24  WSquo: 768
Queprio: 0  TQElm: 20  WSextent: 1536
CPU: (none)  Enqlm: 30  Pgfliquo: 10000
Authorized Privileges:
BYPASS LOG_ID PRMBX TMPMBX OPER NETMBX PHY_ID SYSPRV
Default Privileges:
BYPASS LOG_ID PRMBX TMPMBX OPER NETMBX PHY_ID SYSPRV

```

Now! Optical Disk Mass Storage for VAX/VMS™ Users!



A Completely Integrated System Including Software.

The new Perceptics LaserSystem™ finally solves the mass storage problem for VAX/VMS users. Fully integrated, tested, and ready-to-use, LaserSystem features an OSI optical disk drive, SCSI host adapter, Perceptics LaserWare™ software, media, complete installation and on-site maintenance.

LaserSystem includes several advanced features, such as Direct Read During Write (DRDW) data verification, automatic bad block reallocation, and extensive self-diagnostics. A removable 12-inch cartridge is used to permanently store up to 2 GBytes of data.

Our revolutionary LaserWare software, which has become the industry standard, is completely transparent to your VMS utilities and applications. LaserWare requires **no changes** to your existing software.

perceptics

Perceptics Corporation
Pellissippi Corporate Center
Knoxville, Tennessee 37922
(615) 966-9200

VAX and VMS are trademarks of Digital Equipment Corporation.
LaserSystem and LaserWare are trademarks of Perceptics Corporation.

ENTER 144 ON READER CARD

branches to BAD_TERMINAL and logs the user out.

If the procedure is executed by a user other than BACKUP, or from an account that isn't captive, the branch to NOT_AUTHORIZED also terminates the session.

The normal procedure at the site was for a member of the staff to enter the computer room, load the appropriate tape on the drive and then log in as BACKUP. The original procedure did no error checking, and if the drive were allocated by someone else or the tape didn't mount properly, it simply would bomb through the rest of the procedure and exit, confounding and confusing the user.

INCBACK checks the status of the allocate and mount commands, and if either fails, warns the users on the system. It waits a minute, then tries again. Without the /NOASSIST qualifier to the MOUNT command, the procedure simply would notify the operator terminals to mount a tape. Sometimes this

message would go unnoticed for hours, especially if the procedure were started by someone who was going offshift.

The actual backup commands are straightforward. At this site, the in-

crementals all fit on one tape, so no provision was made to notify users should a second volume be necessary. Captive accounts provide one easy-to-implement method of permitting non-technical users to perform tasks that require potentially dangerous privileges, with-

out compromising the integrity of the system.
What's your method of handling situations such as these? Send your suggestions to me at any of the addresses

“
INCBACK checks the status of the allocate and mount commands, and if either fails, warns the users on the system.
”

listed in the box accompanying this article.
Author's notes: Dave Smith, a SYSS OUTPUT user, noted the privilege stacking procedures in the July issue were more complicated than necessary. Dave takes issue with the section where

listed in the box accompanying this article.
Author's notes: Dave Smith, a SYSS OUTPUT user, noted the privilege stacking procedures in the July issue were more complicated than necessary. Dave takes issue with the section where

PROGRAM 1.

```

! INCBACK.COM
! Command procedure to perform incremental backups.  Designed to be run
! by a captive account named BACKUP from the system operator's console.
!-----
! Disable error processing:
$ SET NOON
!-----
! Make certain the procedure is being executed from the
! captive BACKUP account, at the operator's console:
$ IF F$GETJPI("","TERMINAL") .NES. "DPAO:" THEN GOTO BAD_TERMINAL
$ IF F$GETJPI("","USERNAME") .NES. "BACKUP" .OR. -
  .NOT. F$ENVIRONMENT("CAPTIVE") THEN GOTO NOT_AUTHORIZED
!-----
! Allocate the tape drive.  Substitute your tape device throughout,
! or use a logical name assignment.
$ ALLOCATE DRIVE:
$ ALLOCATE MTAO:
!-----
! Store the value of $STATUS
$ $ALLOSTAT = $STATUS
!-----
! If ALLOCATE failed, scream bloody murder:
$ IF .NOT. $ALLOSTAT THEN GOTO BAD_ALLOCATE
!-----
! Mount the tape.  The /NOASSIST qualifier forces MOUNT to fail and return
! an error, rather than print out a message at the operator console:
$ MOUNT_TAPE:
$ MOUNT/NOASSIST/FOREIGN MTAO:
!-----
! Store the value of $STATUS:
$ $MOUNTSTAT = $STATUS
! Notify users if MOUNT fails:
$ IF .NOT. $MOUNTSTAT THEN GOTO BAD_MOUNT
!-----
! Perform the actual backup.  Change disk device names as necessary.
$ ON SEVERE ERROR THEN GOTO ERROR_1
$ REPLY/ALL/BELL "Backing up system disk..."
$ BACKUP/REWIND/RECORD/FAST/JOURNAL=SYSSMANAGER:INCSYS.BJL/-
  IGNORE=INTERLOCK/VERIFY/BUFFER=5 -
  SYSSYSDEVICE:[*...]/SINCE=BACKUP MTAO:INCSYS.BCK
$ REPLY/ALL/BELL "Backing up DISK1..."
$ BACKUP/NOREWIND/RECORD/FAST/JOURNAL=SYSSMANAGER:INCDISK1.BJL/-
  IGNORE=INTERLOCK/VERIFY/BUFFER=5 -

```

```

DISK1:[*...]/SINCE=BACKUP MTAO:INCDISK1.BCK
!-----
! Notify users when backup is completed:
$ REPLY/ALL/BELL "Incremental backup completed."
!-----
! Exit gracefully:
$ FINISH:
$ DISMOUNT MTAO:
$ DEALLOCATE MTAO:
$ EOJ
!-----
! Error handlers:
! Notify users of backup error and exit:
$ ERROR_1:
$ REPLY/ALL/BELL/URGENT "WARNING! BACKUP FAILURE!"
$ REPLY/ALL/BELL/URGENT "NOTIFY SYSTEM MANAGER!"
$ DISMOUNT MTAO:
$ DEALLOCATE MTAO:
$ EOJ
!-----
! Notify users of MOUNT failure and tell them why it failed:
$ BAD_MOUNT:
$ REPLY/URGENT/BELL/ALL "ERROR MOUNTING TAPE! PLEASE CHECK!!"
$ REPLY/URGENT/BELL/ALL "Error: '$FSMESSAGE($MOUNTSTAT)'"
! Wait one minute, then try to mount the tape again:
$ WAIT 00:01:00
$ GOTO MOUNT_TAPE
!-----
! Notify users of ALLOCATE failure and tell them why it failed:
$ BAD_ALLOCATE:
$ REPLY/URGENT/BELL/ALL "ERROR ALLOCATING DRIVE! PLEASE CHECK!!"
$ REPLY/URGENT/BELL/ALL "Error: '$FSMESSAGE($ALLOSTAT)'"
! Wait one minute, then try to allocate the drive again:
$ WAIT 00:01:00
$ GOTO ALLOCATE_DRIVE
!-----
$ BAD_TERMINAL:
$ WRITE SYSSOUTPUT "BACKUP must be run from the operator's console."
$ EOJ
!-----
$ NOT_AUTHORIZED:
$ WRITE SYSSOUTPUT "You are not authorized to use this procedure."
$ EOJ

```

A Classic Approach to Mass Storage! Optical Disk Jukebox for VAX/VMS™



Introducing LaserStar™, a complete optical disk jukebox subsystem.

Perceptics' LaserStar brings the massive storage capacity of optical disk jukeboxes to the fingertips of VAX/VMS users. Combining the latest in optical storage technology with the classic "jukebox" concept of disk handling, LaserStar provides convenient, on-line storage and retrieval of vast amounts of data using write-once optical disks.

The LaserStar jukebox consists of a robotic disk handling mechanism, a media storage unit, and one or more optical disk drives. The system also includes a host adapter, Perceptics LaserStar software, and installation. Optional items

include 12-inch double-sided media and on-site maintenance. A variety of drive/media configurations are available to meet your specific budget and performance requirements, with total on-line storage capacities ranging from tens to hundreds of gigabytes. Media are fully compatible with Perceptics' LaserSystem™ optical disk subsystem.

LaserStar software provides automatic, VMS-transparent access to the jukebox optical

disk library. Based upon Perceptics' industry standard LaserWare™ software, LaserStar is completely compatible with VMS utilities and applications. Thus, each optical disk volume in the jukebox may be accessed with **no changes** to your existing software.

perceptics

Perceptics Corporation
Pellissippi Corporate Center
Knoxville, TN 37933-0991, USA
(615) 966-9200
FAX (615) 966-9330

ENTER 145 ON READER CARD

VAX and VMS are trademarks of Digital Equipment Corporation.
LaserStar, LaserSystem, and LaserWare are trademarks of Perceptics Corporation.

2.5 Gigabytes VAX Backup



Gigastore works with the standard VMS, DCL Backup Command and all Qualifiers or standard Unix Dump/Restore Command and all Arguments. It also provides DEC tape emulation for general purpose use.

Utilizing true read-after-write coupled with very powerful error correction, GIGASTORE™ gives you an unsurpassed error rate of 1 in 10²³ bits. In addition, you get a high speed search capability not available in most 9-track drives and the convenience of a T-120 VHS cartridge. An IBM PC interface is also available.

Call Digi-Data, an organization with a 25 year history of manufacturing quality tape drives, at (301) 498-0200.

™GIGASTORE is a trademark of Digi-Data Corporation.



DIGI-DATA CORPORATION
8580 Dorsey Run Road
Jessup, MD 20794-9990
(301) 498-0200
Telex 87-580

... First In Value

In Europe contact: Digi-Data Ltd. • Unit 4 • Kings Grove • Maidenhead, Berkshire
England SL6 4DP • Telephone No. 0628 29555/6 • Telex 847720

ENTER 194 ON READER CARD

FREE ADVICE . . .

Read **ARISTALK** this month and see just how good it can be. Readers talking to readers about computers talking to computers and other issues of concern to you.

Information to save you time and money.

ARISTALK — an exclusive feature of an exclusive magazine - - -

DEC PROFESSIONAL!

we tested CMKRNL privilege. Using UPOPCOM as an example, this is how I would have written the code between the DO_POP: and POP_UIC: labels:

```
$ DO_POP:
$ SAVE_PRIV =
  F$SETPRV("CMKRNL")
$ IF F$PRIVILEGE("CMKRNL")
  THEN GOTO POP_UIC
$ TYPE SY$INPUT
You do not have the privileges
required to use this command.
$ EXIT
$ POP_UIC:
```

Then, at the end of the procedure to restore the previous privilege:

```
$ EXIT:
$ SAVE_PRIV =
  F$PRIVILEGE(SAVE_PRIV)
$ EXIT
```

Dave caught me on this one. My only excuse is laziness. Like any good DCL writer, I frequently steal hunks of code from other procedures. This segment came from a procedure that passed various privileges to the lexicals and checked to determine whether the requested privilege was "legal," because a non-existent one would return an error. So much for saving time!

"YooHoo" Opus

My DCL bulletin board system, SY\$ OUTPUT, should be converted from Fido to Opus software by the time this column appears in print. Opus is a more user-friendly system, but it has several quirks. Then again, how can you not like communications software that has the text "YooHoo!" as part of its file transfer initialization sequence? It isn't DECNET, but it makes running a PC-based BBS simpler. If your local FIDONET BBS isn't carrying the national VAX echomail conference, ask the sysop to request additional information from me at matrix address 129/38. —Kevin G. Barkes is a specialist in VAX systems software, management, tuning and training in Library, Pennsylvania. ■

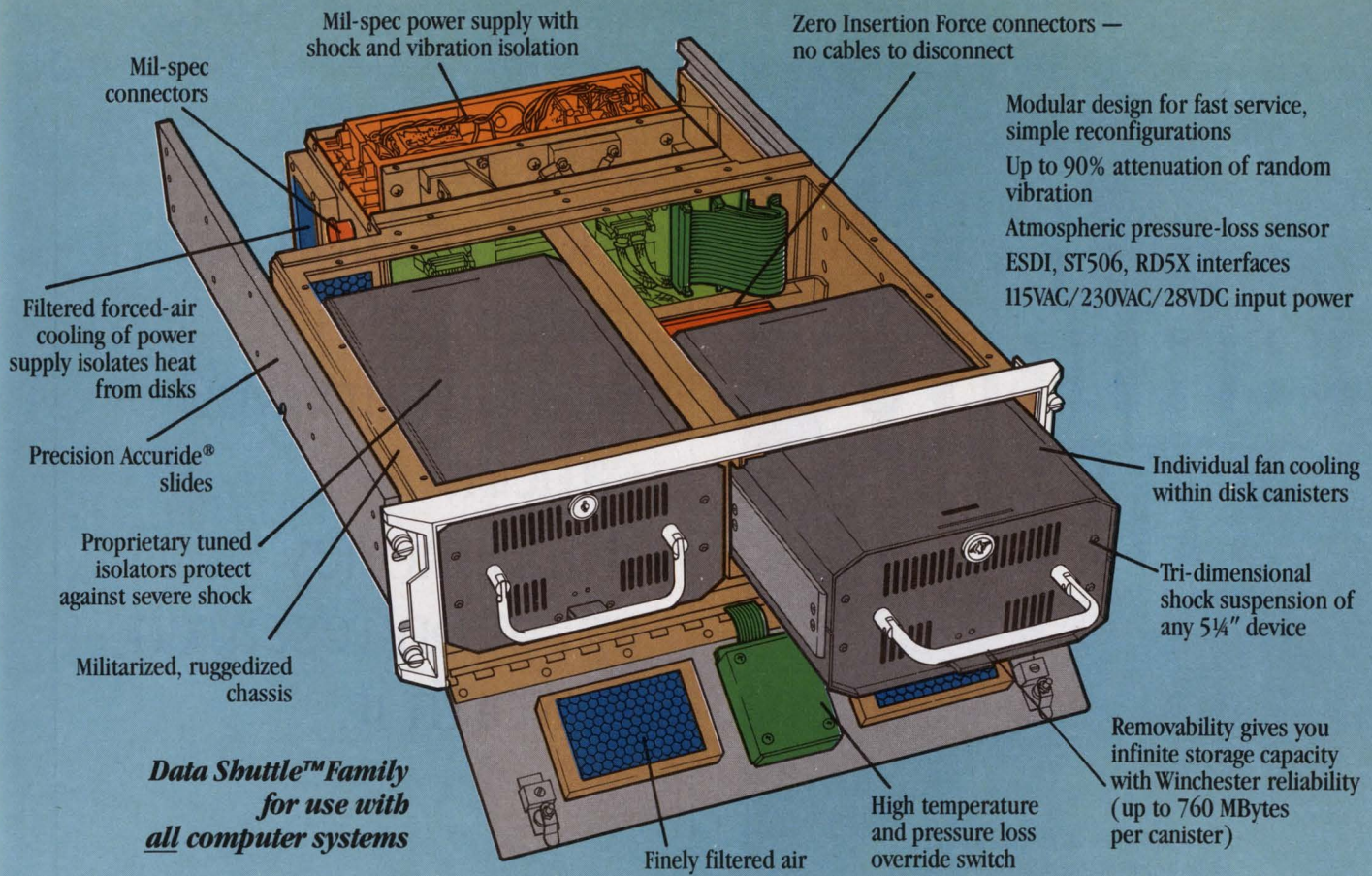

The most ruggedized, militarized, Tempest-certifiable removable-drive subsystem today.

With quick-release failure-proof power-down feature

DATA SHUTTLE 4000™ is the subsystem to specify for hostile environments — proven by actual MDB experience in airborne and shipboard installations. This is the peripheral subsystem (RCS-P) in our RUGGED COMPUTER SYSTEM series. It's designed for militarized computer systems — not just an adaptation of a commercial product. It's put together with thoughtful engineering and proprietary concepts. Power is automatically disconnected from the drives when the canister is being removed. Zero Insertion Force connectors provide long life to an already reliable product. Individually cooled canisters protect drives against shock and vibration within the Data Shuttle and during transport. You can configure *any* 5¼" storage device in canisters, or one with a permanently mounted removable-media back-up drive with shock protection. Available with or without controllers. Call or write for more information.

DATA SHUTTLE 4000™

The peripheral subsystem that's good enough for MDB Rugged Computer Systems — militarized and able to take the harshest operational shock and vibration.

DATA SHUTTLE 3000™

Rock-solid ruggedized for harsh environments, when durability is needed, but not the added cost of Mil-spec.

DATA SHUTTLE 2000™

The only shock-isolated, low-cost design for commercial, lab and industrial applications.

See Us At DEXPO West 87, Disneyland Hotel, Booth 269



MDB
SYSTEMS INC.

Corporate Headquarters 1995 N. Batavia Street, Box 5508, Orange, CA 92613-5508
TEL: (800) 556-0222 • IN CA: (800) 637-2028 • TWX: 910-593-1339 • FAX: 714-637-4060
FOR UNITED KINGDOM MDB Systems U.K., Ltd. Unit 13, Intec 2, Wade Road, Basingstoke, Hants. RG24 ONE • TEL: 0256 464767 • TELEX: 858389 MDBSYS G • FAX: 0256 59748
FOR WESTERN EUROPE MDB Systems IRL., Ltd. Portumna Co. Galway, Republic of Ireland • TEL: (353) 509 41163/41413 • TELEX: 50918 MDBEI • FAX: (353) 509 41447

ENTER 238 ON READER CARD — We put the State of the Art to work —

A BRIGHT IDEA!

Consider Microtek for your next DEC computer purchase and **SAVE 20-50%** over manufacturers list price.

Only Microtek protects your equipment investment with a *three way guarantee*. All equipment leaving our facility is reconditioned and eligible for *DEC Maintenance Service*. And, for added security, is crated to insure against damage during shipping. Whatever your computer hardware needs, Microtek can meet them with our large inventory and DEC application specialists. Call today for current prices and detailed information.

216/234-8040 1-800-828-0303
BUY SELL LEASE TRADE



CDIA Member:
Computer Dealers
& Lessors Association

Ask one of
the 3 million
Americans
who've survived
cancer,
if the money
spent on research
is worth it.

We are
winning.

Please
support the
**AMERICAN
CANCER
SOCIETY®**

ENTER 236 ON READER CARD

SHIPPING NOW.



FREEDOM ONE ANSI.

A HIGH QUALITY, ENTRY LEVEL ANSI TERMINAL OFFERING OUTSTANDING PRICE/PERFORMANCE.

Introducing the newest addition to the Freedom ONE family of terminals from Liberty Electronics. The Freedom ONE ANSI. The ONE terminal for your DEC and Data General requirements. This low-cost, ANSI-only terminal includes many of the same advanced features you'd expect to find in higher priced terminals.

For starters, it provides emulation of DEC VT220,[™] VT100[™] and VT52,[™] as well as Data General DASHER[™] D210 and D211. It has the same sleek, award-winning ergonomic styling of the original Freedom ONE. It comes with a high contrast amber 14-inch flat screen, with full tilt and swivel capability. It includes a choice of two detached, low-profile keyboard styles: DEC VT220 and Data General D210/211.

It's all backed by Liberty's comprehensive warranty programs and nationwide network of authorized service centers.

The new Freedom ONE ANSI. You won't find a higher quality ANSI terminal for the price. Anywhere.

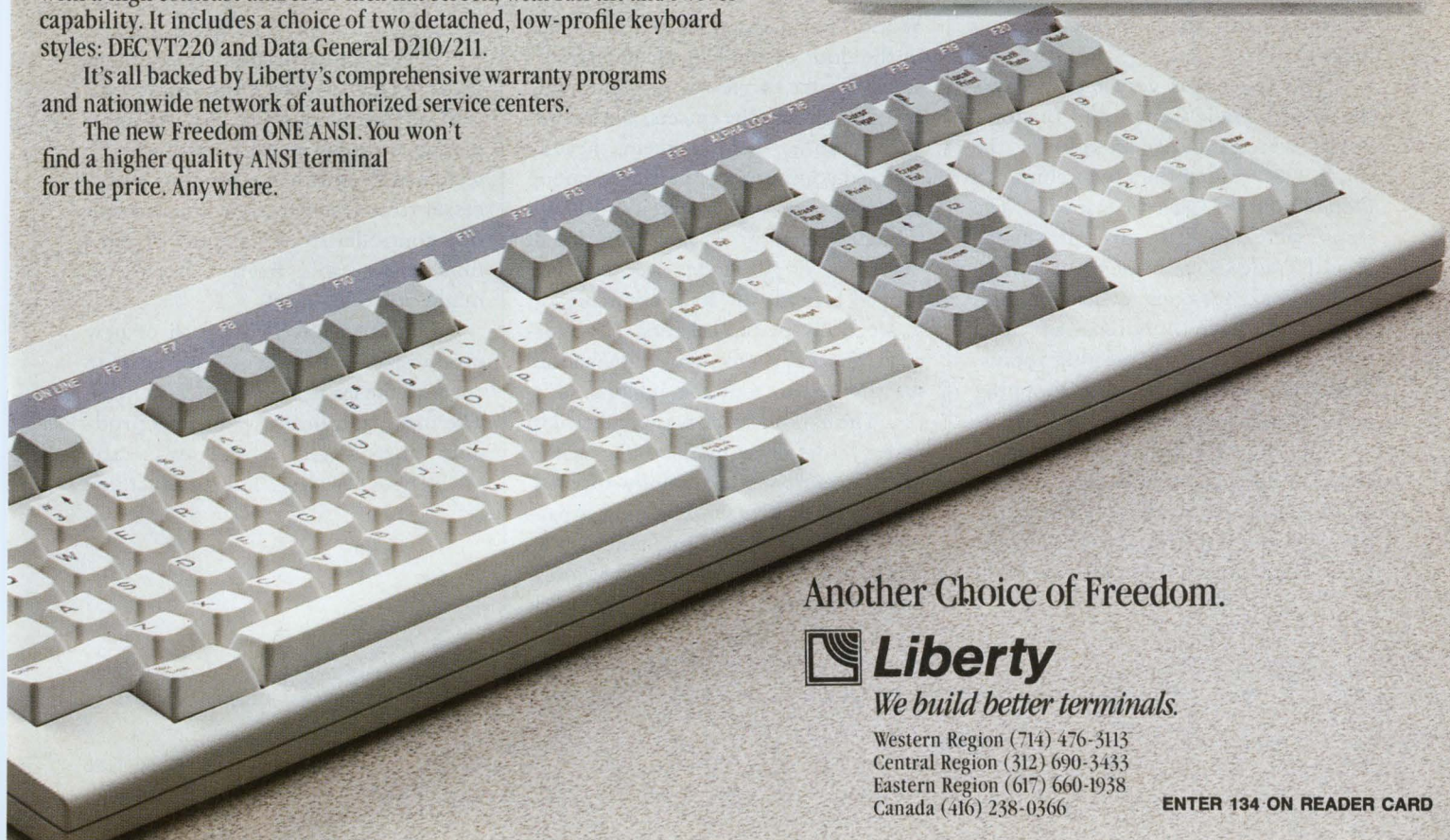

Another Choice of Freedom.



Liberty

We build better terminals.

Western Region (714) 476-3113
Central Region (312) 690-3433
Eastern Region (617) 660-1938
Canada (416) 238-0366

ENTER 134 ON READER CARD

DEC WATCH

Charles Connell

DECWORLD: Digital Scores The Big Win

DECWORLD was the best computer show ever staged and one of the best advertising events ever created. It displayed DEC's products and the corporation in a stunning light for customers, the media, industry pundits and the general public.

For the edification of DEC community members who may have been backpacking in the Andes during September, DECWORLD was a showcase of DEC's products put on by DEC itself. The two-week show overflowed Boston's World Trade Center and attracted 50,000 people.

DECWORLD was designed to promote DEC's sales force. They gave out most of the invitations to customers and potential customers, greeted the arrivals, shepherded them through the display areas, wine and dined them at night, and (hopefully) negotiated lucrative contracts with them in the meeting rooms.

The show was very big. Because the World Trade Center and Boston's hotels weren't large enough for the show, DEC rented the cruise ships S.S. Oceanic and the Queen Elizabeth 2. The ships were docked adjacent to the World Trade Center, one on each side, as floating extensions to the building. The ships have hundreds of hotel rooms, seminar space, meeting rooms, numerous restaurants, bars, shopping galleries and party venues.

DECWORLD also consumed every available hotel room in Boston, in spite of a major hotel building boom in the city over the last several years. People who didn't make reservations early

could only find rooms 30 miles outside the city.

Boston, not just the computer industry, went gaga over DECWORLD. The *Boston Globe* ran several features on the show in the weeks leading up to it. On the day it opened, DECWORLD occupied part of the first page and the entire front of the business section. A large, color cartoon on the first business page featured a giant, muscled Ken Olsen standing on top of his company headquarters. The caricature was using his sinewy arms to plug in the network that united DECWORLD. It's impossible to buy this kind of advertising.

As the show progressed, it received additional media coverage nearly every day. For two weeks in Boston, it was almost as chic to have a ticket into DECWORLD and the QE2 as it was to have been at Live Aid.

DECWORLD revolved around an exhibit hall on the lower floor of the World Trade Center. As visitors walked in the door of the hall, they entered a small theatre to view a 10-minute talk and slide show. The emcees, and the images flashing behind them, heavily stressed computer connectivity among different parts of a corporation. When the talk ended, green laser beams shot out of a large globe overhead and zapped around the hall, bouncing off strategically placed mirrors. The audience, hopefully agog with anticipation, was invited to tour the exhibits.

The exhibit space was organized in an easy-to-follow manner. The center of the room was technology-focused, with each display highlighting a particular product line. Some booths presented software development tools, others showed local area network capabilities. Some demonstrated DEC's largest systems, others the smallest.

The perimeter of the hall, on the other hand, was solution-focused, and these exhibits were unique. Most computer shows consist of booth after booth of glitzy technology. The bit-twiddlers love it, but anyone without a background in impedance matching or queuing theory is confused. DECWORLD, however, contained approximately a dozen industry-specific display areas. Each one held packaged solutions for particular problems faced by people in that industry.

Some examples: For the retail industry, two third-party vendors showed point-of-sale systems built around DEC processors. The demonstrations featured mockup stores, shelves of products and checkout counters that contain the point-of-sale systems. For the travel industry, a number of major airlines had working reservation systems that contained a DEC front end for a remote mainframe. If you wanted to, you could use them to book your flight home.

These demonstrations were unique because DEC displayed the entire solution to business problems. At most computer shows, a visitor needs enough technical knowledge to see how a processor from Category A, a communication controller from Category B and a fiber optic cable from Category C might solve his need.

DEC also unveiled a rash of new products and used the new products to enhance the excitement of DECWORLD. The most significant set of new products introduced there was the MICROVAX 3000 line. This product line

Managing people is harder than managing projects



If you have to do both, we'd like to show you

TRACKSTAR

**A new generation of project/resource
management software for the VAX.**

Managing projects and people.

We created TrackStar because you have to plan the work of people not just project milestones. Because you have to make commitments to many projects, not just one. Because you're part of a team, with responsibility up and down the line.

**With TrackStar you can
manage many projects at
once, and plan your people
resources right down to the
"key person."**

TrackStar — the *one* software
tool that will help you plan, sche-

ENTER 156 ON READER CARD

TRACKSTAR
from

The Project Management People!
**TB COMPUTING
AND
INC.**

1100 Eisenhower Place,
Ann Arbor, MI 48108
313-973-1900

dule, revise and document the people, the activities and the budgets it will take to bring all your projects in on-time. And let your people go home at night.

**Take a look, then give it a try
with our Special Trial
Installation Offer.**

To really understand and appreciate the power and capability of

TrackStar you need to use it yourself on your own projects on your own computer. To do this we have a low-cost 30 day trial installation offer.

Plus introductory pricing!

Take advantage of our special, introductory pricing, available for a limited time only.



Tell me more about TrackStar

Please send me your color brochure describing all of TrackStar's features and capabilities, plus information about your 30 Day Trial Installation and Introductory Pricing.

Name _____

Title _____

Company _____

Address _____

City _____ St _____ Zip _____

Phone (_____) _____

VAX model(s) currently in use: _____

Mail to: T and B Computing, Inc., 1100 Eisenhower Place, Dept. 7211
Ann Arbor, MI 48108

**DEC UNIBUS USER:
 CONVERT YOUR OBSOLETE
 PDP-11
 TO A POWERFUL '87 MODEL**

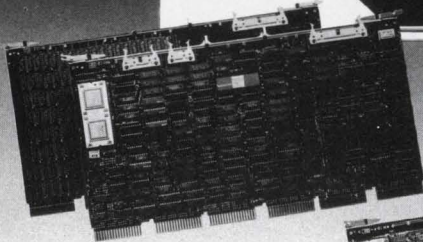
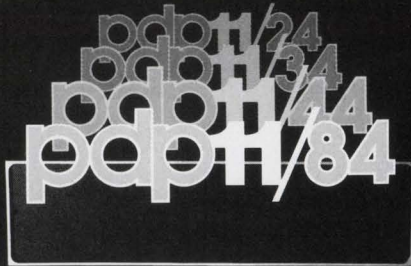

N1100 PLUS

- 4 Mbytes DRAM
- 8 KBytes Cache
- Hardware Floating Point
- Memory Management

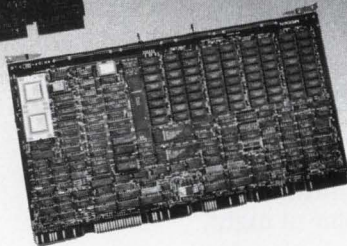

N1100

- 2 Mbytes DRAM
- Memory Management
- Serial Line Unit
- Universal Boot ROM

**J-11 POWER FOR OPTIMUM
 PERFORMANCE
 FITS ALL EXISTING CPUs —
 NO BACKPLANE CHANGE**

Call ED GRIFFIN for FREE PRODUCT INSTALLATION GUIDE
 (800) 233-1837 Ext. 370 In Calif. (714) 261-8811 Ext. 370

*UNIBUS *PDP *J-11 are registered trademarks of DIGITAL EQUIPMENT CORPORATION

NISSHO
 ELECTRONICS

17310 Red Hill Avenue, Suite 200, Irvine, California 92714 • FAX (714) 261-8819, TLX 181-308
 ENTER 207 ON READER CARD

is based on a new set of Complementary Metal Oxide Semiconductor (CMOS) chips that implement the MICROVAX instruction set. Emerging from this processor technology are two new computers (MICROVAX 3500 and 3600), three new processing servers for local area networks (VAXSERVER 3500, 3600 and 3602) and two new workstations (VAXSTATION 3200 and 3500).

The MICROVAX 3500 and 3600 probably will attract the most attention. They are based on the same Q-bus architecture as the popular MICROVAX II, but are expected to run three to four times faster. (The 3500 and 3600 differ only in their cabinetry and expansion options.) The machines will sell for base prices of \$74,800 and \$99,800, respectively.

What did customers think of DEC-WORLD? I interviewed a number of people on the floor and most were impressed. One customer commented on the amount of work he could get done in a short time at the show. He said that although he could see the same demonstrations at home, it would require dozens of separate meetings with DEC salespeople and third-party vendors. At DECWORLD, he could do six months' worth of product reviews in an afternoon.

Another attendee said that he was getting valuable ideas about how to apply new technology at his company. He had looked at the automated assembly line in the manufacturing area, and was thinking of using some of those methods in his company's manufacturing plants.

The only negative comment I heard was from a pair of customers who were frustrated by the lack of technical knowledge of the people running the display booths. These customers complained that whenever they asked a question beyond the canned demos, the person staffing the booth didn't know the answer. This criticism appeared to be an unusual case, however, compared to the many positive impressions.

All in all, DECWORLD was a winner for Digital.

SYSTEM NAVIGATION

IMPROVED USER PRODUCTIVITY • REDUCED TRAINING COSTS

Traverse is a clean, simple interface that integrates any or all of the activities on a VAX/VMS system. This software allows applications, utilities, DCL commands and inhouse development to be incorporated into a cohesive user environment.

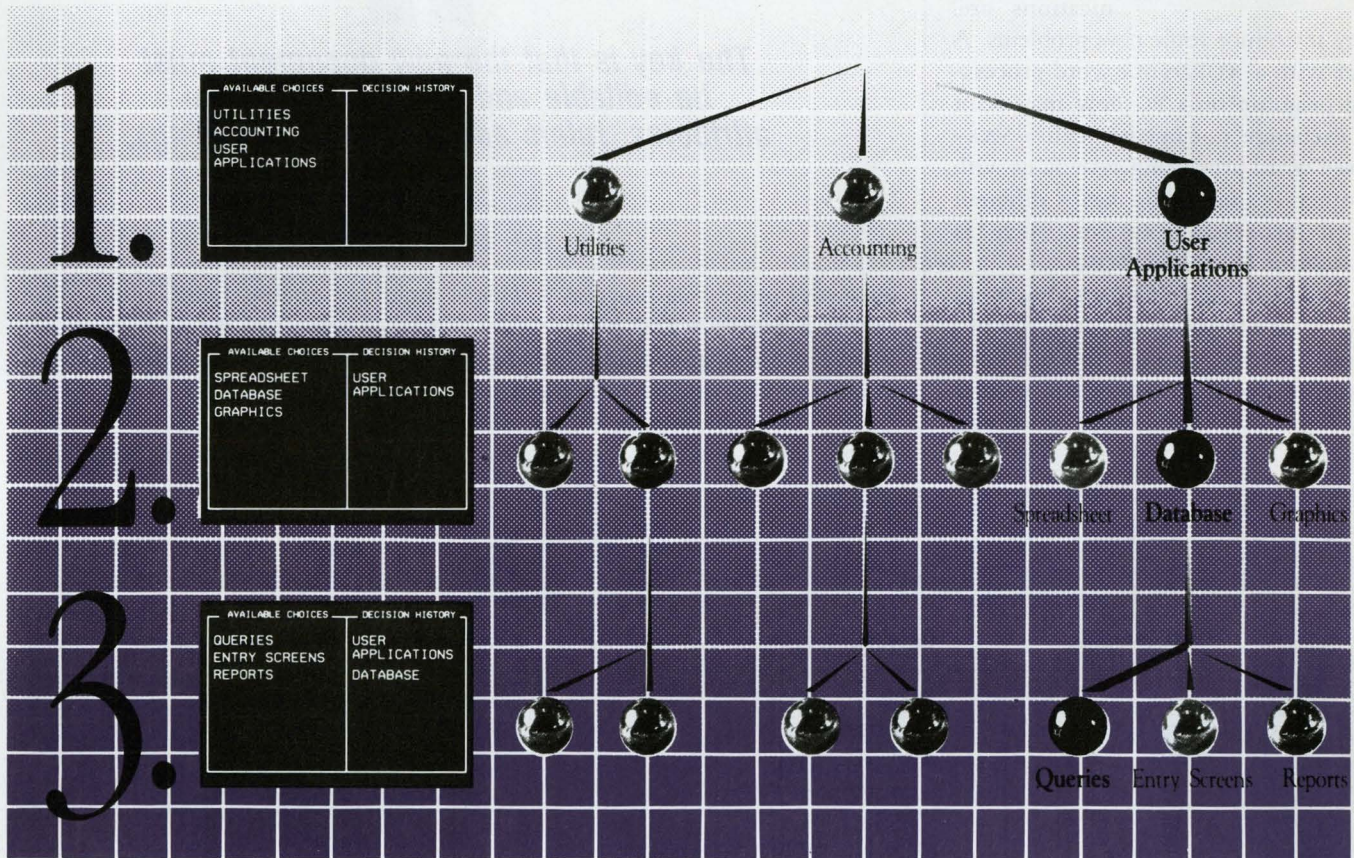

Using Traverse simply involves defining Nodes (activities) and Paths between nodes (relationships between activities). In this way, any activity that can be performed using DCL can be built into a screen driver system.

BENEFITS:

- Reduced training costs
- Less user frustration
- Higher productivity
- Speaks the user's language
- Flexible & expandable

CALL (403) 250-1266

VISITECH

ENTER 217 ON READER CARD

VISITECH GRAPHIC RESOURCES INC.
3115 12th St. N.E., Calgary, Alberta T2E 7J2

VAX and VMS are trademarks of Digital Equipment Corporation. Traverse is a trademark of Vistech Graphic Resources Inc.



FROM THE LAB

Carl B. Marbach

Keyword's *KEYPAK*

As wonderful as connectivity and communications are, they introduce some new problems. A user with a *WORDSTAR* word processing program on a PC now may want to exchange documents with a VAX-based word processing system, or with another PC user who has a different word processing system, such as *SAMNA* or Microsoft *WORD*.

Exchanging documents always has been possible using an ASCII file between the two systems. You first convert from word processing to a regular ASCII (print) file using word processing program A, then convert the ASCII file

into word processing program B. This approach usually works because most word processing applications include a utility for translating into and out of ASCII. The problem is that using this process loses attributes (underlining,

bolding, double underlining, rulers, etc.). There's also the problem of hard carriage returns, hyphenation and pagination.

Real document translation must move "editable" documents, including all attributes and page parameters, from one system to another. The key is that the new document must be editable and include all special attributes, rulers and pagination markings. There often will be incompatibilities among different systems; for example, some won't support double underlining and the translation then must make some reasonable conversion.

Document translation should be used when:

1. You want to edit another person's document and he's using a word processing system different from yours.
2. You have a PC at home that uses a different word processing system from the one on your VAX at the office.
3. You want to edit a document you created when you were using that old word processor that's no longer on the VAX.
4. A friend at another installation is going to edit your work but he has a different word processing system from yours.
5. You don't want to make everyone in

The key is that the new document must be editable and include all special attributes, rulers and pagination markings.

T A B L E 1 .

Mnemonic	Document Type
AF	ASCII
DC	DCA/RFT
DX	WPS-Plus (DX)
IP	DisplayWrite 2/3
M1	MASS-11
MCMW	Microsoft WORD (Macintosh)
MM	MultiMate
MW	Microsoft WORD (PC)
ND	Navy/DIF
OW	OfficeWriter
Q1	Quadatron Q-ONE
SA	SAMNA
WC	Wang PC
WF	Wang Flat
WP	WordPerfect
WS	WordStar
XF	XF Xerox Flat (Xerox 860)
XW	Xerox (Writer II, III)

KEYPAK supports many different types of documents, each of which is identified with a mnemonic.

your office use the same word processing system just for compatibility sake; the secretary needs a simple system and the engineers need equation capability.

6. You're converting from a standalone system to shared word processing on the VAX.

7. A remote office has a standalone system and they want you to archive their documents on the VAX.

8. You'll be working in a different office for a short time and you want to take some documents with you, but they use a different word processing system from yours.

KEYPAK To The Rescue

Keyword Office Technologies in Calgary, Alberta, Canada, distributes *KEYPAK*, a document translation program for the VAX. We tested the product on our Lab's VAX 750 using

Microsoft's *WORD* and Microsystems Engineering Corporation's *MASS-11*. We found the product easy to use and able to do the job.

KEYPAK is delivered as a VMS executable image and is ready to run. The program, *KW.EXE*, operates like any other DCL command, once the logical has been installed.

Converting a Microsoft *WORD* document that exists on a Macintosh to a VAX-based *MASS-11* format was straightforward. First we transferred the *WORD* document to the VAX (using a basic file transfer utility), making sure that all eight bits were transferred. This required that the terminal line be configured for */EIGHTBIT* and */PASSALL* and that the transmission protocol understood that the data is eight bit. Note: Since the file may contain some strange characters, pretending that the file is binary is a good idea. This way

the transmission protocol simply will transfer everything, including *CNTL-C* or *CNTL-Z*, that it finds in the file.

Once the *WORD* file was on the VAX, we used the command format:

```
KW <source id code >
  <destination id code >
  /Source = filename
  /Target = filename
  /log = filename
```

Thus our transfer was:

```
KW MCMW M1 /S=MWD.DOC
  /T=MASS.DOC /L=LOGFILE.OUT
```

or

```
KEYPAK from Microsoft WORD to
MASS-11 with the source (WORD) file
called MWD.DOC, and the output
```

FOR THE VAXmate • IBM PC • XT • AT • PS/2

WPS-PC

- Spelling checker with 60,000 word dictionary.
- DX and AX serial communication.
- List processing with SORT.
- Document transfer to WPS-PLUS/VMS and ALL-IN-1.
- Convert documents to other word processors.

DECmate STYLE WORD PROCESSING

WPS-PC gives you familiar Gold-key style word processing on the IBM PC and compatibles. Maintain your investment in DECmate training and DECmate documents and still move to the IBM PC. Read and write your DECmate II or III document diskettes in the 1.2MB drive of a PC AT or transfer the DECmate documents to any PC using DX communications.

\$275

PLUS \$3.75 SHIPPING

See us at
DEXPO West '87
Booth #558.

Designed for fast response on a minimum configuration of 128KB of memory and two floppy diskettes; runs on hard disks as well ■ VT-102 terminal emulation and CX communication ■ Supports over 50 popular serial and parallel printers, including the LN03 and the HP LaserJet ■ Distributed on 5¼ and 3½ inch floppy diskettes ■

Call for information on a demonstration system. Dealer inquiries invited. Educational discounts available.

IBM PC, XT, PS/2 and AT are trademarks of IBM Corp. WPS-PC and WPS-DOS are trademarks of Exceptional Business Solutions, Inc. VAX, VMS, WPS-PLUS, VAXmate, ALL-IN-1, DECmate and RAINBOW are trademarks of Digital Equipment Corp. HP LaserJet is a trademark of Hewlett Packard Corp.

**Exceptional
Business
Solutions Inc.**

10811 Washington Blvd.
#240 • Culver City • CA
90232-3658
213/558-3435

WPS-DOS

FOR THE RAINBOW

ENTER 120 ON READER CARD

Norm De Nardi Presents:

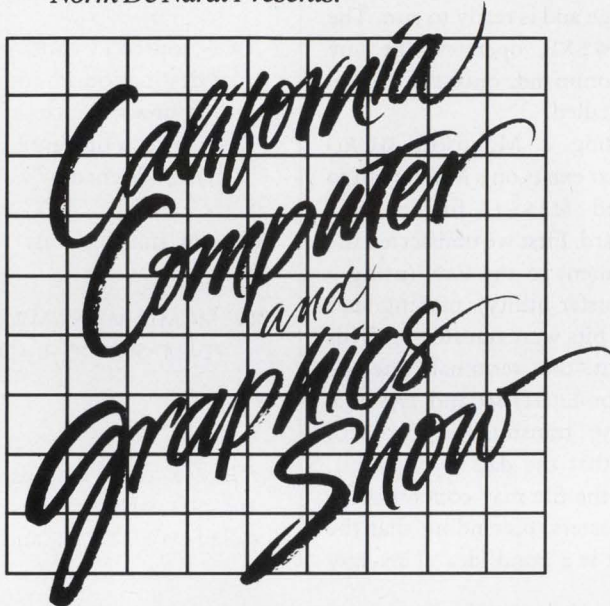

The only Computer and Graphics Show in California that highlights technology for the OEM, systems integrator, software and hardware designer.

... attention Aerospace and Defense Contractors!

Held right here in Silicon Valley, this one day show gives you the opportunity to meet today's industry leaders and tomorrow's innovators who can furnish you with solutions to your hardware and software needs.

Exhibit Features:

- Graphic Displays & Controllers
- Supercomputers
- Workstations
- UNIX
- Desktop Publishing
- CAD/CAM
- Printers/Plotters
- Imaging Systems & Controller Boards
- Software
- Artificial Intelligence

WHEN! Dec. 3, 1987 12 P.M.-6 P.M.

**WHERE! Palo Alto Hyatt Hotel
4290 El Camino Real
Palo Alto, CA**

Update your calendar now.

Call or write Norm De Nardi Enterprises for your free invitation, 289 S. San Antonio Rd., Suite 204, Los Altos, CA 94022, (415) 941-8440.



I'll Be There! Please send me an invitation to the California Computer and Graphics Show, Dec. 3, 1987. My interest is: Computers Peripherals IBM Graphic Displays UNIX DBC VME Workstation CAD/CAM H.R.

Data Communications

Name _____ Title _____
 Company/Division _____
 Address _____ City _____
 State _____ Zip _____
 Phone _____

NDN Enterprises 289 So. San Antonio Rd., Suite 204
 Los Altos, CA 94022 (415) 941-8440



(target file) to be MASS.DOC and write a log file called LOGFILE.OUT.

In our Lab tests, **KEYPAK** translated a large 120,000-character document with a CPU time of 6:25, a little more than 300 characters per second (about 3600 baud). A smaller document processed approximately 500 characters per second, demonstrating that there are complexities in translations beyond just handling pure characters. If your document has many rulers, centered words, underlining and a lot of bolding, then translation can take longer. If you want to know how much text 120,000 characters is, think of a page with 66 lines of 72 characters (every space filled with a let-

ter), and multiply by 25. It would take 25 completely filled pages to equal 120,000 characters.

Once the file has been converted and MASS.DOC exists, it must be entered into your **MASS-11** directory using the Utilities menu. Our test document converted properly, but the

PAGE/PRINT attributes were set improperly for our configuration and weren't set to the default. Therefore, the output didn't work correctly on our laser printer. Changing the PAGE/PRINT settings to our regular ones, however, provided the fix. We then converted a complex document with a lot of under-

KEYPAK

Keyword Office Technologies Ltd.
2816 Eleventh St. N.E.

Calgary, AB Canada T2E 7S7
(800) 661-8161
(403) 250-1770

Entry level system price: \$2,000
(includes server and any two modules) for MICROVAX, VAX 11/725, 11/730. Additional 15 percent annual maintenance fee. Successive modules — \$2,000 each.

Top level system price: \$15,000
(includes server and any two modules) for VAX 8800, 8900. Additional 15 percent annual maintenance fee. Successive modules — \$6,000 each.

ENTER 483 ON READER CARD

WORD

Microsoft
10700 Northup Way
Box 97200

Bellview WA 98009
(800) 426 9400

ENTER 485 ON READER CARD

MASS-11

Microsystems Engineering Corp.
2400 W. Hassell Rd., Ste. 400
Hoffman Estates, IL 60195

(312) 882-0111

ENTER 484 ON READER CARD

Quantum RS

The flexible VAX* resource accounting and chargeback solution.

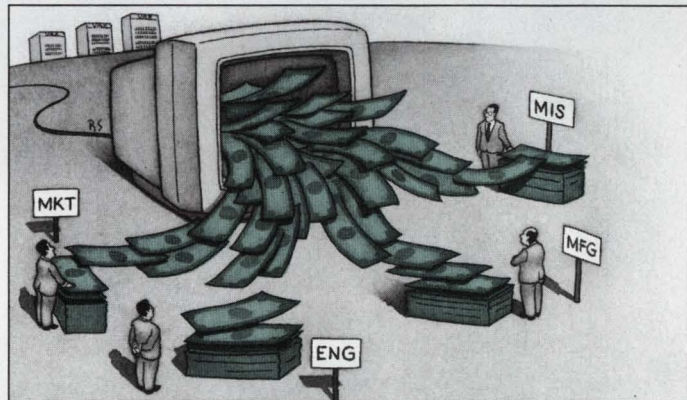

Quantum RS is a powerful system management tool whether your need is ■ Chargeback/Cost Allocation ■ Project/Department Accounting ■ Network/Cluster Accounting ■ Capacity Planning ■ Report Generation

- Establishes rate schedules for nodes, accounts, projects, departments, users, terminals and user-defined entities.
- Offers project and department level accounting without traditional VMS* accounting limitations.
- Operates in single or multiple VAX environments from a central database whether the nodes are connected via DECNET*, Ethernet, in a cluster or any combination of methods.

Quantum RS is the easy-to-use software package that offers the VAX manager a complete solution to resource accounting!

Free Demonstrations Available. Call TOLL-FREE 1-800-232-5215, in Massachusetts or outside U.S. call 617-848-7515, or return the coupon for details.

Computer Information Systems, Inc.
165 Bay State Drive, Braintree, MA 02184 U.S.A., 1-800-232-5215.
In Massachusetts or outside U.S., 617-848-7515. Telex 9102500738 CIS INC

DP8711

Computer Information Software, Ltd
Yeomans Court, Ware Road, Hertford SG13 7HJ England, (0992) 500006

Attached is my business card or letterhead.

I would like more information about:

- VAX Chargeback VAX Resource Utilization
 VAX Performance Monitoring Number of VAX Systems _____



COMPUTER
INFORMATION
SYSTEMS, INC.

*VAX, VMS, and DECNET are trademarks of Digital Equipment Corporation.

ENTER 111 ON READER CARD

BORN BRILLIANT



Introducing
PHANTOM™
The First
INTELLIGENT
DMA Controller
From Multiware

Name: Phantom.

Mother: Virtual memory disk. *Father:* DMA controller.

DEC Family: Runs on PDP-11's and MicroVAXes with Q-Bus.

Character: High real-time data transfer rates without CPU intervention.

Brief Description: Highly capable. Peripheral I/O processor with parallel and serial ports, DMA engine, and VMS virtual disk software.

Speed: Fastest available — call for details.

Immunized against: I/O bottlenecks, disk "data late" errors.

Siblings: 1 brother and 2 sisters under development.

Doctor's Comments: "I've delivered a lot of babies, but I've never seen one like this before . . . It's phenomenal!"

Time of Birth: Shipping December 1, 1987.

More Information: Call us for a full pedigree at 1/800/522-0202.



MULTIWARE
INCORPORATED

2121 Second St., Building B, Suite 107
Davis, California 95616
In California call 916/756-3291

INNOVATION AT WORK

ENTER 221 ON READER CARD

See us at Dexpo West, Booth #2040

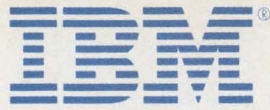

Who says you have to pay extra to get an ASCII terminal equipped with these three letters?

Introducing the new family of IBM 3151 ASCII displays.

Now you can have the most versatile ASCII terminals IBM has ever made, for the lowest price IBM has ever offered. Our new 3151 family gives you more functions, and greater compatibility with more ASCII host system computers, for single unit purchase prices starting at less than \$400* per terminal.

Three models and up to 16 emulations make them flexible.

The entry level Model 110 comes with 10 non-IBM emulations built in, and provides an 84-key keyboard with 12 definable function keys.

The full-function Models 310 and 410 come with 11 emulations, and are easily capable of more (such as DEC VT220/100/52™ and WYSE WY-50/50 +™) by simply adding a new low-cost, slimline cartridge.

Their 102-key keyboards, equipped with up to 36 definable function keys, are also recappable, so you can adapt them to fit just about any program.

We worked harder to make them easier to use.

Besides being designed for compatibility with other computers, IBM's new ASCII terminals are more compatible with people.

New 14" flat screen displays provide a non-glare viewing surface and smooth scrolling. Our 310 and 410 models also offer a choice of 80 or 132 column displays, with crisp character resolution, in green or amber-gold.

What's more, we built the logic into the monitors, making all three models more compact and more reliable.

However, the most important feature of our new displays isn't on the screen, but above it: the IBM name. IBM provides not only a choice of a one or three year warranty, but a tradition of quality, service and support.

It's no wonder these three letters have come to symbolize so much to so many people. And at these prices, they'll be even more in demand. For additional information, contact your IBM Marketing Representative, or call 1-800-IBM-2468 for a supplier near you.



Model 310

Model 410

Model 110

* Prices subject to change without notice.

© IBM 1987. IBM is a registered trademark of the IBM Corporation. DEC VT220/100/52 are trademarks of Digital Equipment Corporation. WYSE WY-50/50+ is a trademark of WYSE Technology.

lines and many rulers, and it worked perfectly in *MASS-11*.

KEYPAK is distributed with only the conversion modules needed. Conversion routines are stored in object modules that are contained in a VMS object library. Using the VMS *LIBRARIAN*, object modules can be

added or removed.

The user can customize the translation using *KEYPAK*'s configuration control. While *KEYPAK* has optimized the configuration for the majority of conversions, users can modify source, target and character definitions. For instance, some word processors have a special

ruler tab that allows all tab spaces to be represented by dots. Thus:

```
xxxxxx(tab).....YYYYY
```

If your target word processor doesn't support this construct, you can translate to:

```
xxxxxx.....YYYYY
```

which has no tabs, or

```
xxxxxx(tab)    YYYYY
```

which has a tab, but no dots.

The configuration parameters in *KEYPAK* allow you to modify decisions made by the defaults. By using the configuration option, users can customize most conversion parameters to match their own needs.

Other Keyword Products

KEYPAK + 1 is an *ALL-IN-1* user interface for the VAX conversion software. *KEYPAK + 1* includes electronic messaging of external files, like documents on workstations or from spreadsheets. It uses the standard *ALL-IN-1* interface and includes *GOLD* key support and *HELP* facilities. *ALL-IN-1* users will need little or no training in the use of *KEYPAK + 1*.

Keyword also produces a PC version of the conversion software called *SOFTPAK*. This software is customized to run on a PC and will convert among different word processors. *KEYWORD COMMANDER* is a complete menuing and command processor for the PC.

In addition, Keyword markets complete PC-based systems for doing document exchange. Some of these systems include 8-inch as well as 5¼-inch and 3½-inch floppy disks. The *KEYWORD 7000 System* includes a 5¼-inch 48-TPI floppy, a 5¼-inch 96-TPI floppy and two 8-inch 48-TPI floppies. The new *KEYWORD 8000 System* also can include 3 1/2-inch diskettes for Macintosh, Data General, PC portables, HP 150, Grid Computers, Toshiba and others. ■



Presto!
**A Link to
Mainframe
Graphics**

EMU-TEK Seven Plus Graphics Terminal Emulation Software

Compatible—works with virtually all 4107 compatible programs. *PATRAN*®, *UNIRAS*®, *REACCS*® and *DI-3000*® are just a few.

Sensible—adds versatility to your PC-based workstation. The PC you use for word processing or spread sheets can be used as a graphics terminal, too.

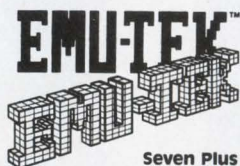

ENTER 122 ON READER CARD

FTG DATA SYSTEMS

(714) 995-3900 (800) 962-3900 (800) 972-3900 (Calif.)
10801 Dale St., Suite M-2, P.O. Box 615
Stanton, CA 90680 Telex: 887840

Affordable—at \$695, our 4107 emulation software is the cost-effective way to link a PC to host computer graphics.

Reasonable—find out how our whole family of graphics terminal emulation software makes good sense for the work you do. Call today for more information.

DI-3000 is a registered trademark of Precision Visuals, Inc., PATRAN is a trademark of PDA Engineering, REACCS is a registered trademark of Molecular Design, Ltd., and UNIRAS is a trademark of UNIRAS, Inc.

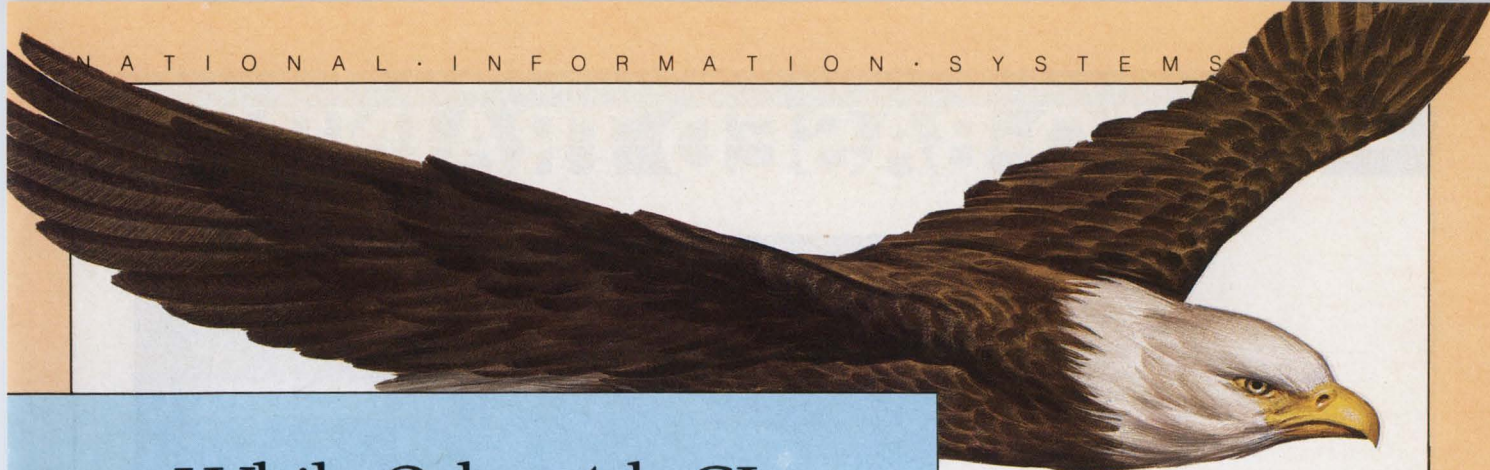

While Other 4th GLs Make You Crawl Through Programming, ACCENT R® Lets You Fly.

ACCENT R gets your VAX/VMS multi-user production applications off the ground fast.

The reason: Speed.

ACCENT R is actually much more than a 4th GL and RDBMS. It's a Total Applications Development Environment providing complete control.

For you, this means a product that finally breaks the language barrier. Simply, you'll never revert to Cobol, Fortran, or C again.

You take advantage of ACCENT R's powerful and efficient programming language. One that features "Application Models"—a unique framework for

dramatically reducing programming time; a full complement of debugging tools; error and syntax checking; and intuitive commands for prototyping and developing sophisticated applications.

ACCENT R even delivers custom reports, data entry and display forms, and menus; all without coding.

Still, that's not the only reason why applications developed in ACCENT R take wing. ACCENT R generates compiled code and is optimized for VAX/VMS environments.

So your resulting multi-user applications can run as much as forty times faster than interpretive systems.

Better yet, ACCENT R even provides upward mobility for existing applications. That's because ACCENT R can use VAX RMS files.

Which means you can easily expand without redesigning your application or re-loading your data.



Fact is, ACCENT R will keep your applications flying for years. It's no surprise that FORTUNE 1000 companies, government agencies, and universities have chosen ACCENT R for developing their full-blown applications.

That's why you should call National Information Systems at (408) 985-7100 for more information. After all, why crawl through programming when you can now fly?

ACCENT R®
408-985-7100

National Information Systems, Inc.
1190 Saratoga Avenue
San Jose, CA 95129

ENTER 219 ON READER CARD

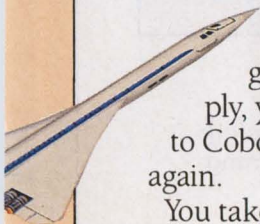

VIDEO-BASED TRAINING

For Your Free
Demonstration Package,
or courseware catalog, call:
(800) 323-8649
or
(312) 987-4084

COMPUTER TECHNOLOGY GROUP

Telemedia, Inc.

310 S. Michigan Ave.
Chicago, IL 60604

In Europe:
Bush House, 72 Prince St.
Bristol BS1 4HU
Telephone: (0272) 290651

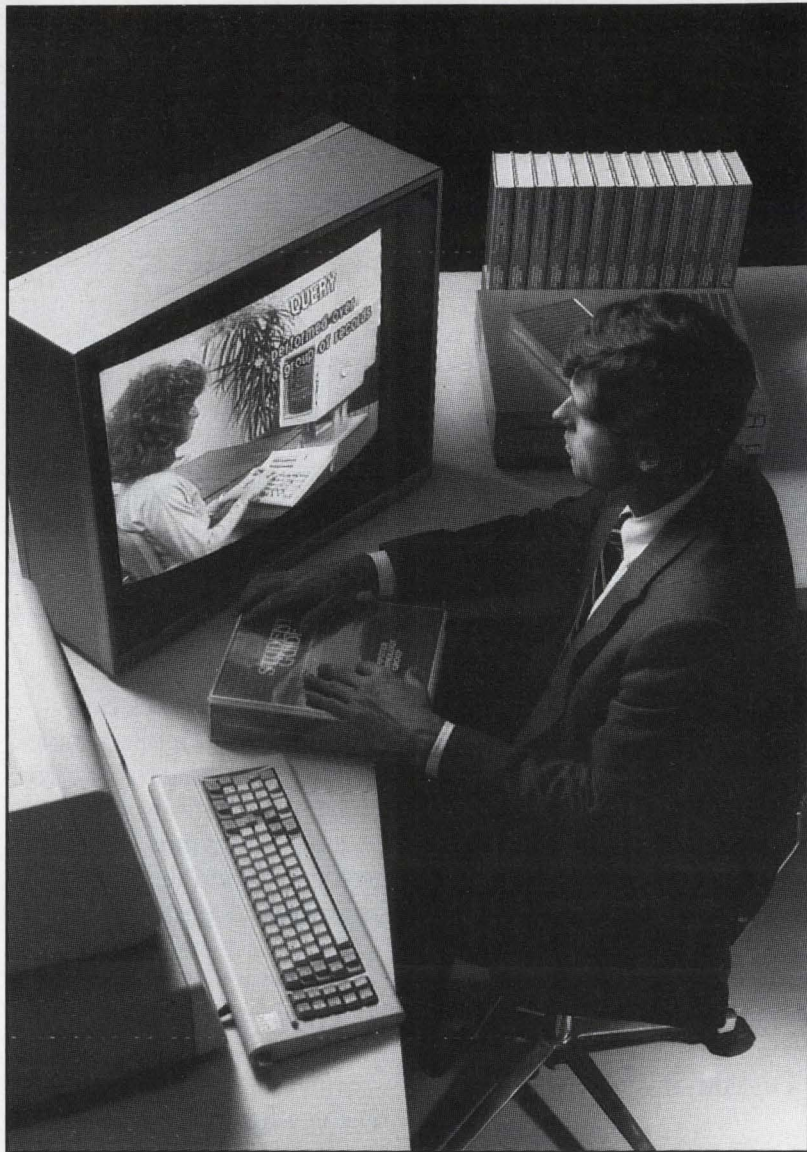

DEC

VAX/VMS for Programmers
VAX/VMS for Users

PC

PC Primer
MS-DOS
Lotus 1-2-3
dBase III
dBase III Plus
R:Base 5000
Enable
Multimate
Multiplan
Symphony
Displaywrite
Word Perfect

'C' Language

'C' Language Programming
Advanced 'C' Programming

UNIX®

UNIX Executive Perspective
UNIX Overview
UNIX Fundamentals for
Programmers
UNIX Shell
vi Editor
UNIX System V Internals

professional press publications

Professional Press launched the DEC-specific publishing industry in 1979 with the publication of its first DEC magazine RSTS PROFESSIONAL.

Today Professional Press offers two DEC-oriented publications and a third, geared to the Hewlett-Packard marketplace. Plus two important texts for computing pros who want to learn about C language and VAX/VMS.

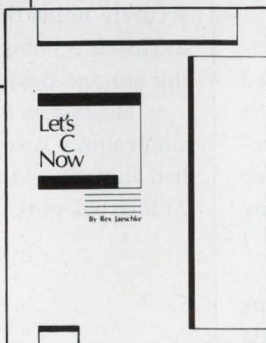
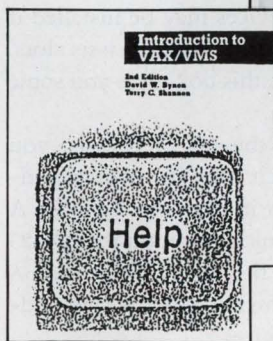

DEC PROFESSIONAL

The largest circulation DEC publication in existence — 100% buyer qualified* and dedicated to improving staff and equipment performance at DEC installations.

VAX PROFESSIONAL—The Software Journal for VMS

This bimonthly publication is the only technical journal dedicated solely to the users of VAX/VMS. It's the source of practical advice on how to write better software and make better use of the hardware on every VAX system — from the MicroVAX to the 8800.

HP PROFESSIONAL

A monthly magazine written for professional users and managers of Hewlett-Packard's business/commercial and technical computer systems. With 30,000 buyer qualified-subscribers, it offers by far the largest and most clearly targeted circulation in its marketplace.

INTRODUCTION TO VAX/VMS

This self-teaching text explains and illustrates how to use VAX/VMS systems. Easy to learn for the computing novice . . . an excellent reference for VAX/VMS pros. Covers the basics and teaches systems and programming as well. plus glossary and appendices.

Author: Terry Shannon. Updated and revised by David Bynon.

LET'S C NOW

A complete guide to learning C language in two volumes. Over 300 pages in 26 chapters in a self-instructing workbook format. All the information needed to become proficient in C. Plus chapter summaries, glossary and author, Rex Jaeschke's hints and suggestions.

PROFESSIONAL
press

*June 1987 BPA Publisher's Statement, May issue analyzed.

For More Information Call (215) 542-7008



FROM THE LAB

David W. Bynon

TRIMM Industries' DA 123 Cabinet

There comes a time in the life of a MICROVAX when it must

be upgraded. These upgrades come in the form of more memory, new or additional storage systems, cartridge tape drives, serial port controllers, and so on.

For the BA 123 "world box" MICROVAX II owner, this isn't much of a problem. The BA 123 chassis has enough space to house five 5¼-inch storage peripherals and plenty of power to run them. The BA 23, pedestal, chassis, however, doesn't provide you with this luxury (unless you convert to a rack-mount system). Space for two storage peripherals and too few I/O panels leaves little, if any, growth path.

TRIMM Industries recognized this

problem. Already having a strong presence in the MICROVAX market, TRIMM came out with its DA 123 series of MICROVAX cabinets. The DA 123, as its name implies is a world box cabinet, like

for the Digital BA 23 chassis. The idea behind this cabinet is brilliant; the left half of the DA 123 expansion cabinet is used to house the BA 23 chassis, and the right half provides mounting space for



To install the BA 23 chassis, you simply remove it from its original pedestal and slide it into the DA 123.



the Digital BA 123. The likeness, however, is only in appearance.

TRIMM DA 123 systems are built around two base models: an integrated expansion cabinet and a full system chassis/cabinet. Many custom configurations can be created from these basic designs. For this Lab test, I ordered both DA 123 models with an assortment of peripheral mounting hardware.

When the cabinets arrived, I was surprised to discover their combined weight to be almost 400 pounds. These are heavy-duty plated steel cabinets; you won't find any plastic. The finish exactly matches the DEC equipment. All exterior surfaces are painted in a durable, textured enamel.

The DA 123 cabinets have removable front and side panels, and a hinged rear door for access to the I/O panels. It takes some time to get the knack of removing and replacing the front and side panels but, once learned, access to any system component takes seconds. I found this ease of access a big plus.

The first unit I tried was the expansion cabinet, designed to be an upgrade

additional storage devices and a power supply. The brilliance of the design is that the BA 23 chassis isn't modified, it thus remains warranty and DEC Field Service eligible.

The DA 123 expansion cabinet provides mounting space for as many as four 5¼-inch devices or one 5¼-inch device and two 8-inch drives. A total of six 5¼-inch devices may be installed if you use the original BA 23 chassis slots. Needless to say, this box gives you some growing room.

To install the BA 23 chassis, you simply remove it from its original pedestal and slide it into the DA 123. A special mounting bracket on the DA 123 securely holds the BA 23. Once the BA 23 chassis is bolted in, you can start adding storage devices.

The system I used to test the expansion cabinet was a perfect candidate. It had an RX50 and an RD54 in the two BA 23 internal slots, and a TK50, RD53 and

DA 123 Cabinet

TRIMM Industries Inc.
11939 Sherman Rd.
North Hollywood, CA 91605
(818) 983-1833
Price: Configurations from \$895 to \$3,000

ENTER 436 ON READER CARD

Maxtor 4380

Maxtor Corporation
150 River Oaks Pkwy.
San Jose, CA 95134
(408) 842-1700

ENTER 455 ON READER CARD

RQDX Signal Distribution Board

Zoltech Corporation
7023 Valjean Ave.
Van Nuys, CA 91406-3997
(818) 780-1800

ENTER 437 ON READER CARD

Empress

the High Tech RDBMS Now with full remote update



Discover It!

Other RDBMS vendors are claiming full distributed functionality, but delivering "read - only remote."

EMPRESS Version II gives you full remote update single or multi-database distributed operation on such popular networks as NFS, DecNet and the Apollo Ring, with two-phase commit protocol to guarantee database integrity in the event of system failure.

Now for the first time, you can really optimize systems/network resources.

And that's not all.

In conjunction with our Bulk datatype, User Defined Functions allow you to store *any* type of data (in effect you can create new data-types) as well as design and integrate your own customized operators into EMPRESS. It's that flexible.

In addition, EMPRESS Version II provides Referential Integrity and the ability to update through complex views, as well as many enhancements to our powerful

application development tool M-Builder.

With its built-in adaptability and open architecture, EMPRESS dispels the myth that a commercially available RDBMS can't handle such high tech applications as CAD, voice and photogrammetry. It can, and does, and is currently available on most UNIX Systems as well as VMS and DOS.

Call us today for more information.

Empress

The High Tech RDBMS

Rhodnius

Rhodnius Incorporated

250 Bloor Street East, Toronto, Ontario, Canada M4W 1E6

Tel: (416) 922-1743 Fax: (416) 922-0162

*UNIX, VMS and DecNet, NFS, and Empress, are trademarks of AT&T, Bell Labs, Digital Equipment Corporation, Sun Microsystems, Inc. and Rhodnius Incorporated respectively.

ENTER 151 ON READER CARD

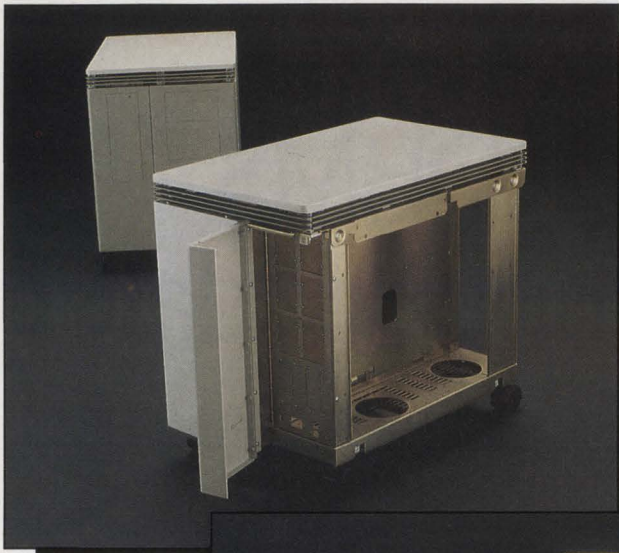

The expansion cabinet takes a BA 23, which resolves any DEC-related service issues.



This model is equipped for 8-inch drives.



The DA 123 has a TRIMM-supplied backplane and shelving to hold four 5¼-inch drives.

Maxtor 4380 in individual external boxes. It was a sloppy situation that I was forever griping about.

Fortunately, all of the cables to the external storage devices were long. This saved me from having to make new cables, and it made the installation painless. I simply had to remove the devices from their individual cabinets, screw on the TRIMM slide mount brackets (DEC compatible I might add), and route the cables. The total conversion took about two and a half hours. The result is a neatly integrated MICROVAX system in a handsome cabinet. With the original

BA 23 control panel and RX50 showing in front, it looks like it's an original DEC system.

In addition to providing space and power for more storage devices, the TRIMM boxes have a DEC-compatible, hinged I/O panel (optional on the DA 123 expansion cabinet). The panel provides 50 percent more space for I/O cabinet kits than the BA 23. This was great news for me, because I was having to buy special remote mount cabinet kits for the DHVs.

The second cabinet was not as easy to build as the expansion cabinet, although it turned out to be a fun project. This DA 123 cabinet is designed for

the OEM or systems integrator. It's a beautiful piece of craftsmanship that includes an eight-slot Q22/CD backplane and card cage, 540 watt power supply, CPU front control panel, fans, circuit breaker, and an assortment of 5¼- and 8-inch storage device mounting possibilities.

The card cage and backplane are mounted on a hinged door, which makes working on the system a breeze. Additionally, this door serves as a radio frequency interference (RFI) seal. I liked this feature very much, even though I had to make longer cables for every circuit board in the system. It took a full day to size and make up the cables. The end result, though, was worth the time spent. It turned out to be neat and professional. The ribbon cable guides and stays, built into the card cage, were a blessing.

To keep the use of my RDxx and RX50 drives, I had to find an RQDX distribution board. On the Digital BA

Software AG's VMS Product Family.

ADABAS: flexible, high-performance data base management

ADABAS is a relational-oriented data base management system (DBMS) uniquely designed to fully utilize the power of VAX architecture and the VMS operating system. ADABAS features a modular design, and is written in VAX Macro to maximize the benefits provided by the VMS operating system within the VAX architecture, and to ensure efficient usage of computer resources (I/O, CPU, and disk space).

NATURAL: advanced 4th Generation applications development technology

NATURAL combines all the components necessary to implement sophisticated, practical applications in the high-volume production environments of both VAX and IBM users. NATURAL allows for data entry, data manipulation, ad hoc queries, development and editing of programs and forms, report generation, library management, and security systems. This integration of functions in one, easy-to-learn technology significantly enhances programmer productivity, while reducing application development time by up to 90%.

PREDICT: integrated, active data dictionary*

PREDICT is an online, interactive data dictionary which serves as the focal point of Software AG's advanced information management and applications development system. Fully integrated with ADABAS and NATURAL, PREDICT actively defines and documents the format and nature of data in ADABAS and its usage in NATURAL and ADABAS SQL applications.

SUPER NATURAL: interactive applications generation for end users*

SUPER NATURAL is an integrated, menu-driven, and easy-to-learn system that allows novice users—as well as experienced ones—to generate inquiries and reports, manipulate data, and create and maintain user files, making easy work of applications development.

NET-WORK: powerful communications for distributed processing*

NET-WORK meets the complex communications needs of VAX and VAX/IBM environments, allowing transparent access to, and update of, remote data residing in ADABAS data bases on VAX or IBM processor nodes. NET-WORK supports a wide variety of communication protocols used within VAX environments and between Digital and IBM systems.

And all of these tools can be presented to the VMS user through simple menus, using Software AG's "WORKBENCH" technology.

Just another way in which Software AG delivers the Digital Advantage.

For a free color brochure on the Software AG VMS product family, call toll-free: 1-800-843-9534
(In Virginia and Canada, call 703-860-5050)

ENTER 241 ON READER CARD

*New for VAX users in 1987

 **SOFTWARE AG**
PROGRAMMING BUSINESS SUCCESS

23, the distribution board is mounted to the rear of the backplane. While I could have used the BA 23 distribution panel for this Lab test, I decided to search for an OEM solution. Zoltech Corporation had just the ticket. Its RQDX signal distribution board (CA-RQDX-VQ11) is

designed to bolt directly to your RDxx drive. Rather than using it in this manner, I decided to mount it in the cabinet, in an area where the drive cables were being routed. Nylon PC board stand-offs served as a stable mounting solution.

At first I was concerned that an eight-slot backplane wouldn't be large enough for everything that I wanted in my MICROVAX. A year ago this would have been true, but we now have manufacturers putting 16 MB of MICROVAX II memory on a single quad-height board, 16 serial ports on a single dual-height board, and multifunction disk/

**“LEAF”
IT ALL TO
US!**

SCHERERS
6145 Scherers Place
Dublin, Ohio 43017
(614) 889-0810

digital
Authorized Distributor

ENTER 173 ON READER CARD

“

I was so impressed with the TRIMM Industries DA 123 cabinets in the Lab, that I bought them.

”

tape controllers. Eight slots is plenty for most systems.

There's no doubt that the DA 123 cabinet is the supreme choice for the systems integrator. I have, however, several items to go on a TRIMM DA 123 wish list.

First, and foremost, the use of DC fans. AC fans, while efficient and powerful, are simply too loud for an office environment. DC fans, on the other hand, can be controlled easily through the use of a thermostat. A thermostat located in the card cage area would control the speed of the fans, keeping the sound level to a minimum.

Second, a secure cabinet option would be beneficial. As with Digital's MICROVAX systems, the DA 123s leave the MICROVAX vulnerable to tampering or theft. This could be resolved with a panel and door lock system. Finally, a front bezel on which to mount drive write-protect panels, like those built by Emulex and Digital. The drive write-protect panels, while not required, are nice items to have.

I was so impressed with the TRIMM Industries DA 123 cabinets in the Lab, that I bought them. ■

Chrislin Memory

EDC MEMORY FOR PDP 11/73, PDP 11/83, PDP 11/84

CI-PMI-EDC

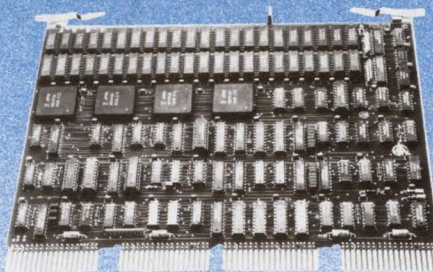

Visit Us At DEXPO West '87
Disneyland Hotel, Anaheim, CA
December 8-10, 1987, Booth #358

FULL PMI SUPPORT
4MB ON ONE CARD

MICRO 11/73 TO MICRO 11/83
UPGRADE. CALL FACTORY
BLOCK MODE DMA
BATTERY BACK-UP

The CI-PMI-EDC is an ULTRA HIGH DENSITY, HIGH SPEED, State-of-the-Art dynamic random access memory with built in Error Detection and Correction circuitry. The module has access and cycle times in the range of most memories without EDC capability. The CI-PMI-EDC supports the PMI interface on the PDP 11/83 and PDP 11/84.

CI-QBUS-EDC

LSI-11, J-11, MICROVAX I

- Single bit error correction, double bit error detection
- Runs complete DEC diagnostics
- Dual width card
- 2 or 4 megabytes on one board
- Block Mode DMA

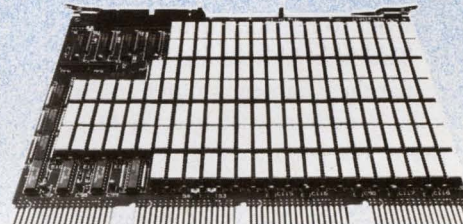
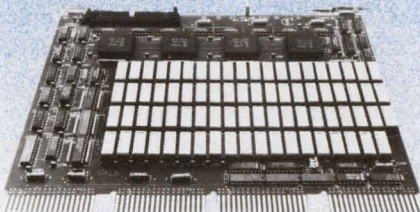

CI-MIV8-EDC

- Single bit error correction, double bit error detection
- 8 megabytes on one board
- MicroVAX II hardware & software compatible
- Control Status Register (CSR)
- MicroVAX error logger support

CI-MIV16

- 4, 8 and 16 megabytes on one board
- On-board parity
- Plug compatible to any MicroVAX II
- Completely hardware and software compatible with the MicroVAX II

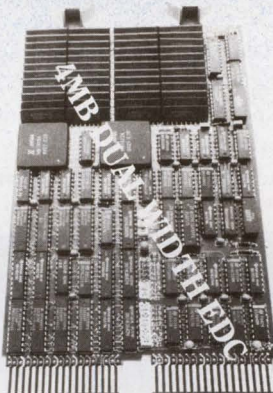

- IBM-RT PC compatible memory board
- Standard configuration of 8 megabytes
- Supports cycle interleaving

CI-RT-PC-MEMORY

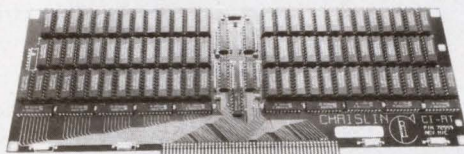

- Fast Cycle Times of 170 nanoseconds
- Error Detection and Correction for added reliability
- 100NS access times

CHRISLIN ALSO CARRIES STATE-OF-THE-ART MEMORIES FOR
VMEbus, MULTIBUS, IBM PC or AT

Call Toll Free: **800-468-0736** (est.)



Chrislin Industries Caribe, Inc.

ENTER 228 ON READER CARD

P.O. BOX 1657, SAN JUAN, PR 00629
TEL. 809-876-5205 TELEX 3454170 (CHRISLN PD)

31352 VIA COLINAS, WESTLAKE VILLAGE, CA 91362
TEL. 818-991-2254 TWX 910 494-1253

REPRESENTATIVES: CANADA-TECH-TREK, ONTARIO (416)238-0366, MONTREAL (514)337-7540
W. GERMANY-DEMA Computertechnik (089) 272 3240, SWITZERLAND-DAP (01) 948 0580

PDP, QBUS, LSI-11, J-11 MicroVAX, VAX are Trademarks of Digital Equipment Corporation. IBM is a Trademark of International Business Machines.
MULTIBUS is a trademark of Intel Corporation.



FROM THE LAB

Dave Mallery

The Emulex QD33 Controller Upgrade

We've been using an Emulex QD32 for many months in our

MICROVAX II. This is the dual-high MSCP controller that has been available for some time. The QD33 is an upgrade that's capable of supporting the newest 3 MB/second drives that are just coming on the market.

I set out to replace the QD32 with the 33. The first consideration was to ensure that the parameters stored in the controller's memory matched the FUJI 2333 drive. The parameters given in the manual matched those in the QD32, so the only problem was to program the same ones into the EPROM on the QD33. There are two ways to do this: one is to use ODT; the other is via an Emulex supplied diagnostic program.

Figuring that real men use ODT, I went for the first alternate method. (I used to get my kicks from toggling in long memory diagnostics on 11/40 consoles!)

Basically, you deposit a list of parameters in low memory that are specific to the drive(s) you wish to use. Then, you have the controller load this list into its nonvolatile RAM. The manual supplies a list of parameters for all the popular disk drives:

```

CDC RSD 9710
CDC 9715-340
CDC 9715-515
CDC 9771 XMD
CDC 9772 XMD
CDC 9772-13 XMD
Fujitsu M2351A
Fujitsu M2361A
Fujitsu M2333
CDC 9720

```

The parameters for the FUJI 2333 are shown in Table 1.

These are deposited in low memory as follows:

```

D/W/P 0 1
D/W/P 2 1
D/W/P 4 0
D/W/P 6 43
D/W/P 8 A
D/W/P A 335
...
D/W/P 1A 10C
D/W/P 1C 0
D/W/P 1E 0
D/W/P 20 0

```

This last one is to terminate the list. A single-drive system has to have rotational position sensing turned off, so you deposit a 6 at location 10.

Hexadecimal notation is the bane of

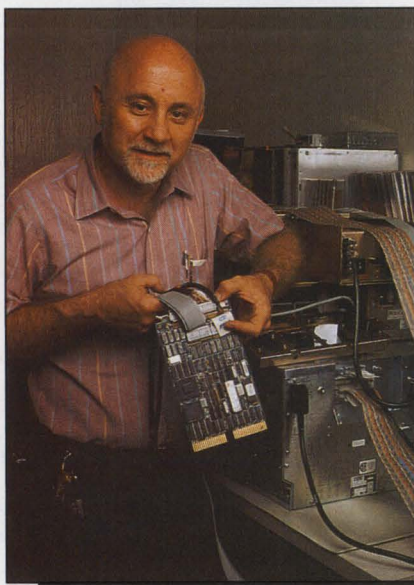

The QD33 and two drives. The CDC is using round, shielded XMD cables; the FUJI 2333 is using standard SMDs.

VAX ODT. Your familiar octal bus addresses are no good here. My controller is DUA, the first one.

Therefore, the old familiar 772150, first controller CSR, becomes 20001468 in hex (see Table 2).

The actual procedure to cause the nonvolatile RAM on the controller to accept this list of values is a series of ODT deposits and examines covered in Section 6.5.2 of the manual. Once these parameters are in place in the controller, it's able to deal with the physical realities of the drive attached. MSCP puts all the burden of physical device location determination on the shoulders of the controller, leaving the host CPU with a simple linear sequence of relative blocks. All bad blocks are revectorred by the controller so that a "seamless" error free "device" is presented to the host.

The big advantage of MSCP then, is that all drives are the same, save for size. All error recovery is the controller's problem, and effectively is offloaded from the host CPU's problem list.

The QD33 doesn't emulate the DEC Diagnostic and Utility command protocol, and therefore will not support any DEC MSCP diagnostics.

The QD33 can control two physical drives. Each could be partitioned into two logical drives, giving the subsystem a capacity of four logical drives. About the only argument for partitioning an MSCP drive is perhaps to make a very small second drive on one of the very big ones that's bootable and has a few basics on it like backup. I'd keep that drive in reserve for a rainy day.

The controller is a simple card. There are three sets of dip switches: one on the board edge, which has one switch you might want to toggle if running the onboard diagnostics, another four-banger that selects the 18- or 22-bit ad-



Now the best seller comes in an illustrated edition.

With the WY-85 at left, Wyse authored the best selling alternative to DEC's VT-220. It's fully compatible with the VT-220, but loaded with features that make it even more compatible with the people who use it.

Like a larger 14" screen. Tilt and swivel base. An easier set-up mode.

And while our keyboard is identical to DEC's in layout, they can't touch our touch.

Our new WY-99GT at right further illustrates Wyse's continuing drive to improve on a standard. It features the same advantages as the WY-85. Plus graphics, with full Tektronix 4010/4014 compatibility, and high resolution characters.

Our dual resolution mode lets you retain full VT-220 compatibility and shift from DEC resolution to hi res.

And there's a happy ending. The WY-85 is just \$599, the WY-99GT \$649. Both are made, serviced, and supported by the company that ships more terminals than anyone but IBM.*

Wyse. When it comes to quality and value in terminals, we wrote the book. For more information, call 1-800-GET-WYSE.

WYSE
| | | |

We make it better, or we just don't make it.

Trademarks/Owners: Wyse, WY-85, WY-99GT/Wyse Technology; DEC, VT-220, Digital Equipment Corporation; Tektronix, 4010, 4014/Tektronix. Screen image on WY-99GT created using Cognos Power House. *IDC 1986 U.S. Terminal Census.

ENTER 169 ON READER CARD

T

TABLE 1.

Word	Oct	Hex	Description
1 0	1	1	Number of Drives
2 2	1	1	Type Code
3 4	0	0	Head Offset
4 6	103	43	Sectors per Track
5 8	12	A	Heads
6 A	1465	335	Cylinders
7 C	1	1	Spare Sectors per Track
8 E	2	2	Spare Cylinders
9 10	101406/6*	8306/6*	Configuration Bits
10 12	0	0	Split Code
11 14	0	0	Removable Media Flag
12 16	403	103	Gap 0 Parameter
13 18	10020	1010	Gap 1 Parameter
14 1A	414	10C	Gap 2 Parameter
15 1C	0	0	Cylinder Offset
16 1E	0	0	Spiral Offset
2	0	0	end

*Value after slash is with RPS disabled.

Fujitsu M2333 NOVRAM parameters.

T

TABLE 2.

Register	Octal	MICROVAX I and II
IP	772150	20001468
SA	772152	2000146A
IP	772154	2000146C
SA	772156	2000146E
IP	760334	200000DC
SA	760336	200000DE
IP	760340	200000E0
SA	760342	200000E2
IP	760344	200000E4
SA	760346	200000E6
IP	760350	200000E8
SA	760352	200000EA
IP	760354	200000EC
SA	760356	200000EE
IP	760360	200000F0
SA	760362	200000F2

QD33 IP and SA registers.

Emulex Corporation
 3545 Harbor Blvd.
 P.O. Box 6725
 Costa Mesa, CA 92626
 (800) EMU-LEX3
 ENTER 498 ON READER CARD

Fujitsu America Inc.
 3055 Orchard Drive
 San Jose, CA 95134
 (408) 946-8777
 ENTER 499 ON READER CARD

dress mode, and a 10-position switch that handles the bus address and a few other particulars. If you're adding a QD33 to an existing MICROVAX without replacing the original RQDX controller and drive, you'll want to set the address to the first alternate: 772154. If you're building a system and this is your only disk, then you need 772150. The full range of legal addresses are available for super systems.

Features are available that are for MICROVAX installations specifically — 22-bit memory addressing and bootstrap.

There are three controller-resident functions. First, is the ability to load the NOVRAM with a block of disk size parameters. Without this, the controller makes a good book marker. The second is the format command sequence. This will write a format on all the cylinders defined by the size parameters. Third is the drive verify. I was unable to make this work. It would start but fail after a few hundred sectors, leaving the error indication illuminated on the LED on the edge of the controller. Fortunately, the diagnostic set supplied by Emulex works well. I recommend using it. There also is a boot function. This isn't for the MICROVAX, so I didn't try it.

I have always had good luck with Emulex controllers. The QD32 predecessor to this controller worked normatively for the many months we used it as the baseline standard for Lab comparisons. I have every reason to believe that the QD33 also will live up to its lineage. ■

Business Management Systems From Collier-Jackson



Because Overtime Is Overhead.

For financial managers, time is an eminent factor, accurate information a must. We've spent over 12 years developing financial, accounting and personnel systems to help you process, analyze and present information more efficiently, more effectively.

We're an award-winning software firm with a full-range of products, hardware expertise, service and support.



Collier-Jackson, Inc.
Corporate Offices:
3707 West Cherry Street
Tampa, FL 33607
(813) 872-9990

digital

Cooperative Marketing
Program

CJ/ADVANCED GENERAL LEDGER™
CJ/ACCOUNTS PAYABLE™
CJ/ACCOUNTS RECEIVABLE™
CJ/FIXED ASSETS™
CJ/PAYROLL™
CJ/PERSONNEL™
CJ/EMPLOYEE FUND ADMINISTRATION™
CJ/REPORT WRITER™
CJ/EXECULINK™

ENTER 110 ON READER CARD

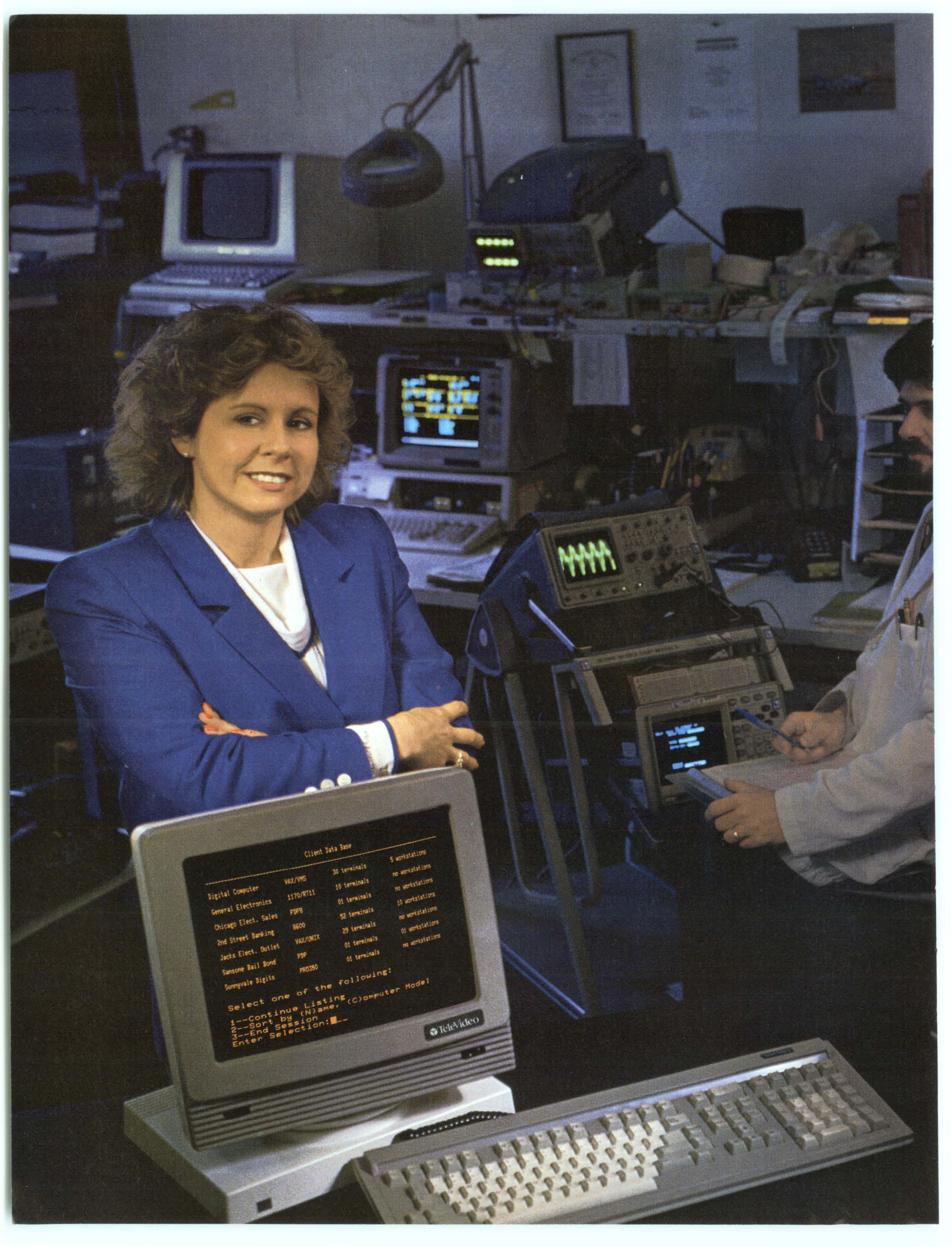

Client Data Base

Digital Computer	VAX/VMS	30 terminals	5 workstations
General Electronics	1170/RT11	10 terminals	no workstations
Chicago Elect. Sales	PDP8	01 terminals	no workstations
2nd Street Banking	6600	52 terminals	10 workstations
Jacks Elect. Outlet	VAX/VMS	29 terminals	no workstations
Sansone Bail Bond	PDP	01 terminals	01 workstations
Sunnyvale Digis	PR3350	01 terminals	no workstations

Select one of the following:
1--Continue Listing
2--Sort by (H) Name, (C) Computer Model
3--End Session
Enter Selection: █

TeleVideo

Here's the most reliable DECTM-compatible terminal ever built. The TeleVideo 9220.

"Why do we own thousands of TeleVideo[®] terminals? Because we can't afford thousands of problems."

Susan Kennedy is a product analyst at Leasametric, a company that rents, sells, and services DP equipment all over the country. Including thousands of terminals. And if reliability is important to the average user, it's critical to Leasametric.

Because everything they offer not only has to stand up to the rigors of shipping, but the extra wear and tear that rental equipment always takes. And if a Leasametric machine breaks down, so does the cash flow it generates.

So before Leasametric approves one unit, they tear it apart piece by piece. And give it an evaluation that makes an MIT exam seem easy by comparison. We talked to Susan recently, and these are just a few of the things she said:

"Too many terminals just don't measure up... I've seen machines with questionable ergonomics... keyboards that flex in the middle when you type... even cheap little diodes that could drop off... all these factors combine to make a product you either want or don't want in your product line..."

"But with TeleVideo, the whole product is well designed.

They start with solid engineering, and follow through with every detail, down to the steel brace in the keyboard. Overall they've built the same quality into the 9220 that's made all their other terminals last so long. Obviously, we want to make sure that, two years from now, our equipment will still be working for us. That's why we feel so good about TeleVideo."

Of course, Susan is talking about quality and reliability. When you check the features you get for the money, we look just as good.

As you can see from the chart,

the 9220 gives you full VT 220 compatibility. A 14" amber screen. And the best thought-out ergonomics around. All for only \$619.

The TeleVideo 9220. If you'd like more information, call us toll-free or write, today.

TeleVideo Systems, Inc.,
1170 Morse Avenue, Sunnyvale,
CA 94088-3568.

In the meantime, we'd like to leave you with a quote from Susan Kennedy, "Keeping customers happy is what my job is all about. And TeleVideo definitely makes my job a lot easier."

9220 KEY FEATURES			
Super dark 14" amber screen (green optional)	✓	30 non-volatile programmable function keys	✓
Full VT 220 compatibility	✓	VT100 compatible keyboard	✓
DB25 connector for printer port	✓	Compose key disable control	✓
Tilt and swivel base	✓	Graphics model available	✓

 **TeleVideo[®]**
THE VISION YOU NEED TO SUCCEED
ENTER 158 ON READER CARD
Call 1-800-835-3228

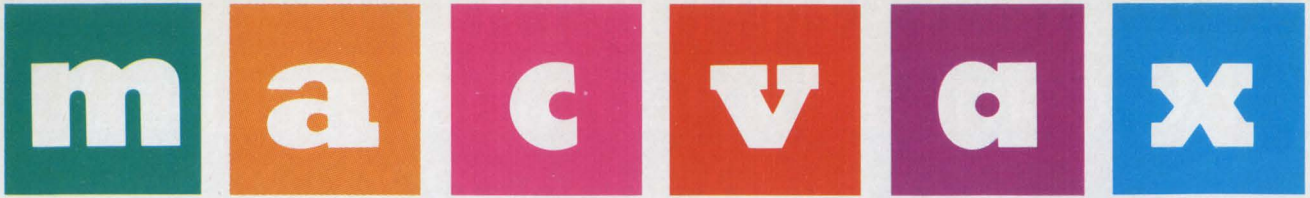

A Tale Of Two Protocols

Deciding On The Optimal Protocol
For Your Macintosh Is No Easy Task.

BY AL CINI

EVEN THOUGH MOST Macintosh/VAX communication products can be installed and used by people with little or no technical computer expertise, a general behind-the-scenes knowledge of the underlying mechanics, or communication protocols, can help you decide which products might be best for a given application.

Computer systems cooperate with each other by exchanging information, and the rules that define the format of this information are known collectively as a protocol. Protocols range in complexity from the simple conventions that might exist between two loosely coupled systems (like KERMIT), to the comprehensive standards required by a large computer network (DECNET and AppleTalk).

Simple agreement on a common computer alphabet, like ASCII, is the only protocol required for two computers to exchange text with each

other over a point-to-point wire. Terminal emulator products like Apple's MacTerminal download host text simply by recording the host's character transmissions to a Macintosh file, or upload it by playing back a similar file as though it were typed at the Mac's keyboard.

The transfer of binary data, on the other hand, like program files, requires the data transparency and error correction capabilities of a real communications protocol. On transmission, the sending system organizes its outgoing data into specially formatted envelopes called packets, which include control information like byte counts and checksums.

The receiver, in turn, can use the packet's control information to determine whether the data it received is correct and intact. If an error is detected, the receiver can send a special response packet to request retransmission of the invalid packet.

Beyond error correction and recovery, both DECNET and AppleTalk protocols provide the end-to-end message routing and many other advanced functions a large computer network needs.

WHICH PROTOCOL FOR YOUR MACINTOSH

TO PARTICIPATE IN DECNET networks, you can program your Macintosh to speak DECNET. A DECNET-equipped Macintosh can send and receive electronic mail, or submit networked print and batch jobs, as though it were just another VAX or PDP-11.

This approach may sacrifice some of the Macintosh's user-friendliness (you might have to run special Macintosh utilities to perform the functions of DEC network programs like NCP and VAX/VMS Mail), but it offers easy integration into existing DEC networks. Macintosh-based DECNET alternatives include products like Alisa

DECNET, TCP/IP and Local-Area Transport (LAT is the specialized protocol used by DEC's terminal servers to establish interactive VAX sessions) to share a common Ethernet without interfering with each other. Apple and third-party developers, such as Kinetics, have announced hardware to connect Macintosh systems directly to an Ethernet, or to provide protocol gateway services between Ethernet and standard AppleTalk networking hardware.

Macintosh systems and other AppleTalk devices constitute network nodes, and are identified by an eight-bit node number that's dynamically determined when the node enters the network. Within a node, up to 255 separate logical AppleTalk channels (sockets) can be defined to handle simultaneously either separate electronic mail or printer client-to-server requests.

While Apple's usual twisted-pair hardware limits an AppleTalk network to no more than 32 nodes for electrical reasons, the software architecture actually will support as many as 255 nodes in a network. A network, in turn, is identified within a larger internet by its 16-bit network number, and connected to other networks through specially programmed AppleTalk bridge nodes, serving as internetwork packet forwarding agents. The long form of an AppleTalk address, therefore, is an eight-bit socket number within an eight-bit node number within a 16-bit network number, for a theoretical maximum (after you take some reserved values into account) of millions of separately addressable network entities.

Names, of course, are much easier to remember than numbers, so AppleTalk provides special name-binding procedures in its transport layer to permit servers to associate human-intelligible 32-character names with their machine-intelligible 32-bit network addresses. Later, Macintosh net-

work users can select these named servers easily using the CHOOSEr. In large internets, which can confuse users with perhaps hundreds of named servers, AppleTalk permits a network manager to organize an internet's bridges into arbitrary zones. After it's defined, a user could choose

processes appear as AppleTalk nodes.

By calling various AppleTalk sub-routines provided in the package, these virtual AppleTalk node processes can communicate with each other in their virtual network, or across Ethernet to various real AppleTalk networks in the outside world through

A properly programmed VAX can use AppleTalk's protocols to communicate with networked Macintoshes.

the LASERWRITER server in the ACCOUNTING zone, as distinct from LASERWRITER servers in the SHIPPING or ORDER PROCESSING zones.

Individual AppleTalk networks configure themselves automatically and, except for routine network hardware plug tightening, require no management attention. Larger internets need manual one-time configuration of their bridges and perhaps a little AppleTalk zone planning. As a companion to their *PhoneNet* twisted-pair AppleTalk hardware products, Farallon offers AppleTalk network management software for use in diagnosing and correcting problems in large AppleTalk internetworks.

APPLETALK FOR VMS

A PROPERLY PROGRAMMED VAX can use AppleTalk's protocols to communicate with networked Macintoshes. Developed in conjunction with Alisa Systems, Apple licenses a VAX/VMS implementation of AppleTalk, called AppleTalk for VMS, to developers interested in writing VAX-based servers for networked AppleTalk users. Using AppleTalk for VMS, a VAX/VMS system becomes an AppleTalk network and its

the provided AppleTalk/VMS Bridge process. This bridge process can even communicate via DECNET with bridge processes running on other VAX/VMS systems, enabling an AppleTalk internet to be extended transparently across a wide geography using existing DECNET point-to-point or X.25 links.

AlisaTalk's VAX/VMS-based file and print server software uses AppleTalk for VMS to provide their services to Macintosh clients. Similarly, Odesta's *Helix VMS* database package offers VAX/VMS-based database services to AppleTalk-networked Macintosh users. Future developments from these and other third parties are sure to include applications like electronic mail and videotex services.

Depending on your needs, connecting a Macintosh to a VAX can be as simple as using a terminal emulator to exchange text, or as involved as running DECNET on your Macintosh or AppleTalk on your VAX — or even both at the same time. The successful construction of a Macintosh/VAX network will require that you know the relative pluses and minuses of each of the many alternatives. ■

Memory Upgrades For VAX 8000 Series

EMC Corporation announced the development of memory upgrades for VAX 8000s. EMC released 32-MB and 64-MB arrays for VAX Memory Interconnect (MI)-based computers, which include the 8500, 8530, 8550, 8700 and 8800. EMC's expanded capacity is achieved through use of state-of-the-art, zig-zag inline packaging (ZIP) technology, and 1-megabit chips. VMS 5.0, the newest revision of DEC's VMS operating system, is expected by the end of the year. VMS 5.0 will allow users to configure up to 256 MB of memory in their VAX systems. To find out more, contact EMC Corp., Hopkinton, MA 01748-9103; (800) 222-EMC2. Stop by Booth No. 1300.

Enter 344 on reader card

Pennington Has Translation Services

Pennington Systems Incorporated announces program conversion and language translation services available on a contract basis. One such translation tool is XTRAN. XTRAN functions in a fully symbolic, rather than a mechanical fashion, and is inherently language independent. The initial language combinations implemented are PDP-11 and VAX-11 Assembly code to C. Another tool is CONPAX, which converts PDP-11 Assembly code (MACRO-11) to VAX native mode assembly code (VAX MACRO).

Further information is available from Pennington Systems Inc., 65 S. Main St., Bldg. C, Pennington, NJ 08534; (609) 737-2727. Telex: 981032 PENNSYS. Visit Booth No. 257.

Enter 345 on reader card

Unisys Servicing VAX-11/700

Unisys Corporation has announced CUSTOMCARE for VAX-11/700 customers nationwide. Unisys is offering a special promotion called "Reach for the Power," which provides new Unisys customers with the first month of service on a free-trial basis. Customers may cancel during this time if not satisfied.

Unisys initially will offer VAX 11/700 service in areas with concentrations of DEC users (including most major US cities) and later extend it to the remaining sites.

DEC maintenance is offered as part of CUSTOMCARE Service, which encompasses all Unisys education services, professional services, and services for hardware and software support.

For further information, contact Unisys Corporation, P.O. Box 500, Blue Bell, PA 19424-0001; (215) 542-2243. Visit Booth No. 1338.

Enter 351 on reader card

The Link Increases PDP-11 CPU Power

The Link, a system software package, recently was introduced from Northwest Digital Software Inc. The Link is designed to extend the life span of existing PDP-11 systems. It allows two PDP-11 systems running RSTS/E to be joined so that disk information can be shared by both systems. This effectively can double the performance of a PDP-11 system.

Designed to run on RSTS/E version 9.2 and newer, The Link uses standard DEC hardware. The Link allows full file protection and record-locking, and doesn't require any modification of existing applications programs.

Additional information may be obtained by contacting Northwest Digital Software Inc., Box 1797, W. 405 Walnut, Newport, WA 99156; (509) 447-5631. Stop by Booth No. 453.

Enter 301 on reader card

IMSL Announces FORTRAN Libraries

IMSL has restructured the IMSL Library. Contents of the Library have been expanded and divided into MATH/LIBRARY, for solving mathematical problems; STAT/LIBRARY, for analyzing statistical data; and SFUN/LIBRARY, for evaluating special functions.

The Libraries' nearly 800 user-callable subprograms add more than 150 new areas of functionality to those available in the IMSL Library. The new products implement state-of-the-art algorithms and modern FORTRAN-77 programming techniques. The new task-oriented documentation is reorganized for ease of use.

For more information, contact IMSL Sales Division, 2500 ParkWest Tower One, 2500 CityWest Blvd., Houston, TX 77042-3020; (713) 782-6060, Telex: 791 923 IMSL INC HOU, outside TX call (800) 222-IMSL. Visit Booth No. 716.

Enter 302 on reader card

Editor's note: DEXPO West 87 is fast approaching. This year the 13th National DEC-Compatible Exposition will be held in Anaheim, California, from December 8 through December 10.

Approximately 300 exhibitors and 10,000 visitors are expected to participate. Professional Press' exhibition booth number will be 454. Plan to see us there; we enjoy meeting our readers.

Many of the companies mentioned in "Products" this month will be exhibitors at DEXPO West 87. Their booth numbers are indicated, so stop by and visit.

GRAFkit Available On ULTRIX

International Computer Exchange (ICEX) Inc. will introduce its ULTRIX version of GRAFkit at DEXPO WEST 87. The ULTRIX implementation will compliment existing GRAFkit routines available under VMS and will allow users to obtain high-level graphic capability for graphs, 3-D solids and surfaces, histograms, scatter diagrams, mapping, map data overlays, streamlines, and vector representations for the entire VAX family of computers.

Prices for an entire GRAFkit package start at less than \$3,000.

Additional information can be obtained by calling International Computer Exchange (ICEX) Inc., 740C S. Pierce Ave., Louisville, CO 80027; (303) 666-5400 ext. 845 or (800) 222-4239 ext. 845. Stop by Booth No. 809.

Enter 303 on reader card

PIVOTAL Offers Guide To VAX/VMS Management

In conjunction with its ALL-IN-1 and VAX/VMS system, performance, network and security management training and consulting offerings, PIVOTAL Inc. offers a new practical guide to VAX/VMS performance management based on its popular two-day seminar, How To Tune Your VAX.

Written as a practical performance management guide by a team of practicing VAX/VMS system managers, *How to Tune Your VAX — An Introduction to VAX/VMS Performance Management* features sections explaining how each of the major components of the VAX and VAX/VMS work as well as sections on how to manage their performance.

Learn more by contacting PIVOTAL Inc., 6892 E. Dorado Ct., Tucson, AZ 85715; (602) 886-5563. Stop by Booth No. 1048.

Enter 304 on reader card

MARK 12 Provides Mathematical Subroutines

Mark 12 of the NAG FORTRAN Library provides 688 FORTRAN mathematical and statistical subroutines for more than 80 computer/operating system combinations, from workstations to supercomputers, including all DEC systems. There have been 175 user-level routines added. Among these are 97 routines including Level 1 and Level 2 BLAS (Basis Linear Algebra Subprograms) that enhance performance on vector and parallel computer systems. Mark 12 now is a comprehensive, integrated library of numerical algorithms for computational science and

engineering. The Online Information Supplement and Graphical Supplement also are available to complement the NAG FORTRAN Library.

For more information, contact Numerical Algorithms Group Inc., 1101 31st St., Ste. 100, Downers Grove, IL 60515; (312) 971-2337. Visit Booth No. 642.

Enter 305 on reader card

NISSHO Introduces N1100-Plus

NISSHO Electronics Corporation introduced the N1100-Plus Dual Board Computer based on the DEC J-11 microcomputer chip. The N1100-Plus is an enhanced version of the N1100 and includes a memory capacity of 4 MB, 8K of cache, floating point ac-

ports the following Ethernet cards: Ungermann-Bass (NIC), and the Excelan 205; as well as the previously supported 3-Com 501, the 3-Com 505, and the MICOM NI-5010. Using RAF over Ethernet enables VAX to PC data transfer at a speed of more than 100,000 characters per second. RAF Remote Access Facility is a PC-to-host integration system. RAF enables PC users to access and use the processing power of a remote VAX without any knowledge of remote computer commands.

The cost for RAF is \$395 per PC and \$395 per host.

For further information, contact Datability Software Systems, 322 Eighth Ave., New York, NY 10001; (800) 342-5377 or in NY (212) 807-7800. Stop by Booth No. 2150.

Enter 306 on reader card

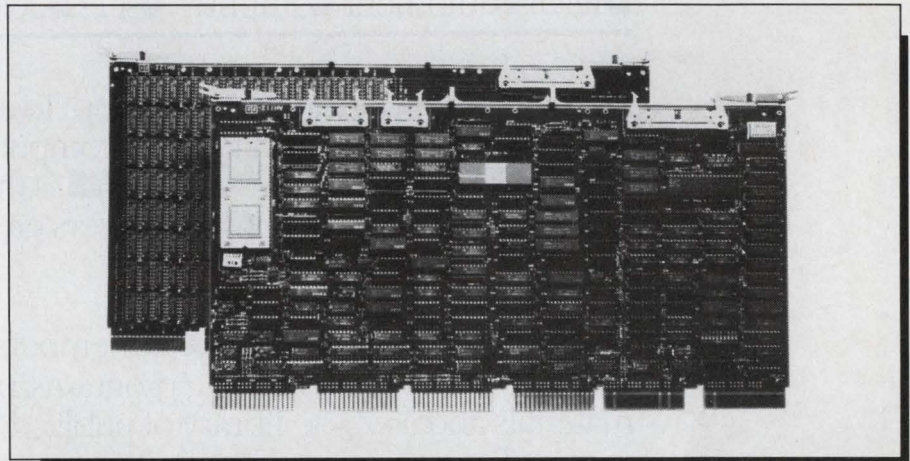

NISSHO Electronics introduces the N1100-Plus.

celerator option and memory management unit. The N1100-Plus incorporates an independent memory bus (IMB) which, combined with high-speed DRAM, provides any PDP-11/24/34 with PDP-11/84-type performance.

The N1100-Plus consists of two HEX size UNIBUS boards and can be installed in any standard SPC slots without backplane changes. The processor operates on the 18-bit backplane and provides UNIBUS Mapping to its own IMB.

The price for the N1100-Plus is \$12,000. For further information, contact NISSHO Electronics Corp., Inwood Pk., Ste. 200, 17310 Red Hill Ave., Irvine, CA 92714; (714) 261-8811. Stop by Booth No. 362.

Enter 308 on reader card

Datability Expands Ethernet Capabilities

Datability announces the release of version 1.9.2 featuring enhanced Ethernet capabilities. This latest version of RAF sup-

Pulizzi Introduces PC 585

Pulizzi Engineering Inc. introduced the Z-LINE PC 585 multiple time delay (sequenced) up-and-down power distribution and control system. The four-second time delay between switches 1, 2 and 3 lets your system power up large amounts of current, without tripping the circuit breaker. In the power down mode, the controller shuts down in an orderly sequential manner, starting from switched 3, 2 and then 1 to safely bring the power down on your system. Two remote I/O connectors are provided for on/off, emergency shut down, and power up of additional Z-LINE controller systems down line. Remotes also provide DEC system connectivity.

Learn more by contacting Pulizzi Engineering Inc., 3260 S. Susan St., Santa Ana, CA 92704-6865; (714) 540-4229, FAX (714) 641-9062. Visit Booth No. 813.

Enter 309 on reader card

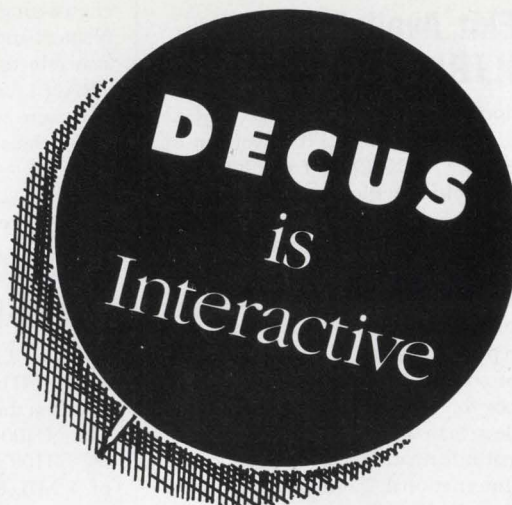

You'll have your say at
Digital **E**quipment **C**omputer **U**sers **S**ociety Symposia.

Here's your opportunity to speak up. To ask questions. To swap war stories. And to meet computer professionals who share your interests. **DECUS** is the largest, independent professional computer users group in the industry.

There are over 100,000 **DECUS** members who have access to year-round training programs, published materials and a whole library of public domain software—all designed specifically for users of Digital's computers.

If you'd like to plug into this network, join us at our Fall '87 Symposium that will be held in Anaheim, California, December 7-11.

You can choose from 800 different sessions. Talk to the actual Digital developers about DECworld product announcements. Meet experienced users. And build your personal network.

For membership and symposium information,*
telephone 617-480-3328 or write:



DECUS U.S. Chapter
219 Boston Post Road, BP02
Marlboro, MA 01752-1850

*Pre-registration savings end November 16th; for your convenience walk-in registration will be accepted.

BBN Software Introduces Programmer's Toolkit

BBN Software Products Corporation announced the RPL Programmer's Toolkit for VAX users. This new programming tool enables the company's RS/1 users to build and maintain custom applications with greater performance and cost benefits.

The new capabilities in the RPL Toolkit include automated procedure editing and loading, run-time profiling, code preprocessing, indexing and cross referencing, and batch loading of group and public procedures. Another key feature of the RPL Toolkit, the code preprocessor, allows developers to define and use macros and to specify conditional compilation of code.

Learn more by contacting BBN Software Products, 10 Fawcett St., Cambridge, MA 02238; (617) 864-1780. Visit Booth No. 1619.

Enter 307 on reader card

X Window Support On GraphOn GO-250 & GO-235

GraphOn Corporation announced the availability of X Window System support for

the GO-250 and GO-235 monochrome graphics terminals as a no-cost option. GraphOn provides X Window compatibility for a desktop graphics terminal.

A GraphOn terminal with the X Window option provides a graphical windowing environment in which multiple applications can be executed concurrently. Terminal users in large centralized computing environments can benefit from windowing system productivity without redesigning their computer system architecture.

The GO-250 costs \$2,495 and the GO-235 costs \$1,695.

More information can be obtained by contacting GraphOn Corp., Tower One, Fifth Floor, 1901 S. Bascom Ave., Campbell, CA 95008; (408) 371-8500. Visit Booth No. 1814.

Enter 310 on reader card

ISE Releases New Version

ISE released its latest version of its Tape/Disk Media Librarian System for the VAX/VMS system. The MEDIA Librarian is a general-purpose media management system designed to solve the problem of managing and controlling all types of off-line storage.

Full support is provided for any combination of VAX CPUs either single, clustered or networked. The Librarian uses a detached server process to monitor and control the allocation of removable tape and disk drives. All assistance requests are sent to the system operator in a consistent fashion. Geographically distributed media libraries are supported fully while maintaining a central database.

Learn more by contacting ISE Inc., P.O. Box 241740, Los Angeles, CA 90024-1740; (213) 837-8339; TWX: (910) 340-6449 (ISE LA); TLX: 322616 (ISE LA UW). Visit Booth No. 1844.

Enter 311 on reader card

Access Technology Demonstrates 20/20

Access Technology Inc. will demonstrate a new database interface product for spreadsheet users, called the 20/20 Database Connection, at Dexpo West '87.

The 20/20 Database Connection is a new extension to the 20/20 spreadsheet which provides a seamless bridge between 20/20 and several VAX databases. It was designed for spreadsheet users as a quick, easy way to retrieve database information directly from

RSX CONSULTING

- M, S, M-PLUS, Micro-RSX
- Performance Analysis/Tuning
- Device Drivers a Specialty
- Call-Up Support Service
- Disk Corruption Recovery

James A. McGlinchey
(Author of "The RSX Clinic")
Software Engineering Consultant
5 Skyline Drive
Post Office Box 81
Essex Junction, VT 05452-0081
802-879-6014

ENTER 132 ON READER CARD

Ethernet & ThinWire Cables & Assemblies

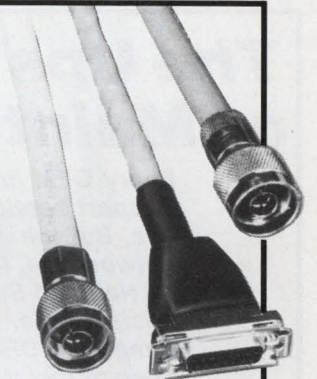

...with
24-48 hour
turn-around
on all orders.

- Ethernet/IEEE 802.3 coax and transceiver cable available for plenum and nonplenum applications
- All cables and assemblies electronically tested and guaranteed to conform to Ethernet/IEEE 802.3 specifications
- Custom-length, in-stock network cabling

In addition, Cabletron Systems manufactures coax and fiber optic repeaters and transceivers, multipoint repeaters and transceivers and LAN test equipment.

Ask for literature and prices.

CABLETRON
SYSTEMS Inc. (603) 332-9400 • TELEX: 988059
CABLETRON INDUSTRIAL PARK
10 MAIN STREET, BOX 6257
E. ROCHESTER, NH 03867

Manufacturer of Network Products • Nationwide Turnkey Systems

ENTER 106 ON READER CARD

corporate databases and bring it into 20/20 for analysis. With it, users need not know a query language, and there is no need for intermediate temporary files.

For more information, contact Access Technology Inc., 6 Pleasant St., So. Natick, MA 01760; (617) 655-9191. Visit Booths No. 348 and 350.

Enter 312 on reader card

Sigma Introduces SA H165

Sigma Information Systems announced a new expansion enclosure for high-capacity Winchester disk drives. Designated the SA-H165, the enclosure supports Fujitsu 2300 or Toshiba MK-280 series drives. The enclosure includes a 350 watt heavy-duty power supply, all internal drive cables, plus a front switch/display panel. The front display panel includes control switches and status indicator LEDs.

The price of the SA-H165 is \$1,270.

For more information, contact Sigma Sales, 3401 E. La Palma Ave., Anaheim, CA 92806; (714) 630-6553; Telex: 298607 SGMA; FAX: (714) 630-5417. Stop by Booth No. 2145.

Enter 314 on reader card

Minitab Releases 6.1 For VAX/VMS Analysis

Minitab Inc. announced that Release 6.1 of its Minitab Data Analysis Software is available for the VAX series of computers. Minitab Release 6.1 has 18 new features, including multifactor analysis of variance, covariance and discriminant analysis.

Minitab also performs basic statistics, regression, nonparametric statistics and tabulation. New users need less than one hour of instruction to get started.

For more information, contact Minitab Inc., 3081 Enterprise Dr., State College, PA 16801; (814) 238-3280. Stop by Booth No. 200.

Enter 313 on reader card

Intellisys Demonstrated At DEXPO

Intellisys, from Genex Technology Group, is an intelligent menu-driven tool that allows users and data processing professionals to easily and quickly develop custom database applications. No programming is required to develop, test or operate serious filing, forms management, accounting, and manufactur-

ing applications. Intellisys is easy to use and powerful. Multifile and form applications can be developed easily and quickly.

The combination of power and ease of use in a single product makes Intellisys ideal for developing personal and departmental applications for MicroVAX, VAX, and PDP-11 systems.

For more information, contact Genex Technology Group, 224 King St. West, Hamilton, ON, Canada L8P 1A9; (416) 527-2191; FAX: (416) 522-6183. Stop by Booth No. 1426.

Enter 315 on reader card

Chrislin Introduces The CI-MIV8-EDC

Chrislin Industries introduced the CI-MIV8-EDC module for the MicroVAX II computer system. The CI-MIV8-EDC uses the most advanced technology available: 1 megabit Dynamic Rams. It has a quarter the amount of chips as other modules using 256K rams.

The memory is available with 8 MB and error detection and correction on a single card. It corrects single-bit and detects double-bit errors. In an average parity

The Ups & Downs of Maintenance #3

Every OEM and VAR knows that great support service is great for the bottom line. But the costs of a national service network are, for many, too high.

At National Support Group we bring costs in line. We are specialists in integrated DEC and DEC compatible system maintenance. We've been saving VAR's and OEM's bottom line dollars since 1980. It's done with well trained, experienced field and staff service engineers, custom diagnostic software, technical phone support, logistic support, and a commitment to keeping your users UP and costs DOWN. We'd like to show you how. Call us today at 713-496-4004.

NSG

NATIONAL SUPPORT GROUP

14925-A Memorial Drive • Houston, Texas 77079

Telephone: (713) 496-4004 for more information.

DEC is a trademark of Digital Equipment Corp.

ENTER 235 ON READER CARD

DON'T BUY A VAX SPREADSHEET

Without trying GRAPHIC OUTLOOK from Stone Mountain Computing.

If you are looking for LOTUS-like capability on the VAX, try GRAPHIC OUTLOOK. It's powerful. It's useable. And it's affordable.

GRAPHIC OUTLOOK provides

- A LOTUS command mode that makes it as easy to operate as 1-2-3.
- Automatic transfer of worksheets to and from 1-2-3 (versions 1A and 2) and Symphony.
- High-quality business graphics on most popular graphics terminals, plotters, and laser printers.
- 2-user, 6-user licenses, a lease plan and right-to-copy discounts for clustered VAXes.
- Probably more capability than you've ever seen in a spreadsheet program.

Call about our demonstration package. GRAPHIC OUTLOOK. Tomorrow's VAX spreadsheet program that's available now.



Stone Mountain Computing
P.O. Box 1369
Goleta, CA 93116
(805) 964-9101

VAX is a registered trademark of Digital Equipment Corporation.
LOTUS and 1-2-3 are registered trademarks of Lotus Development Corporation.

ENTER 227 ON READER CARD

How can you get the best of both VMS™ and UNIX™?

VMS is the system of choice for many VAX users. But UNIX systems are increasingly becoming an accepted standard. From micros to workstations to supercomputers, most sizable installations have, or soon will have, at least one UNIX system.

So, how can you get the best of both worlds? Buy an extra machine? Inconvenient, costly, one more thing to manage. Install a package that modifies VMS? Dangerous. Use a "UNIX-like shell?" Not fully compatible. Replace VMS? Not likely.

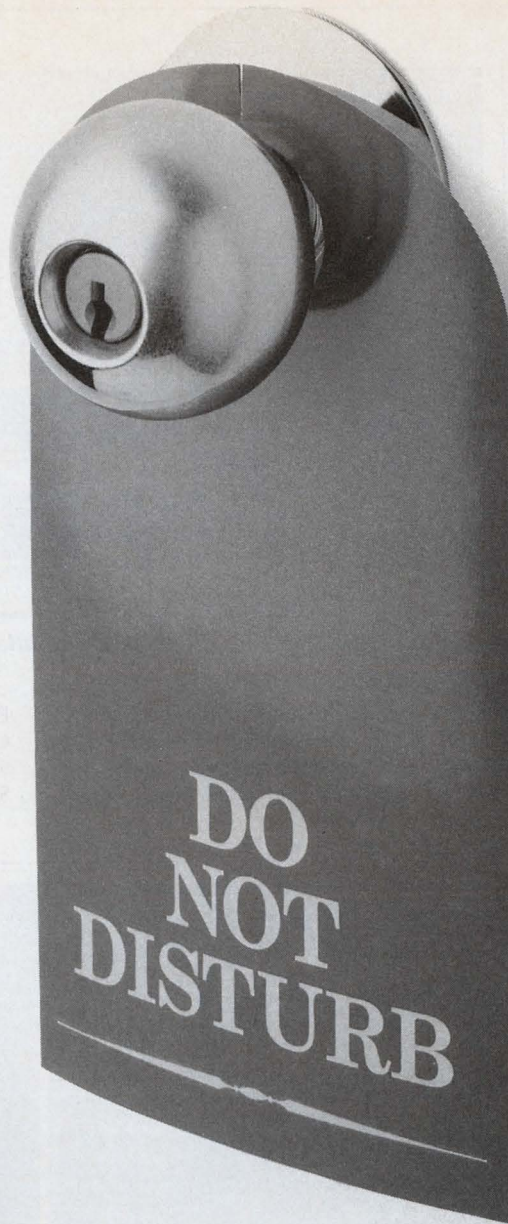

HCR has the answer

The UNITY® Operating System allows you to use UNIX and VMS on the same machine at the same time.

Based on UNIX System V Release 2, UNITY runs under VMS providing simultaneous environments. UNITY provides UNIX programming tools including C and Fortran, transparent access to VMS files, and even 'uucp' for linking to other machines. VMS and UNITY users can obtain applications from either system, thereby gaining the leverage to create quality software. At last you can have a compatible UNIX environment without disturbing VMS.

For the key to VMS and UNIX compatibility, please call or write.

The best of UNIX™ software without disturbing VMS™



HCR Corporation

130 Bloor Street West
10th Floor
Toronto, Ontario
Canada M5S 1N5
Telephone (416) 922-1937
Telex 06-218072 HCR TOR
Fax (416) 922-8397

ENTER 211 ON READER CARD

See us at booth H7327
 **COMDEX/Fall '87**
November 2-6, 1987
Las Vegas Hilton Hotel
Las Vegas, Nevada

memory, an error could occur in a matter of days; with the EDC function, the likelihood of an error is a matter of years. It also includes CSR register where memory errors are logged so you can do on-site repair to the board.

The memory is completely hardware and software compatible with DEC's MicroVAX II system.

For more information, contact Chrislin Industries Caribe Inc., P.O. Box 1657, Canovanas, PR 00629-1657; (809) 876-5205 or (809) 876-6160. Stop by Booth No. 358.

Enter 316 on reader card

Zoltech Displays Hybrid Chassis Series

The versatile family of Q-bus and VME chassis and system packages from Zoltech Corporation will be on display at DEXPO West 87. Included in the display will be the new VME/PDOS development system, the VV-11/Model 1610 featuring a 10 MHz 68010 CPU with 512K of RAM. The system comes complete with a 20-MB Winchester disk drive, and an 800K 5¼-inch floppy disk drive. Included is the PDOS software development package, a high-performance

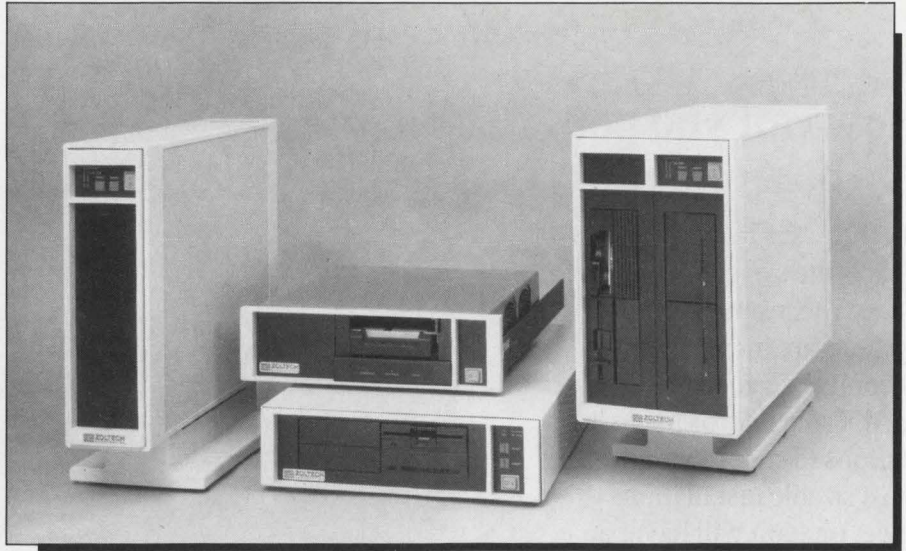

Zoltech Corporation's Q-bus and VME system packages.

real-time, multitasking, multiuser operating system. The chassis includes a 5-slot 6x160 cardcage with four slots unoccupied.

The basic desktop VV-11/Model 1610-A is priced at \$5,995.

For more information, contact Zoltech Corp., 7023 Valjean Ave., Van Nuys, CA 91406-3997; (818) 780-1800; Telex: 755451. Stop by Booth No. 654.

Enter 318 on reader card



"What we need is a family of software that's integrated and easy to use..."

There's only one choice. And you can grow with it from word processing and spreadsheets to data base and business graphics.

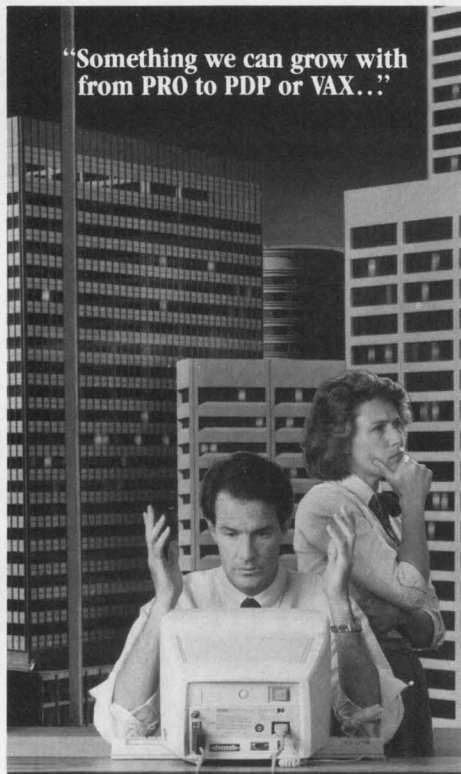

"Something we can grow with from PRO to PDP or VAX..."

It's software you only need to learn once whether you run on a PRO, PDP or VAX.



"It's got to have support we can count on..."

With it comes complete software support including telephone hot-lines, year-round training courses and quarterly publications.

VAX/VMS Spreadsheet Offers 3-D Graphics

Stone Mountain computing recently announced release 4.3 of Graphic Outlook, the first spreadsheet to offer 3-D perspective plots of spreadsheet data. Graphic Outlook reads and writes LOTUS and Symphony spreadsheets including the LOTUS version 2 format. Under the "Lotus Mode" user interface option, the command structure closely parallels that of LOTUS 1-2-3, allowing users to move spreadsheet work between PCs and VAXs without having to learn separate programs.

Learn more by contacting Stone Mountain Computing, 42 Aero Camino, Ste. 209, Goleta, CA 93117; (805) 964-9101. Visit Booth No. 266.

Enter 317 on reader card

INTOUCH Includes GQL For VAX/VMS

Touch Technologies Inc. will demonstrate the latest release of its INTOUCH product at DEXPO West. INTOUCH is the Next Generation Language for VAX/VMS com-

puters, and now includes a natural language interface. Guided Query Language (GQL) is intended for end users who wish to access complex databases without learning a traditional procedural language. As user requests are made and validated, a full mock-up of the final output is displayed on the screen. GQL includes line-by-line error checking, takes only seconds to modify, and comes with a full HELP system.

Contact Touch Technologies Inc. for more information at 9990 Mesa Rim Rd., Ste. 220, San Diego, CA 92121; (619) 455-7404 or (800) 525-2527 in the U.S., (800) 325-2527 in CA. Visit Booth No. 512.

Enter 319 on reader card

Phoenix Data Announces New Products

Phoenix Data Inc. announced hardware and software products to interface its Intelligent Data Acquisition Systems (IDAS) to VAX, MicroVAX II, VAXstation, VAX 8000 series and the PDP-11. IDAS interfaces are available for systems with a Q-bus using the DRQ3B and DRV11-WA, the UNIBUS using the DR11-W, and the VAXBI bus using the DRB32-W. The available software for the

DRV11-WA, DR11-W and DRB32-W is either low-level drivers or high-level menus using the VMS operating system. The software for the DRQ3B is contained in LABSTAR subroutines.

Learn more by contacting Phoenix Data Inc., 3384 W. Osborn Rd., Phoenix, AZ 85017; (602) 278-8528; Telex: (910) 951-1364. Stop by Booth No. 1440.

Enter 321 on reader card

UserWare Announces UserBase V3.2

UserWare International Inc. announced the first customer shipments of Release 3.2. UserBase version 3.2 fully supports RMS fixed-length record file types, RMS alternate keys and VAX native data types. This software allows any VAX user the ability to write reports quickly or develop multiwindow-oriented screen inquiries or updates from their existing RMS files without any programming knowledge.

Find out more by contacting UserWare International, 2235 Meyers Ave., Escondido, CA 92025-1070; (619) 745-6006. Visit Booth No. 470.

Enter 325 on reader card



Put Saturn on your system and explore any one of 5 programs individually or all together as a fully integrated office automation system.

ENTER 218 ON READER CARD

Before anyone promises you the moon, take a good look at Saturn.

Instead of a demo, give everybody a 45 day hands-on tryout of the real thing with Saturn Live.

Work with SATURN-CALC[®] electronic spreadsheet, SATURN-WP[®] word and list processor, SATURN-BASE[®] data base management system, SATURN-GRAPH[®] business graphics and SATURN-

CALC+[™] spreadsheet and business graphics—one at a time or all at once—with all the support services you'll need.

Call 1-800-328-6145 ext. 116 for more information on how to see Saturn Live. International and Minnesota residents call 612-944-2452. Dealer inquiries welcome.

Show me Saturn Live.

Name _____
 Company _____
 Address _____
 City _____ State _____ Zip _____
 Phone _____ Telex _____

Operating system:
 P/OS TSX Plus MICRO-RSX RSX RSTS MICRO-VMS VMS

SATURN

Saturn Systems, Inc., 6875 Washington Ave. So.
 Minneapolis, MN 55435 TELEX: 290 322

DP1187

DynService Network Offers Alternative

DynService Network announced DEPOT support for DEC's RA80/81 HDAs. DSN offers competitive pricing, 90-day warranty, fast turnaround with expedite service available and an overnight exchange program.

DynService Network also repairs more than 1,600 other DEC subassemblies. Add to this its buy/sell parts department coupled with a full exchange program and you have a comprehensive DEPOT support service. For more information, contact DynService Network, 1875 Whipple Rd., Hayward, CA 94544-7834; (415) 489-6996. Stop by Booth No. 1726.

Enter 320 on reader card

NIS Shows Options For ACCENT R 4th GL

National Information Systems Inc. announced the DEXPO debut of three enhancements to the ACCENT R Applications Development Environment/4th GL for VAX/VMS systems.

ACCENT R Express is an end-user productivity tool that lets you quickly create custom database applications without coding. Express makes developing complete applications easy as it guides you through with pull-down menus and help at any level. DataPaint II is a user-friendly yet powerful forms design program generator that complements existing ACCENT R applications. DataPaint II enhancements provide pull-down menu-oriented PC-like features and help that simplify file creation and maintenance.

The ACCENT R interface for Britton Lee represents the next generation of software for managing large databases by combining the speed and efficiency of ACCENT R's compiled code with the latest technology in database machines.

More information can be obtained from National Information Systems Inc., 1190 Saratoga Ave., San Jose, CA 95129; (408) 985-7100. Stop by Booth No. 671.

Enter 322 on reader card

Online Access To VAX Site Database

Computer Intelligence (CI) offers Online Access to its VAX Special Interview Program. Online Access offers CI clients an effective, efficient way to analyze buying intentions, develop telemarketing and direct mail campaigns, identify competitive sales situations, generate custom prospect lists, and perform product planning.

The database is kept current through thousands of telephone interviews completed

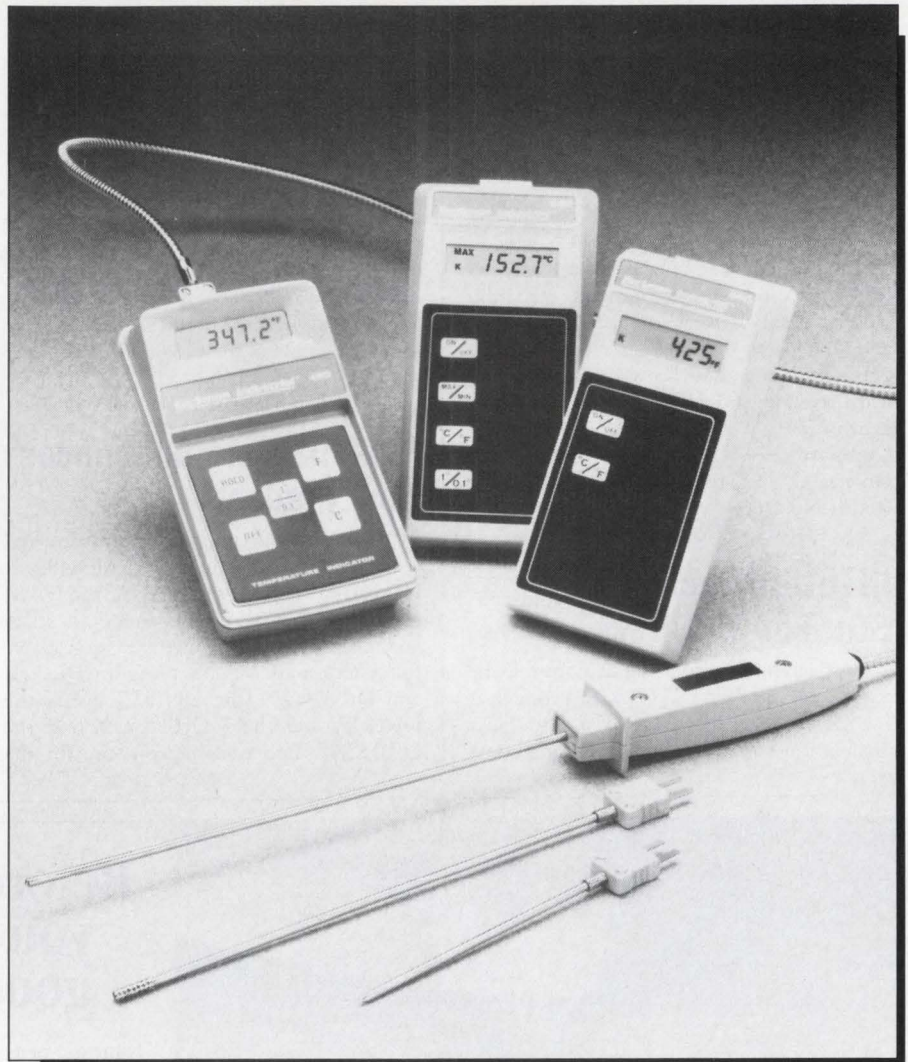

Beckman Industrial Corporation's three new digital thermometers.

monthly. Businesses ranging from Fortune 1000 companies to small businesses, in addition to large government, medical and education sites, are interviewed.

To learn more, contact Computer Intelligence, 3344 N. Torrey Pines Ct., La Jolla, CA 92037; (619) 450-1667. Visit Booth No. 658.

Enter 323 on reader card

VAX Link/APPC Unveiled

Systems Strategies Inc., an AGS Company, will introduce its new VAX Link/APPC connectivity software package at DEXPO West. The new package is part of the company's DEC-to-IBM communications software line.

VAX Link/APPC is a software interface that provides peer-to-peer communications capabilities between VAX and MicroVAX systems and IBM mid-range systems in an

SNA environment. The package provides complete support for IBM's LU6.2, known as Advanced Program-to-Program Communications (APPC), and T2.1 nodes. This enables the DEC systems to share data and applications with IBM devices supporting LU6.2, such as System/36s and System/38s, without mainframe intervention.

Find out more by contacting Systems Strategies Inc., 225 W. 34th St., New York, NY 10001; (212) 279-8400; Telex: 380226. Stop by Booth No. 1039.

Enter 324 on reader card

Beckman Introduces Digital Thermometers

Beckman Industrial Corporation, Instrumentation Products Division, has added three digital thermometers to the company's product line. Models 440, 445 and 450 handheld thermometers all offer a number of

features for use in the field or laboratory: an LCD display that is read easily in all lighting conditions; auto-off to extend battery life; the ability to switch from Fahrenheit to Celsius; and a splash-proof "touch-type" keyboard that ensures the model's portability to field locations without the risk of weather damage.

Model 440 lists for \$99, the 445 lists for \$169, and the 450 lists for \$295.

For additional information, contact Beckman Industrial Corporation, 3883 Ruffin Rd., San Diego, CA 92123-1898; (619) 565-4415.

Enter 330 on reader card

Companion Color Printer Presented By DEC

Digital Equipment Corporation recently introduced LJ250/LJ252 Companion Color Printer. This product offers superior text and graphics color printing capabilities. When using the Companion Color Printer, you can print graphs, pie charts, bar charts, CAD/CAM drawings and schematics on paper or transparencies. Its advanced technology allows up to 255 colors to be printed on a single page. Text and graphic protocols are supported for Digital's computer systems, as well as IBM and other compatible PCs.

For more information, contact Digital Equipment Corporation, 129 Parker St., Maynard, MA 01754; (800) DECINFO.

Enter 327 on reader card

Softwind Develops XTEND

Softwind Ltd. has released XTEND, an extension of X-WINDOWS, CGI and Tektronix protocols, bound into a user-friendly, portable graphics development system. The environment of XTEND is X-WINDOWS and UNIX. XTEND allows you to port existing applications or develop new portable applications that are hardware independent. For example, in a few hours, XTEND and EDS-386 (a graphics editor) were ported from a MicroVAX to three different 386 implementations.

Find out more by contacting Softwind Ltd., Dept. 109-171, P.O. Box 38003, Los Gatos, CA 95031-8003; (408) 356-3180; Telex: 797720 GRI SLG; FAX: (408) 356-3180.

Enter 329 on reader card

DEC Announces VAX Enhancements

DEC has announced a number of performance enhancements to its VAX 8000 series, significantly lower prices on its MicroVAX 2000 computers, and price-performance adjustments across its entire product line.

Digital has made effective performance

enhancements resulting in an increased throughput of up to 40 percent, made possible by two new high-density memory products that expand the system capacities of all VAX 8000 series systems; price reductions on the VAX 8250, VAX 8350, and VAX 8530 system configurations, and system enhancements and price adjustments across the balance of the VAX 8000 line to more accurately reflect system performance and customer value; the ability of all VAX 8000

series systems to directly attach to Local Area VAXclusters; a 50 percent reduction in the footprint size of 8530 and 8550 VAXcluster systems to six square feet, resulting in high power in a small space significant price reductions on PDP-11 computers; and much more.

Find out more by contacting Digital Equipment Corporation, Maynard, MA 01754-2571; (800) DECINFO.

Enter 326 on reader card

FOR VAX, PDP & IBM PC

RDM: THE APPLICATION DEVELOPER FOR THE DISTRIBUTED DATABASE

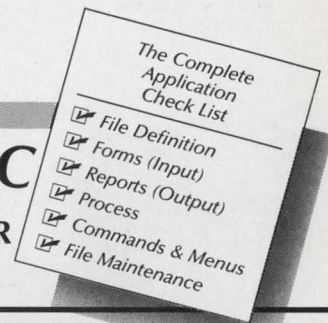

PORTABILITY REDUCES DEVELOPMENT COSTS

You will save time and money if you use the same software on your new VAX, your old PDP, and your workstation PC. RDM applications can be transferred between a total of 10 supported operating systems for DEC and IBM personal computers without change or rewrite.

SHARE DATA ACROSS YOUR NETWORK

With RDM forms, processes and reports, you can store or retrieve your data from related files located on either your VAX, PC Workstation or both.

NON LANGUAGE

Software development is more complex and costly when you pay for the time it takes to learn or relearn a language. RDM's fill-in-the-blank definition method eliminates the need to learn language syntax, the most difficult part of language learning.

WITH INTERACTIVE DESIGN — YOU SEE WHAT YOU GET

There is no better way to get what you want than to see it and change it on-line. RDM's interactive tools speed your development process by showing the result.

COMPLETED APPLICATION

Just as the job's not complete 'till the paperwork's done, your application's not finished until it's ready for the end-user. RDM command menus and help files bring your whole application together.

IT'S GOOD TO BE WITH GOOD COMPANY

RDM is used throughout the US, Canada and around the world by such corporations as American Hospital Supply, Argonne National Labs, BC Telephone, Boeing, Butler Manufacturing, Compudyne, DEC, Dow Chemical, ESI, FAA, Gannett News Service, GE . . .

JOIN THE CROWD. CALL OR WRITE TODAY. 800-362-6203

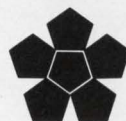

INTERACTIVE TECHNOLOGY, INC.

10700 SW Beaverton-Hillsdale Highway
460 Park Plaza West
Beaverton, OR 97005
503-644-0111 TLX: 703920

VAX, PDP-11, PRO-350 & VAXmate are registered trademarks of Digital Equipment Corp., Inc., Maynard, MA. RDM and The APPLICATION DEVELOPER are trademarks of Interactive Technology Incorporated. IBM PC is a trademark of IBM.

Exclusively UNIX.[®] Biweekly.

Now put the latest UNIX news at your fingertips. ■ You don't have to wade through other software and hardware news to find the UNIX information you need. ■ It's all right here in every biweekly issue of */usr/digest*. ■ Each edition is packed with information of the greatest interest to the UNIX systems community—new product information, new partnership announcements, product enhancement news, standards updates, executive moves. ■ The only news you'll find in */usr/digest* is UNIX news. ■ Subscribe today and make */usr/digest* your one-stop for complete UNIX information.

*/usr/group's
biweekly
industry
report*

JULY 27, 1987
Vol. 1 No. 3

/usr/digest

new products

A NEWLY ANNOUNCED "GENERIC" 386 multiprocessor system for 386 PC-compatibles—the ATtain 386 from Corollary, Inc.—will run SCO Xenix and accommodate up to five 386 processors, supporting as many as 64 users. ATtain 386 will include an 80386 processor, 4MB of memory and four specialized I/O ports that can each interconnect to Corollary's current eight-line terminal concentrator. On the significance of the new product, Corollary President George White explains, "Generic, a multiple-sourced hardware and software IBM PC and MS-DOS, and the real microcomputers and minicomputer, the same binary interchangeability enables Xenix to be used by the existing White

puters' new low-end RISC-based superminicomputer, the Ridge 32 Turbo/RX. The new computer supports up to 32 interactive users, and runs 2.3 VAX MIPS and I/O of 8MB per second, according to Ridge. Its CPU provides 16KB of cache memory and up to 32MB of main memory. The system can be configured with a 60MB cartridge tape, 150MB or 300MB Winchester disk, and 8 to 32 RS-232 ports. The computer is available now.

Contact: Ridge Com.,
Santa Clara, CA 95054
7/13/87

TWO SERIAL COMMUNICATIONS BOARDS for the AIX-based IBM RT PC are now available from Dickens Data Systems. The DDS 8-Port Standard is based on the Intel 8088-2 processor, with baud rates up to 38.4Kbps. The DDS 8-Port Plus is based on the Intel 80186 processor, with baud rates up to 76.8Kbps. Both boards provide eight additional serial ports for each PC.

Dickens Data Systems, 3850 Holcomb
30, Norcross, GA 30092; (404) 471/10/87

NEW RISC-BASED 10-MIPS Sun-4, delivers 1.6 Mflops floating-point performance. The workstation offers 16MB of memory, and is source-code compatible with Sun-3 and Sun-2 workstation families. The Sun-4 system provides performance comparable to Sun-3 and Sun-2 systems, but at a lower price. The Sun-4, which is the initial entry point into Sun's RISC-based workstation family, is based on Sun's RISC Processor Architecture. The processor architecture that Sun calls SunOS, NFS, NEWS, SunView, and Sun-4 as well as C, Fortran and Pascal. Sun-4 targeted applications include CAD, electrical-CAD, artificial intelligence, earth resources and molecular modeling. Sun-4 models: Sun-4/260, Sun-4/330, Sun-4/380, Sun-4/420, Sun-4/480, Sun-4/540, Sun-4/600, Sun-4/660, Sun-4/720, Sun-4/780, Sun-4/840, Sun-4/900, Sun-4/960, Sun-4/1020, Sun-4/1080, Sun-4/1140, Sun-4/1200, Sun-4/1260, Sun-4/1320, Sun-4/1380, Sun-4/1440, Sun-4/1500, Sun-4/1560, Sun-4/1620, Sun-4/1680, Sun-4/1740, Sun-4/1800, Sun-4/1860, Sun-4/1920, Sun-4/1980, Sun-4/2040, Sun-4/2100, Sun-4/2160, Sun-4/2220, Sun-4/2280, Sun-4/2340, Sun-4/2400, Sun-4/2460, Sun-4/2520, Sun-4/2580, Sun-4/2640, Sun-4/2700, Sun-4/2760, Sun-4/2820, Sun-4/2880, Sun-4/2940, Sun-4/3000, Sun-4/3060, Sun-4/3120, Sun-4/3180, Sun-4/3240, Sun-4/3300, Sun-4/3360, Sun-4/3420, Sun-4/3480, Sun-4/3540, Sun-4/3600, Sun-4/3660, Sun-4/3720, Sun-4/3780, Sun-4/3840, Sun-4/3900, Sun-4/3960, Sun-4/4020, Sun-4/4080, Sun-4/4140, Sun-4/4200, Sun-4/4260, Sun-4/4320, Sun-4/4380, Sun-4/4440, Sun-4/4500, Sun-4/4560, Sun-4/4620, Sun-4/4680, Sun-4/4740, Sun-4/4800, Sun-4/4860, Sun-4/4920, Sun-4/4980, Sun-4/5040, Sun-4/5100, Sun-4/5160, Sun-4/5220, Sun-4/5280, Sun-4/5340, Sun-4/5400, Sun-4/5460, Sun-4/5520, Sun-4/5580, Sun-4/5640, Sun-4/5700, Sun-4/5760, Sun-4/5820, Sun-4/5880, Sun-4/5940, Sun-4/6000, Sun-4/6060, Sun-4/6120, Sun-4/6180, Sun-4/6240, Sun-4/6300, Sun-4/6360, Sun-4/6420, Sun-4/6480, Sun-4/6540, Sun-4/6600, Sun-4/6660, Sun-4/6720, Sun-4/6780, Sun-4/6840, Sun-4/6900, Sun-4/6960, Sun-4/7020, Sun-4/7080, Sun-4/7140, Sun-4/7200, Sun-4/7260, Sun-4/7320, Sun-4/7380, Sun-4/7440, Sun-4/7500, Sun-4/7560, Sun-4/7620, Sun-4/7680, Sun-4/7740, Sun-4/7800, Sun-4/7860, Sun-4/7920, Sun-4/7980, Sun-4/8040, Sun-4/8100, Sun-4/8160, Sun-4/8220, Sun-4/8280, Sun-4/8340, Sun-4/8400, Sun-4/8460, Sun-4/8520, Sun-4/8580, Sun-4/8640, Sun-4/8700, Sun-4/8760, Sun-4/8820, Sun-4/8880, Sun-4/8940, Sun-4/9000, Sun-4/9060, Sun-4/9120, Sun-4/9180, Sun-4/9240, Sun-4/9300, Sun-4/9360, Sun-4/9420, Sun-4/9480, Sun-4/9540, Sun-4/9600, Sun-4/9660, Sun-4/9720, Sun-4/9780, Sun-4/9840, Sun-4/9900, Sun-4/9960, Sun-4/10020, Sun-4/10080, Sun-4/10140, Sun-4/10200, Sun-4/10260, Sun-4/10320, Sun-4/10380, Sun-4/10440, Sun-4/10500, Sun-4/10560, Sun-4/10620, Sun-4/10680, Sun-4/10740, Sun-4/10800, Sun-4/10860, Sun-4/10920, Sun-4/10980, Sun-4/11040, Sun-4/11100, Sun-4/11160, Sun-4/11220, Sun-4/11280, Sun-4/11340, Sun-4/11400, Sun-4/11460, Sun-4/11520, Sun-4/11580, Sun-4/11640, Sun-4/11700, Sun-4/11760, Sun-4/11820, Sun-4/11880, Sun-4/11940, Sun-4/12000, Sun-4/12060, Sun-4/12120, Sun-4/12180, Sun-4/12240, Sun-4/12300, Sun-4/12360, Sun-4/12420, Sun-4/12480, Sun-4/12540, Sun-4/12600, Sun-4/12660, Sun-4/12720, Sun-4/12780, Sun-4/12840, Sun-4/12900, Sun-4/12960, Sun-4/13020, Sun-4/13080, Sun-4/13140, Sun-4/13200, Sun-4/13260, Sun-4/13320, Sun-4/13380, Sun-4/13440, Sun-4/13500, Sun-4/13560, Sun-4/13620, Sun-4/13680, Sun-4/13740, Sun-4/13800, Sun-4/13860, Sun-4/13920, Sun-4/13980, Sun-4/14040, Sun-4/14100, Sun-4/14160, Sun-4/14220, Sun-4/14280, Sun-4/14340, Sun-4/14400, Sun-4/14460, Sun-4/14520, Sun-4/14580, Sun-4/14640, Sun-4/14700, Sun-4/14760, Sun-4/14820, Sun-4/14880, Sun-4/14940, Sun-4/15000, Sun-4/15060, Sun-4/15120, Sun-4/15180, Sun-4/15240, Sun-4/15300, Sun-4/15360, Sun-4/15420, Sun-4/15480, Sun-4/15540, Sun-4/15600, Sun-4/15660, Sun-4/15720, Sun-4/15780, Sun-4/15840, Sun-4/15900, Sun-4/15960, Sun-4/16020, Sun-4/16080, Sun-4/16140, Sun-4/16200, Sun-4/16260, Sun-4/16320, Sun-4/16380, Sun-4/16440, Sun-4/16500, Sun-4/16560, Sun-4/16620, Sun-4/16680, Sun-4/16740, Sun-4/16800, Sun-4/16860, Sun-4/16920, Sun-4/16980, Sun-4/17040, Sun-4/17100, Sun-4/17160, Sun-4/17220, Sun-4/17280, Sun-4/17340, Sun-4/17400, Sun-4/17460, Sun-4/17520, Sun-4/17580, Sun-4/17640, Sun-4/17700, Sun-4/17760, Sun-4/17820, Sun-4/17880, Sun-4/17940, Sun-4/18000, Sun-4/18060, Sun-4/18120, Sun-4/18180, Sun-4/18240, Sun-4/18300, Sun-4/18360, Sun-4/18420, Sun-4/18480, Sun-4/18540, Sun-4/18600, Sun-4/18660, Sun-4/18720, Sun-4/18780, Sun-4/18840, Sun-4/18900, Sun-4/18960, Sun-4/19020, Sun-4/19080, Sun-4/19140, Sun-4/19200, Sun-4/19260, Sun-4/19320, Sun-4/19380, Sun-4/19440, Sun-4/19500, Sun-4/19560, Sun-4/19620, Sun-4/19680, Sun-4/19740, Sun-4/19800, Sun-4/19860, Sun-4/19920, Sun-4/19980, Sun-4/20040, Sun-4/20100, Sun-4/20160, Sun-4/20220, Sun-4/20280, Sun-4/20340, Sun-4/20400, Sun-4/20460, Sun-4/20520, Sun-4/20580, Sun-4/20640, Sun-4/20700, Sun-4/20760, Sun-4/20820, Sun-4/20880, Sun-4/20940, Sun-4/21000, Sun-4/21060, Sun-4/21120, Sun-4/21180, Sun-4/21240, Sun-4/21300, Sun-4/21360, Sun-4/21420, Sun-4/21480, Sun-4/21540, Sun-4/21600, Sun-4/21660, Sun-4/21720, Sun-4/21780, Sun-4/21840, Sun-4/21900, Sun-4/21960, Sun-4/22020, Sun-4/22080, Sun-4/22140, Sun-4/22200, Sun-4/22260, Sun-4/22320, Sun-4/22380, Sun-4/22440, Sun-4/22500, Sun-4/22560, Sun-4/22620, Sun-4/22680, Sun-4/22740, Sun-4/22800, Sun-4/22860, Sun-4/22920, Sun-4/22980, Sun-4/23040, Sun-4/23100, Sun-4/23160, Sun-4/23220, Sun-4/23280, Sun-4/23340, Sun-4/23400, Sun-4/23460, Sun-4/23520, Sun-4/23580, Sun-4/23640, Sun-4/23700, Sun-4/23760, Sun-4/23820, Sun-4/23880, Sun-4/23940, Sun-4/24000, Sun-4/24060, Sun-4/24120, Sun-4/24180, Sun-4/24240, Sun-4/24300, Sun-4/24360, Sun-4/24420, Sun-4/24480, Sun-4/24540, Sun-4/24600, Sun-4/24660, Sun-4/24720, Sun-4/24780, Sun-4/24840, Sun-4/24900, Sun-4/24960, Sun-4/25020, Sun-4/25080, Sun-4/25140, Sun-4/25200, Sun-4/25260, Sun-4/25320, Sun-4/25380, Sun-4/25440, Sun-4/25500, Sun-4/25560, Sun-4/25620, Sun-4/25680, Sun-4/25740, Sun-4/25800, Sun-4/25860, Sun-4/25920, Sun-4/25980, Sun-4/26040, Sun-4/26100, Sun-4/26160, Sun-4/26220, Sun-4/26280, Sun-4/26340, Sun-4/26400, Sun-4/26460, Sun-4/26520, Sun-4/26580, Sun-4/26640, Sun-4/26700, Sun-4/26760, Sun-4/26820, Sun-4/26880, Sun-4/26940, Sun-4/27000, Sun-4/27060, Sun-4/27120, Sun-4/27180, Sun-4/27240, Sun-4/27300, Sun-4/27360, Sun-4/27420, Sun-4/27480, Sun-4/27540, Sun-4/27600, Sun-4/27660, Sun-4/27720, Sun-4/27780, Sun-4/27840, Sun-4/27900, Sun-4/27960, Sun-4/28020, Sun-4/28080, Sun-4/28140, Sun-4/28200, Sun-4/28260, Sun-4/28320, Sun-4/28380, Sun-4/28440, Sun-4/28500, Sun-4/28560, Sun-4/28620, Sun-4/28680, Sun-4/28740, Sun-4/28800, Sun-4/28860, Sun-4/28920, Sun-4/28980, Sun-4/29040, Sun-4/29100, Sun-4/29160, Sun-4/29220, Sun-4/29280, Sun-4/29340, Sun-4/29400, Sun-4/29460, Sun-4/29520, Sun-4/29580, Sun-4/29640, Sun-4/29700, Sun-4/29760, Sun-4/29820, Sun-4/29880, Sun-4/29940, Sun-4/30000, Sun-4/30060, Sun-4/30120, Sun-4/30180, Sun-4/30240, Sun-4/30300, Sun-4/30360, Sun-4/30420, Sun-4/30480, Sun-4/30540, Sun-4/30600, Sun-4/30660, Sun-4/30720, Sun-4/30780, Sun-4/30840, Sun-4/30900, Sun-4/30960, Sun-4/31020, Sun-4/31080, Sun-4/31140, Sun-4/31200, Sun-4/31260, Sun-4/31320, Sun-4/31380, Sun-4/31440, Sun-4/31500, Sun-4/31560, Sun-4/31620, Sun-4/31680, Sun-4/31740, Sun-4/31800, Sun-4/31860, Sun-4/31920, Sun-4/31980, Sun-4/32040, Sun-4/32100, Sun-4/32160, Sun-4/32220, Sun-4/32280, Sun-4/32340, Sun-4/32400, Sun-4/32460, Sun-4/32520, Sun-4/32580, Sun-4/32640, Sun-4/32700, Sun-4/32760, Sun-4/32820, Sun-4/32880, Sun-4/32940, Sun-4/33000, Sun-4/33060, Sun-4/33120, Sun-4/33180, Sun-4/33240, Sun-4/33300, Sun-4/33360, Sun-4/33420, Sun-4/33480, Sun-4/33540, Sun-4/33600, Sun-4/33660, Sun-4/33720, Sun-4/33780, Sun-4/33840, Sun-4/33900, Sun-4/33960, Sun-4/34020, Sun-4/34080, Sun-4/34140, Sun-4/34200, Sun-4/34260, Sun-4/34320, Sun-4/34380, Sun-4/34440, Sun-4/34500, Sun-4/34560, Sun-4/34620, Sun-4/34680, Sun-4/34740, Sun-4/34800, Sun-4/34860, Sun-4/34920, Sun-4/34980, Sun-4/35040, Sun-4/35100, Sun-4/35160, Sun-4/35220, Sun-4/35280, Sun-4/35340, Sun-4/35400, Sun-4/35460, Sun-4/35520, Sun-4/35580, Sun-4/35640, Sun-4/35700, Sun-4/35760, Sun-4/35820, Sun-4/35880, Sun-4/35940, Sun-4/36000, Sun-4/36060, Sun-4/36120, Sun-4/36180, Sun-4/36240, Sun-4/36300, Sun-4/36360, Sun-4/36420, Sun-4/36480, Sun-4/36540, Sun-4/36600, Sun-4/36660, Sun-4/36720, Sun-4/36780, Sun-4/36840, Sun-4/36900, Sun-4/36960, Sun-4/37020, Sun-4/37080, Sun-4/37140, Sun-4/37200, Sun-4/37260, Sun-4/37320, Sun-4/37380, Sun-4/37440, Sun-4/37500, Sun-4/37560, Sun-4/37620, Sun-4/37680, Sun-4/37740, Sun-4/37800, Sun-4/37860, Sun-4/37920, Sun-4/37980, Sun-4/38040, Sun-4/38100, Sun-4/38160, Sun-4/38220, Sun-4/38280, Sun-4/38340, Sun-4/38400, Sun-4/38460, Sun-4/38520, Sun-4/38580, Sun-4/38640, Sun-4/38700, Sun-4/38760, Sun-4/38820, Sun-4/38880, Sun-4/38940, Sun-4/39000, Sun-4/39060, Sun-4/39120, Sun-4/39180, Sun-4/39240, Sun-4/39300, Sun-4/39360, Sun-4/39420, Sun-4/39480, Sun-4/39540, Sun-4/39600, Sun-4/39660, Sun-4/39720, Sun-4/39780, Sun-4/39840, Sun-4/39900, Sun-4/39960, Sun-4/40020, Sun-4/40080, Sun-4/40140, Sun-4/40200, Sun-4/40260, Sun-4/40320, Sun-4/40380, Sun-4/40440, Sun-4/40500, Sun-4/40560, Sun-4/40620, Sun-4/40680, Sun-4/40740, Sun-4/40800, Sun-4/40860, Sun-4/40920, Sun-4/40980, Sun-4/41040, Sun-4/41100, Sun-4/41160, Sun-4/41220, Sun-4/41280, Sun-4/41340, Sun-4/41400, Sun-4/41460, Sun-4/41520, Sun-4/41580, Sun-4/41640, Sun-4/41700, Sun-4/41760, Sun-4/41820, Sun-4/41880, Sun-4/41940, Sun-4/42000, Sun-4/42060, Sun-4/42120, Sun-4/42180, Sun-4/42240, Sun-4/42300, Sun-4/42360, Sun-4/42420, Sun-4/42480, Sun-4/42540, Sun-4/42600, Sun-4/42660, Sun-4/42720, Sun-4/42780, Sun-4/42840, Sun-4/42900, Sun-4/42960, Sun-4/43020, Sun-4/43080, Sun-4/43140, Sun-4/43200, Sun-4/43260, Sun-4/43320, Sun-4/43380, Sun-4/43440, Sun-4/43500, Sun-4/43560, Sun-4/43620, Sun-4/43680, Sun-4/43740, Sun-4/43800, Sun-4/43860, Sun-4/43920, Sun-4/43980, Sun-4/44040, Sun-4/44100, Sun-4/44160, Sun-4/44220, Sun-4/44280, Sun-4/44340, Sun-4/44400, Sun-4/44460, Sun-4/44520, Sun-4/44580, Sun-4/44640, Sun-4/44700, Sun-4/44760, Sun-4/44820, Sun-4/44880, Sun-4/44940, Sun-4/45000, Sun-4/45060, Sun-4/45120, Sun-4/45180, Sun-4/45240, Sun-4/45300, Sun-4/45360, Sun-4/45420, Sun-4/45480, Sun-4/45540, Sun-4/45600, Sun-4/45660, Sun-4/45720, Sun-4/45780, Sun-4/45840, Sun-4/45900, Sun-4/45960, Sun-4/46020, Sun-4/46080, Sun-4/46140, Sun-4/46200, Sun-4/46260, Sun-4/46320, Sun-4/46380, Sun-4/46440, Sun-4/46500, Sun-4/46560, Sun-4/46620, Sun-4/46680, Sun-4/46740, Sun-4/46800, Sun-4/46860, Sun-4/46920, Sun-4/46980, Sun-4/47040, Sun-4/47100, Sun-4/47160, Sun-4/47220, Sun-4/47280, Sun-4/47340, Sun-4/47400, Sun-4/47460, Sun-4/47520, Sun-4/47580, Sun-4/47640, Sun-4/47700, Sun-4/47760, Sun-4/47820, Sun-4/47880, Sun-4/47940, Sun-4/48000, Sun-4/48060, Sun-4/48120, Sun-4/48180, Sun-4/48240, Sun-4/48300, Sun-4/48360, Sun-4/48420, Sun-4/48480, Sun-4/48540, Sun-4/48600, Sun-4/48660, Sun-4/48720, Sun-4/48780, Sun-4/48840, Sun-4/48900, Sun-4/48960, Sun-4/49020, Sun-4/49080, Sun-4/49140, Sun-4/49200, Sun-4/49260, Sun-4/49320, Sun-4/49380, Sun-4/49440, Sun-4/49500, Sun-4/49560, Sun-4/49620, Sun-4/49680, Sun-4/49740, Sun-4/49800, Sun-4/49860, Sun-4/49920, Sun-4/49980, Sun-4/50040, Sun-4/50100, Sun-4/50160, Sun-4/50220, Sun-4/50280, Sun-4/50340, Sun-4/50400, Sun-4/50460, Sun-4/50520, Sun-4/50580, Sun-4/50640, Sun-4/50700, Sun-4/50760, Sun-4/50820, Sun-4/50880, Sun-4/50940, Sun-4/51000, Sun-4/51060, Sun-4/51120, Sun-4/51180, Sun-4/51240, Sun-4/51300, Sun-4/51360, Sun-4/51420, Sun-4/51480, Sun-4/51540, Sun-4/51600, Sun-4/51660, Sun-4/51720, Sun-4/51780, Sun-4/51840, Sun-4/51900, Sun-4/51960, Sun-4/52020, Sun-4/52080, Sun-4/52140, Sun-4/52200, Sun-4/52260, Sun-4/52320, Sun-4/52380, Sun-4/52440, Sun-4/52500, Sun-4/52560, Sun-4/52620, Sun-4/52680, Sun-4/52740, Sun-4/52800, Sun-4/52860, Sun-4/52920, Sun-4/52980, Sun-4/53040, Sun-4/53100, Sun-4/53160, Sun-4/53220, Sun-4/53280, Sun-4/53340, Sun-4/53400, Sun-4/53460, Sun-4/53520, Sun-4/53580, Sun-4/53640, Sun-4/53700, Sun-4/53760, Sun-4/53820, Sun-4/53880, Sun-4/53940, Sun-4/54000, Sun-4/54060, Sun-4/54120, Sun-4/54180, Sun-4/54240, Sun-4/54300, Sun-4/54360, Sun-4/54420, Sun-4/54480, Sun-4/54540, Sun-4/54600, Sun-4/54660, Sun-4/54720, Sun-4/54780, Sun-4/54840, Sun-4/54900, Sun-4/54960, Sun-4/55020, Sun-4/55080, Sun-4/55140, Sun-4/55200, Sun-4/55260, Sun-4/55320, Sun-4/55380, Sun-4/55440, Sun-4/55500, Sun-4/55560, Sun-4/55620, Sun-4/55680, Sun-4/55740, Sun-4/55800, Sun-4/55860, Sun-4/55920, Sun-4/55980, Sun-4/56040, Sun-4/56100, Sun-4/56160, Sun-4/56220, Sun-4/56280, Sun-4/56340, Sun-4/56400, Sun-4/56460, Sun-4/56520, Sun-4/56580, Sun-4/56640, Sun-4/56700, Sun-4/56760, Sun-4/56820, Sun-4/56880, Sun-4/56940, Sun-4/57000, Sun-4/57060, Sun-4/57120, Sun-4/57180, Sun-4/57240, Sun-4/57300, Sun-4/57360, Sun-4/57420, Sun-4/57480, Sun-4/57540, Sun-4/57600, Sun-4/57660, Sun-4/57720, Sun-4/57780, Sun-4/57840, Sun-4/57900, Sun-4/57960, Sun-4/58020, Sun-4/58080, Sun-4/58140, Sun-4/58200, Sun-4/58260, Sun-4/58320, Sun-4/58380, Sun-4/58440, Sun-4/58500, Sun-4/58560, Sun-4/58620, Sun-4/58680, Sun-4/58740, Sun-4/58800, Sun-4/58860, Sun-4/58920, Sun-4/58980, Sun-4/59040, Sun-4/59100, Sun-4/59160, Sun-4/59220, Sun-4/59280, Sun-4/59340, Sun-4/59400, Sun-4/59460, Sun-4/59520, Sun-4/59580, Sun-4/59640, Sun-4/59700, Sun-4/59760, Sun-4/59820, Sun-4/59880, Sun-4/59940, Sun-4/60000, Sun-4/60060, Sun-4/60120, Sun-4/60180, Sun-4/60240, Sun-4/60300, Sun-4/60360, Sun-4/60420, Sun-4/60480, Sun-4/60540, Sun-4/60600, Sun-4/60660, Sun-4/60720, Sun-4/60780, Sun-4/60840, Sun-4/60900, Sun-4/60960, Sun-4/61020, Sun-4/61080, Sun-4/61140, Sun-4/61200, Sun-4/61260, Sun-4/61320, Sun-4/61380, Sun-4/61440, Sun-4/61500, Sun-4/61560, Sun-4/61620, Sun-4/61680, Sun-4/61740, Sun-4/61800, Sun-4/61860, Sun-4/61920, Sun-4/61980, Sun-4/62040, Sun-4/62100, Sun-4/62160, Sun-4/62220, Sun-4/62280, Sun-4/62340, Sun-4/62400, Sun-4/62460, Sun-4/62520, Sun-4/62580, Sun-4/62640, Sun-4/62700, Sun-4/62760, Sun-4/62820, Sun-4/62880, Sun-4/62940, Sun-4/63000, Sun-4/63060, Sun-4/63120, Sun-4/63180, Sun-4/63240, Sun-4/63300, Sun-4/63360, Sun-4/63420, Sun-4/63480, Sun-4/63540, Sun-4/63600, Sun-4/63660, Sun-4/63720, Sun-4/63780, Sun-4/63840, Sun-4/63900, Sun-4/63960, Sun-4/64020, Sun-4/64080, Sun-4/64140, Sun-4/64200, Sun-4/64260, Sun-4/64320, Sun-4/64380, Sun-4/64440, Sun-4/64500, Sun-4/64560, Sun-4/64620, Sun-4/64680, Sun-4/64740, Sun-4/64800, Sun-4/64860, Sun-4/64920, Sun-4/64980, Sun-4/65040, Sun-4/65100, Sun-4/65160, Sun-4/65220, Sun-4/65280, Sun-4/65340, Sun-4/65400, Sun-4/65460, Sun-4/65520, Sun-4/65580, Sun-4/65640, Sun-4/65700, Sun-4/65760, Sun-4/65820, Sun-4/65880, Sun-4/65940, Sun-4/66000, Sun-4/66060, Sun-4/66120, Sun-4/66180, Sun-4/66240, Sun-4/66300, Sun-4/66360, Sun-4/66420, Sun-4/66480, Sun-4/66540, Sun-4/66600, Sun-4/66660, Sun-4/66720, Sun-4/66780, Sun-4/66840, Sun-4/66900, Sun-4/66960, Sun-4/67020, Sun-4/67080, Sun-4/67140, Sun-4/67200, Sun-4/67260, Sun-4/67320, Sun-4/67380, Sun-4/67440, Sun-4/67500, Sun-4/67560, Sun-4/67620, Sun-4/67680, Sun-4/67740, Sun-4/67800, Sun-

EMON Analyzes Ethernet Traffic

Bear Computer Systems Inc. has announced its new Ethernet monitoring utility, EMON. EMON analyzes traffic on the Ethernet via a monitoring process that runs on VAX/VMS. By providing an online window into the Ethernet, it displays complete packet information. All headers, data fields, etc., are available with filter options for capture and display on the terminal. Also, automatic capture to a statistical file for playback with time stamping may be set for predetermined time intervals. Extra hardware isn't needed.

For more information, contact Bear Computer Systems Inc., 5651 Case Ave., North Hollywood, CA 91601-9985; (800) 255-0662 or (818) 508-1894; FAX: (818) 508-1698.

Enter 362 on reader card

Versatec Announces Turbo Option

Users of Versatec graphic plotting systems with the RPM 800 series rasterizers can obtain up to a 30 percent improvement in performance with the new RPM Turbo option available for RPM controllers with the Versatec Parallel Interface.

The RPM 800 series of intelligent controllers off-loads the data ordering and raster conversion tasks from the host computer, controls the plotter and can generate multiple copies of plots without further intervention from the host computer. The power of the RPM and the Turbo RPM allows not only large host computers, but also workstations to access the throughput of high-speed, high-resolution electrostatic and thermal transfer plotters, including 44-inch wide 400 points-per-inch electrostatic color plotters.

The RPM Turbo option is \$2,000 and is available for the RPM 810, 820 and 830 models with the Versatec Parallel Interface. For more information, contact Versatec, 2710 Walsh Ave., Santa Clara, CA 95051; (800) 538-6477. In CA call (800) 341-6060.

Enter 331 on reader card

Tartan Releases Ada Compiler Systems

Tartan Laboratories has released a powerful development and execution environment for the Ada language: TARTAN Ada VMS and TARTAN Ada VMS/1750A. TARTAN Ada combines advanced code generation technology with Ada language expertise.

The compilers are validated to ANSI/MIL-STD-1815A and are suited for Ada language applications. TARTAN Ada

VMS/1750A also is the only 1750A cross compiler to be validated using a VAX/VMS host and three 1750A hardware configurations — Fairchild, Mikros, and Unisys.

TARTAN Ada compilers perform traditional optimizations, code motion transformations, and peephole optimizations. TAR-

TAN Ada VMS/1750 is designed specifically to meet the challenges associated with real-time applications development.

Learn more by contacting Tartan Laboratories Inc., 461 Melwood Ave., Pittsburgh, PA 15213; (412) 621-2210.

Enter 334 on reader card

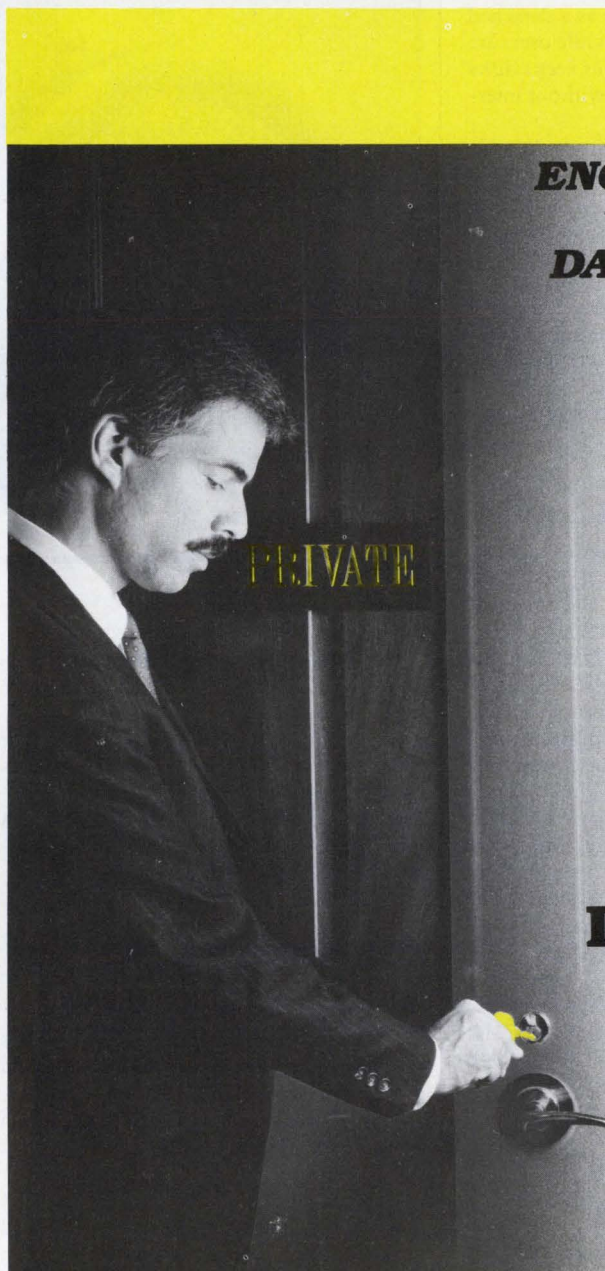

ENCRYPTION — THE KEY TO DATA PRIVACY

Beyond security — there is ultimate privacy.

With **DataLock**, high speed VAX/VMS data encryption software, only you know which one of the 70 billion possible keys will decipher your most confidential information. **DataLock** protects your data — for safekeeping on your own system or while sending it privately to someone else.

Essential whenever sensitive information must be kept secure, **DataLock** transparently encrypts and decrypts data to the US Government Data Encryption Standard. All your data resides on the disk in encoded form so your file appears meaningless to anyone but you.

In exclusive tests, DR Labs found **DataLock** "was easy to use and performed flawlessly."

From the most confidential memos to the most sensitive medical records . . . from the transfer of electronic bank funds to the prevention of unauthorized software copying . . . the **DataLock** defense takes you generations beyond VMS password protection.

DataLock

The Key to Ultimate Privacy

Call today.
Find out how **DataLock** can protect your sensitive data.
800-362-6203
In Canada call: 800-255-6378



INTERACTIVE TECHNOLOGY, INC.
460 Park Plaza West
10700 SW Beaverton-Hillsdale Hwy.
Beaverton, Oregon 97005
(503) 644-0111

VAX and VMS are trademarks of Digital Equipment Corporation. **DataLock** is a trademark of JPY Associates.

ENTER 232 ON READER CARD

Diskeeper V2.0 Announced

Executive Software Inc. announced Diskeeper V2.0, an online disk defragmenter for VAX/VMS. Diskeeper eliminates fragmentation of files to allow data to be read from the disk at maximum speed while also grouping free space at the front of the disk for efficient and contiguous creation of files. With the ability to run online as a detached process (in the background), while users are accessing the system, Diskeeper keeps disks running at peak performance without interrupting users.

Diskeeper's use of the single-I/O file changeover, read-check and write-check and the absence of scratch space on the same disk or a second drive, guarantees complete safety of a user data file while Diskeeper is relocating it.

For further information, contact Executive Software Inc., 3131 Foothill Blvd., Suite F, La Crescenta, CA 91214-2699; (818) 249-4709; Telex: (910) 240-9222.

Enter 337 on reader card

VT220 Emulator Connects Systems

KEA Systems Ltd. announces ZSTEMpc-VT220 version 3.2 for connecting IBM PC/XT/ATs and compatibles and the IBM PS/2 systems to PDP-11 and VAX computers. In version 3.2, support has been added for the PS/2 Video Graphics Array (VGA) display adapter. ZSTEM supports all VT220 attributes including true double-high/double-wide characters, true smooth scrolling, and true 132-column mode.

Additional capabilities have been included in Version 3.2. Ungermann-Bass Net/One now is supported. This is the first network board for the PS/2 systems. The Tektronix 4014 option now supports the full 640 by 480 resolution of the VGA.

Learn more by contacting KEA Systems Ltd., 2150 W. Broadway, Ste. 412, Vancouver, BC Canada V6K 4L9; Support: (604) 732-7411; FAX: (604) 732-0715; Telex: 0435-2848 VCR; telephone orders: (800) 663-8702.

Enter 332 on reader card

Ki Research Offers Phase IV Endnode

Ki Research developed a Phase IV DECnet Endnode-compatible network communications software product for Data General MV Series computers. Ki's DEKnet product provides for cooperating tasks to exchange data between Data General MVs and DEC's VAXs using the DECnet protocol suite.

Ki's DEKnet is user-installable and has



Diskeeper V2.0 from Executive Software.

a menu-driven network configuration program called PCONFIG that allows the MV to be defined as a Phase IV DECnet Endnode. In addition, PCONFIG may accept or generate command file input that contains network configuration information.

For further information, contact Ki Research Inc., 11990-1 Little Patuxent Pkwy., Columbia, MD 21044; (301) 730-0675.

Enter 336 on reader card

CIS Modules Make CAD Simple, Powerful

The CIS Medusa product family comprises an evolving set of computer-aided design and manufacturing (CAD/CAM) software products. CIS Medusa software is modular and can be purchased in a variety of off-the-shelf configurations that can be expanded.

CIS Medusa software consists of general-purpose (core) and specialized modules that make use of close integration with relational database access facilities. General-purpose modules consist of core technologies such as 2-D drafting, 3-D solid modeling, parametrics, engineering drawing analysis (EDA), relational database (MDB) and document manager.

CIS Medusa runs on hardware plat-

forms from DEC and Sun Microsystems. To learn more, contact CIS Medusa Inc., 201 Burlington Rd., Bedford, MA 01730; (617) 276-1288.

Enter 340 on reader card

Imunelec's Series 11 Gives Power Protection

Imunelec's Series 11 consists of an AC-supplied rectifier-charger, a maintenance-free sealed lead storage battery, and an inverter converting power from the rectifier or battery into a pure sine-wave, free from all supply system problems.

The rectifier-charger is a highly reliable isolation transformer with electronically controlled charger, rectifier and filter. The inverter includes a crystal-driven oscillator with high-frequency stability and all electronic circuits for control and processing of the power stages.

Imunelec produces only UPS for micro, mini, supermini, and mainframe models, ranging in power from 300 VA to 600 KVA. Learn more by contacting Imunelec Inc., 7600 Jericho Tpke., Ste. 201, Woodbury, NY 11797; (516) 364-8008; Telex: 475-8122; FAX: (516) 364-0103.

Enter 338 on reader card

L O G I C R A F T

The Leader
In
Integrating
PC's with
DEC
Computers

Logicraft's mission is to provide DEC users economic access to the vast PC Software Library.

Call Logicraft today to arrange for an on-line modem demonstration of how you can run PC programs on your DEC terminal.

386 WARE

- Provides high speed PC capability as a shareable system resource
- Allows any VT terminal on ethernet to run PC software
- Full PC capability for less than 1/10th the cost of a PC



INTRODUCES

386

W A R E

LOGICRAFT

22 Cotton Road
Nashua, NH 03063

(603) 880-0300
Telex 70 3961

Customer Support Offices in
London, Los Angeles,
Dallas, Minneapolis

ENTER 135 ON READER CARD

RABBIT-7 Is Fast And Safe

RAXCO Inc. has announced the RABBIT-7 Disk Optimizer Version 2.0 software. The R-7 runs up to twice as fast on the VAX/VMS computer system, and does a better job at eliminating file fragmentation for better disk performance. R-7 Disk Optimizer V2.0 now runs concurrently on multiple disks, and has an intelligent continuous detached processing algorithm.

For further information, contact RAXCO Inc., 1370 Piccard Dr., Rockville, MD 20850; (301) 258-2620; TWX: (810) 766-2256.

Enter 339 on reader card

Objective-C Available For VAX/VMS

Release 3.3 of the Objective-C object-oriented software engineering language from Productivity Products International Inc. (PPI) is available for VAX/VMS. Objective-C is compatible with all VMS utility programs and productivity tools. Its applications also have full access to all VMS run-time facilities, including graphics and windowing.

VAX/VMS users can integrate Objective-C with the VAX/VMS common language environment, allowing integration with all VAX/VMS language processors, including PASCAL, LISP, COBOL, C, FORTRAN and Macro-32. Objective-C supports all VMS C language extensions and features. Learn more by contacting Productivity Products International Inc., Glen Rd., Sandy Hook, CT 06482; (203) 426-1875; Telex: 506127.

Enter 335 on reader card

Cadre Offers Teamwork For Two VAXstations

Cadre Technologies Inc. announced the availability of Cadre's Teamwork computer-aided software engineering (CASE) tools running on DEC's new VAXstation 3200 and 3500 systems. The CASE tools family includes support for the automation of systems analysis, real-time systems analysis, information modeling, and systems design phases of the software development life cycle.

Cadre and DEC have a CMP agreement and market systems for the CASE industry.

The Teamwork product line is available for the VAX family of computers and

workstations under the VMS operating system.

Teamwork products range in price from \$900 to \$7,500.

Additional information may be obtained by contacting Cadre Technologies, 222 Richmond St., Providence, RI 02903; (401) 351-5950.

Enter 343 on reader card

Power Protection Brochure Available

The new eight-page brochure, *Single Source Power Protection* from International Power Machines, is available. This brochure contains information on uninterruptible power supplies (UPS), why they are needed, how they work, and some of the innovations that International Power Machines has contributed to UPS technology. There are also descriptions and illustrations of its two series of UPS, monitoring options, power conditioners and power distribution units.

A copy of this brochure may be requested by contacting Informational Power Machines, 11534 Pagemill Rd., Dallas, TX 75243; (214) 343-6076; Telex: 794078.

Enter 341 on reader card

★ Utility Package for TSX-Plus™ ★ (You'll wonder how you ever got along without it!)

- Over 60 programs
- System management tools
- Security aids
- Hardware configuration/testing programs
- Program test & development tools
- Full documentation
- One or two of these utilities is worth the price of the entire package!

Here's a sample of what's included—

For use with TSX+ only:

- CTRLC*** Control-C another user's program when it hangs (instead of KILLing the job)
- HANDMP*** Write a snapshot copy of current handler memory to a disk file for later analysis
- HANDLD*** Load a fresh copy of handler ("fixes" some hung device situations)
- LDSHOW*** Show another user's logical disk subset (or subdirectory) mounts
- PDUMP*** Dumps out memory of TSX+ or of another user's running program
- SETOP*** Sets operator console (terminal) that OPERATOR messages go to
- SHRFL*** Lists all open files: file name, size, date for each running program with job number and program name
- SQSY*** Squeeze system disk from non-operator console terminal under TSX+
- TSXBOOT*** Reliably boot RT-11™ from TSX+ (for unsupported TSX+ devices)
- TTYPEX*** Most wanted utility! Displays what is being output to another user's terminal. Invaluable for locating problems with dialup users
- XSEND*** Extended SEND command: sends to terminal whether or not logged on, time/date stamps message
- USAS*** Show another user's assignments

For use with either TSX+ and/or RT-11:

- CMPRES** Data compression program minimizes data transmission time or storage space
- COPYLK** Generalized copy utility. Copies blocks, or byte strings, optionally concatenates at high speed
- CRSEK*** Adds a segment to a directory file with *PIP-F Device full)
- CS** Compute CRCs of files on a disk, or display names of those files that have changed since last run
- DIRBAK*** Create a backup copy of a disk directory in case the directory becomes corrupted. A "must" program
- DIRMPP*** Display directory in dump format (Octal ASCII)
- DIRREST*** Restore a disk directory from the backup copy made by DIRBAK

*A user must have sufficient privileges to use this program

Other Products available for TSX+ and/or RT-11 include:

- MAIL** A comprehensive & user-friendly electronic mail system
- DE Drive** The "Eagle" disk driver for adding a HUGE disk
- DU*** Driver for a HUGE MSCP disk
- TSX-NET** "Transparent" communications between RT & TSX+
- ARCHIVE** Tape utility for saving and restoring disk files and subdirectories in convenient "save-sets"
- CT*OS** Full-featured word processor (now supports complete multi-national character set)
- JSAM** Coming soon: multi-key ISAM for DBL 2.2 users
- TSX-Plus** The user-friendly multi-user operating system
- DBL** Dblol compiler for RT-11 and TSX-Plus

TSX-Plus is a trademark of SAH Computers. DBL is a trademark of Digital Information Systems Corp. RT-11 and DBL are trademarks of Digital Equipment Corp.

- DMPMAC** Convert binary file (e.g. TRANSF SAV) to MACRO for downloading to a remote system
- DSKCOM** High speed disk compare
- FIXDIR*** Patches an invalid directory to ignore bad segments
- MTCOPY*** Copy between magnetic tape and disk files. Duplicate arbitrarily formatted tape (IBM ANSI, DOS, etc.)
- MTDUMP** Dump a tape. Necessary tool for tape analysis
- NCRYPT*** Encrypt or decrypt a file with user-specified encryption key for security of data
- SDIR** Search through (possibly nested) subdirectories without having to mount them
- SEARCH*** High speed search and optional replace through wildcarded file(s) or devices. Many users' favorite program
- SEGSCH*** Search for a file through a selected segment in a loaded up directory
- SET*** Alias SET command of RT-11 handlers under TSX+ or TSX+ handlers under RT-11; also available for debugging SET routines in handlers
- SETSND*** Display device handler set option values, and handler statistics, and SYSGEN configurations
- TRUNC*** Program to truncate a file to a smaller size
- UNDEL*** Undeletes files selected by wildcards. Preserves original date. Works when CREATE command fails. Optionally uses DIRBAK file to locate unlocatable files
- YT** Type a file backwards (for looking at the end of a file—where error messages are found)
- ZFILE*** Zeros a file/device/tape at high speed (for security reasons)

For use with RT-11 only:

- BD** Use BD to recover files on a disk when directory becomes unreadable (if DIRBAK has been run)
- DLTEST** Show CSR/Vector/Speed of DL-11's on system. Emit test pattern to a selected port
- SR** For debugging a program which traps to 4 or 10. Dumps registers, stack, and instructions
- TC** Display trace of EMTs when a program is run (decodes each EMT with directive name and argument values)
- TERMW*** Switch console to DL-11 port (no Multi Terminal Support required)
- ZT** Switch console to DZ-11 port (no Multi Terminal Support required)

ENTER 202 ON READER CARD

Networking Dynamics Corporation
1234 N. Edgemont St., Suite 214
Hollywood, CA 90029
(213) 668-0077
Telex: 311017 (NETWORK)

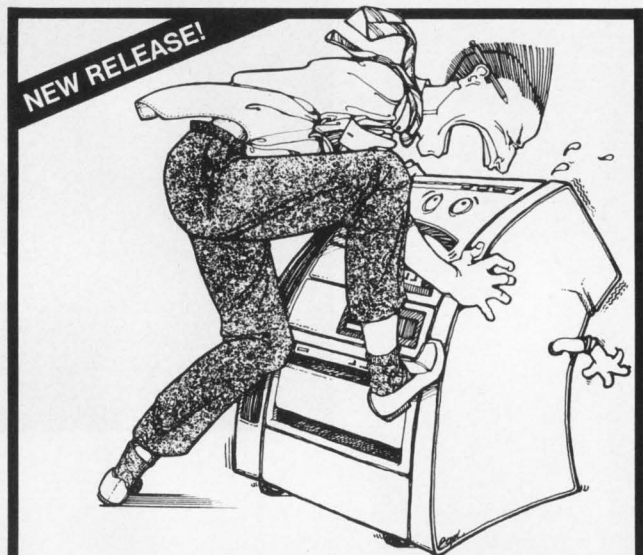

FEELING JUST SLIGHTLY FRUSTRATED
WITH YOUR SYSTEMS PERFORMANCE?

DSKBLD

The Ultimate Disk Optimizer for RSTS/E.

GrayMatter
Software & Consulting

(206) 285-7414

1300 Dexter Avenue North • Suite 550 • Seattle, Washington 98109

ENTER 124 ON READER CARD



A Winning Strategy for Finding Digital Equipment Computer Solutions

Protect Your Investment in DEC Computing

Building your DEC system efficiently demands a winning strategy: *Stay in tune with the latest technological developments and compare alternative solutions.*

In other words, come to DEXPO West 87.

It's your best strategy.

DEXPO brings you the best of DEC-style computing ... 300 vendors demonstrating over 10,000 DEC-compatible products and services. You get the answers you need. Plus hands-on technical assistance. Fast.

Push Your System to its Maximum Potential

Improve the productivity of all your VAXs — from MicroVAX to VAX 8800 clusters. Uncover the mysteries behind PC-VAX connectivity. Explore a universe of DBMS, Storage and Memory, CAD/CAM/CAE products. Keep your PDP-11s and older DEC systems at peak performance levels. You'll discover applications, ideas and solutions you've never even considered!

Register Now ... Call 800-433-0880

Complete and mail the attached reply card today or call to get your **FREE Show Preview** featuring over 100 of the newest DEC-compatibles. (And, be sure to ask for your money-saving VIP tickets!) Admission is **FREE** for Anaheim DECUS* Symposium Attendees.

IDC in cooperation with DEXPO presents:

"Corporate Computing: DEC vs. IBM, The Digital Challenge Continues"
A Two-Day Conference.

DEXPO is organized by Expoconsul International, Inc.,
3 Independence Way, Princeton, NJ 08540.

DEXPO® West 87

World's Largest DEC*-Compatible Exposition

Disneyland Hotel
Anaheim, California
December 8-10, 1987

*Registered trademark of Digital Equipment Corp.
DEXPO is not affiliated with or sponsored by DECUS.

ThumbScan Offers Authentication System

ThumbScan Inc. has announced a biometric authentication system that acquires and analyzes unique fingerprint data to ensure that only authorized users gain access to valuable information or funds.

The ThumbScan system interfaces with PC DOS, VAX, IBM mainframe environments and access control systems such as RACF, ACF-2, TOP SECRET, and VMSECURE. The security device costs \$995 per lot. Mainframe software costs \$9,500 and minicomputer software costs \$5,500.

For more information, contact ThumbScan Inc., Two Mid-America Plaza, Ste. 800, Oakbrook Terrace, IL 60181; (312) 954-2336.

Enter 347 on reader card

PCI Introduces SmartNet 3700

Protocol Computers Inc. (PCI) announces SmartNet 3700. SmartNet 3700 switches more than 100 packets per second.

The 3700 engine is an Intel 80286 16-bit microprocessor equipped with 250K of buffer space, providing high-speed network switching and line concentration. SmartNet diagnostics can be invoked locally or remotely.

SmartNet 3700 is available with two or four 64-Kbps X.25 links and four, eight or 12 medium speed links.

SmartNet 3700 is single-unit priced from \$6,400 with two 64 Kbps and four medium speed X.25 links.

To learn more, contact Protocol Computers Inc., 26630 Agoura Rd., Calabasas, CA 91302-1988; (818) 880-5704.

Enter 349 on reader card

New Line Driver Offered By Hitron

Hitron Systems Ltd. announced the availability of MLD 110, a miniature asynchronous line driver packaged inside a modular RS232 connector assembly. The MLD 110 allows high-speed asynchronous data transmission up to 19.2 Kbps over a two-mile range using telephone wires. It eliminates the need for expensive shielded data cables.

No external power is required. The MLD 110 drives power from RS232 control and data signals supplied by the data equipment. Its low power requirement ensures operation with all types of data equipment. It has built-in protection to guard against lightning strikes and power surges.

The MLD 110 plugs directly into the

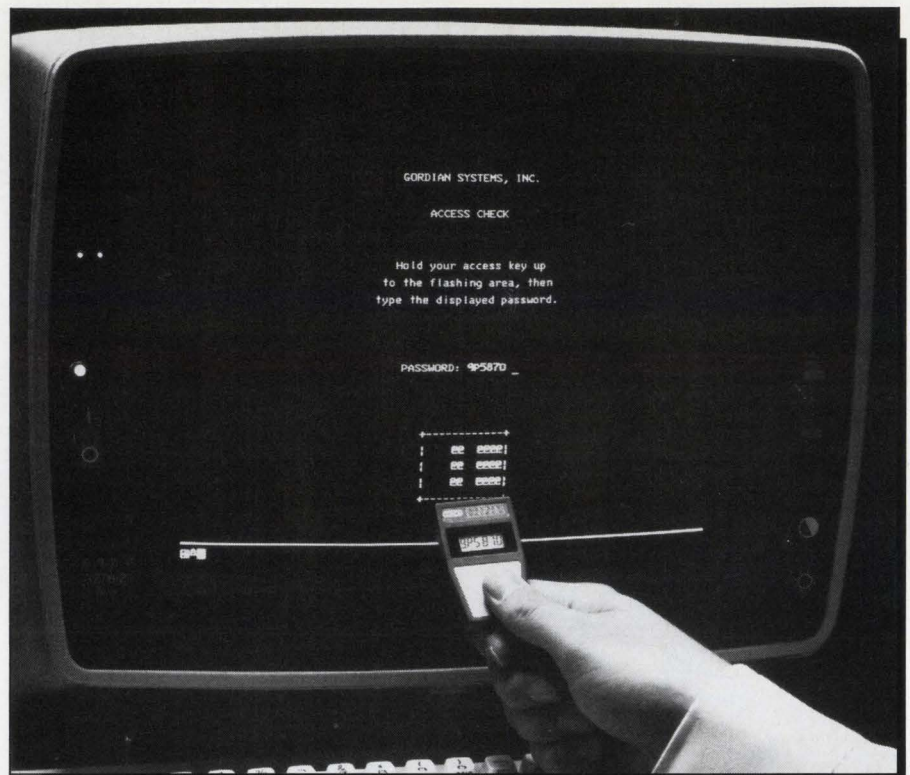

The ThumbScan Inc. system interfaces with VAXs.

RS232 connector of the data equipment. The integral RJ45/RJ11 modular jack allows connection to building wiring with a standard modular cable.

For additional information, contact Hitron Systems Ltd., 330 Brunel Rd., Mississauga, ON L4Z 1T5; (416) 890-3234. Telex: 0696-5553. FAX: (416) 890-5645.

Enter 350 on reader card

MARC And MENTAT For Sun Workstations

Sun Microsystems has announced two software products for mechanical engineering analysis on the Sun-3 family of technical workstations. Through Sun's third-party program, Moldflow Pty Ltd. will offer its computer-aided engineering and design software for plastic injection mold design, and MARC Analysis Research Corporation will offer its MARC and MENTAT finite element analysis software.

The new products allow mechanical and manufacturing engineers to analyze and modify 3-D product designs on the computer, at an earlier and more cost-effective stage of the design process, rather than in the prototype or production stage.

MARC and MENTAT work on all VAX and MicroVAX computers under VMS.

The Moldflow product is available at \$30,000 for a perpetual license, or \$12,000

annually for licensing, maintenance and support.

For more information, contact Sun Microsystems, 2550 Garcia Ave., Mountain View, CA 94043; (415) 960-1300 ext. 7737.

Enter 342 on reader card

EMETEK Enhances MAGIC MENU

MAGIC MENU, from EMETEK, lets users switch among programs. Version 1.3 lets programs run concurrently. Running under VMS 4.x, MAGIC MENU lets a user jump from any point in a program to any point in another program, and back. A single keystroke displays the menu, and the next program is chosen. MAGIC MENU stores the screens and the terminal attributes for each program, working with VT100/220/240 and compatibles, in VT52 or ANSII alphanumeric or line drawing mode. Version 1.3 will allow any program to be active as the user moves from program to program. Programs will continue to run until they need to output to the terminal.

Version 1.3 costs \$100 per user for each installation for the first 70 users, then \$20 per user thereafter.

For further information, contact EMETEK at 9136 Gibson St., Los Angeles, CA 90034; (213) 836-2784.

Enter 346 on reader card

Introducing the Ditto 221XL . . .

Except for superior resolution, incredible graphics, larger screen, over 11 major improvements, and the industry's longest warranty . . . It's just another DEC VT220* Compatible



Upgrade your DEC environment with the Ditto 221XL video display terminal from Networx Data Products Co. It has all the features of the DEC VT220 plus over 11 major improvements, including superior resolution, dual host port ability and a larger screen. And with the 221GXL upgrade you can create incredible graphs, charts, plots, drawings and many other monochrome graphics . . . without disturbing any of the 221XL's alpha-numeric features.

Best of all, the Ditto 221XL is available with a four-year warranty, the longest in the industry. And all this quality, reliability and service comes with a price tag that's hard to beat.

See why thousands of users are choosing the Ditto 221XL over any other VT220 compatible. For more information and spec sheets, write or call Networx today at 1-800-531-0019 or (516) 754-2798 within New York State.

Networx™
DATA PRODUCTS COMPANY, Inc.

188 Main Street • Northport, NY 11768

*DEC VT220 is a trademark of the Digital Equipment Corporation.

Colt Software Releases EasyPage

A desktop publishing system for the VAX and MicroVAX has been announced by Colt Software Technologies Inc. Word processing documents are formatted and composed into typeset quality documents for the LN03 laser printer. EasyPage integrates both text and graphics into illustrated documents.

EasyPage runs on the VAX, MicroVAX or VAXstation under VMS V4.4 or later. It requires a VT100/200/300 compatible terminal and an LN03 laser printer with an add-on memory cartridge. It supports DEC's A-to-Z Word Processing or DECType, and A-to-Z Business Graphics. EasyPage is integrated with DEC's A-to-Z System, but A-to-Z is not required.

EasyPage is available from Colt Software Technologies Inc., P.O. Box 8716, Red Bank, NJ 07701-8716; (201) 308-4404.

Enter 348 on reader card Archimedes Releases ANSI C-8096 Compiler

Archimedes Software Inc. introduced a new C compiler for the 16-bit Intel 8096

microcontroller family, with ANSI-standard C enhancements, several memory models including bankswitching, and universal PROM and emulator support. Archimedes C-8096 is available for the MicroVAX, VAX, IBM PC and compatibles.

The kit includes a C compiler and C library functions, as well as macroassembler, linker and librarian. C-8096 also supports IEEE 32-bit floating point for advanced math routines.

The PC, MicroVAX and VAX versions are priced at \$995, \$3,995 and \$5,995 respectively.

For more information, contact Archimedes Software Inc., 2159 Union St., San Francisco, CA 94123; (415) 567-4010.

Enter 352 on reader card

Interscience Introduces Band Printer Family

Interscience has announced a new family of band printers (1500 and 2000 LPM) that are plug compatible with DEC systems. These products are manufactured by Dataproducts and use Interscience proprietary interfaces.

Setup and operation are quick and easy. A swing open gate facilitates paper, ribbon and steel print band changing. A touch-

sensitive control panel includes a built-in self-test unit with switch selectable 80- or 132-column multiple pattern program. A built-in self-diagnostic display monitors all electronics and system interlocks.

The 1500 LPM and 2000 LPM printers list for \$20,031 and \$25,431 respectively. To find out more, contact Interscience Computer Sciences Inc., 5171 Clareton Dr., Agoura Hills, CA 91301; (818) 707-2000; Telex: 183628.

Enter 353 on reader card

CSD Enhances MRP II System

Computer Systems Development Inc. (CSD) announced IMPCON V3.0, its manufacturing resource planning (MRP II) system for the VAX. IMPCON offers 11 functional modules that can be configured to answer eight distinct application needs. CSD offers a broad range of software systems to extend the capabilities of IMPCON, including the AMSYS asset management system, CON-COST contract costing program, and BAR-CODING for barcode wand input and printing barcode documents. Version 3.0 has important capabilities for U.S. manufacturers facing inventory valuation changes required

KEEP UP IN A CHANGING WORLD

Take advantage of the wealth of knowledge available from your Government. The U.S. Government Printing Office has produced a new catalog. It tells about the most popular books sold by the Government — nearly 1,000 in all. Books on agriculture, business, children, diet, energy, health, history, space, and much more. For a free copy of this new catalog, write —

New Catalog

Post Office Box 37000
Washington, D.C. 20013

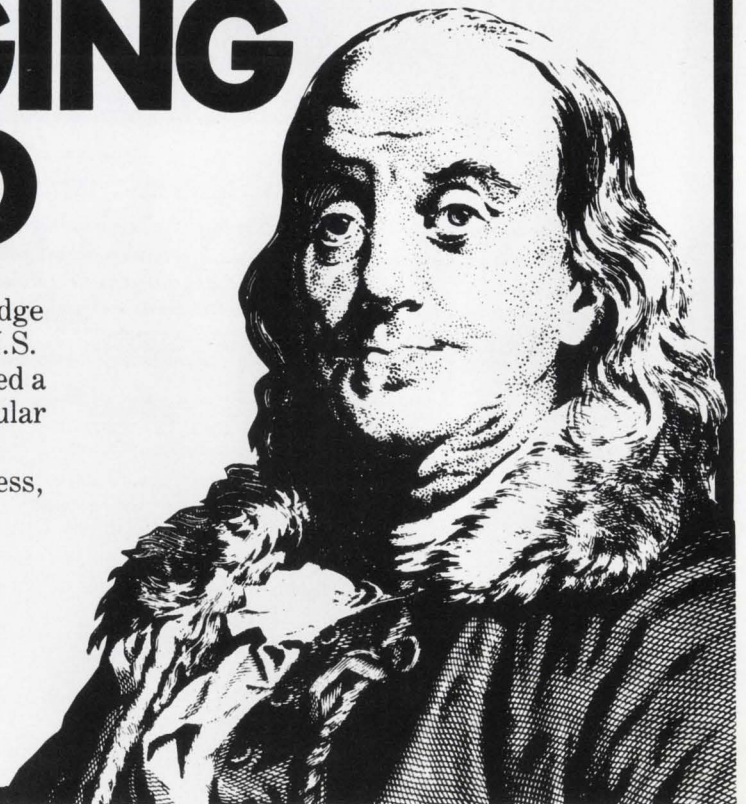

by the Tax Reform Act of 1986.

IMPCON V3.0 is priced between \$35,000 and \$200,000, depending on configuration.

For more information, contact CSD Inc., 910 Boston Post Rd., Marlborough, MA 01752; (617) 460-0330.

Enter 356 on reader card

Access Electronic Mail Via Touchtone Phone

Microtalker V, from Microtel Inc., permits users to call in and receive electronic mail messages from an ALL-IN-1 system. Messages are read to the caller in a human voice, and all of the Microtalker V's extensive voicemail functions are available within the system.

The system reads messages and the user can reply. Notification of replies is presented to the DEC user with a notation of who replied, when the reply was sent, and what number to call to hear the message. Messages are kept on both the DEC and Voicemail systems, and can be replayed, forwarded, or additional replies made.

The Microtel system is available in configurations of from four to 32 ports. A four-port system is \$24,000. Standard Microtel Voicemail systems up to 32 ports are priced between \$16,000 and \$59,000.

To find out more, contact Microtel Inc., 303 W. 42nd St., Ste. 405, New York, NY 10036; (212) 246-3440.

Enter 357 on reader card

CAI Announces M-Link

Century Analysis Inc, has announced the release of its new network management system called M-Link. M-Link manages end user connections to various combinations of mainframes, minis and micros in wide and local area network environments.

M-Link establishes and maintains concurrent end user sessions across various network links. This is accomplished by placing network management software in various types of processors including DEC mainframes and minis.

M-Link is priced between \$5,000 and \$20,000 per application node.

Additional information can be obtained from Century Analysis Inc., 114 Center Ave., Pacheco, CA 94553; (415) 680-7800.

Enter 359 on reader card

Pilot Announces EIS For MicroVAX 3500/3600s

Pilot Executive Software has announced the availability of the Pilot EIS, a software application that resides on the MicroVAX

PROBLEM: High Inrush Current SOLUTION: Multiple Time Delay™

POWER UP WITH

TPC 115-10 MTD™

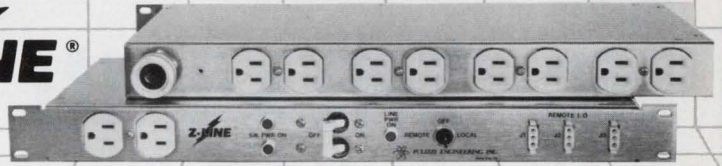

The Smallest Power Distribution & Control System

MTD™: Sequence your computers power-up with a controlled time delay between switched 1 and switched 2.

REMOTE: On/off & emergency shutdown, sequence power-up additional equipment downline. Visit us at WESCON '87, Booth #5032.

LINE PROTECTION: EMI/RFI, Spike & Surge.

PATENT PENDING

PULIZZI ENGINEERING INC.

3260 S. Susan Street, Santa Ana, CA 92704-6865 (714) 540-4229, FAX #714-641-9062

ENTER 185 ON READER CARD

PowerStation™

A Complete VT220 / VT240 Work Station Upgrade for the IBM PC/XT/AT and PS/2



"You'll never know you are not using a real DEC terminal unless you take advantage of the many extended features."

PowerStation™ 240 \$389
VT240 style keyboard and ZSTEM VT240 Emulation Software.

ZSTEM pc™ - VT240 Emulator Emulation Software only. \$250
VT240/241 Emulation software with all the features of ZSTEM VT220 plus ZSTEM 4014 and REGIS graphics.

PowerStation™ 220 \$289
VT220 style keyboard and ZSTEM VT220 emulation Software.

ZSTEMpc™-VT220 Emulator Emulation Software only. \$150
All the features of ZSTEM VT100 plus 8-bit mode, downloadable fonts, user defined keys, full national/multi-national modes. Extended macros/script language. True 132 columns on Hercules, VGAs, Super EGAs, and standard EGAs using the EGAmate option. 128 columns on CGAs. 43 line support on EGAs. Enhanced keyboard support. Ungermann Bass Net/One support.

EGAmate™ \$39
Daughterboard option for 132 columns on most standard EGA adaptors.

PS220/2 \$29
Keyboard adaptor cable for PS/2 systems.

ZSTEMpc™-4014 Emulator \$99
Use with ZSTEM VT100, VT220, or stand-alone. Interactive zoom and pan. Save/recall images from disk. Keypad, mouse, digitizer, printer, plotter, and TIFF support. 4100 color and line style color mapping. 640 x 400 and 640 x 480 on some adaptor/monitors.

ZSTEMpc™-VT100 Emulator \$99
High performance COLOR VT100. True double high/wide, smooth scrolling, ISO and attribute mapped color. XMODEM and KERMIT, softkey/MACROS, DOS access.

KEA Systems Ltd.

#412 - 2150 West Broadway, Vancouver, B.C. Canada V6K 4L9
Support (604) 732-7411 TELEX 04-352848 VCR FAX (604) 732-0715

Order Desk (800) 663-8702 Toll Free
30 day money back guarantee MC/VISA

See us at
COMDEX
HT722

BUILD YOUR COMPUTER LIBRARY with DEC PROFESSIONAL

**Back Issue Sets
Now Available!**

DEC users read our magazine from cover to cover, put it on their bookshelf, use it and reuse it to help solve daily problems, improve their professional skills, and widen their perspectives.

Now you can build your computer library, receive issues you missed and replace well-worn copies.

Order the 40 available back issues of *DEC PROFESSIONAL* as a set and save.

Order Now! Supplies are limited!

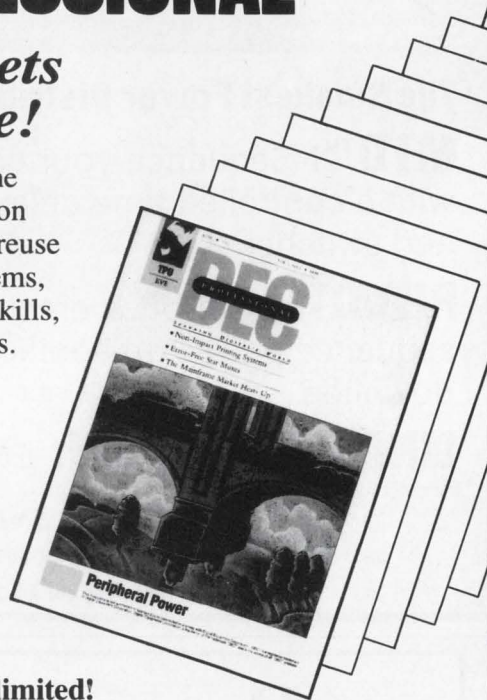

**ORDER NOW!
Supplies Are Limited!**

TO ORDER CALL (215) 542-7008 with your credit card information. Or complete and return the order form below. Payment must be included with your order.

▼ Clip and Send ▼

▼ Clip and Send ▼

BACK ISSUE ORDER FORM - DEC PROFESSIONAL

Please send _____ set(s) of 40 available back issues of *DEC PROFESSIONAL*. \$150 for each set ordered. Includes shipping by surface mail. For foreign airmail service add \$100.00 per set.
PAYMENT MUST BE IN U.S. DOLLARS AND DRAWN ON A U.S. BANK.

Check enclosed for \$ _____

Charge to: VISA MASTERCARD

Account # _____ Expires _____ / _____

Signature _____ Date _____

NAME _____ PLEASE PRINT

ADDRESS _____

CITY _____ STATE _____ ZIP _____

COUNTRY _____ TELEPHONE () _____

Mail completed form with payment to:

PROFESSIONAL PRESS INC., P.O. Box 504, Spring House, PA 19477-0504

3500/3600 systems. Users can interact with Pilot's EIS by using a mouse, touch screen or keyboard.

The Pilot EIS offers three key functions that provide needed information for executives and managers: drill down capability for standard reports, automated exception reports based on each user's predetermined triggers, and graphic and text presentation of time series data revealing patterns over time.

EIS is priced at \$110,000 on the VAX, \$95,000 on the MicroVAX II or MicroVAX 3500/3600.

Learn more by contacting Pilot Executive Software, 40 Broad St., Boston MA 02109; (617) 350-7035.

Enter 360 on reader card

8mm Cartridges Available For VAXs

Transitional Technology Inc. recently announced the CTS-8 family of high-capacity tape subsystems for VAXs and MicroVAXs. The CTS-8 uses 8mm videocassette cartridges. The metal particle tape used in 8mm cartridges has higher coercivity, making it less prone to demagnetization from stray magnetic fields. The cartridge is pocket-sized and, per cubic inch, affords great storage density.

The CTS-8 is available as a complete subsystem for the UNIBUS and Q-bus VAX systems, and can be mounted directly in an existing BA-23 or BA-123 enclosure or supplied in its own tabletop enclosure.

Pricing starts at \$5,995.

Find out more by contacting Transitional Technology Inc., 1401 N. Batavia, Ste., 204, Orange, CA 92667; (714) 744-1030.

Enter 358 on reader card

Edison Software Systems Announces IMAGE

Edison Software Systems has addressed another tape processing problem for VAX users. Its new product, IMAGE, allows VAX users to copy data from one tape to another, copy data from tape to disk, select which files or blocks they wish copied, or print selected portions of a tape, and dump any tape.

IMAGE is an excellent companion to Edison Software Systems' Convert Tape Utility product, which allows for the exchange of tapes between DEC and IBM environments.

The IMAGE product is priced at \$2,550 per CPU license.

If you have any questions contact Edison Software Systems, P.O. Box 211, Metuchen, NJ 08840; (201) 906-1321.

Enter 363 on reader card ■

When it's time to renew the service contract on your DEC® systems, will you be getting the best quality at the right price?

You could save up to 34% on what you may now be paying for comparable DEC service.

You're ready to sign on the dotted line, and then it hits you: Are you about to pay too much for too little on service for your DEC systems?

Unfortunately, the plain and simple truth is that all too often, this is the case.

However, there is a company that can provide you with responsive, dependable service that's truly second to none. A company with proven capabilities and quality of service at the right price.

That's what you get with CUSTOMCARE® Service from Unisys. Here's why.

For starters, we offer some of the most dedicated and experienced people in the service industry. Customer Service Engineers who know your DEC systems and peripherals—even if they are of varied makes and models—because we place the highest priority on both pure technical and "hands on" training.

We support every Customer Service Engineer with a seasoned management team, effective diagnostic tools and the technical expertise of our Customer Support Center.

CUSTOMCARE Service from Unisys



And because of our computerized, on-line dispatching system, RESPOND, we get all our expertise to your site fast.

All this results in more productivity for your organization. And more profit to your bottom line.

But what else should you expect from a \$9 billion company with a 100-year commitment to excellence—the kind of commitment that guarantees cost-effective solutions to fit *your* requirements.

Now when you consider that we can do all this for you and also save you up to 34%, you'll want to give us a call before you sign that DEC service contract.

In fact, you may even qualify for Two FREE Months of CUSTOMCARE Service from Unisys. You can find out how when you send for your FREE CUSTOMCARE Information Kit today. Just complete and mail the coupon below or call us toll-free at **1-800-547-8362, Ext. 03**, now.

FREE CUSTOMCARE Information Kit

After all, there is no substitute for the right quality at the right price.

Visit Us At DEXPO West, Booth #1338
December 8, 9, 10, Anaheim, CA

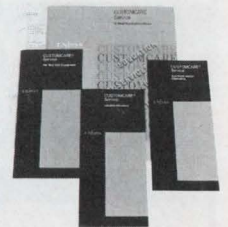

Special Offer: Two FREE Months of CUSTOMCARE Service for Qualified DEC Users.

Mail this form to : Unisys Corporation, CUSTOMCARE Service,
P.O. Box 1804, West Chester, PA 19382.

- Yes, I would like more information on how to qualify for your special limited time offer of Two FREE Months of CUSTOMCARE Service from Unisys—and how to save up to 34% for service on DEC systems. Please send me my FREE CUSTOMCARE Information Kit.
- I'm very interested. Please have a Unisys Representative contact me with the details on how to qualify for Two FREE Months of CUSTOMCARE Service from Unisys. And don't forget my FREE CUSTOMCARE Information Kit.

To see if you are eligible for our special offer of Two FREE Months of CUSTOMCARE Service—and to receive your FREE CUSTOMCARE Information Kit—please complete the information below before mailing.

Host System/Equipment on Site

- DEC PDP®-11 Family, model # _____
- DEC VAX® 11/700 Series, model # _____
- DEC VAX 8000 Series, model # _____
- DEC MicroVAX® II

- DECSYSTEM® 10/20
- STC Tape, Disk and Printer Subsystems
- DEC, IBM® or Compaq PCs, 50 units or more less than 50 units
- DEC or IBM Terminals, 50 units or more less than 50 units
- Other _____

Call Toll-Free 1-800-547-8362, Ext. 03.

Name _____

Title _____

Company _____

Address _____

City _____ State _____ Zip _____

Telephone (_____) _____

Best Time to Call AM _____ PM _____

UNISYS

CUSTOMCARE is a service mark of Unisys Corporation.
DEC, PDP, DECSYSTEM, VAX and MicroVAX are trademarks of Digital Equipment Corporation.
IBM is a trademark of the International Business Machines Corporation.
© August 1987, Unisys Corporation

BDPJ87

ENTER 162 ON READER CARD

KIMBERLY'S FALL DISK AND TAPE CLEARANCE SALE

DIGITAL EQUIPMENT DISK

RA60-AA	205 MB REMOVABLE DISK DRIVE	\$ 12,395
RA81-AA,AD	456 MB DISK DRIVE 120 / 240 VOLT	10,995

FUJITSU DISK DRIVES

M2333K	8 INCH 327 MB WINCHESTER	\$ 3,900
M2344K	8 INCH 690 MB WINCHESTER W/FAN	7,695
M2351A	10.5 INCH 474 MB WINCHESTER	7,595
M2361A	REV E 10.5 INCH 689 MB WINCHESTER	8,495

CIPHER TAPE

F880	MICROSTREAMER 1/2 INCH TAPE DRIVE 1600 BPI	\$ 2,795
M890	CACHE TAPE 1/2 INCH TAPE DRIVE 1600 BPI	3,395
M891	CACHE TAPE 1/2 INCH TAPE DRIVE 1600 BPI	3,695
M990	GCR 1/2 INCH TAPE DRIVE 1600/3200/6250 BPI	6,195

DUAL DENSITY OPTION FOR F880, M890, AND M891 450

SUBSYSTEMS FOR THE ABOVE DISK AND TAPE PRODUCTS ARE ALSO AVAILABLE AT SUPER LOW PRICES.

CONTROL DATA CORP. (CDC)

XMD		
9772-850	MB 14 INCH DISK DRIVE	\$ 9,395
9772-1.3	GB 14 INCH DISK DRIVE	11,595

FSD		
9715-300	MB 9 INCH FIXED STORAGE DISK	5,395
9715-340	MB 9 INCH FIXED STORAGE DISK	6,395
9715-515	MB 9 INCH FIXED STORAGE DISK	6,995

EMD		
9720-368	MB 8 INCH MODULE DRIVE	3,995
9720-500	MB 8 INCH MODULE DRIVE	4,595
9720-750	MB 8 INCH MODULE DRIVE	4,995

RSD		
9710-80	9 INCH 80 MB REMOVABLE STORAGE DISK	4,895

WREN II and III 5-1/4 INCH FULL HEIGHT DISK DRIVES

94155-48 MB	\$ 795	94166-101 MB	\$ 1,295
94155-67 MB	895	94166-141 MB	1,395
94155-85 MB	950	94166-182 MB	1,495



KIMBERLY ELECTRONICS

140 Route 17 North • Suite 210 • Paramus, NJ 07652 • 800-843-4009 • In NJ 201-387-0872

ENTER 286 ON READER CARD

KIMBERLY'S COMMUNICATIONS AND NETWORKING FALL SALE

VAX CLUSTER HARDWARE

HSC5X-BA	Disk data channel	\$9,650
HSC5X-CA	Tape data channel	9,650

COMMUNICATION and NETWORKING

DSRVA-AA	8-line DECserver 100	\$2,495
DSRVB-AA	DECserver 200, RS232 version	3,195
DSRVB-BA	DECserver 200, DEC423 version	2,950
DEMPR-AA	Thinwire Ethernet MLT PRT repeater	2,495
DEREP-AA	Local Ethernet Repeater	1,550
DELUA-M	Ethernet to UNIBUS Controller	2,795
DEQNA-M	Ethernet to Q-bus Controller	1,995
DELNI-AA	Digital Ethernet Local Network Interconnect	995
DESTA-AA	Thinwire Ethernet Station Adaptor	225
H-4000	Ethernet Transceiver for use with DEREP	275
DHV11-M	8-line Q-bus Async Terminal Interface	1,275
DHU11-M	16-line Async Terminal Interface	2,795
DHQ11-M	8-line Async Q-bus Adaptor	1,275



KIMBERLY ELECTRONICS

140 Route 17 North • Suite 210 • Paramus, NJ 07652 • 800-843-4009 • In NJ 201-387-0872

ENTER 292 ON READER CARD

NEW EQUIPMENT

Increase the performance of your DEC C.P.U. 20-60%

With XYPLEX Advanced Network Management System

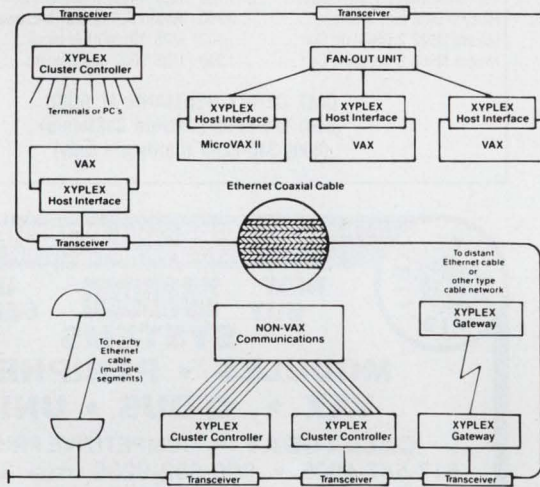

- ▶ Preprocesses terminal I/O with block mode transfer.
- ▶ Data scrambling
- ▶ True load balancing
- ▶ True printer sharing
- ▶ Network Management Software Included

▶ Distributed by **LAMCOM CORPORATION**

22600-C Lambert Street
Suite 908 · El Toro, CA 92630
(714) 380-8144

ENTER 289 ON READER CARD



SECURE COVER

Locking steel panels prevent removal of disk drives and boards. Secured windows control access to on/off, halt/restart and read/write controls.

Available for:

BA123.....	\$395
MV2000.....	245
BA23.....	195
BA23-R.....	145
H9642.....	145

ORDER TODAY,
CALL TOLL FREE: **1-800-832-LOCK**
in MA call 1-617-326-7979

SECURE TECHNOLOGIES, INC., 297 HIGH STREET, DEDHAM, MA 02026

ENTER 287 ON READER CARD

SECURE YOUR DEC TERMINAL WITH STATIONLOCK ACCESS CONTROL

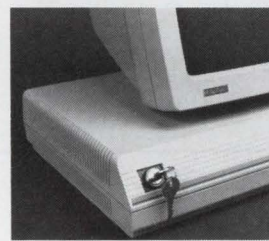

- Fits all VT300 and VT200 terminals
- Fits Rainbow, DECMATE II, and PRO 300
- Masterkeying available
- Based on MEDECO® Lock and Key
- User installable; no wire cutting
- MasterCard and VISA accepted
- Lifetime warranty
- Over 2000 sold

\$49.95 ONLY
2 - 5 units \$47.50
5 - 10 units \$44.95

ORDER TODAY; CALL TOLL FREE:
1-800-832-LOCK
IN MA (617) 326-7979

SECURE TECHNOLOGIES, INC., 297 HIGH STREET, DEDHAM, MA 02026

ENTER 288 ON READER CARD

USED EQUIPMENT

NOTICE

SURPLUS DEC* EQUIPMENT OWNERS

Don't sell your unneeded DEC* Equipment . . . without first contacting our Procurement Division.

There are *tremendous* differences in the way others buy your equipment. Our cash purchases are completely *hassle free* both before and after the sale, and we assume all *resale liability*.

Learn the facts. Call us today.
1-800-328-7000 EXT. 556



2800 Southcross Drive West, Burnsville, MN 55337

*Trademark of Digital Equipment Corporation.

DEC PRO's Used Equipment classifieds give you more value for your equipment dollar.

Many buyers look at used equipment first because they know that performance is the real issue. In **DEC PRO's Used Equipment** classifieds, you'll reap the benefits of a rapidly changing DEC marketplace by getting the proven power and performance you want **NOW** — at the price you want to pay **NOW!**

Don't be a victim of *vaporware*. Go for the goods with a proven track record. Go for them in **DEC PRO's Used Equipment** classifieds! Look for us in the **DEC PROFESSIONAL**, and online in our **ARIS** electronic bulletin board (215) 542-9458.

★ ★ ★ ★ ★

Advertisers: If you want to reach the largest number of computer professionals working in the DEC environment, call:

Mary Browarek at (215) 542-7008.

We Have A Full DEC And We're Ready To Really Deal



- Superior Service
- High Quality
- Systems Custom-Configured To Your Specifications

- Guaranteed
- Best Prices
- Great Deals
- Fast Delivery
- Fully Tested

- Buy, Sell and Trade
- New and Used DEC Equipment
- VAX • PDP-11
- DEC PC
- Complete Systems
- CPU's • Printers
- Drives • Terminals
- Memory

Call Us Today, And
Discover The Security
Computer Sales
Difference For Yourself!

PHONE: (612) 227-5683
FAX: (612) 223-5524

Security Computer Sales, Inc.
622 Rossmor Building
500 North Robert Street
Saint Paul, MN 55101



DATA COMMUNICATIONS EQUIPMENT FOR SALE

Amdahl 983 TDSU-A DSU	\$ 250	Micom Micro 8216 16 CH Data Con	2,300
Emulex CA12 16 CH Multiplexor	1,000	Micom Micro V27+ Modem 4800 bps	600
Emulex CS11 16 CH Multiplexor	800	Micom M481/ERB T1 Multiplexor 32CH	1,500
Emulex CM22/E Port Con	850	Micom M481i 128CH T1MUX	700
Emulex EM820 12 CH Data Con	1,500	Micom M481/EXP T1 Multiplexor Exp	1,200
Emulex EM820 8 CH Data Con	1,000	Micom Port Sel M600/2GR (unused)	7,500
Fuji 1925L Modem 14.4 kbps	1,700	NEC N4810 II Modem 208A/B	500
Halcyon Data Line Monitor	3,800	Racon Full Duplex Microwave	15,000
Micom M922 2 CH Multi Con	400	UDS 801 ACU Autocall	200
Micom M968 8 CH Multi Con	1,300	UDS 9600 bps Modem	750

CALL GERRY HEUMANN AT ADCC
(800) 426-5890 (Outside California)
(800) 345-2265 (California Only)

COMPUTERS AND PERIPHERALS
IN STOCK PROMPT DELIVERY

NEW BUY
digital™
USED SELL

SYSTEMS
MODULES • PERIPHERALS
VAX • Q-BUS • UNIBUS

CALL TODAY • COMPETITIVE PRICING
617-547-4005 • 800-892-9230 TELEX 374-8460
FAX (617) 354-1417 • DEC DEALERS ASSOCIATION
LET US QUOTE YOU ON ALL OF YOUR DEC NEEDS

ELI HEFFRON & Sons inc.
139 HAMPSHIRE STREET, CAMBRIDGE, MA. 02139

Buy • Sell • Lease
NEW & USED
DEC*
EQUIPMENT

Call Today
for Price & Delivery Quotes.

**CLINTON
DIGITAL
INC.**

770 WATER STREET
FRAMINGHAM, MA 01701
TELEPHONE:
(617) 877-9564
On the West Coast
(818) 767-8845

DDA is a registered trademark of Digital Equipment Corporation.

MULTITRONICS INC.

BUYS — SELLS — LEASES NEW & USED DEC® EQUIPMENT
VAX COMPUTER SYSTEMS, PERIPHERALS, DISK & TAPE DRIVES,
MEMORY, MICRO VAX II

IMMEDIATE DELIVERY
ON 90% OF ALL
DEC ITEMS!

digital™

SAVE UP TO
50% OFF
MFG'S LIST PRICE

MULTITRONICS INC.
340 Manley Street
W. Bridgewater, MA 02179
TELEX 517030
FAX 617-584-8172

Call Today For a Quote
WITHIN MA (617)584-2800
OUTSIDE MA 800-BUY-A-VAX

* Registered trademarks of Digital Equipment Corporation

INFORMATION

Rates: 1 time: \$475
 3 times: \$430
 6 times: \$390
 12 times: \$350

Size: 1/9 page — 2 1/4" x 3"

Camera ready mechanical required.

Typesetting and composition available.

For more information call Mary Browarek at (215) 542-7008.

IBM PC/VT220

EM220 • VT220, VT102 emulation
 \$169 • File Transfer
 • 132 Column modes
 • Color Support
 • Hot Key

TEK 4010/4014

EM4010 • Tektronix 4010 emulation
 \$249 • VT220, VT102 emulation
 • Picture files
 • High resolution hardcopy
 • Supports IBM, IBM Enhanced, Hercules, Tecmar and AT&T.



DCS
 3775 Iris Ave., Suite 1B
 Boulder, CO 80301
 (303) 447-9251

Trademarks: VT100 — Digital Equipment; IBM PC, XT — IBM Corp.

ENTER 290 ON READER CARD

When buying used DEC equipment ask the sellers . . .



Do you belong to the DIGITAL DEALERS ASSOCIATION?

It's your assurance of a reputable dealer.



For more information:
 (313) 475-8333

107 S. Main St., Suite 202
 Chelsea, MI 48118

ENTER 293 ON READER CARD

SO
 LEAD
 U
 T
 I
 O
 N
 S
 U
 C
 C
 E
 S
 S

GRAPHICS ON YOUR VT220!

GRAPH220™

generates business and presentation graphics on your VT220 and compatibles without additional hardware!

- Pie charts
- Line graphs
- Bar charts*
- Histograms*
- Clustered bar charts*
- Stacked bar charts*
- Also outputs to file or printer
- Horizontally and Vertically

Micro-VAX® and VAX-11® \$795.

VAX® 8000 Series \$1495.

CALL (408) 734-9511

WILLIAM A. PEDERSEN AND ASSOCIATES
 1037 N. FAIR OAKS AVE. • SUNNYVALE, CA 94089
 VAX® is a registered trademark of Digital Equipment Corporation.

ENTER 285 ON READER CARD

SPECTRA DISK

Offers your application the data transfer rates of your CPU without the costly seek and I/O timing required with disk transfers.

Imagine your applications approaching 200 MB/sec transfer rates on a VAX 780 or 8600 and completing 14% faster. That adds savings to you and your customers.

PRICED FOR VAX SYSTEMS AT \$495.00

- 24-hr support and consulting
- Transfer rates above 160 MB/sec
- Reduce I/O bound application transfers
- Applications process at CPU speed

SPECTRUM SYSTEMS

41 Summer St., Natick, MA 01760
 (617) 653-9407

ENTER 291 ON READER CARD

CONVERSIONS

16 YEARS EXPERIENCE

IBM — VAX
 DOS • MVS • VM • CICS • VSAM

HP — VAX
 HP 1000 • HP 2000 • HP 3000

PDP — VAX

► BASIC ► COBOL ► FORTRAN

For more information call:
 (206) 485-0125
 (206) 462-6820



Continuum Consulting, Limited

ENTER 292 ON READER CARD



MEADOWLARK ENTERPRISES
 37 High Street
 Danvers, MA 01923

We need to buy your excess DEC equipment now!

VAX & PDP-11

Turn your unwanted computer equipment into cash!

- ✓ Large inventory
- ✓ Immediate availability
- ✓ Super Prices

617-777-4666 dda DIGITAL DEALERS ASSOCIATION
 FAX-617-777-8433 800-DEC-DLER

ENTER 282 ON READER CARD

VAX/VMS

Training and Implementation

Information Systems Implementation and Assistance

Manufacturing Applications Assistance

All-In-One Implementation

Site Management Assistance

On-Site Training

For information call:
 (206) 485-0125
 (206) 462-6820

CONTINUUM™
 Continuum Consulting, Limited

ENTER 293 ON READER CARD

This publication is available in microform from University Microfilms International.



Please send information about these titles:

Name _____

Company/Institution _____

Address _____

City _____

State _____ Zip _____

Phone (____) _____

Call toll-free 800-521-3044. Or mail inquiry to: University Microfilms International, 300 North Zeeb Road, Ann Arbor, MI 48106.

LASER PRINTERS

With our color toners and cartridges can now print in full color.

COME ALIVE WITH COLOR

Colors; SuperBlack, Red, Green, Blue, Brown, etc. Printers; Ricoh, Canon, Dec, HP, Apple, IBM, Okidata, Kyocera, Oasys, others.

(We also recharge cartridges.)

Toner Research Inc.
(619) 744-2404
Dealership Available

ENTER 284 ON READER CARD

VAX TIME

- 8600, 785 and 780 Computers
- Rates from \$5.00/Hour
- Timeshared or Dedicated
- Tymnet Access Available
- Hotsite Backup Services



AMERICAN DIVERSIFIED
Costa Mesa, California

CONTACT: KEN CHARLTON
(800) 426-5890 Outside Calif.
(800) 345-2265 Calif. Only

ENTER 275 ON READER CARD



Quality Used Systems Integration You Can Depend On



Member of Digital Dealers Association

RENT • BUY • TRADE • SELL

Our 13th Year Serving the DEC* Community

W. COAST: 800-252-6200 E. COAST: 800-645-1167
206-392-9878 516-273-7777
FAX: 206-391-2384 • TELEX: 4973833 • FAX: 516-273-7648

ENTER 276 ON READER CARD

CLASSIFIED

C LANGUAGE CONSULTING AND EDUCATION by noted **DEC PROFESSIONAL** columnist. Also other languages and packages on RSX, VMS, RSTS and MS-DOS, including DBMS and DECnet. Applications experience includes real-time, process control, engineering, scientific and commercial systems. Rex Jaeschke. (703) 860-0091.

DEVICE DRIVER CONSULTING: VMS, UNIX, RSX. New Drivers, Upgrades, Conversions. Globetrotter Software Inc. (408) 980-7153.

WANTED: Cache memory for PDP 11/45. Able Cache/45 model 10006 or equivalent. Andy Jerison, (513) 767-7975.

DEC SUPPORT — VAX and PDP-11 Specialists. We offer a full range of Applications and Operating System support for: VMS, RSTS, RSX, RT-11, MACRO, C-language, BASIC, COBOL, and DIBOL. Including: new application development and installations, existing application maintenance, and system tuning, on-site or remote via telephone. Contact: West Bay Consulting, 2618 Elliot Street, Santa Clara, CA 95051. (408) 246-6279.

*** DEC**

BUY • SELL • TRADE • LEASE

NEW/USED

SYSTEMS

PERIPHERALS



Time Electronics, Inc.

MA. 617-342-4210 OH. 614-764-2224

FAX: 343-8525

* DEC is a Registered Trademark of Digital Equipment Corp

EQUINOX DS-5

Cabinet (Rackmount)

Processor Set

1 24-RS

3 24-CS

List > \$12,500

Best Offer
Over > \$8,500

Call Kevin
215-542-7008

DEC

SYSTEMS
PERIPHERALS
COMPONENTS

- LSI
- PDP
- VAX

dce DIGITAL
COMPUTER
EXCHANGE INC

27773 Industrial Blvd., Hayward, CA. 94545
CALL-(415) 887-3100
FAX (415) 887-5590 TLX 709536



VAX

SYSTEMS & OPTIONS

C. D. SMITH & ASSOCIATES, INC.

12605 E. Freeway, Suite 318 • Houston, TX 77015

(713) 451-3112

- PRO 350/380 MEMORY BOARDS
 - DISK DRIVES - BIG & FAST FOR PRO
 - RAM-DISK Software for Micro/RSX, 11M (+) & P/OS*
- Call 415-420-9579

Proto Systems

1238 Josephine St, Berkeley, CA 94703

East of the sun. West of the moon. Windjammer.



A place to live your fantasies.
A place to free your soul.

To cozy up to the Caribbean sun.
To dance among a thousand stars
to the rhythms of steel drums.
To play on sparkling white and
pink sand beaches.
To discover the underwater
paradise of the reefs.
To find a new friend and share the
intimacies of a sensuous night.

To come alive and live.
To remember for a lifetime.

6 days and 6 nights. From **\$625.**

Reservations toll free
1-800-327-2600
In Florida 1-800-432-3364

**Windjammer
'Barefoot' Cruises**
Post Office Box 120.
Miami Beach, Florida 33119.



ENTER 181 ON READER CARD

"Cap'n Mike, rush me my free, full color 'Great Adventure' booklet and show
me the way to Paradise for 6 days and 6 nights from \$625."
Windjammer 'Barefoot' Cruises.
P.O. Box 120, Dept. A288 Miami Beach, Fla. 33119.

Name _____
Address _____
City _____
State/Zip _____

ADVERTISERS INDEX

Reader Service Number	Page	Reader Service Number	Page
249	Advanced Technology International.....121	234	MegaTape Corp.....125
192	American Digital Systems.....67	178	MicroTek Systems International ..72
229	American Digital Systems.....69	236	MicroTek Systems International.....132
102	Applied Digital Data Systems.....51	239	MicroTek.....47
103	Aquidneck Systems International.....115	140	Mitchell Management Systems.....42-43
104	AT&T Training.....85	215	Mod-Tap System.....124
237	Avalon Computer Systems.....9	223	MRI Computers.....79
105	BLAST/Communications Research.....109	221	Mutliware.....142
230	C.P. International.....17	222	Multiware.....20
106	Cabletron Systems.....167	219	National Information Systems...145
193	Calcomp.....117	235	National Support Group.....168
	California Computer & Graphics Show.....140	202	Networking Dynamics Corp...178
228	Chrislin Industries, Inc.....153	233	Networx Data Products.....41
107	Clearpoint, Inc.....3	142	Networx Data Products.....181
108	Coefficient Systems Corp.....23	207	Nissho Electronics.....136
109	Cognos Corporation.....27	143	Park Software.....122
110	Collier-Jackson, Inc.....157	144	Perceptics Corp.....127
111	Computer Information Systems..141	145	Perceptics Corp.....129
112	Computer Technology Group...146	500	Persoft, Inc.....10-11
210	Control Data.....53	146	Polygon, Inc.....75
113	Data Processing Design.....83	147	Precision Visuals Inc.....25
246	Data Race, Inc.....I.B. Cover	148	Process Software.....122
114	Datability Software Systems, Inc.....B.Cover		Professional Press.....147,184
	DECUS.....166	185	Pulizzi Engineering.....183
115	Demac Software.....8	204	QMS, Inc.....14-15
	DEXPO.....179	209	RAD Data Communications.....77
194	Digi Data Corp.....130		Raima Corp.....103
200	Digital Data Systems.....120	186	Raxco.....62
116	DynService Network.....119	187	Raxco.....63
214	Edison Software.....104	150	Relational Technology Inc.....87
117	ECC Systems, Inc.....I.F.Cover	151	Rhodnius Inc.....149
118	EMC Corporation.....57		SAS Institute Inc.....99
119	Equinox Systems.....4		SAS Institute Inc.....101
120	Exceptional Business Solutions.139	218	Saturn Systems, Inc.....170-171
122	FTG Data Systems.....144	173	Scherers.....152
175	Gejac, Inc.....97	154	Software AG.....19
123	Grafpoint.....95	241	Software AG.....151
124	GrayMatter Software & Consulting.....178	227	Stone Mountain Computing...168
211	HCR Corp.....169	156	T&B Computing.....135
	Hewlett-Packard.....supplement	157	Tektronix/Information Display Group.....30-31
127	Human Designed Systems.....7	158	TeleVideo Systems.....158-159
	IBM Corporation.....143	245	Teltone Corp.....121
231	ICEX.....16	159	Texas Instruments Inc.....13
129	Information Builders, Inc.....29	226	Trimm Industries.....93
130	Interactive Technology.....173	248	Unbound.....35
232	Interactive Technology.....175	162	Unisys Corp./CUSTOMCARE Service.....185
131	Jager Computer Systems.....91		USR/Group.....174
132	James McGlinchey.....167	164	Vermont Creative Software.....21
244	Kea Systems Ltd.....183	165	Versatec.....193
216	Keyword Office Technologies.....59	217	Visitech Graphic Resources.....137
134	Liberty Electronics.....133	167	Visual Technology.....88-89
135	Logicraft, Inc.....177	220	Walker Richer & Quinn.....81
136	MCBA, Inc.....107	168	Whitesmiths Ltd.....37
224	MDB Systems.....39	181	Windjammer Cruises.....191
238	MBD Systems.....131	242	Wollongong.....112
137	MDBS.....73	243	Wollongong.....113
138	MegaTape Corp.....123	169	Wyse Technology.....155
		225	Zoltech Corp.....105
		185	Z-Line.....183

More information about many of these advertisers is available electronically on our Automated Reader Information Service (ARIS). Dial (215) 542-9458.

SALES OFFICES

Professional Press, Inc.
921 Bethlehem Pike
Spring House, PA 19477
(215) 542-7008

VICE PRESIDENT Helen Marbach
NATIONAL SALES MANAGER Jeffrey Berman
ADVERTISING MANAGER Connie Mahon
ADVERTISING COORDINATOR Lori Goodson
ACCOUNT EXECUTIVE Dan Mainieri
CLASSIFIED ADS & USED EQUIPMENT
 Mary Browarek

REGIONAL SALES MANAGERS

MID-ATLANTIC Connie Mahon
INTERNATIONAL Helen B. Marbach
MIDWEST, SOUTHEAST Peter Senft

NEW ENGLAND

Cynthia Davis
Regional Sales Manager
Trish McCauley
Account Executive
 Professional Press, Inc.
 238 Bedford St., Suite 3
 Lexington, MA 02173
 (617) 861-1994

NORTHERN CALIFORNIA and NORTHWEST

A. G. Germano
Regional Sales Manager
Alonna Doucette
Account Executive
 Professional Press, Inc.
 715 El Camino Real, Suite 206
 San Bruno, CA 94066
 (415) 873-3368

SOUTHERN CALIFORNIA and SOUTHWEST

David Beardslee
Regional Sales Manager
 Professional Press, Inc.
 10635 Riverside Drive
 Toluca Lake, CA 91602
 (818) 985-7008

DEC
PROFESSIONAL

Get more out of your workstation.

Give your workstation the powerful output it deserves. Versatec electrostatic and thermal plotters deliver your drawings, maps, and charts faster, more reliably than any pen plotter.

Draw big, beautiful plots with high speed monochrome or color plotters in plot widths from 11 to 44 inches. Print as you plot using hardware character generators. Present your work on high quality paper and film media.

The right connection. Link your Sun, Apollo, MicroVAX or IBM PC/AT workstation directly with any Versatec plotter via fast parallel interfaces and optimized plotting software, or simultaneously receive plots from six nodes on your Ethernet® TCP/IP network with a Versatec Plot Server.

Versatec delivers more support. More interfaces. More standalone and embedded rasterizers. More experienced electrostatic and thermal plotter service. And more spares at more locations.

Circle our readers' service number or call toll-free 800/538-6477* for your copy of "How to get more out of your workstation."

Move up to Versatec.



*In California, call toll-free 800/341-6060

Sun is a trademark of Sun Microsystems. Apollo is a trademark of Apollo Computer. MicroVAX is a trademark of Digital Equipment Corporation. IBM PC/AT is a trademark of International Business Machines Corporation.

Versatec and Versatec Plot Server are trademarks of Versatec, Inc. Xerox is a trademark of Xerox Corporation.

Plot data courtesy of Xerox, IMI and Zeh Graphic Systems.



VERSATEC
A XEROX COMPANY

ENTER 165 ON READER CARD

The Great American Trade Show Quiz

What's your trade show IQ? Some people enjoy trade

shows. Others hate them. In the computer industry there are a slew of trade shows scattered around the country throughout the year. We're in Atlanta one week, Los Angeles the next. After a while we become more expert on the subject of trade shows than on the subject of computers.

Most people take trade shows too seriously. Here's a valuable trade show IQ quiz that I worked up so you can see how you rate as a trade show attendee:

1. *Before attending the trade show, you must plan ahead. Which of the following best applies to your planning?*

- a. Find out who else might be there and make appointments to see them in advance.
- b. Wait for people to call you for appointments.
- c. Wait until the last minute to make appointments.
- d. Tell everyone that your calendar is full and make no appointments.

2. *You have to stay someplace. When deciding how much to spend on a hotel, you:*

- a. Find a high-quality inexpensive hotel and book months in advance.
- b. Get a cheap room in a luxury hotel and book months in advance.
- c. Get what you can at the last minute.
- d. Find a suite and tell the bookkeepers that's all that was available.

3. *Which of the following best describes your typical morning while attending a trade show?*

- a. Arise at 7. Shower. Read the morning paper. Go to an 8 a.m. sales meeting or product introduction breakfast.
- b. Arise at 7. Shower. Order room service and have a big breakfast. Review previous day's notes and today's schedule.

c. Get up at 8. Shower. Have a continental breakfast. Read the paper and go straight to the show.

d. Sleep in until 11. Tell the boss you had appointments all morning.

4. *How do you like to approach your first encounter with the exhibit halls?*

- a. Sit down with the guide to the show and your Day-Timer to map out the day's activities carefully.
- b. Go straight onto the show floor to see what seems important and new.
- c. Go onto the floor and ask people if they've seen anything interesting, then go there.
- d. Look for the booths with the cutest hostesses and go there.

5. *When in a booth or exhibit area, you:*

- a. Find a company representative and have him show you what's important.
- b. Wander around the area and read each blurb on the walls near the products.
- c. Pick up some literature and leave a card.
- d. Hit on the hostesses and try to get a date for the night.

6. *After the show closes for the day, you:*

- a. Return to the hotel, review what you did that day and make preliminary plans for tomorrow.
- b. Discuss the show with a colleague.
- c. Return to the hotel and watch TV.
- d. Go directly to the hotel events board, find out where the hospitality suites are and go get free drinks.

7. *What best describes your attitude toward drinking at a hospitality suite?*

- a. Order Calisoga water or Perrier with a twist and make it known that you have to be clearheaded. After all, tomorrow is a busy day.
- b. Have one beer, then leave.
- c. Have a few glasses of wine.
- d. Scan the bar and order the most expensive Cognac. If they don't have a decent V.S.O.P., complain to the party giver.

8. *When a hospitality suite has food, you:*

a. Munch a few pieces of the healthiest foods, like the celery and dip.

b. Eat only cheese.

c. Eat some lean roast beef.

d. Pig out on lobster and crab.

9. *When invited to a big evening event, like a rock 'n' roll party, what do you do?*

- a. Decline the invitation because there are better ways to spend your time.
- b. Go to the party hoping that you can make a few business contacts.
- c. Go to the party to unwind.
- d. See if you can get more invitations and hand them out to people as though you're a big shot.

10. *When a big trade show is over and you return home, you:*

- a. Review the show with associates. File the brochures and make notes on who to call for follow-up.
- b. Go back to work, write a short memo about the show and brief other employees.
- c. Put the show out of your mind for a few days and place the literature in a basket to be read later.
- d. Moan and groan about how tough the show was and how you need a vacation.

Scoring

For each A answer, give yourself 10 points. B scores 6, C scores 4 and D scores 0.

If you scored 100 points, then you're one fabulous employee. You must be bored stiff.

A score in the 80-100 range means at least you think about something other than business once in a while.

Tallying 50-80 points is the normal range for the modern show attendee.

Scoring 4-50 means you try your best to mix business with pleasure.

A total of 0 indicates that you're a true party animal. Congratulations! If anyone has fun at a trade show, it's you.

Take us for a test drive.



At speeds from 9,600 to 19,200 bps.

Data Race is offering VARs increased profits in data communications.

Use our high-speed dial up and leased line modems and multiplexers and successfully link Wang, Hewlett-Packard, Data General, DEC, or NCR terminals to their computers.

We have an unbeatable support team and an R&D staff which has been taking the post position for years.

Unlock your profit potential. Call Data Race at (512) 692-3909 and ask us about our aggressive Authorized VAR Starter Kit. Your winning streak is about to begin.

ENTER 246 ON READER CARD

DATA RACE

12758 Cimarron Path, San Antonio, TX 78249
(512) 692-3909 FAX: (512) 692-7632

RAF. THE MAINLINE TO YOUR MAINFRAME.



RAF REMOTE ACCESS FACILITY.™
THE EASIEST, FASTEST, MOST COMPLETE WAY TO TAP DEC MAINFRAME POWER AT YOUR PC.

RAF is a PC-to-host communications system designed to integrate your PC with all the data and power of a VAX or DECSYSTEM-20. RAF does the job transparently, seamlessly and faster than any other PC-to-DEC host software. But read on, because RAF offers a lot more!

EASY ACCESS TO REMOTE DATA

RAF fools the PC into "thinking" that remote files are local. So you can utilize your regular PC software to access data stored on a remote system. It's as if the data were stored locally on your PC! Use WordPerfect, MASS-11 and other PC editors to create or edit files stored on a remote VAX. And use PC spreadsheet programs like Lotus 1-2-3 to manipulate remotely stored spreadsheets.

SHARE REMOTE SYSTEM PRINTERS

Why dedicate a printer to a PC when RAF allows PC's to share remote system printers transparently? With RAF, PC software thinks your PC is equipped with its own local printer! And RAF lets you define all remote printer options. With RAF, you decide which remote printer to use or which forms to utilize.



COMPLETE ACCESS OF REMOTE COMPUTERS

RAF delivers automatic access to remote computers through a scripting mechanism that allows you to define each step of an automatic login. Or complete VT100 and VT220 terminal emulators unlike any other software system. RAF's VT100 and VT220 support allows for instant switching between PC and VAX applications.

ASYNCHRONOUS AND ETHERNET SUPPORT

You can use RAF to communicate asynchronously or over Ethernet. A single copy supports both, so you can install RAF asynchronously now and

switch to Ethernet if it's available in the future. Also, RAF allows some users to operate asynchronously while others utilize Ethernet. RAF supports asynchronous communications over modems, networks or via direct connections—at speeds from 300bps to 38kbps. Over Ethernet, RAF transfers data up to 100,000 characters per second (800 kbps)—that's about ten times faster than any other comparable communications product! And RAF allows Ethernet users to maintain multiple connections with remote systems—as if they're connected through a DEC terminal server.

TRAINING, SUPPORT AND UPDATES

In order to make sure you put every outstanding RAF capability to your fullest advantage, we have prepared a comprehensive RAF videocassette trainer. This two hour cassette — \$29.95 if purchased separately — is yours free with the purchase of a RAF host master license.

For on-going and immediate technical support, eligible RAF users can call our special hotline, 1-800-DIAL-DSS. And as new RAF versions are made available, eligible users can update their PC software automatically through the RAF electronic distribution system. In so many ways, RAF is your main line to the DEC mainframe. Call for more information now.

DATABILITY

1-800-DIAL-DSS

In New York: 212-807-7800
 In Canada: 1-800-267-9205

Datability Software Systems, Inc.
 322 Eighth Avenue New York, NY 10001

DEC, VAX, DECSYSTEM 20, VT 100 and VT220 are registered trademarks of Digital Equipment Corp.; Lotus 1-2-3 is a registered trademark of Lotus Development Corp.; WordPerfect is a registered trademark of WordPerfect Corp.; Mass-11 is a registered trademark of Microsystems Engineering Corp.; Ethernet is a registered trademark of Xerox Corp.



ENTER 114 ON READER CARD