

NOVEMBER 1977 / \$1.00

# AM RADIO HORIZONS

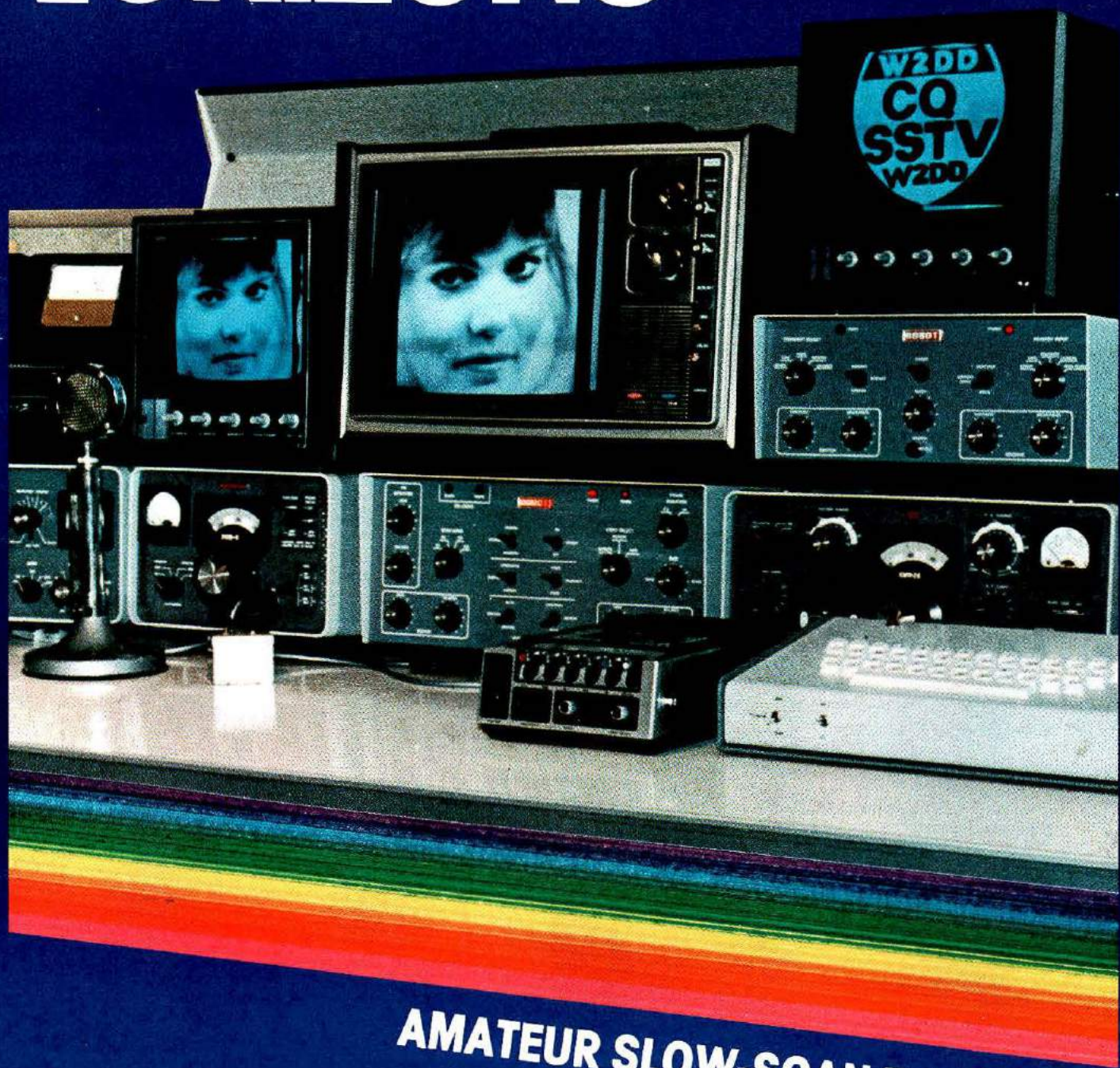

AMATEUR SLOW-SCAN TELEVISION

# Drake Accessories

*designed for convenience and accuracy*

## Drake Directional RF Wattmeters



**W-4** 1.8-54 MHz

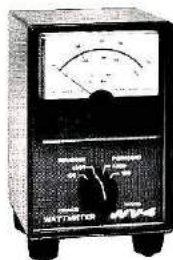

**WV-4** 20-200 MHz

Drake directional, through line wattmeters, using printed circuits, toroids, and state of the art techniques, permit versatile performance and unsurpassed accuracy, yet at a lower cost.

In contrast to VSWR measuring devices of the past, Drake wattmeters are frequency insensitive throughout their specified range, requiring no adjustments for power or VSWR measurements.

Negligible insertion loss allows continuous monitoring of either forward or reflected power for fast accurate tune up and checking of transmitter-antenna performance.

Indirectly measure radiated power (forward power minus reflected power) and VSWR by means of a plastic nomogram included.

Each wattmeter makes possible quick, accurate adjustments of antenna resonance and impedance match, when placed between transmitter and matching network.

High accuracy; ideal as laboratory instruments. Removable coupler allows remote metering.

Specifications	W-4	WV-4
<b>Frequency Coverage</b>	1.8-54 MHz	20-200 MHz
<b>Line Impedance</b>	50 ohm resistive	50 ohm resistive
<b>Power Capability</b>	2000 W continuous	1000 W continuous
<b>Jacks, Removable Coupler</b>	Two SO239 input and output connectors	Type N input and output connectors.
<b>Semiconductors</b>	Two 1N295 power meter rectifiers	Two 1N695 power meter rectifiers
<b>Accuracy</b>	± (5% of reading +1% of full scale)	

## Drake MN-4 & MN-2000 Matching Networks

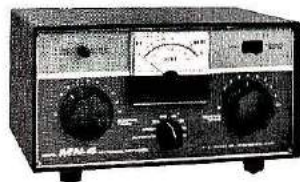

**MN-4** (300 Watts)



**MN-2000** (2000 Watts)

To receive a FREE Drake Full Line Catalog, please send name and date of this publication to:

**R. L. DRAKE COMPANY**



540 Richard St., Miamisburg, Ohio 45342  
Phone: (513) 866-2421 • Telex: 288-017

Western Sales and Service Center, 2020 Western Street, Las Vegas, Nevada 89102 • 702/382-9470

## Drake RCS-4 Remote Coax Switch

- Remotely Selects One of Five Antennas
- Grounds All Unused Antennas
- Grounds All Antennas in Gnd Position for Lightning Protection
- Front Panel Indicator Monitors Antenna Selection Interval
- Protected Against Adverse Weather Conditions
- SO-239 Connectors Provided for Main Coax Feed-Line and Individual Antenna Feed-Lines
- Handles 2000 Watts PEP
- Available in 120 V-ac or 240 V-ac 50/60Hz Versions



- Control unit works on 110/220 V-ac, 50/60 Hz, and supplies necessary voltage to motor.
- Excellent for single coax feed to multiband quads or arrays of monobanders. The five positions allow a single coax feed to three beams and two dipoles, or other similar combinations.
- Control cable (not supplied) same as for HAM-M rotator.
- Selects antennas remotely, grounds all unused antennas. Gnd position grounds all antennas when leaving station. "Rain-Hat" construction shields motor and switches.
- Up to 30 MHz, insertion of switch changes VSWR no more than 1.05:1.
- From 30 MHz to 150 MHz, insertion changes VSWR no more than 1.5:1.
- Motor: 24 V-ac, 2 amp. Lubrication good to -40°F.
- Switch Rf Capability: Maximum legal limit.

- 80-10 Meters
- Antenna Selector and By-Pass Switches included

A Drake matching network is a worthwhile addition to any amateur station where peak performance is desired. Basically identical, except for power handling capabilities, the MN-4 and MN-2000 enable feedline SWR's of 5:1 to be matched to the transmitter. If input impedance is purely resistive, even higher SWR's can be handled. Besides presenting a 50 ohm load to the transmitter, the Matching Network's built in rf wattmeter allows accurate and continuous power measurement and VSWR indication. The advanced wattmeter circuitry yields frequency-insensitive readings from 2 to 30 MHz, and accuracy until now obtainable only in expensive wattmeters.

Specifications subject to change without notice.

# Call 1-800-633-3410 for Dentron\*

\*KENWOOD, YAESU, ICOM, CDE, HYGAIN, CUSHCRAFT, NPC, TPL, TRISTAO, NEWTRONICS, REGENCY, ROHN, WILSON, TEN-TEC, B&W, DRAKE, & MFJ.

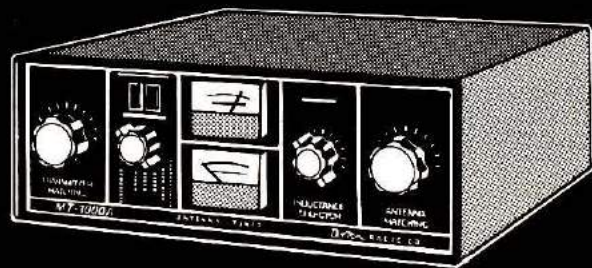

## DENTRON MLA-2500 linear amplifier

- Continuous duty power supply • 160 thru 10 meter coverage • 2000 + watts PEP input on SSB • 1000 watts DC input on CW, RTTY, SSTV • Two external-anode ceramic/metal triodes operating in grounded grid • Covers MARS w/o modifications • 50 ohm input/output impedance • Built-in RF watt meter.

**799.50** is list price. Call Toll-Free for quote.

## DENTRON MT-3000A antenna tuner

- 160 thru 10 meter coverage • Handles a full 3KW PEP • Continuous tuning 1.8 - 30 mc • Built-in dual watt meters • Built-in 50 ohm dummy load for proper exciter adjustment • Antenna selector switch enables you to by-pass the tuner direct or select the dummy load or 5 other antenna systems.

**349.50** is list price. Call Toll-Free for quote.

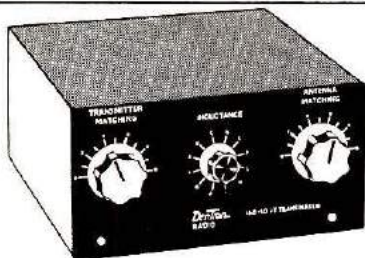

## DENTRON 160-10AT super tuner

Balanced line, coax cable, random, or long wire antennas, the 160-10AT will match it—160 thru 10 meters • Continuous tuning, 1.8-30 mc • 3 inputs • Handles 500 watts DC, 1000 watts PEP • Heavy duty, 2-core Balun (3½" dia. x 3" H) • Tapped inductor #12 ga. wire.

**129.50** list price. Call for quote.

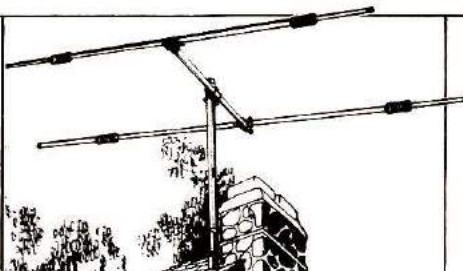

## DENTRON Trim Tenna 20 meter beam

For the amateur who wants fantastic performance with good looks! • Front element: 16' driver with H-Q coils fed directly with 52 ohm coax • Reflector element: 17' with 15 dB F/B ratio • 8½' turning radius • 4 dB forward gain over dipole • Elements 7 feet apart • Weight: 14 lbs.

**129.50** list price. Call for quote.

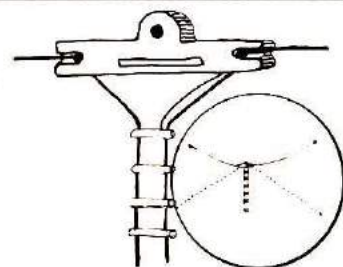

## DENTRON all band doublet antenna

This all band doublet or inverted antenna covers 160 thru 10 meters. Has total length of 130 ft. of 14 ga. stranded copper wire. The doublet is tuned & center fed thru 100 ft. of 470 ohm PVC covered transmission line. Assembly is complete.

**24.50** is Long's low price.

Remember, you can call TOLL-FREE: 1-800-633-3410 in U.S.A. or call 1-800-292-8668 in Alabama for our low price quote. Hours: 9:00 AM til 5:30 PM, Monday thru Friday.



# Long's Electronics



MAIL ORDERS: P.O. BOX 11347 BIRMINGHAM, AL 35202 • STREET ADDRESS: 3521 10TH AVENUE NORTH BIRMINGHAM, ALABAMA 35234

# THIS MONTH'S

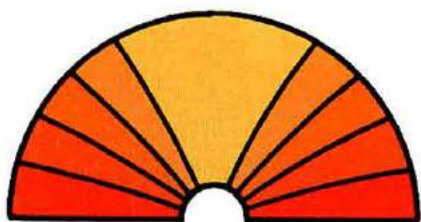

# HORIZONS

## SSTV

You can watch slow-scan television by adding a piece of equipment to your amateur-band receiver. To send a picture, you need only an addition to your transmitter. Thanks to a system that requires no more space in a ham band than a voice signal, you can exchange images with fellow hams the world over. Veteran SSTVer W2DD gives you a tantalizing glimpse of what it takes.

## A Better Code-Practice Oscillator

It is not hard to find instructions for building a code-practice oscillator, nor is it difficult to build one. What makes this one better than the rest? It can be a very useful gadget to have around the shack after you no longer need to practice sending Morse code. Author Blakeslee gives you two versions to choose from: one is a dual-purpose practice oscillator and tester, the other is a minimum-cost box that uses parts from a defunct transistor radio. Maybe you'll like them so much that you'll want to build both!

## Antennas For Tiny Yards

Just because your pool is not deep enough to dive into doesn't mean that you should never learn to swim — and there is a parallel in the antenna situation that many SWLs and hams must contend with. Some surprising results can be obtained from skywires that are far from ideal. K4IPV speaks from experience as he shows you how to make the best of the available space.

## Fried Ham

In some Amateur radio equipment there are voltages and currents high enough to be lethal, if you don't know how to protect yourself and your gear. Proper grounding and insulation — and a thorough understanding of what and what not to do in an emergency — are the keys to safety.

## Accessories For Your Station

Your operating needs and desires will change with time as you progress through the ranks of amateur radio. As you grow, your station will also grow. Here is a guide to the orderly growth of your station equipment, beginning with the most-needed things to get you started and followed by goodies that can wait until later.

## The Oscilloscope

An oscilloscope is a useful analytical tool for the home-builder because it can be used to display both dc and ac signals generated by the circuits you are testing. You can measure voltage, frequency, and a variety of other parameters that affect the health and well-being

of your radio. In fact you will be able to determine a number of things that can only be discovered with this versatile instrument.

## Questions About Linears

Buying a linear amplifier is usually a large investment, and you should be as careful about it as you would with any other expenditure. If you choose wisely, it will last long and serve you well. Here is a brief guide to some areas of comparison to check into before you make your decision.

## Questions? And Answers!

Here is the third part of the series exploring the why and how of the questions and subjects in the FCC Study Guide and the Novice License exam. The Rules and Regulations section is almost finished, and W1SL gets started into the area of Operating Practices.

## The Cover

Amateurs around the world can be seen as well as heard, thanks to slow-scan television. W2DD provided our cover photograph and the story on page 12.

**HAM RADIO HORIZONS** November 1977, Volume 1, No. 9. Published monthly by Communications Technology, Inc., Greenville, New Hampshire 03048. One-year subscription rate, \$10.00; three-year subscription rate, \$24.00. Second-class postage paid at Greenville, New Hampshire 03048 and additional offices.

# Call toll-free 800-647-8660 for products by MFJ ENTERPRISES



**\$69<sup>95</sup>**

### MFJ-16010 ST Super Antenna Tuner

This NEW MFJ Super Antenna Tuner matches everything from 160 thru 10 Meters: dipoles, inverted vees, long wires, verticals, mobile whips, beams, balance lines, coax lines. Up to 200 watts RF OUTPUT. Built-in balun, too!

- Operate all bands with one antenna • Works with all solid state and tube rigs • Ultra compact: 5 x 2 x 6 inches • Uses toroid cores



**\$39<sup>95</sup>**

### MFJ-16010 Antenna Tuner

Now you can operate all bands — 160 thru 10 Meters — with a single random wire and run your full transmitter power output — up to 200 watts RF power OUTPUT.

- Small enough to carry in your hip pocket, 2-3/16 x 3-1/4 x 4 inches • Matches low and high impedance by interchanging input and output • SO-239 coaxial connectors • 12 position tapped inductor. Stacked toroid cores • At 1.8 MHz tuner matches 25 to 200 ohms.



**\$29<sup>95</sup>**

### CWF-2BX Super CW Filter

This MFJ Super CW Filter gives you 80 Hz bandwidth, and extremely steep skirts with no ringing for razor sharp selectivity that lets you pull signals out of heavy QRM. Plugs between receiver and phones or connect between audio stage for speaker operation.

- Selectable BW: 80, 110, 180 Hz • 60 dB down one octave from center frequency of 750 Hz for 80 Hz BW • Reduces noises 15 dB • 9 V battery • 2-3/16 x 3-1/4 x 4 inches • CWF-2PC, wired PC board, \$19.95.



**\$69<sup>95</sup>**

### MFJ-8043 IC Deluxe Electronic Keyer

This NEW MFJ Deluxe Keyer gives you more features per dollar than any other keyer available.

- Uses Curtis 8043 keyer chip • Sends iambic, automatic, semi-automatic, manual • Use squeeze, single lever, or straight key • Dot memory, self-completing dots and dashes, jam proof spacing, instant start • RF proof • Solid state keying  $\pm 300$  V max • Weight, tone, volume, speed controls • Uses 4 C-cells; external power jack • 6 x 6 x 2 inches • Sidetone and speaker • Optional squeeze key: \$29.95



**\$54<sup>95</sup>**

### CMOS-8043 Electronic Keyer

State of the art design uses CURTIS-8043 Keyer-on-a-chip.

- Built-in Key • Dot memory • Iambic operation with external squeeze key • 8 to 50 WPM • Sidetone and speaker • Speed, volume, tone, weight controls • Ultra reliable solid state keying  $\pm 300$  volts max. • 4 position switch for TUNE, OFF, ON, SIDETONE OFF • Uses 4 penlight cells • 2-3/16 x 3-1/4 x 4 inches

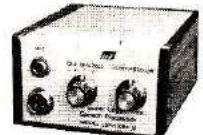

**\$59<sup>95</sup>**

### LSP-520BX II Log Speech Processor

Up to 400% more RF power. Plugs between your microphone and transmitter.

- Gives your audio punch power to slice through QRM • 30 dB IC log amp and 3 active filters • RF protected • 9 V battery • Two Mic jacks: 1/4" phone jacks, uncommitted 4 pin jack • Output cable • 2-1/8 x 3-5/8 x 5-9/16 inches • LSP-520BX, in standard MFJ enclosure, electronically identical, \$49.95.

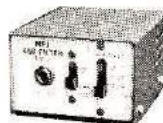

**\$29<sup>95</sup>**

### SBF-2BX SSB Filter

Dramatically improves readability.

- Optimizes your audio to reduce sideband splatter, remove low and high pitched QRM, hiss, static crashes, background noise, 60 and 120 Hz hum • Reduces fatigue during contest, DX, and ragchewing • Plugs between phones and receiver or connect between audio stage for speaker operation • Selectable bandwidth IC active audio filter • Uses 9 volt battery • 2-3/16 x 3-1/4 x 4 inches



**\$29<sup>95</sup>**

### MFJ-200BX Frequency Standard

Provides strong, precise markers every 100, 50, or 25 KHz well into VHF region.

- Exclusive circuitry suppresses all unwanted markers • Markers are gated for positive identification, CMOS IC's with transistor output. • No direct connection necessary • Uses 9 volt battery • Adjustable trimmer for zero beating to WWV • Switch selects 100, 50, 25 KHz or OFF • 2-3/16 x 3-1/4 x 4 inches



**\$49<sup>95</sup>**

### MFJ-1030BX Receiver Preselector

Clearly copy weak unreadable signals (increases signal 3 to 5 "S" units).

- More than 20 dB low noise gain • Separate input and output tuning controls give maximum gain and RF selectivity to significantly reject out-of-band signals and reduce image responses • Dual gate MOS FET for low noise, strong signal handling abilities • Completely stable • Optimized for 10 thru 30 MHz • 9 V battery • 2-1/8 x 3-5/8 x 5-9/16 inches



**\$29<sup>95</sup>**

### MFJ-40T QRP Transmitter

Work the world with 5 watts on 40 Meter CW.

- No tuning • Matches 50 ohm load • Clean output with low harmonic content • Power amplifier transistor protected against burnout • Switch selects 3 crystals or VFO input • 12 VDC • 2-3/16 x 3-1/4 x 4 inches

MFJ-40V, Companion VFO ..... \$29.95  
MFJ-12DC, IC Regulated Power Supply,  
1 amp, 12 VDC ..... \$29.95



**\$17<sup>95</sup>**

### CPO-555 Code Oscillator

For the Newcomer to learn the Morse code.

For the Old Timer to polish his list.

For the Code Instructor to teach his classes.

- Send crisp clear code with plenty of volume for classroom use • Self contained speaker, volume, tone controls, aluminum cabinet • 9 V battery • Top quality U.S. construction • Uses 555 IC timer • 2-3/16 x 3-1/4 x 4 inches

TK-555, Optional Telegraph Key ..... \$1.95



**\$19<sup>95</sup>**

### C-500 Digital Alarm Clock

This digital alarm clock is also an ID Timer. Assembled, too!

- Gives ID buzz every 9 minutes automatically, or after tapping ID/doze button • Pressing ID/doze button displays seconds • Large .63 inch digits • Easily zeros to WWV • AM and PM LED indicators • Power out indicator • Fast set, slow set buttons • 110 VAC, 60 Hz • 3-1/8 x 3-3/4 x 3-3/8 inches • One year warranty by Fairchild

Order any product from MFJ and try it. If not delighted, return within 30 days for a prompt refund (less shipping).

Order today. Money back if not delighted. One year unconditional guarantee. Add \$2.00 shipping/handling.

Order By Mail or Call TOLL FREE 800-647-8660 and Charge It On



**MFJ ENTERPRISES** P. O. BOX 494  
MISSISSIPPI STATE, MISSISSIPPI 39762  
In Europe contact: ING I. STERN, Lohkoppelstrasse 27, 2000 Hamburg 76, West Germany. Tel.: (040) 299-6110, Telex: 2161808 STEX D

# ATB-34

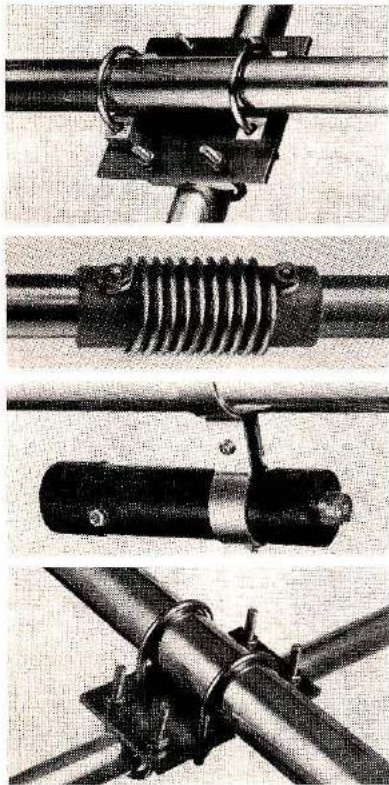
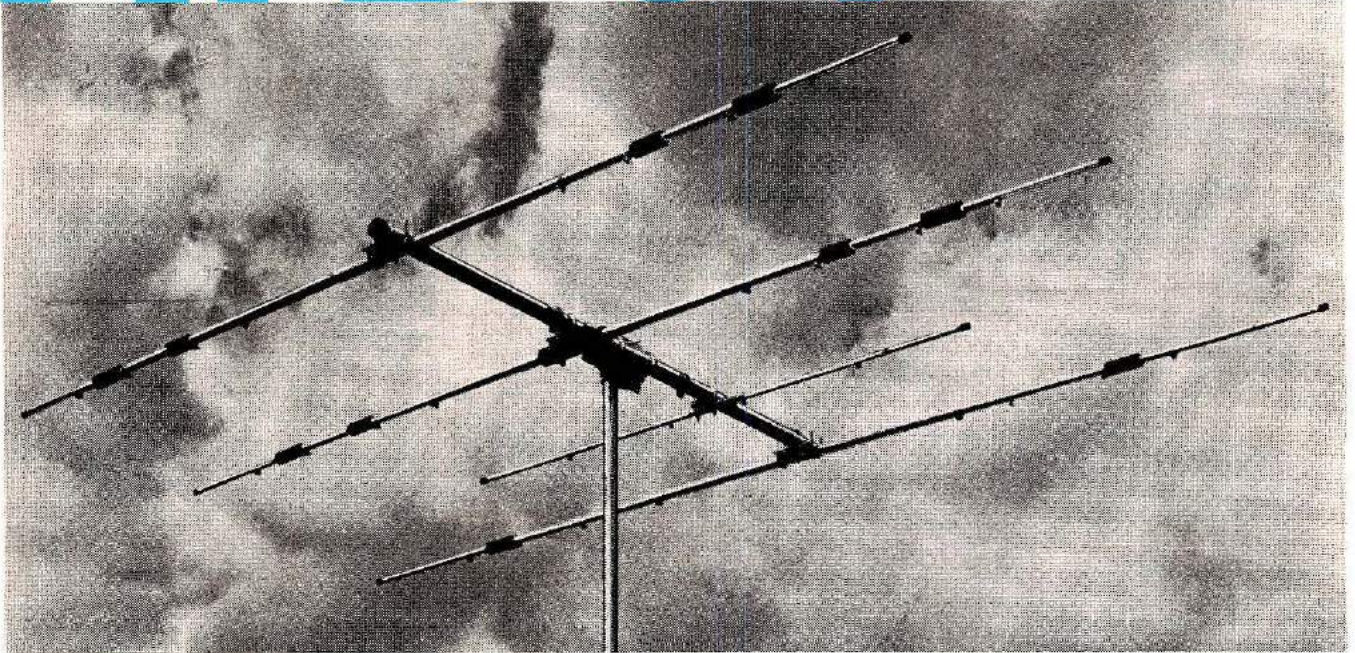

## 4 ELEMENT-3 BAND 10-15-20 METER BEAM

Cushcraft engineers have incorporated more than 30 years of design experience into the best 3 band HF beam available today. **ATB-34** has superb performance with three active elements on each band, the convenience of easy assembly and modest dimensions. Value through heavy duty all aluminum construction and a price complete with 1-1 balun.

Enjoy a new world of DX communications with ATB-34!

### SPECIFICATIONS

FORWARD GAIN -	7.5 dBd	WIND SFC -	5.4 Sq.Ft.
F/B RATIO -	30 dB	WEIGHT -	42 Lbs.
VSWR -	1.5-1	WIND SURVIVAL -	90 MPH.
POWER HANDLING -	2000 WATTS PEP		
BOOM LENGTH/DIA. -	18' x 2 1/8"		
LONGEST ELEMENT -	32'8"		
TURNING RADIUS -	18'9"		

# \$239.95

**COMPLETE**  
NO EXTRAS TO BUY

**UPS SHIPPABLE**

**IN STOCK WITH DISTRIBUTORS WORLDWIDE**



# cushcraft

CORPORATION

BOX 4680, MANCHESTER, N.H. 03108

November, 1977  
Volume 1, Number 9

# HAM RADIO HORIZONS

**T.H. Tenney, Jr., W1NLB**  
Publisher

**James R. Fisk, W1HR**  
Editor-in-Chief

**Editorial Staff**

Thomas F. McMullen, Jr., W1SL  
Managing Editor

Patricia A. Hawes, WA1WPM  
Executive Editor

Charles J. Carroll, K1XX  
Alfred Wilson, W6NIF  
Assistant Editors

**Publishing Staff**

C. Edward Buffington, WB1AMU  
Assistant Publisher

Fred D. Moller, Jr., WA1USO  
Advertising Manager

James H. Gray, W2EUQ  
Assistant Advertising Manager

Therese R. Bourgault  
Circulation Manager

Ham Radio Horizons  
is published monthly by  
Communications Technology, Inc  
Greenville, New Hampshire 03048  
Telephone 603-878-1441

Subscription rates are  
\$10.00 per year, worldwide

Copyright 1977 by Communications  
Technology, Inc. Title registered  
at U.S. Patent Office

Microfilm copies  
are available from  
University Microfilms, International  
Ann Arbor, Michigan 48103

Cassette tapes of selected articles  
from Ham Radio Horizons are available to  
the blind and physically handicapped  
from Recorded Periodicals  
919 Walnut Street, 8th Floor  
Philadelphia, Pennsylvania 19107

## CONTENTS

<b>Slow-Scan Television</b>	<b>12</b>	
William H. DeWitt, W2DD		
<b>A Better Code-Practice Oscillator</b>	<b>20</b>	
Douglas A. Blakeslee, W1KLK		
<b>Antennas for Limited Space</b>	<b>26</b>	
Joseph J. Carr, K4IPV		
<b>Safety Tips for Radio Amateurs</b>	<b>34</b>	
Devere Logan, W1HEO		
<b>Amateur Station Accessories</b>	<b>38</b>	
James H. Gray, W2EUQ		
<b>Basic Oscilloscope Uses</b>	<b>46</b>	
Loran Joly, WB0KTH		
<b>Questions About Linears</b>	<b>54</b>	
Richard W. Ehrhorn, W4ETO		
<b>Questions? And Answers! Part 3</b>	<b>56</b>	
Thomas F. McMullen, W1SL		
<b>Activities Calendar</b>	<b>72</b>	<b>Newsline</b> 11
<b>Ad Check</b>	<b>80</b>	<b>Post Box</b> 68
<b>Ad Scan</b>	<b>75</b>	<b>Product Showcase</b> 64
<b>Advertiser's Index</b>	<b>80</b>	<b>Propagation Chart</b> 71
<b>DX Forecaster</b>	<b>70</b>	<b>The View from Here</b> 6
<b>Focus and Comment</b>	<b>8</b>	<b>This Month's Horizons</b> 2

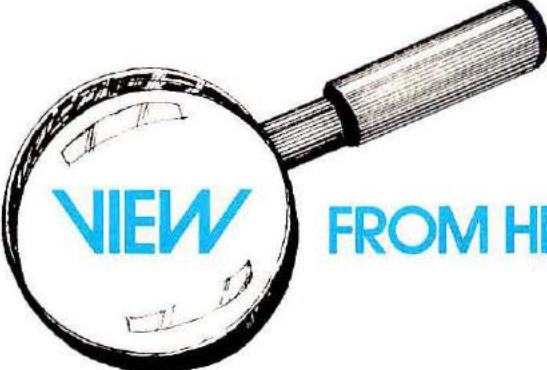

## THE VIEW FROM HERE

**As more and more amateurs switch** to factory-made gear, and as industry uses more ICs and disposable plug-in modules, the life of the dyed-in-the-wool ham homebrewer gets tougher and tougher. If you've recently tried any of the construction articles in the amateur magazines, you are already well acquainted with the hassle involved in obtaining a few needed components.

At one time you could drop in at your local corner radio store with a list of parts and the man behind the counter would fill your order. But that was when the vacuum tubes, resistors, and capacitors in your ham gear were the same as those in the family radio. It's not the same anymore — now the transistors and ICs in the radio and television sets are designed specifically for that purpose and have operating characteristics that are of little use elsewhere. There are exceptions, but they are few and far between.

Another problem that faces the serious home builder is the tremendous variety of transistors and ICs available from different manufacturers. Although some types of devices are made by more than one company, in most cases the semiconductor manufacturers crank out devices that are completely different from those of their competitors. And to add insult to injury, the same device may carry a dozen different part numbers: a 2N number, a replacement number, plus special numbers for units sold in large quantities to equipment manufacturers.

There is only one way to combat this lunacy: arm yourself with a good semiconductor cross-reference guide and a wide selection of electronic parts catalogs. Tops on the list of replacement guides is Howard Sams' *Transistor Substitution Handbook* available from *Ham Radio's* Communications Bookstore. This handy little paper back, which is updated every year, covers practically every transistor ever made, from 2N34 to 2N6500, with recommended substitutes. It also covers devices from Japan and Europe, as well as replacement types manufactured by Delco, General Electric, International Rectifier, Motorola, RCA, Semitronics, Sylvania, and Workman. Most of these manufacturers also publish replacement guides, available for the asking from their authorized distributors.

If you live in a large metropolitan area, chances are that there is an industrial electronics supply house that can fill your parts needs. Many of these firms don't advertise because they are not particularly interested in small quantity sales, but if you show up at their office, they will sell you the parts. If you want to find them, pick up your telephone directory and check the *Yellow Pages*: look under "Electronic Equipment and Supplies."

If you live out in the sticks, the problem is more difficult, unless you can get into the city. If you can't, you must purchase your components through the mail. There are many mail-order electronics supply houses which cater to the needs of amateurs, and many of them advertise in *Ham Radio Horizons* and in our sister publication, *ham radio*. Most of these suppliers publish listings of the components they have in stock, and a postcard request will bring you a copy.

**Jim Fisk, W1HR**  
editor-in-chief



ICOM wants you to

# Begin with the Best

As you develop your skills, increase your participation in Ham Radio activities, and add hardware for ever-increasing flexibility of operations, you'll come to know ICOM. Just ask any old Ham. ICOM is the quality name in VHF/UHF Amateur Radio equipment because it is simply the best. ICOM is the line you'll want to move up to for unequalled quality and features.

But you needn't wait until you can trade in a truck load of equipment to reach up to ICOM. You can begin building your Amateur Radio operations with reasonably priced ICOM units that have flexible add-on features when you purchase your very first voice transceiver. And when you are installing ICOM's top-of-the-line fixed station unit, the ICOM equipment you began with will probably still be an important integral part of your active hardware.

Don't delay in moving up to ICOM: begin with the best.



Clockwise from lower left: IC-211 4MHz. 2 meter, All Mode Transceiver; IC-245 Mobile 2 meter Transceiver; IC-229 Mobile VHF FM Transceiver; IC-502 Portable 50 MHz SSB Transceiver; IC-215 Portable 2 meter FM Transceiver; IC-30A Mobile UHF FM Transceiver.

Ask your dealer for ICOM's complete product line catalog, or mail your request to an address below.

VHF/UHF AMATEUR AND MARINE COMMUNICATION EQUIPMENT

Distributed by:



# ICOM

**ICOM WEST, INC.**  
Suite 3  
13256 Northrup Way  
Bellevue, Wash. 98005  
(206) 747-9020

**ICOM EAST, INC.**  
Suite 307  
3331 Towerwood Drive  
Dallas, Texas 75234  
(214) 620-2780

**ICOM CANADA**  
7087 Victoria Drive  
Vancouver B.C. V5P 3Y9  
Canada  
(604) 321-1833

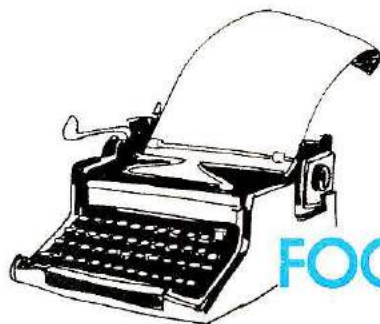

## FOCUS & COMMENT

I'd like to take a moment to talk about Public Relations. Yes, I know many clubs and individuals have taken the time to write stories for their local newspaper, to appear for an interview on local radio or television, and have gotten reporters from the various media to cover their special-event activities. Also, many stations that operate at the fairs and expositions throughout the country are doing a great job of exposing the general public to amateur radio (or is it the other way around). All of this is great stuff, but that is not the part of Public Relations I want to talk about.

I would like to ask: Are you getting the message across?

For instance, look at a typical newspaper release from the local field day group. It's full of news about the great things that amateurs do in emergencies, and tells how this is a practice run for operators and equipment — preparation for the real thing — and all that. Unfortunately, it is also full of the usual ham jargon. You and I understand it perfectly, but John Q. Newspaper-reader is no better off than if he read the list of additives on the side of his favorite brand of canned beans! He has been told that a group of people who call themselves hams have done something, but he is not sure what or how. What is a QSO? Is handling traffic the same thing that the cop on the corner does at rush hour? What kind of propagation are they talking about? It goes on — beams, Yagis, rigs, ARRL, OSCAR, repeaters, points, CW, phone — a truly confusing babble to those we are trying to impress with our good works.

Or maybe your effort never made it into print because the paper had a sharp editor who said, "Our readers will never understand all that junk — dump the story."

I'm sure that many of you have had the experience of trying to answer a question from a fellow-worker, a non-amateur acquaintance, your next-door neighbor, or the like. All they did was ask a very simple question because there was something about amateur radio or your station that they didn't understand. Did you notice a confused or perplexed look on their face when you said, "Oh, I always use a processor on SSB to break the pileups when chasing DX." Or, "Yeah, that's a delta-loop beam for working OSCAR." Did you find the right words to explain what you were talking about, or did you let them go away, still wondering what that funny-looking antenna was?

Believe me, it is worth taking the time to explain amateur radio to the curious, or to the public that reads newspaper releases. You don't have to give them a complete history, theory, or language course, but you can find enough common words to get your message across. You'll be avoiding trouble in the long run, because the more the public understands amateur radio, the less they will tend to blame hams for every flicker on their TV screen, or every squawk from their hi-fi set. The old saw, "Fear and suspicion feed on ignorance," is just as true in our field as any other.

Try it, the next time you are preparing a story for your local newspaper, or talking to a reporter or television crew; find the right words to reach your audience. Avoid the alphabet soup that is legible only to another ham. Now you're communicating!

**Tom McMullen, W1SL**  
Managing Editor

# SERVING HAMS BETTER

NORTH, SOUTH . . . EAST, WEST.

ALL LEADING BRANDS . . . IN-DEPTH STOCKS . . . NEW/USED EQUIPMENT

**VHF**  
MULTI-MODE  
2 METER TRANSCEIVERS

*in stock*  
at  
Ham Radio Outlet



**KLM 2700**  
SSB/FM/CW/AM



**KENWOOD TS-700A**  
SSB/FM/CW/AM



**ICOM IC-211**  
SSB/FM/CW

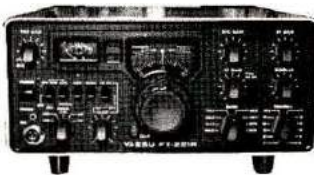

**YAESU 221R**  
SSB/FM/CW/AM

Standard of  
the industry!

**BIRD43**

Model 43 **THRULINE**  
WATTMETER

0. 1- 10,000 watts.  
0.45- 2300 MHz.



## ★ MICROPHONE SPECIALS

Any of the microphones shown **shipped prepaid** anywhere in the U.S.A.



**SHURE 526T**  
35.95

**ASTATIC D-104G**  
36.95

**SHURE 444**  
33.95

**DRAKE 7075**  
36.95

**YAESU YD-844**  
26.95

Calif. residents add 6% sales tax

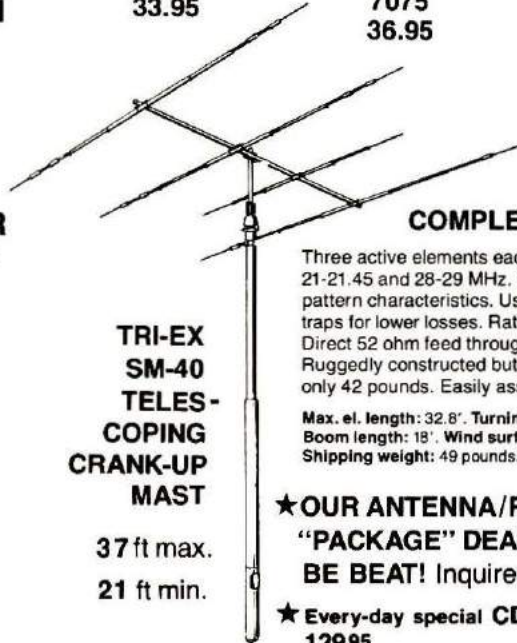

**CUSHCRAFT ATB-34**  
COMPLETE 3-BAND BEAM

Three active elements each band. Covers 14-14.35, 21-21.45 and 28-29 MHz. Excellent gain and pattern characteristics. Uses new High Q coaxial traps for lower losses. Rated at 2 KW p.e.p. Direct 52 ohm feed through 1:1 balun (supplied). Ruggedly constructed but lightweight; weighs only 42 pounds. Easily assembled and installed.

Max. el. length: 32.8'. Turning radius: 18.9'.  
Boom length: 18'. Wind surface area: 5.4 sq. ft.  
Shipping weight: 49 pounds.

**TRI-EX SM-40 TELES-COPING CRANK-UP MAST**

37 ft max.  
21 ft min.

★ **OUR ANTENNA/ROTOR/TOWER "PACKAGE" DEALS CAN'T BE BEAT!** Inquire.

★ **Every-day special CDE HAM II rotator 12995**

OVER THE COUNTER (Mon. thru Sat. 10AM to 5:30PM). PHONE, WRITE. SAME DAY SHIPMENT MOST ITEMS.

# HAM RADIO OUTLET

### SOUTH

Anaheim, Calif. 92801  
2620 W. La Palma, (714) 761-3033  
1 mile east of Knott's Berry Farm.

### NORTH (Main Office)

Burlingame, Calif. 94010  
999 Howard Ave., (415) 342-5757  
5 miles south on 101 from S.F. Airport.

### SOUTH

Van Nuys, Calif. 91401  
13754 Victory Blvd., (213) 988-2212  
Dealer inquiries invited.



**Bob Ferrero, K6AHV/W6RJ.**  
Jim Rafferty, WA9UCE/K6AAR,  
other well known hams,  
give you courteous,  
personalized service.



• ATLAS • BIRD • CDE • COLLINS • CUSHCRAFT • CURTIS • DENTRON • DRAKE • EIMAC • HUSTLER  
• HY-GAIN • ICOM • KENWOOD • KLM • MOSLEY • SWAN • TEMPO • TEN TEC • TRI-EX • YAESU • more.

# introducing the unbelievable ALDA 103

**Totally solid state SSB Transceiver • 80 through 20 meters • 250 watts**

Now, for under \$500, you can get the best deal in the ham radio market today for compactness, power and performance — the new ALDA 103. Unbelievable, but true.

Both brand new novices looking for that ideal first transceiver and seasoned hams wanting to treat themselves to a great second unit for mobile operation will turn on to the ALDA 103's totally broadbanded features. Can you believe fully automatic CW keying with automatic side step and RIT, too, so you can QSO with any make

of transceiver without constant frequency corrections? Or an intermod intercept point of better than 10 dbm? Or the tremendous stability of a VFO oscillator covering 5 to 5.5 MHz (not switched)? And that's just a sampling of the 103's superlative specs.

You won't believe the ALDA 103's clean, simplified engineering and serviceability until you see it for yourself. So see the ALDA 103 today...or write us direct for complete specifications on the ALDA 103 — and believe it.

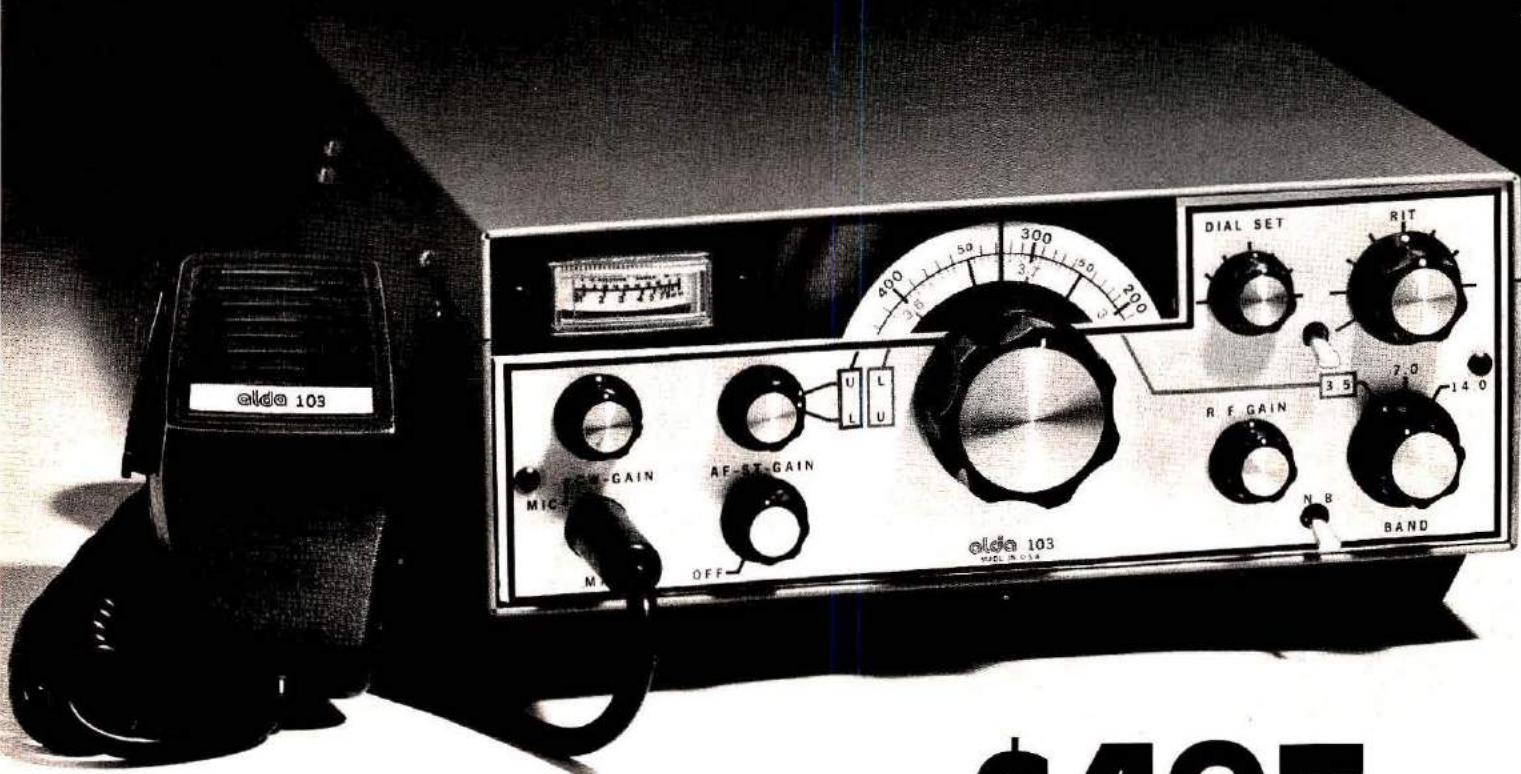

**ALD Industries, Inc.**  
215 Via El Centro  
Oceanside, CA 92054  
(714) 433-6123

# \$495

including microphone and  
mobile mount, too.

# NEWSLINE

---

COMMUNICATOR LICENSE WAS KNOCKED DOWN but not entirely out by the Commissioners in a July meeting (October Newsline) because of budget considerations. As proposed, the Communicator privileges would have been phone only on 220-225 and 420-450 MHz, reserving 435-438 for satellite communications. The Communicator would become the entry-level license, with Element 2 (the present Novice written exam) reoriented to include phone material, and administered by FCC Field Offices. To upgrade to Novice, a Communicator would pass a volunteer-administered CW exam.

Commissioners Final Vote was unanimous against funding the Communicator in next year's budget. Their rejection was tempered, however, by a recommendation that the concept be re-coordinated with the objectors and then resubmitted at a later date. Rejection at this time pretty well pushes the time-table for the Communicator back another year, until early 1980.

CW SENDING TEST is being dropped by the FCC for all Commission administered Amateur examinations, shortening and simplifying (since examiners won't need CW qualifications) the exams.

Novice Exams Administered by volunteer examiners will still require a sending test, however, to weed out really bad fists.

AN "AMATEUR/COMMERCIAL" REPEATER, VK5RTV, has been licensed by the Australian government to operate with 435 MHz in, 579.25 MHz (UHF TV channel 35) out! The precedent-making system has been licensed to the city of Adelaide for the specific purpose of "increasing public awareness of Amateur Radio" — Adelaide boasts a population of over three quarter million.

ANOTHER RFI BILL, this one giving the FCC authority to establish "minimum standards with respect to certain electronic equipment that is susceptible to radio frequency energy interference," was introduced into the U.S. House of Representatives in July by Representative Charles Vanik of Ohio. The new bill, HR8496, would amend Section 302 of the Communications Act of 1934 to give the FCC such authority. The new bill is another in the series introduced by Representative Vanik and by Barry Goldwater in the Senate (S864) that attempt to put the burden of RFI prevention where it belongs — on the makers of potentially susceptible equipment — rather than on the users of properly functioning transmitting equipment. It has been referred to the House Committee on Interstate and Foreign Commerce for study.

EXTENSIVE ELECTRONIC CONTROLS used in 1977 autos are running into problems from RFI. A recent Illinois Bell notice warned that the Cruise Control in 1977 Cadillacs is sensitive to strong RF fields, which could cause sudden speed changes. Some electronic skid control braking systems have locked up from RFI, and complete engine failure in fuel-injected systems has been reported by 2-meter users.

Cadillac Owners With Cruise Control that disengages with RFI have an easy solution to their problem. Request a "Suppressed Speed Sensor," part number 646-6900, from your dealer. It's a "no-charge" fix.

ALMOST 9.3 PER CENT GROWTH in the U.S. Amateur population was recorded for the first six months of 1977, with Novice Class licenses logging a whopping 53% jump! The total number of Amateur licensees went from 290291 to 317223 during the six-month period, an almost 20% annual growth rate!

INTERFERENCE ON 160 and possibly the high end of 75 meters could result from the FCC's recent approval of wide-band swept anti-theft systems. The three bands authorized for such systems are 1.7-2.3, 4.05-4.95, and 7.4-9.0 MHz, with a maximum field strength of 100 microvolts per meter at 30 meters.

Anti-Theft Systems must not interfere with radio communications, so can be shut down if they bother Amateur operations.

UNITED PRESS INTERNATIONAL will be promoting the Amateur Service with a biweekly Amateur Radio column to be distributed to UPI's 8000 subscribers. ARRL will provide much of the input for the column to WAIWVF of UPI — appropriate items should be channeled through Pete O'Dell at the League.

20-KHZ CHANNEL SPACING for 10-meter FM was adopted by the Texas VHF-FM Society at its summer meeting in San Antonio. The decision reversed the group's prior support of the ARRL 10-meter band plan (October Newsline) for 15-kHz channels — the League's new Repeater Directory shows only one system on the 15-kHz channels while 10 are on 20-kHz centers.

FORMER GETTYSBURG Special Licensing Chief Richard Ziegler received a sentence of 90 days in jail and 21 months probation for his conviction for bribery in connection with the issuance of Amateur two-letter callsigns (see Newsline, August and October).

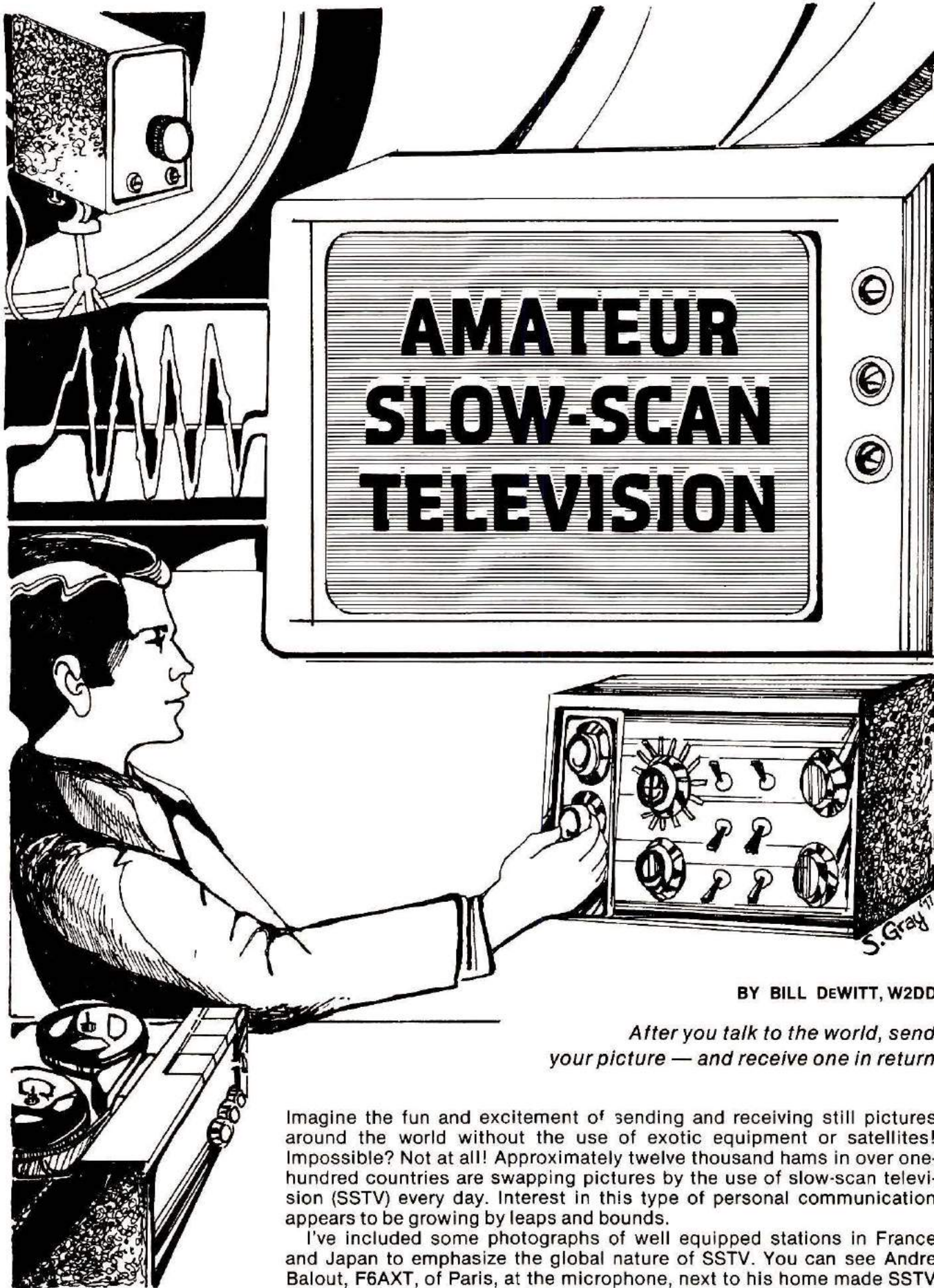

BY BILL DEWITT, W2DD

*After you talk to the world, send  
your picture — and receive one in return*

Imagine the fun and excitement of sending and receiving still pictures around the world without the use of exotic equipment or satellites! Impossible? Not at all! Approximately twelve thousand hams in over one-hundred countries are swapping pictures by the use of slow-scan television (SSTV) every day. Interest in this type of personal communication appears to be growing by leaps and bounds.

I've included some photographs of well equipped stations in France and Japan to emphasize the global nature of SSTV. You can see Andre Balout, F6AXT, of Paris, at the microphone, next to his home made SSTV



Slow-scan television has universal appeal. Starting from the upper left and going clockwise you can see Andre Balout, F6AXT, of Paris, at the microphone of his station which includes a homebrew SSTV monitor. The photograph was furnished by Andre's mother, F6AYF. Next is the well equipped station of K. Sasaki, JA7FS, of Fukushima, Japan. His station puts in a fine signal and good SSTV pictures into the United States. At the bottom right, John Woodruff of Durham, New Hampshire, watches a CQ from G3WW. John has been a "short-wave viewer" for many years, and likes to watch the SSTV scene on his *Robot* monitor, or on a recently acquired *Robot* model 300 scan converter. In the last photograph, a caricature of W2DD watches over the equipment as Bill mans the camera to take a shot of his SSTV hamshack.

equipment. A Japanese SSTV station, JA7FS, heard and seen frequently in the United States, is also shown. Operator of this beautifully equipped station is K. Sasaki of Fukushima.

Not all SSTV viewers are licensed amateurs. In the university town of Durham, New Hampshire, a political-science professor, Dr. John Woodruff, has been a short-wave-viewer for about six years. In addition to watching the ham scene, John likes to experiment with a closed-circuit system. He is shown watching a CQ from G3WW in England. This brings up a point of interest.

#### License requirements for SSTV

Most SSTV activity occurs on the high-frequency bands; it is not permitted in the 160-meter band, but there are specific "meeting places" for slow-scanners on the 75, 40, 20, 15, and 10 meter bands.

At the moment, FCC regulations limit SSTV transmissions on the 3.5 through 21 MHz bands to holders of the Advanced and Extra Class Operator's licenses because SSTV transmissions are permitted only in segments that are within those sub-allocations. General-Class license holders may use SSTV anywhere in the phone portion

of the 10-meter band.

Often-used frequencies are approximately 3845 kHz, 7171 kHz, 14230 kHz, 21340 kHz, and 28680 kHz. In some areas of the country the two-meter band is used for local picture-swapping sessions during the evening hours. Needless to say, the urge to get on SSTV has spurred many hams along in their efforts to obtain higher-class licenses.

#### No special transmitters or receivers are needed

The equipment for receiving and transmitting SSTV is used in conjunction with conventional ssb receivers, trans-

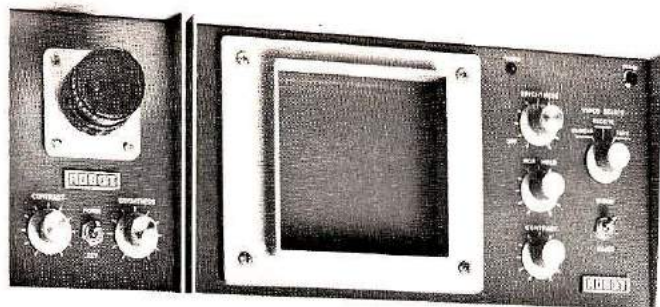

**Fig. 1.** If you are looking for SSTV monitors, you might find a *Robot* like this early Model 70, shown here with matching camera. Later versions would be 70A, B, or C. All are good buys for the newcomer if you can find one secondhand. The *Venus Scientific* SS-2 Monitor at the right also has a P-7 phosphor and is a good unit either assembled or as a kit.

mitters, and transceivers. Further, SSTV pictures can be recorded on an ordinary audio tape recorder.

The output from a slow-scan camera or pattern generator is in the audio range, and can be applied to most transmitters through the microphone jack. The signals required to create an image on a monitor are likewise in the audio range, and can be obtained from either the earphone jack or the speaker connection of your station receiver.

### What's in a name?

SSTV gets its name from the fact that the system operates at slower scanning rates than are used for broadcast television. The device used for

viewing TV images is called a monitor. Using monitors like those shown in **Figs. 1** and **2**, in conjunction with a good communications receiver, you can join the fun of receiving pictures from hams all over the world. There are two kinds of monitors used by SSTV operators.

The *Robot* Model 70 monitor shown in **Fig. 1** uses a cathode ray tube (CRT) like those used in radar sets. The phosphor\* used in its display screen has a long persistency compared to those of regular TV tubes; it is called a P-7 phosphor.

Pictures displayed on a P-7 monitor are seen as a bright scan from top to bottom of the monitor screen. As shown in **Fig. 3**, the picture is seen as a transient image, fading away at the top as it is completed at the bottom. However, a photograph of the screen, and to some extent, the integrating capability of the eye/brain visual-perception system yields a complete image such as that shown in **Fig. 3D**.

### Monitors using the P-7 CRT

\*Phosphor is a coating that is applied to the inside of the face of a cathode-ray tube. It is a chemical compound and when struck by a beam of electrons it emits light. The chemicals can be selected to produce light in various colors and short or long persistence. Short persistence phosphors stop emitting light almost immediately after the electron beam is no longer exciting them. Long persistence screens can continue to emit light for several seconds, depending upon the chemical makeup and the electron beam's intensity.

are called slow-scan monitors because the image appears at the slow scanning rate and cannot be refreshed or renewed at a rate within the persistency of the human eye. **Fig. 4** shows an image of the very attractive wife of F6BIG as received on a P-7 monitor at my station.

### Another kind of monitor

You can view SSTV on a regular TV set (fast scan) type monitor. This is possible through the use of a device called a scan converter. Scan converters are used to convert conventional TV (the output of a regular TV camera) to SSTV — or to convert SSTV to regular TV. The latter conversion offers a great advantage because the transient

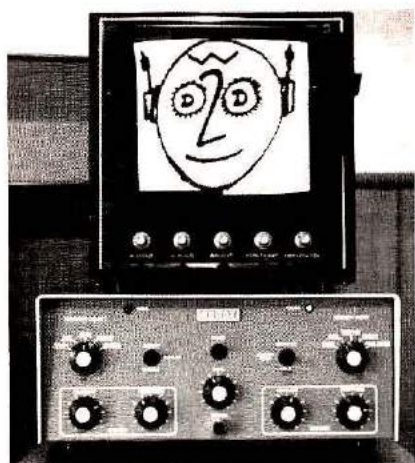
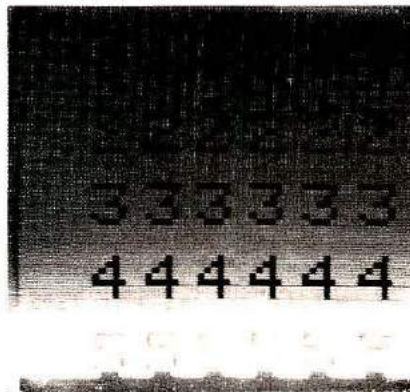
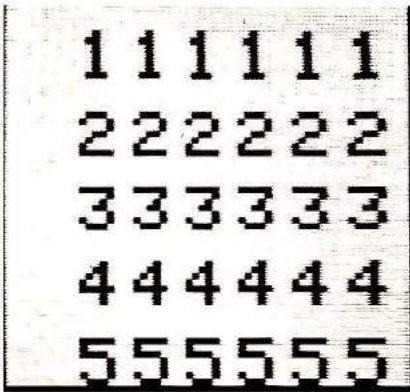
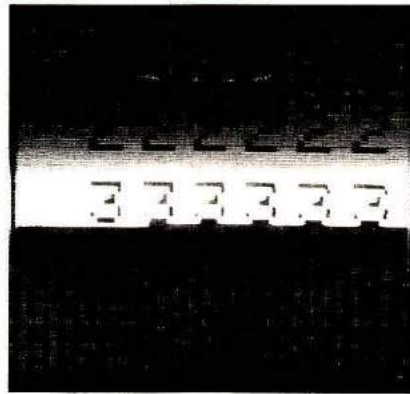
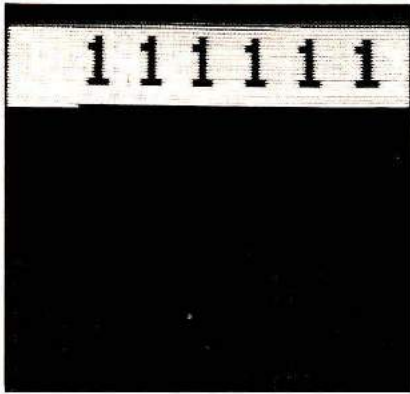

**Fig. 2.** Don't let appearances fool you. The *Panasonic* TV set is monitoring a slow-scan signal that has been converted by the *Robot* digital scan converter below it. It is no accident that the call letters W2DD appear on the face staring at you.



Dexter Phibbs, W4IPA, looks very proud of his homebrew monitor. It is compact and rugged, with a P-7 phosphor screen. The power supply is separate.





**Fig. 3.** A complete frame of slow-scan television requires an 8-second scan of the screen. It starts at the top (upper left), and works its way down the face of the cathode-ray tube (upper right). As it continues and gets near the bottom, the information at the top of the screen is beginning to fade away (lower right). A film-camera exposure of the entire sequence shows the complete image as in the lower left photograph.

complete picture is called a *frame*; every frame is composed of 120 lines rather than 525 lines as used in Commercial TV broadcasting in the United States.

As might be expected, this reduction in the number of lines per picture does reduce overall picture quality. However, as you have already seen, the system produces rewarding results within its limits of detail. See **Fig. 6** for a comparison of 120-line SSTV and 525-line standard TV pictures.

Let's get into the nitty-gritty for a moment and see why MacDonald went to an eight-second frame time.

### Why eight seconds?

Every radio signal occupies a certain bandwidth in the electro-magnetic spectrum. In general, it can be said that the *rate* of transmission of picture information determines the bandwidth of a TV signal. Conventional TV requires about 3 MHz for black and white pictures; in the high-frequency amateur bands such a system would exceed the total frequency range of any given hamband. It was for this reason that MacDonald slowed down the entire process, making it

nature of P-7 SSTV images is eliminated; each picture can be viewed as a bright, complete image for as long as desired.

Take another look at the monitor shown in **Fig. 2**. It's a *Panasonic Model TR-920M*, similar to a TV set without the tuner, and is displaying a slow-scan picture converted to broadcast TV scanning rates by a *Robot Model 400 Scan Converter*. A picture of the wife of YV1AQE, in Venezuela, as received by this system is shown in **Fig. 5**. Another continent and another lovely lady — SSTV is really great! More on monitors and scan converters later. Now let's get back to the story of SSTV in general.

### SSTV is not exactly new!

SSTV as used by hams today is based on a system invented about twenty years ago by Cophorne MacDonald, then a young radio amateur in his junior year at the University of

Kentucky. MacDonald's system makes it possible to transmit a square format black and white, still picture in eight seconds (fifteen lines per second). Each

Amateur Radio and SSTV received nationwide publicity when the Viking Landers sent photographs back from Mars. The Jet Propulsion Laboratory Amateur Radio Club operated a station to commemorate the event. They sent slow-scan pictures of Mars scenes to amateurs all over the world. Stan Brokl, K6YYQ, is at the operating console while being filmed by a member of the NBC Today staff (*photo courtesy K6PGX*).





**Fig. 4.** From France to New York state, the SSTV signal produces an excellent image of the wife of F6BIG, as received at W2DD.



**Fig. 5.** This is the attractive wife of YV1AQE, in Venezuela. The image has a fine dot pattern, which is typical of pictures produced by the *Robot 400* scan converters.

possible to transmit still pictures within the 3-kHz bandwidth allowed for amateur hf-band voice transmissions. In this way, MacDonald opened the door for worldwide amateur video communications!

Virtually all TV systems now in regular use employ the scanning principle to generate and reproduce television images. In a television camera the object being televised is optically imaged on the *target* of a vidicon tube. As this target is electronically scanned, the optical image is transformed into a variable-amplitude signal which corresponds to light and dark areas. This signal is then amplified and used to modulate a TV transmitter. At the receiving end, the video signal is extracted from the radio carrier and is used to control the brightness of a cathode-ray (TV) tube as its screen is scanned in synchronism with the transmitted video.

#### Some differences

In MacDonald's SSTV system, the same principles of scanning are used, but the *rate* of transmission is *much* slower than that used in broadcast

television. As mentioned earlier, SSTV pictures are made up of 120 lines; the frame rate is one every 8 seconds. Normal TV rate is 30 frames per second (made up to two nominal 256-line scans at one sixtieth of a second each). In addition, in the SSTV system, brightness information in the original image is converted to audio tones. Whites are converted to 2300 Hz; blacks are converted to 1500 Hz. Tones for shades of gray vary between these two frequencies.

Synchronizing pulses are an important part of a TV signal. They tell the cathode-ray tube when to start a new line and when to start a new frame. In the SSTV system these sync pulses become short bursts of a 1200 Hz audio tone. Since 1200 Hz is lower than the black-level tone of 1500 Hz, these pulses are not apparent on the screen when a picture is received.

#### Tape recording SSTV

The fact that all of the information necessary to construct an SSTV picture is contained in the audio range between 1200 and 2300 Hz

makes it possible to use a good quality cassette or reel-to-reel tape machine to record material for transmitting or receiving pictures. Most monitors are equipped with phono type connections for recording and playback purposes. Slow-scan operators generally make up a tape containing a CQ, station identification, and a few favorite pictures for regular use.

Maybe you've guessed by this time that an SSTV signal sounds like a bird warbling up and down the scale. Well, almost! The use of a variable frequency (instead of variable amplitude) to convey brightness information was hit upon by MacDonald to reduce the effects of fading and noise on the SSTV picture. So, in effect, SSTV signals are a form of fm superimposed on an ssb signal.

#### Getting started

As in the case with many other facets of ham radio, there are many levels of commitment so far as the time and the money you put into SSTV are concerned.

The basic requirement for joining the fun of viewing SSTV

pictures is a monitor; so your first step is either to build or buy one. If you want to be able to transmit, too, then you need at least a tape recorder (and a friend with a camera who can make up a CQ tape for you). Owning a camera permits you to make your own tapes or live transmissions. SSTV keyboards which generate alpha-numeric characters are also available. More on these items later. What you acquire will certainly depend upon your nature and your pocketbook!

Thousands of hams have built their own P-7 monitors. Depending upon your skill and the availability of parts, this may be the route for you to go. The ARRL publication, *Specialized Communications Techniques for the Radio Amateur*, describes how to convert an oscilloscope to a P-7 monitor. A neat and compact homebrewed monitor was built by Dexter Phibbs, W4IPA. You can see from his photograph that Dexter enjoys building his equipment as much as he does using it to receive SSTV signals.

The task of building a monitor can be greatly simplified by the use of a PC board such as the one shown in Fig. 7. The circuitry of this 6 x 8 inch (15x20cm) board was designed by W0LMD, but the

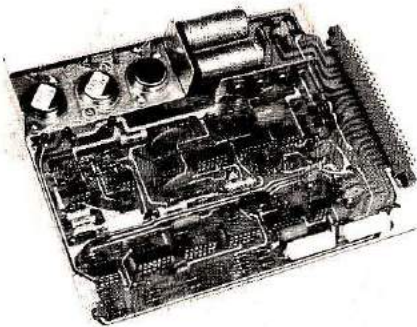

Fig. 7. Experimenters who would like to build their own monitor will find the task made a bit easier if they use printed-circuit board kits such as this one. It was designed by W0LMD, and is sold by Larry Pryor, WA9MFF, 5940 Carrollton, Indianapolis, Indiana 46220, for \$20 plus postage. That price is for the board only; you'll have to buy the parts separately.

board is made and sold by Larry Pryor, WA9MFF, for \$20 plus postage (for the board only). His address is 5940 Carrollton, Indianapolis, Indiana 46220. The WA9MFF board does not include provision for the CRT's high-voltage power supply.

An excellent monitor available in kit form is the *Venus Scientific* model SS-2. Complete with all parts and cabinet it sells for \$235. This *Venus* SS-2 is the only commercially built P-7 monitor now produced in the United States. It sells for \$285 completely wired.

In the second-hand department there are several good possibilities. *Robot Research* made about 4000 of their excellent P-7 monitors over a period of about five years. They were called the model 70, 70A, etc., according to the features they include. Among the *Robot* monitors, your best bet would be the model 70C. However, all of them are well designed and very reliable.

Although fewer are available, the *Venus* monitors and P-7 monitors manufactured by the *Sumner Electronics and Engineering Corporation* (SEEC) are also good buys.

If you have an opportunity to see a homebrew monitor in operation and appraise its performance you may wish to find a bargain in this way. Do yourself a favor and don't buy anything that is non-operational "but could be fixed up — etc." If you can find a good homebrew job, this might be your lowest cost approach to getting started in SSTV.

You really should acquire a tape recorder. Get a cassette recorder if you don't already own one, or a reel-to-reel machine — one that has a wow and flutter figure of less than 0.2 per cent for best results. Cheap ones will give you jittery lines in the picture. You can store pictures on tape for

Fig. 6. A comparison between a slow-scan picture (from a scan converter) and one seen on a normal TV screen such as you would watch your local broadcast station on. The loss of fine detail is because of the restricted bandwidth, and hence less picture information, of the SSTV system.





**Fig. 8.** Double-decker scan conversion in W2DD's shack. The pyramid at the right includes a *Robot* model 300 scan converter on the bottom, a *Robot* model 400 Digital scan converter in the middle, and a *Sony* TV set on top.

playback to the sender — or just to keep for future reference and demonstration purposes.

If you decide that SSTV is for you, then perhaps it's time to own a camera. For the sake of brevity, since cameras represent a very large subject, my suggestion would be that owners of *Robot*, *Venus*, or *SEEC* monitors buy cameras from the same manufacturer.

Homebrewing a camera is a tough job, but it can be done by an experienced builder. A two-part article, "The WB2DCX Plumbicon SSTV Camera," by James McKeown, appearing in the June and July, 1977, issues of *CQ* magazine, is recommended to those inclined to homebrew everything.

An alternative for the builder is to buy a used security type TV camera (they operate at fast-scan rates) and build a scan converter to convert its output to SSTV. W6MXV and DL2RZ sell a fast-to-slow converter kit for this purpose.

### Scan conversion

The biggest single reason for the recent upsurge of interest in SSTV is the availability of scan converters designed for the ham SSTV market. These

scan converters make it possible to view slow-scan TV as bright, complete images on a black and white screen. Any image can be "frozen" for viewing as long as desired.

*Robot Research* has produced two kinds of scan converters capable of both fast-to-slow and slow-to-fast conversion. Their original scan converter, the Model 300, used a storage tube to effect the scan conversion. The currently produced Model 400 scan converter employs a completely solid-state digital conversion system and is simpler to operate, see **Fig. 8**.

If you can afford to go all out and get the best that SSTV offers, a scan converter is the answer. You'll need a fast-scan monitor and a camera to go with it, and of course, a good tape recorder. To round out the equipment array, you might also include an SSTV keyboard. This is a typewriter-like device that can generate alphanumeric characters such as used for signal reports or other messages.

This article was written to bring the SSTV scene into perspective for those relatively new to ham radio. It's difficult to attach firm dollar figures to

the various equipment arrays described here — but it appears that the range of expenditures could be from around \$50 (for a homebrew P-7 monitor) to around \$1000 (for a scan converter, plus camera, plus fast-scan monitor, plus tape recorder). That's a broad span of costs — but don't forget, the fun you'll have isn't necessarily in proportion to the dollars you'll spend! If construction is your favorite indoor sport, building a monitor from scratch or converting an old oscilloscope to SSTV operation can be just as rewarding as plugging in the latest "gray box."

Within the next few years it's certain that the use of microprocessors and signal-processing ICs of many descriptions will greatly change the equipment arrays found in ham stations. This applies to CW, voice, RTTY, facsimile, and of course, SSTV. The rate at which this changeover occurs will depend upon the cost of the chips and the size of the amateur market.

At the risk of sounding like "Father Time," let me say that in 54 years of ham radio nothing but SSTV has equalled the excitement of my first QSO with a spark-coil transmitter! Don't let the question of what might be available "soon" keep you from the fun of what's going on right now. Here's hoping that you will soon be showing up on my monitor screen, and please write to me if you have any questions. My address is 2112 Turk Hill Road, Fairport, New York 14450. **HRH**

If you would like more detailed information about Slow-Scan TV, including technical details about how to set up or build your own station, there is a book that will help. It is called *The Complete Handbook of Slow Scan TV*, by Dave Ingram, K4TWJ. It is available for \$9.95 from *ham radio's* Communications Bookstore, Greenville, New Hampshire 03048. Order T-859.



DENTRON MLA-2500



TEN-TEC TRITON IV



ATLAS 350-XL

LOOK WHAT WE'VE GOT  
IN STORE FOR YOU!!

VARIETY

PLUS . . .

S-E-R-V-I-C-E



YAESU FT-301D



KENWOOD TS-520S

DEAR OM:

There are TWO IMPORTANT FACTORS in any purchase of ham radio gear — the PRODUCT and the DEALER — or, in otherwords, WHAT you buy and WHERE or from whom you buy it. Hence, at BURGHARDT AMATEUR CENTER, we stock & sell AND Guarantee & S-E-R-V-I-C-E only TOP-QUALITY/BRAND-NAME merchandise plus we carry a COMPLETE LINE of operating aids & accessories to fill virtually every ham need. BUT, it's not so much WHAT we sell, rather HOW we sell it that's worth your consideration.

When it comes to FAST DELIVERY, HONEST DEALING and COURTEOUS/DEPENDABLE S-E-R-V-I-C-E, we don't just advertise it — WE GIVE IT!! Ham radio is our ONLY business, and as such, we don't pretend to be "Big



DRAKE TR-4CW



Operators" or "Wheeler-Dealers" but choose instead to offer FRIENDSHIP and PERSONAL S-E-R-V-I-C-E plus RELIABILITY to those

who realize there is MORE to a "GOOD DEAL" than just the "lowest price" available. In the final analysis, the "REPUTATION" of the DEALER standing behind your purchase is worth as much or MORE than the quality of the product itself.

In short, we S-E-R-V-I-C-E WHAT WE SELL as well as those we sell to, and we firmly believe that there is NO SUBSTITUTE for the kind of "GOOD" S-E-R-V-I-C-E that we are READY, WILLING and ABLE to provide you with. Sure, it may cost you a little more "NOW" — but, when you deal with us, it will SAVE YOU a lot of time, a lot of trouble and a lot of hassles in the long run. WE'RE FOR REAL — THERE'S NO DOUBT ABOUT IT!



TEMPO 2020

MAIL & TELEPHONE ORDERS . . . "WELCOMED" — They're our business!! SERVICE?? NO PROBLEM! It's OUR Policy.

73's STAN BURGHARDT WØIT BILL BURGHARDT WBØNBO JIM SMITH WBØMJY ERV HEIMBUCK KØOTZ

STORE HOURS:  
TUESDAY thru SATURDAY  
9:00 A.M. to 5:00 P.M.  
Closed Sunday & Monday

124 First Avenue Northwest  
P.O. Box 73  
Watertown, South Dakota 57201  
Phone 605-886-7314



Write today for our latest Bulletin/Used Equipment list.

"America's Most Reliable Amateur Radio Dealer"

Your Full-Line Ham Dealer Where S-E-R-V-I-C-E is our most important product.

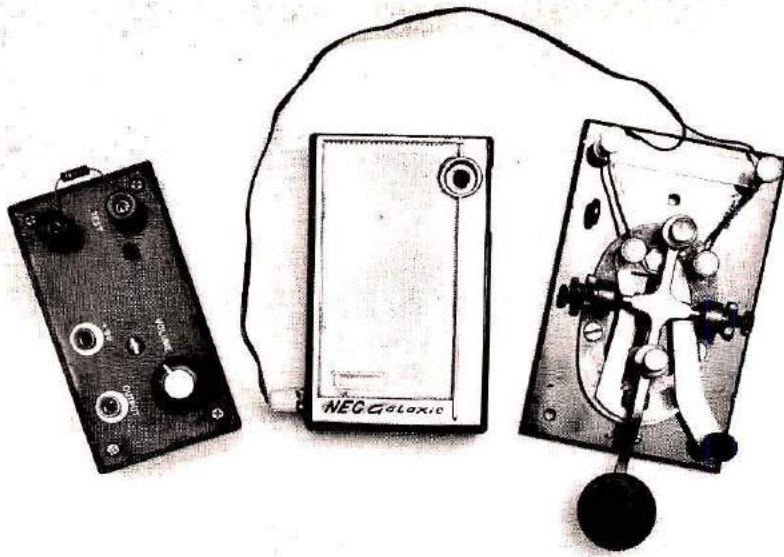

# A Better Code-Practice Oscillator

BY DOUG BLAKESLEE, W1KLK

To obtain their licenses, hams must pass a (Morse) code test and a written examination about radio theory and Federal Communications Commission (FCC) regulations. It is this test of proficiency that sets Amateurs apart from those with radio operator's permits\* or citizen's bands (CB) licenses. The abilities a ham demonstrates by passing the exam bring him two major privileges: First, he is permitted nearly unrestricted use of a wide range of frequency bands extending from just above the broadcast segment to microwaves and, second, he is permitted to transmit information in a number of modes including code, radiotelephone, radio *Teletype*, and television. By way of contrast, permit holders and CBers are restricted to just a few designated channels. Amateurs, because they have shown a level of technical competence, can build and repair their own equipment,

\*A Restricted third class radio telephone permit, such as is issued to pilots for using transmitters aboard aircraft.

where as others must rely on — and pay for — service from FCC-licensed professionals.

The FCC Novice Class license exam is the starting point for most Amateurs, myself included. Novice examinations consist of a Morse code test at five words per minute (sending and receiving) and a multiple-choice written test covering FCC rules and elementary radio theory; individuals and club groups can

provide both training and testing. The American Radio Relay League has developed a program for use by clubs and others interested in organizing Novice classes.

For newcomers as well as old timers who have let their licenses lapse, but want to restart, the Novice experience should not be missed. The friendships that develop during the classes last a lifetime. Operating in the Novice bands provides valuable experience — and fun. There's great comradeship because everyone is a beginner; your mistakes in code and procedure are not noticed; the first confirmation cards you garner become prize possessions.

## The gadget(s)

My device to aid the Novice is a combination code-practice oscillator (CPO) and a continuity meter which gives an audible indication of resistance values. It was developed from an idea published by Cal Graf.<sup>1</sup> Building the gadget will aid in your understanding of how basic radio components are assembled, relating theory to practice. Used as a CPO, the unit will help you learn to send and receive Morse code. When your Novice days are over the unit will continue to be useful for continuity checks.

Two versions of the device

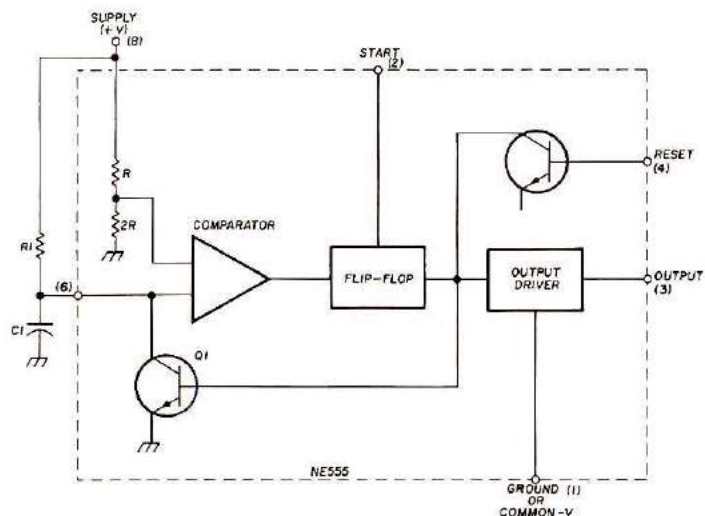

Fig. 1. A functional block diagram of the NE555 timer IC. See the text for an explanation of how the parts of the circuit operate.

have been built: One to provide a full range of features, and the other to function only as a CPO. The second version uses components from a defunct transistor radio to minimize cost, but the circuits for both versions are based on the popular NE555 integrated circuit (IC).

The NE555 was designed as a precision timer which would need a minimum of external components. It was introduced by Signetics several years ago; today most of the large semiconductor houses make 555s.<sup>2</sup> Art Fury, WA6JLJ, who worked for Signetics when the NE555 was developed, delighted in showing off the capabilities of the new IC with a toy tank. The tank performed a series of driving and firing sequences, each controlled by a NE555. Since then, the tank has been retired, and several hundred more practical applications of the IC have been published — everything from a delay timer for windshield wipers to a missing pulse detector.

### Theory of operation

While it isn't necessary to understand how the 555 works to build the gadget, you'll find the learning process that comes with each construction project is enjoyable. A simplified diagram of the internal workings of the NE555 is shown in **Fig. 1**.

In most circuit diagrams, operations and current flow are considered to take place from left to right, so let's begin at

There are two interesting books available on the NE555 timer integrated circuit: *IC Timer Cookbook* by Walter Jung from Howard W. Sams, order 21416, \$9.95. *The 555 Timer Applications Sourcebook With Experiments* by Howard M. Berlin, W3HB, order BB-555, \$6.95. Available from *ham radio's Communications Bookstore*, Greenville, New Hampshire 03048.

the left-hand edge of the diagram. The dotted line shows the IC package. Everything inside the dotted line is inside the IC, and everything outside the dotted line is an external component or lead that you add when building a circuit. At the borders are numbers that correspond to pin numbers on the IC itself, together with function labels that I have added to show what happens, where, and why.

The NE555 contains, among other things, a voltage-divider network consisting of resistors R and 2R, a voltage comparator, two transistors, a flip-flop logic gate,\* and an output driver circuit.

The voltage comparator is a type of electronic switch that compares two voltages appearing at its input terminals (shown at the base of the triangle on the left-hand side). The output of the comparator is at the apex, or point, of the triangle at the right-hand side. When the input voltages are different, the comparator is *on*; that is, a voltage close to the supply voltage appears at its output terminal. When the two input voltages are the same, the voltage at the output drops nearly to zero, or ground, potential. Just as its name

implies, the comparator compares input voltages.

Now, let's take a look at what happens when we try to use this circuit as a timer. Inside the NE555 are two resistors, R and 2R, connected to the power supply (voltage source) in such a way that they supply a *reference* voltage of about 2/3 of the power-supply voltage at their junction. The reference voltage is applied to one terminal of the comparator.

Outside the IC, there is a series combination of a resistor and capacitor, R1 and C1, connected between the positive supply voltage terminal and ground. These establish the timing cycle. The junction between them is connected to the other terminal of the voltage comparator. In this way, the voltage on the external capacitor can be compared to the reference voltage inside the IC.

\*A flip-flop is a digital logic element that stores one *bit* of information in binary language, such as on/off, high/low, 1/0, and the like. The flip-flop may assume either of two stable states, depending upon the input signal. One stable state represents *on*, *high*, or logic 1. The other stable state represents *off*, *low* or logic 0. It will change (or flip) from one state to the other when the proper trigger is applied.

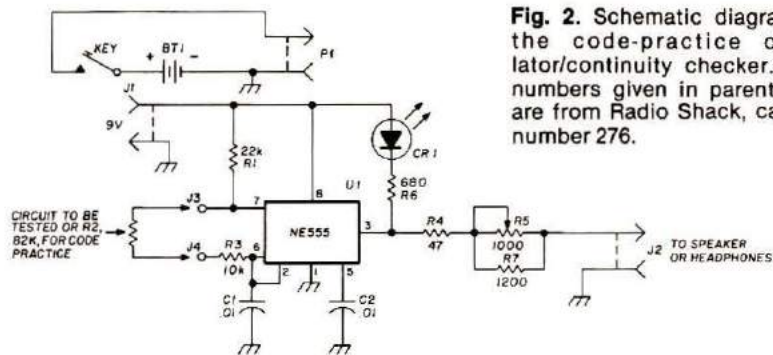

**Fig. 2.** Schematic diagram of the code-practice oscillator/continuity checker. Part numbers given in parenthesis are from Radio Shack, catalog number 276.

BT1	9-volt transistor radio type (23-464)	R1,R2,R3, R4,R6	1/2- or 1/4-watt composition (series 271-000 or 271-1300)
C1,C2	Ceramic, 0.01 $\mu$ F (272-131)	R5	Linear-taper control, 1000 ohm, panel mount (271-1714 shunted with 1200-ohm composition resistor)
CR1	Light-emitting diode, red (276-090 or 276-041)	U1	NE555 timer IC (276-1723)
J1,J2	Phono jack, panel mount (274-346)		
J3,J4	Binding post, panel mount (274-661)		

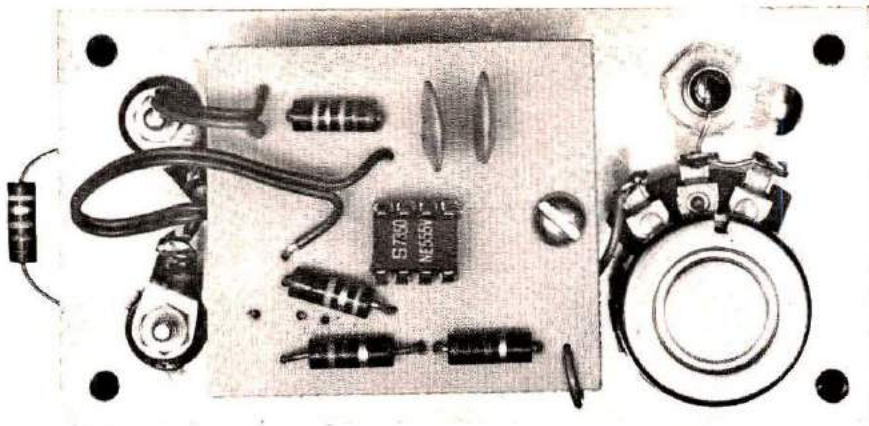

The test oscillator is built on a small square of PC board. Perforated board may be used as well, and the components are connected to each other with small scraps of left-over wire.

A timing cycle begins with a starting pulse when the comparator output voltage drops to nearly ground potential. This voltage drop resets the flip-flop which releases the short placed across C1 by transistor Q1. Current begins to flow through R1, charging capacitor C1. As soon as the capacitor reaches the reference voltage ( $\frac{2}{3}$  supply voltage) the comparator triggers the flip-flop, shorting C1 to ground through transistor Q1. This completes a full cycle. You can change the timing cycle by changing the values of R1 and/or C1, which determines the time constant of the circuit. Notice that during a timing cycle, C1 can also be discharged by an external reset lead. The timing cycle is

initiated by the *start* lead. The output driver circuit is capable of handling a current of 200 mA.

In the practical circuits of Fig. 2 and Fig. 3, the internal parts of the 555 are ignored, and the IC is treated as a block, U1. Pins 6 and 2 have been connected together so the IC automatically resets after each time cycle. With appropriate resistance and capacitance values that make the timing cycle fast enough, the IC functions as an audio oscillator with sufficient output to drive small speakers. A variable resistor, R5 in Fig. 2, can be used to adjust the volume.

Two jacks, J3 and J4, have been provided to allow for connection of external resistances, denoted on the

The resistor between the two terminals on the left of the oscillator panel must be removed before you use the box to check the continuity of a circuit. Leave the resistor in place, and connect a key in series with one battery lead to use the oscillator for code practice. For an interesting effect, connect a light-sensitive resistor (No. 6H3052, 10 for \$1.98 from Poly Paks, P.O. Box 942H, Lynnfield, MA 01940), to the terminals and listen to the tone vary as you change the amount of light that hits the resistor.



drawing as R2. If a short circuit or low resistance is placed across J3 and J4, the audio tone produced is high. As the resistance of R2 is made larger, the frequency goes down. A very high resistance produces an output of only a few cycles per second (hertz) which makes a pulsing or popping sound in the speaker. A light-emitting diode (LED) has been included to provide a visual indication of the slow pulses. (At high frequencies the LED is still pulsing, but the rate is far too fast for the eye to follow, so it appears to be *on* continuously.) Typical frequencies produced by various values of R2 are given in Table 1.

Table 1. Approximate output frequency for various resistance values.

R2, ohms	frequency, hertz
10M	5
1M	45
100k	470
10k	2800
1000	3000
SHORT	5000

For code practice using the circuit of Fig. 2, use a 68-kilohm resistor for R2, and insert the key in series with one of the battery leads. The audio output from J2 can be connected directly to a small 8- or 45-ohm speaker. If high volume is needed, use a 500-ohm primary, 8-ohm secondary transformer (Radio Shack 273-1381 or similar) with the high-impedance winding connected to J2 and the low impedance winding connected to the speaker. Or, output from J2 can be fed to a public address system — if you have a large code class.

The unit is assembled on an etched circuit board. The foil pattern for the board is given in Fig. 4, if you can make your own, or a board can be purchased from Whitehouse.\* Install the components on the board following the layout of Fig. 5. It is worth the money (35 cents) to use a socket (Radio Shack 276-1995 or similar) for



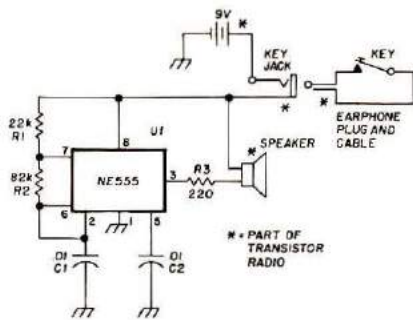

- C1,C2 Ceramic, 0.01  $\mu$ F (272-131)  
 R1,R2,  $\frac{1}{2}$ - or  $\frac{1}{4}$  watt composition (series 271-000 or 271-1300)  
 R3  
 U1 NE555 timer (276-1723)

**Fig. 3.** Schematic diagram of the code-practice oscillator built in a transistor-radio case. Components marked with an asterisk are original parts of the radio. Others with part numbers are from Radio Shack.

U1. Occasionally you may have a bad IC or damage the unit, and it is difficult to remove an IC without damage to both the circuit board and your state of mind. Mount the components on the board a few at a time. Bend the leads slightly to hold the parts in place while you turn the board over. Solder each part in place and then trim the leads close to the board.

Version one of the gadget is built in a 3-1/4 by 2-1/8 by 1-1/8 inch (83x54x29mm) bakelite box with aluminum cover (Radio Shack 270-230). If you intend to mount a speaker within the unit, a slightly larger enclosure will be needed. Don't overlook kitchen cast-aways; many fine enclosures have been made from cookie, cracker, and meat tins. In our version, the jacks and volume control were mounted on the aluminum panel, then the circuit board was mounted using stand-off posts. It is not necessary to duplicate my unit exactly; neither parts placement nor layout is critical. The final assembly step is to wire the

\*The circuit board is available from G. R. Whitehouse, 15 Newbury Drive, Amherst, New Hampshire 03031 for \$3.00 postpaid; or a complete kit of components for Fig. 3 (3 resistors, 2 capacitors, U1, socket, and PC board) for \$5.00 postpaid.

panel components to the circuit board.

Some cost can be saved if the continuity-meter, adjustable-volume, and LED-lamp features are eliminated. An old transistor radio can supply the expensive components: case, speaker, battery, battery clip and key jack. The transistor radio earphone is cut off, and its cord and plug are used to connect a key. The circuit of the simplified CPO is given in Fig. 3. The new components: three resistors two capacitors, and U1, cost approximately \$2.

If you want a different tone or volume level, the values of R2 and R3, respectively, can be varied. Because so few components are used, they can be quickly assembled on a small piece of Perfboard (Radio Shack 276-1395). Bend the leads from the resistors and capacitors until they form appropriate connections, then solder. A lead can be looped through the board and out again to form a convenient tie

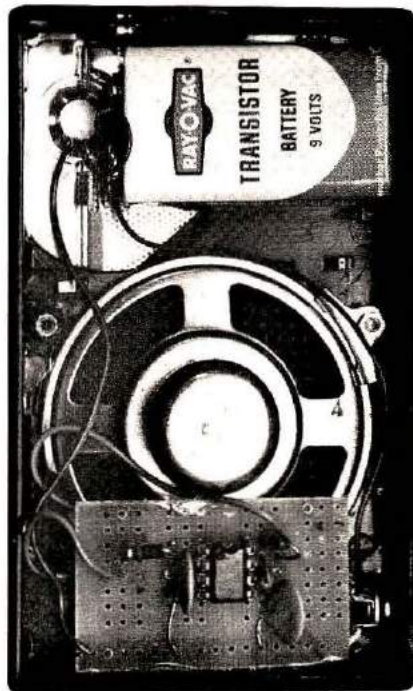

The low-cost version of the code practice oscillator fits inside this discarded transistor-radio case with room to spare. The unit shown here was built on a piece of perforated board. You can build it the same way, or use a printed circuit board as in Fig. 4.

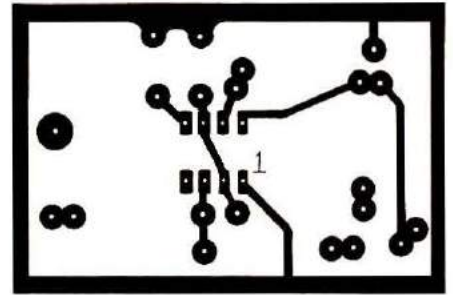

**Fig. 4.** Full-size pattern for the printed-circuit board, foil side. A parts-placement guide is given in Fig. 5.

point for external connections. In my unit I mounted the circuit board and battery using dabs of Duco cement — a method somewhat lacking in elegance, but most effective. Of course, the original transistor-radio circuit board was first removed and discarded.

#### It works

As a CPO, it is only necessary to connect the key, and start to practice. The continuity feature proved most useful when trying to identify cable leads dangling beneath the radio-shack table. A beep from the gadget announced that the right pair of leads has been found.

The transistor-radio version of the unit was built so I could bone up on sending code with a hand key, preparatory to taking an Amateur Extra-Class exam. After years of using electronic and keyboard keyers, practice was needed in hand-sent Morse. For several weeks I carried the gadget in my briefcase, catching a few minutes of practice whenever possible. During one trip, the earphone jack shorted. I returned to find a number of people staring at my case, which was making an unusual noise.

Practice pays off. A few hours with the CPO enabled me to send something approximating the code at 20 words per minute, at least enough to please the FCC examiner in Boston. Six weeks later that coveted Amateur Extra-Class license arrived in the mail. Now, the gadget is in use by a

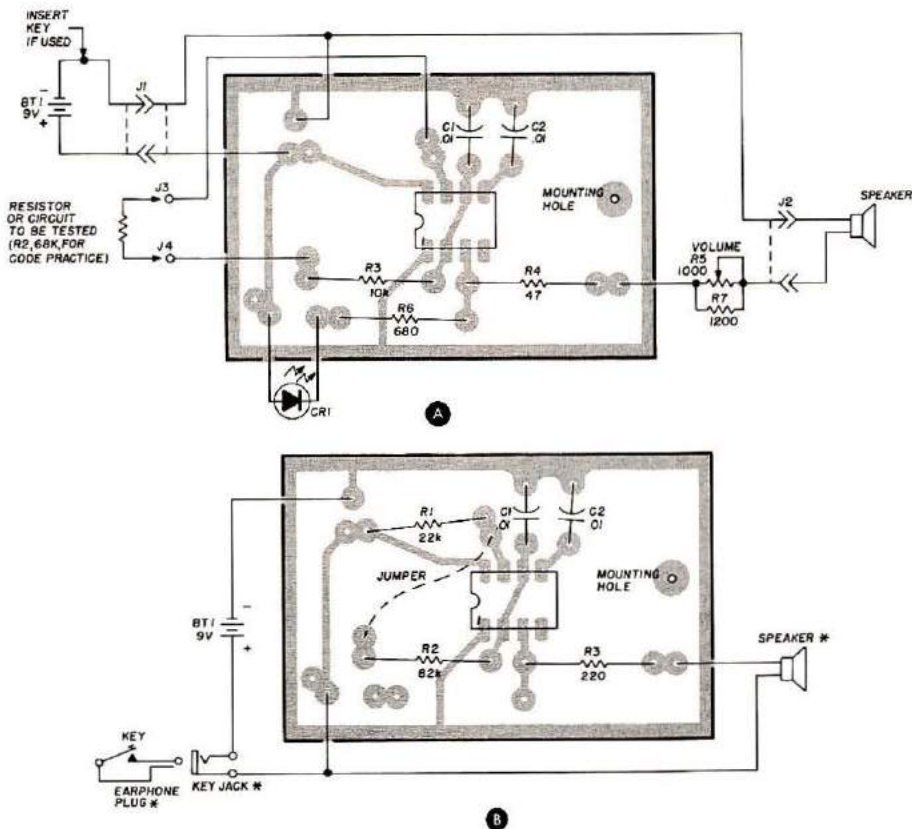

**Fig. 5.** Parts-placement guide for both versions of the oscillator are given here. If you are building the continuity-checker version, use the layout shown at **A** and the schematic diagram in **Fig. 2**. A key may be inserted in the circuit by breaking the battery connection at the point shown. If you are building the code practice oscillator into an old transistor radio case, use the layout shown at **B**, and the schematic diagram in **Fig. 3**. Parts marked with an asterisk (\*) are original parts from the radio.

young lady named Barbara, who is a student in the Novice classes run by the Norwalk (Connecticut) radio club. Learning the code takes some time and concentration, but it isn't hard. Try it yourself; join Barbara, myself, and several hundred thousand others around the world in the fun of Amateur Radio.

### Using the continuity tester

This box can be valuable "third hand" when you want to check the continuity of a circuit that you have just installed. For instance, you have a bundle of wires that disappear into a wall or conduit, and come out somewhere else in the house, maybe for an intercom circuit. The color-coding may not be too clear, or perhaps there is a break in one of the wires. First find a common wire, of whatever color you choose. I

always like to start with white, if possible, because that is the accepted *neutral*, or ground, color coding in most electrical work. Check this wire to be sure that it is not broken by hooking one end of it to J3, and the other end to J4. You may have to use a long jumper to get from J4 to the other end of the wire in question, or, if there is a ground circuit, such as a copper pipe that you can get at from both ends, use that as the return to J4. If there is continuous circuit through the wire you want to test back to the test box, you should hear a high-pitched tone. Be sure that there is *no voltage of any kind* on the wire that you are testing, or you will probably blow out the NE555 IC.

Once you have determined that the common wire that you have chosen is good, you can then find and label each wire in turn by hooking the box to one,

with the unknown wire on J3, and the common wire on J4, and go to the far end of the circuit and short one wire at a time to the common. When you hear the tone, you know you have a complete circuit.

Another example of the use for this handy box would be to test a coaxial cable and fittings. If you can get at both ends of the cable, hook the center conductor at one end to J3, and the center at the other end to J4. If the conductor and the fittings are good, you will hear a tone. If you do not hear a tone, the conductor is open somewhere — perhaps there is a poor connection inside one of the fittings. Next, connect the center conductor to J3, and the braid or outer conductor to J4. The circuit should be open, and you should not hear anything. If you get a tone, then there is a short circuit somewhere. Again, the most likely place is the connector or fitting.

To extend the use of the tester for transmission lines, you can hook the box to the line in your shack or at the bottom of a tower. Then, if you are checking for shorts or opens at the top of the tower, you will be able to hear the results of the test as you work. Some antennas should present a dc short circuit at the end of the line, and others are open circuited to dc, so you should be aware of what the antenna looks like to the test box.

Note that this test indicates only the *short or open* condition of the line for dc — it will tell you nothing about the condition of the line for radio frequencies. Moisture, for example, will upset the performance of the cable for rf energy, but have no effect on the simple test performed with the continuity tester.

### References

1. Cal Graf, "Audio Continuity Tester Indicates Resistance Values," *Electronics*, April 7, 1976.
2. Doug Blakeslee, "Time — IC Controlled," *QST*, June, 1972.

HRH

# THE HEATHKIT HW-101: ONE OF THE FINEST VALUES IN AMATEUR RADIO



only  
**\$339<sup>95</sup>**

Has the features you **NEED** for real operating ease, convenience and versatility.

## A traditional Heathkit value

The Heathkit HW-101 is probably the most popular Amateur Radio transceiver in use today, and with good reason. It's performance-proven design is recognized by Amateurs worldwide for quality and value, and its low kit-form price makes it the least expensive, FULL-FEATURED Amateur transceiver around. Compare the HW-101 with other units selling for much more, and you'll be convinced!

## Full Coverage And Full Power

The HW-101 gives you complete coverage of all Amateur radio frequencies without expensive add-ons or accessories. Its 180 watts input PEP and 170 watts CW means you'll get your signal out loud and clear. It's ideal for setting up a basic operating station, and it's compatible with all Heathkit linears, so you can add even more power when you need it.

## A receiver section that really performs

Less than 0.35  $\mu$ V sensitivity for 10 dB S+N/N on SSB brings in weak stations loud and clear. The high-quality crystal IF filter keeps signals separate with a selectivity of 2.1 kHz at 6 dB down, and 7 kHz at 60 dB down. Image and IF rejection of better than 50 dB help bring you world-wide receiving that's clean, clear and crisp. There's an optional 400 Hz CW filter available too.

## And a transmitter section to match

The HW-101 transmitter operates PTT or VOX on SSB and CW transceive is provided by operating VOX from a keyed tone, using grid block keying. Frequency stability is better

than 100 Hz per hour after 30 minutes warmup, with less than 100 Hz variation for a 10% line voltage variation. An FET VFO provides excellent thermal stability for heavy-duty operating without excessive heat buildup. And the performance-proven 6146 finals give you a much cleaner signal than TV-type sweep tubes.

## Operating features for REAL convenience

The HW-101 is one of the easiest-to-operate transceivers we know of, it's ideal for beginners and it's a real pleasure for experienced radio Amateurs. Smooth dial drive with a 36-1 ratio and an extra-large tuning knob provide backlash-free tuning. An easy-to-read front panel meter shows signal-strength on receive, ALC voltage on transmit, and can be switched to read relative power output or final amplifier cathode current. Frequency readout is on a large, backlighted dial marked with 5 kHz divisions. There's a front panel mike input and phone jack, RF and AF gain controls, mode and bandswitches, MIC/CW level, driver preselector and final controls. All controls are smooth, positive and precise to give you a truly "professional" feel.

## Famous Heathkit ease of assembly

The HW-101 features a wide-open chassis layout for easy assembly and service should you ever need it. Uncrowded circuit boards, a color-coded wiring harness and special "Switch Boards" with built-in wafer switches greatly simplify assembly. Our world-famous step-by-step assembly manual tells you exactly what to do and how to do it, even how to solder. And our "We won't let you fail" promise is your assurance of technical help should you need it.

*There's more for the Ham at Heath*

# FREE HEATHKIT CATALOG

Read about other fine Ham equipment and our wide variety of outstanding electronic kits — everything from lamp dimmers to color television is in our big FREE catalog.

**Send for yours today!**

Heath Company, Dept. 348-350 Benton Harbor, Michigan 49022

HEATH  
Schlumberger Heath Company, Dept. 348-350  
Benton Harbor, Michigan 49022

Please send me my FREE Heathkit Catalog.  
I am not on your mailing list.

Name \_\_\_\_\_

Address \_\_\_\_\_

City \_\_\_\_\_ State \_\_\_\_\_

AM-349 Zip \_\_\_\_\_

Prices and specifications subject to change without notice.

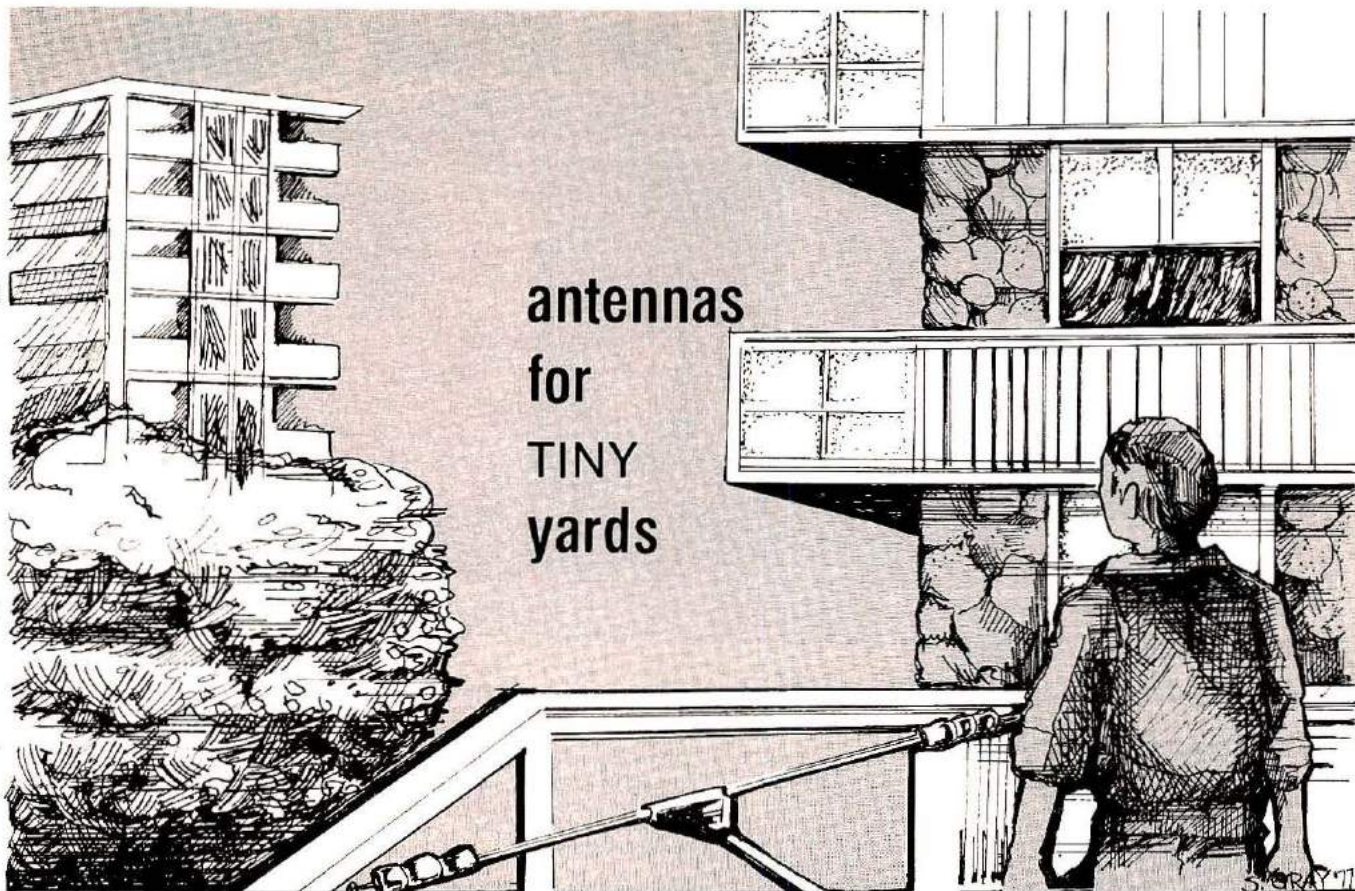

JOSEPH J. CARR, K4IPV

Many people are forced to live with severely limited antenna possibilities. When you are renting an apartment, or living on somebody else's property, then rules other than purely engineering considerations must apply. If an antenna is even permitted in the first place, it must often be a non-permanent and unobtrusive structure. Unfortunately, that can also mean a serious reduction in effectiveness. Of course, we would all like to have a full-sized antenna at optimum height but circumstances force us on occasion to be somewhat more realistic. Now that my wife and I are the proud owners of a little suburban duplex abode, I assumed that those difficulties would be things of the past. Only money, the property layout, and my wife's tastes in outside decor world affect our antenna dreams. Money? Property layout? Aesthetic

preferences? It seems that once again it is necessary to drag out some limited-space antenna tricks.

Many article and textbook treatments of limited-space antennas seem to be lacking in the practical sort of "how to..." information that will allow you to implement these techniques. *The ARRL Antenna Book* is a very good source of ideas for limited-space antennas, especially the later editions, but even that book leaves me with more questions than it answers. In this article an attempt is made to distill the knowledge gained through many years of trying antennas that would perform on the high-frequency bands and thereby give you some of the missing "how to..." wisdom.

#### Standard wisdom

An examination of the standard amateur antenna literature (see bibliography) will reveal a number of designs that

have become popular, although some are more popular with writers than with people who actually have to build them. Let's review some of these designs and look at some practical considerations. It is fairly easy to visualize the limited-space problem but what about the matter of limited access? Even in cases where there is plenty of room to put up an antenna there may be several good reasons for not being able to take advantage of the space: the teenager with parents not too sympathetic to unsightly antenna structures, the location of power lines, no ladder, no money to buy one, no place to store it if you bought a ladder, physical disability, or whatever.

The antennas selected for this article, incidentally, were chosen because they are reasonably easy to build and use. I decided that only coaxially fed antennas would

be described because open feeders, despite their unique flexibility, are often a pain in the neck.

The dipole is probably the most common form of simple amateur radio antenna and, in many instances, may be considered a limited-space type. Ideally, the dipole is center fed with 72 to 75-ohm coaxial cable and is stretched between two widely spaced supports, sags little or none, and is relatively high above the ground. But you can almost bet that real-life dipoles never meet these criteria. Most are so un-ideal, in fact, that it rarely matters much at all whether we use 52- or 72-ohm cable as the feedline. There is little chance that the impedance comes anywhere near the theoretical ideal.

Another bit of standard advice is that the dipole must be run in a straight line perpendicular to the direction that you want to transmit or receive. But again, the advice is applicable only to those situations where an ideal antenna can be erected. In your situation you may not be able to approximate the ideal but must be satisfied with something similar to the antenna lay-outs shown in **Fig. 1**. I have used this type of antenna on numerous occasions with some success. The normal half-wave dipole is constructed but is installed with the legs bent to accommodate the geometry of

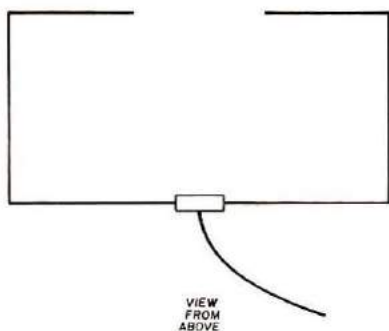

**Fig. 1.** An antenna for an indoor installation can be bent to fit the space available.

your bedroom or attic space. This type of antenna works best when installed in an upstairs bedroom or the attic, but will give at least moderate results when installed in almost any room except the basement. Of course, in a bedroom installation the technique might be pretty well limited to the upper high-frequency bands (14, 21, and 28 MHz) but in even moderate-sized attics a 7-MHz antenna might be possible.

The dipole of **Fig. 2** is for either attic or outdoor installation. In the attic version the horizontal portion might be run along the beam at the peak of the roof and the drooping ends would probably be perpendicular to the main wire. The outside version is suitable for installation where the normal length of a half-wave antenna is greater than the distance between possible support structures. Such antennas are often used on the three lower bands (160, 80, and 40 meters) in city or suburban areas. Insulators are installed at points A and B so that ropes from trees or other supports can be attached.

The antenna layout of **Fig. 3** is unique in that it can be either a side view or a top view. If it is a top view then the bent portions are run horizontally away from the main run. In the side-view version we have a situation where no further horizontal run is possible and the bent portions of the antenna are run up the side of a building or up a tree.

Wire antennas built inside an attic may be supported by TV hardware, specifically the standoff insulators used to support TV transmission line. These are available in either nail or wood-screw configurations that can be fastened directly to the ridge pole at the roof peak. Construction details for the bedroom version are a little more difficult, and are somewhat more subject to

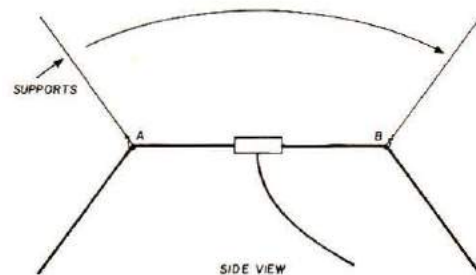
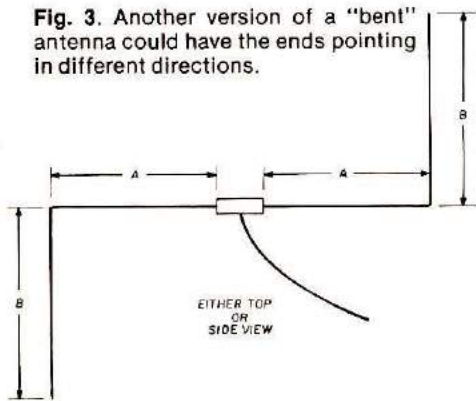

**Fig. 2.** An outdoor installation in limited space can often be accomplished by using plastic rope as supports. Keep the straight portion of the antenna as long as possible for best results.

family, landlord, or other political problems. Of course, you want the main portion of the antenna as high as possible and that means it should be attached to the ceiling. Other considerations, though, may make it mandatory that it be nailed or stapled to the baseboard. I have used both U-shaped tacks and staples to hold light-weight wire to the ceiling/wall junction. You may find that this is unsightly, but it works. Wire supports that take the place of conduit might be less aggravating to others. These plastic races are adhesive-backed and are relatively easy to install. When building any of the antennas of **Figs. 1, 2, or 3**, wherever possible, try your best for symmetry. The two halves of the antenna wire (see **Fig. 3**) should be as nearly equal as possible for the given situation. It also helps to make section A as long as possible; minimizing the lengths of the bent portions seems to pay rich dividends. It might be a good idea to use a 1:1 balun transformer at the feedpoint. Several manufacturers offer such devices for sale.

Another alternative limited-space dipole is shown in **Fig. 4**. This antenna is made shorter than normal and is made resonant by placing an inductor in series with each of the two legs. Again, a 1:1 balun is used at the feedpoint. The exact details of this antenna, along with design instructions and a

**Fig. 3.** Another version of a "bent" antenna could have the ends pointing in different directions.



graph, are given on pages 211 and 212 of the *The ARRL Antenna Book*. This antenna is best installed in a straight line away from any obstructions. The coils do not have the mechanical strength to support the wire so a configuration such as that shown in the photograph must be used. This is a ceramic insulator used to support both the coil stock and the two sections of wire. If you are interested in building this type of antenna, look up the article in the *Antenna Book*. Also, you might want to find a way to waterproof the coils. In the one I built, an afternoon rainstorm detuned the coils and rendered them temporarily useless. One amateur has reported success with the use of Lucite tubing with the ends plugged with GE silicone seal.

**Fig. 5** shows what is, perhaps, the simplest to build, easiest to install, but most maddening to tune of all antennas used by amateurs: the long wire or Marconi antenna. The principle advantage of this antenna is that it can be installed almost anywhere and doesn't have to be straight. The length designated  $A$  in **Fig. 4** should be at least a quarter wavelength long on the lowest band to be covered but even that is not too critical. The long wire is truly a multiband antenna, if you can make it work right. The problem is that a *good* ground, not the kind normally used by most amateurs or SWLs, is absolutely essential. A

shortcoming of many articles written about long wire antennas is that they either understress the importance of a good ground or they do not tell you what constitutes a good ground. You must use a ground system such as that discussed in the *Antenna Book* even if it means chemically treating the earth. I have tried using power-line grounds in the shack (not recommended), water pipes, (have you ever tried grounding to a plastic water pipe? Don't!), and even a run of heavy stranded wire to a 6-foot (2m) copper ground rod driven in the earth outside the shack. None of these methods offered much in the way of success. Even the copper wire to the earth was only partially effective because the length of the grounding wire was excessive. Usually, the very factors that preclude the construction of a really

decent antenna will also prevent you from being successful with the long wire. If, for example, the ground wire is more than a few feet long, your efforts will seem to be in vain. Often a wide range antenna coupler such as the *Transmatch* or at least an L-section network (**Fig. 6**) is mandatory. All of this tends to lessen the apparent low cost of the long wire. The inductor in the coupler can be either B&W coil stock fitted with an alligator clip and lead to short out unwanted turns or it can be a rotary inductor. The latter is a bit more expensive but is very convenient if the antenna is to cover a wide range of frequencies. The coupling circuit is adjusted for best results: A low swr seen by a transmitter, or loudest signal in your receiver. Many long-wire antennas seem to defy their builder's every attempt to make



For those who can use a transmitter to help in determining the performance of an antenna an swr meter is a valuable tool. Experimenters without transmitters will have to use other methods, such as the grid-dip meter shown here.

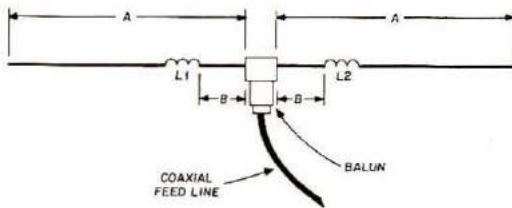

**Fig. 4.** It is possible to use loading, or compensating, coils to obtain good performance from an antenna that is physically short.

them work. In almost all cases where this is true it is usually traceable to an improper or insufficient ground. Believe me, tuning a long wire and coupler with a poor ground system is a lot like trying to nail Jello to the wall!

### Vertical antennas

**Fig. 7** shows one solution to the limited-access problem. It is a vertical dipole that has been tried by many people with success. In fact, some insist that it works better than the classic horizontal dipole. The vertical dipole can be built on the ground and then be raised to the attic vent by using a rope which had been previously dropped out the vent slots. A small fishing weight will make it easier to drop the rope to the ground but be careful to keep it from swinging. Even a tiny weight is quite capable of breaking a window pane! If you

lack a confederate to help, this type of antenna is a little more trouble to put up but is still very easy, even for a single installer. The only real limit is the height of the attic vent. Antennas up to the 20-meter size (although more realistically 15-meters) are possible in most two-story homes. I put together one such antenna in which the feedpoint was just outside the attic vent and a right-angle run, half inside and half outside the house was used. It wasn't nearly as good as one completely outside the building but it worked well enough at the time. The only problem that might pop up, assuming that you have an attic with a vent in the first place, is the danger of rf burns or shocks from a transmitter to small children who wander into or normally play in the yard. Unfortunately, this is a very real consideration but is not insurmountable.

Not to be overlooked in any article on limited-space antennas is the classic quarter-wavelength vertical or ground-plane antenna. A number of manufacturers offer verticals with traps designed to cover many frequency bands. You can try your hand at building one of your own; an example is shown in **Fig. 8**. The main radiator can be a piece of copper wire if your finances are



Compensating inductances for a short antenna (**Fig. 4**) can be made by placing a coil around an insulator.

really at a low ebb, but the system works better if built from aluminum tubing. The larger the tubing, the better the results, or at least so says the "standard wisdom."

It is interesting to note that aluminum tubing is manufactured so that adjacent sizes will fit into one another; the smaller inside the larger. This makes it relatively easy to make a vertical radiator that is strong enough to withstand the rigors of a rooftop installation. Unfortunately, you may have to locate a metal-products distributor or call one of the representatives for the larger aluminum manufacturers in order to find adjacent sizes. Some radio-parts suppliers make it their business to stock popular sizes up to an inch (25mm) or so outside diameter. You will find that most local hardware stores or building-supply houses carry only 1-inch (25mm) and 3/4-inch (19mm) OD tubing and these are *not* suitable for telescoping. Also, they usually stock the six-foot (2m) lengths and it is likely that you will want either eight or ten foot (2.5-3m) sizes. The radials can be made from heavy wire

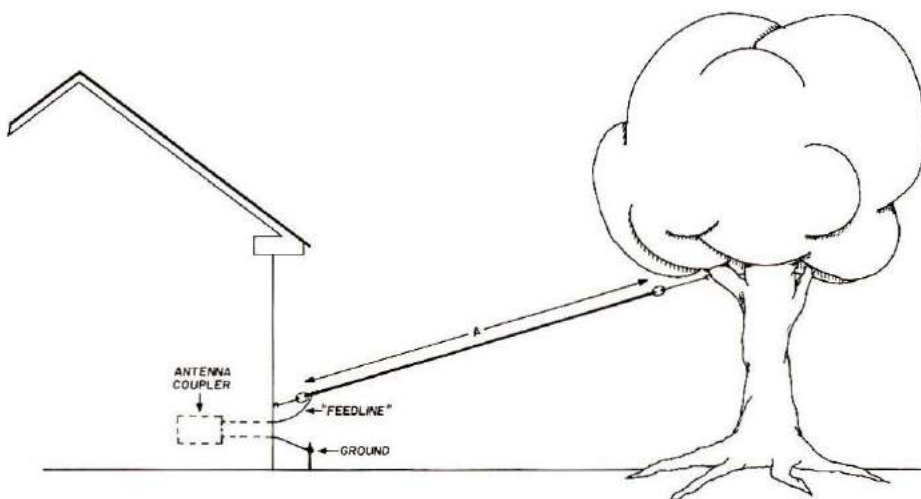

**Fig. 5.** A long-wire antenna can be erected in many configurations, and often is of a random length. To perform well, this antenna requires a superb ground system and a coupler or matching device.

Table 1. B & W Coil Stock

B & W part number	Diameter		Turns per inch	Pitch (mm)	Wire size		Inductance ( $\mu$ H)*
	inches	(mm)			AWG	(mm)	
3025	2.0	(51)	6	(4.0)	12	(2.1)	33.0
3026	2.0	(51)	8	(3.0)	14	(1.6)	59.0
3027	2.0	(51)	10	(2.5)	16	(1.3)	92.0
3029	2.5	(64)	6	(4.0)	12	(2.1)	51.0
3030	2.0	(51)	8	(3.0)	14	(1.6)	90.0
3048	1.25	(32)	6	(4.0)	14	(1.6)	5.0
3049	1.25	(32)	10	(2.5)	18	(1.0)	14.0
3052	1.5	(38)	6	(4.0)	14	(1.6)	7.0
3053	1.5	(38)	8	(3.0)	16	(1.3)	12.5
3054	1.5	(38)	10	(2.5)	18	(1.0)	20.0
3059	1.75	(44)	10	(2.5)	16	(1.3)	26.0
3061	2.0	(51)	4	(6.5)	12	(2.1)	15.0
3063	2.5	(64)	4	(6.5)	12	(2.1)	22.5
3064	3.0	(76)	4	(6.5)	12	(2.1)	32.0

B & W coil stock is manufactured by Barker & Williamson, Canal Street, Bristol, Pennsylvania 19007, and is available from many electronics parts dealers.

\*Inductance of entire piece of coil stock. Smaller inductances can be made by cutting the stock.

(no. 14 AWG or 1.6mm is good). You can use TV-rotor wire of the type that has four insulated conductors. You can cut each wire to a quarter wavelength on different bands. The same admonition about the shock or burn hazard still applies. The radials may be angled upwards away from the ground for increased safety. In fact, it is usually the case that these antennas are mounted on the roof or high on the side of the house. Either a length of 2x4 lumber (5x10cm), bolted to the wall, or regular TV-antenna mounting hardware will work well as a support for the vertical antenna. A multiband vertical-antenna system in which the radials are connected in parallel and the vertical portion is resonated by an inductor is shown in Fig. 9. Coil-tap-selection can be manual, if it is easy to reach that part of the installation, or it can be done through relays.

### Antenna instrumentation

Even with the so-called ideal antennas, it is not too easy to make adjustments without at least some test equipment. Probably the most basic instrument, and one that should be a part of every ham shack, is the swr meter. A great number of swr meters are on the market or can be built from scratch. A popular one is the Heathkit HM-102 which can be assembled as a simple, one-evening project. This particular model also functions as an rf

power meter with 0-200 and 0-2000 watt ranges. It is difficult to overstate the advantages of having an swr meter connected while making antenna adjustments. Also used by many experimenters is the dip meter, an example of which is shown in the photograph. This instrument is a vfo which has its resonant tank-circuit inductor mounted externally to the case. This coil is coupled to the antenna or other circuit under inspection and the oscillator frequency is adjusted. When the vfo is tuned to the resonant frequency of the antenna, power will be absorbed from its coil; this causes a dip in the meter reading.

Although the dip meter can be used to check out an antenna system in this manner, it is better to use it as the signal source for an antenna-impedance bridge. I have used the Leader LIM-870A antenna-impedance bridge in some of the experiments made on antennas and have found it to be very helpful. In many cases you really don't care what the natural resonant frequency of an antenna is so long as you know its impedance at the frequency of interest. Unless the impedance is too extreme this will allow you to build a matching transformer. A meter such as the LIM-870A will help you to determine the impedance of the antenna.

For years I have seen the advertisements for the Omega

and Palomar noise bridges, but it wasn't until recently that they were tried. I thank K4NFU for putting me on to these instruments because they have paid rich dividends; not something one normally expects from such inexpensive instruments.

Our instrumentation package should, or at least could, include an swr meter, a dip meter, an impedance bridge and a noise bridge. All of these have very definite uses in doping out an antenna system and all are recommended. Also to be included is a receiver, preferably a general-coverage type, and a low-power transmitter.

The frustration quotient for antenna installing can be great if you lack certain essentials. When building an antenna that requires inductors to compensate for the length, you will want several sizes of coil available. It is wise to keep some standard B&W coils in stock. Choose those with few turns per inch, large diameter, and large wire size (smaller AWG numbers). Table 1 shows some of the B&W type numbers which I have found to be useful in amateur antenna work. If you prefer to use the rotary-inductor approach, then choose one with a maximum inductance in the 15- to 30- $\mu$ H range. Taps for different bands on non-rating inductors can be either soldered on or they can be made by using alligator clips or coil clips that are sometimes seen in older marine radiotelephones. You will find, though, that any of the clip techniques will be subject to corrosion and will require cleaning from time to time.

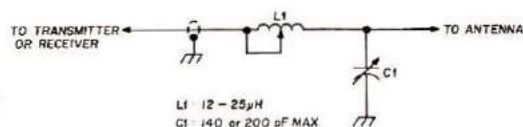

Fig. 6. Matching circuits take on many forms. A very popular one is the L-network shown here, which will cover a wide range because both the inductance and capacitance are variable.



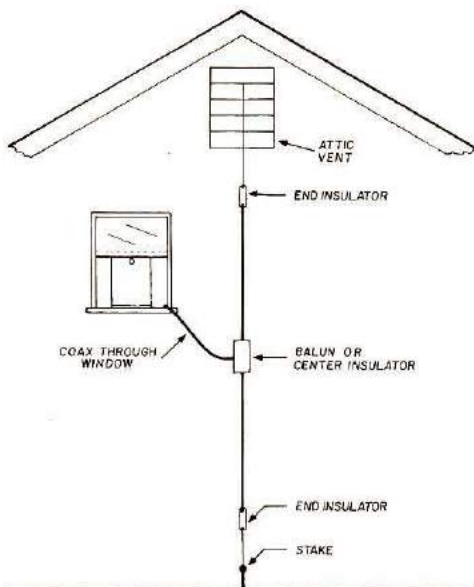

Fig. 7. A simple, yet effective, installation of a vertical antenna can be made by using the features of a house, such as an end wall with a vent or louvre.

One last item that may be desirable when building an antenna is a balun matching transformer. If a relatively standard antenna is contemplated then you can use a standard 1:1 or 4:1 transformer. These are generally low enough in cost to justify their use. In those cases where a really oddball antenna impedance is found then you may want to try one of the non-standard transformer ratios that can be realized using the Amidon toroid Balun kit (about \$5.00) or the Amidon T-200-2 core, some enameled wire and the instructions given in several ARRL books including the new *Data Book*.

### Adjustments

This phase of any antenna construction project may well be the single most important step to the overall success of the antenna. You are strongly advised to keep detailed records of your trials as you make your experimental adjustments. This will allow you to analyze any problems that develop as you work and will also allow you to duplicate your efforts in the future.

When using an antenna noise bridge or the antenna impedance meter just follow the manufacturer's instructions and act according to the information the instrument gives you. Incidentally, not all low-cost instruments are prone to terrible errors. I have used the Palomar and Omega noise bridges and the Leader impedance bridge on the same project with similar results.

Many amateurs use an swr meter for help in making antenna adjustments because it is the most commonly available instrument. This technique works fine if everything goes according to plan but can lead to difficulty if things begin to go wrong. In that case, you might be better off using one of the other instruments listed above; they might lead you to truth and light where the swr meter could not. Additionally, a license is required to operate a transmitter to provide power for an swr meter.

Your initial adjustment might be to short out an arbitrary number of turns on the inductor and measure the swr or impedance at the desired frequency. Then change the frequency, either up or down band (25 kHz or more), and make another measurement. If the swr is lower downband from the original frequency

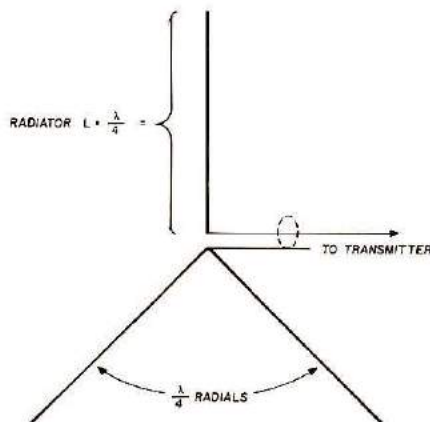

Fig. 8. The classic ground-plane antenna requires radial wires or other well-conducting medium as part of the system. Only two radials are shown here, but performance will increase markedly when more are added.



A plumber's delight with balun and matching coils can be mounted on a piece of board before it is fastened to the end wall of a house.

then the coil has too many turns, but if it is lower upband then the coil has too few turns. Move the tap in the direction indicated by the initial information and measure again. Continue this process, moving the tap a turn or fraction of a turn at a time until the swr is at its minimum point. Your initial selection of turns might be too far off; most people tend toward the optimistic side. In that case you should try picking another "initial" selection of coil turns. On this second attempt try using about half as many turns as you did the first time. If the situation seems to be reversing (see the advantage of keeping written notes?) then split the difference. In a short while you will find the correct placement for the coil taps.

Adjusting previously untuned antennas can be a time consuming and tiring task. This should prompt you to make it as easy on yourself as possible. One of the things which will facilitate the adjustments is to give consideration to the mechanics of the situation. Dipoles, whether vertical or horizontal,

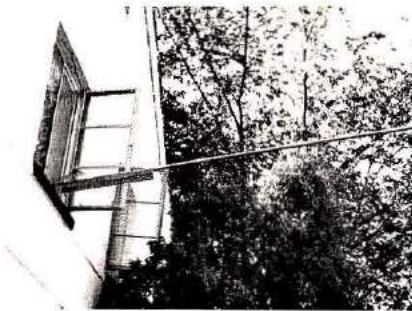

Another answer to the "where to mount it" question is to let the antenna protrude from a window, as my plumber's delight is doing here.

should be fastened at both ends with pulleys and ropes so they may be easily lowered to the ground to be trimmed. You will sometimes find that vertical antennas are easier to rough-in on the ground or leaning up against the wall of the house. At least when the structure is mounted on the roof most of the preliminary work has been completed, leaving only the fine tuning to be done. In some cases the difference in performance between the positions is sufficiently small that it can be ignored.

### Two experiments

Everybody "knows" that a dipole should be either all horizontal or all vertical. At my new location neither was possible. The vertical run was interrupted because the only fenced-in wall on the house had the trash cans and gas meter at its base. Additionally, the wall was simply not high enough for a 20-meter dipole. A horizontal dipole was not possible because, in the first place, my new neighbor was not amenable to amateur radio, and secondly, he did not think my antenna, tied to his tree, was entirely in his own best interests. The only tree on my own lot was so small that my portly (fat) frame would not make it safely to a level suitable for dipole anchoring. Hence, the "slipole" (*slanted dipole*) shown in Fig. 10 was built. A pulley for a flagpole-style rope was installed near

the roof line. This made raising and lowering the wire somewhat easier — especially handy since I was working alone. A 1:1 balun was connected at the feedpoint and the Drake MN-4 was used to tune the system. Although I use only low power from an elderly Heath DX-60B transmitter, the system regularly nets good signal reports from Europe and South America. This is not too exciting to the wizened DXer with a high-performance beam, perhaps, but it is sufficient for many hours of enjoyment.

Several articles and a few antenna manufacturers offer what is usually described as a "cliff dwellers special" or something similar. These are window-ledge-mounted antennas that, although they are not super performers, will work for people who simply cannot install a proper antenna. The photographs show a version of this type of antenna: my own "Plumber's Delight." Most similar antennas shown in the literature suffer from the same nail-and-Jello problem as the long wire does because it is seldom easy for anyone who must use such an antenna to get a decent ground. In my version of the antenna, I used an eight-foot (2.5m) piece of 1-inch (25mm) OD aluminum

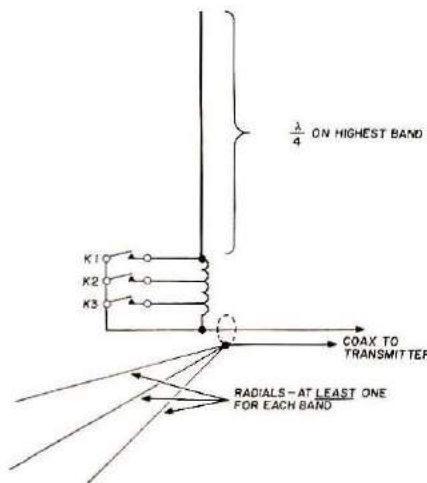

Fig. 9. A vertical or ground-plane antenna can be made to work over a wide range of frequencies by using a tapped coil to change the resonance point.

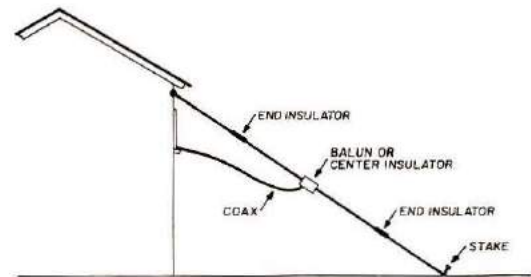
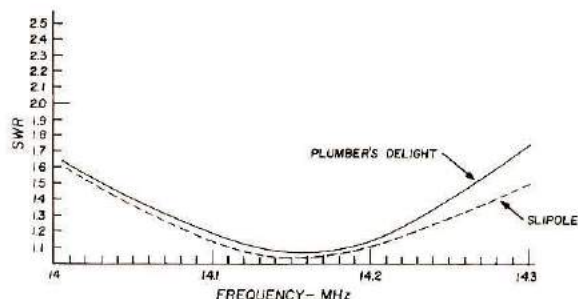

Fig. 10. A "slipole" (*slanted dipole*) antenna should work well, and may be the only answer if your house has metal siding.

tubing for the radiator and a piece of B&W coil stock to make the thing resonant. The grounding, or ground plane, is taken care of by using radials in a manner similar to that of the full-length vertical antenna. One advantage of these radials is that they can be run to almost any support, even if it is necessary that they be bent. It is best to keep them at least 45° from the radiator. WB4ZOH has used a similar system in which an antenna designed for mobile use is mounted on an apartment-house balcony and a rotor-cable radial system was tacked along the baseboard inside the apartment. Bandchanging is possible either by adjusting the loading coil or by changing the resonator. Fig. 11 shows the swr plotted for both the slipole and the plumber's delight on 20-meters. In both cases, the swr seen by the transmitter was reduced to very nearly 1:1 by the Drake MN-4 antenna coupler. A W2AU balun (1:1) was used in the final version of this antenna.

The last offering to be made here is the two-band version of the plumber's delight that I erected on the cinder-block side of the house. Radials form the ground-plane system because the antenna is too high to be properly grounded through a wire. Incidentally, a frequent mistake made by builders of vertical antennas is that they use too few radials. A good rule of thumb, up to the point of being ridiculous, is the

**Fig. 11.** An example of plotting the performance of an antenna is this swr vs frequency graph of two antennas described in the text.



"more the better." At least two radials per band is normally the minimum acceptable arrangement. In most instances where someone obtains poor results from a vertical antenna mounted above the ground, the trouble can be traced to too few, or inappropriately designed, radials. The coil stock used for both antennas is B&W 3063. The relay might be a little hard to obtain. I work in medical electronics and was able to salvage it from some defective equipment. It is a Torr model TMR-10 vacuum relay. Several similar relays have been seen recently in the

surplus advertisements and at a few hamfests. The original tuning was done when the antenna was on the ground and only minor adjustments were needed when the mounting was completed. This makes it easier for a 300 pounder like me to get the antenna up and working (I don't like ladders).

A question that is often asked is "Will these antennas work as well as a high and clear dipole?" The answer, in a word, is *no*. In most cases they do not work as well as a good dipole or vertical. But it is not my purpose to light cigarettes in Asia with my signal but

rather to work stateside stations and whatever DX could be picked off without too much frustration. My initial goal was to get on the air by any means! For a parting shot I would like to officially, humbly, and publicly issue thanks to K4NFU, WB4ZOH, and WA4EPI.

### Bibliography

1. *The ARRL Antenna Book*, 13th Edition, American Radio Relay League, Newington, Connecticut, 1974.
2. Louis M. Dezettel, W5REZ, *Amateur Tests and Measurements*, Editors & Engineers, New Augusta, Indiana, 1969.
3. William I. Orr, W6SAI, *Wire Antennas for Radio Amateurs*, Radio Publications, Inc., Wilton, Connecticut, 1974.
4. William I. Orr, W6SAI, editor *Radio Handbook*, 18th Edition, Editors & Engineers, New Augusta, Indiana, 1970.
5. *The ARRL Radio Amateurs Handbook*, 52nd Edition, American Radio Relay League, Newington, Connecticut, 1975. **HRH**

### Glossary of Terms

**Balun** is a device that will provide a transition between an unbalanced (to ground) line such as coaxial cable, and a balanced line or antenna such as twin-lead or a dipole.

**Dipole** is a balanced antenna, usually (but not necessarily) one-half wave in length. As commonly built it consists of two equal lengths of wire placed end-to-end with some form of transmission line connected at the juncture.

**Ground plane** is commonly used to describe a type of antenna that has a system of radial wires mounted adjacent to the feedpoint of a one-quarter wavelength antenna.

**Noise bridge** is a test instrument that applies a wide-band (noise) type of signal to the circuit being checked, as opposed to a single-frequency (carrier) that more precise instruments require. The most common use is to obtain a

measurement of the impedance characteristic of antennas or feedlines.

**Radiator** is the active portion of an antenna system. Although the term relates to a transmitting antenna, it is proper in a receiving system as well.

**SWR** refers to Standing Wave Ratio, also Voltage Standing Wave Ratio (VSWR). The ratio between the energy being transmitted toward the antenna (or load) and that portion of the energy being reflected back toward the source.

**SWR bridge** is also called SWR Meter, which is more nearly correct because very few are a true bridge type of instrument. In essence, it is an rf detector that samples both the energy going toward the antenna (load) and the energy reflected back. The indicator may be calibrated so that either a direct comparison of

power levels or an indication of ratio is possible.

**Transmatch** is a device that uses a combination of variable capacitors and inductors to provide a means of matching between unequal impedances. Most often used between a low-impedance transmission line and a high-impedance line or antenna.

**VFO** means Variable Frequency Oscillator: The tuning control of most transmitters or receivers. Can be used to describe almost any oscillator that is not fixed (crystal-controlled) in frequency, especially those that have a connection to a dial or knob for adjustment.

$\lambda/4$  is a symbol representing one quarter wavelength. The Greek letter lambda ( $\lambda$ ) is used to represent one wavelength at the frequency of interest. Thus,  $\lambda$  divided by a number or  $\lambda$  multiplied by a number can be used to represent fractions or multiples of a wavelength.



# Don't become a FRIED ham!

BY DEVERE "DEE" LOGAN, W1HEO

As a newcomer to Amateur radio, the most important thing for you to remember is that radio equipment is powered by electricity, and must be treated with respect. Not fear, but knowledgeable caution. Your ham shack is not much different than your garage, your workshop, or even your kitchen; if you are careless, they all contain potential dangers that can put an abrupt and untimely end to your activity.

Hams who work for industry, or in a trade, are made constantly aware of the hazards that surround them, and safe work practices become a normal and routine part of their everyday lives. It's something like driving a car — there is a safe way to operate an automobile, and if you want to become a successful and long-lived driver, you spend a great deal of time learning how to drive properly and safely; then you go out and do

it the right way, every time.

Unfortunately, a small number of drivers, backyard builders, home craftsmen, do-it-yourself electricians, and yes — even hams — become statistics each year because they ignore the basic safety rules, either through not knowing them or through becoming careless.

So, in the interest of keeping new hams alive, well, and on the air, *Ham Radio Horizons* passes along these safety tips that could possibly save your life!

## Ac circuits

An understanding of danger from common 115-volt alternating current is basic to an appreciation of potential trouble around the house and in the shack. Don't ignore the shock potential from a wall socket, and remember that even 50 volts has been known to kill when conditions were just right (or wrong). The real villain lurking in household

wiring is voltage's partner — current; it's the *current* that kills.

Let's look over some different current levels and see what effect they *could* have on your body. At half a milliamperere (0.0005 ampere) there's no sensation, but at about two milliamperes (0.002 to 0.025 ampere) there is a painful shock and at above 16 an inability to let go. When the current hits 25 milliamperes or more, the muscles jerk in violent contractions; and from 50 to 200 milliamperes (0.05 to 0.2 ampere) the heart has convulsions called fibrillation, and death can result. Burns and paralysis of breathing occur at levels over the 100-milliamperere (0.1 ampere) level.

Several things in addition to the amount and duration of current flow determine the severity of shock. For example, the part of the body through which current flows is an important factor. If you remember to keep one hand in your pocket when working around *hot* circuits, you'll keep accidental brushes with current from traveling through your chest, from one hand to another by way of your heart.

The electrical resistance of your body determines how much current flows on contact. When skin becomes moist, its

**Table 1** gives an idea of the relative physiological effects of various current levels on the human body, ranging from no effect through heart convulsions and death. The current depends upon voltage and skin resistance (see text).

Current	Effect on Body
0.5 mA	no sensation
2 mA	awareness
10 mA	muscular contractions
5-25 mA	painful shock
25-50 mA	violent muscle contractions
100 mA	burns, breathing paralysis
50-200 mA	heart convulsions

resistance goes down, and more current can flow. Standard 60-hertz, 115-volts residential wiring circuits produce more pronounced physiological effects than does equivalent uninterrupted dc voltage. Also, at frequencies considerably above 60 hertz, the body doesn't experience



Don't

any sensation of current flow except heat.

Ohms law applies to skin resistance as it does to all electrical circuits. When your skin is dry, it may have a resistance of 100- to 500-thousand ohms, but when you perspire it can drop to 1000 ohms, and when in water, only 150 ohms. By Ohms law, then, if your wet hands come into contact with 110 volts:

$$\frac{110 \text{ (volts)}}{150 \text{ (ohms)}} = \frac{0.73 \text{ ampere}}{(730 \text{ milliamperes})}$$

From the scale mentioned previously, this much current would result in loss of breathing, heart stoppage, and burns.

Safety engineers offer several pointers to avoid shock:

1. Don't handle electrical gear with wet hands or when standing on a damp floor.
2. Remove rings, watches, chains or other objects having exposed conductive material when working near electricity.

3. Treat all equipment as being *hot* until found *cold* by test.
4. Properly ground power tools and avoid making a ground return path through your body.
5. Treat insulated conductors as if they were bare conductors, because the insulation may be faulty.
6. Keep one hand in your pocket while working around *hot* circuits to eliminate a current path by way of your heart, and be alert to other possible ground paths through your bare arms or head.
7. Use extreme caution when installing antennas and be alert to potential shock hazards from nearby power lines or the possibility of an equally fatal fall from a roof-top or ladder.
8. Don't install antennas where they could fall into power lines. (Match your care in developing a well-engineered piece of equipment with a well-engineered installation.)

### Grounds

A good ground system is essential for all stations because it provides protection for the operator and provides a vital part of rf circuits. A solid waterpipe ground using heavy copper wire to connect it to the equipment is good, and the addition of a separate ground wire to a six-foot (2m) ground rod driven into moist soil is better yet. (A ground-strap jumper around the water meter will insure good electrical continuity and prevent a shock hazard at the meter.)

If your radio equipment lacks three-prong grounded plugs, add them by all means. To be sure of zero potential on equipment cabinets, bond the chassis and cabinets together with heavy wire or strap. A final check with an ohmmeter is a good idea to make sure that everything is solidly and completely grounded.

### RF circuits

While direct current and

commercial alternating-current frequencies affect the human body primarily by flash burns and current penetration, radio frequency current (200 kHz through microwaves) has a tendency to flow on the surface of the skin with very little penetration. Body contact with a high-frequency conductor will



Don't

usually result in a severe burn, but the chance of receiving a lethal shock is small, providing there is no dc voltage involved. (Although pinhole-size rf burns do leave a vivid reminder of accidental encounters!) The safe approach to the use of transmitting equipment is to shield the rf conductors and isolate the high voltage.

### High voltage

*High voltage* usually means any potential over 600 volts. It's often a standard procedure in shops and laboratories to provide elaborate safeguards against high voltages, but the ham shack may lack this protection.

The ham literature has advocated interlock switches and circuit breakers for years. While these devices are old reliables, that fact shouldn't diminish their importance; they save lives. If your station has exposed high voltage points (and it shouldn't), the minimum that should be done is to

enclose the area with a screen and post a DANGER — HIGH VOLTAGE sign nearby. Children and pets have a habit of getting into the wrong places, so beware.

Make sure that your station can be cut off from the ac line by means of an emergency relay or circuit breaker in case of accident or overload. A new electrical device that emerged in recent years in the *Ground Fault Circuit Interrupter* (GFCI), which is installed in the ac line and trips when leakage current amounts to only five milliamperes. The GFCI is a fast device, and trips in only one-fortieth of a second — less time than a heartbeat.

Filter capacitors in high-voltage power supplies store plenty of punch unless they are bridged with bleeder resistors to discharge them completely after operation.

Remember that you don't have to make bodily contact with high-voltage conductors to receive a fatal electric shock. The distance an arc will travel from a live, uninsulated conductor to a person's body depends upon several factors: Voltage level to ground; shape, size and arrangement of electrodes; other material in the vicinity of the arc gap; and such factors as temperature, humidity, and pressure of the air. A scale of safe distances would recommend a one-foot (30cm) space at potentials between 750 and 3500 volts, increasing to 45 feet (14m) at around two-million volts.

If it's necessary to test high-voltage devices such as linear amplifiers, the previously mentioned safety practices are a must. In addition, a high-quality electrical insulator such as a rubber mat under the shack work table would add some shock protection, as would the use of nonconducting table surfaces. The insulation on all test leads should have a voltage rating sufficient to handle the equipment under test. Also, plan to conduct as much work

as possible with the power turned off.

### First aid

In an electrical emergency, a rescuer should know what to do quickly! When the heart beat and breathing of an unconscious patient, have stopped, you have only four minutes to act. Life-saving requires more than speed; it demands a knowledge of the most recent heart-lung resuscitation techniques and,



Don't

preferably, recent participation in training and practice sessions.\* If you hear of a training course being given nearby, enroll right away.

In electric shock, the victim must be safely removed from contact with the source of current. Turn off the power or separate the person from the current source with a wooden pole, heavy rubber gloves, an insulated object, or clothing. Make sure your hands are dry and that you're standing on a dry surface. Don't touch the victim with your bare hands, and don't move him any farther than necessary. Even if the patient appears to be dead,

\*The modern technique used in reviving victims of electrical shock (or other causes of heart stoppage) is called cardio-pulmonary resuscitation (CPR). When properly done, it greatly improves the chances that the patient will recover; if applied in a wrong manner, it can cause great harm. The proper technique should be learned by taking a course that is given by the Heart Association or the American Red Cross. It requires 9 to 12 hours of study and practice to acquire the technique, but is well worth the time spent in order to have the ability to save a life.

start resuscitation immediately, using methods developed by the American Red Cross and the American Heart Association.

### Power tools

Hams who do a bit of building should also be familiar with some basic rules of power-tool safety. First, *know* your power tool by reading the manual carefully so that you understand the tool's applications, limitations, and potential hazards. Ground all tools by using three-prong plugs. Keep your work area clean and free from hazards, avoiding damp or wet locations. Keep all children at a safe distance. Use the right tool and don't force it. Wear the proper clothing. (Remember the neck-tie-in-the-machinery cartoon?)

Use safety glasses. Many industrial plants have strict rules about this, and most refuse to allow personnel into shop areas unless safety glasses are worn. Using the same tools in the ham shack at home presents the same potential danger as in the factory. Save your eyes with an inexpensive pair of safety glasses. (Ever notice those flying aluminum chips when you drill a chassis?)

Other tool tips: Secure your work with clamps or a vise. Don't overreach — keep your footing and balance. Maintain your tools, disconnect them when they're not in use, and don't carry a plugged-in tool with your finger on the switch.

Soldering irons can cause nasty burns, so be careful when working with them. Keep combustible materials away from hot irons, use proper holders, and don't leave the shack with an iron still plugged in.

These safety tips are offered in the interest of creating more safety-conscious hams. Safety is a state of mind, and hopefully yours is now on the safe side. Remember — *safety is no accident!* **HRH**

# The Century/21 started with a clean sheet of paper...



**OBJECTIVE:** To design a no-compromise HF transceiver for the beginning Ham or Old Timer and at an economical, affordable price.

**CRITERIA:** Cw transmit, cw and ssb receive. Full break-in. 70 watts input. Full band coverage 80-15 meters, 1 MHz on 10. All solid state. Instant,

no-tune band change. Built-in regulated power supply. Overload protection. Linear crystal mixed VFO. Direct frequency readout. Offset receiver tuning, defeatable. Built-in speaker. Sensitive receiver section. High selectivity — three position. Sidetone with adjustable level. Full line of matching accessories.

## THE RESULT . . . TEN TEC *Century/21*

The Century/21 was designed and tooled from scratch for high performance cw. A unique Double Direct Conversion receiver performs as well as the conventional superhet. Broadband transmitter with instant break-in is a highly desired luxury. Accessory keyer and crystal calibrator available now, with additional accessories to follow. And . . .

### THE AFFORDABLE PRICE:

Century/21, Model 570 .....	\$289.00
Century Keyer, Model 670 .....	29.00
Century Calibrator, Model 276 .....	29.00

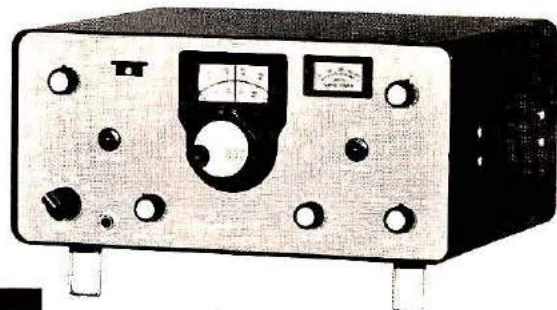

For further information, write:

**TEN-TEC, INC.**  
SEVIERVILLE, TENNESSEE 37862  
EXPORT: 5715 LINCOLN AVE., CHICAGO, ILL. 60646

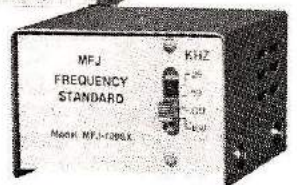
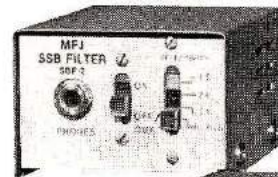
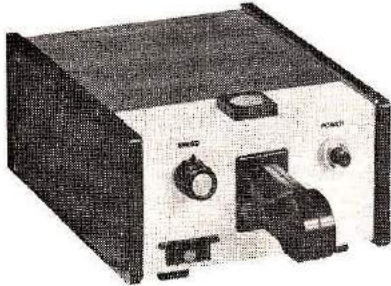

# ham radio

# ACCESSORIES

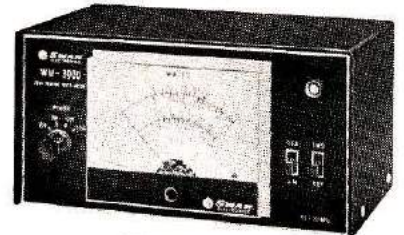

*Station accessories are useful and convenient, but should be selected with certain priorities in mind. It's not only a matter of what, but also when...*

BY JIM GRAY, W2EUQ

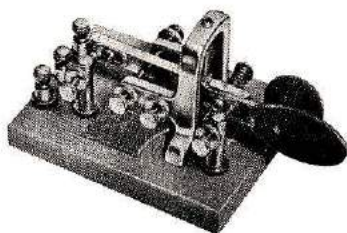
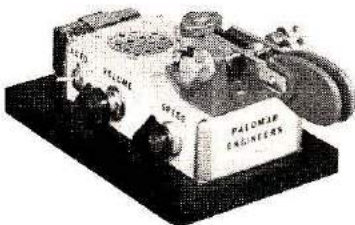



A station accessory is a little like dessert: You can get along without it, but it sure makes life sweeter. When you first became a radio amateur, you knew that you had to have a receiver, transmitter, key, clock, and antenna. Then you figured that you might just as well have a microphone, seeing as how it was on sale at a good price, because you were going to be on phone as soon as you got your next ticket. Then you had that QSO with the antenna expert and he couldn't understand how you were able to go on the air without an swr bridge in the line, so you bought a combined swr bridge and reflected power meter.

After a few months of operating with your straight key, you heard some really nice CW. The ham at the other end told you that he was using an electronic keyer, so you went out and bought one of those, too. Next, you bought a speaker to replace that tinny-sounding one, a digital clock with LED display, and a frequency counter.

About this time your operating desk had to be enlarged to hold all the goodies, so a new chair to match the desk was naturally added. Pretty soon you decided that a phone patch would be a big help when you got your General ticket, so that was added. When your new antenna was put up, you decided that a coaxial switch would be useful, and that was the next addition.

Where does this disease stop? Is there any known cure? What about preventive

medicine? Every Radio Amateur I've ever known has succumbed to this malady, and I'm no exception, just in case you thought I might be on the soap box. The virus is deadly and incurable. The best remedy therefore is preventive medicine and a full knowledge of how best to protect yourself.

As your career in amateur radio progresses, there's no question that station accessories and operating aids will become desirable — even necessary, but there ought to be a preferred method in your madness; some sort of priority list that you can work from and plan against. Your question should be: "Which accessories shall I buy first and which ones later?"

#### Accessories before the fact

You don't have your license yet, but you've already started putting together a station. That's only common sense, right? Right! Now, what do you need, and in what order? Let me suggest right at the beginning that you really don't *need* as much as you think you do, but there are some conveniences that will make operating easier and better for you.

Question: Does your station have a separate transmitter and receiver, or do you use a transceiver? Most transceivers have built-in send/receive relays for automatically changing the antenna back and forth between the transmit and receive functions. If you don't have this luxury but have a separate transmitter and receiver, chances are that you have planned on manually switching the antenna. Let me suggest that you buy a coaxial antenna relay instead. Several different kinds are available, and Dow-Key is one of the most popular.

The coil of the most common type of changeover relay operates from 117 volts, ac. On many transmitters there will be an accessory strip or socket

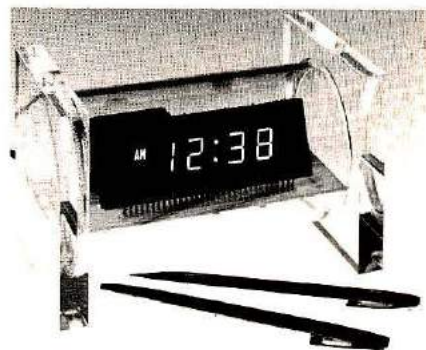

Clocks for your station can take many forms, but the recent trend is to go digital. Even among the digital types there are a lot of choices, ranging from the decorative and modernistic creation as shown, to the bare-bones kit that you can put in your own enclosure. These, and other styles are offered by Digital Concepts Corporation.

which provides the necessary voltage every time the transmitter is switched to "transmit." If your transmitter is one of these, use this voltage source for operating the antenna changeover relay. If not, you will have to find another source of the necessary voltage, usually a wall socket and you'll have to provide a separate switch that goes on and off with your transmitter. An extra set of contacts on the *transmit* switch is a possibility, or an extra set of contacts on an internal relay brought out to the rear panel of the transmitter.

Some changeover relays are available with coils that operate from 6 to 12 volts, ac or dc. If such a power source is more readily available to you, get a relay with the proper coil to match the available power. *Investing* in a good antenna changeover relay will repay you many times in operating convenience and flexibility, so make this your top priority.

#### Where am I?

The next thing — or maybe even the first thing — you must know is your exact frequency. The amateur bands are wide, but if you plan to operate in a narrow sub-band, such as the Novice band, you have to be

The photographs for the lead artwork are compliments of the following advertisers: R. L. Drake, Ham Radio Center, Ten-Tec, Inc., Heath Company, Cubic Corporation, Palomar Engineers, Vibroplex Company, Inc., MFJ Enterprises, Spectronics West, and Yaesu Electronics Corporation.



Call them Antenna Tuners, Matching Networks, Transmatches, Matchboxes, or whatever; they're all accessories to help your transmitter "see" a proper impedance at its output. Most of them also have provision to use either coaxial cable or balanced feedline to the antenna. This one is designed for medium-power applications. Others are available that will handle the full legal amateur power limit. Some, such as the Drake unit shown here, have power and SWR indicating meters as part of the package.

able to stay within its limits. Many receivers and transmitters with variable frequency oscillators lack calibration accuracy, and might cause you to operate on a frequency that is illegal for you, even if you think you're okay. If your transmitter or transceiver does not have a built-in crystal calibrator, buy one. A crystal calibrator is a tiny, low-power transmitter that produces a lot of harmonics, but is controlled by a 100-kHz crystal. The calibrator provides a *marker* signal that is audible in your receiver every 100 kHz throughout the bands from the lowest to the highest. Fancier calibrators provide signals every 25 or even every 5 kHz. You need the 100 kHz marker at least, and a fancy one only if you can afford it.

With a calibrator you can find the band edges and do your own receiver calibrating, knowing that your transmitted signal can always be placed within the proper band or sub-band. The calibrator itself can be calibrated with one of the WWV frequency broadcasts on 5.0, 10.0, and 15 MHz. (Note: 2.5, 20, and 25 MHz may be discontinued). The instructions packed with your calibrator tell you how to properly adjust it for maximum accuracy, using your receiver and WWV as a

comparison. The foregoing assumes that you have a transmitter vfo, and can slide around the bands at will. For those of you who have crystal-controlled transmitters, and cannot move around the bands so easily, your next accessory could very well be a vfo.

### Variable frequency oscillators

There was a time in the history of amateur radio when the transmitting frequency of every station was controlled by quartz crystals. Every Amateur had a handful of crystals for different frequencies in the various bands he wanted to use. These were almost identical to the CB channel crystals, and they insured that the transmitter was exactly on, or very close to, a known frequency. In those bygone days transmitters were not frequency tunable, so every time you wished to change frequency, you inserted a different crystal. Some of those old transmitters are still around today, at bargain prices. Don't be afraid to buy one, because you can add an *external vfo* — purchased separately — and convert your transmitter from its former rock-bound state into a *slider*. The external vfos plug into the crystal sockets of those old transmitters in most

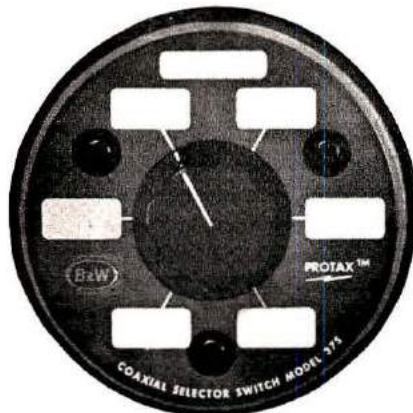

If you operate on more than one band, you might have several antennas. The chore of changing from one feedline to another is eliminated if you install a Barker and Williamson coaxial selector switch in your station. Don't forget to reserve one position for the dummy load (for tuneup purposes).



Dummy loads serve many useful purposes, and the main one is to absorb power output while you tune up your transmitter. You can also make a quick check from time to time to see if all is well in your rig. You can make a comparison between how your transmitter loads into a dummy load and into your antenna — thus gaining an idea of the well-being of the antenna or feedline. The Barker and Williamson unit is rated to 1000 watts, intermittent duty, and a light comes on when it has been overheated.

cases, and instantly give you freedom of movement.

### Listen, you guys

If the transmitter is the heart of your station, the receiver represents its ears and eyes. To be able to *work* another station you must be able to hear it. Very likely you will have purchased the best receiver you can afford, and it will be excellent for 80 and 40 meters, but how is it on 15 meters — or the new Novice segment of 10 meters? The higher frequencies often cause problems for older receivers where a lack of sensitivity and high internal noise (generated by the receiver components themselves) cause them to "hear" poorly.

You can often overcome a poor receiver's inadequacies on the higher frequencies by adding a preamplifier between the antenna and the receiver antenna terminals. The preamplifier amplifies incoming signals without adding



Electronic keyers can be obtained in a wide variety of shapes, sizes, colors, and with a tremendous range of features. Any of them can be a great help to forming code characters with correct spacing. Most of them will key either tube or solid-state rigs. Some, like the Heath HD-1410, have keyer paddles built in. Others require an external keyer paddle, which is an advantage if you want to get at the spring-tension and contact-spacing adjustments.

appreciably to the noise, and gives you the effect of a new receiver for just a comparatively few dollars. Sometimes a combination converter-preamplifier will do the trick. These operate by using the existing receiver as a fixed i-f, and tuning the converter; and sometimes by using the receiver as a tunable i-f. In either case, your hearing will be improved and, along with it, your ability to work weak stations.

### The skywire

Most of us are in a hurry to get on the air and tend to skimp in the antenna department. This is not a good practice, because — next to your receiver — a good antenna is the most valuable piece of equipment you can own. Put up the longest, highest antenna you can manage. If it is a long wire, you will need a tuner to resonate it on the various frequencies you plan to work. The antenna tuner is something like a gearshift in a car, it takes power from the power source and puts it where you need it most, with maximum efficiency. If wire antennas are your choice, get an antenna tuner that will be able to match your antenna to the transmitter. Most of the

new tuners have built-in meters that indicate either swr or reflected power. By tuning your transmitter to its normal rated current, and adjusting the tuner for minimum reflected power, you have done the best thing possible to insure a good signal in the receiver of a far away ham.

Some antennas are cut to frequency and operate over just one band. These are fed with coaxial cable and do not require an antenna tuner to match them to a transmitter.

### Load it, dummy

When you transfer power to your antenna, you are said to be *loading* it. Looking at it from the other end, the antenna represents a resistive load to your transmitter. When your antenna is connected to your transmitter and the transmitter tuned to resonance, a signal will be radiated. Unfortunately, there are times when it is illegal to radiate a signal because it will interfere with another station. Yet you may want to load the antenna and tune the transmitter to that frequency. What do you do? You obtain a *dummy load*, that's what. A dummy load is really a resistor that "looks" like an antenna to the transmitter and accepts power from the transmitter for tuning purposes. You can plug in the dummy load, tune the transmitter, and never put an interfering signal on the air.

Your next purchase ought to be a dummy load. If you can't buy it, make it. Once the transmitter is tuned to the

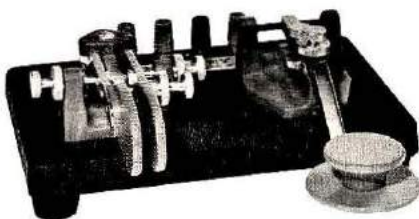

You can buy a single set of keyer paddles on a base, or you can get paddles and a straight key together on one base. Ham Radio Center, St. Louis, Missouri, offers this dual model, and several styles of keyer paddles alone.



The ATRONICS Code Reader receives Morse code and displays it on an alphanumeric readout. It can be used as an aid to teaching or learning code if hooked to a keyer or keyboard, or as an off-the-air copying device if hooked to a receiver. Also, it could be very helpful to people who have a hearing problem.

dummy load, only a minor tweak or touch-up will be necessary when transferring rf to the real load — your antenna. The dummy load will help prevent you from receiving that infamous "*pink ticket*" from the FCC. I got one once and, believe me, it isn't worth the hassle.

### Accessories after the fact

The foregoing items will allow you to put a decent signal on the air and should take care of your immediate needs for equipment. As time goes by, however, you'll want some other items to make your operating easier, smoother, and more pleasant. In short, you'll want to upgrade your station. Here are some ideas.

### Electronic keyer

Electronic keyers are a big convenience and offer an opportunity for you to increase your sending speed and improve the quality of your CW transmissions. Some of the older tube-type keyers are still available at reasonable prices, and do an excellent job. The newer ones are solid-state and battery-powered, in addition to being smaller. An electronic keyer makes self-completing dots and dashes; by holding the lever to the right, dots are produced and by holding the lever to the left, dashes are made — automatically. A disadvantage of an automatic



Next leap past an automatic key for a dyed-in-the-wool CW man is a Morse keyboard. This beautiful accessory works best, of course, if you can touch-type. It makes all of the necessary dots and dashes, together with proper speed and spacing, for any letter or symbol that you type. Besides that, some keyboards are capable of sending code at variable speeds up to 100 words per minute; much faster than most CW operators can copy. A deluxe accessory.

keyer is that it requires you to conform to it, and you tend to lose a characteristic style of sending — or *fist* — as it's called. In some cases this is good, but in general your fist will sound very regular and mechanical when using a keyer. If you are an outright individualist, you may not want to give up your own style.

When you buy a keyer, think about whether you want one with a built-in paddle or an external paddle. The keyers with external paddles usually provide a somewhat superior control of the paddle adjustments and feel, but they tend to be larger and are made up of two units: The paddle, and the box containing the electronic circuits. All-in-one units are smaller, and everything is contained in a single box, but paddle adjustments and feel are not as easy to control.

Kit keyers are also available, and if you feel like beginning some home construction projects, this route is a good one because you can save some money, gain experience, and produce an excellent quality keyer that could last as long as you need a key. One thing, though, don't ever give up your straight key! Leave it at your operating position,

connected in parallel with the electronic keyer, or at least ready to plug in at a moment's notice. There are times when you will want it, even after you become a high-speed operator.

Mechanical keyers are called "bugs." They have adjustable speed and are somewhat less expensive than electronic keyers. Paddle feel is good and many adjustments are possible to suit your individual style. One thing, though, dashes must be made manually; dots are automatic.

Both mechanical bugs and electronic keyers are easily adjusted to a wide range of sending speeds, all the way from about 5 to 50 words per minute. Some of the keyers have memory devices that will store several complete sentences. Contest operators like these because they can put a complete CQ and station identification in the memory and — by pushing a button — have the information sent at any desired speed.

One of the latest innovations is the Morse keyboard, something like a typewriter, that automatically converts typed information into Morse code characters. If you're a good typist, you may want to give one of these a try, although it is a large departure from the old way of doing things. Code sent by keyboard

Among the devices designed to help the CW operator to separate signals on a crowded band is this Binaural Synthesizer-Filter from Hildreth Engineering. It synthesizes a binaural sound from a monaural source, which can be used to separate signals into two groups — one in each ear if you use earphones designed for "both-ears" listening. It also puts a unique "tone-tag" modulation on any signal that is at the crossover point of the two filters. It was originally described in the November, 1976 issue of *ham radio*, page 52.



A device to indicate the amount of power coming out of the transmitter should be very high on your list of desirable accessories. They are available in many power ranges, but most will handle up to 1000 watts. Many of them include circuitry to look at reflected power (or SWR). While obtaining extremely low SWR is usually not very important, this metering feature can be invaluable when you want to make a quick check to see if all is well at the antenna end of things.

is almost perfect and really sounds that way. It is easy to copy, and machine-like in rhythm and speed. Speed is adjustable from about 5 words per minute or less to over 100 words per minute!

#### Antenna rotators and beams

Someday you will want to put up a rotary beam antenna to concentrate your signal in a favored direction and to exclude unwanted signals from other directions. A great variety of beams are available, but the most popular are the Yagi and the cubical quad types. Beams are available in mono-band styles or multiband styles with just one feedline. Multiband beams are usually tri-banders, covering ten, fifteen, and twenty meters. They are large, rather heavy, and quite expensive, but they do give your signal a big advantage over a signal radiated from an ordinary antenna. You will want to put the antenna as high as possible and clear of surrounding objects, which requires a tower.

To point the beam you will need a rotator with a remote directional indicator in the shack. You can build a beam but you will probably want to buy a rotator. For the larger tri-banders, a heavy-duty rotator is a must, but for the small, light

mono-banders for ten or fifteen meters, you can sometimes get away with a heavy-duty TV rotator. Don't expect to put up a beam, support, and rotator cheaply; figure on spending several hundred to a thousand dollars. Like anything else, performance carries a steep price.

### Phone patches

Eventually, after you obtain operating privileges in the phone bands, you may want to perform a service for overseas stations in countries having third-party traffic agreements with the United States. In particular, U.S. servicemen overseas are always looking for a way to talk to their families and friends back home. Amateur radio has been a traditional means of doing this, and stations equipped with phone-patch facilities can perform this useful and happy service.

Basically, a phone patch is a device that connects your home telephone to your receiver and transmitter, so that a party at the other end of the line can speak through your transmitter and listen through your receiver. Phone patches can be built or bought, but must be designed not to interfere in any way with the telephone company circuits. This requires an interface device approved by the telephone company.

Phone patches are mixed blessings because many stations make nuisances of themselves requesting your services, at times and places most inconvenient to you. You will want to treat this whole matter cautiously, and not go roaring into phone patching without listening to other stations performing this service. Listen first, then decide.

### Monitor scopes and such

A good way to "look" at your signal, or signals from other stations, is with an oscilloscope — a device that displays a signal in the form of



Phone patches are devices to allow you to connect your receiver and transmitter to the telephone lines. In this way you can let someone on the air talk directly to friends or relatives at the other end of a telephone line. It is also helpful in emergency situations, where the speed of a direct conversation, without a go-between, is essential. Most of the "patches" available have features similar to this one by Heath — simple controls to adjust the transmit and receive audio, and a meter so you can monitor the audio level across the phone line.

a wiggly green line on an illuminated screen.

Oscilloscopes are similar to television sets because they display visual information on cathode-ray tubes in somewhat the same manner. For example, you can see what your modulated signal looks like, and compare its waveform with an ideal waveform. By this comparison you can adjust your transmitter to provide the desired waveform, and know that your transmitted signal is beyond reproach. Another type of oscilloscope can be connected to your receiver and shows a panoramic display of signals over a considerable portion of the band you're using. You can compare relative signal strengths, find open spaces where you can transmit and receive with minimum interference, and generally get an overall view of what's going on.

Monitor scopes are available in kit form and can be built into useful and interesting station accessories. You can also buy them ready to use, at a higher price of course. Some types have the ability to serve as both waveform monitors and panoramic viewers, serving both your transmitter and receiver needs. When another station asks, "How's my signal?" you can tell him *exactly* how it is. This may, or may not, win friends and

influence people. The choice is up to you.

### Some final ideas

By now, you may have a good idea of what your station needs, but you may wonder just where to put all this equipment and how to arrange it. Above all, your operating position should be convenient and comfortable. Many amateurs arrange their stations in console form, with the major pieces of equipment arranged in the center, and accessories placed on either side or above the major items, possibly arranged in a U-shape. Leave plenty of space at the front of the desk for writing, and room for your forearm to rest when you use your key or keyer. A good lamp that provides illumination but doesn't shine in your eyes will be a big help, and you may want to consider the type having an adjustable arm that can be fastened to an edge of your table or desk.

A station clock should be easily visible from the operating position, and will probably be a digital type set to GMT. If you are a DXer, a world map will be helpful to you. Try to find a map that has call sign prefixes for the various countries marked in it, and also the various zones of the world prominently displayed. Great circle bearings from your location to other countries will be a help in pointing your beam in the proper direction.

Last but not least, you'll want a microphone that compliments your voice and transmitter. My suggestion would be a dynamic microphone of restricted audio range, designed for single-sideband operation. There are dozens of types and makes from which to choose. So listen to the stations that sound the best and ask their operators what they use.

With a completely equipped station, the rest is up to you. Use it conservatively and courteously, and make friends for amateur radio. **HRH**

# DenTron Radios... Built by Americans for the whole world.

One of the greatest pleasures ham radio brings is contact with distant lands. What other organization can boast of daily communication among its members throughout the world?

It's a great hobby and we want to make it more fun for you!

DenTron antenna tuners do just that. Our Super Tuners are the only tuners on the market capable of matching everything between 160 and 10 meters, plus handling 1-3 KW PEP.



*Professional hams depend*

**A. The Original Super Tuner 1KW PEP \$129.50.**

If you're new at ham radio you'll find it's invaluable.

**B. Super Super Tuner 3KW \$229.50.**

If you've added more power to your station it's a must. Both the Super Tuner and the Super Super Tuner match balanced feed, coax, random or long wire. Both transfer maximum power from the transmitter to the antenna.

**C. NEW! The MT-3000A \$349.50.**

The MT-3000A was designed for the serious ham interested in professionalizing his station. It is a rugged antenna tuner that easily handles 3KW PEP. It has built-in dual watt meters, and a built-in dummy load. The antenna selector switch: (a) enables you to by-pass the tuner direct; (b) select the dummy load or 5 other antenna systems.

**D. 80-10 Wire Tuner \$59.50.**

Our random wire tuner handles 500 watts and is ideal for the ham on the move.

**E. W-2 Watt meter \$99.50.**

DenTron's dual in-line Wattmeter allows you to read forward and reflected watts simultaneously.

**F. SuperAmp \$574.50.**

The SuperAmp is one of the best amplifier values currently on the market. It covers 160-10 meters, and features four 572B triodes in grounded grid. With it add 2000 watts PEP SSB and 1KW CW power. No other amplifier delivers so much at such a reasonable price.

**G. NEW! MLA-2500 \$799.50.**

The MLA-2500 is one of the world's finest high performance military amateur amplifiers. It was designed for the discriminating buyer who knows and appreciates precision plus power. Coast along with a full 2000 watts PEP input on SSB, 1000 watts DC input on CW, RTTY, or SSTV. The heart of the MLA-2500 is a heavy duty, self contained power supply, and it features 2 Eimac 8875's.

**H. NEW! MLA-1200 \$399.50,**

external AC supply, \$159.50, DC supply \$199.50. The MLA-1200 shares many fine features with its famous big brother, the MLA-2500, but also has a few distinctive features of its own. It employs a single Eimac 8875, running 1200 watts PEP or 1KW DC. It incorporates the same built-in ALC as the 2500. The MLA-1200 is the smallest 1200 watt linear amplifier on the market, great for your mobile home, boat or car!

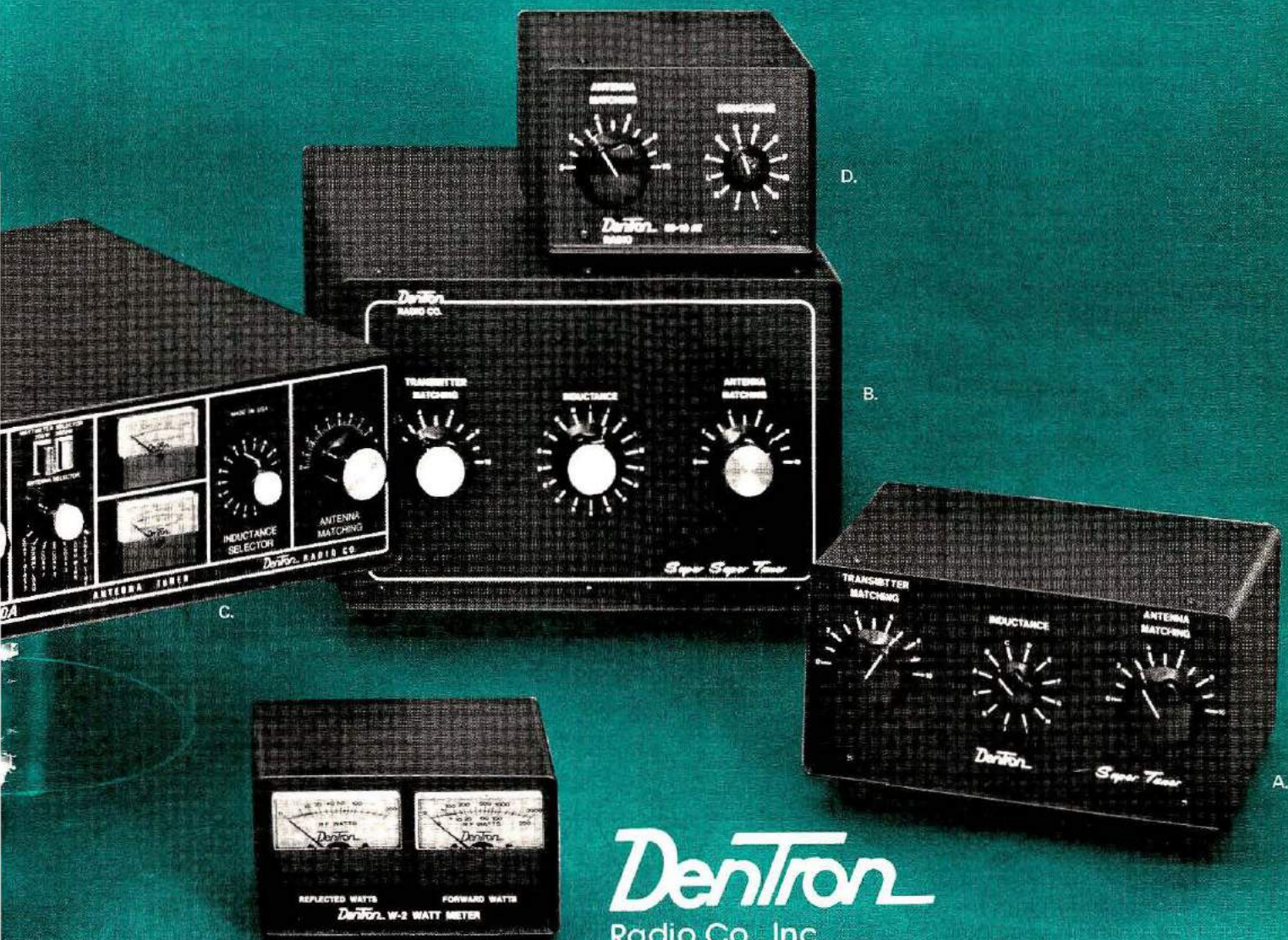

*on DenTron for Amateur fun!*

# DenTron

Radio Co., Inc.

2100 Enterprise Parkway  
Twinsburg, Ohio 44087  
Phone (216) 425-3173





# THE OSCILLOSCOPE

BY LORAN JOLY, WB6KTH

*A magic looking-glass that lets you probe the innermost secrets of your radio. Watch the wiggly green line on the screen of this miniature TV set and learn more about the nature and condition of electronic circuits.*

An oscilloscope is one of the most useful pieces of test equipment available for the electronic hobbyist, builder, experimenter, and radio amateur. You can use it to display peak voltage against a time base, to measure peak-to-peak voltages, for signal waveform analysis, and — with the aid of a small outboard accessory — for testing semiconductors. Before we take a closer look at some of its details, let's first find out a little about what kind of animal the oscilloscope really is, and where it comes from.

An oscilloscope is related to your television set because both contain a cathode-ray tube capable of displaying information on its screen. A cathode-ray tube produces a stream of electrons that are focused or concentrated in a beam and accelerated to a phosphor screen placed on the inside surface of the tube's faceplate. The beam of electrons excites the phosphor screen and forms a glowing, greenish-white dot. The oscilloscope and TV set also have deflection circuits that act upon the electron beam and move it up or down and left or right, or in some direction that

is a combination of these two basic directions. The moving dot is said to *sweep* across the screen and form a *trace* in the phosphor. Phosphors can be selected for their persistence, that is, the length of time they will glow after being excited by the electrons, but this is determined by the manufacturer of the cathode-ray tube and really doesn't concern us now.

The controls on an oscilloscope may seem bewildering at first, but once the basic purpose of each control is learned, the oscilloscope becomes a very simple instrument to use. Most 'scopes have the following controls, and some may have more:

**Intensity** — for adjusting the brightness of the trace on the

screen of the cathode-ray tube (CRT).

**Focus** — for adjusting the sharpness of the trace from a blur to a distinct line.

**Vertical-Horizontal Position** — for centering the trace on the screen.

**Vertical Attenuator** — for adjusting the strength of the signal presented to the vertical amplifier circuit in the scope. When set in the X1 position, the signal is fed directly to the vertical amplifier. When set to X10, the signal is attenuated (reduced in strength) by a factor of 10. Some scopes have numerous attenuator steps.

**Vertical Gain** — for adjusting the amplification of the vertical amplifier circuit and the height of display.

**Horizontal Selector** — for selecting one of various horizontal inputs such as sawtooth sweep, 60 Hz source, or external synchronization, to be applied to the horizontal amplifier circuits.

**Phasing Control** — for adjusting the starting point of a trace to any desired point on the displayed waveform.

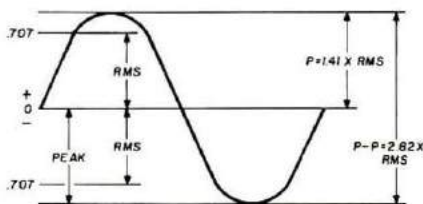

Fig. 1. Shows a typical sine-wave trace of one complete cycle, and illustrates the differences between peak-to-peak and rms voltages.



**Coarse Sweep** — for adjusting the range of sweep frequencies (coarse tuning) applied to the horizontal amplifier.

**Vernier Sweep** — for adjusting the frequency of the sweep voltage applied to the horizontal amplifier (fine tuning) within the range set by the *Coarse Sweep* control.

### Inserting the Signal

When it is desired to observe

a waveform representing an externally-generated signal, that signal is introduced through the *vertical input* terminal on the front panel of the oscilloscope. The horizontal-sweep frequency is adjusted to the frequency of the input signal by adjusting the *Coarse* and *Vernier* sweep controls, until the waveform trace is stabilized on the screen. Example: A single sine wave, that is,

one complete cycle.

Expensive oscilloscopes have a desirable feature known as *triggered sweep*, meaning that the input pulse or signal starts and stops the sweep. Triggered-sweep oscilloscopes have precisely-calibrated vertical and horizontal gain controls to facilitate time and voltage measurements, and usually have a square-wave voltage terminal for calibration purposes.

The input signal passes through a *blocking* capacitor on its way to the vertical amplifier circuit of the oscilloscope. The capacitor may be switched in or out of the signal path. If the capacitor is switched in, any dc voltage present on the input signal will be prevented from appearing on the displayed trace. If the capacitor is switched out, a trace representing the ac voltage, as well as the dc voltage, will be displayed on the screen.

### Using the Oscilloscope

The active ham or experimenter can find a number of different and valuable uses for the oscilloscope. For example: Voltage measurement. The oscilloscope can display dc, sine wave, square wave, sweep, and synchronizing voltages. The sine wave voltage is used for calibrating the scope for peak-to-peak (p-p) voltage measurements. Fig. 1 shows the relationship between *peak* and *rms* voltage.

Rms voltage is usually read with the aid of a meter, and *peak-to-peak* voltage may be determined by multiplying the rms value by 2.82. Therefore, the common line voltage found in the home will read 117 volts ac on the meter, but is actually 330 volts peak-to-peak. Having calibrated the oscilloscope by adjusting the sine waveform trace to the proper height on the screen, other voltages may be displayed and accurately determined.

To calibrate the *vertical gain* control, hook up the low

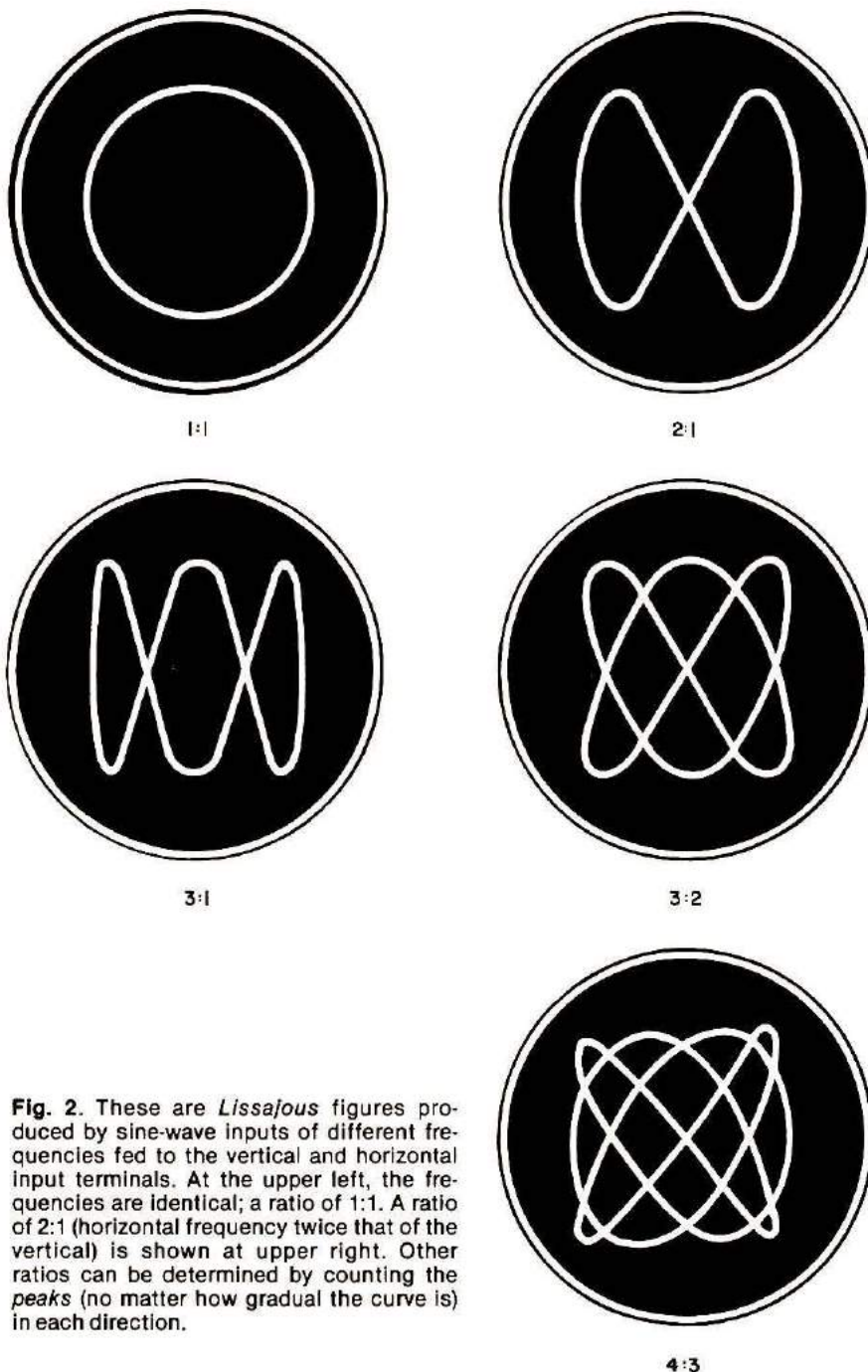

**Fig. 2.** These are *Lissajous* figures produced by sine-wave inputs of different frequencies fed to the vertical and horizontal input terminals. At the upper left, the frequencies are identical; a ratio of 1:1. A ratio of 2:1 (horizontal frequency twice that of the vertical) is shown at upper right. Other ratios can be determined by counting the *peaks* (no matter how gradual the curve is) in each direction.

voltage (output) side of a 117- to 6.3-volt ac transformer to the vertical input terminal of the oscilloscope. Since the p-p value of 6.3 volts rms is approximately 18 volts (actually 17.77 volts), adjust the *vertical gain* control until the trace pattern occupies a vertical height of 18 divisions on the plastic grid that overlies the face of the cathode ray tube. This grid, or *reticule*, is divided into tenths of an inch (2.54mm), just for this purpose. As long as the vertical gain control is left at this calibration point, each mark on the plastic reticule will represent one volt. Now you may apply any ac voltage up to 6.3 volts rms to the vertical input terminals of the oscilloscope, and accurately "read" its exact peak-to-peak value. The same procedure may be followed with other voltages by first calibrating the 'scope to a known voltage in the manner described above.

### Frequency measurement

*Lissajous figures* are used to measure frequency. A Lissajous figure is a waveform trace appearing on the screen

as the result of applying sine wave signals to both the vertical and horizontal input terminals of the oscilloscope. For example, a known, standard-frequency, ac voltage, such as the 60-cycle power frequency, is applied to the horizontal amplifier terminals, while an unknown-frequency ac voltage is applied to the vertical amplifier terminals of the oscilloscope. The resulting waveform displayed on the screen will be a symmetrical pattern of interlocking traces whose dimensions and appearance are the result of the ratio between the horizontal and vertical input frequencies. By counting the loops on both sides of the patterns, you can find the ratio and, therefore, determine the unknown frequency. **Fig. 2** shows a few patterns that you may encounter, and how to count the loops to find the ratio.

### Power output measurement

Suppose you want to measure the power output of an audio amplifier. Connect the speaker-output terminals of the amplifier to a load resistor across the vertical-input

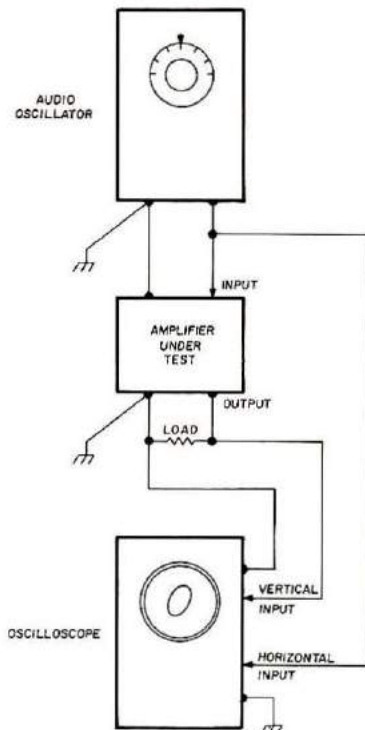

**Fig. 3** Block diagram showing the basic connections between an audio oscillator, and audio amplifier and an oscilloscope for the purpose of determining the phase relationship between the signal fed into the amplifier and the amplified output signal.

terminals of the oscilloscope. Hook up a signal generator, set it to 1000 Hz, and connect its output to the input of the amplifier. Now increase the gain of the audio amplifier until the displayed waveform begins to look distorted, and then reduce it until the distortion just disappears. Then, having first calibrated your 'scope to a known voltage as mentioned earlier, you can read the peak-to-peak voltage put out by the amplifier. You then multiply the peak-to-peak value by 0.355 to find the rms voltage, and use the following formula to determine power:

$$P = \frac{E^2}{R} \quad (1)$$

where E is the rms voltage, R is the voice coil impedance (or load resistance) in ohms, and P is power in watts.

### Phase shift

An amplifier is supposed to shift the phase of an input

The real value of a oscilloscope becomes apparent when you use it as a diagnostic tool to look inside an ailing electronic circuit.



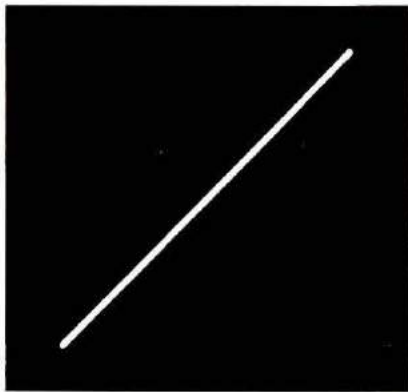

0 degrees (in phase)

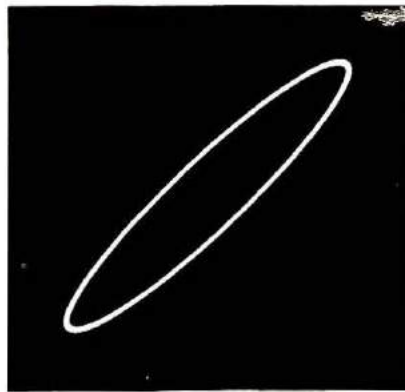

10 to 15 degrees

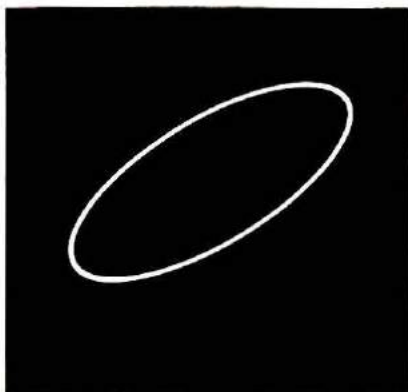

20 to 30 degrees

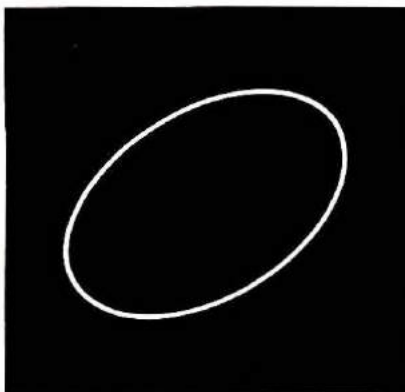

60 to 80 degrees

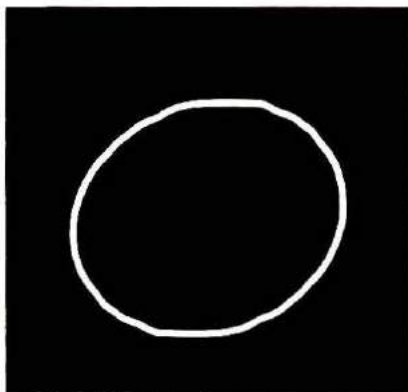

90 degrees



Approximately 150 degrees

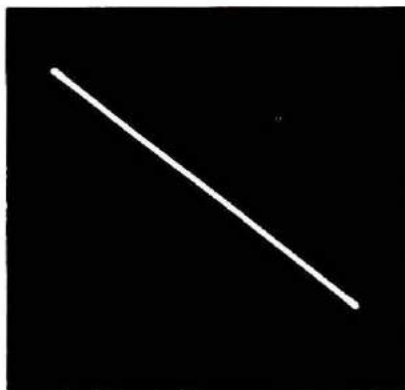

180 degrees

**Fig. 4.** Illustrates the *Lissajous* patterns obtained with the setup of **Fig. 3** when a variety of phase relationships between input and output signals are displayed on the oscilloscope. In a properly designed and operating amplifier, the relationship should be 180 degrees.

signal by a multiple of 180 degrees, but the actual phase shift may be more or less than this. To determine the input — output phase relationship of a particular amplifier, proceed as follows. Hook up an audio oscillator and an audio frequency amplifier as shown in **Fig. 3**. On the oscilloscope, set the vertical and horizontal amplifier gain controls for the same amount of amplification. Now, vary the frequency of the audio oscillator through the range of frequencies for which the amplifier was designed and compare the patterns you see on the oscilloscope with those shown in **Fig. 4**.

For a permanent record of your amplifier's performance, plot a chart of frequency vs phase shift, using graph paper. Lay out values of phase shift from 0 to 180 degrees, using convenient steps of ten or fifteen degrees per increment, along the ordinate (vertical axis), and lay out frequencies, from the lowest to the highest you intend to measure, along the abscissa (horizontal axis) of the paper. Now, by watching the 'scope patterns at any particular frequency in the range you should be able to find the number of degrees of input/output phase shift at that frequency. Make a mark on the graph paper where each of the frequency and phase-shift values intersect. After plotting frequency vs phase shift for all the frequencies you are interested in observing, connect the plotted points on the graph to form a smooth curve. At some point, the input/output phase relationship should be 180 degrees. If not, there may be some problems with the amplifier design or its function. In any case, your 'scope will have given you an accurate picture of your amplifier's performance. The abscissa represents zero phase shift.<sup>1</sup>

#### **Audio response measurement**

To test an amplifier for audio response, you need a square



Oscilloscopes can be simple or complicated, but don't let the number of knobs and controls scare you. They all fit into one of three categories: one group controls the brightness and focus of what is on the screen; another group controls the speed, timing, and width of scanning in a horizontal direction; and another group controls the gain of the amplifiers for vertical movement of the spot. With a bit of practice, you can use a scope for anything that you would need a volt-ohm-milliammeter for, plus a lot more.

wave generator which is another form of signal generator that produces square waves instead of the sine waves produced by an ordinary audio oscillator. The output of the square wave generator should be connected to input of the amplifier under test. The output of the amplifier is connected to the vertical input

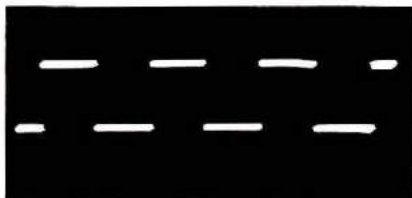

Output from an amplifier having good high-frequency response, indicated by the steep sides of the waveform and good low frequency response indicated by the flat tops of the waveform

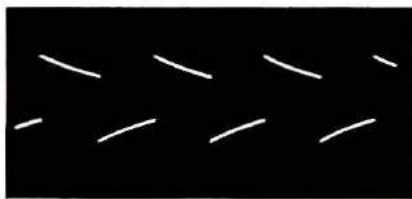

Waveform displayed with the amplifier has poor low-frequency response; note the steeply sloping tops on the waveform

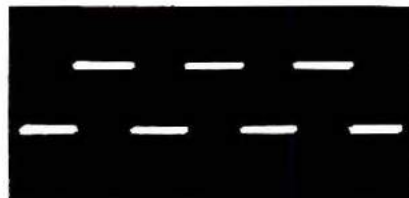

Phase shift, indicated by the square wave pattern distorted toward something that approximates a sine wave

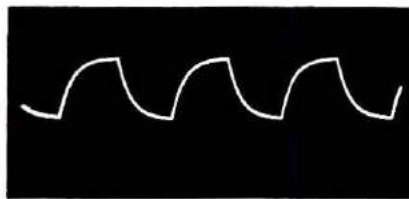

Waveform when high-frequency response is poor; note the rounded corners and sloping sides

**Fig. 5.** Variations of a square wave pattern that could be obtained when a square wave oscillator, an audio amplifier and an oscilloscope are used to determine "linearity" of the amplifier's frequency response.

**Fig. 6** An auxiliary or "out-board" device that can be attached to an oscilloscope for the purpose of analyzing circuit components such as semiconductors, resistors, capacitors; and shorted or open circuits.

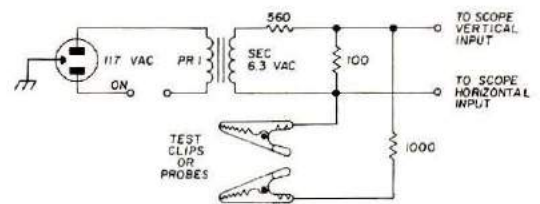

terminals of the oscilloscope, as before. Connect the *sweep* terminal of the square wave generator to the horizontal input terminal of the oscilloscope. If the square wave generator has no sweep terminal, then the square wave output signal will also serve as a sweep signal merely by connecting the generator output to the horizontal input terminal of the 'scope. Now observe the patterns on the oscilloscope as you set the square wave generator to several frequencies within the frequency range of the amplifier being tested.

**Fig. 5** illustrates the various waveforms, based on square wave forms, obtainable with a simple set up. In a properly operating amplifier, the steep sides show good high-frequency response, and the flat tops indicate good low-frequency response. You can

see the waveform from an amplifier having poor low-frequency response, with phase shift, and with poor high-frequency response.

### Outboard devices

In order to extend the versatility and usefulness of your oscilloscope, there are several outboard devices that you can use to "convert" your 'scope for making other measurements. The device shown in **Fig. 6** is a simple circuit that will allow you to test transistors, diodes, resistors, capacitors, and inductors.<sup>2</sup> It is called a *semiconductor tracer* and "draws" Lissajous figures on the oscilloscope screen. The circuit is very handy for testing semiconductors without removing them from their circuits. For example, a "noisy" semiconductor will produce a very "fuzzy" pattern on the

# ME-3 microminiature tone encoder

Compatible with all sub-audible tone systems such as: Private Line, Channel Guard, Quiet Channel, etc.

- Powered by 6-16vdc, unregulated
- Microminiature in size to fit inside all mobile units and most portable units
- Field replaceable, plug-in, frequency determining elements
- Excellent frequency accuracy and temperature stability
- Output level adjustment potentiometer
- Low distortion sinewave output
- Available in all EIA tone frequencies, 67.0 Hz-203.5 Hz
- Complete immunity to RF
- Reverse polarity protection built-in



**\$29.95 each**

Wired and tested, complete with K-1 element

**communications specialists**

P. O. BOX 153  
BREA, CALIFORNIA 92621  
(714) 998-3021



K-1 FIELD REPLACEABLE,  
PLUG-IN, FREQUENCY  
DETERMINING ELEMENTS

**\$3.00 each**

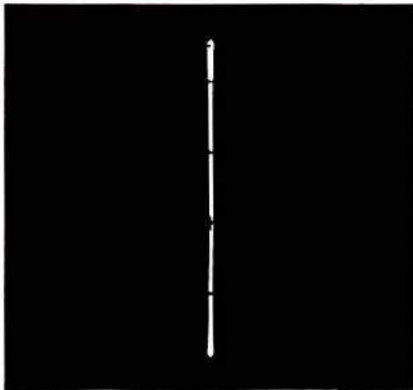

Short circuit or shorted component

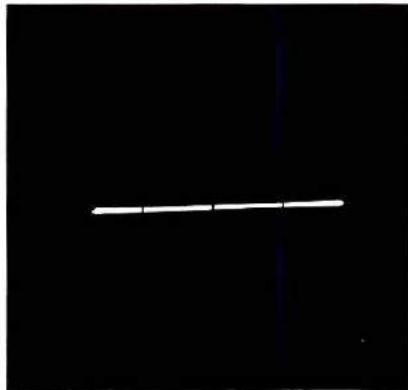

Open circuit or component

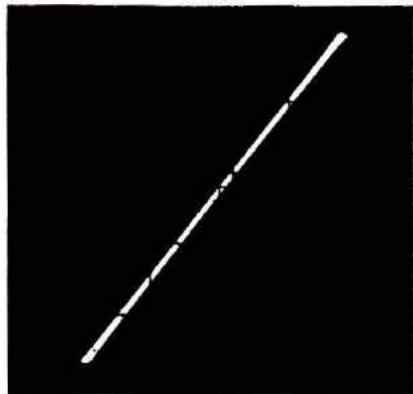

Resistance

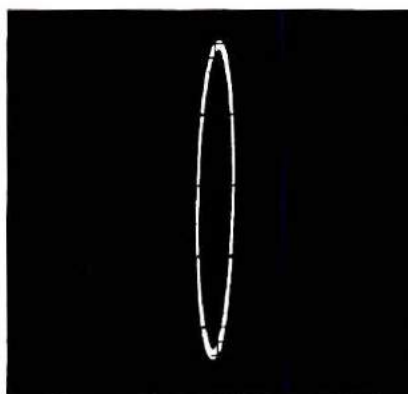

Inductance

**Fig. 7.** Typical *Lissajous* patterns obtained using the circuit of **Fig. 6** to analyze various components and circuit conditions.

oscilloscope. **Fig. 7** illustrates a variety of patterns that can be produced by the circuit of **Fig. 6** when its two probes are bridged across the part to be tested. This handy circuit applies only one volt at one milliamper to the semiconductor, ensuring that no damage will be done to it. Circuit components arranged in series or parallel configurations may also be tested with this outboard device.

### Monitoring your ssb transmitter

A single-sideband transmitter cannot be completely tested by a meter because a meter cannot follow the complex output waveform produced by the fluctuations of the human voice. To view the output of a ssb transmitter, you need several pieces of test

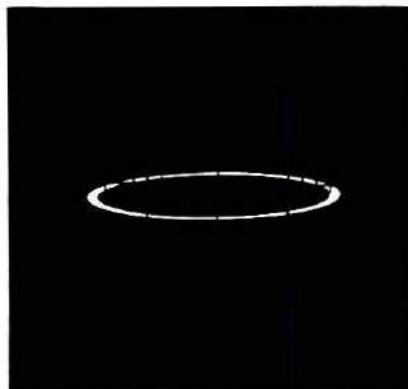

Capacitance

equipment in addition to the oscillator, and a pick-up/tuning unit are needed. ARRL's publication, *The Radio Amateur's Handbook*, gives the necessary information needed to construct and use these pieces of test equipment.<sup>3</sup>

When using your oscilloscope, you should use a shielded cable to reduce hum pickup that will affect the waveform trace. Unfortunately, shielded cable introduces

capacitance that often distorts the waveform. Low capacitance probes can be constructed or purchased that will eliminate the problem of capacitance as well as hum pick-up. Although the probe attenuates the signal appreciably, most oscilloscopes have sufficient amplifier gain to increase the signal voltage sufficiently to obtain a viewable display.

### Safety and precautions

1. Use shielded leads to all inputs of the oscilloscope. This reduces pick-up of hum and unwanted signals.

2. Do not align a receiver until the oscilloscope and the receiver have had a warm-up time of at least ten minutes. In fact, this is a good rule to remember with any test equipment. Allow enough warm-up time for the equipment to stabilize.

3. Always ground the chassis of the oscilloscope to protect yourself from shock and to reduce the pick-up of stray signals, such as 60- or 120-Hz hum for example, that may be present in the test equipment or in the equipment being tested.

### References

1. George Zwick, *The Oscilloscope*, Gernsback Publications, Inc., 1954, page 136.
2. David L. Ludlow, "The Octopus", *QST*, January, 1975, page 40.
3. *The Radio Amateur's Handbook*, American Radio Relay League, Newington, Connecticut, 1976, pages 374, 399.

HRH

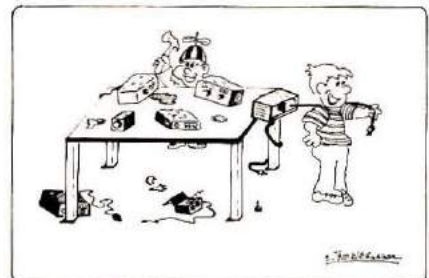

"No daddy don't care if we play in here..."

Calling  
All Hams...



...All Hams  
Call Us!

It's Toll Free... So Dial Away!

# 1-800-325-3636

**FOR NEW OR USED AMATEUR RADIO GEAR**... we're specialists and carry *in stock* most of the famous-brand lines. Or, we will talk trade.

**FOR FAST, DOOR-STEP DELIVERY**... give us a call. You'll be amazed; for we guarantee we'll ship your equipment the same day. Plus, most shipments are **PRE-PAID**.

**TO SAVE MONEY**... join thousands of our satisfied customers who buy from us as easily as from their local supplier. So, remember your call is *Toll Free*.



We welcome your Master Charge or Bank Americard



## HAM RADIO CENTER, INC.

8340-42 Olive Blvd. P.O. Box 28271 St. Louis, MO 63132

### NEW VISUAL CODE READER AND ELECTRONIC KEYS



Works with any keyer, including squeeze keyer in speeds from 7 WPM to 40 WPM. Both in a single unit.  
Model CR101EK  
\$249

from **ATRONICS**

- Display letters, numbers, and commonly used punctuation visually, as Morse Code signal is received.
- Operating speed 5 to 50 WPM at selected speeds.
- All Solid State
- Makes code learning faster and easier
- A single connection to your receiver or transceiver speaker puts it into operation.
- Hard copy read-out of CW available with TU-102 TTY interface Module accessory.

Our popular, lowest priced CODE READER KIT  
Model KCR101 ..... \$149  
Ready made CODE READER... Model CR101 ..... \$225

**BUY FACTORY DIRECT & SAVE! SEND FOR FREE LITERATURE.  
USE YOUR BANKAMERICARD OR MASTER CHARGE**

P.O. BOX 77 ESCONDIDO, CA 92025 (714) 745-1971

# Atronic

## The World's Greatest QSL Cards

Para-Graphics is now offering the finest quality cards available anywhere. Our stock cards are designed by a staff of professional designers. We offer a selection of 20 stock cards covering a wide variety of subject matter, all designed with your QSL needs in mind. Or if you would like to design your own cards, we offer a large selection of Art Samples, type styles, and colors for you to choose from. We even have several cards that we will custom design for you using a photograph of you, your family, or whatever you like. **Whatever your QSL needs, Para-Graphics offers you the very best.**

Send 50¢ with this coupon  
for your **FULL COLOR CATALOG.**

<b>para-graphics</b>	Dept. HRH-2 P. O. Box 268 Whitehall, Pa. 18052
Name _____	
Address _____	
City _____ State _____ Zip _____	

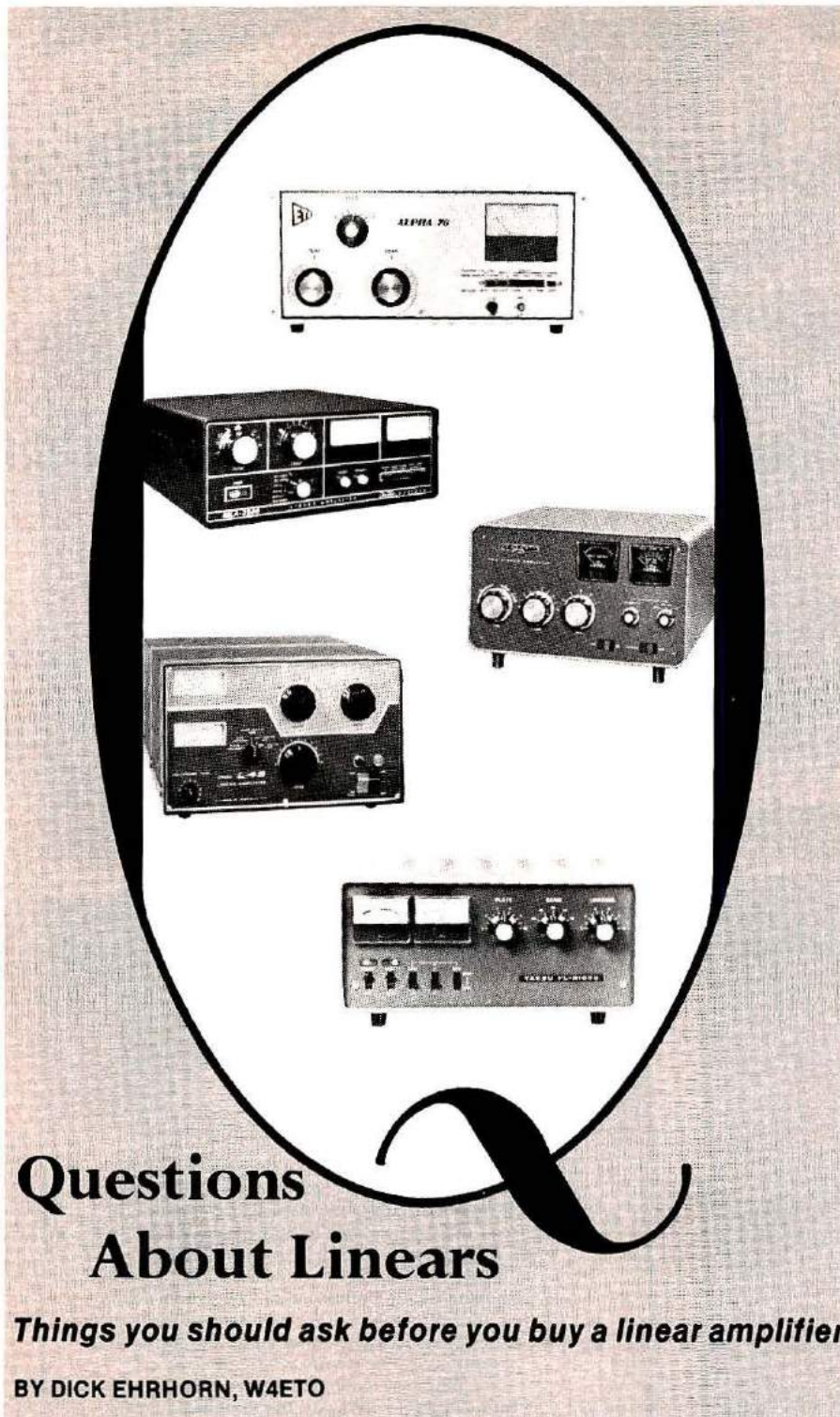

## Questions About Linears

*Things you should ask before you buy a linear amplifier*

BY DICK EHRHORN, W4ETO

Linear amplifiers are different things to different people. To some, a linear may be useful to boost 10 watts from a two-meter ssb rig up to the 60- or 100-watt level for extending their mobile range. To others, it is a means of having the convenience of a low-power (QRP) rig for travel, but the punch of a big signal at home when the going gets rough in a

contest. At some stations, the linear is capable of reaching the full legal power limit that amateurs are allowed; other linears work at half that level. Whatever the use you have for a linear amplifier, it is wise to ask some searching questions and read the specifications carefully. Not only do you want it to last a long time, but you don't need a failure during a

contest or at the crucial moment when you are trying to crack the pile-up on that rare once-in-a-lifetime DX station.

### Specifications meaningful?

You bet they are; but what's *not* specified may tell you as much as what *is*. Look for hard, precise numbers and facts — *look out* for glittering generalizations and grandiose phraseology.

Long-term average d-c power input tells you more about an amplifier's real ruggedness than does any other specification, but you won't find such a figure in many specification sheets. This is also referred to as "continuous-duty, no-time-limit (NTL), fsk at 100 per cent duty cycle," or in a variety of other, equivalent ways. It's more impressive to emphasize peak (PEP) or CW power limits which assume, often implicitly rather than openly, a duty cycle limited to as little as 20 to 50 per cent. Responsible manufacturers clearly and unambiguously specify the duty cycle for each mode.

### How important is PEP?

Peak Envelope Power is the maximum level to which the amplifier can be driven *momentarily* on voice peaks. It is largely determined by tube (or transistor) characteristics and typically ranges from 2 to 5 times the long-term average power capability of the equipment. Unless your operation is confined to occasional periods of ssb, PEP alone is not a very useful indicator of a particular amplifier's servicability for your purposes.

### How about the efficiency?

Most high-quality, modern, amplifiers using Eimac (or similar) grounded-grid triode tubes tend to deliver about the same level of efficiency — commonly around 60 per cent — on the lower frequency amateur bands. Some deteriorate noticeably on 10 meters; some don't. Some fairly popular, lower-priced linears



using older tube types and/or poorly designed output circuits may operate at less than 50 per cent efficiency on some bands. Manufacturers of quality equipment generally specify efficiency and/or typical rf power output as well as dc input.

### Should I worry about distortion?

A new FCC rule requires that each harmonic or other spurious (i.e., outside the amateur band in use) output from any high-power amplifier operating below 30 MHz be at least 40-41 dB weaker than the fundamental frequency output. As a rule, amplifiers incorporating full Pi-L output networks will have harmonics at least 10-15 dB lower than those that use a simple Pi circuit. Manufacturers are not ordinarily hesitant to point out this feature and specify harmonic suppression, which is typically 50 dB or greater with the Pi-L. If harmonic output is not specified for an amplifier that has a simple Pi network, it is well to check further.

### What can I tell about a linear by looking?

A close look *inside* can tell you a great deal about components, workmanship, and overall quality.

**Transformer.** The size and weight of the power transformer(s) provide an excellent guide to long-term average power capability. A conventional transformer capable of powering an amplifier to 1000 watts dc input on a true no-time-limit basis typically weighs 40-45 pounds and would just fit in a rectangular box of roughly 300 cubic inches (4900 cm<sup>3</sup>).

The use of a filter choke reduces required transformer capacity by about 30 per cent, and a custom transformer using a tape-wound core of special grain-oriented steel may be only one-half the size and weight of a conventional unit — but much more expensive. Other factors being

equal, a power transformer's capability goes down *faster* than its size and weight.

**Tubes:** Nearly all modern, high-quality amplifiers use triodes specifically designed and rated for grounded-grid rf linear-amplifier service. The tube manufacturers' ratings are the best indication of maximum potential power capability. Eimac's operating-hours warranty illustrates the point: it's pro-rated to 3000 hours for tubes used in amateur linears. However, don't forget that plate dissipation capability — and hence the average power that any tube(s) can safely handle — depends entirely on the effectiveness of the cooling system provided by the equipment manufacturer!

**Plate output network.** At 14 MHz and above, plate-tuning-coil losses can become significant unless heavy, low-loss inductors are used and the operating *Q* is well controlled. Quality equipment has heavy copper tubing for these coils, which are silver plated to keep the losses low over many years of use. The Pi-L type output network also permits the use of lower loaded *Q* and hence yields lower losses than are practical with a straight Pi circuit.

Vacuum-variable tuning capacitors are compact, flashover resistant, and help to maintain a more efficient tank circuit *Q* at the higher frequencies; unfortunately their cost limits their use to the more expensive linear amplifiers.

The high-powered output circuit is also an excellent area to inspect for design details and workmanship that spell *quality*. Check for the use of heavy conductors which are neatly wrapped or crimped, and thoroughly sweat-soldered into smooth, shiny joints.

**Cooling system.** Amplifiers generate heat, and heat is the enemy of electronic equipment. Look for thoughtful design that circulates cool incoming air

over all major heat-generating components — particularly the power transformer — *before* pushing it over or through the tubes. What happens to the hot air after it's heated by the tubes? Is it exhausted directly to the outside, or does it circulate inside the cabinet and contribute to heating of the other components? How is the transformer cooled? At the very least, provision should be made for relatively unobstructed natural convection; forced-air cooling is much better. Restricting transformer ventilation, or perhaps even exposing it to radiated or convected tube heat, is simply poor design.

### "Special features" are really worthwhile?

It costs relatively little to include full frequency coverage of 160 through 10 meters in a typical new amplifier, and the extra versatility can be very convenient to have. A built-in rf directional wattmeter capable of measuring both forward and reflected power makes it easy to check amplifier performance and antenna vswr without the extra cost of an external instrument. Finally, a HI/LO or SSB/CW switch, which provides a choice of high or medium plate voltages, can be very convenient for tuning up or for switching quickly from ssb to CW or slow-scan TV at full legal power without the need to readjust the loading. It might also be worth checking for suitable reduction drives on the tuning and loading controls to make amplifier adjustment easy on the higher amateur bands.

### Does the factory warranty mean anything?

The manufacturer's warranty is by far your best protection against defects or major failures. The terms and duration of the factory warranty also may offer a pretty good idea of the confidence he has in his product — confidence built up as a result of the reliability record of the equipment.

HRH



# QUESTIONS & ANSWERS

BY THOMAS McMULLEN, W1SL

I hope you can bear with me as I continue going through the Rules and Regulations part of this series. Sure, there are a lot of them, but remember that the planning committee had to think of a lot of possibilities, and try to formulate rules that would fit any situation that might arise. The world changed, technology advanced, and as the amateurs made use of the changes they brought up questions and situations that did not fit the original rules. This called for revisions and, in some cases, additions to the rules. There will still be changes, of course, but we can do our best to understand what we have to use at the moment. So, smile . . . here we go again.

## Station operation

As an amateur, you have great flexibility in how you operate your station, when you operate it, and who you can talk to. There are very few restrictions on what you say over your station, and the paperwork that goes with keeping your station legal is minimal. Station identification is required, not only to tell the other amateur who you are, but to aid the FCC (or anyone else) in locating you if the need arises. Here are the FCC rules regarding identification:

### 97.87 Station identification.

(a) An amateur station shall be

identified by the transmission of its call sign at the beginning and end of each single transmission or exchange of transmissions and at intervals not to exceed 10 minutes during any single transmission or exchange of transmissions of more than 10 minutes duration. Additionally, at the end of an exchange of telegraphy (other than teleprinter) or telephony transmissions between amateur stations, the call sign (or the generally accepted network identifier) shall be given for the station, or for at least one of the group of stations, with which communication was established.

(b) Under conditions when the control operator is other than the station licensee, the station identification shall be the assigned call sign for that station. However, when a station is operated within the privileges of the operator's class of license but which exceed those of the station licensee, station identification shall be made by following the station call sign with the operator's primary station call sign (i.e. WN4XXZ/W4XX).

(c) A repeater station shall be identified by radio-telephony or by radio telegraphy when in service at intervals not to exceed 5 minutes at a level of modulation sufficient to be intelligible through the repeated transmission.

(d) A control station must be identified by its assigned station call sign unless its emissions contain the call sign identification of the remotely controlled station.

(e) An auxiliary link station must be identified by its assigned station call sign unless its emissions contain the call sign of its associated station.

(f) When operating under the authority of an Interim Amateur

Permit with privileges authorized by the Permit, but which exceed the privileges of the licensee's permanent operator license, the station must be identified in the following manner:

(1) On radiotelephony, by the transmission of the station call sign, followed by the word "interim", followed by the special identifier shown on the interim permit;

(2) On radiotelegraphy, by the transmission of the station call sign, followed by the fraction bar DN, followed by the special identifier shown on the interim permit.

(g) The identification required by this section shall be given on each frequency being utilized for transmission and shall be transmitted either by telegraphy using the international Morse code, or by telephony, using the English language. If the identification required by this section is made by an automatic device used only for identification by telegraphy, the code speed shall not exceed 20 words per minute. The Commission encourages the use of a nationally or internationally recognized standard phonetic alphabet as an aid for correct telephone identification.

I would guess that the practice of over-identifying is one that is most noticeable among the beginning amateur on the high-frequency bands, and almost all amateur stations identify too frequently when they are talking through repeaters or on vhf fm. Perhaps it is because they misread the first paragraph in section 97.87. The confusing part seems to be that phrase, "each single transmission." There is more to the sentence, and the very next part should clear it up, "or exchange of transmissions,"

What they are trying to say is that if you are going to make just one transmission, or you think that there is a chance that you will make just one, you should identify at the beginning and end of it. For instance, you have been listening to your friend on 80-meter CW for several minutes, and he is going to turn it back to you. You have an interruption and know that it will be some time before you come back to finish up the

QSO, but you don't want to leave him hanging there. You might answer him something like this:

WB6XXX DE WB1XXX R TNX JOE  
BT SORRY BUT MUST GO NW BT  
WIFE CANT GET CAR STARTED  
BT WILL CALL U WHEN I GET  
BACK BT WB6XXX DE  
WB1XXX AR

That was one single transmission from you, but you hope there will be more. You have identified properly and everyone is aware of who is talking and what they are doing. Later, you have the car problem taken care of, and come back to see if Joe is still around.

WB6XXX DE WB1XXX ARE YOU  
STILL HERE JOE BK  
WB1XXX DE WB6XXX YES I AM  
HERE BT WHAT'S WRONG? BK  
BK THE CARB FLOODED AND  
BATT WAS LOW BT HAD TO  
USE JUMPERS BK  
BK R R THAT HAPPENED TO ME  
LAST MO BT ...

The conversation continues like this for several more exchanges. You notice that it has been more than 8 or 9 minutes since you called Joe, so on the next break (BK) from him you go through a complete identification procedure:

WHAT YEAR FORD IS THAT? BK  
WB6XXX DE WB1XXX IT IS 1971  
YOU KNOW GOOD CURE FOR  
FLOODING CARB? BK  
WB1XXX DE WB6XXX NO NOT  
FOR TT YEAR BT MY 1955  
HAD A ...

You have satisfied the "end of a series of transmissions" part of the rules, and because he took the hint from you, Joe did the same. Of course at the end of the whole contact (QSO) you should both identify again.

The part of the rules about network or group identification is very nice. I can remember when a station signing out of a net or roundtable discussion had to give the call of every station in the group! It is no longer necessary to do that — you simply state the name of

the net, your call, and away you go. If the group is not an organized net with a name, then you can use the call of one of those you have been talking to as the one you are signing out with. This can be the "net control" station, or one who seems to be in charge of things. Those who are in the net or group must still identify



"Whose call do I use?"

every ten minutes. It might go like this:

"WD9ZZZ AND THE GROUP THIS  
IS WB1YYY ..."

### License availability

There are no tricks hidden in the language of this section. It states simply that you must have your original operators license with you when you operate an amateur station, and that it must be available upon demand if a representative of the FCC wants to see it. Amateurs who are invited to operate ARRL's Maxim Memorial Station, W1AW, are always asked to bring their *original* operators license along. This is so the control operator at that station can be sure of your license class and privileges before letting you at the key or microphone. It's his obligation as the control operator to do so. The *station-license* requirement is similar, but with a couple of important differences. The *original* station

license must be posted in a conspicuous place (that means where it can be seen) in your station, or you can keep it on your person (in a wallet or pocket). However, if you operate portable or mobile, you can have a *photocopy* of the license with the mobile station while the original stays at home. This provision keeps you from having to take the original license out of its frame and put it in your car every time you go anywhere, and it allows you to provide a guest mobile operator with proof that the station he is using is properly licensed. Also, if you are licensee of more than one station (maybe you have a remotely-controlled station, or are trustee of a club station) you can post the original at that remote location, and have a photocopy at your home or control point.

The important things to remember here are that the document which licenses you as an individual must stay with you if you expect to operate any place other than home; the one that licenses your station must stay with that station.

### Frequency measurement

Broadcast stations, commercial two-way radio services, television stations, and the like must all determine their transmitting frequency to a very precise degree, and maintain it within some very narrow tolerances. You, as an amateur, do not have to be that precise. You must be certain that you are within your authorized band or sub-band, and if you are operating close to the edge of that band, be aware of the accuracy of your measuring equipment and stay within the limits of that accuracy. The section of the FCC rules that governs frequency measurements is as follows:

#### 97.75 Frequency measurement and regular check.

The licensee of an amateur station shall provide for measurement of the emitted carrier frequency or frequencies

and shall establish procedure for making such measurement regularly. The measurement of the emitted carrier frequency or frequencies shall be made by means independent of the means used to control the radio frequency or frequencies generated by the transmitting apparatus and shall be of sufficient accuracy to assure operation within the amateur frequency band used.

In the early days of radio, you could check the wavelength of your transmitter by using a simple tuned circuit with a calibrated dial and an indicator, such as a small bulb or meter in series with the coil. As the radio spectrum became more crowded, the simple tuned circuit, or wavemeter, was no longer accurate enough. The amateur frequency segments were becoming more sharply defined and an amateur needed to know just where the limits of his band of frequencies were; this required a more sophisticated means of checking. Frequency standards were the usual piece of equipment that ruled the day, and many versions were described in amateur literature.

They were highly stable crystal-controlled oscillators, usually working at 100 kHz, and had good harmonic output so you could check frequencies every 100 kHz up as far as 30 MHz. A modernized version of this oscillator is still recommended to check your operating frequency. Many receivers or transceivers have them built in, under the name crystal calibrator, or simply calibrator. They are of sufficient accuracy to enable you to determine the safe limits of the band edge or segment, provided that you check them against WWV or another standard-frequency station on a regular basis.

It is not sufficient to use your station receiver alone to check your transmitter frequency, especially in the case where you have a transmitter separate from the receiver. A strong signal, such as you will

hear from your own transmitter, will cause several spurious signals to be generated right in the receiver itself. One of these could be fooling you into thinking it was the main signal, while in fact the actual transmitted energy was outside the band, or perhaps in a different part of the band, causing interference to someone.



"Amateurs cannot communicate with other services."

If your station does not have a crystal calibrator of some sort in it, by all means get one. There are several makes offered in the advertisement in most ham magazines, and some will operate for many months while powered by small batteries. A sample question for the frequency-checking part of the rules might go something like this:

The accuracy of measurement of your transmitter frequency shall be

- (a) 0.01%
- (b) sufficient to be sure that you are within the amateur band or segment
- (c) 0.5%
- (d) as stated by the manufacturer of the transmitter

The correct answer (b), is easy to live with as long as you know the limitations of your ability to read your dial or meter. If you cannot determine the frequency, as shown on a dial or digital readout, to better than 100 hertz, and if your crystal calibrator is no more stable than, say, 50 hertz, you have to allow for those uncertainties in your measurement system. The responsibility for determining the accuracy of

measurement is upon your shoulders.

### One-way transmissions

When the Amateur Radio Service was being established, and the rules for its operation were being put together, there was some concern that a few amateurs might want to use the frequencies for broadcasting purposes. The commercial broadcast stations wanted to protect their interests, and the people behind the amateur service wanted to protect their frequencies, so a provision prohibiting broadcasting (one-way transmissions) was included. Personally, I think this was a very wise decision — imagine having to wait through a couple of commercial messages while you wanted to work that choice bit of DX. Or the hard-to-get station in Idaho (which you need for WAS) was on only for the purpose of advertising potatoes!

Anyway, there had to be a prohibition against broadcasting, but there had to be some exceptions for emergency situations, code practice, or for radio control of models. Here is the text concerning one-way transmissions starting with an excerpt from section **97.89**:

(b) Amateur stations may be used for transmitting signals, or communications, or energy, to receiving apparatus for the measurement of emissions, temporary observation of transmission phenomena, radio control of remote objects, and similar experimental purposes and for the purposes set forth in **97.91**.

#### **97.91 One-way communications.**

In addition to the experimental one-way transmission permitted by **97.89**, the following kinds of one-way communications, addressed to amateur stations, are authorized and will not be construed as broadcasting:

- (a) Emergency communications, including bonafide emergency drill practice transmissions;
- (b) Information bulletins consisting solely of subject matter having direct interest to the amateur radio service as

## NEW FROM TEN-TEC



TRITON IV  
DIGITAL

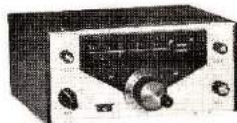

REMOTE VFO

The NEW Triton IV Digital Transceiver, Model 544, includes all of the fine qualities that Amateurs the world over have appreciated in the proven Triton IV PLUS a built-in digital readout. Visit us today (or call or write) for a description of the many superior features designed into Ten-Tec equipment. You have a friend at "Ham" Buerger.

Triton IV Digital .....\$869.00 list  
Triton IV ..... 699.00 list  
Remote VFO Model 242 ..... 169.00 list  
Argonaut, QRP Xcvr ..... 359.00 list  
CW Filter, Model 208 ..... 29.00 list

TODAY call or write for your very best deal on: Drake, Ten-Tec, Regency, Mosley, Hy-Gain, Telex, Wilson, Antenna Specialists, Rohm, Astatic and Amcomm.

"HAM" BUERGER, INC.

ELECTRONIC EQUIPMENT DISTRIBUTOR

WA3ZID 68 North York Rd.  
WB3GXP Willow Grove, Pa. 19090  
WB3HOF 215-659-5900



# you're carefree

## when you know you've got the very best!



## Larsen Kūlrod® antennas

Repeater or simplex, home station or mobile, 1 watt or 50 . . . what really counts is the intelligence that gets radiated. Jim Larsen, W7DZL found that out years ago when he was both hamming and running a two-way commercial shop. That's when he started working with mobile antennas . . . gain antennas that didn't waste power in useless heat. Today, thousands and thousands of Larsen Antennas are being used. We call it the Larsen Kūlrod® Antenna. Amateurs using them on 2 meters, on 450 and six call them **the antenna that lets you hear the difference.**

Larsen Kūlrod Antennas are available for every popular type of

**Illustrated . . . Larsen JM-150-K Kūlrod Antenna and mount for 2 meter band. Comes complete with coax, plug and all mounting hardware. Easy to follow instructions. Handles full 200 watts.**

mount. For those using a 3/4" hole in their vehicle we suggest the LM mount for fastest, easiest and most efficient attachment.

For the 3/8" hole advocates there's the JM mount . . . fully patented and the first real improvement in antenna attaching in 25 years.

And for the "no holes" gang there's the unbeatable MM-LM . . . the magnetic mount that defies all road speeds.

**Send today** for data sheets that give the full story on Larsen Kūlrod Antennas that let you hear the difference and give you carefree communications.

Dealer Inquiries Invited



## Larsen Antennas

11611 N.E. 50th Ave. • P.O. Box 1686 • Vancouver, WA 98663 • Phone: 206/573-2722  
In Canada write to: Canadian Larsen Electronics, Ltd.  
1340 Clark Drive • Vancouver, B.C. V5L 3K9 • Phone: 604/254-4936

® Kūlrod . . . a registered trademark of Larsen Electronics.

## 77/78 AMATEUR RADIO EQUIPMENT DIRECTORY



Here's everything you want to know about Amateur Radio Equipment. Featuring descriptions, specification, prices and pictures. A one stop buying and reference guide to all your amateur needs. The new 77/78 supplement (32 pages) updates the 1977 Edition and brings the total number of pages to 168 (2 volumes). Almost 100 manufacturers/distributors are included. Only \$3.50 (plus postage and handling) for both volumes! Send for your directory today! (The 77/78 supplement is available for \$1.00 postpaid if you have already purchased the 1977 Edition.)

KENGORE CORPORATION, Dept. A  
9 James Avenue  
Kendall Park, N. J. 08824

Please send the 1977/78 AMATEUR RADIO EQUIPMENT DIRECTORY (2 volumes). I'm enclosing \$3.75 (\$3.50 plus 25¢ postage and handling—U.S. only.) Canadian orders \$4.00, Foreign orders \$5.00 (air).

Name/Call \_\_\_\_\_

Address \_\_\_\_\_

City \_\_\_\_\_ State \_\_\_\_\_ Zip \_\_\_\_\_

such; (c) Round-table discussions or net-type operations where more than two amateur stations are in communication, each station taking a turn at transmitting to other station(s) of the group; and (d) Code practice transmissions intended for persons learning or improving proficiency in the International Morse Code.

In addition to the early fears about broadcasting and the possibility that broadcasters might want to use the amateur frequencies, there was a need to keep the amateur stations and the other services apart. Again, it is mostly a matter of protection. Ship-to-shore, point-to-point, land mobile (police, taxi, business radio), aircraft, all of these services had their place in the spectrum and had no business talking to amateurs, nor did the amateurs need to talk to them. All of the business-related radio services had plenty to do with their time, and to them, time is money. They just do not need the distraction and confusion that would result if an amateur station could talk to their operators. Thus the following section concerns amateur communication with stations in other services:

#### 97.89 Points of Communications.

(a) Amateur stations may communicate with:

(1) Other amateur stations, excepting those prohibited by Appendix 2.

(2) Stations in other services licensed by the Commission, and with U.S. Government stations for civil defense purposes in accordance with Subpart F of this part, in emergencies and, on a temporary basis, for test purposes.

(3) Any station which is authorized by the Commission to communicate with amateur stations.

(b) Amateur stations may be used for transmitting signals or communications, or energy, to receiving apparatus for the measurement of emissions, temporary observation of transmission phenomena, radio control or remote objects, and similar experimental purposes and for the purposes set forth in 97.91.

(c) [Reserved]

(d) Control stations and auxiliary link stations may not be used to communicate with any other station than those shown in the system network diagram.

### Radio phenomena — again

Okay, enough of the rules for a while. Let's get back to the radio phenomena explanation that I started last month.

As you recall, I showed how



"Imagine waiting through an Idaho potato commercial in your quest for Worked All States."

some signals were bent back to earth by an ionized layer, and that the density of that layer determined what frequency was bent (refracted, reflected), and what frequency was either absorbed or allowed to pass through into space.

There is likely to be a question on your examination that talks about *sky wave* and *ground wave*. This is tied directly into the ionosphere and the way a signal propagates. Any signal that arrives at your station by way of the reflective layers of the ionosphere is a sky wave; a signal that arrives directly, without reflection, is a ground wave. The a-m broadcast station that is located a few miles away from you is reaching you by ground wave — indeed, that type of coverage is what they use to serve the community that they are licensed for. When you hear a broadcast station from the other side of the country, the signal is arriving by reflection or refraction, and is a sky wave. It works the same way on the amateur bands. How do you tell the difference? By knowing what to expect, and by listening to the characteristics of the signal. If you have heard

an amateur signal many times, and he is always approximately the same strength, day or night, then he must be reaching you by ground wave and is not too far away — ground-wave signals follow a predictable rule of decreasing strength versus distance. However, if you hear an amateur signal that has a fading characteristic, and eventually disappears entirely, the station was some distance away and the signal was reflected to you — a sky wave. A little experience in listening, and studying the diagrams and propagation information in *Horizons* and other publications, and you'll be able to predict where you will be hearing signals from at any given time of day, or on a particular amateur band.

Let me take a moment here to talk about the terms reflected and refracted. Strictly speaking, a reflected wave is not the same as a refracted one. *Reflection* is what you see in a mirror, where the light from the subject bounces from the shiny surface and returns to you. *Refraction* means the rays are bent upon passing through an area of differing density. You will notice this effect when you have part of your arm or leg under water; it appears to bend at the point where it enters the water. This is because the light rays reaching your eye from the portion of your leg that is under water bends as it crosses the boundary between water and air. This bend displaces the image that you see.

In amateur radio circles the two terms are often interchanged. Fig. 1, page 54, in part 2 of this series, shows that the radio signal is actually refracted (bent) by passing through the ionized layers; if the frequency-to-ionization relationship is critical the signal will be bent enough to return to earth. It appears to the person on earth that it has been *reflected* from the ionosphere, and as far as the results are concerned, this

# henry radio

a name  
that says  
it all

For over 40 years...dedicated to amateur radio...to offering the finest products...to dependable service.

## TEMPO VHF/ ONE PLUS



The Tempo/ONE PLUS offers full 25 watt output or a selectable 3 to 15 watt low power output, remote tuning on the microphone, sideband operation with the SSB/ONE adapter, MARS operation capability, 5 KHz numerical LED, and all at a lower price than its time tested predecessor... the Tempo VHF ONE.

Full 2 meter coverage, 144 to 148 MHz for both transmit and receive • Full phase lock synthesized (PLL) • Automatic repeater split—selectable up or down • Two built-in programmable channels • All solid state • 800 Selectable receive frequencies with simplex and  $\pm 600$  KHz transmit frequencies for each receive channel.

Sold at Tempo dealers throughout the U.S. and abroad. Please call or write for further information.

The VHF/ONE PLUS...\$399.00 The SSB/ONE...\$199.00

## KENWOOD TS-700A



The promise of 2 meter operation...the Kenwood way. The TS-700A operates all modes: SSB (upper & lower) /FM/AM/CW and provides the dependability of solid state circuitry. Has tunable VFO and 4 MHz band coverage (144 to 148 MHz). Automatically switches transmit frequency 600 KHz for repeater operation. AC and DC capability through its built-in power supply. Outstanding frequency stability Complete with microphone and built-in speaker. . . . . \$599.00

## YAESU FT-221R

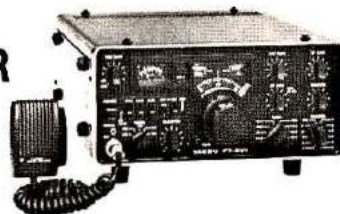

A compact, versatile transceiver designed for the active 2 meter enthusiast. Features all mode operation — SSB/FM/CW/AM — with repeater offset capability. Advanced phase lock loop circuitry, computer-type modular construction. Preset pass band tuning provides the optimum selectivity and performance needed on today's active 2 meter band. Complete 144-148 MHz coverage. Built-in AC and DC power supplies and speaker. . . . . \$595.00



## ICOM IC-211

ICOM's new fully synthesized 4 MHz FM, USB, LSB, CW 2 meter transceiver. 100 Hz or 5 KHz steps, with dual tracking, optically coupled VFO's displayed by seven-segment LED readouts. Features new styling, new versatility and a new approach to the integration of functions. A compact "do everything" radio for 2-meters. The IC-211 . . . . . \$749.00

Now,  
meet  
Henry  
Radio...



Walt Henry  
W6ZN  
ANAHEIM



Ted Henry  
W6UOU  
LOS ANGELES



Bob Henry  
WØARA  
BUTLER

Plus a large staff of highly qualified sales and service personnel pledged to serve you. Henry Radio carries large stocks of all major brands. We take trade-ins, sell used equipment and offer better terms because we carry our own financing. Our reconditioned equipment carries a 15 day trial, 90 day warranty and may be traded back within 90 days for full credit toward the purchase of new equipment. Export inquiries solicited. Also, military, commercial, industrial, and scientific users...please write for information on our custom line of high power linear amplifiers and RF power generators.

We stock the Bird Model 43 Wattmeter and accessories.

Prices subject to change without notice.

# Henry Radio

11240 W. Olympic Blvd., Los Angeles, Calif. 90064 213/477-6701  
931 N. Euclid, Anaheim, Calif. 92801 714/772-9200  
Butler, Missouri 64730 816/679-3127

is true. Refraction is more noticeable when amateurs talk through the OSCAR satellites a few minutes before the satellites are actually above the visual horizon; the ionosphere has bent (*refracted*) the radio waves enough to get them to the satellite when it was not in a line-of-sight position.

Of course, the activity of the sun has a lot to do with the distance and strength of the signals that you will be hearing, too. If you want to really get involved in the DX predicting game, you'll want to listen regularly to the Bureau of Standards station WWV on 2.5, 5, 10, or 15 MHz. They provide daily information about the solar activity and the effects that this activity has upon the ionosphere and magnetic field around the earth.

From time to time they will make announcements about solar storms in progress or expected. They give this warning so that people who must have communications for their business can plan ahead — set up alternative circuits for use in case their main one goes dead. Severe magnetic storms (solar flares, very high activity) can actually cause a communications blackout that extends from just above the broadcast band up to 30 or 40 MHz. When you experience one of these, you'll think your receiver just died. It can happen very fast — you'll be listening to another ham giving you a signal report and location, etc., and before he can finish, the whole band goes dead. It's a strange sensation to hear the radio "world" die like that!

I have covered a lot of territory in this installment, so here are some sample questions to sharpen you up a bit:

#### An amateur operator license

- (a) should be kept in the personal possession of the licensee
- (b) must be available for inspection by an FCC representative

(c) may be posted where it can be seen at a fixed location

(d) all of the above

A school club station in New Jersey wishes to set up a schedule with another club station in Colorado during their noon break. They should try

- (a) 40 meters
- (b) 80 meters
- (c) 15 meters
- (d) 160 meters

You should identify your station

- (a) on the hour and half hour
- (b) at the beginning and end of a series of transmissions, and at intervals not longer than 10 minutes
- (c) at least twice a day
- (d) none of the above

There is no way of guessing what subjects are going to be covered in the examination papers you will receive from the FCC, and there certainly will not be a question on every subject that we cover in the series, but you can sort of play a game with the study material by looking at a section or subject and try to find ways to ask questions about it. For example, suppose you were giving a test on the subject of station logs. Read the material and make up questions in the same style that the FCC does. Remember, they must be multiple choice (for ease in scoring them), and can be answered by checking only one box in answers column. A game like that will not only help you learn the material, but also will get you accustomed to the type of questions you will see on the exam sheet.

Now, to the answers to the questions I just gave you. The answer to the first one is (d), because all three answers are correct, and you can find them in the text of the rules section about *operator* license availability (97.83).

The second question takes a bit of thought, but you can reason it out in short order. Note that the time specified was noon, requiring a band that

provides daytime propagation, and that the distance was great enough to require skywave propagation. Recall that the lower bands (longer wavelengths) are absorbed during daylight hours, so 160, 80, and 40 meters are out. That leaves 15 meters as the correct answer (c). Twenty meters might be a good band also, but these questions are for the Novice class license, and there are no Novice privileges on that band. Therefore, I didn't include that band in the choices.

The answer to the third question is (b), but don't let the legal-sounding language and the length of the answer fool you — it is just possible that someone could word an incorrect answer so that it had the same style and language.

#### Next subject

We've gone through more of the Rules and Regulations section, finished off the radio phenomena subjects, and had a few sample questions to see if you are paying attention. Let's look at the next subject in the Study Guide: Operating Procedures.

There are three sub-sections here: Basic Principles, Telegraphy Procedures, and Public Service Operating. Much of the material in this section is not covered in the Rules and Regulations, but the FCC wants to know if you are prepared to operate in the amateur bands. It's sort of like visiting a foreign country; you should be able to use the native language well enough to survive before you go there. The longer you stay, the easier it will be for you to talk to people. Becoming a ham radio operator works like that; a little study will teach you enough of the basic language and courtesy and procedures so you can start. The longer you are at it, the more relaxed you will be in operating on the ham bands, and the more you will enjoy it.

Courtesy is, of course, an



important part of amateur radio operating. The courtesy and patience you need for hamming is the same as that you need for everyday life. You wouldn't walk up to two people on the street and break into their conversation, and the same applies to conversation (QSOs) you hear on the air. If you really want to join them, wait until the right moment, and then ask. This can be done during a break or during the procedure of turning it over to the other station. If they are busy, they'll ask you to wait; if not, they will invite you to join them.

In almost all parts of the great world of amateur radio courtesy and common sense will make life a lot easier for everyone. Of course there are the bad actors, the clods, who will try your patience, but you'll find them in other parts of life, too — amateur radio has no more and no less a percentage of them than the rest of the world has. If someone persists in ruining your party, just remember that it is supposed to be a relaxing, fun-type, hobby. If you get worked up over what the other guy is doing, then he is succeeding but you are not.

Then too, another ham may not realize that he is bothering someone. You can often hear two or three stations at the same time on the same frequency. The usual circumstance is that two of them are having a QSO, but because of propagation conditions, the third guy cannot hear either one of them. He is sure that the frequency is clear, and starts calling CQ, or tuning his rig (it's supposed to be done into a dummy load, though) or begins a QSO of his own. You, off to the side, can hear the whole thing, because you have good propagation conditions to all three of the stations, so it may sound to you as if the last guy in was being discourteous. Now, obviously, if you were to say, "I'll fix him — give him a dose of his own medicine," and jump in on top just to annoy

him, you would be bothering not only him, but the other two stations as well. Meantime, the first two are getting burned up because of all this commotion on top of *their* frequency. So, courtesy counts.

A couple of common-sense rules will help here. One is to always listen first before you call. A good way to start on a crowded band is to find what appears to be a clear spot, then send QRL? de WB1YYY (Are you busy?). If someone is listening to a station you cannot hear, he should reply "QRL (or QRM) pse QSX." Meaning "I am busy (or the frequency is in use) please move to another frequency." He might also send "QRM," which means that you are interfering with another station. You will hear a similar procedure used on the phone parts of the amateur bands, and it is the mark of an operator who is considerate of his fellow ham.

Well, that's enough for this time — I'll get into Q signals, beginning and ending signs, frequency selection and sharing, and avoiding interference, to finish up the operating procedures next time. And maybe, just maybe, I'll be able to get to the end of the Rules and Regulations portion. Then we can get into the really interesting parts, like Electrical Principles — and that's what makes the whole electronic world possible. **HRH**



"There, there, dear, of course he's not sending CW... After all it's just an old movie."

## 5 KW PEP INPUT

WITH THIS NEW BALUN

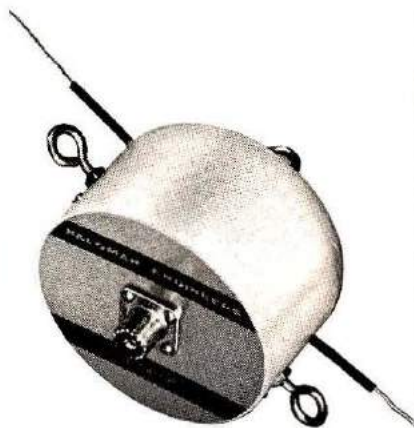

On all bands 160 to 10 meters.

Runs cool as a cucumber at its CCS rating of 2 KW (Continuous output power through the balun at matched load).

4" dia. Wt. 24 oz. \$32.50 PPD.

AND FOR FULL LEGAL POWER

the time tested Model 1K balun is still available. Rated at 1 KW CCS (3 KW PEP input).

2 1/2" dia. Wt. 9 oz. \$16.95 PPD.

ONLY PALOMAR BALUNS  
HAVE ALL THESE FEATURES

- Toroidal core for highest efficiency.
- Teflon insulated wire to prevent arc-over. OK for tuned feeders.
- Stainless steel eyebolts take antenna tension. Won't rust, won't pull apart.
- Epoxy filled case. Absolutely waterproof.
- Lightning protection built-in.
- Wideband 1.7 to 30 MHz.
- Hang-up hook provided.
- Now available in either 1:1 or 4:1 ratio. 1:1 ratio matches 50 or 75 ohm coax to 50 or 75 ohm balanced load (dipoles and inverted Vees). 4:1 ratio matches 50 or 75 ohm coax to 200 to 300 ohm balanced load.

Free descriptive brochure on request.  
Order direct.

Model 2K \$32.50 Model 1K \$16.95  
Center insulator without balun \$7.95

Postpaid U.S. & Canada.

Specify ratio 1:1 or 4:1

California residents add 6% tax.

Send check or money order to:

**PALOMAR  
ENGINEERS**

BOX 455, ESCONDIDO, CA 92025

Phone: (714) 747-3343

## PRODUCT

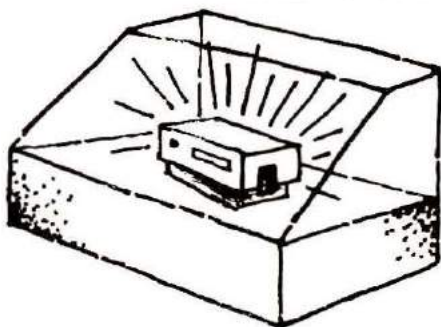

## SHOWCASE

### The French Atlantic Affair

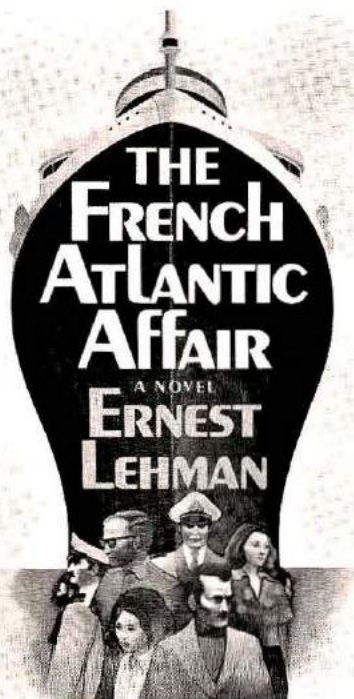

In the midst of so much mistaken publicity about Amateur Radio, wherein problems caused by CB stations are blamed on the ham by an uninformed press, it is refreshing to see a book that has amateur radio woven into the plot as one of the "good guys." Moreover, the book is not one that would normally rate just a casual glance and then be placed on the shelf.

*The French Atlantic Affair*, by Ernest Lehman, is a novel of such length that will keep the

average reader at it for several evenings, if he can force himself to put it down, or all night if he cannot. There is almost continuous action throughout the story, and the way author Lehman has brought amateur radio into focus early in the converging lives of the characters portrayed almost guarantees that it will play a significant part in the unfolding story.

Not that hams are all portrayed as knights in shining armor — their feet of clay are clearly evident so that the uninformed reader can see that they are ordinary human beings like everyone else. As such they have their hang-ups, problems, and families whose patience with this obsession wears thin at times. The attitudes and opinions about hams and their technical vices are all too familiar to many of us who have been the focal point of similar comments from friends and wives who are not completely dedicated to the hobby of chasing DX or burning the midnight hours away conversing with a stranger in a far corner of the land.

To an experienced amateur, it would seem that the author knows about ham radio from the inside — the equipment is real, the procedures are correct, the language is right, and the bands go dead at the right time; there is even the right kind of nit-wit who clobbers the frequency in the middle of an important exchange. To balance the scale against the baddies there is the good guy who provides a phone-patch across the continent to overcome the dead-band problem, and a very understanding ham on Long Island who cancels out of an important golf engagement to take part in the high drama.

The author *does* know about amateur radio — he is K6DXK, and has been as busy on the air as at the typewriter. The way he tells it, the time spent at the ham rig at times overshadowed the writing, so the book was somewhat of a combination of the two important factors in his life.

However, Lehman is definitely accustomed to writing top-grade material; he has written screen plays for several well-known films such as *West Side Story*, *The King and I*, and *Who's Afraid of Virginia Woolf*, and others. He has received six Writer's Guild awards and six Academy Award nominations.

*The French Atlantic Affair* was not written for hams alone — you don't pin your hopes of making a best seller on a potential audience of a few hundred thousand. The book is written to appeal to people who would be spellbound with such stories as *Hotel*, *Airport*, and *Where Eagles Dare*; it can be very favorably compared to these best sellers. The action is almost non-stop, and one segment builds suspense that is guaranteed to evoke interest in the next page or chapter — this reviewer suffered the consequences of lack of sleep all the next day because of the irresistible urge to see how things ended.

The plot involves desperate people, hijacking, ruthless murder, high suspense, exhilarating triumphs, computers and people in a nerve-grinding think-tank session, and through it all, some skillful radio amateurs try to provide hope and salvation for the doomed. There is also much man-and-woman action in the explicit manner of many contemporary novels, therefore the book is recommended for adult reading only.

While it is unlikely that any of you hams who read it will become heroes of the level attained by the operators involved in this story, you will be comforted to know that you are not alone in being a member of a group whose hobby, ability, and dedication is misunderstood and underrated.

Amateur radio plays a vital part in *The French Atlantic Affair*, and the resulting publicity should be most beneficial to our hobby and image. If the story makes it into a hit movie (the screen rights have been pur-

chased by MGM), that's all to the better.

*The French Atlantic Affair* has been selected by the Literary Guild and by the Playboy Book Club, and is being published by Atheneum Publishers; copies are available from Ham Radio's Communications Bookstore, Greenville, New Hampshire 03048; \$10.95 postpaid. Not recommended for young readers.

## Speech compressor



If you have been concerned about your transmitter's talk power, and haven't decided whether or not to use a speech compressor, you may be interested in Dynamic Electronics DE-120 Speech Compressor designed to shape the speech waveform for improved voice communications.

Amplitude compression is obtained by reducing the amplitude of large voice peaks while increasing the amplitude of small ones to effect a great increase in average talk power. In order to reduce transmitter strain the frequency response is limited to a range of approximately 300 to 1800 Hertz.

The output level of the DE-120 can be adjusted by means of a trim pot located on the circuit board, while the compression level is adjusted by means of a front panel control. With a high compression level setting, the peak output remains the same whether the operator whispers or shouts into the microphone, and maintains a 100% modulation level without overmodulation at all voice levels.

Power is supplied by an internal battery activated by the microphone push-to-talk switch, to minimize battery drain and

prolong battery life. The DE-120 is available for most standard microphone connectors (please specify when ordering) and is priced at \$49.95 plus \$2.00 shipping. For additional information, write Dynamic Electronics, Inc., Box 896, Hartselle, Alabama 35640, or use *ad check* on page 80.

## National Semiconductor CB Radio IC Brochure

A new booklet describing several components designed for use in Citizen's Band radio manufacture is now available from National Semiconductor

THIS YEAR . . .

## GET ON TOP WITH ALPHA

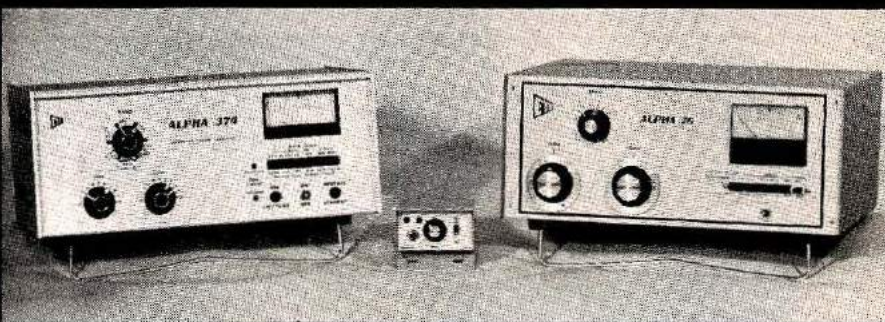

**A GREAT OPERATING YEAR IS STARTING RIGHT NOW.  
SUNSPOTS ARE UP — CONDITIONS SHOULD BE THE BEST IN YEARS.  
THOUSANDS OF ENTHUSIASTIC NEW AMATEURS ARE ON THE BANDS.  
HAMMING WILL BE TERRIFIC —  
BUT COMPETITION WILL BE ROUGH!**

### WHEN QRM RAGES AND THE PILE-UPS DEEPEN, WOULDN'T YOU LIKE TO HAVE . . .

- ALL THE ROCK-CRUSHING POWER YOUR LICENSE ALLOWS — on *all* modes — with no need to 'baby' your linear, no duty cycle or time limit at all?
- INSTANT BANDCHANGE 'NO-TUNE-UP' all the way from 10 through 80 meters, with the exclusive **ALPHA 374?**
- COVERAGE ALL THE WAY DOWN TO 160 METERS with the smooth-tuning, extra-rugged **ALPHA 76** powerhouse?
- CRISP, PENETRATING "TALK POWER" — as much as 10 dB extra to 'punch through' when the going gets really tough, with the **ALPHA/VOMAX** split band speech processor? It's as effective as the best rf processor, lower in distortion, and very easy to use with *any* rig!
- THE PROTECTION OF A FACTORY WARRANTY THAT RUNS A FULL 18 MONTHS — *six times as long* as competitive units? [ETO tries to build every ALPHA to last forever . . . and we're making progress: not one single case of ALPHA 76, 77D, or 374 power transformer failure has ever been reported!]
- THE PURE PLEASURE OF OWNING ALPHA?

### **ALPHA:** SURE YOU CAN BUY A CHEAPER LINEAR — BUT IS THAT *REALLY* WHAT YOU WANT?

START ENJOYING THE ALPHA EDGE NOW. Call or visit your nearest ALPHA/ETO dealer, or ETO direct, right away, and you can have prompt delivery of your new ALPHA linear amplifier and ALPHA/VOMAX processor. While you're at it, ask for illustrated literature describing all ALPHA products in detail, as well as a copy of "Everything You Always Wanted to Know About (Comparing) Linears . . . But Didn't Know Whom to Ask."



**EHRHORN TECHNOLOGICAL OPERATIONS, INC.**  
BOX 708, CANON CITY, CO 81212 (303) 275-1613

Corporation. It contains a description of products and options for CB radio manufacturers, which reflect National's sophisticated approach to electronic technology.

National began designing integrated circuits specifically for CB radios in 1975, and now offers a comprehensive selection of consumer-oriented CB

products. Each of five new IC devices replaces thirty or more components, reducing the part count and manufacturing cost. One of the ICs, a new microprocessor-controlled tuning system, is particularly designed to provide a wide range of user features.

The products described in the booklet include synthesizer sys-

tems, 5-pin audio amplifiers, microprocessor-controlled tuning systems, linear ICs, light emitting diodes (LEDs), clock modules, rf-output discrete components, and voltage regulators.

The booklet emphasizes that use of National's CB devices means maximum cost effectiveness, volume availability, and extensive application backup services to facilitate successful and speedy implementation of CB design. Titled *National Semiconductor Personal Communications: CB radio*, the booklet is available without charge from National Semiconductor Corp., 2900 Semiconductor Drive, Santa Clara, California 95051; or use *ad check* on page 80.

## QUALITY KENWOOD TRANSCEIVERS ... from KLAUS RADIO

The TS-820 is the rig that is the talk of the Ham Bands. Too many built-in features to list here. What a rig and only \$830.00 ppd. in U.S.A. Many accessories are also available to increase your operating pleasure and station versatility.



**TS-820  
160-10M TRANSCEIVER**

Super 2-meter operating capability is yours with this ultimate design. Operates all modes: SSB (upper & lower), FM, AM and CW. 4 MHz coverage (144 to 148 MHz). The combination of this unit's many exciting features with the quality & reliability that is inherent in Kenwood equipment is yours for only \$599.00 ppd. in U.S.A.



**TS-700A  
2M TRANSCEIVER**

Guess which transceiver has made the Kenwood name near and dear to Amateur operators, probably more than any other piece of equipment? That's right, the TS-520. Reliability is the name of this rig in capital letters. 80 thru 10 meters with many, many built-in features for only \$629.00 ppd. in U.S.A.



**TS-520  
80-10M TRANSCEIVER**

This brand new mobile transceiver (TR-7400A) with the astonishing price tag is causing quite a commotion. Two meters with 25W or 10W output (selectable), digital read-out, 144 through 148 MHz and 800 channels are some of the features that make this such a great buy at \$399.00 ppd. in U.S.A.



**TR-7400A  
2M MOBILE TRANSCEIVER**

Send SASE NOW for detailed info on these systems as well as on many other fine lines. Or, better still, visit our store Monday thru Friday from 8:00 a.m. thru 5:00 p.m. The Amateurs at Klaus Radio are here to assist you in the selection of the optimum unit to fulfill your needs.

# KLAUS RADIO Inc.

8400 N. Pioneer Parkway, Peoria, IL 61614  
Jim Plack W9NWE — Phone 309-691-4840

## Battery-check

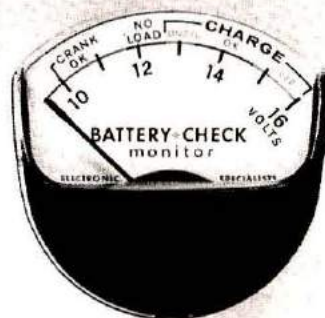

Enjoyable, trouble-free mobile operation requires vehicle batteries that are in topnotch condition. Battery-check continuously monitors the status of battery, charging system, and electrical loads. These top-quality, expanded-scale meters feature exceptional accuracy and reading ease, and are individually calibrated. Battery-check gives a warning indication of trouble allowing you to take early, money-saving corrective action. Available for 12, 24, and 28 volt systems. Price is \$39.95 postpaid for the panel-mount version. Other mounting styles are available. For more information write to Frank Stifter at Electronic Specialists, Box 122, Natick, Massachusetts 01760, or use *ad check* on page 80.

# Sooner or later . . .

## every Ham will probably own at least one

### Small size . . . giant performance

**TWO MODELS AVAILABLE:  
2.5 Watt MARK II and  
4 Watt MARK IV**

**SPECIFICATIONS:**

- Range: 144-148 MHz
- 6 Channel Operation
- Individual Trimmers on all TX and RX Xtals.
- Current Drain: RX 15 mA, TX - Mark II, 500 mA. Mark IV 900 mA
- 12 KHz Ceramic Filter
- 10.7 MHz and 455 kHz IF
- Spurious and Harmonics: 50 dB below carrier
- BNC (Twist type) Antenna Connector
- .3 Microvolt Sensitivity for 20 dB Quieting
- Uses special rechargeable Ni-Cad Battery Pack
- New improved Rubber Duck included
- One pair Xtals 52/52 included
- Weight: 16 oz. (.45 Kg) inc. batteries
- Size: 6" x 1.770" x 2.440"

**ACCESSORIES AVAILABLE**

Include LC-4 Leather Case, WC12 AC Wall Battery Charger, BC4 Desk Type Battery Charger, SM4 Speaker Mic, Touch Tone Pad, Tone Options.

# Wilson Hand-Held



The new arrivals to the Wilson family of quality high performing hand-held radios are the small American-made small sized MARK II and MARK IV. The ultimate hand-held for the amateur who demands quality, performance and value.

**FEATURES:**

- Lightweight and compact size - fits comfortably in the palm of your hand.
- Rugged Lexan® case.
- Same dependable performance as all Wilson Hand-Helds.
- Microswitch Speaker-Mic built in.

- Priced at

**\$199<sup>95</sup>** MARK II (2.5 watt)

**\$239<sup>95</sup>** MARK IV (4 watt)



Other Wilson units available are the VHF Models 1402SM, 2.5 watt, Model 1405SM Switchable 1 and 5 watt and 4502SM, 450 MHz, 2202SM, 220 MHz UHF units and Wilson's WE800 synthesized 2 meter portable rig.



FOR SIZE COMPARISON, THE NEW MARK IV IS ILLUSTRATED NEXT TO WILSON'S 1405SM SWITCHABLE 1 & 5 WATT RADIO.



**ATTENTION AMATEUR DEALERS:**

Wilson is accepting new dealers in many areas . . . contact us if you are interested.

For an illustrated Amateur Products Buyers Guide, write:  
**Wilson Electronics Corp.**

P.O. Box 19000 • Las Vegas, Nevada 89119 • (702) 739-1931 • TELEX 684-522



**Dear Horizons:**

Thank you for the sample copy of your new publication. After reading "The Far Horizon — An Evening of DX," and "Get on the Air on a Budget," I had to have my own subscription. "The Far Horizon — An Evening of DX," was written with such reality that I actually felt myself at the operating position of the rig working the DX mentioned. I believe your magazine is what we have needed for some time. I am looking forward to receiving it.

**O. T. Webb, Jr., K4ADT  
Morganton, North Carolina**

*We have more of the same on hand, and author W9KNI is still writing (and working DX). I asked Bob if he wasn't worried about the competition that he would be stirring up, to which he replied, "No, I figure I've a few years start on them!" Maybe we'll see your call in his stories sometime. Thank you for writing. Editor*

**Dear Horizons:**

I would kinda like to drop a few lines to say how good your *Horizons* magazine is. I am not a ham but an avid SWL. I hope this magazine will give me some much needed material and help for my ticket!

My old ham friend, K9STU, hasn't been on the air for some twenty years but the ham spirit is still there. He gave me his old receivers. This shows me that hams are really self sacrificing for the hobby as well as for those who are willing to join the ranks.

This is why I'm subscribing to your fine magazine that is written

for the non-hams too. I'll be looking forward to the next issue with confidence that it will broaden my horizons and may bring a laugh or two as well.

**William Marvin  
Superior, Wisconsin**

**Dear Horizons:**

In your "Not so Rocky Road from CB to Ham" article, in your very first issue, I would suggest that you correct the values of what little amount a ham rig can cost. A centibuck — never, a hectobuck — yes!

**Buck Table**

kilobuck =	\$1000.00
hectobuck =	100.00
decabuck =	10.00
buck =	1.00
decibuck =	.1
centibuck =	.01
millibuck =	.001

If you are to change to the metric system please start right. Hi!

Please enter me for a 3-year subscription.

**Dave Douglas, WB5BAY  
New Orleans, Louisiana**

*Dave, would you believe that we were trying to beat the pain of inflation by driving the cost down? Didn't think so. Thanks for your letter, and I'll write on the blackboard one hectotimes . . .*  
**Editor**

**Dear Horizons:**

Your short story, "The Call From Cedro Canyon," emphasizes the use of QRRR as the amateur's call for help. Although originally used by ships on the sea, SOS is universally understood by everyone, amateurs or otherwise, as a distress signal. It is also much shorter to send SOS than QRRR. I doubt that the greater majority of amateurs know what QRRR means.

Would it not be more practical and effective to forget the QRRR and stick with SOS?

**M. Michael Dorr, WB9WCR  
Palatine, Illinois**

*You are correct, Michael, in stating that SOS would be more practical and effective. I did some digging into the QRRR emergency call, and found that at one time the signal QRR was used by amateurs to some*

*extent. It was acquired by another service and used for a non-emergency operating signal, so the Amateurs attempted to salvage some of the use by adding another R to the call. However, the QRRR call has been discontinued because of lack of interest or use. The Morse Code call SOS, and the voice call MAY-DAY are in current use for emergency situations.*

**Editor**

**Dear Horizons:**

Congratulations on the fine, new magazine. I'm glad to be a charter subscriber.

The article in the May issue on transmission lines by W1HR was most interesting and answered some questions for me. One question that was not touched, however, concerns the braid covering on coaxial cable — more specifically, the amount of braid. At one time RG-8/U was built to military specifications so the amount of braid coverage was stipulated. Is that still true? It seems to me that the braid on some coaxial cable is becoming more and more skimpy.

Also, I was surprised to see that the losses of polyfoam coax are very similar to those of solid polyethylene. Is this really true?

**Raymond Brock, WA1WIP  
Madison, Connecticut**

*Cable loss is a direct function of the insulating material, and since polyfoam consists of foamed polyethylene, the small difference in loss is accurate. Manufacturers advertise polyfoam as low loss, but the actual difference between polyfoam and solid polyethylene cables is insignificant.*

*Although some manufacturers still build RG-8/U to military specifications, other manufacturers do not. In many cases, in fact, you'll find coax advertised as RG-8 "type." This is a euphemism for coax which doesn't meet military requirements. The price of copper has increased in recent years, and rather than increase the cost of cable, some manufacturers have simply reduced braid coverage. To make sure you're getting good braid, select RG-213/U when you want 50-ohm coax. An additional benefit of RG-213/U is that it has a non-contaminating outer jacket.*  
**Editor**

# MORSE CODE COURSES

INCLUDES SPECIAL PREP FOR THE NEW COMPREHENSIVE CODE EXAM

*Specially Designed for Beginners*

OUR 2 NOVICE COURSES TAKE YOU FROM DAY 1 (NO KNOWLEDGE OF ANY CODE) THRU 6 OR 8 WORDS PER MINUTE.

## NO CLASSES - LEARN AT HOME

THIS NEW METHOD SUCCESSFULLY USED BY PEOPLE FROM 10 THRU 65 YEARS OLD. INCLUDES EXCLUSIVE NOVICE TRAINING SCHEDULE ALL REFERENCE MATERIALS, CHECKING SHEETS TO VERIFY ACCURACY, INFO ON OTHER HAM LICENSE REQUIREMENTS.

STANDARD 2 TRACK MONAURAL CASSETTES PROVIDE 60 MINUTES EACH OF SCIENTIFICALLY PREPARED CODE PRACTICE (LETTERS, NUMBERS, PUNCTUATION, CODE GROUPS, WORDS) CASSETTES ARE DESIGNED TO MINIMIZE LEARNING PLATEAUS, EMPHASIZE NEW MATERIAL

SET 1	0-6 WPM (Novice License)	6 CASSETTES	\$15.95
SET 2	0-8 WPM (Novice License)	7 CASSETTES	17.95
SET 3	7-14 WPM (General Class License)	3 CASSETTES	8.95
	First class postage required per CASSETTE		0.40

**SPECIALISTS** - OUR ONLY PRODUCTS ARE TAPE COURSES  
**THE HERRMAN CO.**  
 DEPT J, BOX 1101, LARGO, FLA. 33540

**CLUBS - GROUPS** ANY 10 OR MORE SETS  
 5% OFF + 25¢ PER CASSETTE 1st CLASS SHIPPING



76th Edition

**ARRL Radio Amateur's LICENSE MANUAL**

Just released! Brand new completely restyled, rewritten and updated version of the popular ARRL License Manual. New 8 1/2" x 11" format - over 3 times more copy than 75th edition.

Now written in a conversation style with multiple choice questions similar to FCC exam for Tech, General, Advanced and Extra. Study guide provided for Novice. Most up-to-date compilation of rules and regulations - a must for every active Amateur.

Order AR-LG2 **\$3.00**

ham radio's bookstore  
**hrc** communications

GREENVILLE, NH 03048

# the famous HAM KEYS



The keys that are easy to put your fingers on!

JUST DIAL  
**1-800-325-3636**  
 TOLL FREE

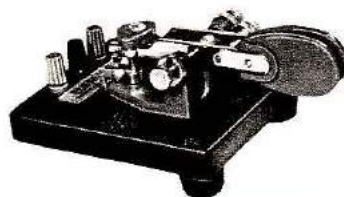

### Model HK-1

- Dual-lever squeeze paddle
- Use with HK-5 or any electronic keyer
- Heavy base with non-slip rubber feet
- Paddles reversible for wide- or close-finger spacing

**\$29<sup>95</sup>**

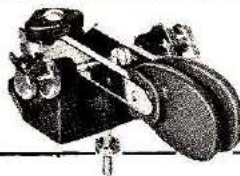

### Model HK-2

- Same as HK-1, less base for incorporation in own keyer

**\$19<sup>95</sup>**



### Model HK-3

- Deluxe straight key
- Heavy base... no need to attach to desk
- Velvet smooth action

**\$16<sup>95</sup>**

### Model HK-3A

- Same as above less base \$9.95

Navy type knob, only \$2.75

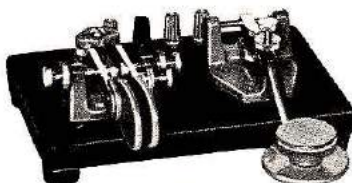

### Model HK-4

- Combination of HK-1 and HK-3 on same base

**\$44<sup>95</sup>**

- Base only with rubber feet \$12.00

Terminals, red or black, \$ .75 each



### Model HK-5 Electronic Keyer

- Iambic Circuit for squeeze keying
- Self-completing dots and dashes
- Dot memory
- Battery operated with provision for external power

**\$69<sup>95</sup>**

- Built-in side-tone monitor
- Speed, volume, tone and weight controls
- Grid block or direct keying
- For use with external paddle, such as HK-1

Same day shipment... PREPAID

We welcome the use of your



## HAM RADIO CENTER, INC.

8340-42 Olive Blvd. • P.O. Box 28271 • St. Louis, MO 63132

# 2 METER FM

and HF too . . .

SATELLITE  
HEADQUARTERS

See Erickson  
for all of your  
Oscar  
communications  
needs!



Call or Write for  
Erickson's Deal

- Ameco • ASP • Atlas
- Belden • Bird • CDE
- CES • Collins • Cushcraft
- Dentron • Drake • HAL
- Hy-Gain • Icom • KLM
- Kenwood • Larsen • MFJ
- Midland • Mosley • NPC
- Newtronics • Nye
- Regency • Shure • Swan
- Standard • TPL • Tempo
- Ten-Tec • Wilson • Yaesu



Hours: 9:30-9 Mon. & Thurs,  
9:30-5:30 Tues, Wed. & Fri.  
9-3 Sat.



**E** ERICKSON  
COMMUNICATIONS  
5935 N. Milwaukee Ave.  
Chicago, IL 60646  
(312) 631-5181

## DX forecaster

### November, 1977

November is contest month, with the second (CW) section of CQ's Worldwide DX Contest taking place on November 26 and 27, and the ARRL Sweepstakes on November 5 and 6 (CW), and November 19 and 20 (Phone).

Sunspot Cycle 21 is really on the upswing now, and its beneficial effects will combine with the normal seasonal increase in propagation to provide good-to-excellent DX conditions during much of the month.

*Ten and Fifteen meters* are expected to provide good DX possibilities during the daylight hours, with *ten* showing its best form around local midday, and *fifteen* being good substantially all day. Central and South American DX should be commonplace on both bands while, on good days, openings to Europe and Africa may be expected during the early forenoon hours. Openings to the Pacific and Far East should be present during the local late-afternoon hours on good days.

*Twenty meters* is always the DXer's workhorse, and will be open most days from sunrise until sunset and later, local time, to various areas of the globe. Use the chart on the facing page for where and when.

*Forty meters* will offer signals from Europe, beginning in the late afternoon hours, and the band will remain open all night until after sunrise. For best reception of DX to the south and east of your location, listen from early evening until about 2 AM; for DX to the north and west of your location, listen from about 2 AM until after sunrise.

*Eighty meters* is an excellent DX band during the fall and winter, so be sure to have your antennas ready to go before the bad weather sets in. You'll find signals from Europe and Africa coming in best around midnight, from Central and South America between midnight and sunrise, and from the South Pacific and Far East just before sunrise.

*One-Sixty meters*, although an excellent winter-time band, will begin to slump for DXers as the effects of sunspot cycle 21 become more prominent. However, there will still be a lot of DX activity for the next year or two on this band. Be alert for DX when the path between you and the area of the world you want to work lies in darkness, with the sun beginning to rise at the eastern end of the path. A set of sunset and sunrise tables is of great help to the top-band DXer.\*

*Special Notice.* The period between November 3rd and 11th is expected to be disturbed ionospherically, with the peak expected on the 9th and 10th. Unusual weather conditions may coincide or shortly follow, lasting through the 13th. A minor disturbance is expected on the 16th or 17th, with unusual weather conditions following by a day or two. In general, the first two weeks of the month may be disturbed, and the last two weeks will be relatively quiet.

\**The American Ephemeris and Nautical Almanac, 1977*, available for \$10.30 from the US Government Printing Office, Washington, DC.

†ON4UN's sunrise/sunset booklet is available for \$10 from John A. Devoldere, ON4UN, Poelstraat 215, 9220 Merelbeke, Belgium. Send name, address, and QTH coordinate, for a personal computer print out for your own location.



**WESTERN USA**



**MID USA**

**EASTERN USA**

GMT	WESTERN USA										MID USA										EASTERN USA											
	PST	CENTRAL ASIA	EUROPE	S. AFRICA	S. AMERICA	ANTARCTICA	NEW ZEALAND	W. AUSTRALIA	OCEANIA	FAR EAST	MST	CENTRAL ASIA	EUROPE	S. AFRICA	S. AMERICA	ANTARCTICA	NEW ZEALAND	W. AUSTRALIA	OCEANIA	FAR EAST	CST	CENTRAL ASIA	EUROPE	S. AFRICA	S. AMERICA	ANTARCTICA	NEW ZEALAND	W. AUSTRALIA	OCEANIA	FAR EAST	EST	
0000	15	15	20	20	15	15	15	15	15	15	5:00	15	20	15	15	15	15	15	15	15	6:00	15	40	40	40	40	40	40	40	40	7:00	
0100	20*	20*	20	20	20	20	20	20	20	20	6:00	15	40	15	15	15	15	15	15	20*	7:00	20	40	40	40	40	40	40	40	40	8:00	
0200	20*	20*	20	20	20	20	20	20	20	20	7:00	40	40	40	40	40	40	40	40	20*	8:00	20	80*	40	40	40	40	40	40	40	40	9:00
0300	40	80	80*	40	20	20	20	20	20	20	8:00	20	80*	40	20	20	20	20	20	20	9:00	20	80*	40	40	40	40	40	40	40	40	10:00
0400	40	40	40	40	20	20	20	20	20	20	9:00	20	80*	40	20	20	20	20	20	20	10:00	80*	80*	80	80*	80*	80*	80*	80*	80*	80*	11:00
0500	40	40	40	40	20	20	20	20	20	20	10:00	80*	80*	80*	80*	80*	80*	80*	80*	80*	11:00	80*	80*	80*	80*	80*	80*	80*	80*	80*	80*	12:00
0600	40	40	40	40	20	20	20	20	20	20	11:00	80*	80*	80*	80*	80*	80*	80*	80*	80*	12:00	80*	80*	80*	80*	80*	80*	80*	80*	80*	80*	1:00
0700	40	40	40	40	20	20	20	20	20	20	12:00	80	80	80*	80*	80*	80*	80*	80*	80*	1:00	80*	80*	80*	80*	80*	80*	80*	80*	80*	80*	2:00
0800	40	40	40	40	20	20	20	20	20	20	1:00	80	80	80*	80*	80*	80*	80*	80*	80*	2:00	80	80	80*	80*	80*	80*	80*	80*	80*	80*	3:00
0900	40	40	40	40	20	20	20	20	20	20	2:00	80	80	80*	80*	80*	80*	80*	80*	80*	3:00	80	80	80*	80*	80*	80*	80*	80*	80*	80*	4:00
1000	40	40	40	40	20	20	20	20	20	20	3:00	80	80	80*	80*	80*	80*	80*	80*	80*	4:00	80	80	80*	80*	80*	80*	80*	80*	80*	80*	5:00
1100	40	40	40	40	20	20	20	20	20	20	4:00	40	40	40	40	40	40	40	40	40	5:00	40	40	40	40	40	40	40	40	40	40	6:00
1200	40	40	40	40	20	20	20	20	20	20	5:00	40	40	40	40	40	40	40	40	40	6:00	40	40	40	40	40	40	40	40	40	40	7:00
1300	40	40	40	40	20	20	20	20	20	20	6:00	40	40	40	40	40	40	40	40	40	7:00	40	40	40	40	40	40	40	40	40	40	8:00
1400	80*	80*	20	20	20	20	20	20	20	20	7:00	20	20	20	20	20	20	20	20	20	8:00	20	20	20	20	20	20	20	20	20	20	9:00
1500	80*	80*	20	20	20	20	20	20	20	20	8:00	20	20	20	20	20	20	20	20	20	9:00	20	20	20	20	20	20	20	20	20	20	10:00
1600	40	15	20	10	20	20	20	20	20	20	9:00	20	15	15	15	15	15	15	15	15	10:00	20	15	15	15	15	15	15	15	15	15	11:00
1700	40	15	20	10	20	20	20	20	20	20	10:00	20	15	15	15	15	15	15	15	15	11:00	20	15	15	15	15	15	15	15	15	15	12:00
1800	15	15	15	10	20	20	20	20	20	20	11:00	20	15	15	15	15	15	15	15	15	12:00	20	15	15	15	15	15	15	15	15	15	1:00
1900	20	20	20	10	20	20	20	20	20	20	12:00	20	15	15	15	15	15	15	15	15	1:00	20	15	15	15	15	15	15	15	15	15	2:00
2000	20	20	20	10	20	20	20	20	20	20	1:00	20	15	15	15	15	15	15	15	15	2:00	20	15	15	15	15	15	15	15	15	15	3:00
2100	15	15	20	10	15	15	15	15	15	15	2:00	20	20	15	15	15	15	15	15	15	3:00	15	15	15	15	15	15	15	15	15	4:00	
2200	15	15	20	10	15	15	15	15	15	15	3:00	20	20	15	15	15	15	15	15	15	4:00	15	15	15	15	15	15	15	15	15	5:00	
2300	15	15	20	10	15	15	15	15	15	15	4:00	20	20	15	15	15	15	15	15	15	5:00	15	15	15	15	15	15	15	15	15	6:00	

# HAM CALENDAR

# November 1977

SUNDAY	MONDAY	TUESDAY	WEDNESDAY	THURSDAY	FRIDAY	SATURDAY
 <p><b>HAWAII WEEK</b> See November 4th</p> <p>*All international events such as contests are shown on the GMT days on which they take place even though they may actually begin on the evening of the preceding day in North America</p>	<p>*All international events such as contests are shown on the GMT days on which they take place even though they may actually begin on the evening of the preceding day in North America</p> <p>WEST COAST BULLETIN Edited &amp; Transmitted by W6ZF — 8PM PST 3:40 KCS, A-1, 72 WPM</p>	<p>AMSAT Eastcoast Net 3850 kHz 8PM EST (10:00Z Wednesday Morning)</p> <p>AMSAT Mid Continent Net 3850 kHz 8PM CST (0200Z Wednesday Morning)</p> <p>AMSAT Westcoast Net 3850 kHz 7PM PST (0300Z Wednesday Morning)</p> <p>West Coast Qualifying Run</p>		<p>YI RU Anniversary Phone Party — 3-4</p>	<p><b>SAROC</b></p> <p>SAROC HAWAII WEEK — 4-11 Hyatt Kaimana Resort Hotel and Country Club on Dana's Narrows Shore — Info, SAROC, Box 91-5, Balauser City, Nevada 89005</p> <p>Electronic Center, Inc. Birthday Party — 2825 N. Haskell — Buda, Texas — 4-5</p>	<p>ARRL CW Sweepstakes — 4-6 RSGB 7 MHz CW Contest — 5-6</p>
6	7	8	9	10	11	12
13	14	15	16	17	18	19
20	21	22	23	24	25	26
 <p>See Nov 1, 5, 7, 12, 16, 19, 21, 26</p>	<p>WEST COAST BULLETIN Edited &amp; Transmitted by W6ZF — 8PM PST 3:40 KCS, A-1, 72 WPM</p>	<p>AMSAT Eastcoast Net 3850 kHz 8PM EST (10:00Z Wednesday Morning)</p> <p>AMSAT Mid Continent Net 3850 kHz 8PM CST (0200Z Wednesday Morning)</p> <p>AMSAT Westcoast Net 3850 kHz 7PM PST (0300Z Wednesday Morning)</p>	<p>WYAW Qualifying Run</p>	<p><b>Thanksgiving</b></p> 	<p>CO WW DX CW Contest — 26-27</p>	<p>ARRL Phone Sweepstakes — 19-20 Honeywell 1200 Radio Ham Auction — in the cafeteria at Honeywell Information Systems — 300 Concord Road — Billerica, MA (off Route 3 at exit 27) — noon to 5PM WWDK &amp; International CW Contest — 0003Z 11/19-2400Z 11/20* OBJECTIVE: To conduct as many amateur radio stations in as many ITU zones and sub-zones as possible. List countries using all available frequencies. (FREQ) (KCS, A-1, 72 WPM) 1 MHz to 25 GHz, including transmitters and receivers of amateur satellites. SASE for info. Frank Jerome, W5AT, 908 Holloway, Mowest City, OK USA 73110 ARRL Florida Gulf Coast Convention — By the Florida Gulf Coast ARC — Clearwater Beach, FL — 19-20</p>
27	28	29	30			

\*The International Police Association (IPA) is organizing a contest which will enable participants to work the SHERLOCK HOLMES ARABO (SHA). The contest is open to all radio amateurs and SWLs. Contest dates: 0800-1000Z, 3-1400Z, 11/17-18 — 0800-1000Z, 11/19-20. CW, SSB, RTTY, Morse. Contest dates: 2400Z-2600Z, 11/24-25. CW, SSB, RTTY, Morse. For more details, rules, SASE, member dir. list, etc. send SASE to: Vance Gambino, W94040, 7686 Kingsbury Road, Alexandria, VA 22310.

\*\*Delaware QSO Party — By the Delaware ARC — 0001-0600Z & 1600-2200Z 11/12 — 0001-0600Z & 1600-2200Z 11/13. Stations may be worked once per band, per mode, for QSO points. EXCHANGE QSO 10. RS(T) and DTI. SCORING: Delaware stations score 1 point for each QSO. Multiply total by number of ARRL sections and DX countries worked. Others get 5 points for each Delaware contact. Multiply total by 1 if one Delaware country is worked, by 3 if two countries, and by 5 if all three countries are worked (then, Lucie, Karl & Susan). FREQUENCIES: CW — 3350, 7060, 14000, 21300, 21130, 21120, 29160, 5355, Dec. 31 to John R. Cox, K3VHR, 11 Southside Drive, Newark, DE 19113.

## CFP . . . FOR ALL YOUR AMATEUR NEEDS



YAESU FT-101EE

ORDER TODAY! Write or  
Call WA2KTJ, WB2LVW

CUSHCRAFT      ATLAS  
CIR (Astro 200)    TEMPO  
DENTRON          TEN TEC  
DRAKE             YAESU\*

\*Remember, we take care of your warranty repairs during warranty for Yaesu.

Transmitter sales to licensed amateurs only.

**WANTED:** Good clean trades!

Mail Orders accepted. N. Y. residents add sales tax. SASE will get our list of used Amateur Equipment.

### CFP COMMUNICATIONS

211 NORTH MAIN STREET  
HORSEHEADS, N. Y. 14845  
PHONE: 607-739-0187

STORE HOURS: Tues. to Fri. 10-6. Sat. 10-4  
subject to Hamfests. Closed Sun. and Mon.

## MADISON

### SUPER STATION BUYS

HY GAIN 18AVT/WB + 100 ft. R8B coax . . . \$100. 18V vertical . . . \$19.95. Model 214 2m Yagi . . . \$21.50  
VHF SPECIAL: Kenwood TS-700A List . . . \$599      Call for quote  
KLM: Antennas, Linears, Accessories in Stock. FREE balun w/2m base antenna.  
ROTORS: NEW HAM X (turns 28 sq. ft. of antenna) List . . . \$325    Order now for \$289.  
KLM KR400 Rotor . . . \$85.00. CDE Big Talk Rotor . . . \$79.00. CDE HAM-II . . . \$129.00

WE STOCK JANEL PREAMPS, TECHNICAL BOOKS (ARRL, Sams, Tab, TI, RCA & more).

BIRD 43 WATTMETER & slugs. TELEX HEADSETS.

SWAN: WM 6200 VHF Wattmeter . . . \$49.95  
SWR 1A Meter      \$21.95

CETRON 572B tubes      \$24.95 ea.

KESTER Solder 1#60/40, .062      \$6.50

NYLON CORD 5000 ft. + per roll      \$15.00

BELDEN 14 gauge copper stranded antenna wire      \$5.00/100 ft.

R8B foam Xtra-Flex coax      23¢ ft.

R8B foam Superflex coax      23¢ ft.

22 gauge plastic covered for long wire, radials      \$3.50/1000 ft.

**CALL FOR FAST QUOTE ON THESE OR ITEMS NOT LISTED: YAESU FT301D, FT301, FT101E, ATLAS 350XL, KENWOOD TS520S, TS600A, TR7400A, TEMPO 2020 & ETO ALPHA. CALL FOR FAST QUOTE OR WRITE & INCLUDE YOUR PHONE NUMBER. IF WE HAVE YOUR BARGAIN, WE'LL CALL YOU.**

**TERMS:** All prices FOB Houston. Prices subject to change without notice. All Items Guaranteed. Some items subject to prior sale. Send letterhead for Amateur dealers price list. Texas residents add 5% tax. Please add postage estimate, excess refunded.

**MADISON  
ELECTRONICS SUPPLY, INC.**

1508 McKinney      Houston, Texas 77002  
713/658-0268      Nites 713/497-5683

# VLF CONVERTER

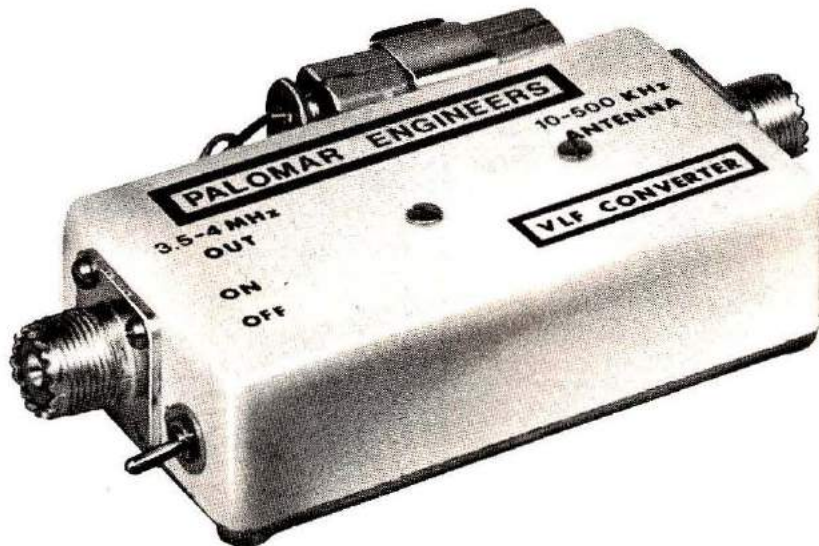

- New device opens up the world of Very Low Frequency radio.
- Gives reception of the 1750 meter band at 160-190 KHz where transmitters of one watt power can be operated without FCC license.
- Also covers the navigation radiobeacon band, standard frequency broadcasts, ship-to-shore communications, and the European low frequency broadcast band.

The converter moves all these signals to the 80 meter amateur band where they can be tuned in on an ordinary shortwave receiver.

The converter is simple to use and has no tuning adjustments. Tuning of VLF signals is done entirely by the receiver which picks up 10 KHz signals at 3510 KHz, 100 KHz signals at 3600 KHz, 500 KHz signals at 4000 KHz.

The VLF converter has crystal control for accurate frequency conversion, a low noise rf amplifier for high sensitivity, and a multipole filter to cut broadcast and 80 meter interference.

All this performance is packed into a small 3" x 1 1/2" x 6" die cast aluminum case with UHF (SO-239) connectors.

The unique Palomar Engineers circuit eliminates the complex bandswitching and tuning adjustments usually found in VLF converters. Free descriptive brochure sent on request.

Order direct. VLF Converter \$55.00 postpaid in U.S. and Canada. California residents add sales tax.

**Explore the interesting world of VLF. Order your converter today! Send check or money order to:**

## PALOMAR ENGINEERS

P.O. Box 455, ESCONDIDO, CA. 92025 — Phone [714] 747-3343

# NEW! IC KEYER

The World's Greatest  
Sending Device

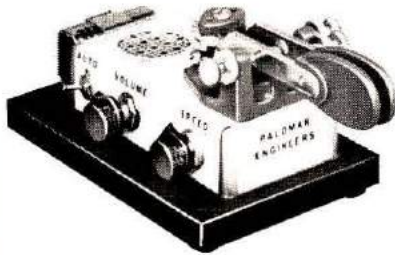

Adjustable to Any  
Desired Speed

Now available from Palomar Engineers — the new Electronic IC KEYER. Highly prized by professional operators because it is **EASIER, QUICKER, and MORE ACCURATE.**

It transmits with amazing ease **CLEAR, CLEAN-CUT** signals at any desired speed. Saves the arm. Prevents cramp, and enables anyone to send with the skill of an expert.

► SPECIAL  
RADIO MODEL ◀

Equipped with large specially constructed contact points. Keys any amateur transmitter with ease. Sends Manual, Semi-Automatic, Full Automatic, Dot Memory, Squeeze, and Iambic — **MORE FEATURES** than any other keyer. Has built-in sidetone, speaker, speed and volume controls, **BATTERY OPERATED**, heavy shielded die-cast metal case. **FULLY ADJUSTABLE** contact spacing and paddle tension. The perfect paddle touch will **AMAZE** you.

Every amateur and licensed operator should know how to send with the IC KEYER. **EASY TO LEARN.** Sent anywhere on receipt of price. Free brochure sent on request.

Send check or money order. IC KEYER \$97.50 postpaid in U.S. and Canada. IC KEYER LESS PADDLE and non-skid base \$67.50. Add 6% sales tax in California.

Italy write i2VTT, P.O. Box 37, 22063 Cantu.

Fully guaranteed by the world's oldest manufacturer of electronic keys. **ORDER YOURS NOW!**

## PALOMAR ENGINEERS

BOX 455, ESCONDIDO, CA 92025  
Phone: (714) 747-3343

# This is easy- anyone can solder- WITH KESTER SOLDER

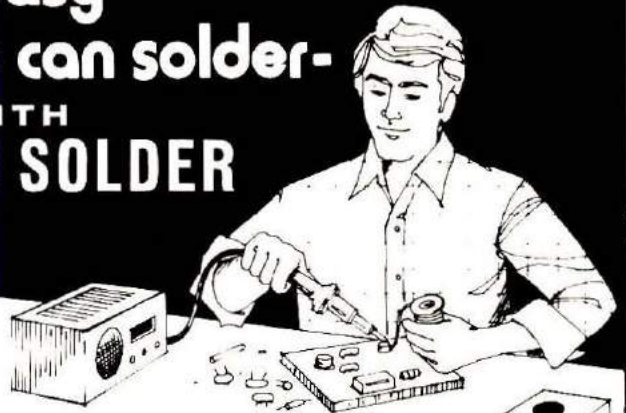

## Handymen! Hobbyists! DO-IT-YOURSELFERS!

Let Kester Solder aid you in your home repairs or hobbies. For that household item that needs repairing — a radio, TV, model train, jewelry, appliances, minor electrical repairs, plumbing, etc. — Save money — repair it yourself. Soldering with Kester is a simple, inexpensive way to permanently join two metals.

When you Solder go "First Class" — use Kester Solder.

For valuable soldering information send self-addressed stamped envelope to Kester for a FREE Copy of "Soldering Simplified".



**KESTER SOLDER**

Litton 4201 WRIGHTWOOD AVENUE/CHICAGO, ILLINOIS 60639

# AMATEUR PRODUCTS GALORE!

## YAESU

FT-301D all solid-state transceiver; 160-10 meters; AM, CW, SSB, FSK; 200 watts PEP input on SSB, 200 watts DC input on CW, and 50 watts DC input on AM or FSK; features 100-Hz frequency stability, 6-digit LED frequency display; tailored audio response, 0.25  $\mu$  sensitivity, variable selectivity from 0.6 to 12 kHz, requires only 13.5-volts DC power source; matching AC supply and speaker available.

## YAESU



FT-101E TRANSCEIVER

Popular? I guess! Over 200,000 units of this FT-101 series are in service around the world. 10 thru 160M, SSB, CW, AM, built-in WWV reception, solid state, RF speech processor, VOX, AC or DC operation are some of the many reasons for this rig's popularity. We'll be happy to discuss the many fine features of the FT-101E with you today.

## KENWOOD

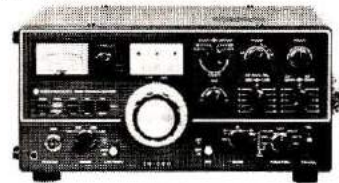

TS-520S  
160-10M TRANSCEIVER

Ask around about Kenwood's TS-520. It's in constant use around the globe and has a record of reliability that is universally admired. USB, LSB, CW, operates AC or DC, WWV receiver, RIT, VOX and noise blanker are some features that make the TS-520 a very welcome companion in your shack.

Also, come in and ask about the **NEW** Kenwood TS-820 that has all of the great features found in the TS-520 plus so many truly unique operating advantages that it is the Pacesetter of the industry.

## KENWOOD

TR-7400A two-meter FM transceiver covers 144-148 MHz in 5-kHz steps, selectable simplex and 600-kHz offset; PLL circuitry with unlock protection; LED digital frequency display; CTCSS encode-decode, plus tone-burst; MOSFET with helical resonators, plus 2-pole 10.7-kHz crystal IF filter for superior sensitivity and selectivity, and much more. Write today for details and price.

Call or visit with us today for assistance in selecting the Amateur product that is the most likely to meet your operating requirements.



## RSE HAM SHACK

1207 W. 14 MILE, CLAWSON, MICHIGAN 48017

313-435-5660



# HORIZONS

## ad-scan

**RATES** Regular classified is available at 50¢ per word. Display classified (1 inch deep x 2 1/4 inches wide) is \$50, or at the 12x rate is \$35. All Ad Scan payable in advance. No cash discounts or agency commissions allowed.

**HAMFESTS** Sponsored by non-profit organizations receive one free regular classified ad (subject to our editing). Repeat insertions of hamfest ads pay the standard rate.

**COPY** No special layout or arrangements available. Material should be typewritten or clearly printed (not all capitals) and must include full name and address. We reserve the right to reject unsuitable copy. **Ham Radio** cannot check each advertiser and thus cannot be held responsible for claims made. Liability for correctness of material limited to corrected ad in next available issue.

**DEADLINE** 15th of fourth preceding month.

**SEND MATERIAL TO:** Ad Scan, Ham Radio Horizons, Greenville, N. H. 03048.

**FREE PASSES** are available to HAM RADIO HORIZONS subscribers upon request, from Cal-Comm/Expo'77, the first total communications show anywhere! Seminars will be held at the new Los Angeles Bonaventure Hotel, and free shuttle service will be provided back & forth to the Convention Center. September 24 - 26, 1977. Interested individuals may obtain COMP tickets by writing: CAL-COMMEXPO'77, 809 E. Victoria, Dominguez Hills, CA 90745. Phone 213/CAL-COMM.

**THE VIDEO AMATEUR** is a new publication of, and by the video enthusiast. Look to us for service tips, modifications, bargains on video gear and a wide exchange of products and information. Send for a free copy to P.O. Box 250 Coyote, CA 95013.

**4R TRIPOLE MULTI-BAND**

All-band antenna. 30 to 6 Meters plus 160' 5 SWL. Bands: Built-in balun. 2 KW PEP rating. No returning 130 of trap changes. 82 to 120 ft inverted V or boom optional. Available in kit form at a special price.

Guaranteed: 1 year.

KR T80-K ..... \$54.95 cash PPD in USA.

Universal Radio Co. Dept. HQ  
P.O. Box 2141 El Paso, TX 79925  
Telephone (512) 592-1916

Send \$4.95 for information kit. Send postal order for information kit. TRIPOL is a registered trademark.

**MOBILE IGNITION SHIELDING** provides more range with no noise. Bonding strap sale less than 50¢ each. Literature. Estes Engineering, 930 Marine Drive, Port Angeles, Wash. 98362.

**VHF CONFERENCE** Western Michigan University will hold its 23rd annual VHF Conference, November 19, 1977. Contact Dr. Glade Wilcox, W9UHF/8, Dept. of Electrical Eng., WMU Kalamazoo, Michigan 49008.

### AWARD CERTIFICATES

Award for Public Service or Emergency Communications Award. Send 2.00 each, event, name and address. FREE Information. 49'er RADIO CLUB, Box 1400-HH, Downey, Calif. 90240.

**NEW** Color video tape recorders \$250.00, TV camera \$150.00, videotapes \$4.00, Cartrivision manuals, parts and accessories. D. Trimble 5835 Herma St., San Jose, CA 95123.

**TOROIDS** 88 or 44 mH. Same day shipment. 5 for \$3.50 postpaid. Gull Electronics, 12690 Rt. 30, N. Huntingdon, PA 15642.

**ENGRAVED NAMETAGS** 1 1/2" x 2 1/2" — \$3.00. QTH added \$0.50. Black, blue, red, green, walnut. White letters. Beveled. Locking pin. Other colors available. Tag-it Co., Box 2062, Indianapolis, In. 46206.

In ORLANDO

The "New Guys On The Block" have those hard-to-find parts for Amateurs, plus

KLM	Mini-Products	Bearcat 210
Hy-Gain	Shure	and much
Cushcraft	Astatic	more!

**LAFAYETTE RADIO ELECTRONICS**  
Assoc. Store

1811 Hwy 17-92, Maitland, FL 32751  
Dick K4RYR 305-831-2271 Bob W4YYS

**HAMFEST** Lima, Ohio October 9. The Northwest Ohio ARC 3rd annual hamfest at the Allen County Fairgrounds. Two large buildings, tables and table space available. Dealers welcome. For information and reservations write, N.O.A.R.C., P.O. Box 211, Lima, Ohio 45802 Phone 640-1433 or 991-2716.

**QSL CARDS**, \$10/500, postage paid. Includes all pertinent data. Bowman Printing Service, 743 Harvard, St. Louis, MO 63130.

**SASE** for my lists of old tubes, magazines, literature for sale. Harold L. Hasbrouck, 1157 Palms Blvd., Venice, CA 90291.

**NEW YORK:** Greater Syracuse (RAGS) Hamfest Saturday, October 8 from 9 A.M. to 6 P.M. at the Syracuse Auto Auction, 4 miles south of Syracuse, N.Y. on U.S. Route 11 between Nedrow and LaFayette. Flea market, cw and wiring contests, forums, panels and eyeball QSOs. Lunch counter, nearby campsite and Apple Festival for the family. Talk-in on 31/91. Tickets are \$1.50 before October 1 and \$2.00 at the gate. For further information, contact Roger Hamilton, WA2AEW, c/o RAGS, P.O. Box 88, Liverpool, New York 13088.

**CODE PRACTICE OSCILLATORS**, hand keys, electronics keyers, other products. Free catalog. Globalman Products, Box 246, El Toro, CA 92630. 714-533-4400.

**1977 ARRL FLORIDA GULF COAST CONVENTION**, Clearwater Beach, November 19 & 20. Sponsored by Florida Gulf Coast A.R.C. Exhibits, flea market, technical sessions, FCC exams, forums and much more. Full info and reservation for Sheraton Hotel, contact: F.G.C.A.R.C. Convention, P.O. Box 157, Clearwater, FL 33517.

**FREE LICENSING CLASSES** in Flushing, NY area. Send inquiries to FRATS (Flushing Radio Amateur Technical Society), 62026 Boelsen Crescent, Rego Park, NY 11374.

**VARIABLE AND TRIMMER CAPACITORS** — RF chokes — Miniductors; stocked for immediate shipment. First class stamp for flyer. D & V Radio Parts, Rt#2, 12805 Sarle, Freeland, Michigan 48623.

**CADILLAC" of QSL's!** — New! Samples: \$1.00 (Refundable) — MAC'S SHACK, Box #1171-G, Garland, Texas 75040.

**QSL's** with class! Unbeatable quality — reasonable price. Samples. QSL's Unlimited, Box 27553, Atlanta, GA 30327.

**STOP THIEVES!** Protect your rig with guaranteed slide mount. \$7.95 ppd. Adams H-101, Box 408, Chadron, NE 69337.

**KNIGHT RAIDERS VHF CLUB** auction and flea market at St. Joseph's Church, East Rutherford, NJ; 10 AM, October 8, 1977. Free admission, free parking, exhibitions, make reservations before October 1st through Knight Raiders VHF Club, P.O. Box 1054, Passaic, NJ 07055. For more information, call Bob Kovaleski (201)473-7113.

**SST T-1 RANDOM WIRE ANTENNA TUNER**

All band operation (160-10 meters) with most any random length wire. 200 watt output power capability. Ideal for portable or home operation. Toroid inductor for small size. 3 x 4-1/4 x 2-3/8. Built-in beam tune-up indicator. SO-239 coax connector. Guaranteed for 1 yr., 10 day trial. Compact — easy to use. Only \$29.95 postpaid. (Add Sales Tax in Calif.) (213) 376-5887

SST ELECTRONICS, P.O. BOX 1, LAWDALE, CA 90260

**FREE** Catalog. Solar Cells, Nicads, Kits, Calculators, Digital Watch Modules, Ultrasonics, Strobes, LEDS, Transistors, IC's, Unique Components. Chaney's, Box 27038, Denver, CO. 80227.

**PAN AMERICAN HAM JAMBOREE/EXPOSITION**, Ft. Lauderdale, FL, National Guard Armory (State Road 84). October 29 & 30 starting at 12 noon on Saturday to 10 PM. Sunday 9 AM to 5 PM. Talk-in on 31/91 & 52 simplex. Additional information from WA4ZRW (305) 581-2718.

**NEW ORLEANS HAMFEST/COMPUTERFEST** at the ARRL Delta Division Convention for 1977. September 24th & 25th at the Hilton Inn, Kenner, LA (directly across from the New Orleans International Airport). Banquet, prizes, entertainment, exhibits, forums, flea markets, hospitality suite, ladies events, FCC examinations and more. Contact New Orleans Hamfest/Computerfest, P.O. Box 10111, Jefferson, LA 70181 for more information.

# STEREO CW FILTER

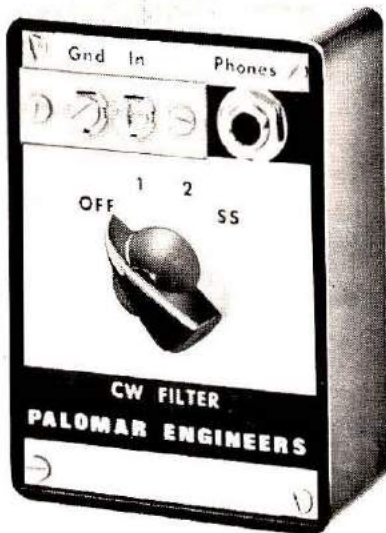

Now an audio filter that really works. Connect to your receiver phone jack, plug your phones into the filter and hear the difference a stable 8-pole active filter can make. Does not ring or sound "tinny". Multiple low Q filters add up to sharp skirt selectivity without ringing.

Switch position 1 gives "wide band" filtering (300 Hz bandwidth, wide skirts). Removes hum and splatter, peaks the signal, but lets off-frequency signals come through.

Switch position 2 gives "narrow-band" filtering (80 Hz bandwidth, steep skirts). Selects the signal you want, eliminates the rest. Greatly improves reception in heavy QRM.

Switch position SS (Simulated-Stereo) puts the narrow band filter to one earphone, the wide band filter to the other. The signal is in both 'phones — the QRM in only one. By the almost magical action of the ears and the brain, the interference is rejected. Yet off-frequency calls can be heard. Great for contest operators, cw nets.

Send for free brochure.

Order direct. \$39.95 postpaid in U.S. and Canada. California residents add sales tax.

## PALOMAR ENGINEERS

BOX 455, ESCONDIDO, CA 92025  
Phone: (714) 747-3343

# YOUR KENWOOD HEADQUARTERS



**TR-7500**  
FM, 10W, 100 Channels, Digital Readout  
Price \$299

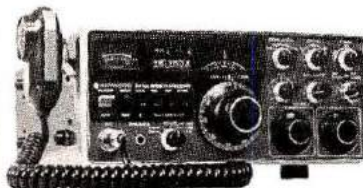

**TS-700A**  
2M TRANSCEIVER  
FM/AM/SSB/CW  
Price \$599

## ELECTRONIC DISTRIBUTORS, Inc.

Communication Specialists  
for over 38 years

1960 PECK ST., MUSKEGON, MICH. 49441  
TEL. (616) 726-3196 TELEX 22-8411

## AT LAST! AN AFFORDABLE FIVE BANDER.

### THE HF5V TRAP VERTICAL ANTENNA

COVERS 80 THROUGH 10 METERS  
WITH AUTOMATIC BANDSWITCHING  
and features:

- EASY, FAST ASSEMBLY
- STURDY ALUMINUM ALLOY CONSTRUCTION
- HIGH Q TRAPS
- FIBERGLASS MOUNTING POST
- RADIAL WIRE
- 27 FT. HEIGHT

### DX PROVEN!

ONLY \$64.50\*  
plus \$3.00 shipping cont. U.S.  
\$14.00 Alaska & Hawaii



BUTTERNUT  
ELECTRONICS  
COMPANY

ROUTE ONE  
LAKE CRYSTAL, MN. 56055  
phone 507-947-3126

S.A.S.E. for information on this and other models.

\*MN. residents add 4%.



## 3 for the adventure of it!

### The adventure of

80 METER DXing  
by John Devoldere, ON4UN

Invaluable knowledge for any DXer, with a special section on Grey-line propagation. Discussion of antennas, basic to advanced.

Order HR-80M

\$4.50

### Pure adventure:

FRENCH ATLANTIC AFFAIR  
by Ernest Lehman, K6DXX

Intrigue and adventure on the high seas where Amateur Radio is the hero! Award-winning author — as reviewed in the August issue of QST. (recommended for mature readers)

Order A-FAA hardcover

\$10.95

The adventure of 160 to 190 kHz  
LOW & MEDIUM FREQUENCY RADIO SCRAPBOOK  
by Ken Cornell, W2IMB

Everything you want to know about the license-free 160-190 kHz band! See W1FB's review in the May issue of QST

Order HR-LF

\$6.95

Ham Radio's Communications Bookstore  
GREENVILLE, NH 03048

Enclosed is check or MO for the following

- |   |   |   |
|---|---|---|
| <input type="checkbox"/> 80 METER DXing | <input type="checkbox"/> FRENCH ATLANTIC AFFAIR | <input type="checkbox"/> LOW & MEDIUM FREQUENCY RADIO SCRAPBOOK |
|---|---|---|

NAME \_\_\_\_\_

ADDRESS \_\_\_\_\_

CITY \_\_\_\_\_

STATE \_\_\_\_\_ ZIP \_\_\_\_\_

# RADIO & ELECTRONICS CONSTRUCTOR

Here is an interesting general electronics hobby magazine. It's loaded with lots of interesting simple circuits and ideas, not only about radio, but in all phases of electronics including test gear, audio, remote control and security electronics.

We are sure that you will find a number of worthwhile projects in this British magazine.

1 Year (12 issues) \$11.00

Radio & Electronics  
Constructor  
Greenville, NH 03048

## HALF-SIZE FULL PERFORMANCE Multi-Band HF Communications Antennas

ESPECIALLY SUITABLE FOR THE NEW AMATEUR



MOR-GAIN HD DIPOLE SPECIFICATIONS			
MODEL	BANDS (Meters)	LENGTH (feet)	PRICE
40-20 HD	40/20	36	\$49.50
40-10 HD	40/20/15/10	36	59.50
80-40 HD	80/40 + 15	69	57.50
75-40 HD	75/40	66	55.00
75-40 HD (SP)	75/40	66	57.50
75-20 HD	75/40/20	66	66.50
75-20 HD (SP)	75/40/20	66	66.50
75-10 HD	75/40/20/15/10	66	74.50
75-10 HD (SP)	75/40/20/15/10	66	74.50
80-10 HD	80/40/20/15/10	69	76.50

NOTE: 75 meter models are factory tuned to resonate at 3950 KHz. (SP) models are factory tuned to resonate at 3800 KHz. 80 meter models are factory tuned to resonate at 3650 KHz.

### WHY MOR-GAIN?

**NOVICE LICENSE OPERATION.** The MOR-GAIN HD Dipole is the ideal antenna for the new or Novice operator. As the Novice progresses to higher license classes, he can easily re-tune the HD Dipole to the new frequencies of his higher license frequency privileges. The HD Dipole is thus a one-time investment. HD Dipoles are available for all Novice frequencies.

**LEAST COST.** Dollar for dollar, the HD dipoles are the highest performance least cost multi-band antennas on the market today. For Example: the 5-band 75-10 HD dipole costs less than \$15.00 per band - an unbeatable low cost.

Contact your favorite dealer or order direct from MOR-GAIN today. Write for fully descriptive four page brochure.



Manufactured & Guaranteed by

**MOR-GAIN**  
2200N South 4th Street  
Leavenworth, Kansas 66048  
(913) 682-3142



### MOR-GAIN HD Dipoles . . .

- One half the length of conventional half-wave dipoles.
- Multi-band, Multi-frequency.
- Maximum efficiency - no traps, loading coils, or stubs.
- Fully assembled and pre-tuned - no measuring, no cutting.
- Proven performance - more than 10,000 have been delivered.
- Permit use of the full capabilities of today's 5-band xcvrs.
- One feedline for operation on all bands.
- Lowest cost/highest performance antenna on the market today.
- Highest performance for the Novice as well as the Extra-Class Op.
- Guaranteed ONE YEAR.

**LIMITED REAL ESTATE.** Where real estate for antenna installation is limited, the HD dipole is the ideal solution. Operation on 80/75/40 meters is now possible since the HD dipole is only half the length of a conventional half-wave dipole. For all-around operation, the HD dipole will outperform any trap loaded horizontal or vertical dipole.

## 1977 ARRL FLORIDA GULF COAST CONVENTION



Clearwater Beach

November 19 and 20

Only REAL Convention in the Southeast with Exhibitors, Flea Mkt., Technical Sessions, FCC Exams, Forums, QCWA, AWA, SMIRK, 10-10 Club, etc. Full Ladies activities plus hotel facilities on the Gulf.

Ray Spence, FCC Chief Eng., Bob and Ellen White, of ARRL as guest speakers at Forums. Saturday Eve Banquet with IARU President, Noel Eaton, VE3CJ, as guest speaker.

Tickets: Adv'd. \$3 Single; \$5 Family + 2 Bonus tickets. Banquet: \$9 (Reserve early)

Sponsored By  
Florida Gulf Coast  
Amateur Radio Council

Full Info and reservation for Sheraton Hotel contact:

F.G.C.A.R.C. Convention  
P. O. Box 157  
Clearwater, Florida 33517

Save  
time  
and  
energy

the easy way — just call  
**TOLL FREE**  
**800-258-5353**

to order books from Ham Radio's Communications Bookstore and subscriptions to Amateur Radio's best publications, Ham Radio HORIZONS, HAM RADIO Magazine and HR Report.

**SAVE MONEY TOO!**  
5% discount plus Free Shipping on orders of \$35 or more.

Please use this number to PLACE ORDERS ONLY. To inquire about book orders and subscriptions please write, or call (603) 878-1441.



GREENVILLE  
NH 03048

We're Amateur Radio's Book People!



### Factory Authorized

- DRAKE • TEN-TEC • ICOM
- KLM • CUSHCRAFT • HYGAIN
- SWAN • MFJ • DENTRON
- NYE VIKING • MIDLAND • CDE

CUSHCRAFT ATB-34 \$199.95

WE DEAL • WE TRADE  
WE DISCOUNT • WE SHIP

CALL OR WRITE

**ham-bone  
radio**

LEE  
WA2ACF

ART  
WB2YPP

— Div. of Stereo Repair Shop

3206 ERIE BLVD. EAST  
SYRACUSE, N. Y. 13214  
315-446-2266

# SAROC™

## HAWAII WEEK

INCLUDING

### SAROC'S THIRD HAWAIIAN CONVENTION November 1 to 8, 1977

SPEND 8 FABULOUS DAYS IN EXCITING HAWAII ON SAROC'S HAWAII WEEK



**Your holiday includes:**

- Attendance at SAROC Hawaiian Convention, Saturday and Sunday, November 5 and 6.
- Seven nights at the fabulous HYATT KUILIMA RESORT HOTEL and COUNTRY CLUB on Oahu's North Shore.
- Roundtrip air transportation, double occupancy in hotel room and SAROC Advance Registration just \$350 per person. Limit 2 pieces of luggage per person. Tax and gratuity included.
- Departs Los Angeles, November 1, 1977 — Returns November 8, 1977. (United Airlines OTC Flight)
- \$100 deposit immediately, full payment by September 15, 1977.
- SAROC Advance Registration \$3.00, with Saturday Banquet \$11 per person.

*Write for further details*

### SAROC™

BOX 945, BOULDER CITY, NEVADA 89005



# ANTENNAS

VERTICALS    QUADS    YAGIS

## VERTICALS FREIGHT FREE!

With loading coil      To the lower 48

FOR 80-40-20-15-10-6 METERS ALL ON THE SAME ANTENNA!!! COMPLETE PACKAGE!

Ideal for low space requirements. Ominidirectional "Rag-Chew" ability

SPECIFY Model Number TTV-80 — **\$35.00**

## QUADS—QUADS—QUADS

PREFERRED BY THOSE WITH "DX" IN MIND

STEEL REINFORCED STRESS POINTS KEEP YOUR QUAD DURABLE

Tri-bander 20-15-10 meters COMPLETE AND READY TO ASSEMBLE

SHIPPED cheapest way.

Freight charge C.O.D.

SPECIFY Model TTQ-3 — **\$68.75**

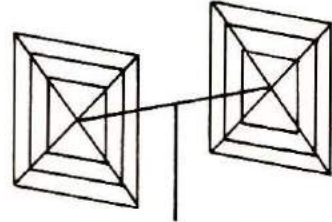

## YAGI BEAMS

	3 ELEMENTS	4 ELEMENTS
10 METERS	TT103— <b>42.00</b>	TT104— <b>46.00</b>
15 METERS	TT153— <b>49.00</b>	TT154— <b>55.00</b>
20 METERS	TT203— <b>55.00</b>	TT204— <b>65.00</b>

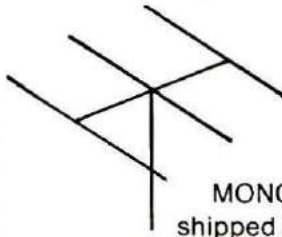

PROVEN PERFORMERS  
MONOBANDERS FOR BEST RESULTS  
shipped cheapest way. Freight charge C.O.D.

Send check or  
money order to:  
(TEXAS ADD 5% SALES TAX.)

## TEXTEC SYSTEMS

6003 Maple Ave. Dept. 101-J  
Dallas, Texas 75235

## PARTS PANIC

### POPULAR TOROID ASSORTMENT

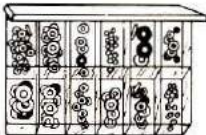

ONLY \$9.95  
(\$15.00 Value)

We Stock a Complete Line of Powdered Iron and Ferrite Products.

FOR CONVENIENCE AND LOWER COST, ASSORTMENT INCLUDES: 2 pcs. each, T25-2, T25-6, T37-2, T37-6, T37-10, T37-12, T50-10, T50-12, T68-10, T-80-2, T80-6, T-94-2, 3 pcs. each, T50-2, T50-3, T50-6, T68-2, T68-3, T68-6 AND CONVENIENT STORAGE BOX AND SPEC SHEETS.

### FERRITE BEAD ASSORTMENT

Includes convenient plastic storage box and one dozen each of FB43-101, FB43-801, FB64-101, FB64-801, FB73-101 and FB73-801 plus new spec sheets. Value \$7.50 for \$6.95.

### NOW IN STOCK

Transmitting Variables — Roller Inductors — Counter Dials — Air Wound Coils — Couplings — Knobs — Receiving Variables — Toroids — R. F. Chokes — Coil Forms and more from Miller - E. F. Johnson - Barker & Williamson - JW Miller - Hammarlund. Send First Class Stamp for Flyer. Add \$2.00 to each order for shipping and handling. Prices subject to change.

G.R. WHITEHOUSE & CO.  
15 Newbury Drive, Amherst, N. H. 03031



502-886-4534



## YAESU — TEN-TEC — TEMPO — DENTRON

- WE HAVE FULL SERVICE ON WARRANTY AND NON-WARRANTY RADIOS.
- ALL NEW DIGITAL MODELS ARE NOW IN STOCK.
- CALL US SOON FOR PERSONAL SERVICE.



TEN-TEC  
544 DIGITAL

TRENTON, KY. 42286

## COHOON

AMATEUR SUPPLY

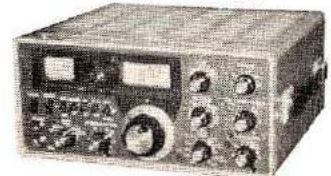
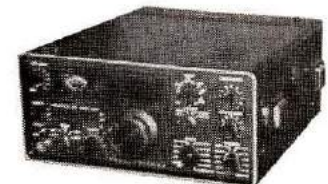

# AD CHECK

... for literature, in a hurry — we'll rush your name to the companies whose names you check.

Place your check mark in the space between name and number. **Example:** HRH  150.

AGL ___ 558	Ham Outlet ___ 595
ALD ___ 625	Heath ___ 060
ARRL * ___	Henry ___ 062
Atlas ___ 198	Herrman ___ 568
Atronic ___ 382	Icom ___ 065
Burghardt ___ 530	Kengore ___ 073
Butternut ___ 603	Kenwood * ___
CFP ___ 022	Kester * ___
Cohoon ___ 559	Klaus ___ 430
Comm. Center ___ 534	Larsen ___ 078
Comm. Spec. ___ 330	Long's ___ 468
Cushcraft ___ 035	MFJ ___ 082
Dentron ___ 259	Madison * ___
Drake ___ 039	Mor-Gain ___ 089
Dynamic Elect. ___ 041	National ___ 323
E. T. O. * ___	Palomar ___ 093
Elect. Dist. ___ 044	Para-Graphics ___ 618
Elect. Spec. ___ 372	RSE Hamshack ___ 607
Erickson ___ 047	Radio Constructor ___ 586
Ham-Bone Radio ___ 617	SAROC * ___
"Ham" Buerger ___ 604	Ten-Tec * ___
Ham Center ___ 491	Textec ___ 619
H. R. C. B. ___ 150	Whitehouse ___ 378
	Wilson ___ 123

\*Please contact this advertiser directly.

Limit 15 inquiries per request.

NOVEMBER, 1977

Please use before December 31, 1977

Tear off and mail to  
**HAM RADIO HORIZONS — "Ad Check"**  
 Greenville, N. H. 03048

NAME \_\_\_\_\_

CALL \_\_\_\_\_

STREET \_\_\_\_\_

CITY \_\_\_\_\_

STATE \_\_\_\_\_ ZIP \_\_\_\_\_

## CALL TOLL FREE 800-228-4097

for prices on Yaesu, Tempo, Swan, Ten-Tec, Icom, MFJ, Nye-Viking, Drake, Hy-Gain, Dentron, CDE, and Midland.

Until Aug. 1 or Nebr. residents call 402-466-3733.

### DRAKE

TR4-CW 80-10m hf trans. with CW filter reg. \$699.00 Now \$629.00  
 34PNB Noise blanker for TR-4C reg. \$100.00 Now \$90.00  
 RV-4C Remote VFO/speaker reg. \$150.00 Now \$134.95  
 AC-4 AC power supply for TR-4C & T-4XC reg. \$120.00 Now \$109.00  
 DC-4 DC power supply reg. \$135.00 Now \$124.00  
 L4B Linear amplifier reg. \$895.00 Now \$789.00  
 SSR-1 Gen. coverage rcvr. 5-30 MHz reg. \$350.00 Now \$279.00  
 R-4C 80-10m receiver reg. \$579.95 Now \$539.95  
 4-NB Noise blanker for R-4C reg. \$70.00 Now \$64.00  
 T-4XC 80-10m transmitter reg. \$599.95 Now \$539.95  
 TV-3300LP Low pass filter reg. \$26.60 Now \$19.95  
 MN-2000 Antenna Tuner reg. \$240.00 Now \$219.95  
 MN-4 Antenna Tuner reg. \$120.00 Now \$109.95  
 1525 Encoder Microphone reg. \$49.95 Now \$45.95  
 TR-33C, 2m Portable Xcvr reg. \$229.95 Now \$209.95

### HY-GAIN

TH6DX 6 element super Thunderbird reg. \$249.95 Now \$209.95  
 TH3-MK3 3 element tri-band reg. \$199.95 Now \$169.95  
 204BA 4 element 20m beam reg. \$189.95 Now \$159.95  
 Hy-Quad, 2 el. Quad, 10-20 meters reg. \$219.95 Now \$189.95  
 TH3JR 3 element tri-band reg. \$144.50 Now \$129.95  
 TH2MK3, 2 element tri-band reg. \$139.95 Now \$124.95  
 402BA 2 element, 40m reg. \$199.95 Now \$169.95  
 203BA 3 element 20m reg. \$129.95 Now \$109.95  
 153BA 3 element 15m reg. \$79.95 Now \$69.95  
 103BA 3 element 10m reg. \$54.95 Now \$49.95  
 DB10-15A 3 element 10, 15m reg. \$149.95 Now \$134.95  
 18HT Hy-Tower, reg. \$279.95 Now \$239.95  
 2BDQ Trap Doublet 40, 80m reg. \$49.95 Now \$44.95  
 5BDQ Trap Doublet 10 thru 80m reg. \$79.95 Now \$69.95  
 12AVQ 10-20m vertical reg. \$37.95 Now \$33.95  
 14AVQ/WB 10-40m vertical reg. \$67.00 Now \$57.00  
 18AVT/WB 10-80m vertical reg. \$97.00 Now \$84.95  
 LA-1 Lightning Arrestor reg. \$44.95 Now \$39.95  
 BN-86 Ferrite Balun reg. \$15.95 Now \$14.95  
 203 3 el 2m beam \$12.95  
 205 5 el 2m beam \$16.95  
 208 8 el 2m beam \$19.95  
 214 14 el 2m beam \$26.95  
 273 4 el J-Pole \$49.95  
 3806 2m Handheld  
 3750 Transceiver reg. \$189.00 Now \$169.00  
 reg. \$1895.00 Now \$1695.00

CALL FOR DAILY SPECIALS  
OPEN 7 DAYS A WEEK

Talk to Bob, WB0RQZ, Joe, WA0WRI, Don, WB0YEZ, Roy, WB0WWA, or Bill WB0YHJ.

## 800-228-4097

Nebr. residents call  
402-466-3733 collect

### Communications Center

2226 North 48th Street  
Lincoln, NE 68504

# AD INDEX

AGL Electronics	81
ALD Industries	10
ARRL Fla. Gulf Coast	77
Atlas Radio	Cover IV
Atronic	53
Burghardt Amateur Center	19
Butternut Electronics	76
CFP Communications	73
Cohoon Amateur Supply	79
Communications Center	80
Communications Specialists	51
Cushcraft	4
Dentron Radio Co.	44, 45
Drake Co., R.L.	Cover II
Ehrhorn Technological Operations	65
Electronic Distributors	76
Erickson Communications	70
Ham-Bone Radio	77
"Ham" Buerger	59
Ham Radio Center	53, 69
Ham Radio's	Communications Bookstore 69, 76, 77
Ham Radio Outlet	9
Heath Company	25
Henry Radio Stores	61
The Herrman Co.	69
Icom	7
Kengore Corporation	59
Trio-Kenwood Communications, Inc.	82, 83, 84, 85, 86, 87, 88, Cover III
Kester Solder	74
Klaus Radio, Inc.	66
Larsen Antennas	59
Long's Electronics	1
MFJ Enterprises	3
Madison Electronic Supply	73
Mor-Gain	77
Palomar Engineers	63, 73, 74, 76
Para-Graphics	53
RSE Hamshack	74
Radio & Electronics Constructor	77
SAROC	78
Ten-Tec	37
Textec Systems	79
G. R. Whitehouse & Co.	79
Wilson Electronics	67

### Foreign Subscription Agents for Ham Radio HORIZONS

Ham Radio Austria  
Karin Ueber  
Postfach 2454  
D-7850 Loerrach  
West Germany

Ham Radio Holland  
MRL Electronics  
Postbus 88  
NL-2204 Drift  
Holland

Ham Radio Belgium  
Stereohouse  
Brusselsesteenweg 416  
B-9218 Gent  
Belgium

Ham Radio Italy  
STE. Via Maniago 15  
I-20134 Milano  
Italy

Ham Radio Canada  
Box 114, Goderich  
Ontario, Canada N7A 3Y5

Ham Radio Switzerland  
Karin Ueber  
Postfach 2454  
D-7850 Loerrach  
West Germany

Ham Radio Europe  
Box 444  
S-194 04 Upplands Vasby  
Sweden

Ham Radio UK  
P.O. Box 63, Harrow  
Middlesex HA3 6HS,  
England

Ham Radio Germany  
Karin Ueber  
Postfach 2454  
D-7850 Loerrach  
West Germany

Holland Radio  
143 Greenway  
Greenside, Johannesburg  
Republic of South Africa



K9TRG

# A Message from Art ... About AGL

We'll See You —

September 17th & 18th at **RADIO EXPO**, Chicago

October 7th, 8th & 9th at the **ARRL WEST GULF**

**DIVISION CONVENTION**, Austin

October 28th, 29th & 30th at the **LAKE TEXOMA HAMFEST**

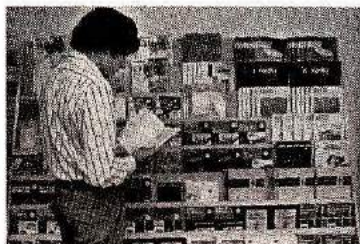

## AGL Electronics

LARRY ESSARY  
President

ART HOUSHOLDER  
Vice President

GORDON FOGG  
Secretary-Treasurer

Q: —

A.G.L. is a comparatively new company with an old-fashioned philosophy about giving our customers the best service we can deliver at the most competitive price.

Everyone at A.G.L. is a licensed ham operator with a strong electronics background, and although A.G.L. is new, we've probably met and talked with most of you at hamfests for the past many years. (We would rather not discuss how many.)

We think we have accumulated one of the most complete inventories of electronics in the southwest. We've combined that with our own skills and backgrounds and created a business that we hope you will like doing business with.

By the way, if you like to "horse trade" on equipment, you are more than welcome. In fact, we encourage it.

Stop in and see for yourself, you are going to like A.G.L.

73.

*Art Housholder*

Art Housholder, K9TRG  
Vice President

3068 Forest Lane, Suite 309 • Dallas, Texas 75234 • 214/241-6414

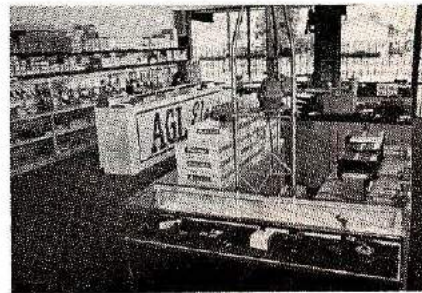
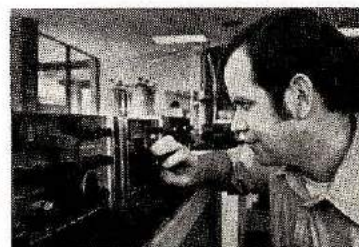

**CALL US TODAY TOLL FREE AT 1-800-527-7418**

CALL 214-241-6414 (in Texas)

LARRY WA5WWH

GORDON N5AU

MIKE WA5UOB

MIKE WB5ACM

TOM K5TM

BOB W5XC



## AGL Electronics



3068 FOREST LANE, SUITE 309 • DALLAS, TEXAS 75234

**KENWOOD**  
...pacesetter in amateur radio

# TS-520S

AND DG-5 DIGITAL FREQUENCY DISPLAY



#### FULL COVERAGE TRANSCEIVER

The TS-520S provides full coverage on all amateur bands from 1.8 to 29.7 MHz. Kenwood gives you 160 meter capability, WWV on 15.000 MHz., and an auxiliary band position for maximum flexibility. And with the addition of the TV-506 transverter, your TS-520S can cover 160 meters to 6 meters on SSB and CW.

#### DIGITAL DISPLAY DG-5 (option)

The Kenwood DG-5 provides easy, accurate readout of your operating frequency while transmitting and receiving.

#### OUTSTANDING RECEIVER SENSITIVITY AND MINIMUM CROSS MODULATION

The TS-520S incorporates a 3SK35 dual gate MOSFET for outstanding cross modulation and spurious response characteristics. The 3SK35 has a low noise figure (3.5 dB typ.) and high gain (18 dB typ.) for excellent sensitivity.

#### NEW IMPROVED SPEECH PROCESSOR

An audio compression amplifier gives you extra punch in the pile

ups and when the going gets rough.

#### VERNIER TUNING FOR FINAL PLATE CONTROL

A vernier tuning mechanism allows easy and accurate adjustment of the plate control during tune-up.

#### FINAL AMPLIFIER

The TS-520S is completely solid state except for the driver (12B-Y7A) and the final tubes. Rather than substitute TV sweep tubes as final amplifier tubes in a state of the art amateur transceiver,

Kenwood has employed two husky S-2001A (equivalent to 6146B) tubes. These rugged, time-proven tubes are known for their long life and superb linearity.

#### HIGHLY EFFECTIVE NOISE BLANKER

An effective noise blanking circuit developed by Kenwood that virtually eliminates ignition noise is built into the TS-520S.

#### RF ATTENUATOR

The TS-520S has a built-in 20 dB attenuator that can be activated by a push button switch conveniently located on the front panel.

#### PROVISION FOR EXTERNAL RECEIVER

A special jack on the rear panel of the TS-520S provides receiver signals to an external receiver for increased station versatility. A switch on the rear panel determines the signal path... the receiver in the TS-820 or any external receiver.

#### VFO-520 — NEW REMOTE VFO

The VFO-520 remote VFO matches the styling of the TS-520S and provides maximum operating flexibility on the band selected on your TS-520S.

#### AC POWER SUPPLY

The TS-520S is completely self-contained with a rugged AC power supply built-in. The addition of the DS-1A DC-DC converter (optional) allows for mobile operation of the TS-520S.

#### EASY PHONE PATCH CONNECTION

The TS-520S has 2 convenient RCA phono jacks on the rear panel for PHONE PATCH IN and PHONE PATCH OUT.

#### CW-520 — CW FILTER (OPTION)

The CW-520-500 Hz filter can be easily installed and will provide improved operation on CW.

#### AMPLIFIED TYPE AGC CIRCUIT

The AGC circuit has 3 positions (OFF, FAST, SLOW) to enable the TS-520S to be operated in the optimum condition at all times whether operating CW or SSB.

The TS-520S retains all of the features of the original TS-520 that made it tops in its class: RIT control • 8-pole crystal filter • Built-in 25 KHz calibrator • Front panel carrier level control • Semi-break-in CW with sidetone • VOX/PTT/MOX • TUNE position for low power tune up • Built-in speaker • Built-in Cooling Fan • Provisions for 4 fixed frequency channels • Heater switch.

## TS-520 Specifications

Amateur Bands: 160-10 meters plus WWV (receive only)

Modes: USB, LSB, CW

Antenna Impedance: 50-75 Ohms

Frequency Stability: Within  $\pm 1$  kHz during one hour after one minute of warm-up, and within 100 Hz during any 30 minute period thereafter

Tubes & Semiconductors:

Tubes ..... 3  
(S2001A x 2, 12BY7A)  
Transistors ..... 52  
FETs ..... 19  
Diodes ..... 101

Power Requirements: 120/220 V AC, 50/60 Hz, 13.8 V DC (with optional DS-1A)

Power Consumption: Transmit: 280 Watts Receive: 26 Watts (with heater off)

Dimension: 333(13 1/4) W x 153 (6-0) H x 335(13-13 3/16) D mm(inch)

Weight: 16.0 kg(35.2 lbs)

#### TRANSMITTER

RF Input Power: SSB: 200 Watts PEP CW: 160 Watts DC

Carrier Suppression: Better than -40 dB

Sideband Suppression: Better than -50 dB

Spurious Radiation: Better than -40 dB

Microphone Impedance: 50k Ohms

AF Response: 400 to 2,600 Hz

#### RECEIVER

Sensitivity: 0.25  $\mu$ V for 10 dB (S+N)/N

Selectivity: SSB: 2.4 kHz/-6 dB, 4.4 kHz/-60 dB

Selectivity: CW: 0.5 kHz/-6 dB, 1.5 kHz/-60 dB (with optional CW-520 filter)

Image Ratio: Better than 50 dB

IF Rejection: Better than 50 dB

AF Output Power: 1.0 Watt (8 Ohm load, with less than 10% distortion)

AF Output Impedance: 4 to 16 Ohms

#### DG-5

##### SPECIFICATIONS

Measuring Range: 100 Hz to 40 MHz

Input Impedance: 5 k Ohms

Gate Time: 0.1 Sec.

Input Sensitivity: 100 Hz to 40 MHz... 200 mV rms or over, 10 kHz to 10 MHz... 50 mV or over

Measuring Accuracy: Internal time base accuracy  $\pm 0.1$  count

Time Base: 10 MHz

Operating Temperature: -10° to 50° C/14° to 122° F

Power Requirement: Supplied from TS-520S or 12 to 16 VDC (nominal 13.8 VDC)

Dimensions: 167(6-9/16) W x 43(1-11/16) H x 268(10-9/16) D mm(inch)

Weight: 1.3 kg(2.9 lbs)



## DG-5

The luxury of digital readout is available on the TS-520S by connecting the DG-5 readout (option). More than just the average readout circuit, this counter mixes the carrier, VFO, and heterodyne frequencies to give you your exact frequency. This handsomely-styled accessory can be set almost anywhere in your shack for easy to read operation... or set it on the dashboard during mobile operation for safety and convenience. Six bold digits display your operating frequency while you transmit and receive. Complete with DH (display hold) switch for frequency memory and 2 position intensity selector. The DG-5 can also be used as a normal frequency counter up to 40 MHz at the touch of a switch. (Input cable provided.)

NOTE: TS-520 owners can use the DG-5 with a DK-520 adapter kit.

# KENWOOD

...pacesetter in amateur radio



# TS-820S

## WITH DIGITAL FREQUENCY DISPLAY

We told you that the TS-820 would be best. In little more than a year our promise has become a fact. Now, in response to hundreds of requests from amateurs, Kenwood offers the TS-820S\*... the same superb transceiver, but with the digital readout factory installed. As an owner of this beautiful rig, you will have at your fingertips the combination of controls and features that even under the toughest operating conditions make the TS-820S the Pacesetter that it is.

Following are a few of the TS-820S' many exciting features.

**PLL** • The TS-820S employs the latest phase lock loop circuitry. The single conversion receiver section performance offers superb protection against unwanted cross-modulation. And now PLL allows the frequency to remain the same when switching sidebands (USB, LSB, CW) and eliminates having to recalibrate each time.

**DIGITAL READOUT** • The digital counter display is employed as an integral part of the VFO readout system. Counter mixes the carrier VFO, and first heterodyne frequencies to give exact frequency. Figures the frequency down to 10 Hz and digital display

reads out to 100 Hz. Both receive and transmit frequencies are displayed in easy to read, Kenwood Blue digits.

**SPEECH PROCESSOR** • An RF circuit provides quick time constant compression using a true RF compressor as opposed to an AF clipper. Amount of compression is adjustable to the desired level by a convenient front panel control.

**IF SHIFT** • The IF SHIFT control varies the IF passband without changing the receive frequency. Enables the operator to eliminate unwanted signals by moving them out of the passband of the receiver. This feature alone makes the TS-820S a pacesetter.

\*The TS-820 and DG-1 are still available separately.

# TS-600



Experience the excitement of 6 meters. The TS-600 all mode transceiver lets you experience the fun of 6 meter band openings. This 10 watt, solid state rig covers 50.0-54.0 MHz. The VFO tunes the band in 1 MHz segments. It also

has provisions for fixed frequency operation on NETS or to listen for beacons. State of the art features such as an effective noise blanker and the RIT (Receiver Incremental Tuning) circuit make the TS-600 another Kenwood "Pacesetter".



## TV-506

An easy way to get on the 6 meter band with your TS-520/520S, TS-820/820S and most other transceivers. Simply plug it in and you're on... full band coverage with 10 watts output on SSB and CW.



# TR-8300

Experience the luxury of 450 MHz at an economical price. The TR-8300 offers high quality and superb performance as a result of many years of improving VHF/UHF design techniques. The trans-

ceiver is capable of F<sub>3</sub> emission on 23 crystal-controlled channels (3 supplied). The transmitter output is 10 watts. The TR-8300 incorporates a 5 section helical resonator and a

two-pole crystal filter in the IF section of the receiver for improved intermodulation characteristics. Receiver sensitivity, spurious response, and temperature characteristics are excellent.

**KENWOOD**  
...pacesetter in amateur radio

# TS-700S

WITH DIGITAL FREQUENCY DISPLAY



Check out the new "built-ins":  
digital readout, receiver pre-amp,  
VOX, semi-break in, and CW sidetone!  
Of course, it's still all mode, 144-148  
MHz and VFO controlled.

Features: Digital readout with "Kenwood Blue" digits • High gain receiver pre-amp • 1 watt lower power switch • Built in VOX • Semi-break in on CW • CW sidetone • Operates all modes: SSB (upper & lower), FM, AM and CW • Completely solid state circuitry provides stable, long lasting, trouble-free operation • AC and DC capability (operate from your car, boat, or as a base station through its built-in power supply) • 4 MHz band coverage (144 to 148 MHz) • Automatically switches transmit frequency 600 KHz for repeater operation. Simply dial in your receive frequency and the radio does the rest... simplex, repeater, reverse • Or accomplish the same by plugging a single crystal into one of the 11 crystal positions for your favorite channel • Transmit/Receive capability on 44 channels with 11 crystals.



## VFO-700S

Handsomely styled and a perfect companion to the TS-700S. This unit provides you with the extra versatility and the luxury of having a second VFO in your shack. Great for split frequency operation and for tuning off frequency to check the band. The function switch

on the VFO-700S selects the VFO in use and the appropriate frequency is displayed on the digital readout in the TS-700S. In addition a momentary contact "frequency check" switch allows you to spot check the frequency of the VFO not in use.



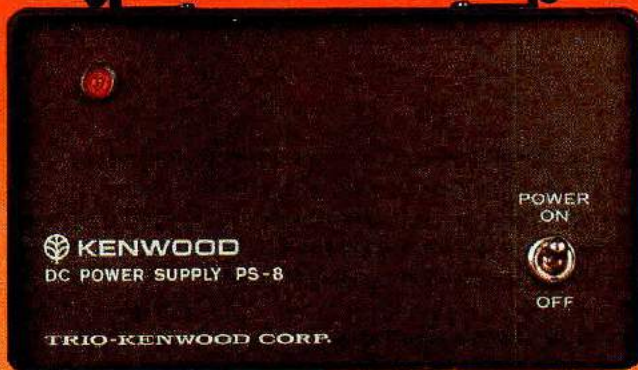

# TR-7400A

Features Kenwood's unique Continuous Tone Coded Squelch system, 4 MHz band coverage, 25 watt output and fully synthesized 800 channel operation. This compact package gives you the kind of performance specifications you've always wanted in a 2-meter amateur rig.

Outstanding sensitivity, large-sized helical resonators with High Q to minimize undesirable out-of-band interference, and give a 2-pole 10.7 MHz monolithic crystal filter combine to give your TR-7400A outstanding receiver performance. Intermodulation characteristics (Better than 66dB), spurious (Better than -60dB), image rejection (Better than -70dB), and a versatile squelch system make the TR-7400A tops in its class.

Shown with the PS-8 power supply

(Active filters and Tone Burst Modules optional)



# TR-7500

This 100 channel PLL synthesized 146-148 MHz transceiver comes with 88 pre-programmed channels for use on all standard repeater frequencies (as per ARRL Band Plan) and most simplex channels. For added flexibility, there are 6 diode-programmable switch positions. The 15 KHz shift function makes these 6 positions into 12 channels. 10 watt output,  $\pm 600$  KHz offset and LED digital frequency display are just a few of the many fine features of the TR-7500. The PS-6 is the handsomely styled, matching power supply for the TR-7500. Its 3.5 amp current capacity and built-in speaker make it the perfect companion for home use of the TR-7500.

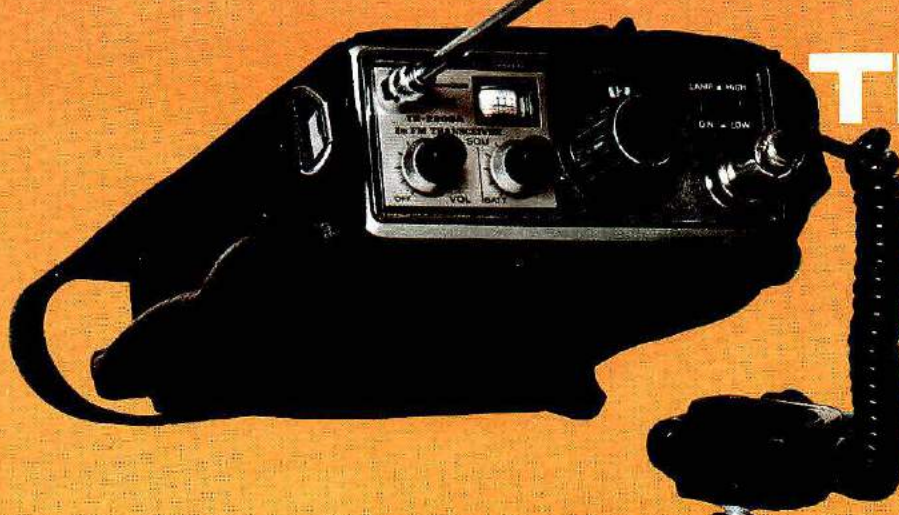

# TR-2200A

The high performance portable 2-meter FM transceiver. 146-148 MHz, 12 channels (6 supplied), 2 watts or 400 mW RF output. Everything you need is included: Ni-Cad battery pack, charger, carrying case and microphone.

# KENWOOD

...pacesetter in amateur radio

Kenwood developed the T-599D transmitter and R-599D receiver for the most discriminating amateur.

The R-599D is the most complete receiver ever offered. It is entirely solid-state, superbly reliable and compact. It covers the full amateur band, 10 through 160 meters, CW, LSB, USB, AM and FM.

The T-599D is solid-state with the exception of only three tubes, has built-in power supply and full metering. It operates CW, LSB, USB and AM and, of course, is a perfect match to the R-599D receiver.

If you have never considered the advantages of operating a receiver/transmitter combination... maybe you should.

Because of the larger number of controls and dual VFOs the combination offers flexibility impossible to duplicate with a transceiver.

Compare the specs of the R-599D and the T-599D with any other brand. Remember, the R-599D is all solid state (and includes four filters). Your choice will obviously be the Kenwood.



## R-599D T-599D

# R-300

Dependable operation, superior specifications and excellent features make the R-300 an unexcelled value for the shortwave listener. It offers full band coverage with a frequency range of 170 KHz to 30.0 MHz • Receives AM, SSB and CW • Features large, easy to read drum dials with fast smooth dial action • Band spread is calibrated for the 10 foreign broadcast bands, easily tuned with the use of a built-in 500 KHz calibrator • Automatic noise limiter • 3-way power supply system (AC/Batteries/External DC) ... take it anywhere • Automatically switches to battery power in the event of AC power failure.





*Fine equipment that belongs in every well equipped station*

#### HF LINES

##### 820 Series

- TS-820S... TS-820 with Digital Installed
- TS-820... 10-160 M Deluxe Transceiver
- DG-1... Digital Frequency Display for TS-820
- VFO-820... Deluxe Remote VFO for TS-820/820S
- CW-820... 500 Hz CW Filter for TS-820/820S
- DS-1A... DC-DC Converter for 520/820 Series

##### 520 Series

- TS-520S... 160-10 M Transceiver
- DG-5... Digital Frequency Display for TS-520 Series
- VFO-520... Remote VFO for TS-520 and TS-520S
- SP-520... External Speaker for 520/820 Series
- CW-520... 500 Hz CW Filter for TS-520/520S
- DK-520... Digital Adaptor Kit for TS-520

##### 599D Series

- R-599D... 160-10 M Solid State Receiver
- T-599D... 80-10 M Matching Transmitter
- S-599... External Speaker for 599D Series

- CC-29A... 2 Meter Converter for R-599D
- CC-69... 6 Meter Converter for R-599D
- FM-599A... FM Filter for R-599D

#### SHORT WAVE LISTENING

- R-300 General Coverage SWL Receiver

#### VHF LINES

- TS-600... 6 M All Mode Transceiver
- TS-700S... 2 M All Mode Digital Transceiver
- VFO-700S... Remote VFO for TS-700S
- SP-70... Matching Speaker for TS-600/700 Series
- TR-2200A... 2 M Portable FM Transceiver
- TR-7400A... 2 M Synthesized Deluxe FM Transceiver

- TR-7500... 100 Channel Synthesized 2 M FM Transceiver
- TR-8300... 70 CM FM Transceiver (450 MHz)
- TV-506... 6 M Transverter for 520/820/599 Series

#### POPULAR STATION ACCESSORIES

- HS-4... Headphone Set
- MB-1A... Mounting Bracket for TR-2200A
- MC-50... Desk Microphone
- PS-5... Power Supply for TR-8300
- PS-6... Power Supply for TR-7500
- PS-8... Power Supply for TR-7400A
- VOX-3... VOX for TS-600/700A

Trio-Kenwood stocks a complete line of replacement parts, accessories, and manuals for all Kenwood models.

#### MORE ACCESSORIES:

Description	Model #	For use with
Rubber Helical Antenna	RA-1	TR-2200A
Telescoping Whip Antenna	T90-0082-05	TR-2200A
Ni-Cad Battery Pack (set)	PB-15	TR-2200A
4 Pin Mic. Connector	E07-0403-05	All Models
Active Filter Elements	See Service Manual	TR-7400A
Tone Burst Modules	See Service Manual	TS-700A, TR-7400A
AC Cables	Specify Model	All Models
DC Cables	Specify Model	All Models

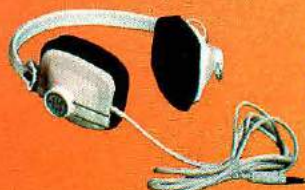

The Kenwood HS-4 headphone set adds versatility to any Kenwood station. For extended periods of wear, the HS-4 is comfortably padded and is completely adjustable. The frequency response of the HS-4 is tailored specifically for amateur communication use. (300 to 3000 Hz, 8 ohms).



The MC-50 dynamic microphone has been designed expressly for amateur radio operation as a splendid addition to any Kenwood shack. Complete with PTT and LOCK switches, and a microphone plug for instant hook-up to any Kenwood rig. Easily converted to high or low impedance. (600 or 50k ohm).

TRIO-KENWOOD COMMUNICATIONS INC.  
1111 WEST WALNUT/COMPTON, CA 90220

 **KENWOOD**  
...pioneer in amateur radio



## The ATLAS 210x/215x fits them all!

**ECONOMICAL ■ POWERFUL ■ RELIABLE COMMUNICATIONS  
FOR MOBILE ■ PORTABLE OR MARITIME MOBILE.**

The Atlas transceiver is by far the most popular single sideband amateur SSB transceiver for mobile and maritime service. With its low power consumption, small size: 3½" x 9½" x 9½", and light weight: 7 pounds, it fits into any automobile, boat, or even an attache case.

Despite its compact design it packs a hefty 200 watts of power providing inexpensive world wide communications on 5 amateur bands.

And with the exclusive Atlas Mobile Mounting Kit, the 210x/215x can easily be transferred from boat to car in seconds. Simply slip it out of one mounting kit into the other, and connections for the antenna jack, mic jack and AC or DC input are made automatically.

The Atlas 210x/215x is a powerful, reliable, yet lightweight amateur radio that fits almost anything that moves, and is available at most amateur radio stores.

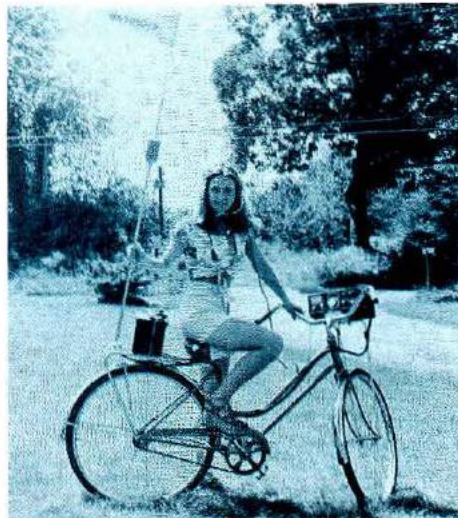

**NOW!**

**AN EXCITING NEW  
ADVENTURE NOVEL  
ABOUT HAM RADIO!**



**"The  
French Atlantic  
Affair"  
by Ernest Lehman  
K6DXK.**

The Atlas 210x is the seven pound superstar of this suspense thriller, published by Atheneum. The "French Atlantic Affair" dramatizes amateur radio as only a ham could write it.

Get it at your local bookstore or from the Ham Radio Communications Bookstore, Greenville, New Hampshire 03048.

Atlas 210x or 215x ..... **\$679.**

Model 210x covers 3.5, 7, 14, 21 and 28 MHz ham bands. Model 215x covers 1.8, 3.5, 7, 14, and 21 MHz ham bands.

Plug-in Mobile Kit ..... **\$ 48.**

*For complete information see your Atlas dealer, or drop us a card and we'll mail you a brochure with dealer list.*



**ATLAS  
RADIO INC.**

417 Via Del Monte, Oceanside, CA 92054  
Phone (714) 433-1983  
Special Customer Service Direct Line  
(714) 433-9591.