

SCS1600 and SCS3200 User Guide



Copyright & Trademark

© 2003, Lantronix. All rights reserved. No part of the contents of this book may be transmitted or reproduced in any form or by any means without the written permission of Lantronix. Printed in the United States of America.

Ethernet is a trademark of XEROX Corporation. UNIX is a registered trademark of The Open Group. Windows 95, Windows 98, Windows 2000, and Windows NT are trademarks of Microsoft Corp. Netscape is a trademark of Netscape Communications Corporation.

Contacts

Lantronix Corporate Headquarters

15353 Barranca Parkway
Irvine, CA 92618, USA
Phone: 949-453-3990
Fax: 949 453-3995

Technical Support

Phone: 800-422-7044 or 949-453-7198
Fax: 949-450-7226
Online: www.lantronix.com/support
E-mail support@lantronix.com

Sales Offices

For a current list of our domestic and international sales offices, go to the Lantronix web site at <http://www.lantronix.com/about/contact/>

Disclaimer & Revisions

Operation of this equipment in a residential area is likely to cause interference in which case the user, at his or her own expense, will be required to take whatever measures may be required to correct the interference.

Note: *This product has been designed to comply with the limits for a Class A digital device pursuant to Part 15 of FCC Rules. These limits are designed to provide reasonable protection against such interference when operating in a commercial environment. This equipment generates, uses, and can radiate radio frequency energy, and if not installed and used in accordance with this guide, may cause harmful interference to radio communications.*

Changes or modifications to this device not explicitly approved by Lantronix will void the user's authority to operate this device.

The information in this guide may change without notice. The manufacturer assumes no responsibility for any errors that may appear in this guide.

| Date | Rev. | Part No. | Comments |
|-------|------|----------|---|
| 4/02 | C | 900-234 | Reformatted manual; added section on SSH Connections; added information about Break Safe feature. |
| 12/03 | D | 900-234 | Added new features: SSH connections, enhanced security, break sequences, modem mode, boot gateway, DHCP, and additional authentication for Web browser. Expanded list of cables and added list of adapters available from Lantronix. Updated contacts and warranty information. |

Contents

| | |
|---|------------|
| Copyright & Trademark | i |
| Contacts | i |
| Disclaimer & Revisions | i |
| Contents | ii |
| 1: Introduction to the SCS Family | 1-1 |
| Features | 1-1 |
| Protocol Support | 1-2 |
| 2: Connections and Physical Requirements | 2-1 |
| Connections | 2-1 |
| Pinouts | 2-2 |
| RJ45 Serial Connectors | 2-2 |
| RJ45 to DB25 | 2-3 |
| RJ45 to DB9 | 2-4 |
| Cables and Adapters | 2-5 |
| Specifications | 2-6 |
| Power | 2-6 |
| Temperature | 2-6 |
| Humidity | 2-6 |
| Altitude | 2-6 |
| 3: Installation | 3-1 |
| Connecting the SCS | 3-1 |
| Assigning an IP Address | 3-2 |
| EZWebCon Method | 3-2 |
| DHCP Method | 3-4 |
| Command Line Method | 3-4 |
| ARP and Ping Method | 3-5 |
| UNIX Host | 3-5 |
| Windows Host | 3-5 |
| Changing the IP Address Permanently | 3-5 |
| BOOTP or RARP Reply Method | 3-6 |
| Configuring the SCS | 3-6 |
| EZWebCon Method | 3-6 |
| Web Browser Method | 3-8 |

| | |
|--|------------|
| Telnet Login Method _____ | 3-1 |
| Command Line Method _____ | 3-1 |
| 4: Application Setup _____ | 4-1 |
| Login Banner Pages _____ | 4-1 |
| Menus _____ | 4-1 |
| Connecting _____ | 4-1 |
| Enabling Menu Mode _____ | 4-2 |
| Creating the Menu _____ | 4-3 |
| Using Menu/Connection Commands _____ | 4-4 |
| Enabling Menu Mode for a Port _____ | 4-5 |
| Using the Menu _____ | 4-6 |
| Remote User Dial-Up _____ | 4-7 |
| Break Sequences _____ | 4-8 |
| Serial Breaks _____ | 4-8 |
| Alternate Break Sequences _____ | 4-8 |
| Modem Mode _____ | 4-9 |
| Event Port Logging and Email Notification _____ | 4-10 |
| Creating an Email Site _____ | 4-11 |
| Dial-Out ISP Connection _____ | 4-12 |
| Com Port Redirector _____ | 4-13 |
| SSH Connections _____ | 4-14 |
| Defining Supported SSH Connections _____ | 4-14 |
| Creating an AUTHORIZED_KEYS File _____ | 4-14 |
| Shared Key Authentication Process _____ | 4-15 |
| Setting up RSA Shared Key Authentication (for SSHv1) _____ | 4-15 |
| Setting up DSA Shared Key Authentication (for SSHv2) _____ | 4-16 |
| Setting up Username/Password Authentication (SSHv1 or SSHv2) _____ | 4-16 |
| Forming SSH Incoming Connections (Unix and Non-Unix) _____ | 4-17 |
| Non-Unix Platforms _____ | 4-17 |
| UNIX Platforms _____ | 4-17 |
| Security Enhancements _____ | 4-18 |
| Incoming Security _____ | 4-18 |
| Port User Restrictions _____ | 4-18 |
| 5: Troubleshooting _____ | 5-1 |
| Technical Support _____ | 5-1 |
| LEDs _____ | 5-2 |

| | |
|---|------------|
| Power-up Troubleshooting | 5-3 |
| BOOTP Troubleshooting | 5-4 |
| RARP Troubleshooting | 5-4 |
| Boot Prompt Commands | 5-4 |
| Flash | 5-5 |
| Flush NVR | 5-5 |
| Help | 5-5 |
| Init 451 | 5-5 |
| Set Server BOOTP {Enabled, Disabled} | 5-5 |
| Set Server Hardware <i>xx-xx-xx</i> | 5-6 |
| Set server IPAddress <i>ip_address</i> | 5-6 |
| Set server loadhost <i>ip_address</i> | 5-6 |
| Set Server RARP {Enabled, Disabled} | 5-6 |
| Set Server Secondary <i>ip_address</i> | 5-6 |
| Set Server Software <i>filename</i> | 5-6 |
| Set Server Bootgateway <i>ip_address</i> | 5-5 |
| Show Server | 5-6 |
| 6: Updating Software | 6-1 |
| Choosing the Right Software File | 6-1 |
| Obtaining Software | 6-1 |
| Via the Web | 6-1 |
| Via FTP | 6-1 |
| Reloading Software | 6-2 |
| EZWebCon Method | 6-2 |
| FTP Method | 6-2 |
| Web Interface Method | 6-2 |
| Command Line Methods | 6-3 |
| TFTP Method | 6-3 |
| MOP | 6-3 |
| Troubleshooting Flash ROM Updates | 6-4 |
| A: Compliance and Warranty Information | 1 |
| Compliance Information | 1 |
| Warranty | 2 |

1: Introduction to the SCS Family

The Lantronix SCS family of Secure Console Servers enables IT professionals to remotely and securely configure and administer servers, routers, switches, telephone equipment, or other devices equipped with a serial port.

Features

- ◆ TCP/IP compatibility
- ◆ Remote networking
 - Dial-in access
 - Dial-out ISP connections
 - Event port logging
 - Email event notification
 - Authentication
 - Accountability
- ◆ Browser-based configuration
 - HTML pages in firmware
 - Server configuration via any browser
- ◆ EZWebCon utility
 - Provides initial SCS configuration
 - Extracting and downloading configuration to multiple SCS units.
- ◆ Command line editing
- ◆ Context-sensitive online help
- ◆ Re-loadable operating code
 - Stored in Flash ROM
 - Upgradeable using FTP, TFTP, and EZWebCon
- ◆ Diagnostics for network and serial line troubleshooting
- ◆ Break safe for Sun Solaris systems (Solaris Ready Certified)

Note: See [Using Menu/Connection Commands](#) for information on how to send intentional breaks to connected equipment.

Protocol Support

The SCS supports the TCP/IP network protocol as well as:

- ◆ SSH, Telnet, and Rlogin for connections in and out of the SCS
- ◆ DNS and WINS for text-to-IP address name resolution
- ◆ SNMP for remote monitoring and management
- ◆ FTP for file transfers and firmware upgrades
- ◆ TFTP for firmware upgrades
- ◆ BOOTP, RARP, and DHCP for IP address assignment
- ◆ HTTP for easy browser-based configuration
- ◆ NTP for time synchronization and authentication
- ◆ NAT for enabling private networks to share a connection to the Internet.

SSH (Secure Shell): A secure transport protocol based on public-key cryptography.

Telnet: This terminal protocol provides an easy-to-use method of creating terminal connections to any network host supporting Telnet.

Rlogin: Allows you to initiate a TCP/IP login session.

DNS (Domain Name Servers): Lets a network nameserver translate text node names into numeric IP addresses.

SNMP (Simple Network Management Protocol): Commands that allow system administrators to monitor and manage nodes on a LAN (Local Area Network) and respond to queries from other network hosts. One community name can be configured with read/write access. Refer to the *SCS Reference Manual* for SNMP configuration instructions.

BOOTP, RARP, and DHCP: Methods for automatically assigning an IP address and network settings.

NTP (Network Time Protocol): Used to synchronize time on networked computers and equipment.

NAT (Network Address Translation): Allows private networks to share a single connection to the Internet. With Port Mapping, specific IP Ports can be mapped from the Internet to a private IP address and port.

2: Connections and Physical Requirements

This chapter provides a physical description of the unit and requirements for installing and connecting it. The topics include:

- ◆ [Connections](#)
- ◆ [Pinouts](#)
- ◆ [Cables and Adapters](#)
- ◆ [Specifications](#)

Connections

The SCS1600 and SCS3200 are distinguished by the number of asynchronous RJ45 serial ports they are equipped with. The SCS1600 has 16 ports, while the SCS3200 has 32 ports. Both units include an AUI connector and a UTP port (10/100BASE-T) for Ethernet connections. They both support baud rates between 300 and 230,400 bits per second.

SCS1600 Front Panel

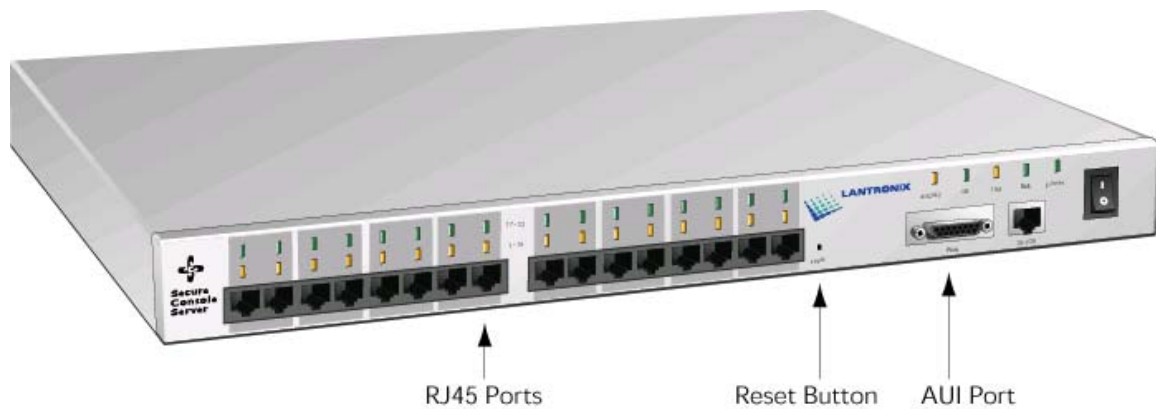

SCS3200 Front Panel

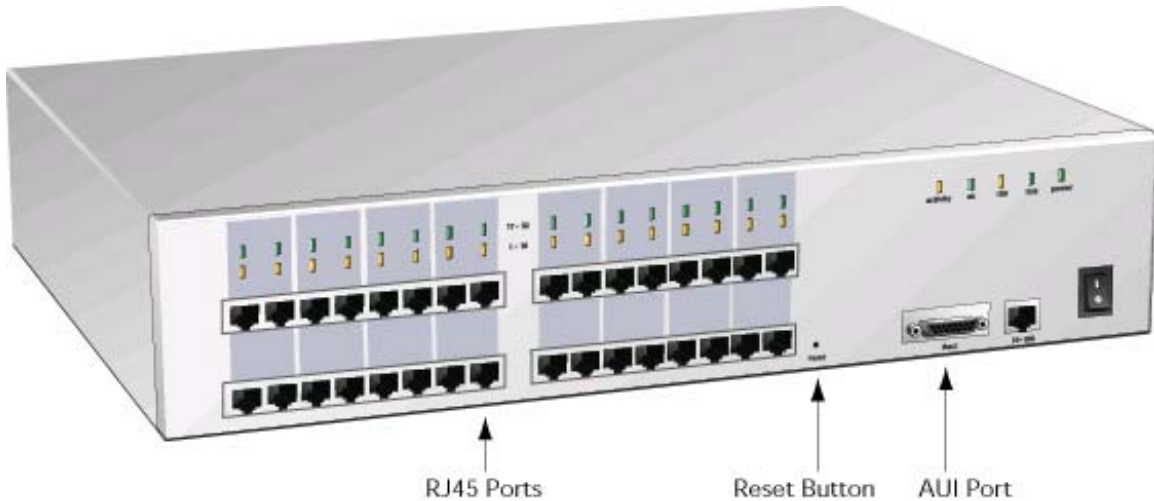

Note: The Reset button returns the SCS to its factory default configuration when you press and hold it during the power-up and boot process. Resetting to factory default will enable DHCP.

Pinouts

The SCS3200 has 32 asynchronous RJ45 serial ports. The SCS1600 has 16 asynchronous RJ45 serial ports. Pinout information for these ports is discussed in the following sections.

RJ45 Serial Connectors

Lantronix servers are RS-423 compliant and are thus limited by the equipment at the remote end of the serial line. If the SCS is connected to an RS-232 device, it is subject to the RS-232 limits shown below. If connected to an RS-423 device, it is subject to the RS-423 limitations.

RS-232 lines are limited to 15m (50 ft) in length at 9600 baud, and 2 m (6 ft) at 115.2K baud. RS-423 lines are limited to 300m (1000 ft) at 9600 baud, 85m (260 ft) at 115.2K baud, and 40m (120 ft) at 230.4K baud. They will generally work at longer lengths.

The pinout of the serial ports is displayed below.

RJ45 Serial Connector

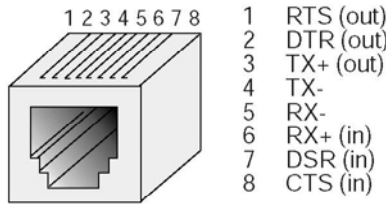

RJ45 to DB25

If you are connecting an RJ45 port to a DTE device (such as a terminal) that has a DB25 connector, you will need to use an RJ45-DTE DB25 adapter. To connect an RJ45 port to a DB25 connector on a DCE device, you will need an RJ45-DCE DB25 adapter. The pinout information for both connections is shown below.

Pinouts of RJ45-DB25 Connections

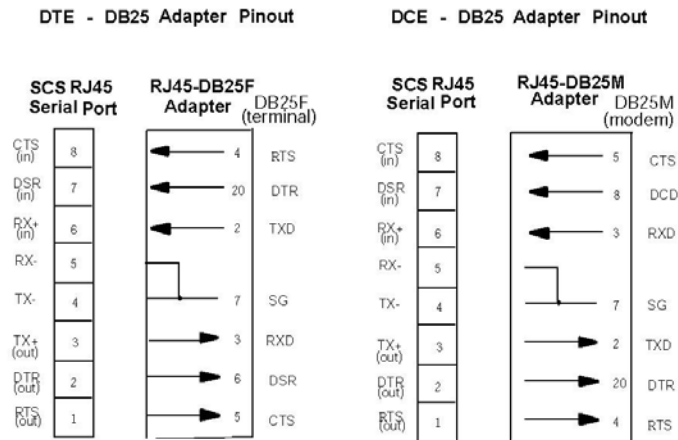

RJ45 to DB9

The arrows in the figure below represent the direction of the signal. Both the transmit and receive ground signals on the SCS connector are wired to the signal ground on a DB9 adapter.

RJ45-DTE DB9 Adapter

**SCS RJ45
Serial Port**

| | |
|--------------|---|
| CTS (in) | 8 |
| DSR (in) | 7 |
| RX+ (in) | 6 |
| RX- | 5 |
| TX- | 4 |
| TX+ (out) | 3 |
| DTR (out) | 2 |
| RTS (out) | 1 |

**RJ45-DB9F
Adapter**

DB9F
(terminal)

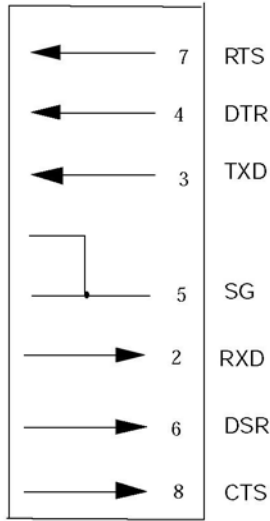

Cables and Adapters

Lantronix offers the following accessory cables and adapters for use with the SCS products. Contact Lantronix for details.

Lantronix Cable Part Numbers

| Part | Description |
|----------|--|
| 500-101 | Cable: 6' (1.8M) RJ45 to DB9 Male connects to DCE Device (modems, csu/dsu, etc.) |
| 500-102 | Cable: 6' (1.8M) RJ45 to DB25 Male connects to DCE Device (modems, csu/dsu, etc.) |
| 500-103 | Cable: 6' (1.8M) RJ45 to DB9 Female connects to DTE Device (terminals, printers, console ports, etc.) |
| 500-104 | Cable: 6' (1.8M) RJ45 to DB25 Female connects to DTE Device (terminals, printers, console ports, etc.) |
| 500-137 | Cable: 10' (3M) RJ45-RJ45 Rolled |
| | |
| 200.0062 | Cable: 6.6' (2M) RJ45 to RJ45 Cat5 |
| 200.0063 | Cable: 16.4' (5M) RJ45 to RJ45 Cat5 |
| 200.0064 | Cable: 32.8' (10M) RJ45 to RJ45 Cat5 |
| 2000065 | Cable: 49.2' (15M) RJ45 to RJ45 Cat5 |
| 200.0112 | Cable: 100' (30M) RJ45 to RJ45 Cat5 |

Adapters listed below are pinned for use with straight through Cat5 cable.

Lantronix Adapter Part Numbers

| Part | Description |
|-----------|--|
| 200.2066A | Adapter: RJ45 to DB25M DCE for ETS, SCSxx00, SCSxx05 |
| 200.2067A | Adapter: RJ45 to DB25F DCE for ETS, SCSxx00, SCSxx05 |
| 200.2069A | Adapter: RJ45 to DB9M DCE for ETS, SCSxx00, SCSxx05 |
| 200.2070A | Adapter: RJ45 to DB9F DCE for ETS, SCSxx00, SCSxx05 |
| 200.2071 | Adapter: RJ45 to DB25M DTE for ETS, SCSxx00, SCSxx05 |
| 200.2072 | Adapter: RJ45 to DB25F DTE for ETS, SCSxx00, SCSxx05 |
| 200.2073 | Adapter: RJ45 to DB9M DTE for ETS, SCSxx00, SCSxx05 |
| 200.2074 | Adapter: RJ45 to DB9F DTE for ETS, SCSxx00, SCSxx05 |
| 200.2225 | Adapter: RJ45 to RJ45 Rolled Coupler |

Specifications

Power

The unit can operate using 100 to 240 Volts AC without switches or jumpers.

| | |
|-------------------|---|
| Voltage | 95 to 250 Volts AC 3-wire single phase, autoranging |
| Frequency | 47 to 63HZ |
| Operating Current | 0.5 Amps (maximum) |
| Power consumption | 35 Watts |

Temperature

Note: Rapid temperature changes may affect operation. Do not operate near heating or cooling devices or areas that open to the outdoors.

| | |
|------------------|--------------------------------|
| Operating range | 5° to 50° C (41° to 122° F) |
| Storage range | -40° to 66° C (-40° to 151° F) |
| Max. temp change | 20° C (36° F) per hour |

Humidity

| | |
|-----------|---------------------------|
| Operation | 10% to 90% non-condensing |
| Ideal | 40% to 60% |
| Storage | 10% to 90% non-condensing |

Altitude

Note: For operations above 2.4 km (8,000 ft), decrease the operating temperature rating by 1.8°C for each 1,000 m (1°F for each 1,000 ft).

| | |
|-----------|--------------------|
| Operation | 2.4 km (8,000 ft) |
| Storage | 9.1 km (30,000 ft) |

3: Installation

This chapter covers all of the steps needed to get the SCS online and working. EZWebCon is the preferred method for initial configuration, but this chapter also explains alternative methods such as the command line interface. The full command set is discussed in the *SCS Reference Manual*. **Before you begin**, consider the following points:

- ◆ The IP address must be configured before any TCP/IP functionality is available. You cannot use the web browser interface until an IP address is assigned.
- ◆ Most configuration commands require privileged user status. You must enter the **Set Privileged** command to become the privileged user. The default privileged password is **system**.

Connecting the SCS

Your SCS should be rack mounted in a secured environment. Refer to the following illustration of a typical installation.

Installation Overview

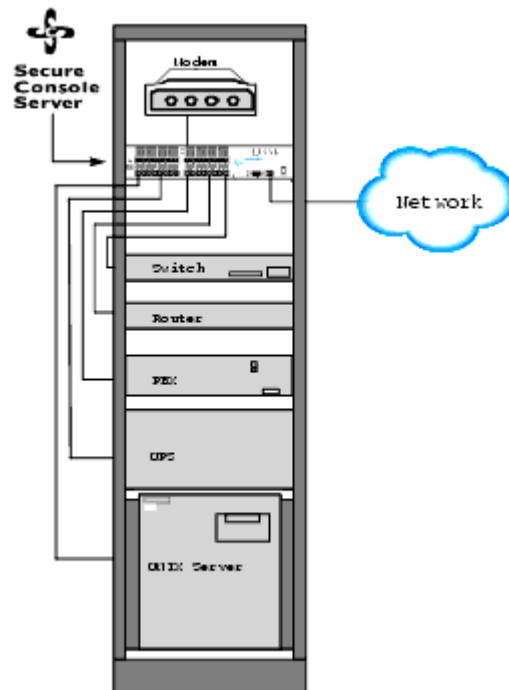

1. Mount or place the SCS in a secure location.
2. Connect your active serial devices to the SCS's RJ45 serial connectors.
3. Connect the Ethernet network to the SCS via the 10/100BASE-T port **or** the AUI port, not both ports.
4. Connect the power cord to a power outlet.
5. Set the power switch to **ON**.
6. Confirm the following:
 - a) The green Power LED lights up immediately.
 - b) After about 20 seconds, the green Link LED lights up.
 - c) After about 30 seconds, the green OK LED blinks every two seconds.

Assigning an IP Address

You must assign an IP address to the SCS before you can perform any configurations. We recommend you use the first method listed below, EZWebCon.

EZWebCon Method

EZWebCon is the recommended method for initially configuring the SCS. EZWebCon is located on the distribution CD-ROM. Installation instructions are provided in the README file.

Use the following steps to assign an IP address using EZWebCon:

1. Start EZWebCon.
2. On the menu bar, click **Action** → **Assign IP Address**. The Assign IP address – Select Device window displays.



3. Select the SCS that appears in the next window and click **Next**. The Assign IP address -Assignment Method Select window displays.

Select the Assignment Method

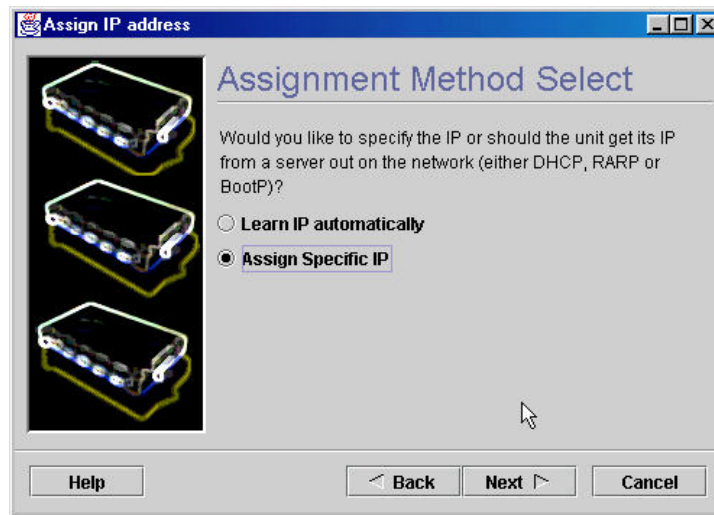

4. Select **Assign Specific IP** and click **Next**. The Assign address – IP Settings window displays.

Enter IP Settings

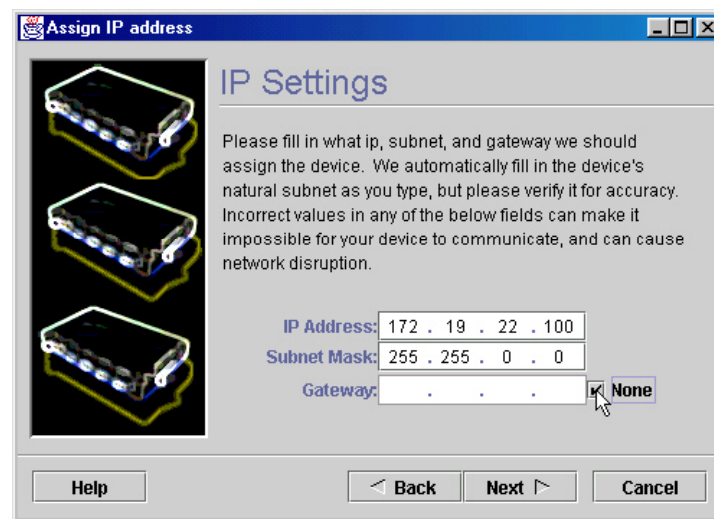

5. Enter the IP-related settings:
 - a) For **IP Address**, enter the desired IP address.
 - b) For **Subnet Mask**, change the values provided only if you wish to use a mask other than the default. The default value should be correct in most cases.
6. For **Gateway Address**, select **None**.
7. Click **Next**. The Assign IP address – Assignment Status window displays.

Assign IP

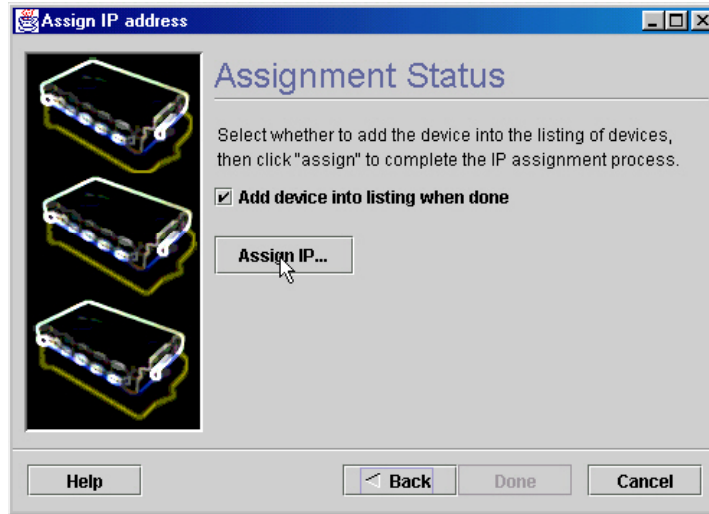

8. Click the **Assign IP...** button.
9. Wait for instructions from EZWebCon.

For assistance once EZWebCon is running, refer to EZWebCon's online help.

DHCP Method

If DHCP is enabled on the SCS, the SCS will accept an IP address, gateway address, and subnet mask from a DHCP host. DHCP can be enabled or disabled with the following command:

Set/Define Server DHCP [Enabled | Disabled]

DHCP is disabled in production. Resetting the unit to factory defaults via the reset button, command line, or web interface will enable DHCP. (See page.3-1for information on resetting hardware or page 5-5 for information on the Flush NVR command.)

Command Line Method

To assign an IP address to the SCS via a terminal:

1. Attach a terminal to the first serial port (port 1) and press **Enter**. You see a **Local>** prompt at which you can enter configuration commands.
2. Once you are connected, become the privileged user and enter the **Define IP IPaddress** command.

Note: The default privileged password is **system**.

Entering IP Address at Local Prompt

```
Local> SET PRIVILEGED
Password> system (not echoed)
Local>> DEFINE IP IPADDRESS 192.0.1.228
```

3. Reboot the SCS for the IP address to take effect.

4. If the SCS encounters an Ethernet network problem while booting, it sends an alert message to port and waits ten seconds to detect serial port activity before attempting to finish booting. If you press **Enter** when the error message is displayed, you will access the **Boot>** prompt.

Note: For more information on Boot Configuration Program (BCP) commands, see [Troubleshooting](#).

ARP and Ping Method

The ARP/ping method is available under UNIX and Windows. If the SCS has no IP address, it sets its address from the first directed IP packet it receives.

When the SCS receives the ping packet, it notices that its IP address is not set and sends out broadcasts to see if another node is using the specified address. If no duplicate is found, the SCS uses that IP address and responds to the ping packet.

UNIX Host

1. Create an entry in the host's ARP table and substitute the SCS's hardware address and intended IP address.
2. Ping that IP address. This process typically requires super-user privileges.

Entering ARP and Ping (UNIX)

```
# arp -s 192.0.1.228 00:80:a3:xx:xx:xx
% ping 192.0.1.228
```

Windows Host

1. Type **ARP -A** at the DOS command prompt to verify that there is at least one entry in the ARP table.
2. If there is no other entry beside the local machine, ping another IP machine on your network to build the ARP table. This has to be a host other than the machine on which you are working.
3. Use the following commands to ARP the IP address to the SCS and make the SCS acknowledge the IP assignment.

Entering ARP and Ping (Windows)

```
C:\ ARP -s 192.0.1.228 00-80-A3-XX-XX-XX
C:\ PING 192.0.1.228
```

Note: If the ARP command works, replies from the IP address display.

Changing the IP Address Permanently

With the ARP method, the SCS does not save the learned IP address permanently. This procedure is just a temporary measure to enable a web browser or allow an administrator to Telnet into the SCS. Once logged in, the administrator can enter the **Define IP IPaddress** command to make the address permanent.

Changing the IP Address

```
% telnet 192.0.1.228 7000

# access (not echoed)

Lantronix Version n.n/n (yymmdd)
Type Help at the `Local_>' prompt for assistance.

Username> [gopher]
Local> SET PRIVILEGED
Password> system (not echoed)
Local>> DEFINE IP IPADDRESS 192.0.1.228
```

Note: The default login password is **access**. The default privileged password is **system**. After you have entered both passwords and gained access, change those passwords from their default settings.

BOOTP or RARP Reply Method

A host-based BOOTP or RARP server can provide information for the SCS to use to configure an IP address. See the host-based documentation pages for configuration information. Keep in mind that many BOOTP daemons do not reply to a BOOTP request if the download file name in the configuration file does not exist. If this is the case, create a file in the download path to get the BOOTP daemon to respond.

BOOTP and RARP are enabled by default on the SCS. If you wish to disable them, use the **Define Server BOOTP Disabled** and **Define Server RARP Disabled** commands.

Configuring the SCS

Once you have assigned the IP address, you can configure your SCS using any of the methods discussed below:

EZWebCon Method

If you have just assigned the IP address using EZWebCon, you may want to continue using EZWebCon to launch the web browser interface for SCS configuration. The EZWebCon user interface allows you to set up menus and change passwords without needing to know commands.

Once the IP address for your SCS is set, perform the following steps to launch the web browser interface from EZWebCon.

1. Click to select the device you wish to configure.
2. On the menu bar, click **Action → Manage**. This action launches the web browser interface to your device.

Authentication on the Web Browser Interface

Lantronix - Authentication for SCS_57065A - Microsoft Internet Explorer

File Edit View Favorites Tools Help

Address http://172.19.21.51/

Server: Lantronix SCS3200
SCS_57065A at 172.19.21.51

Authentication Required

Non-privileged pages still require a login-level authentication.

Username:

Password:

3. Type **login** (default username) in the **Username** field and **access** (default login password) in the **Password** field.
4. Click the **Login** button. The Server Configuration window displays.

Server Configuration Window

Lantronix Web Manager - Microsoft Internet Explorer

File Edit View Favorites Tools Help

Address http://172.19.21.51/index.html

[Hardware](#) [Email](#)

LANTRONIX

SCS3200

Quick Setup:
[Users](#)
[Authentication](#)
[Menu](#)
[Modems](#)
[Dial-Out](#)
[Port Tunnelling](#)

Advanced Settings:
[Ports](#)
[Logging](#)
[Email](#)
[Services](#)
[TCP/IP](#)
[IP Routing](#)
[Sites](#)
[Server](#)

[Stats & Counters](#)
[Tech Support](#)
[Home](#)

SERVER CONFIGURATION:

Server Name: SCS_57065A
 Boot Code Version: V1.2 (Jun 15, 2001)
 Firmware Version: Version B2.0/305(030617)
 Uptime: 9 Days 04:18
 Hardware Address: 00-80-a3-57-06-5a
 IP Address: 172.19.21.51
 Subnet Mask: 255.255.0.0

SSH STATUS: Available

SERVICES AVAILABLE:

| | | |
|----------|---------|-----------|
| serial26 | Port 26 | Available |
|----------|---------|-----------|

PORTS:

| # | Name/Log | Access | Status | Connect |
|---|----------|---------|--------|------------------------|
| 1 | Port_1 | Dynamic | Idle | Telnet |
| 2 | Port_2 | Dynamic | Idle | Telnet |
| 3 | Port_3 | Remote | Idle | Telnet |
| 4 | Port_4 | Dynamic | Idle | Telnet |
| 5 | Port_5 | Dynamic | Idle | Telnet |
| 6 | Port_6 | Dynamic | Idle | Telnet |
| 7 | Port_7 | Dynamic | Idle | Telnet |

5. Select a link from the left navigation column to configure the SCS. The root (privileged) level authorization window displays.

Root Level Authentication

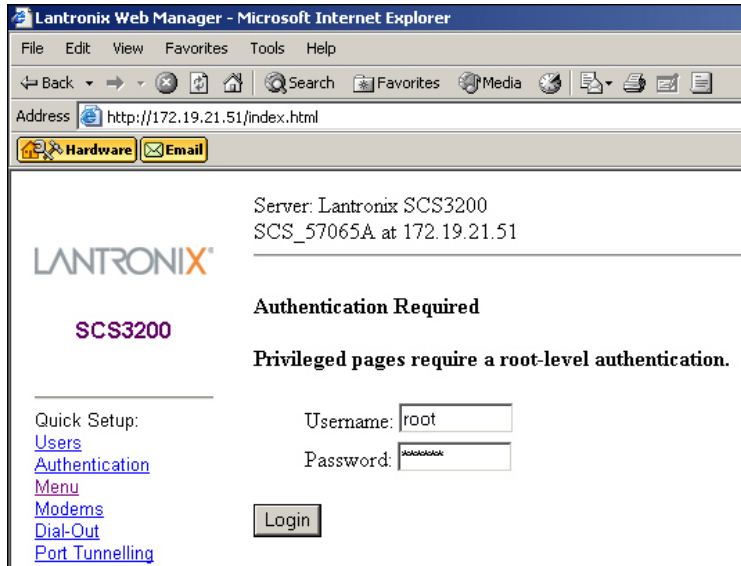

6. Type **root** in the **Username** field and **system** (default privileged password) in the **Password** field. (If a “remember password” popup window displays, select **No** and re-enter the password if necessary.)
7. Click the **Login** button. The desired configuration page displays.

Note: For added security, change the login and privileged passwords from their default settings. You can set both passwords in the Server section of the web pages.

Web Browser Method

To launch the web browser interface outside of EZWebCon, open a standard browser and enter the SCS's IP address (for example, <http://172.19.21.51>) or resolvable text name into the URL/Location field. Follow the login process starting with step 3 in [EZWebCon Method above](#).

Sample Web Browser Login



Telnet Login Method

Standard Telnet connections are not encrypted and pose a security risk. Incoming Telnet and SSH (Secure Shell) are enabled by default to allow TCP/IP connections.

To form a Telnet connection to the SCS:

1. Enter the Telnet command followed by the SCS's IP address, a space, and 7000.
2. Enter the login password. The default login password is **access**. Until authentication is configured and users are added, any username works.

Forming a Telnet Connection

```
%telnet 192.0.1.88 7000

#access (not echoed)

Lantronix SCS Version n.n/n (yyymmdd)

Type Help at the 'Local>' prompt for
assistance.

Enter Username>
```

Command Line Method

To monitor or configure the SCS via a terminal, attach a terminal to the serial port (port) and press **Enter**. You will see a **Local>** prompt at which you can enter configuration commands. See the *SCS Reference Manual* for a complete list of available commands.

Note: For overall help, type and enter **Help** in a command line. For information regarding a specific command, type and enter **Help <command>**. For information regarding a command you do not fully know, type and enter the partial command followed by a question mark as follows: **Help <xxx?>**.

4: Application Setup

This chapter describes how to configure or use:

- ◆ [Login Banner Pages](#)
- ◆ [Menus](#)
- ◆ [Remote User Dial-Up](#)
- ◆ [Break Sequences](#)
- ◆ [Event Port Logging and Email Notification](#)
- ◆ [Dial-Out ISP Connection](#)
- ◆ [SSH Connections](#)

Login Banner Pages

Banner Pages allow you to display text messages to users before and after authentication. Banner text information is taken from two files named **prelogin.txt** and **postlogin.txt** stored in the **/ram** or **/flash** directory on the SCS. The SCS does not store or display files stored in the **/ram** directory after rebooting.

To implement login and logout banner text:

1. Create text files named **prelogin.txt** and/or **postlogin.txt**.
2. FTP to the IP address of the SCS.
3. Log in with the username **root** and enter the privileged password (**system** by default).
4. Change directories to **/flash**.
5. “**Put**” the text files into the desired directory.
6. Reboot the SCS.

Subsequent users logging in or out of the SCS see the text in the **prelogin.txt** and **postlogin.txt** files, respectively. The standard company/product/version banner displays if either of these two files is not present in the SCS.

7. To configure an external serial modem, attach the modem to any serial port and

Menus

Connecting

The SCS console server allows you to remotely manage devices and equipment from anywhere on the network or from a remote dial-in through an attached modem. To use the SCS as a console server, connect its serial ports to the serial console/management ports of equipment such as UNIX servers, PBX switches, routers, network switches, or other similar devices.

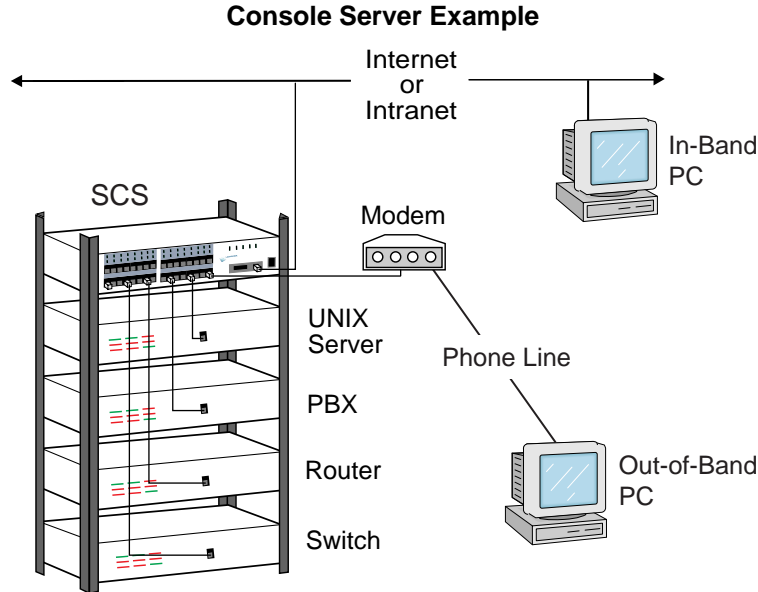

Once you have completed the physical connections, you can establish an SSH or Telnet connection to the SCS's IP address and socket number of the desired port.

The SCS's serial ports allow three types of socket connections: SSH connections at socket 22xx, Telnet IAC interpretation at socket 20xx, and raw TCP connections at socket 30xx, where xx is the port number. For example, to open a Telnet connection to port 2 of an SCS at IP address 192.0.1.168, issue the command **telnet 192.0.1.168 2002** from your system prompt.

Note: The syntax for SSH connections depends on your SSH client software.

Enabling Menu Mode

If others need to access devices attached to the SCS, but you wish to limit their options, use menu mode. Menus allow users to access often-used hosts and services without needing to know command syntax, the IP address of the non-local devices, or the socket numbers involved. You can enable menu mode on either individual serial ports or on **port 0** (the network port template) so users who Telnet to the SCS see the configured menu rather than the **Local>** prompt.

When menu mode is enabled, a user who logs in to an SCS port (or, if menu mode is enabled for port 0, a user who Telnets to the SCS) sees a menu listing various descriptive entries. Each menu entry corresponds to a command. For example, selecting option 4 from the following menu connects the user to the SCS **Local>** prompt.

Sample Menu

| | |
|--------------------------|------------------|
| Lantronix Console Server | |
| 1) Cisco Router | 4) Local> Prompt |
| 2) Sun Server | 5) Logout |
| 3) Linux Server | 6) |
| Enter Selection: | |

For a single global menu, the system administrator defines menus using the menu configuration web page. For multiple, group, or nested menus, the system administrator defines menu text files and uploads them to the SCS. For more information on defining menus, see the *SCS Reference Manual*.

Creating the Menu

Create a menu with the web browser interface by performing the following steps:

1. Click the **Menu** link under the Quick Setup options.

Menu Settings

LANTRONIX
SCS3200

Quick Setup:
[Users](#)
[Authentication](#)
[Menu](#)
[Modems](#)
[Dial-Out](#)
[Port Tunnelling](#)

Advanced Settings:
[Ports](#)
[Logging](#)
[Email](#)
[Services](#)
[TCP/IP](#)
[IP Routing](#)
[Sites](#)
[Server](#)

[Stats & Counters](#)
[Tech Support](#)
[Home](#)

MENU SETTINGS:
Specify a filename for Menu Settings, or enter individual items below.

Filename:

Title:

| Item | Description | Command |
|------|------------------------|----------------------|
| 1 | Cisco Router | telnet 172.19.21.56 |
| 2 | Sun Server | telnet 172.19.o.80 |
| 3 | Linux Server | connect local port_3 |
| 4 | Local Prompt | exit |
| 5 | Logout | logout |
| 6 | Resume Last Session | resume |
| 7 | isconnect Last Session | disconnect |
| 8 | | |
| 9 | | |
| 10 | | |
| 11 | | |
| 12 | | |

2. Enter a title for your menu in the **Title** field.
3. Create menu entries by entering a description, which will be displayed in the menu, and a corresponding command that will be run when that entry is selected.

Each menu entry can do **one** of the following:

- ◆ Connect to a device on the network using a Telnet command.

Telnet Menu Entry

| Item | Description | Command |
|------|--------------|---------------------|
| 1 | Cisco Router | telnet 172.19.21.51 |

- ◆ Connect to a device attached to the SCS with a **Connect Local Port** command. The port is the port name listed in the SCS, such as port_2.

Connect Local Menu Entry

| | | |
|---|--------------|----------------------|
| 3 | Linux Server | connect local port_3 |
|---|--------------|----------------------|

- ◆ Access a local service on the SCS with a general SCS command.

Local Service Menu Entry

| | | |
|---|-------------------------|------------|
| 4 | Local Prompt | exit |
| 5 | Logout | logout |
| 6 | Resume Last Session | resume |
| 7 | Disconnect Last Session | disconnect |

Note: The **Exit** command, which only works in menu mode, allows users to return to the SCS **Local>** prompt. It is helpful to include this command in your menus until you have fully tested them--otherwise there is no way for users on menu mode ports to return to the **Local>** prompt. To return to the menu from the **Local>** prompt, type **menu**.

4. Click the **Update** button to save the menu settings.

Using Menu/Connection Commands

You can change a port name to reference the type of device that port is connected to. For example, a port attached to a router could be named **router**. To change the name of a port, open the configuration page for that port (**Ports** → **Configure**) and enter the new name in the **Port Name** field.

Changing the Port Name

| | |
|------------|--------|
| Port Name: | Router |
|------------|--------|

You can enter more than one command in the **Command** field by separating each command with a semicolon (;). The most common use of this is in the form:

connect {local or remote} portname;command

for example: **connect local port_2;disconnect**.

This command can be shortened to **con loc port_2;disc**. The **disconnect** command closes the connection to that port when you return to the menu.

The SCS has default hot keys defined for Telnet connections to a port or from the menu. To change the default hot key; see the *SCS Reference Manual*.

Ctrl+L: Allows you to jump back to the menu from a port connection.

Ctrl+F: Allows you to jump forward to another connect session.

Ctrl+B: Allows you to jump backward to a previous connect session.

Ctrl+Y: Allows you to send a break from a Telnet or SSH connection. (The SCS will not cause unintentional breaks that can halt a Sun Solaris server.)

If you would like to open more than one port connection and jump between those connections, remove the **disconnect** command from your menu entry. Then, use the default hot keys to return to the menu (**Ctrl+L**) and select another connection. Once more

than one connection is open, you can jump between connections using the **Ctrl+B** and **Ctrl+F** hot keys.

Note: If you do not include the **disconnect** command in the menu entry, you must manually disconnect each session using the **disconnect** command at the **Local>** prompt or from a menu selection. An alternative is to enable *Inactivity Logout* on each port to automatically logout a port. See the *SCS Reference Manual* for additional information.

To switch between several connections from a serial port using a terminal, you must configure four things on the serial port configuration pages: the **Local** switch, **Forward** switch, **Backward** switch, and the **Break Control** setting (which must be changed from **Local** to **Remote**).

Enabling Menu Mode for a Port

For a port to use the menu you just configured, you must enable menu mode for that port. Menu mode can also be enabled on port 0 for any users who Telnet to the SCS.

After you define and save all menu items, perform the following steps to enable menu mode.

1. Click the **Ports** link under Advanced Settings.

Serial Port Page

| PORTS: | | | |
|--------|-----------------------|---------------|--|
| 0 | Network Port Template | | Configure |
| 1 | Local Mode | (Serial Port) | Configure Clone settings |
| 2 | Idle | (Serial Port) | Configure Clone settings |
| 3 | Idle | (Serial Port) | Configure Clone settings |
| 4 | Idle | (Serial Port) | Configure Clone settings |
| 5 | Idle | (Serial Port) | Configure Clone settings |
| 6 | Idle | (Serial Port) | Configure Clone settings |
| 7 | Idle | (Serial Port) | Configure Clone settings |
| 8 | Idle | (Serial Port) | Configure Clone settings |
| 9 | Idle | (Serial Port) | Configure Clone settings |
| 10 | Idle | (Serial Port) | Configure Clone settings |
| 11 | Idle | (Serial Port) | Configure Clone settings |
| 12 | Idle | (Serial Port) | Configure Clone settings |
| 13 | Idle | (Serial Port) | Configure Clone settings |
| 14 | Idle | (Serial Port) | Configure Clone settings |

2. Click the **Configure** link next to the desired serial port.
3. Check the **Menu** checkbox.

Enabling Menu Mode

The screenshot shows the 'SERIAL PORT SETTINGS' section of the Lantronix SCS3200 configuration page. The 'Menu' checkbox is checked, indicating that menu mode is enabled for the selected port (Port 2). Other settings include Speed: 9600, Char: 8, Stop: 1, Parity: none, Access: dynamic, and Flow: xonxoff. A list of quick setup options is visible on the left, including Users, Authentication, Menu, Modems, Dial-Out, and Port Tunnelling.

4. Click the **Update Port Settings** button.
5. If desired, enable menu mode on other ports by repeating these steps.

Using the Menu

Once you have both configured the menu and enabled menu mode on a port, you can test the menu by forming a Telnet connection to that port.

When you log into a port with menu mode enabled, you are presented with an initial login screen.

Login Screen

```
Lantronix SCSxx Version B3.6/3 (000410)

Type HELP at the 'Local> ' prompt for
assistance.

Username>
```

1. Enter your user name (in this case, user) and press **Enter**.

Login Screen, part 2

```
Username> user

Press <CR> to continue...
```

2. As instructed, press **Enter** once more to see the actual menu.
3. Type the number of the desired menu option and press **Enter**. For example, to connect to the Linux server, type **3** and then press **Enter**.

Remote User Dial-Up

Dial-up access to the SCS can be accomplished either using a data-link protocol, typically PPP, or using an ASCII-based terminal connection with a terminal emulation application such as HyperTerminal.

Connectivity to the SCS from a remote location requires that you create a user account, connect and configure a modem, enable authentication, and specify an IP address range for use during remote sessions.

To configure your SCS for remote user dial-up:

1. Create a user account.
 - a) From the Quick Setup column on the left, select **Users**.
 - b) Enter the user name and click **Create**.
 - c) Click the **Configure** link next to the user name.
 - d) Enter a password in the **Password** field.
 - e) For a PPP connection, type **set PPP** in the **Login Command** field.
 - f) For a terminal emulation connection to the console menu, enter menu in the **Login Command** field.
 - g) For a terminal emulation connection to the local SCS prompt, leave the **Login Command** field blank.
 - h) Click the **Update** button.

Creating a User Account

LANTRONIX
SCS3200

Quick Setup:
[Users](#)
[Authentication](#)
[Menu](#)
[Modems](#)
[Dial-Out](#)
[Port Tunnelling](#)

Advanced Settings:
[Ports](#)
[Logging](#)
[Email](#)
[Services](#)
[TCP/IP](#)
[IP Routing](#)
[Sites](#)
[Server](#)
[Stats & Counters](#)

USER CONFIGURATION:

Username: bob

Password: [masked]

User can alter password:

Expire user's password now:

Login Command: [text box]

Example login commands
 Remote Dialup Users: SET PPP
 Menu Users: MENU

Port Restrictions

Serial logins allowed on ports: All

Network/local connects allowed to ports: All

Serial logins are character/modem/PPP sessions.
 Network/local connects are TCP socket (20xx, 30xx, SSH)
 and Connect Local commands from a command line.
 Use All or None for all or no ports, respectively.

Update

2. Follow these steps:
 - a) Click the **Modem** link.
 - b) Click the **Configure** link for the port with the attached modem.
 - c) Select the modem type from the drop-down list.

- d) If you want to enable authentication, check the **Authenticate Users** box.
- e) Click the **Update** button.

Note: If you inserted a PC-card modem while the SCS was powered up, you need to restart the SCS.

3. Specify an IP Pool address range for remote users:
 - a) Click the **Modems** or **Back to Modems** link.
 - b) Enter the IP pool address range for remote users.

Note: The IP pool range must be in the same subnet range as the SCS IP address and cannot be used by any other device on the network. If only one modem is connected to the SCS, then only one IP address is required for the pool. For this configuration, enter the same IP address in the **Start** and **End** fields.

4. Reboot the SCS for the pool range settings to take effect.

Break Sequences

This section describes how to specify serial breaks and alternate break sequences.

Serial Breaks

Break conditions originating from serial connections are controlled on a per port basis. Break conditions originating from incoming Telnet and SSH connections are based on the settings for port 0, the network (template) port.

You must define where the break condition will be processed using the **Set/Define Port Break [Local | Remote]** command for each serial port and port 0.

The default break sequence for port 0 is **<Ctrl+Y>**. There is no default break sequence for the serial ports.

Alternate Break Sequences

You can additionally specify an alternate break (AltBreak) character for use with terminals that cannot natively generate a break condition and for Telnet or SSH clients that cannot generate break IAC sequences. The syntax for specifying an AltBreak sequence is:

Set/Define Port Break Character [<char> | None]

where **<char>** is a single character enclosed in quotes. You can specify non-printable characters using the notation **\xx**, where xx is the hexadecimal representation for the desired character. The **Show Port** command displays the current setting.

The table below shows some examples to help you understand how the SCS handles breaks.

Examples of Alternate Break Sequences

| If | And | Then |
|--|--|--|
| The user Telnets to a remote network host from a local (SCS) serial port | The serial port is set to Break = Local | The AltBreak sequence returns the user to a local (SCS) command prompt. |
| | The Serial port is set to Break = Remote | The AltBreak sequence causes the SCS to transmit a Telnet Break IAC sequence to the remote host. |
| The user issues a Connect Local command to another serial port from a local (SCS) serial port | The user serial port is set to Break = Local | The AltBreak sequence returns the user to a local (SCS) command prompt. |
| | The user serial port is set to Break = Remote | The AltBreak sequence causes a break condition to be generated to the target port. <i>Note: The target port's break settings do not apply or affect this situation.</i> |
| The user Telnets to the SCS Local> prompt and issues a Connect Local command to a serial port | Template port 0 is set to Break = Local | The AltBreak sequence returns the user to a local (SCS) command prompt. |
| | Template port 0 is set to Break = Remote | The AltBreak sequence causes a break condition to be generated to the target port. <i>Note: The target port's break settings do not apply or affect this situation.</i> |

Modem Mode

Modem mode allows the SCS to emulate a modem for performing network connections. To configure specific ports to emulate modems, use the following command:

Set/Define Port <n> Modem Emulation [Enabled | Disabled]

When the port is in modem mode, the following modem commands are available:

Modem Mode Commands

| Command | Function |
|---------------------|---|
| ATC | Provides passthru to the normal CLI |
| ATDT ipaddress | Forms a TCP connection |
| ATE _x | Enables or disables echo command: 0 = echo off 1 = echo on (default) |
| ATH | Hangs up (disconnects) network session |
| ATI | Displays software version information |
| ATQ _x | Enables or disables result codes: 0 = result codes on (default) 1 = result codes off |
| ATS[xx=yy] | Sets/shows register: 0: 0 means ATA answers; otherwise SCS autoanswers All other registers are unimplemented. |
| ATS _{xx} ? | Shows register value |
| ATV _x | Bit 0 sets response type: 0 = numeric responses 1 = text responses (default) Bit 1 sets response to unknown AT commands: 0 = do not accept unknown AT commands 1 = do accept unknown AT commands (default) |
| ATX[_y] | Accepted and ignored |
| ATZ | Restores settings from NVR |
| AT&F | Resets modem NVR to factory settings |
| AT&V | Views current and NVR settings |
| AT&W | Writes settings to NVR |
| AT&Z | Restores settings from NVR |

The SCS holds DTR low until it forms a valid network session. The attached device can then monitor the SCS DTR output by tying it to its CD input. In addition, the SCS has DSRLLogout enabled, so if the attached device drops its DTR, the network connection terminates, and the serial port logs out.

Event Port Logging and Email Notification

You can configure each SCS serial port to store its console output in a log file. If email notification is also enabled, a system administrator receives an email through an SMTP mailserver if the connected device reboots or otherwise produces a burst of console output.

To enable email notification, configure the features discussed in the following sections. For more information on any of these features, see the *SCS Reference Manual*.

To enable port event logging:

1. Click the **Ports** link under Advanced Settings.

- Click **Configure** next to the desired serial port. The Serial Port Settings window displays.

Serial Port Settings

- Enable port logging (also referred to as serial logging) by changing the **Serial Log Size** from 0 to any number between 1 and 250 Kbytes.

Enabling Serial Logging and Email Events

Serial Log Size: Kbytes Email Events

This setting creates a log file on the /ram disk in the format **/ram/Port_xx.log** where xx is the port name and changes the specified port to access remote.

- Click the **Email Events** checkbox. This setting enables email notification for the serial log.
- Click the **Update Port Settings** button to save changes.
- When a port that has **Email Events** enabled receives a burst of 20 or more characters in its serial log, the port buffers incoming data for up to 25 seconds or until the log file reaches 1500 bytes before sending the contents of the file via email.

Creating an Email Site

Once port buffering is enabled, configure an email site for that port. An **email site** contains the information necessary to generate and send an email message at any system crash.

Note: Email sites are not related to the sites used by the SCS to manage connections. Sites are discussed in the SCS Reference Manual.

To create an Email site using the web browser interface:

1. Click the **Email** link under Advanced Settings.
2. Choose a port from the **Create Email Site** pull-down menu. You can also select a default. The settings for the default email site are used if a port-specific email site is not completely configured.
3. Click the **Create** button.
4. Configure the email site:
 - a) In the **To** field, enter the email address for the recipient. To enter a series of email addresses, separate each address with a comma. The maximum number of characters for this field is 64.
 - b) In the **From** field, enter the text to be displayed in the **From** field of the email message. The maximum number of characters for this field is 32.
 - c) In the **Mailhost** field, enter a valid SMTP mailhost. The mailhost can be either a numeric IP address or, if a nameserver and domain name are configured, a hostname. The maximum number of characters for this field is 24.
 - d) In the **Reply-to** field, enter an email address that will receive any responses to the email message. The maximum number of characters for this field is 32.
 - e) In the **Subject:** field, enter the text that will be displayed in the subject line. The maximum number of characters for this field is 48.

Configuring an Email Site

| EMAIL SITE SETUP: | |
|-------------------|--|
| PORT2 | In order for Serial Events on port 2 to be emailed to this site, the Port Log size must be > 0, and Email Serial Events must be enabled. |
| Log Size: | <input type="text" value="250"/> k <input checked="" type="checkbox"/> Email Events |
| To: | <input type="text" value="admin@host.com"/> |
| From: | <input type="text" value="scs3200@host.com"/> |
| SMTP Host: | <input type="text" value="mail.host.com"/> |
| Reply-to: | <input type="text" value="sysman@host.com"/> |
| Subject: | <input type="text" value="Error from server port 2"/> |

5. Click the **Update** button to save changes.

Dial-Out ISP Connection

In some cases, you may require the SCS to connect to an ISP to access email or the Internet. You can configure the SCS to automatically connect to an ISP and accept a dynamically assigned IP address from the ISP.

When you configure a dial-out ISP connection using the web browser interface, a site named **outgoing** is created. Once the site is properly configured, outbound packets should cause the site **outgoing** to start and dial out using the modem.

1. Configure a modem to handle connections from the SCS as described earlier.
2. Click the **Dial-Out** link under Quick Setup.
3. Complete the following fields:
 - a) The **Remote Username** and **Password** for the ISP.
 - b) The **Port** that the modem is attached to (for a PC card modem, enter port 3).
 - c) The ISP's **Telephone** number.
 - d) If necessary, a static **IP Address**.

Note: Most ISPs assign a dynamic IP address. Set the IP address field on the web page to **DYNAMIC** for this situation.

- e) Specify a **Nameserver**.

Configuring a Dial-Out ISP Connection

DIAL-OUT ISP CONFIGURATION:

Remote Username:

Remote Password:

Ports: eg: 3,6-11
Configure [modems](#) on these ports.

Telephone #:

IP Address:

Nameserver:

Backup Nameserver:

Changes require a reboot to take effect
Warning! This ISP site will be the default route after reboot, and local ethernet routers will not be used. Check to make sure this default route will not conflict with any configured on the TCP/IP web page.

4. Click the **Update** button. The default route is now set to site **outgoing**.

Note: Local Ethernet routes should not be used. To share an ISP connection with the local LAN, NAT (Network Address Translation) must be used. For more information on SCS IP routing and NAT, see the SCS Reference Manual.

5. Reboot the SCS for these changes to take effect.

Com Port Redirector

The Com Port Redirector application allows Microsoft Windows-based PCs to access modems or other serial devices connected to a Secure Console Server as if those serial devices were local Comm ports. The Redirector creates virtual comm ports and intercepts communications from existing device software, then redirects those communications over the IP network to the serial ports on your SCS. The Com Port Redirector works in the background.

The Com Port Redirector software and installation instructions are included on the distribution CD-ROM or from the Lantronix web site at:
<ftp://ftp.lantronix.com/pub/redirector>

SSH Connections

Secure Shell (SSH) is a program that uses strong user authentication and encryption methods to secure communication from one host to another on a network. The SCS products support SSHv1 and the more robust SSHv2. This section describes how to configure the SCS to support either method. To use SSH you need an SSH client program on your computer.

Defining Supported SSH Connections

By default, the SCS is configured to allow both SSHv1 and SSHv2 client connections. In the default mode, the remote client is prompted to choose the version to use when an SSH connection attempt is made to or from the SCS.

You can change this setting and specify the types of SSH connections allowed from the command prompt of the SCS. Use the following syntax:

Set/Define Protocol SSH Mode [V1Only | V1Prefer | V2Prefer | V2Only]

In conjunction with the **Set/Define SSH Mode** command, you can use the following parameters

SSH Parameters

| Parameter | Effect | |
|--------------------|--|--|
| | Incoming (host to SCS) | Outbound (SCS to host) |
| V1ONLY | SCS offers only SSHv1 connections | SCS only connects using SSHv1 |
| V2ONLY | SCS offers only SSHv2 connections | SCS only connects using SSHv2 |
| V1PREFER | SCS offers both v1 and v2 and the client chooses | If both SSHv1 and SSHv2 are available, chooses SSHv1 |
| V2PREFER (default) | SCS offers both v1 and v2 and the client chooses | If both SSHv1 and SSHv2 are available, chooses SSHv2 |

If a compatible protocol version is not agreed upon (one node wants SSHv1 and the other wants SSHv2), the connection does not occur.

Creating an AUTHORIZED_KEYS File

RSA and DSA are commonly used Internet encryption and authentication systems included as part of the web browsers from Netscape and Microsoft. To use RSA and DSA user authentication for connections to the SCS, you must create an **AUTHORIZED_KEYS** file and store it in the **/flash/ssh/** directory of the SCS.

The **AUTHORIZED_KEYS** file consists of each user's public key. For example, on a UNIX host, your public key is stored in a file called **.ssh/identity.pub**. The SSH client's key generation software creates both an unreadable private key file (often called **identity**) and a human readable public key file (**identity.pub**).

Note: Not all clients come with this program. If yours does not, you may need to use the Username/Password Authentication method described below.

Once you have created a public key file:

1. Copy the contents of the public key file (**identity.pub**) to a text file.
2. Save the file with the name **AUTHORIZED_KEYS**. (**AUTHORIZED_KEYS** file names are case sensitive.)

Note: Make sure there is **no** file extension. In Windows, you may need to save the file as a .txt file and then rename the file to remove the extension.

Shared Key Authentication Process

RSA, DSA, and/or username/password authentication can be used to ensure only authorized users access the SCS and connected equipment. The following sections explain how to configure each of these.

Briefly, here's how public/private key authentication works on the SCS. We assume that the user's public/private key pair has been generated. In this example, RSA user authentication is used. DSA authentication is similar.

1. The SSH client on the user's computer sends the public half of the user's identity key to the SCS.
2. The SCS checks to see if this user's identity key is listed in the **AUTHORIZED_KEYS** (or **AUTHORIZED_KEYS2**) file on the SCS.

If the user's identity key is not listed in the **AUTHORIZED_KEYS** file on the SCS, then the authentication attempt fails. If the identity key is listed, then the process continues.

3. The SSH client then sends the private half of the user's identity key to the SCS.
4. The SCS compares the private half of the user's identity key to the key stored in the **host_rsa_key** (or **host_dsa_key**) file on the SCS.
5. If the private keys match, then the user's identity is confirmed and an SSH connection forms.

If RSA or DSA user authentication fails, the SCS prompts for a username and password (or just a password, if the SSH client forwarded the username). The user's name and password are then checked against the Radius, SecurID, or local user databases, in order of their precedence settings. (See the *SCS Reference Manual* for information on authentication precedence.)

Setting up RSA Shared Key Authentication (for SSHv1)

This procedure assumes you have generated the RSA authentication keys and copied the public half of the key pair to a file called **AUTHORIZED_KEYS** on your local computer.

1. FTP to the IP address of the SCS.
2. Log in with the username of **root** and enter the privileged password (**system** by default).
3. Change directories to **/flash/ssh/**.
4. "Put" the **AUTHORIZED_KEYS** file into that directory.
5. Reboot the SCS.

RSA Method from Unix (OpenSSH) - No Passphrase

```
sshuser@UNIXHOST /# SSH -1 SSHUSER 172.19.21.51  
  
Lantronix SCS      Version B1.0/405(011102)  
  
Type HELP at the 'Local_33>' prompt for assistance.  
Username>
```

RSA Method from Unix (OpenSSH) - with Passphrase

```
sysadmin@UNIXHOST/# -lsysadmin  
172.19.21.51  
sysadmin@172.19.21.51's password:  
Lantronix SCS200 Version B1.0/405(011102)  
Type HELP at the 'Local_34>' 'prompt for assistance  
  
Username>  
Username/Password Authentication Setup
```

New authentication keys are generated within a few minutes based on the list of authorized user public keys. A file called **host_rsa_key** contains the authorized users' private identity keys. A file called **host_rsa_key.pub** contains the authorized users' public identity keys.

As you add individual users, add their public keys to the **AUTHORIZED_KEYS** file on your workstation and FTP the updated file to the SCS.

Setting up DSA Shared Key Authentication (for SSHv2)

This procedure assumes you have generated the DSA authentication keys and copied the public half of the key pair to a file called **AUTHORIZED_KEYS2** on your local computer.

1. FTP to the IP address of the SCS.
2. Log in with the username **root** and enter the privileged password (**system** by default).
3. Change directories to **/flash/ssh/**.
4. Put the **AUTHORIZED_KEYS2** file into that directory.
5. Reboot the SCS. New authentication keys will be generated within a few minutes based on the list of authorized user public keys.

A file called **host_dsa_key** contains the authorized users' private identity keys. A file called **host_dsa_key.pub** contains the authorized users' public keys.

As you add individual users, add their public keys to the **AUTHORIZED_KEYS2** file on your workstation and FTP the updated file to the SCS.

Setting up Username/Password Authentication (SSHv1 or SSHv2)

The SCS also supports username/password authentication through an internal user database, Radius, or SecureID.

If RSA authentication fails, the SCS prompts for a username and password (or just a password, if the SSH client forwarded the username). The SCS checks the user's name and password against the Radius, SecureID, and local authentication databases, in order

of their precedence settings, if configured. You can use the SCS's web interface to configure authenticated users and set the authentication precedences.

Note: The SCS does **not** update expired local passwords or run login scripts at this point in the SSH process.

Authenticated User from Unix (OpenSSH)

```
sshuser@UNIXHOST /# ssh -l sshuser 172.19.21.51
The authenticity of host '172.19.21.51 (172.19.21.51)' can't be established.
RSA1 key fingerprint is e8:9b:7f:ee:9d:58:47:88:2e:72:a3:61:84:67:d0:d1.
Are you sure you want to continue connecting (yes/no)? yes
Warning: Permanently added '172.19.21.51' (RSA1) to the list of known hosts.

sshuser@172.19.21.51's password:

Lantronix SCS200 Version B1.0/405(011102)
Type HELP at the 'Local_33> ' prompt for assistance.

Username>
```

Forming SSH Incoming Connections (Unix and Non-Unix)

Non-Unix Platforms

To form an SSH connection from a non-Unix platform to an SCS:

1. Start your SSH client software.
2. Enter the SCS host name or IP Address and specify the public key file to use.
3. If connecting directly to a serial port on the SCS, specify the port number **22xx**, where xx is the port number.
4. If your RSA key is passphrase protected, enter your password.
5. If you are not using an RSA key, specify the username and password the SCS will use to authenticate you.

UNIX Platforms

To form a connection from Unix, your computer must have an SSH client installed (OpenSSH, for example).

1. At the command prompt enter **ssh** followed by the SCS host name or IP Address. You may also specify a username by adding a **-l (username)** or **(username)@hostname**.

Forming an SSH Connection (UNIX)

```
% ssh -l (username) (hostname or IP)
or
% ssh (username)@(hostname or IP)
```

Depending on whether your RSA key pair is passphrase protected, you may then be prompted for a password.

2. To connect to a specific SCS port, use serial port **22xx**, where xx is the port number.

Forming an SSH Connection to a Port

```
% ssh -p2202 (hostname or IP)
```

Security Enhancements

This section describes methods for increasing the security of the SCS.

Incoming Security

You can make the SCS into a highly secure host by turning off the FTP and HTTP services using the command:

```
Set/Define Proto [ HTTP | FTP ] [Enabled | Disabled]
```

Note: *The web interface will no longer be available.*

You can further restrict access to only SSH connections to the SCS command line and serial ports, using the following command:

```
Set/Define Server Incoming Secure
```

The **Server Incoming Secure** command disallows unsecure Telnet and TCP connection attempts. Access is through SSH only.

Port User Restrictions

You can constrain user access to specific ports on the SCS using the **Set/Def Authentication User** command. This command currently only affects users authenticated against the local SCS database.

To reject network connections to ports not on a user's port target list, use the command:

```
Set/Define Authentication User <username> Port Target <portlist>
```

To reject serial logins to ports not on a user's port list, use the command:

```
Set/Define Authentication User <username> Port Serial <portlist>
```

To show the user's current port restrictions, use the command:

```
Show Authentication User <username>
```

To reset the permissions back to the default, use the command:

```
Set/Define Authentication User <username> Port Factory
```

5: Troubleshooting

This chapter discusses how you can diagnose and fix errors quickly without having to contact a dealer or Lantronix. It helps to connect a terminal to the serial port while diagnosing an error to view summary messages that may be displayed.

When troubleshooting, always ensure that the physical connections (power cable, network cable, and serial cable) are secure. If you have trouble with wireless networking, it may help to connect the SCS to a wired Ethernet network to verify that it is working properly and to check the wireless settings.

Note: Some unexplained errors might be caused by duplicate IP addresses on the network. Make sure that your SCS's IP address is unique.

Technical Support

If you are experiencing an error that is not described in this chapter, or if you are unable to fix the error, you may:

- ◆ Check our online knowledge base at www.lantronix.com/support
- ◆ E-mail us at support@lantronix.com
- ◆ Call us at:
 - (800) 422-7044 Domestic
 - (949) 453-7198 International
 - (949) 450-7226 Fax

Our phone lines are open from 6:00AM - 5:30 PM Pacific Time Monday through Friday excluding holidays.

Firmware downloads, FAQs, and the most up-to-date documentation are available at: www.lantronix.com/support

Technical Support Europe, Middle East, and Africa

Phone: +49 (0) 7720 3016 57

E-mail: eu_techsupp@lantronix.com

When you report a problem, please provide the following information:

- ◆ Your name, and your company name, address, and phone number
- ◆ Lantronix SCS model number
- ◆ Lantronix SCS serial number
- ◆ Software version (use the **Show Server** command to display)
- ◆ Network configuration, including the information from a **Netstat** command
- ◆ Description of the problem
- ◆ Debug report (stack dump), if applicable
- ◆ Status of the unit when the problem occurred (please try to include information on user and network activity at the time of the problem)

LEDs

LEDs indicate serial port activity. On the SCS1600, two LEDs indicate receive and transmit activity for each serial port. On the SCS3200, a single LED does the same for each port. The five other LEDs on the right side of the unit are labeled:

- ◆ Activity
- ◆ OK
- ◆ 100
- ◆ Link
- ◆ Power

A red LED during boot mode typically signals an error, but red LED patterns during normal operations do not signal an error. Refer to the following table for an understanding of LED functions.

LED Functions

| LED | Function |
|----------|--|
| TX | Indicates that the serial port associated with this LED is currently transmitting (SCS1600 only) |
| RX | Indicates that the serial port associated with this LED is currently receiving (SCS1600 only) |
| Activity | Indicates network activity |
| OK | Indicates the general status of the SCS |
| 100 | Indicates that there is a valid 100BASE-T connection |
| Link | Indicates that the 10/100BASE-T port has established a good link |
| Power | Indicates that the SCS is currently receiving power |

Power-up Troubleshooting

Problem situations and error messages are listed in the table below. If you cannot find an explanation for your problem, try to match it to one of the other errors. If you cannot remedy the problem, contact your dealer or Lantronix Technical Support.

Problems and Error Messages

| Problem/Message | Error | Remedy |
|---|--|--|
| The SCS is connected to a power source, but there is no LED activity. | The unit or its power supply is damaged. | Contact your dealer or Lantronix Technical Support for a replacement. |
| The SCS is unable to complete power-up diagnostics. | This generally indicates a hardware fault. One of the LEDs will be solid red for three seconds, followed by one second of another color. | Note the blinking LED and its color, and then contact your dealer or Lantronix Technical Support. The SCS will not be operational until the fault is fixed. |
| The SCS completes its power-up and boot procedures, but there's no noticeable serial activity. | There is a problem with the serial connection or the set-up of the serial device. | Check the terminal setup and the physical connections, including the cable pinouts. Try another serial device or cable, or cycle power on the SCS. |
| | A rapidly blinking OK LED may signal boot failure. | Reboot the unit. When the SCS is running normally, the OK LED blinks every two seconds. |
| The terminal shows a Boot> prompt rather than a Local> prompt. | The SCS is not connected properly to the Ethernet. | Ensure that the SCS is firmly connected to a functional and properly terminated network node. |
| The terminal shows a Boot> prompt rather than a Local> prompt. | The SCS Ethernet address is invalid. | The SCS Ethernet address is on the bottom of the unit. Use the Set Server Hardware command to set the correct address (enter the last three hex pairs of the address), and then reboot. |
| | Init Nboot command was entered. | See Boot Prompt . |
| The SCS passes power-up diagnostics, but attempts to download new Flash ROM code from a network host. | If the OK LED blinks rapidly, the Flash ROM code may be corrupt. | Reboot the unit. If you get the same message, you will need to reload Flash ROM. |
| | If you did not request a TFTP boot, the flash ROM code is corrupt. The unit will remain in boot mode. | See Updating Software . |

BOOTP Troubleshooting

If the BOOTP request is failing and you have configured your host to respond to the request, check these areas:

BOOTP Troubleshooting

| Area to Check | Explanation |
|--|---|
| BOOTP is in your system's /etc/services file. | BOOTP must be an uncommented line in /etc/services . |
| The SCS is in the loadhost's /etc/hosts file. | The SCS must be in this file for the host to answer a BOOTP or TFTP request. |
| The download file is in the correct directory and is world-readable. | The download file must be in the correct directory and world-readable. Specify the complete pathname for the download file in the BOOTP configuration file, or add a default pathname to the download filename. |
| The SCS and host are in the same IP network. | Some hosts do not allow BOOTP replies across routed IP networks. Either use a host running a different operating system or put the SCS in the same IP network as the host. |

RARP Troubleshooting

If the unit is unable to get an IP address using RARP, check these areas:

RARP Troubleshooting

| Area to Check | Explanation |
|---|---|
| The SCS name and hardware address in the host's /etc/ethers file | The SCS name and hardware address must be in this file for the host to answer an RARP request. |
| The SCS name and IP address in the /etc/hosts file | The SCS name and IP address must be in this file for the host to answer a RARP request. |
| The operating system | Many operating systems do not start an RARP server at boot time. Check the host's RARPD documentation for details, or use the ps command to see if there is an RARPD process running. |

Boot Prompt Commands

If the **Boot>** prompt appears on the serial console instead of the **Local>** prompt, one of two things may be wrong. Either the SCS does not have enough information to boot, or the network or flash reloading procedure has failed. If pressing **Enter** does not display a prompt, press any other key. The **Boot>** prompt should appear.

If the SCS does not have enough information to boot, or the network or flash reloading procedure has failed, it prints a message to the console and waits ten seconds for serial port activity. If the SCS detects serial port activity, it continues booting provided the flash is good. However, if the user presses a key during that time period, the SCS displays the **Boot>** prompt.

Note: If you see the message "Will attempt another download in x minutes," press any key for the **Boot>** prompt.

You can enter a series of commands called Boot Configuration Program (BCP) commands at the **Boot>** prompt to configure the SCS. These commands are a subset of the entire SCS command set. For example, a typical TCP/IP configuration might use the following commands:

BCP Command Examples

```
Boot> SET SERVER IPADDRESS 192.0.1.229
Boot> SET SERVER SOFTWARE /tftpboot/SCS200.SYS
Boot> SET SERVER LOADHOST 192.0.1.188
Boot> SET SERVER SECONDARY 192.0.1.22
Boot> FLASH
% Initialization begins in 5 seconds.....
```

These commands set the SCS's address, the software loadfile, and the loadhost's IP address (as well as that of a backup loadhost). The SCS then reboots using the **Flash** command and attempts to load the file firmware file from the host at 192.0.1.188.

Flash

This command forces the SCS to download new operational code and reload it into Flash ROM. This is necessary when a new version of software is released and you wish to upgrade your unit. If the SCS cannot download the file, the code in Flash ROM is still usable.

Flush NVR

This command is used to restore the SCS's non-volatile RAM to its factory default settings. It resets everything that is configurable on the SCS, including the unit's IP address.

Help

Displays a one-page summary of available commands and what they do.

Init 451

Reboots the SCS after it has been configured. If the SCS can find and load the specified software loadfile, it restarts itself with full functionality. If the loadfile is not found, the SCS attempts to reload continuously. If there is an error, or if the console's **Enter** key is pressed, the SCS re-enters the Boot Configuration Program.

Set Server BOOTP {Enabled, Disabled}

Enables or disables the sending of BOOTP queries during the boot sequence. It is enabled by default.

Set Server Bootgateway *ip_address*

Specifies the address of a router so TFTP upgrades can be performed over a routed network. This requires Boot version 1.3 or higher. TFTP (UDP port 69) must not be blocked on the routers.

Set Server Hardware *xx-xx-xx*

Specifies the last three numbers of the SCS's Ethernet address. The first three numbers are supplied automatically.

The Ethernet address should have been set at the factory. Setting an incorrect address could cause serious network problems.

Set Server IPAddress *ip_address*

Specifies this SCS's IP address. Uses the standard numeric format.

Set Server loadhost *ip_address*

Specifies the host to attempt to load the file from. The IP address should be in standard numeric format (no text names are allowed).

Set Server RARP {Enabled, Disabled}

Enables or disables the sending of RARP queries during the boot sequence. It is enabled by default.

Set Server Secondary *ip_address*

Specifies a backup loadhost. The IP address should be in standard numeric format (no text names are allowed). The backup loadhost is queried if the primary host cannot load the server.

Set Server Software *filename*

Specifies the name of the file to load. The SCS automatically adds **.SYS** to the filename you specify. Note that all protocols must have a filename specified (either the default or set by the user). For more information, see [Updating Software](#). TCP/IP users must use the Software option to specify the loadhost, the loadfile, and their own network address.

TFTP users can specify a complete path name (up to 31 characters) if the file is located in a directory other than the default. The case of the filename must match that of the filename loaded onto the host computer.

Show Server

Use this command when issuing other commands to view the current SCS setup.

6: Updating Software

Choosing the Right Software File

Lantronix intends to provide multiple software files for each SCS model. The software file name corresponds to the model name, as shown in the table below.

Software Files

| Software File Name | Models Supported |
|--------------------|------------------|
| SCS1600.SYS | SCS1600 |
| SCS3200.SYS | SCS3200 |

The SCS stores its software in Flash ROM. The software controls the initialization process, the operation of the SCS, and the processing of commands. The contents of Flash ROM can be updated by downloading a new version of the operational software.

Obtaining Software

You can obtain a current firmware file and release notes for the SCS from the Lantronix web site (www.lantronix.com) or by using anonymous FTP ([ftp.lantronix.com](ftp://lantronix.com)).

Via the Web

You can download the latest version of the firmware from the Technical Support area of the Lantronix web site. The files are listed as:

- ◆ **SCS1600.SYS**
- ◆ **SCS3200.SYS**

Note: Netscape Navigator may try to open the file as an ASCII text file. To avoid this, hold down the **Shift** key when choosing the software file.

Via FTP

The SCS software resides on the Lantronix FTP server ([ftp.lantronix.com](ftp://lantronix.com)). Most of these files are binary data, so the binary option must be used to transfer the files. All released files are in the **pub** directory. Always download the README file in the **pub** directory before downloading anything else; it contains a list of available software files.

To log into the FTP server, type **anonymous** as the username and enter your full email address as the password.

Reloading Software

The SCS stores software in Flash ROM to control the initialization process, operation, and command processing. You can update the contents of Flash ROM by downloading a new version of the operational software via EZWebCon, FTP, the web interface, TFTP, or MOP. Regardless of which protocol you use to update Flash ROM, the following points are important:

- ◆ The Flash ROM software file name should not be changed.
- ◆ The download file should be world-readable on the host.
- ◆ The path name has a sixteen-character length limit.
- ◆ The file name has a twelve-character limit for the filename.

Note: If you experience problems reloading Flash ROM, refer to *Troubleshooting Flash ROM Updates*.

EZWebCon Method

You can use EZWebCon to update your software.

1. In EZWebCon, highlight the **SCS**.
2. Select **Action** → **Reload Firmware**.
3. Follow the EZWebCon prompts.

FTP Method

Note: This feature is supported on firmware versions v1.0/5 and higher.

1. Use an FTP client to open an FTP session to the IP address of the SCS.
2. Log in with the username of **root**.
3. Enter the privileged user password (the default is **system**).
4. Make sure your FTP client is set to do a binary transfer.
5. Stay in the same directory; the default login directory is the correct directory.
6. Do an FTP **Put** of the **scs***.sys** file (for example, **scs3200.sys** for the SCS3200).

Once the file is downloaded, the SCS writes the file to Flash (this takes a few moments) and then automatically reboots. After rebooting, the unit runs the new firmware.

Web Interface Method

This method requires an external TFTP server. You can obtain one for Windows from the Lantronix web site.

1. Open your web browser and enter the IP address of the SCS in the **URL** field.
2. Under **Advanced Settings**, select **Server**.
3. Specify the TFTP loadhost and verify the software file.
4. Check the **Reload Firmware** checkbox.
5. Click the **Update Server Settings** button.

Command Line Methods

If BOOTP or RARP is enabled on the SCS, the download process is delayed by approximately 30 seconds. The SCS first tries TFTP, and then tries MOP loading, provided that it has enough information to try each download method.

Downloading and rewriting the Flash ROM and rebooting take approximately two minutes from the time the **Initialize Reload** command is issued. If the SCS cannot find or access the download file, you can reboot the SCS with the code still in Flash ROM. The OK/Activity LED blinks quickly while the SCS is booting (and reloading code) and then slowly when it returns to normal operation.

Note: Before entering the **Initialize Reload** command, check your settings using the **List Server Boot** command.

If you are attempting to update the operating code of an SCS not on a local network, you must specify a boot gateway (router). To specify the boot gateway, use the command:

Set/Define Server Boot Gateway <ip_address>

The SCS directs subsequent IP traffic to the specified IP address.

Note: This functionality requires boot code V1.3.

TFTP Method

Some TFTP implementations require a specific directory for the firmware file. See your host's documentation for instructions.

To manually configure the SCS's IP parameters for a TFTP software reload, use the following process:

1. Log in to the SCS via Telnet or by direct serial connection.
2. Enter the commands shown in the figure below.

Configuring TCP/IP Reload

```
Local> SET PRIVILEGED
Password> SYSTEM (not echoed)
Local>> DEFINE SERVER LOADHOST nnn.nnn.nnn.nnn
Local>> DEFINE SERVER SOFTWARE "/SCS1600.SYS"
Local>> LIST SERVER BOOT
Local>> INITIALIZE RELOAD
```

Note: For instructions on how to log into the SCS to enter these commands, see [Installation](#).

The path and filename are case-sensitive and must be enclosed in quotation marks. When attempting to boot across an IP router, configure the router to proxy-ARP for the SCS.

MOP

The firmware filename is the only parameter that the SCS needs to reload via MOP. Make sure the service characteristic is enabled on the host's Ethernet circuit, copy the firmware file to the **MOM\$LOAD** directory, and reload the SCS using the **Initialize Reload** command. Be sure to use binary mode for any file transfers.

Troubleshooting Flash ROM Updates

Running the following checks can solve problems that may occur when updating the Flash ROM:

Troubleshooting Flash ROM Updates

| Protocol | Area to Check |
|----------|---|
| | Check the file and directory permissions. |
| | Ensure the loadhost name and address are specified correctly and that their case matches that of the filenames on the host system. |
| TFTP | Ensure the file and pathnames are enclosed in quotes to preserve case. |
| | Ensure that TFTP is enabled on the host; several major UNIX vendors ship their systems with TFTP disabled by default. |
| | For remote network reload, specify a boot gateway (router) with the Set/Define Server Boot Gateway <ip_address> command. |
| MOP | Ensure that the Ethernet circuit has the service characteristic enabled. |
| | Ensure that the MOM\$LOAD search path includes the directory containing the firmware file. |
| FTP | Ensure that you are using firmware version v1.0/5 and higher. |
| | Ensure that your FTP client is set to do a binary transfer. |

A: Compliance and Warranty Information

Compliance Information

(according to ISO/IEC Guide 22 and EN 45014)

Manufacturer's Name & Address:

Lantronix 15353 Barranca Parkway, Irvine, CA 92618 USA

Declares that the following product:

Product Name & Model: Secure Console Server SCS1600 and SCS3200

Conforms to the following standards or other normative documents:

Safety:

EN60950: 1992+A1, A2, A3, A4, A11

Electromagnetic Emissions:

EN55022: 1998 (CISPR 22, Class A: 1993, A1: 1995, A2: 1996)

IEC 1000-3-2/A14: 2000

IEC 1000-3-3: 1994

Electromagnetic Immunity:

EN55024: 1998 Information Technology Equipment-Immunity Characteristics

IEC61000-4-2: 1995 Electro-Static Discharge Test

IEC61000-4-3: 1996 Radiated Immunity Field Test

IEC61000-4-4: 1995 Electrical Fast Transient Test

IEC61000-4-5: 1995 Power Supply Surge Test

IEC61000-4-6: 1996 Conducted Immunity Test

IEC61000-4-8: 1993 Magnetic Field Test

IEC61000-4-11: 1994 Voltage Dips & Interrupts Test

Supplementary Information:

This Class A digital apparatus complies with Canadian ICES-003 (CSA) and has been verified as being compliant within the Class A limits of the FCC Radio Frequency Device Rules (FCC Title 47, Part 15, Subpart B CLASS A), measured to CISPR 22: 1993 limits and methods of measurement of Radio Disturbance Characteristics of Information Technology Equipment. This product also complies with the requirements of the Low Voltage Directive 72/23/EEC and the EMC Directive 89/336/EEC.

Manufacturer's Contact:

Director of Quality Assurance, Lantronix
15353 Barranca Parkway, Irvine, CA 92618 USA

Tel: 949-453-3990

Fax: 949-453-3995

Warranty

Lantronix warrants each Lantronix product to be free from defects in material and workmanship for a period of **ONE YEAR** after the date of shipment. During this period, if a customer is unable to resolve a product problem with Lantronix Technical Support, a Return Material Authorization (RMA) will be issued. Following receipt of a RMA number, the customer shall return the product to Lantronix, freight prepaid. Upon verification of warranty, Lantronix will -- at its option -- repair or replace the product and return it to the customer freight prepaid. If the product is not under warranty, the customer may have Lantronix repair the unit on a fee basis or return it. No services are handled at the customer's site under this warranty. This warranty is voided if the customer uses the product in an unauthorized or improper way, or in an environment for which it was not designed.

Lantronix warrants the media containing its software product to be free from defects and warrants that the software will operate substantially according to Lantronix specifications for a period of **60 DAYS** after the date of shipment. The customer will ship defective media to Lantronix. Lantronix will ship the replacement media to the customer.

* * * *

In no event will Lantronix be responsible to the user in contract, in tort (including negligence), strict liability or otherwise for any special, indirect, incidental or consequential damage or loss of equipment, plant or power system, cost of capital, loss of profits or revenues, cost of replacement power, additional expenses in the use of existing software, hardware, equipment or facilities, or claims against the user by its employees or customers resulting from the use of the information, recommendations, descriptions and safety notations supplied by Lantronix. Lantronix liability is limited (at its election) to:

- ◆ Refund of buyer's purchase price for such affected products (without interest)
- ◆ Repair or replacement of such products, provided that the buyer follows the above procedures.

There are no understandings, agreements, representations or warranties, express or implied, including warranties of merchantability or fitness for a particular purpose, other than those specifically set out above or by any existing contract between the parties. Any such contract states the entire obligation of Lantronix. The contents of this document shall not become part of or modify any prior or existing agreement, commitment or relationship.

For details on the Lantronix warranty replacement policy, go to our web site at <http://www.lantronix.com/support/warranty/index.html>