



iPhone | Internet Radio | Satellite

for select Toyota/Lexus/Scion vehicles

**Installation Guide/User manual**

Made for



iPod



iPhone

## Copyrights and Trademarks

Copyright 2012 Audiovox Electronics Corporation

The Audiovox and Audiovox Driven by DICE Electronics logos are trademarks of Audiovox Electronics Corporation

iPod and iPhone are trademarks of Apple, Inc.

All Trademarks and Logos are the property of their respective owners.

All rights reserved.

Printed in the U.S.A.

## Table of Contents

Warning and safety .....	4	Operating the DUO in MP3 emulation .....	19
Product registration .....	5	Text display fields in CDC/MD emulation .....	20
Silverline DUO kit contents .....	6	Operating the DUO iPod source .....	21
Identify your audio system .....	7	Operating the DUO in SAT emulation .....	22
DIP switch overview .....	8	Text display fields in SAT emulation .....	24
DIP switch settings .....	9	Controlling the DUO SIRIUS source .....	26
Supported iPod models .....	10	Internet Radio Application support .....	27
Note to Installer .....	11	Data connection requirements .....	27
Connection diagram .....	12	Controlling the Internet Radio App .....	28
Installation .....	13	Text display from the Internet Radio App .....	29
iPod content browsing .....	14	Auxiliary audio source .....	31
Charging .....	14	Optional Remote Kit: iPod/App .....	32
iPod locked/unlocked settings and features .....	15	Optional Remote Kit: SIRIUS .....	33
Basic operation .....	16	Troubleshooting .....	34
Operating the DUO in CDC/MD emulation .....	17	Firmware update .....	37
		Warranty .....	38

## Warning and safety!

Please read these instructions carefully before proceeding. Failure to follow instructions may result in improper operation or injury. Neither Audiovox Electronics Corporation nor Apple Inc., its regional offices, distributors or resellers take any responsibility for any damage or injury as a result of using the integration kit.

- Do not open, disassemble or alter the interface in any way.
- Do not insert anything into the casing.
- Do not cut or try to alter cables in any way and always use the correct connections.
- Only operate unit when stationary or ask passengers to operate it for you.
- Do not allow the Apple iPod/iPhone to distract you from driving.
- Exercise good judgement and keep your eyes on the road at all times.
- Do not expose unit to extreme temperatures, humidity or shock.
- Keep the unit and iPod/iPhone away from fluids.
- Keep away from children! - Interface components may contain small parts, can be broken or disassembled and components may become loose from vibration and heat. Small components and packaging materials may be a choking hazard when handled by children.



## **Congratulations on your purchase!**

Thank you for purchasing this integration kit. Please review this booklet before operating the unit. This interface was designed and manufactured to seamlessly integrate with your vehicle's factory audio system.

## **Product registration**

We recommend registering your Audiovox product so you can receive news about important firmware updates and have unlimited access to our online support system.

### **To register your Audiovox product, please complete the following steps:**

1. Visit <http://www.audiovoxproducts.com>
2. Look up and save the serial number of the product.
3. Complete the product registration form.
4. Submit the form.
5. Save the registration sheet in a safe place for future reference.

If you are unable to complete the registration via internet, please call Audiovox at 1-800-645-4994.



Prior to installation make sure the module's firmware is up to date to ensure compatibility with the latest features and enhancements. Please refer to page 37 to update firmware.

## Silverline DUO kit contents



Silverline DUO module



user manual

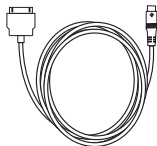

iPod docking  
cable

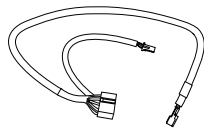

Vehicle Interface  
Harness

### Optional accessories (sold separately):



AUX connector

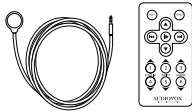

IR Receiver &  
Remote controller

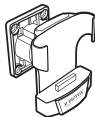

Cradle  
(A-DCR-50-PTH)

For more accessories, visit [www.audiovoxproducts.com](http://www.audiovoxproducts.com)

## Identify your audio system

Select the emulation that best suits your vehicle. The following chart identifies the recommended emulation for the listed radios. Note that your vehicle may support more than one type of emulation.

Radios	External CDC	Factory SAT	CDC	MD*	SAT**	MP3
03-06 Tape/CD	not installed or disconnected	not installed	✓	✓	✓	X
03-06 Tape/CD	not installed or disconnected	present	✓	✓	X	X
03-06 Tape/CD	present	not installed	X	✓	✓	X
03-06 Tape/CD	present	present	X	✓	X	X
06-11 MP3 Navigation	not available	not present	X	X	✓	✓
06-11 MP3 Navigation	not available	present	X	X	X	✓

Note: Years and feature sets listed are shown as a guideline only and do not guarantee compatibility or limit applicability.

\* Not all radios support MD mode. If an external MD changer is present, it must be disconnected.

\*\* Scrolling text function is available in Satellite emulation, please see page 26 for details.

## DIP switches overview



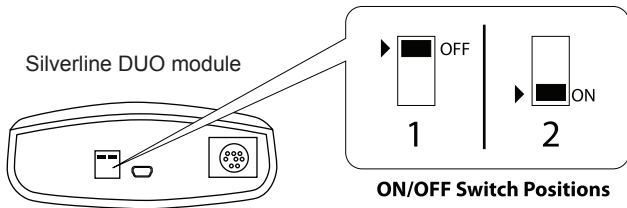

The configuration switches located on the Silverline DUO module are used to set various operation modes of the interface. Incorrect DIP switch settings may cause the interface to not work properly or to not operate at all. **Disconnect the vehicle harness from the module and set the ignition to the off position for 60 seconds after changing the switches then reconnect the module!**





## DIP switch settings

The following DIP switch settings are used to configure the Silverline DUO module to interface with the various vehicle radios. Before installation, set the DIP switch to the position shown for the corresponding radios.

<b>Car configuration switches</b>			
Satellite (SAT)	CD changer (CDC)	MP3	Mini DISC (MD)
			
<p>Use this setting for best user experience. Only available on SAT capable radios. <b>To enable use of the SIRIUS Connect tuner, SAT emulation must be used.</b> Available on selected North American radios only.</p>	<p>Use to retain factory SIRIUS/XM module, or on radios with integrated satellite tuner. Also for radios that do not support SAT mode. External CDC (trunk or glove box) must be disconnected.</p>	<p>Use with late model radios where factory Sirius/XM module is present (integrated) and CDC emulation is not supported (i.e. no text).</p>	<p>Use with early model year radios with external MD changer support. MD text is available only on a selected few radios, typically navigation models.</p>

## Supported iPod models and firmware version requirements

Model	Firmware / OS Version
1G nano	1.3.1
iPod 5G	1.3
2G nano	1.1.3
iPod classic	1.1.2
3G nano	1.1.3
iPod touch	iOS 3.1.3
iPhone	iOS 3.1.3
iPhone 3G	iOS 4.2.1
4G nano	1.0.4
120 GB classic	2.0.1
2G touch	iOS 4.2.1
iPhone 3GS	iOS 5

Model	Firmware / OS Version
160 GB classic	2.0.4
5G nano	1.0.2
3G touch	iOS 5
iPhone 4	iOS 5
iPhone 4S	iOS 5
4G touch	iOS 5
6G nano	1.2

## **Attention installer! Please read the following!**

**Audiovox strongly recommends that the unit be installed in an easily accessible place!**

**DO NOT PLACE IT BEHIND THE RADIO AND DO NOT HIDE UNDER CARPET!**

Whether the unit is professionally or self installed, put the module where you, the end user can get to it easily in the future. (Have the installer show you where the interface module is installed.)

Installing the module behind the radio will make it difficult to:

- Add possible future upgrades, changing software, adding new features, improving operation;
- Access the AUX input on the module to attach any audio device;
- Access the DIP switches located on the module;
- Remove the unit in case of failure.

**MAKE SURE THAT THE MODULE IS IN AN ACCESSIBLE PLACE!**

## Connection diagram

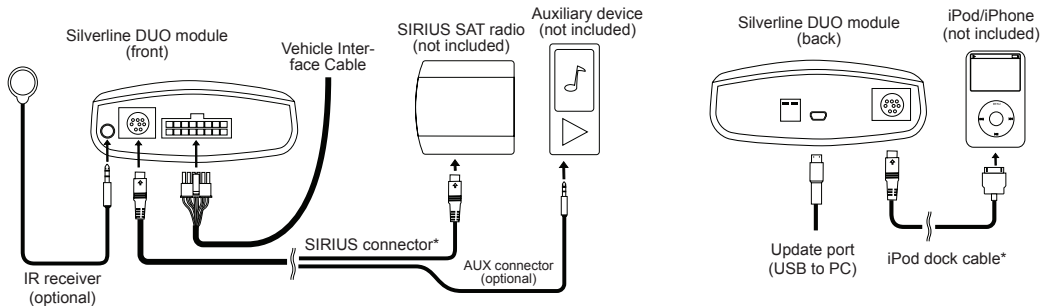

\*Do not connect the iPod dock cable under any circumstance to the SIRIUS module connector! Improper connection can cause permanent damage to iPod/SIRIUS module.

## Installation

1. Verify compatibility

2. Disconnect battery



3. Remove radio from car

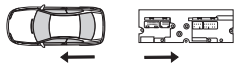

4. Install Silverline DUO cable



5. Route kit to glove box or other accessible location

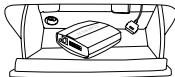

6. Connect battery & test



7. Complete install by re-installing radio

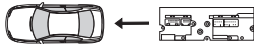

Some radios will enter an anti-theft security mode and will lock requiring the radio's security code to be entered to unlock it. This code can be requested from the vehicle's dealership.

## iPod content browsing

By default, the interface creates a Playlist having a name that is the same as the name of the iPod. This Playlist is the very first on the list of Playlists shown while browsing in Playlist mode. This Playlist contains all the songs on the iPod. Once a Playlist is selected an Artist may be selected within that Playlist using the Artist Mode. Albums by the selected Artist within the selected Playlist may be selected in Album Mode. “ALL ARTIST” and “ALL ALBUM” designate all available content in those categories.



## Charging

The interface automatically charges the battery of the iPod when connected and your vehicle ignition key is in the ACC/ON position.

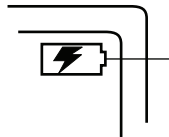

Charging may be shown by an icon that appears on the upper right corner of the iPod screen. May vary by model.

## iPod locked/unlocked settings and features

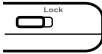
	iPod hold ON	iPod hold OFF
		
Radio control	✓	Limited
iPod control	✗	✓
	Before connecting the iPod to the module, turn the hold switch <b>ON</b> to fully control and browse the songs from the wireless remote. The iPod is locked in this state.	Before connecting the iPod to the module, turn the hold switch <b>OFF</b> to fully control and browse the songs from iPod. Browsing capabilities are limited from the wireless remote.

**Note:** Setting the iPod's hold switch must be done prior to connecting it to the dock cable.  
iPod nano 6th generation will always be in locked mode since it does not have a lock switch.



For iPod touch and iPhone, when the screen is not active (as shown on the left), the iPod/iPhone is locked (Press the power button to lock the iPhone/iPod Touch).

## **Basic operation**

### **Accessing the DUO as the audio source:**

Much like the radio's AM/FM tuner, satellite radio or CD audio sources, the Silverline DUO is integrated to be part of the vehicle's audio system. To access the DUO source, press the SAT button (if SAT emulation is set) or DISC button (if CDC, MD or MP3 emulation is set) on the radio. Pressing this button repeatedly will cycle through sources present in the vehicle (CD > DUO).

### **DUO source selection:**

The DUO adds additional audio sources including iPod, SIRIUS Satellite Radio\* and/or auxiliary audio input\*. To cycle between these sources, use the SEEK, TRACK or TUNE buttons within the first 5 seconds of accessing the DUO as the audio source.

*\*These sources require additional parts/accessories/service from Audiovox and/or third parties.*

### **Silverline DUO Interface settings (within first 5 seconds of accessing the DUO as the audio source):**

**Select DISC/PRESET 1** to apply settings and resume audio playback.

**Select DISC/PRESET 3** to change default volume level; use track up/down to adjust between Min and Max.

**Select DISC/PRESET 4** to enable/disable scrolling text. (SAT emulation only)

**Select DISC/PRESET 6** to view Silverline DUO serial number and firmware version.

DISC 2 and 5 have no settings available.



## Operating the DUO in CDC/MD emulation mode (non-NAV radio)

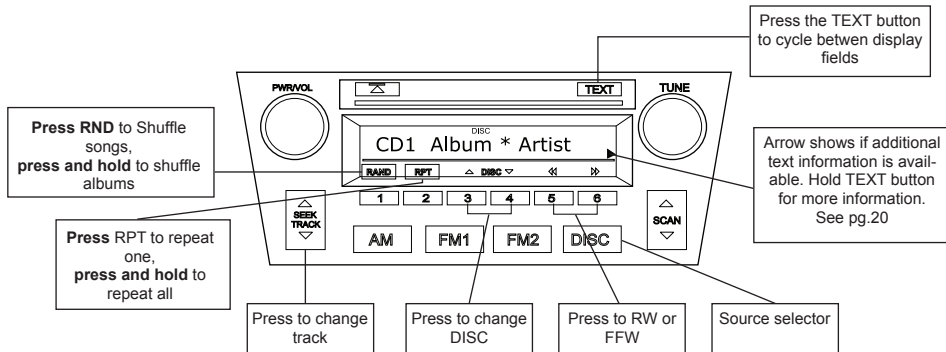

## Operating the DUO in CDC/MD emulation mode (NAV radio)

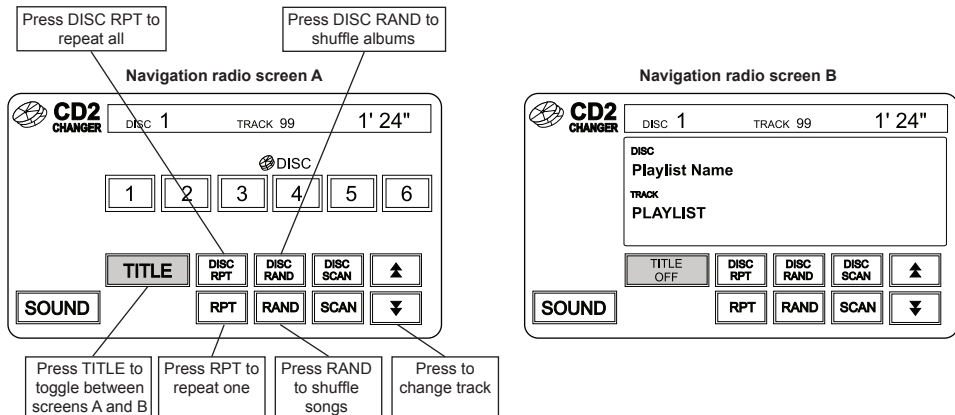

Note that in MD mode MD1/2 will be displayed instead of CD1/2. Some display types vary and don't have all available buttons.

## Operating the DUO in MP3 emulation mode

Some display types vary and don't have all available buttons.

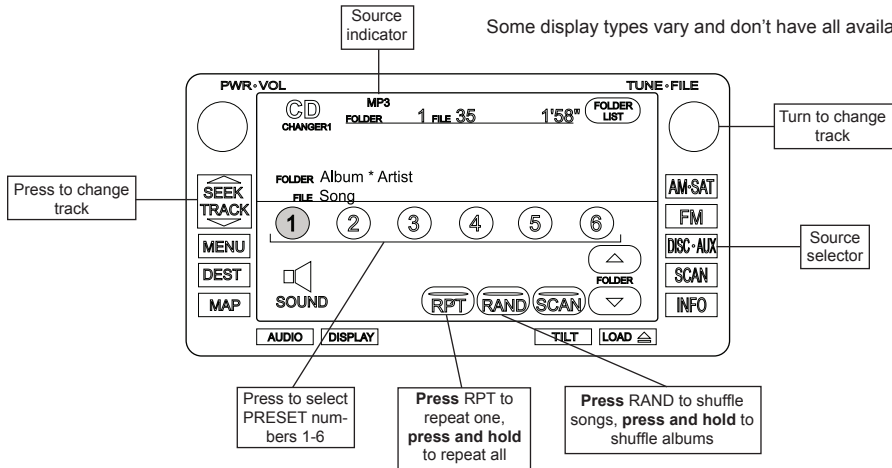

## Text display fields in CDC and MD emulation modes (non-NAV radio)

Press the TEXT button to cycle through the available text fields. In CDC and MD modes there are two available text fields. Please see illustration below for an example of how the text button works in Playlist mode (DISC 2):



Text is paged in these modes (where supported). Additional text information can be viewed by pressing the and holding the TEXT button. A little arrow in the right bottom corner indicates additional page of text information:



## Controlling the DUO iPod source in CDC, MD or MP3 emulation modes

The Silverline DUO features content browsing making it easy to find by song, playlist, artist, podcast and audiobook. After connecting the iPod, select the desired browsing mode by selecting the appropriate DISC. Press the SEEK button or turn the TUNE dial repeatedly to browse contents; 1 second after releasing the button, your selection is executed. The browsing below is illustrated in the “track” text field.

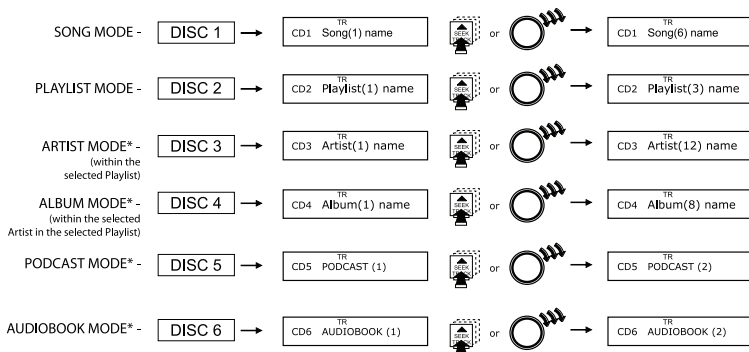

\*Only available when iPod is locked. When iPod is unlocked the radio will only display song titles.

## Operating the DUO in SAT emulation mode (non-NAV radio)

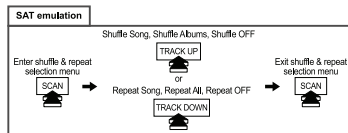
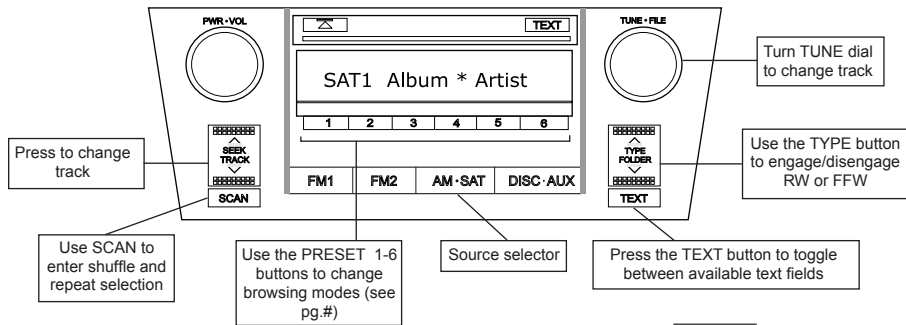

## Operating the DUO in SAT emulation mode (NAV radio)

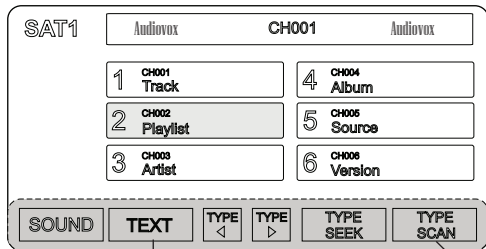

Press the TEXT button to toggle between available screens

Use TYPE SCAN to enter shuffle & repeat selection

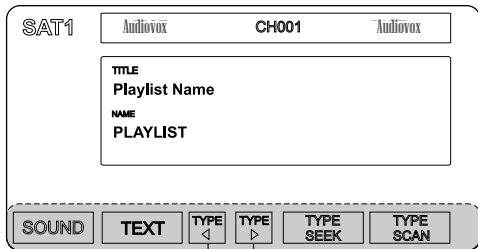

Use the TYPE button to engage/disengage RW or FFW

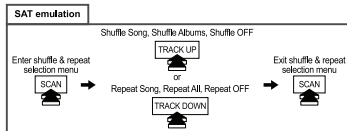

## Text display fields - SAT emulation (non-NAV radios)

Press the TEXT button to cycle through text fields. In SAT emulation there are three available text fields. Please see illustration below for an example of how the TEXT button works for song mode (PRESET 1):

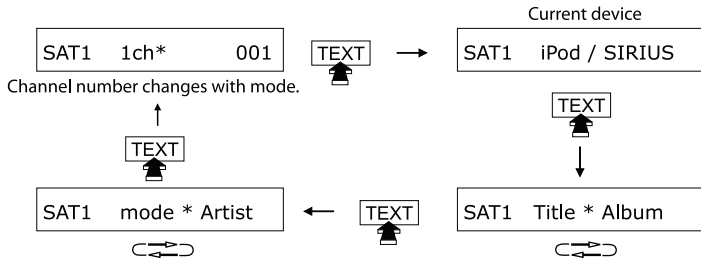

\*Channel number changes with mode; indicating browsing mode for iPod and preset association for SIRIUS channel.



## Text display fields - SAT emulation (non-NAV radios)

The Silverline DUO features content browsing making it easy to find by song, playlist, artist, podcast and audiobook. After connecting the iPod, select the desired browsing mode by selecting the appropriate PRESET button. Press the SEEK button or turn the TUNE dial repeatedly to browse contents; after releasing the button, your selection is executed.

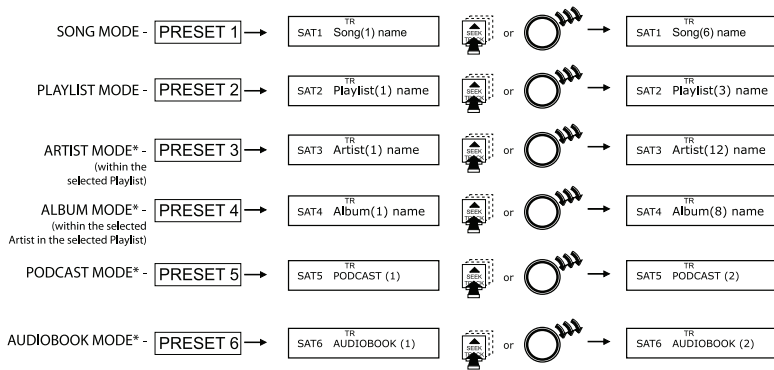

\*Only available when iPod is locked.

## Controlling the DUO SIRIUS source (SAT emulation only)

The Silverline DUO integration kit features SIRIUS connectivity. Use the SEEK button or TUNE dial to browse between subscribed channels.

### To store a subscribed channel to memory:

Tune to the station to be stored, **press and hold** the desired PRESET buttons to save.

**To recall a memorized channel:** Simply press the desired PRESET button (PRESET 1-6).

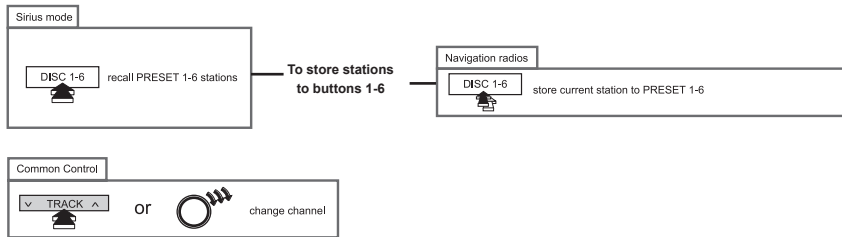

- If a SIRIUS CONNECT compatible tuner is not detected, then a “No Tuner” vehicle message is displayed.
- Go to Channel 000 to view the SIRIUS Tuner ID for activation. The 12 digit SID display format is shown in two parts as SID “123456-” followed by “-789ABC”.

## Internet Radio Application support (iPhone/iPod touch)

This kit includes support for internet radio streaming apps available on the iTunes® Store. Thousands of stations can be streamed through data connections. Supported apps include Livio Car Internet Radio, Pandora, iHeart Radio and more. Supported features such as text display on screen, and next/previous track functions will vary by app.

To learn more about each app specifically, please visit the website for the app you need information about.

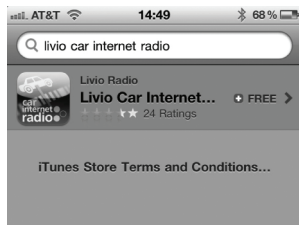

## Data connection requirements (3G/4G/WiFi)

Users must have an active wireless data connection in order to stream music from an app while in the car. Data connections including "3G" or "4G" through wireless carriers, or a third party wireless Internet access point connected to your mobile device through WiFi will work. Because this app requires a data connection, it will only work on connected devices such as the iPhone and iPod touch.

## Controlling Internet Radio Apps

NOTE: The following features may not be supported by all apps. For demonstration purposes the following examples will show the features for the Livio Car Internet Radio app.

The app must be active on the screen of the device. To do so, simply tap the app's icon and it will load.

**Next/previous TRACK buttons** execute application specific features such as skipping stream or cycling between station presets. **DISC/PRESET (1-6) buttons** are associated with station presets when used with the Livio Car Internet Radio application..

iPhone operating system iOS5 enabled application developers to share the “now playing” screen information. For example, when using the Pandora App, you will see artist, album and song information on the radio's screen. When using an application that doesn't implement this feature, or running iOS4, only the name of the application will be shown.

Please note that although iOS 4 (4.2.1) is supported on iPhone 3G and iPod touch 2nd generation, applications do not run in the background. As such, loading the app takes longer than on devices where the app is present in the background.



If your listening experience is interrupted by a call, under most conditions, the app will resume playback at the end of the call.

Music playback apps running on your iPhone are sent to background automatically when the home button of the phone is pressed, but the music playback itself is not stopped.

To resume playback of your iPod music library, stop Livio playback by tapping on the screen below the Livio Radio logo. An icon representing “stop” will show on the main Livio screen. Press the home button to send the application to the background. (Other apps may need to be terminated manually. Please see next page.)

A few seconds after this, the iPod music playback application will reinitialize itself and become active again if the iPod was locked when it was connected to the kit. (This is indicated by an Accessory Connected message being shown when the iPod icon is tapped.)

If the iPod was in unlocked state when it was connected to the kit, press the play button on the iPod application.

## **Text Display from the Internet Radio App**

Text that scrolls across the radio’s screen is associated with the stream shown on the radio and displays current song or station information. Stream must be playing before information on the display is updated.

## **Terminate (kill) the App**

If you need to terminate (kill) the app please follow the steps below:

1. Double-tap on the home button of the iPhone to bring up the list of running apps. If you don't see the app's icon right away, swipe the screen left or right to locate it. Note: If you do not see such task bar but rather a music control popup then you have an iOS device that does not support background run of apps, therefore this section is not applicable to you.
2. Press and hold the icon of the app until a red minus icon shows.
3. Tap the red minus icon shown on top of the app.
4. This will close the app.
5. In a few seconds, the iPod music playback app should reinitialize itself and become active again. This can be verified by going back to the list of running apps and swiping the screen until the music control section is shown. The iPod app icon next to the music control sections shows that iPod is your audio source.

## **Internet Radio App Settings**

Many radio stations offer lower bitrates. Selecting streams with a lower bitrate will reduce data usage and may reduce stream interruptions during the drive. For example with the Livio Car Internet Radio app, to adjust bitrates manually, users can:

Go to the Setting menu of the device, select the Livio Radio settings the change the Maximum Bitrate Filter and set it to 64K. Other settings such as Buffer time and Reliability filter may also help in getting a more stable connection.

## Auxiliary audio source (only with optional AUX connector)

The DUO AUX cable (A-ACC-106-AUX) can be used to connect an auxiliary device, such as an MP3 player, DVD player or other audio source.

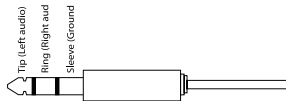
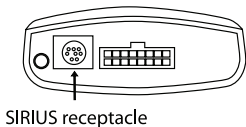

1/8" mini stereo jack

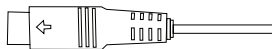

mini DIN connector

**The auxiliary audio source can be accessed in both CDC and SAT emulation modes.**

To access AUX audio source:

- Plug the mini DIN connector of the AUX adapter cable into the SIRIUS receptacle and connect the 1/8" mini stereo jack to the sound output of your audio device.
- Enter AUX mode (see pg. 16).
- All music playback is controlled through your audio device.

## Optional Remote Kit: Functions for iPod/App

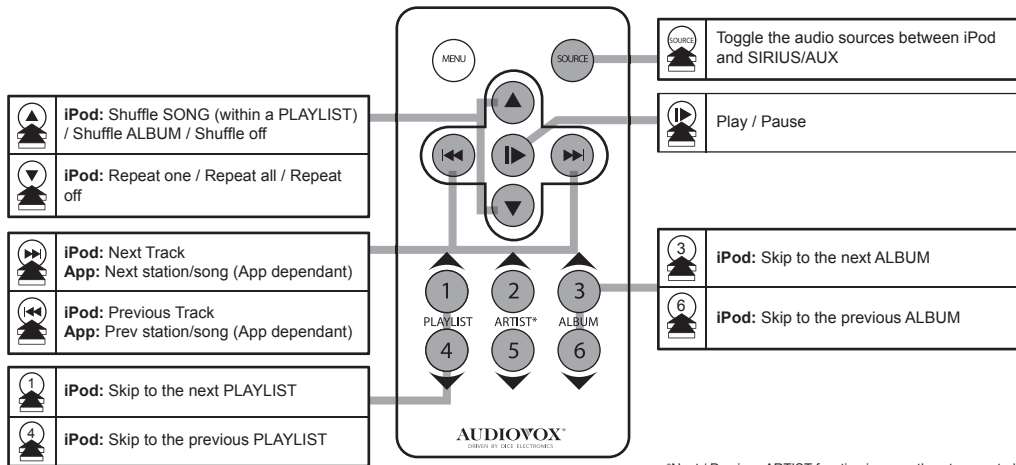

\*Next / Previous ARTIST function is currently not supported.



## Optional Remote Kit: Functions for SIRIUS

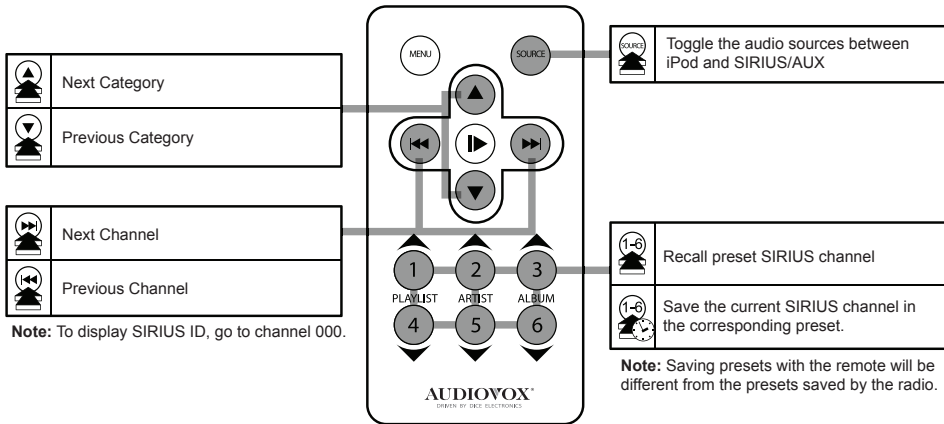

## Troubleshooting

<b>Problem</b>	<b>Solution</b>
<b>Radio/NAV display only shows DISC and track number and there is no iPod control.</b>	Make sure DIP switch settings are correctly set for text display (refer to page 8 for DIP switch settings).
<b>No text display on radio.</b>	Make sure DIP switch settings are correctly set for text display (refer to page 8 for DIP switch settings).
<b>Radio/steering wheel controls do not operate iPod.</b>	Reset iPod and make sure most recent iPod firmware is installed.
<b>Music is distorted or sound level is too low with iPod connected.</b>	Make sure all EQ and BASS boost options are turned off on your iPod. Adjustments to the gain setting may be required (refer to page 19).
<b>No audio from iPod source.</b>	Reset the iPod. Verify proper connection to iPod/interface. Check for compatibility. Older iPod models don't support USB audio.

<b>Problem</b>	<b>Solution</b>
<b>Sirius tuner can't be selected.</b>	Ensure the cable connecting SIRIUS tuner is securely connected to the correct receptacle.
<b>Why does the radio display show "EMPTY/STOP" and no music plays?</b>	The iPod has reached the end of a playlist. Please select a new Playlist.
<b>Cannot select the interface.</b>	Ensure the cable connecting DUO is securely connected to the correct receptacle. Verify that the correct button is used to access the interface (DISC/SAT).
<b>Radio/ steering wheel controls do not operate iPod.</b>	Reset iPod and make sure the most recent iPod firmware is installed. Check vehicle user manual on how steering wheel controls work, long presses may toggle alternate function.
<b>Why does category read "PRESELCTD"?</b>	Playback of content selected on the iPod before it is connected to the interface continues until new content is selected.

<b>Problem</b>	<b>Solution</b>
<b>Why does the message “iPod UNLOCKED” display on screen?</b>	When the Silverline DUO is playing iPod music in UNLOCKED mode, browsing mode information isn't available so the “iPod UNLOCKED” notification is shown. To view information associated with browsing modes, ensure the iPod's hold button is set before connecting it to Silverline DUO.
<b>The radio displays track/channel 99 (“TR 99” or ”CH99”). Track up/down controls do not work.</b>	Track 99 indicates that the Silverline DUO is in auxiliary audio (AUX) mode. See page 16 on how to enter/exit this mode.

## Updating Firmware (Mac OS illustrated)



Connect module via mini USB



Device specifications and update selection

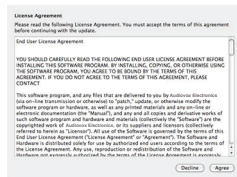

License Agreement (click Agree to proceed)

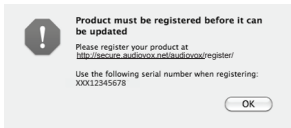

Product registration notification

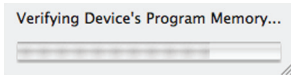

Firmware update progress

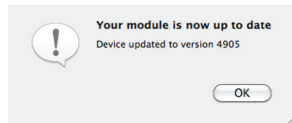

Module updated successfully!

The above screen shots are for illustration purposes only.

**AUDIOVOX**<sup>®</sup>**12 MONTH LIMITED WARRANTY**

AUDIOVOX ELECTRONICS CORP. (the Company) warrants to the original retail purchaser of this product that should this product or any part thereof, under normal use and conditions, be proven defective in material or workmanship within 12 months from the date of original purchase, such defect(s) will be repaired or replaced with reconditioned product (at the Company's option) without charge for parts and repair labor. A game controller, if supplied, is similarly warranted for ninety (90) days.

To obtain repair or replacement within the terms of this Warranty, the product is to be delivered with proof of warranty coverage (e.g. dated bill of sale), specification of defect(s), transportation prepaid, to the Company at the address shown below.

This Warranty does not extend to the elimination of externally generated static or noise, to correction of antenna problems, to costs incurred for installation, removal or reinstallation of the product, or to damage to digital memory/media devices, gaming devices, discs, speakers, accessories, or vehicle electrical systems.

This Warranty does not apply to any product or part thereof which, in the opinion of the Company, has suffered or been damaged through alteration, improper installation, mishandling, misuse, neglect, accident, or by removal or defacement of the factory serial number/bar code label(s). THE EXTENT OF THE COMPANY'S LIABILITY UNDER THIS WARRANTY IS LIMITED TO THE REPAIR OR REPLACEMENT PROVIDED ABOVE AND, IN NO EVENT, SHALL THE COMPANY'S LIABILITY EXCEED THE PURCHASE PRICE PAID BY PURCHASER FOR THE PRODUCT.

This Warranty is in lieu of all other express warranties or liabilities. ANY IMPLIED WARRANTIES, INCLUDING ANY IMPLIED WARRANTY OF MERCHANTABILITY, SHALL BE LIMITED TO THE DURATION OF THIS WRITTEN WARRANTY. ANY ACTION FOR BREACH OF ANY WARRANTY HEREUNDER INCLUDING ANY IMPLIED WARRANTY OF MERCHANTABILITY MUST BE BROUGHT WITHIN A PERIOD OF 24 MONTHS FROM DATE OF ORIGINAL PURCHASE. IN NO CASE SHALL THE COMPANY BE LIABLE FOR ANY CONSEQUENTIAL OR INCIDENTAL DAMAGES FOR BREACH OF THIS OR ANY OTHER WARRANTY. No person or representative is authorized to assume for the Company any liability other than expressed herein in connection with the sale of this product.

Some states do not allow limitations on how long an implied warranty lasts or the exclusion or limitation of incidental or consequential damage so the above limitations or exclusions may not apply to you. This Warranty gives you specific legal rights and you may also have other rights which vary from state to state.

## Installation notes:

Installed by:

Installed date:

Other notes:

Illustration:

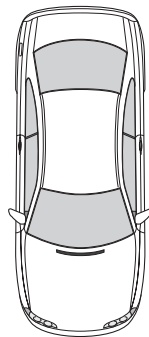

Toyota/Lexus/Scion compatible integration  
for iPod, iPhone, Internet Radio and SIRIUS.  
[www.audiovoxproducts.com](http://www.audiovoxproducts.com)

OMA-DUO-101-TOY-012012



For Customer Service  
Visit Our Website At  
[www.audiovoxproducts.com](http://www.audiovoxproducts.com)  
Product Information, Photos,  
FAQ's, Owner's Manuals



**AUDIOVOX**  
ELECTRONICS CORP.

150 Marcus Blvd., Hauppauge, New York 11788  
©2012 Made in China • Fabriqué en Chine • Hecho en China



SAVE ENVIRONMENT  
PLEASE RECYCLE  
+  
ECONOMISER L'ENVIRONNEMENT  
RECYCLEZ S'IL VOUS PLAÎT  
+  
EXCEPTO EL AMBIENTE  
RECICLE POR FAVOR