

Yealink



Yealink T2 Series & SIP-T19(P) E2 IP Phones User Guide

Copyright

Copyright © 2017 YEALINK(XIAMEN) NETWORK TECHNOLOGY

Copyright © 2017 Yealink (Xiamen) Network Technology CO., LTD. All rights reserved. No parts of this publication may be reproduced or transmitted in any form or by any means, electronic or mechanical, photocopying, recording, or otherwise, for any purpose, without the express written permission of Yealink (Xiamen) Network Technology CO., LTD. Under the law, reproducing includes translating into another language or format.

When this publication is made available on media, Yealink (Xiamen) Network Technology CO., LTD. gives its consent to downloading and printing copies of the content provided in this file only for private use but not for redistribution. No parts of this publication may be subject to alteration, modification or commercial use. Yealink (Xiamen) Network Technology CO., LTD. will not be liable for any damages arising from use of an illegally modified or altered publication.

Trademarks

Yealink®, the logo and the name and marks is trademark of Yealink (Xiamen) Network Technology CO., LTD, which are registered legally in China, the United States, EU (European Union) and other countries.

All other trademarks belong to their respective owners. Without Yealink's express written permission, recipient shall not reproduce or transmit any portion hereof in any form or by any means, with any purpose other than personal use.

Warranty

(1) Warranty

THE SPECIFICATIONS AND INFORMATION REGARDING THE PRODUCTS IN THIS GUIDE ARE SUBJECT TO CHANGE WITHOUT NOTICE. ALL STATEMENTS, INFORMATION, AND RECOMMENDATIONS IN THIS GUIDE ARE BELIEVED TO BE ACCURATE AND PRESENTED WITHOUT WARRANTY OF ANY KIND, EXPRESS OR IMPLIED. USERS MUST TAKE FULL RESPONSIBILITY FOR THEIR APPLICATION OF PRODUCTS.

(2) Disclaimer

YEALINK (XIAMEN) NETWORK TECHNOLOGY CO., LTD. MAKES NO WARRANTY OF ANY KIND WITH REGARD TO THIS GUIDE, INCLUDING, BUT NOT LIMITED TO, THE IMPLIED WARRANTIES OF MERCHANTABILITY AND FITNESS FOR A PARTICULAR PURPOSE. Yealink (Xiamen) Network Technology CO., LTD. shall not be liable for errors contained herein nor for incidental or consequential damages in connection with the furnishing, performance, or use of this guide.

(3) Limitation of Liability

Yealink and/or its respective suppliers are not responsible for the suitability of the information contained in this document for any reason. The information is provided "as is", and Yealink does not provide any warranty and is subject to change without notice. All risks other than risks caused by use of the information are borne by the recipient. In no event, even if Yealink has been suggested the occurrence of

damages that are direct, consequential, incidental, special, punitive or whatsoever (Including but not limited to loss of business profit, business interruption or loss of business information), shall not be liable for these damages.

End User License Agreement

This End User License Agreement ("EULA") is a legal agreement between you and Yealink. By installing, copying or otherwise using the Products, you: (1) agree to be bounded by the terms of this EULA, (2) you are the owner or an authorized user of the device, and (3) you represent and warrant that you have the right, authority and capacity to enter into this agreement and to abide by all its terms and conditions, just as if you had signed it. The EULA for this product is available on the Yealink Support page for the product.

Patent Information

China, the United States, EU (European Union) and other countries are protecting one or more patents of accompanying products and/or patents being applied by Yealink.

Customer Feedback

We are striving to improve our documentation quality and we appreciate your feedback. Email your opinions and comments to DocsFeedback@yealink.com.

Technical Support

Visit Yealink WIKI (<http://support.yealink.com/>) for the latest firmware, guides, FAQ, Product documents, and more. For better service, we sincerely recommend you to use Yealink Ticketing system (<https://ticket.yealink.com>) to submit all your technical issues.

GNU GPL INFORMATION

Yealink T2X series and SIP-T19(P) E2 IP phones firmware contain third-party software under the GNU General Public License (GPL). Yealink uses software under the specific terms of the GPL. Please refer to the GPL for the exact terms and conditions of the license.

The original GPL license, source code of components licensed under GPL and used in Yealink products can be downloaded online:

<http://www.yealink.com/GPLOpenSource.aspx?BaseInfoCateId=293&NewsCateId=293&CateId=293>.

About This Guide

Thank you for choosing Yealink T2 series IP phones, which deliver the industry's leading HD audio quality and a wide range of business telephony features, such as Call Hold, Call Transfer, Busy Lamp Field, Call Recording, Multicast Paging and Conference over an IP network. Meanwhile, it features a compact appearance, robust performance and cost efficiency for daily desktop voice communications.

This guide provides everything you need to quickly use your new phone. First, verify with your system administrator that the IP network is ready for phone configuration. Also be sure to read the Quick Start Guide in your phone package before you set up and use the IP phone. As you read this guide, keep in mind that some features are configurable by your system administrator or determined by your phone environment. As a result, some features may not be enabled or may operate differently on your phone. Additionally, the examples and graphics in this guide may not directly reflect what is displayed or is available on your phone screen.

This user guide contains information for the following Yealink products:

- SIP-T29G IP phones
- SIP-T27G IP phones
- SIP-T27P IP phones
- SIP-T23G IP phones
- SIP-T23P IP phones
- SIP-T21(P) E2 IP phones (including SIP-T21 E2 and SIP-T21P E2 IP phones)
- SIP-T19(P) E2 IP phones (including SIP-T19 E2 and SIP-T19P E2 IP phones)

Read the [Yealink Products Regulatory Notices guide](#) for all regulatory and safety guidance.

Related Documentation

You can obtain additional information on the following phone's support pages:

- [IP Phone SIP-T29G](#)
- [IP Phone SIP-T27G](#)
- [IP Phone SIP-T27P](#)
- [IP Phone SIP-T23G](#)
- [IP Phone SIP-T23P](#)
- [IP Phone SIP-T21\(P\) E2](#)
- [IP Phone SIP-T19\(P\) E2](#)

The following types of related documents are available on each support page:

- Release Notes, which details bug fixes and feature enhancements when an update is released.
- Quick Start Guide, which describes how to assemble your phone and configure the basic phone features.
- Wall Mount Installation Guide, which provides detailed instructions for how to use an optional wall mount bracket to mount your phone on the wall.
- Administrator Guide, which provides the detailed information on how to configure phone features for system administrator.
- Regulatory Notice, which provides information for all regulatory and safety guidance.

In This Guide

This guide mainly takes the SIP-T27G IP phone as an example. Chapters in this guide include:

- Chapter 1 [Overview](#)
- Chapter 2 [Getting Started](#)
- Chapter 3 [Customizing Your Phone](#)
- Chapter 4 [Basic Call Features](#)
- Chapter 5 [Advanced Phone Features](#)
- Chapter 6 [Using Optional Accessories](#)
- Chapter 7 [Maintaining Your Phone](#)

Table of Contents

About This Guide v

Related Documentation	v
In This Guide	vi

Table of Contents..... vii

Overview 1

Hardware.....	1
Icons and Status Indicators Instructions.....	4
Status Indicators.....	4
Line Key Icons.....	5
Other Icons.....	10
LED Instructions.....	11
Power LED Indicator	11
Line Key LED.....	11
User Interfaces	13
Phone User Interface.....	14
Web User Interface.....	21
Features Configurable via Phone/Web User Interface.....	22

Getting Started..... 29

Phone Initialization.....	29
Phone Status.....	29
Viewing the Phone Status	30
Basic Network Settings.....	31
Configuring the DHCP.....	31
Configuring the Static IPv4 Address.....	32
Configuring the Static IPv6 Address.....	33
Registration.....	33
Registering an Account	34
Disabling an Account	35
Configuring the Default Account	35

Customizing Your Phone..... 37

General Settings.....	37
-----------------------	----

Wallpaper.....	37
Screen Saver.....	39
Power Saving	43
Logo Customization.....	46
Configuring the Backlight.....	46
Configuring the Contrast.....	47
Changing the Language.....	48
Time & Date.....	49
Changing the Administrator Password	51
Configuring Key As Send	52
Phone Lock.....	52
Audio Settings.....	56
Adjusting the Volume	56
Ring Tones.....	56
Configuring the Key Tone	58
Contact Management	59
Configuring List(s) for the Directory (Dir) Soft Key	59
Local Directory	61
Blacklist	69
Mobile Contacts	71
Remote Phone Book.....	73
Call History Management.....	75
Viewing History Records.....	75
Placing a Call from History Records	75
Adding a Contact to the Local Directory/Blacklist.....	76
Deleting History Records.....	76
Disabling History Record	77
DSS Keys.....	78
Line Keys.....	78
Programmable Keys.....	87
Dial Plan.....	90
Configuring the Replace Rule	91
Configuring the Dial Now.....	92
Configuring the Area Code.....	94
Configuring the Block Out	95
Basic Call Features.....	97
Switching among the Handset, Speakerphone and Headset Modes	97
Placing Calls	98
Placing a Call	98
Placing Multiple Calls.....	99
Placing a Call Using a Speed Dial Key	99
Placing a Call from the Recent Calls/Search Source List	100
Placing a Call Back to the Last Incoming Call	101

Dialing the Hotline Number	101
Redialing Numbers	102
Answering Calls.....	102
Answering When Not in Another Call	103
Answering When in Another Call	103
Answering Calls Automatically	104
Configuring the Call Waiting.....	105
Ending Calls.....	106
Auto Redial	106
Enabling the Auto Redial	106
Redialing a Call Automatically	107
Call Completion	107
Enabling Call Completion	107
Using Call Completion	108
Call Mute	109
Muting and Unmuting a Call.....	109
Muting and Unmuting While Dialing.....	110
Call Hold/Resume	110
Holding a Call.....	110
Resuming a Held Call	111
Do Not Disturb (DND).....	111
Configuring the DND Modes.....	112
Phone Mode	112
Custom Mode.....	113
Configuring DND Emergency and Authorized Numbers.....	114
Call Forward	115
Static Forwarding	116
Dynamic Forwarding	120
Call Transfer.....	121
Configuring Transfer Mode via Dsskey	121
Enabling Allow Trans Exist Call.....	121
Performing a Blind Transfer.....	122
Performing a Semi-attended/Attended Transfer	123
Conference	124
Local Conference	124
Network Conference.....	127
Call Park/Retrieve.....	129
FAC Mode.....	129
Transfer Mode.....	131
Call Pickup	133
Directed Call Pickup.....	133
Group Call Pickup	135
Anonymous Call	137
Configuring the Anonymous Call	137

Placing an Anonymous Call	138
Anonymous Call Rejection	138
Configuring the Anonymous Call Rejection.....	139
Placing a Call to Anonymous Rejected User.....	139
Advanced Phone Features.....	141
Busy Lamp Field (BLF).....	141
Configuring a BLF Key.....	141
Configuring Visual and Audio Alert for BLF Pickup	142
Placing a Call to the Monitored User.....	144
Transferring a Call to the Monitored User.....	144
Picking Up an Incoming Call of the Monitored User.....	145
Parking a Call/Retrieving a Parked Call to the Monitored User	146
BLF List	146
Configuring BLF List Settings	147
Call Recording	149
Recording Using a USB Flash Drive	149
Recording Using a Record Key.....	154
Hot Desking	156
Configuring a Hot Desking Key.....	157
Using a Hot Desking Key	157
Intercom	158
Configuring the Intercom Feature on the IP Phone.....	158
Using Intercom	160
Multicast Paging.....	161
Sending RTP Stream	162
Receiving RTP Stream	165
Using Multicast Paging.....	166
Automatic Call Distribution (ACD)	168
Configuring an ACD Key	168
Logging into the ACD System	168
Shared Call Appearance (SCA).....	170
Configuring SCA Feature on the IP Phone	171
Using SCA Feature on the IP Phone	174
Bridged Line Appearance (BLA).....	182
Configuring BLA Feature on the IP Phone.....	183
Using BLA Feature on the IP Phone.....	184
Messages.....	187
Short Message Service (SMS).....	187
Voice Mail	189
Using Optional Accessories with Your Phone	193
Using a Headset	193

Using Bluetooth Feature	196
Connecting to the Wireless Network.....	203
Using an Expansion Module.....	208
Maintaining Your Phone	211
Diagnosing the Network.....	211
Checking the Network Using "Ping" Method.....	211
Checking the Network Using "Trace Route" Method.....	212
Rebooting Your Phone	212
Resetting to Factory Settings.....	213
Updating the Phone Configuration	214
Export All Diagnostic Files	215
Appendix.....	217
Appendix A - Time Zones.....	217
Appendix B - Menu Structure.....	219
For the SIP-T29G IP phone.....	219
For the SIP-T27G/T27P/T23G/T23P/T21(P) E2/T19(P) E2 IP Phone	220

Overview

Before using your phone, you'd better get familiar with its features and user interface. This chapter details your phone's component, the icon and LED instructions, the screen layout of your phone, and how to navigate the phone/web user interfaces. Topics include:

- [Hardware](#)
- [Icons and Status Indicators Instructions](#)
- [LED Instructions](#)
- [User Interfaces](#)





Contact your system administrator for assistance or more information.

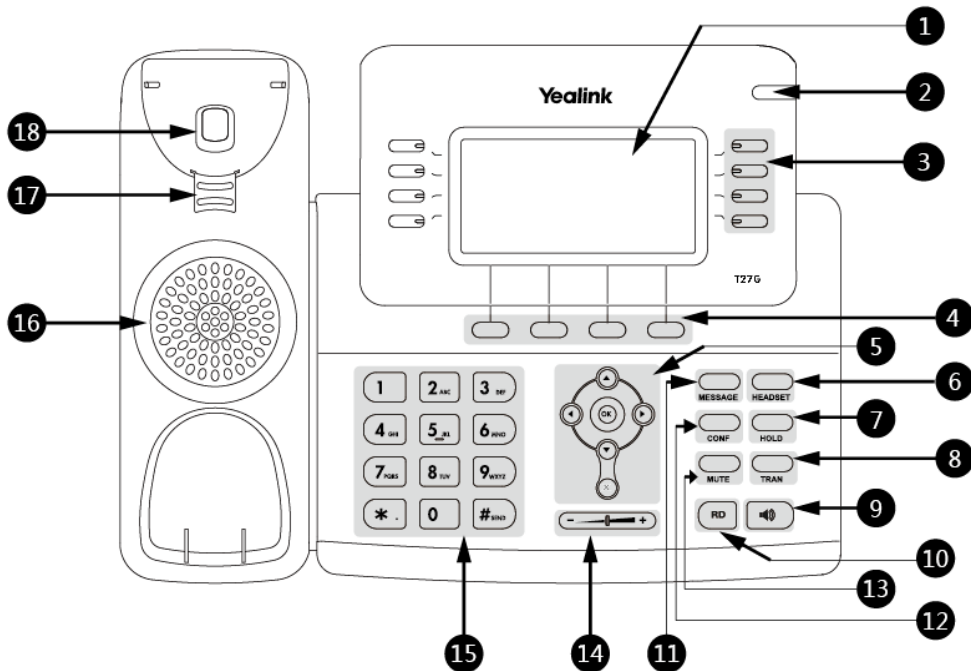

Hardware

The main hardware of IP phones are the LCD screen and the keypad. The following figure displays the hardware features here takes SIP-T27G IP phone as an example:



Hardware features description:

























































	Item	Description
①	LCD Screen	Shows information about your phone, such as calls, messages, soft keys, time and date: <ul style="list-style-type: none"> • Default account • Call information—caller ID, call duration • Icons (for example, DND) • Missed call or second incoming caller information • Message (for example, "Saving config file!") • Time and date
②	Power Indicator LED	Indicates call status, message status and phone's system status. <ul style="list-style-type: none"> • Receives an incoming call—Fast-flashing • Receives a voice mail or text message—Slow-flashing
③	Line Keys	<ul style="list-style-type: none"> • Activates accounts • Assigns function or feature to the line key. Note: There is no Line key on the SIP-T19(P) E2 IP phone.
④	Soft Keys	Enable you to select context sensitive keys that display along the bottom of the screen.
⑤	Navigation Keys	Scrolls through menus, information or options displayed on the phone's screen.
	 OK Key	Confirms actions or answers incoming calls.
	Cancel Key	Cancels actions or rejects incoming calls. On the SIP-T23G/T23P/T21P E2 IP phone, you can also use it to mute or unmute an activate call. Note: There is no Cancel Key on SIP-T19(P) E2 IP phone.
⑥	 HEADSET Key	Toggles the headset mode on or off. On the SIP-T29G/T27G/T27P IP phone, the LED indicator glows green when headset mode is activated.
⑦	HOLD Key	Hold an active call or resumes a held call. Note: There is no HOLD Key on SIP-T23G/T23P/T21(P) E2/T19(P) E2 IP phone.
⑧	 TRAN Key	Transfers a call to another party.
⑨	 Speakerphone Key	Toggles the hands-free (speakerphone) mode on or off.









	Item	Description
⑩	RD Key	Dials the most recently dialed number.
⑪	 MESSAGE Key	<ul style="list-style-type: none"> • Accesses voice messages when the voice mail code is configured. • Configures the voice mail code when the voice mail code is not configured. The LED indicator glows green when receiving a new voice mail except on SIP-T19(P) E2 IP phone.
⑫	CONF Key	Creates a conference with another party. Note: There is no CONF key on SIP-T23G/T23P/T21(P) E2/T19(P) E2 IP phones.
⑬	 MUTE Key	Mutes or un-mutes your audio during calls. Note: There is no MUTE key on SIP-T23G/T23P/T21(P) E2 IP phones.
⑭	 Volume Key	Adjusts the volume of the handset, headset, speaker or ringer.
⑮	Keypad	Allows you to enter numbers, letters and special characters as well as select menu items which are with index numbers.
⑯	Speaker	Provides hands-free (speakerphone) audio output.
⑰	Reversible Tab	Secures the handset in the handset cradle when the IP phone is mounted vertically. For more information on how to adjust the reversible tab, refer to Yealink Wall Mount Quick Installation Guide for Yealink IP Phones .
⑱	Hookswitch	<ul style="list-style-type: none"> • Lifts the handset from the handset cradle, then the hookswitch bounces and the phone connects to the line. • Rests the handset on the handset cradle, then the phone disconnects from the line automatically.

Icons and Status Indicators Instructions

Status Indicators

Phone icons and status indicators displaying on the status bar are described in the following table:











Icons				Description
T29G	T27G	T27P	T23G/T23P/ T21(P) E2/T19(P) E2	
				Wired network unavailable
				Hands-free (speakerphone) mode
				Handset mode
				Headset mode
				Voice Mail
				Text Message
				Auto Answer
				Do Not Disturb (DND)
				Keep Mute
				Silent Mode
				Phone Lock
				Missed Calls
				Call Forward
		/	/	Recording in progress (Using a USB flash drive)
		/	/	Recording paused (Using a USB flash drive)













Icons				Description
T29G	T27G	T27P	T23G/T23P/ T21(P) E2/T19(P) E2	
		/	/	Bluetooth Mode
		/	/	Bluetooth headset paired and connected
	/	/	/	Bluetooth-Enabled mobile phone paired and connected
		/	/	Wi-Fi connection successful
		/	/	Wi-Fi connection failed

Line Key Icons















Icons for line key are described in the following tables:



Icon indicators (associated with line key features on the SIP-T29G IP phone only):

Icons	Description
	Hold/Public Hold Private Hold
	DND
	Voice Mail
	SMS
	Direct Pickup
	Group Pickup
	DTMF Prefix
	Local Group XML Group LDAP
	XML Browser
	Conference





Icons	Description
	Forward
	Transfer
	ReCall
	Record URL Record
	Recording in process (Record/URL Record)
	Multicast Paging Group Listening Paging List
	Hot Desking
	Zero Touch
	URL
	Phone Lock
	Directory
	Speed Dial

Icon indicators (associated with line)







Icons			Description
T29G	T27G/T27P	T23G/T23P/ T21(P) E2	
			The private line registers successfully
			The shared/bridged line registers successfully
			Register failed
			Registering
			DND is enabled on this line

Icons			Description
T29G	T27G/T27P	T23G/T23P/ T21(P) E2	
			Call forward is enabled on this line

Icon indicators (associated with call park/retrieve park on the SIP-T29G IP phone only)

Icons	Description
	Park successfully/Idle state
	Park failed
	Ringing state
	Retrieve parked call





Icon indicators (associated with BLF/BLF List on the SIP-T29G IP phone only)

Icons	Description
	Monitored line is available.
 (Flashing)	Monitored line is ringing.
 (Flashing)	Monitored line is dialing.
	Monitored line is busy or in a call.
	Monitored line is placed on hold.
	Monitored line is parked.
	BLF/BLF List registers failed.









Note

Your system administrator can customize the BLF key LED status and BLF key behavior for the phone.

Icon indicators (associated with intercom on the SIP-T29G IP phone only)



Icons	Description
	Target extension is available.
	Target extension is ringing.
	Target extension is dialing.
	Target extension is busy or is in a call.
	Target extension registers failed.







Icon indicators (associated with ACD)

Icon		Description
T29G	T27G/T27P/T23G/ T23P/T21(P) E2	
		Log in
		Available
		Wrap up
	 and x	Unavailable

Icon indicators (associated with a shared line on the SIP-T29G IP phone only)







The Local SCA Phone is involved in an SCA call, while the Monitoring SCA Phone is not involved in the SCA call and used for monitoring shared line.

Icon	Description
	The shared line is idle.
 (Monitoring SCA Phone)	The shared line is seized.
	The shared line receives an incoming call.

Icon	Description
	The shared line is dialing.
	The shared line is busy or is in a call.
	The call on shared line is placed on public hold.
 (Local SCA Phone)  (Monitoring SCA Phone)	The call on shared line is placed on private hold.
	The call on shared line is barged in by the other shared line party.
	In a multi-party call, all the participants place the call on hold.

Icon indicators (associated with a bridged line on the SIP-T29G IP phone only)











The Local BLA Phone is involved in a BLA call, while the Monitoring BLA Phone is not involved in a BLA call and used for monitoring bridged line.

Icon	Description
	The bridged line is idle.
 (for monitoring BLA phone)	The bridged line is seized.
	The bridged line receives an incoming call.
	The bridged line is dialing.
	The bridged line is busy or is in a call.
	The call on bridged line is placed on hold.









Other Icons

Icons for specific features are described in the following tables:



Icon indicators (associated with call recording while using a record key)

Icon		Description
T29G	T27G/T27P/T23G/T23P/ T21(P) E2	
		Recording box full
		Record failed
		Recording
		Start recording failed
		Stop recording failed

Icon indicators (associated with call history)

Icon		Description
T29G	T27G/T27P/T23G/T23P /T21(P) E2/T19(P) E2	
		Received Calls
		Placed Calls
		Missed Calls
		Forwarded Calls

Icon indicator (associated with contact)

Icon		Description
T29G	T27G/T27P/T23G/T23P /T21(P) E2/T19(P) E2	
		The default contact icon
	/	The default contact photo

LED Instructions

Power LED Indicator

Power LED Indicator

LED Status	Description
Solid red	The phone is initializing.
Fast-flashing red (300ms)	The phone is ringing.
Slow-flashing red (1s)	The phone receives a voice mail or text message.
Solid red for 500ms and off for 3000ms alternately	The phone enters power-saving mode. It is only available on SIP-T29G IP phone.
Off	The phone is powered off. The phone is idle. The phone is busy. The call is placed on hold by you or by the remote party. The call is muted.

Note

The above is the default LED status, since the status of the power LED indicators may be configured by your system administrator. For more information, please contact your system administrator.

Line Key LED

Line key LED is not available on the SIP-T19(P) E2 IP phone.

Line key LED

LED Status	Description
Solid green	The line is seized. The line is busy or is in a call.
Fast-flashing green	The line receives an incoming call.
Slow-flashing green	The call is placed on hold.
Off	The line is inactive.

Line key LED (configured as a Forward key with a value (destination number))

LED Status	Description
Solid green	The always forward feature is activated.
Off	The always forward feature is deactivated.

Note

If the value (the destination number) is not configured for a Forward key, the key LED solids green when the always/busy/no answer forward feature is activated. It is off when the always/busy/no answer forward feature is deactivated.

Line key LED (configured as a BLF key or BLF List key)

LED Status	Description
Solid green	The monitored user is idle.
Fast-flashing red (200ms)	The monitored user receives an incoming call.
Solid red	The monitored user is busy. The monitored user's conversation is placed on hold (This LED status requires server support).
Slow-flashing red (1s)	The call is parked on the monitored user.
Off	The monitored user does not exist.

Line key LED (used as a page switch key)

LED Status	Description
Solid red	There is a call parked on the line whose line key is not on the current page.
Fast-flashing green	The line receives an incoming call on the line key of the non-current page.
Fast-flashing red	The monitored user receives an incoming call line whose line key is not on the current page.
Off	The line keys are idle.

Line key LED (associated with a shared line)

The Local SCA Phone is involved in an SCA call, while the Monitoring SCA Phone is not involved in the SCA call and used for monitoring shared line.

LED Status	Description
Off	The shared line is idle.
Fast-flashing green	The shared line receives an incoming call.
Solid green (Local SCA Phone)	The shared line is busy or is in a call.

LED Status	Description
Solid red (Monitoring SCA Phone)	The shared line is dialing. The shared line is seized. The call on shared line is barged in by the other shared line party.
Slow-flashing green (Local SCA Phone) Slow-flashing red (Monitoring SCA Phone)	The call on shared line is placed on public hold.
Slow-flashing green (Local SCA Phone) Solid red (Monitoring SCA Phone)	The call on shared line is placed on private hold. In a multi-party call, all the participants place the call on hold.

Line key LED (associated with a bridged line)

The Local BLA Phone is involved in a BLA call, while the Monitoring BLA Phone is not involved in a BLA call and used for monitoring bridged line.

LED Status	Description
Off	The bridged line is idle.
Fast-flashing green	The bridged line receives an incoming call.
Solid green (Local BLA Phone) Solid red (Monitoring BLA Phone)	The bridged line is busy or is in a call. The bridged line is dialing. The bridged line is seized.
Slow-flashing green (Local BLA Phone) Slow-flashing red (Monitoring BLA Phone)	The call on bridged line is placed on hold.

Note

The above is the default LED status, since the status of the power LED indicators may be configured by your system administrator. For more information, please contact your system administrator.

User Interfaces

There are two ways to configure your IP phone:

- Via phone user interface
- Via web user interface

The phone user interface, being made up of keypad and LCD screen, allows users to perform all call operations and change basic configuration settings directly on the phone. But if you want to access all configuration settings, you should use web user interface instead. In most cases, it is possible to configure your IP phone via both phone user interface and web user interface. While in some particular cases, only via phone user interface or via web user interface is available for you to operate or configure your IP phone. This guide mainly takes phone user interface as an example.

Phone User Interface

Before you use the phone, you need to understand the phone screen layout, how to navigate menus and fields, and how to enter and edit data.

Idle Screen

After starting up successfully, the phone enters Idle screen automatically. From the Idle screen, you can access the Menu screen, History screen, Directory screen and Line Key screen. These screens are described in the following chapters:

- [Menu Screen](#)
- [History Screen](#)
- [Directory Screen](#)
- [Line Key Screen](#)

Note

The menu system will automatically exit to the Idle screen after 60 seconds of inactivity.

For the SIP-T29G IP phone, the page icons appear only when you assign functionality to line key located in line key 11-27, refer to [DSS Keys](#) for more information. The wallpaper can be customized, refer to [Changing Wallpaper on the Idle Screen](#) for more information. The Idle screen on SIP-T29G IP phone is shown as below:

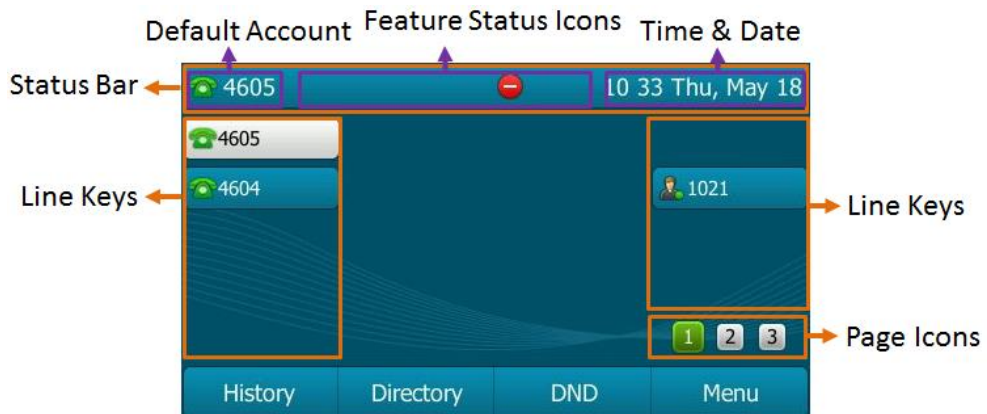

For the SIP-T27G/T27P IP phone, the page icons appear only when you assign functionality to line key located in line key 9-21, refer to [DSS Keys](#) for more information. The Idle screen on SIP-T27G/T27P IP phone is shown as below:

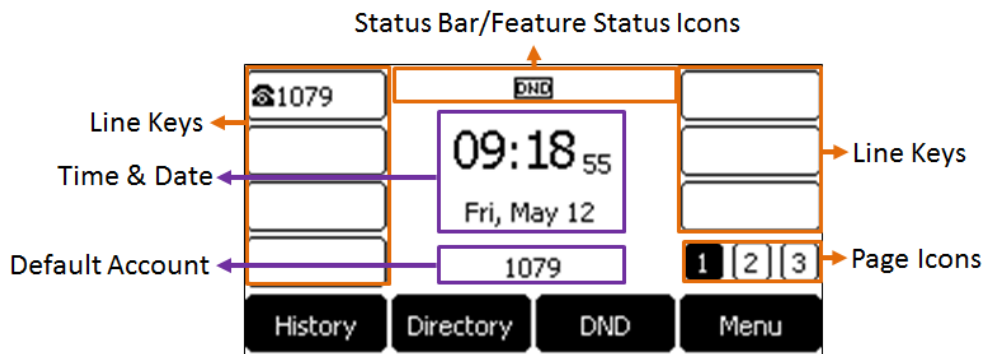

The Idle screen on SIP-T23G/T23P IP phone is shown as below:

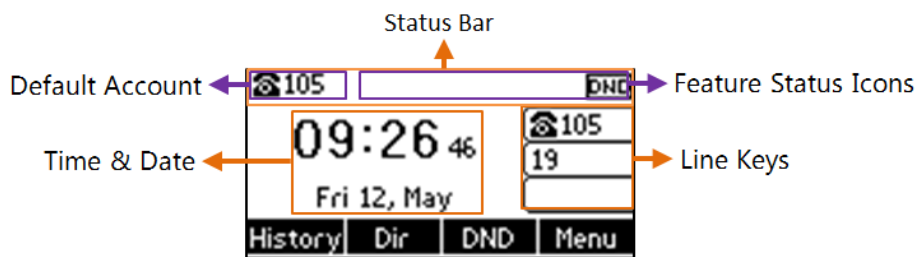

Note If your IP phone does not display the default account, please contact your system administrator.

Menu Screen

When the phone is idle, you can press the **Menu** soft key to access the Main Menu screen. From the Main Menu screen, you can access the desired sub menu, such as Status, Features, Settings, Message, History, Directory and USB to navigate menus and fields and customize your phone. Note that the Advanced (Advanced Settings) option is only accessible to the administrator, and the default administrator password is "admin" (case-sensitive).

Note For a better understanding of the menu structure, please refer to [Appendix B - Menu Structure](#).

The Menu screen on SIP-T29G IP phone is shown as below:

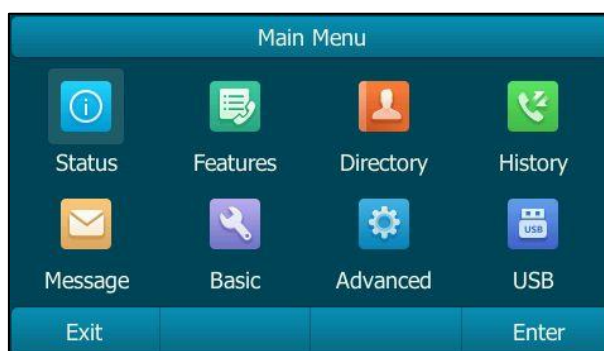

The Menu screen on SIP-T27G/T27P IP phone is shown as below:

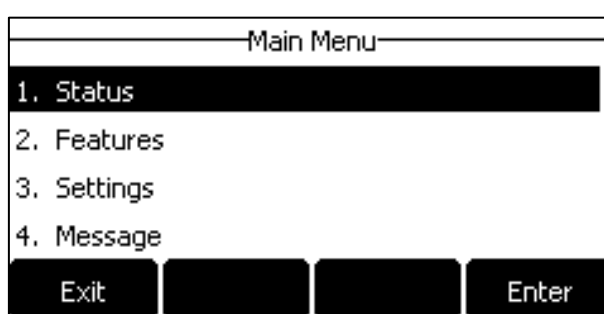

History Screen

When the phone is idle, you can press the **History** soft key or navigate to **Menu->History** to access the History screen for viewing and managing the history records. For more information, refer to [Call History Management](#).

The History screen on SIP-T27G/T27P IP phone is shown as below:

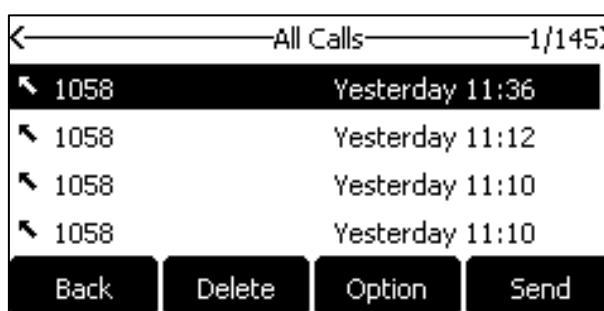

You can press the left and right navigation key to switch among the history lists on all IP phones.

Directory Screen

The Directory screen is made up of Groups screen and Contacts screen. When the phone is idle, you can press the **Directory (Dir)** soft key or navigate to **Menu->Directory** to access the Groups screen. From this screen, you can view and manage groups, or select the desired groups

to view and manage the contacts. For more information, refer to [Contact Management](#).

You can press the navigation key to switch among the groups on all IP phones. The Directory screen on SIP-T29G/T27P IP phone is shown as below:

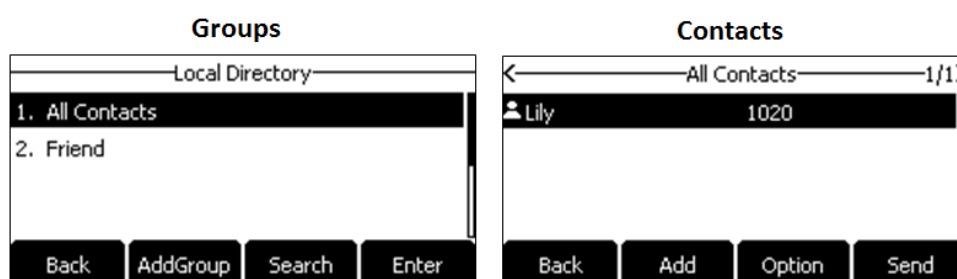

Line Key Screen

When the phone is idle, you can also long press the desired line key or navigate to **Menu->Features->DSS Keys** to assign functionality. For more information, refer to [Line Keys](#). It is not available on the SIP-T19(P) E2 IP phone.

The Line Key screen on the SIP-T27G/T27P IP phone is shown as below:

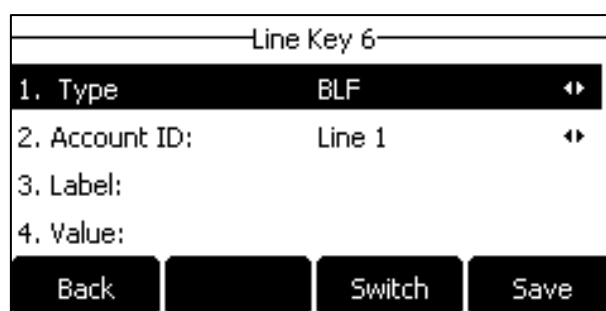

Dialing/Pre-dialing Screen

When the phone is idle, you can pick up the handset, press a line key (except the SIP-T19(P) E2 IP phone) or Speakerphone key to access the Dialing screen. Or you can enter a number directly using the dialpad to access the Pre-dialing screen. The placed call records display on the LCD screen. From Dialing/Pre-dialing screen, you can use phone dialpad to enter and edit data. The contacts whose name or phone number matches the entered characters appear on the LCD screen. You can select the desired contact to place a call directly.

Note

Your system administrator can configure the search source list in dialing and disable the phone to display the placed call records. Check with your system administrator to find out if they are available on your phone.

You can press Directory soft key to access the directory list. For more information, refer to [Configuring List\(s\) for the Directory \(Dir\) Soft Key](#). The Dialing screen on the SIP-T27G/T27P IP phone is shown as below:

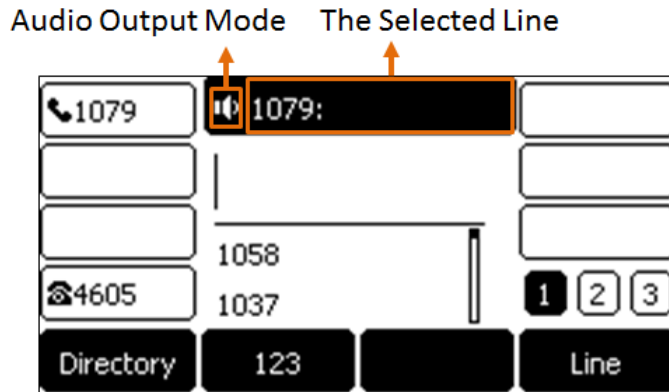

Calls Screen

All of your active and held calls display on the Calls screen.

When you have an active call and one or more held calls on your phone, you can press up and down navigation keys to switch among calls. When there is an active call and a held call, the Calls screen on SIP-T27G/T27P IP phone is shown as below:

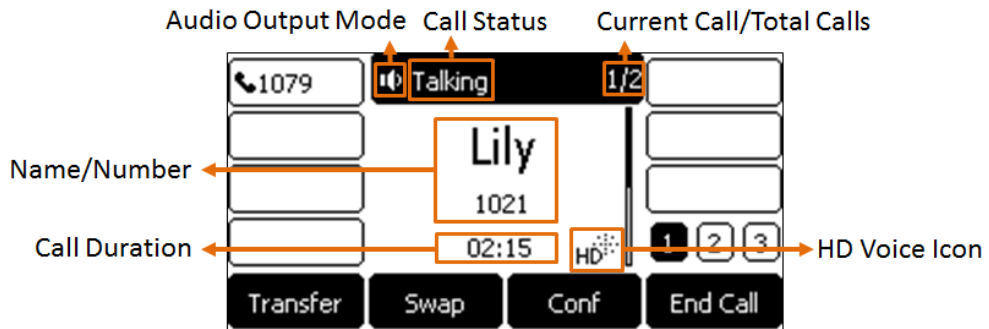





Navigating Menus and Fields

Press soft keys, navigation keys or dialpad keys on the phone to navigate menus and fields.

To operate your phone, follow these tips:

If you want to	Action
Enter the main menu.	Press the Menu soft key.
Go back to the previous menu.	<ul style="list-style-type: none"> Press  (not available on the SIP-T19(P) E2 IP phone). Press the Back soft key.











Select an item.	<ul style="list-style-type: none"> • Scroll to the item by pressing  or , and then press . • Use the dialpad keys to select items that have index numbers.
Scroll through values for a field.	<ul style="list-style-type: none"> • Press  or , or the Switch soft key to switch among available values one by one.

Entering Data and Editing Fields

You can enter data and edit fields using the dialpad keys on the phone console.

The IP phones provide 5 different input methods, including **2aB**, **abc**, **Abc**, **ABC** and **123**, and different input methods provide different characters on dialpad for editing and updating field information. No matter what kind of input method you are using, press the dialpad key one or more times to view the character (or number) options and stop to select. Wait for one second after you input a character (or number), then input the next character (or number).

The following table lists character (or number) options on dialpad in different input methods:





Input Modes Dialpad	2aB	abc	Abc (title case)	ABC	123
	1				1
	2abcABC	abc2äæååå âäç	abc2äæååå âäç	ABC2ÄÆÅ ÀÁÃÄÇ	2
	3defDEF	def3èéëëë ôõ	def3èéëëë ôõ	DEF3ÈÉÊËË ÒÓÔÕÑ	3
	4ghiGHI	ghi4ìíîï	ghi4ìíîï	GHI4ÌÍÎÏ	4
	5jklJKL	jkl5£	jkl5£	JKL5£	5
	6mnoMNO	mno6öøòó ôõñ	mno6öøòó ôõñ	MNO6ÖØ ÒÓÔÕÑ	6
	7pqrsPQRS	pqrs7ß	pqrs7ß	PQRS7ß	7
	8tuvTUV	tuv8ùúûü	tuv8ùúûü	TUV8ÙÚÛÜ ÿ	8
	9wxyzWXYZ Z	wxyz9ýþ	wxyz9ýþ	WXYZ9ÝÞ	9
	0	space	space	space	0

Input Modes Dialpad	2aB	abc	Abc (title case)	ABC	123
	*,?!\\-()@/: _+&%=<> £\$¥¤[]{}~ ^i¿\$#"	*,?!\\-()@/: _+&%=<> £\$¥¤[]{}~ ^i¿\$#"	*,?!\\-()@/: _+&%=<> £\$¥¤[]{}~ ^i¿\$#"	*,?!\\-()@/: _+&%=<> £\$¥¤[]{}~ ^i¿\$#"	*,?!\\-()@/: _+&%=<> £\$¥¤[]{}~ ^i¿\$#"
	#	#	#	#	#

To enter or edit data:

1. Do one of the following:

If you want to	Then you can
Enter only digits (1), uppercase (A) characters, lowercase (a) characters, or alphanumeric (2aB) characters.	<p>Press a keypad key one or more times (depending on what input mode you're in) to enter the characters that is displayed on the keypad key.</p> <p>You can press the abc/ABC/123/2Ab/Abc/abc soft key one or more times to switch among uppercase (ABC), numeric (123), alphanumeric (2aB), uppercase and lowercase (Abc) and lowercase (abc) input modes.</p> <p>For example, if the input mode is ABC:</p> <ul style="list-style-type: none"> - To enter "A", press once. - To enter "B", press twice quickly. - To enter "C", press three times quickly. - To enter "2ÄÆÅÀÁÂÃÄÇ", press more than three times quickly. <p>Note: When you are in the uppercase (ABC), uppercase and lowercase (Abc) or lowercase (abc soft key) input mode, is not available.</p>
Enter special characters.	<p>Press the keypad key or , or press .</p> <p>For Key:</p> <ul style="list-style-type: none"> - If it is in the uppercase (ABC), uppercase and lowercase (Abc) or lowercase (abc) input mode, it will only provide the space character. - If it is in the numeric (123) or alphanumeric (2aB) input mode, it will only provide the digit 0. - If it is in the numeric (123) or alphanumeric (2aB) input mode, it will provide the special

If you want to	Then you can
	<p>character + by long pressing about 2 seconds on the dialing/pre-dialing screen.</p> <p>For  key:</p> <ul style="list-style-type: none"> - It only provides the pound character #. <p>For  key:</p> <ul style="list-style-type: none"> - If it is in the uppercase (ABC), lowercase (abc), uppercase and lowercase (Abc) or alphanumeric (2aB) input mode, it will provide the following special characters: <code>*.,'?!\\-()@/,:;+&%=<> £ \$ ¥ ¢ [] {} ~ ^ ¡ ¢ \$ # "</code> - If it is in the numeric (123) input mode, it will provide the following special characters: <code>./:@[]</code>.
Delete text you entered.	<p>Press  or  to position the cursor to the right of the text you want to delete, and then press the Delete soft key to delete one character at a time.</p>

Web User Interface

In addition to the phone user interface, you can also customize your phone via web user interface. In order to access the web user interface, you need to know the IP address of your new phone by pressing the OK key on the phone when the phone is idle. Enter the IP address (for example, `http://192.168.0.10` or `192.168.0.10` for IPv4; `http://[2005:1:1:1:215:65ff:fe64:6e0a]` or `[2005:1:1:1:215:65ff:fe64:6e0a]` for IPv6) in the address bar of a web browser on your PC. The default administrator user name and password are both "admin" (case-sensitive).

Note

The access to the Advanced settings of the Account or Network via web user interface may be blocked by the web browser (for example, Chrome, Firefox) if you have installed "Adblock Plus plugin".

Navigating the Web User Interface

When you log into the web user interface successfully, the phone status is displayed on the first page of the web user interface. You can click each menu to customize or click **Log out** to log out of the web user interface.

The following figure is an example that navigates to **Settings->Preference**:

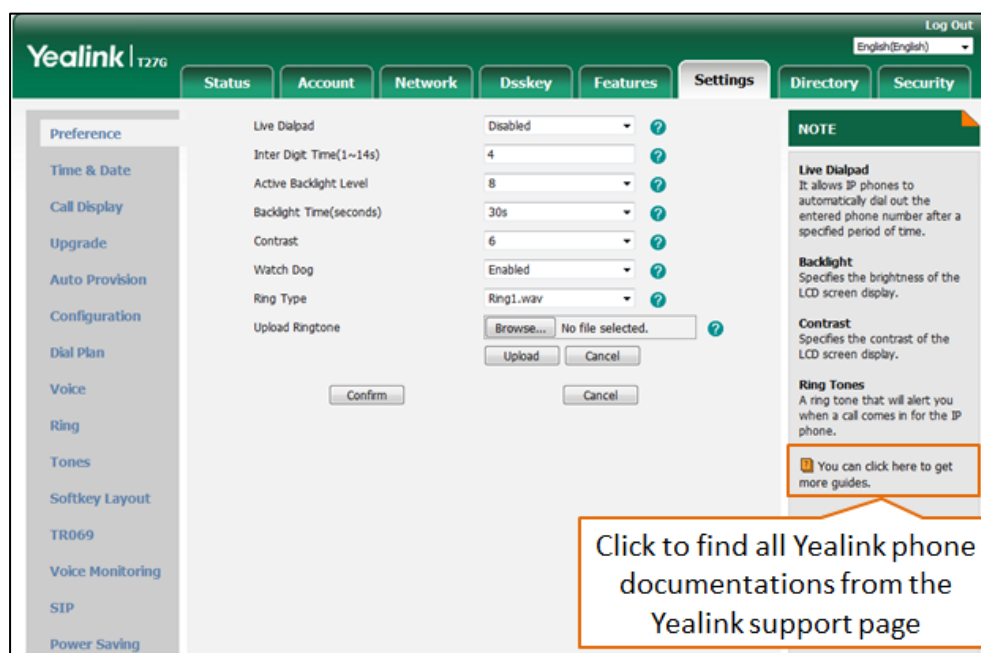

Features Configurable via Phone/Web User Interface

The main features you can customize for the IP phone via phone user interface and/or via web user interface are listed in the following table:

Features	Phone User Interface	Web User Interface	Note
Network Settings			
--Basic Network Settings			
--DHCP	✓	✓	
--IPv4	✓	✓	
--IPv6	✓	✓	
Registration			
--Account Registration	✓	✓	
--Default Account	✓	X	
Basic Phone Settings			
--Wallpaper			Only available for the SIP-T29G IP phone
--Wallpaper Customization	X	✓	
--Wallpaper on the Idle Screen	✓	✓	
--Screen Saver			
--Screensaver Customization	X	✓	Only available for the SIP-T29G IP phone

Features	Phone User Interface	Web User Interface	Note
--XML Browser URL	X	√	
--Screen Saver Settings	√	√	
--Power Saving	X	√	Not available for the SIP-T19(P) E2 IP phone
--Logo Customization	X	√	Not available for the SIP-T29G IP phone
--Backlight	√	√	Not available for the SIP-T19(P) E2 IP phone
--Contrast	√	√	Not available for the SIP-T29G IP phone
--Language			
--Phone Language	√	X	
--Web Language	X	√	
--Time & Date			
--SNTP Settings	√	√	
--Manually Settings	√	√	
--Time & Date Format	√	√	
--Administrator Password	√	√	
--Key As Send	√	√	
--Phone Lock			
--Phone Lock Settings	√	√	
--Unlock PIN	√	√	
--Emergency Number	X	√	
--Audio Settings			
--Ring Tones			
--Phone Ring Tone	√	√	
--Account Ring Tone	√	√	
--Ring Tone Customization	X	√	
--Key Tone	√	√	
--Contact Management			
--Directory list(s) Settings	X	√	
--Local Directory			
--Groups Management	√	√	
--Contacts Management	√	√	
--Contact Photo Customization	X	√	Only available for the SIP-T29G IP phone
--Contact Lists Import/Export	X	√	

Features	Phone User Interface	Web User Interface	Note
--Blacklist			
--Blacklist Management	√	√	
--Mobile Contact	√	√	Only available for the SIP-T29G IP phone
--Remote Phone Book			
--Remote Phone Book URL	X	√	
--Remote Phone Book Management	√	X	
--Call History Management			
--History Management	√	X	
--History Settings	√	√	
--DSS Keys			
--Line Keys			
--Line Keys Configuration	√	√	Not available for the SIP-T19(P) E2 IP phone
--Multiple Line Key per Account	√	√	
--Auto Linekeys	X	√	
--Number of Line key	X	√	
--Label Length	X	√	Only available for the SIP-T29G IP phone
--Page Tips	X	√	Only available for the SIP-T29G/T27G/T27P IP phone
--Programable Keys	X	√	
--Soft Keys	√	√	Not available for the SIP-T29G IP phone
--Dial Plan			
--Replace Rule	X	√	
--Dial Now	X	√	
--Area Code	X	√	
--Block Out	X	√	
Basic Call Features			
--Speed Dial Key	√	√	Configurable via phone user interface except on SIP-T19(P) E2 IP phone
--Hotline	√	√	
--Auto Answer	√	√	
--Auto Redial	√	√	
--Call Completion	√	√	

Features	Phone User Interface	Web User Interface	Note
--Do Not Disturb (DND)			
--DND Mode	X	√	Not available for the SIP-T19(P) E2 IP phone
--DND Emergency	X	√	
--Call Forward			
--Forward Mode	X	√	Not available for the SIP-T19(P) E2 IP phone
--Forward Emergency	X	√	
--Call Transfer			
--Transfer Mode via Dsskey	X	√	
--Allow Trans Exist Call	X	√	Not available for the SIP-T29G IP phone
--Call Waiting	√	√	
--Network Conference	X	√	
--Call Park/Retrieve			
--FAC Mode	X	√	
--Transfer Mode	X	√	
--Call Pickup			
--Directed Call Pickup	X	√	
--Group Call Pickup	X	√	
--Anonymous Call	√	√	
--Anonymous Call Rejection	√	√	
Advanced Phone Features			
--Busy Lamp Field (BLF)			
--BLF Pickup	X	√	Not available for the SIP-T19(P) E2 IP phone
--BLF List			
--BLF Key	√	√	Not available for the SIP-T19(P) E2 IP phone
--BLF List Settings	X	√	Not available for the SIP-T19(P) E2 IP phone
--Call Recording			
--USB Record	√	X	Only available for the SIP-T29G/T27G IP phone
--Record/URL Record Key	√	√	
--Hot Desking			
--Hot Desking Key	√	√	

Features	Phone User Interface	Web User Interface	Note
--Intercom			
--Intercom Key	√	√	
--Intercom Settings	√	√	
--Multicast Paging			
--Multicast Paging Key	√	√	Configurable via phone user interface except on SIP-T19(P) E2 IP phone
--Paging List Key	√	√	Configurable via phone user interface except on SIP-T19(P) E2 IP phone
--Paging List	√	√	
--Multicast Listening	X	√	
--Automatic Call Distribution (ACD)			
--ACD Key	√	√	Configurable via phone user interface except on SIP-T19(P) E2 IP phone
--Shared Call Appearance (SCA)			
--SCA Line Settings	X	√	
--Private Hold Soft Key	X	√	
--Private Hold Key	√	√	Not available for the SIP-T19(P) E2 IP phone
--Call Pull	X	√	
--Bridged Line Appearance (BLA)			
--BLA Account Settings	X	√	
--Messages			
--Short Message Service (SMS)	√	√	
--Voice Mail Settings	√	√	
Optional Accessories			
--Headset			
--Headset Prior	X	√	
--Dual Headset	X	√	
--Bluetooth			Only available for the SIP-T29G/T27G IP phone
--Mobile Contacts Synchronization	√	X	
--Device Name	√	X	
--Wireless Network Settings			Only available for the SIP-T29G/T27G IP phone
--Wi-Fi	√	√	

Features	Phone User Interface	Web User Interface	Note
--Ext Keys	√	√	Only available for the SIP-T29G/T27G/T27P IP phone

Note The table above lists most of the feature options. Please refer to the relevant sections for more information.

Getting Started

This chapter provides the following information for obtaining the best performance with your IP phone. Topics include:

- [Phone Initialization](#)
- [Phone Status](#)
- [Basic Network Settings](#)
- [Registration](#)

Before using your phone, make sure that your phone has been successfully installed. For more information on how to install the phone, read the Quick Start Guide in your phone package or download from Yealink Support page for the product.

Contact your system administrator for assistance or more information.

Phone Initialization

After your phone is powered on, the system boots up and performs the following steps:

Automatic Phone Initialization

The phone finishes the initialization by loading the saved configuration. A message "Welcome Initializing...Please wait" is displayed on the LCD screen during the initialization.

DHCP (Dynamic Host Configuration Protocol)

The phone attempts to contact a DHCP server in your network to obtain valid IPv4 network settings (for example, IP address, subnet mask, default gateway address and DNS address) by default.

Note

If your network does not use DHCP, proceed to [Basic Network Settings](#).

Phone Status

Available information on phone status includes:

- General information (IPv4 address or IPv6 address, phone MAC address, Wi-Fi dongle MAC address and firmware version).
 - IPv4 uses a 32-bit address.
 - IPv6 using a 128-bit address, which is an updated version of the current Internet Protocol to meet the increased demands for unique IP addresses.
- Network status (IPv4 status or IPv6 status, IP mode, phone MAC address and Wi-Fi dongle

MAC address).

- Phone status (product name, hardware version, firmware version, product ID, phone MAC address, Wi-Fi dongle MAC address, Bluetooth dongle MAC address and device certificate status).
- Account status (registration status of SIP accounts).

Note

Wi-Fi dongle MAC address and Bluetooth dongle MAC address are only available on the SIP-T29G/T27G IP phone.

Viewing the Phone Status

You can view phone status via phone user interface by pressing the OK key or navigating to **Menu->Status**.

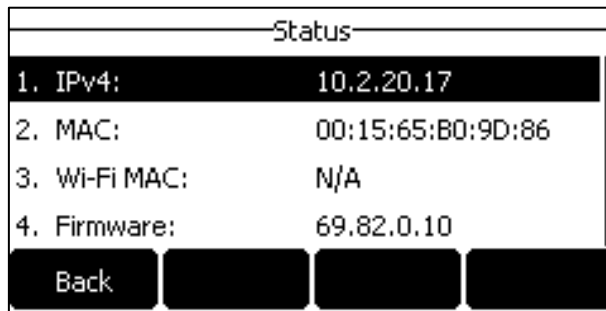

You can also view the phone status via web user interface.

Procedure:

1. Open a web browser on your computer.
2. Enter the IP address in the browser's address bar, and then press the **Enter** key.
For example, "http://192.168.0.10" for IPv4 or "http://[2005:1:1:1:215:65ff:fe64:6e0a]" for IPv6.
3. Enter the user name (admin) and password (admin) in the login page.

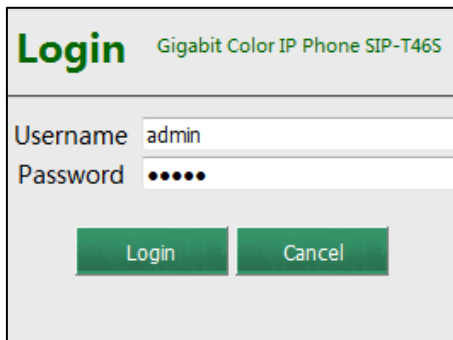

4. Click **Login** to login.

The phone status is displayed on the first page of the web user interface.

The screenshot shows the Yealink T276 web user interface. The top navigation bar includes 'Status', 'Account', 'Network', 'Dsskey', 'Features', 'Settings', 'Directory', and 'Security'. The 'Status' page is active, displaying the following information:

Category	Parameter	Value
Version	Firmware Version	69.82.0.10
	Hardware Version	69.0.0.0.0.0.0
Device Certificate	Device Certificate	Factory Installed
Network	Internet Port	IPv4
	WAN Port Type	DHCP
IPv4	WAN IP Address	10.2.20.17
	Subnet Mask	255.255.255.0
	Gateway	10.2.20.254
	Primary DNS	192.168.1.22
	Secondary DNS	192.168.1.20

A 'NOTE' section on the right side of the page provides additional information:

- Version:** It shows the version of firmware and hardware.
- Network:** It shows the network settings of Internet (WAN) port.
- Account:** It shows the registration status of SIP accounts.

A link is provided: 'You can click here to get more guides.'

Note IPv6 is not available on all servers. Contact your system administrator for more information.

Basic Network Settings

In order to get your IP phones running, you must perform basic network setup. You can use DHCP or configure a static address to connect your IP phone to the network. If your phone cannot contact a DHCP server for any reason, you need to configure network settings manually. The IP phone can support either or both IPv4 and IPv6 addresses.

Note The wrong network settings may result in inaccessibility of your phone and may also have an impact on your network performance. For more information on these parameters, contact your system administrator.

Configuring the DHCP

You can configure DHCP for IPv4 or IPv6. The following takes IPv4 as an example:

Procedure:

1. Navigate to **Menu->Settings->Advanced Settings** (default password: admin)
->**Network->WAN Port**.
For the SIP-T29G IP phone, navigate to **Menu->Advanced** (default password: admin)
->**Network->WAN Port**.
2. Select **IPv4** or **IPv4 & IPv6** from the **IP Mode** field.
3. Navigate to **IPv4->DHCP IPv4 Client**.

For the SIP-T29G IP phone, Enter **IPv4**, and then select **DHCP** from the **Type** field.

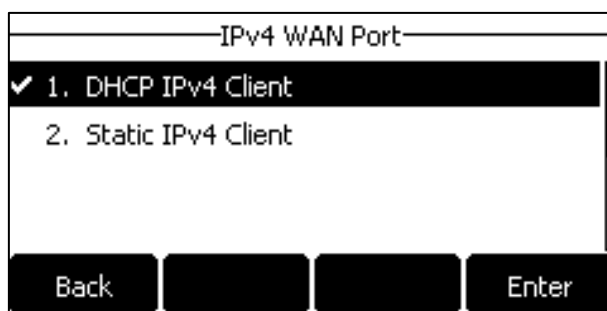

4. Press **Save**.

If you want to configure DHCP for IPv6, select **IPv6** or **IPv4 & IPv6** from the **IP Mode** in the step 2.

DHCP is configurable via web user interface at the path **Network->Basic**.

Configuring the Static IPv4 Address

Procedure:

1. Navigate to **Menu->Settings->Advanced Settings** (default password: admin)
->**Network->WAN Port**.

For the SIP-T29G IP phone, navigate to **Menu->Advanced** (default password: admin)
->**Network->WAN Port**.

2. Select **IPv4** or **IPv4 & IPv6** from the **IP Mode** field.
3. Navigate to **IPv4->Static IPv4 Client**.

For the SIP-T29G IP phone, enter **IPv4**, and then select **Static IP** from the **Type** field.

4. Enter the desired value in the **IP Address**, **Subnet Mask**, **Default Gateway**, **Pri. DNS** and **Sec.DNS** field respectively.

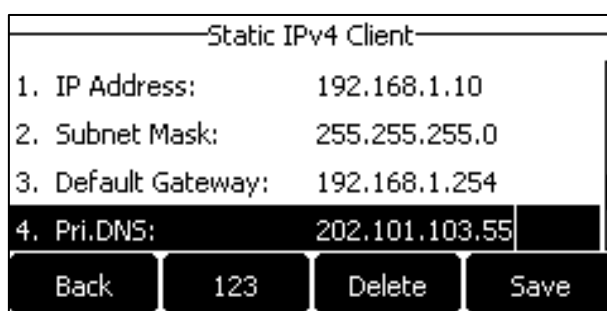

5. Press **Save**.

Static IPv4 address is configurable via web user interface at the path **Network->Basic**.

Configuring the Static IPv6 Address

Procedure:

1. Navigate to **Menu->Settings->Advanced Settings** (default password: admin)
->**Network->WAN Port**.
For the SIP-T29G IP phone, navigate to **Menu->Advanced** (default password: admin)
->**Network->WAN Port**.
2. Select **IPv6** or **IPv4 & IPv6** from the **IP Mode** field.
3. Navigate to **IPv6->Static IPv6 Client**.
For the SIP-T29G IP phone, enter **IPv6**, and then select **Static IP** from the **Type** field.
4. Enter the desired value in the **IP Address**, **IPv6 IP Prefix**, **Default Gateway**, **Pri. DNS** and **Sec.DNS** field respectively.

Static IPv6 Client	
1. IP Address:	2005:1:1:1::25
2. IPv6 IP Prefix:	64
3. Default Gateway:	2005:1:1:1::1
4. Pri.DNS:	2005:1:1:1::89
Back	123
Delete	Save

5. Press **Save**.

Static IPv6 address is configurable via web user interface at the path **Network->Basic**.

Registration

Generally, your system administrator will set the phone parameters beforehand, and performs centralized deployment on all IP phones. In this case, after the phone starts up, it is ready to use and the account has been registered already. But if the account is not registered, you should register it manually. You can register one or multiple accounts on the IP phone.

You can configure one or multiple line keys to associate with an account. For more information, refer to [Configuring Multiple Line Keys per Account](#) for more information.

The maximum registered accounts vary from different phone models:

Phone Model	Accounts
SIP-T29G	<=16
SIP-T27G/T27P	<=6
SIP-T23G/T23P	<=3
SIP-T21(P) E2	<=2
SIP-T19(P) E2	1

Note

Contact your system administrator for the account information.

Registering an Account

Procedure:

1. Navigate to **Menu->Settings->Advanced Settings** (default password: admin)
->**Accounts**.
For the SIP-T29G IP phone, navigate to **Menu->Advanced** (default password: admin)
->**Accounts**.
2. Select a desired account.
3. Select **Enabled** from the **Activation** field.
4. Enter the desired value in the **Label, Display Name, Register Name, User Name, Password** and **SIP Server1/2** field respectively.
5. If you use the outbound proxy servers, do the following:
 - 1) Select **Enabled** from the **Outbound Status** field.
 - 2) Enter the desired value in the **Outbound Proxy1/2** and **Proxy Fallback Interval** field respectively.
6. Press **Save**.

You can repeat steps 2 to 6 to register more accounts.

Account registration is configurable via web user interface at the path **Account->Register**.

The following figures demonstrate single or multiple accounts registered on the phone:

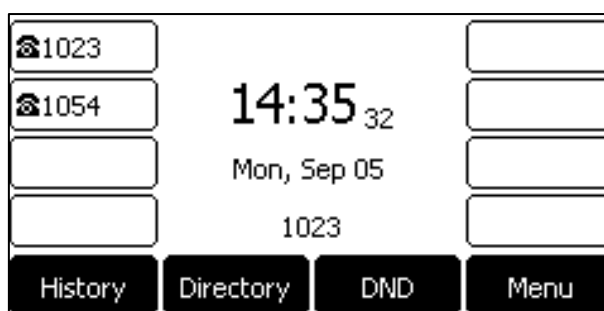
Single account:**Multiple accounts:**

Disabling an Account

You can disable an account after registering.

Procedure:

1. Navigate to **Menu->Settings->Advanced Settings** (default password: admin)
->**Accounts**.
For the SIP-T29G IP phone, navigate to **Menu->Advanced** (default password: admin)
->**Accounts**.
2. Select a desired account.
3. Select **Disabled** from the **Activation** field.
4. Press **Save**.

Account can be disabled via web user interface at the path **Account->Register**.

Configuring the Default Account

If there are multiple accounts registered on the phone, the phone will use the default account to dial out by default.

From the Idle screen, you can press the left or right navigation key to select the desired account as the default account except on SIP-T19(P) E2 IP phone. For the SIP-T29G IP phone, you can also do the following to configure the default account.

Procedure:

1. Navigate to **Menu->Features->Others->Default Account**.
2. Select a desired account from the **Default Account** field.

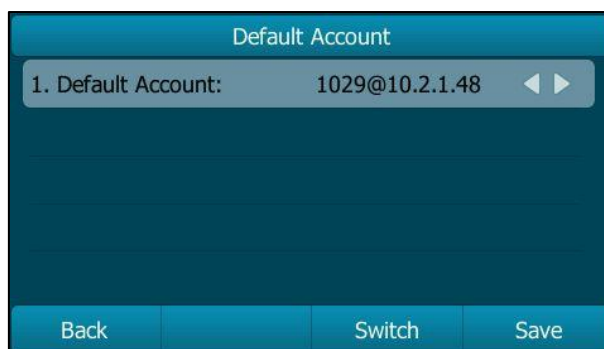

3. Press **Save**.

Customizing Your Phone

You can customize your IP phone by configuring certain settings, including changing wallpaper, setting time and date and personalizing different ring tones for different callers. You can also add contacts to the phone's local directory manually or from call history.

This chapter explains how to customize your phone. Topics include:

- [General Settings](#)
- [Audio Settings](#)
- [Contact Management](#)
- [Call History Management](#)
- [DSS Keys](#)
- [Dial Plan](#)

Contact your system administrator for assistance or more information.

General Settings

Wallpaper

On SIP-T29G IP phone, you can change the wallpaper via phone/web user interface. Meanwhile, you can also upload custom pictures as wallpaper via web user interface.

Uploading a Custom Picture as Wallpaper

The custom picture must meet the following:

Phone Model	Format	Resolution	Single File Size	Screen Size
SIP-T29G	*.jpg *.png *.bmp *.jpeg	<=1.8 megapixels	<=5MB	4.3 inches (Resolution: 480x272)

Note

Either the smaller or larger picture will be scaled proportionally to fit the screen.
2MB of space should be reserved for the phone.

Procedure:

1. Click **Settings->Preference**.

- In the **Upload Wallpaper(480*272)** field, click **Browse** to choose a desired picture from your local system.

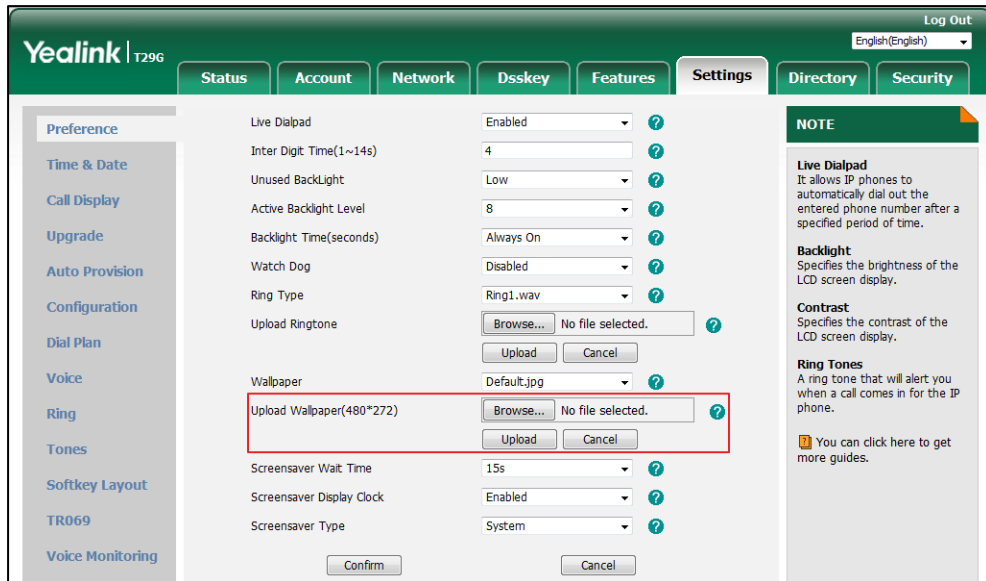

- Click **Upload**.

The custom picture you uploaded just now appears in the pull-down lists of **Wallpaper**. Only the custom pictures you upload can be deleted by clicking **Del** from the pull-down list in the **Wallpaper** field.

Deleting the Custom Picture

On SIP-T29G IP phones, you can delete the custom wallpaper via phone user interface or via web user interface.

Procedure:

- Navigate to **Menu->Basic->Display->Wallpaper**.
- Select the desired picture.



- Press **Delete** to delete the corresponding picture.

Deleting the custom picture is configurable via web user interface at the path **Settings->Preference**.

Changing Wallpaper on the Idle Screen

You can change the wallpaper to display on the Idle screen.

Procedure:

1. Navigate to **Menu->Basic->Display->Wallpaper**.
2. Select the desired wallpaper.

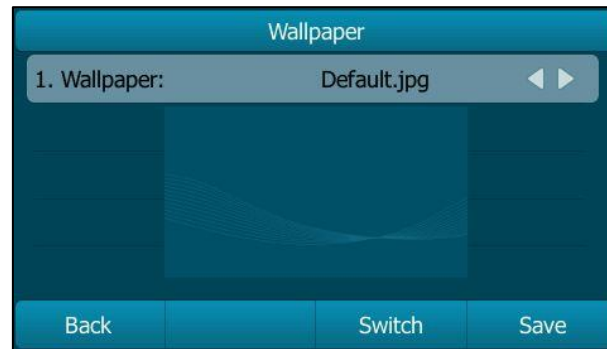

3. Press **Save**.

Wallpaper on the Idle screen is configurable via web user interface at the path **Settings->Preference->Wallpaper**.

Screen Saver

The screen saver will automatically start when the IP phone is idle for the preset waiting time.

The screen saver will be stopped if one of the following phone events occurs:

- Press any key.
- Pick up/hang up the handset.
- There is an incoming call.
- A new prompt (for example, missed call, new voice mail or forwarded call).
- The status of BLF key changes.

If your phone is idle again for a specified period of time, the screen saver will start again. The time & date and certain feature status icons (for example, a new text message, auto answer, DND,) will also display on the screen saver. For more information on the icons, refer to [Status Indicators](#).



SIP-T29G

For SIP-T29G IP phone, you can upload custom pictures to set up a screen saver of your picture, configure the screen saver type and screen saver display clock. For all IP phones, you can also configure the screen saver wait time and configure the phone whether to display custom XML items (for example, notifications or company logo) on the screen saver or not. The custom XML items are preset by your system administrator.

Uploading a Custom Picture as Screen Saver

Uploading custom pictures is only available for SIP-T29G IP phone. The custom picture must meet the following:

Format	Resolution	Single File Size	Screen Size
*.jpg *.png *.bmp *.jpeg	<=1.8 megapixels	<=5MB	4.3 inches (Resolution: 480x272)

Procedure:

1. Click **Settings**->**Preference**.
2. Select **Custom** from the **Screensaver Type** field.
3. In the **Upload Screensaver** field, click **Browse** to choose a custom picture from your local system, and then click **Upload**.

This field appears only if **Screensaver Type** is set to **Custom**.

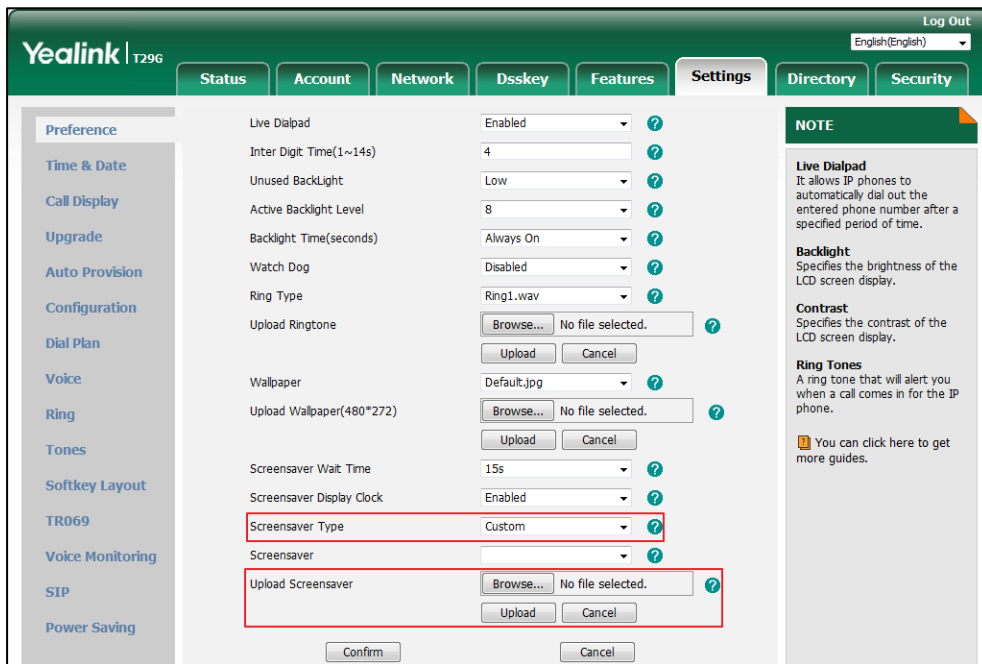

The custom picture appears in **Screensaver** list. You can only delete the custom picture by clicking **Del** in the **Screensaver** field.

Configuring the XML Browser URL

Procedure:

1. Click **Settings**->**Preference**.
2. For SIP-T29G IP phone, select **Server XML** from the **Screensaver Type** field.
3. Enter the XML browser URL in the **XML Browser URL** field.

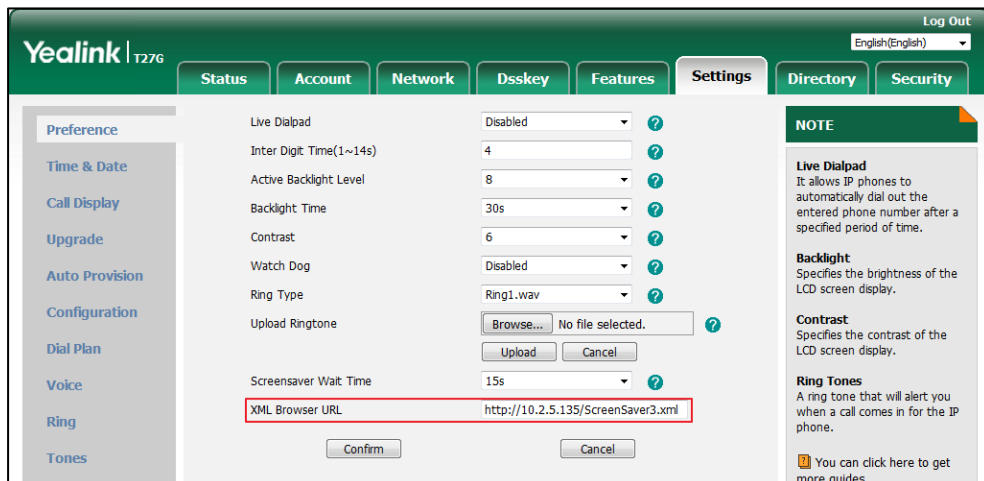

4. Click **Confirm**.

Note

For the XML browser URL, contact your system administrator.

Configuring the Screen Saver

Procedure:

1. Navigate to **Menu->Settings->Basic Settings->Display->Screensaver**.
For SIP-T29G IP phone, navigate to **Menu->Basic->Display->Screensaver**.
2. Select the desired wait time from the **Wait Time** field.
3. (Optional.) For SIP-T29G IP phone, select the desired value from the **Display Clock** field.
It is not available when you select **Server XML** from the **Screensaver Type** field.
4. For SIP-T29G IP phone, select the desired screen saver type from the **Screensaver Type** field.
 - If you select **System**.
The IP phone will automatically set the system picture as the screen saver.
 - If you select **Custom**.
The IP phone will automatically set the custom pictures (refer to [Uploading a Custom Picture](#)) you upload as the screen saver, and display in slide-show style.
 - If you select **Server XML**.
The IP phone will automatically display the XML items (for example, notifications or company logo, refer to [Configuring the XML Browser URL](#)) along with system picture or custom pictures (if uploaded) as the screen saver.

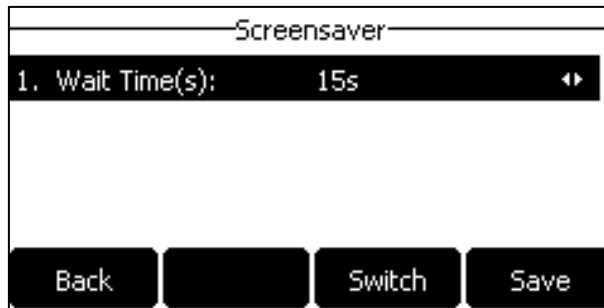

5. Press **Save**.

Screen saver is configurable via web user interface at the path **Settings->Preference**.

Note

For all IP phones except SIP-T29G IP phone, the screen saver works only when the XML Browser URL is configured.

Power Saving

The power saving feature is used to turn off the backlight and screen (only for SIP-T29G IP phone) to conserve energy. The IP phone, except SIP-T19(P) E2 IP phone, enters power-saving mode after it has been idle for a certain period of time. For SIP-T29G IP phone, the power LED glows red for 500ms and goes out for 3000ms alternately.

Note Your system administrator can disable the power LED indicator for power saving.

The IP phone will exit power-saving mode if one of the following phone events occurs:

- Press any key.
- Pick up/hang up the handset.
- There is an incoming call.
- A new prompt (for example, missed call, new voice mail or forwarded call).
- The status of BLF key changes.

If the screen saver is enabled (refer to [Screen Saver](#)) on your phone, power-saving mode will still occur.

You can configure the following power-saving settings:

- Office Hour
- Idle Timeout (minutes)

Enabling the Power Saving

Procedure:

1. Click **Settings**->**Power Saving**.

2. Select **Enabled** from the **Power Saving** field.

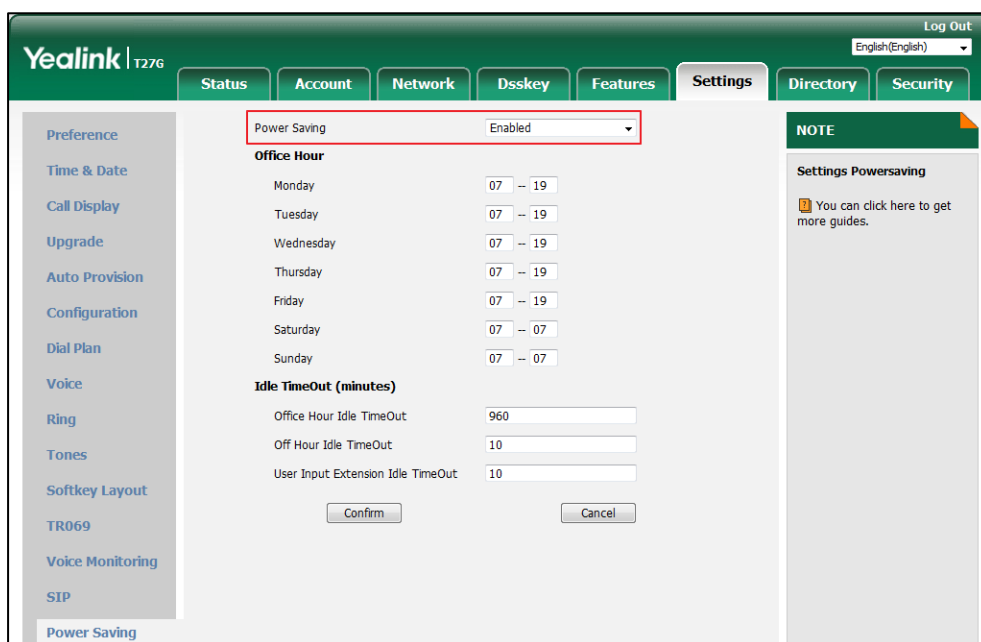

3. Click **Confirm**.

Configuring the Office Hour

Office Hour enables you to specify when you start and end work in the office each day.

Procedure:

1. Click **Settings**->**Power Saving**.
2. Enter the starting and ending time respectively in the desired day field.

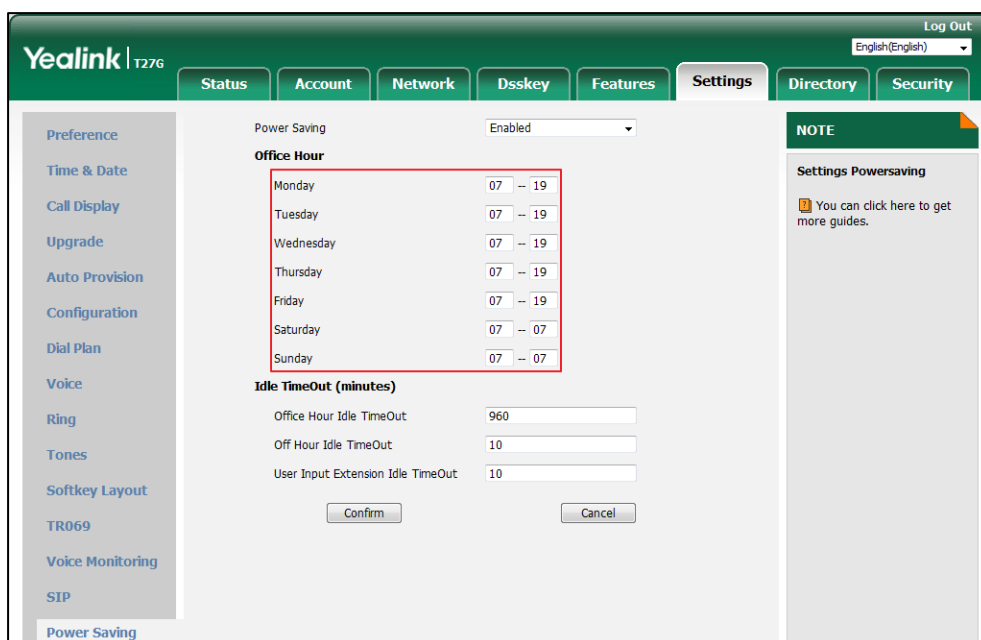

3. Click **Confirm**.

Configuring the Idle Timeout

Idle Timeout specifies the period of time that the IP phone is idle before entering power-saving mode. There are three different types of idle timeout:

- **Office Hours Idle TimeOut:** Configures the idle timeout for office hours.
- **Off Hours Idle TimeOut:** Configures the idle timeout for non-office hours.
- **User Input Extension Idle TimeOut:** Configures idle timeout that applies after you use the IP phone (for example, press a key on the phone or pick up/hang up the handset). You can choose to set a higher User Input Extension Idle TimeOut than the Office Hours Idle TimeOut and Off Hours Idle TimeOut so that when you're actively using the phone, power-saving mode doesn't initiate as often.

By default, the Office Hours Idle Timeout is much longer than the Off Hours Idle Timeout. If you use the IP phone, the idle timeout that applies (User Input Extension Idle Timeout or Office Hours/Off Hours Idle TimeOut) is the timeout with the highest value. If the phone has an incoming call or new message, the User Input Extension Idle TimeOut is ignored.

Procedure:

1. Click **Settings**->**Power Saving**.
2. Enter the desired value between 1 and 960 (minutes) in the **Office Hours Idle TimeOut** field.
3. Enter the desired value between 1 and 10 (minutes) in the **Off Hours Idle TimeOut** field.
4. Enter the desired value between 1 and 30 (minutes) in the **User Input Extension Idle TimeOut** field.

The screenshot shows the Yealink T276 web interface. The 'Settings' tab is selected, and the 'Power Saving' section is expanded. The 'Power Saving' dropdown is set to 'Enabled'. Under the 'Office Hour' section, the days of the week are listed with their respective time ranges: Monday (07 -- 19), Tuesday (07 -- 19), Wednesday (07 -- 19), Thursday (07 -- 19), Friday (07 -- 19), Saturday (07 -- 07), and Sunday (07 -- 07). Below this, the 'Idle TimeOut (minutes)' section is highlighted with a red box. It contains three input fields: 'Office Hour Idle TimeOut' with the value 960, 'Off Hour Idle TimeOut' with the value 10, and 'User Input Extension Idle TimeOut' with the value 10. At the bottom of this section are 'Confirm' and 'Cancel' buttons. A 'NOTE' box on the right side of the interface states: 'Settings Powersaving. You can click here to get more guides.'

5. Click **Confirm**.

Logo Customization

You can upload your custom logo shown on the LCD screen. It is not available for the SIP-T29G IP phone.

Procedure:

1. Click **Features**->**General Information**.
2. Select **Custom logo** from the pull-down list of **Use Logo**.
3. Click **Browse** to choose a logo file from your local system.

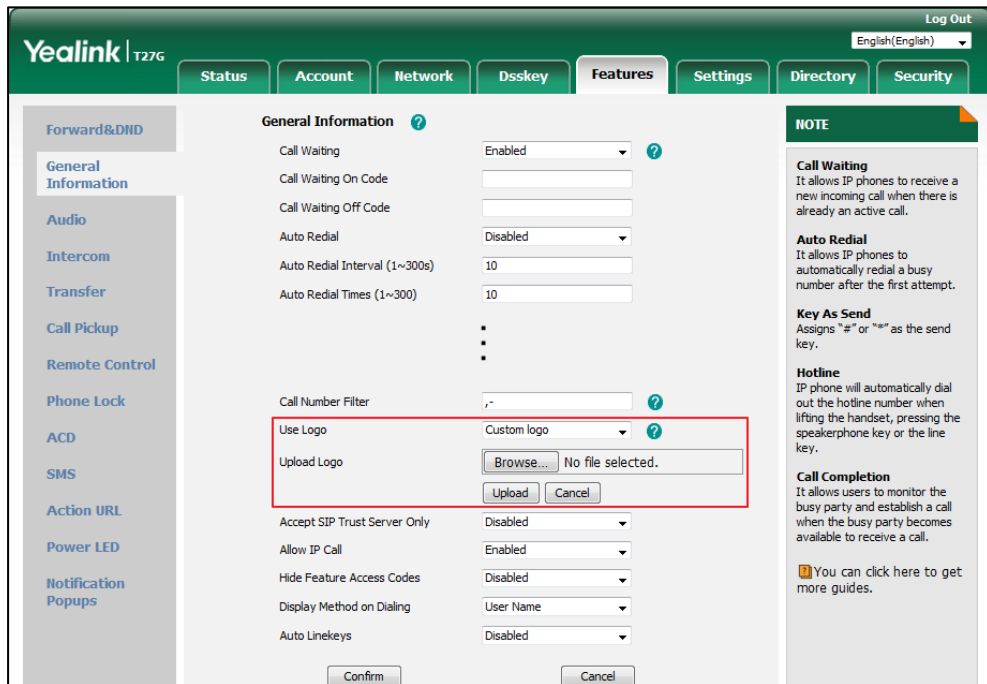

4. Click **Upload** to upload the file.

Note

Only after you upload a custom logo, can you click **Delete** to delete the custom logo. The logo file format must be *.dcb, contact your system administrator for more information. Logo customization is configurable via web user interface only.

Configuring the Backlight

Backlight has three options:

Active Level: The brightness of the LCD screen when the phone is active. Digits (1-10) represent different backlight intensities and 10 is the highest level. It is only available for the SIP-T29G/T27G/T27P IP phone.

Inactive Level: The brightness of the LCD screen when the phone is inactive. You can select a low intensity or turn off the backlight. It is only available for the SIP-T29G IP phone.

Backlight Time: The delay time to change the brightness of the LCD screen when the phone is

inactive. You can configure the phone to change its backlight intensity after a period of time or always turn on the backlight. It is not available for the SIP-T19(P) E2 IP phone.

- **Always On:** Backlight is always on.
- **Always Off:** Backlight is always off. It is not available for the SIP-T29G IP phone.
- **15s, 30s, 1min, 2min, 5min, 10min or 30min:** Backlight intensity changes when the phone is inactive after a period of time.

Procedure:

1. Navigate to **Menu->Settings->Basic Settings->Display->Backlight**.

For the SIP-T29G IP phone, navigate to **Menu->Basic->Display->Backlight**.

2. For the SIP-T29G/T27G/T27P IP phone, select the desired level from the **Active Level** field.
3. For the SIP-T29G IP phone, select the desired value from the **Inactive Level** field.
4. Select the desired time from the **Backlight Time** field.

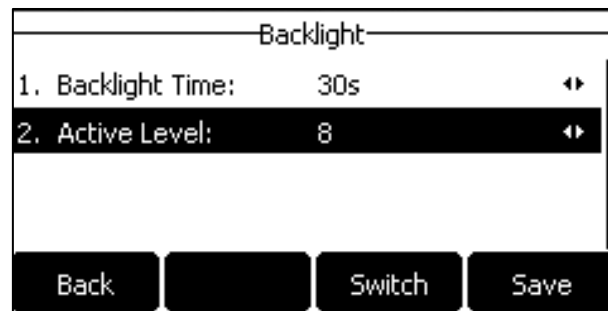

5. Press **Save**.

Backlight is configurable via web user interface at the path **Settings->Preference**.

Configuring the Contrast

You can configure the LCD screen contrast to a comfortable level for all IP phones except the SIP-T29G IP phone. The level ranges from 1 to 10 and 10 is the highest level.

Procedure:

1. Navigate to **Menu->Settings->Basic Settings->Display->Contrast**.

2. Select the desired value in the **Contrast** field.

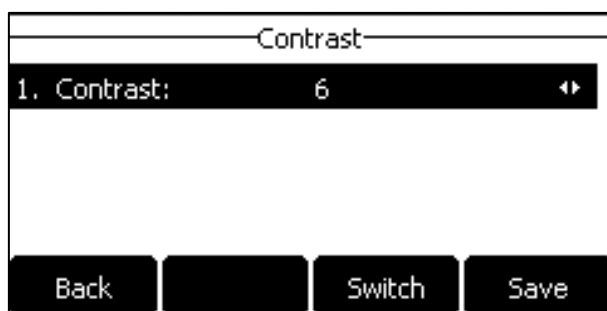

3. Press **Save**.

Contrast is configurable via web user interface at the path **Settings->Preference**.

Changing the Language

The default language of the phone user interface is English. If the language of your web browser is not supported by the phone, the web user interface will use English by default. You can change the language for the phone user interface and the web user interface respectively.

Changing the Language for the Phone User Interface

Procedure:

1. Navigate to **Menu->Settings->Basic Settings->Language**.
For the SIP-T29G IP phone, navigate to **Menu->Basic->Language**.
2. Select the desired language.



3. Press **Save**.

Text displayed on the phone user interface will change to the selected language.

Changing the Language for the Web User Interface

Procedure:

1. Select the desired language from the pull-down list at the top-right corner of web user interface.

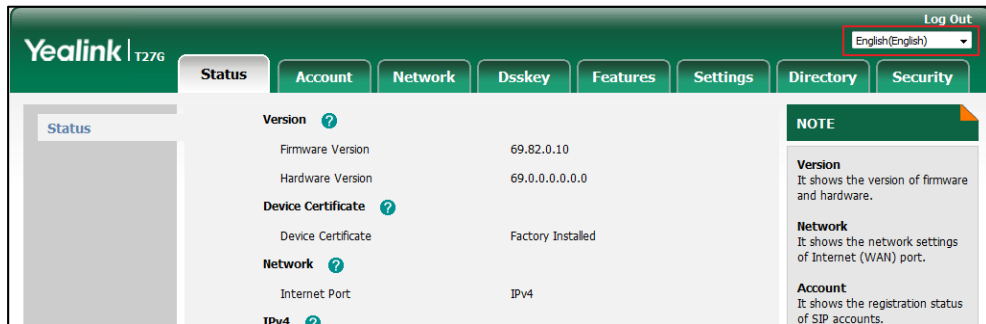

Text displayed on the web user interface will change to the selected language.

Time & Date

You can configure the phone to obtain the time and date from the SNTP server automatically, or configure the time and date manually.

Configuring the SNTP Setting

Procedure:

1. Navigate to **Menu->Settings->Basic Settings->Time & Date->SNTP Settings**.
For the SIP-T29G IP phone, navigate to **Menu->Basic->Time & Date->General->SNTP Settings**.
2. Select the time zone that applies to your area from the **Time Zone** field.
3. Enter the domain name or IP address of SNTP server in the **NTP Server1** and **NTP Server2** field respectively.
4. Select the desired value from the **Daylight Saving** field.
5. Select the desired time zone name from the **Location** field.

This field appears only if **Daylight Saving** field is selected to **Automatic**.

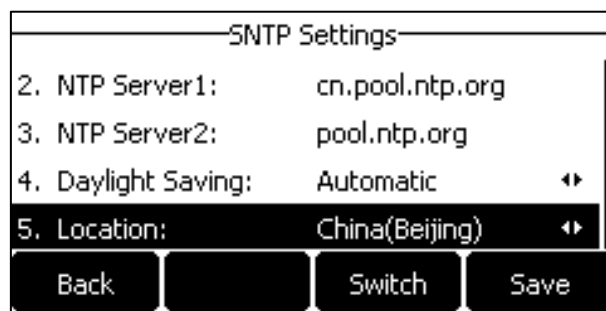

6. Press **Save**.

SNTP Setting is configurable via web user interface at the path **Settings->Time & Date**.

Note

Please refer to [Appendix A - Time Zones](#) for the list of available time zones on the IP phone.

If the phone cannot obtain the time and date from the Simple Network Time Protocol (SNTP) server, contact your system administrator for more information.

Configuring the Time and Date Manually

Procedure:

1. Navigate to **Menu->Settings->Basic Settings->Time & Date->Manual Settings**.
For the SIP-T29G IP phone, navigate to **Menu->Basic->Time & Date->General->Manual Settings**.
2. Enter the specific date and time in the corresponding fields.
For the SIP-T29G IP phone, you can also press the up or down navigate key to select the desired date and time.

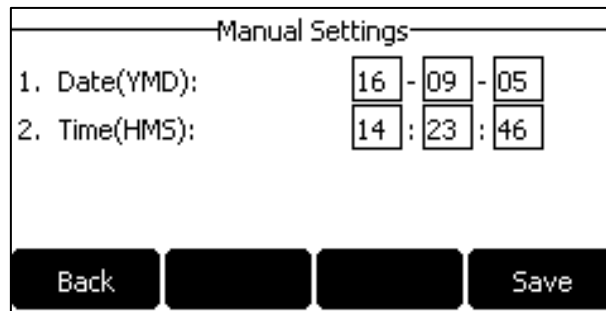

3. Press **Save**.
The time and date displayed on the LCD screen will change accordingly.

Time and date are configurable via web user interface at the path **Settings->Time & Date**.

Configuring the Time and Date Format

Procedure:

1. Navigate to **Menu->Settings->Basic Settings->Time & Date->Time & Date Format**.
For the SIP-T29G IP phone, navigate to **Menu->Basic->Time & Date->Time & Date Format**.
2. Select the desired time format from the **Time Format** field.

3. Select the desired date format from the **Date Format** field.

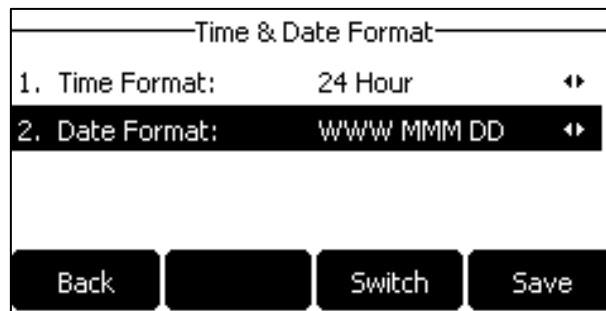

4. Press **Save**.

Time and date format are configurable via web user interface at the path **Settings->Time & Date**.

There are 7 available date formats. For example, for the date format “WWW DD MMM”, “WWW” represents days of the week, “DD” represents the day, and “MMM” represents the month.

The date formats available:

Date Format	Example (2016-09-02)
WWW MMM DD	Fri, Sep 02
DD-MMM-YY	02-Sep-16
YYYY-MM-DD	2016-09-02
DD/MM/YYYY	02/09/2016
MM/DD/YY	09/02/16
DD MMM YYYY	02 Sep, 2016
WWW DD MMM	Fri, 02 Sep

Note Your system administrator can customize the date format.

Changing the Administrator Password

The Advanced option is only accessible to the administrator. The default administrator password is “admin”. For security reasons, you should change the default administrator password as soon as possible.

Procedure:

1. Navigate to **Menu->Settings->Advanced Settings->Change Password**.
For the SIP-T29G IP phone, navigate to **Menu->Advanced** (default password: admin) ->**Change Password**.
2. Enter the desired value in the **Old PWD**, **New PWD** and **Confirm PWD** field respectively.

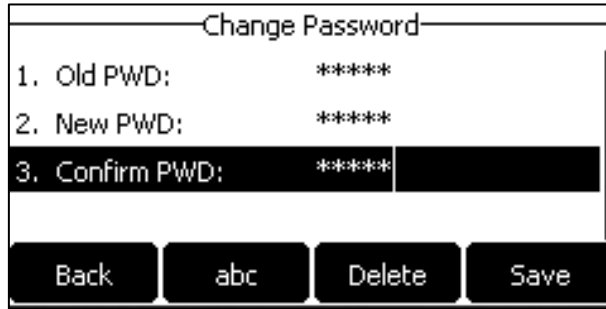

3. Press **Save**.

Administrator password is configurable via web user interface at the path **Security->Password**.

Configuring Key As Send

You can set the “#” key or “*” key to perform as a send key while dialing.

Procedure:

1. Navigate to **Menu->Features->Key As Send**.
For the SIP-T29G IP phone, navigate to **Menu->Features->Others->General**.
2. Select # or * from the **Key As Send** field, or select **Disabled** to disable this feature.

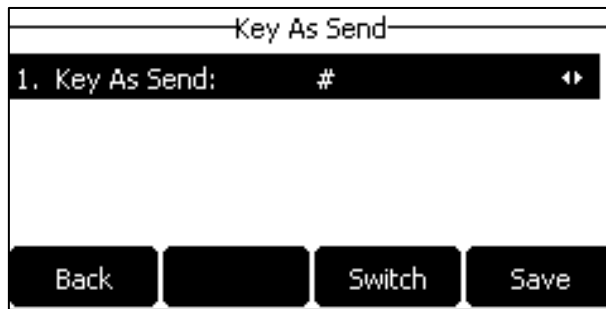

3. Press **Save**.

Key as send is configurable via web user interface at the path **Features->General Information**.

Phone Lock

You can lock your phone temporarily when you are not using it. This feature helps to protect your phone from unauthorized use.

The phone lock consists of the following:

- Menu Key:** The **Menu** soft key is locked. You cannot access the menu of the phone until unlocked.
- Function Keys:** The function keys are locked. You cannot use the MESSAGE, REDIAL, HOLD, MUTE, TRANSFER, OK, Cancel, navigation keys and soft keys until unlocked.

All Keys: All keys are locked except the Volume key, digit keys, # key, * key, HEADSET key and Speakerphone key. You are only allowed to dial emergency numbers, reject incoming calls by pressing the Cancel key or the **Reject** soft key, answer incoming calls by lifting the handset, pressing the Speakerphone key, the HEADSET key, the OK key or the **Answer** soft key, and end the call by hanging up the handset, pressing the Speakerphone key, the **End Call (EndCall)** soft key or the Cancel key.

Emergency Number

Public telephone networks in countries around the world have a single emergency telephone number (emergency services number), that allows a caller to contact local emergency services for assistance when necessary. The emergency telephone number may differ from country to country. It is typically a three-digit number so that it can be easily remembered and dialed quickly. Some countries have a different emergency number for each of the different emergency services. The emergency number setting, if desired, must be made before lock activation. For more information, refer to [Configuring the Emergency Number](#).

Activating the Phone Lock

Procedure:

1. Navigate to **Menu->Settings->Basic Settings->Phone Lock**.
For the SIP-T29G IP phone, navigate to **Menu->Basic->Phone Lock**.
2. Enter the desired PIN (default PIN: 123) in the **Unlock PIN** field, and then press **OK**.
3. Select **Enabled** from the **Lock Enable** field.
4. Select a desired type from the **Lock Type** field.
5. Enter the desired interval between 0 and 3600 (seconds) of automatic phone lock in the **Auto Lock** field.

If it is set to 0, the phone will not be automatically locked. You need to long press # key to lock it when the phone is idle.

If it is set to other values except 0 (for example, 5), the phone will be locked when the phone is inactive in the Idle screen for the designated time (in seconds).

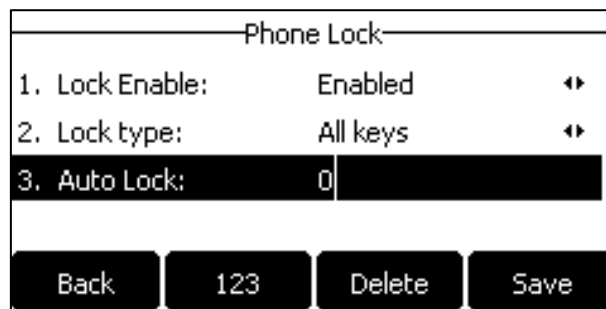

6. Press **Save**.

When the phone is locked, the lock icon will display on the LCD screen.

Phone Lock activation is configurable via web user interface at the path **Features->Phone Lock**.

Changing the Phone Unlock PIN

Procedure:

1. Navigate to **Menu->Settings->Basic Settings->Change PIN**.
For the SIP-T29G IP phone, navigate to **Menu->Basic->Change PIN**.
2. Enter the desired value in the **Old PIN**, **New PIN** and **Confirm PIN** field respectively.

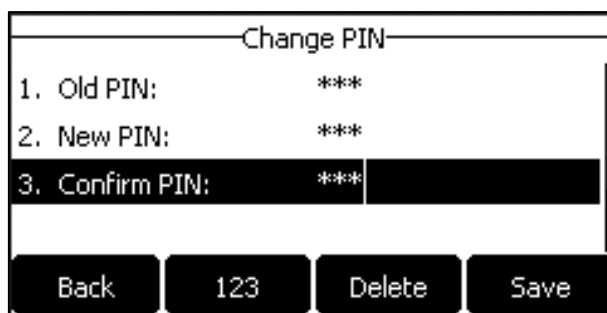

3. Press **Save**.

Phone Lock PIN is configurable via web user interface at the path **Features->Phone Lock**.

Note The unlock PIN length must be less than 15 digits.

Unlocking the Phone

Procedure:

1. Press any locked key, the LCD screen prompts you to enter an unlock PIN.
2. Enter the desired PIN in the **Unlock PIN** field.

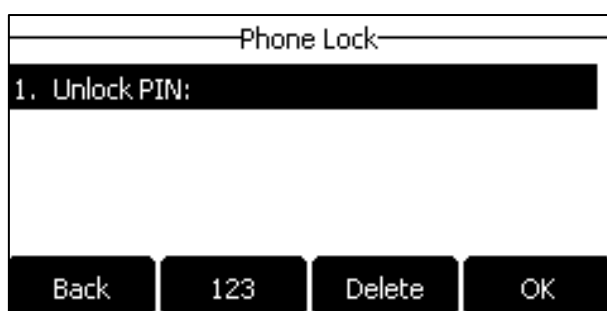

3. Press **OK**.

The lock icon disappears from the LCD screen.

You can long press the # key or wait for a period of time (if configured) to lock the phone again.

Note

You can also unlock the phone by administrator password. When you enter the administrator password to unlock the phone, the phone will turn to the Change PIN screen.

Deactivating the Phone Lock

Procedure:

1. Navigate to **Menu->Settings->Basic Settings->Phone Lock**.
For the SIP-T29G IP phone, navigate to **Menu->Basic->Phone Lock**.
2. Enter the desired PIN (default PIN: 123) in the **Unlock PIN** field, and then press **OK**.
3. Select **Disabled** from the **Lock Enable** field.

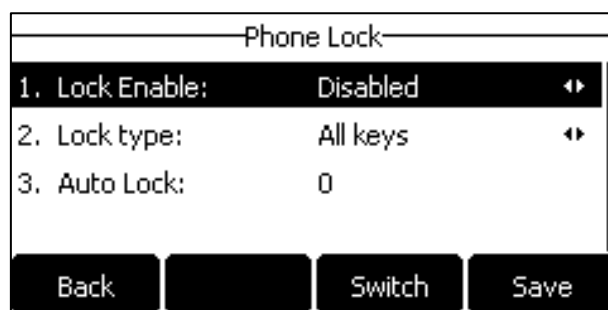

4. Press **Save**.

Phone lock deactivation is configurable via web user interface at the path **Features->Phone Lock**.

Configuring the Emergency Number

You can specify the emergency telephone numbers on the IP phone for contacting the emergency services for assistance in case of emergency. You can dial these numbers even when the phone is locked.

Note

Contact your local phone service provider for available emergency numbers in your area.

The IP phone also supports the emergency dialplan, which allows users to make emergency calls if the phone is locked or unregistered. For more information, contact your system administrator.

Procedure:

1. Click **Features->Phone Lock**.
2. Enter the emergency number in the **Emergency** field.

For multiple emergency numbers, enter a comma between every two numbers.

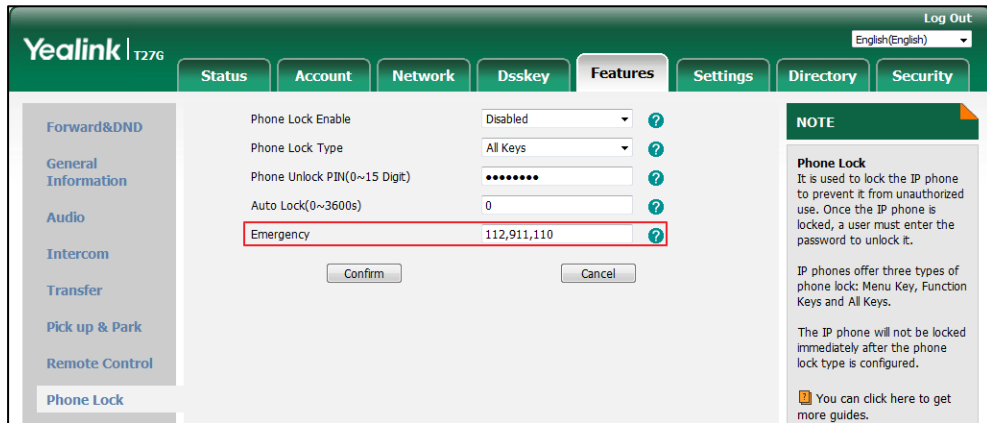

3. Click **Confirm**.

Audio Settings

Adjusting the Volume

You can adjust the ringer volume when the phone is idle or ringing and adjust the receiver volume of currently engaged audio devices (handset, speakerphone or headset) when the phone is in use.

Procedure:

1. Press the Volume key to adjust the ringer and audio volume.
- If ringer volume is adjusted to minimum, the minimum volume icon will appear on LCD screen.

Note

Your system administrator can disable you to adjust the ringer volume.

Ring Tones

Ring tones are used to indicate incoming calls. You can select different ring tones to distinguish different accounts registered on your phone, or to distinguish your phone from your neighbor's.

Selecting a Ring Tone

Procedure:

1. Navigate to **Menu->Settings->Basic Settings->Sound->Ring Tones->Common**.
For the SIP-T29G IP phone, navigate to **Menu->Basic->Sound->Ring Tones->Common**.

2. Select a desired ring tone.

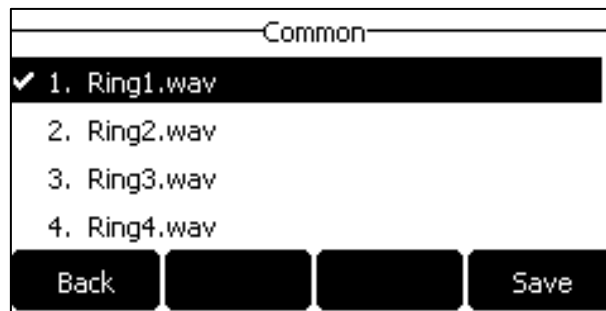

3. (Optional.) Press the Volume key to adjust the ringer volume.
4. Press **Save**.

A ring tone for the phone is configurable via web user interface at the path **Settings->Preference->Ring Type**.

Selecting a Ring Tone for an Account

Procedure:

1. Navigate to **Menu->Settings->Basic Settings->Sound->Ring Tones**.
For the SIP-T29G IP phone, navigate to **Menu->Basic->Sound->Ring Tones**.
2. Select a desired account.
3. Select a desired ring tone.

If **Common** is selected, this account will use the ring tone selected for the phone.

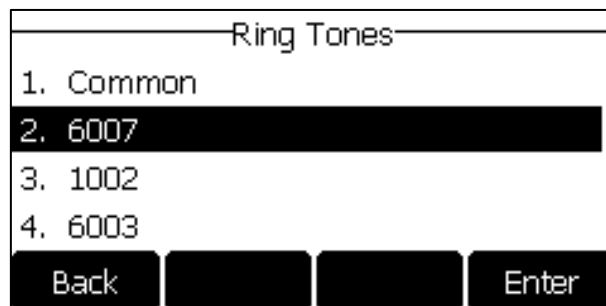

4. (Optional.) Press the Volume key to adjust the ringer volume.
5. Press **Save**.

A ring tone for the account is configurable via web user interface at the path **Account->Basic->Ring Type**.

Uploading a Custom Ring Tone

The ring tone file must meet the following:

Phone Model	Format	Single File Size	Note
SIP-T27G	.wav	<=8MB	2MB of space should be reserved for the phone
SIP-T29G	.wav	<=8MB	2.4MB of space should be reserved for the phone)
SIP-T27P/T23G/T23P/ T21(P) E2/T19(P) E2	.wav	<=100KB	5KB of space should be reserved for the phone

Procedure:

1. Click **Settings->Preference**.
2. In the **Upload Ringtone** field, click **Browse** to choose a ring tone file (the file format must be *.wav) from your local system.

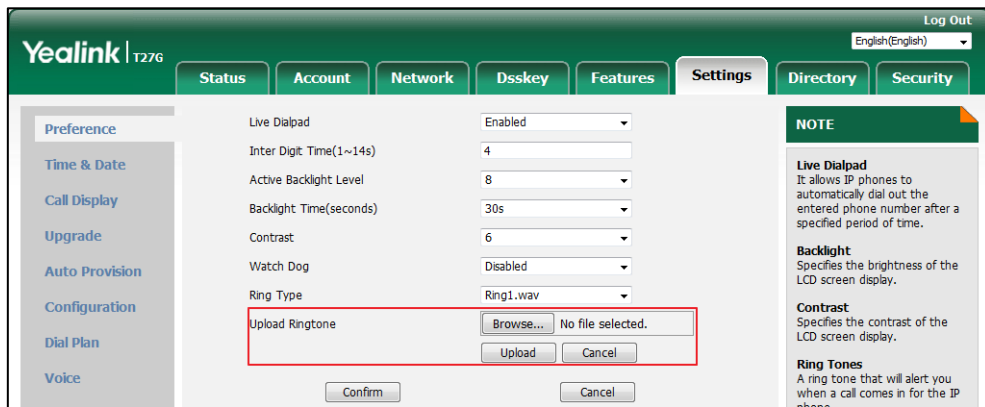

3. Click **Upload**.

The custom ring tone you uploaded appears in the **Ring Type** field.

You can only delete the custom ring tone by clicking **Del** when selecting the desired custom ring tone in the **Ring Type** field.

Note

The priority of ring tone for an incoming call on the phone is as follows:
 Contact ring tone (refer to [Adding Groups](#)) > Group ring tone (refer to [Adding Groups](#)) > Account ring tone > Phone ring tone.

Configuring the Key Tone

If you enable key tone, the phone will produce a sound when you use the dialpad.

Procedure:

1. Navigate to **Menu->Settings->Basic Settings->Sound->Key Tone**.

For the SIP-T29G IP phone, navigate to **Menu->Basic->Sound->Key Tone**.

2. Select the desired value from the **Key Tone** field.

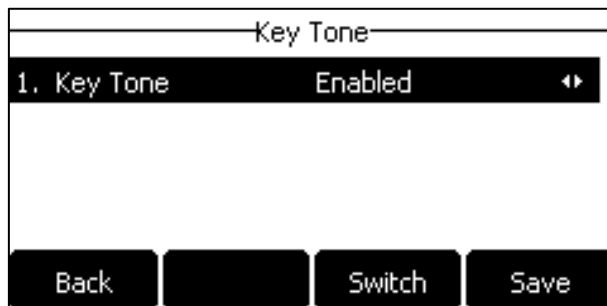

3. Press **Save**.

Key tone is configurable via web user interface at the path **Features->Audio**.

Contact Management

This section details how to manage contacts. Topics include:

- [Configuring List\(s\) for the Directory \(Dir\) Soft Key](#)
- [Local Directory](#)
- [Blacklist](#)
- [Remote Phone Book](#)

Configuring List(s) for the Directory (Dir) Soft Key

Directory provides an easy access to the contacts lists. The lists may contain Local Directory, History, Remote Phone Book and LDAP. You can configure the list(s) to be accessed when pressing the **Directory (Dir)** soft key on the Idle screen.



Note

LDAP is disabled by default. Check with your system administrator to find out if this feature is available on your phone.

Procedure (via web user interface):

1. Click **Directory->Setting**.
2. In the **Directory** block, select the desired list from the **Disabled** column and then click .

The selected list appears in the **Enabled** column.
3. Repeat the step 2 to add more lists to the **Enabled** column.
4. To remove a list from the **Enabled** column, select the desired list and then click .

- To adjust the display order of the enabled lists, select the desired list and then click  or  .

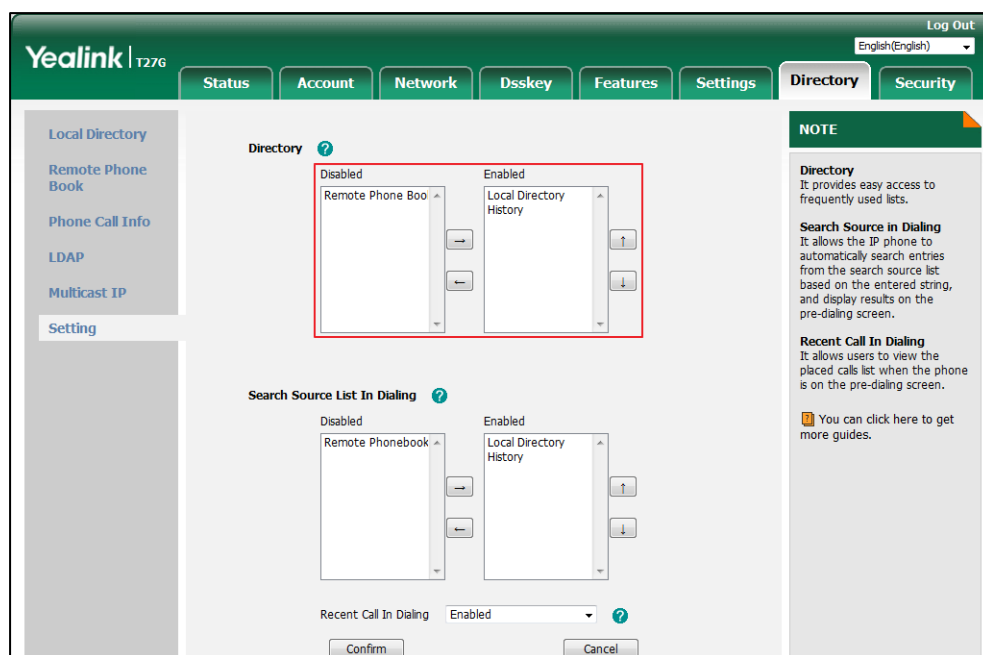

- Click **Confirm**.

Procedure (via phone user interface):

- Press **Directory (Dir)** when the phone is idle.

The LCD screen displays the enabled list(s) in the directory

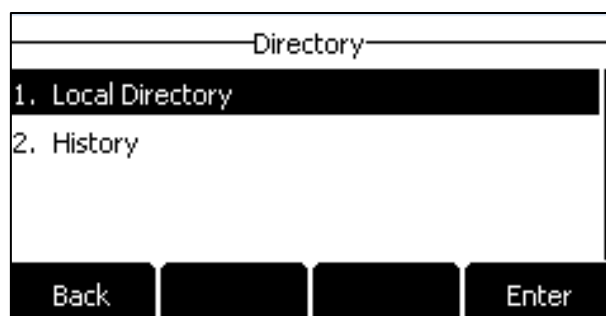

If there is only one list in the directory, press **Directory (Dir)** to enter this list directly.

Note

If the remote phone book and LDAP are not configured in advance, you cannot view remote phone book and LDAP lists in the phone user interface. For more information on remote phone book, refer to [Remote Phone Book](#). For more information on LDAP, contact your system administrator.

Local Directory

You can store up to 1000 contacts and 48 groups in your phone's local directory, allowing you to edit, delete, search or simply dial a contact from the local directory.

Note

You can back up the local directory to the provisioning server. For more information, contact your system administrator.

Adding Groups

Procedure:

1. Press **Directory (Dir)** or navigate to **Menu->Directory->Local Directory** to enter the local directory.
2. Press **AddGroup (AddGr)**.
3. Enter the desired group name in the **Name** field.
4. Select the desired group ring tone from the **Ring** field.

Add Group			
Name:	Test		
Ring:	Auto		
Back	Abc	Delete	Add

If **Auto** is selected, this group will use the ring tone according to the priority: Contact ring tone (refer to [Adding Contacts](#)) >Account ring tone (refer to [Ring Tones](#)) >Phone ring tone (refer to [Ring Tones](#)). If a specific ring tone is selected, this group will use the ring tone according to the priority: Contact ring tone (refer to [Adding Contacts](#)) >Group ring tone.

5. Press **Add**.

On the SIP-T29G IP phone, press **Save**.

Adding groups is configurable via web user interface at the path **Directory->Local Directory**.

Editing Groups

Procedure:

1. Press **Directory (Dir)** or navigate to **Menu->Directory->Local Directory** to enter the local directory.
2. Highlight a desired group.

3. Press **Option**, and then select **Detail**.

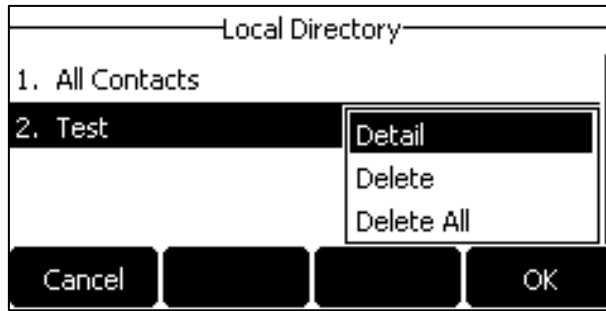

4. Edit the group information.
5. Press **Save** to accept the change.

Editing groups is configurable via web user interface at the path **Directory->Local Directory**.

Deleting Groups

Procedure:

1. Press **Directory (Dir)** or **Menu->Directory->Local Directory** to enter the local directory.
2. Highlight a desired group.
3. Press **Option**, and then select **Delete**.

A message is displayed on the LCD screen:

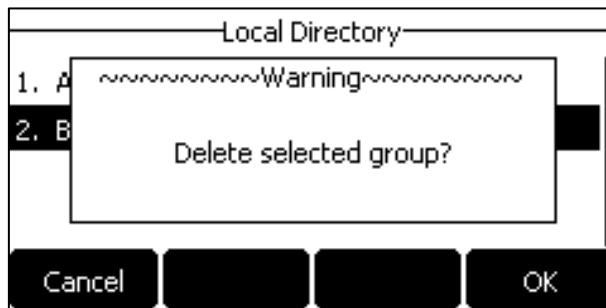

4. Press **OK** to delete.

Deleting groups is configurable via web user interface at the path **Directory->Local Directory**.

Adding Contacts

You can add contacts to the local directory in one of the following ways:

- Manually
- From call history
- From a remote phone book

Adding Contacts Manually

Procedure:

1. Press **Directory (Dir)** or navigate to **Menu->Directory->Local Directory** to enter the local directory.
2. Enter the desired contact group.
If the contact you want to add doesn't belong to any group, enter the **All Contacts**.
3. Press **Add**.
4. Enter the name and the office, mobile or other numbers in the corresponding fields.

The screenshot shows a mobile phone interface titled "Add Contact". It has four input fields: "Name:" with the value "Abby", "Office Number:" with the value "1008", "Mobile Number:", and "Other Number:". Below the fields are four buttons: "Back", "123", "Delete", and "Add".

5. Select the desired account from the **Account** field.
If **Auto** is selected, the phone will use the default account when placing calls to the contact from the local directory.
6. Select the desired ring tone from the **Ring** field.
If **Auto** is selected, this contact will use the ring tone according to the priority: Group ring tone (refer to [Adding Groups](#)) >Account ring tone (refer to [Ring Tones](#)) >Phone ring tone (refer to [Ring Tones](#)).
7. On the SIP-T29G IP phone, highlight the **Photo** field, and then press **Enter**.
8. On the SIP-T29G IP phone, select a desired photo from the **Photo** field.
9. Press **Add**.
On the SIP-T29G IP phone, press **Save**.
If the contact already exists in the local directory, the LCD screen will prompt "Contact name existed?".

Adding contacts is configurable via web user interface at the path **Directory->Local Directory**.

For more information on how to add a contact from history/remote phone book, refer to [Adding a Contact to the Local Directory/Blacklist/Adding a Contact to the Local Directory/Blacklist](#).

Editing Contacts

Procedure:

1. Press **Directory (Dir)** or navigate to **Menu->Directory->Local Directory** to enter the local directory.

2. Enter the desired contact group.
If the contact is not in any group, enter the **All Contacts**.
3. Highlight a desired contact, and then press **Option**. Select **Detail**.
4. Edit the contact information.

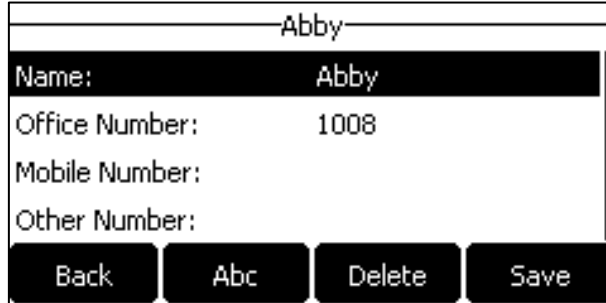

5. Press **Save**.

Editing contacts is configurable via web user interface at the path **Directory->Local Directory**.

Deleting Contacts

You can delete a contact or all contacts from the local directory.

Delete a Contact

Procedure:

1. Press **Directory (Dir)** or navigate to **Menu->Directory->Local Directory** to enter the local directory.
2. Enter the desired contact group.
If the contact is not in any group, enter the **All Contacts**.
3. Highlight a desired contact, and then press **Option**.
4. Select **Delete**.

A message is displayed on the LCD screen:



5. Press **OK** to delete.

Delete All Contacts

Procedure:

1. Press **Directory (Dir)** or navigate to **Menu->Directory->Local Directory** to enter the local directory.
2. Enter the desired contact group.
3. Press **Option**, and then select **Delete All**.

A message is displayed on the LCD screen:



4. Press **OK** to delete.

Deleting contacts is configurable via web user interface at the path **Directory->Local Directory**.

Uploading Contact Photos

You can upload contact photos for the SIP-T29G IP phone.

Procedure:

1. Click **Directory->Local Directory**.
2. Click **Browse**, and then choose a photo file from your local system.

3. Click **Upload Photo** to upload the photo.

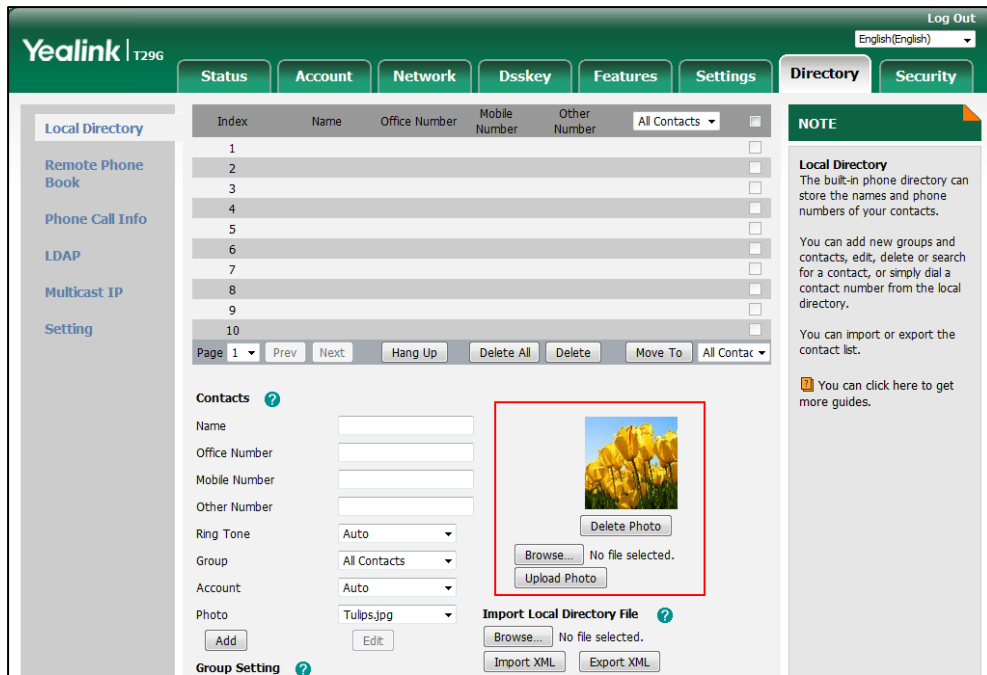

You can click **Delete Photo** to delete the custom photo.

Note The phone only supports *.png, *.jpg, *.jpeg and *.bmp files.
You can only delete custom photos.

Placing Calls to Contacts from the Local Directory

Procedure:

1. Press **Directory (Dir)** or navigate to **Menu->Directory->Local Directory** to enter the local directory.
2. Enter the desired contact group.
If the contact is not in any group, enter the **All Contacts**.
3. Highlight a desired contact, and then press **Send**.
 - If only one number for the contact is stored in the local directory, the contact number will be dialed out.
 - If multiple numbers for the contact are stored in the local directory, the LCD screen will prompt a list of numbers. Select a desired number to dial out.

Searching for Contacts

Procedure:

1. Press **Directory (Dir)** or navigate to **Menu->Directory->Local Directory** to enter the local directory.

2. Press **Search**.
3. Enter a few continuous characters of the contact name or continuous numbers of the contact number (office, mobile or other number) using the dialpad.

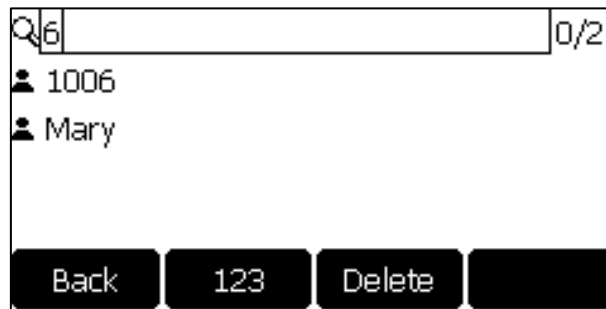

The contacts whose name or phone number matches the entered characters will display in the result list. You can dial from the result list directory.

Importing/Exporting Contact Lists

You can manage your phone's local directory via phone user interface or web user interface. But you can only import or export the contact list via web user interface.

Note For the local directory files (*.xml" and "*.csv"), contact your system administrator.

Importing an XML Contact List File

Procedure:

1. Click **Directory**->**Local Directory**.
2. Click **Browse** to choose a contact list file (the file format must be *.xml) from your local system.

3. Click **Import XML** to import the contact list.

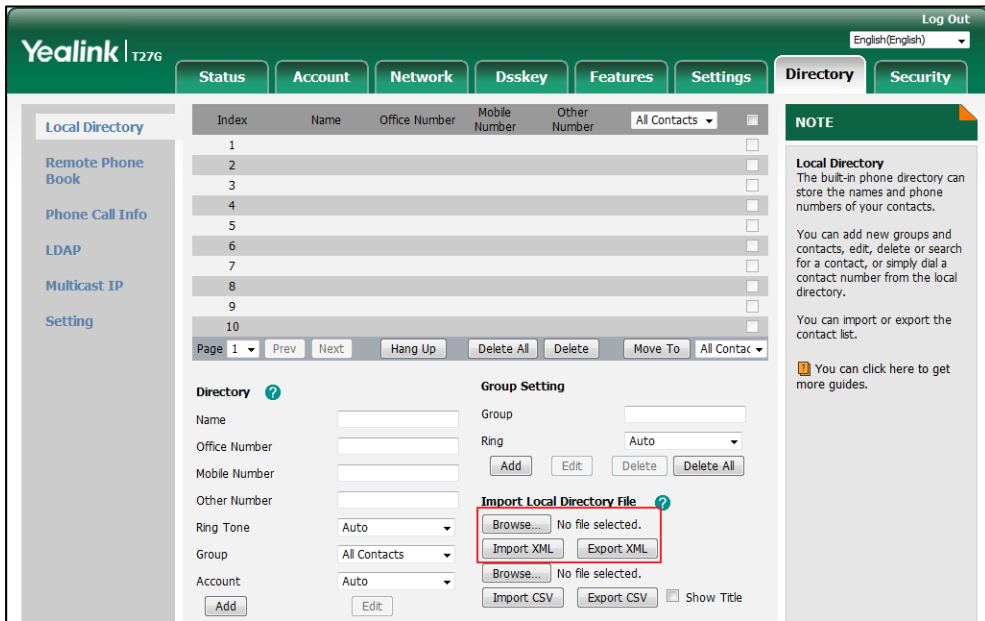

The web user interface prompts "The original contact will be covered, continue?".

4. Click **OK**.

Importing a CSV Contact List File

Procedure:

1. Click **Directory->Local Directory**.
2. Click **Browse** to choose a contact list file (the file format must be *.csv) from your local system.
3. (Optional.) Check the **Show Title** checkbox.

It will prevent importing the title of the contact information which is located in the first line of the CSV file.

4. Click **Import CSV** to import the contact list.
5. (Optional.) Mark the **On** radio box in the **Del Old Contacts** field.

It will delete all existing contacts while importing the contact list.

6. Select the contact information you want to import into the local directory from the **Index** field.

At least one item should be selected to be imported into the local directory.

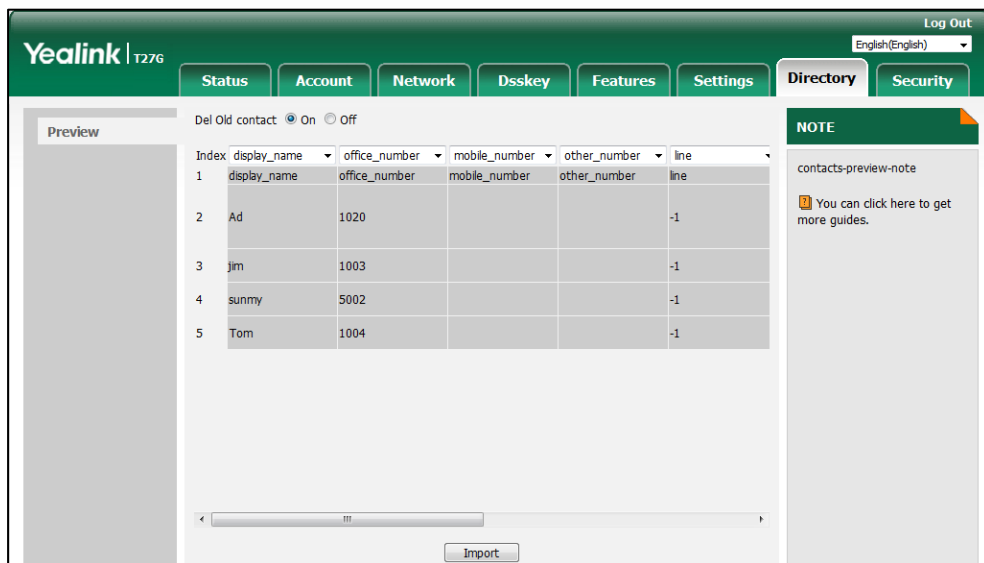

7. Click **Import**.

Exporting an XML/CSV Contact List

Procedure:

1. Click **Directory**->**Local Directory**.
2. Click **Export XML** (or **Export CSV**).
3. Click **Save** to save the contact list to your local system.

Blacklist

You can store up to 30 contacts; add, edit, delete or search for a contact in the blacklist, and even call a contact from the blacklist. Incoming calls from the blacklist contacts will be rejected automatically.

For how to edit, delete, place calls to and/or search for contacts in the blacklist, refer to [Editing Contacts](#), [Deleting Contacts](#), [Placing Calls to Contacts](#) and/or [Searching for Contacts](#).

Adding a Contact to the Blacklist Manually

Procedure:

1. Navigate to **Menu**->**Directory**->**Blacklist**.
2. Press **Add**.

3. Enter the contact's name and the office, mobile or other numbers in the corresponding fields.

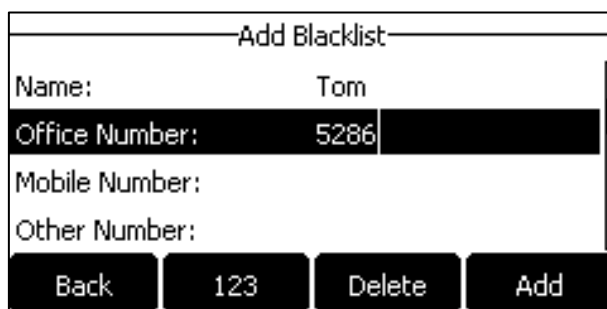

4. Select the desired account from the **Account** field.
If **Auto** is selected, the phone will use the default account when placing calls to the contact from the blacklist.

5. Press **Add**.

On the SIP-T29G IP phone, press **Save**.

Adding a contact to the Blacklist is configurable via web user interface at the path **Directory->Local Directory**.

Adding a Contact from the Local Directory

Procedure:

1. Press **Directory (Dir)** or navigate to **Menu->Directory->Local Directory** to enter the local directory.
2. Enter the desired contact group.
If the contact is not in any group, enter the **All Contacts**.
3. Highlight a desired contact, and then press **Option**.
4. Select **Add to Blacklist**.

A message is displayed on the LCD screen:

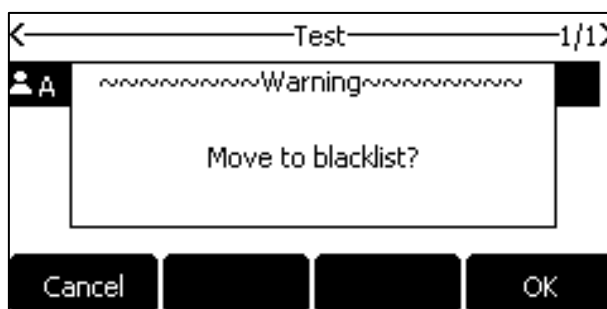

5. Press **OK**.

Adding a contact to the blacklist is configurable via web user interface at the path **Directory->Local Directory**.

Adding a Contact to the Local Directory

Procedure:

1. Navigate to **Menu->Directory->Blacklist**.
2. Highlight a desired contact, and then press **Option**.
3. Select **Add to Contact**.

A message is displayed on the LCD screen:

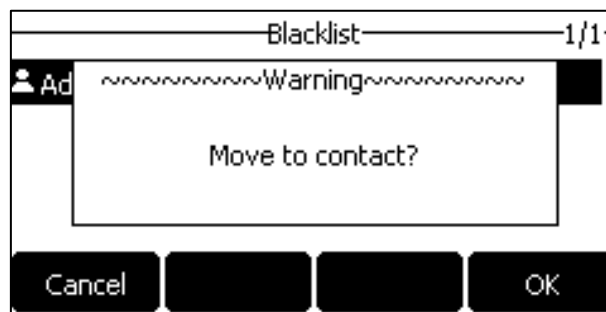

4. Press **OK**.

Adding a contact to the local directory is configurable via web user interface at the path **Directory->Local Directory**.

Mobile Contacts

On SIP-T29G IP phone, after your Bluetooth-enabled mobile phone is paired and connected, you can temporarily synchronize mobile phone contacts. The mobile phone contacts will be imported to your IP phone under Mobile Contacts directory. You can add mobile contacts to the local directory or blacklist, but you cannot add a contact to Mobile Contacts directory on your IP phone.

For more information, refer to [Syncing the Mobile Contacts to the IP Phone](#).

Note

If you disconnect the Bluetooth-enabled mobile phone from IP phone or disable the IP phone to sync phone contacts, the mobile contacts will not display.

Adding a Contact to the Local Directory

1. Navigate to **Menu->Directory->Mobile Contacts**.
2. Highlight a desired contact, and then press **Option**.
3. Select **Add to Contact**.

4. Edit the corresponding fields.

Add to Contact							
1. Name:	Ajm						
2. Office Number:	Old Number	◀▶					
3. Mobile Number:	057982526302	◀▶					
4. Other Number:	Old Number	◀▶					
5. Account:	Auto	◀▶					
<table border="1"> <tr> <td>Back</td> <td>Abc</td> <td>Delete</td> <td>Save</td> </tr> </table>				Back	Abc	Delete	Save
Back	Abc	Delete	Save				

5. Press **Save**.

The entry is successfully saved to the local directory.

Adding a Contact to the Blacklist Directory

1. Navigate to **Menu->Directory->Mobile Contacts**.
2. Highlight a desired contact, and then press **Option**.
3. Select **Add to Blacklist**.
4. Edit the corresponding fields.

Add to Blacklist							
1. Name:	Nj						
2. Office Number:	Old Number	◀▶					
3. Mobile Number:	057982526302	◀▶					
4. Other Number:	Old Number	◀▶					
5. Account:	Auto	◀▶					
<table border="1"> <tr> <td>Back</td> <td>Abc</td> <td>Delete</td> <td>Save</td> </tr> </table>				Back	Abc	Delete	Save
Back	Abc	Delete	Save				

5. Press **Save**.

The entry is successfully saved to the blacklist directory.

For how to place calls to and/or search for contacts in the mobile contacts directory, refer to [Placing Calls to Contacts](#) and/or [Searching for Contacts](#).

Note

The mobile contact that is added to the local directory or blacklist will not disappear, even after you disconnect the mobile phone from the IP phone.

Updating the Mobile Contacts Directory

1. Navigate to **Menu->Directory->Mobile Contacts**.
2. Press **Option**, and then select **Update**.

The LCD screen prompts "Updating, please wait...". Note that the IP phone should be

authorized first to temporarily synchronize the contacts stored on your mobile phone.

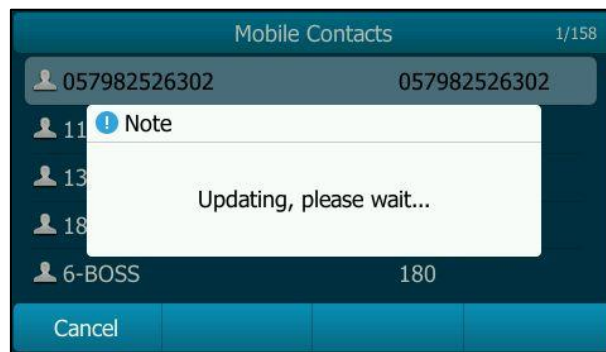

After updating, the contacts you add, edit, delete on the mobile phone will sync with the Mobile Contacts directory.

Note

If you disconnect the mobile phone from IP phone when the IP phone is updating the Mobile Contacts directory, the LCD screen will prompt "Fail to download mobile contacts!", and the mobile contacts will disappear from the IP phone directory list.

Remote Phone Book

You can add contacts to the local directory, search for a contact, or simply dial a contact from the remote phone book.

You can configure your IP phone to access up to 5 remote phone books.

For how to place calls to and/or search for contacts in the remote phone book, refer to [Placing Calls to Contacts](#) and/or [Searching for Contacts](#).

Configuring an Access URL

Procedure:

1. Click **Directory->Remote Phone Book**.
2. Enter the access URL in the **Remote URL** field.
3. Enter the name in the **Display Name** field.

4. Enter the desired refresh period in the **Update Time Interval(Seconds)** field.

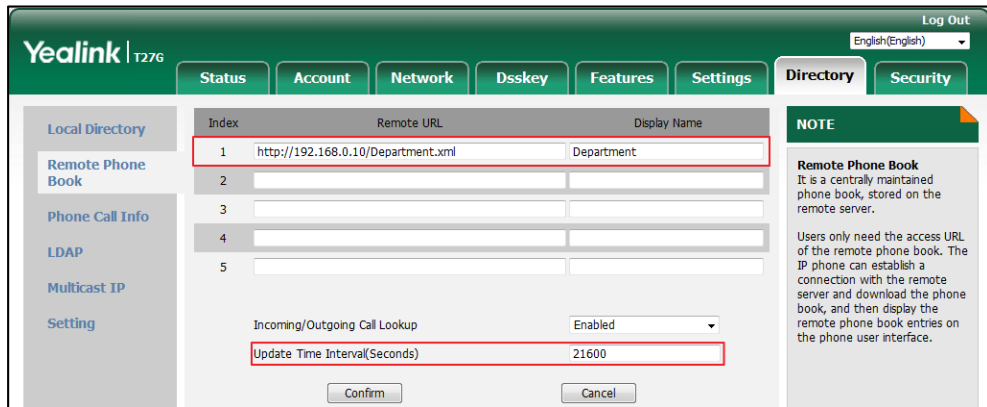

5. Click **Confirm**.

Note

For the access URL of the remote phone book, contact your system administrator.

For the SIP-T23G/T23P/T21(P) E2/T19(P) E2 IP phone, we recommend you to download less than 3000 remote contacts from the remote server, and the size of a remote phone book file should be less than 750K.

For the SIP-T29G/T27G/T27P IP phone, we recommend you to download less than 5000 remote contacts from the remote server, and the size of a remote phone book file should be less than 1.5M.

Accessing the Remote Phone Book

After the access URL of remote phone book is configured successfully, you can obtain the contact from the remote phone book on the phone.

Procedure:

1. Navigate to **Menu->Directory->Remote Phone Book**.
2. Select the desired remote phone book.

The phone then connects to the remote phone book and proceeds to load it. The contacts in the remote phone book are displayed on the LCD screen.

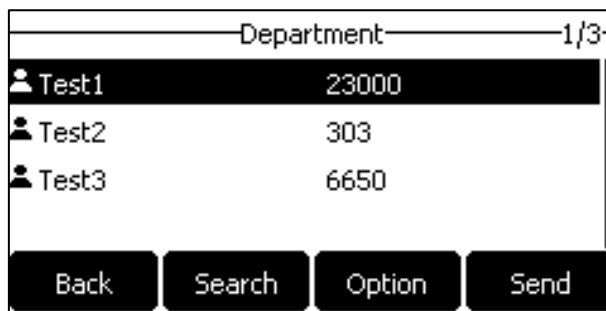

Adding a Contact to the Local Directory/Blacklist

Procedure:

1. Navigate to **Menu->Directory->Remote Phone Book**.
2. Select the desired remote phone book.
3. Highlight a desired contact, and then press **Option**.
4. Select **Add to Contact** (or **Add to Blacklist**).
5. Edit the corresponding fields.
6. Press **Save**.

Call History Management

The IP phones maintain call history lists of Missed Calls, Placed Calls, Received Calls and Forwarded Calls.

Viewing History Records

In the Call History list, you can view a list of up to 100 missed, placed, received and forwarded call records.

Procedure:

1. Press **History**.
The LCD screen displays all call records.
2. Select a desired list.
3. Press **Option**, and then select **Detail**.
The detailed information of the entry appears on the LCD screen.

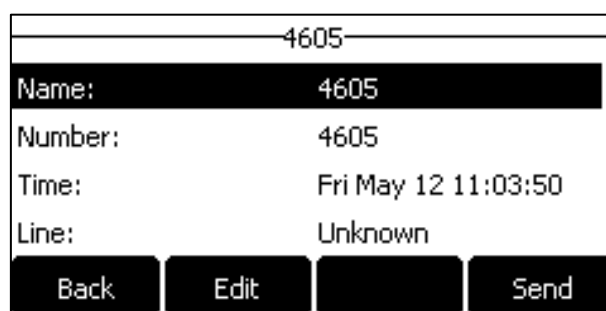

History records are visible via the web user interface at the path **Directory->Phone Call Info**.

Placing a Call from History Records

You can place a call from the history records.

Procedure:

1. Press **History**.
The LCD screen displays all call records.
2. Select a desired list.
3. Highlight a desired entry, and then press **Send**.

Placing a call from the history records is operable via web user interface at the path **Directory->Phone Call Info**.

Adding a Contact to the Local Directory/Blacklist

From the History screen, you can save a contact to the Local Directory or to Blacklist.

Procedure:

1. Press **History**.
The LCD screen displays all call records.
2. Select a desired list.
3. Highlight a desired entry, and then press **Option**.
4. Select **Add to Contact** (or **Add to Blacklist**).
5. Edit the corresponding fields.
6. Press **Save**.

For more information on local directory and/or blacklist, refer to [Local Directory](#) and/or [Blacklist](#).

Deleting History Records

You can delete an entry or all entries from the call history list.

Deleting an Entry from the Call History List

Procedure:

1. Press **History**.
The LCD screen displays all call records.
2. Select a desired list.
3. Highlight a desired entry, and then press **Delete**.

Deleting all Entries from the Call History List

Procedure:

1. Press **History**.
The LCD screen displays all call records.

2. Select a desired list.
3. Press **Option**, and then select **Delete All**.

A message is displayed on the LCD screen:

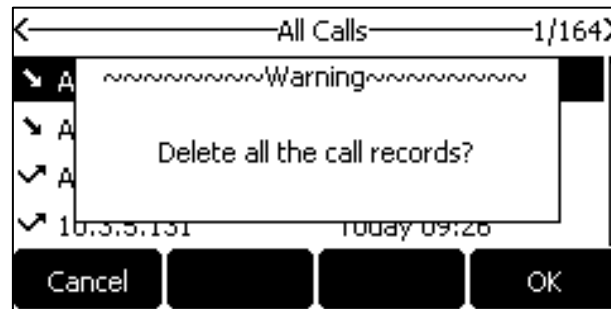

4. Press **OK** to delete.

Disabling History Record

History record feature is enabled by default, if you don't want to save the call history, you can disable the feature.

Procedure:

1. Navigate to **Menu->Features->History Setting**
For the SIP-T29G IP phone, navigate to **Menu->Features->Others->General**.
2. Select **Disabled** from the **History Record** field.

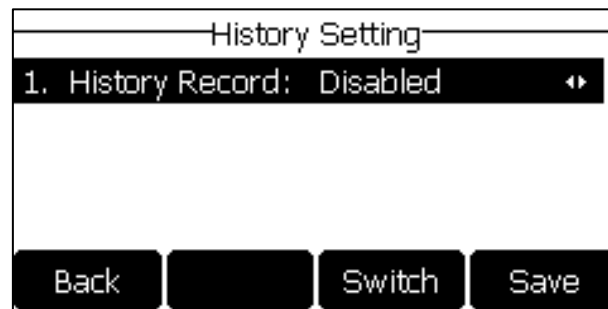

3. Press **Save**.

History record is configurable via web user interface at the path **Features->General Information->Save Call Log**.

DSS Keys

There are three types of DSS keys: Line Keys, Programmable Keys and Ext Keys. Ext Keys are only available when the expansion module (EXP20) is connected to SIP-T29G/T27G/T27P IP phone.

For more information on how to configure the Ext Keys, refer to [Assigning the Features for Ext Keys](#). Details are introduced in the following:

Phone Model	Line Keys	Programmable Keys
SIP-T29G	27	14
SIP-T27G/T27P	21	14
SIP-T23G/T23P	3	11
SIP-T21(P) E2	2	11
SIP-T19(P) E2	/	11

Line Keys

You can assign predefined functionalities to line keys as well as define a label for a line key except on SIP-T19(P) E2 IP phone. Line keys allow you to quickly access features, such as recall and voice call, and monitor a specific line when the line keys are assigned with particular features, such as BLF. The default line key type is Line or N/A (meaning that this line key provides no functionality until being configured). The line keys on SIP-T29G/T27P/T27G IP phone can be indicated on three pages.

Details are introduced in the following:

Phone Module	Key Type		Pages Display		
	Line	N/A	First	Second	Third
SIP-T29G	1-16	17-27	1-9	10-18	19-27
SIP-T27G/T27P	1-6	7-21	1-7	8-14	15-21
SIP-T23G/T23P	1-3	/	/	/	/
SIP-T21(P) E2	1-2	/	/	/	/
SIP-T19(P) E2	/	/	/	/	/

The following figure shows an example on the SIP-T27G IP phone when assigning functionality to line keys located in line key 1-8, the labels of line keys are indicated on the first page.







The following figure shows an example on the SIP-T27G IP phone when assigning functionality to line keys located in line key 9-21, the label of the line key 8-14 are indicated on the second page, and the labels of the line key 15-21 are indicated on the third page.



The line key in the right bottom is used to switch pages.

The following table lists the page icons displayed on the SIP-T29G/T27G/T27P IP phone:

SIP-T29G	SIP-T27G/T27P	Description
		Indicates the current page of line keys.
		Indicates the non-current page of line keys.

Configuring Line Keys

There are two ways to enter the setting screen of line keys via phone user interface:

- Navigate to **Menu->Features->DSS Keys**, and then select a desired line key.
- Long press a desired line key on the Idle screen.

Line key is configurable via web user interface at the path **Dsskey->Line Key**.

Configuring line keys are not available for the SIP-T19(P) E2 IP phone.

You can configure line key to quickly access the features for more convenience. The following subchapters explain the configuration for some line keys:

- [Configuring a Forward Key](#)

- [Configuring a Transfer Key](#)
- [Configuring a Call Park Key](#)
- [Configuring a Park Retrieve Key](#)
- [Configuring a Directed Pickup Key](#)
- [Configuring a Group Pickup Key](#)
- [Configuring a Voice Mail Key](#)

Configuring a Forward Key

When the phone receives an incoming call, you can press the Forward key to forward the incoming call to the pre-defined number. When the phone is idle, the key behavior depends on the forward modes:

Forward Modes	Key Behavior
<p>Phone Mode (refer to Phone Mode)</p>	<p>Destination number is configured: Press the Forward key to activate/deactivate the always forward feature or switch the target among Forward keys.</p> <p>Destination number is blank: Press the Forward key to enter the forward setting screen or activate/deactivate the forward feature (if forward has been configured from the Call Forward menu).</p>
<p>Custom Mode (refer to Custom Mode)</p>	<p>Press the Forward key to enter the forward setting screen.</p>

Procedure:

1. Navigate to **Menu->Features->DSS Keys**, and then select a desired line key.
2. Select **Key Event** from the **Type** field.
3. Select **Forward (FWD)** from the **Key Type** field.
4. (Optional.) Enter the string that will display on the LCD screen in the **Label** field.
5. (Optional.) Enter the destination number you want to forward the incoming calls to in the **Value** field.
6. Press **Save**.

Note

If the **Value** field is left blank, the Forward key performs the same as the **Forward (FWD)** soft key when receiving an incoming call.

Configuring a Transfer Key

You can perform a Blind, Semi-Attended or Attended Transfer by pressing the transfer key during a call.

Procedure:

1. Navigate to **Menu->Features->DSS Keys**, and then select a desired line key.
2. Select **Key Event** from the **Type** field.
3. Select **Transfer (Trans)** from the **Key Type** field.
4. (Optional.) Enter the string that will display on the LCD screen in the **Label** field.
5. (Optional.) Enter the destination number you want to transfer the call to in the **Value** field.
6. Press **Save**.

Note

If the **Value** field is left blank, the Transfer key performs the same as **Transfer (Trans)** soft key during a call.

Configuring a Call Park Key

You can park a call directly by pressing the call park key during a call.

Procedure:

1. Navigate to **Menu->Features->DSS Keys**, and then select a desired line key.
2. Select **Key Event** from the **Type** field.
3. Select **Call Park** from **Key Type** field.
4. (Optional.) Select the desired line from the **Account ID** field.
Check with your system administrator if it is necessary.
5. (Optional.) Enter the string that will display on the LCD screen in the **Label** field.
6. (Optional.) Enter the park destination number or call park code you want to park the call to in the **Value** field.
7. Press **Save**.

Note

If the **Value** field is left blank, the Call Park key performs the same as the **Park** soft key during a call.

Configuring a Park Retrieve Key

You can retrieve a parked call directly by pressing the park retrieve key when the phone is idle.

Procedure:

1. Navigate to **Menu->Features->DSS Keys**, and then select a desired line key.
2. Select **Retrieve Park** from the **Type** field.
3. (Optional.) Select a desired line from the **Account ID** field.
Check with your system administrator if it is necessary.
4. (Optional.) Enter the string that will display on the LCD screen in the **Label** field.
5. (Optional.) Enter the parked call destination number or retrieve code in the **Value** field.
6. Press **Save**.

Note

If the **Value** field is left blank, the Park Retrieve key performs the same as the **Retrieve** key on the dialing screen.

Configuring a Directed Pickup Key

When the specified phone number receives an incoming call, you can press the directed pickup key to answer the call on your phone.

Procedure:

1. Navigate to **Menu->Features->DSS Keys**, and then select a desired line key.
2. Select **Key Event** from the **Type** field.
3. Select **Pick Up** from the **Key Type** field.
4. Select a desired line from the **Account ID** field.
5. (Optional.) Enter the string that will display on the LCD screen in the **Label** field.
6. (Optional.) Enter an extension you want to pick up calls from in the **Value** field.
7. Press **Save**.

Note

If the **Value** field is left blank, the Directed Pickup key performs the same as **DPickup** key on Dialing/Pre-dialing screen.

Configuring a Group Pickup Key

When any number in the group receives an incoming call, you can press the group pickup key to pick up the incoming call.

Procedure:

1. Navigate to **Menu->Features->DSS Keys**, and then select a desired line key.
2. Select **Key Event** from the **Type** field.
3. Select **Group Pick Up** from the **Key Type** field.
4. Select a desired line from the **Account ID** field.
5. (Optional.) Enter the string that will display on the LCD screen in the **Label** field.
6. (Optional.) Enter group call pickup code in the **Value** field.
7. Press **Save**.

Note

If the **Value** field is left blank, the Group Pickup key performs the same as **GPickup** key on Dialing/Pre-dialing screen.

Configuring a Voice Mail Key

When you receive a voice mail, you can press the voice mail key to quickly connect voice mail for specific line.

Procedure:

1. Navigate to **Menu->Features->DSS Keys**, and then select a desired line key.
2. Select **Key Event** from the **Type** field.
3. Select **Voice Mail** from the **Key Type** field.
4. Select a desired line from the **Account ID** field.
5. (Optional.) Enter the string that will display on the LCD screen in the **Label** field.
6. (Optional.) Enter voice mail code in the **Value** field.
7. Press **Save**.

Configuring Multiple Line Keys per Account

You can configure multiple line keys to associate with an account, which enhances call visualization and simplifies call handling. To use this feature, you need to enable Auto LineKeys feature in advanced. It is not available for the SIP-T19(P) E2 IP phone.



Incoming calls as well as outgoing calls to/from this account will be distributed evenly among the available line keys.

Your phone can be configured to have a combination of accounts with a single line key and accounts with multiple line keys.

Configuring the Auto Linekeys

Procedure:

1. Click **Features**->**General Information**.
2. Select **Enabled** from the pull-down list of **Auto LineKeys**.

The screenshot shows the Yealink T276 web interface. The 'Features' tab is selected, and the 'General Information' sub-tab is active. The 'Auto Linekeys' option is set to 'Enabled' and is highlighted with a red box. Other options include Call Waiting (Enabled), Call Waiting On Code, Call Waiting Off Code, Auto Redial (Disabled), Auto Redial Interval (1~300s) (10), Auto Redial Times (1~300) (10), Play Local DTMF Tone (Enabled), DTMF Repetition (3), Multicast Codec (G722), Play Hold Tone (Enabled), Play Hold Tone Delay (30), Allow Mute (Enabled), Hide Feature Access Codes (Disabled), Display Method on Dialing (User Name), and Auto Linekeys (Enabled). A 'NOTE' sidebar on the right provides details for Call Waiting, Auto Redial, Key As Send, Hotline, and Call Completion.

3. Click **Confirm**.

Configuring the Number of Line Key

If **Auto LineKeys** is enabled, you can automatically assign multiple DSS keys with Line type for a registered line on the phone.

Procedure:

1. Navigate to **Account**->**Advanced**.
2. Enter the desired number in the **Number of line key** field.
This field appears only if **Auto Linekeys** is enabled.

In this example, the value is set to 2.

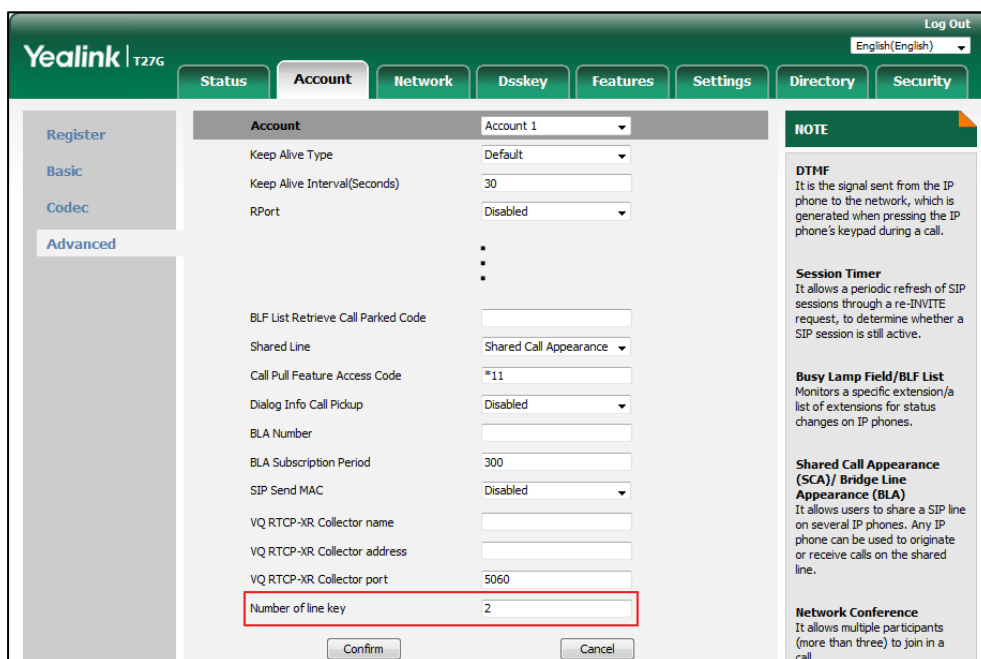

3. Click **Confirm**.

Configuring the Label Length

For the SIP-T29G IP phone, you can specify labels for some key features, which will be displayed on the Idle screen. If the length of the label exceeds the maximum display length, the phone will only display the first few characters. You can configure the phone to display more characters via label length feature if necessary.

The following figure shows an example of label display when the label length feature is set to Extended:

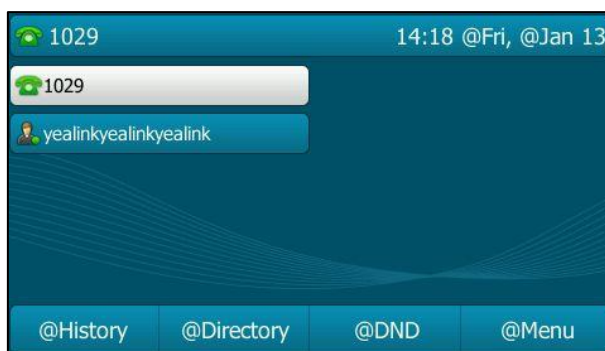

The following figure shows an example of label display when the label length feature is set to Mid-range:



The following figure shows an example of label display when the label length feature is set to Default:



Procedure:

1. Click **Dsskey**->**Line Key**.
2. Select the desired value from the **Label Length** field.

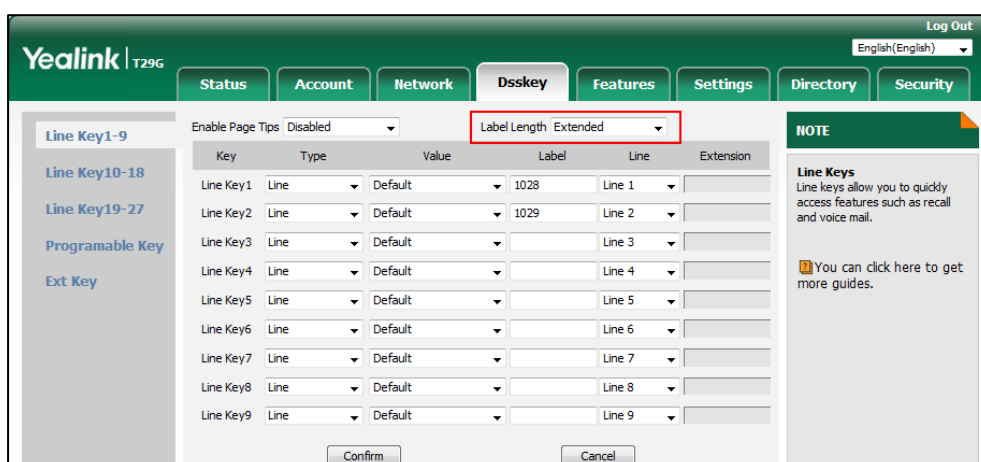





3. Click **Confirm**.

Configuring the Page Tips

You can use page tips feature to enable the page icon and page switch key LED to indicate different statuses on SIP-T29G/T27G/T27P IP phone. This feature is disabled by default.

The following table lists the page icons to indicate different statuses:

Phone Models	Icons	Description
SIP-T29G		Fast-flashing: the BLF monitored user receives an incoming call on the non-current page. Solid: there is a parked call to the line on the non-current page.
		Fast-flashing: the line receives an incoming call on the non-current page.
SIP-T27G/T27P		Fast-flashing: The BLF monitored user receives an incoming call on the non-current page. The line receives an incoming call on the non-current page.
		Solid: There is a parked call on the non-current page.

For more information on the page switch key LED status, refer to [LED Instructions](#).

Procedure:

1. Click **Dsskey->Line Key**.
2. Select **Enabled** from the pull-down list of **Enable Page Tips**.

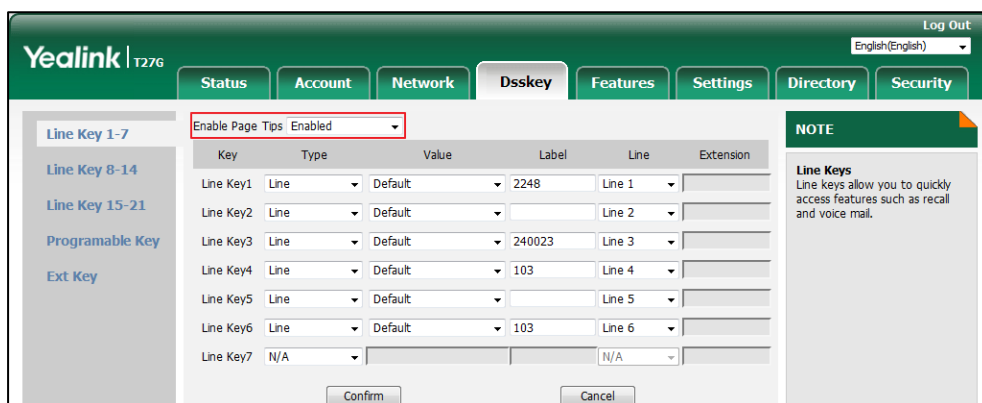

3. Click **Confirm** to accept the change.

Programmable Keys

You can customize the soft keys, navigation keys and function keys.

Customizing the Soft Keys

You can customize the soft keys displayed on the Idle screen via phone user interface for all IP phones except the SIP-T29G IP phone.

Procedure:

1. Navigate to **Menu->Settings->Advanced Settings** (default password: admin) ->**Softkey Label**.
2. Select the desired soft key, and then press **Enter**.
3. Select the desired key type from the **Type** field.

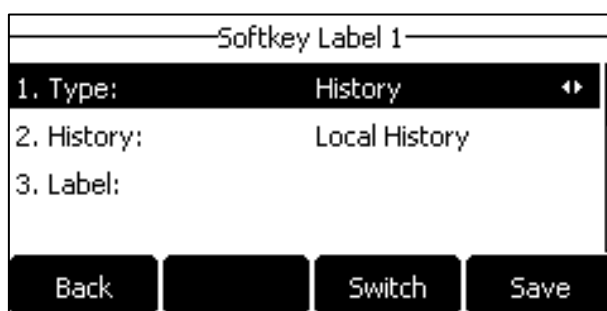

4. (Optional.) Select the desired line from the **Account ID** field.
5. (Optional.) Enter the string that will display on the LCD screen in the **Label** field.
6. (Optional.) Enter the corresponding value in the **Value** field.
7. Press **Save**.

Customizing the Programable Keys

Procedure:

1. Click **Dsskey->Programable Key**.

2. Customize specific features for these keys.



3. (Optional.) Enter the string that will display on the LCD screen in the **Label** field.

Label is configurable only when customizing SoftKey (1-4).

4. Click **Confirm**.

Note

The MUTE key cannot be customized when keep mute feature is enabled. For more information, contact your system administrator.

You can click **Reset To Default** to reset custom settings to defaults.

Then you can press the keys on the phone to perform the features you configured.

For example:

Switch Account Up

You can use this key feature to change the default account.

Dependencies: *Type (Switch Account Up)*

Usage: Press the **Switch Account Up** key to scroll up the account list to select the desired default account.

Switch Account Down

You can use this key feature to change the default account.

Dependencies: *Type (Switch Account Down)*

Usage: Press the **Switch Account Down** key to scroll down the account list to select the desired default account.

Dial Plan

Dial plan is a string of characters that governs the way your IP phone processes the inputs received from your phone dialpad.

Yealink IP phones support the following dial plan features:

- [Configuring the Replace Rule](#)
- [Configuring the Dial Now](#)
- [Configuring the Area Code](#)
- [Configuring the Block Out](#)

The basic expression syntax you need to know:

.	The dot "." can be used as a placeholder or multiple placeholders for any character. Example: "12." would match "123", "1234", "12345", "12abc", etc.
x	An "x" can be used as a placeholder for any character. Example: "12x" would match "121", "122", "123", "12a", etc.
-	Numeric ranges are allowed within the brackets: Digit "-" Digit. Example: "[5-7]" would match the number "5", "6" or "7".
[]	The square brackets "[]" can be used as a placeholder for a single character which matches any of a set of characters. Example: "91[5-7]1234" would match "9151234", "9161234", "9171234".
()	The parentheses "()" can be used to group together patterns, for instance, to logically combine two or more patterns. Example: "([1-9])([2-7])3" would match "923", "153", "773", etc.
\$	The "\$" should be followed by the sequence number of a parenthesis. The "\$" plus the sequence number means the whole character or characters placed in the parenthesis. The number directs to the right parenthesis when there are more than one. Example: A replace rule configuration, Prefix: "001(xxx)45(xx)", Replace: "9001\$145\$2". When you dial out "0012354599" on your phone, the IP phone will replace the number with "9001 2354599 ". "\$1" means 3 digits in the first parenthesis, that is, "235". "\$2" means 2 digits in the second parenthesis, that is, "99".

Note

The IP phone supports a new dial plan mechanism - digit map. Digit maps are defined by a single string or a list of strings. If a number you dial matches any string of a digit map, the call is automatically placed.

Note that if digit map feature is enabled, the old dial plan rules (described in this chapter) will be ignored. For more information, contact your system administrator.

Configuring the Replace Rule

Configuring a replace rule can speed up the pace of dialing out a long number. You can configure up to 100 replace rules, a pattern(s) with wildcards (refer to the expression syntax in the table above), so that any string that matches the pattern(s) will be replaced. For example, a replace rule is configured as "prefix: 1" and "replace: 1234", when you try to dial out the number "1234", you just need to enter "1" on the phone and then press the **Send** soft key.

Adding a Replace Rule

Procedure:

1. Click **Settings**->**Dial Plan**->**Replace Rule**.
2. Enter the string (for example, 1) in the **Prefix** field.
3. Enter the string (for example, 1234) in the **Replace** field.
4. Enter the desired line ID in the **Account** field or leave it blank (not available for the SIP-T19(P) E2 IP phone).

The valid values for the **Account** field can be one or more digits, and every two digits must be separated by a comma. For example, when you enter the value "1, 2" in the **Account** field, this replace rule will apply to account 1 and account 2. If you leave the **Account** field blank or enter 0, the replace rule will apply to all accounts. For more information on available accounts of each phone, refer to [Registration](#).

Index	Prefix	Replace	Account	
1				<input type="checkbox"/>
2				<input type="checkbox"/>
3				<input type="checkbox"/>
4				<input type="checkbox"/>
5				<input type="checkbox"/>
6				<input type="checkbox"/>
7				<input type="checkbox"/>
8				<input type="checkbox"/>
9				<input type="checkbox"/>
10				<input type="checkbox"/>

Prefix 1 Replace 1234 Account

Add Edit Del

NOTE

Replace Rule: An alternative string that replaces the entered numbers.
Dial-now: Automatically dial out the entered numbers.
Area Code: Automatically add the area code before the numbers when dialing.
Block Out: It prevents users from dialing out specific numbers.

","; represents any string.
"x": represents any character.
"-": match a range of characters within the brackets.
";": a separator within the bracket.
"[]": a character matches any of character sets.
"()": combines two or more patterns.
"\$": followed by the sequence number of a parenthesis means the characters placed in the parenthesis.

5. Click **Add** to add the replace rule.

Editing a Replace Rule

Procedure:

1. Click **Settings**->**Dial Plan**->**Replace Rule**.
2. Select the desired replace rule by checking the checkbox.

3. Edit the values in the **Prefix** and **Replace** fields.
4. Enter the desired line ID in the **Account** field or leave it blank.
5. Click **Edit** to accept the change.

Deleting a Replace Rule

Procedure:

1. Click **Settings->Dial Plan->Replace Rule**.
2. Select one or more replace rules by checking the checkbox(es).
3. Click **Del** to delete the replace rule(s).

Configuring the Dial Now

You can configure up to 100 dial now rules on your phone. When the dialed number matches the dial now string, the number will be dialed out automatically. For example, a dial now rule is configured as "2xx", any entered three-digit string beginning with 2 will then be dialed out automatically on the phone.

Adding a Dial Now Rule

Procedure:

1. Click **Settings->Dial Plan->Dial Now**.
2. Enter the desired value (for example, 2xx) in the **Rule** field.
3. Enter the desired line ID in the **Account** field or leave it blank (not available for the SIP-T19(P) E2 IP phone).

The valid values for the **Account** field can be one or more digits, and every two digits must be separated by a comma. For example, when you enter the value "1, 2" in the **Account** field, this replace rule will apply to account 1 and account 2. If you leave the **Account** field blank or enter 0, the replace rule will apply to all accounts. For more information on available accounts of each phone, refer to [Registration](#).

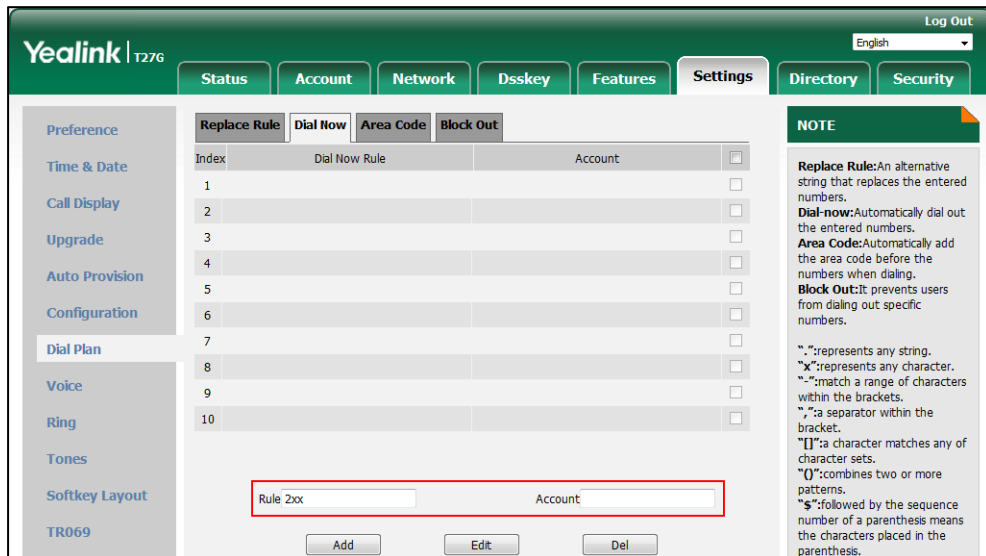

4. Click **Add** to add the dial now rule.

Note You can also edit or delete the dial now rule, refer to [Editing a Replace Rule](#) or [Deleting a Replace Rule](#) for more information.

Configuring Time Out for Dial Now Rule

You can configure the delay time for dial now rules. That is, if the entered number matches a dial now rule, the phone will automatically dial out the phone number after designated delay time.

Procedure:

1. Click **Features**->**General Information**.
2. Enter the time between 0 and 14 (seconds) in the **Time Out for Dial Now Rule** field.

The screenshot shows the Yealink T276 web interface. The 'Features' tab is selected, and the 'General Information' sub-tab is active. The 'Time Out for Dial Now Rule' field is highlighted with a red box and contains the value '1'. Other settings include Call Waiting (Enabled), Call Waiting On Code, Call Waiting Off Code, Auto Redial (Disabled), Auto Redial Interval (1~300s) (10), Auto Redial Times (1~300) (10), Key As Send (#), Reserve # in User Name (Enabled), Hotline Number, Hotline Delay (0~10s) (4), Busy Tone Delay (Seconds) (0), Return Code When Refuse (486 (Busy Here)), Return Code When DND (480 (Temporarily Unavail)), Call Completion (Disabled), Feature Key Synchronization (Disabled), and RFC 2543 Hold (Disabled). A 'NOTE' section on the right provides details for Call Waiting, Auto Redial, Key As Send, Hotline, and Call Completion.

3. Click **Confirm**.

Configuring the Area Code

Area codes are also known as Numbering Plan Areas (NPAs) which are encoded numerically with a phone number prefix, allowing you to dial a phone number which does not belong to your plan area. For example, an area code is configured as "Code: 0592, Min Length: 1, Max Length: 15". When you dial out the number "56789" (the length of the number should be between 1 and 15), the phone will add the area code and dial out the number "059256789". You can only configure one area code rule on your phone.

Procedure:

1. Click **Settings**->**Dial Plan**->**Area Code**.
2. Enter the desired values in the **Code**, **Min Length (1-15)** and **Max Length (1-15)** fields.
3. Enter the desired line ID in the **Account** field or leave it blank (not available for the SIP-T19(P) E2 IP phone).

The valid values for the **Account** field can be one or more digits. Every two digits must be separated by a comma. For example, when you enter the value "1, 2" in the **Account** field, this replace rule will apply to account 1 and account 2. If you leave the **Account** field blank or enter 0, the replace rule will apply to all accounts. For more information on available accounts of each phone, refer to [Registration](#).

The screenshot shows the Yealink T276 web interface. The 'Settings' tab is active, and the 'Block Out' sub-tab is selected. The 'Code' field contains '0592', 'Min Length (1-15)' is '1', and 'Max Length (1-15)' is '15'. The 'Account' field is empty. A red box highlights the 'Code', 'Min Length', and 'Max Length' fields. A 'NOTE' section on the right explains the fields: 'Replace Rule' is an alternative string, 'Dial-now' automatically dials out numbers, 'Area Code' adds the area code, and 'Block Out' prevents dialing specific numbers. A 'Confirm' button is visible at the bottom.

4. Click **Confirm**.

Configuring the Block Out

You can block up to 10 numbers from being dialed out from your phone. The dialing attempts of these 10 numbers will fail and the LCD screen will prompt "Forbidden Number".

Procedure:

1. Click **Settings**->**Dial Plan**->**Block Out**.
2. Enter the desired value in the **BlockOut NumberX** field.
3. Enter the desired line ID in the **Account** field or leave it blank (not available for the SIP-T19(P) E2 IP phone).

The valid values for the **Account** field can be one or more digits. Every two digits must be separated by a comma. For example, when you enter the value "1, 2" in the **Account** field, this replace rule will apply to account 1 and account 2. If you leave the **Account** field blank or enter 0, the replace rule will apply to all accounts. For more information on available accounts of each phone, refer to [Registration](#).

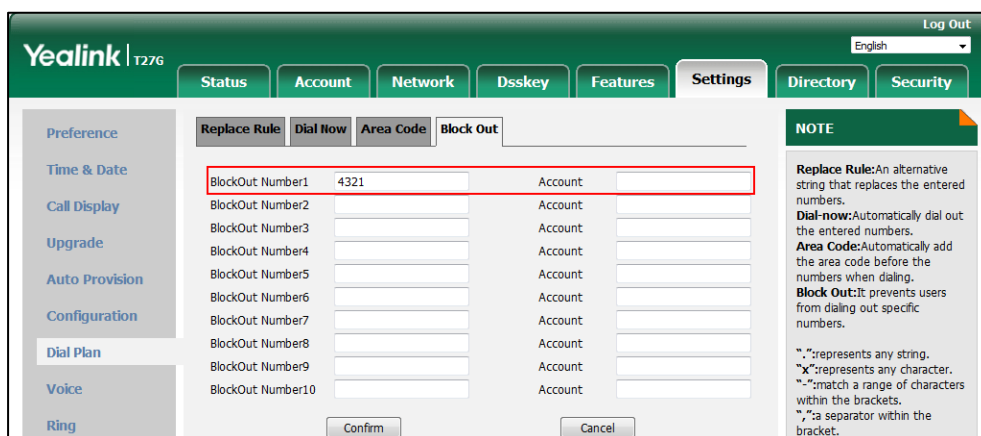

4. Click **Confirm** to add the block out number.

Basic Call Features

The Yealink IP phone is as easy to use as a traditional fixed phone on a public switched telephone network (PSTN), which enables you to place/answer/transfer a call, create a conference call, etc.

This chapter provides basic operating instructions for the IP phones. Topics include:

- [Switching among the Handset, Speakerphone and Headset Mode](#)
- [Placing Call](#)
- [Answering Calls](#)
- [Ending Calls](#)
- [Auto Redial](#)
- [Call Completion](#)
- [Call Mute](#)
- [Call Hold/Resume](#)
- [Do Not Disturb \(DND\)](#)
- [Call Forward](#)
- [Call Transfer](#)
- [Conference](#)
- [Call Park/Retrieve](#)
- [Call Pickup](#)
- [Anonymous Call](#)
- [Anonymous Call Rejection](#)

Contact your system administrator for assistance or more information.

Switching among the Handset, Speakerphone and Headset Modes

You can place and answer calls on your phone in one of the following three ways:

- Pick up the handset to be in the handset mode.
- Press the Speakerphone key to be in the speakerphone mode.
- Press the HEADSET key to be in the headset mode. The key LED glows green on the SIP-T29G/T27G/T27P IP phone.

You can select a desired mode before or after you dialing a number. Meanwhile, during a call you can switch among Speakerphone modes by pressing the speakerphone key, Handset

modes by pressing the HEADSET key or Handset mode by picking up the handset.

Note

If you prefer to place or answer the call in headset mode, refer to [Enabling the Headset Prior](#).

Placing Calls

You can place calls in numerous ways, including placing multiple calls, placing a call using a speed dial key, placing a call from the recent calls/search source list, placing a call back to the last incoming call, dialing the hotline number or redialing numbers. You can also dial an entry/contact from local directory, remote phone book or call history. For more information, refer to [Contact Management](#) and [Call History Management](#).

Placing a Call

Procedure:

1. Do one of the following:
 - Pick up the handset.
 - Press the Speakerphone key.
 - Press the HEADSET key.
2. Enter a number.

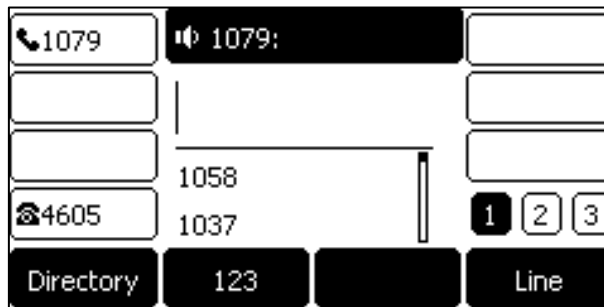

You can also select a desired contact from the search list, or select a contact from the placed call list or Directory before you enter the number.

3. Press the OK key, # key or **Send**.

The # key is configured as a send key by default. You can also set the * key as the send key, or set neither. For more information, refer to [Configuring Key As Send](#).

If live dialpad feature is enabled, the IP phone will automatically dial the number after a period of time without pressing the send key. Check with your system administrator to find out if this feature is enabled on your phone.

Note

You can also dial the SIP URI (for example: 3606@sip.com) or IP address (for example, 192.168.1.15, 192*168*1*15) directly with the maximum length of 32 characters. To obtain the IP address of your phone, press the **OK** key when the phone is idle. Check with your system administrator to find out if this feature is enabled on your phone.

Placing Multiple Calls

The IP phones can handle up to 50 calls at one time, while only one active call can be in progress and the others on hold.

Procedure:

1. Do one of the following:
 - Press the line key. The active call is placed on hold.
 - Press the HOLD key or **Hold** to place the original call on hold.

2. Press **New Call (NewCall)**.

3. Enter the desired number.

You can also select a desired contact from the search list, or select a contact from the placed call list or Directory before you enter the number.

4. Press the OK key, # key or **Send**.

You can select the desired call, and then press **Resume** to retrieve it.

Note

If multiple accounts are registered on the phone, you can first press the desired line key on the Idle screen or select the desired line from the dialing/pre-dialing screen, and then you can use the selected account to place a call.

Placing a Call Using a Speed Dial Key

You can configure a speed dial key to quickly dial a number which is used frequently or hard to remember.

Procedure:

1. Navigate to **Menu->Features->DSS Keys**.
2. Select a desired line key.
3. Select **SpeedDial** from the **Type** field.
4. Select a desired line from the **Account ID** field.
5. (Optional.) Enter the string that will display on the LCD screen in the **Label** field.

- Enter the desired number you want to dial directly in the **Value** field.

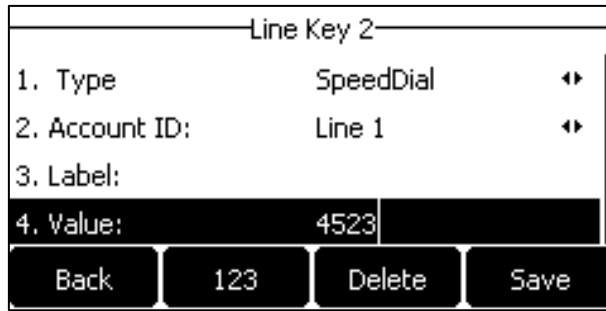

- Press **Save**.

Speed dial key is configurable via web user interface at the path **Dsskey->Line key**. For the SIP-T19(P) E2 IP phone, you can only configure a programable key as speed dial key via web user interface at the path: **Dsskey->Programable key**.

Placing a Call from the Recent Calls/Search Source List

You can place calls from the recent calls list or search source list, which has calls that were recently placed, answered, or missed on your phone.

Note

Your system administrator can configure the source list for searching and disable to display the placed call records. Check with your system administrator to find out if they are available on your phone.

Procedure:

- Pick up the handset, press Speakerphone key or the line key.
The LCD screen displays the placed calls list.
- Enter a few continuous characters of the contact name or continuous numbers of the contact number (office, mobile or other number) to search for a desired contact.

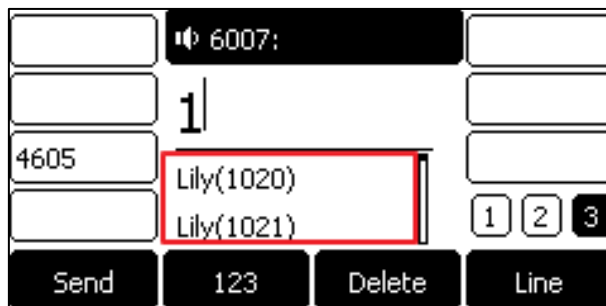

- Select a desired contact to dial out.

Placing a Call Back to the Last Incoming Call

You can configure a Recall key to place a call back to the last incoming call quickly.

Procedure:

1. Navigate to **Menu->Features->DSS Keys**.
2. Select a desired line key.
3. Select **Key Event** from the **Type** field.
4. Select **ReCall** from the **Key Type** field.
5. (Optional.) Enter the string that will display on the LCD screen in the **Label** field.

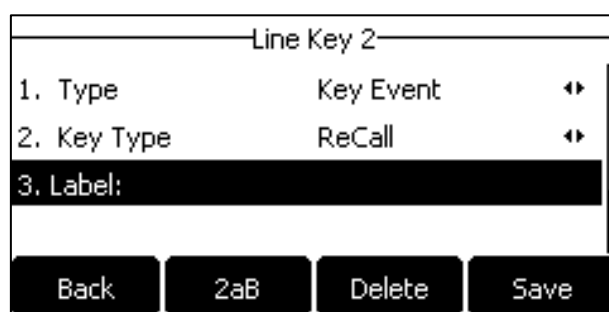

6. Press **Save**.

Recall key is configurable via web user interface at the path **Dsskey->Line key**. For the SIP-T19(P) E2 IP phone, you can only configure a programable key as Recall key via web user interface at the path: **Dsskey->Programable key**.

Dialing the Hotline Number

You can configure the hot line feature with a hotline number and hotline delay. Then the IP phone will dial out the hotline number automatically after the delay time when you lift the handset, press the Speakerphone key or the line key.

Procedure:

1. Navigate to **Menu->Features->Hot Line**.
On the SIP-T29G IP phone, navigate to **Menu->Features->Others->Hot Line**.
2. Enter the desired number in the **Hotline Number** field.

3. Enter the desired delay time between 0 and 10 (seconds) in the **Hotline Delay** field.

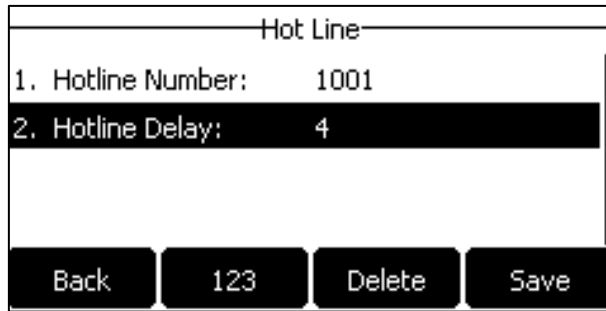

4. Press **Save**.

Hotline is configurable via web user interface at the path **Features->General Information**.

Redialing Numbers

The phone can keep a record of all the placed calls.

You can redial the last contact you call from your phone.

Procedure:

1. Press the RD key twice.
A call to your last dialed number is attempted.

You can also redial your most recently called contacts.

Procedure:

1. Press the RD key when the phone is idle.
2. Select the desired entry from the placed calls list to dial out.

Answering Calls

When you receive an incoming call on your phone, you can choose to answer it in various ways.

You can answer a call or multiple calls, or answer calls automatically.

Note

You can reject incoming calls by pressing the Cancel key or the **Reject** soft key. You can also activate the Do Not Disturb mode to directly reject the incoming calls without ringing on your phone. For more information, refer to [Do Not Disturb \(DND\)](#).

You can forward incoming calls to someone else by pressing the **Forward** soft key. For more information, refer to [Call Forward](#).

Answering When Not in Another Call

Procedure:

Do one of the following:

- Pick up the handset.
- Press the Speakerphone key.

With the handset on-hook and headset mode deactivated, you can press **Answer** or the line key (not available on the SIP-T19(P) E2 IP phone) on which receives an incoming call..

- Press the HEADSET key. The key LED glows green on the SIP-T29G/T27G/T27P IP phone.

With the headset mode activated, you can press **Answer** or the line key (not available on the SIP-T19(P) E2 IP phone) on which receives an incoming call.

Note

Your system administrator can disable you to answer a call by picking up the handset, pressing the Speakerphone key or HEADSET key.

Answering When in Another Call

If you are in an active call and an incoming call arrives on the same or a different line, the incoming call information is displayed on the LCD screen.



Procedure:

1. Press **Answer**.

The incoming call is answered and the original call is placed on hold.

If the phone just plays a warning tone instead of displaying the incoming call information, you can only answer the incoming call after ending the current call. It is configurable by your system administrator.

Note The call waiting should be enabled first, otherwise, the incoming call is automatically rejected by the phone with a busy message when there is an active call on the phone. For more information, refer to [Configuring the Call Waiting](#).

Answering Calls Automatically

You can enable auto answer feature to automatically answer an incoming call using the speakerphone. Auto answer is configurable on a per-line basis.

You can choose to mute the local microphone when an incoming call is answered automatically.

Procedure:

1. Navigate to **Menu->Features->Auto Answer**.
2. For all IP phones except the SIP-T19(P) E2 and SIP-T29G IP phone, select a desired line from the **Line ID** field.

For the SIP-T29G IP phone, select a desired line.

3. Select **Enabled** from the **Status** field.

For the SIP-T29G IP phone, select **Enabled** from the **Auto Answer** field.

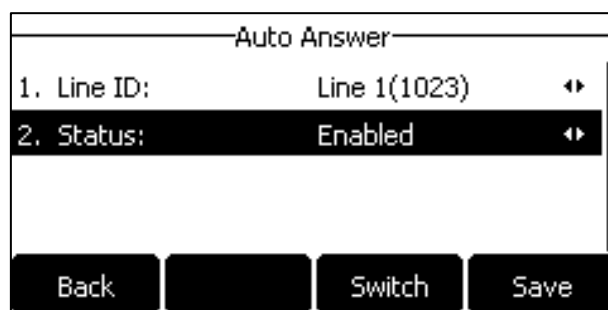

4. Press **Save**.

The auto answer icon appears on the LCD screen only when the auto answer feature is enabled for the default account.



Auto answer is configurable via web user interface at the path **Account->Basic**.

Note Auto answer only takes effect when there is no other call in progress on the phone. If there is a call in progress, the second incoming call cannot be automatically answered after ending the current call by default. If you want to make the phone automatically answer the incoming call after ending all calls, contact your system administrator for more information.

Configuring the Call Waiting

You can enable or disable call waiting on the phone. If call waiting is enabled, you can receive another call when there is already an active call on the phone. Otherwise, another incoming call is automatically rejected by the phone with a busy message when there is an active call on the phone. You can also enable or disable the phone to play a warning tone when receiving another call.

Procedure:

1. Navigate to **Menu->Features->Call Waiting**.
2. Select **Enabled** from the **Call Waiting** field.
3. Select **Enabled** from the **Play Tone** field.
4. (Optional.) Enter the call waiting on code or off code respectively in the **On Code** or **Off Code** field.

If on code or off code is configured, the IP phone will send the corresponding code to activate or deactivate call waiting on the server. It is not available on all servers.

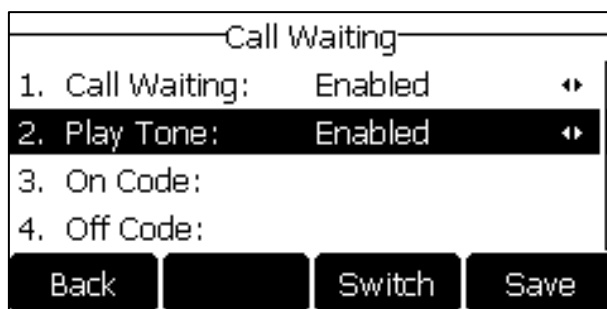

5. Press **Save**.

Call waiting is configurable via web user interface at the path **Features->General Information**.

Note If on code or off code is not configured, the call waiting may not take effect. It depends on your server. Contact your server administrator for more information.

Ending Calls

Procedure:

Do one of the following:

- If you are using the handset, press the Cancel key, **End Call (EndCall)** or hang up the handset.
- If you are using the headset, press the Cancel key or **End Call (EndCall)**.
- If you are using the speakerphone, press the Cancel key, Speakerphone key or **End Call (EndCall)**.

Note

To end a call placed on hold, you can press the **End Call (EndCall)** soft key to end the call directly, or press the **Resume** soft key to resume the call before ending it.

Auto Redial

When a called party is busy, the phone can be enabled to automatically redial his phone number until the call is answered. You can configure the max attempts of auto redial (Redial Times) and the interval between every two redial attempts (Redial Interval).

Enabling the Auto Redial

Procedure:

1. Navigate to **Menu->Features->Auto Redial**.
For the SIP-T29G IP phone, navigate to **Menu->Features->Others->Auto Redial**.
2. Select **Enabled** from the **Auto Redial** field.
3. Enter the desired time between 1 and 300 (seconds) in the **Redial Interval** field.
4. Enter the desired number between 1 and 300 in the **Redial Times** field.

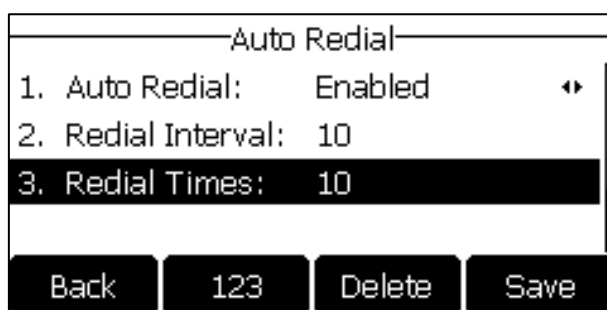

5. Press **Save**.

Auto redial is configurable via web user interface at the path **Features->General Information**.

Redialing a Call Automatically

Procedure:

When the called party is busy, a message is displayed on the LCD screen of the phone:



1. Press **OK** to activate auto redial.

A message is displayed on the LCD screen:



2. Wait for the designated period of time or press **OK** to redial the phone number.

The phone will retry as many times as configured until the called party answers the call.

Call Completion

You can enable call completion to notify the caller who failed to reach a desired party when the desired party becomes available to receive a call.

Enabling Call Completion

Procedure:

1. Navigate to **Menu->Features->Call Completion**.

For the SIP-T29G IP phone, navigate to **Menu->Features->Others->Call Completion**.

2. Select **Enabled** from the **Call Completion** field.

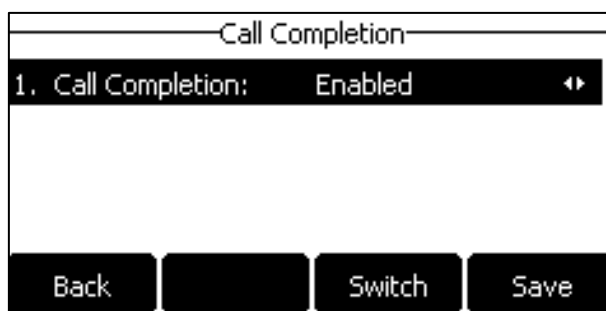

3. Press **Save**.

Call completion is configurable via web user interface at the path **Features->General Information**.

Using Call Completion

Procedure:

When the called party is busy, a message is displayed on the LCD screen:



1. Press **OK**, the phone will then return to the Idle screen and call completion will be activated.

When the called party becomes idle, a message is displayed on the LCD screen:

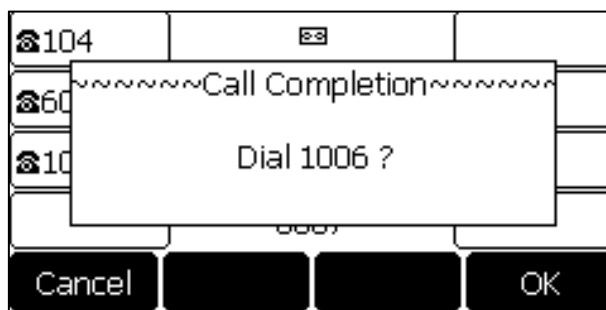

1. Press **OK** to redial the number.

Note

Call completion is not available on all servers. For more information, contact your system administrator.

Call Mute

You can mute the microphone during an active call so that the other party cannot hear you. You can also mute the microphone while dialing or ringing so that the other party cannot hear you when the call is set up. It helps prevent the other party from hearing the informal discussion when auto answer is enabled on his/her phone.

Call mute applies to all modes (Handset, Headset and Speakerphone).

Keep Mute

Keep mute feature enables you to make the mute state of your phone persist across calls. When keep mute is enabled and you press the MUTE key (Cancel key for the SIP-T23G/T23P/T21(P) E2 IP phone), the phone stays in the mute state until you unmute the microphone or until the phone restarts. When you mute the phone in an idle state or initiate a new call with mute on, the mute icon appears on the Idle screen of the IP phone.



Note

Keep Mute should be pre-configured by your system administrator.

Muting and Unmuting a Call

Procedure:

1. Press the MUTE key during an active call.

On the SIP-T23G/T23P/T21(P) E2 IP phone, press the Cancel key.

The LCD screen indicates that the call is now muted.

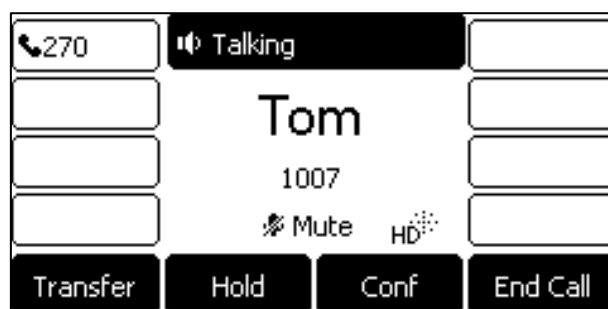

2. Press the MUTE key again to unmute the call.

On the SIP-T23G/T23P/T21(P) E2 IP phone, press the Cancel key again.

Muting and Unmuting While Dialing

Procedure:

1. Press the MUTE key on the pre-dialing, dialing or calling screen.
On the SIP-T23G/T23P/T21(P) E2 IP phone, press the Cancel key.
The call is muted automatically when set up successfully.
2. Press the MUTE key again to unmute.
On the SIP-T23G/T23P/T21(P) E2 IP phone, press the Cancel key again.

Note You can also mute the microphone when the IP phone is ringing.

Call Hold/Resume

You can place an active call on hold. Only one active call can be in progress at any time. Other calls can be made and received while placing the original call on hold. The phone will play beep of a specified frequency softly to remind you that you still have a call on hold. Your system administrator can customize the frequency and configure when to play beep.

Note If Music on Hold is enabled, the held party will hear a piece of music from IP PBX while waiting. Check with your system administrator to find out if this feature is enabled on your phone.

Holding a Call

Procedure:

1. Press the HOLD key or **Hold** during a call.
The LCD screen indicates that the call is on hold.

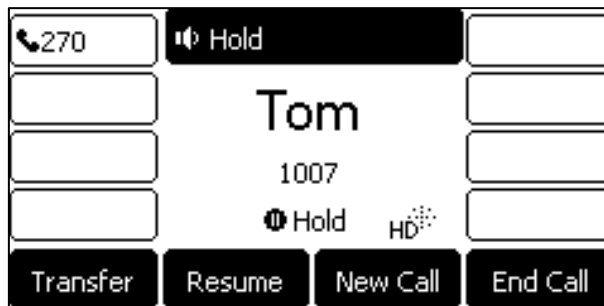

Note The phone ignores engaged audio device (handset or headset) and plays beep in the Speakerphone mode by default.

Resuming a Held Call

Procedure:

1. Press the HOLD key again or **Resume**.

If multiple calls are placed on hold, do one of the following:

- Select the desired call, and then press the HOLD key again or **Resume**.
- Select the desired call, and then press the corresponding line key.

Do Not Disturb (DND)

You can activate DND to reject incoming calls automatically on the phone. The message “**n New Missed Call(s)**” (“n” indicates the number of missed calls, for example, 1 New Missed Call(s)) will appear on the LCD screen, and callers will receive a busy message. All calls you receive while DND is activated are logged to your missed calls list.



Note

The message will display only if Missed Call Log for the line is enabled. Missed call log is configurable via web user interface at the path **Account->Basic**.

You cannot activate or deactivate DND when DND feature is disabled. Contact your system administrator for more information.

When DND feature is activated, the IP phone supports displaying a large DND icon on the Idle screen.



DND is configurable via web user interface at the path **Feautres->Forward&DND**.

Note Large DND icon should be pre-configured by your system administrator.

Configuring the DND Modes

There are two DND modes:

- **Phone** (default): DND is effective for the phone system. You can apply DND to all line registrations on the phone.
- **Custom**: DND can be configured for each or all accounts. You can specify individual or all registrations on a phone that has multiple registered lines.

Note that SIP-T19(P) E2 IP phone only support Phone mode, and it is not configurable.

Procedure:

1. Click **Features->Forward&DND**.
2. In the **DND** block, mark the desired radio box in the **Mode** field.

The screenshot shows the Yealink T276 web interface. The 'Features' tab is selected, and the 'Forward&DND' sub-tab is active. The 'Forward' section is configured with 'Forward Emergency' set to 'Enabled', 'Forward Authorized Numbers' set to '1025,1024', and 'Mode' set to 'Phone'. The 'DND' section is also configured with 'DND Emergency' set to 'Enabled', 'DND Authorized Numbers' set to '1025,1026', and 'Mode' set to 'Phone'. The 'Account' field is empty. The 'DND Status' is set to 'Off'. The 'On Code' and 'Off Code' fields are empty. The 'Confirm' and 'Cancel' buttons are visible at the bottom.

3. Click **Confirm**.

Phone Mode

Activating DND in Phone Mode

Procedure:

1. Press **DND**.

The DND icon appears on the status bar.



Note

When DND and busy forward are activated in phone mode, calls will be forwarded to the configured destination number. For more information on busy forward, refer to [Call Forward](#).

Deactivating DND in Phone Mode

You can deactivate DND to receive incoming calls.

Procedure:

1. Press **DND** again when the phone is idle.
The DND icon disappears on the status bar.

Custom Mode

You can activate/deactivate DND in custom mode except on SIP-T19(P) E2 IP phone. If there is only one account registered on the phone, you can directly press the **DND** soft key to activate or deactivate DND on the Idle screen. The following shows you to activate or deactivate DND when there are multiple registered accounts.

Activating DND in Custom Mode

Procedure:

1. Press **DND**.

The LCD screen displays a list of accounts registered on the phone.

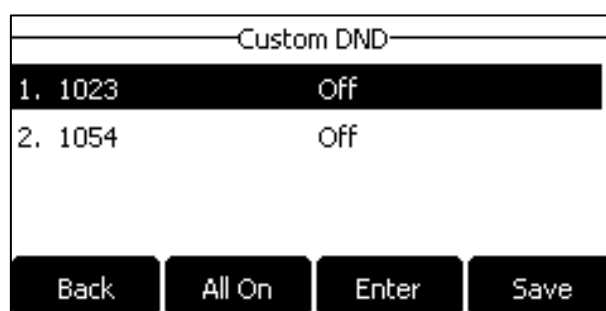

2. Select a desired account.





3. Select **Enabled** from the **DND Status** field.
4. (Optional.) Enter the DND on code or off code respectively in the **On Code** or **Off Code** field.

If the on code or off code is configured, the IP phone will send the corresponding code to activate or deactivate DND on the server. It is not available on all servers.



5. Press **Save**.

If you want to activate DND for all accounts, you can press the **All On** soft key.





When you activate DND for the default account, the following occurs:

- On the SIP-T29G IP phone, the associated line icon changes to , and the icon  appears on the status bar.
- On other IP phones, the associated line icon changes to , and the icon  appears on the status bar.

When you activate DND for the non-default account, the following occurs:

- On the SIP-T29G IP phone, only the associated line icon will change to .
- On other IP phones, only the associated line icon will change to .

When you activate DND for all accounts, the following occurs:

- On the SIP-T29G IP phone, all line icons changes to , and the icon  appears on the status bar.
- On other IP phones, all line icons changes to , and the icon  appears on the status bar.

Note

When DND and busy forward are activated for a specific account, incoming calls will be forwarded from this specific account to the configured destination number. For more information on busy forward, refer to [Call Forward](#).

Deactivating DND in Custom Mode

You can deactivate DND to receive incoming calls on the specific account.

Procedure:

1. Press **DND** when the phone is idle.
2. Select a desired account.
3. Select **Disabled** from the **DND Status** field.
4. Press **Save**.

Configuring DND Emergency and Authorized Numbers

You can receive incoming calls from authorized numbers when DND is activated.

Procedure:

1. Click **Features**->**Forward&DND**.
2. Select **Enabled** from the **DND Emergency** field.
3. Enter the authorized numbers in the **DND Authorized Numbers** field.
For multiple numbers, enter a comma between every two numbers.

The screenshot shows the Yealink T27G web interface with the 'Features' tab selected. The 'Forward&DND' sub-tab is active. The 'Forward' section includes settings for Forward Emergency (Disabled), Forward Authorized Numbers, Mode (Phone selected), Account (1012), Always Forward (Off selected), Busy Forward (Off selected), and No Answer Forward (Off selected). The 'DND' section is highlighted with a red box, showing DND Emergency set to 'Enabled' and DND Authorized Numbers set to '1025,1026'. A 'NOTE' panel on the right provides details about Call Forward and DND features.

4. Click **Confirm**.

Call Forward

You can configure your phone to forward incoming calls to another party (static forwarding) or forward calls while your phone is ringing (dynamic forwarding).

Note

When the phone forwards a call, a message window will pop up by default. Your system administrator can disable this feature.

You cannot activate or deactivate call forward when call forward feature is disabled. Contact your system administrator for more information.

Static Forwarding

Three types of static forwarding are:

- **Always Forward:** All incoming calls are immediately forwarded.
- **Busy Forward:** Incoming calls are immediately forwarded if the phone is busy.
- **No Answer Forward:** Incoming calls are forwarded if not answered after a period of time.

Static Forwarding is configurable via web user interface at the path **Features->Forward&DND**.

Configuring the Forward Modes

There are two call forward modes:

- **Phone** (default): Call forward is effective for the phone system. You can apply call forward to all line registrations on the phone.
- **Custom:** Call forward can be configured for each or all accounts. You can specify individual or all registrations on a phone that has multiple registered lines.

Note that SIP-T19(P) E2 IP phone only support Phone mode, and it is not configurable.

Procedure:

1. Click **Features->Forward&DND**.
2. In the **Forward** block, mark the desired radio box in the **Mode** field.

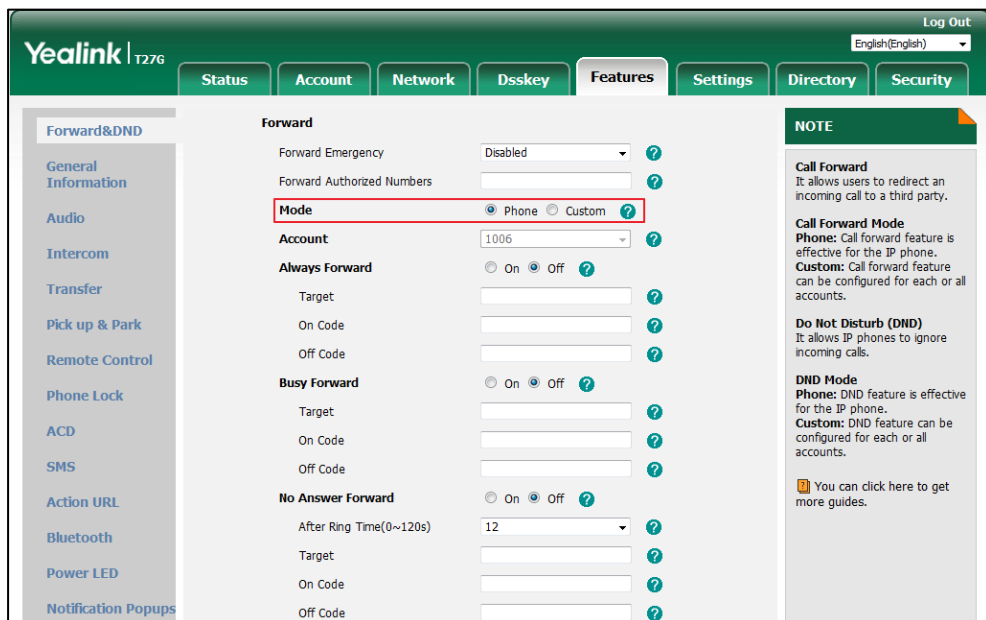

3. Click **Confirm**.

Phone Mode

Activating Call Forward in Phone Mode

Procedure:

1. Navigate to **Menu->Features->Call Forward**, and then select a desired forwarding type.
2. Select **Enabled** from the **Always Forward/Busy Forward/No Answer Forward** field.
3. Enter the destination number you want to forward incoming calls to in the **Forward to** field.
4. If you select the **No Answer Forward** option, select the desired ring time to wait before forwarding from the **After Ring Time** field.
5. (Optional.) Enter the always/busy/no answer forward on code or off code respectively in the **On Code** or **Off Code** field.

If the forward on code or off code is configured, the IP phone sends the corresponding code to the server when a certain action takes place. For example, if you set the Always Forward on code to be *71 (may vary on different servers), and the target number to be 1234. When you activate Always Forward on the IP phone, the IP phone sends *711234 to the server, and then the server will activate Always Forward feature on the server side, hence being able to get the right status of the extension.

6. Press **Save**.

The call forward icon on the Idle screen indicates that the call forward is activated.

For all IP phones except SIP-T19(P) E2 IP phone, you can also press the Forward key (refer to [Configuring a Forward Key](#)) on the Idle screen to activate always forward feature. The forward key LED is solid green.

You can also press the TRAN key when the phone is idle to activate always/busy/no answer forward.

Deactivating Call Forward in Phone Mode

You can deactivate call forward when you no longer want to forward your calls.

Procedure:

1. Navigate to **Menu->Features->Call Forward**, and then select a desired forwarding type.
2. Select **Disabled** from the **Always Forward/Busy Forward/No Answer Forward** field.
3. Press **Save**.

For all IP phones except SIP-T19(P) E2 IP phone, you can also press the Forward key (refer to [Configuring a Forward Key](#)) on the Idle screen to deactivate forward feature. The Forward key LED goes out.

You can also press the TRAN key when the phone is idle to deactivate always/busy/no answer forward.

Custom Mode

You can activate/deactivate call forward in custom mode except on SIP-T19(P) E2 IP phone.

Activating Call Forward in Custom Mode





Procedure:

1. Navigate to **Menu->Features->Call Forward** or press the TRAN key when the phone is idle.
2. If your phone has multiple accounts, select an desired account.
3. Select a desired forwarding type.
4. Select **Enabled** from the **Always Forward/Busy Forward/No Answer Forward** field.
5. Enter the destination number you want to forward incoming calls to in the **Forward to** field.
6. If you select the **No Answer Forward** option, select the desired ring time to wait before forwarding from the pull-down list **After Ring Time**.
7. (Optional.) Enter the always/busy/no answer forward on code or off code respectively in the **On Code** or **Off Code** field.



If the forward on code or off code is configured, the IP phone sends the corresponding code to the server when a certain action takes place. For example, if you set the Always Forward on code to be *71 (may vary on different servers), and the target number to be 1234. When you activate Always Forward on the IP phone, the IP phone sends *711234 to the server, and then the server will activate Always Forward feature on the server side, hence being able to get the right status of the extension.

8. Do one of the following:
 - If you want to activate call forward for all accounts, Highlight the **Always Forward/Busy Forward/No Answer Forward** field and press the **All Lines** soft key. Press **OK**.
 - If you want to activate call forward for the selected account, Press **Save**.

When you activate call forward for the default account:

- On the SIP-T29G IP phone, the associated line icon changes to  , and the icon  appears on the status bar.
- On other IP phones, the associated line icon changes to  , and the icon  appears on the status bar.



When you activate call forward for the non-default account:

- On the SIP-T29G IP phone, only the associated line icon will change to .
- On other IP phones, only the associated line icon will change to .

When you activate call forward for all accounts:

- On the SIP-T29G IP phone, all line icons changes to  , and the icon  appears on the

status bar.

- On other IP phones, all line icons changes to  , and the icon  appears on the status bar.

Deactivating Call Forward in Custom Mode

You can deactivate call forward when you no longer want to forward your calls from the specific account.

Procedure:

1. Navigate to **Menu->Features->Call Forward** or press the TRAN key when the phone is idle.
The LCD screen displays a list of accounts registered on the phone.
2. Select a desired account.
3. Select the desired forwarding type.
4. Select **Disabled** from the **Always Forward/Busy Forward/No Answer Forward** field.
5. Do one of the following:
 - If you want to deactivate call forward for all accounts, press the **All Lines** soft key.
Press **OK**.
 - If you want to activate call forward for the selected account, press **Save**.

Configuring Forward Emergency and Authorized Numbers

You can still receive incoming calls from authorized numbers when call forward is activated.

Procedure:

1. Click **Features->Forward&DND**.
2. Select **Enabled** from the **Forward Emergency** field.
3. Enter the numbers in the **Forward Authorized Numbers** field.

For multiple authorized numbers, enter a comma between every two numbers.

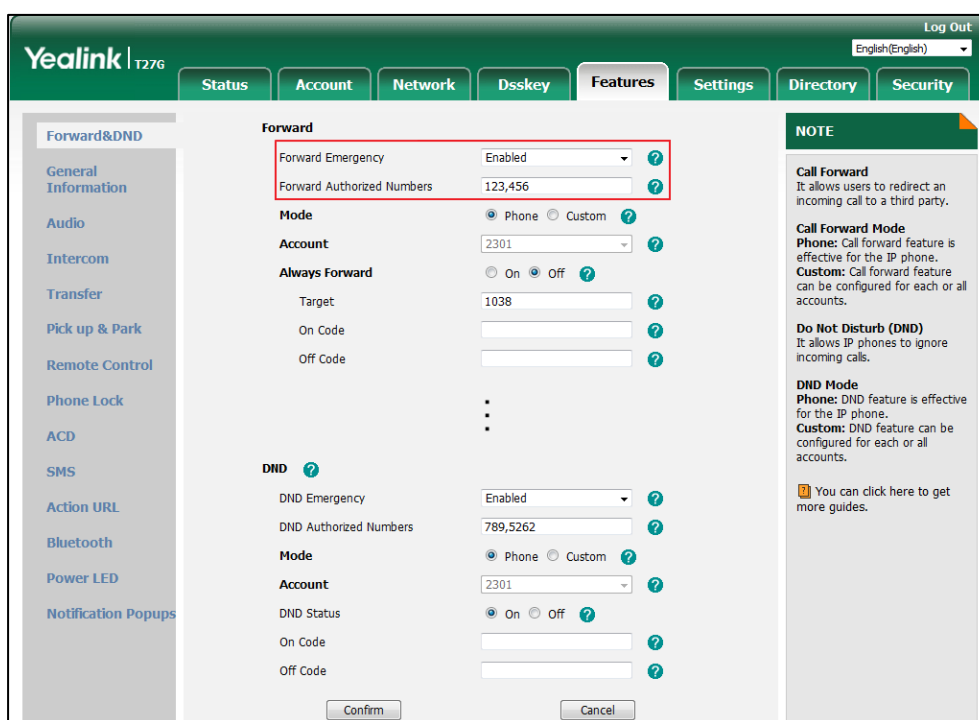

4. Click **Confirm**.

Dynamic Forwarding

You can manually forward the call to another number while your phone rings.

Procedure:

1. When the phone is ringing, press **Forward**.
2. Enter the number you want to forward the incoming call to.



3. Press the OK key, # key, or **Send**.

The LCD screen prompts a call forward message.

When your phone is ringing, you can also press a Forward key (refer to [Configuring a Forward Key](#)) to forward the call to the pre-defined number directly.

Call Transfer

You can transfer a call to another party during a call in one of three ways:

- **Blind Transfer:** Transfer a call directly to another party without consulting.
- **Semi-Attended Transfer:** Transfer a call when receiving ringback.
- **Attended Transfer (Consultative Transfer):** Transfer a call with prior consulting.

Configuring Transfer Mode via Dsskey

When there is a call (either active or hold/held) on the IP phone, you can transfer the call differently using a Transfer key, BLF/BLF List key or Speed Dial key. The phone behavior depends on the configuration of Transfer Mode via Dsskey.

Procedure:

1. Click **Features**->**Transfer**.
2. Select the desired transfer mode from the **Transfer Mode via Dsskey** field.
 - If you select **Blind Transfer**, press the Transfer key, BLF/BLF List key or Speed Dial key to blind transfer the call to the desired contact.
 - If you select **Attended Transfer**, press the Transfer key, BLF/BLF List key or Speed Dial key to dial out the desired contact and then perform an attended or a semi-attended transfer.
 - If you select **New Call**, press the Transfer key, BLF/BLF List key or Speed Dial key to place a new call to the desired contact.

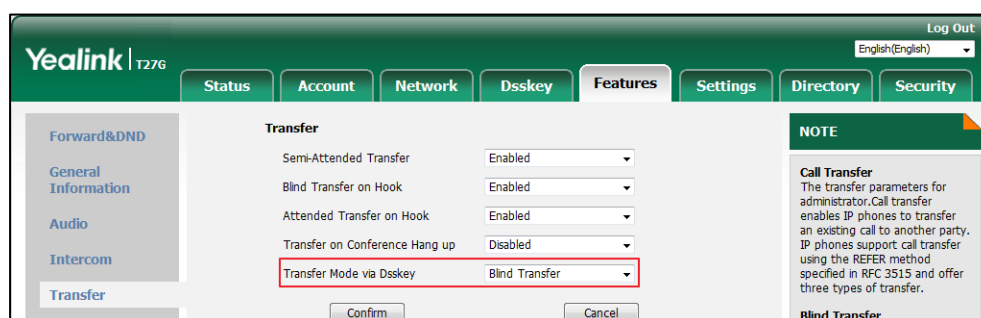

3. Click **Confirm**.

Enabling Allow Trans Exist Call

On all IP phones except the SIP-T29G IP phone, you can transfer a call to another existing call when Allow Trans Exist Call is enabled. Make sure the IP phone has more than one call.

Procedure:

1. Click **Features->General Information**.
2. Select **Enabled** from the pull-down list of **Allow Trans Exist Call**.

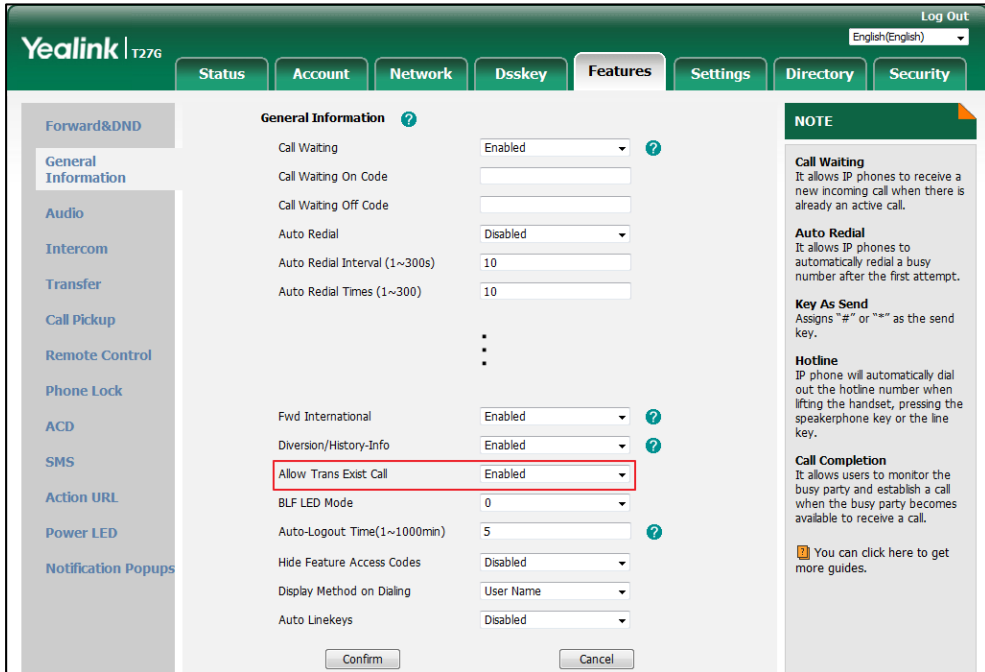

3. Click **Confirm** to accept the change.

Performing a Blind Transfer

Procedure:

1. Press the TRAN key or **Transfer (Trans)** during a call.
2. You can do one of the following:
 - Enter the number or select a contact from the placed call list you want to transfer to.
 - Press **Directory (Dir)**. Select a desired contact from the Directory list(s).
3. Press **B Transfer (B Trans)** to complete the transfer.

You can also hang up the handset or press the TRAN key when transferring a call by entering number.

From the Calls screen or Transfer to screen, you can also use a Transfer key (refer to [Configuring a Transfer Key](#)), BLF/BLF List key (refer to [Configuring a BLF Key/Configuring BLF List Settings](#)) or Speed Dial key (refer to [Placing a Call Using a Speed Dial Key](#)) to perform blind transfer to the pre-defined number directly. Before performing a blind transfer using these keys, make sure that the Transfer Mode via Dsskey is configured as **Blind Transfer**. For more information on how to configure it, refer to [Configuring Transfer Mode via Dsskey](#).

Note

If the entered transferee number matches the Dial Now rule, the phone will dial out the number by default. You can also perform blind transfer when the entered number matches the Dial Now rule. Check with your system administrator to find out if this feature is available on your phone. For more information on Dial Now rule, refer to [Configuring the Dial Now](#).

You can also perform a blind transfer to an existing call. On all IP phones except the SIP-T29G IP phone, make sure that the **Allow Trans Exist Call** is enabled before performing a blind transfer to another existing call. For more information, refer to [Enabling Allow Trans Exist Call](#).

Procedure:

1. Press the TRAN key or **Transfer (Trans)** during a call.
2. Select the desired hold call you want to transfer the call to.

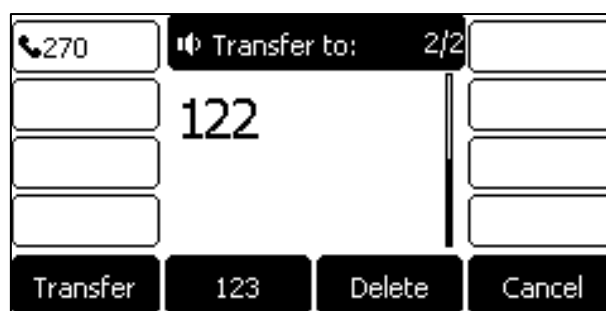

The call is then connected to the call to which you are transferring.

Performing a Semi-attended/Attended Transfer

Procedure:

1. Press the TRAN key or **Transfer (Trans)** during a call.
2. You can do one of the following:
 - Enter the number you or select a contact from the placed call list want to transfer the call to.
 - Press **Directory (Dir)**. Select a desired contact from the Directory list(s).
3. Press the OK key, # key or **Send** to dial out.
4. Press the TRAN key or **Transfer (Trans)** to perform a semi-attended transfer when you hear the ring-back tone, or perform an attended transfer after the party answers the call.

If you are using a handset, the transfer can be completed by hanging up the handset. From the Calls screen or Transfer to screen, you can also use a Transfer key (refer to [Configuring a Transfer Key](#)), BLF/BLF List key (refer to [Configuring a BLF Key/Configuring BLF List Settings](#)) or Speed Dial key (refer to [Placing a Call Using a Speed Dial Key](#)) to perform semi-attended/attended transfer to the pre-defined number directly. Before performing a semi-attended/attended transfer using these keys, make sure that the Transfer Mode via Dsskey is configured as **New Call** or **Attended Transfer**. For more information on how to configure it, refer to [Configuring Transfer Mode via Dsskey](#).

Conference

The IP phones support three-way local conference and multi-way network conference.

Note

Network conference is not available on all servers. For more information, contact your system administrator.

Local Conference

The IP phones support three-way (including yourself) conference call, which is the default conference type called Local Conference. You can set up a conference between an active call and a hold call at any time by pressing the **Conference (Conf)** soft key on all IP phones or press CONF key on the SIP-T29G/T27G/T27P phone.

Note

To set up a local conference call, make sure local conference feature is enabled. For more information, contact your system administrator.

Setting Up a Local Conference Call

Procedure:

1. Place a call to the first party.
2. When the first party answers the call, press **Conference (Conf)** to place a new call.
On the SIP-T29G/T27G/T27P IP phone, you can also press the CONF key.
3. Enter the number of the second party to dial out.
You can also select a desired contact from the search list, or select a contact from the placed call list or Directory before you enter the number.
The active call is placed on hold.
4. When the second party answers the call, press **Conference (Conf)** again to join all parties in the conference.

On the SIP-T29G/T27G/T27P IP phone, you can also press the CONF key again.

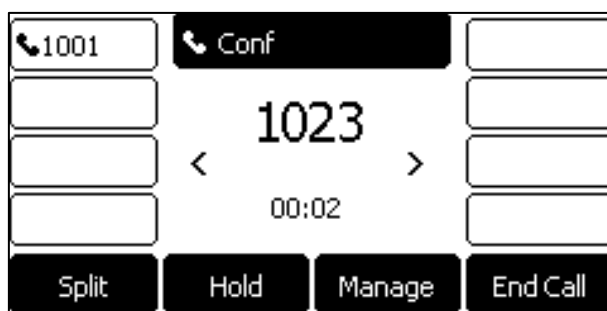

Joining Two Calls in a Conference

You can select a hold call to join into a conference call with the active call.

Procedure:

1. Place two or more calls using the same or different accounts on the phone.
2. Select the desired call for conference and ensure that the call is active.
3. Press **Conference (Conf)**.
4. Select a desired hold call, and then press **Select**.

On SIP-T29G IP phone, press **Send**.

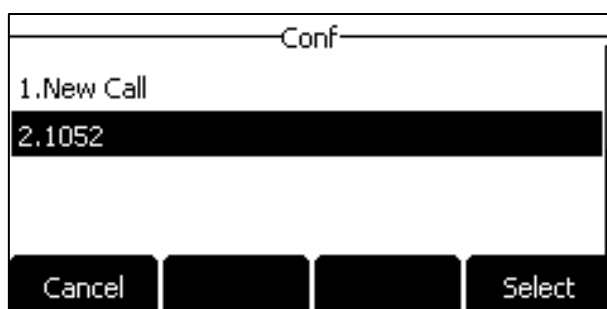

The active call and the selected hold call are joined into a conference. If there are multiple hold calls, the other hold calls on the same or different accounts remain hold.

You can also set up a conference call when performing attended transfer (refer to [Performing a Semi-attended/Attended Transfer](#)), press **Conference (Conf)** after talking with the transferee party.

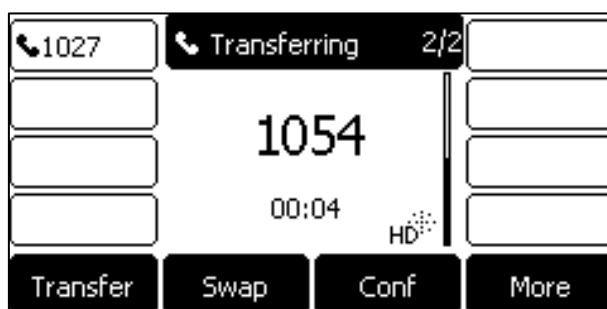

Holding/Resuming a Conference Call

When you place a conference call on hold, both the other two participants are placed on hold. The other two participants cannot hear the audio of each other until you resume the held conference call.

Procedure:

1. Press the HOLD key or **Hold** to place the conference on hold.
When the conference is placed on hold, you can press **New Call (NewCall)** to place a new call.
2. Press the HOLD key again or **Resume** to resume the held conference call.

Muting and Unmuting a Conference Call

You can mute the local microphone during a conference call so that the other two participants can hear each other except you.

Procedure:

1. Press the MUTE key to mute the conference.
On the SIP-T23G/T23P/T21(P) E2 IP phone, press the Cancel key.
2. Press the MUTE key again to unmute the conference.
On the SIP-T23G/T23P/T21(P) E2 IP phone, press the Cancel key again.

Splitting a Conference Call

You can split the conference call into two individual calls. After you split a conference call, the conference call is ending, and the other two parties are held. You can resume one of the hold calls.

Procedure:

1. Press **Split**.

Managing Conference Participants

You can manage conference participants in the following ways:

- Mute a participant
- Hold a participant
- Remove a participant from the conference

Procedure:

Press **Manage**, and then select the desired party, you can do the following:

- Press **Far Mute (FarMute)** to mute the party. The muted party can hear everyone, but no one can hear the muted party.

- Press **Far Hold (FarHold)** to hold the party. The held party cannot hear anyone, and no one can hear the held party.
- Press **Remove** to remove the party from the conference call.
- Press **Back** to return to the previous screen.

Ending a Conference Call

By default, the other two parties drop the call when you end the conference call. However, your system administrator can set up your phone so that the other two parties remain connected when you end the conference call.

Procedure:

1. Press **End Call (EndCall)** to drop the conference call.

Network Conference

You can use network conference feature on your IP phone to initiate a conference with multiple participants.

This feature allows you to perform the following:

- Join two calls together into a conference call.
- Invite another party into an active conference call.

Note

To use network conference, contact your system administrator for the network conference URI in advance.

Configuring the Network Conference

Procedure:

1. Click **Account->Advanced**.
2. Select the desired account from the **Account** field.
3. Select **Network Conference** from the **Conference Type** field.

- Enter the conference URI (for example, conference@example.com) in the **Conference URI** field.

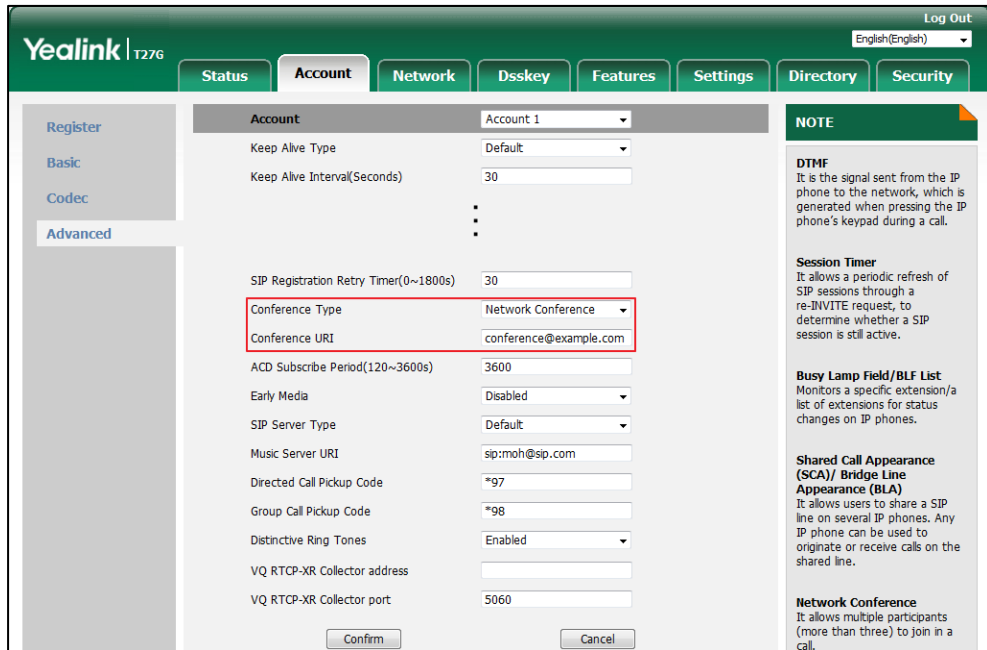

- Click **Confirm**.

Setting Up a Network Conference

Procedure:

- Place a call to the first party.
- Press **Conference (Conf)** to place a new call.
On the SIP-T29G/T27G/T27P IP phone, you can also press the CONF key.
The active call is placed on hold.
- Enter the number of the second party, and then press the OK key, # key or **Send**.
- When the second party answers the call, press **Conference (Conf)** to add the second party to the conference.
On the SIP-T29G/T27G/T27P IP phone, you can also press the CONF key.
- Press **Conference (Conf)** to place a new call.
On the SIP-T29G/T27G/T27P IP phone, you can also press the CONF key.
The conference call is placed on hold.
- Enter the number of the new party, and then press the OK key, # key or **Send**.
- When the new party answers the call, press **Conference (Conf)** to add the new party to the conference.
On the SIP-T29G/T27G/T27P IP phone, you can also press the CONF key.
- Repeat steps 5 to 7 until you add all intended parties.

The procedures for setting up a network conference call on specific servers may be different

from introduced above. Contact your system administrator for more information.

Call Park/Retrieve

You can use call park feature to place a call on hold, and then retrieve the call from another phone in the system (for example, a phone in another office or conference room). You can park an active call by pressing the **Park** soft key or call park key (if configured) on the phone. If the call is parked successfully, there is a voice prompt confirming that the call was parked. You can retrieve the parked call by pressing the **Retrieve** soft key or the retrieve park key (if configured). But if the parked call is not retrieved within a period of time defined by the system, the phone performing call park will receive the call back.

Note

Call park is not available on all servers. Contact your system administrator for more information.

The IP phone supports call park feature under the following modes:

- **FAC mode:** park the call to the local extension or a desired extension through dialing the park code.
- **Transfer mode:** park the call to shared parking lot through performing a blind transfer to a call park number (call park code).

FAC Mode

Configuring Call Park Feature in FAC Mode

Procedure:

1. Click **Features->Pick up & Park**.
2. Select **FAC** from the **Call Park Mode** field.
3. Select **Enabled** from the **Call Park** field.
If **Enabled** is selected, the **Park** will display on the LCD screen during a call, and the **Retrieve** will display on the dialing screen.
4. Enter the call park code in the **Call Park Code** field.
It is configured for the **Park** soft key. This call park code will also apply to the call park key.
5. Enter the park retrieve code in the **Park Retrieve Code** field.

It is configured for the **Retrieve** soft key. This park retrieve code will also apply to the retrieve park key.

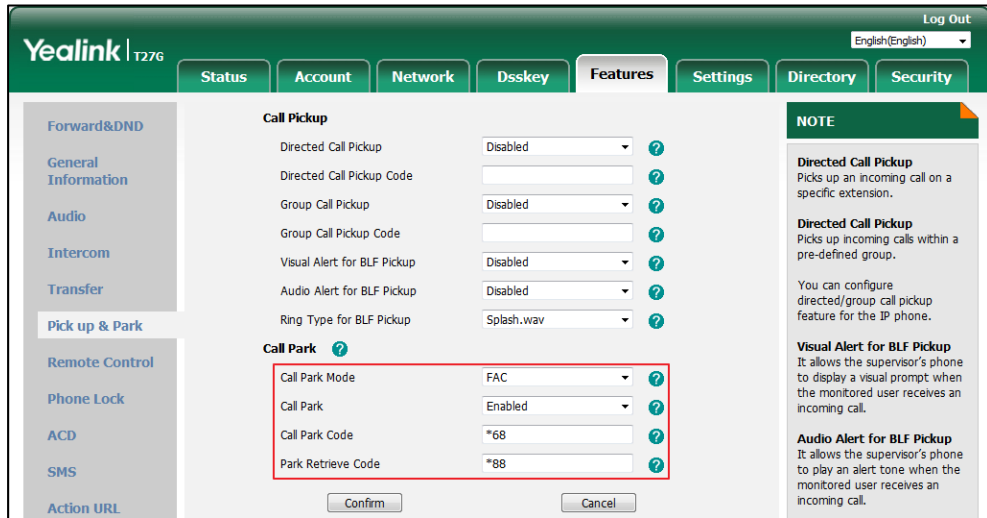

6. Click **Confirm**.

Note If the **Park** or **Retrieve** soft key doesn't appear on the LCD screen, please select **Disabled** from the pull-down list of **Custom Softkey** via web user interface at path **Settings->Softkey Layout**.

Parking a Call in FAC Mode

Procedure:

1. During a call, press **Park** (You may need to press the **More** soft key to see the **Park** soft key).

The phone will dial the configured call park code shown as below:

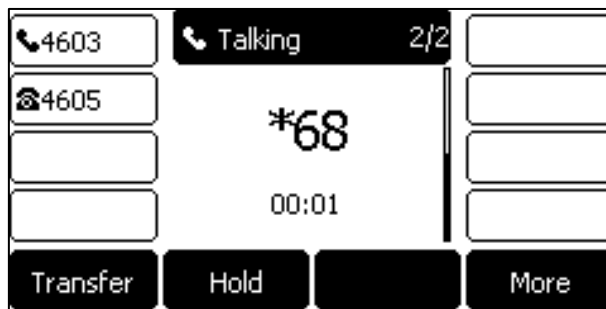

2. Do one of the following:
 - a) If you want to park the call against the local extension, press the # key.
If the call is parked successfully, you will hear a voice prompt confirming that the call is parked.
 - b) If you want to park the call against desired extension.
 - 1) Enter the extension (for example, 4606) where you want to park the call.

- 2) Press the OK key or # key.

If the call is parked successfully, you will hear a voice prompt confirming that the call is parked. The call is parked against the extension you entered.

From the Calls screen, you can also use a Call Park key (refer to [Configuring a Call Park Key](#)) to park the call to desired destination directly.

Note You can also press the desired BLF or BLF List key to park a call directly. For more information, refer to [Parking a Call/Retrieving a Parked Call to the Monitored User](#).

Retrieving a Parked Call in FAC Mode

Procedure:

1. Press **Retrieve** (You may need to press the **More** soft key to see the **Retrieve** soft key) on the pre-dialing screen.

The phone will dial the configured park retrieve code and the Retrieve screen is shown as below:

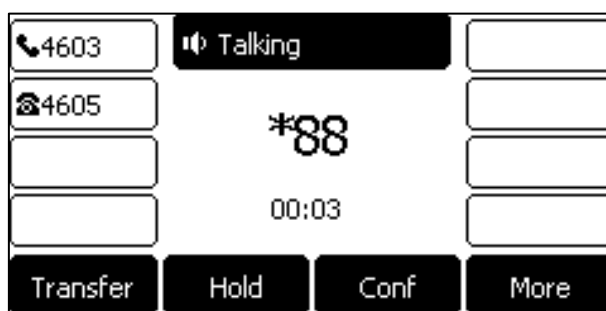

2. Follow the voice prompt, do one of the following:
 - Press the # key on the phone where the call is parked.
 - Enter the desired extension followed by # (for example, 4606#) on any phone.

From the Idle screen, you can also use a Park Retrieve key (refer to [Configuring a Park Retrieve Key](#)) to retrieve the parked call from desired destination directly.

Note You can also press the desired BLF or BLF List key to retrieve a parked call directly. For more information, refer to [Parking a Call/Retrieving a Parked Call to the Monitored User](#).

Transfer Mode

Configuring Call Park Feature in Transfer Mode

Procedure:

1. Click **Features->Pick up & Park**.

2. Select **Transfer** from the **Call Park Mode** field.
3. Select **Enabled** from the **Call Park** field.
If **Enabled** is selected, the **Park** soft key will display on the LCD screen during a call, and the **Retrieve** soft key will display on the dialing screen.
4. Enter the call park code in the **Call Park Code** field.
It is configured for the **Park** soft key. This call park code will also apply to the call park key.
5. Enter the park retrieve code in the **Park Retrieve Code** field.
It is configured for the **Retrieve** soft key. This park retrieve code will also apply to the retrieve park key.

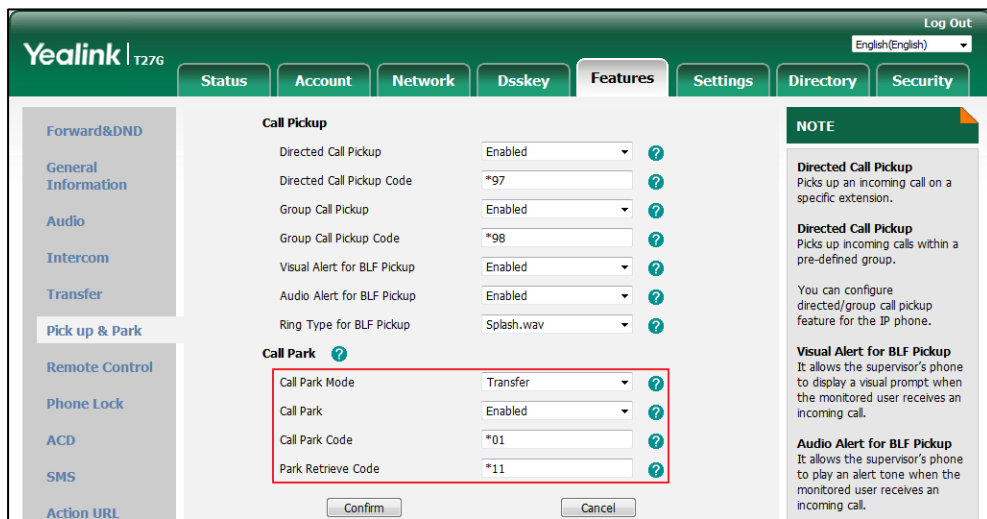

6. Click **Confirm**.

Note If the **Park** or **Retrieve** soft key doesn't appear on the LCD screen, please select **Disabled** from the pull-down list of **Custom Softkey** via web user interface at path **Settings->Softkey Layout**.

Parking a Call in Transfer Mode

Procedure:

1. During a call, press **Park** (You may need to press the **More** soft key to see the **Park** soft key).

The call will be directly transferred to the shared parking lot.

From the Calls screen, you can also use a Call Park key (refer to [Configuring a Call Park Key](#)) to park the call to shared parking lot directly during a call.

Note For some servers, the system will return a specific retrieve park number (park retrieve code) from which the call can be retrieved after parking successfully.

Retrieving a Parked Call in Transfer Mode

Procedure:

1. Press **Retrieve** (You may need to press the **More** soft key to see the **Retrieve** soft key) on the pre-dialing screen.

The phone will retrieve the parked call from the shared parking lot.

From the Idle screen, you can also press a Park Retrieve key (refer to [Configuring a Park Retrieve Key](#)) to retrieve the parked call from shared parking lot directly when the phone is idle.

Call Pickup

You can use call pickup to answer someone else's incoming call on your phone. The IP phones support directed call pickup and group call pickup. Directed call pickup allows you to pick up incoming calls to another phone, while group call pickup allows you to pick up incoming calls to any phones within a predefined group of phones.

To use call pickup, you need to configure the call pickup code beforehand on a global or per-line basis via web user interface, then you can press the **DPickup/GPickup** soft key to pick up an incoming call directly. Note that the call pickup code configured on a per-line basis takes precedence over that configured on a global basis.

Note If there are many incoming calls at the same time, pressing the **GPickup** soft key on the phone will pick up the first incoming call.
The pickup group should be predefined by your system administrator.

Directed Call Pickup

Configuring the Directed Call Pickup

Procedure:

1. Click **Features->Pick up & Park**.
2. Select **Enabled** from the **Directed Call Pickup** field.

- Enter the directed call pickup code in the **Directed Call Pickup Code** field.

The screenshot shows the 'Features' configuration page for a Yealink T276 phone. The 'Call Pickup' section is highlighted with a red box. The 'Directed Call Pickup' dropdown is set to 'Enabled', and the 'Directed Call Pickup Code' text field contains '*97'. Below this, 'Group Call Pickup' is also set to 'Enabled' with a code of '*98'. Other options include 'Visual Alert for BLF Pickup', 'Audio Alert for BLF Pickup', and 'Ring Type for BLF Pickup'. The 'Call Park' section includes 'Call Park Mode' (FAC), 'Call Park' (Enabled), 'Call Park Code' (*01), and 'Park Retrieve Code' (*11). A 'NOTE' section on the right explains the 'Directed Call Pickup' feature, which picks up an incoming call on a specific extension, and the 'Visual Alert for BLF Pickup' feature, which displays a visual prompt on a supervisor's phone.

- Click **Confirm**.

You can also configure the directed call pickup code on a per-line basis:

Procedure:

- Click **Account->Advanced**.
- Select the desired account from the **Account** field.
- Enter the directed call pickup code in the **Directed Call Pickup Code** field.

The screenshot shows the 'Account' configuration page for a Yealink T276 phone, specifically the 'Advanced' sub-tab. The 'Directed Call Pickup Code' field is highlighted with a red box and contains '*97'. Other settings include 'Keep Alive Type' (Default), 'Keep Alive Interval(Seconds)' (30), 'RPort' (Disabled), 'Subscribe Period(Seconds)' (1800), and 'DTMF Type' (RFC2833). The 'BLF DTMF Code' field is empty. Other options include 'Group Call Pickup Code', 'Distinctive Ring Tones' (Enabled), 'Unregister When Reboot' (Disabled), 'Out Dialog BLF' (Disabled), and VQ RTPC-XR Collector settings (name, address, port: 5060). A 'NOTE' section on the right explains the 'DTMF' signal, 'Session Timer' for SIP sessions, 'Busy Lamp Field/BLF List' for status changes, 'Shared Call Appearance (SCA)/ Bridge Line Appearance (BLA)' for sharing a SIP line, and 'Network Conference' for multiple participants.

- Click **Confirm**.

Picking Up a Call Directly

Procedure:

1. Pick up the handset, press the line key or the Speakerphone key.

The **DPickup** soft key appears on the LCD screen (You may need to press the **More** soft key to see the **DPickup** soft key).

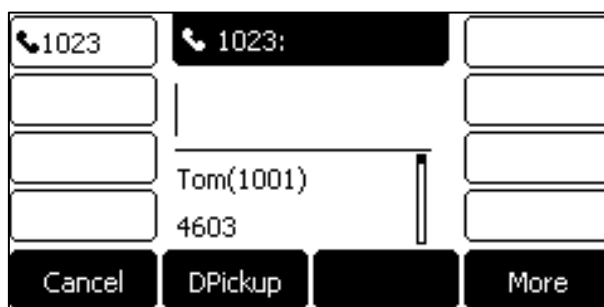

2. Press **DPickup** on your phone when the target phone receives an incoming call.
3. Enter the phone number which is receiving an incoming call.
4. Press **DPickup** again.

The call is answered on your phone.

You can also use a Directed Pickup key (refer to [Configuring a Directed Pickup Key](#)) or BLF/BLF List key (refer to [Configuring a BLF Key/Configuring BLF List Settings](#)) to pick up a call directly.

Group Call Pickup

Configuring the Group Call Pickup

Procedure:

1. Click **Features->Pick up & Park**.
2. Select **Enabled** from the **Group Call Pickup** field.

- Enter the group call pickup code in the **Group Call Pickup Code** field.

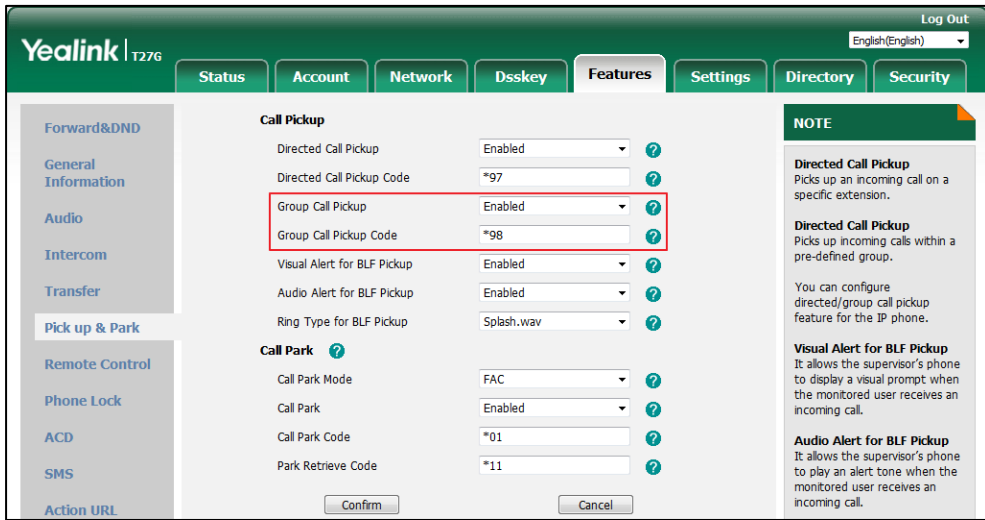

- Click **Confirm**.

You can also configure the group call pickup code on a per-line basis:

Procedure:

- Click **Account->Advanced**.
- Select the desired account from the **Account** field.
- Enter the group call pickup code in the **Group Call Pickup Code** field.

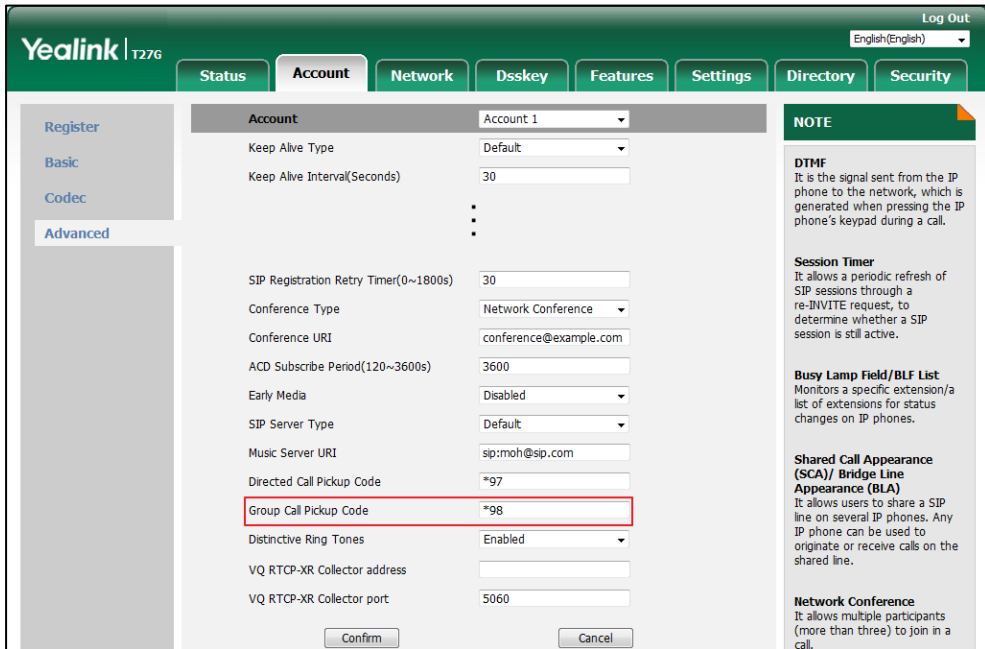

- Click **Confirm**.

Picking Up a Call in the Group

Procedure:

1. Pick up the handset, press the line key or the Speakerphone key.

The **GPickup** soft key appears on the LCD screen.

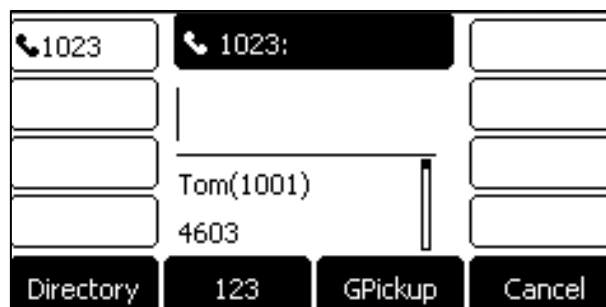

2. Press **GPickup** on your phone when any phone in the group receives an incoming call.

The call is answered on your phone.

You can also use a Group Pickup key (refer to [Configuring a Group Pickup Key](#)) to pick up a call directly.

Note

The directed call pickup code and group call pickup code are predefined by your system administrator on the system server.

The call pickup code configured on a per-line basis takes precedence over that configured on a global basis.

Anonymous Call

Anonymous call, which is configurable on a per-line basis, allows you to place a call to someone without revealing your identification by blocking your name or phone number from being displayed on the called party's phone screen. You can also configure the phone to send anonymous call on/off code to the server to activate/deactivate anonymous call on the server side.

Note

Anonymous call is not available on all servers. Contact your system administrator for the anonymous call on code and off code.

Configuring the Anonymous Call

Procedure:

1. Navigate to **Menu->Features->Anonymous Call**.
For the SIP-T29G IP phone, navigate to **Menu->Features->Anonymous**.
2. Select a desired line from the **Line ID** field (except the SIP-T19(P) E2 IP phone).

For the SIP-T29G IP phone, select a desired line.

3. Select **Enabled** from the **Local Anonymous** field.
4. (Optional.) Select the desired value from the **Send Anonymous Code (Send Anony Code)** field.
5. (Optional.) Enter the anonymous call on code and off code respectively in the **On Code** and **Off Code** field.

The phone will send the configured on code or off code depending on your selection when you enable or disable anonymous call feature on the phone.

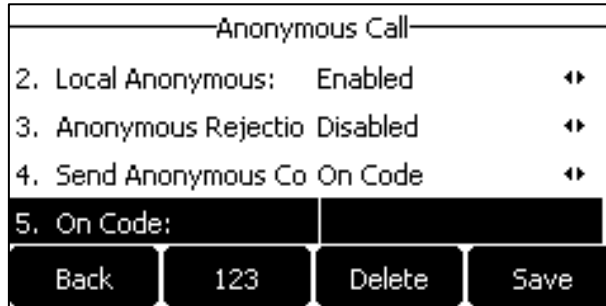

6. Press **Save**.

Anonymous call is configurable via web user interface at the path **Account->Basic**.

Placing an Anonymous Call

Procedure:

1. Using the specific line which has been configured with anonymous call feature to place a call to phone B.

The LCD screen of phone B prompts an incoming call from anonymity.



Anonymous Call Rejection

Anonymous call rejection, which is configurable on a per-line basis, allows you to automatically reject incoming calls from callers who have blocked their caller ID information (including name, phone number, etc.). You can also configure the phone to send anonymous call rejection on/off code to the server to activate/deactivate anonymous call rejection on the server side.

Configuring the Anonymous Call Rejection

Procedure:

1. Navigate to **Menu->Features->Anonymous Call**.
For the SIP-T29G IP phone, navigate to **Menu->Features->Anonymous**.
2. Select a desired line from the **Line ID** field (except the SIP-T19(P) E2 IP phone).
For the SIP-T29G IP phone, select a desired line.
3. Select **Enabled** from the **Local Anonymous Rejection (Local Anony Reject)** field.
4. (Optional.) Select the desired value from the **Send Rejection Code** field.
5. (Optional.) Enter the anonymous call rejection on code and off code respectively in the **On Code** and **Off Code** field.

The phone will send the configured on code or off code depending on your selection when you enable or disable anonymous call rejection feature on the phone.

Anonymous Call	
6. Off Code:	*66
7. Send Rejection Code Off Code	↔
8. On Code:	*67
9. Off Code:	*68
Back	123
Delete	Save

6. Press **Save**.

Anonymous call rejection is configurable via web user interface at the path **Account->Basic**.

Placing a Call to Anonymous Rejected User

If phone B has anonymous call feature enabled and places a call to your IP phone, the call cannot be dialed out on phone B, and the LCD screen of the phone B will display the following:

☎1027	📞 Call failed!	
	19	
	Anonymity disallowed!	
New Call		Cancel

Advanced Phone Features

This chapter explains how to use the advanced features on the IP phone. Topics include:

- [Busy Lamp Field \(BLF\)](#)
- [BLF List](#)
- [Call Recording](#)
- [Hot Desking](#)
- [Intercom](#)
- [Multicast Paging](#)
- [Automatic Call Distribution \(ACD\)](#)
- [Shared Call Appearance \(SCA\)](#)
- [Bridged Line Appearance \(BLA\)](#)
- [Messages](#)

Contact your system administrator for assistance or more information.

Busy Lamp Field (BLF)

You can use BLF to monitor a specific line for status changes except on SIP-T19(P) E2 IP phone. For example, you can configure a BLF key on the phone to monitor the status of a friend's line (busy or idle). The BLF key LED glows red when the friend's line is in use.

You can also enable visual and audio alert features for BLF pickup on the phone.

You can use the BLF key to do the following:

- Placing a call to the monitored user
- Transferring a call to the monitored user
- Pick up an incoming call of the monitored user
- Parking a call to/retrieving a parked call from the monitored user

Configuring a BLF Key

You can configure a BLF key to monitor a specific line for status changes on the phone. You can also initiate an outgoing intercom call to the monitored user, or assign a pick up code for BLF key first to pick up an incoming call of the monitored user. Check with your system administrator to find out if these features are available on your phone.

Procedure:

1. Navigate to **Menu->Features->DSS Keys**.

2. Select a desired line key.
3. Select **BLF** from the **Type** field.
4. Select the desired line from the **Account ID** field.
5. (Optional.) Enter the string that will display on the LCD screen in the **Label** field.
6. Enter the phone number or extension you want to monitor in the **Value** field.
7. (Optional.) Enter the directed call pickup code in the **Extension** field.

If it is configured, you can press the BLF key to pick up the call directly when the monitored user receives an incoming call.

If you leave it blank, and a call pickup code is configured in advance (refer to [Configuring the Directed Call Pickup](#)), you can also use the BLF key to pick up the call directly.

Line Key 5	
1. Type:	BLF
2. Account ID:	Line 1
3. Label:	
4. Value:	1008
<div style="display: flex; justify-content: space-around;"> Back 123 Delete Save </div>	

8. Press **Save**.

BLF key is configurable via web user interface at the path **Dsskey->Line key**.

Note

The pickup code is used in the following order of preference: Extension (**Dsskey->Line Key**)>Directed Call Pickup Code (**Account->Advanced**)>Directed Call Pickup Code (**Features->Pick up & Park**).

Configuring Visual and Audio Alert for BLF Pickup

The visual alert feature for BLF pickup allows the monitoring phone to display the caller ID when the monitored line receives an incoming call; the audio alert feature for BLF pickup allows the monitoring phone to play an audio alert or a distinctive ring tone when the monitored line receives an incoming call.

When the monitored line receives an incoming call, the following occurs on your phone:

- The phone plays a specific ring tone (if enabled).
- The BLF key LED flashes red.
- The caller ID appears on the LCD screen (if enabled).

In the following figure, the LCD screen shows an incoming call from 1077 to the monitored line.



Note

If your phone is locked, you cannot use the **Pick Up**, **Send**, **New Call (NewCall)** and **Cancel** soft keys until unlocked. For more information, refer to [Phone Lock](#).

Configuring the Visual and Audio Alert Features

Procedure:

1. Click **Features**->**Pick up & Park**.
2. Select **Enabled** from the pull-down list of **Visual Alert for BLF Pickup**.
3. Select **Enabled** from the pull-down list of **Audio Alert for BLF Pickup**.

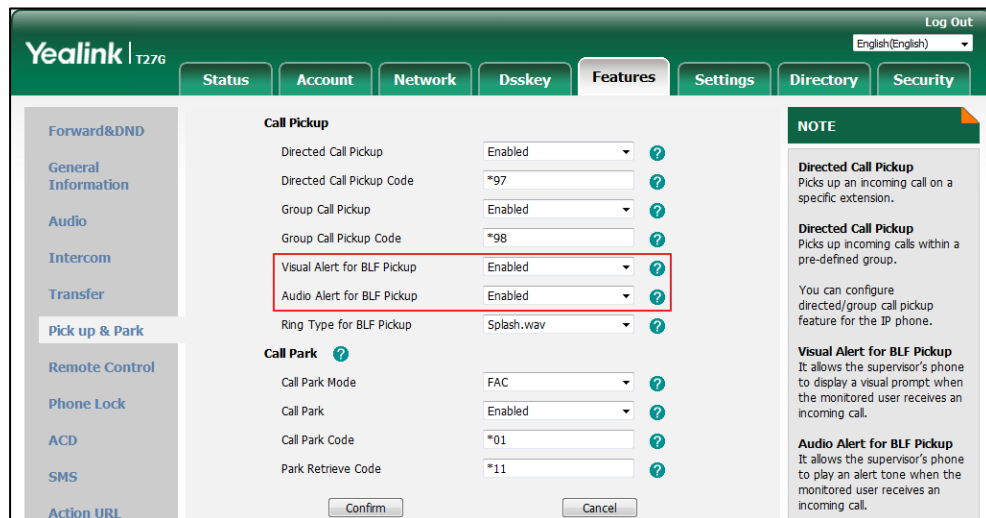

4. Click **Confirm**.

Configuring the BLF Ring Type

Procedure:

1. Navigate to **Menu**->**Settings**->**Basic Settings**->**Sound**->**BLF Ring Type**.
For the SIP-T29G IP phone, navigate to **Menu**->**Basic**->**Sound**->**BLF Ring Type**.

2. Select the desired ring tone.

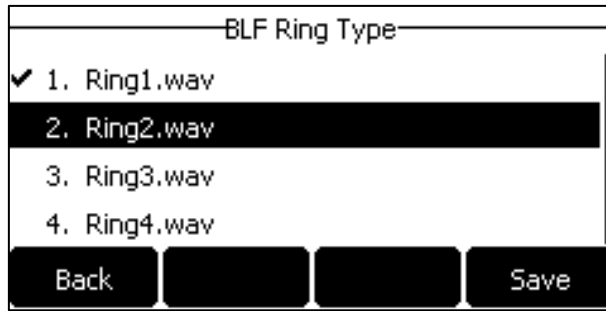

3. (Optional.) Press the Volume key to adjust the ringer volume.
4. Press **Save**.

BLF ring type is configurable via web user interface at the path **Features->Pick up & Park**.

Placing a Call to the Monitored User

You can press a BLF key to dial out the monitored phone number when the monitored line is idle.

Procedure:

1. Press the BLF key.
The IP phone dials out the phone number of the monitored user.

Transferring a Call to the Monitored User

When there is already an active call on the IP phone, you can transfer the active call to the monitored user by pressing the BLF key. The phone handles the active call differently depending on the configuration of Transfer Mode via Dsskey (refer to [Configuring Transfer Mode via Dsskey](#)). The Transfer Mode via Dsskey has the following modes:

- Blind Transfer
- Attended Transfer
- New Call

Performing a Blind Transfer

When the Transfer Mode via Dsskey is set to **Blind Transfer** and there is already an active call on the IP phone, you can do the following:

Procedure:

1. Press the BLF key of the monitored user which you want to transfer this call to.

Performing a Semi-attended Transfer

When the Transfer Mode via Dsskey is set to **Attended Transfer** and there is already an active call on the IP phone, you can do the following:

Procedure:

1. Press the BLF key of the monitored user which you want to transfer this call to. The phone will dial the number of the monitored user.
2. Press the BLF key of the monitored user again or **Transfer (Trans)** to complete the transfer when receiving ringback.

Performing an Attended Transfer

When the Transfer Mode via Dsskey is set to **Attended Transfer** and there is already an active call on the IP phone, you can do the following:

Procedure:

1. Press the BLF key of the monitored user which you want to transfer this call to. The phone will dial the number of the monitored user.
2. Press the BLF key of the monitored user again or **Transfer (Trans)** to complete the transfer after the monitored user answers the call.

Performing a New Call

When the Transfer Mode via Dsskey is set to **New Call** and there is already an active call on the IP phone, you can do the following:

Procedure:

1. Press the BLF key of the monitored user you want to call.
The phone will dial the number of the monitored user. The original call is placed on hold.

Picking Up an Incoming Call of the Monitored User

When the monitored user receives an incoming call, the BLF key indicator of the monitored user will flash red. You can pick up the incoming call by pressing the BLF key, or by pressing the **DPickup** soft key (if visual indication feature is enabled). Before picking up an incoming call, make sure that the directed call pickup code has been configured in advance.

Procedure:

1. Press the BLF key.

The incoming call of the monitored user is answered on the IP phone.

Note

If the directed call pickup code is not configured, the phone will place a call to the monitored user instead of picking up an incoming call of the monitored user when you press the BLF key or the **DPickup** soft key.

Parking a Call/Retrieving a Parked Call to the Monitored User

You can use the BLF key to park a call or retrieve a parked call directly in FAC mode. Make sure that the call park feature is configured in advance (refer to [Configuring Call Park Feature in FAC Mode](#)).

Parking a Call in FAC Mode

Procedure:

1. During a call, press **Park** (You may need to press the **More** soft key to see the **Park** soft key).
2. Press the desired BLF key to park the call to the monitored user.

Retrieving a Parked Call in FAC Mode

Procedure:

1. Press **Retrieve** on the dialing screen.
2. Press the desired BLF key to retrieve a call that is parked to the monitored user.

BLF List

BLF List feature enables you to monitor a list of users defined by your system administrator. For example, your system administrator has enabled BLF List feature and created a BLF List URL (for example, BLFList@example.com) with user1 and user2 in the list on the server. After configuration, the BLF List keys on the IP phone can present the status of user1 and user2, and the respective key LEDs or icons will illuminate either flashing or solid depending on the status of monitored lines. For more information on BLF List key LED indicators, refer to [LED Instructions](#).

You can use the BLF List key to do the following:

- Placing a call to the monitored user.
- Transferring a call to the monitored user. The phone handles the active call differently depending on the configuration of Transfer Mode via Dsskey. For more information on the Transfer Mode via Dsskey, refer to [Configuring Transfer Mode via Dsskey](#).
- Picking up an incoming call of the monitored User. Before picking up an incoming call, ensure that the BLF List Pickup Code has been configured in advance. For more information on how to configure the BLF List Pickup Code, refer to [Configuring BLF List](#)

Settings.

- Barging in a conversation and setting up a conference call. Before barging in an active call, ensure that the BLF List Barge In Code has been configured in advance. For more information on how to configure the BLF List Barge In Code, refer to [Configuring BLF List Settings](#).
- Retrieving a parked call from the monitored user. Before retrieving the parked call, ensure that the BLF List Retrieve Call Parked Code has been configured in advance. For more information on how to configure the Retrieve Call Parked Code, refer to [Configuring BLF List Settings](#).

For more information on how to use these features, refer to [Busy Lamp Field \(BLF\)](#).

Configuring BLF List Settings

Procedure:

1. Click **Account**->**Advanced**.
2. Select the desired account from the pull-down list of **Account**.
3. Enter the BLF List URI in the **BLF List URI** field.
4. (Optional.) Enter the directed call pickup code in the **BLF List Pickup Code** field.
If the code is not configured, the phone will place a call to the monitored user instead of picking up the incoming call of the monitored user when you press the BLF List key.
5. (Optional.) Enter the barge-in code in the **BLF List Barge In Code** field.
If the code is not configured, the phone will place a call to the monitored user instead of barging in an active call of the monitored user when you press the BLF List key.
6. (Optional.) Enter the park retrieve code in the **BLF List Retrieve Call Parked Code** field.

If the code is not configured, the phone will place a call to the monitored user instead of retrieving the parked call when you press the BLF List key.

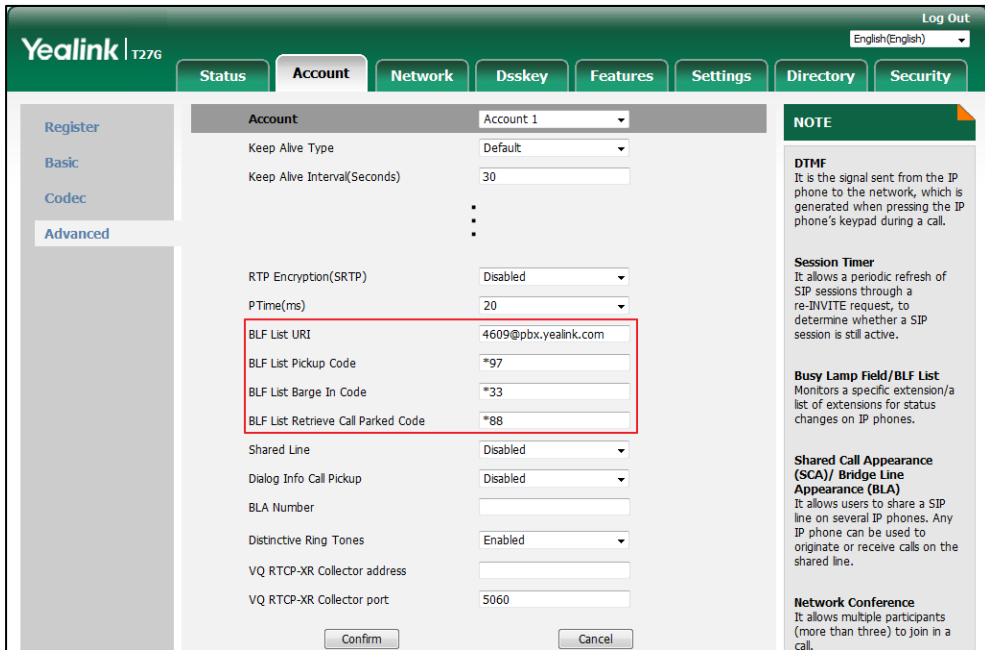

7. Click **Confirm**.

Note

For more information on BLF List URI/BLF List Pickup Code/BLF List Barge In Code/BLF List Retrieve Call Parked Code, contact your system administrator.

The pickup code is used in the following order of preference:
 BLF List Pickup Code (**Account->Advanced**)>Directed Call Pickup Code (**Account->Advanced**)>Directed Call Pickup Code (**Features->Pick up & Park**). If all of them are not configured, pressing the BLF List key will directly call the monitored user when he/she receives an incoming call. For more information on pickup code, refer to [Call Pickup](#).

According to the response message from the server, the IP phone will automatically configure the BLF List keys beginning from the first unused DSS key (The default order of BLF List keys assigned automatically is Line Key->Ext Key.). Once any DSS key is seized, the IP phone will skip to configure the next DSS key.

Note

Your system administrator can customize the assignment order.

Call Recording

The IP phones support local and server recording. Only on the SIP-T29G/T27G IP phone, you can record active calls onto a USB flash drive connected to your IP phone, and the recordings are saved as *.wav files. If you press the record key (refer to [Recording Using a Record Key](#)) during an active call, this active call will be recorded and saved on the server.

Note

Before call recording, especially those involving PSTN, it is necessary to know about the rules and restrictions of any governing call-recording in the country where you are. It is also very important to inform all the call parties that you are recording and ask for their consent before recording the conversation.

Recording Using a USB Flash Drive

On the SIP-T29G/T27G IP phone, you can record calls onto a USB flash drive connected to your phone.

If you insert a USB flash drive to the IP phone when the phone is idle, the phone will detect the USB flash drive and display a flashing USB icon. After detecting the USB flash drive, the icon stops flashing and a message will display on the screen:

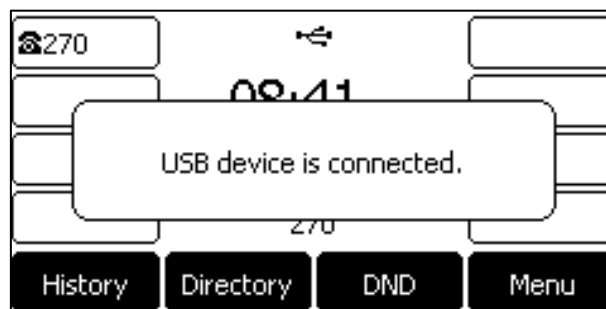

If you insert a USB flash drive to the IP phone during a call, a message will pop up to tell you how much time is available for recording. For more information on the available recording time, refer to [Viewing the Storage Space](#).



Note

Recording using a USB flash drive is not available by default. Check with your system administrator to find out if this feature is available on your phone.

The size of a single recording file should be less than 2G.

The Start REC soft key controls the recording function, and is available:

- When the free space of USB flash drive is sufficient
- When there are one or more calls connected to your IP phone
- During an active call
- When calls are on hold or muted
- During an attended transfer
- During a conference call

The Start REC soft key is not available when:

- You place a new call
- No free space of USB flash drive
- Receiving an incoming call

Recording a Call

You can record active calls or conferences.

Procedure:

1. Press **More**, and then press **StartREC** during a call.

The LCD screen displays a recording icon and recording duration.



During the recording, you can do the following:

- Press **More**, and then press **PauseREC**. Then the pause recording icon appears on the LCD screen and the duration stops counting. Both you and other parties are not recorded. Press **ResumeREC** to continue recording.

- Press **More**, and then press **StopREC**. Recording stops and a message is displayed on the screen:



Press **StartREC** to start recording again, the recording will be saved as a new ".wav" file.

- Press the HOLD key or **Hold** while recording, recording is paused. Then the pause recording icon appears on the LCD screen and the duration stops counting. Both you and the callee are not recorded.

Press **Resume** to resume the call, the recording is continued.

- Press the MUTE key while recording, the muted party is not recorded.
- If there is insufficient free space (30 minutes left) on the USB flash drive during recording, a message will display on the screen:

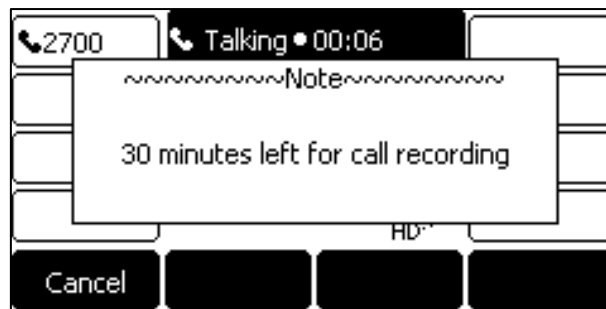

Press **Cancel** to return to the previous screen.

- If there is insufficient free space (10 minutes left) on the USB flash drive during recording, a message will display on the screen:

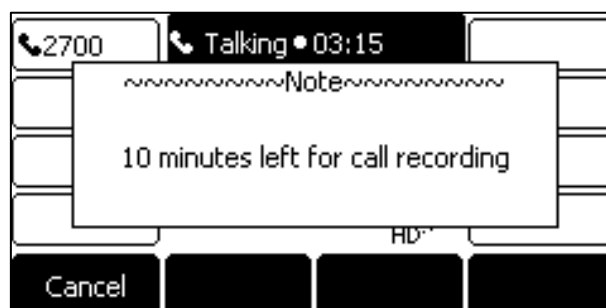

Press **Cancel** to return to the previous screen.

If no free space on the USB flash drive during recording, recording is stopped and saved on the USB flash drive automatically. The related soft keys during recording disappear. You cannot

record a call unless the space of your USB flash drive is released.

Note You can transfer or set up a conference call while recording. All the calls are recorded in the same way and will be saved in a ".wav" file.

Stop Recording a Call

When you end a call during recording, the recording will be stopped and saved as *.wav file on the USB flash drive automatically.

Procedure:

- Press **More**, and then press **StopREC**.

The recording icon and recording duration disappears. A message is displayed on the LCD screen:



- Press **More** and then press **End Call (EndCall)**.

The recording icon and recording duration disappears, and the phone returns to the Idle screen. A message is displayed on the LCD screen:



Playing Back Recorded Calls

You can play back, browse and delete the recorded files on your phone.

Note You can play back the recorded calls on the phone or on a computer using an application capable of playing ".wav" files.

Procedure:

1. Navigate to **Menu->USB->Browse Audio**.

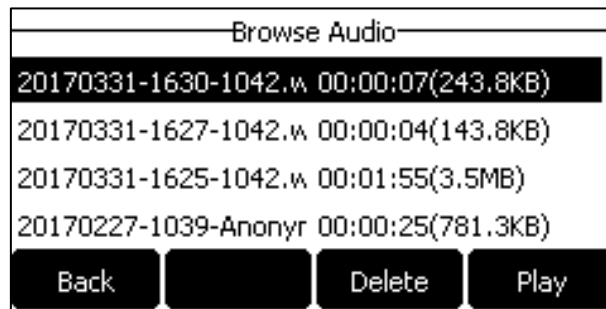

The LCD screen shows all recorded files (file name, duration time and file size) in the **Browse Audio** list. The filename consists of the recording time & date, the other party's number/IP address/name (or the first person's number/IP address/name you called).

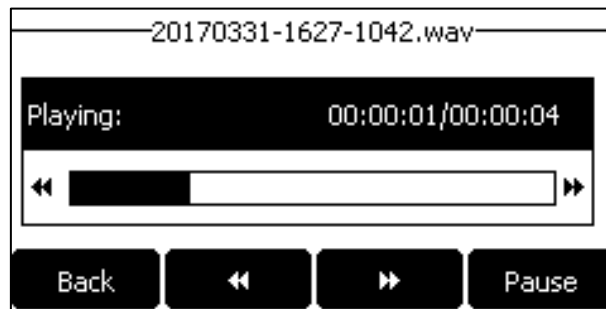

2. Select a desired file to play.



During the recording playback, you can do the following:

- Press the Speakerphone key, the HEADSET key, or pick up the handset to switch among Speakerphone, Headset and Handset modes.
- Press the Volume key to adjust the volume of audio output.
- Press **Pause** to pause the playback.
Press **Play** to continue the playback.
- Press **F.Fwad** () to skip forward (8 seconds at a time) the playback.
- Press **F.Rew** () to rewind (8 seconds at a time) the playback.
- Press **Back** to stop the playback. The phone returns to the Browse Audio screen.

When you receive an incoming call while playing a recording, the recording is paused automatically and the phone rings. If you reject the incoming call or after you end the call, the recording remains paused until you press **Play** again.

Deleting the Recorded File

Procedure:

1. Navigate to **Menu->USB->Browse Audio**.
2. Highlight a desired recording, and then press **Delete**.

A message is displayed on the LCD screen:



3. Press **OK** to delete.

Viewing the Storage Space

You can view the storage space (for example, total space, used space, free space) of the USB flash drive on the phone.

Procedure:

1. Navigate to **Menu->USB->Storage Space**.

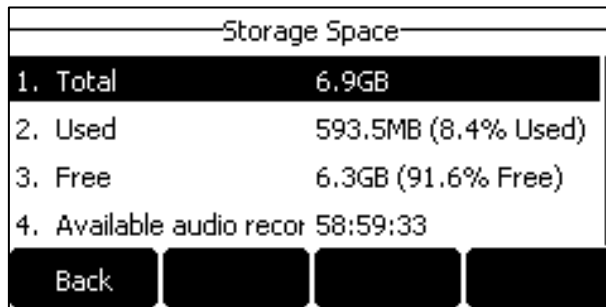

Recording Using a Record Key

You can record calls by pressing a record key on the phone. The IP phones support record and URL record.

Two ways of call recording:

- **Record:** The phone sends a SIP INFO message containing a specific header "Record: on/off" to trigger a recording.
- **URL Record:** The phone sends an HTTP URL request to trigger a recording.

Note

Server recording is not available on all servers. Contact your system administrator for more information on predefined URL.

The Record and URL Record keys control the recording function, and are available:

- During an active call
- When calls are placed on hold or muted
- During a blind or attended transfer
- During a conference call

The Record and URL Record keys are not available when:

- There are no connected calls on your phone
- You are placing a new call

Configuring a Record Key

Procedure:

1. Navigate to **Menu->Features->DSS Keys**.
2. Select a desired line key.
3. Select **Key Event** from the **Type** field.
4. Select **Record** from the **Key Type** field.
5. (Optional.) Enter the string that will display on the LCD screen in the **Label** field.

Line Key 5		
1. Type:	Key Event	↔
2. Key Type:	Record	↔
3. Label:		

Back 2aB Delete Save

6. Press **Save**.

Record key is configurable via web user interface at the path **Dsskey->Line Key**.

Configuring a URL Record Key

Procedure:

1. Navigate to **Menu->Features->DSS Keys**.
2. Select a desired line key.
3. Select **URL Record** from the **Type** field.
4. (Optional.) Enter the string that will display on the LCD screen in the **Label** field.

5. Enter the URL (for example, `http://10.1.2.224/phonerecording.cgi`) in the **Value** field.

The screenshot shows a configuration screen titled "Line Key 5". It contains three rows of configuration data:

- 1. Type: URL Record
- 2. Label:
- 3. Value: http://10.1.2.224/phon

At the bottom of the screen, there are four buttons: "Back", "abc", "Delete", and "Save".

6. Press **Save**.

URL record key is configurable via web user interface at the path **Dsskey->Line Key**.

Recording a Call

Procedure:

1. Press the record key or URL record key during a call.
If the recording starts successfully, the recording icon will appear on the LCD screen.
2. Press the record key or URL record key again to stop recording.
The recording icon disappears from the LCD screen.

You can listen to the recordings stored on your server system. For example, you can dial an access code to listen to the recordings.

Note

The way in which you listen to the recordings may be different depending on the server. Contact your system administrator for more information.

Hot Desking

Hot desking originates from the definition of being the temporary physical occupant of a work station or surface by a particular employee. A primary motivation for hot desking is cost reduction through space saving. This feature is regularly used in places where not all the employees are in the office at the same time, or not in the office for very long, which means that actual personal offices would be often vacant, consuming valuable space and resources.

You can use hot desking to log out from the current account and then log into a new account. As a result, many users can share one same phone resource at different times. To use this feature, you need to configure a hot desking key in advance.

Note

Hot desking is not available on all servers. Contact your system administrator for more information.

Configuring a Hot Desking Key

Procedure:

1. Navigate to **Menu->Features->DSS Keys**.
2. Select a desired line key.
3. Select **Key Event** from the **Type** field.
4. Select **Hot Desking** from the **Key Type** field.
5. (Optional.) Enter the string that will display on the LCD screen in the **Label** field.

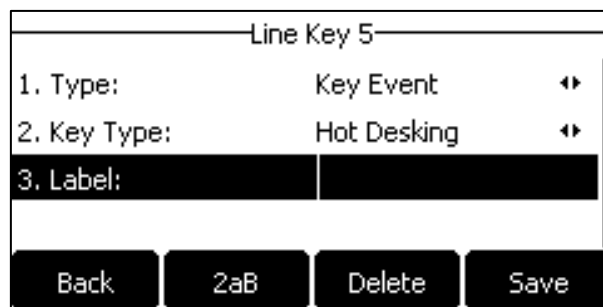

6. Press **Save**.

Hot desking key is configurable via web user interface at the path **Dsskey->Line Key**. For the SIP-T19(P) E2 IP phone, you can only configure a programmable key as hot desking key via web user interface at the path: **Dsskey->Programmable key**.

Using a Hot Desking Key

Procedure:

1. Press the hot desking key when the phone is idle.

A message is displayed on the LCD screen:

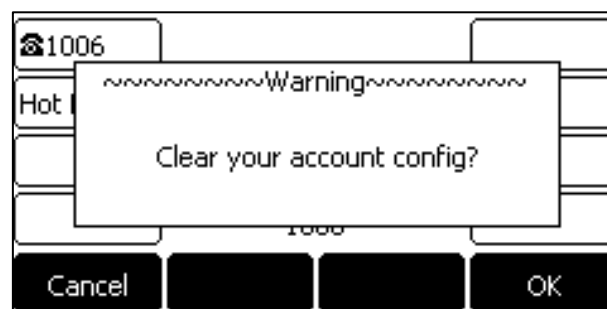

2. Press **OK**.

Registration configurations of all accounts on the phone will be cleared immediately.

The login wizard will be displayed as below:

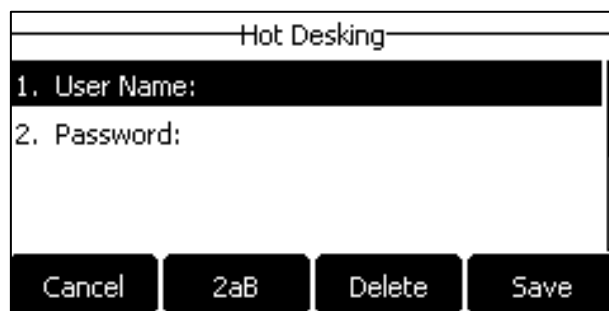

3. Enter the login information in each field.
4. Press **Save** to login.

Intercom

Intercom is a useful feature in an office environment to quickly connect with the operator or the secretary. You can press the intercom key to place a call to a contact that is answered automatically on the contact's phone as long as the contact is not in an active call. In addition, the intercom key can be used for monitoring the status changes of a specific line on the phone.

Note Intercom is not available on all servers. Contact your system administrator for more information.

Configuring the Intercom Feature on the IP Phone

Configuring an Intercom Key

Procedure:

1. Navigate to **Menu->Features->DSS Keys**.
2. Select a desired line key.
3. Select **Intercom** from the **Type** field.
4. Select the desired line from the **Account ID** field.
5. (Optional.) Enter the string that will display on the LCD screen in the **Label** field.

6. (Optional.) Enter the target extension number in the **Value** field.

Line Key 2		
1. Type:	Intercom	↔
2. Account ID:	Line 1	↔
3. Label:		
4. Value:	1008	
<div style="display: flex; justify-content: space-around;"> Back 123 Delete Save </div>		

7. (Optional.) Enter the directed call pickup code in the **Extension** field.

If it is configured, when the target extension receives an incoming call, the supervisor can press the intercom key to pick up the call directly.

8. Press **Save**.

Intercom key is configurable via web user interface at the path **Dsskey->Line Key**.

Note Your system administrator can disable you to press the intercom key to pick up a call. Check with your system administrator to find out if this feature is available on your phone, and contact your system administrator for the directed call pickup code.

Configuring the Intercom

By default, when there is an incoming intercom call, the phone will play a warning tone and this incoming call will be answered automatically. In addition, you can enable the phone to mute the microphone when the incoming intercom call is answered automatically. If there is already an active call on the phone, you can allow the incoming intercom call to be automatically answered while the active call is then placed on hold.

Intercom Allow

Intercom Allow allows the IP phone to automatically answer an incoming intercom call. If you disable this feature, the IP phone will handle an incoming intercom call like a normal incoming call. Intercom Allow is enabled by default.

Note Your administrator can set a period of delay time before the phone automatically answers intercom calls.

Intercom Mute

Intercom Mute allows the IP phone to mute the microphone for incoming intercom calls. Intercom Mute is disabled by default.

Intercom Tone

Intercom Tone allows the IP phone to play a warning tone before answering an intercom call. Intercom Tone is enabled by default.

Intercom Barge

Intercom Barge allows the IP phone to automatically answer an incoming intercom call while an active call is in progress. The active call will be placed on hold. If you disable this feature, the IP phone will handle an incoming intercom call like a normal incoming call while there is already an active call on the IP phone. Intercom Barge is disabled by default.

Note

To enable the phone to receive a new incoming call when it has an active call, make sure that call waiting feature is enabled on the phone in advance. For more information, refer to [Configuring the Call Waiting](#).

Procedure:

1. Navigate to **Menu->Features->Intercom**.
2. Make the desired changes.

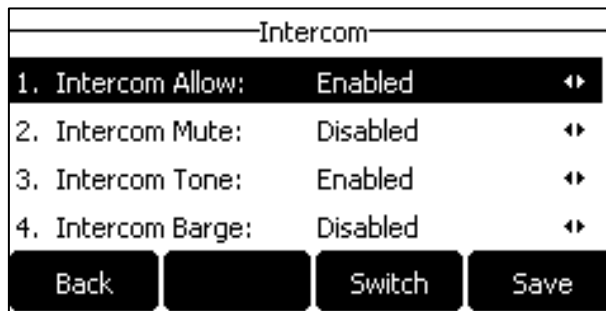

3. Press **Save**.

Intercom features are configurable via web user interface at the path **Features->Intercom**.

Using Intercom

You can use the intercom key in the following ways:

- Place a call to the target extension
- Pick up an incoming call of the target extension

Note

To use the intercom key to pick up an incoming call, make sure the intercom subscription feature is enabled. For more information, contact your system administrator.

Placing an Intercom Call to the Target Extension

Procedure:

1. Press the intercom key.

The target extension plays a warning tone and automatically answers the call in the hands-free (speakerphone) mode by default.

2. To end the intercom call, press the intercom key again or **End Call (EndCall)**.

You can also press the BLF/BLF List key (refer to [Configuring a BLF Key/Configuring BLF List Settings](#)) to initiate an outgoing intercom call to the monitored user. Check with your system administrator to find out if it is available on your phone.

Picking Up an Incoming Call of the Target Extension

When the target extension receives an incoming call, the intercom key LED of the target extension will flash green on the IP phone. If you configure the directed call pickup code in advance (refer to [Configuring the Directed Call Pickup](#)), you can pick up the target extension's incoming call by pressing the intercom key. The directed call pickup code can be configured with the intercom key. For more information, refer to [Configuring an Intercom Key](#).

Procedure:

1. Press the intercom key.

The incoming call of the target extension is answered on your IP phone.

Note

If the directed call pickup code is not configured, the phone will place a call to the target extension instead of picking up an incoming call of the target extension when you press the intercom key.

Multicast Paging

Multicast Paging allows you to easily and quickly broadcast instant audio announcements to users who are listening to a specific multicast group on a specific channel. You can configure a multicast paging key or the paging list key on the phone, which allows you to send a Real Time Transport Protocol (RTP) stream to the pre-configured multicast address(es) on specific channel(s) without involving SIP signaling. You can also configure the phone to receive an RTP stream from pre-configured multicast listening address(es) on specific channel(s) without involving SIP signaling. Up to 31 multicast listening addresses and channels can be configured on your phone.

The IP phone supports the following 31 channels:

- **0:** Broadcasts are sent to channel 0. Note that the Yealink IP phones running firmware version 80 or earlier can be regarded as listening to channel 0. It is the default channel.
- **1 to 25:** Broadcasts are sent to channel 1 to 25. We recommend that you specify these channels when broadcasting with Polycom IP phones which have 25 channels you can

listen to.

- **26 to 30:** Broadcasts are sent to channel 26 to 30. We recommend that you specify these channels when broadcasting with Yealink IP phones running firmware version 81 or later.

The IP phone can only send and receives broadcasts to/from the listened channels. Other channels' broadcasts will be ignored automatically by the IP phone.

Note

If G722 codec is used for multicast paging, the LCD screen will display an "HD" icon to indicate that the broadcasts are using Yealink HD voice. Check with your system administrator to see if this feature is available on your phone.

Sending RTP Stream

Configuring a Multicast Paging Key

Procedure:

1. Navigate to **Menu->Features->DSS Keys**.
2. Select a desired line key.
3. Select **Key Event** from the **Type** field.
4. Select **Multicast Paging** from the **Key Type** field.
5. (Optional.) Enter the string that will display on the LCD screen in the **Label** field.
6. Enter the multicast IP address and port number (for example, 224.5.6.20:10008) in the **Value** field.

The valid multicast IP addresses range from 224.0.0.0 to 239.255.255.255.

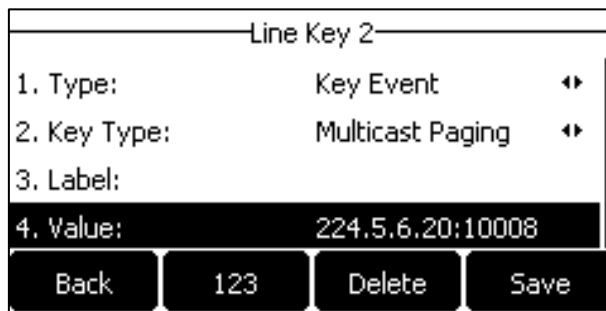

7. Enter the desired channel between 0 and 30 in the **Channel** field.
8. Press **Save**.

Multicast paging key is configurable via web user interface at the path **Dsskey->Line Key**.

Configuring a Paging List Key

Procedure:

1. Navigate to **Menu->Features->DSS Keys**.

2. Select a desired line key.
3. Select **Key Event** from the **Type** field.
4. Select **Paging List** from the **Key Type** field.
5. (Optional.) Enter the string that will display on the LCD screen in the **Label** field.

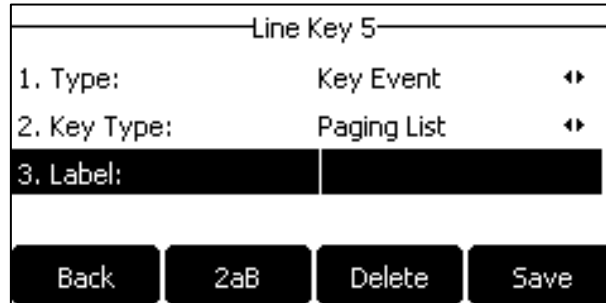

6. Press **Save**.

Paging list key is configurable via web user interface at the path **Dsskey->Line Key**.

Configuring Paging List

Procedure:

1. Press the paging list key when the phone is idle.
If the paging list key is not configured, you can also navigate to **Menu->Features->Others->Paging List** for the SIP-T29G IP phone or **Menu->Features->Paging List** for other IP phones to configure the paging list.
2. Select a desired paging group.
The default tag is Empty if it is not configured before.

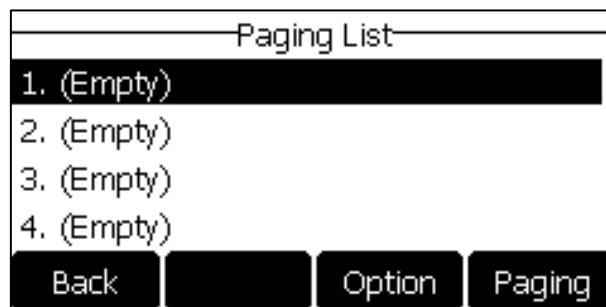

3. Press **Option**, and then select **Edit**.
4. Enter the multicast IP address and port number (for example, 224.5.6.20:10008) in the **Address** field.

The valid multicast IP addresses range from 224.0.0.0 to 239.255.255.255.

5. Enter the string that will display on the LCD screen in the **Label** field.

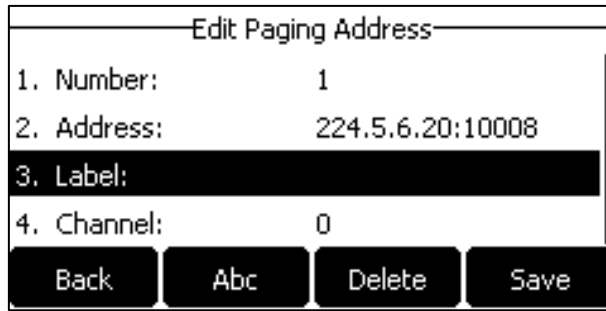

6. Enter the desired channel between 0 and 30 in the **Channel** field.
7. Press **Save**.
8. Repeat steps 2 to 7, if you want to add more paging groups.

Paging list is configurable via web user interface at the path **Directory->Multicast IP**.

Deleting a Paging Group

Procedure:

1. Press the paging list key when the phone is idle.
If the paging list key is not configured, you can also navigate to **Menu->Features->Others->Paging List** on the SIP-T29G IP phone or **Menu->Features->Paging List** on other IP phones to configure the paging list.
2. Select a desired paging group.
3. Press **Option**, and then select **Delete**.

A message is displayed on the LCD screen:

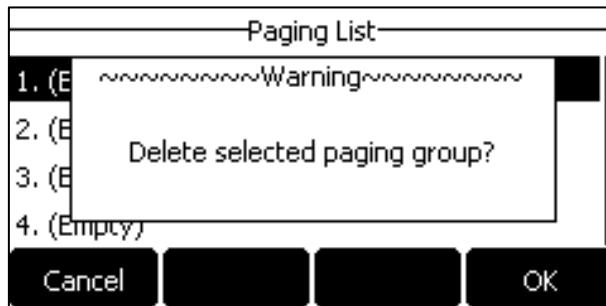

4. Press **OK**.

If you want to delete all paging groups, select the **Delete All**.

Receiving RTP Stream

You can configure the phone to receive a Real Time Transport Protocol (RTP) stream from the pre-configured multicast address(es) and channel(s) without involving SIP signaling. Up to 31 multicast addresses and channels that the phone listens to on the network can be configured.

Note

RTP stream is listened in the hands-free (speakerphone) mode by default. If you want to listen the RTP stream using other engaged audio devices (speakerphone, handset or headset), contact your system administrator for more information.

Fixed volume to play RTP stream for specified paging group is configurable by your system administrator.

How the phone handles incoming multicast paging calls depends on Paging Barge, Ignore DND and Paging Priority Active configured via web user interface.

Paging Barge

Paging Barge feature defines the lowest priority of the multicast listening address from which the phone can receive an RTP stream when there is a voice call (a normal phone call rather than a multicast paging call) in progress. If it is disabled, all incoming multicast paging calls will be automatically ignored. If it is set to a specify priority value, the incoming multicast paging calls with higher or equal priority are automatically answered and the ones with lower priority are ignored. Valid values for Paging Barge:

- **1 to 31:** Define the lowest priority of the multicast listening address from which the phone can receive an RTP stream, 1 with the highest priority, 31 with the lowest.
- **Disabled:** The voice call in progress will take precedence over all incoming paging calls.

Ignore DND

Ignore DND feature defines the lowest priority of multicast listening address from which the phone can receive an RTP stream when DND is activated. If a priority is selected from the pull-down list of Ignore DND, the phone will ignore incoming multicast paging calls with lower priorities when DND is activated in phone mode. Valid values for Ignore DND:

- **1 to 31:** Define the lowest priority of the multicast listening address from which the phone can receive an RTP stream, 1 with the highest priority, 31 with the lowest.
- **Disabled:** All the incoming multicast paging calls will be ignored when DND is activated in phone mode.

The phone will automatically answer all incoming multicast paging calls when DND is activated in custom mode.

Paging Priority Active

Paging Priority Active feature decides how the phone handles incoming multicast paging calls when there is already a multicast paging call on the phone. If enabled, the phone will ignore

incoming multicast paging calls with lower priorities, otherwise, the phone will answer incoming multicast paging calls automatically and place the previous multicast paging call on hold. If disabled, the phone will automatically ignore all incoming multicast paging calls.

Configuring the Multicast Listening

Procedure:

1. Click **Directory**->**Multicast IP**.
2. Select the desired value from the pull-down list of **Paging Barge**.
3. Select the desired value from the pull-down list of **Ignore DND**.
4. Select the desired value from the pull-down list of **Paging Priority Active**.
5. Enter the multicast IP address(es) and port number (for example, 224.5.6.20:10008) which the phone listens to for incoming RTP multicast in the **Listening Address** field.
6. (Optional.) Enter the label in the **Label** field.
Label displays on the LCD screen when receiving the multicast RTP stream.
7. Select the desired channel to listen from the pull-down list of **Channel**.

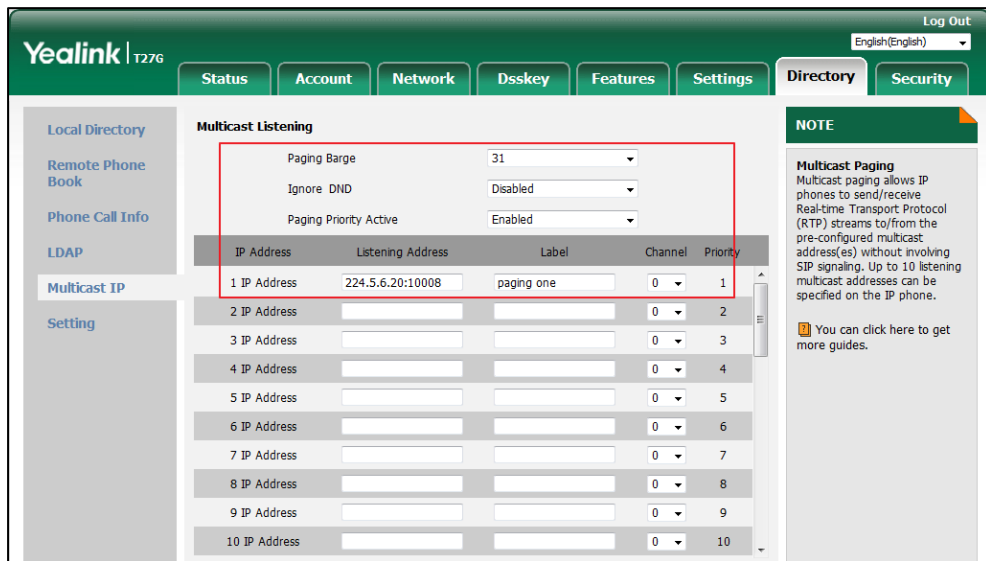

8. Click **Confirm**.

Note The priorities of listening addresses are predefined: 1 with the highest priority, 31 with the lowest.

Using Multicast Paging

Sending RTP Stream via a Multicast Paging Key

Procedure:

1. Press the multicast paging key when the phone is idle.

The phone sends RTP to a preconfigured multicast address (IP: Port).

Both the sender's and receiver's phones play a warning tone and the multicast RTP session will be automatically answered on the receiver's phone in the hands-free (speakerphone) mode.

On other IP phones, the multicast paging key LED glows green.

The following figure shows a multicast RTP session on the phone:

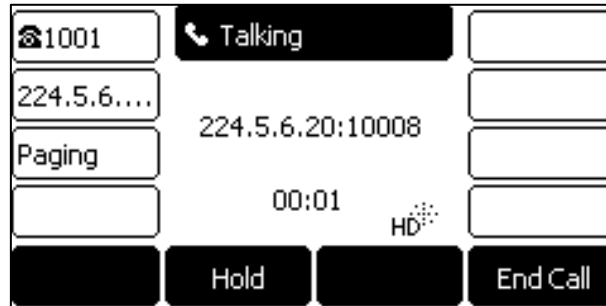

2. You can do the following:

- Press **Hold** to place the current multicast RTP session on hold.

The sender's phone places the multicast RTP session on hold and receiver's phone releases the session.

To resume the held multicast RTP session, press **Resume**.

The multicast RTP session is re-established.

- Press **End Call (EndCall)** to end the multicast RTP session.

Note

Multicast RTP is one way only from the sender to the multicast address(es) (receiver). For outgoing RTP multicasts, all other existing calls on the phone will be placed on hold.

Sending RTP Stream via a Paging List Key

Procedure:

1. Press the paging list key when the phone is idle.

2. Select a desired paging group.

3. Press **Paging** to send RTP.

4. You can do the following:

- Press **Hold** to place the current multicast RTP session on hold.

The sender's phone places the multicast RTP session on hold and receiver's phone releases the session.

To resume the held multicast RTP session, press **Resume**.

The multicast RTP session is re-established.

- Press **End Call (EndCall)** to end the multicast RTP session.

Automatic Call Distribution (ACD)

ACD is often used in offices for customer service, such as call center. The ACD system handles large volumes of incoming calls from callers who have no need to talk to a specific person but who require assistance from any of multiple persons at the earliest opportunity. ACD on the all IP phone allows the ACD system to distribute large volumes of incoming calls to the registered ACD users. To use this feature, you should configure an ACD key in advance.

Note

ACD is not available by default. Check with your system administrator to find out if this feature is available on your phone.

Configuring an ACD Key

Procedure:

1. Navigate to **Menu->Features->DSS Keys**.
2. Select a desired line key.
3. Select **ACD** from the **Type** field.
4. (Optional.) Enter the string that will display on the LCD screen in the **Label** field.

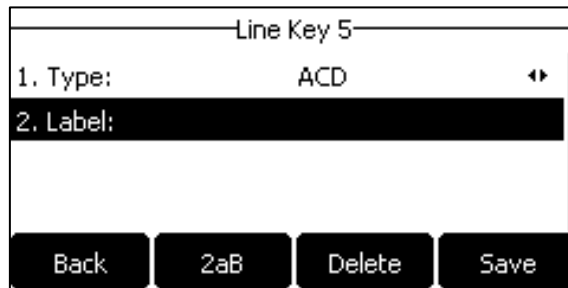

5. Press **Save**.

ACD key is configurable via web user interface at the path **Dsskey->Line Key**. For the SIP-T19(P) E2 IP phone, you can only configure a programmable key as ACD key via web user interface at the path: **Dsskey->Programmable key**.

Logging into the ACD System

Procedure:

1. Press the ACD key when the phone is idle.
A message is displayed on the LCD screen:

User ID: the identity used to log into the queue.

Password: the password used to log into the queue.



The image shows a screenshot of a phone's ACD (Automatic Call Distribution) login screen. The screen has a title bar at the top that says "ACD". Below the title bar, there are two numbered prompts: "1. User ID:" and "2. Password:". At the bottom of the screen, there are four buttons: "Cancel", "123", "Delete", and "Login".

2. Press **Login** to log in.

Note

Contact your system administrator for the User ID and Password to access the ACD system.

After configuring an ACD key, you can press the ACD key to log into the ACD system. After logging in, you are ready to receive calls from the ACD system. You can press the ACD key to show your current ACD user status. You can press the **Available (Avail)/Unavailable (Unavail)** soft key to change your ACD user status. ACD user status synchronizes on both IP phone and ACD system.

When you set the ACD user status to be available, the ACD key LED glows green, and then the server begins distributing calls to your IP phone.

When you set the ACD user status to be unavailable, the ACD key LED flashes green, and then the server temporarily stops distributing calls to your IP phone. To log out of the ACD system, press the **Logout** soft key.

Note

It is recommended that you configure only one ACD key per phone, since only one ACD key can be in use on your phone at any time.

Shared Call Appearance (SCA)

You can use SCA feature to share an extension which can be registered on more than one IP phones at the same time. The shared line is indicated by a different line icon.

In the following figure, the first line is a private line while the second line is a shared line:



If two phones share a line, an incoming call to this extension will cause both phones to ring simultaneously. The incoming call can be answered on either phone but not both.

This feature is very useful in the boss and secretary scenario. For example, the boss shares his extension with the secretary. When there is an incoming call to the extension of the boss, both the phones of the boss and the secretary will ring simultaneously, and either the boss or the secretary can answer the call. Calls on the shared line can be placed on hold, barged in or retrieved from another shared phone.

Configuring SCA Feature on the IP Phone

You can configure a primary account on a IP phone and other alternate accounts on other IP phones. In a SCA Hybrid Key System scenario, you can automatically assign multiple DSS keys with Line type for a registered shared line on the phone (If auto linekeys feature is enabled). For example, boss and secretary share the account 4603, boss phone registers the primary account 4603 (register name and user name are 4603) and assigns line key 1 and line key 2 for the account 4603, secretary phone registers the alternate account 4603_1 (register name is 4603, user name is 4603_1) and assigns line key 1 and line key 2 for the account 4603_1, third party phone registers the account 4604. For more information on how to register an account, refer to [Registering an Account](#).

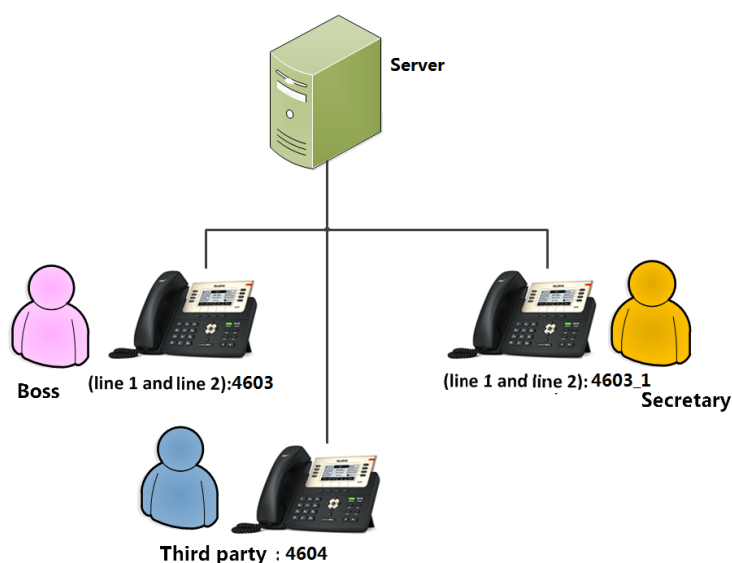

Configuring the Shared Line and Number of Line Key

You can configure a primary account on boss phone and an alternate account on secretary phone. The number of line key is not available for the SIP-T19(P) E2 IP phone.

Note

Contact your system administrator for the account information.

Procedure:

1. Register the primary account on boss phone and alternate account on secretary phone.
2. Click **Advanced**, and then select **Shared Call Appearance** from the pull-down list of **Shared Line**.
3. Enter the desired number in the **Number of line key** field.
This field appears only if **Auto Linekeys** (refer to [Configuring the Auto Linekeys](#)) is enabled.

In this example, the value is set to 2.

The screenshot shows the Yealink T276 web interface. The 'Account' tab is selected, and the 'Account' settings are displayed. The 'Number of line key' field is highlighted with a red box and contains the value '2'. Other fields include 'Shared Line' (Shared Call Appearance), 'Call Pull Feature Access Code' (*11), 'Dialog Info Call Pickup' (Disabled), 'BLA Number', 'BLA Subscription Period' (300), 'SIP Send MAC' (Disabled), 'VQ RTPC-XR Collector name', 'VQ RTPC-XR Collector address', 'VQ RTPC-XR Collector port' (5060), and 'BLF List Retrieve Call Parked Code'. A 'NOTE' section on the right provides information about DTMF, Session Timer, Busy Lamp Field/BLF List, Shared Call Appearance (SCA)/ Bridge Line Appearance (BLA), and Network Conference.

4. Click **Confirm**.

The boss phone and secretary phone will automatically configure the line keys from the first unused DSS key, according to the configured number in the **Number of line key** field.

Configuring Private Hold Soft Key or Private Hold Key

Public hold allows any shared line to retrieve the held call, while private hold only allows the hold party to retrieve the held call. For example, you can retrieve the held call on either boss phone or secretary phone when you place a call on public hold; but you can retrieve the held call only on boss phone when you place a call on private hold on boss phone. You need to configure either the private hold soft key or a private hold key before you place the call on private hold.

Configuring a Private Hold Soft Key

Procedure:

1. Click **Settings**->**Softkey Layout**.
2. Select **Enabled** from the pull-down list of **Custom Softkey**.
3. Select **On Talk** from the pull-down list of **Call States**.
4. Select **PriHold** from the **Unselected Softkeys** column and then click  .

The **PriHold** appears in the **Selected Softkeys** column.

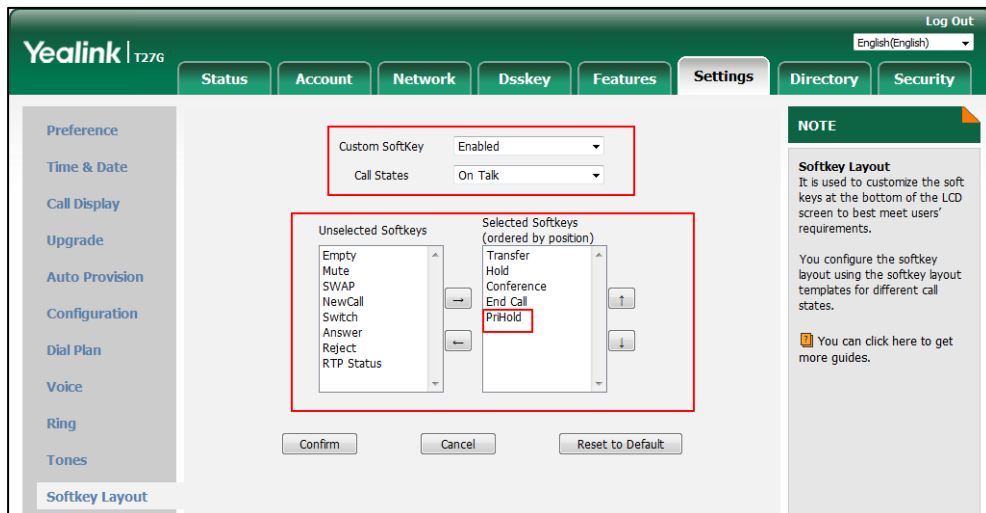

5. Click **Confirm**.

Note Configuring the private hold soft key may affect the softkey layout in the Talking state. Contact your administrator for more information.

Configuring a Private Hold Key

You can configure a private hold key except on SIP-T19(P) E2 IP phone.

Procedure:

1. Navigate to **Menu->Features->DSS Keys**.
2. Select a desired line key.
3. Select **Key Event** from the **Type** field.
4. Select **Private Hold** from the **Key Type** field.
5. (Optional.) Enter the string that will display on the LCD screen in the **Label** field.

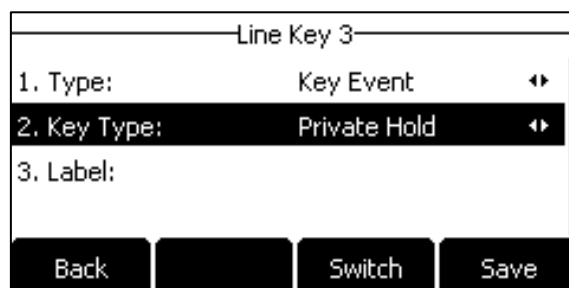

6. Press **Save**.

Private hold key is configurable via web user interface at the path **Dsskey->Line Key**.

Configuring Call Pull Feature

Call pull feature allows users to retrieve an existing call from another shared phone that is in active or public hold status.

Procedure:

1. Click **Account**->**Advanced**.
2. Select the desired account from the pull-down list of **Account**.
3. Enter the call pull feature access code (for example, *11) in the **Call Pull Feature Access Code** field.

The screenshot shows the Yealink T27G web interface. The 'Account' tab is selected, and the 'Advanced' sub-tab is active. The 'Call Pull Feature Access Code' field is highlighted with a red box and contains the value '*11'. Other settings include Keep Alive Type (Default), Keep Alive Interval (30), RPort (Disabled), BLF List Retrieve Call Parked Code, Shared Line (Shared Call Appearance), Dialog Info Call Pickup (Disabled), BLA Number, BLA Subscription Period (300), SIP Send MAC (Disabled), VQ RTPC-XR Collector name, VQ RTPC-XR Collector address, VQ RTPC-XR Collector port (5060), and Number of line key (2). A 'NOTE' section on the right provides information about DTMF, Session Timer, Busy Lamp Field/BLF List, Shared Call Appearance (SCA)/ Bridge Line Appearance (BLA), and Network Conference.

4. Click **Confirm**.

The phone will dial out “*11” automatically when you press the **Call Pull (CallPull)** soft key.

Using SCA Feature on the IP Phone

This section provides you with detailed information on using the IP phone in a SCA Hybrid Key System scenario. In a SCA Hybrid Key System scenario, the status of the line key LED which associates with a shared line will change. For more information on line key LED indicators, refer to [LED Instructions](#). Line key is not available on the SIP-T19(P) E2 IP phone.

You can do the following using the IP phone in a SCA Hybrid Key System scenario:

- Placing calls
- Answering calls
- Placing a call on hold
- Retrieving a held call
- Barging in an active call

- Call Pull

Placing Calls

Boss or secretary can have one call or multiple calls on the shared line.

Placing a Call on the Shared Line

Procedure:

Do one of following:

- Enter the desired number using the dialpad when the phone is idle. Press the OK key, # key, or **Send**.
The phone dials the entered number using the first line key.
- Press the line key when the phone is idle to enter the dialing screen.
Enter the desired number using the dialpad, and then press the OK key, # key, or **Send**.
The phone dials the entered number using the selected line key.

Placing Multiple Calls on the Shared Line

Procedure:

You can have more than one call on the shared line. To place a new call when there is an active call on the line key 1, do one of the following:

- Press the HOLD key or **Hold**. The original call is placed on hold.
Press **New Call (NewCall)** to enter the dialing screen.
Enter the desired number using the dialpad.
Press the OK key, # key, or **Send**.
The phone dials the entered number using the line key 2 automatically.
- Press the line key. The original call is placed on hold.
Enter the desired number using the dialpad.
Press the OK key, # key, or **Send**.
The phone dials the entered number using the selected line key.

Answering Calls

You can have one call or multiple calls on the shared line. Incoming calls will be distributed evenly among the available line keys.

Answering a Call on the Shared Line

When an incoming call arrives on the shared line, the phones of boss and secretary will ring simultaneously, the LED indicators of the line key 1 on both boss's and secretary's phones will flash green. The incoming call can be answered either by boss or secretary but not both.

Procedure:

Role	You can do...	Status
Boss	Press the line key 1, the Speakerphone key, OK key or Answer on the phone.	The LED indicator of the line key 1 glows red.
Secretary		

Answering Multiple Calls on the Shared Line

An incoming call arrives on the shared line when there is an active call on line key 1 of boss phone. The incoming call can be answered either by boss or secretary but not both. The LCD screen of boss phone displays the information of the incoming call.



Note Make sure call waiting feature is enabled on boss's phone. For more information, refer to [Configuring the Call Waiting](#).

Procedure:

Role	You can do...	Status
Boss	Press the line key 2.	Secretary phone stops ringing.
	Press the Answer soft key.	The original call is placed on hold.
	Press the down navigation key to access the new call. Press the OK key or the	The LED indicators of the line key 1 on boss phone slowly flashes green and secretary phone slowly flashes red indicating that there is the held call on the line key 1. The LED indicators of the line key 2 on boss phone glows green and secretary phone glows red indicating that there is an active call on

Role	You can do...	Status
	Answer soft key.	the line key 2.
Secretary	Press the line key 2.	Boss phone stops ringing. The LED indicators of the line key 2 on boss phone glows red and secretary phone glows green indicating that there is an active call on the line key 2. Meanwhile, The LED indicators of the line key 1 on boss phone glows green and secretary phone glows red indicating that there is an active call on the line key 1.
	Press the OK key or the Answer soft key.	

Note If the number of incoming calls is greater than the configured line keys, the line keys will be used by sequence circulation.

Placing a Call on Hold

Placing a Call on Public Hold

Procedure:

Role	You can do...	Status
Boss	Press the HOLD key or the Hold soft key.	The LED indicators of line key 1 on boss phone slowly flashes green and secretary phone slowly flashes red.
Secretary		The LED indicators of line key 1 on secretary phone slowly flashes green and boss phone slowly flashes red.



Placing a Call on Private Hold

Procedure:

Role	You can do...	Status
Boss	Press the PriHold soft key or private hold key on the phone when there is an active call on the shared line (You may need to press the More soft key to see the PriHold soft key).	The line key LED slowly flashes green when the shared line call is placed on private hold.
Secretary		



Retrieving a Held Call

Retrieving a Call Placed on Public Hold

You can retrieve the public held call on either boss phone or secretary phone when there is a call between boss and other party.

Procedure:

Role	You can do...	Status
Boss	Press the line key, the HOLD key or the Resume soft key.	The conversation between boss and the third party is retrieved.
Secretary	<ul style="list-style-type: none"> - Press the line key. - Long press the desired line key. The Cancel , Call Pull , New Call and Retrieve soft keys appear on the LCD screen. Press the Retrieve soft key to retrieve the call.	The conversation is established between secretary and the third party, while boss phone disconnects the call automatically. And the line key LEDs on boss phone glows red and secretary phone glows green.

Retrieving a Call Placed on Private Hold

The private held call can be only retrieved by the hold party.

Procedure:

Role	You can do...	Status
Boss	Call is private held by boss: Press the line key, the HOLD key or the Resume soft key.	The conversation between boss and the third party is retrieved.
Secretary	Call is private held by secretary: Press the line key, the HOLD key or the Resume soft key.	The conversation between secretary and the third party is retrieved.

Barging In an Active Call

Both the boss and the secretary can barge in an activate call and set up a conference call with the other parties. It is not available on the SIP-T19(P) E2 IP phone.

During the conference, if any party in the conference call presses the HOLD key or the **Hold** soft key, two-way voice can be heard between the remaining parties. If boss or secretary press the **End Call (EndCall)** soft key, the remaining parties are still connected. If the other party (not the shared line party) press the **End Call (EndCall)** soft key, the conference call is ended.

If there is only one active call on the shared line, do the following:

Procedure:

Role	You can do...	Status
Boss	Long press the line key. The Cancel , Call Pull , New Call and Barge In soft keys appear on the LCD screen.	Barge in the call between secretary and the third party. A conference call is set up with the secretary and the third party in the active call.
Secretary	Press the Barge In soft key to interrupt the active call.	Barge in the call between boss and the third party. A conference call is set up with the boss and the third party in the active call.



If there are more than one call on the shared line, do the following:

Procedure:

Role	You can do...	Status
Boss	Long press the line key, and then select the activate call. The Cancel , Call Pull , New Call and Barge In soft keys appear on the LCD screen.	Barge in the call between secretary and the third party. A conference call is set up with the secretary and the third party in the active call.
Secretary	Press the Barge In soft key to interrupt the active call.	Barge in the call between boss and the third party. A conference call is set up with the boss and the third party in the active call.



Call Pull

Call pull feature allows users to retrieve an existing call from another shared phone that is in active or hold status. For example, when there is a call between boss phone and another party, you can use call pull feature on secretary phone to retrieve this call from boss phone. Then the call is established between secretary phone and another party. It is not available on the SIP-T19(P) E2 IP phone.

Pulling an Active Call

If there is an active call on the shared line, do the following:

Procedure:

Role	You can do...	Status
Boss	Long press the line key. The Cancel , Call Pull , New Call and Barge In soft keys appear on the LCD screen.	The call between secretary and other party is retrieved, and it is established between boss and the third party.

Role	You can do...	Status
Secretary	Press the Call Pull soft key to interrupt the active call.	The call between boss and the third party is retrieved, and it is established between secretary and the third party.

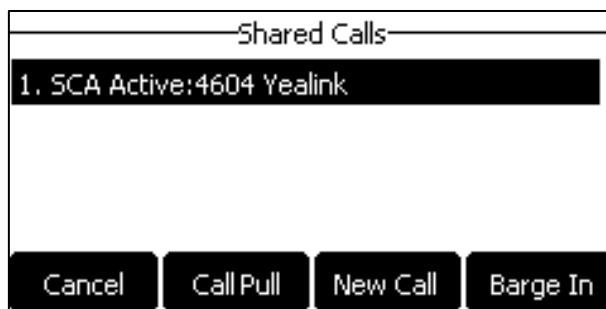

Pulling a Held Call

If there is a held call on the shared line, do the following:

Procedure:

Role	You can do...	Status
Boss	Long press the line key. The Cancel , Call Pull , New Call and Retrieve soft keys appear on the LCD screen.	The call between secretary and the third party is retrieved, and it is established between boss and the third party.
Secretary	Press the Call Pull soft key to interrupt the active call.	The call between boss and the third party is retrieved, and it is established between secretary and the third party.



Bridged Line Appearance (BLA)

BLA allows users to share a SIP line on two or more IP phones. Users can monitor the specific

extension (BLA number) for status changes on each IP phone. To use this feature, a BLA group should be pre-configured on the server and one of them is specified as a BLA number. BLA depends on the support from a SIP server.

In the following figure, the first line is a private line while the second line is a shared line:

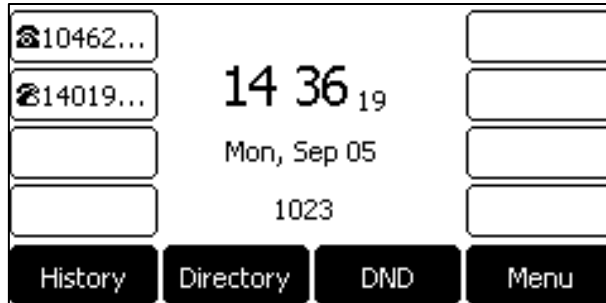

Any IP phone can be used to originate or receive calls on the bridged line. An incoming call to the BLA number can be presented to multiple phones in the group simultaneously, but only one IP phone within the group can answer this call.

Configuring BLA Feature on the IP Phone

You can share a BLA number on two or more phones. For example, phone A registers the account 14019833020 (register name is 14019833020 and user name is 14084588327) and assigns BLA number, phone B registers the account 10462190020 (register name is 10462190020, user name is 14084588327) and assigns BLA number, phone C registers the account 14755608020. Phone A and phone B share the BLA number 14084588327. For more information on how to register an account, refer to [Registering an Account](#).

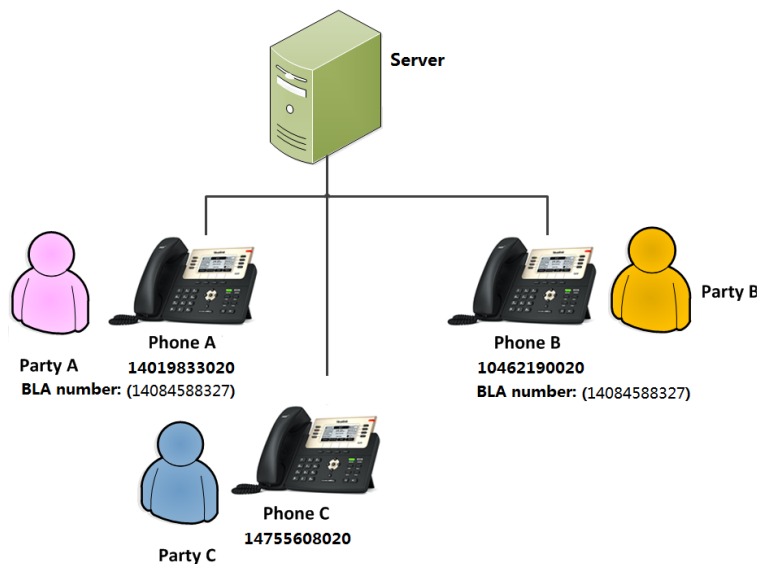

Configuring an Account and BLA Feature

You can configure an account on phone A and phone B separately.

Note Contact your system administrator for the account information.

Procedure:

1. Register the account.
2. Click **Advanced**, and then select **Draft BLA** from the pull-down list of **Shared Line**.
3. Enter the desired number in the **BLA Number** field.

The screenshot shows the Yealink T27G web interface. The 'Account' tab is active, and the 'Advanced' sub-tab is selected. The 'Shared Line' dropdown menu is set to 'Draft BLA', and the 'BLA Number' field contains the value '14084588327'. The interface includes a sidebar with navigation options (Register, Basic, Codec, Advanced) and a 'NOTE' sidebar on the right with technical details. At the bottom, there are 'Confirm' and 'Cancel' buttons.

4. Click **Confirm**.

Using BLA Feature on the IP Phone

This section provides you with detailed information on using IP phone in a BLA scenario. In a BLA scenario, the status of the line key icon which associates with a bridged line will change. For more information on line key LED indicators, refer to [LED Instructions](#). Line key is not available on the SIP-T19(P) E2 IP phone.

You can do the following using the IP phone in a BLA scenario:

- Placing calls
- Answering calls
- Place a call on hold
- Retrieving a held call

Placing Calls

You can have one or multiple calls on the bridged line.

Placing a Call on the Bridged Line

Procedure:

Do one of following:

- Enter the desired number using the dialpad when the phone is idle.
Press the OK key, # key, or **Send**.
The phone dials the entered number.
- Press the line key when the phone is idle to enter the dialing screen.
Enter the desired number using the dialpad, and then press the OK key, # key or **Send**.
The phone dials the entered number.

Placing Multiple Calls on the Bridged Line

Procedure:

You can have more than one call on the bridged line. To place a new call when there is an active call on phone A, do one of the following on the phone A:

- Press the HOLD key or **Hold**. The original call is placed on hold.
Press **New Call (NewCall)** to enter the dialing screen.
Enter the desired number using the dialpad.
Press the OK key, # key, or **Send**.
Phone A dials the entered number.
- Press the line key. The original call is placed on hold.
Enter the desired number using the dialpad.
Press the OK key, # key, or **Send**.
Phone A dials the entered number.

Answering Calls

When the phone C dials the BLA number "14084588327", an incoming call will arrive on the bridged line. The phone A and phone B ring simultaneously. You can answer the incoming call on either phone A or phone B but not both.

Procedure:

Role	You can do...	Status
Phone A	Press the OK key, Speakerphone key or the Answer soft key.	Phone B stops ringing. The LED indicator of the line key on the phone A glows green. In the meanwhile, the LED indicator of the line key on the phone B glows red indicating that there is an active call on the phone A.
Phone B		Phone A stops ringing. The LED indicator of the line key on the phone B glows green. In the meanwhile, the LED indicator of the line key on the phone A glows red indicating that there is an active call on the phone B.

Placing a Call on Hold**Procedure:**

Role	You can do...	Status
Phone A	Press the HOLD key or the Hold soft key.	The line key LEDs on phone A slowly flash green and on phone B slowly flash red when the bridged line call is placed on hold.
Phone B		The line key LEDs on phone B slowly flash green and on phone A slowly flash red when the bridged line call is placed on hold.

Retrieving a Held Call

If there is a held call between phone A and phone C, you can retrieve a held call on either phone A or phone B.

Procedure:

Role	You can do...	Status
Phone A	Press the line key, HOLD key or the Resume soft key	The conversation between phone A and phone C is retrieved.
Phone B	Press the line key.	The conversation is established between phone B and phone C, while phone A disconnects the call automatically.

Messages

Short Message Service (SMS)

You can send and receive text messages. When receiving a new text message, the phone will play a warning tone and the power indicator LED will slowly flash red. A message of “n New Text Message(s)” (“n” indicates the number of unread text messages) and a message icon are displayed on the phone.



Note When the phone receives a text message, the text message window will pop up by default. Your system administrator can disable this feature.

Text messages can be stored in your phone’s Inbox, Sentbox, Outbox or Draftbox, and each of the boxes can store up to 100 text messages. If there are more than 100 test messages in any one of the boxes, the phone will directly delete the oldest text message in the box.

Note SMS is not available on all servers. Contact your system administrator for more information.

Reading a Text Message

Procedure:

1. Navigate to **Menu->Message->Text Message->Inbox**.

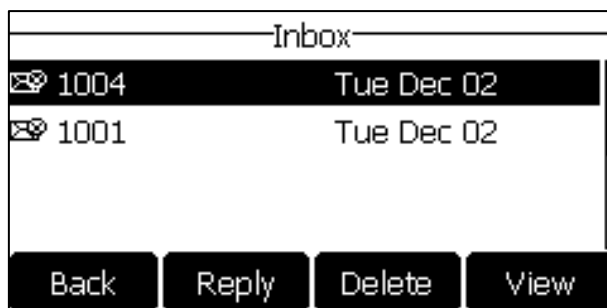

2. Highlight a desired message, and then press **View**.

Note

If the phone prompts you there is a new text messages, you can also press the **View** soft key to read the new messages directly.

Sending a Text Message

Procedure:

1. Navigate to **Menu->Message->Text Message->New Message**.
2. Compose the new text message.

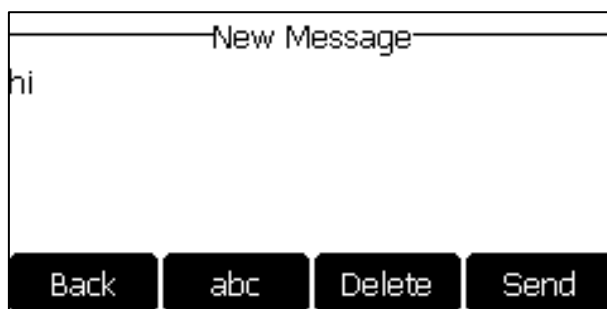

3. Press **Send**.
4. Select the desired account from the **From** field.
5. Enter the number you want to send the message to in the **To** field.
6. Press **Send** to send the message.

You can send a text message via web user interface at the path **Features->SMS**.

Replying to a Text Message

Procedure:

1. Navigate to **Menu->Message->Text Message->Inbox**.
2. Highlight the desired message, and then press **Reply**.

3. Compose the new text message.

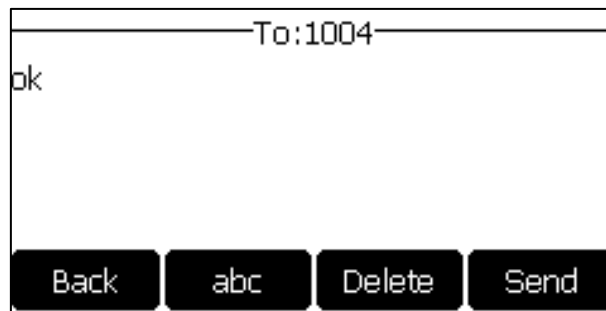

4. Press **Send** to send the message.

Deleting a Text Message

Procedure:

1. Navigate to **Menu->Message->Text Message->Inbox (Sentbox, Outbox or Draftbox)**.
2. Highlight the desired message.
3. Press **Delete**.

On the SIP-T29G IP phone, **Option**, select **Delete**.

A message is displayed on the LCD screen:

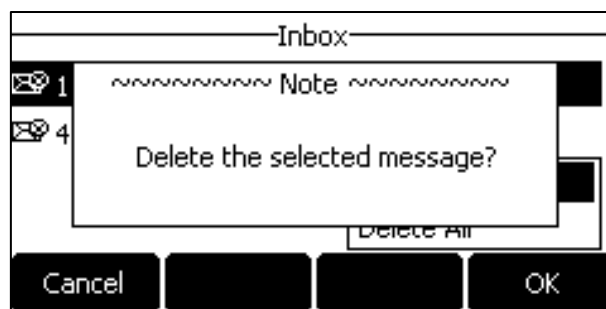

4. Press **OK** to delete.

You can also delete all text messages by selecting the **Delete All**.

Voice Mail

Voice Mail feature allows you to leave voice mails for someone or listen to the mails stored in a voice mailbox on your IP phone. This feature is set up on the server side and not all servers support this feature.

When receiving a new voice mail, the phone plays a warning tone and the power indicator LED slowly flash red. A message of “n New Voice Mail(s)” (“n” indicates the number of unread voice messages) are displayed on the LCD screen.

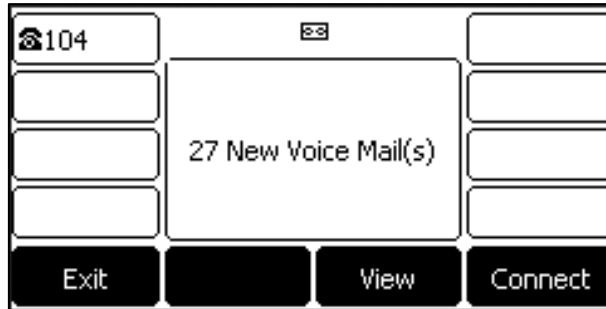

If the voice mail pop-up message box disappears, it won't pop up again unless the user receives a new voice mail or the user re-registers the account that has unread voice mail(s).

Note When the phone receives a voice mail, the text message window will pop up by default. Your system administrator can disable this feature.

Configuring the Voice Mail Code

Procedure:

1. Navigate to **Menu->Message->Voice Mail->Set Voice Mail Code**.
You can also press the MESSAGE key when the voice mail code is not configured.
2. Enter the voice mail code (for example, *97) in the desired account field.

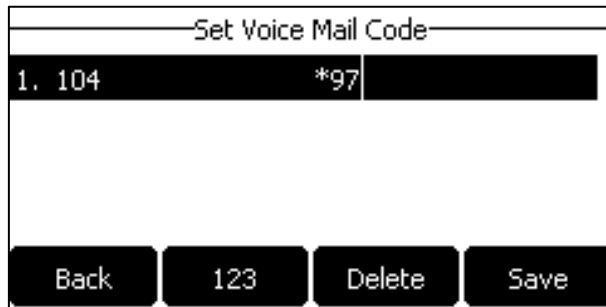

3. Press **Save**.

Voice mail code is configurable via web user interface at the path **Account->Advanced**.

Note Voice mail access codes must be predefined by your system administrator on the system server.

Leaving Voice Mails

You can leave a voice mail for someone when he/she is busy or inconvenient to answer the call. Follow the voice prompt from the system server to leave a voice mail, and then hang up.

Listening to Voice Mails

Procedure:

1. Navigate to **Menu->Message->Voice Mail->View Voice Mail**.

The LCD screen displays the amount of new and old voice mails.

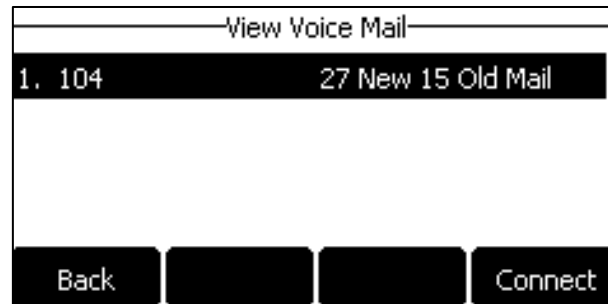

When the LCD screen prompts that the phone receives a new voice mail, you can press the MESSAGE key or **Connect** to dial out the voice mail access code.

2. Highlight an account, and then press **Connect** to listen to voice mails.
3. Follow the voice prompt to listen to your voice mails.

From the Idle screen, you can also press a Voice Mail key to listen to voice mail directly. For more information on how to configure a Voice Mail key, refer to [Configuring a Voice Mail Key](#).

Note Before listening to voice mails, ensure that the voice mail code has been configured.

Using Optional Accessories with Your Phone

This section describes the optional accessories that you can use to extend your phone's capabilities. You can do the following:

- Using a Headset
- Using Bluetooth feature
- Connecting to the Wireless Network
- Using an Expansion Module

The following items are optional accessories for your IP phone:

- Headset YHS32/YHS33
- Wireless Headset Adapter EHS36
- Bluetooth USB Dongle BT40
- Wi-Fi USB Dongle WF40
- Expansion Module EXP20

You need to purchase them separately if required.

Note

We recommend that you use the accessories provided or approved by Yealink. The use of unapproved third-party accessories may result in reduced performance.

Using a Headset

You can connect an analog or USB headset to your phone and use the headset to place and answer calls. If you want to use the analog headset, you require an optional headset YHS32/YHS33. Only the SIP-T29G/T27G IP phones support USB headset. For more information on how to use your USB headset, see your USB headset documentation from the manufacturer.

You can also pair and connect a Bluetooth headset with your SIP-T48S/T48G/T46S/T46G/T42S/T41S IP phone. For more information, refer to [Pairing and Connecting the Bluetooth Headset](#).

Note

Your system administrator can disable the headset feature. Check with your system administrator to find out if it is available on your phone.

Using an Analog Headset

If you want to use the analog headset, a headset YHS32/YHS33 is required.

Connecting a YHS32/YHS33 Headset

Procedure:

1. Simply insert the modular connector into the headset port on the back of your IP phone.
For the information on how to connect headset YHS32/YHS33, see the YHS32/YHS33 user guide on [Yealink Technical Support](#) page.

Note

If both a Bluetooth headset and an analog headset are connected, only the Bluetooth headset can be used.

Activating the Headset Mode

After connecting a headset to your phone, you can activate the headset mode and use headset when answering and placing calls.

Procedure:

1. Press the HEADSET key on the phone.

The HEADSET key LED glows green on the SIP-T29G/T27G/T27P IP phone, and the headset icon appears on the LCD screen of all IP phone except the SIP-T27G/T27P IP phone.

When you press the line key or **Answer** to answer an incoming call, the call is answered in Headset mode automatically. For more information on using the headset to answer a call, refer to [Answering Calls](#).

With the handset on-hook, enter the desired number and press **Send**, the phone will then place a call using the headset automatically. For more information on using the headset to place a call, refer to [Placing Calls](#).

Deactivating the Headset Mode

If you don't want to use a headset to handle calls, you can deactivate the headset mode.

Procedure:

1. Press the HEADSET key again on the phone.

The HEADSET key LED goes out on the SIP-T29G/T27G/T27P IP phone. The headset icon disappears from the LCD screen of all IP phone except the SIP-T27G/T27P IP phone.

Enabling the Headset Prior

You can use headset in priority when receiving or placing calls. This feature is especially useful for permanent or full-time headset users. To use this feature, you need to enable headset prior feature in advance.

Procedure:

1. Click **Features**->**General Information**.
2. Select **Enabled** from the pull-down list of **Headset Prior**.

The screenshot shows the Yealink T27G web interface. The 'Features' tab is selected, and the 'General Information' sub-tab is active. The 'Headset Prior' setting is highlighted with a red box and is set to 'Enabled'. Other settings include Call Waiting (Enabled), Call Waiting On Code (empty), Call Waiting Off Code (empty), Auto Redial (Disabled), Auto Redial Interval (1~300s) (10), Auto Redial Times (1~300) (10), Allow Mute (Enabled), Dual Headset (Enabled), Auto-Answer Delay (1~4s) (1), Enable auto answer tone (Enabled), DTMF Replace Tran (Disabled), Hide Feature Access Codes (Disabled), Display Method on Dialing (User Name), and Auto Linekeys (Disabled). A 'NOTE' panel on the right provides details for Call Waiting, Auto Redial, Key As Send, Hotline, and Call Completion.

3. Click **Confirm**.

Note

If headset prior is enabled, the headset mode will not be deactivated until you press the **HEADSET** key again.

If headset prior is disabled, the headset mode can be deactivated by pressing the Speakerphone key or the **HEADSET** key.

Enabling the Dual Headset

You can use two headsets when dual headset feature is enabled. To use this feature, you must physically connect one headset to the headset jack and the other one to the handset jack respectively. Once the phone connects to a call, the headset connected to the headset jack will have full-duplex capability, while the one connected to the handset jack will only be able to listen.

Procedure:

1. Click **Features**->**General Information**.
2. Select **Enabled** from the pull-down list of **Dual Headset**.

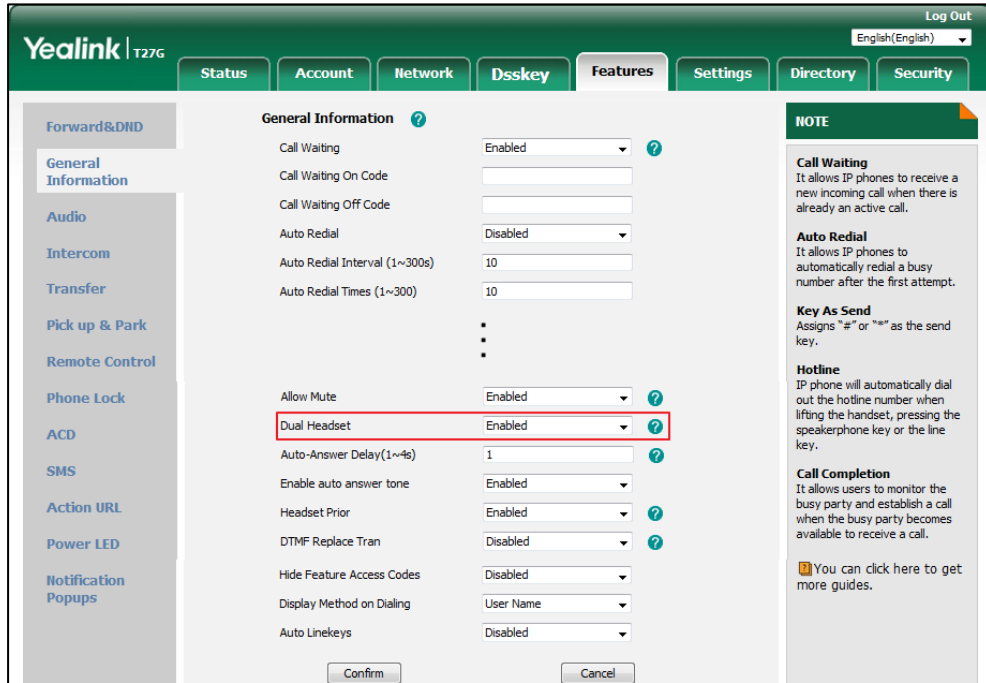

3. Click **Confirm**.

Using the Wireless Headset Adapter EHS36

EHS36 provides the technical interface between your IP phone and an EHS-compatible wireless headset, such as Sennheiser/Jabra (GN Netcom) or Plantronics headset.

For more information on how to connect EHS36, see the EHS36 User Guide on [Yealink Technical Support](#) page.

After the EHS36 and your headset are connected successfully, you can handle calls by your headset. For more information on how to use your headset, see your headset documentation from the manufacturer.

Using Bluetooth Feature

The SIP-T29G/T27G IP phone supports Bluetooth. Bluetooth enables low-bandwidth wireless connections within a range of 10 meters (32 feet). The best performance is in the 1 to 2 meters (3 to 6 feet) range. To use Bluetooth feature, you require a Bluetooth USB dongle BT40 to activate the Bluetooth mode.

Bluetooth mode is configurable via web user interface at the path **Features**->**Bluetooth**.

Connecting the Bluetooth USB Dongle BT40

Procedure:

Insert the USB dongle with "TOP" facing upwards into the USB port on the back of the phone.

For more information on Bluetooth USB dongle BT40, see the user guide on the Bluetooth USB dongle BT40's support page on [Yealink Technical Support](#).

Activating the Bluetooth Mode

When you insert Bluetooth USB dongle BT40 into the USB port on the back of the IP phone, a message is displayed on the LCD screen:

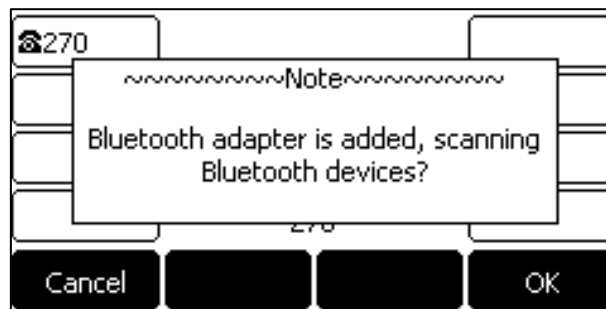

You can press **OK** to activate Bluetooth mode directly.

If you press **Cancel**, you can activate Bluetooth mode when you want to use the Bluetooth feature.

Procedure:

1. Navigate to **Menu->Settings->Basic Settings->Bluetooth**.
On the SIP-T29G IP phone, navigate to **Menu->Basic->Bluetooth**.
2. Select **On** from the **Bluetooth** field.
3. Press **Save**.

Bluetooth activation is configurable via web user interface at the path **Features->Bluetooth**.

Deactivating the Bluetooth Mode

You can deactivate the Bluetooth mode when you no longer use a Bluetooth device.

Procedure:

1. Navigate to **Menu->Settings->Basic Settings->Bluetooth**.
On the SIP-T29G IP phone, navigate to **Menu->Basic->Bluetooth**.
2. Select **Off** from the **Bluetooth** field.
3. Press **Save**.

The Bluetooth device won't be connected anymore, but it will still be paired. When you activate the Bluetooth mode again, the paired Bluetooth device will appear in the **Paired Bluetooth Device** list.

Bluetooth deactivation is configurable via web user interface at the path **Features->Bluetooth**.

Using a Bluetooth Device

When the Bluetooth mode is activated, you can pair and connect your Bluetooth device (Bluetooth headset or Bluetooth-Enabled mobile phone) to the phone. You can scan and pair up to 60 Bluetooth devices with your phone. However, only one device can be connected at a time. If you connect your Bluetooth-Enabled mobile phone to the SIP-T29G/T27G IP phone, you can synchronize the mobile contacts to the IP phone.

This section provides you how to pair and connect/disconnect your Bluetooth device (Bluetooth headset or Bluetooth-Enabled mobile phone) to the phone, sync the mobile contacts, view and edit the Bluetooth device information, and delete the paired Bluetooth device.

Pairing and Connecting the Bluetooth Headset

Before pairing a Bluetooth headset, make sure that the Bluetooth headset is discoverable. For more information, refer to the documentation from the Bluetooth headset manufacturer.

Procedure:

1. Navigate to **Menu->Settings->Basic Settings->Bluetooth**.
On the SIP-T29G IP phone, navigate to **Menu->Basic->Bluetooth**.
2. Activate the Bluetooth mode (refer to [Activating the Bluetooth Mode](#)).
3. Press **Scan** to search the Bluetooth devices.

The phone proceeds to scan the local Bluetooth devices, and LCD screen displays the available Bluetooth devices.

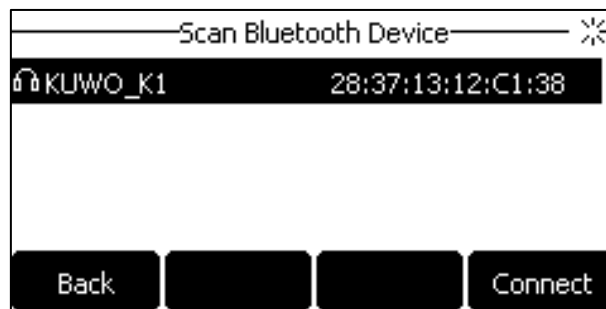

4. Find your Bluetooth headset, and then press **Connect**.

The Bluetooth icon appears on the LCD screen.

With the Bluetooth headset paired and connected, you can use the Bluetooth headset to place and answer calls. For more information, refer to the documentation from the Bluetooth headset manufacturer.

Pairing and Connecting the Bluetooth-Enabled Mobile Phone

You can pair and connect the Bluetooth-Enabled mobile phone to SIP-T29G/T27G IP phone.

Before pairing a Bluetooth-Enabled mobile phone, make sure that the Bluetooth-Enabled mobile phone is discoverable.

Procedure:

1. Navigate to **Menu->Settings->Basic Settings->Bluetooth**.
On the SIP-T29G IP phone, navigate to **Menu->Basic->Bluetooth**.
2. Activate the Bluetooth mode.
3. Press **Scan** to search for the Bluetooth-Enabled mobile phone.
4. Find your Bluetooth-Enabled mobile phone, and then press **Connect**.

The IP phone will prompt the connect passkey on the LCD screen, as shown below:

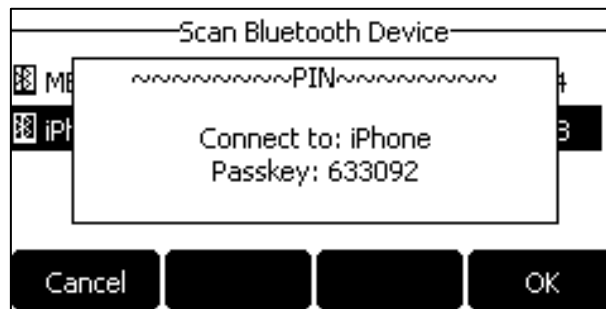

5. Make sure your mobile phone is showing the same passkey, and then press the **OK** on both mobile phone and IP phone.

A message is displayed on the LCD screen:

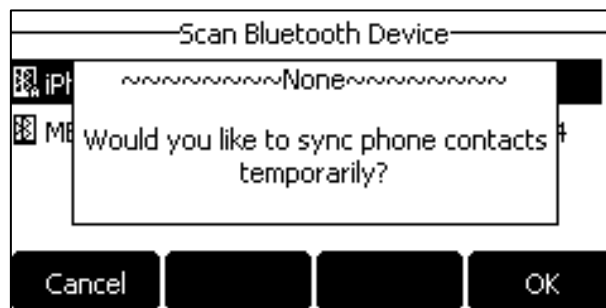

6. (Optional.) Press **OK** to enable the mobile contacts sync feature and the IP phone will sync the mobile contacts temporarily, or press **Cancel** to disable mobile contacts sync feature and the IP phone will not sync the mobile contacts. If you press **Cancel**, you can also manually enable the mobile contacts sync feature on the IP phone. For more information, refer to [Syncing the Mobile Contacts to the IP Phone](#).

If you enable mobile contacts sync feature, you also need to authorize the IP phone to sync the contacts temporarily on the mobile phone.

Syncing the Mobile Contacts to the IP Phone

If you disable the mobile contacts sync feature when you pair and connect the Bluetooth-Enabled mobile phone to the SIP-T29G/T27G IP phone (refer to [Pairing and](#)

(Connecting the Bluetooth-Enabled Mobile Phone), you need to enable the mobile contacts sync feature manually when you want to sync the mobile contacts to your IP phone.

Enabling the Mobile Contacts Sync Feature Manually

Procedure:

1. Navigate to **Menu->Settings->Basic Settings->Bluetooth->Paired Bluetooth Device**.
On the SIP-T29G IP phone, navigate to **Menu->Basic->Bluetooth->Paired Bluetooth Device**.
2. Press **Option**, and then select **Detail**.
3. Select **On** from the **Mobile Contacts Sync** field.

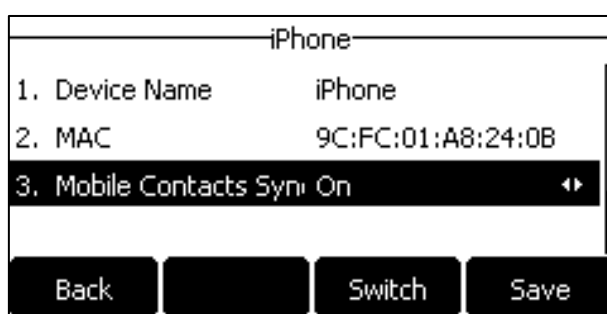

You need to authorize the IP phone to sync the contacts temporarily on the mobile phone first, and then the mobile contacts directory will appear in the IP phone directory list.

Viewing your Mobile Contacts on the IP Phones

You can view your mobile contacts on the SIP-T29G/T27G IP phone.

Procedure:

1. Navigate to **Menu->Directory->Mobile Contacts**.

The contacts stored in your mobile phone will display in the Mobile Contacts list.

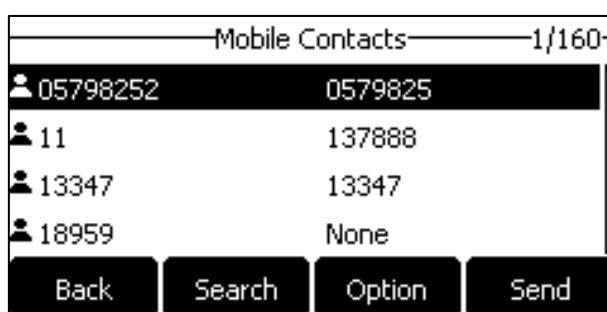

For how to add contact to local directory/blacklist from mobile contacts, update the mobile contacts or place calls to and search for contacts in the mobile contacts, refer to the [Mobile Contacts](#).

Viewing the Bluetooth Device Information

When Bluetooth mode is activated and the LCD screen displays a list of Bluetooth devices, you can view the Bluetooth device information.

Procedure:

1. Navigate to **Menu->Settings->Basic Settings->Bluetooth**.
On the SIP-T29G IP phone, navigate to **Menu->Basic->Bluetooth->Paired Bluetooth Device**.
2. Press **Option**, and then select **Detail** to view the Bluetooth device information:
 - **Device Name**: the name of the Bluetooth device.
 - **MAC**: the MAC address of the Bluetooth device.
 - **Mobile Contacts Sync**: mobile contacts synchronization when Bluetooth-enabled mobile phone is connected.

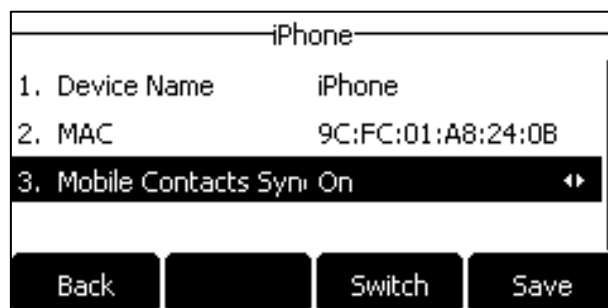

Editing Bluetooth Device Information

Procedure:

1. Navigate to **Menu->Settings->Basic Settings->Bluetooth->Edit My Device Information**.
On the SIP-T29G IP phone, navigate to **Menu->Basic->Bluetooth->Edit My Device Information**.
The LCD screen displays the device name and MAC address. The MAC address cannot be edited.

2. Enter the desired name in the **Device Name** field.

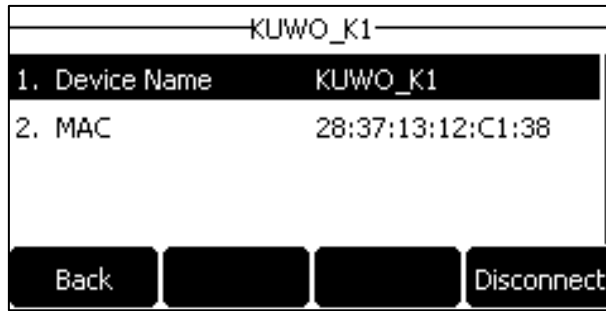

3. Press **Save**.

The preconfigured Bluetooth device name will display in scanning list of other devices.

Deleting the Paired Bluetooth Device

You can delete your Bluetooth device from your phone. When you delete the Bluetooth device, it disappears from the **Paired Bluetooth Device** list. To connect it to your IP phone again, you need to scan it first, and then connect it again.

Procedure:

1. Navigate to **Menu->Settings->Basic Settings->Bluetooth->Paired Bluetooth Device**.

On the SIP-T29G IP phone, navigate to **Menu->Basic->Bluetooth->Paired Bluetooth Device**.

2. Press **Option**, and then select **Delete** or **Delete All**.

A message is displayed on the LCD screen:

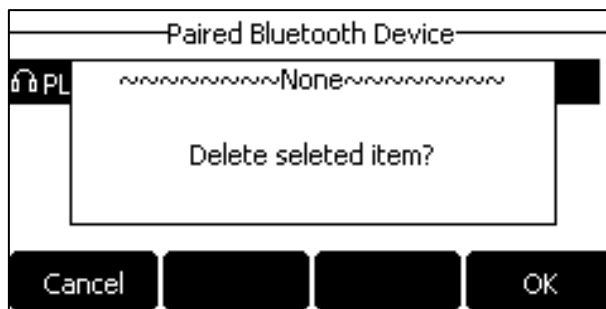

3. Press **OK** to delete.

Disconnecting the Bluetooth Device

You can disconnect the Bluetooth device from your phone. After you disconnect the Bluetooth device, it will still remain paired. So you can easily connect it to your IP phone again.

Procedure:

1. Navigate to **Menu->Settings->Basic Settings->Bluetooth->Paired Bluetooth Device**.

On the SIP-T29G IP phone, navigate to **Menu->Basic->Bluetooth->Paired Bluetooth Device**.

2. Highlight the connected Bluetooth device, and then press **Disconnect**.

The Bluetooth device is disconnected. To connect it to your IP phone again, press **Connect**.

Connecting to the Wireless Network

You can use Wi-Fi USB dongle WF40 to wirelessly connect SIP-T29G/T27G IP phone to available wireless networks.

Wi-Fi mode is configurable via web user interface at the path **Network->Wi-Fi**.

Connecting the Wi-Fi USB Dongle WF40

Procedure:

Insert the Wi-Fi USB Dongle WF40 into the USB port on the back of the phone.

For more information on WF40, see the Wi-Fi USB dongle WF40 user guide on [Yealink Technical Support](#) page.

Activating the Wi-Fi Mode

When Wi-Fi USB dongle WF40 is connected to the USB port on the back of the IP phone, a message will display on the LCD screen:

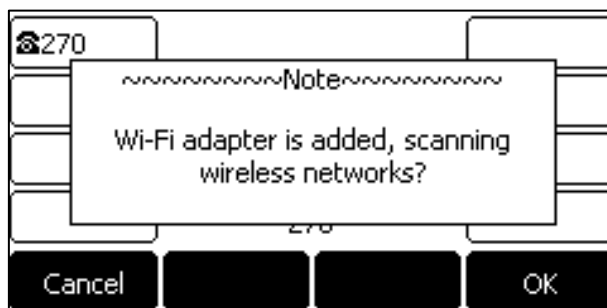

You can press **OK** to activate Wi-Fi mode directly and scan Wi-Fi devices automatically.

If you press **Cancel**, you can activate Wi-Fi mode manually when you want to use the Wi-Fi feature.

Procedure:

1. Navigate to **Menu->Settings->Basic Settings->Wi-Fi**.

On the SIP-T29G IP phone, navigate to **Menu->Basic->Wi-Fi**.

2. Select **On** from the **Wi-Fi** field.
3. Press **Save**.

The IP phone scans the available wireless networks in your area.

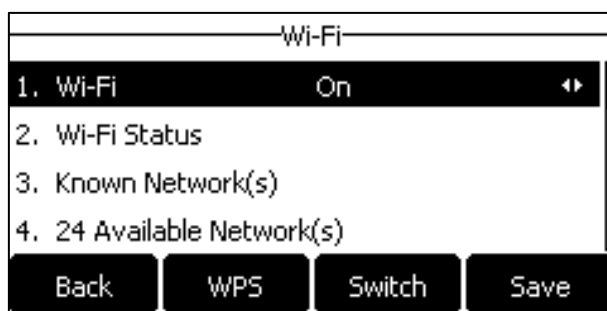

Deactivating the Wi-Fi Mode

You should deactivate the Wi-Fi mode when you need to connect your phone to the wired network.

Procedure:

1. Navigate to **Menu->Settings->Basic Settings->Wi-Fi**.
On the SIP-T29G IP phone, navigate to **Menu->Basic->Wi-Fi**.
2. Select **Off** from the **Wi-Fi** field.

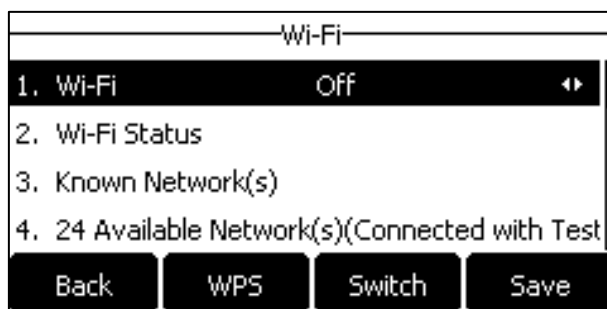

3. Press **Save**.

Wireless Network Settings

Wi-Fi is a popular wireless networking technology that uses radio waves to provide wireless high-speed Internet and network connections. You can connect SIP-T29G/T27G IP phone to a wireless network.

When the Wi-Fi mode is activated on the IP phone, you can connect your phone to the desired wireless network. This section provides you how to connect and disconnect to the wireless network, and how to view and manage the wireless network.

Connecting to the Wireless Network

Three ways to connect IP phone to the wireless network:

- Manually connect to an available wireless network

- Wi-Fi Protected Setup (WPS)
- Manually add a wireless network

Connecting to an Available Wireless Network Manually

Procedure:

1. Navigate to **Menu->Settings->Basic Settings->Wi-Fi**.
On the SIP-T29G IP phone, navigate to **Menu->Basic->Wi-Fi**.
2. Activate the Wi-Fi mode (refer to [Activating the Wi-Fi Mode](#)).
3. Highlight the **X Available Network(s)** (X represents the number of available networks), and then press **Enter**.
4. (Optional.) To re-search the available network, press **Scan**.
5. Select the desired wireless network and then press **Connect**.
6. If the network is secure, enter its password.

7. Press **OK**.

Note

For more information on the password of the wireless network, contact your system administrator.

Connecting to the Wireless Network Using Wi-Fi Protected Setup (WPS)

Wi-Fi Protected Setup (WPS) provides simplified mechanisms to configure secure wireless networks which can automatically configure a wireless network with a network name (SSID) and strong WPA data encryption and authentication.

Two methods supported by Yealink IP phones in the Wi-Fi protected setup:

- **Push Button Configuration (PBC):** The user simply has to press WPS key on both the IP phone and gateway/router to connect.
- **Personal Identification Number (PIN):** The user has to enter a PIN generated randomly by the IP phone on the gateway/router to connect.

Push Button Configuration (PBC)

Procedure:

1. Navigate to **Menu->Settings->Basic Settings->Wi-Fi**.
On the SIP-T29G IP phone, navigate to **Menu->Basic->Wi-Fi**.
2. Activate the Wi-Fi mode (refer to [Activating the Wi-Fi Mode](#)).
3. Press the **WPS**, and then select **WPS**.
The LCD screen prompts "WPS has been activated, connect in 120s!".
4. Long press the WPS key on your gateway/router.
Once WPS setup has completed successfully, the LCD screen will prompt "Connect Success."

Personal Identification Number (PIN)

Procedure:

1. Navigate to **Menu->Settings->Basic Settings->Wi-Fi**.
On the SIP-T29G IP phone, navigate to **Menu->Basic->Wi-Fi**.
2. Activate the Wi-Fi mode (refer to [Activating the Wi-Fi Mode](#)).
3. Press the **WPS**, and then select **WPS-PIN**.
The LCD screen prompts "Please input below PIN code on your Wi-Fi router and press OK to connect: xxx".
4. Log into your gateway/router's web interface, and configure it to search the clients. For more information, refer to the documentation from the gateway/router manufacturer.
Once WPS-PIN setup has completed successfully, the gateway/router's web interface will prompt success.

Note

Contact your gateway/router provider for more information.

Adding a Wireless Network Manually

If your gateway/router has SSID broadcast disabled, it might not appear in the scanning results. In that case, you must manually add a wireless network.

Procedure:

1. Navigate to **Menu->Settings->Basic Settings->Wi-Fi**.
On the SIP-T29G IP phone, navigate to **Menu->Basic->Wi-Fi**.
2. Activate the Wi-Fi mode (refer to [Activating the Wi-Fi Mode](#)).
3. Highlight **Known Network(s)**, and then press **Add**.
4. Use the WLAN settings obtained from your gateway/router to configure this WLAN Profile on the IP phone. Do the following:
 - a) If you select **None** or **WEP** from the **Security Mode** field:

Enter the profile name, SSID and WPA shared key in the corresponding fields.

- b)** If you select **WPA-PSK, WPA2-PSK, WPA-EAP** or **WPA2-EAP** from the **Security Mode** field:

Select the desired Cipher type (**TKIP, AES** or **TKIP AES**) from the **Cipher Type** field.

Enter the profile name, SSID, user name and WPA shared key in the corresponding fields.

- 5.** Press **Save**.

The connected wireless networks will be saved to **Known Network(s)** list. The **Known Network(s)** list can store up to 5 wireless networks, you can specify the priority to connect to the corresponding wireless network.

Viewing the Wireless Network Information

When Wi-Fi mode is activated, you can view the wireless network information.

Procedure:

- Navigate to **Menu->Settings->Basic Settings->Wi-Fi->X Available Network(s)**.
On the SIP-T29G IP phone, navigate to **Menu->Basic->Wi-Fi->X Available Network(s)** (X represents the number of available networks).
- Press **Detail** to view the detailed wireless network information (for example, Profile Name, SSID or Signal Strength).

If the IP phone is connected to a wireless network successfully, you can also navigate to **Menu->Basic->Wi-Fi->Wi-Fi Status** to view the connected wireless network information.

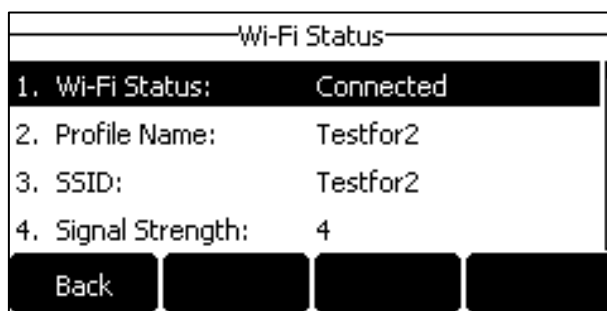

Managing the Saved Wireless Network

Once the IP phone has ever been connected to a wireless network successfully, this wireless network profile will be saved in **Known Network(s)** list. The next time you activate Wi-Fi feature, the IP phone will be automatically connected to the wireless network which has the highest priority (the top one). Up to 5 wireless network profiles can be saved in **Known Network(s)** list. If you want to add a new one when the IP phone has already saved 5 wireless network profiles, please delete an older one before adding.

Procedure:

1. Navigate to **Menu->Settings->Basic Settings->Wi-Fi->Known Network(s)**.

On the SIP-T29G IP phone, navigate to **Menu->Basic->Wi-Fi->Known Network(s)**.

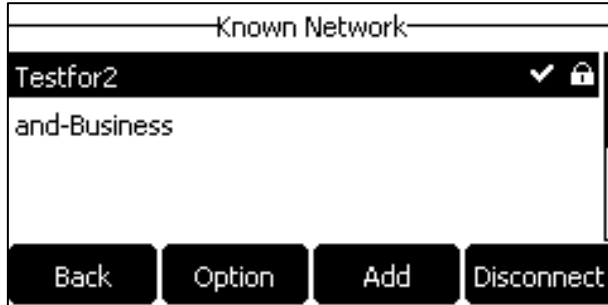

2. Press **Option**.
3. Do one of the following:
 - To edit the wireless network profile:
 - 1) Select **Edit**.
 - 2) Edit the desired wireless network information.
 - 3) Press **Save**.
 - To change the priority of the wireless network:
 - 1) Select **Move Up** or **Move Down** to assign higher or lower priority of the wireless network that the IP phone automatically connects to.
 - To delete the saved wireless network profile:
 - 1) Select **Delete** or **Delete All**.

If you delete your wireless network profile from your phone, you need to manually connect to it next time.

Disconnecting the Wireless Network Connection

Procedure:

1. Navigate to **Menu->Settings->Basic Settings->Wi-Fi**.
On the SIP-T29G IP phone, navigate to **Menu->Basic->Wi-Fi**.
2. Highlight the **X Available Network(s)** (X represents the number of available networks), and then press **Enter**.
3. Highlight the connected wireless network, and then press **Disconnect**.
The wireless network is disconnected. You can press **Connect** to connect again.

Using an Expansion Module

The expansion module is a console you can connect to an IP phone to add additional line keys

and expand the functions of your phone. Yealink SIP-T29G/T27G/T27P IP phone supports expansion module EXP20. It features a 160*320 graphic LCD screen and 20 physical keys with dual-color LEDs. You can add 20 additional keys via a page switch key, bringing the number of keys up to 40. This section provides you how to connect the expansion module EXP20, how to assign the features for ext keys and how to adjust the contrast and backlight of expansion module EXP20.

For more information on expansion module EXP20, see the LCD Expansion Module EXP20 user guide on [Yealink Technical Support](#) page.

Connecting the Expansion Module

Procedure:

1. Connect the EXP20 expansion module to the IP phone using the supplied connecting sheet and screws.
2. Connect the supplied cord from the Ext jack on the host phone to the Ext in jack on the expansion module.

Assigning the Features for Ext Keys

If EXP20 is connected to the phone, you can customize features for ext keys.

Procedure:

1. Long press the desired ext key on EXP20.
The IP phone LCD screen will enter the user setting interface of this key.
2. Customize the specific feature for this key on the IP phone.
3. Press **Save**.

Ext keys are configurable via web user interface at the path **Dsskey->Ext Key**.

Adjusting the Contrast of Expansion Module EXP20

You can configure the contrast of the expansion module EXP20 via the host phone.

Procedure:

1. Navigate to **Menu->Settings->Basic Settings->Display->Contrast**.

If EXP20 is not connected to SIP-T29G IP phone, navigate to

Menu->Basic->Display->Contrast, the Contrast screen displays "No EXP".

2. Select the desired value between 1 and 10 (highest intensity) from the **Contrast** field.

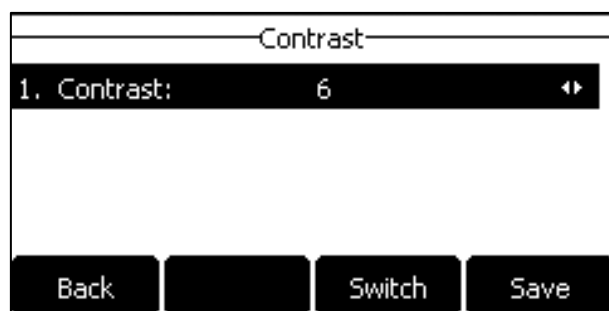

3. Press **Save**.

Adjusting the Backlight of Expansion Module

When you change the backlight intensity settings on your SIP-T29G/T27G/T27P IP phone, the backlight on EXP20 connected to your phone automatically changes to match the new settings. For more information on how to configure the backlight, refer to [Configuring the Backlight](#).

Maintaining Your Phone

When your phone is unable to operate properly, you need to investigate or troubleshoot issues among other tasks your administrator may ask you to perform. This chapter explains how to perform maintenance tasks on your phone:

- [Diagnosing the Network](#)
- [Rebooting Your Phone](#)
- [Resetting to Factory Settings](#)
- [Updating the Phone Configuration](#)
- [Export All Diagnostic Files](#)

Diagnosing the Network

The wrong network settings may result in inaccessibility of your phone and poor network performance. In this case, your system administrator may ask you to use the “Ping” or “Trace Route” method to check whether the network is connected, and to analyze the network fault.

Checking the Network Using “Ping” Method

Procedure:

1. Navigate to **Menu->Features->Diagnostics->Network->Ping**.
2. Enter the desired IP address or URL in the **Ping IP or URL** field.
3. Press **Start**.

The screen displays the network status information.

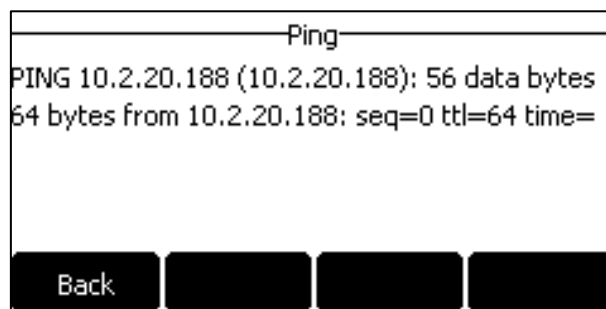

4. Press **Back** to back to the preview screen.

Checking the Network Using “Trace Route” Method

Procedure:

1. Navigate to **Menu->Features->Diagnostics->Network->Trace Route**.
2. Enter the desired IP address or URL in the **Trace Route IP or URL** field.
3. Press **Start**.

The screen displays the network status information.

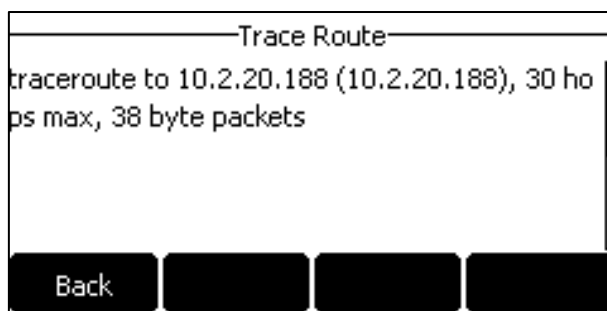

4. Press **Back** to back to the preview screen.

Rebooting Your Phone

The improper operation may cause malfunction. When your phone is malfunctioning, your system administrator may ask you to reboot your phone.

Procedure:

1. Navigate to **Menu->Settings->Advanced Settings** (default password: admin)->**Reboot**.

On the SIP-T29G IP phone, navigate to **Menu->Advanced** (default password: admin) ->**Reboot**.

A message is displayed on the LCD screen:

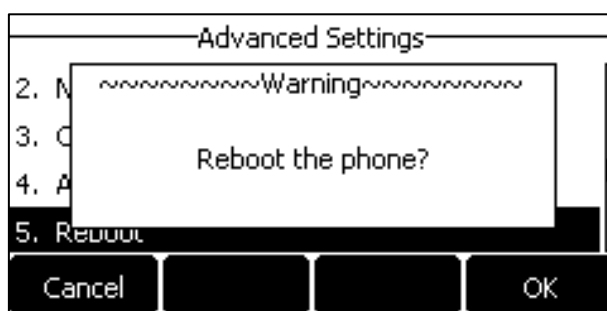

2. Press **OK** to reboot the phone.

You can update the phone configuration via web user interface at the path **Settings->Upgrade**.

Resetting to Factory Settings

Generally, some common issues may occur while using the IP phone. Your system administrator may ask you to reset your phone to factory configurations after you have tried all troubleshooting suggestions but still do not solve the problem. This operation will delete all your personal configuration settings, and reset all settings to the manufacturer default setting. Check with your system administrator if the personalized settings are kept before resetting your phone to factory settings.

Procedure:

1. Navigate to **Menu->Settings->Advanced Settings** (default password: admin) -> **Reset Config**.

On the SIP-T29G IP phone, navigate to **Menu->Advanced** (default password: admin) -> **Reset Config**.

2. Highlight the **Reset to factory settings**, and then press **Reset**.

A message is displayed on the LCD screen:

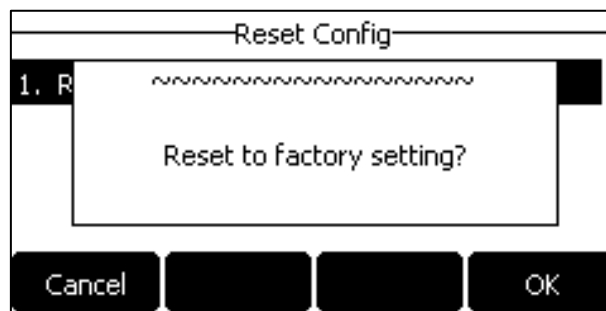

3. Press **OK**.

The phone begins resetting.

You can also long press the OK key when the phone is idle.

After reset, the LCD screen prompts "Welcome Initializing...Please wait".



The phone will be reset successfully after startup.

Resetting to factory settings is operable via web user interface at the path

Settings->Upgrade.

Note

Reset of your phone may take a few minutes. Do not power off until the phone has started up successfully.

Updating the Phone Configuration

Your system administrator may ask you to update your phone configurations.

Procedure:

1. Navigate to **Menu->Settings->Advanced Settings** (default password: admin)->**Auto Provision**.

On the SIP-T29G IP phone, navigate to **Menu->Advanced** (default password: admin) ->**Auto Provision**.

2. Enter the provision information in the corresponding field.



3. Press **Save**.

A message is displayed on the LCD screen:

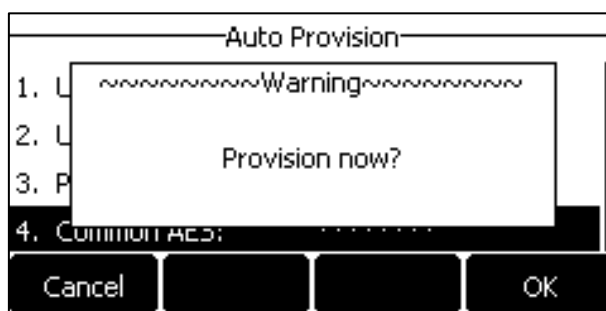

4. Press **OK**.

Updating the phone configuration is operable via web user interface at the path

Settings->Auto Provision.

Note

Ask your system administrator for the provision information.

Export All Diagnostic Files

Your system administrator may ask you to export all diagnostic files to analyze your phone problem.

Procedure:

1. Click **Settings**->**Configuration**.
2. Click **Start** in the **Export All Diagnostic Files** field to begin capturing signal traffic.
The system log level will be automatically set to 6.
3. Reproduce the issue.
4. Click **Stop** in the **Export All Diagnostic Files** field to stop the capture.
The system log level will be reset to 3.
5. Click **Export** to open file download window, and then save the diagnostic file to your local system.

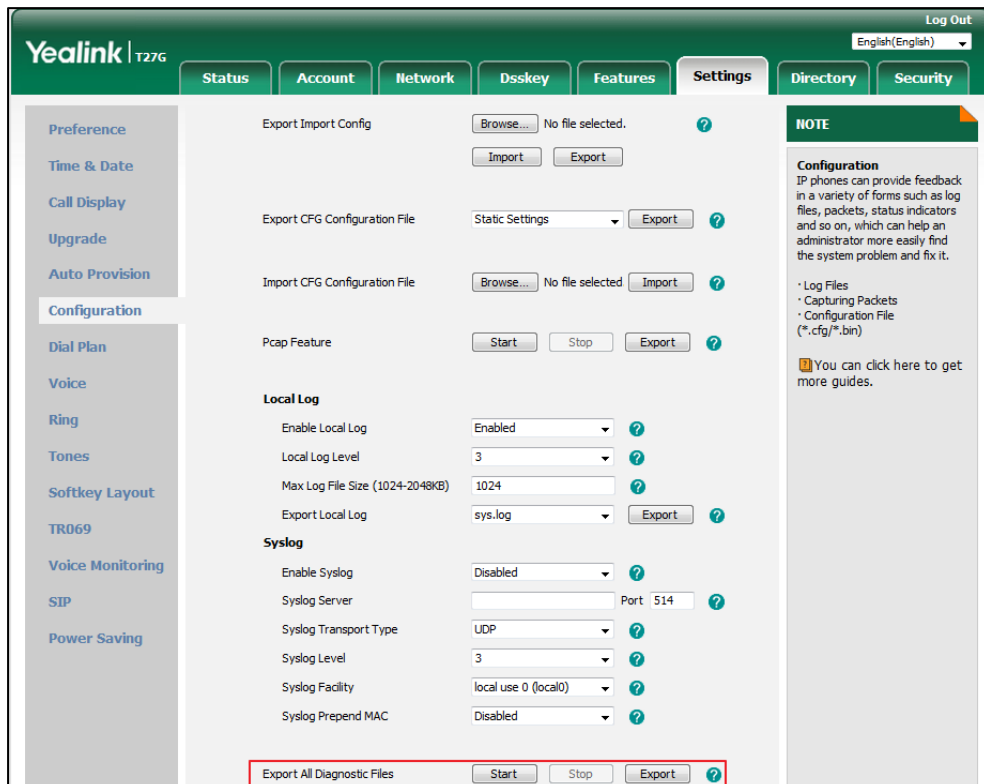

A diagnostic file named **allconfig.tgz** is successfully exported to your local system.

Note

If the issue cannot be reproduced, just directly click **Export** to export all diagnostic files.

Appendix

Appendix A – Time Zones

Time Zone	Time Zone Name
-11	Samoa
-10	United States-Hawaii-Aleutian, United States-Alaska-Aleutian
-9:30	French Polynesia
-9	United States-Alaska Time
-8	Canada(Vancouver,Whitehorse), Mexico(Tijuana,Mexicali), United States-Pacific Time
-7	Canada(Edmonton,Calgary), Mexico(Mazatlan,Chihuahua), United States-MST no DST, United States-Mountain Time
-6	Canada-Manitoba(Winnipeg), Chile(Easter Islands), Mexico(Mexico City,Acapulco), United States-Central Time, Guatemala, El Salvador, Honduras, Nicaragua, Costa Ricam, Belize
-5	Bahamas(Nassau), Canada(Montreal,Ottawa,Quebec), Cuba(Havana), United States-Eastern Time, Peru
-4:30	Venezuela(Caracas)
-4	Canada(Halifax,Saint John), Chile(Santiago), Paraguay(Asuncion), United Kingdom-Bermuda(Bermuda), United Kingdom(Falkland Islands), Trinidad&Tobago
-3:30	Canada-New Foundland(St.Johns)
-3	Argentina(Buenos Aires), Brazil(DST), Brazil(no DST), Denmark-Greenland(Nuuk)
-2:30	Newfoundland and Labrador
-2	Brazil(no DST)
-1	Portugal(Azores)
0	Denmark-Faroe Islands(Torshavn), GMT, Greenland, Ireland(Dublin), Morocco, Portugal(Lisboa,Porto,Funchal), Spain-Canary Islands(Las Palmas), United Kingdom(London)
+1	Albania(Tirane), Austria(Vienna), Belgium(Brussels), Caicos, Chad, Croatia(Zagreb), Czech Republic(Prague), Denmark(Kopenhagen), France(Paris), Germany(Berlin), Hungary(Budapest), Italy(Rome), Luxembourg(Luxembourg), Macedonia(Skopje), Namibia(Windhoek), Netherlands(Amsterdam), Spain(Madrid)
+2	Estonia(Tallinn), Finland(Helsinki), Gaza Strip(Gaza), Greece(Athens), Israel(Tel Aviv), Jordan(Amman), Latvia(Riga), Lebanon(Beirut), Moldova(Kishinev), Romania(Bucharest), Russia(Kaliningrad),

Time Zone	Time Zone Name
	Syria(Damascus), Turkey(Ankara), Ukraine(Kyiv, Odessa)
+3	East Africa Time, Iraq(Baghdad), Russia(Moscow)
+3:30	Iran(Teheran)
+4	Armenia(Yerevan), Azerbaijan(Baku), Georgia(Tbilisi), Kazakhstan(Aktau), Russia(Samara)
+4:30	Afghanistan(Kabul)
+5	Kazakhstan(Aqtobe), Kyrgyzstan(Bishkek), Pakistan(Islamabad), Russia(Chelyabinsk)
+5:30	India(Calcutta)
+5:45	Nepal(Katmandu)
+6	Kazakhstan(Astana, Almaty), Russia(Novosibirsk,Omsk)
+6:30	Myanmar(Naypyitaw)
+7	Russia(Krasnoyarsk), Thailand(Bangkok)
+8	Australia(Perth), China(Beijing), Russia(Irkutsk, Ulan-Ude), Singapore(Singapore)
+8:45	Eucla
+9	Japan(Tokyo), Korea(Seoul), Russia(Yakutsk,Chita)
+9:30	Australia(Adelaide), Australia(Darwin)
+10	Australia(Brisbane), Australia(Hobart), Australia(Sydney,Melboume,Canberra), Russia(Vladivostok)
+10:30	Australia(Lord Howe Islands)
+11	New Caledonia(Noumea), Russia(Srednekolymsk Time)
+11:30	Norfolk Island
+12	New Zealand(Wellington,Auckland), Russia(Kamchatka Time)
+12:45	New Zealand(Chatham Islands)
+13	Tonga(Nukualofa)
+13:30	Chatham Islands
+14	Kiribati

Appendix B – Menu Structure

For the SIP-T29G IP phone

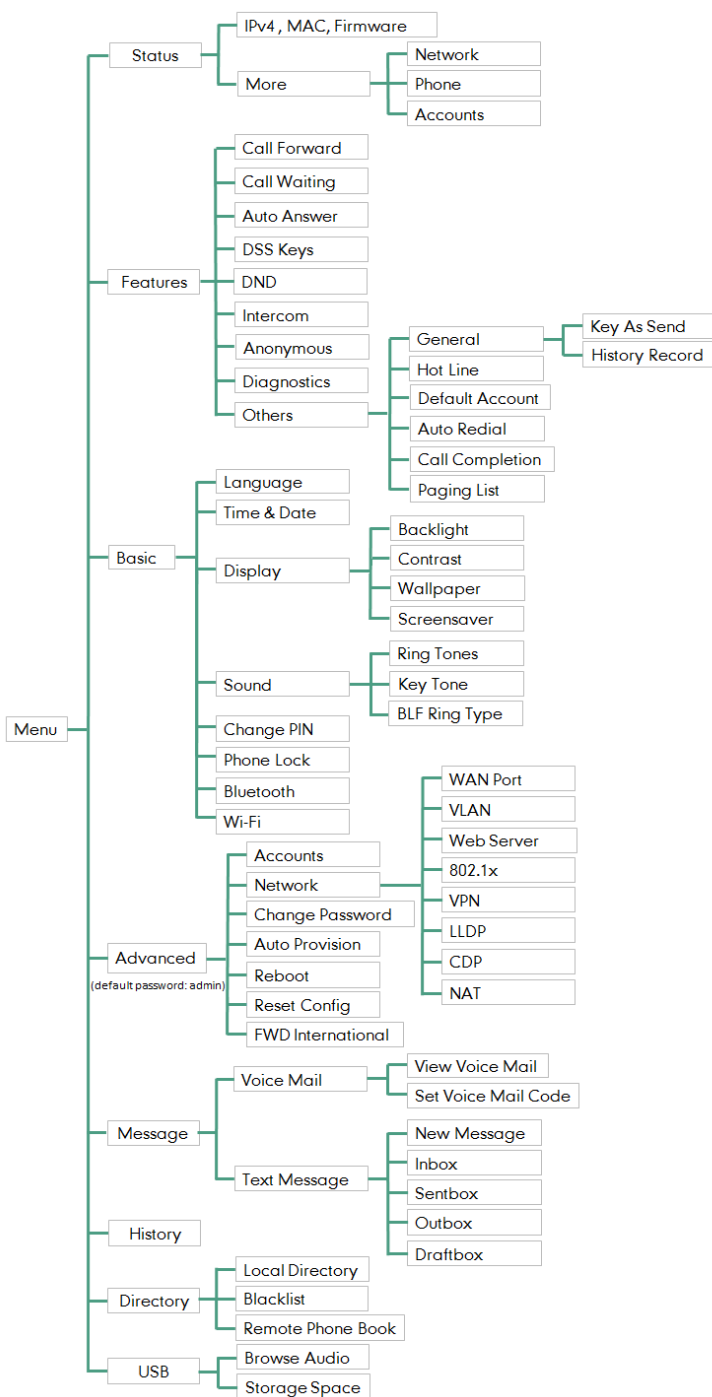

For the SIP-T27G/T27P/T23G/T23P/T21(P) E2/T19(P) E2 IP Phone

Phone

