

**BERG**

ELECTRONICS

McK McKenzie Socket Division

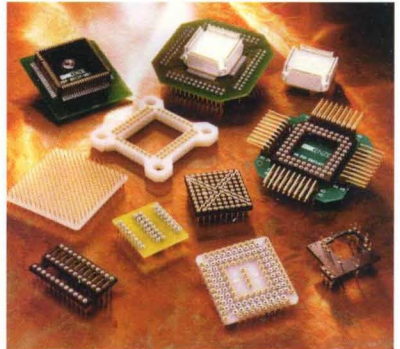
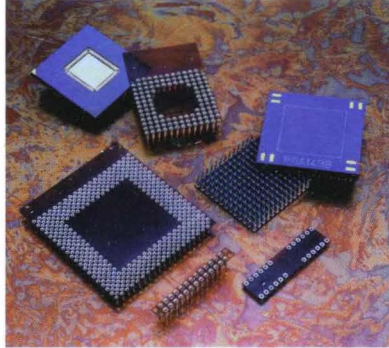
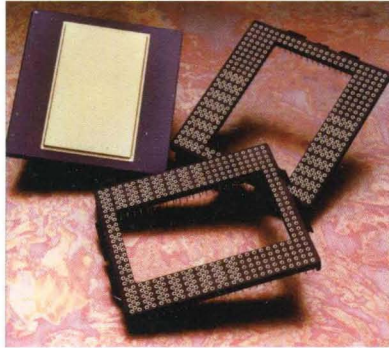

# IC Socket & Adapter Catalog

**ISO 9001**  
REGISTERED

**EDITION 13A**

**A few words about our catalog**



**AVAILABLE**

Where this logo is displayed  
Hi-Temp options are available for  
infrared and vaporphase applications

Inches and millimeters  
are displayed one over the other

.100 inches  
(2.54 millimeters)

Pentium, Intel 80387, Intel 80386, P6 and Turbocache 486 Module are trademarks of INTEL. Wire wrap is a registered trademark of Gardner Denver. Ekta is a registered trademark of the Engineering Chemical Division of the Eastman Kodak Company. Ryton is a registered trademark of Phillips 66. Tefzel and FR50 are registered trademarks of the Dupont Corporation. Valox is a registered trademark of General Electric. Vectra and Fortron are registered trademarks of the Engineering Plastics Division of Hoechst Celanese.

McKenzie Technology reserves the right to change specifications without prior notice on any and all parts shown in this catalog as long as the function of the part remains the same.

Every effort has been made to assure the accuracy of the data furnished in this catalog. McKenzie Technology does not assume responsibility for typographical errors or errors of omission.

© McKenzie Technology, 1995

Editor: Michael Knight

Designer: Jim Falvey

The catalog crew: Rudy Aguilar, Fred Baldwin, Anne Kopp, Kari Trautman, E'van Wang and Donald Wood.

Photography: Fine Arts Photography, Eric DuBois, Joe Watson, C&I Photography and Stan Bean Photography

*McKenzie Technology is an environmentally conscious company, constantly striving to maximize our positive impact on the planet.*

Printed on recycled paper

**New Inside:**

- Stamped and Formed Sockets — Page D
- P6 Sockets — Page F44

- Tape Pin Carrier — D1
- Application Specific Module — Page H8

- ZIF Sockets — Page F43

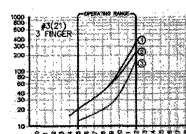
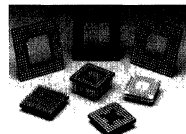
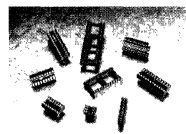
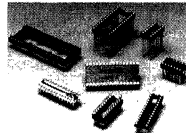
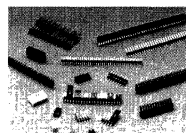
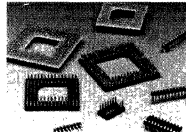
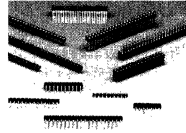
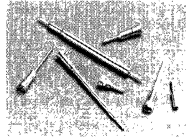

**Contact Specifications**

**DIP Sockets, Adaptors, and Headers**

**SIP Sockets, Adaptors, and Headers**

**Stamped and Formed Sockets**

**Press Fit Sockets and ZIP Sockets**

**PGA Sockets and Headers, ZIF Sockets, Insertion / Extraction Tools**

**Thru-Hole and SMT PLCC Sockets SOJ Sockets / Extraction Tools**

**Adaptors and Application Specific Modules**

**Board to Board Interconnect Systems .050" and .100" pitch**

**MicroShunts™ and Jumpers**

**Specialty Interconnects**

**Material and Technical Specifications**

**Index**

**A**

**B**

**C**

**D**

**E**

**F**

**G**

**H**

**I**

**J**

**K**

**X**

*McKenzie offers the broadest selection of screw machine and stamped contacts ready to assemble to your socket and interconnection requirements. The following 10 pages list a vast array of contacts and terminals, providing a variety of:*

- plating styles
- solder tail length and diameters
- insertion and extraction forces
- multi-finger hi-rel contacts
- Hi-Temp beryllium nickel inner contacts (-55°C to +225°C)
- flush profiles
- elevated board to board contact profiles
- press-fit contacts

McKenzie Technology's Applications Engineers will assist you in selecting the right contact for your design. We are pleased to quote your custom screw machine or stamped contact requirements.

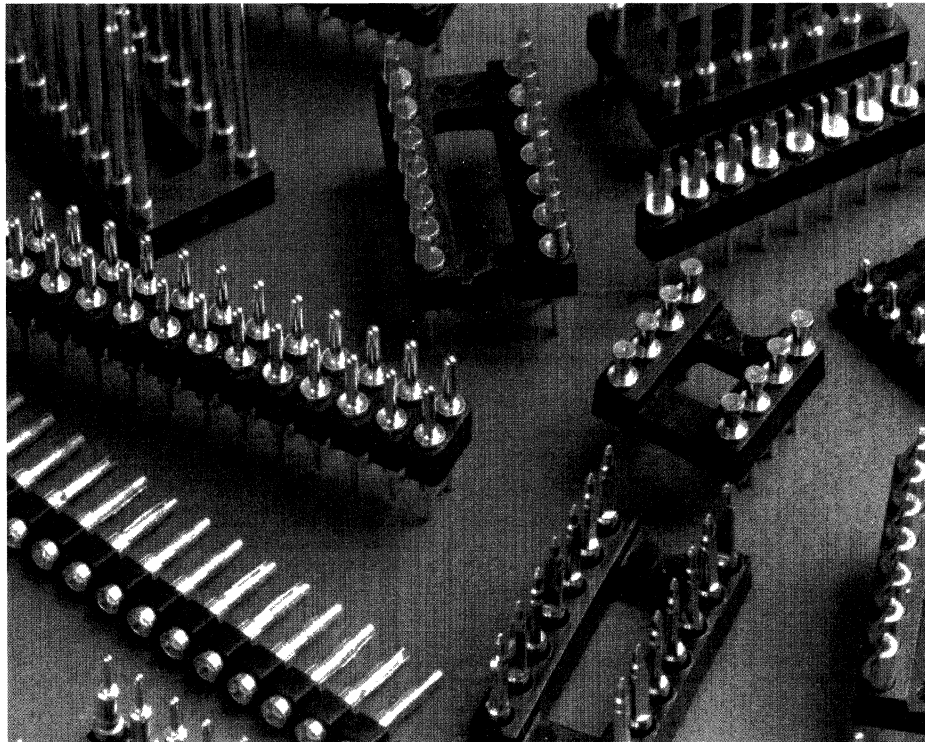

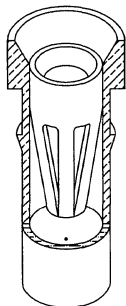

6 Finger Clip

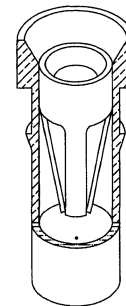
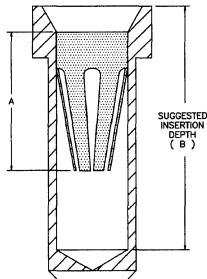

4 Finger Clip

**A**

CLIP NUMBER*	MATERIAL**	SPECIAL FEATURES	ACCEPTABLE PIN RANGE	A	B	INSERTION FORCE (GMS) <sup>7</sup>	WITHDRAWAL FORCE (GMS) <sup>7</sup>
6(10)	BeCu	Micro miniature	.012/.017 (0,30/0,43)	.060 (1,52)	.085/.115	80 <sup>6</sup>	30 <sup>6</sup>
3(11)	BeCu	I.C. Leads - Standard	.015/.021 (0,38/0,53)	.075 (1,91)	.100/.160	80 <sup>1</sup>	40 <sup>1</sup>
3(21)	BeCu	Very Low Force (VLI)	.015/.022 (0,38/0,56)	.075 (1,91)	.100/.160	45 <sup>1</sup>	20 <sup>1</sup>
3(48)	BeCu	Extremely Low Force (ELIF) <sup>™</sup>	.015/.024 (0,38/0,61)	.085 (2,16)	.110/.140	20 <sup>1</sup>	12 <sup>1</sup>
6(22)	BeCu	Very Low Force (VLI)	.015/.022 (0,38/0,56)	.064 (1,62)	.190/.115	90 <sup>1</sup>	55 <sup>1</sup>
4(12)	BeCu	Ultra Low profile	.015/.022 (0,38/0,56)	.062 (1,57)	.090/.110	350 <sup>1</sup>	150 <sup>1</sup>
6(32)	BeCu	Very Low Force (VLI)	.015/.026 (0,38/0,66)	.083 (2,10)	.110/.140	65 <sup>1</sup>	28
6(35)	BeCu	Ultra Low Force (ULIF) <sup>™</sup>	.015/.026 (0,38/0,66)	.083 (2,10)	.110/.140	35 <sup>1</sup>	20 <sup>1</sup>
6(43)	BeCu	Ultra Low Force (ULIF) <sup>™</sup>	.015/.026 (0,38/0,66)	.083 (2,10)	.110/.140	20 <sup>1</sup>	11 <sup>1</sup>
4(38)	BeNi	I.C. Leads - Hi-Temp	.015/.025 (0,38/0,64)	.083 (2,10)	.110/.140	190 <sup>1</sup>	120 <sup>1</sup>
4(30)	BeCu	I.C. Leads - Standard	.015/.025 (0,38/0,64)	.083 (2,10)	.110/.140	175	90 <sup>1</sup>
4(20)	BeCu	I.C. Leads - Low Force	.015/.026 (0,38/0,66)	.083 (2,10)	.110/.135	55 <sup>1</sup>	25 <sup>1</sup>
6(16)	BeCu	Mates to .025" sq. pins	.022/.034 (0,56/0,86)	.086 (2,18)	.110/.160	140 <sup>1</sup>	85
4(06)	BeCu		.022/.032 (0,56/0,81)	.113 (2,87)	.140/.170	100 <sup>2</sup>	50 <sup>2</sup>
6(47)	BeCu	.025" sq./Very Low Force	.025/.037 (0,64/0,94)	.086 (2,18)	.110/.160	75 <sup>2</sup>	35 <sup>2</sup>
4(34)	BeCu		.032/.047 (0,81/1,19)	.120 (3,05)	.145/.180	225 <sup>5</sup>	120 <sup>5</sup>
4(03)	BeCu		.040/.060 (1,02/1,52)	.150 (3,81)	.175/.210	250 <sup>3</sup>	125 <sup>3</sup>
6(23)	BeCu		.045/.067 (1,14/1,70)	.100 (2,54)	.125/.180	350 <sup>3</sup>	180 <sup>3</sup>
4(13)	BeCu		.048/.064 (1,22/1,63)	.124 (3,15)	.150/.180	140 <sup>3</sup>	100 <sup>3</sup>
4(07)	BeCu		.065/.082 (1,65/2,08)	.150 (3,81)	.175/.210	170 <sup>4</sup>	115 <sup>4</sup>

\* Number of fingers (clip style)

\*\*BeCu is Beryllium Copper, BeNi is Beryllium Nickel

<sup>1</sup> Average force with .018 polished steel test pin with bullet nose

<sup>2</sup> Average force with .025 polished steel test pin with bullet nose

<sup>3</sup> Average force with .050 polished steel test pin with bullet nose

<sup>4</sup> Average force with .075 polished steel test pin with bullet nose

<sup>5</sup> Average force with .040 polished steel test pin with bullet nose

<sup>6</sup> Average force with .014 polished steel test pin with bullet nose

<sup>7</sup> Force plots available for various pin ranges in section X

### Plating Abbreviations

#### Sockets (Inner contact/Outer shell)

GT = 30μ" Au/200μ" Sn  
 LT = 10μ" Au/200μ" Sn  
 GG = 30μ" Au/10μ" Au

LG = 10μ" Au/10μ" Au  
 TT = 200μ" Sn/200μ" Sn  
 PP = 200μ" SnPb/100μ" SnPb

#### Pins

G = 10μ" Au  
 T = 200μ" Sn  
 P = 200μ" SnPb  
 N1 = 50μ" Ni  
 N2 = 100μ"-150μ" Ni

**NOTE: All references to Sn plate throughout this catalog imply a minimum Pb content of 2%, unless stated otherwise.**

# Contact Specifications



McK McKenzie Socket Division

PART NO.	FIG NO.	PLATING	CLIP STYLE	PCB MOUNT	MATING MIN/MAX	TAIL LENGTH T	OVER-ALL A	BODY HEIGHT B	HEAD HEIGHT C	E	F	G	HEAD DIA. H	BARB DIA. J	BODY DIA. K	TAIL DIA. L	PIN DIA. M	MAX DEPTH Z	
<b>STANDARD CONTACTS</b>																			
001B	1	GT	#4(30)	.057/.024	.015/.025	.125	.290	.165	.030	-	-	-	.072	.060	.053	.020	-	.153	
002B	1	GG	#4(30)	.057/.024	.015/.025	.125	.290	.165	.030	-	-	-	.072	.060	.053	.020	-	.153	
003B	1	GT	#6(32)*	.057/.024	.015/.026	.125	.290	.165	.030	-	-	-	.072	.060	.053	.020	-	.153	
004B	1	GG	#6(32)*	.057/.024	.015/.026	.125	.290	.165	.030	-	-	-	.072	.060	.053	.020	-	.153	
008B	1	LT	#6(35) <sup>§</sup>	.057/.024	.015/.026	.125	.290	.165	.030	-	-	-	.072	.060	.053	.020	-	.153	
009B	1	GT	#6(35) <sup>§</sup>	.057/.024	.015/.026	.125	.290	.165	.030	-	-	-	.072	.060	.053	.020	-	.153	
010B	1	GG	#6(35) <sup>§</sup>	.057/.024	.015/.026	.125	.290	.165	.030	-	-	-	.072	.060	.053	.020	-	.153	
011B	1	LT	#4(30)	.057/.024	.015/.025	.125	.290	.165	.030	-	-	-	.072	.060	.053	.020	-	.153	
012B	1	LT	#6(32)*	.057/.024	.015/.026	.125	.290	.165	.030	-	-	-	.072	.060	.053	.020	-	.153	
013B	1	GG	#6(32)*	.057/.024	.015/.026	.125	.290	.165	.031	PHOSBRONZE			.072	.060	.053	.020	-	.153	
014B	1	TT	#4(30)	.057/.024	.015/.025	.125	.290	.165	.030	-	-	-	.072	.060	.053	.020	-	.153	
015B	1	TT	#6(32)*	.057/.024	.015/.026	.125	.290	.165	.030	-	-	-	.072	.060	.053	.020	-	.153	
016B	1	GT	#4(30)	.057/.024	.015/.025	.125	.290	.165	.031	-	-	-	.072	.060	.053	.020	-	.153	
018B	1	TT	#4(30)	.057/.024	.015/.025	.100	.265	.165	.031	-	-	-	.072	.060	.053	.020	-	.153	
022B	1	LG	#6(32)*	.057/.024	.015/.025	.125	.290	.165	.030	-	-	-	.072	.060	.053	.020	-	.153	
027B	1	TT	#6(35)	.057/.024	.015/.026	.125	.290	.165	.030	-	-	-	.072	.060	.053	.020	-	.146	
030B	1	GT	#3(48)	.057/.024	.015/.026	.125	.290	.165	.030	-	-	-	.072	.060	.053	.020	-	.146	
033B	1	LT	#6(43)	.057/.024	.015/.026	.125	.290	.165	.030	-	-	-	.072	.060	.053	.020	-	.146	

## LOW PROFILE CONTACTS — .083" TO .132"

001M	2	LT	#6(35) <sup>§</sup>	.057/.033	.015/.025	.133	.255	.122	.031	HOLLOW TAIL			.072	.060	.053	.030	-	.175
153B	2	GT	#6(22)*	.057/.032	.015/.020	.082	.165	.083	.010	HOLLOW TAIL			.072	.060	.053	.029	-	.146
156B	2	GT	#4(12)	.057/.032	.015/.020	.082	.165	.083	.010	HOLLOW TAIL			.072	.060	.053	.029	-	.146
157B	2	TT	#4(12)	.057/.033	.015/.020	.095	.190	.095	.020	HOLLOW TAIL			.072	.060	.052	.030	-	.152
160B	2	GT	#4(12)	.057/.033	.015/.020	.095	.190	.095	.020	HOLLOW TAIL			.072	.060	.053	.030	-	.152
161B	2	GG	#4(12)	.057/.033	.015/.020	.095	.190	.095	.020	HOLLOW TAIL			.072	.060	.052	.030	-	.152
164B	2	GT	#6(22)*	.057/.033	.015/.020	.095	.190	.095	.020	HOLLOW TAIL			.072	.060	.052	.030	-	.152
185B	2	GT	#4(30)	.057/.033	.015/.025	.108	.230	.122	.031	HOLLOW TAIL			.072	.062	.053	.030	-	.154
186B	2	GT	#6(32)*	.057/.033	.015/.026	.108	.230	.122	.031	HOLLOW TAIL			.072	.060	.053	.030	-	.154
187B	2	GT	#6(35) <sup>§</sup>	.057/.033	.015/.026	.108	.230	.122	.031	HOLLOW TAIL			.072	.060	.053	.030	-	.154
196B	2	GT	#4(30)	.057/.031	.015/.025	.118	.244	.126	.031	HOLLOW TAIL			.072	.060	.053	.028	-	.120
197B	2	GT	#6(32)*	.057/.031	.015/.026	.118	.244	.126	.031	HOLLOW TAIL			.072	.060	.053	.028	-	.120
199B	2	GT	#6(32)*	.057/.031	.015/.026	.108	.234	.126	.031	HOLLOW TAIL			.072	.060	.053	.028	-	.120
208B	1	GT	#4(12)	.057/.024	.015/.022	.125	.257	.132	.020	-	-	-	.072	.060	.052	.020	-	.120
209B	1	GT	#6(22)*	.057/.024	.015/.022	.125	.257	.132	.020	-	-	-	.072	.060	.052	.020	-	.120
210B	1	GG	#6(22)*	.057/.024	.015/.022	.180	.312	.132	.020	-	-	-	.072	.060	.052	.020	-	-
213B	1	GG	#4(12)	.057/.024	.015/.022	.125	.257	.132	.020	-	-	-	.072	.060	.052	.020	-	.120

## LONG TAIL CONTACTS — .183" TO 1.215"

024B	1	GG	#6(35) <sup>§</sup>	.057/.024	.015/.026	.273	.445	.173	.031	-	-	-	.072	.060	.053	.020	-	.155
026B	1	GT	#6(35) <sup>§</sup>	.057/.024	.015/.026	.150	.315	.165	.030	-	-	-	.072	.060	.053	.020	-	.146
054B	1	GT	#4(30)	.057/.024	.015/.025	.183	.356	.173	.030	-	-	-	.072	.060	.053	.020	-	.153
055B	1	GT	#6(32)*	.057/.024	.015/.026	.183	.356	.173	.030	-	-	-	.072	.060	.053	.020	-	.153
057B	1	TT	#4(30)	.057/.024	.015/.025	.183	.356	.173	.030	-	-	-	.072	.060	.053	.020	-	.153
059B	1	GT	#6(35) <sup>§</sup>	.057/.024	.015/.026	.183	.356	.173	.030	-	-	-	.072	.060	.053	.020	-	.153
067B	1	GT	#4(30)	.057/.024	.015/.025	.273	.446	.173	.030	-	-	-	.072	.060	.053	.020	-	.153
068B	1	GT	#6(32)*	.057/.024	.015/.026	.273	.446	.173	.030	-	-	-	.072	.060	.053	.020	-	.153
079B	1	GT	#4(30)	.059/.024	.015/.025	.382	.555	.173	.030	-	-	-	.072	.062	.053	.020	-	.153
080B	1	GT	#6(32)*	.059/.024	.015/.026	.382	.555	.173	.030	-	-	-	.072	.062	.053	.020	-	.153
091B	1	GG	#4(30)	.057/.024	.015/.025	.183	.356	.173	.030	-	-	-	.072	.060	.053	.020	-	.153
100B	1	GG	#6(32)*	.057/.024	.015/.026	.183	.356	.173	.030	-	-	-	.072	.060	.053	.020	-	.153

\* Very low insertion clip  
 § Ultra low insertion force

Contact Tolerances: Lengths: ±.005  
 Diameters: ±.002  
 Angles: ± 2°

Contact Diameter Tolerances  
 for PCB Mount: Barb: ±.002  
 Tail: ±.002

Note: These are suggested PTH sizes. Review contact diameters and tolerances carefully. Dimensions are in inches.

For more information on plating and clip styles see page A1

**A**

PART NO.	FIG NO.	PLATING	CLIP STYLE	PCB MOUNT	MATING MIN/MAX	TAIL LENGTH T	OVER-ALL A	BODY HEIGHT B	HEAD HEIGHT C	E	F	G	HEAD DIA. H	BARB DIA. J	BODY DIA. K	TAIL DIA. L	PIN DIA. M	MAX DEPTH Z
101B	1	GG	#6(32)*	.057/.024	.015/.026	.183	.356	.173	.030				.072	.060	.053	.020	-	.155
105B	1	GG	#6(32)*	.057/.024	.015/.026	.210	.380	.170	.030	-	-	-	.072	.060	.053	.020	-	.155
114B	1	GG	#6(32)*	.057/.024	.015/.026	.273	.446	.173	.030	-	-	-	.072	.060	.053	.020	-	.155
115B	1	GG	#6(32)*	.057/.024	.015/.026	.273	.446	.173	.030	PHOSBRONZE			.072	.060	.053	.020	-	.153
116B	1	GG	#4(30)	.059/.024	.015/.025	.382	.555	.173	.030	-	-	-	.072	.062	.053	.020	-	.15
117B	1	GG	#6(32)*	.059/.024	.015/.026	.382	.555	.173	.030	-	-	-	.072	.062	.053	.020	-	.153
139B	1	GT	#4(30)	.057/.024	.015/.025	.455	.645	.190	.031	-	-	-	.072	.060	.053	.025	-	.140
235B	1	GT	#4(30)	.057/.024	.015/.025	1.215	1.405	.190	.031	-	-	-	.072	.060	.053	.025	-	.149
236B	1	GT	#6(32)*	.057/.024	.015/.026	1.215	1.405	.190	.031	-	-	-	.072	.060	.053	.025	-	.149
259B	3	GT	#6(32)*	.057/.033	.015/.026	.215	.382	.167	.031	-	-	-	.072	.060	.053	.030	-	.160

### LONG TAIL CONTACTS — .183" TO 1.215" (Continued)

### INTERSTITIAL TYPE CONTACTS

003A	5	GT	#6(43) <sup>S</sup>	.058/.022	.015/.026	.100	.265	.165	-	-	-	-	.056	.059	.046	.018	-	.145
009A	5	GT	#3(48) <sup>S</sup>	.057/.024	.015/.025	.150	.315	.165	-	-	-	-	.056	.059	.046	.018	-	.145
010A	5	LT	#3(48) <sup>S</sup>	.057/.024	.015/.025	.125	.290	.165	-	-	-	-	.056	.059	.046	.018	-	.145
011A	5	LT	#6(43) <sup>S</sup>	.057/.024	.015/.025	.125	.290	.165	-	-	-	-	.056	.059	.046	.018	-	.145
012A	5	GT	#3(48) <sup>S</sup>	.057/.024	.015/.025	.100	.265	.165	-	-	-	-	.056	.059	.046	.018	-	.145
013A	5	GG	#3(48) <sup>S</sup>	.057/.024	.015/.025	.125	.290	.165	-	-	-	-	.056	.059	.046	.018	-	.145
014A	5	LT	#3(48)*	.057/.024	.015/.025	.100	.265	.165	-	-	-	-	.056	.059	.046	.018	-	.145
015A	5	LT	#6(43)*	.057/.024	.015/.025	.100	.265	.165	-	-	-	-	.056	.059	.046	.018	-	.145
016A	5	LT	#6(43)*	.057/.024	.015/.025	.080	.330	.250	-	-	-	-	.056	.059	.046	.018	-	.145
018A	5	GT	#4(38)*	.057/.024	.015/.025	.125	.290	.165	-	-	-	-	.056	.059	.046	.018	-	.145
118B	5	GG	#6(43) <sup>S</sup>	.058/.024	.015/.026	.270	.435	.165	-	PHOSBRONZE			.057	.059	.046	.018	-	.145
120B	5	GG	#6(43) <sup>S</sup>	.058/.024	.013/.026	.180	.345	.165	-	PHOSBRONZE			.057	.059	.046	.018	-	.145
122A	5	GT	#3(48) <sup>S</sup>	.058/.024	.015/.026	.125	.290	.165	-	-	-	-	.057	.059	.046	.018	-	.145
282B	4	GT	#6(32)*	.059/.024	.015/.026	.125	.290	.165	-	-	-	-	.056	.062	.052	.018	-	.149
285B	4	GG	#6(32)*	.059/.024	.015/.026	.125	.290	.165	-	-	-	-	.056	.062	.052	.018	-	.149
286B	4	LT	#6(32)*	.059/.024	.015/.026	.125	.290	.165	-	-	-	-	.056	.062	.052	.018	-	.149
320B	5	GT	#6(22)*	.057/.024	.015/.020	.125	.290	.165	-	-	-	-	.056	.059	.046	.020	-	.142
321B	5	GT	#6(22)*	.057/.024	.015/.020	.125	.439	.314	-	-	-	-	.056	.059	.046	.018	-	.142
509A	5	GG	#6(43) <sup>S</sup>	.058/.022	.015/.026	.125	.290	.165	-	-	-	-	.056	.059	.046	.018	-	.145
509B	5	GT	#6(43) <sup>S</sup>	.058/.024	.015/.026	.125	.290	.165	-	-	-	-	.057	.059	.046	.018	-	.145

### ELEVATED PROFILE CONTACTS — .177" TO .699"

002D	7	GG	#4(30)	.057/.024	.015/.025	.124	.682	.167	.030	-	.358	-	.071	.060	.035	.020	-	.160
003D	7	GT	#4(30)	.059/.024	.015/.025	.158	.542	.208	.031	-	.384	-	.072	.062	.035	.020	-	.180
040B	1	GG	#4(30)	.057/.024	.015/.025	.125	.355	.230	.030	-	-	-	.072	.060	.053	.020	-	.156
041B	1	GT	#4(30)	.057/.024	.015/.025	.125	.355	.230	.030	-	-	-	.072	.060	.053	.020	-	.156
042B	1	GT	#6(32)*	.057/.024	.015/.026	.125	.355	.230	.030	-	-	-	.072	.060	.053	.020	-	.156
043B	1	GG	#6(32)	.057/.024	.015/.025	.125	.355	.230	.030	-	-	-	.072	.060	.053	.020	-	.156

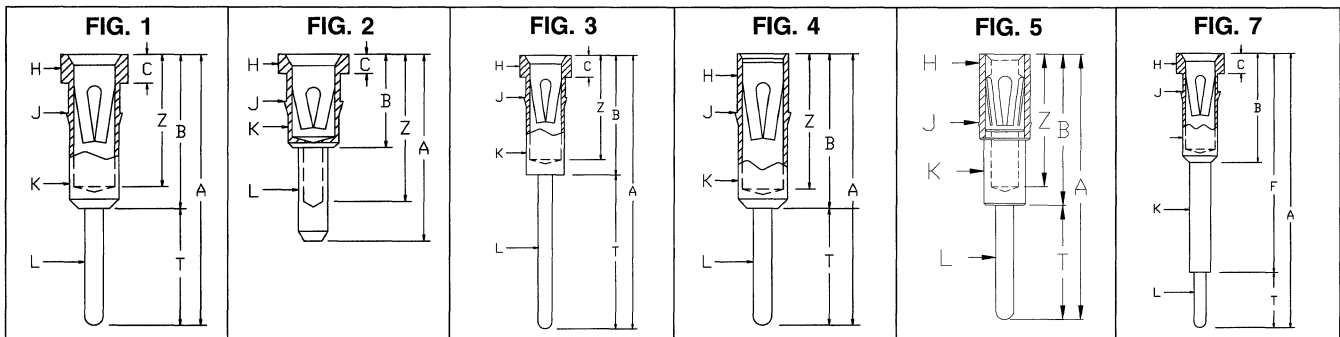

PART NO.	FIG NO.	PLATING	CLIP STYLE	PCB MOUNT	MATING MIN/MAX	TAIL LENGTH T	OVER-ALL A	BODY HEIGHT B	HEAD HEIGHT C	E	F	G	HEAD DIA. H	BARB DIA. J	BODY DIA. K	TAIL DIA. L	PIN DIA. M	MAX DEPTH Z
----------	---------	---------	------------	-----------	----------------	---------------	------------	---------------	---------------	---	---	---	-------------	-------------	-------------	-------------	------------	-------------

**ELEVATED PROFILE CONTACTS — .177" TO .699" (Continued)**

220B	1	GT	#4(30)	.059/.024	.015/.025	.165	.665	.500	.380	-	-	-	.072	.062	.052	.020	-	.210
248B	1	GG	#4(30)	.057/.021	.015/.025	.126	.303	.177	.031	-	-	-	.072	.060	.053	.018	-	.148
300B	7	GT	#4(30)	.057/.021	.015/.025	.126	.566	.165	.031	-	.440	-	.072	.060	.033	.018	-	.149
301B	7	GT	#4(30)	.059/.021	.015/.025	.135	.703	.193	.031	-	.568	-	.072	.060	.035	.018	-	.150
302B	7	GT	#4(30)	.059/.021	.015/.025	.170	.542	.208	.031	-	.372	-	.072	.062	.035	.020	-	.180
303B	7	TT	#4(30)	.057/.021	.015/.025	.170	.542	.208	.031	-	.372	-	.072	.062	.035	.020	-	.180
310B	7	GG	#4(30)	.057/.021	.015/.025	.124	.547	.167	.030	-	.423	-	.071	.059	.035	.020	-	.160
312B	7	GG	#4(30)	.057/.021	.015/.025	.124	.705	.167	.030	-	.581	-	.071	.059	.035	.020	-	.160
313B	7	GG	#4(30)	.057/.021	.015/.025	.124	.823	.167	.030	-	.699	-	.071	.059	.035	.020	-	.160
314B	7	GG	#6(32)*	.057/.021	.015/.026	.130	.664	.173	.030	-	.488	-	.072	.060	.035	.018	-	.154

**.070" PROGRESSION CONTACTS**

340B	1	GT	#3(11)	.043/.023	.015/.021	.120	.290	.170	.030	-	-	-	.055	.046	.041	.020	-	.151
341B	1	GT	#3(21)*	.043/.023	.015/.022	.120	.290	.170	.030	-	-	-	.055	.046	.041	.020	-	.151
342B	1	GG	#3(21)*	.043/.023	.015/.022	.200	.370	.170	.030	PHOSBRONZE	-	-	.055	.046	.041	.018	-	.151
343B	1	GG	#3(21)*	.043/.023	.015/.022	.120	.290	.170	.030	-	-	-	.055	.046	.041	.020	-	.151

**WIRE WRAP CONTACTS**

398B	12	GT	#4(30)	.057/.037	.015/.025	.260 WW	.453	.193	.030	-	-	-	.072	.060	.053	.025	SQ.	.170
400B	12	GT	#4(30)	.057/.037	.015/.025	.360 WW	.553	.193	.030	-	-	-	.072	.060	.053	.025	SQ.	.170
401B	12	GG	#4(30)	.057/.037	.015/.025	.360 WW	.553	.193	.030	-	-	-	.072	.060	.053	.025	SQ.	.170
402B	12	GT	#6(32)*	.057/.037	.015/.026	.360 WW	.553	.193	.030	-	-	-	.072	.060	.053	.025	SQ.	.170
403B	12	GG	#6(32)*	.057/.037	.015/.026	.360 WW	.553	.193	.030	-	-	-	.072	.060	.053	.025	SQ.	.170
410B	12	GT	#4(30)	.057/.037	.015/.025	.500 WW	.693	.193	.030	-	-	-	.072	.060	.053	.025	SQ.	.170
411B	12	GG	#4(30)	.057/.037	.015/.025	.500 WW	.693	.193	.030	-	-	-	.072	.060	.053	.025	SQ.	.170
412B	12	GT	#6(32)*	.057/.037	.015/.026	.500 WW	.693	.193	.030	-	-	-	.072	.060	.053	.025	SQ.	.170
413B	12	GG	#6(32)*	.057/.037	.015/.026	.500 WW	.693	.193	.030	-	-	-	.072	.060	.053	.025	SQ.	.170
415B	9	GG	#4(30)	.057/.040	.015/.025	.510 WW	.705	.195	.031	-	-	-	.072	.060K	.053	.025	SQ.	.170

**CONTACTS MATING TO .025" SQUARE POSTS**

420B	8	GT	#4(06)	.067/.024	.022/.032	.125	.310	.185	.031	.068	.125	.160	.085	.070K	.061	.020	-	.170
424B	1	LT	#6(47)*	.067/.024	.025/.037	.125	.310	.185	.032	-	.125	.155	.077	.070	.062	.020	-	.165
426B	1	LT	#6(46)*	.067/.024	.025/.037	.087	.272	.185	.032	-	.125	.155	.077	.070	.062	.020	-	.165
435B	1	GT	#6(47)*	.061/.029	.025/.037	.230	.490	.260	.032	-	-	-	.072	.064	.061	.025	-	.235
445B	9	GT	#6(16)*	.067/.038	.022/.034	.370 WW	.545	.175	-	-	-	-	-	.070K	.061	.025	SQ.	.155
455B	12	GT	#4(06)	.080/.038	.022/.032	.510 WW	.812	.302	.030	-	-	-	.085	.083	.073	.025	SQ.	.274

**BeNi CONTACTS FOR HI-TEMP APPLICATIONS**

498B	1	GG	#4(38)	.057/.024	.015/.025	.124	.297	.173	.030	-	-	-	.072	.060	.053	.020	-	.156
502B	4	TT	#4(38)	.059/.024	.015/.025	.270	.410	.140	-	HEADLESS	-	-	.056	.062	.052	.020	-	.117

**FLAT HEAD TERMINALS**

540B	1	G	-	.059/.024	FLAT TOP	.124	.297	.173	.030	-	-	-	.072	.062	.053	.020	-	-
541B	1	T	-	.059/.024	FLAT TOP	.124	.297	.173	.030	-	-	-	.072	.062	.053	.020	-	-

\* Very low insertion clip  
§ Ultra low insertion force

Contact Tolerances: Lengths: ±.005  
Diameters: ±.002  
Angles: ± 2°

Contact Diameter Tolerances  
for PCB Mount: Barb: ±.002  
Tail: ±.002

Note: These are suggested PTH sizes. Review contact diameters and tolerances carefully. Dimensions are in inches.

For more information on plating and clip styles see page A1

PART NO.	FIG. NO.	PLATING	CLIP STYLE	PCB MOUNT	MATING MIN/MAX	TAIL LENGTH T	OVER-ALL A	BODY HEIGHT B	HEAD HEIGHT C	E F G			HEAD DIA. H	BARB DIA. J	BODY DIA. K	TAIL DIA. L	PIN DIA. M	MAX DEPTH Z

### DUMMY TERMINALS

553B	11	N1		.057	FLAT TOP	-	.115	.115	.031	-	-	-	.072	.060	.053	-	-	-
565B	1	-		.057/.025	HOLE .043	.183	.356	.173	.031	-	-	-	.072	.060	.053	.020	-	-
567B	1	-		.057/.025	NO CLIP	.132	.280	.148	.031	-	-	-	.072	.060	.053	.018	-	-

### NAIL HEAD WIRE WRAP TERMINALS

570B	10	G		.057/.038	FLAT TOP	.260 WW	.453	.193	.030	-	-	.260	.062	.060	.053	.025	SQ.	-
571B	10	G		.057/.038	HOLE .043	.260 WW	.453	.193	.030	-	-	.260	.072	.060	.053	.025	SQ.	.170
582B	10	G		.057/.038	FLAT TOP	.360 WW	.553	.193	.030	-	-	.360	.072	.060	.053	.025	SQ.	-
583B	10	G		.057/.038	FLAT TOP	.360 WW	.553	.193	.030	-	-	.360	.062	.060	.053	.025	SQ.	-
584B	10	G		.057/.038	HOLE .043	.360 WW	.553	.193	.030	-	-	.360	.072	.060	.053	.025	SQ.	.170
590B	10	G		.057/.038	FLAT TOP	.510 WW	.711	.201	.031	-	-	.510	.072	.060	.053	.025	SQ.	-
591B	10	G		.057/.038	FLAT TOP	.500 WW	.693	.193	.030	-	-	.500	.072	.060	.053	.025	SQ.	-
592B	10	G		.057/.038	FLAT TOP	.500 WW	.693	.193	.030	-	-	.500	.062	.060	.053	.025	SQ.	-
593B	10	G		.057/.038	HOLE .043	.500 WW	.693	.193	.030	-	-	.500	.072	.060	.053	.025	SQ.	-

### BARBLESS CONTACTS WITH TAILS

600C	15	GT	#4(30)	.057/.024	.015/.025	.124	.297	.173	.030	-	-	-	.072	-	.053	.020	-	.154
601C	15	GG	#4(30)	.057/.024	.015/.025	.124	.297	.173	.030	-	-	-	.072	-	.053	.020	-	.154

### LOW PROFILE CONTACTS — PRESSFIT AND SURFACE MOUNTABLE

002C	46	GT	#3(21)	.050 PAD	.015/.022	-	.166	.114	.030	-	-	-	.055	.048	.043	.038	-	.147
004R	46	TT	#4(12)	.050 PAD	.015/.022	-	.095	.095	.031	-	-	-	.072	.048	.053	.038	-	.072

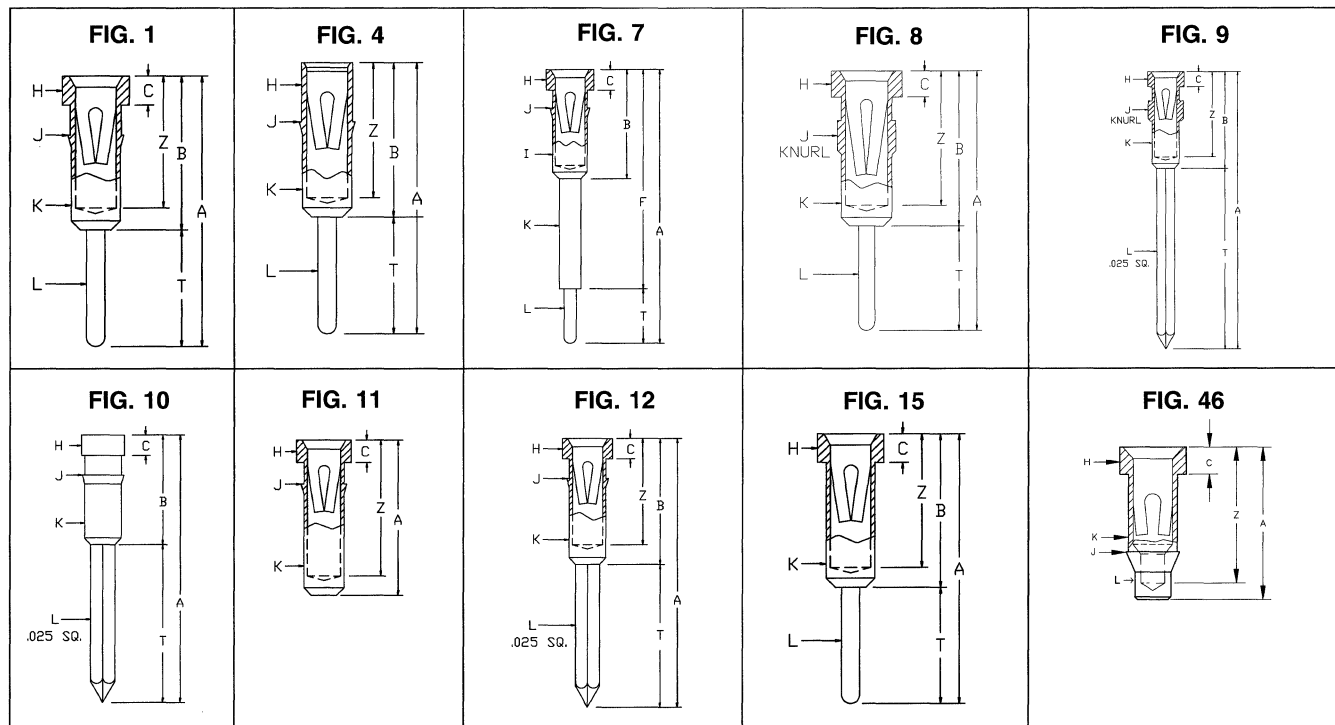



# Contact Specifications



McKenzie Socket Division

PART NO.	FIG NO.	PLATING	CLIP STYLE	PCB MOUNT	MATING MIN/MAX	TAIL LENGTH T	OVER-ALL A	BODY HEIGHT B	HEAD HEIGHT C	E	F	G	HEAD DIA. H	BARB DIA. J	BODY DIA. K	TAIL DIA. L	PIN DIA. M	MAX DEPTH Z
<b>LOW PROFILE CONTACTS — PRESSFIT AND SURFACE MOUNTABLE (Continued)</b>																		
619C	46	GT	#6(35) <sup>§</sup>	.050 PAD	.015/.026	-	.166	.166	.030	-	-	-	.072	.058	.053	.039	-	.147
622C	46	GT	#6(32) <sup>*</sup>	.050 PAD	.015/.026	-	.166	.166	.030	-	-	-	.072	.058	.053	.039	-	.156
623C	46	TT	#6(32) <sup>*</sup>	.050 PAD	.015/.026	-	.166	.166	.030	-	-	-	.072	.058	.053	.039	-	.156
631C	11	GT	#4(30)	.057	.015/.025	-	.169	.169	.031	-	-	-	.072	.060	.053	-	-	.150
635C	11	GT	#6(32) <sup>*</sup>	.057	.015/.026	-	.146	.146	.031	-	-	-	.070	.059	.053	-	-	.132
636C	11	TT	#4(30)	.057	.015/.025	-	.146	.146	.031	-	-	-	.070	.059	.053	-	-	.132
645C	11	GT	#4(30)	.057	.015/.025	-	.203	.203	.030	-	-	-	.072	.060	.053	-	-	-

## LOW PROFILE CONTACTS

002R	16	TT	#3(21) <sup>*</sup>	.042	.015/.021	-	.140	.140	.050	-	-	-	.055	-	.038	-	-	.123
620C	16	GT	#4(30)	.057	.015/.025	-	.165	.165	.031	-	-	-	.072	-	.053	-	-	.156
647C	16	GT	SPECIAL	.042	.018/.021	-	.142	.142	.014	-	-	-	.057	-	.038	-	-	.135
654C	16	GT	#4(30)	.062	.015/.025	-	.180	.180	.088	-	-	-	.080	-	.056	-	-	.164
656C	16	GG	#4(30)	.062	.015/.025	-	.180	.180	.088	-	-	-	.080	-	.056	-	-	.164
657C	16	GT	#4(30)	.059	.015/.025	-	.161	.161	.016	-	-	-	.072	-	.055	-	-	.153
658C	16	GG	#4(30)	.059	.015/.025	-	.161	.161	.016	-	-	-	.072	-	.055	-	-	.153
659C	16	GT	#4(30)	.061	.015/.025	-	.125	.125	.020	-	-	-	.072	-	.057	-	-	.115
661C	16	GG	#4(38)	.061	.015/.025	-	.125	.125	.020	-	-	-	.072	-	.057	-	-	.115
672C	16	GT	#6(32)	.053	.015/.026	-	.248	.248	.040	-	-	-	.065	-	.049	-	-	.166
690C	16	GT	#4(30)	.059	.015/.025	-	.135	.135	.050	-	-	-	.072	-	.057	-	-	.124
730C	16	GT	#3(21) <sup>*</sup>	.042	.015/.022	-	.160	.160	.038	-	-	-	.055	-	.038	-	-	.146
775C	16	GT	#4(20)	.055	.015/.026	-	.160	.160	.038	-	-	-	.072	-	.051	-	-	-
777C	16	GT	#4(12)	.053	.015/.022	-	.200	.200	.020	-	-	-	.068	-	.049	-	-	-
785C	16	GT	#4(30)	.062	.015/.025	-	.180	.180	.088	-	-	-	.080	-	.058	-	-	-

## FLUSH PROFILE CONTACTS — .016" ABOVE PCB

710C	16	GT	#3(11)	.042	.015/.021	-	.136	.136	.016	-	-	-	.055	-	.038	-	-	.124
711C	16	GG	#3(11)	.042	.015/.021	-	.136	.136	.016	-	-	-	.055	-	.038	-	-	.124
712C	16	GT	#3(21) <sup>*</sup>	.042	.015/.022	-	.136	.136	.016	-	-	-	.055	-	.038	-	-	.124
714C	16	PP	#3(21) <sup>*</sup>	.042	.015/.022	-	.136	.136	.016	-	-	-	.055	-	.038	-	-	.124
720C	16	GT	#3(11)	.042	.015/.021	-	.170	.170	.016	-	-	-	.055	-	.038	-	-	.151
722C	16	GT	#3(21) <sup>*</sup>	.042	.015/.022	-	.170	.170	.016	-	-	-	.055	-	.038	-	-	.151
723C	16	GG	#3(21) <sup>*</sup>	.042	.015/.022	-	.170	.170	.016	-	-	-	.055	-	.038	-	-	.151

## LOW PROFILE CONTACTS — REQUIRES .038" MOUNTING HOLE

725C	16	GT	#3(21) <sup>*</sup>	.038	.015/.022	-	.155	.155	.031	LOW CLIP	-	-	.058	-	.034	-	-	.141
726C	16	TT	#3(21) <sup>*</sup>	.038	.015/.018	-	.155	.155	.031	LOW CLIP	-	-	.058	-	.034	-	-	.141

## FLUSH PROFILE AND HEX PRESSFIT CONTACTS

004C	17	GT	#3(21) <sup>*</sup>	.041	.015/.021	-	.282	.282	.016	-	-	-	.055	.044	.038	-	-	.266
742C	17	GT	#3(21) <sup>*</sup>	.042	.015/.022	-	.140	.140	.016	-	-	-	.055	.043	.038	-	-	-

## LOW PROFILE CONTACTS — WITH THRU HOLE BODY

750C	19	GT	#3(21) <sup>*</sup>	.041	.015/.022	-	.083	.083	.025	-	-	-	.058	-	.037	-	-	-
752C	19	GT	#3(21) <sup>*</sup>	.041	.015/.022	-	.138	.138	.025	-	-	-	.058	-	.037	-	-	.139

\* Very low insertion clip  
 § Ultra low insertion force

Contact Tolerances: Lengths: ±.005  
 Diameters: ±.002  
 Angles: ± 2°

Contact Diameter Tolerances  
 for PCB Mount: Barb: ±.002  
 Tail: ±.002

Note: These are suggested PTH sizes. Review contact diameters and tolerances carefully. Dimensions are in inches.

For more information on plating and clip styles see page A1

PART NO.	FIG. NO.	PLATING	CLIP STYLE	PCB MOUNT	MATING MIN/MAX	TAIL LENGTH T	OVER-ALL A	BODY HEIGHT B	HEAD HEIGHT C	E F G			HEAD DIA. H	BARB DIA. J	BODY DIA. K	TAIL DIA. L	PIN DIA. M	MAX DEPTH Z

### LOW PROFILE CONTACTS — WITH THRU HOLE BODY (Continued)

760C	19	GT	#6(22)	.065	.015/.022	-	.138	.138	.018	-	-	-	.075	-	.061	-	-	.139
------	----	----	--------	------	-----------	---	------	------	------	---	---	---	------	---	------	---	---	------

### LOW PROFILE CONTACTS — MATING TO .025" — .080" POSTS

792C	13	GT	#6(16)*	.067	.022/.034	-	.145	.145	.018	.065	.086	.120	.078	HEX	-	-	-	.120
802C	16	GT	#4(06)*	.064	.022/.032	-	.259	.259	.014	-	-	-	.077	-	.060	-	-	.236
804C	16	GG	#4(34)*	.076	.032/.047	-	.206	.206	.018	-	-	-	.090	-	.073	-	-	.180
810C	16	TT	#4(34)	.089	.032/.047	-	.240	.240	.031	-	-	-	.120	-	.085	-	-	.205
815C	16	GG	#4(13)	.104	.048/.064	-	.290	.290	.012	-	-	-	.118	-	.100	-	-	.296
819C	16	TT	#4(07)	.160	.065/.082	-	.309	.309	.032	-	-	-	.188	-	.156	-	-	-

### PCB EDGE MOUNT SOCKET

820C	26	GT	#6(16)*	.065	.025-SQ.	-	.407	.257	.014	.010	FLAT SIDE	.077	-	.060	-	-	.238
------	----	----	---------	------	----------	---	------	------	------	------	-----------	------	---	------	---	---	------

### THRU HOLE EYELET

821C	34	T	-	.051	.028	-	.110	.110	.010	THRU HOLE BODY		.060	.054	.047	-	-	-
------	----	---	---	------	------	---	------	------	------	----------------	--	------	------	------	---	---	---

### BIFURCATED TERMINALS

830G	20	G	-	.056/.024	-	.124	.417	.293	.157	.100	.035	-	.071	.059	.053	.020	-	-
831G	20	T	-	.056/.024	-	.124	.417	.293	.157	.100	.035	-	.071	.059	.053	.020	-	-
832G	20	G	-	.057/.021	PHOSBZ	.156	.416	.260	.157	.100	.035	-	.072	.060	.052	.018	-	-
834G	20	T	-	.057/.021	PHOSBZ	.156	.416	.260	.157	.100	.035	-	.072	.060	.052	.018	-	-
837G	22	G	-	.057/.038	-	.390 WW	.719	.329	.153	.100	.034	.390	.072	.060	.053	.025 SQ.	-	-
838G	22	G	-	.057/.038	-	.510 WW	.839	.329	.158	.100	.036	-	.072	.060	.053	.025 SQ.	-	-

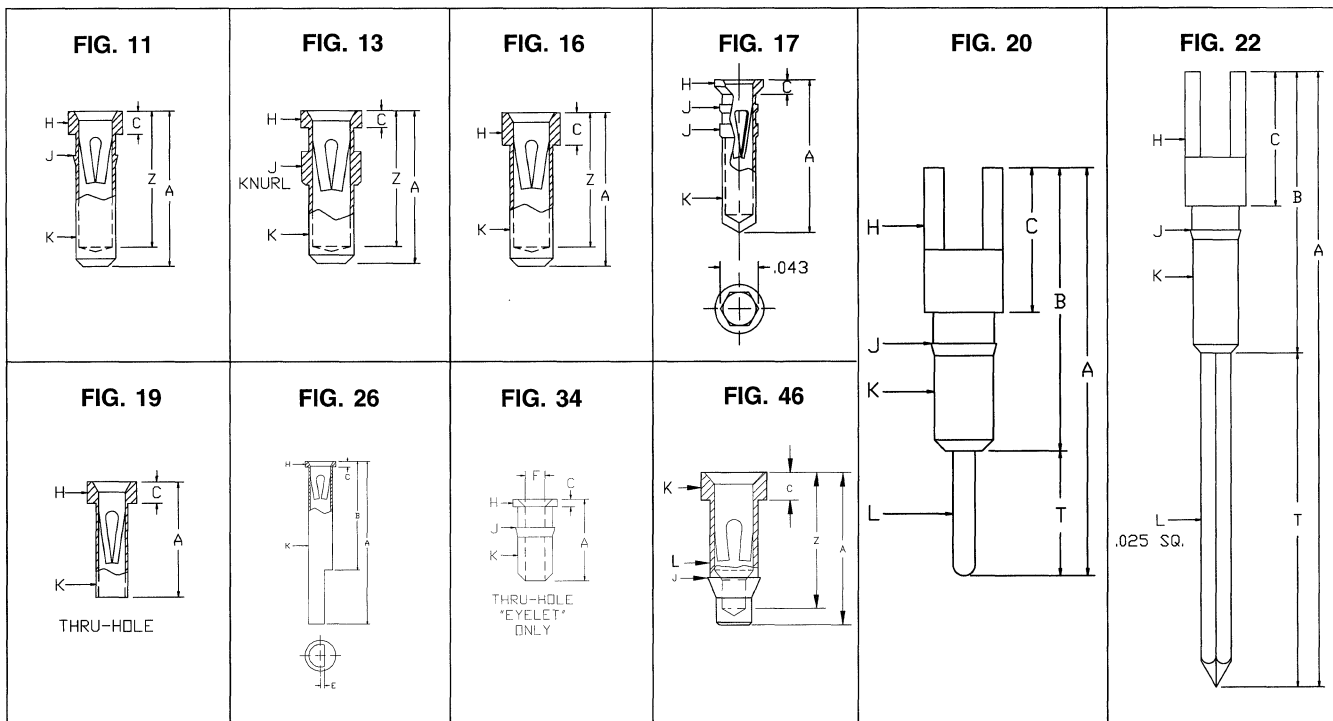

PART NO.	FIG NO.	PLATING	CLIP STYLE	PCB MOUNT	MATING MIN/MAX	TAIL LENGTH T	OVER-ALL A	BODY HEIGHT B	HEAD HEIGHT C	E	F	G	HEAD DIA. H	BARB DIA. J	BODY DIA. K	TAIL DIA. L	PIN DIA. M	MAX DEPTH Z
----------	---------	---------	------------	-----------	----------------	---------------	------------	---------------	---------------	---	---	---	-------------	-------------	-------------	-------------	------------	-------------

**SOLDER CUP TERMINALS**

840K	21	G	-	.056/.024	-	.124	.417	.293	.153	.126	.035	-	.071	.059	.053	.020	-	-
841K	21	T	-	.056/.024	-	.124	.417	.293	.157	.126	.035	-	.071	.059	.053	.020	-	-
842K	23	G	-	.056/.038	-	.390	.719	.329	.157	.126	.035	.390	.071	.059K	.053	.025 SQ.	-	-
843K	23	G	-	.056/.038	-	.510	.839	.329	.157	.126	.035	.510	.071	.059K	.053	.025 SQ.	-	-

**TURRET TERMINALS**

850L	25	G	-	.057/.024	-	.121	.402	.281	.142	.071	.051	-	.072	.060	.053	.020	.039	-
851L	25	T	-	.057/.024	-	.121	.402	.281	.142	.071	.051	-	.072	.060	.053	.020	.039	-
852L	25	G	-	.057/.024	-	.181	.462	.281	.142	.071	.051	-	.072	.060	.053	.020	.039	-
853L	25	T	-	.057/.024	-	.181	.462	.281	.142	.071	.051	-	.072	.060	.053	.020	.039	-
854L	24	G	-	.057/.038	-	.390 WW	.703	.313	.142	.071	.051	.390	.072	.060	.053	.025 SQ.	.039	-
855L	24	G	-	.057/.038	-	.510 WW	.823	.313	.142	.071	.051	.510	.072	.060	.053	.025 SQ.	.039	-

**MALE/MALE PINS**

002S	31	G	-	.057/.022	-	.230	.446	.216	.022	.150	.066	-	.070	.060	.052	.018	.018	-
004S	31	T	-	.057/.022	-	.105	.325	.220	.060	.150	.066	-	.055	.029	-	.018	.018	-
005S	36	G	-	.057/.022	-	.100	.316	.216	.022	.150	.066	-	.070	.060	.052	.018	.018	-
857S	36	T	BRASS	.057/.022	-	.125	.460	.335	.050	.125	.210	.060	.072	.060	.052	.018	.018	-
858S	36	T	BRASS	.057/.022	-	.125	.585	.460	.050	.125	.335	.185	.072	.060	.052	.018	.018	-
859S	36	T	BRASS	.057/.022	-	.125	.835	.710	.050	.125	.585	.435	.072	.060	.052	.018	.018	-
860S	36	T	BRASS	.057/.022	-	.125	1.085	.960	.050	.125	.835	.685	.072	.060	.052	.018	.018	-
861S	36	G	BRASS	.057/.022	-	.125	.460	.335	.050	.125	.210	.060	.072	.060	.052	.018	.018	-
862S	36	G	BRASS	.057/.022	-	.125	.585	.460	.050	.125	.335	.185	.072	.060	.052	.018	.018	-
863S	36	G	BRASS	.057/.022	-	.125	.835	.710	.050	.125	.585	.435	.072	.060	.052	.018	.018	-
864S	36	G	BRASS	.057/.022	-	.125	1.085	.960	.050	.125	.835	.685	.072	.060	.052	.018	.018	-
867S	36	G	PHOSBZ	.057/.022	-	.180	.585	.405	.050	.155	.250	.100	.070	.060	.053	.018	.018	-
868S	31	G	BRASS	.057/.022	-	.108	.299	.191	.022	.125	.066	-	.070	.060	.052	.018	.018	-
869S	31	T	BRASS	.057/.022	-	.108	.299	.191	.022	.125	.066	-	.070	.060	.052	.018	.018	-
870S	31	G	BRASS	.057/.025	-	.115	.482	.367	.052	.170	.197	-	.072	.060	.053	.021	.030	-
874S	31	G	BRASS	.057/.022	-	.156	.477	.321	.052	.166	.155	-	.072	.060	.052	.018	.025	-
876S	31	G	PHOSBZ	.057/.021	-	.156	.477	.321	.051	.166	.155	-	.072	.060	.052	.018	.018	-
877S	31	T	PHOSBZ	.057/.021	-	.156	.477	.321	.051	.166	.155	-	.072	.060	.052	.018	.018	-
878S	31	G	BRASS	.057/.021	-	.156	.477	.321	.051	.166	.155	-	.072	.060	.052	.018	.018	-
879S	31	T	BRASS	.057/.021	-	.156	.477	.321	.051	.166	.155	-	.072	.060	.051	.018	.018	-
880S	31	G	PHOSBZ	.057/.024	-	.125	.335	.210	.020	.125	.085	-	.070	.060	.052	.020	.020	-
881S	31	T	PHOSBZ	.057/.024	-	.125	.335	.210	.020	.125	.085	-	.070	.060	.052	.020	.020	-
882S	31	G	PHOSBZ	.057/.024	-	.125	.335	.210	.020	.125	.085	-	.070	.060	.052	.020	.020	-

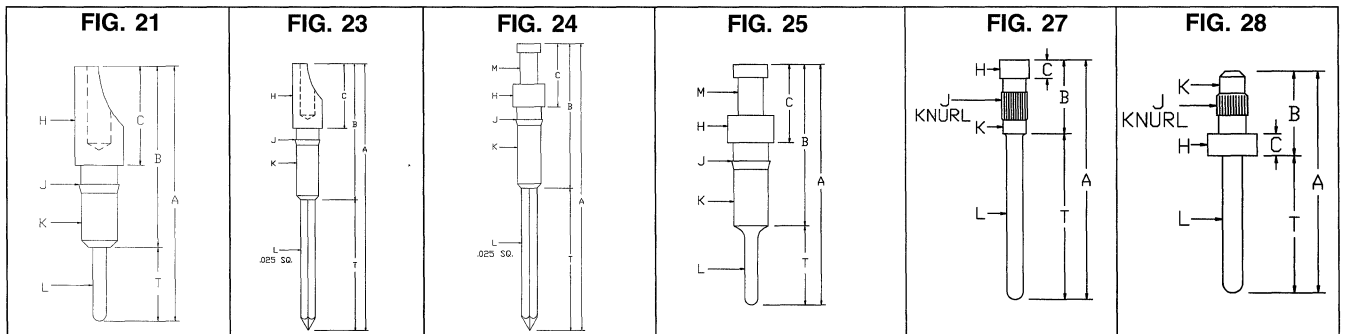

\* Very low insertion clip  
 § Ultra low insertion force

Contact Tolerances: Lengths: ±.005  
 Diameters: ±.002  
 Angles: ± 2°

Contact Diameter Tolerances for PCB Mount: Barb: ±.002  
 Tail: ±.002

Note: These are suggested PTH sizes. Review contact diameters and tolerances carefully. Dimensions are in inches.

For more information on plating and clip styles see page A1

### McKenzie Socket Division

PART NO.	FIG NO.	PLATING	CLIP STYLE	PCB MOUNT	MATING MIN/MAX	TAIL LENGTH T	OVER-ALL A	BODY HEIGHT B	HEAD HEIGHT C			HEAD DIA. H	BARB DIA. J	BODY DIA. K	TAIL DIA. L	PIN DIA. M	MAX DEPTH Z	
									E	F	G							
884S	31	G	BRASS	.057/.022	-	.114	.394	.280	.035	.142	.138	-	.072	.060	.053	.018	.018	-
886S	31	G	BRASS	.057/.022	-	.141	.524	.383	.052	.217	.166	-	.072	.060	.053	.018	.030	-
888S	31	G	BRASS	.057/.022	-	.149	.724	.575	.052	.417	.158	-	.072	.060	.053	.018	.030	-
895S	31	G	BRASS	.057/.022	-	.121	.381	.260	.035	.142	.118	-	.072	.060	.053	.018	.018	-

### MALE/MALE PINS (Continued)

### MALE/MALE PINS — INTERSTITIAL APPLICATIONS

901S	31	G	PHOSBZ	.032/.021	-	.125	.335	.210	.015	.125	.085	-	.040	.035	.030	.018	.018	-
902S	31	T	PHOSBZ	.032/.021	-	.125	.335	.210	.015	.125	.085	-	.040	.035	.030	.018	.018	-

### ELEVATED MALE/MALE PINS

920H	33	G	BRASS	.057/.025	-	.115	.890	.605	-	.170	.460	-	.072	.060	.053	.021	.030	-
922H	33	G	BRASS	.056/.024	-	.166	.516	.236	-	.114	.091	-	.071	.059	.053	.020	.030	-
924H	33	G	BRASS	.057/.025	-	.115	.600	.315	-	.170	.170	-	.072	.060	.053	.021	.030	-
926H	33	G	BRASS	.057/.032	-	.118	.866	.630	-	.118	.484	-	.072	.060	.053	.028	.028	-
930H	33	G	BRASS	.057/.025	-	.115	.730	.500	-	.115	.350	-	.072	.060	.053	.021	.021	-
931H	33	T	BRASS	.057/.025	-	.115	.730	.500	-	.115	.350	-	.072	.060	.053	.021	.021	-
932H	33	G	BRASS	.057/.025	-	.115	.980	.750	-	.115	.600	-	.072	.060	.053	.021	.021	-
935H	33	G	BRASS	.057/.025	-	.115	.530	.245	-	.170	.100	-	.072	.060	.053	.021	.030	-

### PCB SUBSTRATE PINS

002P	29	G	NO CLIP	.028	-	.120	.210	-	.030	-	.060	-	.040	.031	.022	.018	-	-
940P	28	G	PHOSBZ	.026	-	.125	.190	.065	.020	.010	.030	.125	.045	.028K	.023	.018	-	-
944P	27	G	PHOSBZ	.026	-	.180	.260	.080	.020	.015	.045	.180	.032	.028K	.025	.018	-	-
945P	27	P	PHOSBZ	.026	-	.180	.260	.080	.020	.015	.045	.180	.032	.028K	.025	.018	-	-
948P	28	G	PHOSBZ	.026	-	.180	.290	.110	.050	.015	.045	.180	.045	.028K	.025	.018	-	-
951P	30	T	BRASS	.028/.021	-	.115	.170	.055	.015	-	-	.115	.040	.031	.026	.018	-	-
952P	30	G	BRASS	.028/.021	-	.115	.170	.055	.015	-	-	.115	.040	.031	.026	.018	-	-
953P	29	P	PHOSBZ	.028/.022	-	.120	.210	-	.030	-	.060	.120	.040	.031	.022	.018	-	-

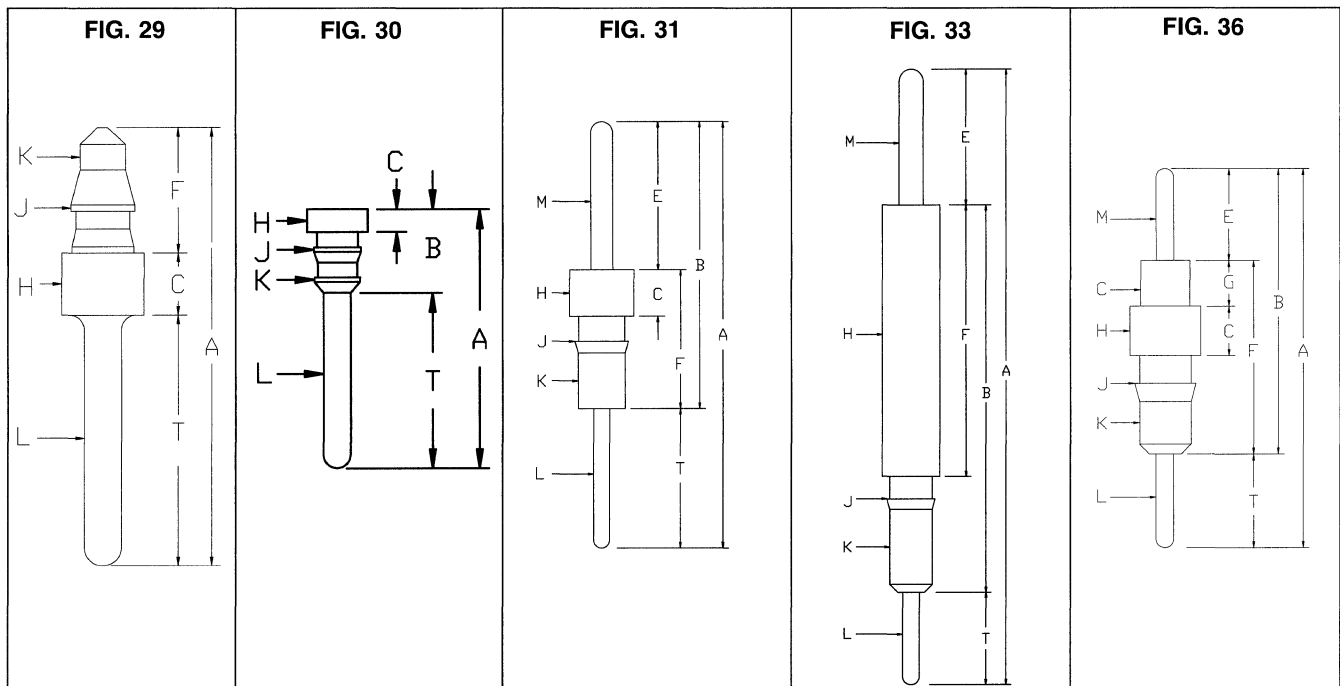

# Contact Specifications



McKenzie Socket Division

PART NO.	FIG NO.	PLATING	CLIP STYLE	PCB MOUNT	MATING MIN/MAX	TAIL LENGTH T	OVER-ALL A	BODY HEIGHT B	HEAD HEIGHT C	E	F	G	HEAD DIA. H	BARB DIA. J	BODY DIA. K	TAIL DIA. L	PIN DIA. M	MAX DEPTH Z
<b>PRESSFIT AND COMPLIANT CONTACTS</b>																		
001Z	44	GT	#6(35) <sup>§</sup>	.057/.040	.015/.025	.120	.293	.173	.031	-	-	-	.072	.059	.055	.038/.035	-	.150
003Z	44	GT	#6(35) <sup>§</sup>	.057/.040	.015/.025	.176	.349	.173	.031	-	-	-	.072	.060	.045	.35	-	.150
970E	39	GG	#4(30)	.057/.040	.015/.025	-	.350	.177	.030	.087	.028	.115	.071	.059	.053	.026	.035	-
972E	39	PP	#4(30)	.057/.040	.015/.025	-	.350	.177	.030	.087	.028	.115	.071	.059	.053	.026	.035	-
975E	39	GG	#4(30)	.057/.040	.015/.025	-	.425	.175	.030	.140	.040	.180	.072	.060	.056	.025	.036	-
977E	39	PP	#4(30)	.057/.040	.015/.025	-	.425	.175	.030	.140	.040	.180	.072	.060	.056	.025	.036	-
995E	41	TT	#6(32) <sup>*</sup>	.055/.035	.016/.026	.120	.320	.200	.040	-	.175	.075	.062	-	.052	.025	.031 SQ.	.175
998E	44	TT	#4(30)	.057/.040	.015/.025	.175	.348	.173	.031	-	.045	.050	.072	.060	.056	.038/.035 TAPER	-	.150

## SURFACE MOUNT MALE PINS

001P	47	G	NO CLIP	.050PAD	SMT FLT PIN	.115	.210	.095	.025	-	-	-	.035	.030	.027	.018	-	-
003P	48	G	NO CLIP	.050 PAD	SMT FLT PIN	.165	.320	.155	.025	-	-	-	.035	.039	.027	.018	.025	-
976P	45	G	PHOSBZ	.050 PAD	SMT FLT PIN	.125	.240	.115	.035	.057	-	-	.060	.039	.036	.018	-	-

**For additional Contact Information and Technical Specifications See Section X**

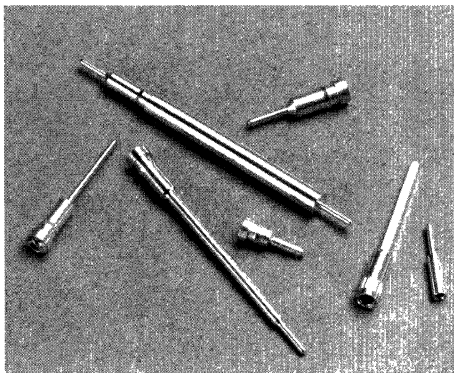

Can't find the contact you're looking for? Custom screw machine contacts are available from McKenzie Technology! Please call with your requirements.

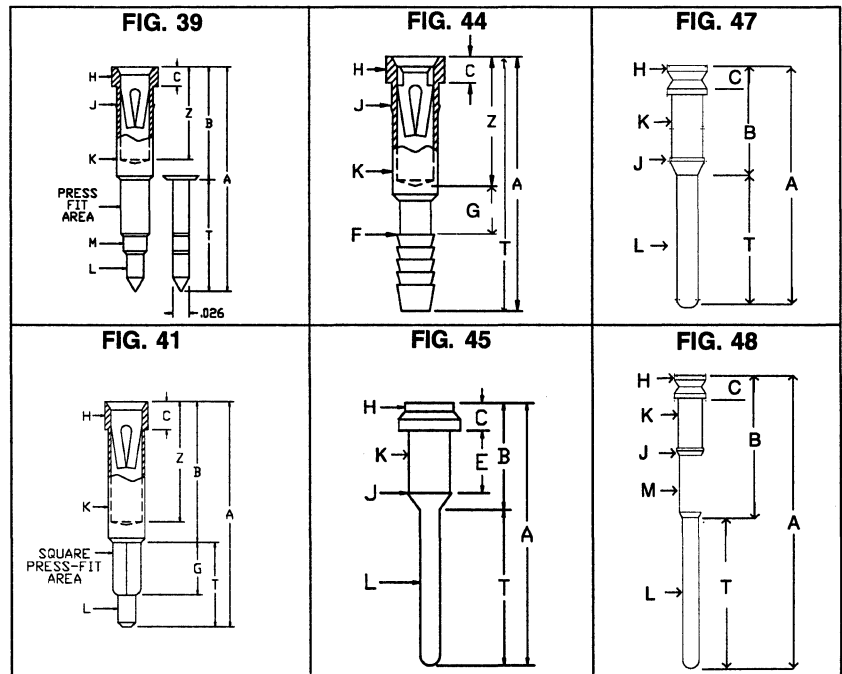

\* Very low insertion clip  
 § Ultra low insertion force

Contact Tolerances: Lengths: ±.005  
 Diameters: ±.002  
 Angles: ± 2°

Contact Diameter Tolerances for PCB Mount: Barb: ±.002  
 Tail: ±.002

Note: These are suggested PTH sizes. Review contact diameters and tolerances carefully. Dimensions are in inches.

For more information on plating and clip styles see page A1

### McKenzie Delivers Choices!!

- Largest selection of Contact Options
- Open or Closed frame
- Disposable Plastic Pin Carrier™ Option
- True Hi-Temp Options – IR and Vapor Phase compatible
- End-to-End and Side-to-Side stackable
- Wide variety of DIP Adaptors
- Precision Multi-Finger Hi-Rel Contacts
- No solder wicking or flux intrusion
- Integral DeCoupling Capacitors

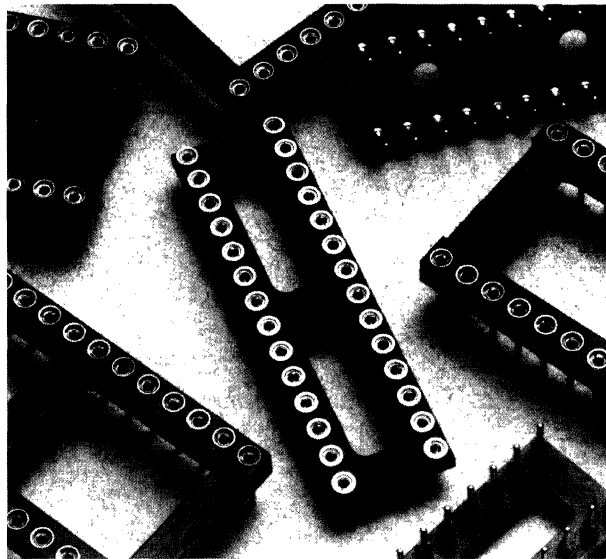

**B**

### Standard Insulator Materials

P/N	MATERIAL	DESCRIPTION	CONTINUOUS USE TEMP.
*	<b>PBT</b>	Glass Reinforced Polyester Thermoplastic, UL 94V-0	≤ 140°C

\* Part number information specifying material is not necessary to select standard material

### Hi-Temp alternatives suitable for IR and Vapor Phase soldering.

P/N	MATERIAL	DESCRIPTION	CONTINUOUS USE TEMP.
<b>R</b>	<b>PPS</b>	Glass Reinforced Polyphenylene Sulfide, UL 94V-0	≤220°C
<b>F</b>	<b>FR4</b>	Glass Reinforced Epoxy Laminate, UL 94V-0	≤140°C
<b>H</b>	<b>Hi-3003</b>	Glass Reinforced Polyimide Laminate, UL 94V-0	≤250°C



AVAILABLE

*For complete material specifications see Section X.*

### Insulator Options

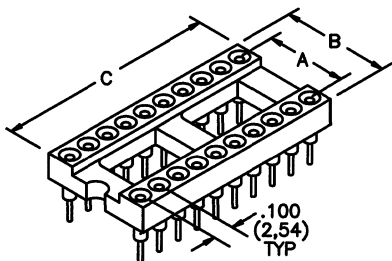

**OPEN FRAME**

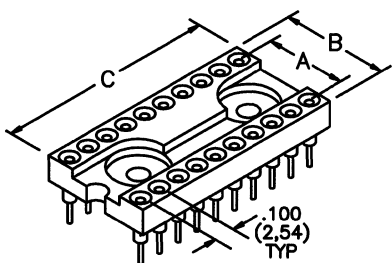

**CLOSED FRAME**

Insulators are  
UL 94V-0 Rated  
Thermoplastic



AVAILABLE

See page B1 for Hi-Temp Options

### OUR MOST POPULAR CONTACT

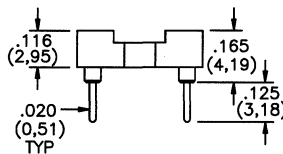

- | Specify      | Contact/Shell       |
|--------------|---------------------|
| <b>001B</b>  | 30μ" Gold/200μ" Tin |
| <b>002B</b>  | 30μ" Gold/10μ" Gold |
| <b>011B</b>  | 10μ" Gold/200μ" Tin |
| <b>014B</b>  | 200μ" Tin/200μ" Tin |
| <b>016B*</b> | 30μ" Gold/200μ" Tin |
| <b>PTH =</b> | .026 ± .003         |

\*CLINCHABLE SOFT BRASS

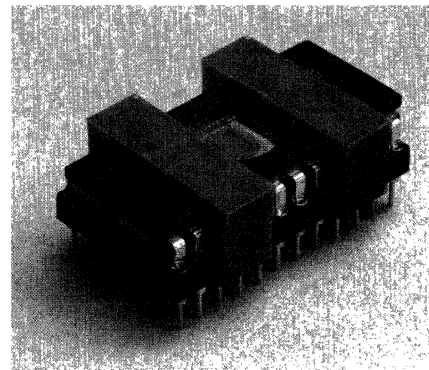

IC Retention DIP Clamps See Page B19

### SHORTER SOLDER TAIL — NO TRIMMING

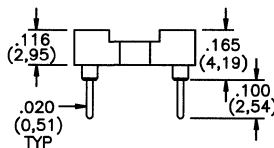

- | Specify      | Contact/Shell       |
|--------------|---------------------|
| <b>018B</b>  | 200μ" Tin/200μ" Tin |
| <b>PTH =</b> | .026 ± .003         |

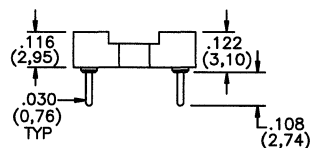

- | Specify      | Contact/Shell       |
|--------------|---------------------|
| <b>185B</b>  | 30μ" Gold/200μ" Tin |
| <b>PTH =</b> | .036 ± .003         |

### HIGHER PCB STANDOFF

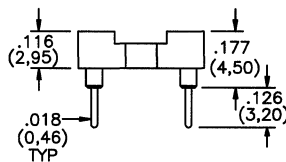

- | Specify      | Contact/Shell       |
|--------------|---------------------|
| <b>248B</b>  | 30μ" Gold/10μ" Gold |
| <b>PTH =</b> | .024 ± .003         |

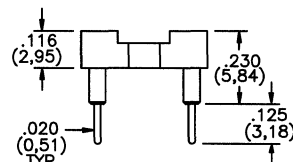

- | Specify      | Contact/Shell       |
|--------------|---------------------|
| <b>040B</b>  | 30μ" Gold/10μ" Gold |
| <b>041B</b>  | 30μ" Gold/200μ" Tin |
| <b>PTH =</b> | .026 ± .003         |

**Contact/Shell:**

Inner Contact — Beryllium Copper  
Outer Shell — 1/2 Hard Brass

**Plating:**

Outer Shell — Gold over 100μ" Nickel or Tin over 100μ" Nickel  
Inner Contact — Gold over 50μ" Nickel or Tin over 100μ" Nickel

Other contact and plating styles available, see Section A or consult the factory

McK McKenzie Socket Division

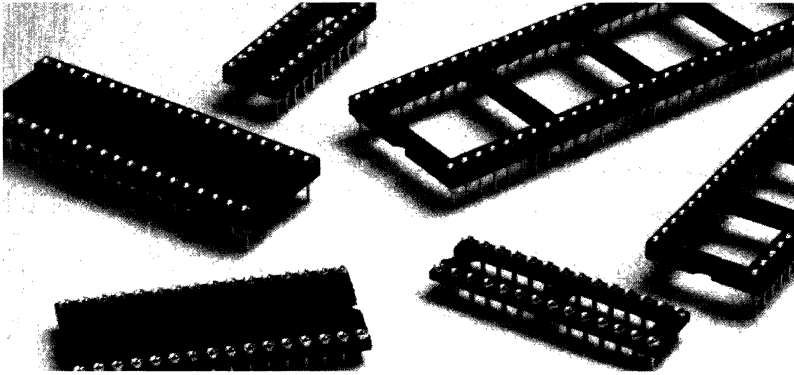

Open and Closed Frame DIP Sockets

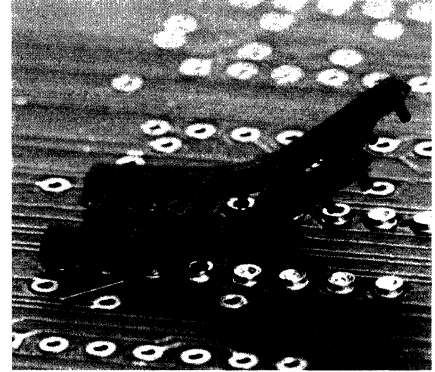

B

### EXTRA LONG SOLDER TAILS

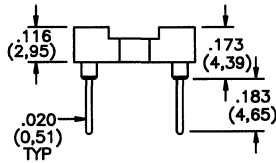

Specify Contact/Shell

- 091B** 30μ" Gold/10μ" Gold
- 054B** 30μ" Gold/200μ" Tin
- 057B** 200μ" Tin/200μ" Tin
- PTH =** .026 ± .003

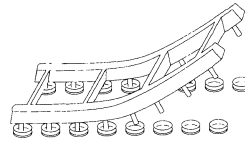

All contact styles are available in our Patented PPC™ Disposable Carrier System. Specify PPC in part number.

### How To Order

PPC - DIP - 320 - 011B - CF - R

For pins on a carrier strip begin the part number with "PPC"  
or "HPC" (option) \*

Product Code      # of Contacts      Contact Style      Closed Frame (Option)      Hi-Temp Material Call Out (Option)\*\*

Row-to-Row Spacing

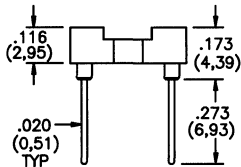

Specify Contact/Shell

- 067B** 30μ" Gold/200μ" Tin
- 113B** 30μ" Gold/10μ" Gold
- PTH =** .026 ± .003

\*Only add the "PPC" option to the front of the part number if a carrier system is required.

\*\*See page B1 for Material Call Outs. Open frame is standard and available for all sizes and row-to-row spacing. Closed frame available in sizes shaded in table below. Add "CF" to the end of the p/n.

NO. OF CONTACTS	6	8	14	16	18	20	22	24	28	20	22	24	24	28	32	40	48	64
<b>A</b>					.300 (7,62)						.400 (10,16)				.600 (15,24)			.900 (22,86)
<b>B</b>					.400 (10,16)						.500 (12,70)				.700 (17,78)			1.000 (25,40)
<b>C</b>	.300 (7,62)	.400 (10,16)	.700 (17,78)	.800 (20,32)	.900 (22,86)	1.000 (25,40)	1.100 (27,94)	1.200 (30,48)	1.400 (35,56)	1.000 (25,40)	1.100 (27,94)	1.200 (30,48)	1.200 (30,48)	1.400 (35,56)	1.600 (40,64)	2.000 (50,80)	2.400 (60,96)	3.200 (81,28)



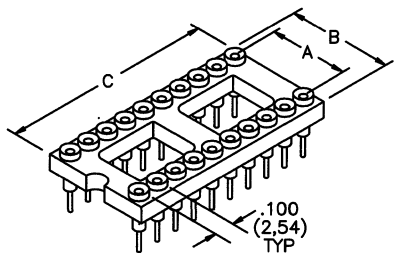

**OPEN FRAME**

**Features**

- Profiles to .083" (2,11) above PCB
- Available in our PPC™ disposable carrier system
- Hi-Rel multifinger contacts are non-solder wicking

**ULTRA LOW PROFILE OPTIONS**

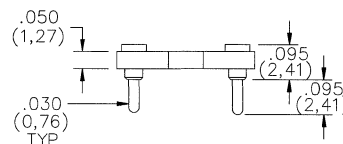
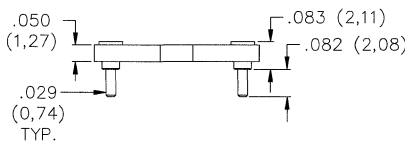

Specify	Contact/Shell
<b>156B</b>	30μ" Gold/200μ" Tin
<b>153B*</b>	30μ" Gold/200μ" Tin
<b>PTH =</b>	.035 ± .003

\* Very Low Insertion Force (VLI)  
Recommended for socketing IC's  
that have stamped leads

Specify	Contact/Shell
<b>157B</b>	200μ" Tin/200μ" Tin
<b>160B</b>	30μ" Gold/200μ" Tin
<b>161B</b>	30μ" Gold/10μ" Gold
<b>164B*</b>	30μ" Gold/200μ" Tin
<b>PTH =</b>	.036 ± .003

Insulators are  
UL 94V-0 Rated  
Thermoplastic.



**AVAILABLE**

See page B1 for Hi-Temp Options

**How To Order**

with Low Profile Molded Insulator

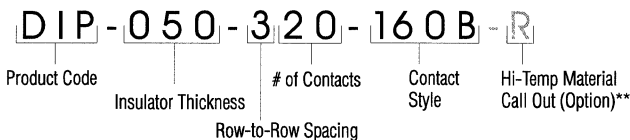

**How To Order**

our PPC Disposable Carrier System

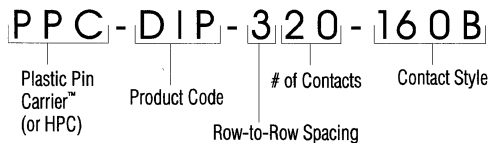

\*\*See page B1 for Material Call Outs

Other contact and plating styles available, see Section A or consult the factory

NO. OF CONTACTS	6	8	14	16	18	20	22	24	28	20	22	24	24	28	32	36	40	48	50	64				
<b>A</b>					.300 (7,62)									.400 (10,16)					.600 (15,24)					.900 (22,86)
<b>B</b>					.400 (10,16)									.500 (12,70)					.700 (17,78)					1.000 (25,40)
<b>C</b>	.300 (7,62)	.400 (10,16)	.700 (17,78)	.800 (20,32)	.900 (22,86)	1.000 (25,40)	1.100 (27,94)	1.200 (30,48)	1.400 (35,56)	1.000 (25,40)	1.100 (27,94)	1.200 (30,48)	1.200 (30,48)	1.400 (35,56)	1.600 (40,64)	1.800 (45,72)	2.000 (50,80)	2.400 (60,96)	2.500 (63,50)	3.200 (81,28)				

### Features

- Rigid Pin Carrier for ease in assembly
- Contact is fully masked and protected during solder and washing.
- No expensive RTV compounds
- No contact intrusion – Eliminates damage or oversizing of contacts
- Full inspectability of solder joints
- Easy flux removal

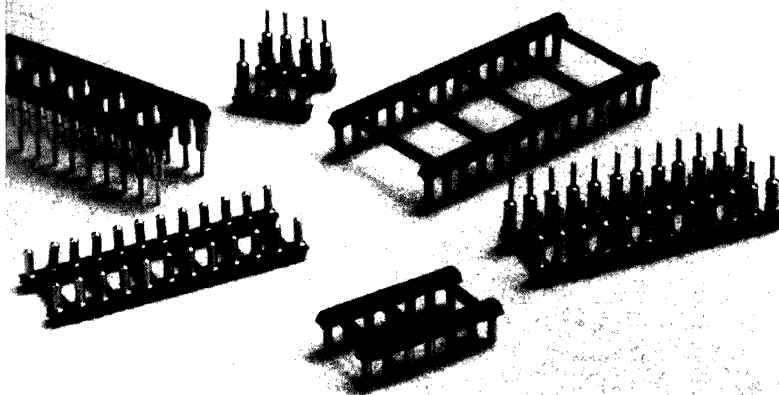

Achieve near flush socket profile with our patented Plastic Pin Carrier (PPC™) Disposable Carrier System — Patent No. 4,420,877

#### .016" (0,41) ABOVE PC BOARD

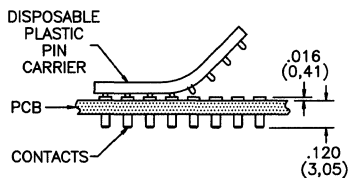

#### .016" (0,41) ABOVE PC BOARD

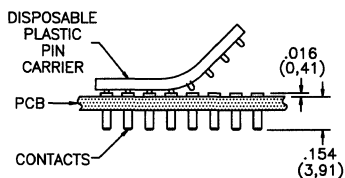

#### .031" (0,79) ABOVE BOARD

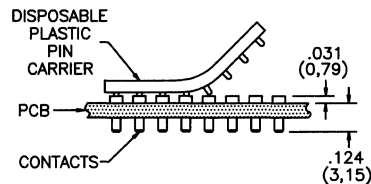

**Specify Contact/Shell**  
**710C** 30μ" Gold/200μ" Tin  
**711C** 30μ" Gold/10μ" Gold  
**714C** 200μ" Tin-Lead/200μ" Tin-Lead  
**PTH =** .042 ± .003

**Specify Contact/Shell**  
**720C** 30μ" Gold/200μ" Tin  
**721C** 30μ" Gold/10μ" Gold  
**PTH =** .042 ± .003

**Specify Contact/Shell**  
**725C** 30μ" Gold/200μ" Tin  
**726C** 200μ" Tin/200μ" Tin  
**PTH =** .038 ± .003

## How To Order

PPC - DIP - 320 - 710C

Plastic Pin Carrier™  
HPC for Hi-Temp  
Material

Product Code

# of Contacts

Contact Style

Row-to-Row Spacing

**Contact/Shell:**  
Outer Shell — 1/2 Hard Brass  
Inner Contact — Beryllium Copper

**Plating:**  
Outer Shell — Gold over Nickel or Tin over Nickel  
or 93/7 Tin/Lead over Nickel  
Inner Contact — Gold over Nickel or Tin over Nickel

NO. OF CONTACTS	6	8	14	16	18	20	22	24	28	30	32	36	40	48	50	64		
CENTER TO CENTER					.300 (7,62)				.400 (10,16)				.600 (15,24)				.900 (22,86)	

**Insulator Options**

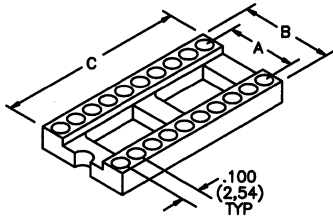

**OPEN FRAME**

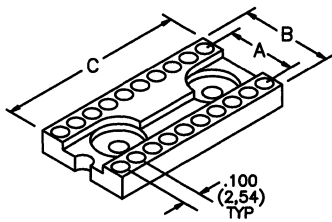

**CLOSED FRAME**

Insulators are  
UL94-V0 Rated  
Thermoplastic



**AVAILABLE**

See page B1 for complete  
material specifications

**Popular Elevated DIP Sockets**

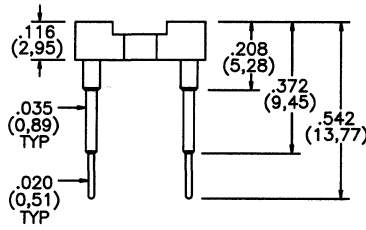

**Specify Contact/Shell**  
**302B** 30μ" Gold/200μ" Tin  
**PTH =** .026 ± .003

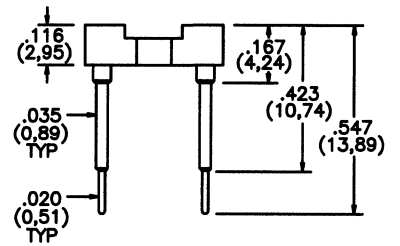

**Specify Contact/Shell**  
**310B** 30μ" Gold/10μ" Gold  
**PTH =** .026 ± .003

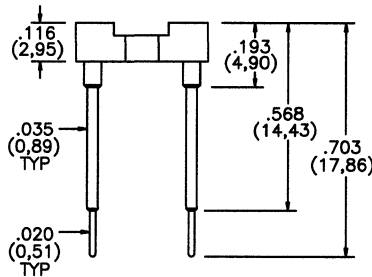

**Specify Contact/Shell**  
**301B** 30μ" Gold/200μ" Tin  
**PTH =** .026 ± .003

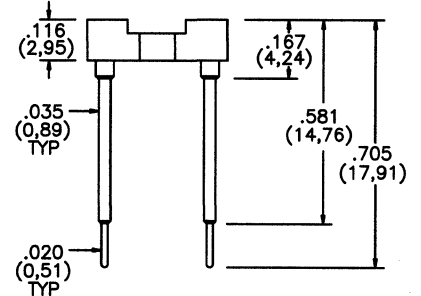

**Specify Contact/Shell**  
**312B** 30μ" Gold/10μ" Gold  
**PTH =** .026 ± .003

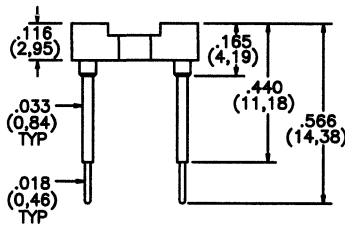

**Specify Contact/Shell**  
**300B** 30μ" Gold/200μ" Tin  
**PTH =** .024 ± .003

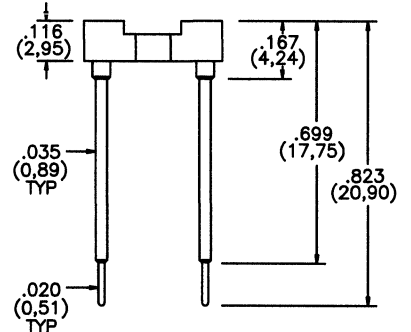

**Specify Contact/Shell**  
**313B** 30μ" Gold/10μ" Gold  
**PTH =** .026 ± .003

**Contact/Shell:**  
Outer Shell — 1/2 Hard Brass  
Inner Contact — Beryllium Copper

**Plating:**  
Outer Shell — Gold over 100μ Nickel or Tin over 100μ Nickel  
Inner Contact — Gold over 50μ Nickel or Tin over 100μ Nickel

Other contact and plating styles available, see section A or consult the factory

McK McKenzie Socket Division

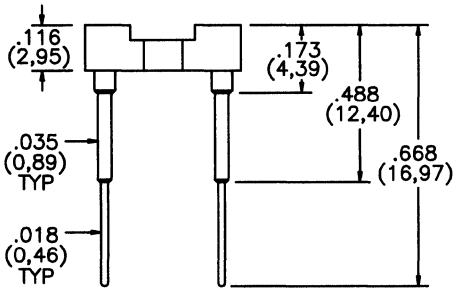

**Specify Contact/Shell**  
**314B** 30μ" Gold/10μ" Gold  
**PTH =** .024 ± .003

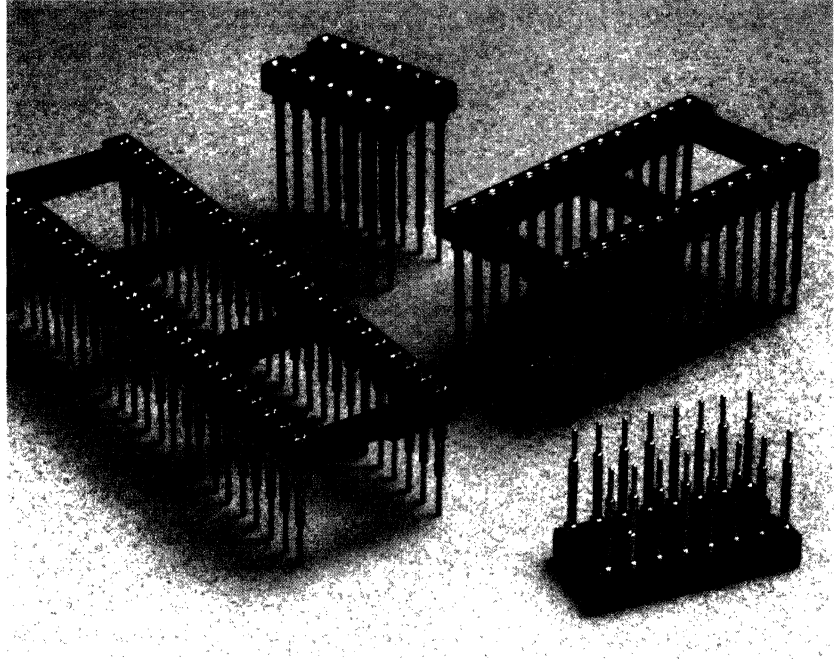

Elevated DIP Sockets

**B**

### How to Order

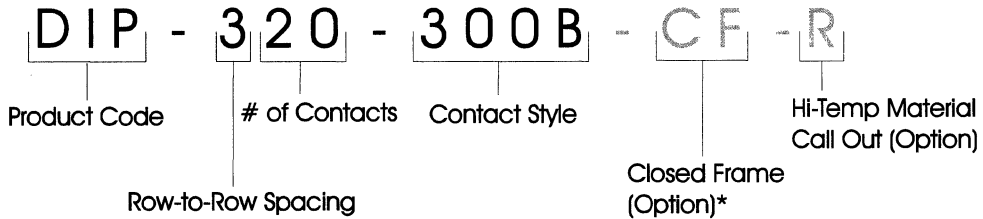

*\*Open frame is standard and available for all sizes and row-to-row spacing. Closed frame available in sizes shaded in table below. Add "CF" to the end of the p/n.*

**\*\*See page B1 for Material Call Outs**

NO.OF CONTACTS	6	8	14	16	18	20	22	24	28	20	22	24	24	28	32	36	40	48	50	64
A					.300 (7,62)						.400 (10,16)				.600 (15,24)				.900 (22,86)	
B					.400 (10,16)						.500 (12,70)				.700 (17,78)				1.000 (25,40)	
C	.300 (7,62)	.400 (10,16)	.700 (17,78)	.800 (20,32)	.900 (22,86)	1.000 (25,40)	1.100 (27,94)	1.200 (30,48)	1.400 (35,56)	1.000 (25,40)	1.100 (27,94)	1.200 (30,48)	1.200 (30,48)	1.400 (35,56)	1.600 (40,64)	1.800 (45,72)	2.000 (50,80)	2.400 (60,96)	2.500 (63,50)	3.200 (81,28)

### Insulator Options

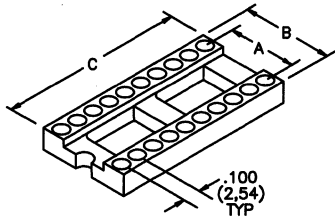

**OPEN FRAME**

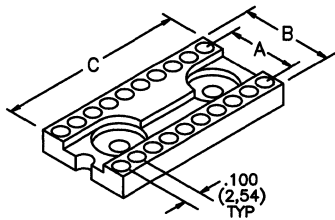

**CLOSED FRAME**

Insulators are  
UL 94V-0 Rated  
Thermoplastic



**AVAILABLE**

See page B1 for complete  
material specifications

### 2 LEVEL WIRE WRAP

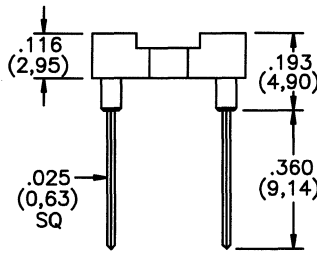

**Standard Insertion Force**

**Specify Contact/Shell**

- 400B** 30μ" Gold/200μ" Tin
- 401B** 30μ" Gold/10μ" Gold

**Very Low Insertion Force**

**Specify Contact/Shell**

- 402B** 30μ" Gold/200μ" Tin
- 403B** 30μ" Gold/10μ" Gold

### 3 LEVEL WIRE WRAP

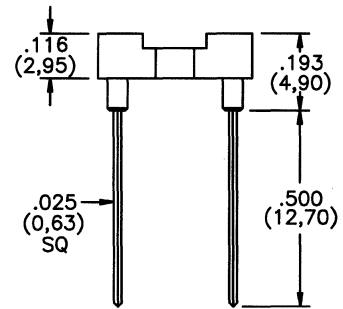

**Standard Insertion Force**

**Specify Contact/Shell**

- 410B** 30μ" Gold/200μ" Tin
- 411B** 30μ" Gold/10μ" Gold

**Very Low Insertion Force**

**Specify Contact/Shell**

- 412B** 30μ" Gold/200μ" Tin
- 413B** 30μ" Gold/10μ" Gold

## How To Order

**D W W 3 2 0 - 4 0 0 B - C F - R**

Product Code      Number of Contacts      Contact Style      Closed Frame (Option)\*      Hi-Temp Material Call Out (Option)\*\*

Row-to-Row Spacing

*\*Open frame is standard and available for all sizes and row-to-row spacing. Closed frame available in sizes shaded in table below. Add "CF" to the end of the p/n.*

**Also available in PPC™**

**\*\*See page B1 for Material Callouts**

**Contact/Shell:**  
Outer Shell — 1/2 Hard Brass  
Inner Contact — Beryllium Copper

**Plating:**  
Outer Shell — Gold over Nickel or Tin over Nickel  
Inner Contact — Gold over Nickel

**Other contact and plating styles available, see section A or consult the factory**

NO. OF CONTACTS	6	8	14	16	18	20	22	24	28	20	22	24	24	28	32	36	40	48	50	64
<b>A</b>					.300 (7,62)						.400 (10,16)				.600 (15,24)				.900 (22,86)	
<b>B</b>					.400 (10,16)						.500 (12,70)				.700 (17,78)				1.000 (25,40)	
<b>C</b>	.300 (7,62)	.400 (10,16)	.700 (17,78)	.800 (20,32)	.900 (22,86)	1.000 (25,40)	1.100 (27,94)	1.200 (30,48)	1.400 (35,56)	1.000 (25,40)	1.100 (27,94)	1.200 (30,48)	1.200 (30,48)	1.400 (35,56)	1.600 (40,64)	1.800 (45,72)	2.000 (50,80)	2.400 (60,96)	2.500 (63,50)	3.200 (81,28)

### Insulator Options

- Integral Decoupling Capacitor reduces noise
- SMT construction eliminates capacitor intermittence during thermal cycling
- Three standard capacitance values: .01, .10, .33  $\mu\text{f}$  — Specify in part number
- For other capacitance values, please consult factory

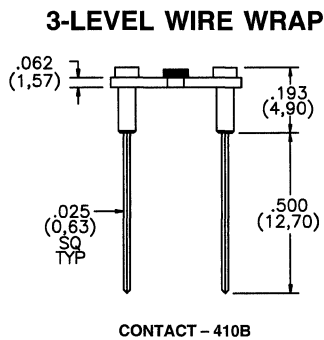
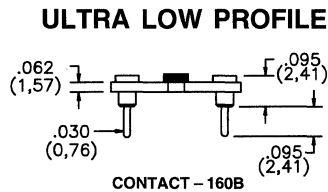
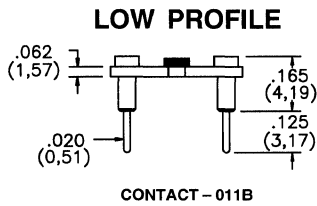
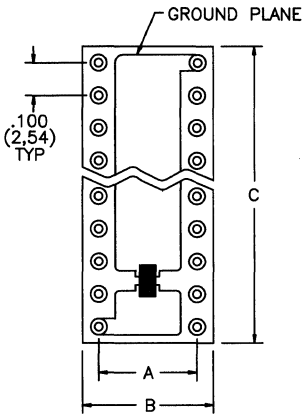

Other contact and plating styles available, see Section A or consult factory

NO. OF CONTACTS	A	B MAX	C MAX	PART NUMBER	PART NUMBER	PART NUMBER
				Low Profile	Ultra Low Profile	Wire Wrap 3-Level
<i>Standard .100" DIP Spacing      Fill in One of Three Standard Capacitance Values as XX - .01, .10, .33 <math>\mu\text{f}</math></i>						
8			0.400 (10,16)	DXC 308 - 011B - XX	DXC 308 - 160B - XX	DXC 308 - 410B - XX
14			0.700 (17,78)	DXC 314 - 011B - XX	DXC 314 - 160B - XX	DXC 314 - 410B - XX
16			0.800 (20,32)	DXC 316 - 011B - XX	DXC 316 - 160B - XX	DXC 316 - 410B - XX
18	0.300 (07,62)	0.400 (10,16)	0.900 (22,86)	DXC 318 - 011B - XX	DXC 318 - 160B - XX	DXC 318 - 410B - XX
20			1.000 (25,40)	DXC 320 - 011B - XX	DXC 320 - 160B - XX	DXC 320 - 410B - XX
22			1.100 (27,94)	DXC 322 - 011B - XX	DXC 322 - 160B - XX	DXC 322 - 410B - XX
24			1.200 (30,48)	DXC 324 - 011B - XX	DXC 324 - 160B - XX	DXC 324 - 410B - XX
28			1.400 (35,56)	DXC 328 - 011B - XX	DXC 328 - 160B - XX	DXC 328 - 410B - XX
22	0.400 (10,16)	0.500 (12,70)	1.100 (27,94)	DXC 422 - 011B - XX	DXC 422 - 160B - XX	DXC 422 - 410B - XX
24			1.200 (30,48)	DXC 424 - 011B - XX	DXC 424 - 160B - XX	DXC 424 - 410B - XX
24	0.600 (15,24)	0.700 (17,78)	1.200 (30,48)	DXC 624 - 011B - XX	DXC 624 - 160B - XX	DXC 624 - 410B - XX
28			1.400 (35,56)	DXC 628 - 011B - XX	DXC 628 - 160B - XX	DXC 628 - 410B - XX
32			1.600 (40,64)	DXC 632 - 011B - XX	DXC 632 - 160B - XX	DXC 632 - 410B - XX
40			2.000 (50,80)	DXC 640 - 011B - XX	DXC 640 - 160B - XX	DXC 640 - 410B - XX
48			2.400	DXC 648 - 011B - XX	DXC 648 - 160B - XX	DXC 648 - 410B - XX

### Consult Factory for Alternative Contact and Capacitance Values

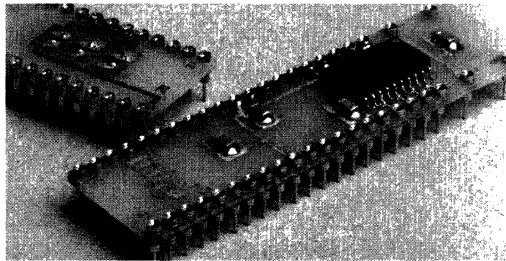

**Design Your Own — Consult the factory**

#### Insulator:

1oz. Copper clad FR4  
Minimum PbSn plating 300 $\mu$

#### Contact/Shell:

Outer Shell — 1/2 Hard Brass  
Inner Contact — Beryllium Copper

#### Plating:

Outer Shell — Tin over Nickel  
Inner Contact — Gold over Nickel

#### Capacitor:

Standard Capacitance Tolerance is  $\pm 10\%$ .  
Maximum Height above board is .065"

### Insulator Options

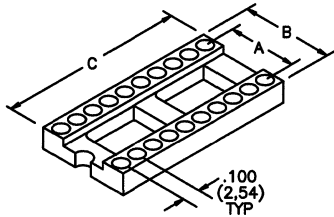

**OPEN FRAME**

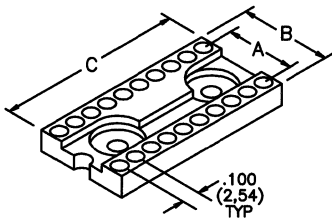

**CLOSED FRAME**

Insulators are  
UL 94V-0 Rated  
Thermoplastic



**AVAILABLE**

See page B1 for complete  
material specifications

### Turret Terminal

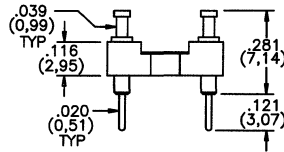

**Specify Plating**  
**850L 10μ" Gold**

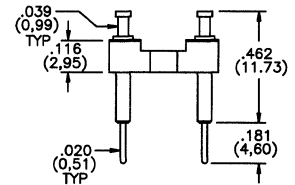

**Specify Plating**  
**853L 200μ" Tin**

### WIRE WRAP

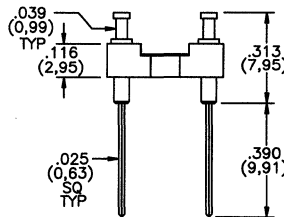

**Specify Plating**  
**854L 10μ" Gold**

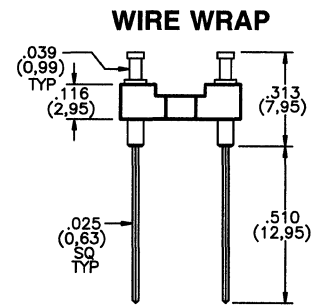

**Specify Plating**  
**855L 10μ" Gold**

### Bifurcated Terminal

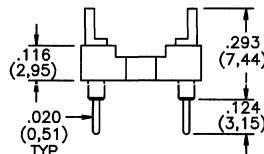

**Specify Plating**  
**830G 10μ" Gold**  
**831G 200μ" Tin**

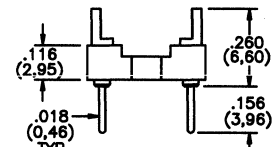

**Specify Plating**  
**832G 10μ" Gold**  
**834G 200μ" Tin**

### WIRE WRAP

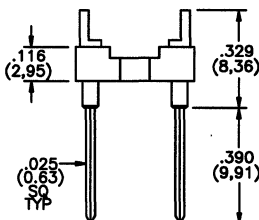

**Specify Plating**  
**837G 10μ" Gold**

### WIRE WRAP

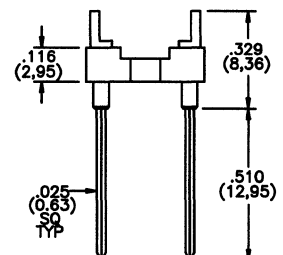

**Specify Plating**  
**838G 10μ" Gold**

### Solder Cup

#### WIRE WRAP

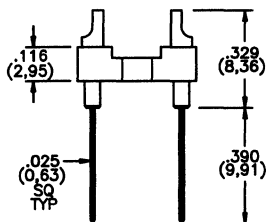

Specify Plating  
842K 10µ" Gold

#### WIRE WRAP

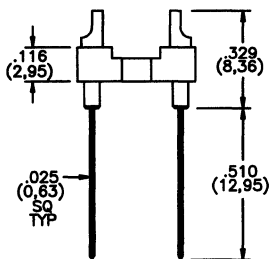

Specify Plating  
843K 10µ" Gold

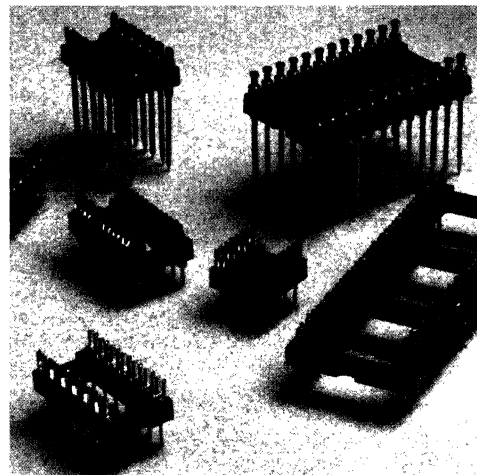

**B**

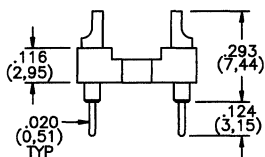

Specify Plating  
840K 10µ" Gold

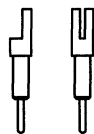

Bifurcated contact at 90° Rotation

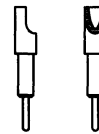

Solder Cup contact at 90° Rotation

#### Contact/Shell:

Outer Shell — 1/2 Hard Brass  
Inner Contact — Beryllium Copper

#### Plating:

Outer Shell — Gold over Nickel or Tin over Nickel  
Inner Contact — Gold over Nickel or Tin over Nickel

Other contact and plating styles available,  
see Section A or consult factory

### How to Order

DPL - 320 - 850L - CF - R

Specify Product Code  
DPG - DIP Bifurcated Adaptor  
DPK - DIP Solder Cup Adaptor  
DPL - DIP Turret Adaptor

# of Contacts  
Row-to-Row Spacing

Contact Style

Hi-Temp Material Call Out (Option)\*\*  
Closed Frame (Option)\*

**\*Open frame is standard and available for all sizes and row-to-row spacing. Closed frame available in sizes shaded in table below. Add "CF" to the end of the p/n.**

**\*\*See page B1 for Material Call Outs**

NO.OF CONTACTS	6	8	14	16	18	20	22	24	28	20	22	24	24	28	32	36	40	48	50	64
A				.300 (7,62)							.400 (10,16)				.600 (15,24)					.900 (22,86)
B				.400 (10,16)							.500 (12,70)				.700 (17,78)					1.000 (25,40)
C	.300 (7,62)	.400 (10,16)	.700 (17,78)	.800 (20,32)	.900 (22,86)	1.000 (25,40)	1.100 (27,94)	1.200 (30,48)	1.400 (35,56)	1.000 (25,40)	1.100 (27,94)	1.200 (30,48)	1.200 (30,48)	1.400 (35,56)	1.600 (40,64)	1.800 (45,72)	2.000 (50,80)	2.400 (60,96)	2.500 (63,50)	3.200 (81,28)



### Insulator Options

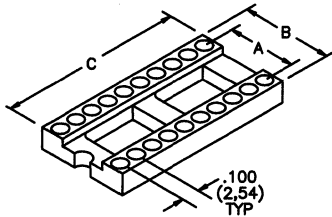

**OPEN FRAME**

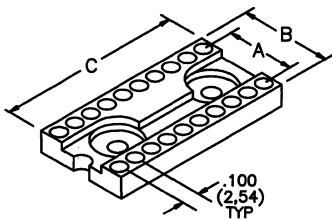

**CLOSED FRAME**

Insulators are  
UL 94V-0 Rated  
Thermoplastic.



**AVAILABLE**

*\*See page B1 for complete material specifications*

### Low Profile Options

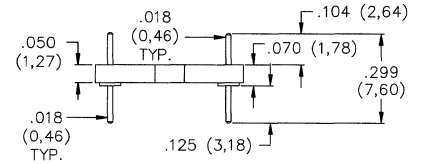
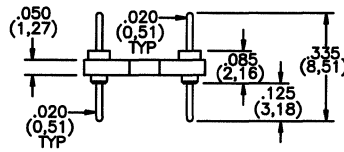

**Specify Plating/Material**  
**880S** 10μ" Gold/Phosphor Bronze  
**881S** 200μ" Tin/ Phosphor Bronze  
**PTH = .026 ± .003**

**Specify Plating/Material**  
**868S** 10μ" Gold/Brass  
**869S** 200μ" Tin/ Brass  
**PTH = .024 ± .003**

### How to Order

**DST - 050 - 320 - 880S - R**

Product Code      Insulator Thickness      Row-to-Row Spacing      Number of terminals      Terminal Style      Hi Temp Material Callout (Option)\*

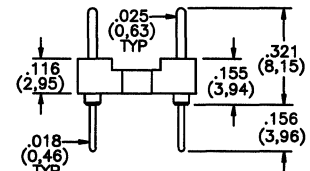
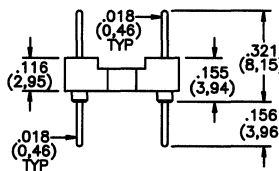

**Specify Plating/Material**  
**876S** 10μ" Gold/Phosphor Bronze  
**878S** 10μ" Gold/Brass  
**879S** 200μ" Tin/Brass  
**PTH = .024 ± .003**

**Specify Plating/Material**  
**874S** 10μ" Gold/Brass  
**PTH = .024 ± .003**

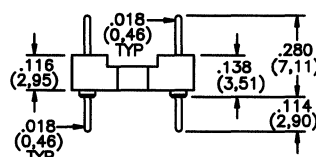

**Specify Plating/Material**  
**884S** 10μ" Gold/Brass  
**PTH = .024 ± .003**

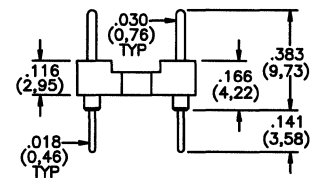

**Specify Plating/Material**  
**886S** 10μ" Gold/Brass  
**PTH = .024 ± .003**

*Other contact and plating styles available, see section A or consult the factory*

McKenzie Socket Division

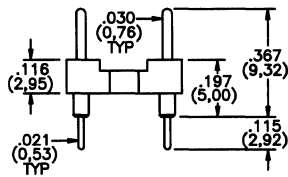

**Specify Plating/Material**  
**870S** 10μ" Gold/Brass  
**PTH =** .027 ± .003

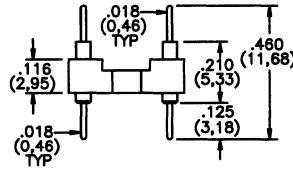

**Specify Plating/Material**  
**861S** 10μ" Gold/Brass  
**857S** 200μ" Tin/Brass  
**PTH =** .024 ± .003

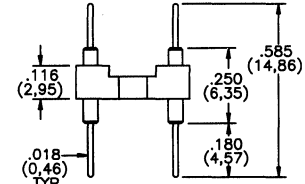

**Specify Plating/Material**  
**867S** 10μ" Gold/Phosphor Bronze  
**PTH =** .024 ± .003

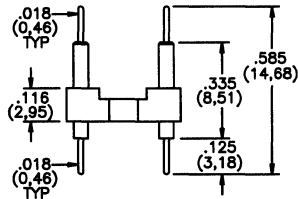

**Specify Plating/Material**  
**862S** 10μ" Gold/Brass  
**858S** 200μ" Tin/Brass  
**PTH =** .024 ± .003

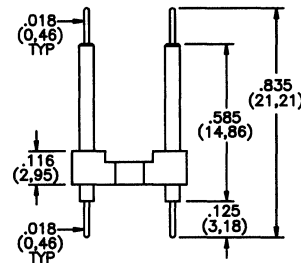

**Specify Plating/Material**  
**863S** 10μ" Gold/Brass  
**859S** 200μ" Tin/Brass  
**PTH =** .024 ± .003

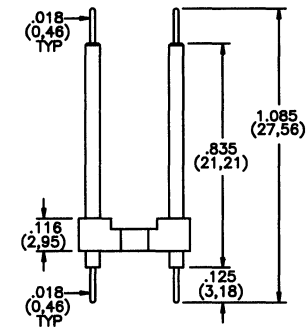

**Specify Plating/Material**  
**864S** 10μ" Gold/Brass  
**860S** 200μ" Tin/Brass  
**PTH =** .024 ± .003

### WIRE WRAP

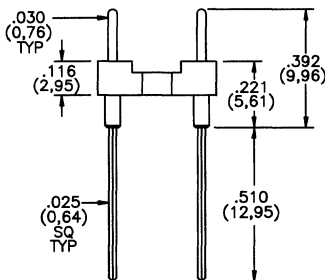

**Specify Plating/Material**  
**900S** 10μ" Gold/Brass

### How to Order

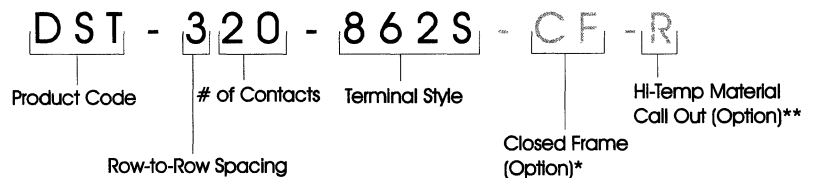

*\*Open frame is standard and available for all sizes and row-to-row spacing. Closed frame available in sizes shaded in table below. Add "CF" to the end of the p/n.*

**\*\*See page B1 for Material Call Outs**

NO. OF CONTACTS	6	8	14	16	18	20	22	24	28	20	22	24	24	28	32	36	40	48	50	64
<b>A</b>					.300 (7,62)						.400 (10,16)				.600 (15,24)					.900 (22,86)
<b>B</b>					.400 (10,16)						.500 (12,70)				.700 (17,78)					1.000 (25,40)
<b>C</b>	.300 (7,62)	.400 (10,16)	.700 (17,78)	.800 (20,32)	.900 (22,86)	1.000 (25,40)	1.100 (27,94)	1.200 (30,48)	1.400 (35,56)	1.000 (25,40)	1.100 (27,94)	1.200 (30,48)	1.200 (30,48)	1.400 (35,56)	1.600 (40,64)	1.800 (45,72)	2.000 (50,80)	2.400 (60,96)	2.500 (63,50)	3.200 (81,28)

**B**

### Insulator Options

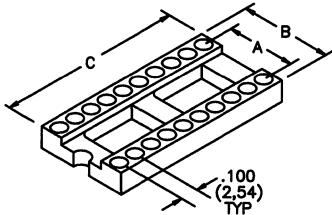

**OPEN FRAME**

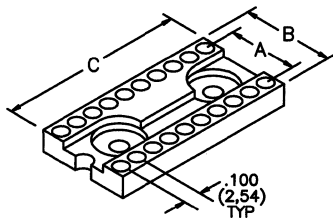

**CLOSED FRAME**

Insulators are  
UL 94-V0 Rated  
Thermoplastic.



**AVAILABLE**

See page B1 for complete  
material specifications

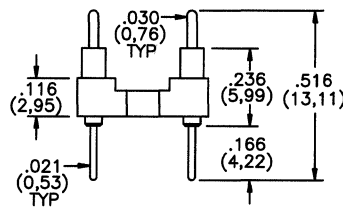

**Specify Plating**  
**922H** 10μ" Gold  
**PTH =** .027 ± .003

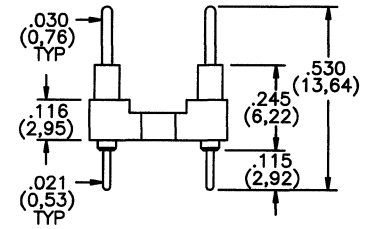

**Specify Plating**  
**935H** 10μ" Gold  
**PTH =** .027 ± .003

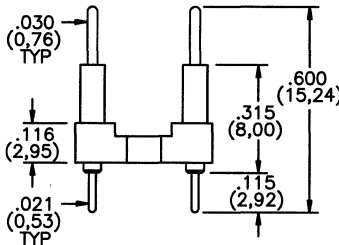

**Specify Plating**  
**924H** 10μ" Gold  
**PTH =** .027 ± .003

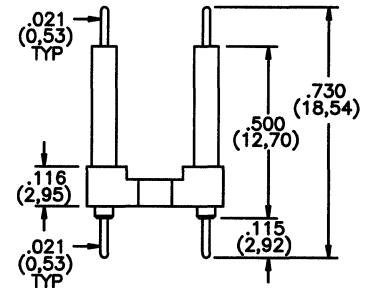

**Specify Plating**  
**930H** 10μ" Gold  
**PTH =** .027 ± .003

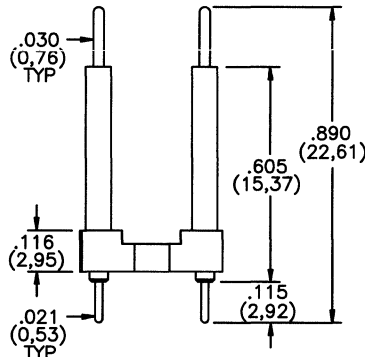

**Specify Plating**  
**920H** 10μ" Gold  
**PTH =** .027 ± .003

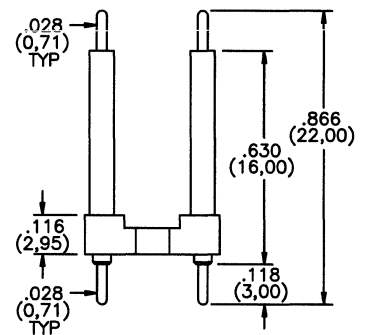

**Specify Plating**  
**926H** 10μ" Gold  
**PTH =** .034 ± .003

**Plating:**

Gold over Nickel or Tin over Nickel

**Terminal:**

1/2 Hard Brass

Other contact and plating styles available, see section A or consult the factory

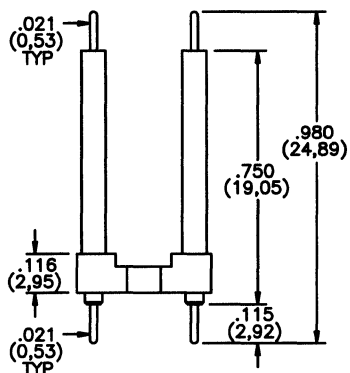

**Specify Plating**  
**932H** 10μ" Gold  
**PTH =** .027 ± .003

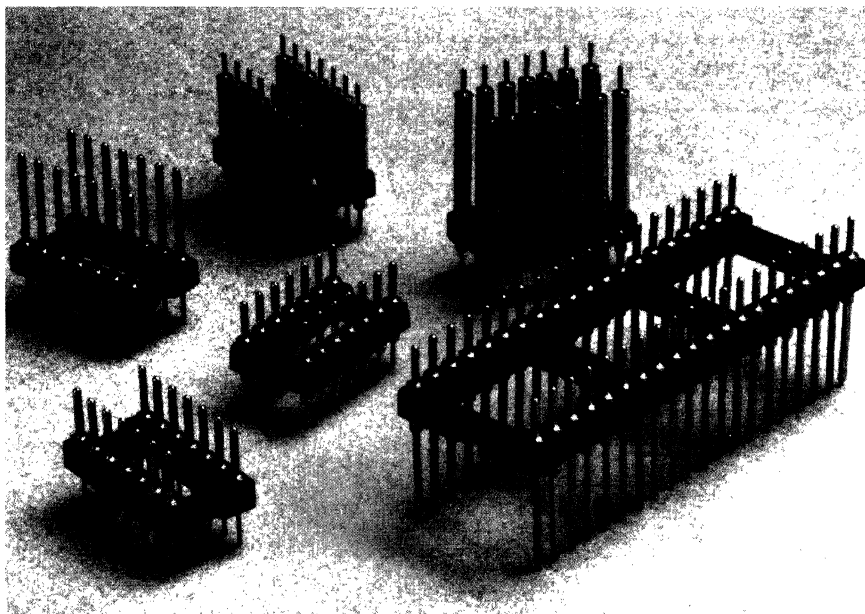

**Open Frame DIP Headers**

- Male to Male DIP Headers are useful for interconnecting two or more printed circuit boards
- Dozens of between board dimensions are achievable when combined with various mating DIP Sockets

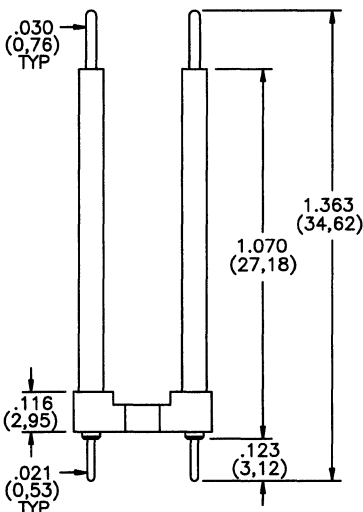

**Specify Plating**  
**928H** 10μ" Gold  
**PTH =** .027 ± .003

### How to Order

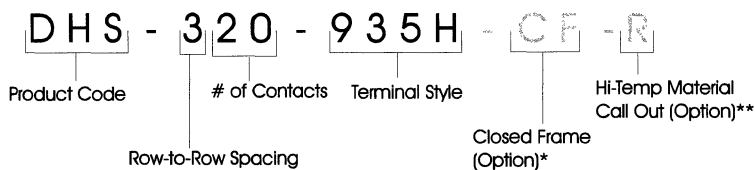

**\*Open frame is standard and available for all sizes and row-to-row spacing. Closed frame available in sizes shaded in table below. Add "CF" to the end of the p/n.**

**\*\*See page B1 for Material Call Outs**

NO.OF CONTACTS	6	8	14	16	18	20	22	24	28	20	22	24	24	28	32	36	40	48	50	64
A				.300 (7,62)							.400 (10,16)				.600 (15,24)					.900 (22,86)
B				.400 (10,16)							.500 (12,70)				.700 (17,78)					1.000 (25,40)
C	.300 (7,62)	.400 (10,16)	.700 (17,78)	.800 (20,32)	.900 (22,86)	1.000 (25,40)	1.100 (27,94)	1.200 (30,48)	1.400 (35,56)	1.000 (25,40)	1.100 (27,94)	1.200 (30,48)	1.200 (30,48)	1.400 (35,56)	1.600 (40,64)	1.800 (45,72)	2.000 (50,80)	2.400 (60,96)	2.500 (63,50)	3.200 (81,28)

## Insulator Options

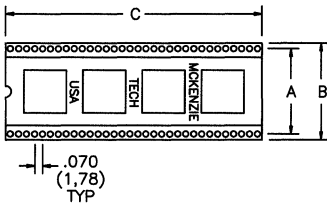

**OPEN FRAME**

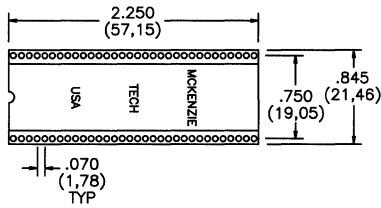

**CLOSED FRAME**

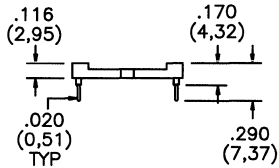

PTH = .026 ± .003

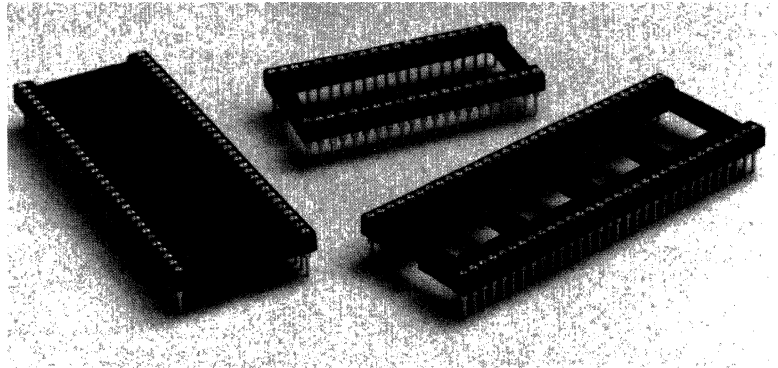

## Features

- High Density .070" (1,78 ) progression
- Hi-Rel multi-finger Beryllium copper contact
- Closed bottom contact – no solder wicking

NO. OF CONTACTS	A	B MAX	C MAX	PART NUMBER	PART NUMBER
			<i>Contact: 200µ" Tin</i>		<i>Contact: 30µ" Gold</i>
<i>Open Frame</i>					
16	0.300 (7,62)	0.400 (10,16)	0.600 (15,24)	DIP 70 - 3016 - 345B	DIP 70 - 3016 - 340B
28			1.000 (25,40)	DIP 70 - 4028 - 345B	DIP 70 - 4028 - 340B
30	0.400 (10,16)	0.500 (12,70)	1.060 (26,92)	DIP 70 - 4030 - 345B	DIP 70 - 4030 - 340B
48			1.700 (43,18)	DIP 70 - 4048 - 345B	DIP 70 - 4048 - 340B
28			1.000 (25,40)	DIP 70 - 6028 - 345B	DIP 70 - 6028 - 340B
40			1.400 (35,56)	DIP 70 - 6040 - 345B	DIP 70 - 6040 - 340B
42			1.500 (38,10)	DIP 70 - 6042 - 345B	DIP 70 - 6042 - 340B
48	0.600 (15,24)	0.700 (17,78)	1.700 (43,18)	DIP 70 - 6048 - 345B	DIP 70 - 6048 - 340B
52			1.850 (46,99)	DIP 70 - 6052 - 345B	DIP 70 - 6052 - 340B
56			2.00 (50,80)	DIP 70 - 6056 - 345B	DIP 70 - 6056 - 340B
64			2.250 (57,15)	DIP 70 - 6064 - 345B	DIP 70 - 6064 - 340B
68	0.750 (19,05)	0.845 (21,46)	2.400 (60,96)	DIP 70 - 6068 - 345B	DIP 70 - 6068 - 340B
64	0.750 (19,05)	0.845 (21,46)	2.250 (57,15)	DIP 70 - 7564 - 345B	DIP 70 - 7564 - 340B
<i>Closed Frame</i>					
64			2.250 (57,15)	DIP 70 - 7564 - 345B - CF	DIP 70 - 7564 - 340B - CF

Outer Shell: 1/2 Hard brass; 200µ" Tin over 50µ" Nickel · See page B21 for Shrink DIP Adaptors

### 318/320 DIP PATTERNS

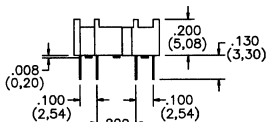
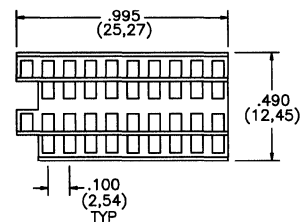

DDP 318/320-SAF-B

**Insulator:**

Glass Reinforced Thermoplastic,  
UL 94V-0

**Contact:**

Stamped Phosphor Bronze  
(Alloy 5210)

**Plating:**

150µ" Tin over Nickel

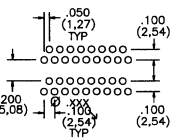

RECOMMENDED PCB LAYOUT

"A" STYLE PCB

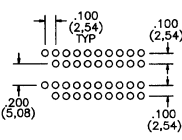

RECOMMENDED PCB LAYOUT

"B" STYLE PCB LAYOUT

### Features

- High density 64K/256K and 256K/1 Megabyte memory arrays
- Two sizes available
- Side-to-side and end-to-end stackable
- Anti-solder wicking closed bottom design
- Economical Dual Wipe contact design

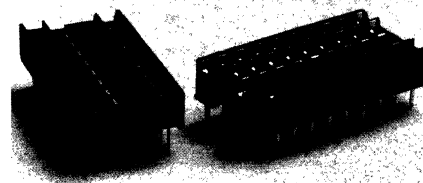

Stamped and Formed Contacts

### How to Order

DDP-318/320-SAF-A  
DDP-316/318-SAF-B

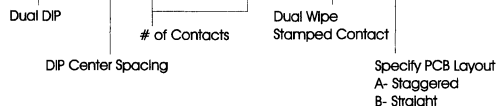

### HI-REL DUAL DIP SOCKETS

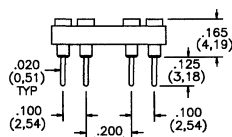
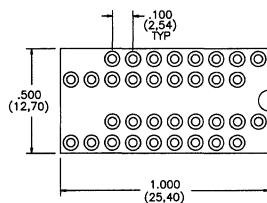

CONTACT - 011B

Other contact and plating styles available,  
see Section A or consult the factory

### Features

- Hi-Rel multi-finger Beryllium Copper contact
- Side-to-side and end-to-end stackable
- Non-solder wicking design



### How To Order

DDP-316/318-011B

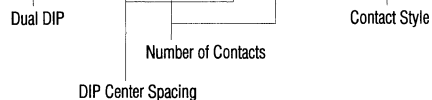

### PPC™ DUAL DIP ARRAY

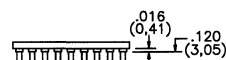
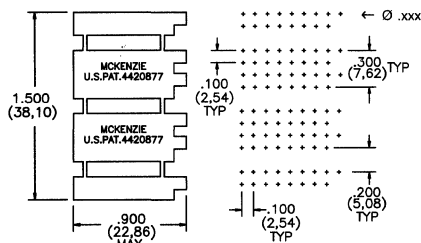

CONTACT - 710C

### Features

- PPC™ Disposable Carrier System is ideal for low profile applications
- Use 3 for 9 chip memory arrays, X and Y stackable
- Hi-Rel multi-finger contacts are non-solder wicking

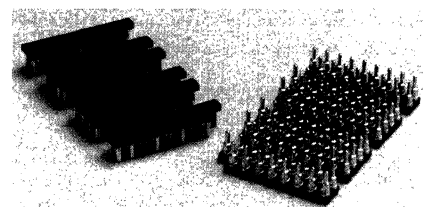

### How To Order

PPC-DDP-316/318-710C

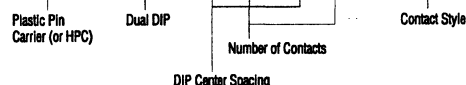

PPC™ molded of  
UL 94V-0 Rated Thermoplastic  
Patent No. 4,420,877

## Microcache™ Socket

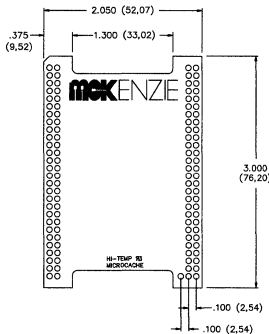
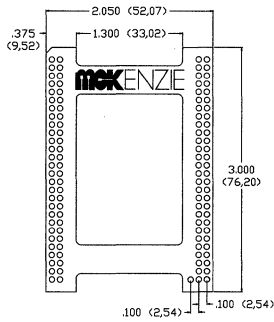

- CF Option



AVAILABLE

- Socket for INTEL® TURBOCACHE 486™ Module
- Two contact options available to mate with either .020" (0,51) round leads or .025" (0,64) square leads
- Pin 1 location notch and polarity pin
- Closed Frame option available — add "CF" to part number
- A cost effective molded PPS insulator is used for both versions.

### Material Specifications

#### Plating:

Outer shell — Tin over Nickel  
Inner contact — Gold over Nickel

#### Insulator Material:

Hi-Temp, Glass Reinforced Thermoplastic  
UL 94V-0

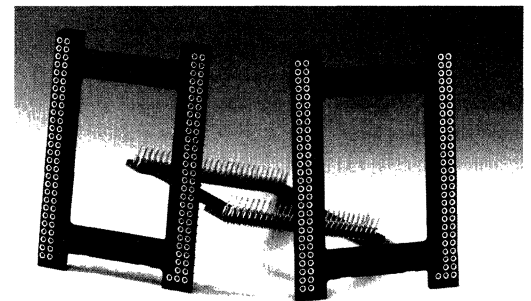

### CONTACT OPTIONS

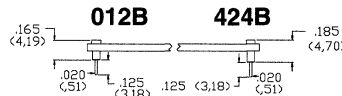

### Part Numbers

**DQD 17/113-012B** — accepts .020 (0,51) round leads  
**DQD 17/113-424B** — accepts .025 (0,64) square leads

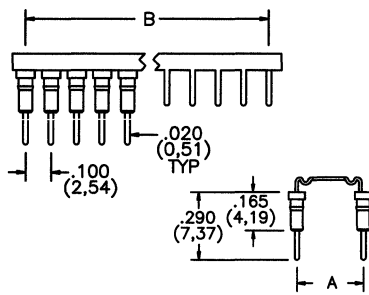

Contact Style 011B

Other contact and plating styles available, see Section A or consult factory

#### Carrier:

Stamped Brass

#### Contact/Shell:

Outer Shell — 1/2 Hard Brass  
Inner Contact — Beryllium Copper

#### Plating:

Outer Shell — Gold over Nickel or Tin over Nickel  
Inner Contact — Gold over Nickel or Tin over Nickel

## Metal Pin Carrier

- Disposable metal carrier system
- Supports a wide variety of female contacts in DIP patterns
- Rigid carrier speeds assembly
- X and Y stackable
- Suitable for IR or vapor phase soldering

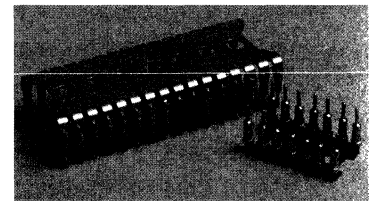

DIP Configuration

## How To Order

**MPC - 632 - 011B**

Product Code      Number of Contacts      Specify Contact Style  
Center to Center DIP Spacing

NO. OF CONTACTS	6	8	14	16	18	20	24	28	32	40	48
<b>A</b>			.300 (7,62)				.600 (15,24)				
<b>B</b>	.200 (5,08)	.300 (7,62)	.600 (15,24)	.700 (17,78)	.800 (20,32)	.900 (22,86)	1.100 (27,94)	1.300 (33,02)	1.500 (38,10)	1.900 (48,26)	2.300 (58,42)

### DIP Clamps

- Positive IC retention in high shock or vibration environments
- Designed to fit McKenzie Technology's standard open or closed frame DIP sockets

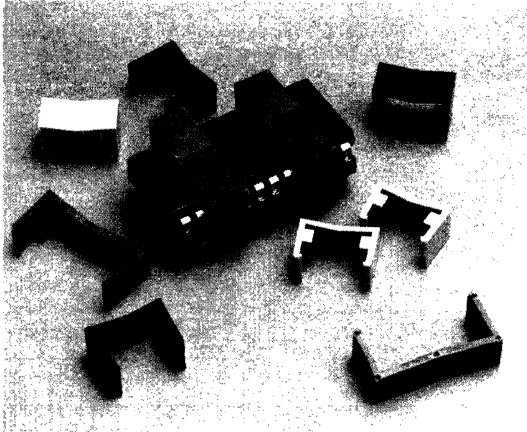

DIP CENTERS	INSULATOR THICKNESS	PART NUMBER
.300	.115 - .120	CPP DC300C-118- FR50
.300	.085 - .095	CPP DC300P-090-FR50
.600	.115 - .120	CPP DC600P-118-FR50

*Consult the factory for custom applications and samples*

**B**

### Right Angle Sockets

- Ideally suited for mounting LED's, Lamps, DIP switches, test points, and programming jumpers
- Hi-Rel multi-finger Beryllium Copper contacts are non-solder wicking

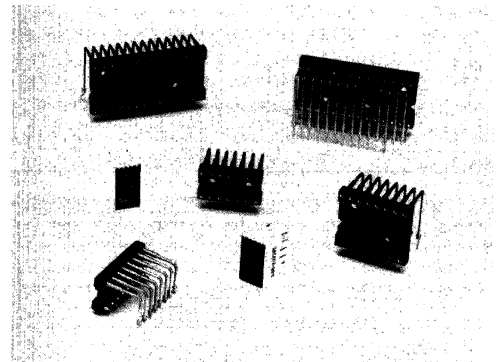
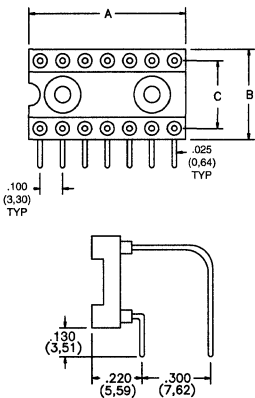

*Many sizes and footprints*

### How To Order

**DRA - 320 - GT**

Product Code      Number of Contacts      Gold Contact and Shell  
Center Spacing 3 or 6

Insulator is Glass Reinforced Thermoplastic, UL 94V-0

NO. OF CONTACTS	8	14	16	18	20	8	14	16	18	20	24	28	32	36	40	48
<b>A</b>	.400 (10,16)	.700 (17,78)	.847 (21,50)	.900 (22,86)	1.000 (25,40)	.400 (10,16)	.700 (17,78)	.800 (20,32)	.900 (22,86)	1.000 (25,40)	1.200 (30,48)	1.400 (35,56)	1.600 (40,64)	1.800 (45,72)	2.000 (50,80)	2.400 (60,96)
<b>B</b>	.400 (10,16)					.750 (19,00)					.700 (17,80)					
<b>C</b>	.300 (7,62)					.600 (15,24)										



**STANDARD SIZE**

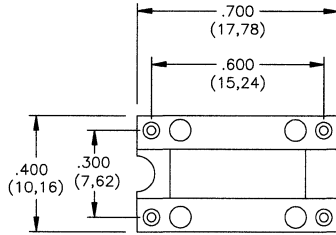

**STANDARD SIZE WITH STANDOFFS**

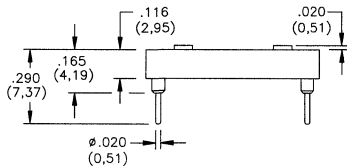

**HALF SIZE**

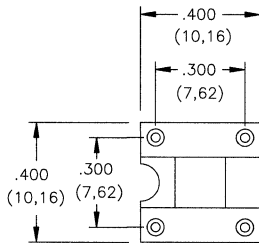

Insulators are  
UL 94V-0 Rated  
Thermoplastic

**Crystal Oscillator Socket**

- Accepts four lead crystal oscillators
- Half size Crystal Oscillator sockets now available!
- Top side standoff option prevents shorting to can
- Hi-Rel multi-finger contact accepts round leads from .015" (0,38) to .025" (0,64)
- Please consult the factory for clamp options

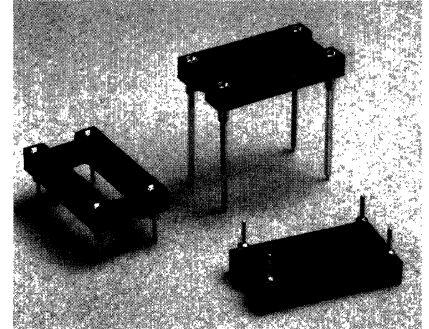

Also available in PPC™

TYPE	PART NUMBER	CONTACT/SHELL PLATING
Standard size	DCO 304-014B	Tin / Tin
Standard size with standoffs	DCO 304-014B-ST	Tin / Tin
Half size	DCO 304-014B/308	Tin / Tin

**Contact/Shell:**

Inner Contact — Beryllium Copper  
Outer Shell — 1/2 Hard Brass

**Plating:**

Outer Shell — Gold over Nickel or Tin over Nickel  
Inner Contact — Gold over Nickel or Tin over Nickel

Other contact and plating styles available, see Section A or consult the factory

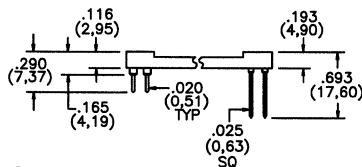
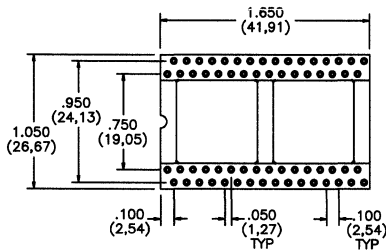

Specify **011B**  
or **014B** for  
solder tail

Specify **410B**  
for Wire Wrap

Insulators are  
UL 94V-0 Rated  
Thermoplastic

**Quad DIP Sockets**

- Accepts staggered row DIP patterns for NEC and Rockwell devices
- Hi-Rel multi-finger contacts are non-solder wicking
- See Section D for other standard socket alternatives

TYPE	PART NUMBER	CONTACT/SHELL PLATING
Solder tail version	DQD Q64-014B	Tin / Tin
Solder tail version	DQD Q64-011B	Gold/Tin
Wire Wrap version	DQD Q64-410B	Gold/Tin

Other pin counts available. Consult the factory.

**Contact/Shell:**

Inner Contact — Beryllium Copper  
Outer Shell — 1/2 Hard Brass

**Plating:**

Outer Shell — Tin over Nickel  
Inner Contact — Gold over Nickel or Tin over Nickel

Other contact and plating styles available, see Section A or consult the factory

### DIP Package Convertor

- No need to scrap or redesign existing PCBs!
- Converts .3" (7,62) DIP device to the .6" (15,24) PCB configuration for either a 24 pin or 28 pin device
- Converts .6" (15,24) DIP device to the .3" (7,62) PCB configuration for either a 24 pin or 28 pin device
- Hi-Rel multi-finger contacts are non-solder wicking
- Other adaptors made to your requirements, consult factory

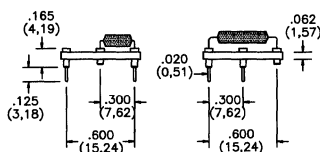
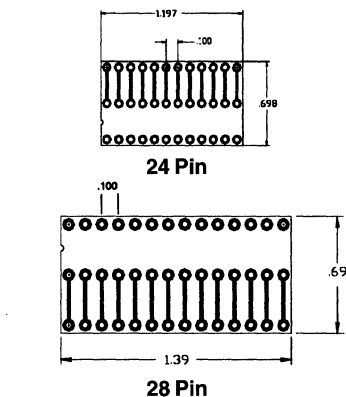

**Material:**  
Copper clad FR4

### How To Order

ADP - 324 / 624 - 011B

Adaptor Product Code      Device      PCB DIP Layout      Contact Style

### Molded DIP Adaptor

- Economical molded UL 94V-0 Thermoplastic
- Converts .3" (7,62) DIP device to .6" (15,24) PCB
- Hi-Rel multi-finger contacts are non-solder wicking
- Gold plated contact and tin plated shell

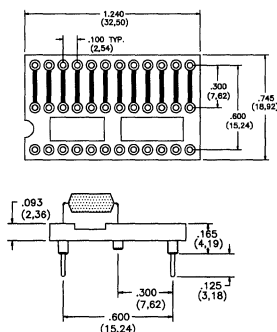

**Part Number: ADP DIP-324/624**

### Shrink DIP Adaptor

- Converts Shrink DIP .070" (1,78) to standard .100" (2,54) DIP pattern for prototype boards
- Hi-Rel multi-finger contacts are non-solder wicking
- Copper clad FR4 epoxy construction

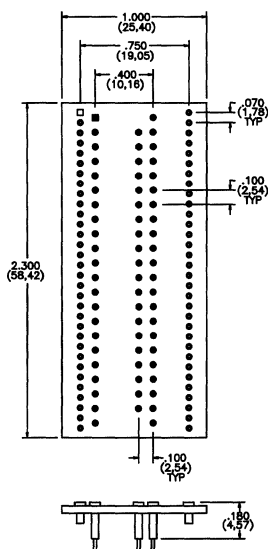

**ADP SDIP64-02**

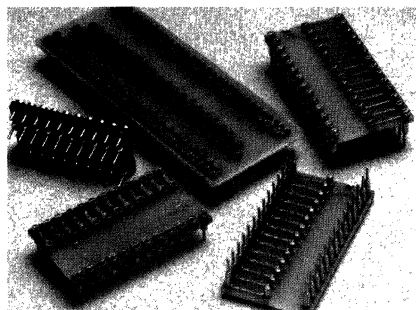

*Consult factory for socket part numbers for your application*

**B**

**DISPOSABLE PPC™**

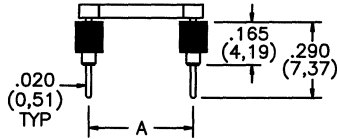
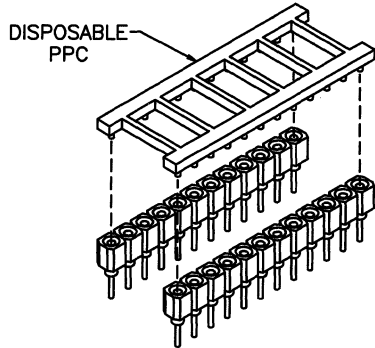

Contact - 011B

PPC™ and Insulators are UL 94V-0 Rated Thermoplastic



AVAILABLE

**Contact/Shell:**

Outer Shell — 1/2 Hard Brass  
Inner Contact — Beryllium Copper

**Plating:**

Outer Shell — Tin over Nickel  
Inner Contact — Gold over Nickel

PPC Patent No. 4,420,877

**Features**

- Frees space between insulators for other components
- Holds SIP strips parallel during soldering
- Speeds assembly
- Masks contacts from flux and cleaning solutions
- Better airflow
- All SIP strips in Section C can be configured with disposable PPC™

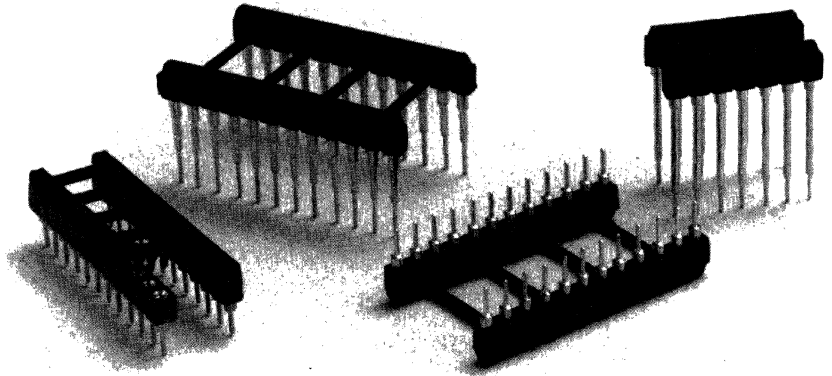

For SIP socket alternatives, see Section C

**How To Order**

PPC 2 SIP - 6 2 4 - 0 1 1 B

Plastic Pin Carrier™  
(or HPC)

Product Code

Row-to-Row Spacing

Contact Style

Number of Contacts

See Section A for Contact and Plating Options  
See Section C for Material Call Outs

NO. OF CONTACTS	6	8	14	16	18	20	22	24	28	20	22	24	24	28	32	36	40	48	50	64
A					.300 (7,62)					.400 (10,16)					.600 (15,24)					.900 (22,86)

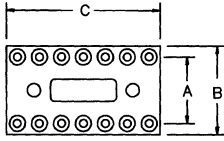

TYPICAL 2 STAND-OFF

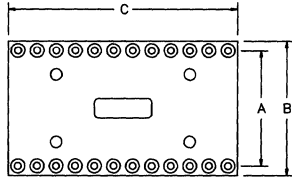

TYPICAL 4 STAND-OFF

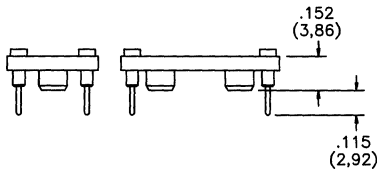

Contact 498B



AVAILABLE

**Material:**

High-Temp  
Glass Reinforced Polyimide

**Contact/Shell:**

Outer Shell — 1/2 Hard Brass  
Inner Contact — Beryllium Copper  
or  
Hi-temp Beryllium Nickel

**Plating:**

Outer Shell — Gold over Nickel  
Inner Contact — Gold over Nickel

**Other contact and plating styles available,  
see Section A or consult the factory**

## For Your Harshest Environments

- Down Hole Oil Field Equipment
- Burn-in and Test Applications
- Industrial Equipment

## Features

- Polyimide Glass Laminate -60°C to +250°C continuous – UL 94V-1
- Available with or without standoffs
- Your choice of Super Hi-Temp Beryllium-Nickel contacts (-55°C to +225°C) or standard Beryllium Copper contacts (-55°C to +150°C)
- Optional decoupling capacitor able to withstand -55°C to +260°C continuous

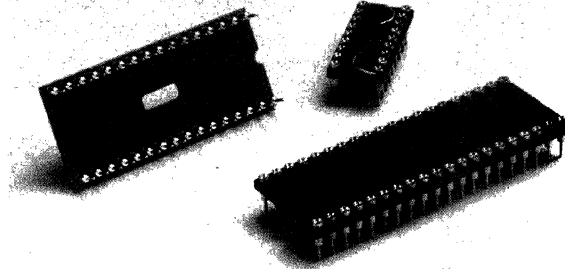

With and without optional capacitor

## How To Order

DVD624-498B-S-01

Devil DIP  
Product Code

Number of  
Contacts

Contact Style

Standoffs  
(Option)

Row-to-Row Spacing

Axial Leaded Capacitor  
Value (Option)

NO.OF CONTACTS	6	8	14	16	18	20	22	24	28	30	32	34	36	38	40	44	48	50	64	
A				.300 (7,62)						.400 (10,16)			.600 (15,24)					.900 (22,86)		
B				.400 (10,16)						.500 (12,70)			.700 (17,78)					1.000 (25,40)		
C	.300 (7,62)	.400 (10,16)	.700 (17,78)	.800 (20,32)	.900 (22,86)	1.000 (25,40)	1.100 (27,94)	1.200 (30,48)	1.400 (35,56)	1.000 (25,40)	1.100 (27,94)	1.200 (30,48)	1.200 (30,48)	1.400 (35,56)	1.600 (40,64)	1.800 (45,72)	2.000 (50,80)	2.400 (60,96)	2.500 (63,50)	3.200 (81,28)
NO.OF STANDOFFS	2 Standoffs												4 Standoffs							

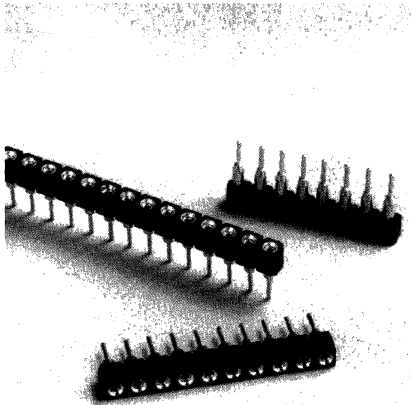

Single Row SIP Sockets

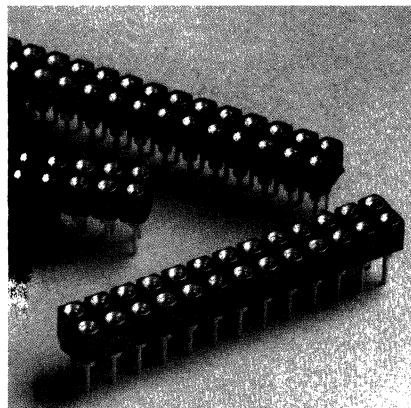

Dual Row SIP Sockets

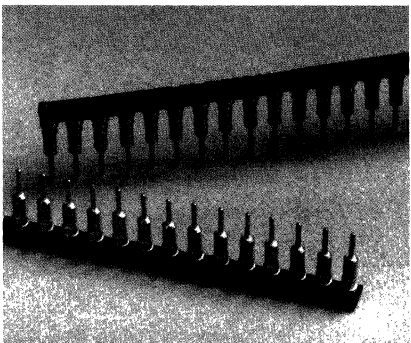

PPC™ SIP Sockets  
(disposable carrier system)

Patent No. 4,420,877

## Features

- Hi-Temp Options — IR and Vapor Phase Compatible
- X and Y Stackable
- Disposable Plastic Pin Carrier (PPC™) System Option
- Hi-Rel multifinger contact
- Insulators are notched for convenient cut down

### STANDARD TEMPERATURE GLASS REINFORCED THERMOPLASTIC

Continuous use temperature 140°C

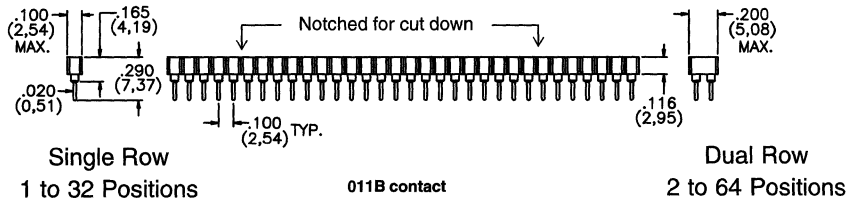

### HI-TEMP PPS GLASS REINFORCED THERMOPLASTIC

Continuous use temperature 220°C

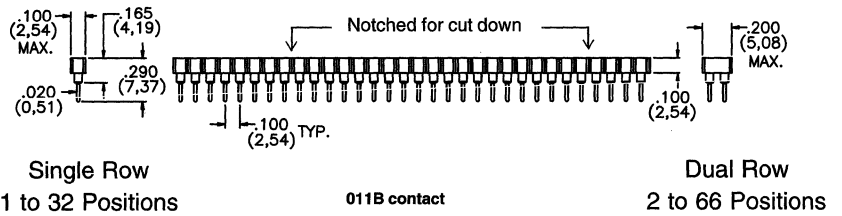

### PLASTIC PIN CARRIER (PPC™) SYSTEM

Patent #4,420,877

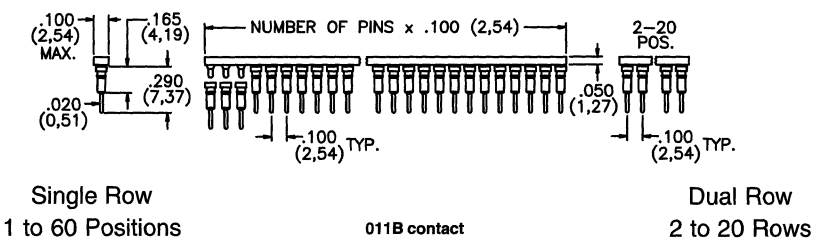

Insulators are all UL 94V-0 Rated Thermoplastic

#### SHORTER SOLDER TAIL — NO TRIMMING

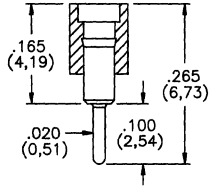

**Specify Contact/Shell**  
**018B** 200μ" Tin/200μ" Tin  
**PTH =** .026 ± .003

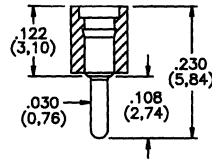

**Specify Contact/Shell**  
**185B** 30μ" Gold/200μ" Tin  
**PTH =** .036 ± .003

#### OUR MOST POPULAR CONTACT

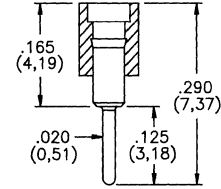

**Specify Contact/Shell**  
**001B** 30μ" Gold/200μ" Tin  
**002B** 30μ" Gold/10μ" Gold  
**011B** 10μ" Gold/200μ" Tin  
**014B** 200μ" Tin/200μ" Tin  
**016B\*** 30μ" Gold/200μ" Tin  
**PTH =** .026 ± .003  
*\*CLINCHABLE SOFT BRASS*

#### HIGHER PCB STANDOFF

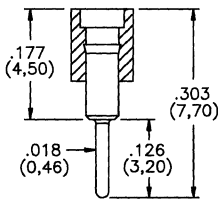

**Specify Contact/Shell**  
**248B** 30μ" Gold/10μ" Gold  
**PTH =** .024 ± .003

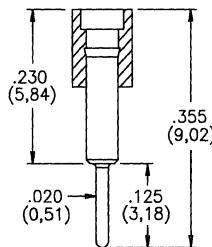

**Specify Contact/Shell**  
**040B** 30μ" Gold/10μ" Gold  
**041B** 30μ" Gold/200μ" Tin  
**PTH =** .026 ± .003

#### WIRE WRAP™ SIPs

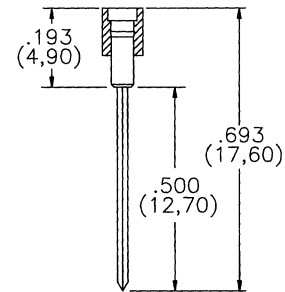

**Specify Contact/Shell**  
**410B** 30μ" Gold/200μ" Tin  
**411B** 30μ" Gold/10μ" Gold

#### EXTRA LONG SOLDER TAILS

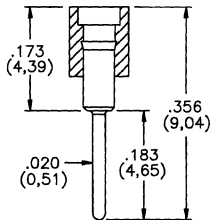

**Specify Contact/Shell**  
**057B** 200μ" Tin/200μ" Tin  
**054B** 30μ" Gold/200μ" Tin  
**091B** 30μ" Gold/10μ" Gold  
**PTH =** .026 ± .003

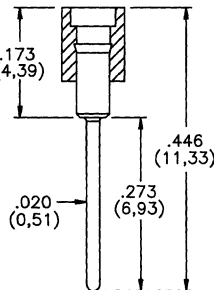

**Specify Contact/Shell**  
**067B** 30μ" Gold/200μ" Tin  
**PTH =** .026 ± .003

## How To Order

PPC SIP - 1 x 32 - 011B - R

For pins on a carrier strip begin the part number with "PPC" or HPC for Hi-Temp Material

Product Code

Number of Rows

Number of Contacts per Row

Contact Style

Hi-Temp Material Call Out (Option)\*

**Contact/Shell:**  
 Outer Shell — 1/2 Hard Brass  
 Inner Contact — Beryllium Copper

**Plating:**  
 Outer Shell—Gold over 100μ" Nickel or Tin over 100μ" Nickel  
 Inner Contact — Gold over Nickel or Tin over Nickel

**Other contact and plating styles available, see Section A or consult the factory**

**\*See page B1 for Material Call Outs**

**LOWEST PROFILE OPTIONS**

**ULTRA LOW PROFILE OPTIONS**

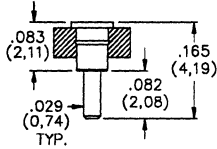

**Specify Contact/Shell**  
**156B** 30μ" Gold/200μ" Tin  
**PTH =** .035 ± .003

**VERY LOW PROFILE**

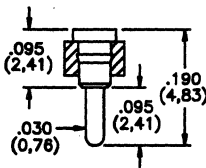

**Specify Contact/Shell**  
**157B** 200μ" Tin/200μ" Tin  
**160B** 30μ" Gold/200μ" Tin  
**PTH =** .036 ± .003

**FLUSH PROFILE**

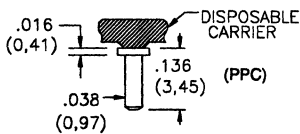

**Specify Contact/Shell**  
**710C** 30μ" Gold/200μ" Tin  
**711C** 30μ" Gold/10μ" Gold  
**714C** 200μ" Tin-Lead/200μ" Tin-Lead  
**PTH =** .044 ± .003

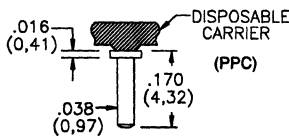

**Specify Contact/Shell**  
**720C** 30μ" Gold/200μ" Tin  
**721C** 30μ" Gold/10μ" Gold  
**PTH =** .044 ± .003

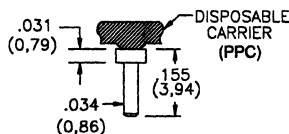

**Specify Contact/Shell**  
**725C** 30μ" Gold/200μ" Tin  
**726C** 30μ" Tin/200μ" Tin  
**PTH =** .040 ± .003

**Features**

- Profiles as low as .016" (0,41) above PCB
- X and Y stackable
- Single and Dual Row available

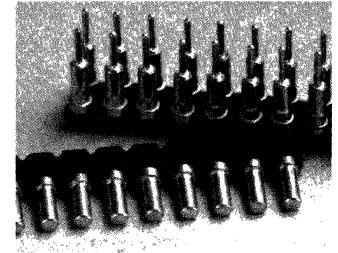

**STANDARD SOCKET BODY**

**GLASS REINFORCED THERMOPLASTIC, UL 94V-0**

Continuous use temperature 140°C

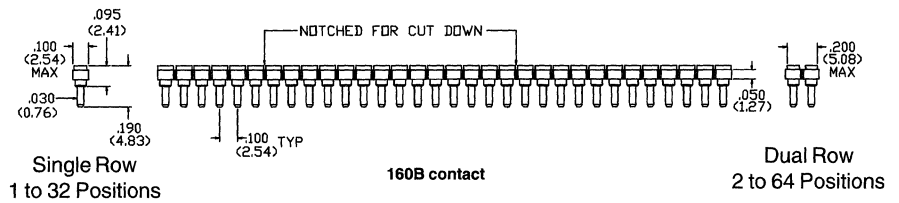

**How To Order**

**SIP 050 - 1 x 32 - 160B - R**

Product Code    Insulator Thickness    Number of Rows    Number of Contacts per Row    Contact Style    Hi-Temp Material Call Out (Option)\*

**PLASTIC PIN CARRIER (PPC™) SYSTEM**

Patent # 4,420,877

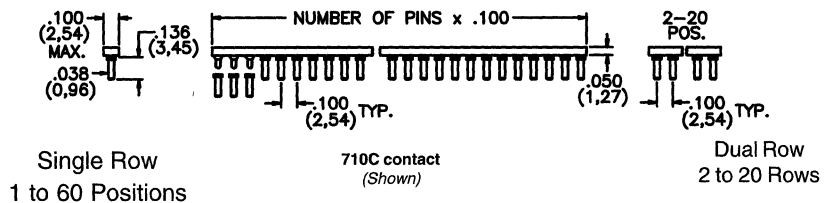

**How To Order**

**PPC SIP - 1 x 32 - 160B**

Plastic Pin Carrier™ (or HPC)    Product Code    Number of Rows    Number of Contacts per Row    Contact Style

See Section A for other contact/plating options    \*See page B1 for Material Call Outs

## Features

- Elevated Sockets allow for greater package density
- Allows stacking of PCB
- Maximizes airflow
- Available in Hi-Temp PPS Insulator material

## STANDARD TEMPERATURE — UL 94V-0 THERMOPLASTIC

Continuous use temperature 140°C

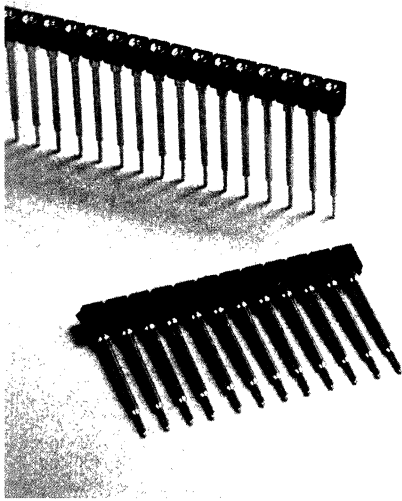

Elevated SIP Socket

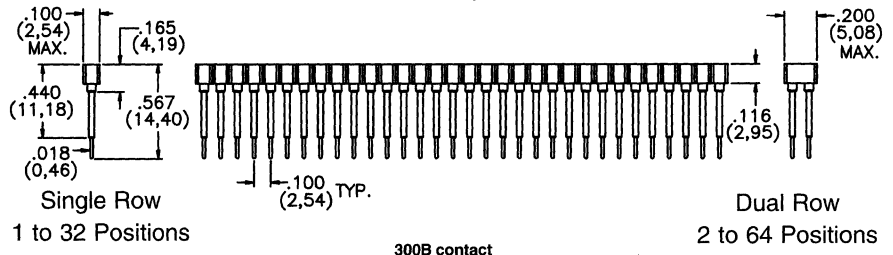

## Popular Elevated SIP Sockets

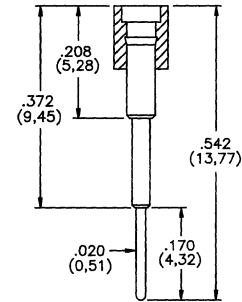

**Specify Contact/Shell**  
**302B** 30μ" Gold/200μ" Tin  
**PTH =** .026 ± .003

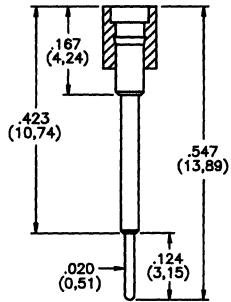

**Specify Contact/Shell**  
**310B** 30μ" Gold/10μ" Gold  
**PTH =** .026 ± .003

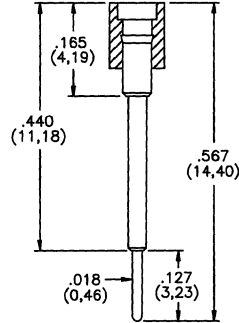

**Specify Contact/Shell**  
**300B** 30μ" Gold/200μ" Tin  
**PTH =** .024 ± .003

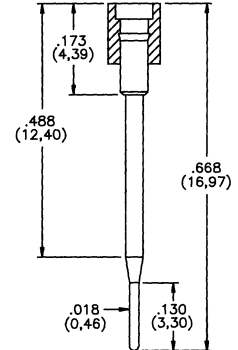

**Specify Contact/Shell**  
**314B** 30μ" Gold/10μ" Gold  
**PTH =** .024 ± .003

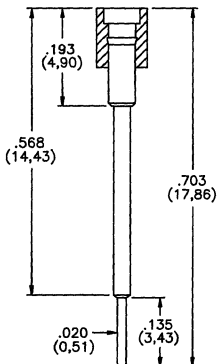

**Specify Contact/Shell**  
**301B** 30μ" Gold/200μ" Tin  
**PTH =** .026 ± .003

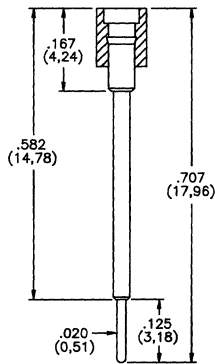

**Specify Contact/Shell**  
**312B** 30μ" Gold/10μ" Gold  
**PTH =** .026 ± .003

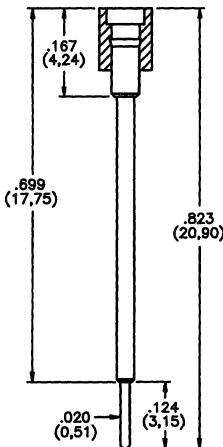

**Specify Contact/Shell**  
**313B** 30μ" Gold/10μ" Gold  
**PTH =** .026 ± .003

## How To Order

SIP 1 x 32 - 300B - R

Product Code    Number of Rows    Contact Style    Hi-Temp Material Call Out (Option)\*  
Number of Contacts per Row



**Contact/Shell:**  
Outer Shell — 1/2 Hard Brass  
Inner Contact — Beryllium Copper

**Plating:**  
Outer Shell — Gold over 100μ Nickel or Tin over 100μ Nickel  
Inner Contact — Gold over Nickel or Tin over Nickel

*Other contact and plating styles available, See Section A or consult the factory.*

*\*See page B1 for Material Call Outs*



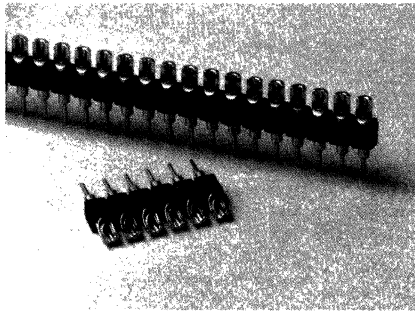

Solder Cup

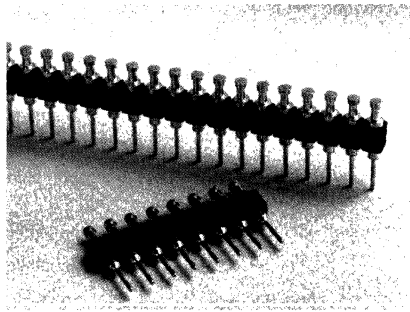

Turret

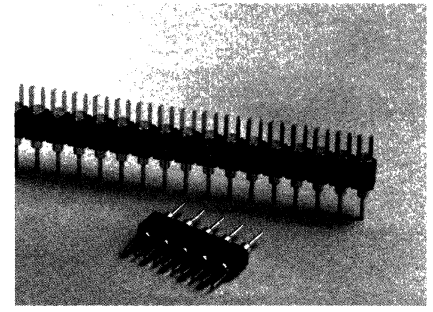

Bifurcated

### Features

- Pin Styles - solder cup, turret or bifurcated
- Termination - solder tail, wire wrap or solder cup
- Available in standard insulator or Hi-Temp PPS

### STANDARD TEMPERATURE — GLASS REINFORCED THERMOPLASTIC, UL 94V-0

Continuous use temperature 140°C

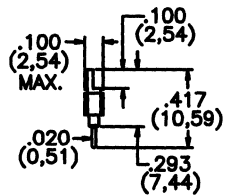

Single Row  
1 to 32 Positions

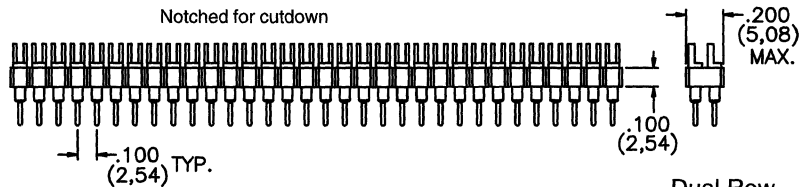

830G contact

Dual Row  
2 to 64 Positions

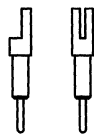

Bifurcated contact at 90° Rotation

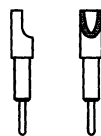

Solder Cup contact at 90° Rotation

### How To Order

SPL 1 x 32 - 850L - R

Specify Product Code  
 SPG - SIP Bifurcated Adaptor  
 SPK - SIP Solder Cup Adaptor  
 SPL - SIP Turret Adaptor

Number of Rows  
 Number of Contacts per Row

Contact Style  
 Hi-Temp Material Call Out (Option)\*

\*See page B1 for Material Callouts

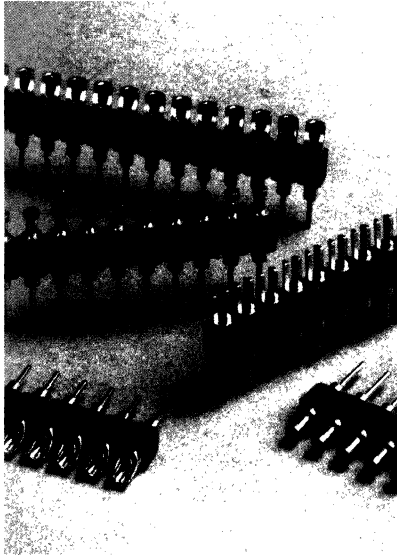

### Turret Terminals

#### WIRE WRAP™

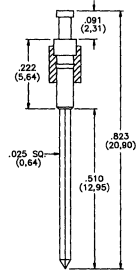
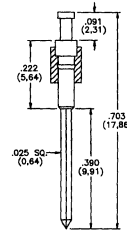
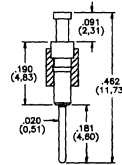
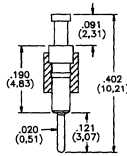

Specify Plating  
850L 10µ" Gold

Specify Plating  
853L 200µ" Tin

Specify Plating  
854L 10µ" Gold

Specify Plating  
855L 10µ" Gold

### Bifurcated Terminals

#### WIRE WRAP™

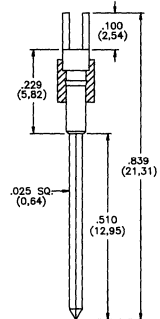
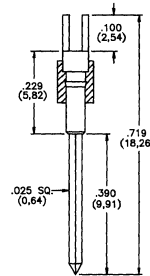
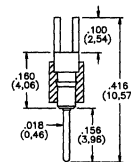
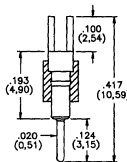

Specify Plating  
830G 10µ" Gold  
831G 200µ" Tin

Specify Plating  
832G 10µ" Gold  
834G 200µ" Tin

Specify Plating  
837G 10µ" Gold

Specify Plating  
838G 10µ" Gold

Insulators are  
UL 94V-0 Rated  
Thermoplastic



AVAILABLE

#### Contact/Shell:

Outer Shell — 1/2 Hard Brass  
Inner Contact — Beryllium Copper

#### Plating:

Outer Shell — Gold over Nickel or Tin over Nickel  
Inner Contact — Gold over Nickel or Tin over Nickel

Other contact and plating styles available,  
see Section A or consult the factory

See page B1 for complete  
material specifications

### Solder Cup

#### WIRE WRAP™

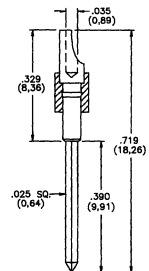
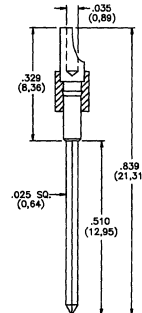
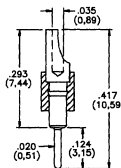

Specify 840K  
Plating  
10µ" Gold

Specify 843K  
Plating  
10µ" Gold

Specify 842K  
Plating  
10µ" Gold

## SST — Male to Male Header Options

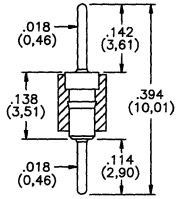

**Specify** **Plating/Material**  
**884S** 10µ" Gold/Brass  
**PTH =** .024 ± .003

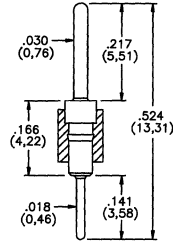

**Specify** **Plating/Material**  
**886S** 10µ" Gold/Brass  
**PTH =** .024 ± .003

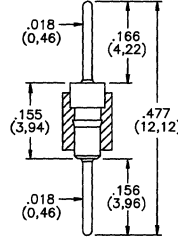

**Specify** **Plating/Material**  
**876S** 10µ" Gold/  
Phosphor Bronze  
**878S** 10µ" Gold/Brass  
**879S** 200µ" Tin/Brass  
**PTH =** .024 ± .003

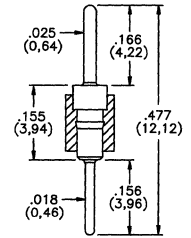

**Specify** **Plating/Material**  
**874S** 10µ" Gold/Brass  
**PTH =** .024 ± .003

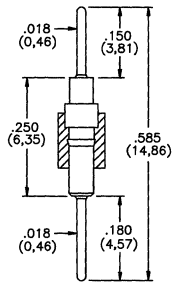

**Specify** **Plating/Material**  
**867S** 10µ" Gold/  
Phosphor Bronze  
**PTH =** .024 ± .003

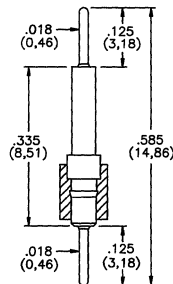

**Specify** **Plating/Material**  
**862S** 10µ" Gold/Brass  
**868S** 200µ" Tin/Brass  
**PTH =** .024 ± .003

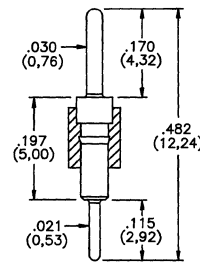

**Specify** **Plating/Material**  
**870S** 10µ" Gold/Brass  
**PTH =** .027 ± .003

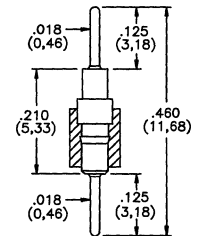

**Specify** **Plating/Material**  
**861S** 10µ" Gold/Brass  
**857S** 200µ" Tin/Brass  
**PTH =** .024 ± .003

### Low Profile Options

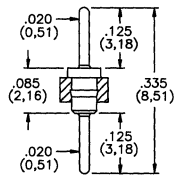

**Specify** **Plating/Material**  
**880S** 10µ" Gold/Phosphor Bronze  
**881S** 200µ" Tin/Phosphor Bronze  
**PTH =** .026 ± .003

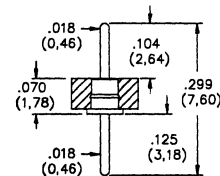

**Specify** **Plating/Material**  
**868S** 10µ" Gold/Brass  
**869S** 200µ" Tin/Brass  
**PTH =** .024 ± .003

### How To Order

SST 050 - 1 x 32 - 881S - R

Product Code    Insulator Thickness (Option)    Number of Rows    Number of Contacts per Row    Contact Style    Hi-Temp Material Call Out (Option)\*

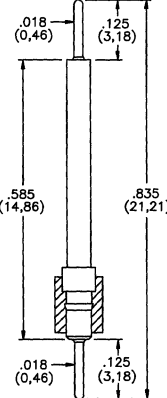

**Specify** **Plating/Material**  
**863S** 10µ" Gold/Brass  
**859S** 200µ" Tin/Brass  
**PTH =** .024 ± .003

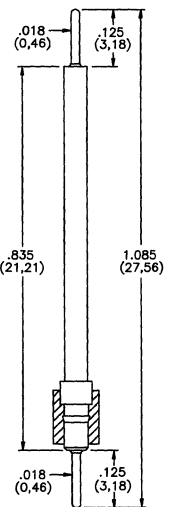

**Specify** **Plating/Material**  
**864S** 10µ" Gold/Brass  
**860S** 200µ" Tin/Brass  
**PTH =** .024 ± .003

McK McKenzie Socket Division

### SHS — Extended Header Options

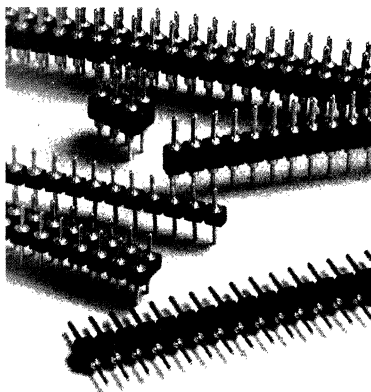

SST: Male-to-Male SIP Headers

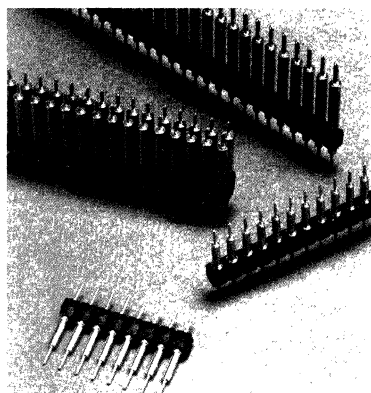

SHS: Extended Male-to-Male SIP Headers

Insulators are  
UL 94V-0 Rated  
Thermoplastic



AVAILABLE

**Plating:**

Gold over 100µ" Nickel or Tin over 100µ" Nickel

**Terminal:**

½ Hard Brass or Phosphor Bronze

Other contact and plating styles available,  
see Section A or consult the factory

See page B1 for complete  
material specifications

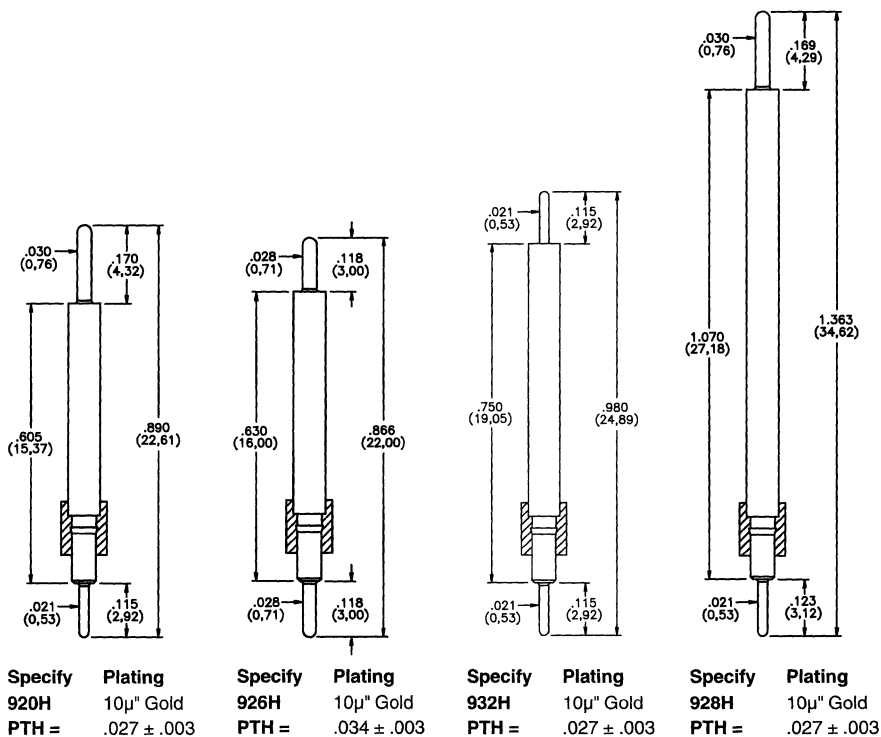
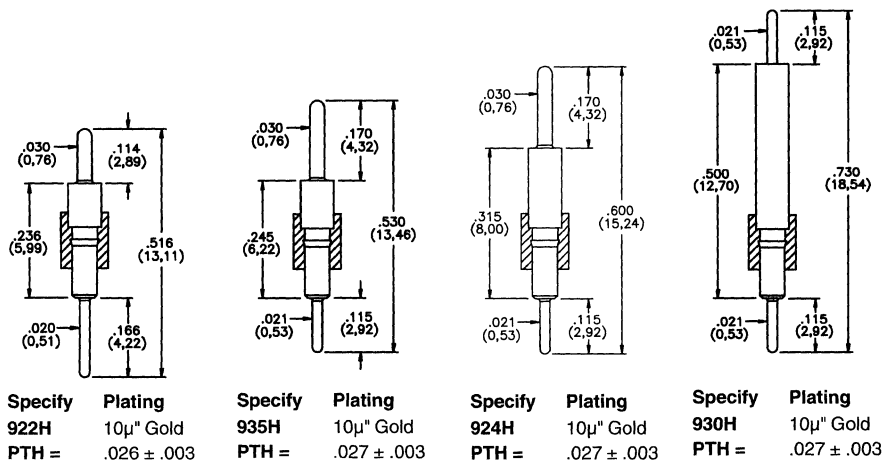

### How To Order

SHS 1 x 32 - 926H - R

Specify Product Code      Number of Rows      Contact Style      Hi-Temp Material Call Out (Option)\*  
SST - Male to Male Header      Number of Contacts per Row

\*See page B1 for Material Callouts



## Dual In Line (DIP)

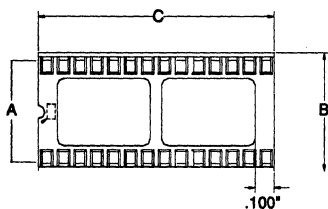

Top View

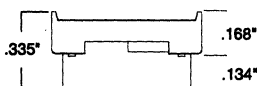

End View

## Zig Zag In Line (ZIP)

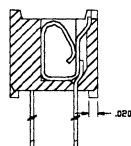

End View



Top View

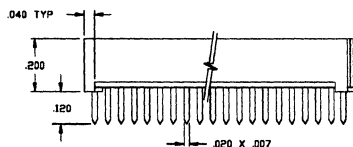

Side View

## Features

- Stamped and Formed Contacts
- Closed bottom construction for anti solder-wicking
- Side-to-side and end-to-end stackable
- Double beam, preloaded contacts

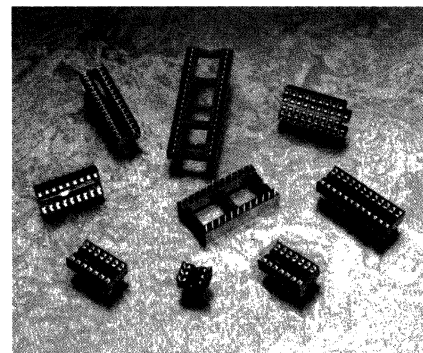

## Ordering Information

Part Number	# Contacts	A	B	C
SAF LCS-306-OT	6	.300	.395	.295
SAF LCS-308-OT	8	.300	.395	.395
SAF LCS-314-OT	14	.300	.395	.695
SAF LCS-316-OT	16	.300	.395	.795
SAF LCS-318-OT	18	.300	.395	.895
SAF LCS-320-OT	20	.300	.395	.995
SAF LCS-322-OT	22	.300	.395	1.095
SAF LCS-324-OT	24	.300	.395	1.195
SAF LCS-328-OT	28	.300	.395	1.395
SAF LCS-624-OT	24	.600	.695	1.195
SAF LCS-628-OT	28	.600	.695	1.395
SAF LCS-632-OT	32	.600	.695	1.595
SAF LCS-640-OT	40	.600	.695	1.995
SAF LCS-648-OT	48	.600	.695	2.395
SAF ZIP -16-T	16	.825	.800	.750
SAF ZIP -18-T	18	.925	.900	.850
SAF ZIP -20-T	20	1.025	1.000	.950
SAF ZIP -24-T	24	1.225	1.200	1.150

## Specifications

Insulator Material: glass-filled PBT (UL 94V-O)

Contact Material: Phosphor Bronze

Contact Plating: Tin over Nickel

Current Rating: 1A per contact

Contact Resistance: 20mΩ max

Withstanding Voltage: 500 v ac (1 minute)

Insulator Resistance: 5,000 mΩ min. (500v dc)

Operating Temperature: -55°C to +105°C

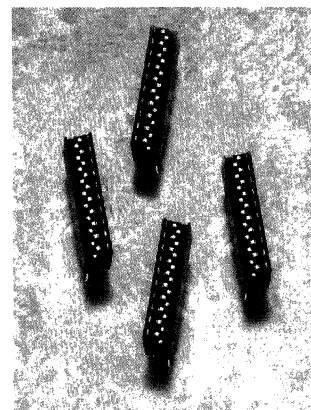

### Features

- High temperature solder process compatible.
- Polyimide film can be removed after soldering, leaving only the specified pattern of socket pins.
- Ultra low profile (0.015" above the board profile) contacts available.
- Available in SIP, DIP, PGA, and PZA configurations.
- Call for part numbers and more detailed information.

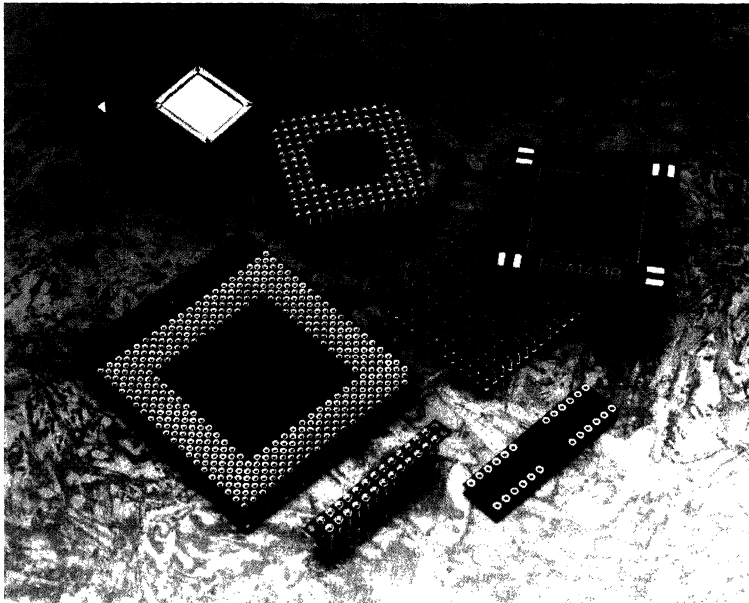

**D**

### Contact Options

004R			005R			009R			001J			003J		
DIMENSION	MIN.	MAX.	DIMENSION	MIN.	MAX.	DIMENSION	MIN.	MAX.	DIMENSION	MIN.	MAX.	DIMENSION	MIN.	MAX.
B DIAMETER	.073	.074	D DIAMETER	.058	.059	C DIAMETER	.058	.059	B DIAMETER	.069	.075	A LENGTH	.285	.295
C DIAMETER	.0525	.055	F DIAMETER	.004	.036	D DIAMETER	.037	.038	F DIAMETER	.053	.059	B LENGTH	.162	.168
M LENGTH	.030	.032	M LENGTH	.015	.017	M LENGTH	.030	.032	A LENGTH	.287	.293	D LENGTH	.030	.032
N DEPTH	.067	.072	O DEPTH	.135	.141	N DEPTH	.131	.136	C DEPTH	.029	.035	F DIAMETER	.043	.044
L LENGTH	.090	.095	L LENGTH	.152	.158	L LENGTH	.155	.160	D LENGTH	.142	.148	G DIAMETER	.058	.059

	004R	005R	009R	001J	003J
<b>Inner Clip</b>	4(30)	3(21)	3(11)	N/A	3(21)
<b>No. Contact Points</b>	4	3	3	N/A	3
<b>Clip/Shell Plating</b>	G/T	G/T	G/T	G/T	G/T
<b>Avg. Insertion Force</b>	175g	45g	80g	N/A	45g
<b>Avg. Extraction Force</b>	90g	20g	40g	N/A	20g
<b>Recommended For:</b>	DIP/SIP	PZA	DIP/SIP	Headers	PGA

**Features**

- New Compliant Pressfit does not distort plated through hole (PTH)
- Eliminates solder process
- Designed for .040" (1,02) ± .003" (0,08) Plated Thru-Holes (PTH)
- 16 pounds retention force in .040" (1,02) PTH in .062" (1,57) thick PCB
- Available in a variety of socket styles: SIP, DIP, Inverted DIP, and PGA

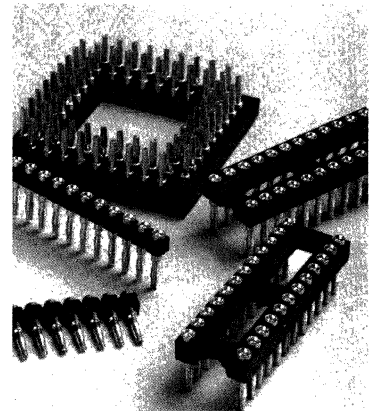

PGA, DIP and SIP

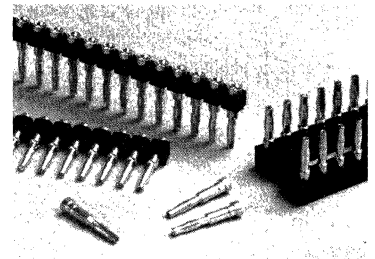

SIP and DIP

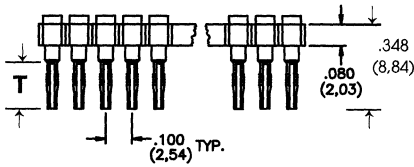
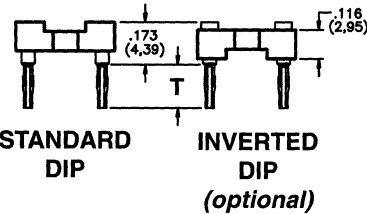
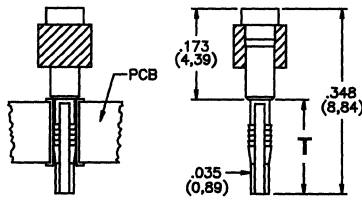

STANDARD SIP

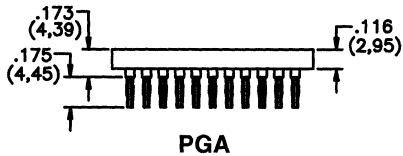

PGA

Recommended PCB plated Thru-Hole diameter is  $\varnothing$  .040" ± .003"

Insulators are  
UL 94V-0 Rated  
Thermoplastic.



AVAILABLE

**Contact/Shell:**

Outer Shell — 1/2 Hard Brass  
Inner Contact — Beryllium Copper

**Plating:**

Outer Shell — Gold over 50µ" Nickel or  
Tin over 50µ" Nickel  
Inner Contact — Gold over 50µ" Nickel or  
Tin over 50µ" Nickel

	Specify Contact/Shell	Tail Length (T)
998E	200µ" Tin/200µ" Tin	.175 (4,45)
0012	30µ" Gold/200µ" Tin	.120 (3,05)

**How To Order  
DIP Pressfit**

D P F 3 2 0 - 9 9 8 E -

DIP Pressfit      Number of Contacts      Inverted (Optional)  
Row-to-Row      Contact Style  
Spacing

**How To Order  
SIP Pressfit**

S P F 0 8 0 - 1 x 1 8 - 9 9 8 E

SIP Pressfit      Number of Rows      Contact Style  
Insulator      Number of Contacts per Row  
Thickness      (Max. Number of Contacts per Row = 18)

See Section F for PGA patterns and additional information.

McK McKenzie Socket Division

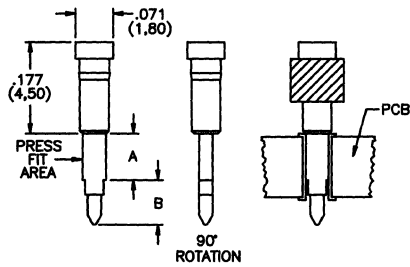

Flats are randomly oriented in Sockets.

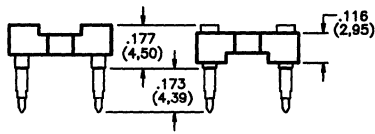

**STANDARD  
DIP**

**INVERTED  
DIP  
(optional)**

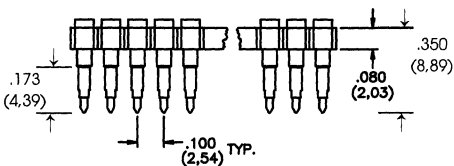

**SIP**

**Recommended PCB plated Thru-Hole diameter is  $\varnothing .039" \pm .003"$**

Insulators are  
UL 94V-0 Rated  
Thermoplastic



**AVAILABLE**

**Contact/Shell:**

Outer Shell — 1/2 Hard Brass  
Inner Contact — Beryllium Copper

**Plating:**

Outer Shell — Gold or 93/7 Tin/Lead over 50 $\mu$ " Nickel  
Inner Contact — Gold over 50 $\mu$ " Nickel

### Features

- Pressfit eliminates soldering
- Ideal for backplane applications
- Retention force exceeds 12 pounds in .039" (0,99) plated Thru-Hole (PTH)
- Sizes for .062" (1,57) and .125" (3,18) PCB thickness
- Suggested PCB hole size  
Use 1.15mm drill prior to plating  
Plate .001" copper per side of hole  
Finished hole size .036-.041

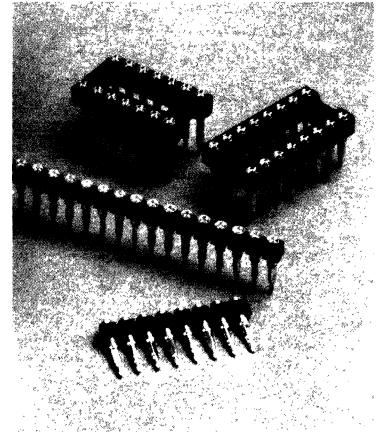

SPECIFY	CONTACT/SHELL	A DIM	B DIM	PCB THICKNESS
970E	30 $\mu$ "Gold/10 $\mu$ "Gold	.075 (1,91)	.100 (2,54)	.062 (1,57)
972E	200 $\mu$ "Tin Lead/100 $\mu$ "Tin-Lead			
975E	30 $\mu$ "Gold/10 $\mu$ "Gold	.140 (3,56)	.110 (2,79)	.125 (3,18)
977E	200 $\mu$ "Tin Lead/100 $\mu$ "Tin-Lead			

### How To Order DIP Pressfit

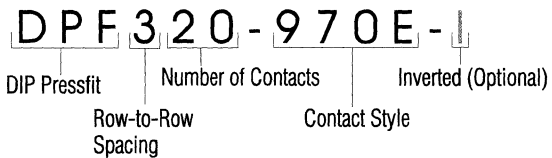

### How To Order SIP Pressfit

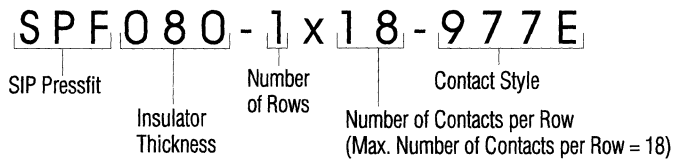



**LOW PROFILE**

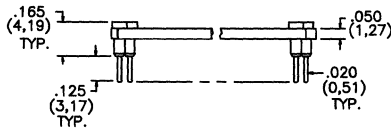

Specify	Contact/Shell
<b>001B</b>	30μ" Gold/200μ" Tin
<b>002B</b>	30μ" Gold/10μ" Gold
<b>011B</b>	10μ" Gold/200μ" Tin
<b>014B</b>	200μ" Tin/200μ" Tin
<b>PTH =</b>	.026 ± .003

**FLUSH PROFILE PPC™**

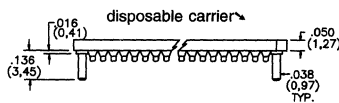

Specify	Contact/Shell
<b>710C</b>	30μ" Gold/200μ" Tin
<b>711C</b>	30μ" Gold/10μ" Gold
<b>714C</b>	200μ" Tin-Lead/200μ" Tin-Lead
<b>PTH =</b>	.044 ± .003

**PATTERN OPTIONS**

**Top View**

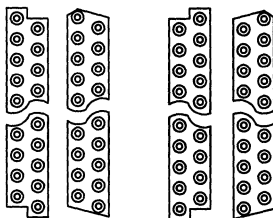

Standard Pattern    Inverted Patterns

Insulators are  
UL 94V-0 Rated  
Thermoplastic

**Features**

- For high density memory using vertical zig-zag in-line patterns
- Available in 16, 18, 20, 24, and 28 positions
- End-to-end and side-to-side stackability
- PPC™ option provides as low as .016" (0,41) above board profile — near flush
- Wide variety of contact styles available
- Use inverted style to create Quad in-line patterns — no insulator crossbars

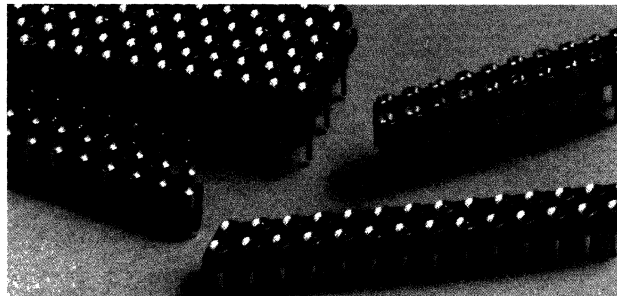

**Ganged ZIP Pattern**

- Ganged packages maximize device density
- Ganged ZIPs are available in arrays up to 20 ganged ZIPs of 32 pins each for a total of 640 pins
- Available in molded insulator or disposable PPC™

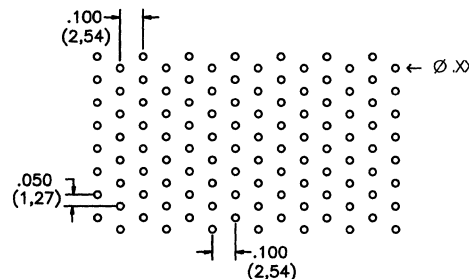

**TYPICAL GANGED ZIP PCB LAYOUT**

## Parallelogram Insulators

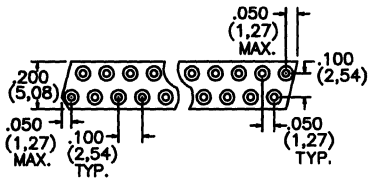

VIEWED FROM TOP  
OF CONTACTS

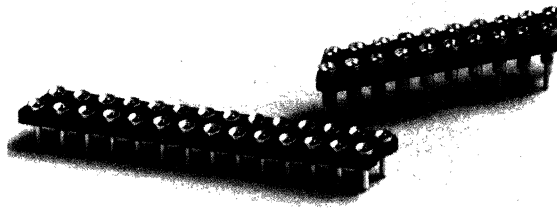

## How To Order

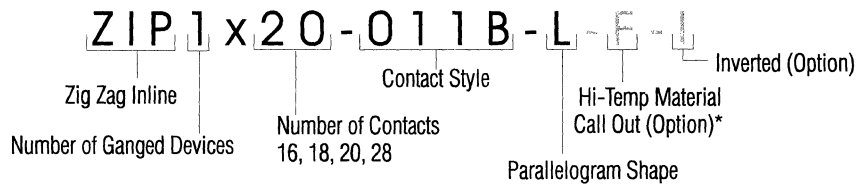

\*See page B1 for Material Callouts

## Stepped Insulators

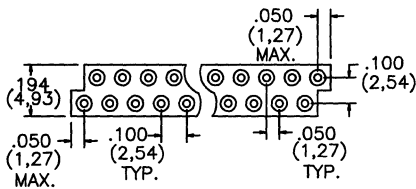

VIEWED FROM TOP  
OF CONTACTS

## How To Order

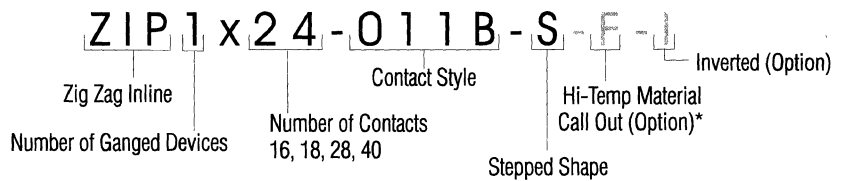

\*See page B1 for Material Callouts

## Disposable Plastic Pin Carriers

- Available in a wide variety of contacts
- Ideal for flush profile or high-density ganged applications



Patent No. 4,420,877

## How To Order

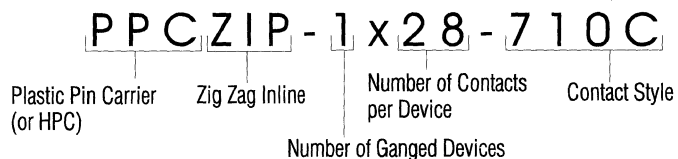

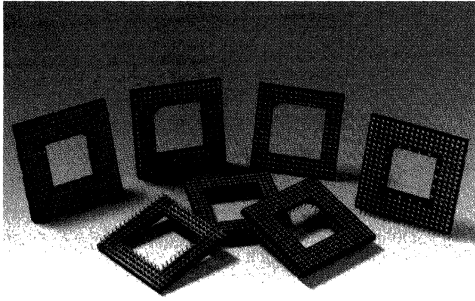

**Largest Selection of Footprints**

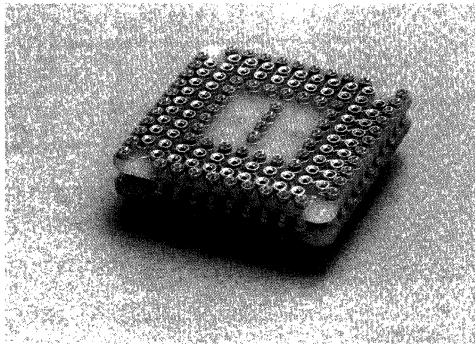

**Custom Configurations**

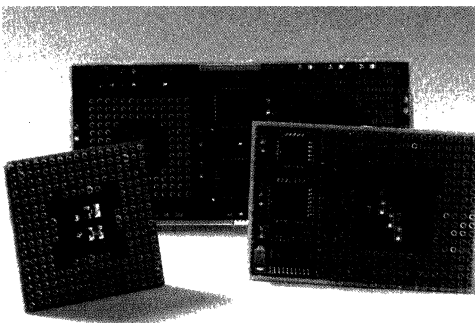

**Hybrid PGA Sockets, Application and  
Customer Specific Modules**

## Pin Grid Array Sockets

***Delivery + Quality + Selection + Price = McKenzie PGA***

McKenzie Technology is the source for Pin Grid Array Sockets. We offer the largest selection of footprints and contact options in the industry.

State of the art, on-site molding and automated assembly mean unbeatable quality and delivery at a very competitive price.

With a reputation built on engineered innovation, our PGA Socket family includes many leading edge products designed to deliver solutions for your most difficult requirements.

*Among these are:*

- Ultra Low Insertion Force (ULIF) screw machine contacts with a third of the insertion/extraction forces found in industry standard PGA Sockets (recommended for pin counts greater than 150).
- Extremely low profile (.016" [0,41] above board height) contacts on our patented plastic pin carrier (PPC) system for applications short on head room or needing the lowest lead length possible for high speed digital requirements.
- Application Specific Modules, Circuit Correction and Hybrid Sockets designed to correct bugs in ASIC's and errors in board layouts.
- Impedance controlled (ZGA) for high speed devices.

If you do not find the PGA Socket you are looking for in this section, please complete the worksheet found on page F10 of this catalog and fax it to us.

***Standard to custom, no one does it better!***

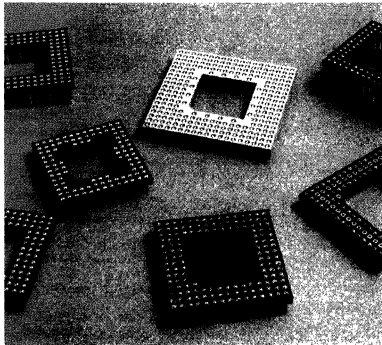

*Options, options, options...*

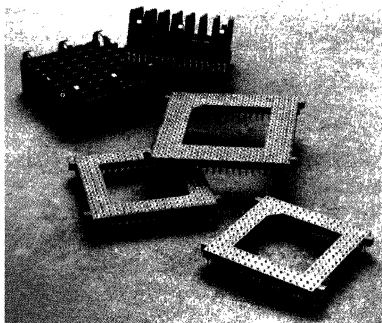

*Heatsink options*

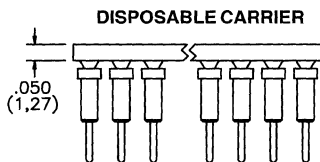

**Plastic Pin Carrier™**  
Pat. #4,420,877

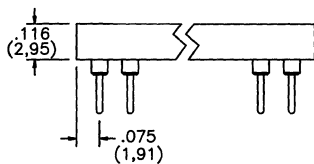

**Molded PPS Thermoplastic**

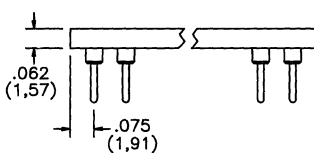

**Molded Glass Laminate**

### Sockets from the Industry's Source!

- Largest selection of molded PGA footprints
- Widest variety of contact styles — over 140 contact options listed in Section A
- Insulator materials that meet your toughest Hi-Temp application needs
- Contact options ensure the lowest possible insertion and extraction forces
- Custom patterns and high pin count PGA's are our specialty.

#### Plastic Pin Carrier (PPC™) Option

- Rigid disposable carrier keeps contact lined up for easy insertion
- Ultra low profile applications as low as .016" (0,41) max. above the surface of your board
- Self masks against solder, flux, and solvent contamination
- Ideal for high speed systems to reduce propagation delays by shortening interconnect paths between devices

#### Heat Sink Attachment Option

- Molded bezel attaches to bottom of PGA Socket giving it tabs to which a heatsink can be clipped
- Rotatable so that the heatsink can be clipped on relative to the direction of the airflow
- Designed to mate with leading heatsink manufacturers' heatsink and clip assemblies
- Can be applied to any PGA socket with a standard soldered tail contact

#### Hi-Temp Insulator Materials

- R PPS** Glass Reinforced Polyphenylene Sulfide, UL 94V-0, ≤220°C
- F FR4** Glass Reinforced Epoxy Laminate, UL 94V-0, ≤140°C
- H Hi-3003** Glass Reinforced Polyimide Laminate, UL 94V-0, ≤250°C



INSULATOR CENTER OPTIONS

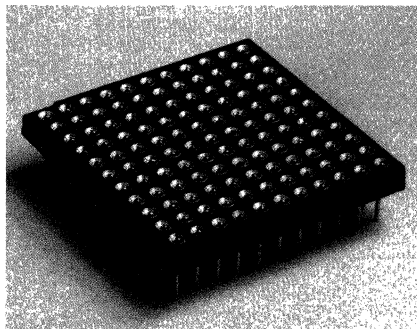

Full matrix of holes-option "M"

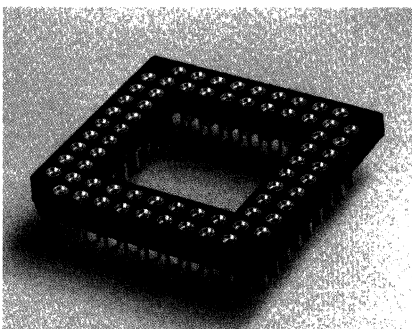

Square center hole-option "H"

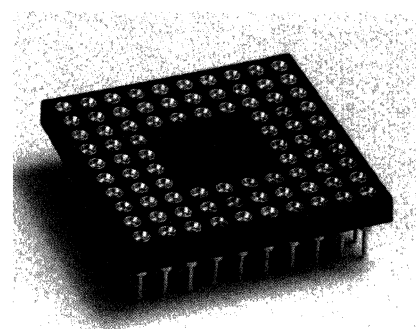

Solid center-option "S"

OUR MOST POPULAR CONTACTS

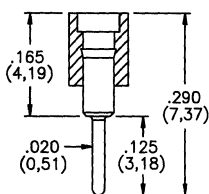

Specify	Contact/Shell
003B*	30µ" Gold/200µ" Tin
004B*	30µ" Gold/10µ" Gold
012B*	10µ" Gold/200µ" Tin
015B*	200µ" Tin/200µ" Tin
008B§	10µ" Gold/200µ" Tin
009B§	30µ" Gold/200µ" Tin
010B§	30µ" Gold/10µ" Gold

\* Very low insertion force (VLI)  
§ Ultra low insertion force (ULIF)

See section A for details

Follow These Steps to Order:

1. Select pattern and socket body center style from this section
2. Choose contact style from table at left or, from Section A
3. Determine insulator material best suited to your application or use Plastic Pin Carrier (PPC™ or HPC™).
4. Specify Heatsink attachment if required
5. See page F12 for recommended PCB layout diagrams
6. Please call for application assistance or samples

For other features please consult the factory:

- E = Standoff feet located on the top surface of the insulator
- P = 'Pick-n-Place', circular tab in middle of ins. for auto placement
- S = Standoff feet located on the bottom surface of the insulator
- T = Heat sink mounting feature provided by the socket

How To Order

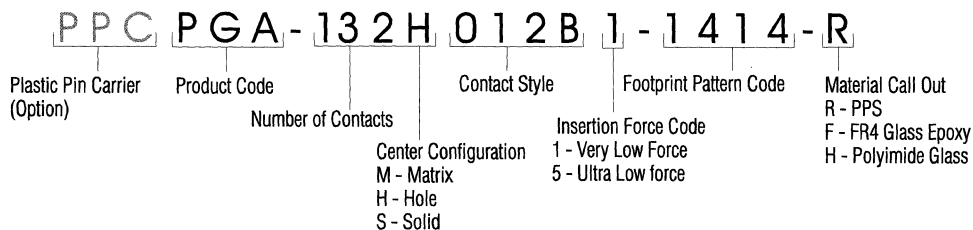

All McKenzie Molded Sockets



Insertion Force Note: McKenzie Technology strongly recommends using an Ultra Low Insertion Force (ULIF) style contact where the pin count exceeds 150 pins.

### Ultra Low Force Contacts for High Pin Count PGA Sockets

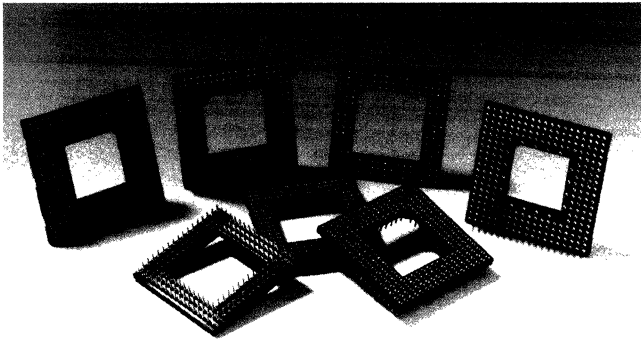

Standard PGA's

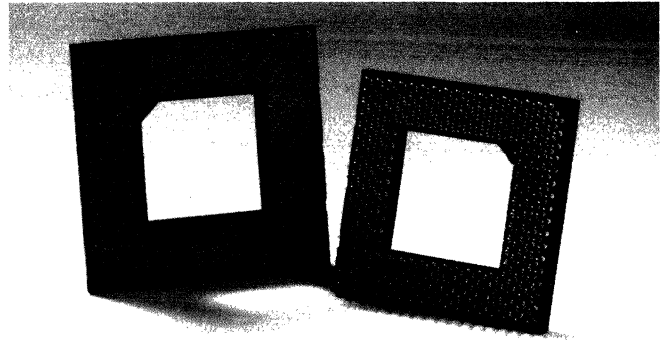

Interstitial PZA Sockets

Contact	Contact/Shell Plating	Tail Length	Above PCB Height
008B	10µ" Gold/200µ" Tin	.125 (3,18)	.165 (4,19)
009B	30µ" Gold/200µ" Tin	.125 (3,18)	.165 (4,19)
187B	30µ" Gold/10µ" Gold	.108 (2,74)	.122 (3,10)
010B	30µ" Gold/10µ" Gold	.125 (3,18)	.165 (4,19)
059B	30µ" Gold/200µ" Tin	.183 (4,65)	.173 (4,39)
026B	30µ" Gold/200µ" Tin	.150 (3,81)	.165 (4,19)
022B	10µ" Gold/10µ" Gold	.125 (3,18)	.165 (4,19)
024B	30µ" Gold/10µ" Gold	.273 (6,93)	.173 (4,39)
001M	10µ" Gold/200µ" Tin	.133 (3,38)	.122 (3,10)
027B	200µ" Tin/200µ" Tin	.125 (3,18)	.165 (4,19)
030B	30µ" Gold/200µ" Tin	.125 (3,18)	.165 (4,19)
033B	10µ" Gold/200µ" Tin	.125 (3,18)	.165 (4,19)

Contact	Contact/Shell Plating	Tail Length	Above PCB Height
509B	30µ" Gold/200µ" Tin	.125 (3,18)	.165 (4,19)
118B	30µ" Gold/10µ" Gold	.270 (6,86)	.165 (4,19)
120B	30µ" Gold/10µ" Gold	.180 (4,57)	.165 (4,19)
003A	30µ" Gold/200µ" Tin	.100 (0,00)	.165 (4,19)
509A	30µ" Gold/10µ" Gold	.125 (3,18)	.165 (4,19)
009A	30µ" Gold/200µ" Tin	.150 (3,81)	.165 (4,19)
010A	10µ" Gold/200µ" Tin	.125 (3,18)	.165 (4,19)
011A	10µ" Gold/200µ" Tin	.125 (3,18)	.165 (4,19)
012A	30µ" Gold/200µ" Tin	.100 (2,54)	.165 (4,19)
013A	30µ" Gold/10µ" Gold	.125 (3,18)	.165 (4,19)
014A	10µ" Gold/200µ" Gold	.100 (2,54)	.165 (4,19)
015A	10µ" Gold/200µ" Gold	.100 (2,54)	.165 (4,19)
016A	10µ" Gold/200µ" Gold	.080 (2,03)	.250 (6,35)
018A	30µ" Gold/200µ" Gold	.125 (3,18)	.165 (4,19)

Solder tail / Diameter .018 ± .002

### Features

- Screw machine contacts utilize a specially designed six finger inner clip which has an average insertion force of 1 ¼ oz. (35 grams) and less than ¾ oz. (21 grams) extraction forces.
- Available in all PGA patterns including custom footprints for your ASIC and RISC devices.
- Sockets are molded in Hi-Temp PPS material and are surface mount compatible.
- Ideal for devices with 150 or more pins.
- Typical insertion/extraction forces in ganged arrangements will experience 15% to 25% increase due to accumulated dimensional tolerance mismatch between the device and socket.
- See page X2, for further insertion/extraction force data.

### TYPICAL CONTACTS AVAILABLE

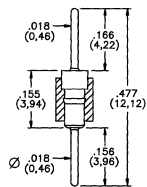

**878S — gold**  
**879S — tin**

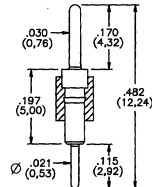

**870S - gold**

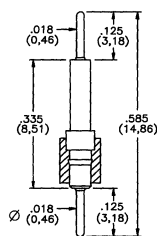

**862S — gold**  
**858S — tin**

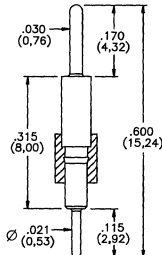

**924H — gold**  
**925H — tin**

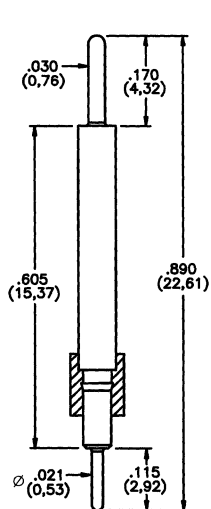

**920H — gold**

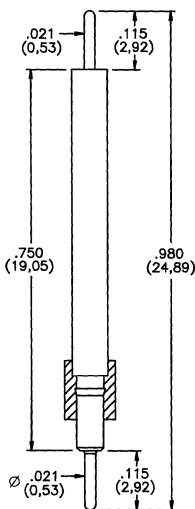

**932H — gold**

**Many more to choose from**

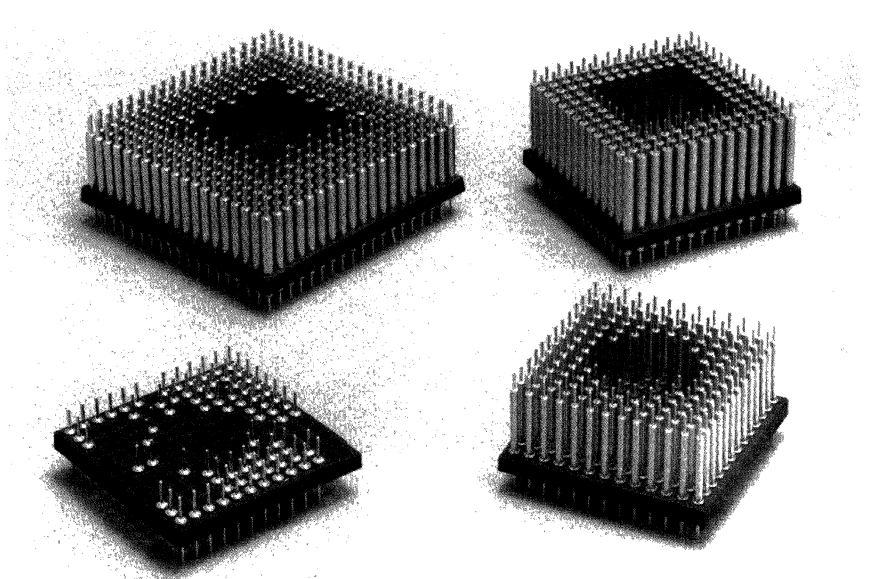

### Features

- Widest selection of contacts styles available in the industry!
- Standard and Hi-Temp insulator styles
- Call for samples

*See Section A for complete terminal selection*

### How To Order

**PGA132H862S-1414-R**

Product Code	Number of Contacts	Terminal Style	Footprint Pattern Code	Material Call Out
P	A	13	2	H
8	6	2	S	-
1	4	1	4	-
R				

Center Configuration  
M - Matrix  
H - Hole  
S - Solid

R - PPS  
F - FR4 Glass Epoxy  
H - Polyimide Glass

### Follow these steps:

- Select pattern and socket body center option from pages F12-F42
- Choose terminal styles from Section A
- Select insulator material requirements
- Call the factory for application assistance or samples

## Adjustable Insertion Tool

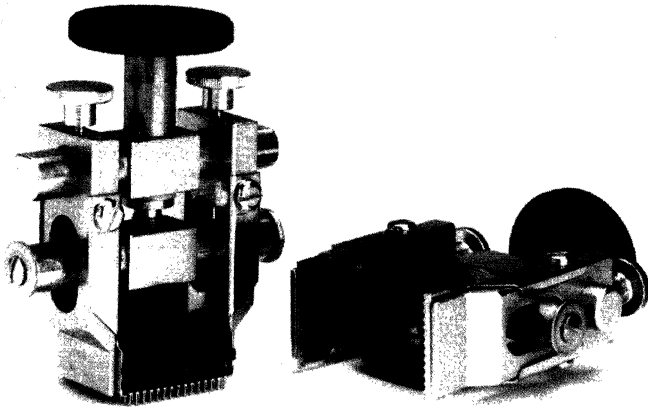

Adjustable TOL PGAIN-10/25-1

- Expensive PGA packages deserve to be handled with care. McKenzie's PGA Insertion tools assure parallel insertion and an even distribution of forces across the entire surface of the device
- Tool grips socket and gently seats device without bending pins or stressing solder joints
- Available in specific size models starting at 10 x 10, and an adjustable model for devices from 10 x 10 to 25 x 25

PART NUMBER	PGA SOCKET SIZE	DIMENSION OF DEVICE
TOL PGAIN-10/25-1	10 x 10 to 25 x 25	1.05 (26,67) to 2.55 (64,77)

F

## Adjustable Extraction Tools

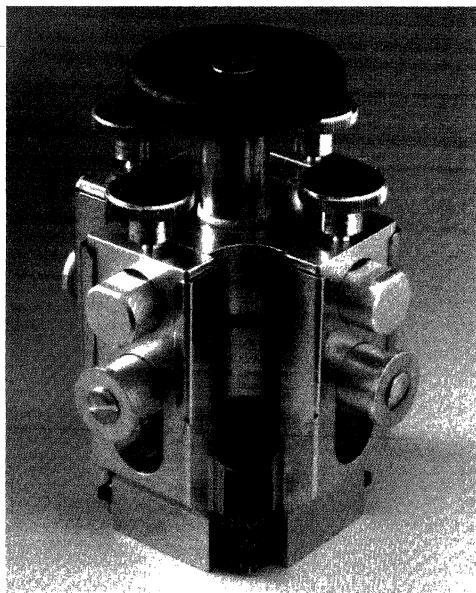

Four sided TOL PGAX-16/25-1

- Design assures parallel extraction
- Heavy duty steel and aluminum construction
- Quick and easy thumb screw adjustment with a high gear ratio
- The wide lift range allows for extraction of devices with attached heat sinks

PART NUMBER	PGA SOCKET SIZE	DIMENSION OF DEVICE
TOL PGAX-16/25-1 (Four Sided)	16 x 16 to 25 x 25	1.65 (41,91) to 2.55 (64,77)
TOL PGAX-10/15-1 (Two Sided)	10 x 10 to 15 x 15	1.05 (26,67) to 1.55 (39,37)

Optional larger knob is available for increased turning power



*Even the most difficult high pin count PGA device can be positively removed with McKenzie Technology's smooth action extraction tool.*

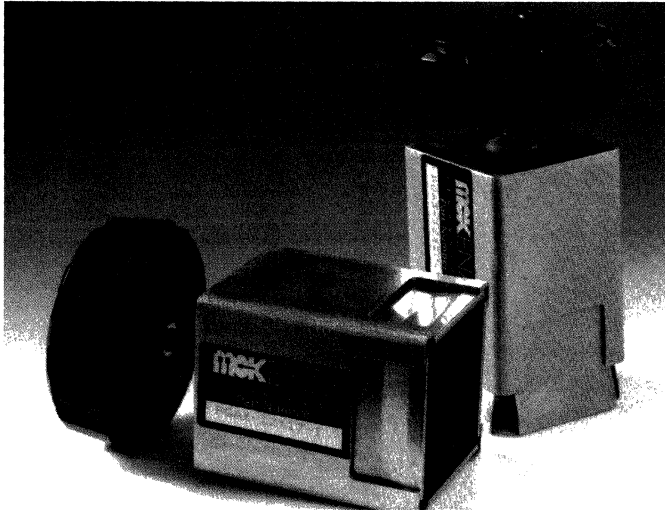

**Features**

- Rugged stainless steel construction assures parallel device removal
- Large molded knob requires minimum turning effort
- Thin wall construction and cut-a-ways minimizes interference with adjacent components
- Removes both standard socketed and flush socketed devices
- Specific size tools require no adjustment and ensure positive engagement with device

**Ordering Note**

Device packages vary in size and dimensional tolerances. Be sure to check specific device dimensions against minimums/maximums listed below before ordering.

Tool P/N's	Minimum	Maximum
TOL PGAX - 10x10 - 1	1.040 (26,42)	1.080 (27,43)
TOL PGAX - 11x11 - 1	1.140 (28,96)	1.180 (29,97)
TOL PGAX - 12x12 - 1	1.240 (31,50)	1.280 (32,51)
TOL PGAX - 13x13 - 1	1.340 (34,04)	1.380 (35,05)
TOL PGAX - 14x14 - 1	1.440 (36,58)	1.480 (37,59)
TOL PGAX - 15x15 - 1	1.540 (39,12)	1.580 (40,13)
TOL PGAX - 16x16 - 1	1.640 (41,66)	1.680 (42,67)
TOL PGAX - 17x17 - 1	1.732 (43,99)	1.780 (45,21)
TOL PGAX - 18x18 - 1	1.840 (46,74)	1.880 (47,75)
TOL PGAX - 19x19 - 1	1.940 (49,28)	1.980 (50,29)
TOL PGAX - 20x20 - 1	2.040 (51,82)	2.080 (52,83)
TOL PGAX - 21x21 - 1	2.140 (54,36)	2.180 (55,37)
TOL PGAX - 22x22 - 1	2.240 (56,90)	2.280 (57,91)
TOL PGAX - 23x23 - 1	2.340 (59,44)	2.380 (60,45)
TOL PGAX - 24x24 - 1	2.440 (61,98)	2.480 (62,99)
TOL PGAX - 25x25 - 1	2.540 (64,52)	2.580 (65,53)

The device package configurations listed below may have changed since the printing of this cross reference. McKenzie Technology can not guarantee the accuracy of this information. Samples are available for engineering review. Please consult the factory for samples for your applications.

DEVICE #	MCKENZIE SOCKET	DEVICE #	MCKENZIE SOCKET	DEVICE #	MCKENZIE SOCKET
<b>ACTEL</b>		<b>AT&amp;T</b>		<b>HITACHI</b>	
A1280-PG176	PGA 176H008B5 - 1512R	3020	PGA 84H012B1 - 1109R	B600	PGA 84H012B1 - 1002R
A1240-PG132	PGA 133H012B1 - 13F7R	32106	PGA 125H012B1 - 1373R	C1275	PGA 64H012B1 - 1011R
<b>ALTERA</b>		32100	PGA 133H012B1 - 13B3R	C2000H	PGA 65H012B1 - 1137R
EP1800	PGA 68H012B1 - 1189R	32103	PGA 133H012B1 - 13B3R	C2000H	PGA 64H012B1 - 1011R
EP1810	PGA 68H012B1 - 1189R	32104	PGA 133H012B1 - 13B3R	C2600VH	PGA 84H012B1 - 1002R
EP1830	PGA 68H012B1 - 1189R	ATT3030	PGA 132H012B1 - 1109R	C3900H	PGA 65H012B1 - 1137R
EPF8452	PGA 160H008B5 - 15C3	ATT3042	PGA 132H012B1 - 1414R	C3900H	PGA 64H012B1 - 1011R
EPF8820	PGA 192H008B5 - 1781	ATT3064	PGA 132H012B1 - 1414R	C440H	PGA 64H012B1 - 1011R
EPM5128	PGA 68H012B1 - 1132R	ATT3090	PGA 175H008B5 - 1608R	C770	PGA 64H012B1 - 1011R
EPM5192	PGA 84H012B1 - 1109R	<b>BIT</b>		MB86901	PGA 179H008B5 - 1510R
EPM5130	PGA 100H012B1 - 13B5R	B6000	PGA 259H008B5 - 1829R	MB86940	PGA 135H012B1 - 1458R
<b>AMD</b>		B6020	PGA 259H008B5 - 1829R	MB87068	PGA 84H012B1 - 1002R
AM29325	PGA 145H012B1 - 1521R	B6010	PGA 259H008B5 - 1829R	MBL80186	PGA 65H012B1 - 1137R
AM95C60	PGA 149H012B1 - 1517R	B2022	PGA 225H008B5 - 1804R	MBL80286	PGA 64H012B1 - 1011R
AM486DX	PGA 168H008B5 - 1706	B2023	PGA 225H008B5 - 1804R	<b>CYPRESS</b>	
AM486SX	PGA 168H008B5 - 1706	B2020	PGA 225H008B5 - 1804R	CY7B138	PGA 68H012B1 - 1132R
29000	PGA 169H008B5 - 1709R	B2021	PGA 225H008B5 - 1804R	CY7B144	PGA 68H012B1 - 1132R
A9850	PGA 68H012B1 - 1132R	<b>HITACHI</b>		CY7C341	PGA 84H012B1 - 1354R
AM2018	PGA 84H012B1 - 1109R	HD61811Y	PGA 68H012B1 - 1015R	CY7C342	PGA 68H012B1 - 1132R
AM2064	PGA 68H012B1 - 1132R	HD63450Y10	PGA 68H012B1 - 1015R	CY7C510	PGA 68H012B1 - 1132R
AM29117	PGA 68H012B1 - 1132R	HD63450Y12	PGA 68H012B1 - 1015R	CY7C516	PGA 68H012B1 - 1132R
AM29030	PGA 146H012B1 - 15B8R	HD63450Y6	PGA 68H012B1 - 1015R	CY7C517	PGA 68H012B1 - 1132R
SERIES 3500	PGA 169H008B5 - 1709R	HD63450Y8	PGA 68H012B1 - 1015R	CY7C600	PGA 209H008B5 - 1725R
AM29331	PGA 120H012B1 - 13E4R	HD63484Y4	PGA 68H012B1 - 1015R	CY7C601A	PGA 207M009B5 - 1760R
AM29334	PGA 120H012B1 - 13E4R	HD63484Y6	PGA 68H012B1 - 1015R	CY7C602A	PGA 144H012B1 - 1523R
AM3020	PGA 84H012B1 - 1109R	HD63484Y8	PGA 68H012B1 - 1015R	CY7C9101	PGA 68H012B1 - 1132R
AM3030	PGA 84H012B1 - 1109R	HD63484Y98	PGA 68H012B1 - 1015R	CY7C9117	PGA 68H012B1 - 1132R
AM3042	PGA 132H012B1 - 1414R	HD64400	PGA 135H012B1 - 1458R	CY7C9117	PGA 68H012B1 - 1132R
AM3064	PGA 132H012B1 - 1414R	HD64530	PGA 68H012B1 - 1015R	CYM7232	PGA 401H008B5 - 2506R
AM3090	PGA 175H008B5 - 1608R	HD68000Y10	PGA 68H012B1 - 1015R	CYM7264	PGA 401H008B5 - 2506R
AM80186	PGA 68H012B1 - 1132R	HD68000Y12	PGA 68H012B1 - 1015R	VIC068-A	PGA 144H012B1 - 1523R
AM80286	PGA 68H012B1 - 1132R	HD68000Y8	PGA 68H012B1 - 1015R	VIC068	PGA 144H012B1 - 1523R
<b>ANALOG DEVICES</b>		HD68450Y	PGA 68H012B1 - 1015R	VIC64	PGA 144H012B1 - 1523R
AD1010	PGA 68H012B1 - 1132R	HD68450Y10	PGA 68H012B1 - 1015R	<b>DIGITAL EQUIPMENT</b>	
ADSP1101	PGA 101H012B1 - 1321R	HD68450Y8	PGA 68H012B1 - 1015R	AXP21064A	PGA 431H008B5 - 2406R
ADSP3201	PGA 145H012B1 - 1521R	HD68450Y12	PGA 68H012B1 - 1015R	AXP21064	PGA 431H008B5 - 2406R
ADSP3202	PGA 145H012B1 - 1521R	HD68800Y8	PGA 68H012B1 - 1015R	AXP 21066	PGA 287H008B5 - 2211R
ADSP3210	PGA 101H012B1 - 1345R	HD68800Y10	PGA 68H012B1 - 1015R	AXP 21068	PGA 287H008B5 - 2211R
ADSP3211	PGA 145H012B1 - 1521R	HD688450Y	PGA 68H012B1 - 1015R	FUTURE ALPHA AXP ..... PZA 499H509B - 43AC	
ADSP3221	PGA 145H012B1 - 1521R	HD688450Y10	PGA 68H012B1 - 1015R	<b>FUJITSU</b>	
ADSP3221	PGA 145H012B1 - 1521R	HD688450Y8	PGA 68H012B1 - 1015R	C8000	PGA 180H008B5 - 1508R
ADSP3220	PGA 145H012B1 - 1521R	HD68HC000	PGA 68H012B1 - 1015R	MB86930	PGA 179H008B5 - 1836R
ADSP3220	PGA 145H012B1 - 1521R	HD68HC000Y10	PGA 68H012B1 - 1015R	MB86940	PGA 135H012B1 - 1458R
ADSP1009/10A	PGA 68H012B1 - 1132R	HD68HC000Y12	PGA 68H012B1 - 1015R	B1100	PGA 84H012B1 - 1002R
ADSP1012	PGA 68H012B1 - 1132R	HD81821	PGA 135H012B1 - 1458R	B2000	PGA 135H012B1 - 1458R
ADSP1016A	PGA 68H012B1 - 1132R	HD81831	PGA 135H012B1 - 1458R	B350	PGA 84H012B1 - 1002R
ADSP7018	PGA 108H012B1 - 1204R	HG28A18	PGA 120H012B1 - 1314R	B500	PGA 64H012B1 - 1011R
ADSP8018	PGA 108H012B1 - 1204R	HG28E10	PGA 120H012B1 - 1314R		
AD1016	PGA 149H012B1 - 1517R	HG61H04	PGA 68H012B1 - 1015R		
AD3220	PGA 176H008B5 - 1512R	HG61H06	PGA 68H012B1 - 1015R		
ADSP1024	PGA 85H012B1 - 1107R	HG61H09	PGA 68H012B1 - 1015R		
		HG61H25	PGA 120H012B1 - 1314R		
		HG61H20	PGA 120H012B1 - 1314R		
		HG61H15	PGA 120H012B1 - 1314R		
		HG61H15	PGA 68H012B1 - 1015R		
		HG61H20	PGA 68H012B1 - 1015R		
		HG61H25	PGA 68H012B1 - 1015R		
		HG61H09	PGA 120H012B1 - 1314R		
		HG62B40	PGA 120H012B1 - 1314R		
		HG62B40	PGA 135H012B1 - 1458R		

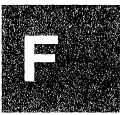





## Customer Worksheet

Fax us at (510) 651-1020 (day or night) for quick engineering evaluation samples and quotation

(As viewed from top of sockets)

### PGA/100 PROGRESSION

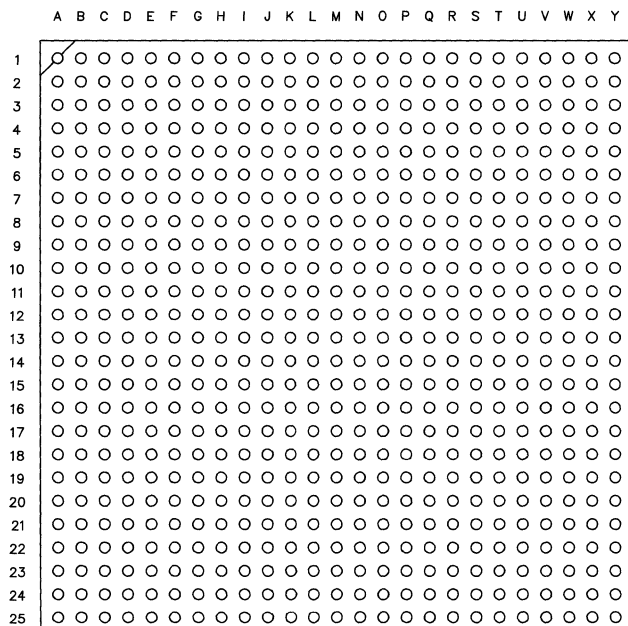

### PZA/INTERSTITIAL PROGRESSION

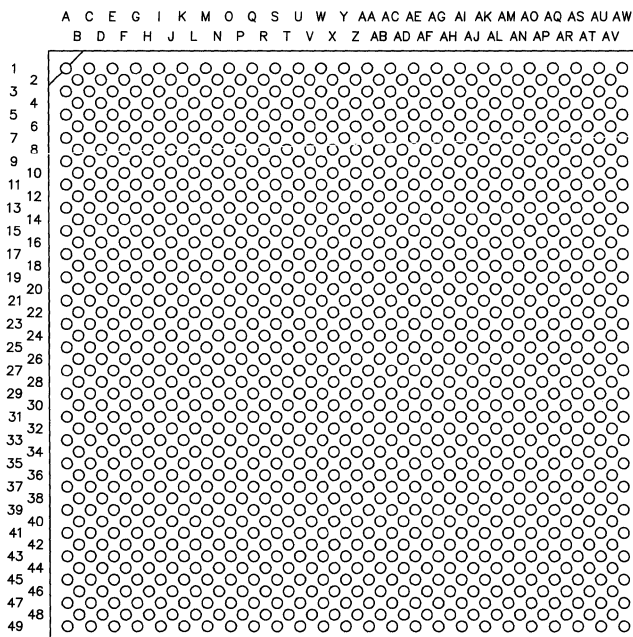

#### LEGEND:

- Blank or empty position
- Shade in each contact position



Device Mfg/Type\* \_\_\_\_\_

\*Include Mfg.'s footprint or datasheet if available

Pin Count \_\_\_\_\_ Lead Dim. \_\_\_\_\_

PCB Thickness  .062" (1,57)  .090" (2,29)  \_\_\_\_\_

Solder tail or  Wire wrap ( 2 LVL  3 LVL)

Specify contact style\*\* \_\_\_\_\_

\*\*See pg. F2-F3 for standard contacts, or section A for other options

Printed Circuit Board PTH Size \_\_\_\_\_

Insulator Material:

Standard Molded Thermoplastic, UL 94V-0

Hi-Temp Molded Thermoplastic, UL 94V-0

FR4 Glass Epoxy, UL 94V-0

Disposable Plastic Pin Carrier (PPC or HPC)

Soldering Temp/Time \_\_\_\_\_ °F / \_\_\_\_\_ sec.

Continuous Operating Temp \_\_\_\_\_ °F

Preferred Center Style:  Hole (ventilated) see example\*

Solid Center  Stand Offs ( Bottom  Top)

Est. monthly production qty.: \_\_\_\_\_ Starting: \_\_\_\_\_

Requested by \_\_\_\_\_

Title \_\_\_\_\_

Address \_\_\_\_\_

City/State/Zip \_\_\_\_\_

Phone \_\_\_\_\_ Fax \_\_\_\_\_

Notes \_\_\_\_\_

\*EXAMPLE:

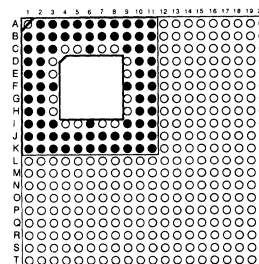

### Features

- Designed for today's high speed integrated circuits.
- Reduces cross talk, controls impedance and protects signal integrity.
- Tunable to the characteristic impedance of the signal line.
- Ultra low insertion force (ULIF) screw machine contacts used for high reliability and managed mating force.

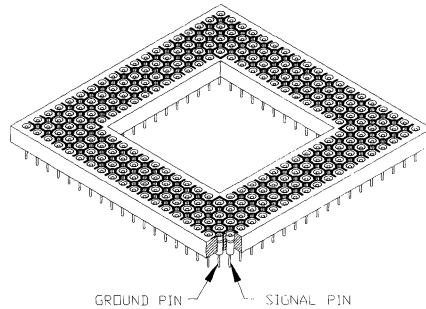

- Ground planes are plated on the top and bottom surface of the socket. The ground plane patterns encircle each contact and are connected through the body of the socket by plated through holes.
- To "tune" the socket to the particular electrical characteristics and net list of the matching device, the ground planes are extended to connect to contacts which house ground pins from the device and the distance between the ground plane pattern and the contacts which house critical signal pins is varied.
- Part Number for Intel Pentium™ CPU socket:  
ZGA 273H509B-2119-002  
Part Number for Intel i486™ CPU socket:  
ZGA 273H509B-2119-004
- Consult factory for further information and to discuss ZGA sockets for your particular processor.

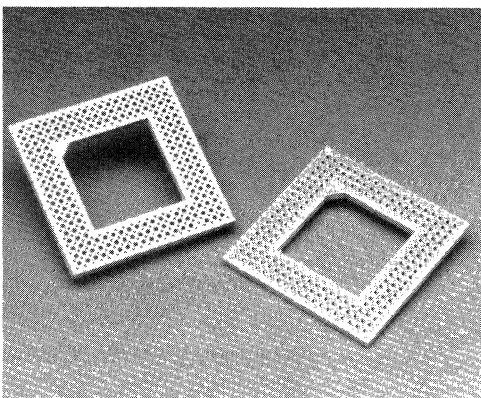
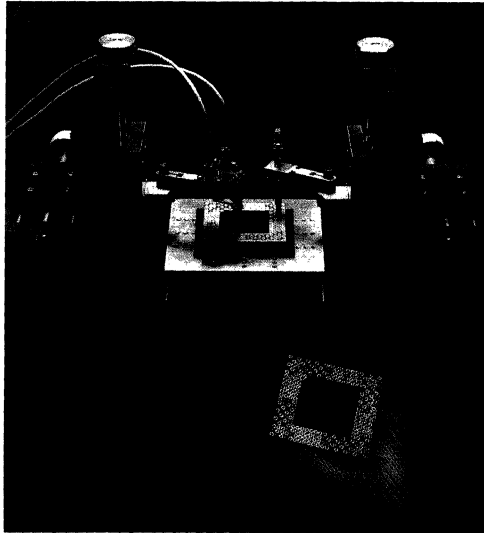

**Example of metallization pattern between the socket ground plane and the signal contact position**

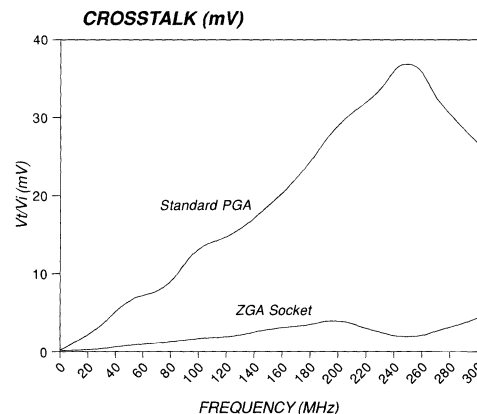
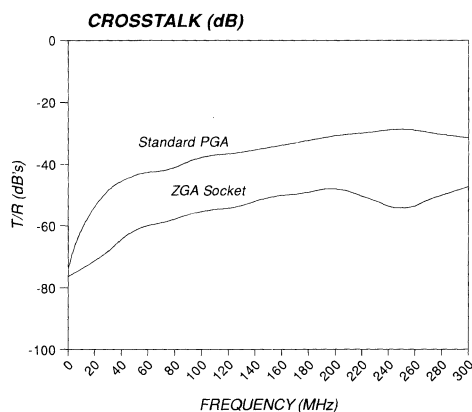

**Plots of crosstalk measurements taken over a bandwidth of 300MHz**

See page F5 and F6 for the industry's most effective PGA Extraction Tools.

### 3 x 3 ARRAYS

DIMENSIONS:

**SOCKETS**  
.350" square  
(8,89)mm square

**PPC™ CARRIERS**  
.300" square  
(7,62)mm square



09M 0301



08S 0310



08M 0302



06M 0303



06M 0304



04M 0305

### 4 x 4 ARRAYS

DIMENSIONS:

**SOCKETS**  
.450" square  
(11,43)mm square

**PPC™ CARRIERS**  
.400" square  
(10,16)mm square



16M 0401



12M 0408



12M 0402



12M 0403



08M 0404



08M 0405



08M 0406



04M 0407

### 5 x 5 ARRAYS

DIMENSIONS:

**SOCKETS**  
.550" square  
(13,97)mm square

**PPC™ CARRIERS**  
.500" square  
(12,70)mm square



25M 0501



24M 0502



23M 0515



22M 0503



21M 0516



21M 0512



21M 0509



20M 0514



20M 0513



20M 0506



20M 0507



16M 0508



16M 0505



15M 0511



12M 0504



10M 0510

MOLDED SOCKETS



RECOGNIZED

Polarity mark (contact #1) is located in upper left corner. Top view of sockets are shown from highest to lowest pin count. Arrays are available in molded Thermoplastic (UL 94V-0 approved) or vapor phase and infrared compatible PPS. Optional FR4 on request.

PGA-6 8 H 0 0 3 B 1 - 1 1 3 2

Pin Count  
Center Configuration

Pattern Number

See page F2 for ordering information

DIMENSIONS: SOCKETS .650" square (16,51)mm square PPC™ CARRIERS .600" square (15,24)mm square **6 x 6 ARRAYS**

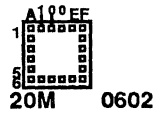
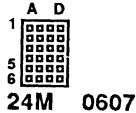
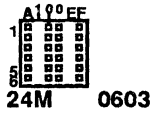
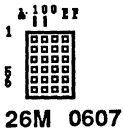
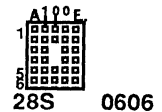
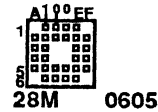
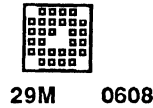
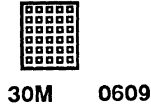
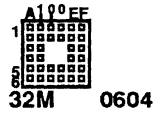
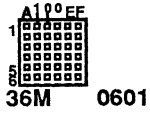

DIMENSIONS: SOCKETS .750" square (19,05)mm square PPC™ CARRIERS .700" square (17,78)mm square **7 x 7 ARRAYS**

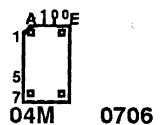
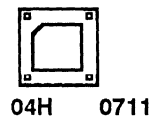
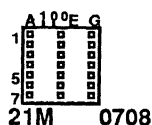
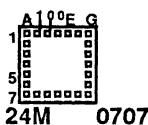
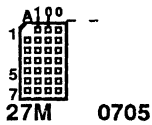
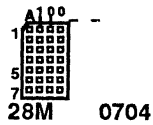
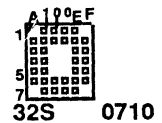
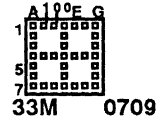
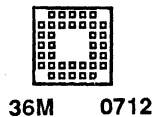
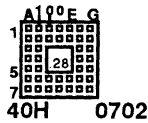
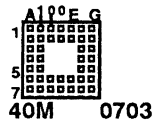
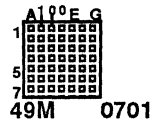

DIMENSIONS: SOCKETS .850" square (21,59)mm square PPC™ CARRIERS .800" square (20,32)mm square **8 x 8 ARRAYS**

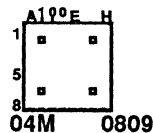
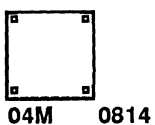
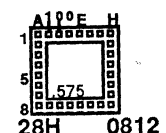
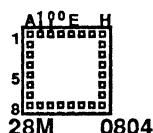
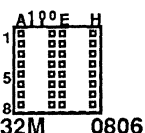
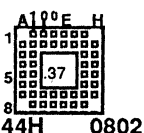
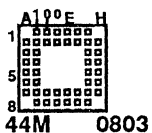
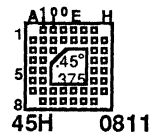
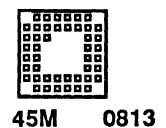
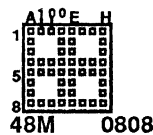
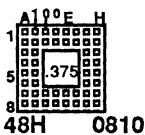
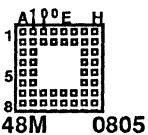
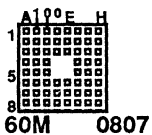
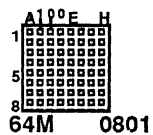



Sockets from the industry's source!

Widest variety of contact styles - over 140 contact options listed in Section A.

## 9 x 9 ARRAYS

DIMENSIONS:

**SOCKETS**  
.950" square  
(24,13)mm square

**PPC™ CARRIERS**  
.900" square  
(22,86)mm square

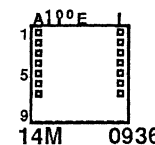
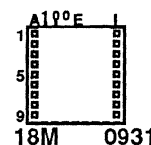
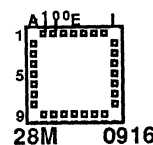
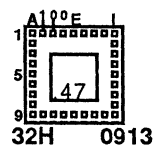
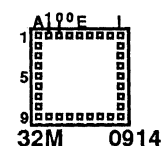
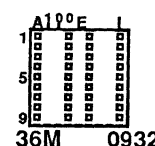
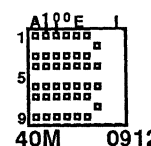
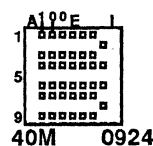
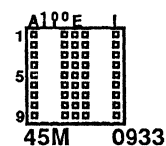
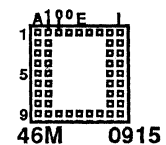
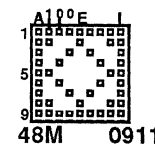
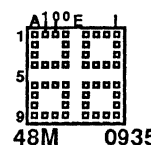
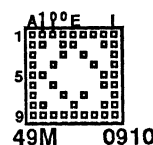
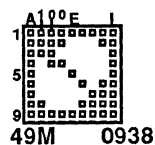
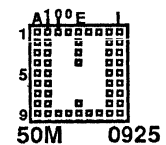
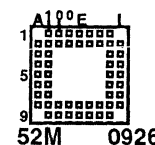
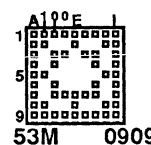
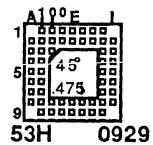
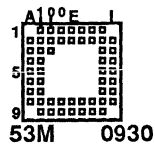
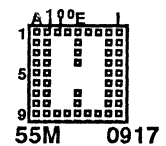
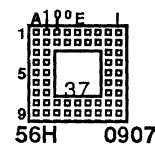
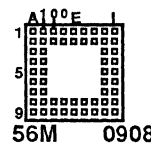
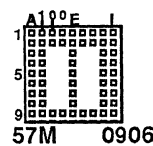
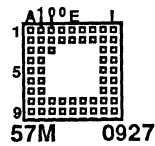
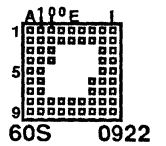
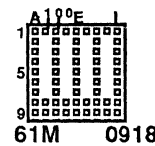
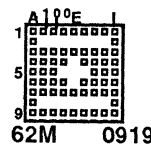
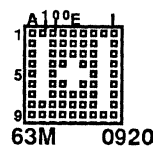
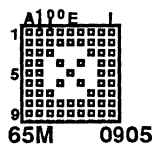
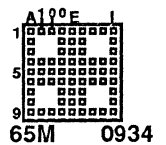
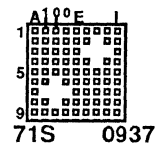
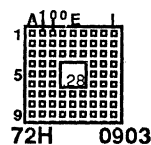
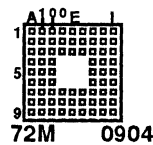
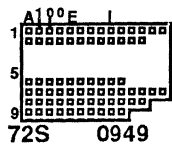
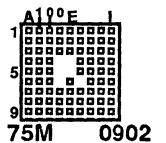
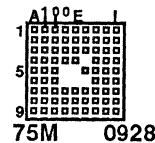
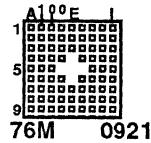
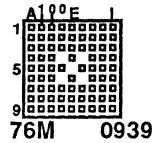
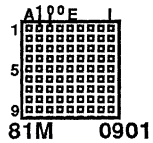

Polarity mark (contact #1) is located in upper left corner. Top view of sockets are shown from highest to lowest pin count. Arrays are available in molded Thermoplastic (UL 94V-0 approved) or vapor phase and infrared compatible PPS. Optional FR4 on request.

**PGA-68H 003B1-1132**

Pin Count

Center Configuration

Pattern Number

See page F2 for ordering information

DIMENSIONS:

**SOCKETS**

1.050" square  
(26,67)mm square

**PPC™ CARRIERS**

1.000" square  
(25,40)mm square

**10 x 10 ARRAYS**

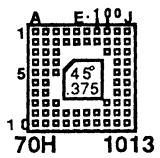
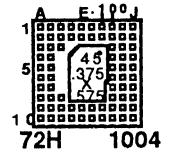
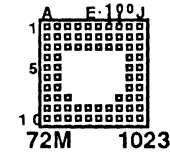
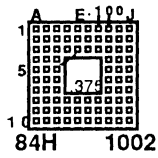
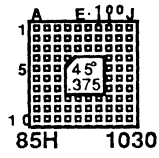
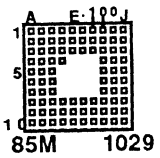
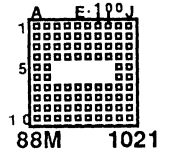
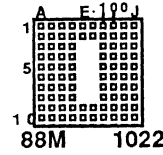
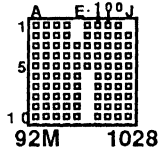
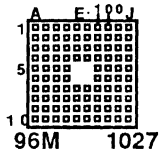
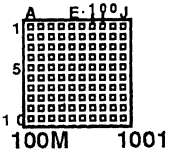

**MOTOROLA 68000**

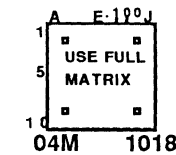
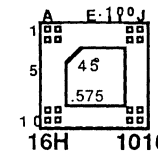
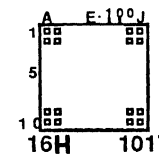
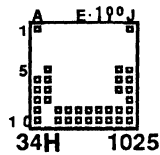
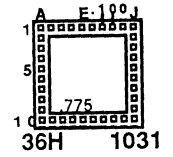
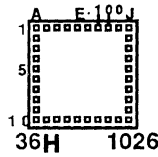
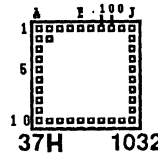
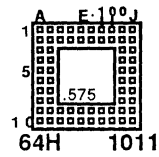
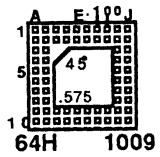
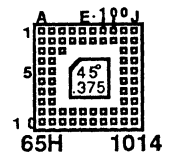
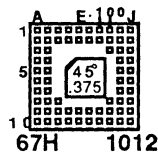
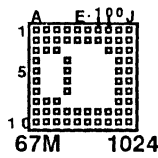
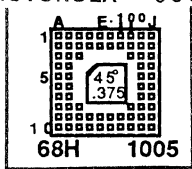

All McKenzie  
Molded Sockets



Select PPC™ (disposable carrier system) Sockets for low profile PGA applications.

## 11 x 11 ARRAYS

DIMENSIONS:

**SOCKETS**  
1.150" square  
(29,21)mm square

**PPC™ CARRIERS**  
1.100" square  
(27,94)mm square

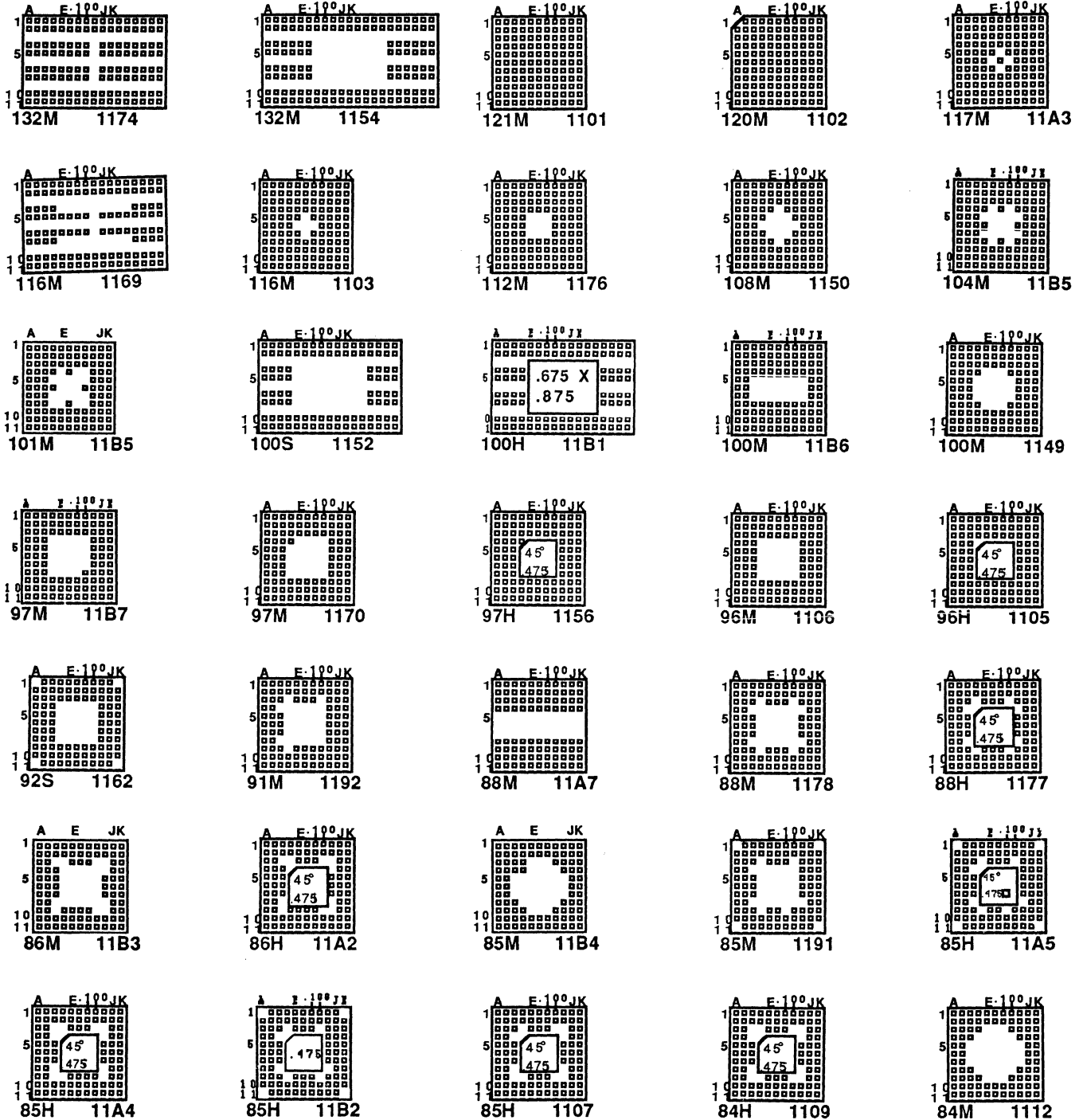

Polarity mark (contact #1) is located in upper left corner. Top view of sockets are shown from highest to lowest pin count. Arrays are available in molded Thermoplastic (UL 94V-0 approved) or vapor phase and infrared compatible PPS. Optional FR4 on request.

P.G.A-68H.003B1-1132

Pin Count  
Center Configuration

Pattern Number

See page F2 for ordering information

DIMENSIONS:

**SOCKETS**  
1.150" square  
(29,21)mm square

**PPC™ CARRIERS**  
1.100" square  
(27,94)mm square

**11 x 11 ARRAYS**

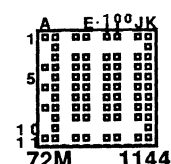
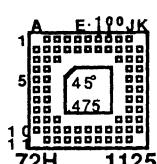
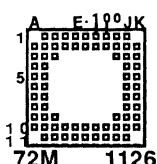
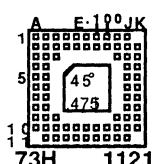
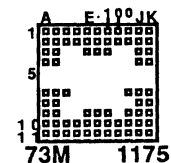
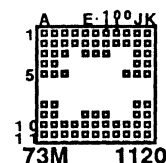
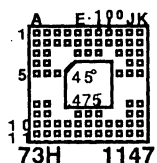
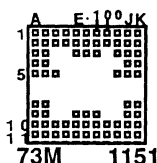
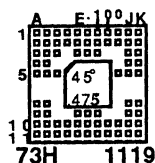
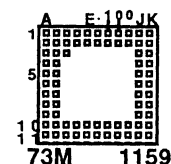
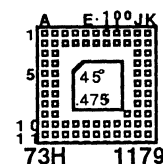
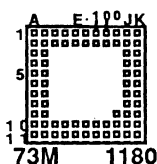
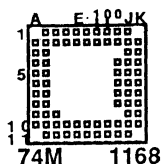
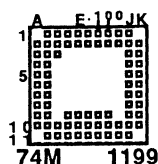
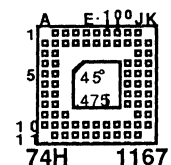
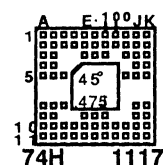
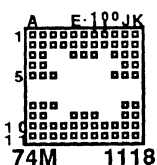
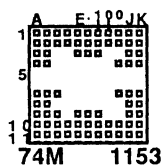
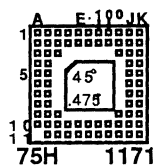
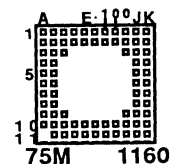
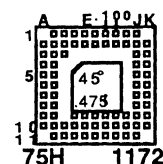
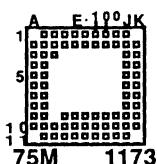
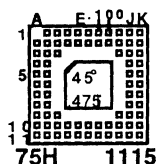
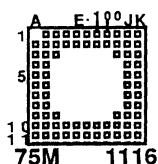
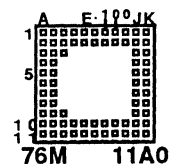
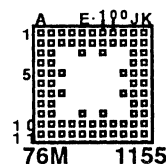
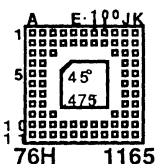
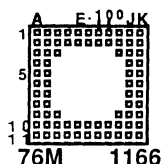
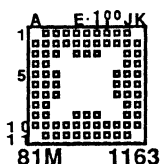
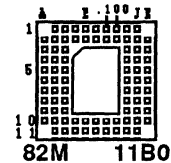
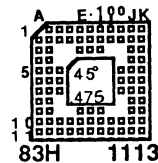
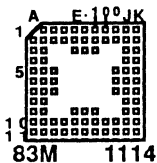
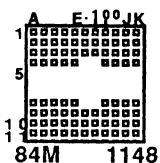
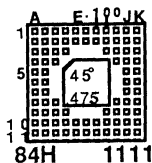

Decoupling Capacitor Sockets manufactured to your specifications.  
Fax us your requirements today.

11 x 11 ARRAYS

DIMENSIONS:

**SOCKETS**  
1.150" square  
(29,21)mm square

**PPC™ CARRIERS**  
1.100" square  
(27,94)mm square

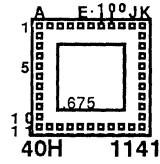
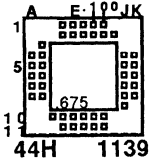
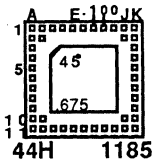
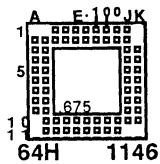
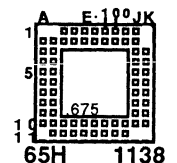
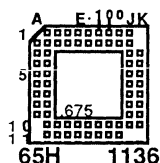
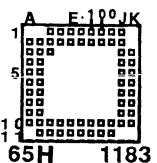
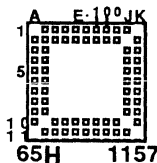
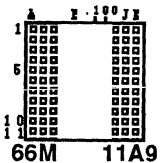
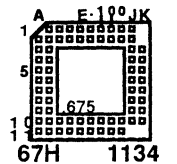
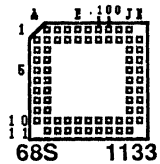
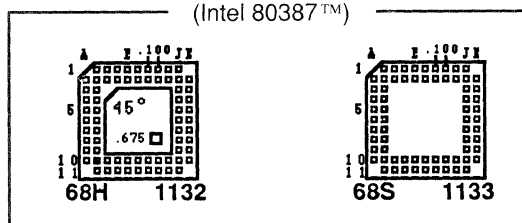
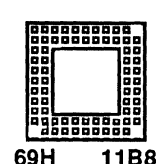
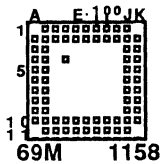
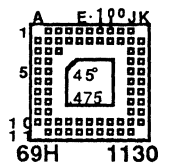
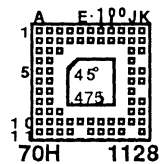
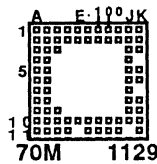
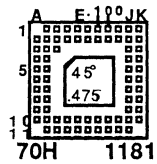
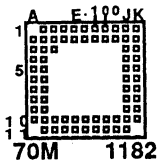
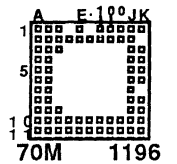
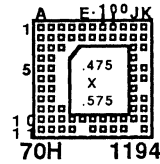
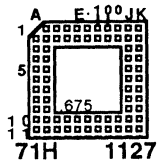
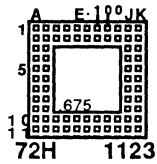
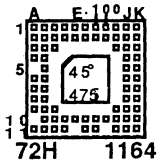

All McKenzie  
Molded Sockets  
**RM**  
Recognized

Polarity mark (contact #1) is located in upper left corner. Top view of sockets are shown from highest to lowest pin count. Arrays are available in molded Thermoplastic (UL 94V-0 approved) or vapor phase and infrared compatible PPS. Optional FR4 on request.

**PGA-68H 003B1-1132**

Pin Count  
Center Configuration

Pattern Number

See page F2 for ordering information

DIMENSIONS:	SOCKETS 1.250" square (31,75)mm square	PPC™ CARRIERS 1.200" square (30,48)mm square	12 x 12 ARRAYS	



See page F5 and F6 for the industry's most effective PGA Extraction Tools.

## 12 x 12 ARRAYS

DIMENSIONS:

**SOCKETS**  
1.250" square  
(31,75)mm square

**PPC™ CARRIERS**  
1.200" square  
(30,48)mm square

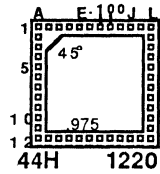
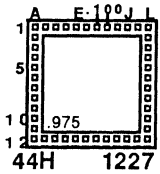
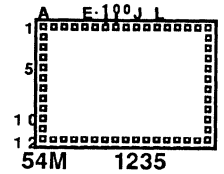
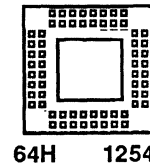
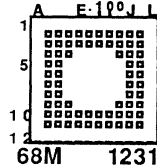
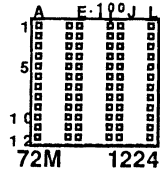
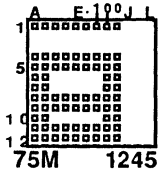

## 13 x 13 ARRAYS

DIMENSIONS:

**SOCKETS**  
1.350" square  
(34,29)mm square

**PPC™ CARRIERS**  
1.300" square  
(33,02)mm square

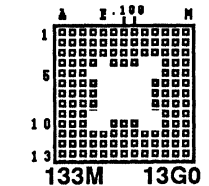
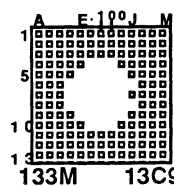
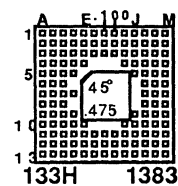
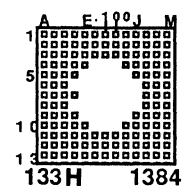
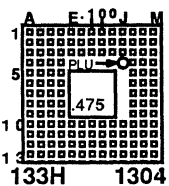
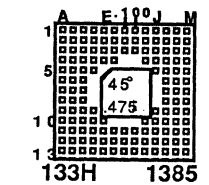
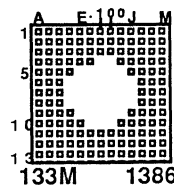
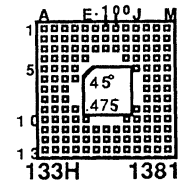
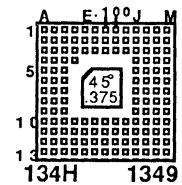
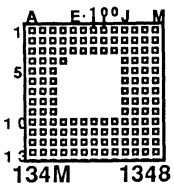
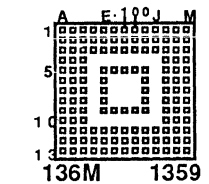
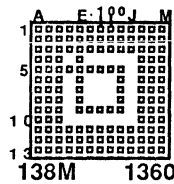
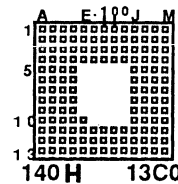
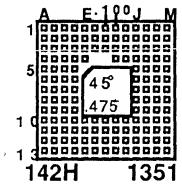
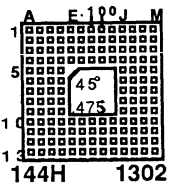
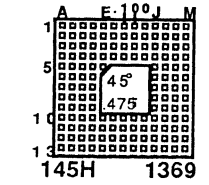
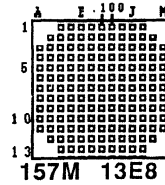
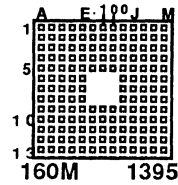
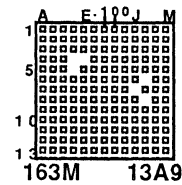
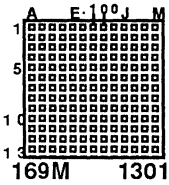

Polarity mark (contact #1) is located in upper left corner. Top view of sockets are shown from highest to lowest pin count. Arrays are available in molded Thermoplastic (UL 94V-0 approved) or vapor phase and infrared compatible PPS. Optional FR4 on request.

**PGA-68H 003B1-1132**

Pin Count

Center Configuration

Pattern Number

See page F2 for ordering information

DIMENSIONS:

**SOCKETS**  
1.350" square  
(34,29)mm square

**PPC™ CARRIERS**  
1.300" square  
(33,02)mm square

**13 x 13 ARRAYS**

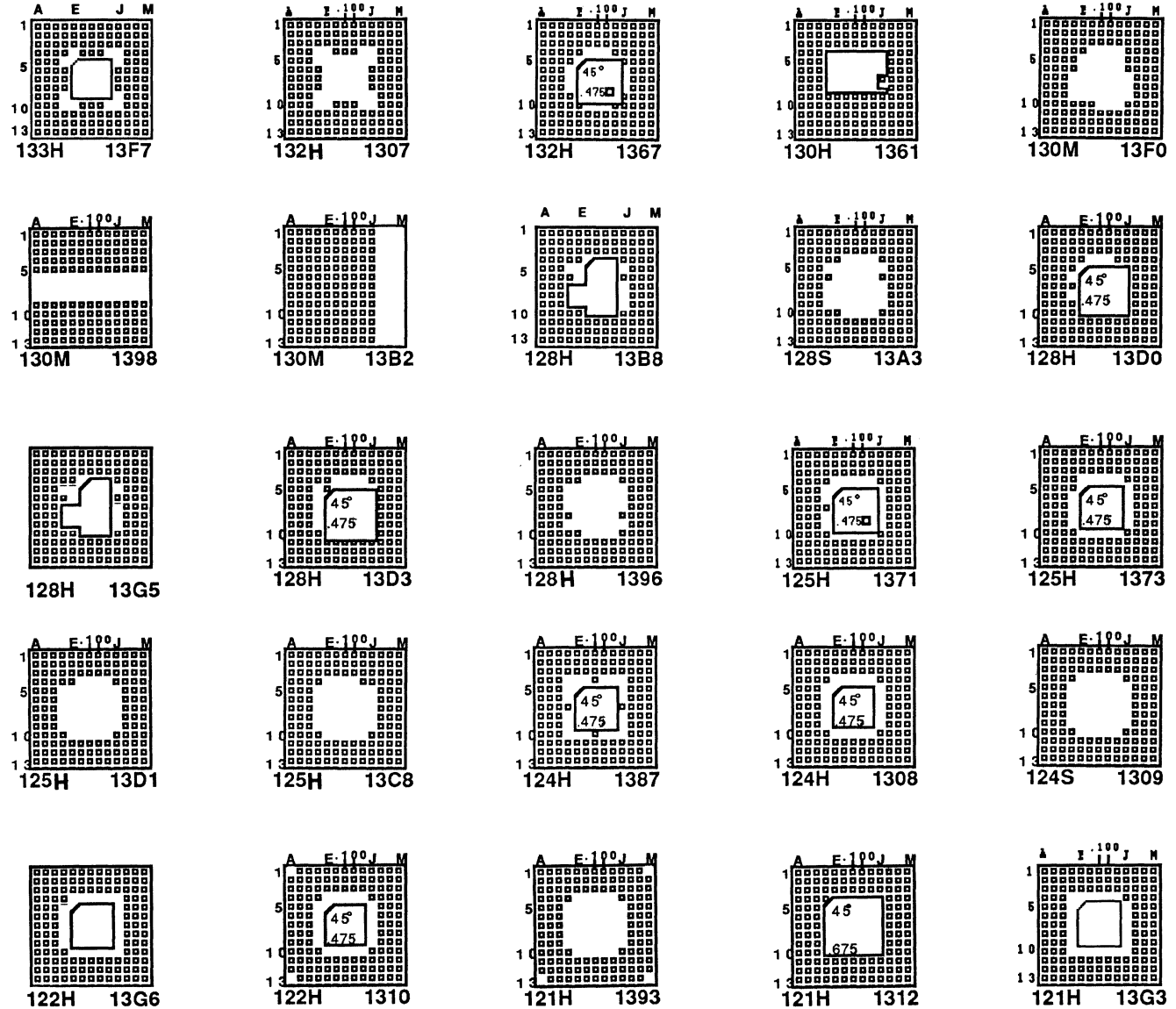



Sockets from the industry's source!

Widest variety of contact styles - over 140 contact options listed in Section A.

## 13 x 13 ARRAYS

DIMENSIONS:

**SOCKETS**  
1.350" square  
(34,29)mm square

**PPC™ CARRIERS**  
1.300" square  
(33,02)mm square

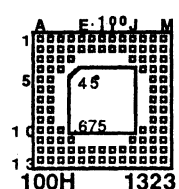
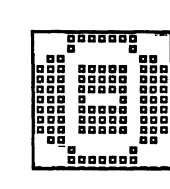
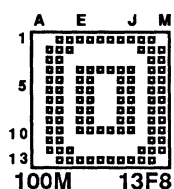
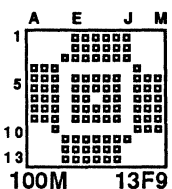
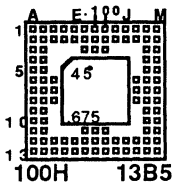
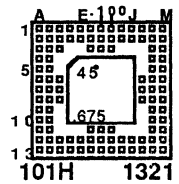
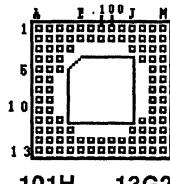
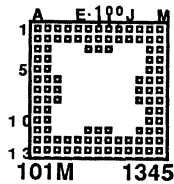
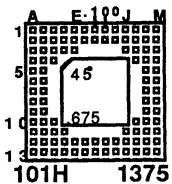
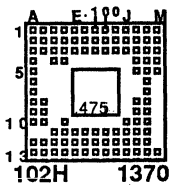
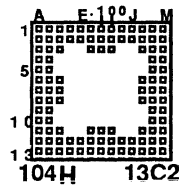
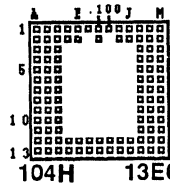
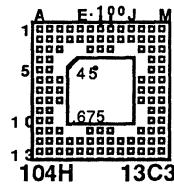
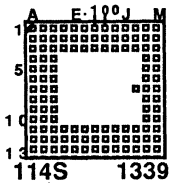
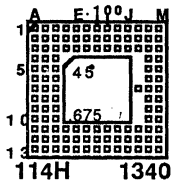
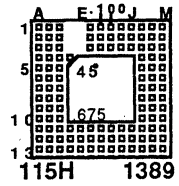
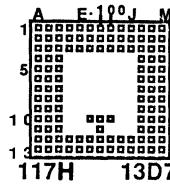
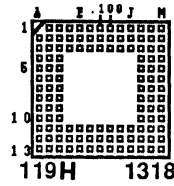
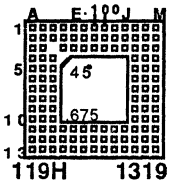
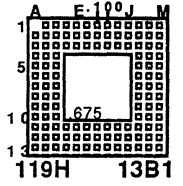
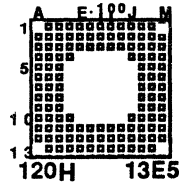
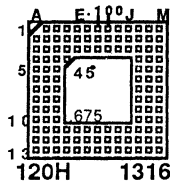
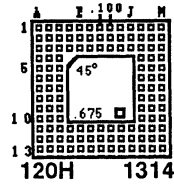
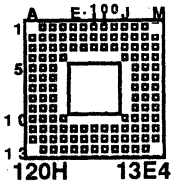

Polarity mark (contact #1) is located in upper left corner. Top view of sockets are shown from highest to lowest pin count. Arrays are available in molded Thermoplastic (UL 94V-0 approved) or vapor phase and infrared compatible PPS. Optional FR4 on request.

PGA-68H 003B1-1132

Pin Count  
Center Configuration

Pattern Number

See page F2 for ordering information

DIMENSIONS:      **SOCKETS**      **PPC™ CARRIERS**      **13 x 13 ARRAYS**  
 1.350" square      1.350" square      1.300" square  
 (34,29)mm square      (33,02)mm square

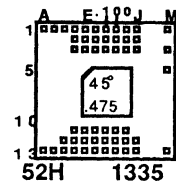
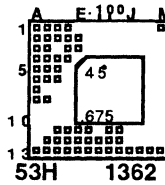
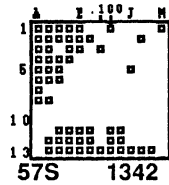
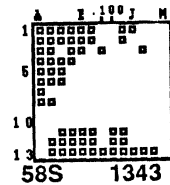
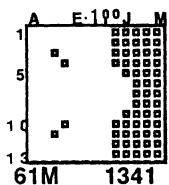
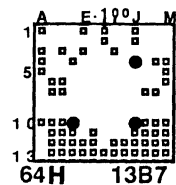
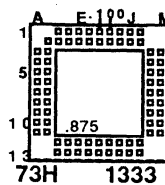
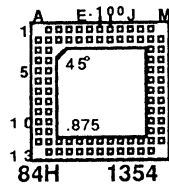
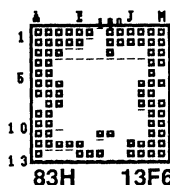
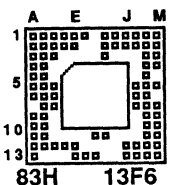
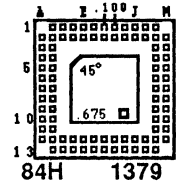
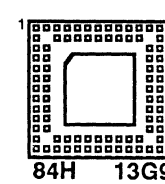
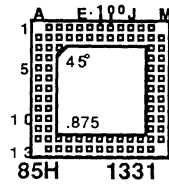
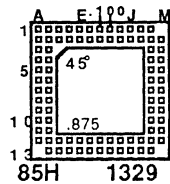
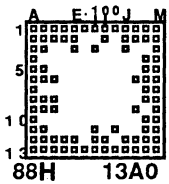
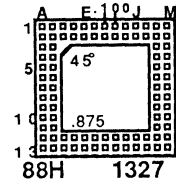
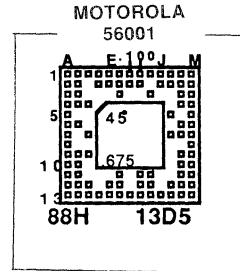
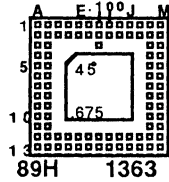
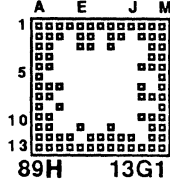
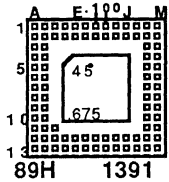
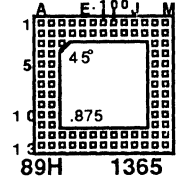
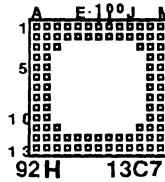
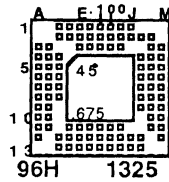
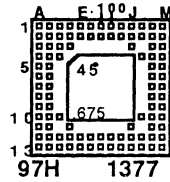
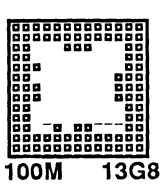

Select PPC™ (disposable carrier system) Sockets for low profile PGA applications.

## 13 x 13 ARRAYS

DIMENSIONS:

**SOCKETS**  
1.350" square  
(34,29)mm square

**PPC™ CARRIERS**  
1.300" square  
(33,02)mm square

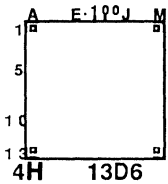
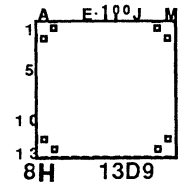
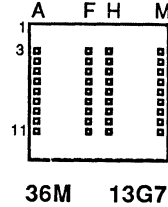
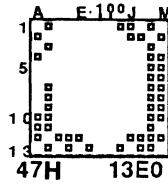
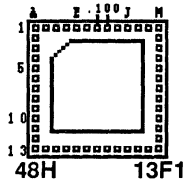
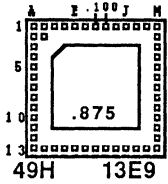

## 14 x 14 ARRAYS

DIMENSIONS:

**SOCKETS**  
1.450" square  
(36,83)mm square

**PPC™ CARRIERS**  
1.400" square  
(35,56)mm square

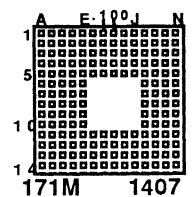
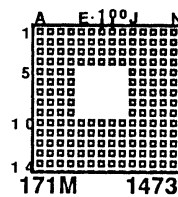
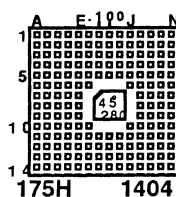
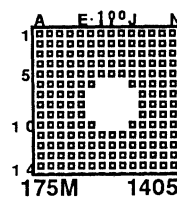
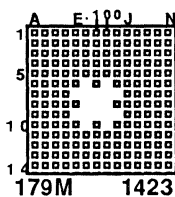
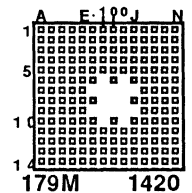
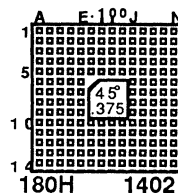
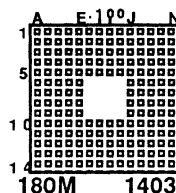
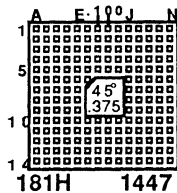
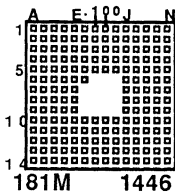
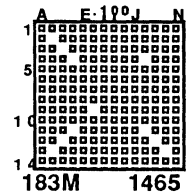
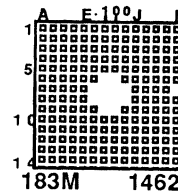
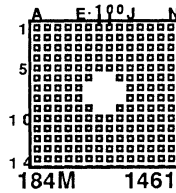
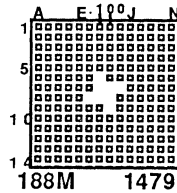
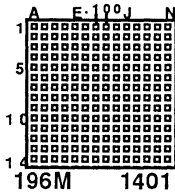

Polarity mark (contact #1) is located in upper left corner. Top view of sockets are shown from highest to lowest pin count. Arrays are available in molded Thermoplastic (UL 94V-0 approved) or vapor phase and infrared compatible PPS. Optional FR4 on request.

PGA-68H 003B1-1132

Pin Count

Center Configuration

Pattern Number

See page F2 for ordering information

DIMENSIONS:      **SOCKETS**      **PPC™ CARRIERS**      **14 x 14 ARRAYS**  
 1.450" square      1.450" square      1.400" square

(36,83)mm square

(35,56)mm square

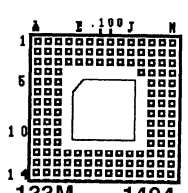
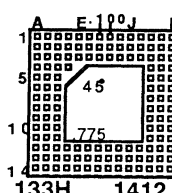
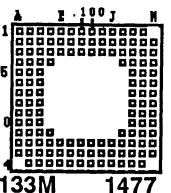
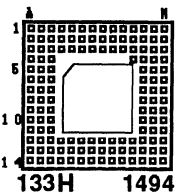
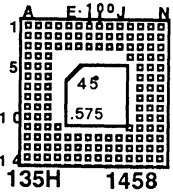
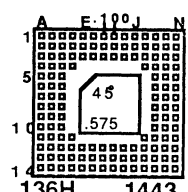
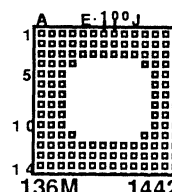
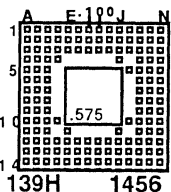
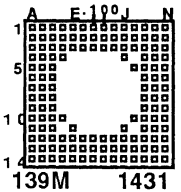
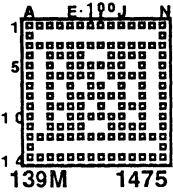
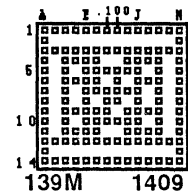
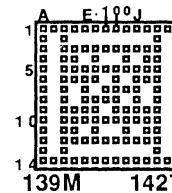
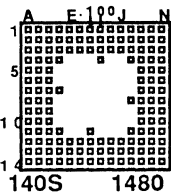
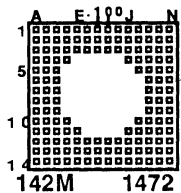
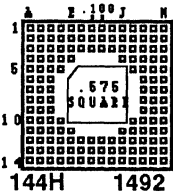
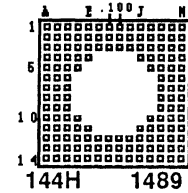
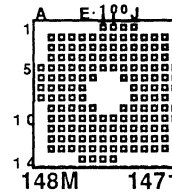
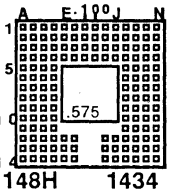
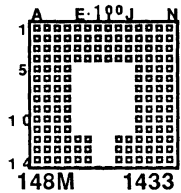
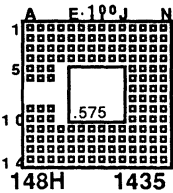
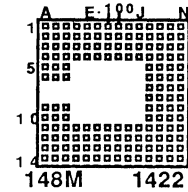
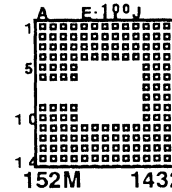
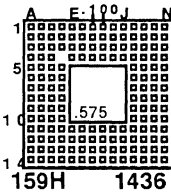
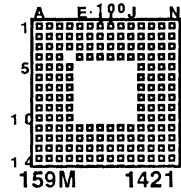
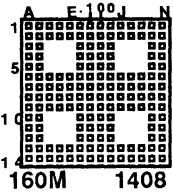
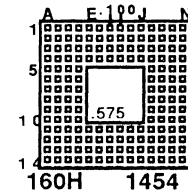
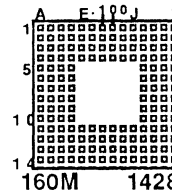
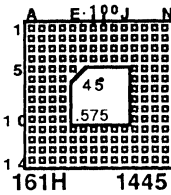
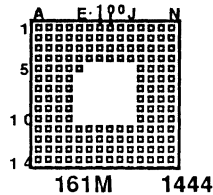
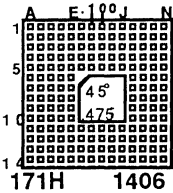

Decoupling Capacitor Sockets manufactured to your specifications.  
 Fax us your requirements today.

14 x 14 ARRAYS

DIMENSIONS:

**SOCKETS**  
 1.450" square  
 (36,83)mm square

**PPC™ CARRIERS**  
 1.400" square  
 (35,56)mm square

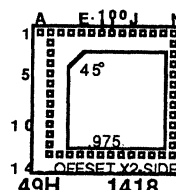
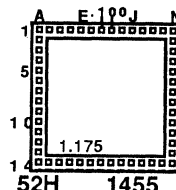
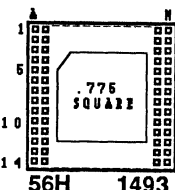
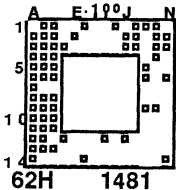
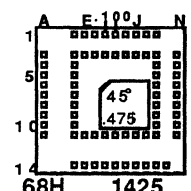
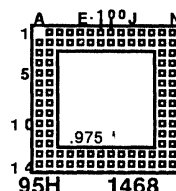
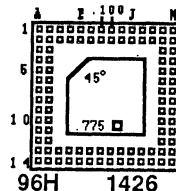
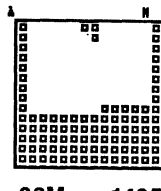
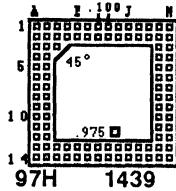
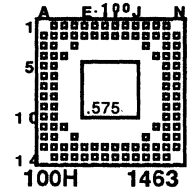
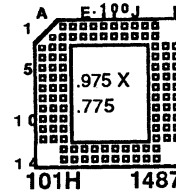
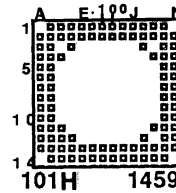
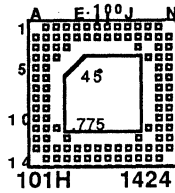
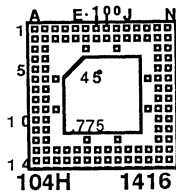
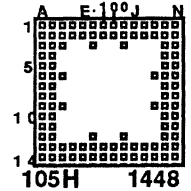
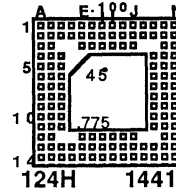
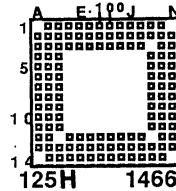
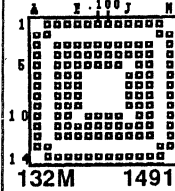
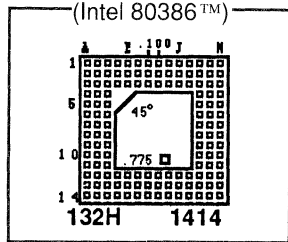

All McKenzie  
 Molded Sockets  
  
 Recognized

Polarity mark (contact #1) is located in upper left corner. Top view of sockets are shown from highest to lowest pin count. Arrays are available in molded Thermoplastic (UL 94V-0 approved) or vapor phase and infrared compatible PPS. Optional FR4 on request.

**PGA-68H 003B1-1132**

Pin Count

Center Configuration

Pattern Number

See page F2 for ordering information

DIMENSIONS:

**SOCKETS**  
1.550" square  
(39,37)mm square

**PPC™ CARRIERS**  
1.500" square  
(38,10)mm square

**15 x 15 ARRAYS**

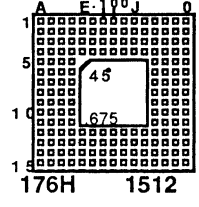
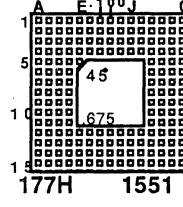
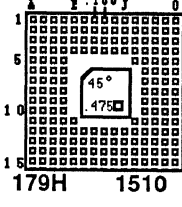
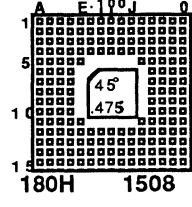
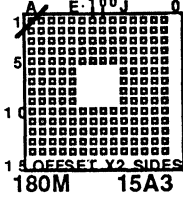
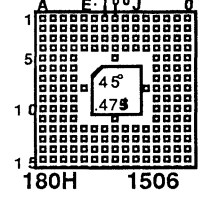
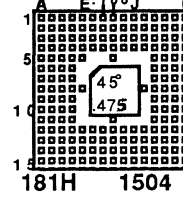
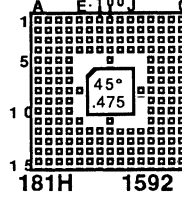
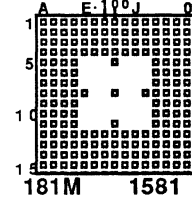
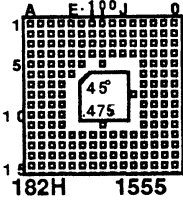
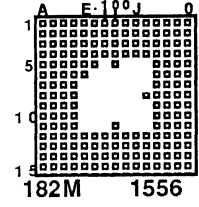
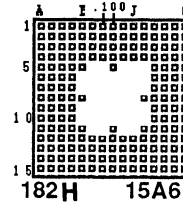
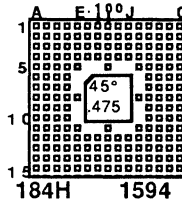
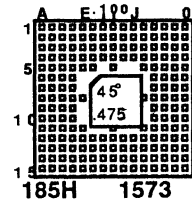
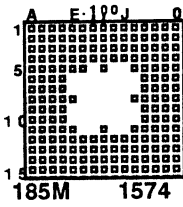
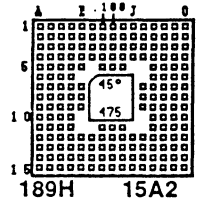
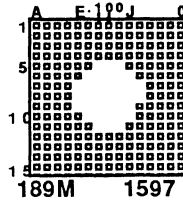
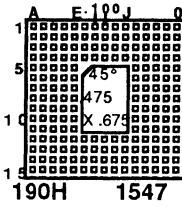
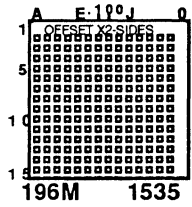
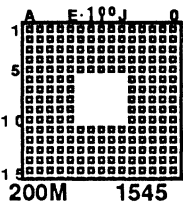
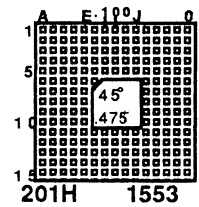
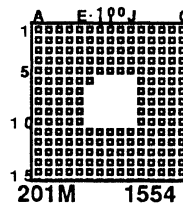
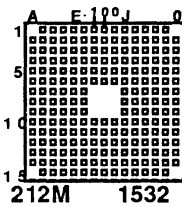
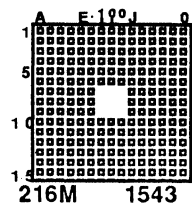
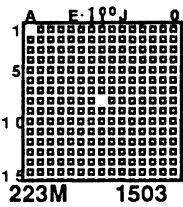
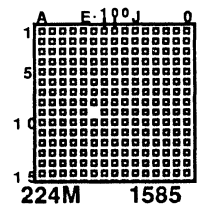
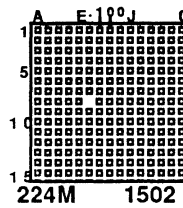
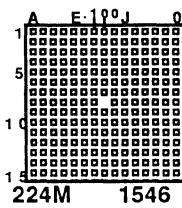
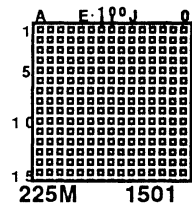
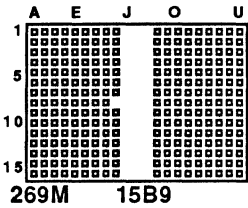



PGA-68H 003B1-1132

Pin Count | Center Configuration | Pattern Number

Polarity mark (contact #1) is located in upper left corner. Top view of sockets are shown from highest to lowest pin count. Arrays are available in molded Thermoplastic (UL 94V-0 approved) or vapor phase and infrared compatible PPS. Optional FR4 on request.

See page F2 for ordering information

DIMENSIONS: SOCKETS 1.550" square (39,37)mm square PPC™ CARRIERS 1.500" square (38,10)mm square 15 x 15 ARRAYS

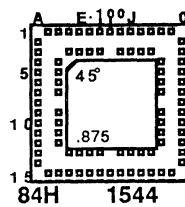
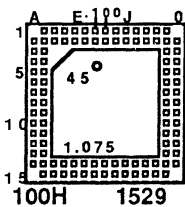
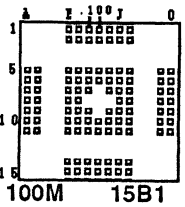
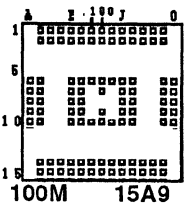
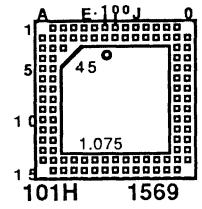
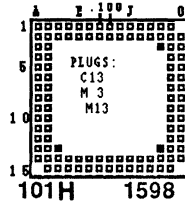
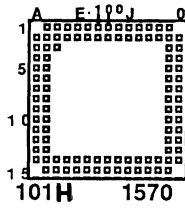
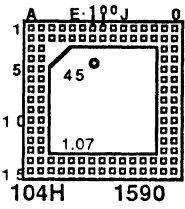
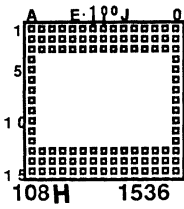
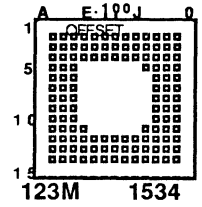
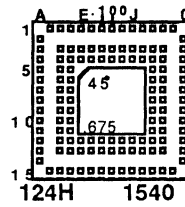
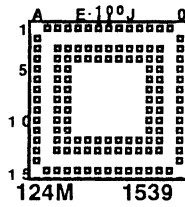
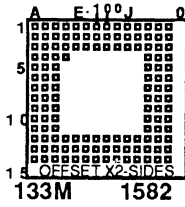
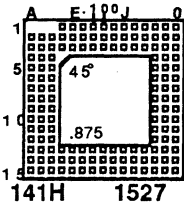
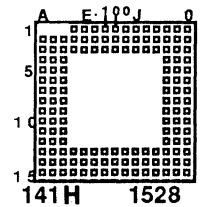
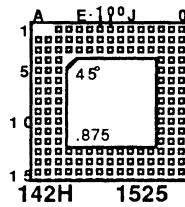
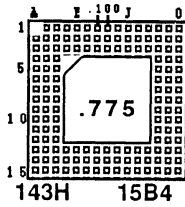
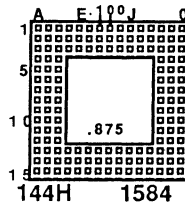
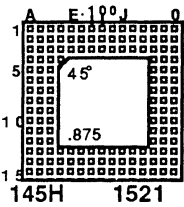
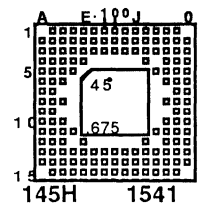
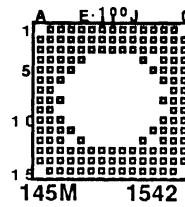
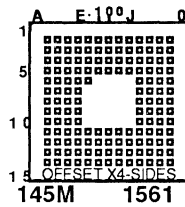
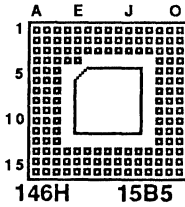
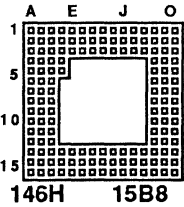



Sockets from the industry's source!  
 Widest variety of contact styles - over 140 contact options listed in Section A.

## 15 x 15 ARRAYS

DIMENSIONS:

**SOCKETS**  
 1.550" square  
 (39,37)mm square

**PPC™ CARRIERS**  
 1.500" square  
 (38,10)mm square

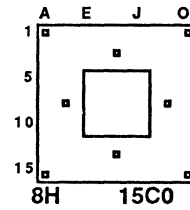
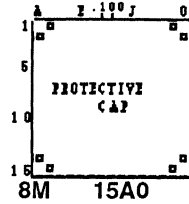
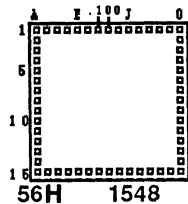
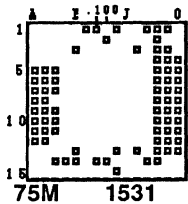

## 16 x 16 ARRAYS

DIMENSIONS:

**SOCKETS**  
 1.650" square  
 (41,91)mm square

**PPC™ CARRIERS**  
 1.600" square  
 (40,64)mm square

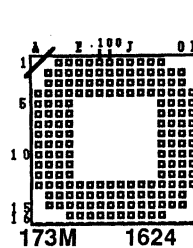
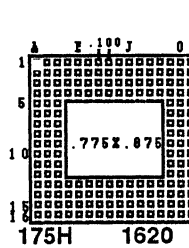
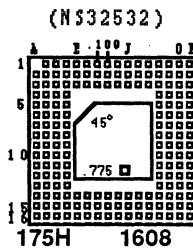
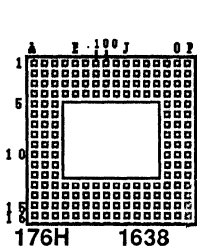
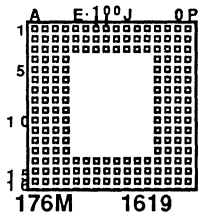
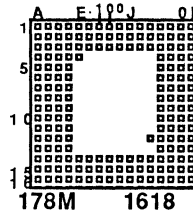
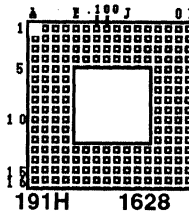
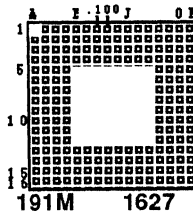
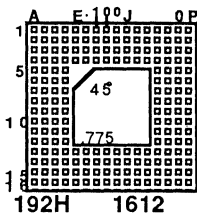
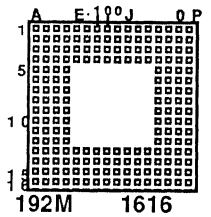
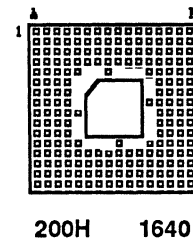
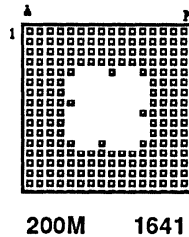
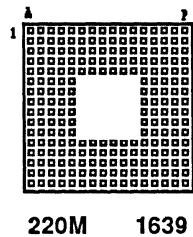
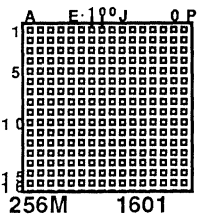

MOLDED SOCKETS



Polarity mark (contact #1) is located in upper left corner. Top view of sockets are shown from highest to lowest pin count. Arrays are available in molded Thermoplastic (UL 94V-0 approved) or vapor phase and infrared compatible PPS. Optional FR4 on request.

PGA-68H 00351-1132

Pin Count

Center Configuration

Pattern Number

See page F2 for ordering information

DIMENSIONS:

#### SOCKETS

1.650" square  
(41,91)mm square

#### PPC™ CARRIERS

1.600" square  
(40,64)mm square

### 16 x 16 ARRAYS

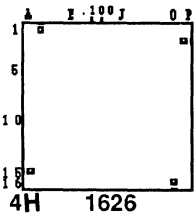
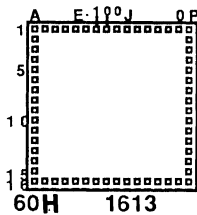
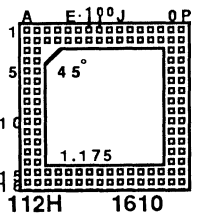
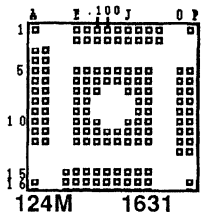
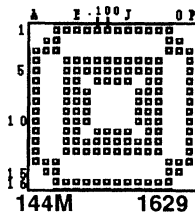
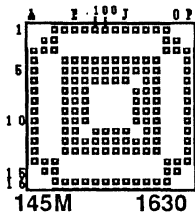
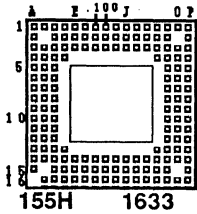
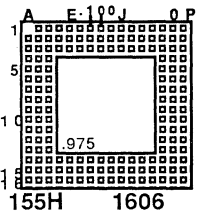
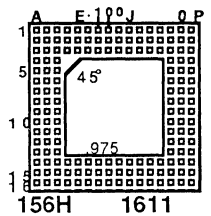
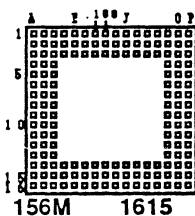
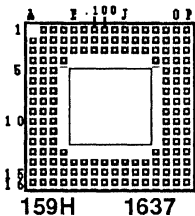
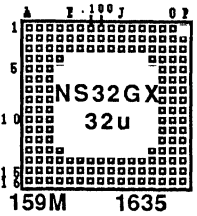
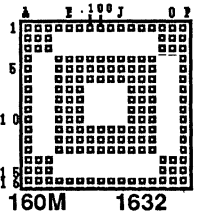
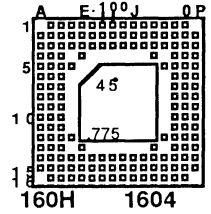
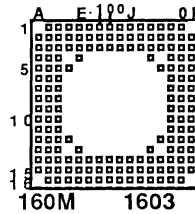
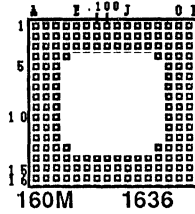
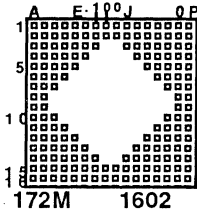
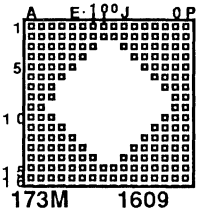

MOLDED INSULATORS



RISC Sockets immediately available

## 17 x 17 ARRAYS

DIMENSIONS:

**SOCKETS**  
1.750" square  
(44,45)mm square

**PPC™ CARRIERS**  
1.700" square  
(43,18)mm square

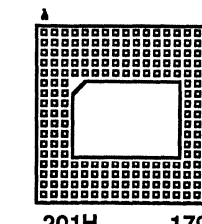
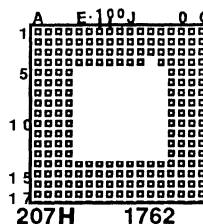
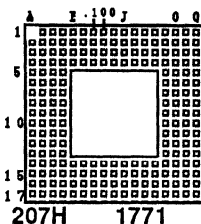
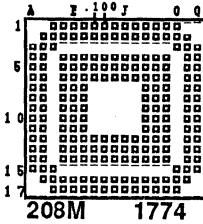
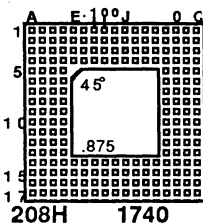
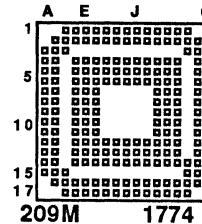
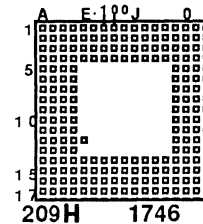
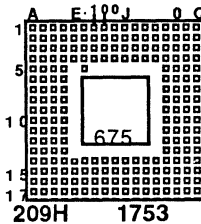
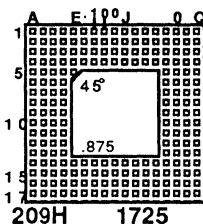
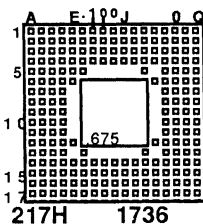
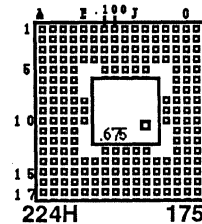
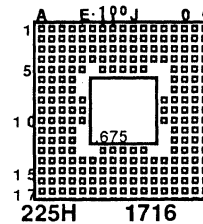
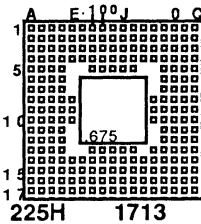
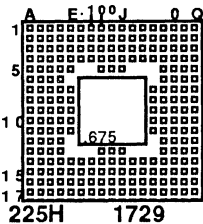
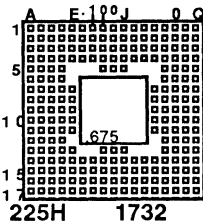
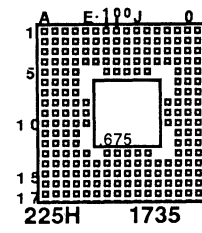
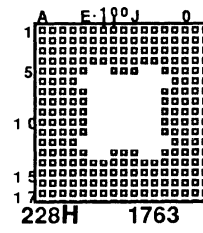
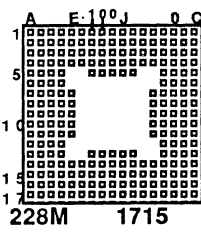
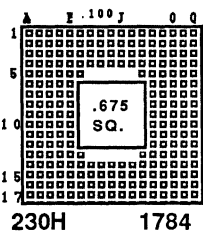
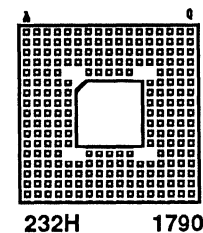
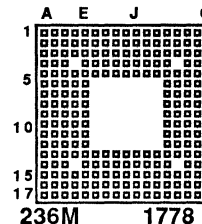
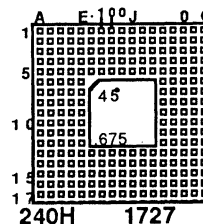
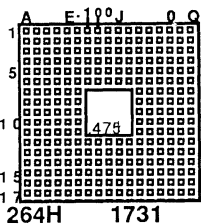
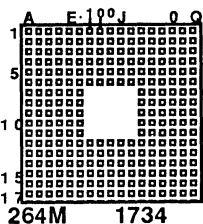
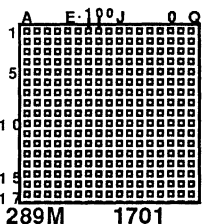

Polarity mark (contact #1) is located in upper left corner. Top view of sockets are shown from highest to lowest pin count. Arrays are available in molded Thermoplastic (UL 94V-0 approved) or vapor phase and infrared compatible PPS. Optional FR4 on request.

PGA-68H 003B1-1132

Pin Count  
Center Configuration

Pattern Number

See page F2 for ordering information

DIMENSIONS:

**SOCKETS**  
1.750" square  
(44,45)mm square

**PPC™ CARRIERS**  
1.700" square  
(43,18)mm square

17 x 17 ARRAYS

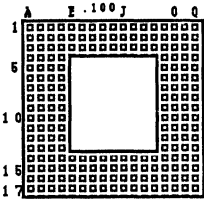

199H 1782

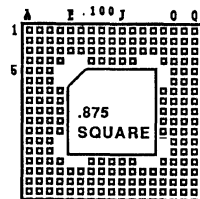

192H 1781

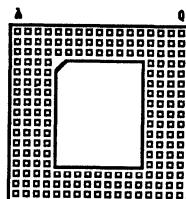

190H 1793

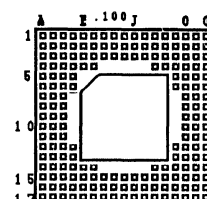

188H 1783

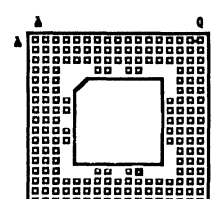

185H 1787

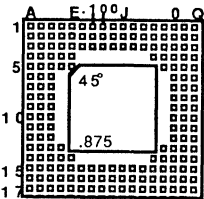

181H 1738

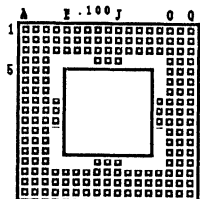

180H 1786

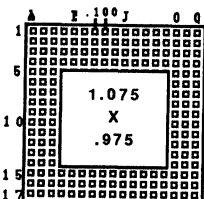

PGA 179H 1765

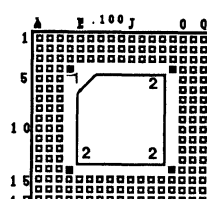

171H 1777

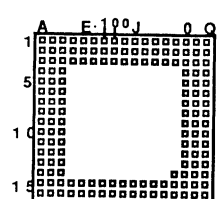

169H 1745

1. EMPTY HOLE NO CONTACT
2. POLARITY PLUG

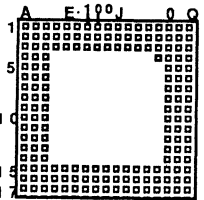

169H 1723

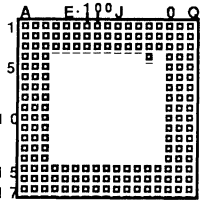

169H 1761

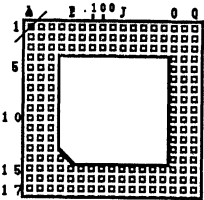

169H 1770

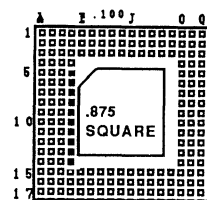

169H 1780

■ SOLID SECTION

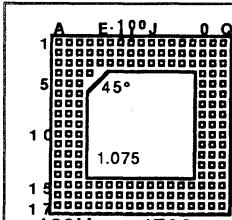

169H 1709

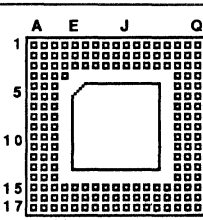

169H 1780

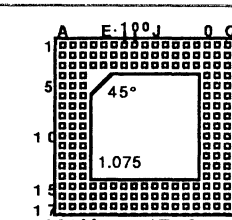

168H 1706



167H 1795

INTEL  
486™

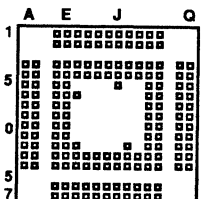

164M 1779

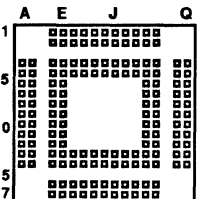

160H 1776

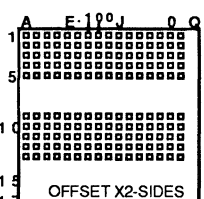

160M 1737

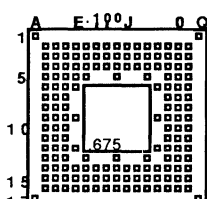

157H 1733

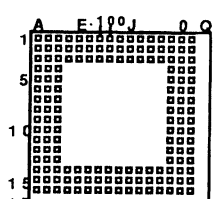

156M 1718

Select PPC™ (disposable carrier system) Sockets for low profile PGA applications.

## 17 x 17 ARRAYS

DIMENSIONS:

**SOCKETS**  
1.750" square  
(44,45)mm square

**PPC™ CARRIERS**  
1.700" square  
(43,18)mm square

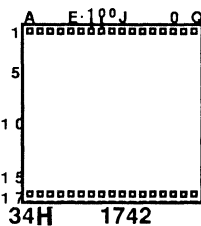
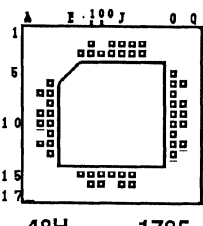
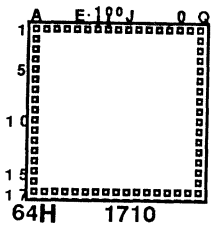
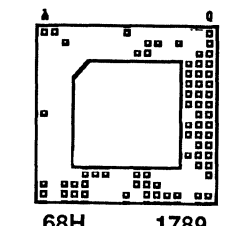
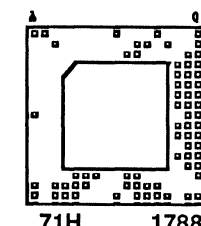
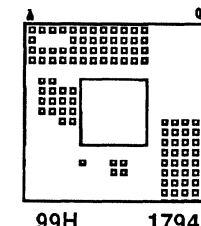
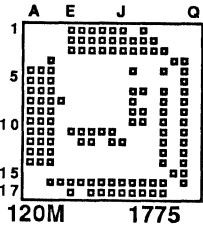
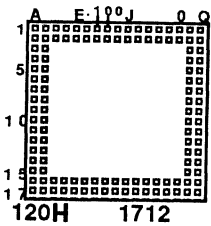
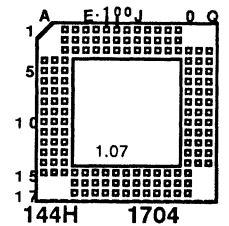
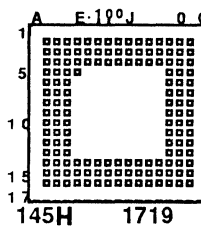
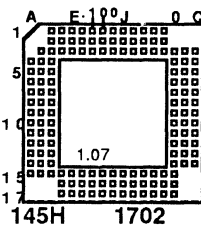
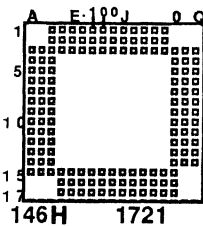
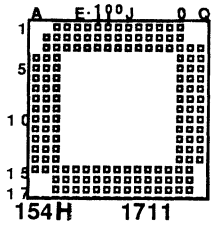

## 18 x 18 ARRAYS

DIMENSIONS:

**SOCKETS**  
1.850" square  
(46,99)mm square

**PPC™ CARRIERS**  
1.800" square  
(45,72)mm square

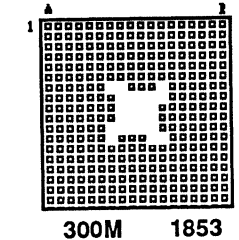
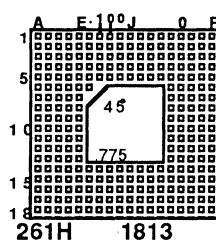
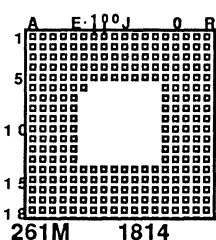
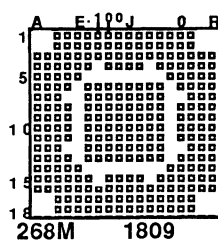
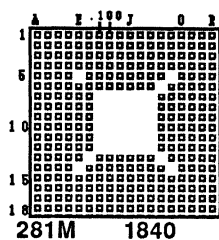
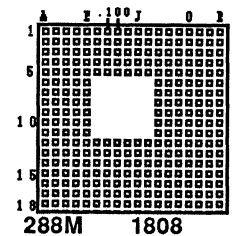
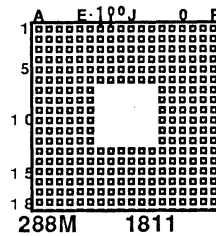
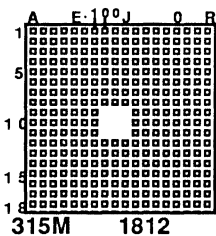
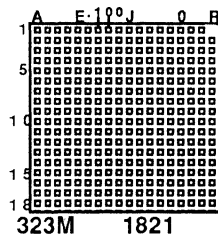
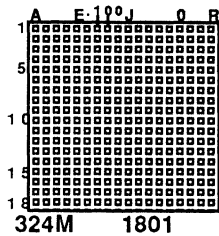

McKenzie Socket Division

Polarity mark (contact #1) is located in upper left corner. Top view of sockets are shown from highest to lowest pin count. Arrays are available in molded Thermoplastic (UL 94V-0 approved) or vapor phase and infrared compatible PPS. Optional FR4 on request.

PGA-6 8 H 003 B1 - 1 1 3 2

Pin Count | Center Configuration | Pattern Number

See page F2 for ordering information

## 18 x 18 ARRAYS

### SOCKETS

1.850" square  
(46.99)mm square

### PPC™ CARRIERS

1.800" square  
(45.72)mm square

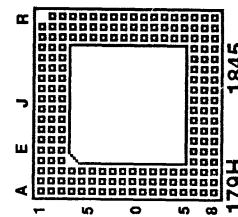
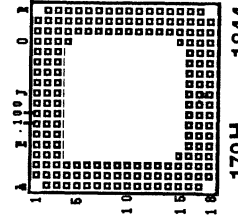
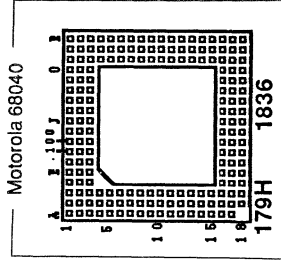
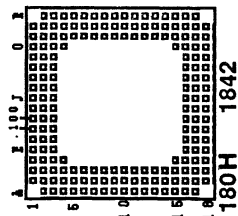
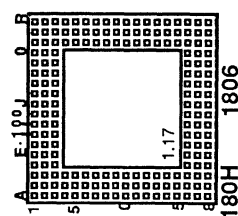
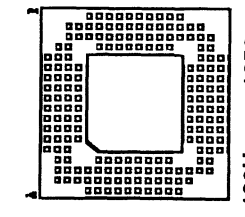
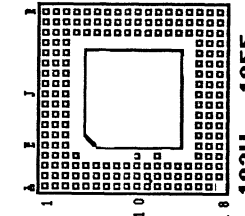
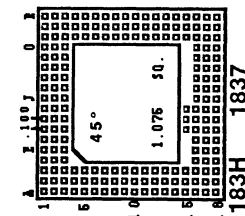
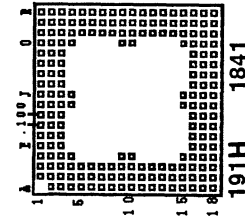
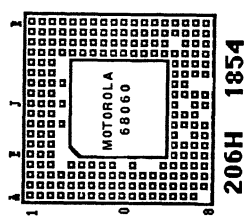
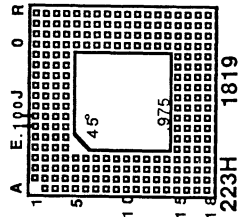
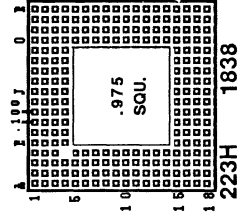
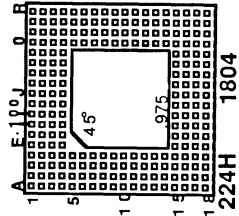
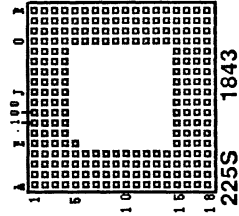
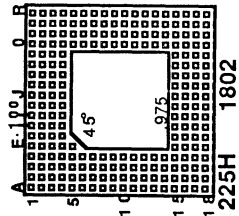
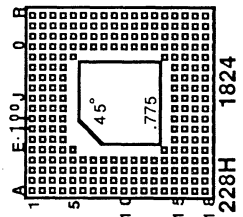
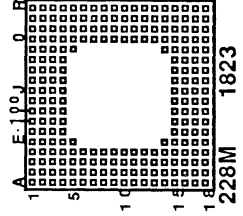
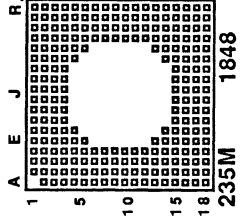
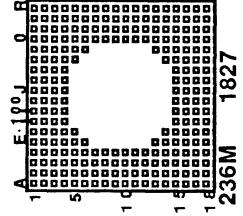
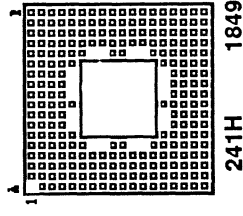
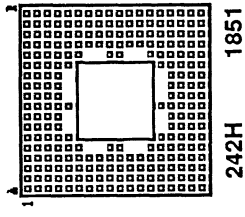
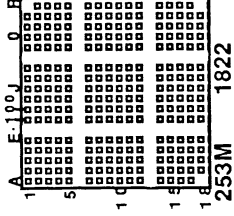
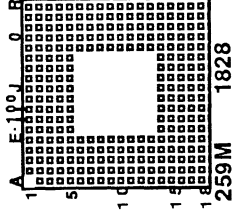
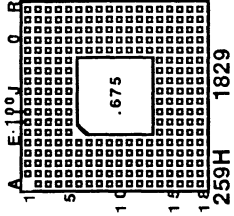
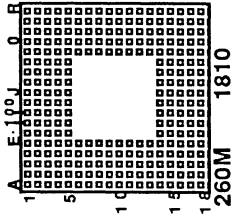

Select PPC™ (disposable carrier system) Sockets for low profile PGA applications.

## 18 x 18 ARRAYS

DIMENSIONS:

**SOCKETS**  
1.850" square  
(46,99)mm square

**PPC™ CARRIERS**  
1.800" square  
(45,72)mm square

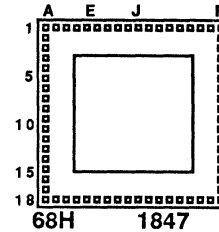
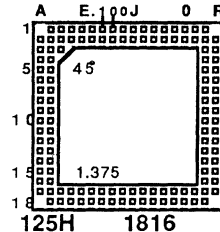
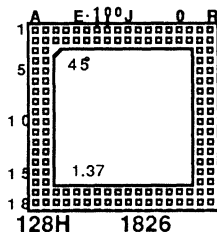
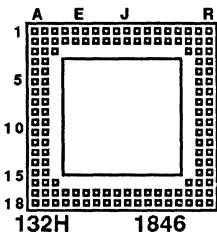
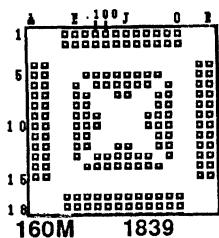

## 19 x 19 ARRAYS

DIMENSIONS:

**SOCKETS**  
1.950" square  
(49,53)mm square

**PPC™ CARRIERS**  
1.900" square  
(48,26)mm square

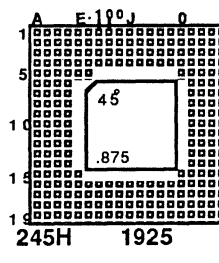
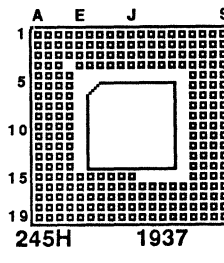
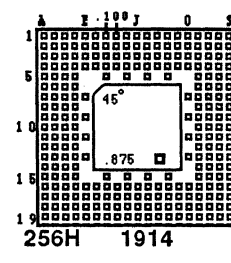
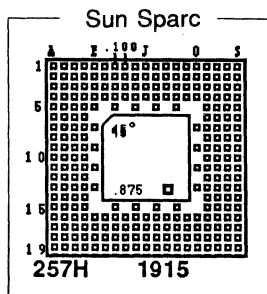
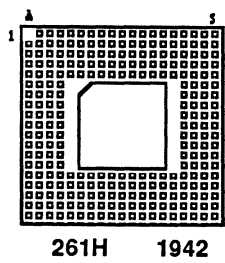
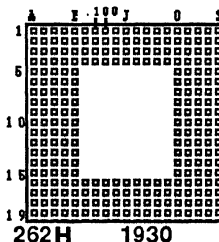
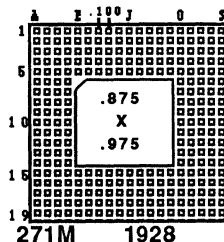
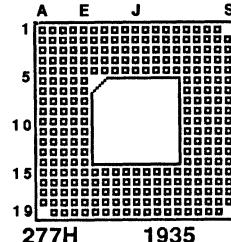
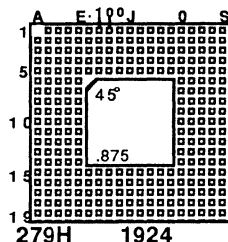
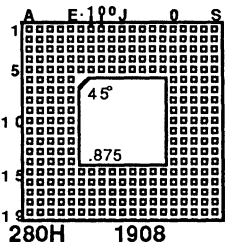
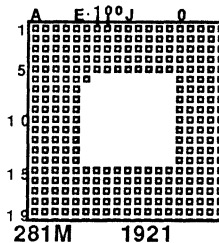
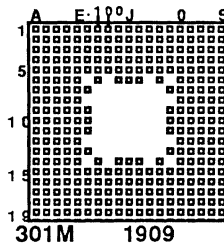
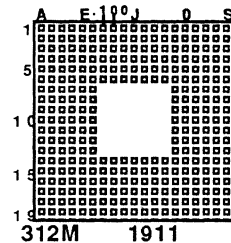
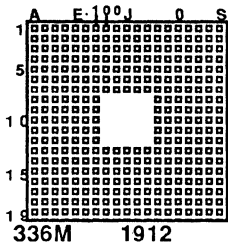
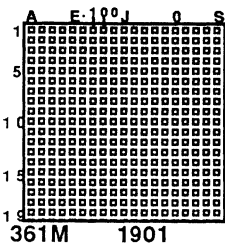

Polarity mark (contact #1) is located in upper left corner. Top view of sockets are shown from highest to lowest pin count. Arrays are available in molded Thermoplastic (UL 94V-0 approved) or vapor phase and infrared compatible PPS. Optional FR4 on request.

PGA-68H 003B1-1132

Pin Count  
Center Configuration

Pattern Number

See page F2 for ordering information

DIMENSIONS:

**SOCKETS**  
1.950" square  
(49,53)mm square

**PPC™ CARRIERS**  
1.900" square  
(48,26)mm square

19 x 19 ARRAYS

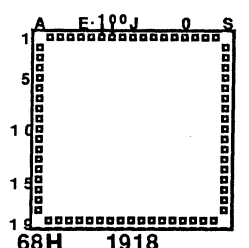
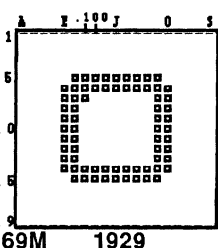
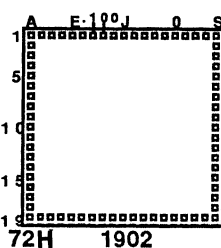
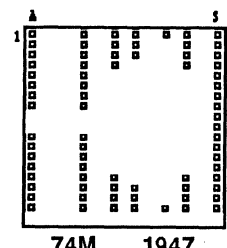
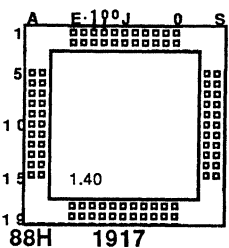
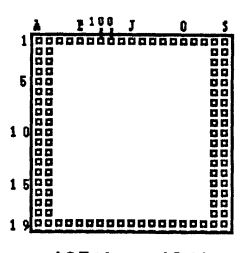
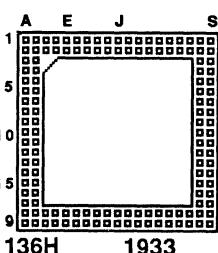
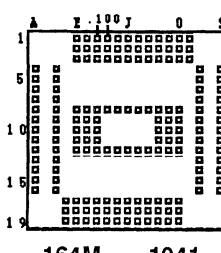
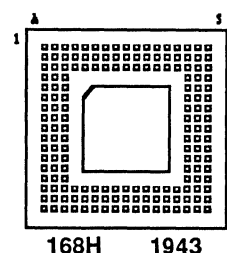
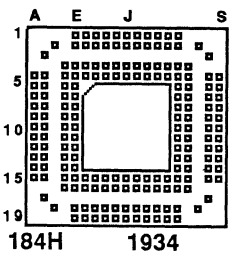
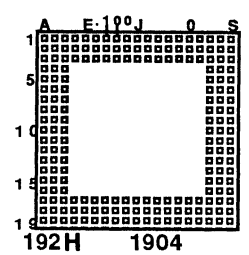
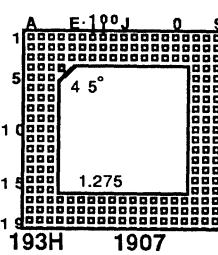
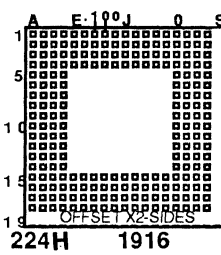
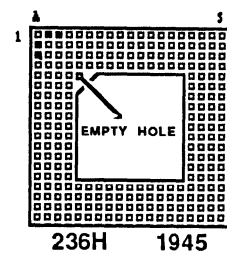
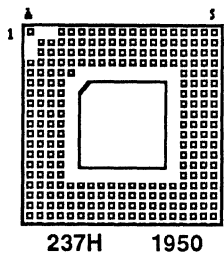
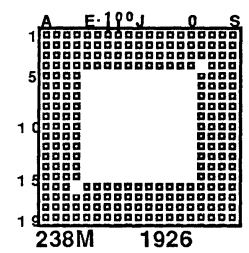
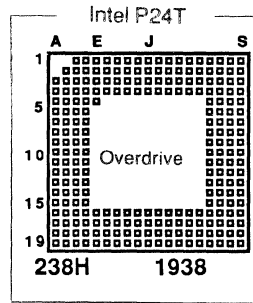
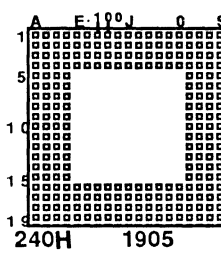
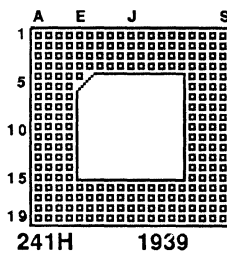
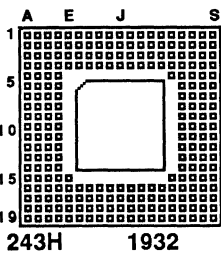
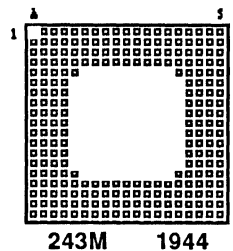
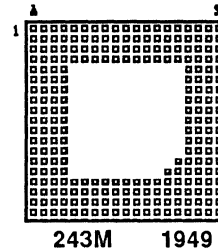
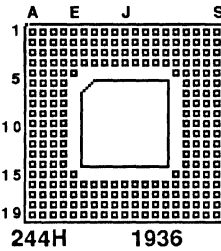
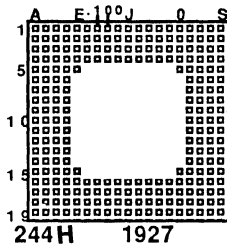
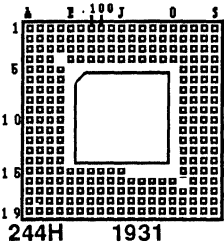



RISC Sockets immediately available.

## 20 x 20 ARRAYS

DIMENSIONS:

**SOCKETS**  
2.050" square  
(52,07)mm square

**PCPTM CARRIERS**  
2.000" square  
(50,80)mm square

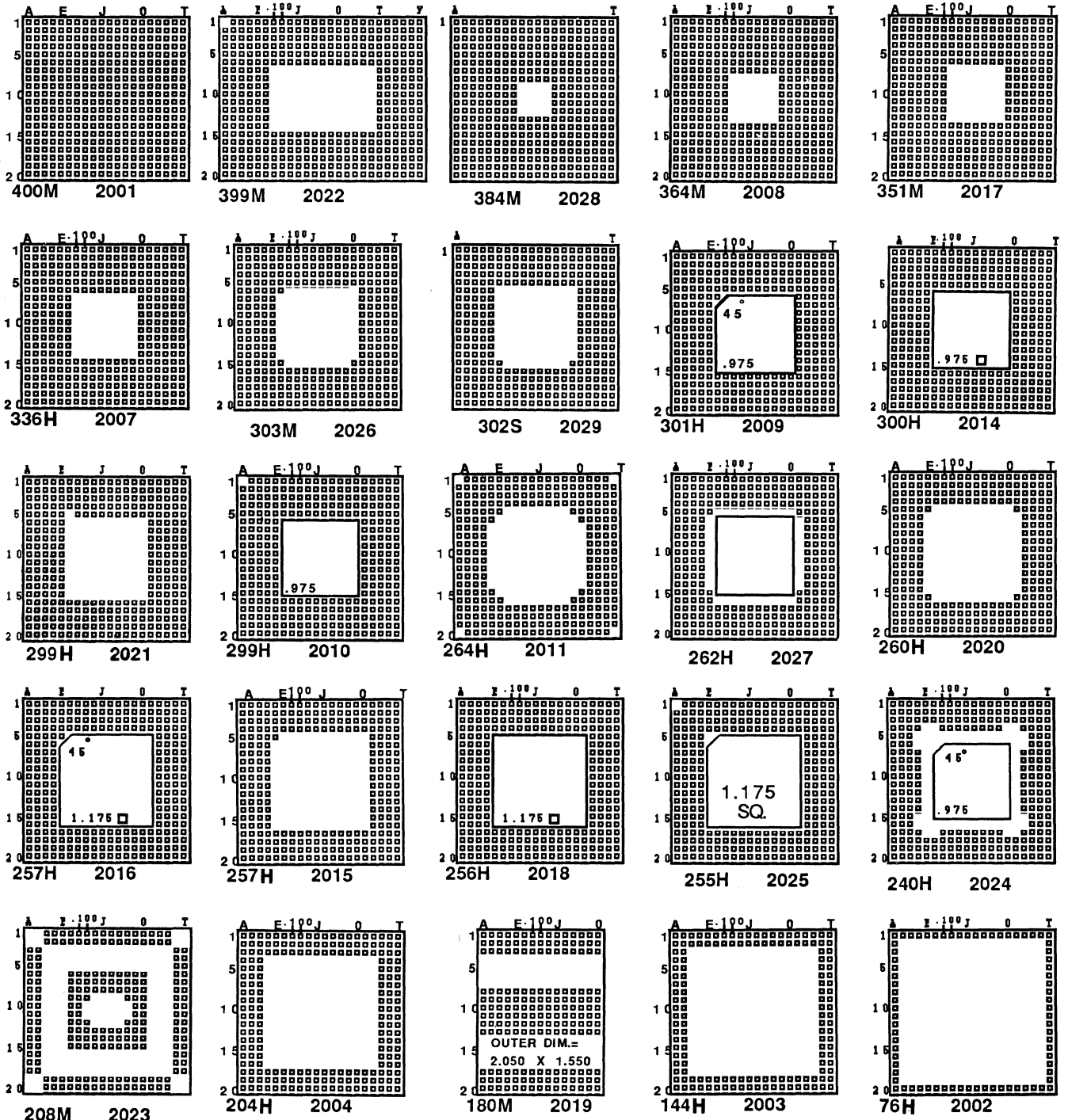

Polarity mark (contact #1) is located in upper left corner. Top view of sockets are shown from highest to lowest pin count. Arrays are available in molded Thermoplastic (UL 94V-0 approved) or vapor phase and infrared compatible PPS. Optional FR4 on request.

PGA-68H 003B1-1132

Pin Count  
Center Configuration

Pattern Number

See page F2 for ordering information

DIMENSIONS:

**SOCKETS**  
2.150" square  
(54.61)mm square

**PPC™ CARRIERS**  
2.100" square  
(53.34)mm square

21 x 21 ARRAYS

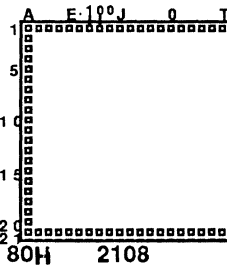
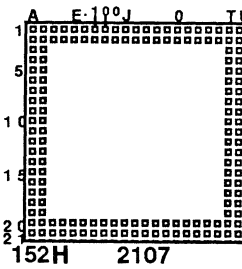
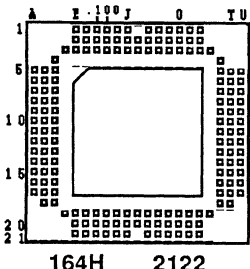
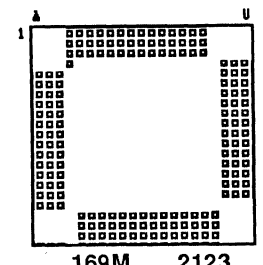
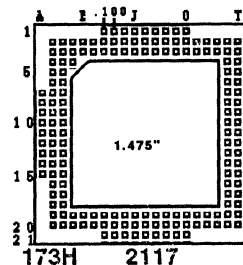
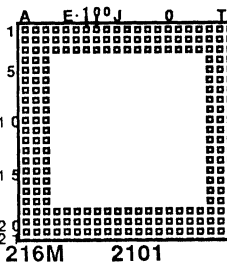
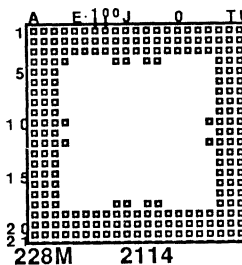
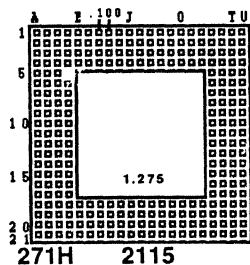
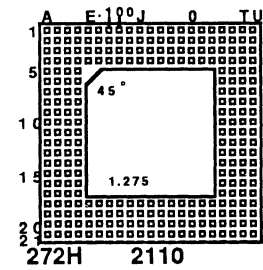
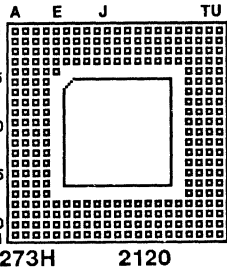
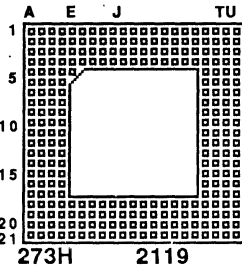
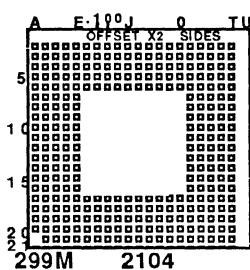
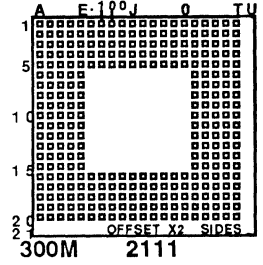
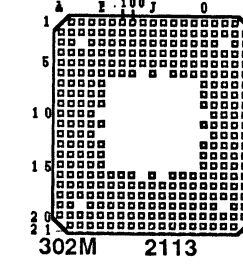
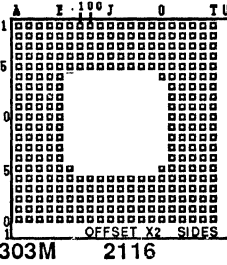
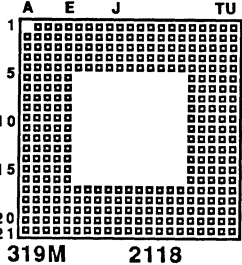
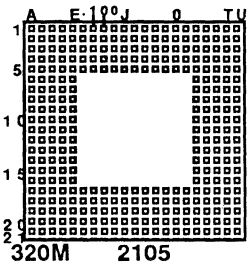
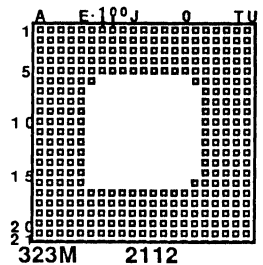
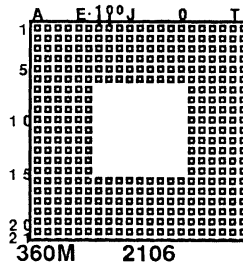
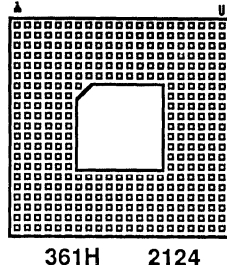
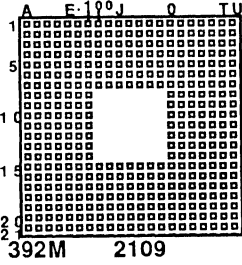
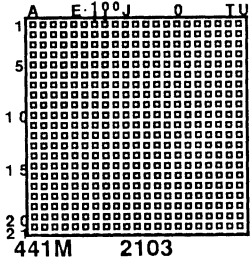

MOLDED SOCKETS



RECOGNIZED

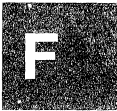

Sockets from the industry's source!

Widest variety of contact styles — over 140 contact options listed in Section A

## 22 x 22 ARRAYS

**SOCKETS**  
DIMENSIONS: 2.250" square  
(57,15)mm square

**PPC™ CARRIERS**  
2.200" square  
(55,88)mm square

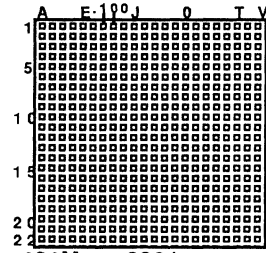

484M 2201

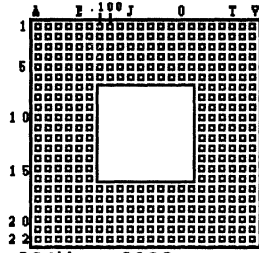

384H 2206

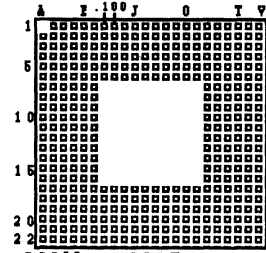

383M 2205

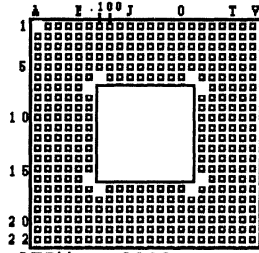

375H 2209

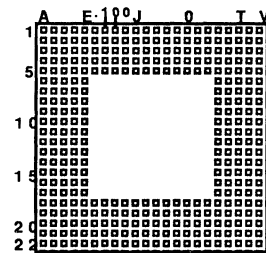

340M 2204

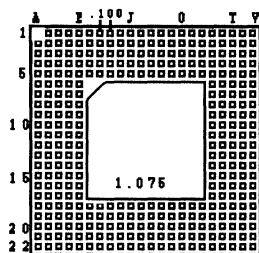

339H 2208

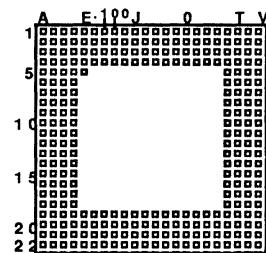

289M 2203

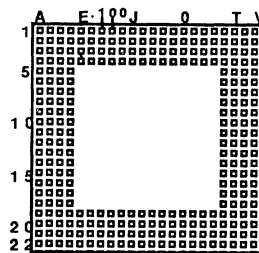

288M 2202

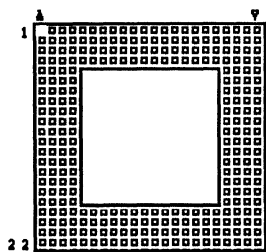

287H 2211

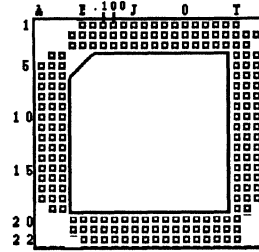

196H 2210

## 23 x 23 ARRAYS

**SOCKETS**  
DIMENSIONS: 2.350" square  
(59,69)mm square

**PPC™ CARRIERS**  
2.300" square  
(58,42)mm square

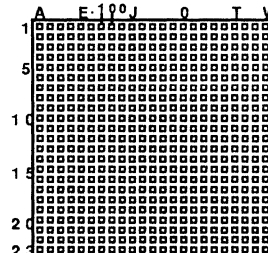

529M 2301

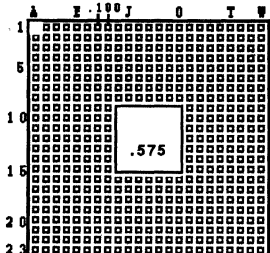

480H 2306

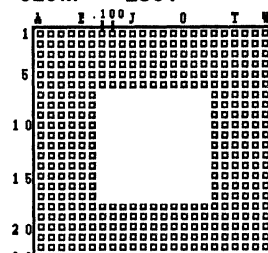

408M 2307

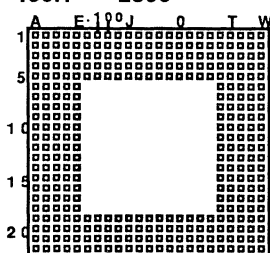

360M 2304

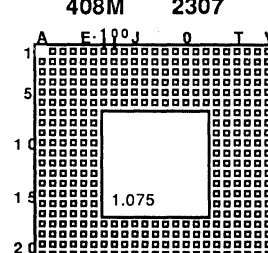

407H 2305

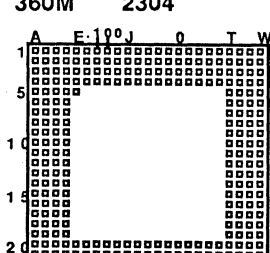

305M 2303

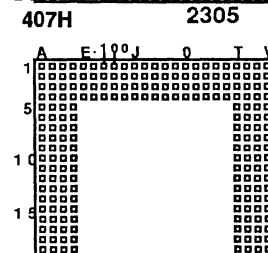

304M 2302

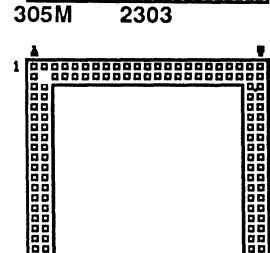

167H 2309

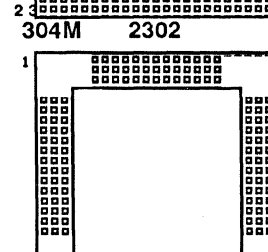

162H 2310

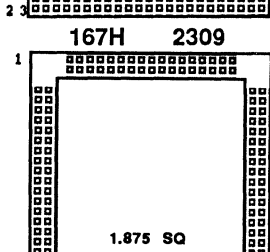

136H 2308

Polarity mark (contact #1) is located in upper left corner. Top view of sockets are shown from highest to lowest pin count. Arrays are available in molded Thermoplastic (UL 94V-0 approved) or vapor phase and infrared compatible PPS. Optional FR4 on request.

PGA-68H 003B1-1132

Pin Count  
Center Configuration

Pattern Number

See page F2 for ordering information

DIMENSIONS: **SOCKETS** 2.450" square (62,23)mm square **PPC™ CARRIERS** 2.400" square (60,96)mm square

### 24 x 24 ARRAYS

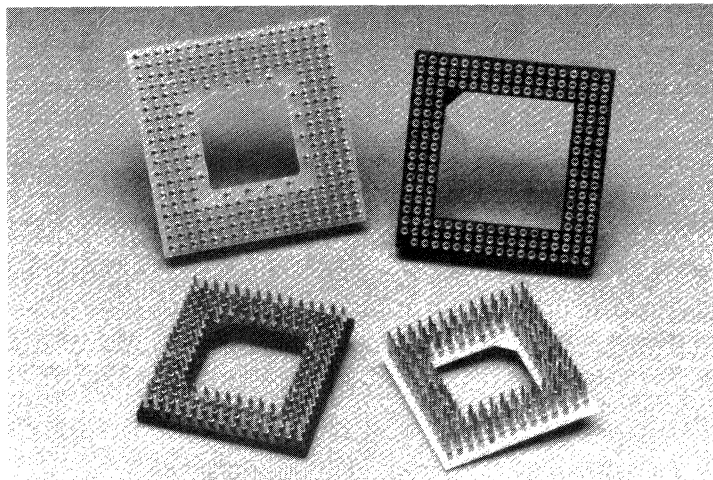
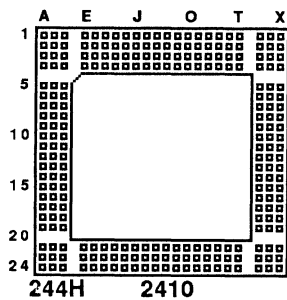
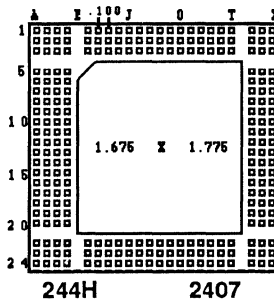
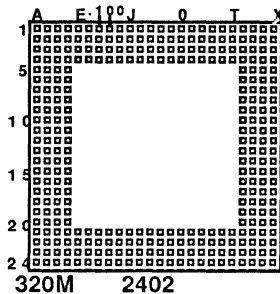
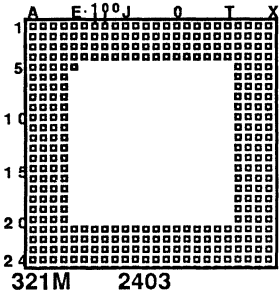
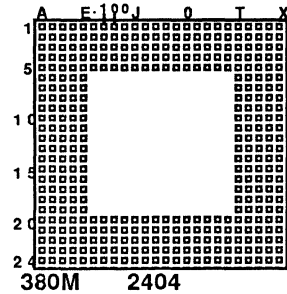
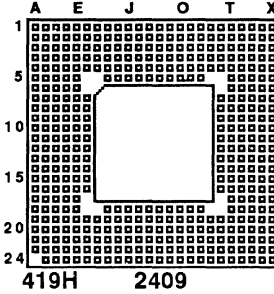
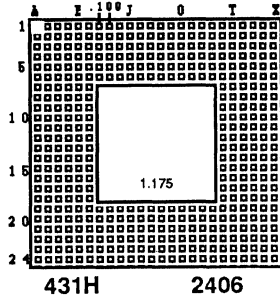
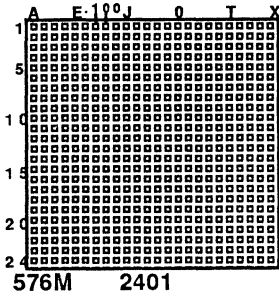

Press Fit PGA Sockets — A Solderless Alternative

Select PPC™ (disposable carrier system) Sockets for low profile PGA applications.

## 25 x 25 ARRAYS

DIMENSIONS:

**SOCKETS**  
2.550" square  
(64,77)mm square

**PPC™ CARRIERS**  
2.500" square  
(63,50)mm square

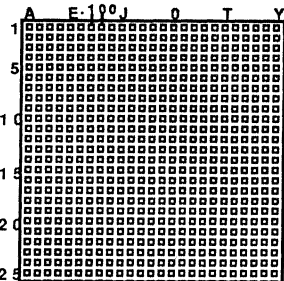

625M 2501

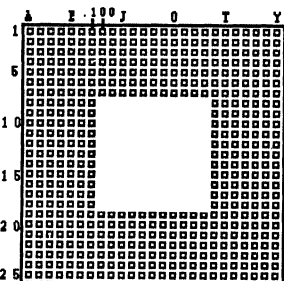

504M 2505

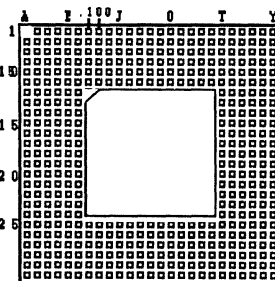

455H 2507

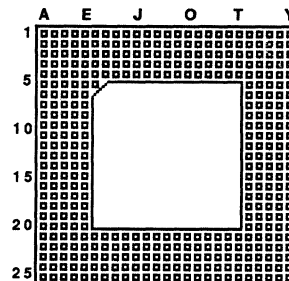

401H 2506

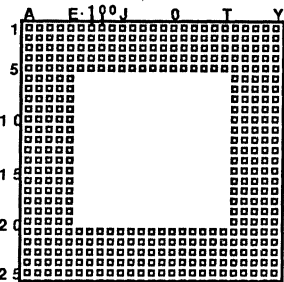

400H 2504

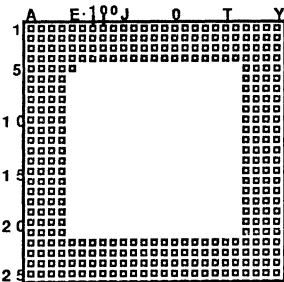

337H 2503

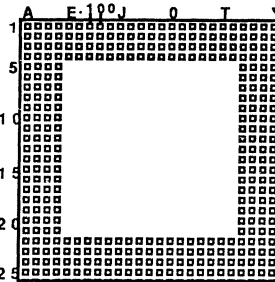

336H 2502

## 26 x 26 ARRAYS

DIMENSIONS:

**SOCKETS**  
2.650" square  
(67,31)mm square

**PPC™ CARRIERS**  
2.600" square  
(66,04)mm square

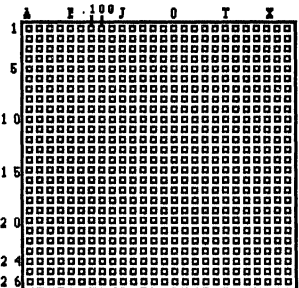

676M 2601

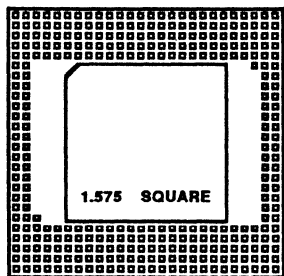

326H 2603

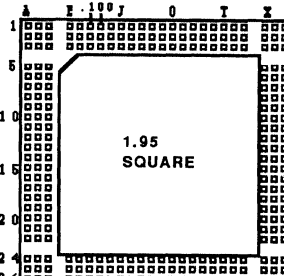

252H 2602

## 27 x 27 ARRAYS

DIMENSIONS:

**SOCKETS**  
2.750" square  
(69,85)mm square

**PPC™ CARRIERS**  
2.700" square  
(68,58)mm square

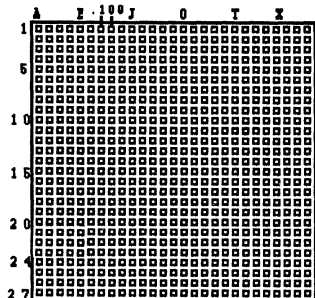

729M 2701

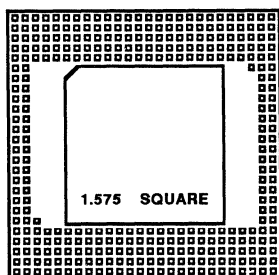

326H 2603

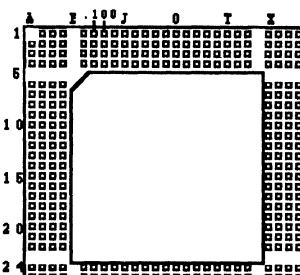

351H 2702

Top View

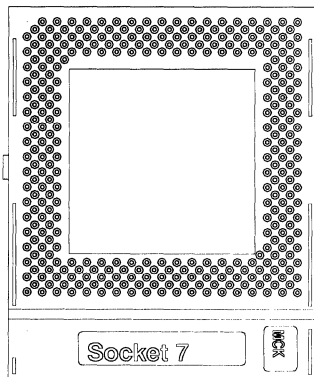

Side View

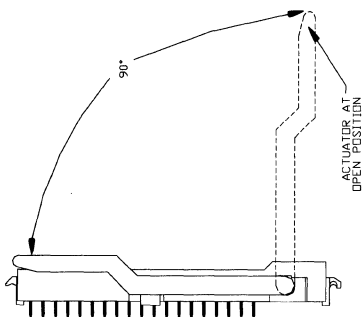

**Materials**

Housing: LCP, glass filled, UL 94V-0 rated  
 Contact: Phosphor Bronze  
 Plating (Solder tail): 100µ" tin-lead over 50µ" nickel  
 Plating (Contact Area): Gold over 50µ" nickel (See Table)  
 Actuator: Die Cast Zinc alloy  
 Operating Temperature: -55°C to 105°C  
 Operating Voltage: 250 VAC

**Environmental Performance**

Temperature & Humidity: 90% RH, 25°C to 65°C, 240 hrs.  
 Temperature Life: 85°C, 300 hrs.  
 Thermal Shock: -55°C to +85°C, 5 cycles  
 Withstanding Temperature: 240°C wave solder reflow

**Electrical Performance**

Dielectric Withstanding Voltage: 1000 VAC  
 Insulation Resistance: 1000 megaohms minimum  
 Capacitance: 1 pf between contacts max.  
 Low Level Contact Resistance: ΔR 10 milliohms max.

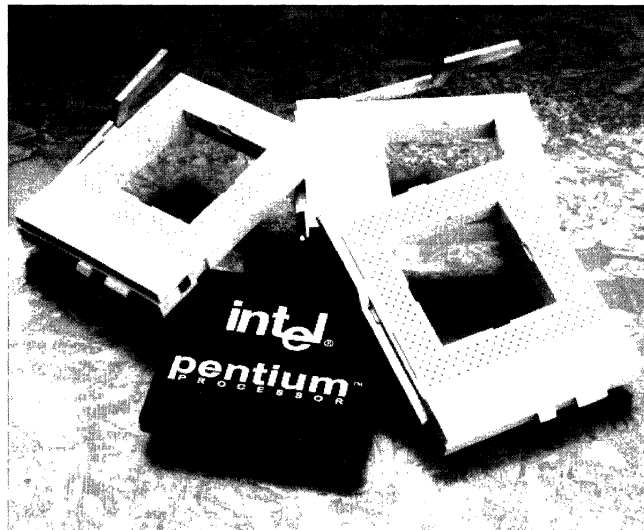

- Call for details on the ultra low profile screw driver actuated ZIF socket.
- Standoffs on the bottom side of the socket allow for easy, post-solder cleaning.
- Tabs for Thermalloy, IERC and AAVID heatsink and clip solutions are standard features.
- An internal stop tab in the cam housing prevents the actuator from being pulled too far back when opened.
- Contact layout is polarized to prevent the upgrade processor from being incorrectly inserted.
- Open center construction enables other components to be placed on the PCB in the center of the socket.



DESCRIPTION	PLATING	TAIL LENGTH	PART NUMBER
Socket 5	10µ" Au	2.35 mm	97050-2120
Socket 5	30µ" Au	2.35 mm	97050-4120
Socket 7	10µ" Au	2.35 mm	97054-2120
Socket 7	30µ" Au	2.35 mm	97054-4120

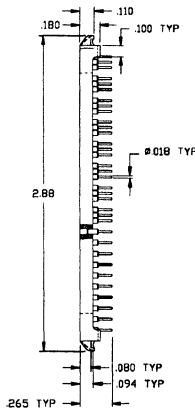
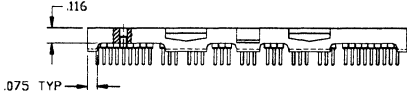
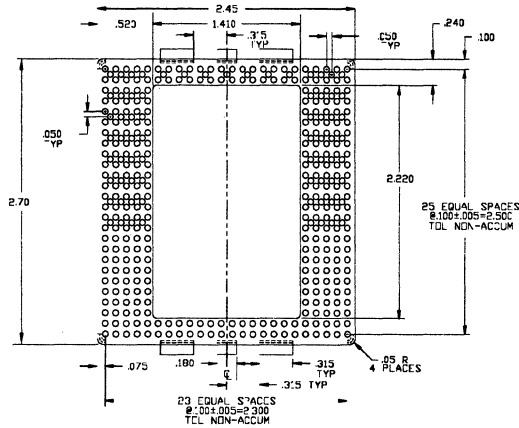

**Materials**

- Insulator: PPS, UL 94V-0  
40% Glass Reinforced.
- Pin - Outer Shell: Brass Alloy 360, 1/2 hard,  
per QQ-B-626.
- Inner Contact: Beryllium Copper (BeCu) -  
Alloy172.
- Plating - Shell: 200µ" (nominal) BRIGHT ACID  
TIN per MIL-T-10727, Type 1,  
over 200µ" (nominal) Nickel per  
QQ-N-290.
- Plating - Contact area: 10µ" or 30µ" (nominal) GOLD per  
MIL-G-45204, GRADE C, over  
50µ" (nominal) Nickel per  
QQ-N-290.

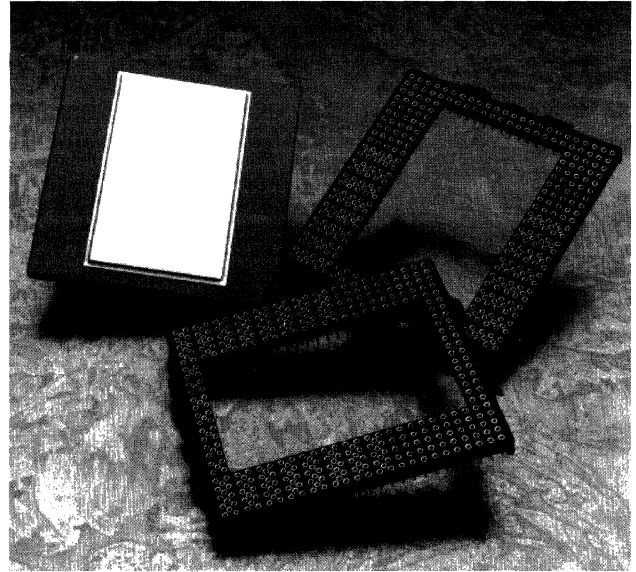

- The socket body is injection molded PPS and features tabs to which a heat sink can be attached via a heat sink clip.
- The dimensions and placement of the heatsink tabs match those detailed in Intel's P6 socket specification.
- Two contact options are available. Both contacts, the 6(43) and 3(48), are Ultra Low Insertion Force (ULIF) contacts, and are available with either 10µ" or 30µ" of gold plating.
- A special extraction tool is also available.

**Average Initial Insertion/Extraction Forces  
For 387 Contacts**

Contact #	Insertion	Extraction
6(43)	74 Lbf.	61 Lbf.
3(48)	41 Lbf.	35 Lbf.

PART NUMBER	PLATING	CLIP	TAIL LENGTH
97211-2642	10µ" Au	3(48)	.085"
97211-4642	30µ" Au	3(48)	.085"
97212-2642	10µ" Au	6(43)	.085"
97212-4642	30µ" Au	6(43)	.085"
97600-0000	Extraction Tool		





PZA - 447H 509B - 39AC

Pin Count      Center Configuration      Pattern Number

Polarity mark (contact #1) is located in upper left corner. Top view of sockets are shown from highest to lowest pin count. Arrays are available in molded Thermoplastic (UL 94V-0 approved) or vapor phase and infrared compatible PPS. Optional FR4 on request.

See page F43 for ordering information

## 19 x 19 ARRAYS

DIMENSIONS:

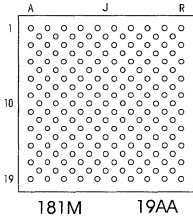

**SOCKETS**  
1.050" square  
(26,67)mm square

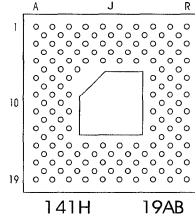

## 23 x 23 ARRAYS

DIMENSIONS:

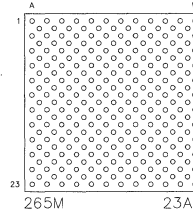

**SOCKETS**  
1.250" square  
(31,75)mm square

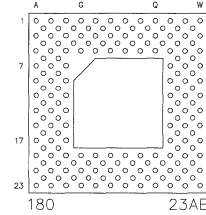

## 27 x 27 ARRAYS

DIMENSIONS:

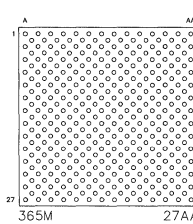

**SOCKETS**  
1.450" square  
(36,83)mm square

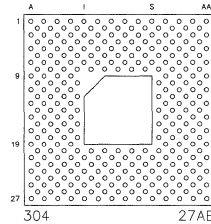

## 29 x 29 ARRAYS

DIMENSIONS:

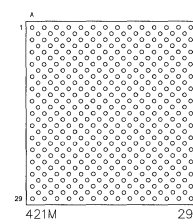

**SOCKETS**  
1.550" square  
(39,37)mm square

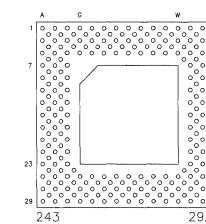

## 31 x 31 ARRAYS

DIMENSIONS:

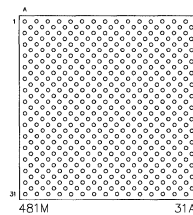

**SOCKETS**  
1.650" square  
(41,91)mm square

## 33 x 33 ARRAYS

DIMENSIONS:

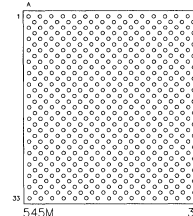

**SOCKETS**  
1.750" square  
(44,45)mm square

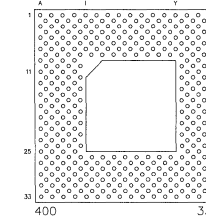

## 33 x 33 ARRAYS

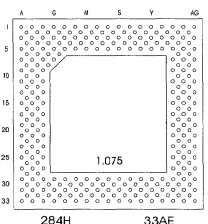
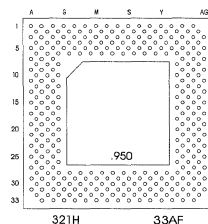
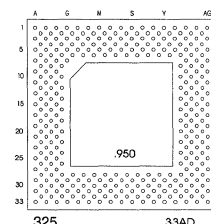
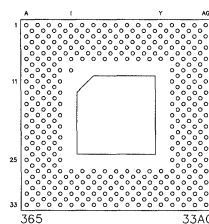

All McKenzie  
Molded Sockets



Polarity mark (contact #1) is located in upper left corner. Top view of sockets are shown from highest to lowest pin count. Arrays are available in molded Thermoplastic (UL 94V-0 approved) or vapor phase and infrared compatible PPS. Optional FR4 on request.

PZA-447H 509B -39AC  
 Pin Count      Center Configuration      Pattern Number

See page F43 for ordering information

DIMENSIONS:

**SOCKETS**  
 1.850" square  
 (46,99)mm square

**35 x 35 ARRAYS**

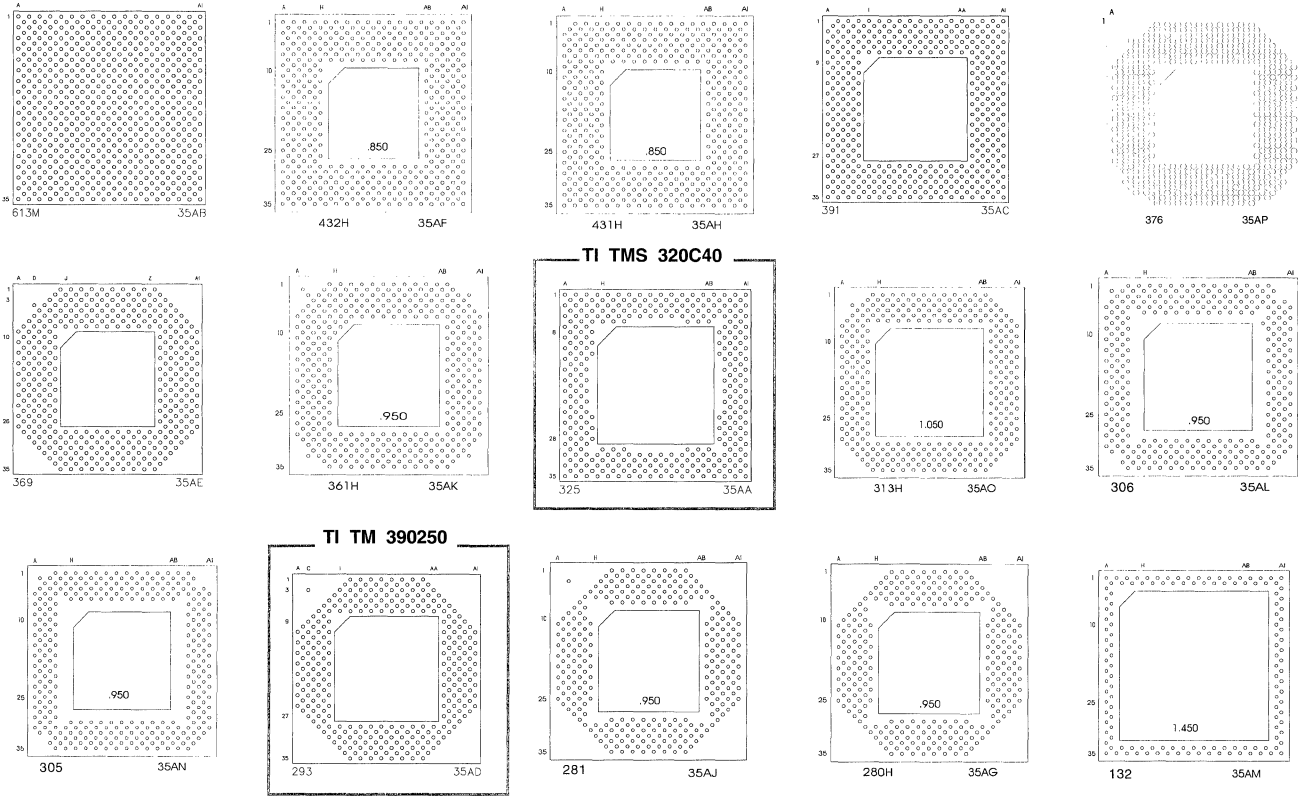

DIMENSIONS:

**SOCKETS**  
 1.950" square  
 (49,53)mm square

**37 x 37 ARRAYS**

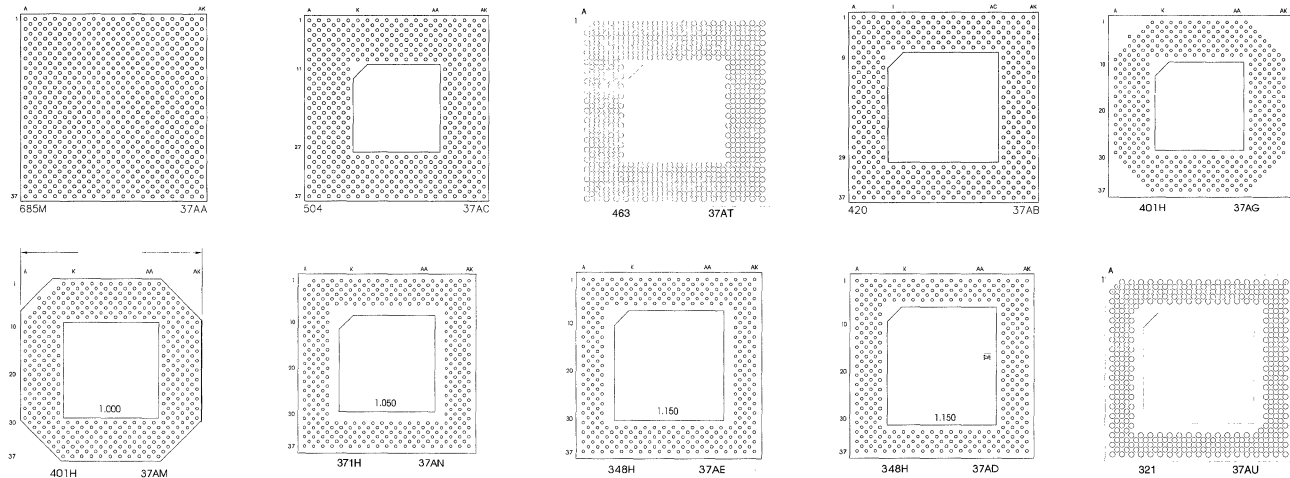

PZA - 447H 509B - 39AC  
 Pin Count      Center Configuration      Pattern Number

Polarity mark (contact #1) is located in upper left corner. Top view of sockets are shown from highest to lowest pin count. Arrays are available in molded Thermoplastic (UL 94V-0 approved) or vapor phase and infrared compatible PPS. Optional FR4 on request.

See page F43 for ordering information

### 37 x 37 ARRAYS

DIMENSIONS:

**SOCKETS**  
 1.950" square  
 (49,53)mm square

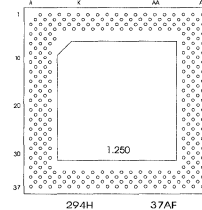
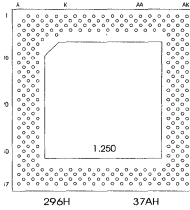
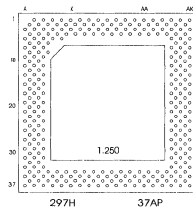
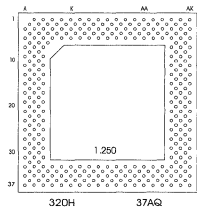

### 39 x 39 ARRAYS

DIMENSIONS:

**SOCKETS**  
 2.050" square  
 (52,07)mm square

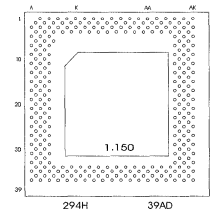
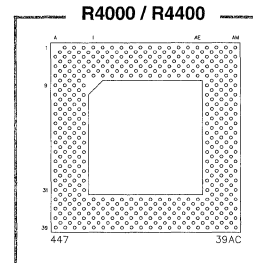
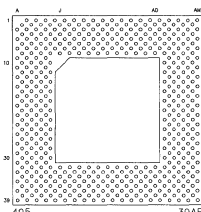
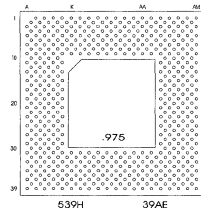
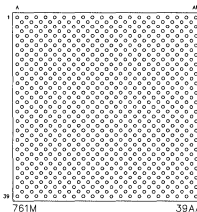

### 41 x 41 ARRAYS

DIMENSIONS:

**SOCKETS**  
 2.150" square  
 (54,61)mm square

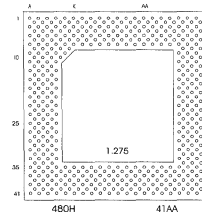
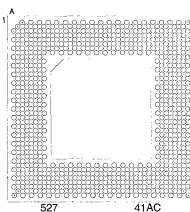
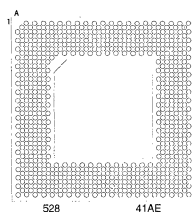
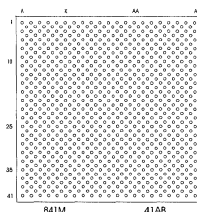

Polarity mark (contact #1) is located in upper left corner. Top view of sockets are shown from highest to lowest pin count. Arrays are available in molded Thermoplastic (UL 94V-0 approved) or vapor phase and infrared compatible PPS. Optional FR4 on request.

**PZA-447H 509B -39AC**

Pin Count      Center Configuration      Pattern Number

*See page F2 for ordering information*

### 43 x 43 ARRAYS

DIMENSIONS:

**SOCKETS**  
2.250" square  
(57,15)mm square

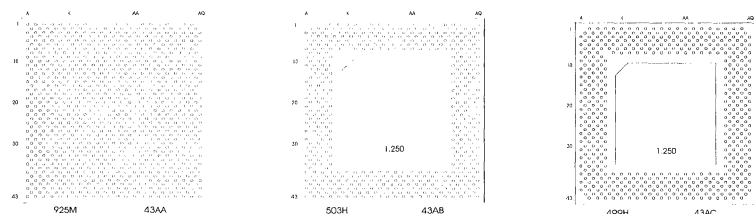

### 45 x 45 ARRAYS

DIMENSIONS:

**SOCKETS**  
2.350" square  
(59,69)mm square

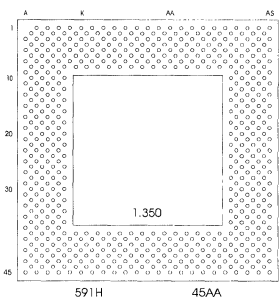

### 49 x 49 ARRAYS

DIMENSIONS:

**SOCKETS**  
2.550" square  
(64,77)mm square

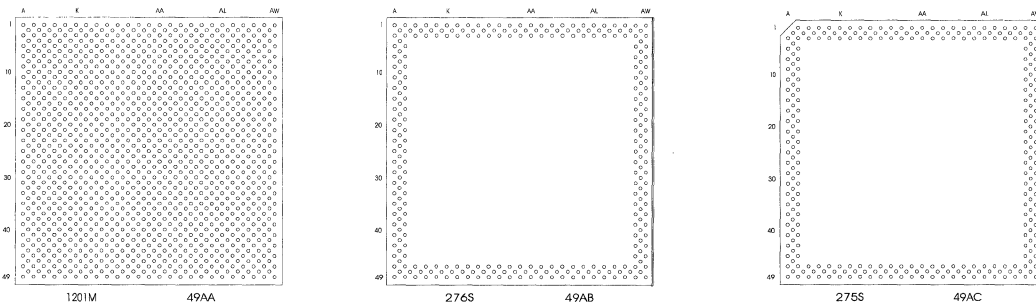



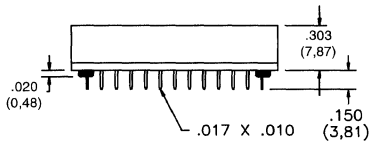
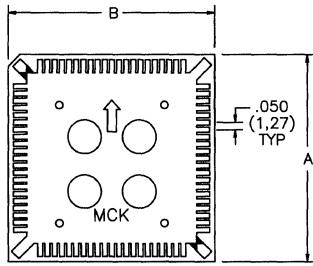

### PCB HOLE LAYOUT

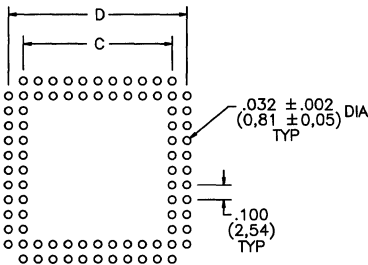

### All sizes (Except 32 Position)

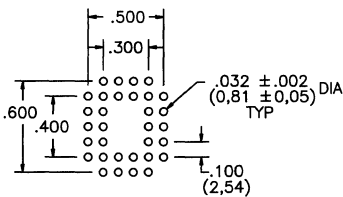

### 32 Position (Only)

#### Technical Specifications

Operating Temp Range: -55°C to +125°C

Current Rating: 1 A

Capacitance: 1.0 picofarads (max.)

Contact Resistance: 30 Milliohms (max.)

Insulation Resistance: 1000 Megohms (min.)

Withstanding Voltage: 600 V AC

#### Material Specifications

Socket Body: Hi-Temp PPS, UL 94V-0, 220°C

Contact: Phosphor Bronze Alloy 5210, full hard

Plating: .000150" Tin/.000040" Nickel (min.)

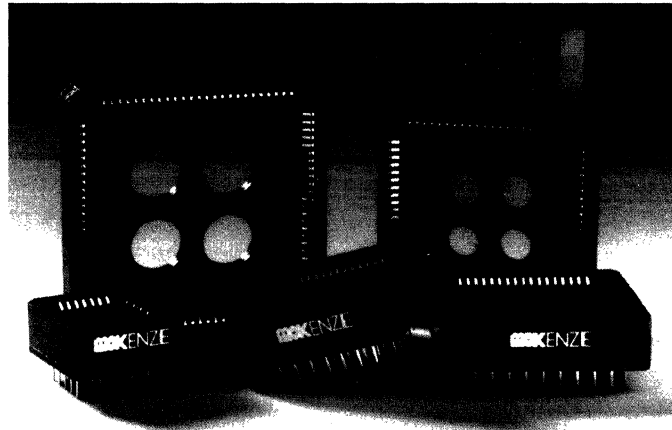

Sizes: 20, 28, 32, 44, 52, 68, 84 and 100 pin

### Plastic Leaded Chip Carrier Sockets

- Conforms to EIA JEDEC outline for Plastic Leaded Chip Carriers on .050" (1,27) centers
- Phosphor bronze contacts with 150µ" tin plating over a 40µ" nickel barrier
- High temperature PPS thermoplastic (UL 94V-0) is infrared and vapor phase compatible
- Easy to use extraction tool provides positive protection for both chip carrier and device during removal — see pg. G2
- Closed bottom prevents solder wicking and bridging
- Open center and standoff provide for thorough cleaning after soldering
- Converts the .050" (1,27) PLCC spacing to .100" (2,54) PC board spacing
- Easy access for testing single contacts
- Polarization indicators assure positive chip carrier orientation

### Dimensional Specifications for ordering PLCC

PART NUMBER	NO. POS.	A	B	C	D	TUBE QTY.
PLCC-20P-T	20	.613 (15,57)	.613 (15,57)	.200 (5,08)	.400 (10,16)	37
PLCC-28P-T	28	.713 (18,11)	.713 (18,11)	.300 (7,62)	.500 (12,70)	32
PLCC-32P-T	32	.795 (20,19)	.700 (17,78)	.300 (7,62)	.500 (12,70)	28
PLCC-44P-T	44	.913 (23,19)	.913 (23,19)	.500 (12,70)	.700 (17,78)	25
PLCC-52P-T	52	1.060 (26,92)	1.060 (26,92)	.600 (15,24)	.800 (20,32)	21
PLCC-68P-T-2	68	1.217 (30,91)	1.217 (30,91)	.800 (20,32)	1.000 (25,40)	18
PLCC-84P-T-2	84	1.417 (35,99)	1.417 (35,99)	1.000 (25,40)	1.200 (30,48)	16
PLCC-100P-T	100	1.663 (42,24)	1.663 (42,24)	1.200 (30,48)	1.400 (35,56)	13

See page H1 for footprint compatible Surface Mount Sockets

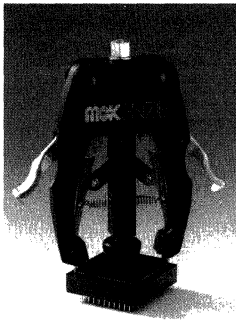

### Precision PLCC Extraction Tool

Positively extracts PLCC devices from 20 to 100 pins from most manufactures SMT style sockets — even low profile versions.

Part Number TOL PLCC-XT-HD

- Infinitely adjustable design reduces the possibility of device damage
- Pressure stop assures parallel extraction
- Quality steel and aluminum mechanism with plastic frame

### Economy PLCC Extraction Tool

McKenzie Technology's Universal PLCC Extraction Tool provides an economical alternative for PLCC chip removal.

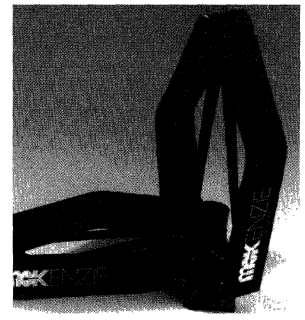

Part Number TOL PLCC-XT-2

- Removes chip sizes 20, 28, 32, 44, 52, 68, 84, and 100 pin
- Compatible with most manufacturers' PLCC sockets
- For Thru-Hole and SMT style sockets

*Extraction tools are not sampled.*

## Socket Solutions for the Dallas Semiconductor NVRAM

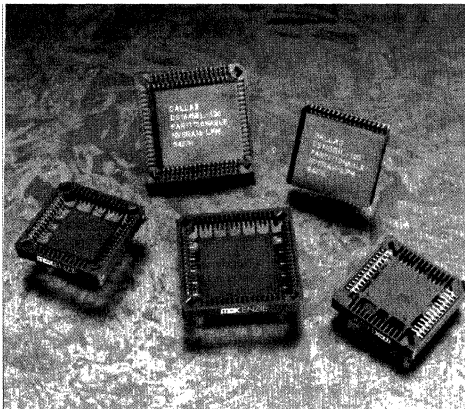

### Features

- Very low profile: 0.175" above the PCB
- Hi-Temp materials compatible with any surface mount solder reflow process.
- Center pad provides area for automated pick-and-place equipment.
- Optional alignment peg for accurate positioning when hand placing: add a "-P" to the end of the part number.
- All solder joints are inspectable
- For high volume requirements, tape and reel packaging is available: add a "-T" to the end of the part number.
- Part number PLCC-26P-SMT-3 is a 26 pin socket for Dallas Semiconductor part number DS1643L. Part number PLCC-34P-SMT-3 is a 34 pin socket for Dallas Semiconductor part number DS1630ABL, DS1630YL, DS1645ABL, DS1645YL, DS1650ABL, DS1650YL, DS1730YL, DS1745YL, DS1750YL and DS1646L.

Part Number	Dimensions ± .008				
	A	B	C	F	G
PLCC-26P-SMT-3	.600	1.000	.770	.734	.133
PLCC-34P-SMT-3	.800	1.213	.980	.934	.140

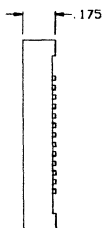

Side View

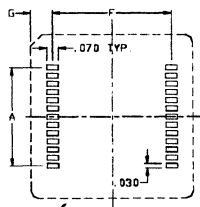

Recommended PCB Layout

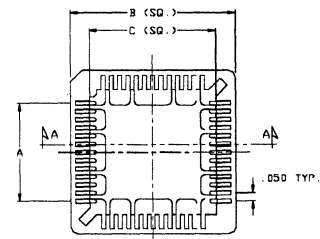

Top View



Same footprint as the device

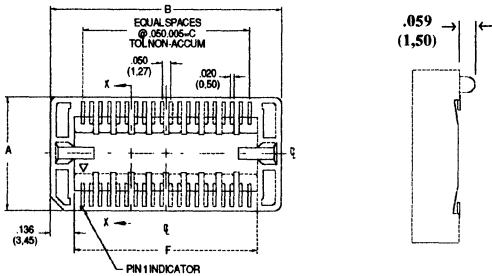

Top View

Optional Peg

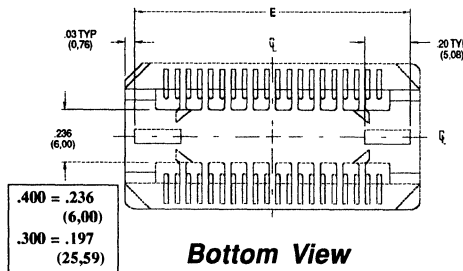

Bottom View

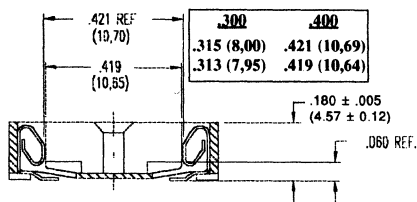

End View

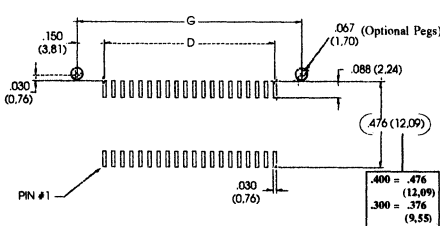

Recommended PCB Layout

### Features

- Available in 28, 32, 40 and 42 pin versions for .400 between row spacing parts, and 24, 26 and 32 pin versions for .300 between row spacing parts.
- Same footprint as the device they socket.
- Low profile of just .180" above the board.
- Molded a high temperature PPS.
- Design incorporates a central pick-and-place tab.
- All solderjoints are 100% inspectable.
- Optional alignment pegs for hand loading.
- Work with a standard PLCC extraction tool.
- Standard packaging is tubes. Many sizes also available in tape and reel.

### Performance

- Contact Resistance: Initial: 15 milliohms maximum  
Final: 10 milliohms max after testing
- Insulation Resistance: Greater than 10,000 ohms
- Operating Temperature: -50°C to +105°C
- Dielectric Withstanding Voltage: 1000 VAC RMS (1 min.)
- Capacitance: Less than 1.0 pf at 1000 KHz
- Durability: 25 cycles

Part Number	No. Pins	A ± .006	B ± .006	C ± .005	D ± .005	E ± .006	F ± .006	G ± .006
SOJ 24P-3.0	24	.546 (13,87)	.915 (23,24)	.550 (13,97)	.550 (13,97)	.852 (21,64)	.644 (16,36)	.850 (21,59)
SOJ 26P-3.0	26	.546 (13,87)	.965 (24,51)	.600 (15,24)	.600 (15,24)	.902 (22,91)	.694 (17,63)	.900 (22,86)
SOJ 28P-3.0	28	.546 (13,87)	1.015 (25,78)	.650 (16,51)	.650 (16,51)	.952 (24,18)	.744 (18,90)	.950 (24,13)
SOJ 28P-4.0	28	.646 (16,41)	1.015 (25,78)	.650 (16,51)	.650 (16,51)	.952 (24,18)	.743 (18,88)	.950 (24,13)
SOJ 32P-4.0	32	.646 (16,41)	1.115 (28,32)	.750 (19,05)	.750 (19,05)	1.052 (26,72)	.843 (21,42)	1.050 (26,67)
SOJ 40P-4.0	40	.646 (16,41)	1.315 (33,40)	.950 (24,13)	.950 (24,13)	1.252 (31,80)	1.043 (26,50)	1.250 (31,75)
SOJ 42P-4.0	42	.646 (16,41)	1.365 (35,67)	1.000 (25,40)	1.000 (25,40)	1.302 (33,07)	1.093 (27,77)	1.300 (33,02)

Add a -P to the end of the part number for peg option.



## PLCC Adaptors

- Low cost Adaptor to standard PGA pattern on .100" (2,54) grid

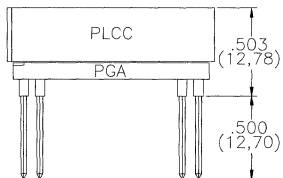

Specify 410B or 411B for Wire Wrap

### Typical PCB Layout



ADP PLCC 68-410B



PLCC	PART NUMBER*	PGA PATTERN*
20	ADP PLCC20-410B*	0514
28	ADP PLCC28-410B*	0605
32	ADP PLCC32-410B*	0710
44	ADP PLCC44-410B*	0803
52	ADP PLCC52-410B*	0926
68	ADP PLCC68-410B*	1132
84	ADP PLCC84-410B*	1354
100	ADP PLCC100-410B*	1530

\*Specify Tail Style:  
 410B – 200µ" Tin 3 Level Wire Wrap  
 411B – 10µ" Gold 3 Level Wire Wrap

\*See Section F For PGA Patterns

## PLCC to Prototype Board Adaptor

- Adapts PLCC to Wire Wrap logic board
- PLCC Socket is soldered to copper clad FR4 PCB

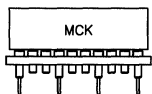
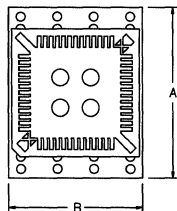

ADP PCC 52-01

PART NUMBER	A	B
ADP PCC 28-02*	1.10" (27,94)	.80" (20,32)
ADP PCC 44-01*	1.20" (30,48)	.90" (22,86)
ADP PCC 52-01*	1.40" (35,56)	1.10" (27,94)
ADP PCC 68-02*	1.40" (35,56)	1.20" (30,48)
ADP PCC 84-02*	1.40" (35,56)	1.40" (35,56)
ADP PCC 100-01*	1.80" (45,72)	1.70" (43,18)

\*Solder tail is standard  
 Add "WW" to Part Number for 3 level Wire wrap

## LCC to Prototype Board Adaptor

- Adapts 68 pin LCC (JEDEC, A, B, D,) to 100" (2,54) logic board spacing
- Available in Solder tail or Wire Wrap versions

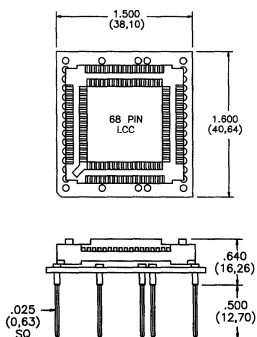

ADP 68LCC55159-591B

PART NUMBER	TAIL STYLE
ADP68 LCC55159-540B	10µ" Gold Solder tail
ADP68 LCC55159-591B	10µ" Gold Wire Wrap

### PLCC Device Carriers

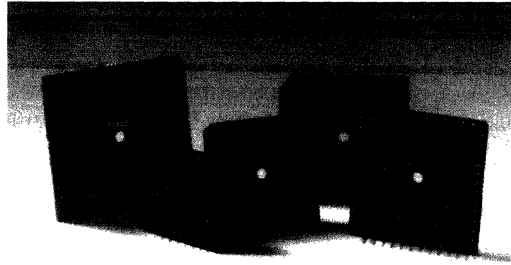
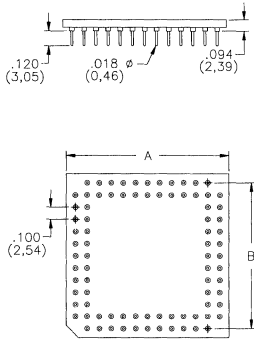

- Adapts JEDEC plastic lead chip carrier to standard PGA footprint
- Allows device to be socketed or Thru-Hole mounted
- McKenzie offers full value added services and can solder your consigned devices to the carriers. Call factory for details.

PLCC and PQFP device carriers pictured

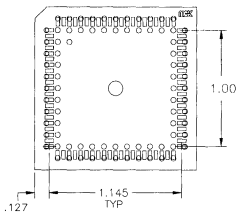

ADP 84DC-PLCC/PGA

PART NUMBER	PGA PATTERN*	A	B
ADP 52DC-PLCC/PGA	0926	.950 (24,13)	.800 (20,32)
ADP 68DC-PLCC/PGA	1132	1.15 (29,21)	1.000 (25,40)
ADP 84DC-PLCC/PGA	1354	1.35 (34,29)	1.200 (30,48)

\*See Section F for Mating PGA Sockets. See page H6 & H7 for adaptor net lists

### QFP Device Carriers

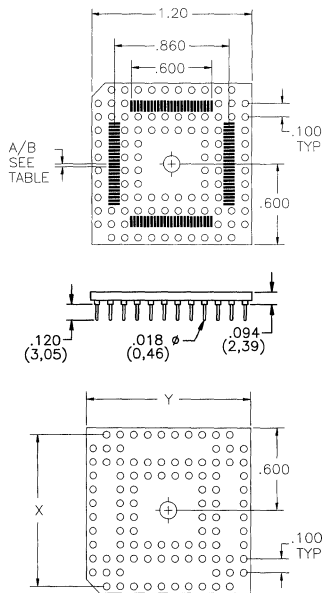

ADP 100ADC-QFP/PGA

**Insulator:**  
Copper Clad FR-4

**Contacts:**  
Tin/Lead Plated Phosphor Bronze  
Radius Tip

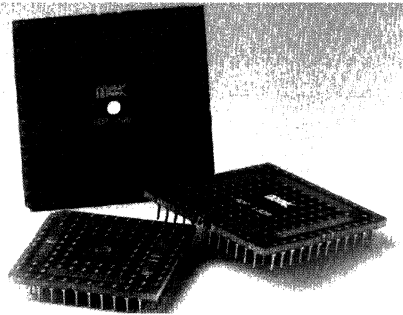

- Adapts JEDEC or EIAJ gull wing devices to .100" (2,54) grid
- Allows for easy testing and prototyping
- Adaptor can be socketed or soldered to PCB

PART NUMBER	X	Y	PGA PATTERN
ADP 100A*DC-QFP/PGA ADP 100B*DC-QFP/PGA	1.100 (27,94)	1.200 (30,48)	1250
ADP 132A*DC-QFP/PGA ADP 132B*DC-QFP/PGA	1.300 (33,02)	1.400 (35,56)	1491
ADP 144A*DC-QFP/PGA ADP 144B*DC-QFP/PGA	1.500 (38,10)	1.600 (40,64)	1629
ADP 160A*DC-QFP/PGA ADP 160B*DC-QFP/PGA	1.500 (38,10)	1.600 (40,64)	1632

\* A = 0.025 inches pitch, B = 0.65 mm pitch

See page H4 & H5 for adaptor net lists. Consult factory for availability of other sizes.

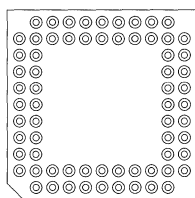

Top View

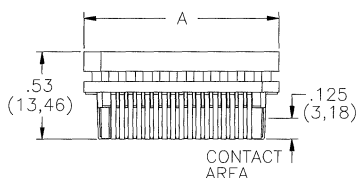

Side View

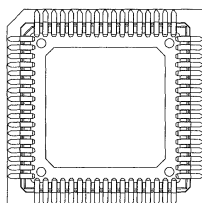

Bottom View  
ADP 68PGA/PLCC

### Features

- Adapts from 44, 52, 68, or 84 pin PGA socket to standard .100" (2,54) grid female PLCC pattern
- Fits securely in most manufacturers' PLCC sockets
- Custom female pin patterns available, consult factory
- Accepts .015" (0,38) -.026" (0,66) round mating pin
- Net list available upon request

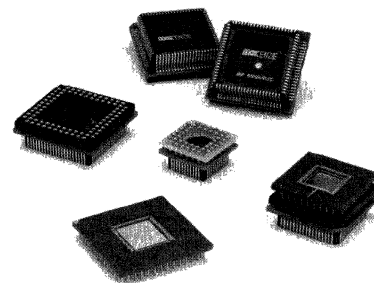

Plug a PGA into a PLCC socket

PART NUMBER	A	PGA PATTERN*
ASM 44PGA/PLCC	.850 (21,59)	0802
ASM 52PGA/PLCC	.950 (24,13)	0926
ASM 68PGA/PLCC	1.200 (30,48)	1132
ASM 84PGA/PLCC	1.400 (35,56)	1354

\*See Section F For PGA Patterns

### Features

- Surface mounts directly to your PCB
- Consult factory for SMT pad specifications
- Fits securely in most manufacturers' PLCC sockets

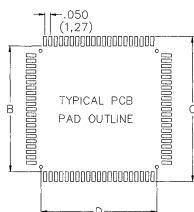
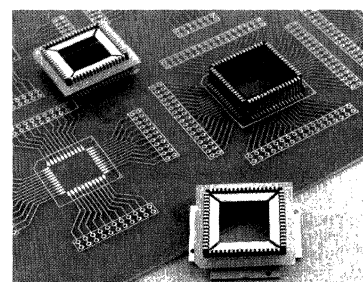

Top View

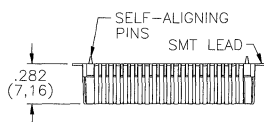

Side View

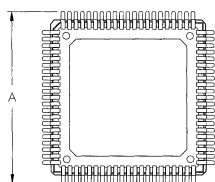

Bottom View  
ADP 84PLCC-SM

PART NUMBER	A	B	C	D
ADP 44PLCC-SM	.820 (20,83)	.660 (16,76)	.840 (21,33)	.580 (14,73)
ADP 52PLCC-SM	.920 (23,37)	.755 (19,18)	.935 (23,75)	.680 (17,27)
ADP 68PLCC-SM	1.120 (28,45)	.970 (24,64)	1.150 (29,21)	.880 (22,35)
ADP 84PLCC-SM	1.320 (33,53)	1.170 (29,72)	1.350 (34,29)	1.08 (27,43)

#### Contact:

Material: Phosphor Bronze/Alloy 510  
Plating: Selective Gold 30µ" (min.) over Nickel in contact area  
Tin/Lead 200µ" (min.) over Nickel in surface mount area

#### Insulator:

Hi-Temp,  
Glass Reinforced Thermoplastic,  
UL 94V-0

### How To Order

ADP 44 PLCC - SM - T

Product Code      Number of Contacts      Surface Mount      T - Tin Lead Plate (Option)  
Blank - Selective Plated (Gold)

### PLCC Adaptor Plug (.050")

- Converts .050" (1,27) thru hole pattern to 68 or 84 position PLCC plug
- Standard plug has gold plated leads, tin plated is available

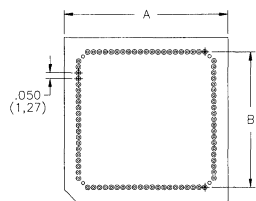

Top View

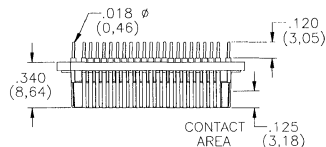

Side View

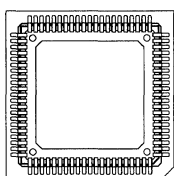

Bottom View  
ADP 84PLCC-050

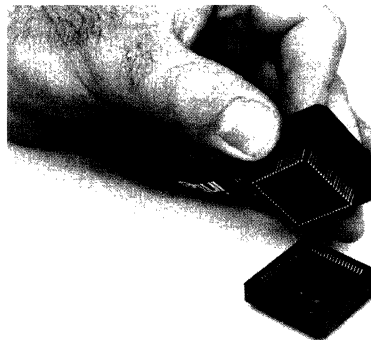

**Male Soldertail:**

Phosphor Bronze, 200µ" Tin/Lead  
over 50µ" Nickel

PART NUMBER	A	B
ASM 68PLCC-050	1.20 (30,48)	.956 (24,28)
ASM 84PLCC-050	1.40 (35,56)	1.156 (29,36)

### PLCC Adaptor Plugs (.100")

- Converts Thru-Hole .100" PGA (2,54) to PLCC plug
- Available in all standard PLCC pin counts
- Excellent for emulator cable, and daughter card to mother board applications
- Standard plug has gold plated leads, tin plated is available

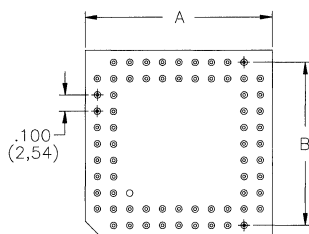

Top View

**Typical application**

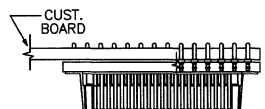
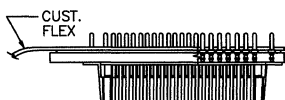
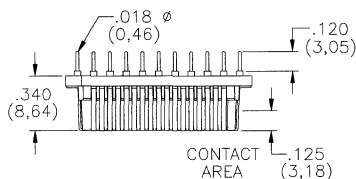

Side View

PART NUMBER	A	B	PGA PATTERN*
ASM 44PLCC/PGA	.850(21,59)	.700(17,78)	0802
ASM 52PLCC/PGA	.950(24,13)	.800(20,32)	0926
ASM 68PLCC/PGA	1.200(30,48)	1.000(25,40)	1132
ASM 84PLCC/PGA	1.400(35,56)	1.200(30,48)	1354

\*See Section F For PGA Patterns

**Male Soldertail:**

Phosphor Bronze, 200µ" Tin/Lead  
over 50µ" Nickel

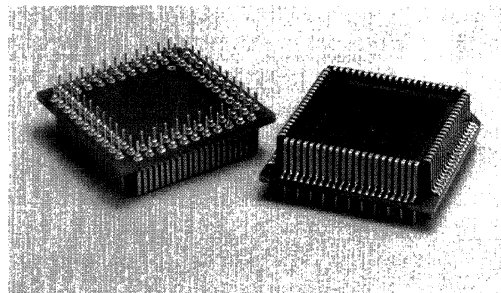

Consult factory for alternative mating configuration

## 100 Pin, .025" and 65mm Pitch QFP Device Carriers

Part Numbers      ADP 100A-DC-QFP/PGA = .025" Pitch  
 ADP 100B-DC-QFP/PGA = .65mm Pitch

### NET LIST — 100

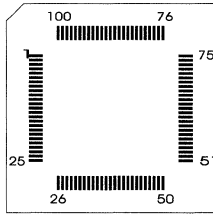

QFP Pads  
Top view of device carrier

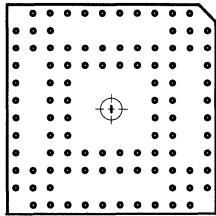

PGA Footprint  
Top view of socket or PCB

QFP PAD	PGA PIN	QFP PAD	PGA PIN	QFP PAD	PGA PIN	QFP PAD	PGA PIN	QFP PAD	PGA PIN
1	B3	21	D8	41	H12	61	J7	81	J1
2	C3	22	A11	42	G9	62	L7	82	H3
3	C4	23	C9	43	I12	63	I7	83	I1
4	A2	24	C10	44	H10	64	L6	84	H4
5	D4	25	B10	45	J12	65	J6	85	H1
6	A3	26	C11	46	H9	66	L5	86	G3
7	C5	27	B11	47	K12	67	I6	87	G1
8	A4	28	D10	48	I10	68	L4	88	G4
9	D5	29	B12	49	K11	69	J5	89	F1
10	A5	30	D9	50	J11	70	L3	90	F3
11	C6	31	C12	51	K10	71	I5	91	E1
12	A6	32	E10	52	J10	72	L2	92	F4
13	D6	33	D12	53	J9	73	J4	93	D1
14	A7	34	E9	54	L11	74	J3	94	E3
15	C7	35	E12	55	I9	75	K3	95	C1
16	A8	36	F10	56	L10	76	J2	96	E4
17	D7	37	F12	57	J8	77	K2	97	B1
18	A9	38	F9	58	L9	78	I3	98	D3
19	C8	39	G12	59	I8	79	K1	99	B2
20	A10	40	G10	60	L8	80	I4	100	C2

Part Numbers      ADP 132A-DC-QFP/PGA = .025" Pitch  
 ADP 132B-DC-QFP/PGA = .65mm Pitch

### NET LIST — 132

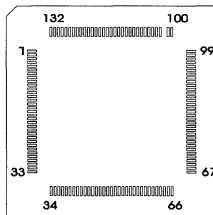

QFP Pads  
Top view of device carrier

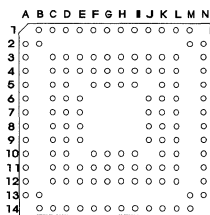

PGA Footprint  
Top view of socket or PCB

QFP PAD	PGA PIN	QFP PAD	PGA PIN	QFP PAD	PGA PIN	QFP PAD	PGA PIN	QFP PAD	PGA PIN	QFP PAD	PGA PIN
1	A2	23	A9	45	G10	67	N13	89	N6	111	H5
2	A3	24	D10	46	G11	68	N12	90	K5	112	H4
3	A4	25	D11	47	G12	69	N11	91	K4	113	H3
4	C4	26	C10	48	G14	70	L11	92	L5	114	H1
5	D5	27	A10	49	H10	71	K10	93	N5	115	G5
6	C5	28	A11	50	H11	72	L10	94	N4	116	G4
7	A5	29	C12	51	H12	73	N10	95	L3	117	G3
8	E6	30	C11	52	H14	74	J9	96	L4	118	G1
9	D6	31	A12	53	I10	75	K9	97	N3	119	F5
10	C6	32	A13	54	I11	76	L9	98	N2	120	F4
11	A6	33	B13	55	I12	77	N9	99	M2	121	F3
12	E7	34	B14	56	I14	78	J8	100	M1	122	F1
13	D7	35	C14	57	J11	79	K8	101	L1	123	E4
14	C7	36	D14	58	K11	80	L8	102	K1	124	D4
15	A7	37	D12	59	J12	81	N8	103	K3	125	E3
16	E8	38	E11	60	J14	82	J7	104	J4	126	E1
17	D8	39	E12	61	K14	83	K7	105	J3	127	D1
18	C8	40	E14	62	L12	84	L7	106	J1	128	C3
19	A8	41	F10	63	K12	85	N7	107	I5	129	D3
20	E9	42	F11	64	L14	86	J6	108	I4	130	C1
21	D9	43	F12	65	M14	87	K6	109	I3	131	B1
22	C9	44	F14	66	M13	88	L6	110	I1	132	B2

Part ADP 144A-DC-QFP/PGA = .025" Pitch

NET LIST — 144

Numbers ADP 144B-DC-QFP/PGA = .65mm Pitch

QFP PAD	PGA PIN	QFP PAD	PGA PIN	QFP PAD	PGA PIN	QFP PAD	PGA PIN	QFP PAD	PGA PIN	QFP PAD	PGA PIN	QFP PAD	PGA PIN	QFP PAD	PGA PIN
1	B3	19	F9	37	C15	55	I11	73	O14	91	K8	109	N2	127	H6
2	B2	20	A9	38	B15	56	I16	74	O15	92	P8	110	O2	128	H1
3	A3	21	D9	39	C16	57	I13	75	P14	93	M8	111	N1	129	H4
4	E5	22	E9	40	E12	58	I12	76	L12	94	L8	112	L5	130	H5
5	A4	23	F10	41	D16	59	J11	77	P13	95	K7	113	M1	131	G6
6	D5	24	A10	42	E13	60	J16	78	M12	96	P7	114	L4	132	G1
7	A5	25	D10	43	E16	61	J13	79	P12	97	M7	115	L1	133	G4
8	E6	26	E10	44	F12	62	J12	80	L11	98	L7	116	K5	134	G5
9	A6	27	D11	45	F16	63	K13	81	P11	99	M6	117	K1	135	F4
10	D6	28	A11	46	F13	64	K16	82	M11	100	P6	118	K4	136	F1
11	F7	29	E11	47	G11	65	K12	83	K10	101	L6	119	J6	137	F5
12	A7	30	A12	48	G16	66	L16	84	P10	102	P5	120	J4	138	E1
13	D7	31	D12	49	G13	67	L13	85	M10	103	M5	121	J1	139	E4
14	E7	32	A13	50	G12	68	M16	86	L10	104	P4	122	J5	140	D1
15	F8	33	D13	51	H11	69	M13	87	K9	105	M4	123	I6	141	D4
16	A8	34	A14	52	H16	70	N16	88	P9	106	P3	124	I1	142	C1
17	D8	35	C14	53	H13	71	N14	89	M9	107	N3	125	I4	143	C3
18	E8	36	B14	54	H12	72	N15	90	L9	108	O3	126	I5	144	C2

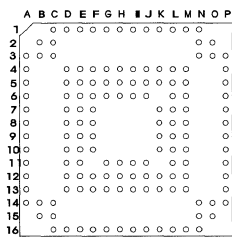

144

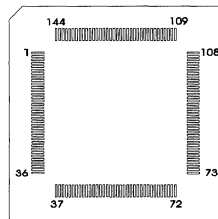

QFP Pads  
Top view of  
device carrier

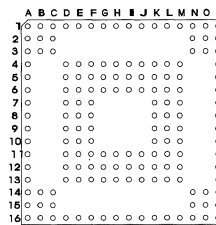

160

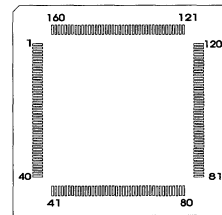

PGA Footprint  
Top view of socket  
or PCB

QFP Pads  
Top view of  
device carrier

Part ADP 160A-DC-QFP/PGA = .025" Pitch

NET LIST — 160

Numbers ADP 160B-DC-QFP/PGA = .65mm Pitch

QFP PAD	PGA PIN	QFP PAD	PGA PIN	QFP PAD	PGA PIN	QFP PAD	PGA PIN	QFP PAD	PGA PIN	QFP PAD	PGA PIN	QFP PAD	PGA PIN	QFP PAD	PGA PIN
1	B3	21	F9	41	C15	61	I11	81	O14	101	K8	121	N2	141	H6
2	A1	22	A9	42	A16	62	I16	82	P16	102	P8	122	P1	142	H1
3	A2	23	D9	43	B16	63	I13	83	P15	103	M8	123	O1	143	H4
4	A3	24	E9	44	C16	64	I12	84	P14	104	L8	124	N1	144	H5
5	F6	25	F10	45	F11	65	J11	85	K11	105	K7	125	K6	145	G6
6	E5	26	A10	46	E12	66	J16	86	L12	106	P7	126	L5	146	G1
7	A4	27	D10	47	D16	67	J13	87	P13	107	M7	127	M1	147	G4
8	D5	28	E10	48	E13	68	J12	88	M12	108	L7	128	L4	148	G5
9	A5	29	D11	49	E16	69	K13	89	P12	109	M6	129	L1	149	F4
10	E6	30	A11	50	F12	70	K16	90	L11	110	P6	130	K5	150	F1
11	A6	31	E11	51	F16	71	K12	91	P11	111	L6	131	K1	151	F5
12	D6	32	A12	52	F13	72	L16	92	M11	112	P5	132	K4	152	E1
13	F7	33	D12	53	G11	73	L13	93	K10	113	M5	133	J6	153	E4
14	A7	34	A13	54	G16	74	M16	94	P10	114	P4	134	J1	154	D1
15	D7	35	D13	55	G13	75	M13	95	M10	115	M4	135	J4	155	D4
16	E7	36	A14	56	G12	76	N16	96	L10	116	P3	136	J5	156	C1
17	F8	37	C14	57	H11	77	N14	97	K9	117	N3	137	I6	157	C3
18	A8	38	A15	58	H16	78	O16	98	P9	118	P2	138	I1	158	B1
19	D8	39	B15	59	H13	79	O15	99	M9	119	O2	139	I4	159	B2
20	E8	40	B14	60	H12	80	N15	100	L9	120	O3	140	I5	160	C2

Part Number ADP 52-DC-PLCC/PGA

Net List — 52

PLCC PAD	PGA PIN	PLCC PAD	PGA PIN	PLCC PAD	PGA PIN	PLCC PAD	PGA PIN
1	E1	14	A5	27	E9	40	I5
2	E2	15	B5	28	E8	41	H5
3	D1	16	A6	29	F9	42	I4
4	D2	17	B6	30	F8	43	H4
5	C1	18	A7	31	G9	44	I3
6	C2	19	B7	32	G8	45	H3
7	B1	20	A8	33	H9	46	I2
8	A2	21	B9	34	I8	47	H1
9	B2	22	B8	35	H8	48	H2
10	A3	23	C9	36	I7	49	G1
11	B3	24	C8	37	H7	50	G2
12	A4	25	D9	38	I6	51	F1
13	B4	26	D8	39	H6	52	F2

Part Number ADP 68-DC-PLCC/PGA

Net List — 68

PLCC PAD	PGA PIN	PLCC PAD	PGA PIN	PLCC PAD	PGA PIN	PLCC PAD	PGA PIN	QFP PAD	PGA PIN
1	F1	15	B4	29	C11	43	J11	57	J4
2	F2	16	A5	30	C10	44	K10	58	K3
3	E1	17	B5	31	D11	45	J10	59	J3
4	E2	18	A6	32	D10	46	K9	60	K2
5	D1	19	B6	33	E11	47	J9	61	J1
6	D2	20	A7	34	E10	48	K8	62	J2
7	C1	21	B7	35	F11	49	J8	63	
8	C2	22	A8	36	F10	50	K7	64	I2
9	B1	23	B8	37	G11	51	J7	65	H1
10	A2	24	A9	38	G10	52	K6	66	H2
11	B2	25	B9	39	H11	53	J6	67	G1
12	A3	26	A10	40	H10	54	K5	68	G2
13	B3	27	B11	41	I11	55	J5		
14	A4	28	B10	42	I10	56	K4		

Part Number ADP 84-DC-PLCC/PGA

Net List — 84

PLCC PAD	PGA PIN	PLCC PAD	PGA PIN	PLCC PAD	PGA PIN	PLCC PAD	PGA PIN	PLCC PAD	PGA PIN	PLCC PAD	PGA PIN
1	G1	15	B3	29	B10	43	G13	57	L11	71	L4
2	G2	16	A4	30	A11	44	G12	58	M10	72	M3
3	F1	17	B4	31	B11	45	H13	59	L10	73	L3
4	F2	18	A5	32	A12	46	H12	60	M9	74	M2
5	E1	19	B5	33	B13	47	I13	61	L9	75	L1
6	E2	20	A6	34	B12	48	I12	62	M8	76	L2
7	D1	21	B6	35	C13	49	J13	63	L8	77	K1
8	D2	22	A7	36	C12	50	J12	64	M7	78	K2
9	C1	23	B7	37	D13	51	K13	65	L7	79	J1
10	C2	24	A8	38	D12	52	K12	66	M6	80	J2
11	B1	25	B8	39	E13	53	L13	67	L6	81	I1
12	A2	26	A9	40	E12	54	M12	68	M5	82	I2
13	B2	27	B9	41	F13	55	L12	69	L5	83	H1
14	A3	28	A10	42	F12	56	M11	70	M4	84	H2

52

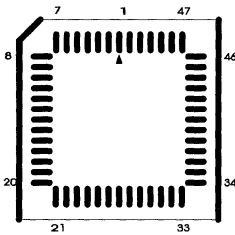

PLCC Pads  
Top view of PLCC side on the device carrier

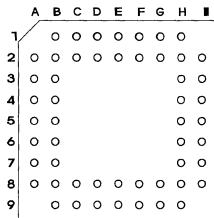

PGA Footprint  
Top view of PGA socket or footprint on PC-Board that the device carrier is plugged into

68

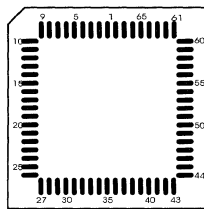

PLCC Pads  
Top view of PLCC side on the device carrier

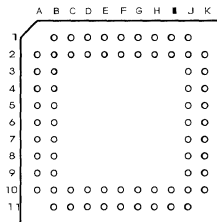

PGA Footprint  
Top view of PGA socket or footprint on PC-Board that the device carrier is plugged into

84

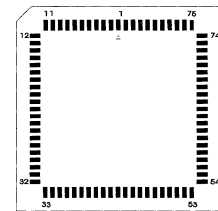

PLCC Pads  
Top view of PLCC side on the device carrier

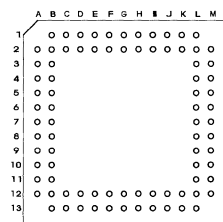

PGA Footprint  
Top view of PGA socket or footprint on PC-Board that the device carrier is plugged into





McKenzie is a leader in the assembly of custom adapters. These adapters range from simple IC package converters to more complicated Application Specific Modules (ASM™). For the entire range of adapters, McKenzie offers a broad range of services.

**Offering**

- Unique interconnect systems which address all design issues.
- Turnkey assembly — In-house pick-and-place machines and reflow chambers enable us to do component attachment.
- Engineering assistance — PCB layout, to creation of gerber plots, to circuit design assistance.
- Materials procurement active and passive components can either be kitted and consigned to McKenzie, or McKenzie's purchasing department can handle and manage the procurement of any material.
- ISO 9001 registered company

**Design Issues**

- Contact coplanarity
- Material selection — TCE mismatch
- Alignment during SMT placement
- Pin tip position after solder attach
- Solder joint inspection
- Contact retention & Solder joint strength
- Manufacturability and yields
- Warpage, testing and packaging
- Minimizing PCB layers
- Cost effective solutions

**Examples of adapters turnkey assembled at McKenzie**

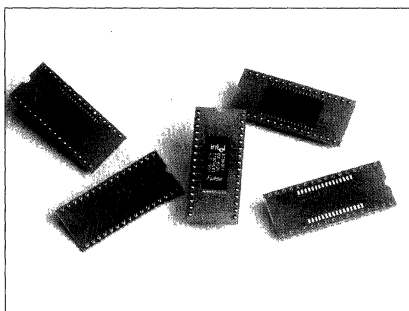

*TSOP Adapters*

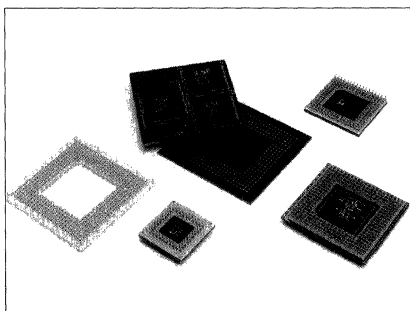

*Specialized SMT Connectors(Page K1)*

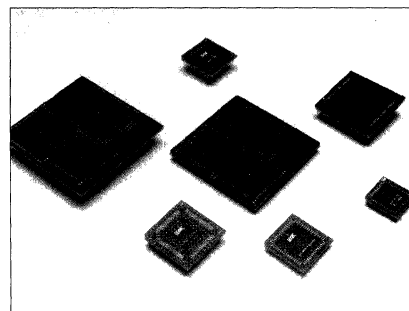

*QFP Adapters*

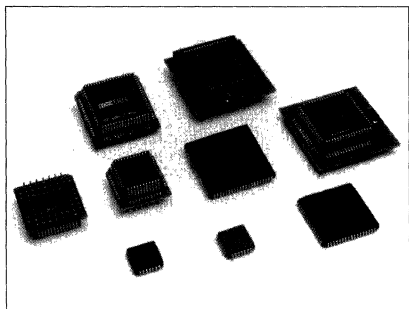

*PLCC Adapters*

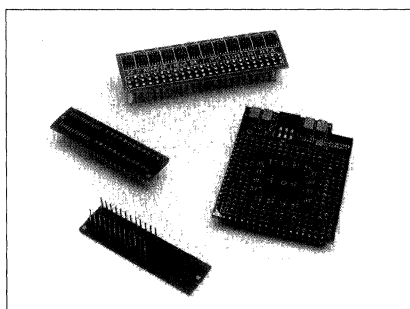

*Pinned Boards*

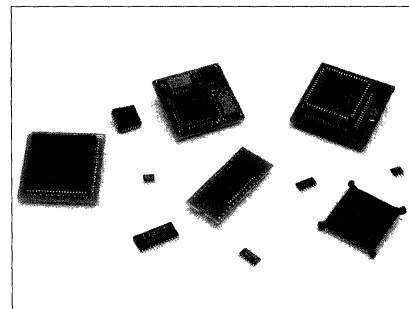

*Fine Pitch Assembly*

**Please contact your local McKenzie source or McKenzie directly for a detailed Design Guideline and Capabilities Brochure.**

### Features

- Designed to be cut without losing a position
- Tin or Gold plating
- Mates to female headers on I5
- Consult factory for custom lengths and unique square post header requirements

### PH1 and PH2 Series

A	B	C
MATING LENGTH	TAIL LENGTH	OVERALL LENGTH
.230 (5,84)	.100 (2,54)	.430 (10,92)
.230 (5,84)	.115 (2,92)	.445 (11,30)
.235 (5,97)	.145 (3,68)	.480 (12,19)
.270 (6,86)	.140 (3,56)	.510 (12,95)
.318 (8,08)	.110 (2,79)	.528 (13,41)
.318 (8,08)	.127 (3,23)	.545 (13,84)
.343 (8,71)	.120 (3,05)	.563 (14,30)

### PH1 Series

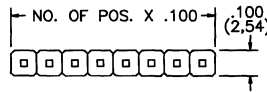
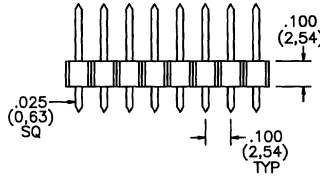
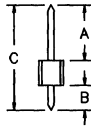

Single row  
1-36 position

### PH2 Series

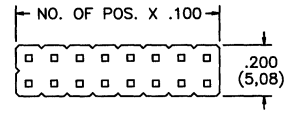
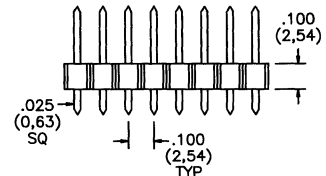
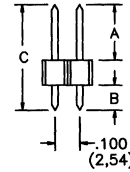

Dual row  
2-72 position

### PH3 Single row/ Right angle

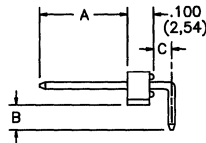

Single row/Right angle  
Horizontal insulator version  
also available.

### PH4 Dual row/ Right angle

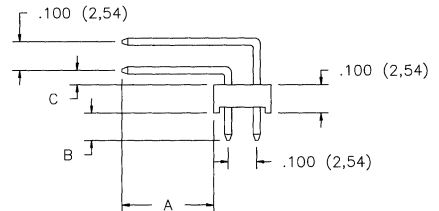

Dual row/Right angle  
Vertical insulator version  
also available.

### PH3 and PH4 Series

A	B	C
MATING LENGTH	TAIL LENGTH	OFFSET DIM.
<b>PH3</b>		
.230 (5,84)	.095 (2,41)	.060 (1,52)
.318 (8,08)	.095 (2,41)	.060 (1,52)
<b>PH4</b>		
.235 (5,97)	.120 (3,05)	.060 (1,52)
.318 (8,08)	.135 (3,43)	.060 (1,52)

### How To Order

PH2 230 / 100 - 36 G

PH1 = Single Row Straight  
PH2 = Dual Row Straight  
PH3 = Single Row Right Angle  
PH4 = Dual Row Right Angle

Mating Length  
(A dim.)

Tail Length  
(B dim.)

Material  
G - 10µ" Gold  
T - 200µ" Tin

Number of Contacts:  
Std. = X36 Single Row  
(Range = 01-36)  
Std. = X72 Dual Row  
(Range = 04-72)

#### Technical Specifications

Temperature Range: -40°C to +150°C min. continuous

Max Load: 4 Amps

Insulator: Glass filled Nylon UL 94V-0

Contact Material: Phosphor Bronze, full hard

#### Contact Plating:

Standard

G=10µ" Gold over 50µ" Nickel, min.

T=200µ" Tin over Nickel 50µ", min.

Custom Option

G30=30µ" Gold over 50µ" Nickel, min.

MOLDED SOCKETS



**Loose piece .025 square posts readily available**

**PHS-H1**  
**Single row**  
**Extended header**

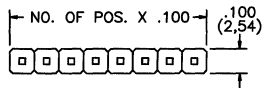
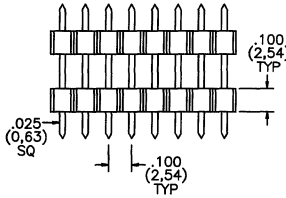
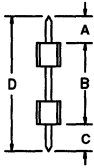

**PHS-H2**  
**Dual row**  
**Extended header**

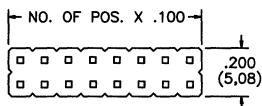
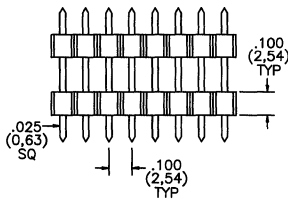
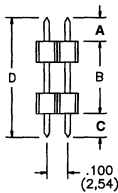

**Features**

- Ideal board-to-board interconnection
- Tin or Gold Plating
- Extended headers are also available in 2mm progression
- Available up to 40 positions in single row or 80 positions in dual row
- Bottom insulator has a .020" board stand off for post soldering wash process

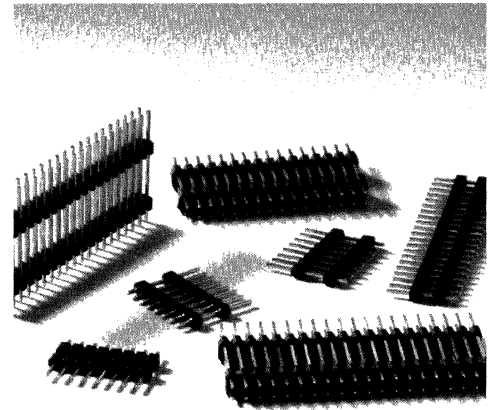

A	B	C	D
MATING LENGTH	STACKING HEIGHT	TAIL LENGTH	OVERALL LENGTH
.235 (5,97)	.200 (5,08)	.100 (2,54)	.535 (13,59)
.235 (5,97)	.300 (7,62)	.100 (2,54)	.635 (16,13)
.260 (6,61)	.375 (9,53)	.100 (2,54)	.735 (18,67)
.320 (8,13)	.430 (10,92)	.185 (4,70)	.935 (23,75)
.235 (5,97)	.570 (14,48)	.230 (5,84)	1.035 (26,29)
.295 (7,50)	.640 (16,26)	.200 (5,08)	1.135 (28,83)
.235 (5,97)	.770 (19,56)	.230 (5,84)	1.235 (31,37)
.255 (6,48)	.815 (20,70)	.265 (6,73)	1.335 (33,91)

*Other pin lengths and stacking heights available - consult factory*

**How to Order**

**PHS H1 3 2 0 / 4 3 0 / 185 - 9 3 5 - 3 6 G**

Product Code

Number of Rows  
Single = H1  
Dual = H2

Mating Length  
(A dim.)

Space between header  
top surface and bottom surface  
(B dim.)

Tail Length  
(C dim.)

Total Length  
(D dim.)

# of Contacts

Plating  
G - 10µ" Gold over 50µ" Nickel  
T - 200µ" Tin over 50µ" Nickel

**Technical Specifications**

- Maximum Current: 3 amps
- Insulator: Glass Reinforced Thermoplastic, UL 94V-0
- Temp. Range: -40°C to +150°C min.
- Contact Material: Phosphor Bronze, full hard
- Contact Plating: G=10µ" Gold/50µ" Nickel  
T =200µ" Tin/50µ" Nickel
- Custom option: G30=30µ" Gold/50µ" Nickel
- A, B, C, D - Dim. Tolerance: +/- .008"

MOLDED SOCKETS



McKenzie Socket Division

### PH2 .050" Series

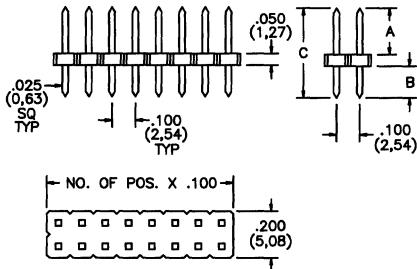

Dual row — 2-72 position

#### Technical Specifications

Temperature Range: -40°C to +150°C min. continuous

Max Load: 4 Amps

Insulator: Glass filled Nylon UL 94V-0

Contact Material: Phosphor Bronze, full hard

Contact Plating:

Standard

G=10µ" Gold over 50µ" Nickel, min.

T=200µ" Tin over 50µ" Nickel, min.

Custom Option

G30=30µ" Gold over 50µ" Nickel, min.



### .050" Series

- New .050" (1,27) insulator provides low above board profile
- Available in Tin or Gold plating
- Can be used in conjunction with our .177" (4,50) MicroShunts to achieve lowest profile (see pages J - J2)

A	B	C
MATING LENGTH	TAIL LENGTH	OVERALL LENGTH
.200	.135	.385
.200	.180	.430

### How To Order

PH2 050 - 200 / 135 - 36 G

Dual Row Style

Plastic Body Thickness

Mating Length (A dim.)

Tail Length (B dim.)

Total Pin Count

Plating

G - 10µ" Gold over 50µ" Nickel

T - 200µ" Tin over 50µ" Nickel

For MicroShunt information, see Section J. Consult the factory for other options

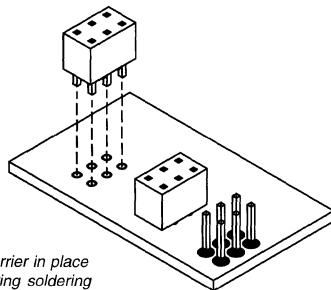

Carrier in place during soldering

After carrier removed

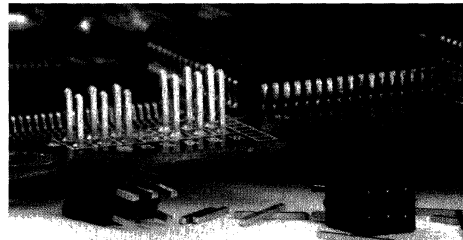

### Pin Header Carriers

- Single, dual, and three row versions
- Removable carrier provides lowest above board profile
- Carrier is removed after soldering
- Available in both .100" (2,54) and 2mm pitch
- Provides .020" (0,51) or .025" (0,64) square post without an insulator
- Available in Tin or Gold plating

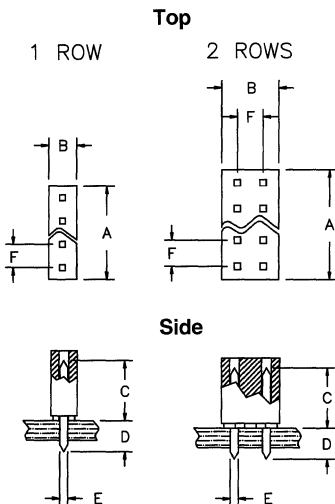

PART NUMBER*	NO. of ROWS	NO. of POSITIONS	A	B	C*	D*	E	F	OVERALL PIN LENGTH
PHC 1x12-190/120 G	1	12	.1195 (30,35)	.098 (2,49)	.190 (4,83)	.120 (3,05)	.025 sq. (0,64)	.100 (2,54)	.310 (7,87)
PHC 2x01-190/085 G	2	1	.095 (2,41)	.196 (4,98)	.190 (4,83)	.085 (2,16)	.025 sq. (0,64)	.100 (2,54)	.275 (6,99)
PHC 2x03-220/090 G	2	3	.295 (7,49)	.196 (4,98)	.220 (5,59)	.090 (2,29)	.025 sq. (0,64)	.100 (2,54)	.310 (7,87)
PHC 2x05-236/114 G	2	5	.495 (12,57)	.196 (4,98)	.236 (5,99)	.114 (2,90)	.025 sq. (0,64)	.100 (2,54)	.350 (8,89)
PHC M - 2x01-138/059 G	2	1	.068 (1,72)	.154 (3,91)	.138 (3,51)	.059 (1,50)	.020 sq. (0,51)	.079 (2,00)	.197 (5,00)
PHC M - 2x12-138/112 G	2	12	.937 (23,80)	.154 (3,91)	.138 (3,51)	.112 (2,85)	.020 sq. (0,51)	.079 (2,00)	.250 (6,35)

\* Available in different lengths and configurations, consult factory

**Screw Machine Contact**

**SH 17 Series**

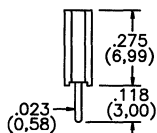
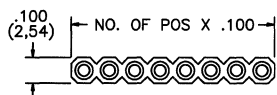

**Single row**  
1-36 position

**SH 27 Series**

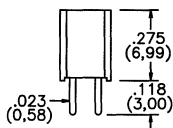
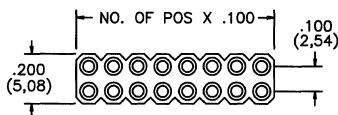

**Dual row**  
2-72 position

**SH 37 Series**

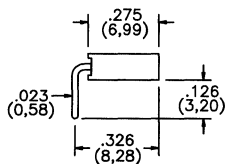
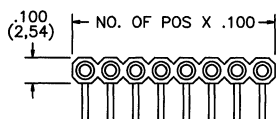

**Single row Right angle**  
1-36 position

**SH 47 Series**

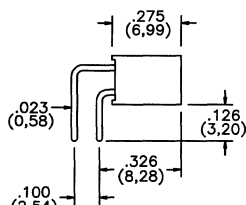
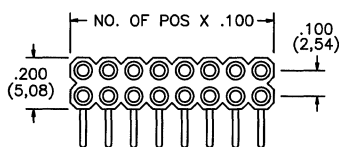

**Dual row Right angle**  
2-72 position

- Designed to mate with .025" (0,64) Square Post Headers (PH1 and PH2 Series on page I2 - I3)
- Screw machine inner contact provides optimal electrical and mechanical interconnection
- Available in single or dual row

**How To Order**

SH - 17 - 36 - ST GT

Product Code      Number of Positions      Gold Contact/Tin outer sleeve

17 - Single Row  
27 - Dual Row  
37 - Single Row Right Angle  
47 - Dual Row Right Angle

Solder Tail

**Material Specifications**

**Material:** Outer Shell - Brass,  
Inner Contact - 6 Fingers,  
Beryllium Copper  
**Plating:** Outer Shell - Tin over Nickel,  
Inner Contact - Gold over Nickel  
**Insulator:** UL 94V-0 Thermoplastic

**Technical Specifications**

Contact Resistance: 10 Milliohm  
Insulation Resistance: 10 Ohm, U=100  
Overload Voltage: 1500 Veff, 50Hz  
Max Current: 3A DC  
Temperature Range: -55 to +105°C  
Mech. Life Cycles: 200

**Design Your Own Custom .025 Square Post Receptacle**

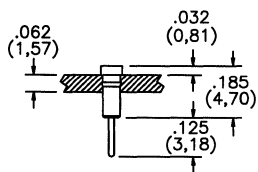

**424B**  
.125 solder tail

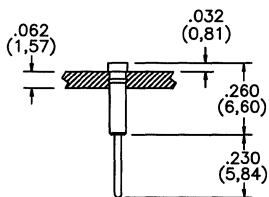

**435B**  
.230 solder tail

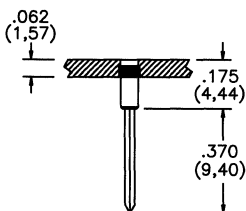

**445B**  
2 level Wire Wrap

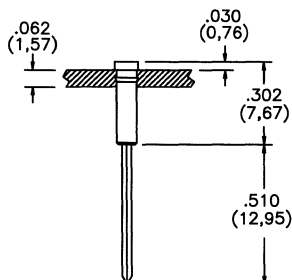

**455B**  
3 level Wire Wrap

- Available in solder tail or Wire Wrap
- Tin or Gold plating
- Hi-Temp insulator
- Available in PPC



AVAILABLE

**How To Order**

PPC SIP - 1 x 3 2 - 0 1 1 B - F

Option      Product Code      Number of Rows      Contact Style      Hi-Temp Material Call Out

Number of Contacts per Row

**Contact/Shell:**

Outer Shell-1/2 Hard Brass  
Inner Contact-Beryllium Copper

**Plating:**

Outer Shell-Tin over Nickel  
Inner Contact-Gold over Nickel

## ULTRA LOW PROFILE

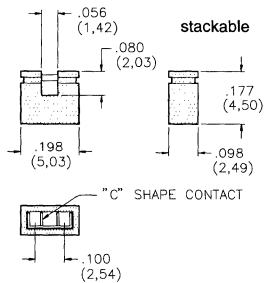

## VERY LOW PROFILE

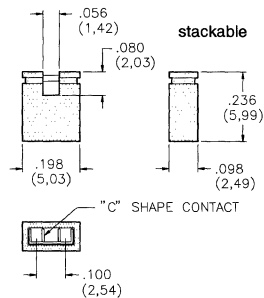

## LOW PROFILE

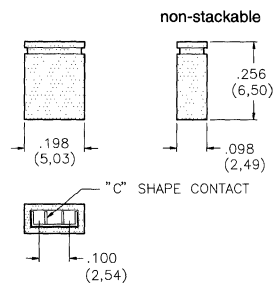

## FLEXIBLE HANDLE WITH TESTPOINT

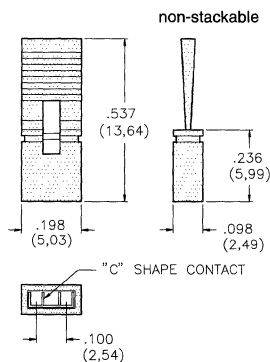

## Ultra Low Profile with testpoint .177" (4,5) high

PART NUMBER	PLATING	COLOR
MSB 1770-G-C-STP	GOLD	BLACK
MSB 1770-T-C-STP	TIN	BLACK
Red, yellow, blue or grey available on request		

## Very Low Profile with testpoint .236"(6,0) high

PART NUMBER	PLATING	COLOR
MSB 2360-G-C-STP	GOLD	BLACK
MSB 2360-T-C-STP	TIN	BLACK
MSB 2362-G-C-STP	GOLD	RED
MSB 2362-T-C-STP	TIN	RED
MSB 2364-G-C-STP	GOLD	YELLOW
MSB 2364-T-C-STP	TIN	YELLOW
MSB 2366-G-C-STP	GOLD	BLUE
MSB 2366-T-C-STP	TIN	BLUE
Grey available on request		

## Low Profile .256" (6,50) high

PART NUMBER	PLATING	COLOR
MSB 2560-G-C-C	GOLD	BLACK
MSB 2560-T-C-C	TIN	BLACK
MSB 2562-G-C-C	GOLD	RED
MSB 2562-T-C-C	TIN	RED
MSB 2564-G-C-C	GOLD	YELLOW
MSB 2564-T-C-C	TIN	YELLOW
MSB 2566-G-C-C	GOLD	BLUE
MSB 2566-T-C-C	TIN	BLUE
MSB 2568-G-C-C	GOLD	GREY
MSB 2568-T-C-C	TIN	GREY

## Flexible Handle with testpoint

PART NUMBER	PLATING	COLOR
MSB 5370-G-H	GOLD	BLACK
MSB 5370-T-H	TIN	BLACK
Red, yellow, blue or grey available on request		

### Technical Specifications

Temperature Range: -40°C to +140°C

Max Load: 3 Amps

Contact Resistance: Gold - Less than 10 milliohm  
Tin - Less than 20 milliohm

Mechanical Life: Gold - A minimum of 200 cycles  
Tin - A minimum of 40 cycles

### Material Specifications

Contact Material: Dual wipe phosphor bronze

Insulator: Glass Reinforced Thermoplastic

Plating: "G" 15µ" gold over 40µ" nickel  
"T" 100µ" tin over 40µ" nickel

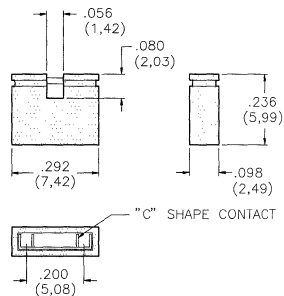

**.200" (5,08) Progression MicroShunt™ with testpoint**

PART NUMBER	PLATING	COLOR
MSB 2368-200-G-C-CTP	GOLD	GREY
MSB 2368-200-T-C-CTP	TIN	GREY

See material and technical specifications on page J

**2mm Shunts**

**Top View**

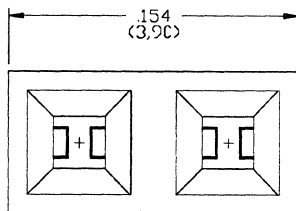

**Front View**

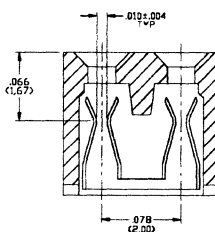

**Side View**

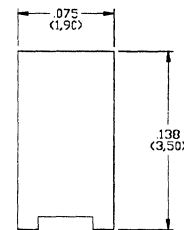

**MSB M - 3,50 - G - STP**

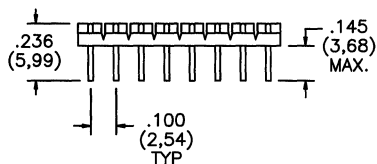
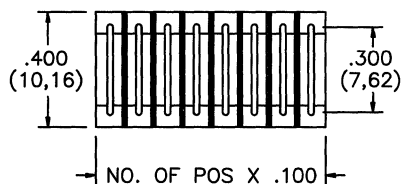

**Insulator:**  
Glass Reinforced Thermoplastic,  
UL 94V-0 Rated

**Contact:**  
Phosphor Bronze  
.018-.020 TYP Diameter

**Plating:**  
10µ" Gold over 50µ" Nickel

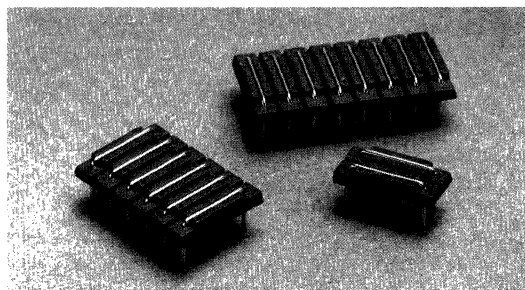

**Programmable Jumper Plugs**

- Available in multiple units of 1 through 8
- .300" (7,62) centers
- Custom configurations available with shorting jumpers installed to customer specifications

**How To Order**

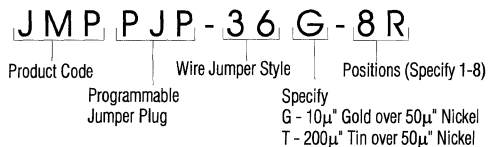

## Insulated and Bare Wire Jumpers

- Available bare or with your choice of two insulation materials
- PVC Insulator suitable for jumpering socket terminals
- Teflon insulation for direct soldering to PCB or other Hi-Temp applications
- Custom configurations and wire gauges available – consult factory

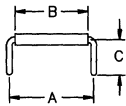
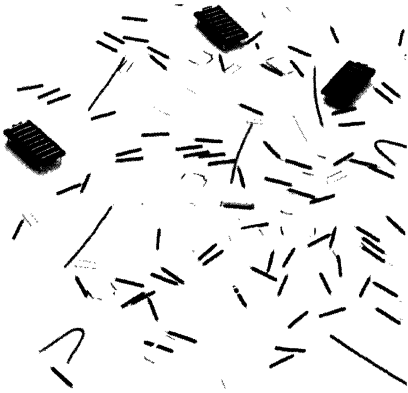

### Material:

24 Gauge AWG. solid Copper wire  
Tin plated per MIL-QQW-343

### Insulator:

Low Temp - PVC per UL1061  
MIL W 16878, TYPE B  
Hi-Temp - Dupont Teflon  
TPFE (TEF)

### BRASS

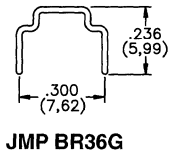
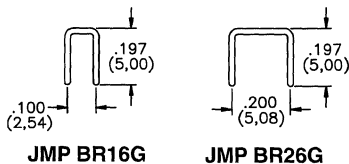

### PHOSPHOR BRONZE

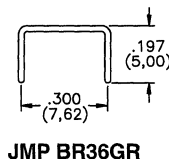

PART NUMBER*	A	B	C
JMP .100 x .125-XXX-24	.100 (2,54)	.085 (2,16)	.125 (3,18)
JMP .100 x .175-XXX-24			.175 (4,45)
JMP .100 x .250-XXX-24			.250 (6,35)
JMP .200 x .125-XXX-24	.200 (5,08)	.175 (4,45)	.125 (3,18)
JMP .200 x .175-XXX-24			.175 (4,45)
JMP .200 x .250-XXX-24			.250 (6,35)
JMP .300 x .125-XXX-24	.300 (7,62)	.275 (6,99)	.125 (3,18)
JMP .300 x .175-XXX-24			.175 (4,45)
JMP .300 x .250-XXX-24			.250 (6,35)
JMP .400 x .125-XXX-24	.400 (10,16)	.375 (9,53)	.125 (3,18)
JMP .400 x .175-XXX-24			.175 (4,45)
JMP .400 x .250-XXX-24			.250 (6,35)
JMP .500 x .125-XXX-24	.500 (12,70)	.475 (12,07)	.125 (3,18)
JMP .500 x .175-XXX-24			.175 (4,45)
JMP .500 x .250-XXX-24			.250 (6,35)
JMP .600 x .125-XXX-24	.600 (15,24)	.575 (14,61)	.125 (3,18)
JMP .600 x .175-XXX-24			.175 (4,45)
JMP .600 x .250-XXX-24			.250 (6,35)

\*To order fill in XXX with: PVC for PVC insulation  
TEF for Teflon insulation  
BAR for Bare (no insulation)

## Uninsulated Wire Jumpers

- Gold plated
- Suitable for jumpering socket terminals
- Inexpensive switching and programming changes
- Lead diameter .020" (0,51)

PART NUMBER	MATERIAL	PLATING
JMP BR16G	BRASS	10µ"GOLD OVER 50µ" NICKEL
JMP BR26G	BRASS	10µ"GOLD OVER 50µ" NICKEL
JMP BR36G	BRASS	10µ"GOLD OVER 50µ" NICKEL



**Immediate  
Availability**

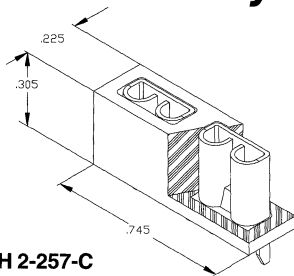

**FSH 2-257-C**

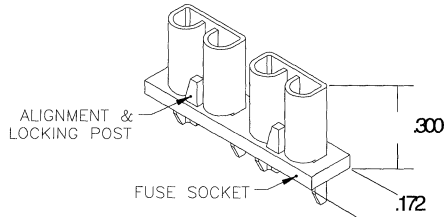

**FSH 2-257**

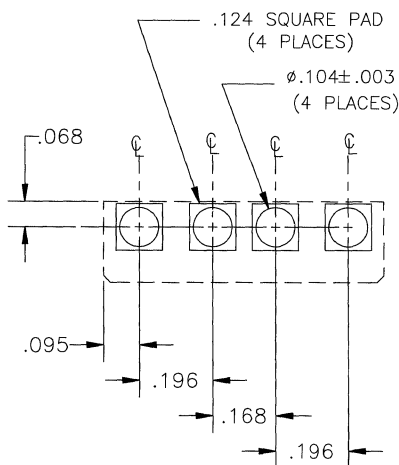

**Suggested footprint for PCB layout**



**AVAILABLE**

**Technical Specifications:**

**Operating Temperature:** 0° C to 100° C  
**Contact Current Rating:** 15 AMP Max.

*Recommended for Wave Soldering Applications*  
(260° C @ 5 seconds max.)

**Material Specifications:**

**Insulator**  
Hi-Temp, Glass Reinforced Thermoplastic,  
UL 94V-0 rated

**Withstanding Voltage:** 500 VAC Min.

**Insulation Resistance:**  
1000 Megohms Min. @ 500 VAC

**Contacts:**

**Contact Material:** Brass alloy, Tin Plated

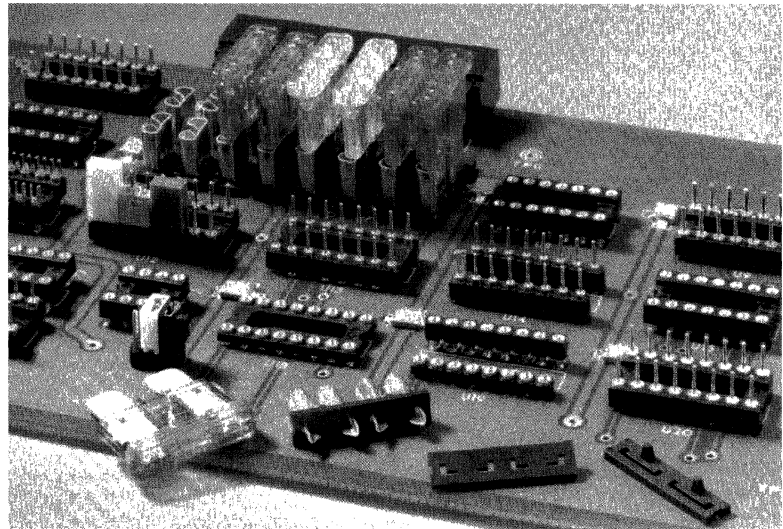

**PART NUMBER: FSH 2-257 (SHROUDED: FSH 2-257-C)**

**Features**

- Compatible with commonly used Littelfuse Series 257 fast-acting, blade type ATO auto fuses
- Solder tails for PCB board mounting
- Unique locking post provides positive contact alignment
- Hi-Temp insulator for wave soldering
- Design prevents solder-wicking into the spring clip area and contamination during wash
- Contacts are rated to 15A
- Shrouded version insures contact isolation
- .020 stand offs aid post solder wash process

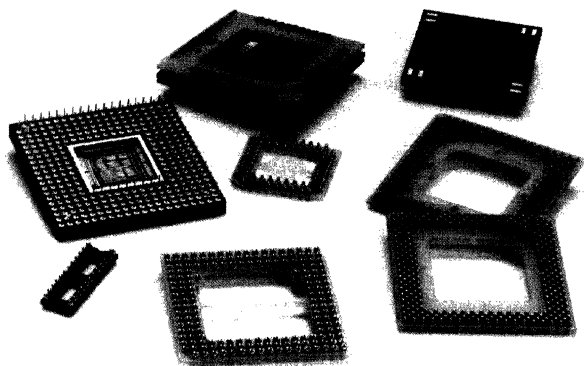

SMT sockets

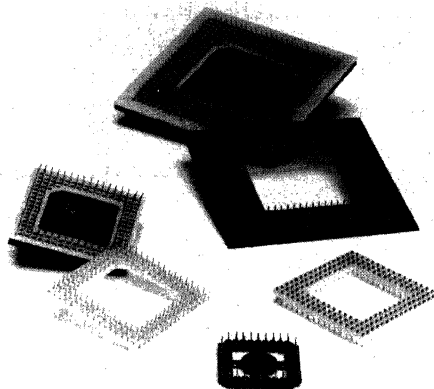

SMT headers

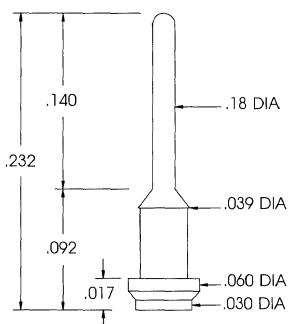

Specify Contact/Shell  
976P 10μ" Gold/PHSBRNZ

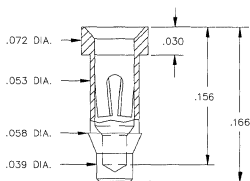
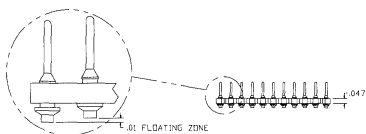

Specify Contact/Shell  
622C 30μ" Gold/Tin  
623C Tin/Tin

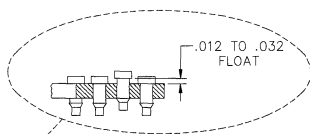

### Features

- Available in either DIP or PGA configurations
- Contacts float on the Z-axis to insure perfect coplanarity
- Socket profile = .166 above PCB
- Header profile = .232 above PCB with bottom of mated connector at .140 above PCB.
- Pick and Place Tabs for Automatic Assembly Equipment.
- Hi-Temp PPS insulators compatible with all SMT processes.
- Specially designed contact insures a high strength, high reliability solder joint every time
- Recommended PCB pad size: .050" round

### How to Order

PGA 132H 622C1-1414

Pin Grid Array

See F section for further information

Contact  
623C  
976P

See F section for pattern options

FR4 Material

DSM 320-622C

DIP Surface Mount

See page B4 for options

Contact  
623C  
976P

FR4 Material

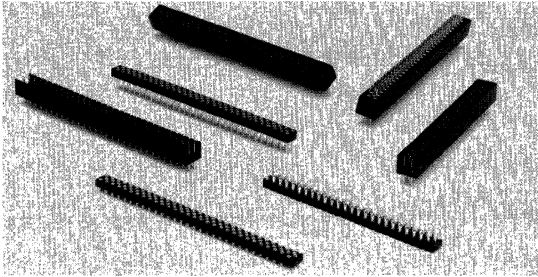

**Features**

- High density, two piece connector system
- Interstitial array provides a 50% increase in density over that of conventional .100" x .100" connector systems
- Mated connector pair provides .295" (7,49) or .433" (11,00) spacing between boards
- Utilizes multi-finger screw machine contacts for high reliability and low insertion forces

**FEMALE**

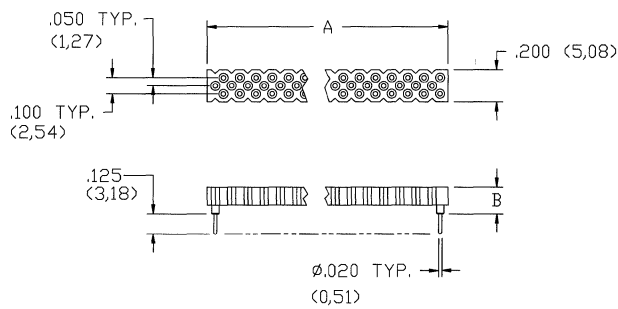

**MALE**

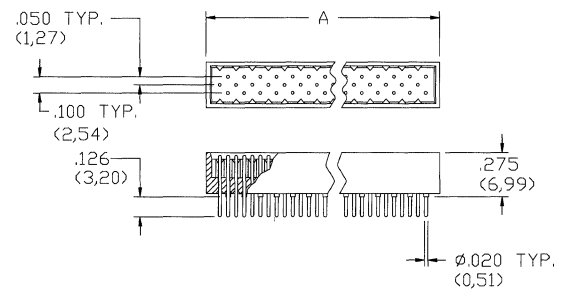

**How To Order (Female)**

PART NUMBER	NO. OF POS.	A	B
ZIP X 50/100 - 3 x 30 - 320B- R	90	3.050 (77,47)	.165 (4,19)
ZIP X 50/100 - 3 x 30 - 321B- R	90	3.050 (77,47)	.314 (7,98)

**How To Order (Male)**

PART NUMBER	NO. OF POS.	A
ZIP X 50/100 - 3 x 25 - P382G50- R	75	2.550 (64,77)
ZIP X 50/100 - 3 x 30 - P382G50- R	90	3.144 (79,86)

**INSULATORS**

UL*	CONTINUOUS USE** TEMPERATURE	HEAT DEFLECTION** TEMPERATURE (@264 psi)
-----	---------------------------------	--

**Hi-Temp - Vapor Phase and IR Compatible**

Polyimide Laminate (H), Glass Reinforced	94V-0	250°C	270°C
Fortron (PPS), (R), 40% Glass Reinforced	94V-0	220°C	260°C
Tefzel HT2004 (EPTFE),			
4% Glass Reinforced	94V-0		
8% Glass Reinforced	94V-0		
25% Glass Reinforced	94V-0	200°C	210°C
Vectra, C130 (LCP), (V)	94V-0	200°C	243°C
FR-4 Glass Epoxy (F)	94V-0	140°C	149°C

**Standard Temp-Wave Solder Compatible**

Tefzel 280 (ETFE)	94V-0	150°C	74°C
Valox Polyester (420-SE0) (PBT)			
30% Fiberglass	94V-0	140°C	204°C
Zytel FR50, 25% Glass Reinforced Nylon	94V-0	130°C	240°C

\*UL Flammability rating

\*\* Typical value as defined by raw material supplier.

**OUTER SHELL AND TERMINAL MATERIALS – Screw Machine Sockets**

Brass - Alloy 360, 1/2 hard, per QQ-B-626

Phosphor Bronze - Alloy 544 (B2), hard, per QQ-B-750, Comp. B

**INNER CONTACT MATERIALS – Screw Machine Sockets**

Beryllium Copper (BeCu) - Alloy 172, heat treated, per QQ-C-533

Beryllium Nickel (BeNi) - Alloy 440, heat treated

**OUTER SHELL AND TERMINAL PLATINGS – Screw Machine Sockets**

200µ" (nominal) BRIGHT ACID TIN per MIL-T-10727, Type 1 over 100µ" (nominal) Nickel per QQ-N-290  
 10µ" (nominal) GOLD per MIL-G-45204, Type 1 GRADE C, over 100µ" (nominal) Nickel per QQ-N-290  
 50µ" (nominal) GOLD per MIL-G-45204, Type 1 GRADE C, over 100µ" (nominal) Nickel per QQ-N-290  
 200µ" (nominal) TIN/LEAD (93%/7%) per MIL-P-81728, Type 1 over 100µ" (nominal) Nickel per QQ-N-290

**INNER CONTACT PLATINGS – Screw Machine Sockets**

10µ" (nominal) GOLD per MIL-G-45204, Type 1, GRADE C, over 50µ" (nominal) Nickel per QQ-N-290  
 30µ" (nominal) GOLD per MIL-G-45204, Type 1, GRADE C, over 50µ" (nominal) Nickel per QQ-N-290  
 50µ" (nominal) GOLD per MIL-G-45204, Type 1, GRADE C, over 50µ" (nominal) Nickel per QQ-N-290



All McKenzie  
Molded Insulators



**PERFORMANCE CHARACTERISTICS\* — Screw Machine Sockets**

Parameter	Value
Contact Resistance	<10 milliohms per contact
Contact Capacitance	0.3 pF
Contact Current Rating (for 10°C temperature rise)	3 A except for #6 (10) which is 2 A
Insulation Resistance (@ 500 V DC)	10,000 megaohms (min)
Contact Operating Temperature Range	-55°C to +150°C (BeCu) -55°C to +225°C (BeNi)
Dielectric Withstanding Voltage	1000 VAC
Rated Voltage	100 V AC
Durability	1000 cycles (min) @10 milliohms maximum change
Inner Contact Retention in Shell	7.5 lbs (3360 grams) minimum
Shell Retention force in Insulator (PGA's/DIP's)	10lbs (4480 grams) minimum

**TEST CONDITIONS**

Test	Results
Thermal Shock (IEC-68-2-14)	<2 milliohms change in contact resistance after 4 cycles (-10°C to +85°C)
Vibration (MIL-S-83505)	No electrical discontinuities or mechanical damage (10-2000Hz, 20G's, 1hr)
Solderability	Conforms to MIL-STD-202, Method 208
Shock (MIL-STD-202)	No discontinuities or mechanical damage (10 cycles of 200G's)
Temperature/Humidity Cycling (MIL-STD-1344)	<2 milliohms increase in contact resistance after 21 days, 40°C, 93% RH
Salt Spray (MIL-7344A)	<2 milliohms increase in contact resistance after 48 hrs, 35°C, 5% NaCl

\*Unless otherwise stated

**SPECIFICATIONS**

When applicable, McKenzie Technology's products and procedures are designed to meet the following general specifications:

<b>MIL-STD 105</b>	Sampling procedures
<b>MIL-STD 109</b>	Quality assurance terms and definitions
<b>MIL-STD 202</b>	Test methods for electronic and electrical components part
<b>MIL-STD 1130</b>	Connections, electrical, solderless, wrapped
<b>MIL-STD 1344</b>	Test methods for electrical connectors
<b>MIL-STD 45662</b>	Calibration system requirements
<b>MIL-I-45208A</b>	Inspection system requirements
<b>MIL-C-39029</b>	General specification for contacts, electrical connectors
<b>MIL-S-83505</b>	General specification for sockets (lead, electronic components)
<b>ASTM-B487-79</b>	Measuring metal/oxide coating thickness by microscopical examination of a cross section
<b>ASTM-B567</b>	Standard method of test for coating thickness by the Beta Backscatter principle
<b>ASTM-A754-79</b>	Standard method of test for coating thickness by X-ray florescence
<b>MIL-M-24519</b>	Molding plastics, electrical, thermoplastic
<b>MIL-S-83734</b>	Sockets, plug in electronic components, DIP, SIP, general specification for
<b>MIL-P-13949</b>	Plastic sheet, laminated, metal clad, general specification for

### INNER CONTACT TEST DATA

KEY:

- ① INITIAL INSERTION FORCE
- ② INSERTION FORCE ON 2nd CYCLE
- ③ WITHDRAWAL FORCE

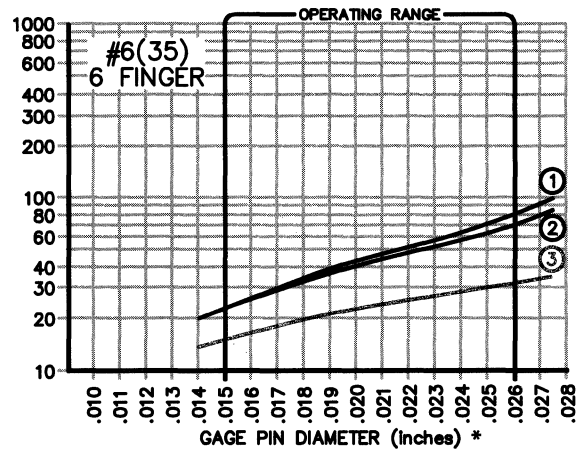
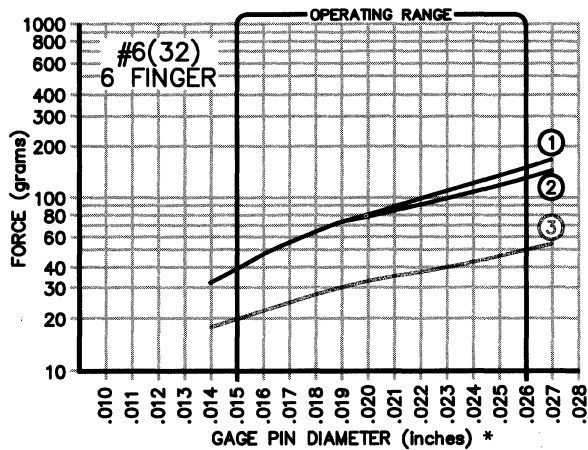
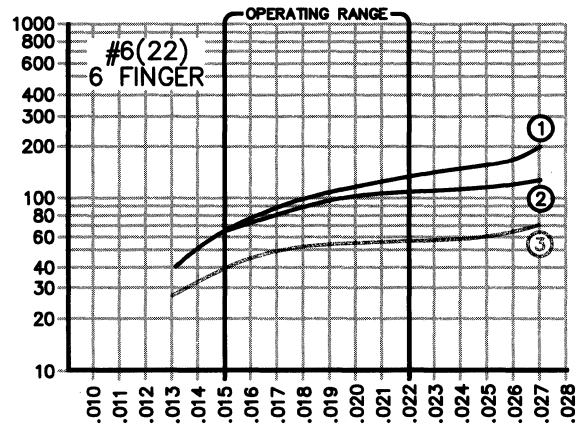
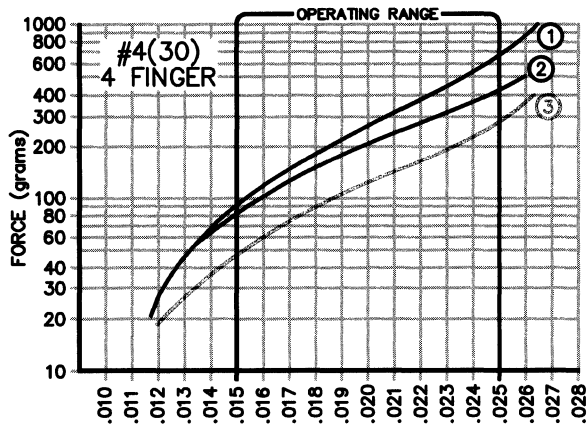
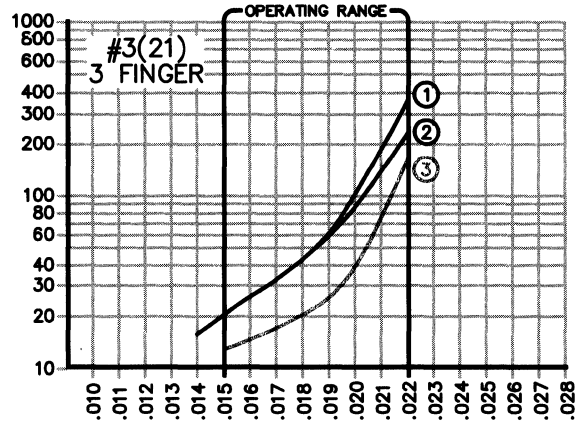
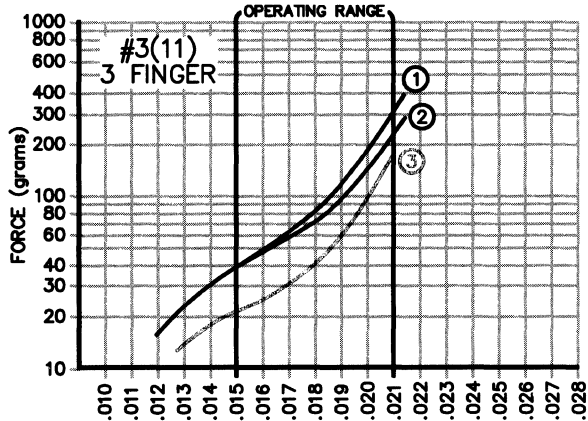

Note: All curves shown represent the average of 5 contacts tested with each size gage pin

\* Polished steel gage pin, round with bullet tip

## OUR COMMITMENT TO QUALITY

**M**CKENZIE TECHNOLOGY, is an ISO 9001 registered company (certificate number 041003243) and as such, is committed to continuous improvement in all our business processes, with the ultimate goal to deliver zero defect electronic interconnection products to our customers worldwide.

### DESIGN

Quality is emphasized at every step of the engineering design process. We employ the latest in Computer Aided Design integrated directly into our in-house CNC (Computer Numerical Control) tooling and mold making equipment. Customer requirements are captured on detailed design drawings which are translated directly to working machine programs. This ensures accuracy and quality of our molded parts and tooling.

### PURCHASING

It is our intent to purchase high quality materials delivered on time while not encumbering our vendors with excessive requirements. Our vendor qualification is a three step process. At a minimum, compliance to delivery, an on site survey and minimum process capability (Cpk) of 1.33 is required with a plan to continuously improve the process.

### MANUFACTURING QUALITY

We believe quality is a process and a philosophy and can not be inspected into the product. Extensive in-house training, certification, process controls and statistical techniques are utilized to continuously monitor and improve quality. Action oriented quality meetings chaired by operators insure involvement and focus at all levels. Quality performance is also used as a critical review criteria for all operations people.

As part of our ongoing SPC implementation, all new process equipment is SPC capable. We have recently added on-board SPC with closed-loop process control to our injection molding operation.

### INSPECTION

McKenzie Technology's Inspection System is designed to be compliant with MIL-I-45208. Both Incoming and Final Quality Control conform to MIL-STD-105E for attributes and MIL-STD-414 for variables. Test sampling is accomplished with sampling plans based on an AQL (Acceptable Quality Level) which supplies the sensitivity for Assurance of Quality. Additional sampling and testing are done as required by Mil Specification, product experience, process capability, or customer requirements. All quality measurement and test equipment is calibrated in accordance with MIL-STD-45662. Every inspection activity addresses feedback and root cause correction in order to satisfy Quality Assurance goals of error prevention.

### TRACKING AND ORDER PROCESSING

Tracking of all orders and data is accomplished via an on-line integrated MRP system. Our on-time shipment performance is treated as quality performance and thus tracked and slated for continuous improvement.

*Consistent with our effort to continuously improve our process and service, we would welcome comments and suggestions from our customers and vendors.*

John V. Anderson



Director of Quality Assurance



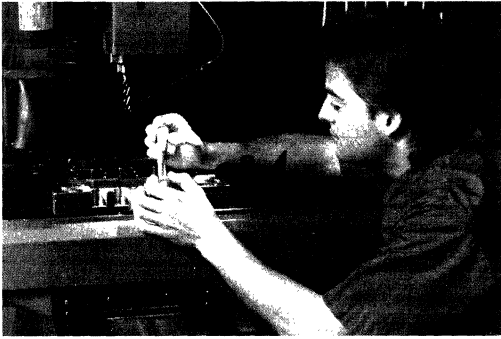

**M**CKENZIE TECHNOLOGY is a dynamic manufacturer of sockets for integrated circuits (IC's) and related board-to-board interconnect systems. An early pioneer of the molded pin grid array (PGA) socket, McKenzie continues to dominate the high density IC socket market.

Founded in 1980 on the principals of service and engineered solutions, McKenzie Technology has established itself with customers throughout the world as a leading source for high quality, competitively priced product.

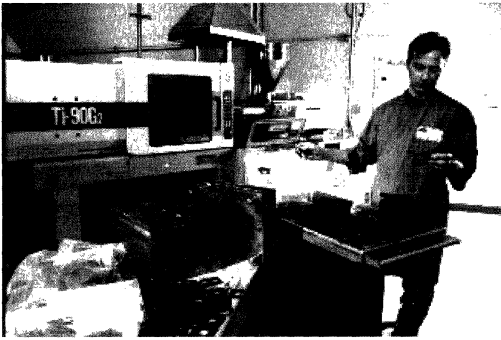

*The keys to our success:*

- Our extensive in-house tool making facility in which all molds, loading and test fixtures are built and maintained.
- On-site injection molding operation.
- A total commitment to quality is evident everywhere in our manufacturing process — from integral inspection stations in the process flow, to statistical process control in both our molding and assembly departments.
- The sample department is independent of the main production area and is committed to turning your sample and small quantity orders around in 48 hours.
- As we continue to experience tremendous growth, an ongoing efficiency improvement program has kept our lead times on catalog product at two weeks or less!
- McKenzie's focus on engineering with a large staff of talented engineers accessible to our customers means ready support of existing product, quick design of customer specific product, and the development of interconnect solutions today for tomorrow's IC packages.

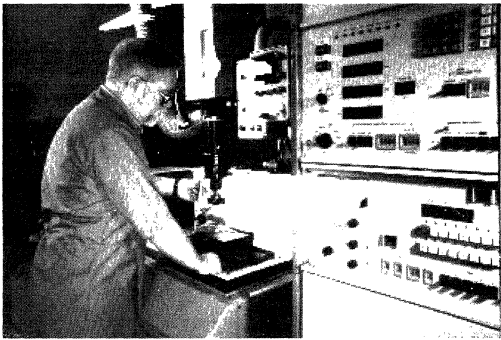

*Put us to the test, you won't be disappointed!*





Product Code	Catalog Page	Product Code	Catalog Page
ADP	H	PH3	I
ADP DIP	B20	PH4	I
ASM	H8	PHC	I2
CONTACT SPECS	A1	PHS	I1
CPP	B18	PLC	G + G2
CROSS REFERENCE	F7	PPC 2 SIP	B21
DCO	B19	PPC DIP	B3
DDP	B16	PPC PGA	F
DHS	B14	PPC SIP	C2
DIP	B2	PZA	F45
DIP 050	B3	SAF	D
DIP 70	B15	SCR	A SECTION
DPF	E1	SH-17	I3
DPG	B10	SH-27	I3
DPK	B10	SH-37	I3
DPL	B10	SH-47	I3
DQD	B17	SHS	C7
DQDQ	B19	SIP	C-C1
DRA	B18	SIP 050	C2
DSM	K1	SOCKET 5 & 7	F43
DST	B12	SOJ	G3
DVD	B22	SPF	E-E1
DWW	B7	SPG	C4
DXC	B8	SPK	C4
FSH	K	SPL	C4
JMP	J2-J3	SST	C6-C7
LCS (SEE SAF)	**	SST 050	C6
MPC	B17	SUB	K2
MSB	J1-J2	TOL PGA IN	F5
MSBM	J2	TOL PGA X	F5-F6
P6	F44	TOL PLCC	G2
PGA	F	TPC	D1
PGA SMT	K1	ZGA	F11
PH1	I	ZIF	F43
PH2	I	ZIP	E2-E3
PH2 050	I2	ZIP X50	K2

**World Headquarters • 101 South Hanley Road • St. Louis, MO 63105**

FOR MORE DETAILED PRODUCT INFORMATION, OR FOR THE LOCATION NEAREST YOU,  
CONTACT ONE OF THE REGIONAL HEADQUARTERS LISTED BELOW.

**AMERICAS REGION**

BERG Electronics, Inc.  
150 Corporate Center Drive #201  
Camp Hill, PA 17011 USA  
TEL: 1-800-237-2374  
FAX: 1-717-938-7604

**EUROPEAN REGION**

BERG Electronics, Inc.  
Helftheuvelweg 11  
P.O. Box 2060  
5202 CB's-Hertogenbosch  
The Netherlands  
TEL: +31 73 206 911  
FAX: +31 73 214 205

**ASIA / PACIFIC REGION**

BERG Electronics, Inc.  
391B Orchard Road  
#18-00 Ngee Ann City  
Singapore 0923  
TEL: 65-738-8277  
FAX: 65-738-4122

## BERG'S LOCATIONS

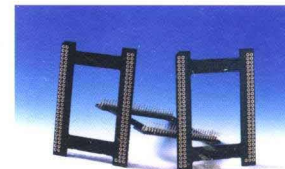
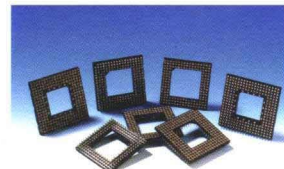
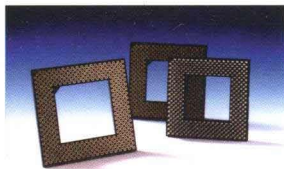
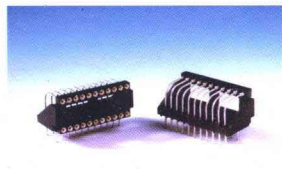
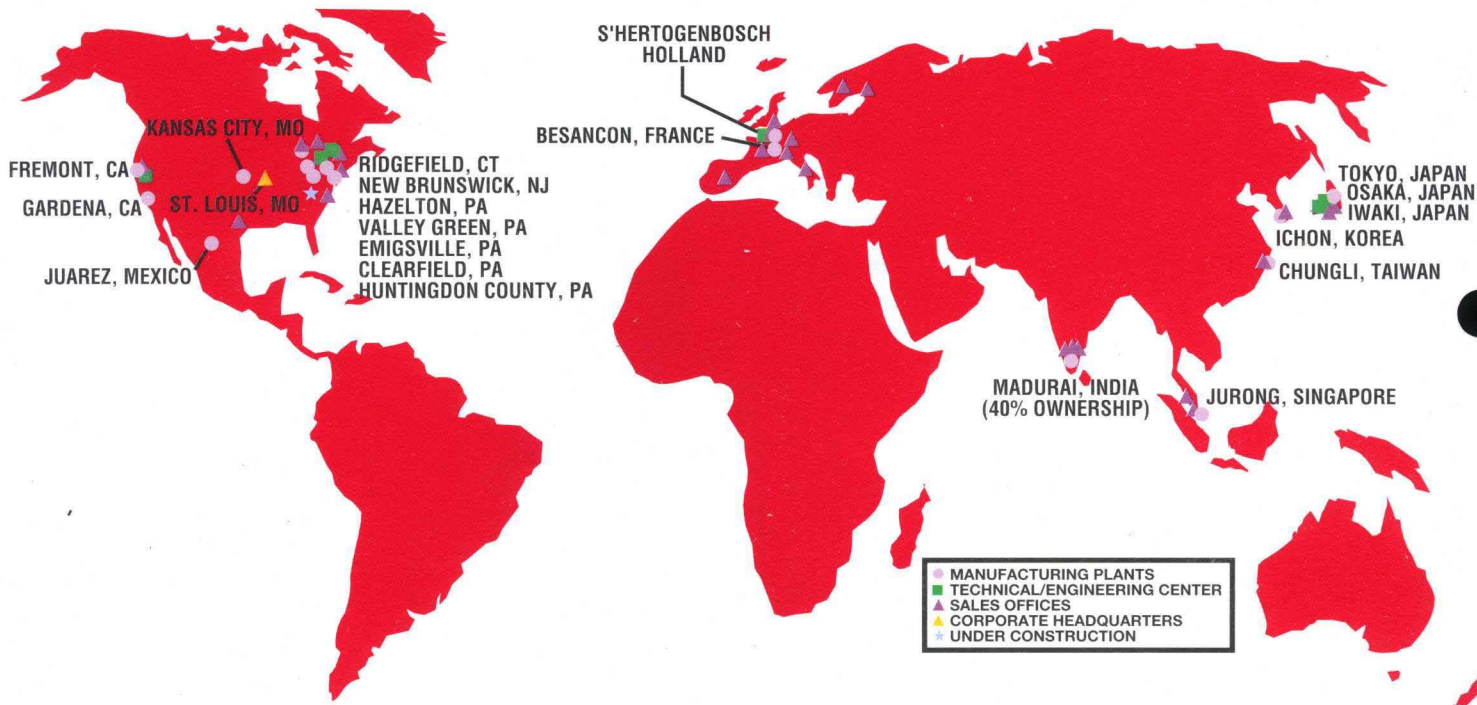

# BERG

ELECTRONICS

**McK McKenzie Socket Division**

McKenzie Headquarters • 910 Page Avenue • Fremont, California 94538 USA  
Phone: (510) 651-2700 Fax: (510) 651-1020