

Emergency Stops

A guide to ABB's Emergency Stop Devices



1. Introduction.....	3
Objectives.....	3
Using this guide.....	3
2. Basic Training.....	4
Product definition.....	4
Terminology.....	4
Applicable industries & markets.....	4
Product description.....	5
Color coding & marking standards.....	5
3. Requirements & Specifications.....	6
Standards.....	6
I. General standards.....	6
ISO 13850.....	6
EN418.....	6
II. Design, function, & testing.....	7
IEC 60947-1.....	7
IEC 60947-5-1.....	7
IEC 60947-5-5.....	7
UL50 (NEMA Ratings).....	8
UL746C.....	9
III. Installation.....	9
IEC 60204-1.....	9
4. ABB's Product Scope.....	10
Introduction.....	10
Modular range.....	10
Compact range.....	12
Assembled stations & enclosures.....	14
A complete range of pilot devices.....	15
5. Tools and Resources.....	16
Catalogs.....	16
Sales literature.....	16
6. Quiz.....	18
Appendix.....	19
Modular technical sheets.....	19
Compact technical sheets.....	21
Dimensions.....	22
NEMA rating definitions.....	23

Section 1 - Introduction

Objectives

The purpose of this guide is to reinforce the basic aspects of ABB's Emergency Stop product offering. This includes the following:

- Understand fundamental Emergency Stop terminology
- Awareness of certifications and regulations for Emergency Stops
- Understand the two product ranges offered by ABB and when to use which range.
- Make educated sales recommendations
- Learn where to find Emergency Stop and other pilot device tools and resources available from ABB

Using this guide

This guide has been designed to give a thorough overview of Emergency Stop devices, both as a general industrial product, and also as a quality ABB offering.

If you are new to the industry, please begin with Section 2, which is a basic training on Emergency Stop devices.

If you have experience with these products, you may skip to Section 3, which begins the description of many of the requirements that our product must meet in order to officially qualify as Emergency Stop Devices.



Section 2 – Basic Training

Product definition

An Emergency Stop is defined as a *fail-safe control switch or circuit that, when de-energized, will stop the operation of associated equipment and will shut off all potential hazards outside the main power enclosure.*

Emergency Stops, or “E-Stops”, are a special type of pilot device that perform the emergency shutdown operation on a machine or electrical system. E-stops are different from a typical “OFF” button in that they must pass a rigorous line of testing and meet a long list of specifications. Many of these specifications will be described later in this manual.

Terminology

Knowledge of some basic pilot device terminology will help you gain a better understanding of Emergency Stop devices:

Contact	The conducting part of a switch that makes or breaks a circuit. Available as “normally open” (NO), in which the circuit is open in its neutral state, or “normally closed” (NC), in which the circuit will be closed. Activation of the operator will reverse the neutral state of the contact.
Contact block	The part of a pilot device that encapsulates the contact. Blocks are held to the back of a device with a contact block holder.
Operator/Actuator	The part of the device that is touched to operate, i.e., the pushbutton head.

Applicable industries & markets

Emergency Stop devices can be found in *any* industry—and we really mean *anywhere*: industrial manufacturing, commercial industries, and even public facilities. They are not only important to the safety of the machinery and people in an industrial environment, but they are also quite often *required* to be present, usually within the line of sight of workers. Furthermore, several E-stops may be necessary to control a single machine, as they are commonly required to be mounted as frequently as every 6 feet along a production line!





Some of many industries with Emergency Stop needs:

- Material handling – packaging, moving,
- Oil & gas mining/extracting, refining, processing
- Food & beverage packaging, distribution
- HVAC(R)
- Water/waste water
- Manufacturing – automotive/heavy equipment, marine/aviation, glass & plastics
- Metals – mining, refining, processing, forming
- Commercial applications
- Amusement park rides
- And many, many more!



Product description

Emergency Stops are available in many shapes and sizes based on their functionality and application. Both IEC and NEMA standards dictate some of the requirements for Emergency Stops. In addition, many markets and industries have their own industry-accepted specifications, which may call for more specific requirements to be met. For example, the Semiconductor Manufacturing Industry requires that Emergency Stop buttons be “mushroom” shaped.

Some basic products and their applications are listed below:

	Emergency Stop – The red button that a human operator can activate to de-energize a control circuit.
	Shroud or Guard – A collar that surrounds a pilot device, to prevent inadvertent activation.
	Enclosure – A protective box (plastic or metal) that encloses the contacts of a control switch. E-stop enclosures are usually yellow to indicate their “emergency” importance. These are rated according to the amount of protection they provide (dust, water, oil, etc.)
	E-Stop Station – An enclosure assembly including the E-Stop button, which can be mounted onto any surface where an emergency off switch should be located.

The three most common types of Emergency Stops are:

	Push-pull – the operator is pushed in and locks into stop; released by pulling back. Indicated by the circle symbol on the head.
	Twist-release – the operator is pushed in and locks into stop, released by twisting. Indicated by the circular arrows on the head.
	Key-release - the operator is pushed in and locks into position to stop; released only with a key.

Color coding

Most standards and specifications require that a true Emergency Stop be a **red** button. In addition, it is often required that the button be located on a **yellow** background. These colors indicate that the device is an emergency control.

Section 3 – Requirements & Specifications

Standards

ABB's E-Stop products are tested and approved according to:

- **IEC:** IEC 60947-5-1 and 60947-5-5
- **EN:** EN 50013, 418, 60947-1, 60947-5-1
- **UL:** UL 508 (File# E76003)
- **CSA:** C22.2 No. 14
- **CCC**
- **cULus**
- **Marine Classifications:** GOST, DNV, GL, RMRS, RRR



Certificates for major approvals are available online. Please visit our website at www.abb.com, and navigate to the Pilot Devices page (*further instructions can be found in Section 5 of this manual*); or contact U.S. Technical Support at **(888) 385-1221**.

An overview of the standards applicable to Emergency Stops:

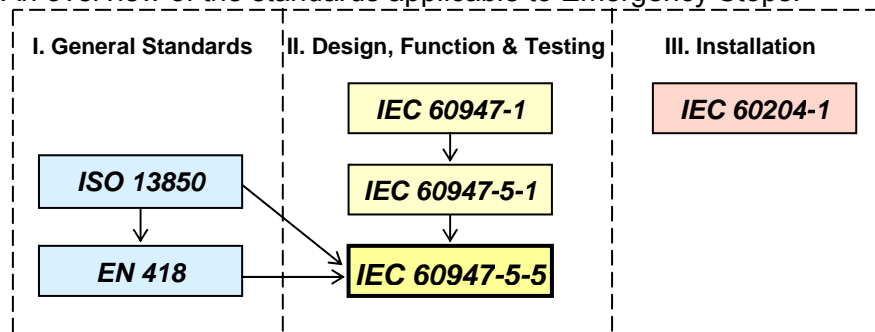

I. General Standards ISO 13850 / 4.4.4

Gives requirements for the emergency stop function of a machine, whatever the energy used may be:

- Once the emergency stop command has been generated during actuation of the Emergency Stop device, the command shall be maintained by latching means. The emergency stop command shall be maintained until the device is reset (disengaged). It shall not be possible for the device to engage without generating the stop command. *[paraphrased]*
- In case of a failure in the emergency stop device (including the engagement means), generation of the stop command shall have priority over the engagement means. *[paraphrased]*

EN418 / 4.1.11

Gives requirements for the emergency stop function of a machine (EN418 / 4.1.11 corresponds to ISO 13850 / 4.4.4).

In addition to the ISO 13850 requirements above, EN418 more specifically states:

- Any action on the device which results in generating the emergency stop command shall also result in the latching-in of the device so that when the action on the device is discontinued, the emergency stop command continues to be maintained until the control device is reset (unlatched). *[paraphrased]*

II. Design, function & testing

IEC 60947-1 Low Voltage Switchgear and Control Gear: General Rules

This is the general standard giving requirements for all low voltage control gear. Requirements specific to E-stops are found a few sections later in the IEC 60947 document.



IEC 60947-5-1 Control-Circuit Devices and Switching Elements, Electromechanical Control Circuit Devices



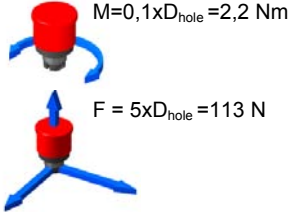

This specifies the electrical characteristics of electromechanical control circuit devices.

IEC60947-5-5 Control-Circuit Devices and Switching Elements, Electrical Emergency Stop Device with Mechanical Latching Function

The present IEC 60947-5-5 deals specifically with Emergency Stop devices with a mechanical latching function and gives electrical and mechanical requirements in addition to those given in previously described International Standards (ISO 13850, IEC 60204-1, IEC 60947-5-1):

- “The Emergency Stop function is intended to be initiated by a single human action.”
- Other testing requirements specified by IEC 60947-5-5 include:

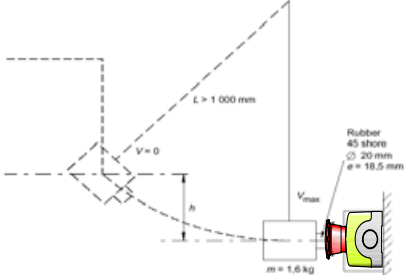
1. Operating durability test	
6050 operations to test the durability of latching parts. This is not a test of mechanical life, which is 100,000 operations.	
2. Robustness	
A force of 113N is applied in three axes.	
	
3. Conditioning	
Verifying function after exposure to:	
<ul style="list-style-type: none"> • 96 hours of 70°C hot, dry atmosphere • 96 hours of changing moist and warm atmosphere (25°C/55°C, 97%/93% RH) • 96 hours of -40°C cold atmosphere • 96 hours of 35°C in a solution of 5% NaCl, saltwater 	
4. Shock test	
Acceleration 15g $\approx 150\text{m/s}^2$ over 11ms During the test, the closed contacts shall not open, the open contacts shall not close, and the latching mechanism shall not latch/unlatch. The checking means shall be able to detect any opening or closing of contacts longer than 0.2ms.	
	

<p>5. Vibration test</p> <p>Frequency: 10-500Hz Duration: 2 hours Max accel: 50m/s² Amplitude: 0.35mm</p>	
<p>6. Latching – contact opening test</p> <p>The actuator of the emergency stop device shall be moved slowly just to the point where latching occurs. The normally closed contacts shall then be opened, verified by an impulse voltage test at 2,500 V.</p>	
<p>7. Latching – forceful closing test</p> <p>To simulate a normal human action, the emergency stop is mounted in front of a 1.6 kg hammer. After the strike, the latching mechanism shall be latched. (h=75mm)</p>	
<p>8. Resetting test</p> <p>Pulling force shall be less than 50N. Torque shall be less than 1Nm.</p>	
<p>9. Impact test</p> <p>Three strikes with the 1.6kg hammer (see #7). After each strike, the emergency stop shall be latched. After three strikes, the actuator shall not be damaged. (h=310mm)</p>	
<p>10. Function test</p> <p>Utilization categories <u>AC-15</u> and <u>DC-13/DC-14</u>, including positive opening NC contacts.</p>	

UL 50 Enclosures for Electrical Equipment

This specifies environmental protection ratings based on NEMA Type codes. ABB's products are approved up to Type 4X.

UL Types 1, 3R, 12, 13, 4, 4X



A full description of each of the NEMA Type ratings can be found in the Appendix.

NEMA 4X: protection against water and corrosion. Tested by spraying low-pressure, high volume (65 gal/min) at the enclosure at a distance of 10-12 ft. from the object.

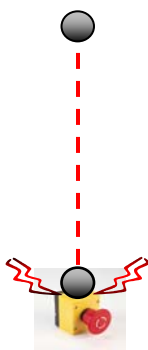
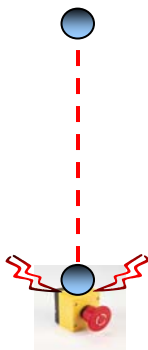

UL 746C Standard for Polymeric Enclosure

This specifies some additional protection requirements for enclosures.

<p>Ball impact test</p> <p>Steel ball, diameter 2in, weight 1.18lb. Dropped from height of 50in onto enclosure. Impact = 5.0 ft-lbs.</p> <p>The enclosure shall withstand the impact without making uninsulated live parts accessible to contact, producing a condition that might affect the mechanical performance of the equipment, or producing a condition that would increase the possibility of an electric shock.</p>	
<p>Cold ball impact test</p> <p>Steel ball, diameter 2in, weight 1.18lb, cooled to -31°F. Dropped from height of 50in onto enclosure. Impact = 5.0 ft-lbs.</p> <p>The enclosure shall withstand the impact without making uninsulated live parts accessible to contact, producing a condition that might affect the mechanical performance of the equipment, or producing a condition that would increase the possibility of an electric shock.</p>	
<p>Five inch flame test</p> <p>A 5-inch flame is applied 5 times, over a period of 5 seconds.</p> <p>The material shall not continue to burn for longer than 1 minute. Drops shall not ignite cotton below the specimen. The material shall not be destroyed to such extent that the integrity is affected.</p>	

III. Installation IEC 60204-1

Gives additional requirements for an emergency stop function realized by the electrical equipment of a machine, specifically installation methods and location requirements.

Section 4 – ABB's Product Scope

Introduction

ABB offers two complete ranges of Emergency Stops designed for most types of industrial environments. The following pages explain the differences and benefits of both ranges.

Modular range

The Modular range of ABB pilot devices is extensive, flexible, and durable.

By combining a few basic components, a large number of different devices can be acquired.

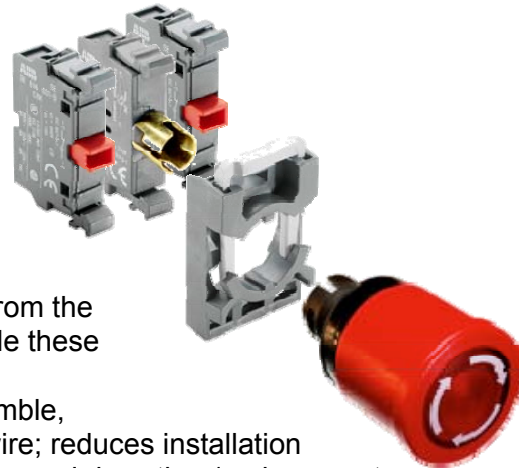

The E-stop buttons from the Modular range include these features:

- Easy to assemble, mount, and wire; reduces installation time for OEMs, and downtime/replacement costs for end-users
- Can be used in tough environments, NEMA Types 1, 3R, 4, 4X, 12, 13 & IP 66
- Large text and push area
- Modern and substantial appearance
- Up to six contacts per actuator
- Available as illuminated operators

Three Benefits of the Modular Range:

- 1. Wide Range:** With our Modular range, the largest selection of device combinations is available. This includes both illuminated and non-illuminated operators, a huge assortment of contact configurations, and operators in several styles.
- 2. Flexible and Customizable:** Any combination of operator, blocks, and accessories can be easily combined into one device, without the need for any tools. Our design features a unique snap-together feature, so assembly, stocking, and mounting are simplified.
- 3. Base-mounted Enclosure Design:** Unique to ABB is our simplistic base-mount contact block design. In each ABB enclosure is a molded rail (sized to match 35mm DIN rail). Our base-mounted contact blocks snap into place in the base of our enclosures. This solution lets our users wire their enclosures neatly efficiently. With competitors' enclosures, the blocks (and wiring) are attached to the back of the lid. This flawed design means that when an enclosure is opened, the wiring is pulled out with the lid of the box. With ABB's design, the blocks and wiring stays neatly in place when the lid is removed, even if the enclosure has been already been mounted. This makes maintenance, rewiring, light bulb changes, and contact rearrangement super-simple.



Assembled Modular Range

ABB also offers our Modular range Emergency Stops as preassembled units. Customers can select a unique combination of components to form a particular device with just one catalog part number.



Our new Assembled Pilot Devices catalog (LV088) simplifies selecting components, building part numbers, and calculating list prices into one easy process.

Compact range

The Compact range from ABB is establishing new standards of performance. This product line increases space-savings and streamlines cost. The all-in-one design makes everything easier: the entire functionality is condensed into one unit. Items do not need to be matched together, and each item has a single, unique part number. The Compact range consists of E-stops in 40mm and 30mm head sizes, with options of twist-release, pull-release, and key-release available.



The main features include:

- Reliable and durable design
- Quick ordering, mounting, and wiring
- Stocking inventory reduction
- Compatible with 30 mm adaptor
- One of the lowest built-in depths on the market (42 mm); this translates to greater clearances for panel components mounted behind the pilot devices
- Positive-opening contacts*
- Front-panel appearance is identical to Modular range, so they can be used side by side on a panel
- Wide selection of marked pushbuttons available
- NEMA Types 1, 3R, 4, 4X, 12, 13 & IEC IP 66, 67
- IP69K – For heavy spray-down applications

*ABB's Emergency Stops include Positive Opening (or Positive Safety) contacts, which apply force directly to the normally closed (NC) contacts, guaranteeing that they open when the button is mechanically operated. This eliminates a potentially unsafe environment in which the circuit does not open and stop the system. Durability tests ensure a minimum mechanical life of 50,000 operations.

Three Benefits of the Compact Range:

1. All-in-one Design: This benefit means that stocking is easier, only one part number needs to be managed, only one list price, only one single part must be installed into a panel... and many more benefits! For panel builders using several identical parts over and over, this is the perfect product to increase productivity and eliminate massive inventory management.

2. Highest Ratings Available:

The Compact range from ABB is available with all the industry-standard NEMA protection ratings: Type 1, 12, 13, 3R, 4, 4X. And now, our Compact range boasts new ratings as well: IP67 and IP69K.

IP67 is an IEC rating approval for the withstand of

submersion in water up to 1m deep. **IP69K** is a rating often requested in the food/beverage, pharmaceutical, and waste treatment industries. This rating protects against high-pressure, high-heat, close-range sprays downs. The IP69K rating is tested with water sprayed onto the device at 1420psi (equivalent to an average-duty sand blaster!), at 176°F, and from the close-range distances of 4-6 inches. Compare this to the NEMA rating of water sprayed from 10 -12 feet away, without the high pressure or high temperature. Often devices rated NEMA 4 or 4X will not protect against ingress of water because the user is spraying the device from much closer distances than 10 feet. IP69K has been around since 1993, but is just catching on in the U.S. ABB is one of the first to offer this rating across a full line of products. Fast Facts sales sheets are available that give further details into this new rating.



3. **E-stop Enclosures:** New enclosures are available from ABB. These compact 1-hole stations are a mere 2 ½” square, versus traditional industry sizes of about 3” by 4” enclosures. The enclosures are designed to enclose our standard Compact range, and are available in both yellow and grey. The smaller size allows for much better usage of space, especially in small spaces where E-stop stations are mandatory (i.e., boom lift buckets, conveyor lines, control towers, airline gateways, etc.) And this doesn't even begin to address the cost-savings involved...



Disadvantages of the Compact Range

The Compact range is an efficient solution for pilot device products. However there are two disadvantages to the range: (1) Only 2 contacts are available per operator, and (2) illuminated pushbuttons are currently not an option. In a situation in which these two options are required, ABB's Modular range can be used to get the job done. Mixing and matching the two ranges on a panel is perfectly acceptable, and the lines have been designed to share a commonality in appearance from the operator side of a panel.

Other stop operators

As a general standard, E-Stops are red with yellow background. We also offer the same buttons, manufactured to the same high standards as our E-Stops, but created in various specialty colors. These non-red operators do not qualify as “Emergency Stops”, but can be applied in a similar way to stop applications.

Black

Black operators can be used as a “Machine Stop”. These buttons provide the same function as E-Stops, but are simply a different color. These can be applied when one would like a machine’s “OFF” button to be manually reset before it can be restarted.



Blue & Yellow

ABB’s blue and yellow Stop devices were designed especially for customers with specific needs. Blue is an accepted designated color for stopping water or sprinkler systems. Yellow is an accepted designated color for shutting off gas lines.

Assembled stations & enclosures

ABB also offers enclosures and shrouds designed specifically for our emergency stops, made of bright yellow polycarbonate. Our Compact range of emergency stop enclosures gives customers maximum performance in the smallest space on the market!

Non-metallic enclosures

ABB’s PBT enclosures feature a unique design in which the contact blocks snap onto the base. This allows for simple maintenance and wiring; if the lid is removed, the blocks and wiring stay in place. With most competitors’ designs, the blocks and wires are pulled out with the lid.



Features of our non-metallic E-Stop enclosures include:

- 5 contact blocks per operator
- NEMA Type 1, 3R, 4, 4X, 12, and 13; IP66
- UL/CSA/CCC certifications
- High impact strength polycarbonate
- Shrouds with weep holes eliminate moisture collection
- Withstands light acid solutions and other chemicals
- Base-mounted contacts allow for easy removal of operator cover; wiring remains with base

Compact enclosures

Our newest additions to the ABB E-Stop enclosure offering are the Compact range. These operator stations are the smallest on the market—perfect for any application where space savings is a must! Available in both yellow and gray, with a complete assortment of accessories.



Metallic enclosures

Type 12 – Oil-tight enclosures are designed to accommodate 22mm pushbuttons, selector switches, pilot lights, and other devices. NEMA Type 12 & 13. These products are primarily used in *indoor* environments to offer protection against *dust, falling dirt, and splashing of non-corrosive liquids.*

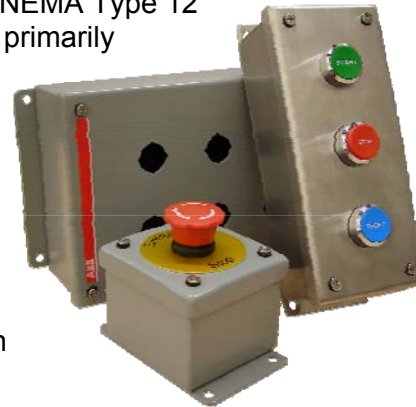

Type 4X Stainless –

Stainless steel enclosures for 22mm pilot devices can withstand a wide range of environments—both indoors and outdoors. NEMA Type 4, 4X, 12, & 13. These products offer protection from *corrosion, wind-blown dust, rain, hose-directed liquids, and ice formation on the enclosure.*

A complete range of pilot devices

Extending beyond our Emergency Stop offering, ABB provides a very broad range of pilot device products for any customer's needs in both the Modular and Compact ranges. This includes some of the following products:



- Pushbuttons
- Selector switches
- Pilot lights
- Buzzers and potentiometers
- Enclosures
- Legend plates and accessories
- Signal towers and beacons

Section 5 – Tools and Resources

Catalogs

All of our literature is available in electronic form from our website:

→ www.abb-control.com

→ Literature Resources

→ Online Literature Library

→ Catalog Index

Then scroll to the Pilot Devices section (sections are listed alphabetically).



Product Selector – LV023

Section 8 of the ABB Product Selector catalog features our complete range of ABB pilot device products, as well as our other control products in our portfolio.



Assembled Pilot Devices – LV088

This catalog is designed to assist you in building up assembled Modular kits, rather than ordering components as individual pieces. By using the selection grids in this catalog, you can create a single part number and list price that includes ALL of the components you want for each pilot device. For example, a G2MP1-60R10 is a 30mm red pushbutton, momentary, flush, with chrome trim, and 1NO contact block and holder. This eliminates the need to order the 4 separate components individually.



30mm Pilot Devices – LV109

This catalog provides part numbers for our operators *including the 30mm adaptor ring*

Sales Literature



Pilot Devices Panorama – LV103

This full-color, four-page brochure shows the complete portfolio of ABB pilot devices, including both the Modular and Compact ranges.



Compact E-stops – LV012

This full-color brochure features our new line of Compact emergency stop pilot devices.



Compact E-stop Enclosures – LV094
Fast Facts sales sheet announcing the new Compact enclosures.



New Ratings: IP69K – LV117
The Compact range of pilot devices just received higher protection ratings! Find out what they are and how they can provide new solutions.

Section 6 – Quiz

1. List three of the standards that apply to Emergency Stop devices:

2. When an application calls for an illuminated E-Stop with 3 NC contacts, which product range would you select from?
- A. Modular
 - B. Compact
 - C. Pilot lights
 - D. No range is possible for this configuration
3. Which is not a benefit of the Modular range?
- A. Wide range of selection
 - B. Flexible and customizable
 - C. AS-I interface capability
 - D. Base-mounted enclosure design
4. Which is not a feature of the Compact range?
- A. 30mm and 40mm operator heads
 - B. Up to 4 contacts per operator
 - C. Compact E-stop enclosures
 - D. IP69K spray-down rating

True or False:

5. Emergency Stops devices are only used by large OEMs.
6. ABB offers Emergency Stop products for both 22mm and 30mm applications.
7. To create a Modular E-Stop, all of the components must be ordered individually.
8. ABB offers Emergency stops in push/pull, twist release, and keyed versions.
9. Both plastic and metallic enclosures are available from ABB.

Answers: 1)see naee 2)A 3)C 4)B 5)F 6)T 7)F 8)T 9)T

Modular technical sheets



Technical data







Approvals

The pushbuttons, selector switches and pilot lights are approved by:
 - National approval agencies: UL, CSA and China Compulsory Product Certification
 For detail information please contact ABB

Standards

<p>IEC 60947-1</p> <p>IEC 60947-5-1</p> <p>8 IEC 60947-5-5</p> <p>IEC 60073</p> <p>IEC 60529</p> <p>EN 60947-1</p> <p>EN 60947-5-1</p> <p>EN 60947-5-5</p> <p>EN 60073</p> <p>EN 60529</p> <p>EN 50013</p> <p>UL 508</p> <p>CSA C22.2 No 14</p>	<p>Low-voltage switchgear and controlgear - Part 1: General rules</p> <p>Low-voltage switchgear and controlgear - Part 5-1: Control circuit devices and switching elements - Electromechanical control circuit devices</p> <p>Low-voltage switchgear and controlgear - Part 5-5: Control circuit devices and switching elements - Electrical emergency stop device with mechanical latching function</p> <p>Basic and safety principles for man-machine interface, marking and identification - Coding principles for indicators and actuators</p> <p>Degrees of protection provided by enclosures (IP Code)</p> <p>Low-voltage switchgear and controlgear - Part 1: General rules</p> <p>Low-voltage switchgear and controlgear - Part 5-1: Control circuit devices and switching elements - Electromechanical control circuit devices</p> <p>Low-voltage switchgear and controlgear - Part 5-5: Control circuit devices and switching elements - Electrical emergency stop device with mechanical latching function</p> <p>Basic and safety principles for man-machine interface, marking and identification - Coding principles for indication devices and actuators</p> <p>Degrees of protection provided by enclosures (IP Code)</p> <p>Low-voltage switchgear and controlgear for industrial use - Terminal marking and distinctive number for particular control switches</p> <p>Industrial Control Equipment</p> <p>Industrial Control Equipment</p>
--	--



Material

No ozone depleting substances in the products.
 All front parts are made of polycarbonate

Material		
PC	Polycarbonate	High impact strength, good outdoor resistance. Can withstand light acid solutions, aliphatic hydrocarbons, paraffin, alcohols, animal and vegetable greases.
PSU	Polysulphone	Can withstand high temperatures, acids, basic solutions, alkaline compounds, oils, alcohols.
PA	Polyamide	Can withstand high temperatures, aliphatic, aromatic and chlorinated hydrocarbons, esters, ketone-aldehydes, alcohols and basic solutions.
PBT		Can withstand high temperature, aliphatic and aromatic hydrocarbons, acids, basic solutions, alcohols, grease and oils
Zinc		Good corrosion resistance in inland-, sea and industrial atmosphere.
Light-alloy		Good corrosion resistance in inland-, sea and industrial atmosphere.
Rubber		Chloroprene Nitrile

Degrees of protection

Operators	IP	UL/CSA
Pushbutton with flush or extended button, MP	IP 66	Type 1, 3R, 4, 4X, 12, 13
Double pushbutton, MPD	IP 66	Type 1, 3R, 4, 4X, 12, 13
Mushroom pushbutton, momentary, MPM	IP 66	Type 1, 3R, 4, 4X, 12, 13
Emergency stop pushbutton, MPMT/P	IP 66	Type 1, 3R, 4, 4X, 12, 13
Selector switch, M2SS/M3SS	IP 66	Type 1, 3R, 4, 4X, 12, 13
Key operated selector switch, M2SSK/M3SSK	IP 66	Type 1, 3R, 4, 4X, 12
Toggle switch, MTS2/MTS3	IP 66	Type 1, 3R, 4, 4X, 12, 13
Definite purpose pushbutton, 30 mm, KP6	IP 66	-
Reset button, KPR	IP 66	Type 1, 3R, 4, 4X, 12, 13
Pilot lights, ML	IP 66	Type 1, 3R, 4, 4X, 12, 13
Buzzer, KB	IP 65	Type 4X
Potentiometer, KT	IP 66	Type 1, 3R, 4, 4X, 12, 13
Contact block & transformer block	IP 20	
Enclosures		
Plastic enclosures	IP 66	
Metallic enclosures	IP 67	

8.28

13XLU 000 023 C0201

Discount schedule CA

Low Voltage Products & Systems

ABB Inc. • 688-385-1221 • www.abb-control.com

Modular technical sheets



Technical data

Mechanical life

Operators

Pushbuttons with flush or extended button, momentary mushroom pushbutton	2 million operations
Selector switch, maintained mushroom pushbutton, key operated selector switch and double pushbutton	0.5 million operations
Emergency stop pushbutton	0.1 million operations
Toggle switch	1 million operations
Lockable pushbuttons	0.3 million operations

Temperature

Ambient temperature during operation	-25 to +70 °C
<i>Exception: All pilot devices with 2 W continuously lit filament bulb</i>	
	-25 to +40 °C
Storage temperature	-30 to +85 °C

Terminals

Plus-minus Pozidriv No.2 screw with DIN-washer.	
Connectable area	min. 1 x 0.5 mm ² /AWG 20 max. 2 x 2.5 mm ² /2 x AWG14
Recommended torque	0.9 Nm

Tightening torque

Locking nut, M22	Min. 2 Nm Max. 2.3 Nm
------------------	--------------------------

Contact blocks

Mechanical endurance 10 million operations
Self cleaning contacts of silver, NC contact with positive opening.
At voltages and currents below 24 V and 5.6 mA two contact blocks in parallel are recommended. As an alternative, gold plated contacts can be used.

	A600	Q600
Ratings as per UL, CSA, NEMA	AC	DC
Rated insulation voltage	600 V	600 V
Rated thermal current	10 A	2.5 A
Rated operational current	at 120 V 6 A 240 V 3 A 480 V 1.5 A 600 V 1.2 A	at 125 V 0.55 A 250 V 0.27 A 480 V 0.10 A 600 V 0.10 A

Ratings as per IEC 60 947-5-1

Rated insulation voltage, U_i	690 V
Rated thermal current, I_{th}	10 A
Rated operational current, I_o	
utilisation category AC 15,	at 120 V 8 A 230 V 6 A 400 V 4 A 690 V 2 A

Rated operational current, I_o

utilisation category DC 13,	at 24 V 5 A 125 V 1.1 A 250 V 0.55 A
-----------------------------	--

Contact resistance

Compulsory function test at 5V, 16 mA

Max. number of contact blocks per operator [⊙]

Pushbutton, toggle switch and mushroom pushbutton	6
Maintained pushbutton	4
Double pushbutton, selector switch, key operated selector switch and emergency stop pushbutton	4
Short circuit protection	
Max. fuse at 1 kA	16 A ordinary 10 A delayed

[⊙] The contact blocks can be stacked in max. two levels on the 3- block holder. Only one level is accepted on the 5-block holder.

Lamp block

Ratings as per IEC 60 947-5-1

Rated insulation voltage	230 V
Base	Ba 9s
Permissible power, up to	2 W

Service life of filament bulb

Relative service life, luminous flux and power consumption at different service voltages. It is generally true to say that bulbs for lower voltages give more light and have better vibration-withstand capability than bulbs for higher voltages.

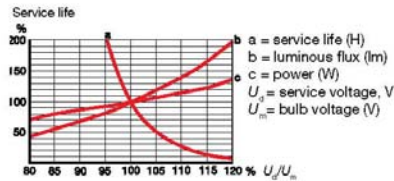

Lamp comparison

Bulb Catalog No.	Approx. life (hours)	Shock and service immunity	High vibration temperature	Low power operating	Brightness consumption
Filament	5000 - 10 000	+	+	+	+++
LED	25 000 - 50 000	+++	++	++	++

Very good +++
Good ++
Less good +

Transformer block

Suitable for filament bulb 6 or 24 V AC and 1.2 W and LED 24 V.

Rated power	1.5 W
Rated voltage	Ratio, see Accessories page 8.25
Rated insulation voltage acc. to IEC 70 °C (DT)	Class E

Compact technical sheets

Technical data

Pilot Devices
Compact range
22mm



Approvals

The pushbuttons, selector switches and pilot lights are approved by:
- National approval agencies: UL and China Compulsory Product Certification

For detail information please contact ABB

Standards

IEC 60947-1	Low-voltage switchgear and controlgear - Part 1: General rules
IEC 60947-5-1	Low-voltage switchgear and controlgear - Part 5-1: Control circuit devices and switching elements - Electromechanical control circuit devices
IEC 60947-5-5	Low-voltage switchgear and controlgear - Part 5-5: Control circuit devices and switching elements - Electrical emergency stop device with mechanical latching function
IEC 60073	Basic and safety principles for man-machine interface, marking and identification - Coding principles for indicators and actuators
IEC 60529	Degrees of protection provided by enclosures (IP Code)
EN 60947-1	Low-voltage switchgear and controlgear - Part 1: General rules
EN 60947-5-1	Low-voltage switchgear and controlgear - Part 5-1: Control circuit devices and switching elements - Electromechanical control circuit devices
EN 60947-5-5	Low-voltage switchgear and controlgear - Part 5-5: Control circuit devices and switching elements - Electrical emergency stop device with mechanical latching function
EN 60073	Basic and safety principles for man-machine interface, marking and identification - Coding principles for indication devices and actuators
EN 60529	Degrees of protection provided by enclosures (IP Code)
EN 50013	Low-voltage switchgear and controlgear for industrial use - Terminal marking and distinctive number for particular control switches
UL 508	Industrial Control Equipment
CSA C22.2 No 14	Industrial Control Equipment

Degrees of protection

Pilot device	IP	UL/CSA
Compact pushbutton, CP1, CP2, CP3, CP4	IP66	Type 1, 3R, 4, 4X, 12, 13
Compact selector switch, C2SS, C3SS	IP66	Type 1, 3R, 4, 4X, 12, 13
Compact pilot light, CL	IP66	Type 1, 3R, 4, 4X, 12, 13
Compact emergency stop pushbutton, CE3T, CE3P, CE4T, CE4P, CE3K1, CE4K1	IP66	Type 1, 3R, 4, 4X, 12, 13
Terminals	IP20	

Temperature

Ambient temperature during operation	-25 to +70 °C
Exception: All pilot devices with 2 W continuously lit filament bulb	-25 to +40 °C
Storage temperature	-30 to +85 °C

Tightening torque

Locking nut, M22	Min. 2 Nm Max. 2.3 Nm
------------------	--------------------------

Contacts

Self-cleaning contacts of silver-coated brass

Ratings as per UL, CSA, NEMA	AC C300	DC R300
Rated insulation voltage	250 V	250 V
Rated thermal current	2.5 A	1 A
Rated operational current		
at 120 V	1.5 A	0.22 A
125 V		
240 V	0.75 A	
250 V		0.11 A
Ratings as per IEC 60947-5-1		
Rated insulation voltage, U_i	300 V	
Rated thermal current, I_{th}	5 A	
Rated operational current, I_o , utilisation category AC-15		
at 120 V	1.5 A	
240 V	1 A	
Rated operational current, I_o , utilisation category DC-13,		
at 24 V	0.3 A	
125 V	0.2 A	
Short circuit protection		
Max. fuse at 1 kA	16 A ordinary 10 A delayed	
Tightening torque		
compact pushbutton & selector switch	0.8 Nm (M3)	
compact pilot light	0.9 Nm (M3.5)	
compact emergency stop pushbutton	0.8 Nm (M3)	
Terminals		
Plus-minus Pozidriv No. 2 Compact pushbutton		
Compact selector switch		
Compact emergency stop		
Connectable area	min. 1 x 0.5 mm ² /1 x AWG22 max. 2 x 1.5 mm ² /2 x AWG14	
Compact pilot light		
Connectable area	min. 1 x 0.5 mm ² /1 x AWG20 max. 2 x 2.5 mm ² /2 x AWG14	

8

Material

No ozone depleting substances in the products.
All front parts are made of polycarbonate

Material	Characteristics
PC Polycarbonate	High impact strength, good outdoor resistance. Can withstand light acid solutions, aliphatic hydrocarbons, paraffin, alcohols, animal and vegetable greases.
PA Polyamide	Can withstand high temperatures, aliphatic, aromatic and chlorinated hydrocarbons, esters, ketone-aldehydes, alcohols and basic solutions.
PBT	Can withstand temperature, aliphatic and aromatic hydrocarbons, acids, basic solutions, alcohols, greases and oils
Zinc	Good corrosion resistance in inland-, sea and industrial atmosphere.
Light-alloy	Good corrosion resistance in inland-, sea and industrial atmosphere.
Rubber	Chloroprene, Nitrile

Modular dimensions

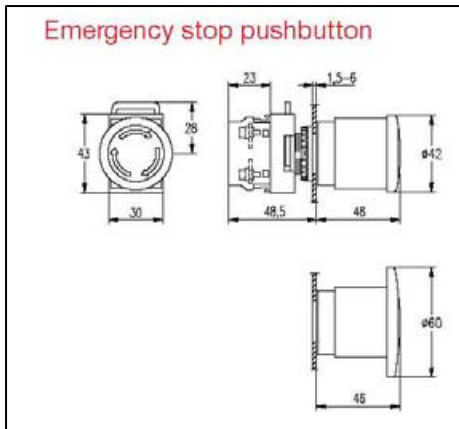

Compact dimensions

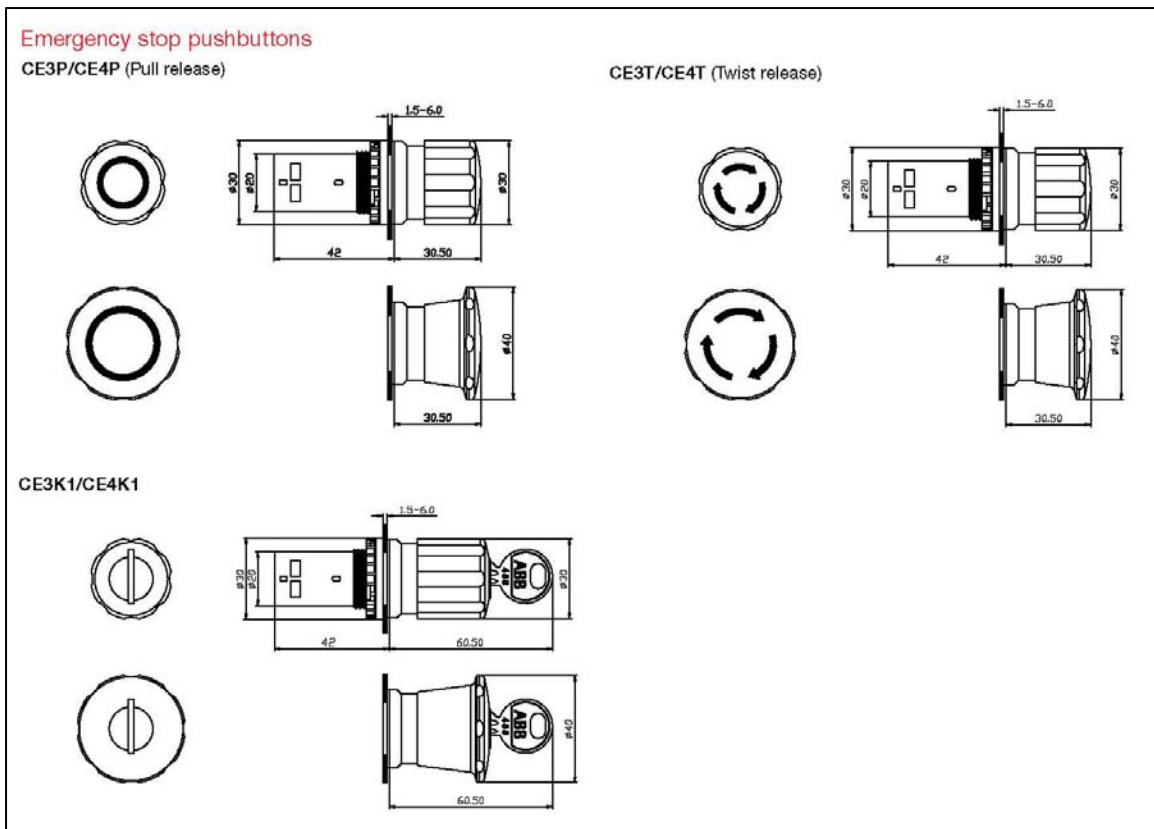

NEMA rating definitions

NEMA Rating	Enclosure Protection:
1	Indoor Falling dirt
2	Indoor Falling dirt Dripping/light splashing of liquids
3	Indoor/Outdoor Falling dirt, rain, sleet, snow, windblown dust, external ice formation
3R	Indoor/Outdoor Falling dirt, rain, sleet, snow, external ice formation
3S	Indoor/Outdoor Indoor/Outdoor Falling dirt, rain, sleet, snow, windblown dust, external mechanism remain operable with ice formation
4	Indoor/Outdoor Falling dirt, rain, sleet, snow, windblown dust, external ice formation, splashing water, hose-directed water
4X	Indoor/Outdoor Falling dirt, rain, sleet, snow, windblown dust, external ice formation, splashing water, hose-directed water, corrosion
5	Indoor Airborne dust, lint, fibers, flyings, light splashing of liquids
6	Indoor/Outdoor Falling dirt, hose-directed water and occasional, temporary submersion, formation of ice
6P	Indoor/Outdoor Falling dirt, hose-directed water and prolonged submersion, undamaged by external formation of ice
12	Indoor Falling dirt, circulating dust, lint, fiber, flyings, dripping and light splashing of liquids
13	Indoor Falling dirt, circulating dust, lint, fiber, flyings, dripping and light splashing of liquids, spray/splashing/seepage of oil and non-corrosive coolants



ABB, Inc.
1206 Hatton Road
Wichita Falls, TX 76302
Customer Service: 888-385-1221
<http://www.abb-control.co>
1SXU150186X0201