

Simple & Powered Machines

MAKER Activities – Years 5-8

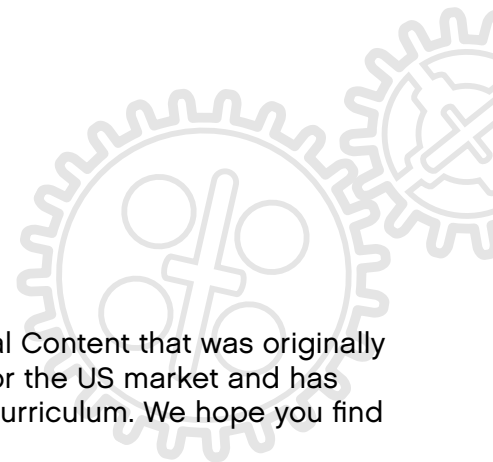

This Educational Content is a certified and direct translation of Educational Content that was originally developed and quality approved by LEGO® Education. It was developed for the US market and has not been changed in any manner to reflect local education standards or curriculum. We hope you find it helpful.

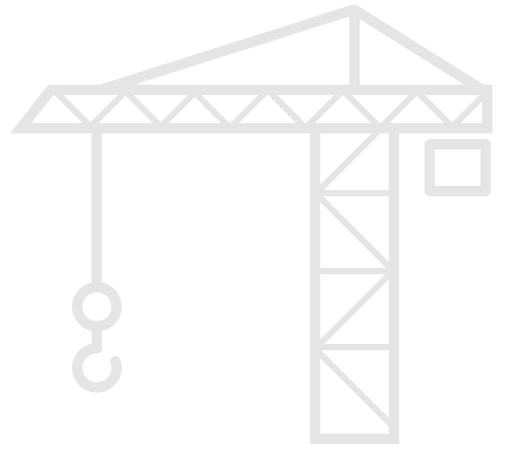



Table of Contents

1. Classroom Management Tips	3
The LEGO® Education MAKER (Design) Process	3
Assessment	4
Share it	5
2. Lesson Plan: Make a Digital Accessory	7
MAKER Connect	10
Student Worksheet	11
Assessment	12
3. Lesson Plan: Wearables	13
MAKER Connect	16
Student Worksheet	17
Assessment	18
4. Lesson Plan: Make a Repeated Pattern	19
MAKER Connect	22
Student Worksheet	23
Assessment	24
5. Additional MAKER Briefs	25
6. Student Worksheet	35
Assessment	36

Classroom Management Tips

Resources

- LEGO® Education Simple and Powered Machines (9686)
- Lesson plan for each project
- Student worksheet for each project
- Inspirational images for each project
- Modeling materials already available in your class

How much time do you need?

Each lesson is designed to take 90 minutes. If you work in shorter class periods, you can break this down into two 45 minute sessions.

Preparation

It is important to establish student groups. Groups of two work well. Ensure that each student has a copy of the MAKER worksheet for recording their design process. They will also need the LEGO Education Simple and Powered Machines set (one set for every two students is recommended).

Prior Learning

Before beginning these MAKER activities, it is recommended that students complete the principle models activities from the booklets supplied with each brick set.

However, if you prefer a more open-ended, explorative method, you can start out with this activity and allow students to find help on their own by referring to the principle models booklets.

The LEGO Education MAKER (Design) Process

Defining the Problem

It is important that students define a real problem to solve from the start. The connect images are provided to help students to think about designing solutions for the needs of others, and not just for themselves. At this stage of the process, it is important that you not show examples of a final or sample solution.

Brainstorm

Brainstorming is an active part of making. Some students will find it easier to explore their thoughts through hands-on experimentation with the LEGO bricks, and others will prefer to make sketches and notes. Group work is essential, but it is important to allow time for students to work alone before sharing their ideas with their group.

Define the Design Criteria

Discussing and finding an agreement about the best solution to build can involve a lot of negotiation, and may require different techniques depending on the students' skills. For example:

- Some students draw well.
- Others may build part of a model and then describe what they mean.
- Other students may be good at describing a strategy.



Encourage an ethos where students can share anything, no matter how abstract it might sound. Be active during this phase and ensure that the ideas the students choose are achievable.

It is important that the students set clear design criteria. Once the solution to the problem has been made, the students will return to these criteria, which will then form the basis for testing how well the solution works.

Go MAKE

Students must make one of their group's ideas using the LEGO® set, and can use other materials if needed. If they are finding it hard to build their idea, encourage them to break problems down into smaller parts. Explain that they do not have to come up with the whole solution from the start. Remind students that this process is iterative and they must test, analyse, and revise their idea as they go.

Using this MAKER process does not mean you are following an inflexible set of steps. Instead, think of it as a set of practices.

For example, brainstorming may be prominent at the beginning of the process. However, students may also need to brainstorm ideas when they are trying to figure out ways to improve their idea, or when they have a bad test result and they must change some features of their design.

Review and Revise Your Solution

To help students develop their critical thinking and communication skills, you may wish to have students from one group observe and critique another group's solution. Peer review and formative feedback helps both the students giving, and the students receiving the feedback to improve their work.

Communicate Your Solution

The student worksheet is helpful for basic documentation of the project. Students can also refer to it when presenting their work in front of the class. You may also wish to use the project as a portfolio for performance evaluations or for student self-evaluation.

Assessment

Where can I find the assessment materials?

Assessment materials are provided for the first three projects. You will find them at the end of each student worksheet.

What learning goals are assessed?

Students use the student worksheet assessment rubric to evaluate their design work according to the learning goals. Each rubric includes four levels: Bronze, Silver, Gold, and Platinum. The intention of the rubric is to help students reflect on what they have done well in relation to the learning goals and what they could have done better.

Design criteria example:

The design must...
The design should...
The design could...



Share It

We encourage you to share your students' brilliant projects on the appropriate social media platforms using the hashtag **#LEGOMAKER**.

Students can also share their own projects if they are over 13 years old and if it complies with the rules of your school / MAKER space.

 **#LEGOMAKER**

The LEGO® Education MAKER (Design) Process

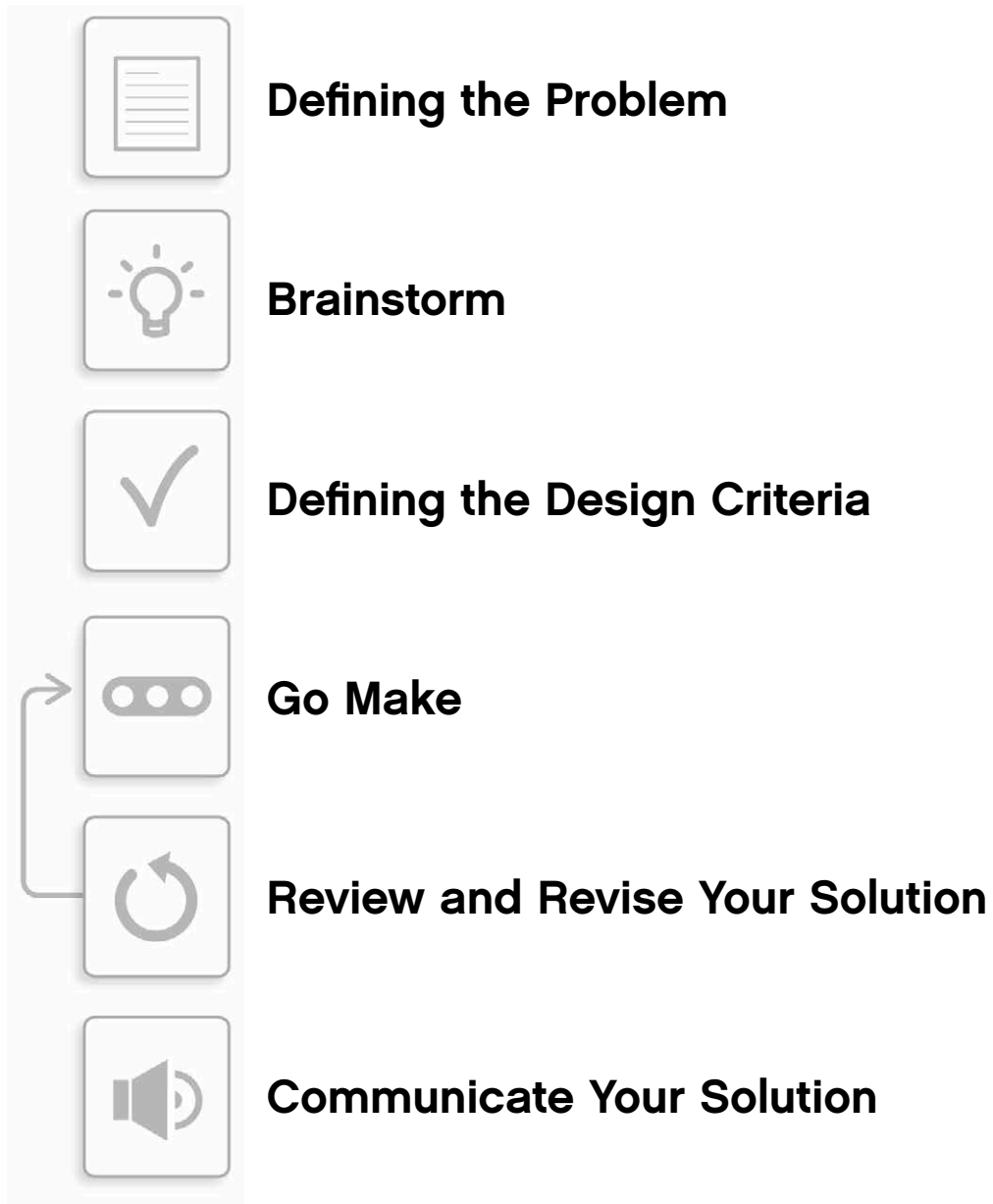



Lesson Plan – Make a Digital Accessory

Learning Goals

After completing this lesson, students will have:

- Defined a clear design need
- Developed their ability to iterate and improve design solutions
- Developed their problem-solving and communication skills

Duration

2 x 45 mins (90 mins)

Preparation

Ensure that each student has a copy of the MAKER worksheet for recording their design process. They will also need the LEGO® Simple and Powered Machines set (one set for every two students is recommended). For this MAKER task you will need a mobile phone and/or a tablet device for testing.

Other Materials Required (Optional)

- Rubber bands
- Thin cardboard
- Thin plastic sheet

Prior Learning

Before beginning this MAKER activity, it is recommended that students complete the following principle models booklets supplied with each 9686 brick set:

- Simple Machines – Lever, Pulley and Screw
- Mechanisms – Gear, Cam, Pawl and Ratchet
- Structures

However, if you prefer a more open-ended, explorative method, you can start out with this activity and allow students to find help on their own by referring to the principle models booklets.

Procedure

1. Introduction/Discussion

Hand out the worksheets and allow the students to interpret the activity for themselves, or read the MAKER connect text aloud to set the scene.

2. Defining the Problem

As students look at the connect images and questions, facilitate a discussion to steer them toward a problem. Once they have decided upon a problem to solve, ensure that they record it on their worksheet.

3. Brainstorm

Students should initially work independently, spending three minutes to generate as many ideas as they can to solve the problem. They can use the bricks from the LEGO set during the brainstorming process, or sketch out their ideas in the space provided on the worksheet.

Students can now take turns sharing their ideas within their groups. Once all of the ideas have been shared, each group should select the best idea(s) to make. Be prepared to help facilitate this process to ensure that the students choose something that is possible to make. Encourage diversity, not all student groups have to make the same thing.

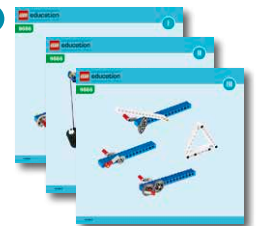

Students must define a problem before they can start brainstorming ideas.



4. Define the Design Criteria

Students must record up to three design criteria on their worksheet so that they can refer to it when they review and revise their solution.

5. Go MAKE

Students make one of the ideas using the LEGO® Simple and Powered Machines set and other materials as needed.

Reinforce that students do not have to come up with the whole solution from the start. For example, if they are making a stand for a mobile phone, they could explore how to support the phone before thinking about how the viewing angle can be adjusted.

During the making process, remind students to test and analyse their idea as they go, making improvements where necessary. If you want students to submit their documentation at the end of the lesson, ensure that they record their design journey during the making stage using sketches and photos of their models.

6. Review and Revise Your Solution

Students test and evaluate their designs against the design criteria they recorded before they started making their solution. They can record notes on their student worksheet.

7. Communicate Your Solution

Allow time for each student or student group to present what they have made to the class. A good way to do this is to set out a table large enough to display all of the models. If time is short, two groups can present to each other.

8. Assessment

Students use the student worksheet assessment rubric to evaluate their design work according to the learning goals. Each rubric includes four levels: Bronze, Silver, Gold, and Platinum. The intention of the rubric is to help students reflect on what they have done well in relation to the learning goals and what they could have done better.

9. Tidy Up

Ensure that you leave enough time at the end of the lesson to break the models down and sort them back into the LEGO boxes. You will need approximately 10 minutes to do this.

Design criteria example:

The design must...
The design should...
The design could...



How well does it work?
What if...?

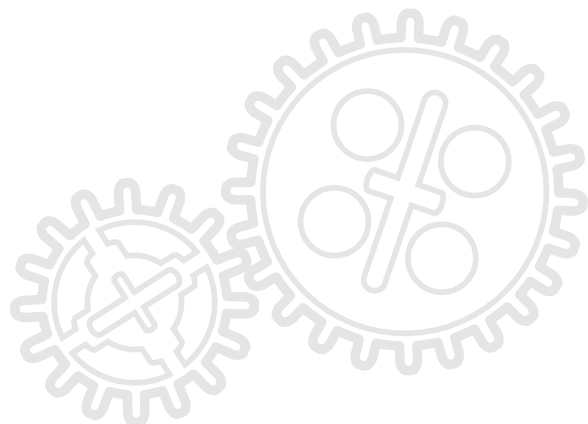

Possible Digital Accessory Solution, for Inspiration

Note: You are advised not to share these images with students.

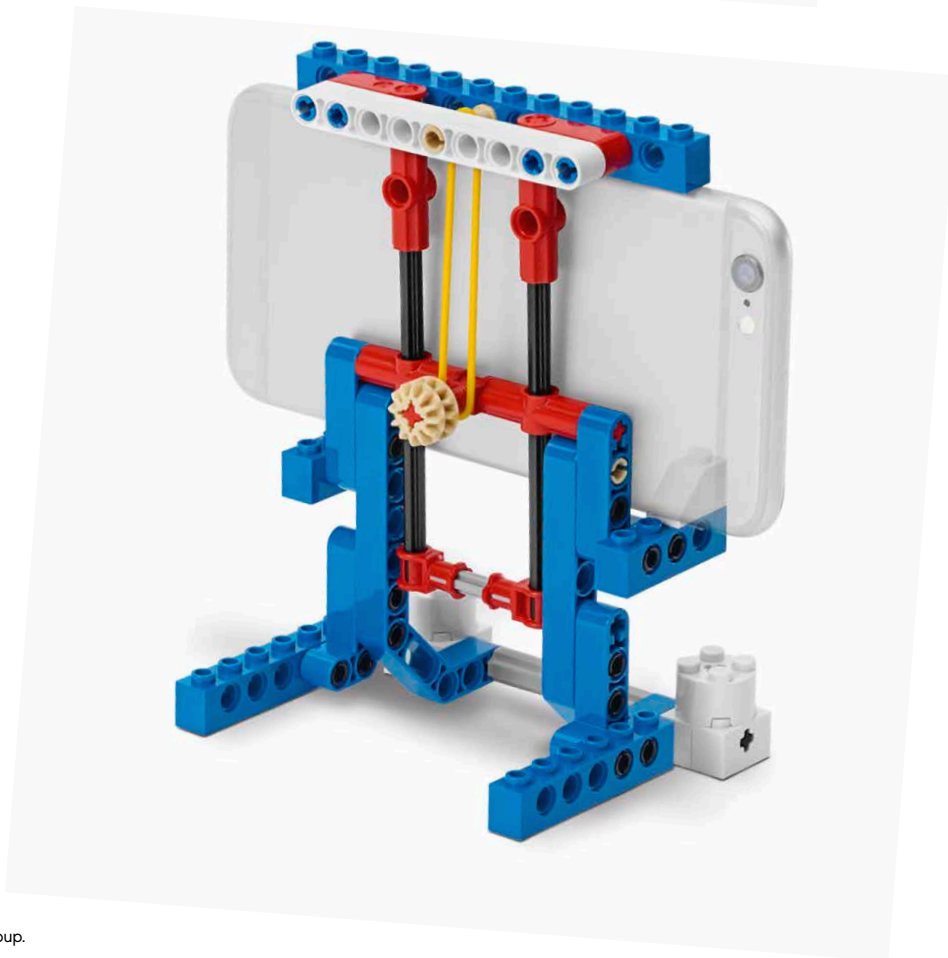
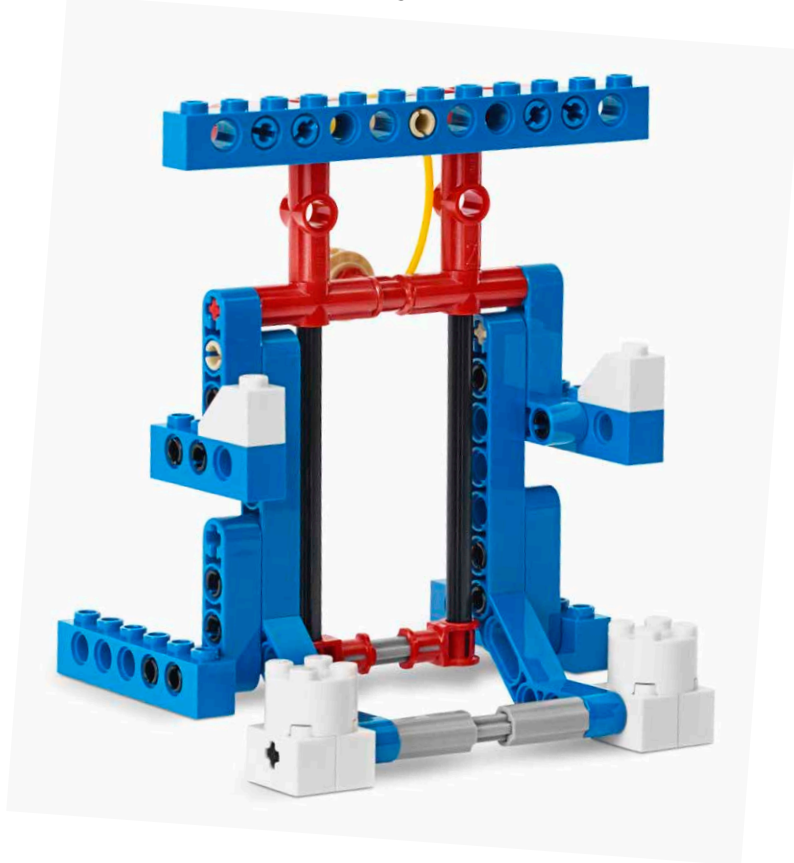

MAKER Connect – Make a Digital Accessory

More and more people are interacting with mobile technology on a daily basis. They use their devices for a number of different things such as telephone calls, surfing the web, playing games, watching movies, and listening to music. With this, they also face many challenges.

Look at the images below.

- What can you see?
- What problems can you see?
- How did these problems occur?
- What new design opportunities are there?

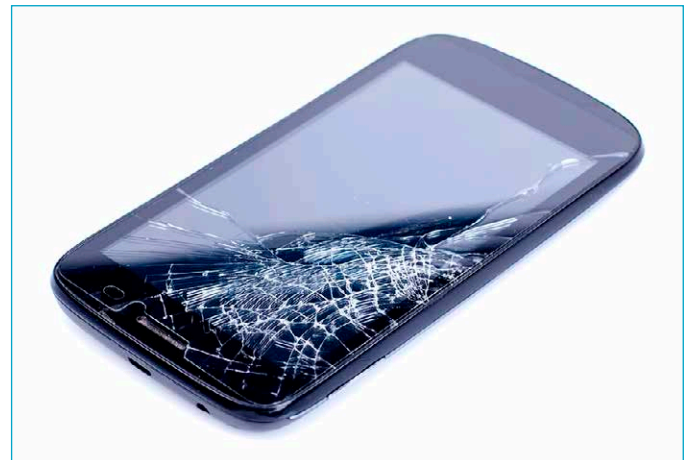
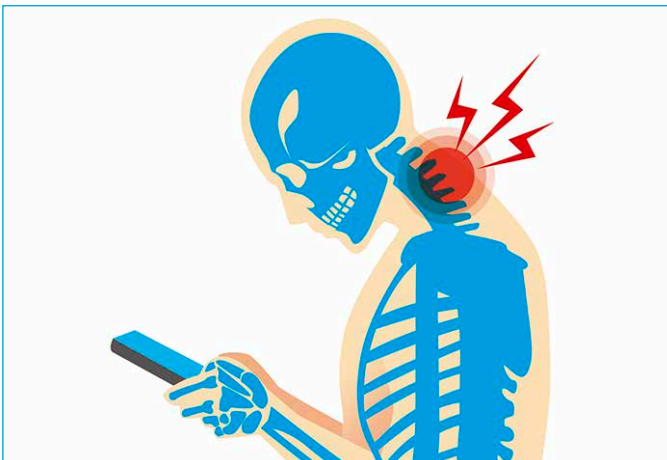

Student Worksheet – Make a Digital Accessory

Name(s): _____ Date: _____

Defining the Problem

What problems can you see in the pictures? Pick one problem and explain it below.

Brainstorm

Individual work: Now that you have defined a problem, take three minutes to generate ideas for solving it. Be prepared to share your ideas with your group.

Group work: Share and discuss your ideas for solving the problem.

Documenting your work is very important during the design process. Record as much as you can through sketches, photos and notes.



Use LEGO® bricks and sketches to explore your ideas.



Sometimes simple ideas are the best ideas.



Define the Design Criteria

You should have generated a number of ideas. Now select the best one to make.

Based upon your brainstorming discussion, write down two or three specific design criteria that your design must meet:

1. _____
2. _____
3. _____

Go MAKE

It is time to start making. Use the components from the LEGO® set to make your chosen solution. Test and analyse your design as you go and record any improvements that you make.

Review and Revise Your Solution

Have you managed to solve the problem that you defined at the beginning of the lesson? Look back at your three design criteria.

How well does your solution work? Use the space below to suggest three improvements to your design.

1. _____
2. _____
3. _____

Communicate Your Solution

Now that you have finished, make a sketch or take a photo of your model, label the three most important parts, and explain how they work. You are now ready to present your solution to the class.

Assessment

				
GOALS	BRONZE	SILVER	GOLD	PLATINUM
MAKER Task: _____ _____	• We successfully built and tested one design based upon a single design criteria and design idea.	• We successfully used two design criteria and ideas to build a solution to the defined problem.	• We met Silver, and refined our idea to improve it further through testing, revising, and retesting.	• We met Gold, and successfully met all three design criteria.
Designing Solutions	<input type="checkbox"/>	<input type="checkbox"/>	<input type="checkbox"/>	<input type="checkbox"/>

Well done! What will you make next?

Design criteria example:
The design must...
The design should...
The design could...



You can use other materials from around the classroom.



Print your photos and attach all of your work to a large sheet of paper or cardboard.



Lesson Plan – Wearables

Learning Goals

After completing this lesson, students will have:

- Defined a clear design need
- Developed their ability to iterate and improve design solutions
- Developed their problem-solving and communication skills

Duration

2 x 45 mins (90 mins)

Preparation

Ensure that each student has a copy of the MAKER worksheet for recording their design process. They will also need the LEGO® Simple and Powered Machines set (one set for every two students is recommended).

Other Materials Required (Optional)

- Card stock
- Thin plastic sheet
- Neoprene rubber sheet

Procedure

1. Introduction/Discussion

Hand out the worksheets and allow the students to interpret the activity for themselves, or read the MAKER connect text aloud to set the scene.

2. Defining the Problem

As students look at the connect images and questions, facilitate if necessary a discussion to steer them toward a problem. Once they have decided upon a problem to solve, ensure that they record it on their worksheet.

3. Brainstorm

Students should initially work independently, spending three minutes to generate as many ideas as they can to solve the problem they have singled out. They can use the bricks from the set during the brainstorming process, or sketch out their ideas in the space provided on the worksheet.

Students can now take turns sharing their ideas within their groups. Once all of the ideas have been shared, each group should select the best idea(s) to make. Be prepared to help facilitate this process to ensure that the students choose something that is possible to make. Encourage diversity, not all student groups have to make the same thing.

4. Define the Design Criteria

Students must record up to three design criteria on their worksheet so that they can refer to it when they review and revise their solution.



Students must define a problem before they can start brainstorming ideas.



Design criteria example:
The design must..
The design should..
The design could..



5. Go MAKE

Students make one of the ideas using the LEGO® Simple and Powered Machines set and other materials as needed.

Reinforce that students do not have to come up with the whole solution from the start. For example, if they are making some eyewear/glasses, they could explore the shape and fit on the face before looking at the temples (ear supports).

During the making process, remind students to test and analyse their idea as they go, making improvements where necessary. If you want students to submit their documentation at the end of the lesson, ensure that they record their design journey during the making stage using sketches and photos of their models.

6. Review and Revise Your Solution

Students test and evaluate their designs against the design criteria they recorded before they started making their solution. They can record notes on their student worksheet.

7. Communicate Your Solution

Allow time for each student or student group to present what they have made to the class. A good way to do this is to set out a table large enough to display all of the models. If time is short, two groups can present to each other.

8. Assessment

Students use the student worksheet assessment rubric to evaluate their design work according to the learning goals. Each rubric includes four levels: Bronze, Silver, Gold, and Platinum. The intention of the rubric is to help students reflect on what they have done well in relation to the learning goals and what they could have done better. Each rubric can be linked to engineering-related learning goals.

9. Tidy Up

Ensure that you leave enough time at the end of the lesson to break the models down and sort them back into the LEGO boxes. You will need approximately 10 minutes to do this.



How well does it work?
What if...?

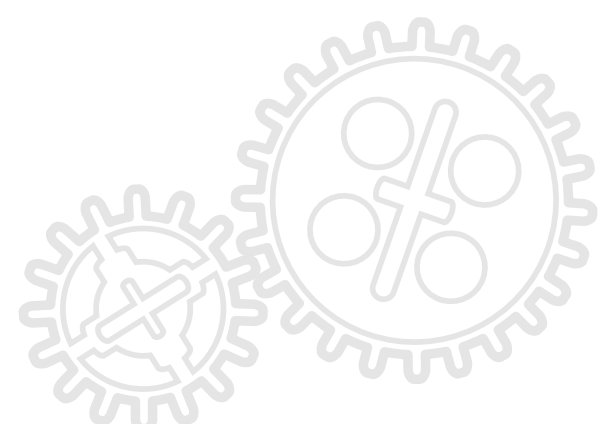

Possible Wearable Technology Solution, for Inspiration

Note: You are advised not to share these images with students.



MAKER Connect – Make a Wearable

Wearables or wearable technology is being used more and more in everyday life. We see wearable technology in the form of health monitors, mind-controlled and gesture-controlled devices, invisibles, VR headsets, and smart watches that can pay for your shopping and even reveal your flight boarding pass. These are just a few of the many products that already exist.

Look at the images below.

- What can you see?
- What problems can you see?
- How did these problems occur?
- What new design opportunities are there?

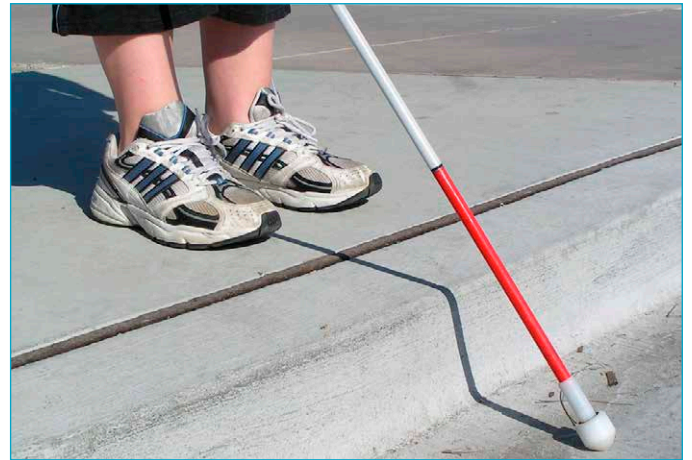

Student Worksheet – Make a Wearable

Name(s): _____ Date: _____

Defining the Problem

What problems can you see in the pictures? Pick one problem and explain it below.

Brainstorm

Individual work: Now that you have defined a problem, take three minutes to generate ideas for solving it. Be prepared to share your ideas with your group.

Group work: Share and discuss your ideas for solving the problem.

Documenting your work is very important during the design process. Record as much as you can through sketches, photos and notes.



Use LEGO® bricks and sketches to explore your ideas.



Sometimes simple ideas are the best ideas.



Define the Design Criteria

You should have generated a number of ideas. Now select the best one to make.

Based upon your brainstorming discussion, write down two or three specific design criteria that your design must meet:

1. _____
2. _____
3. _____

Go MAKE

It is time to start making. Use the components from the LEGO® set to make your chosen solution. Test and analyse your design as you go and record any improvements that you make.

Review and Revise Your Solution

Have you managed to solve the problem that you defined at the beginning of the lesson? Look back at your three design criteria.





How well does your solution work? Use the space below to suggest three improvements to your design.

1. _____
2. _____
3. _____

Communicate Your Solution

Now that you have finished, make a sketch or take a photo of your model, label the three most important parts, and explain how they work. You are now ready to present your solution to the class.

Assessment

				
GOALS	BRONZE	SILVER	GOLD	PLATINUM
MAKER Task: _____ _____	• We understood the design problem.	• We defined a design problem and we used one design criteria and idea to build the solution.	• We achieved Silver, and we used two design criteria and ideas to build the solution.	• We achieved Gold, and we used three design criteria and ideas to build an effective solution.
Defining Problems	<input type="checkbox"/>	<input type="checkbox"/>	<input type="checkbox"/>	<input type="checkbox"/>

Well done! What will you make next?

Design criteria example:
 The design must...
 The design should...
 The design could...



You can use other materials from around the classroom.



Print your photos and attach all of your work to a large sheet of paper or cardboard.



Lesson Plan – Make a Repeated Pattern

Learning Goals

After completing this lesson, students will have:

- Defined a clear design need
- Developed their ability to iterate and improve design solutions
- Developed their problem-solving and communication skills

Duration

2 x 45 mins (90 mins)

Preparation

Ensure that each student has a copy of the MAKER worksheet for recording their design process. They will also need the LEGO® Simple and Powered Machines set (one set for every two students is recommended).

Other Materials Required (Optional)

- Rubber bands
- Sheets of plain paper (A3 and A4)
- Colored felt pens or colored pencils

Procedure

1. Introduction/Discussion

Hand out the worksheets and allow the students to interpret the activity for themselves, or read the MAKER connect text aloud to set the scene.

2. Defining the Problem

As students look at the connect images and questions, facilitate a discussion to steer them toward a problem. Once they have decided upon a problem to solve, ensure that they record it on their worksheet.

3. Brainstorm

Students should initially work independently, spending three minutes to generate as many ideas as they can to solve the problem. They can use the bricks from the set during the brainstorming process, or sketch out their ideas in the space provided on the worksheet.

Students can now take turns sharing their ideas within their groups. Once all of the ideas have been presented, each group should select the best idea(s) to make. Be prepared to help facilitate this process to ensure that the students choose something that is possible to make. Encourage diversity, not all student groups have to make the same thing.

4. Define the Design Criteria

Students must record up to three design criteria on their worksheet so that they can refer to it when they review and revise their solution.



Students must define a problem before they can start brainstorming ideas.



Design criteria example:
The design must...
The design should...
The design could...



5. Go MAKE

Students make one of the ideas using the LEGO® Simple and Powered Machines set and other materials as needed.

Reinforce that students do not have to come up with the whole solution from the start. For example, if they are making a motorised drawing machine, they could first explore how to draw simple circles before drawing more complex shapes.

During the making process, remind students to test and analyse their idea as they go, making improvements where necessary. If you want students to submit their documentation at the end of the lesson, ensure that they record their design journey during the making stage using sketches and photos of their models.

6. Review and Revise Your Solution

Students test and evaluate their designs against the design criteria they recorded before they started making their solution. They can record notes on their student worksheet.

7. Communicate Your Solution

Allow time for each student or student group to present what they have made to the class. A good way to do this is to set out a table large enough to display all of the models. If time is short, two groups can present to each other.

8. Assessment

Students use the student worksheet assessment rubric to evaluate their design work according to the learning goals. Each rubric includes four levels: Bronze, Silver, Gold, and Platinum. The intention of the rubric is to help students reflect on what they have done well in relation to the learning goals and what they could have done better.

9. Tidy Up

Ensure that you leave enough time at the end of the lesson to break the models down and sort them back into the LEGO boxes. You will need approximately 10 minutes to do this.



How well does it work?
What if...?



Possible Repeated Pattern Solution, for Inspiration

Note: You are advised not to share these images with students.

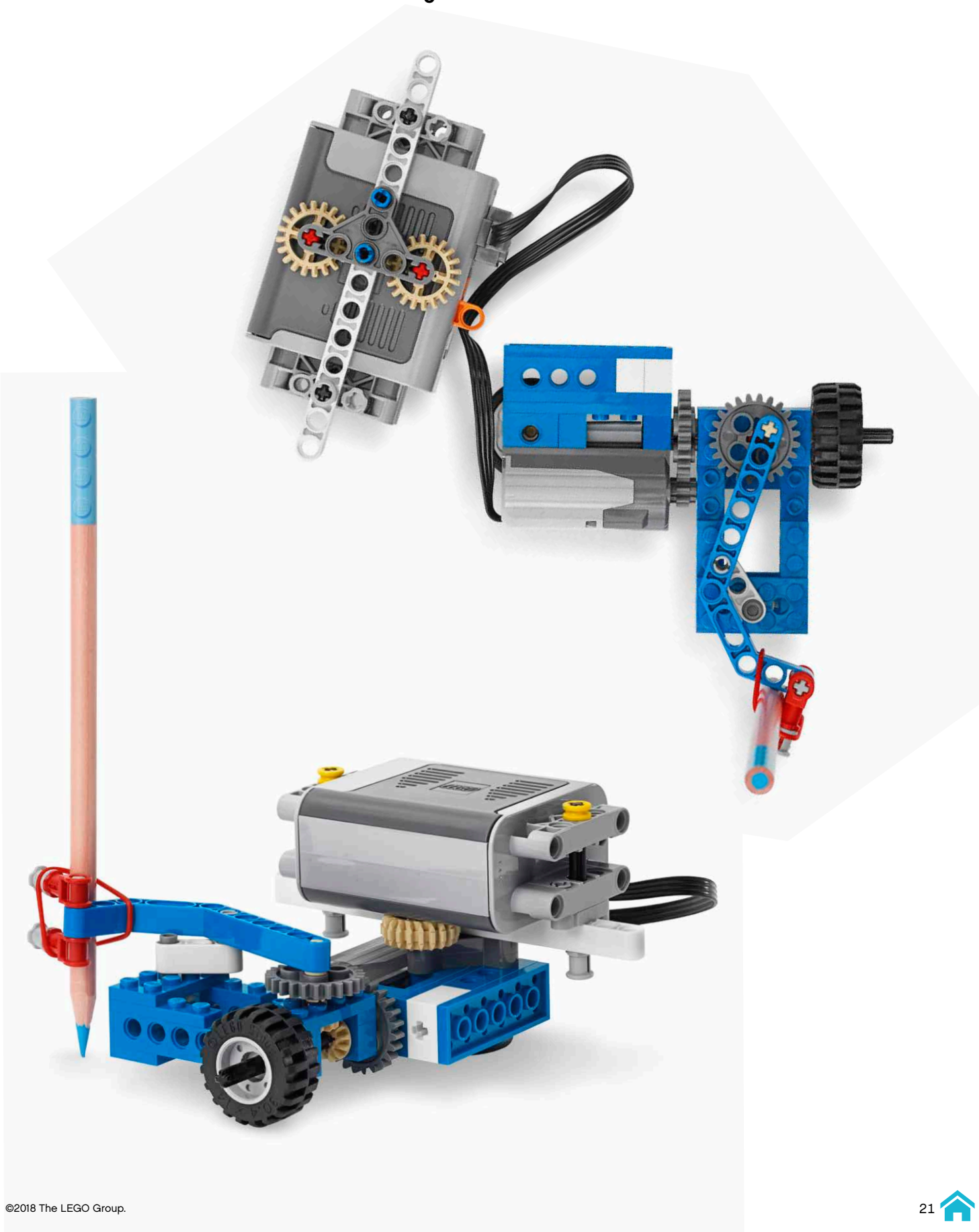

MAKER Connect – Make a Repeated Pattern

We live in a world full of symmetry and math. From this, many artists and designers find inspiration.

Look at the images below.

- What can you see?
- What patterns can you see?
- How did these patterns occur?
- What new design opportunities are there?

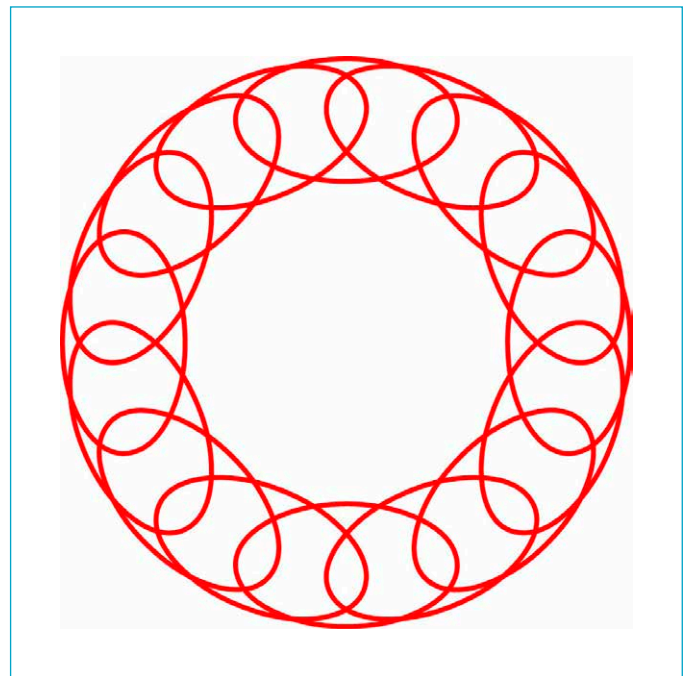
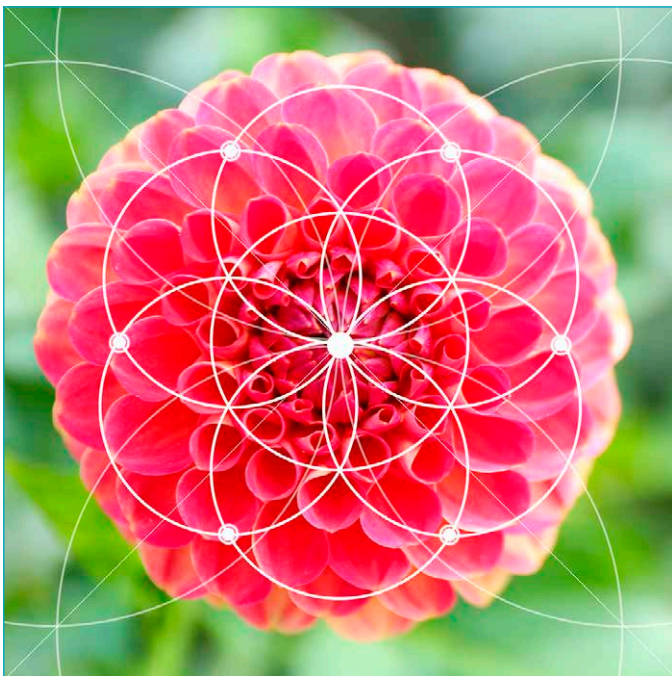

Student Worksheet – Make a Repeated Pattern

Name(s): _____ Date: _____

Defining the Problem

What problems can you see in the pictures? Pick one problem and explain it below.

Brainstorm

Individual work: Now that you have defined a problem, take three minutes to generate ideas for solving it. Be prepared to share your ideas with your group.

Group work: Share and discuss your ideas for solving the problem.

Documenting your work is very important during the design process. Record as much as you can through sketches, photos and notes.



Use LEGO® bricks and sketches to explore your ideas.



Sometimes simple ideas are the best ideas.



Define the Design Criteria

You should have generated a number of ideas. Now select the best one to make.

Based upon your brainstorming discussion, write down two or three specific design criteria that your design must meet:

1. _____
2. _____
3. _____

Go MAKE

It is time to start making. Use the components from the LEGO® set to make your chosen solution. Test and analyse your design as you go and record any improvements that you make.

Review and Revise Your Solution

Have you managed to solve the problem that you defined at the beginning of the lesson? Look back at your three design criteria.





How well does your solution work? Use the space below to suggest three improvements to your design.

1. _____
2. _____
3. _____

Communicate Your Solution

Now that you have finished, make a sketch or take a photo of your model, label the three most important parts, and explain how they work. You are now ready to present your solution to the class.

Assessment

				
GOALS	BRONZE	SILVER	GOLD	PLATINUM
MAKER Task: _____ _____ Obtaining, Evaluating and Communicating Information	• We drew and labeled the parts of our design. <input type="checkbox"/>	• We met Bronze and we identified the location of the key component parts responsible for the pattern we observed. <input type="checkbox"/>	• We met Silver and we included a diagram showing the pattern we observed. <input type="checkbox"/>	• We met Gold and we used words and a diagram to explain how this new design caused the pattern we observed. <input type="checkbox"/>

Well done! What will you make next?

Design criteria example:
 The design must...
 The design should...
 The design could...



Print your photos and attach all of your work to a large sheet of paper or cardboard.





Additional Maker Briefs

The Maker Projects

Start your Maker journey with the following three Maker activities:

- **Make a Digital Accessory**
- **Make a Wearable**
- **Make a Repeated Pattern**

Once you have completed these three Maker activities, use the same Maker design process to try out some of the activities from the list below.

1. **Make a Cable Car**
2. **Make a Classroom Helper**
3. **Make a Sloth Car**
4. **Make a Carnival Game**
5. **Make a Chain Reaction**
6. **Make an Animation Machine**
7. **Make a Mechanical Toy Animal**
8. **Make a Household Helper**
9. **Make a Simple Machine to Move Something**

The following pages include the individual Maker briefs, one possible model solution per brief, a generic Student Worksheet, and a self-assessment rubric that students can use to record their design process.

1. Make a Cable Car

Can you think of some different types of cable cars? How do they move? Where do they travel? What do they carry? How do they balance? Which type of cable car would you most like to make? Would it travel by gravity or use a motor?

Make a cable car that can transport people from one place to another.

Possible Solution

Note: To encourage maximum creativity, you may choose not to share this image with students.

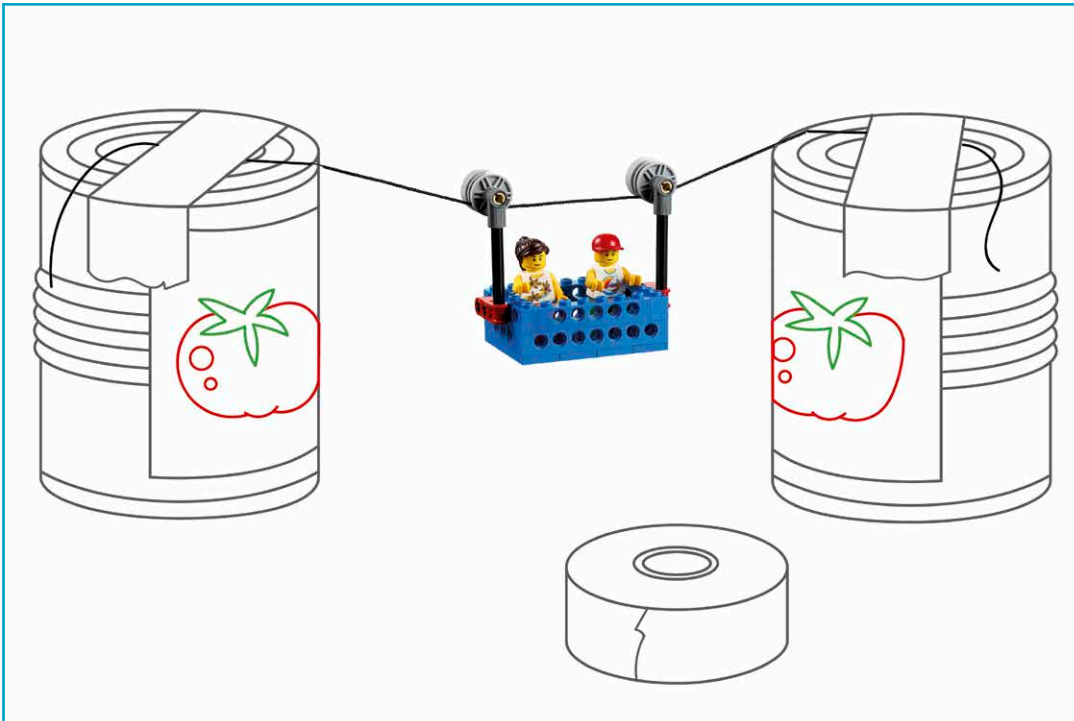

2. Make a Classroom Helper

What type of invention could make your school life easier? What new devices could be useful in your classroom? Do you need a book stand? Do you need help measuring something? What else can you think of?

Make an invention to help you in your classroom.

Possible Solution

Note: To encourage maximum creativity, you may choose not to share this image with students.

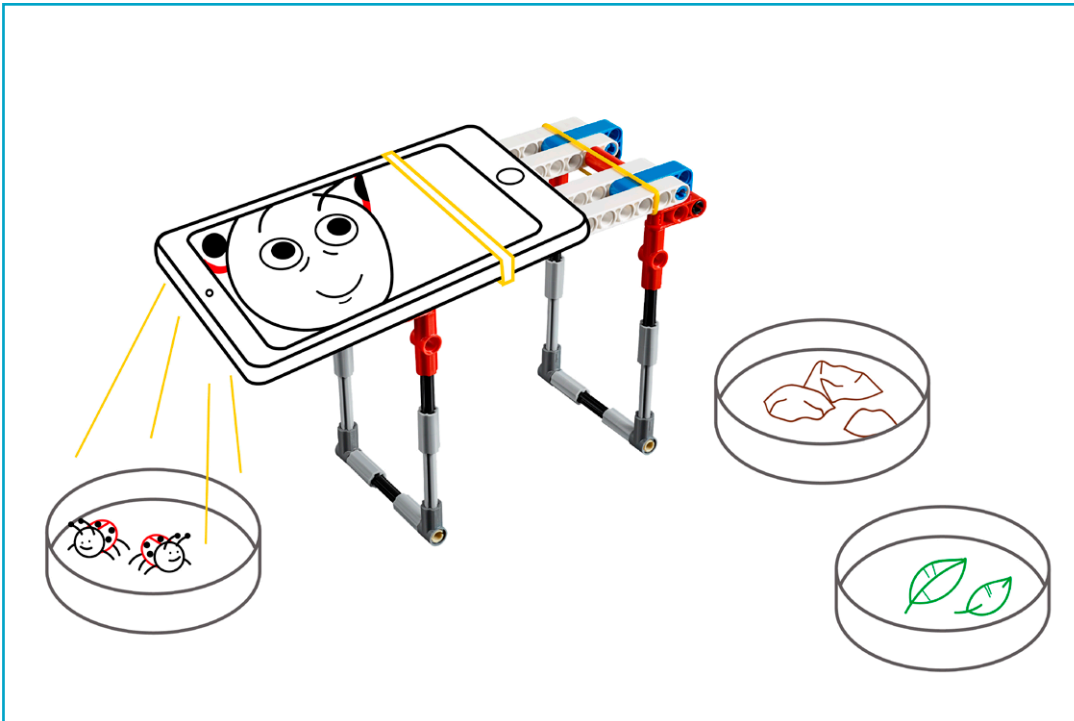

3. Make a Sloth Car

Can you think of situations in which it is important to move slowly? What if there was a special car race where the slowest car was the winner? What would you need to build to make it go slow? How could you use gears to slow rotation and speed?

Make a car that moves at the speed of a sloth.

Possible Solution

Note: To encourage maximum creativity, you may choose not to share this image with students.

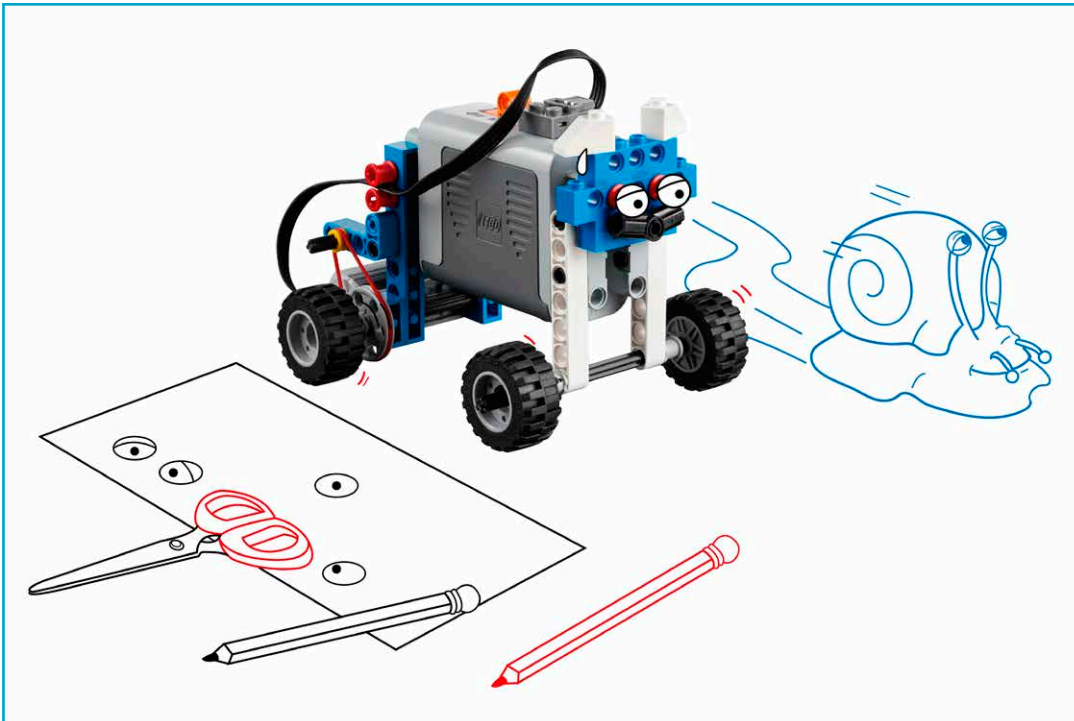

4. Make a Carnival Game

Can you think of some carnival games? How do they work? Do simple machines and mechanisms work together? How? What type of game would you most like to play? Would it use simple machines, a motorized mechanism, or both?

Make a fun carnival game.

Possible Solution

Note: To encourage maximum creativity, you may choose not to share this image with students.

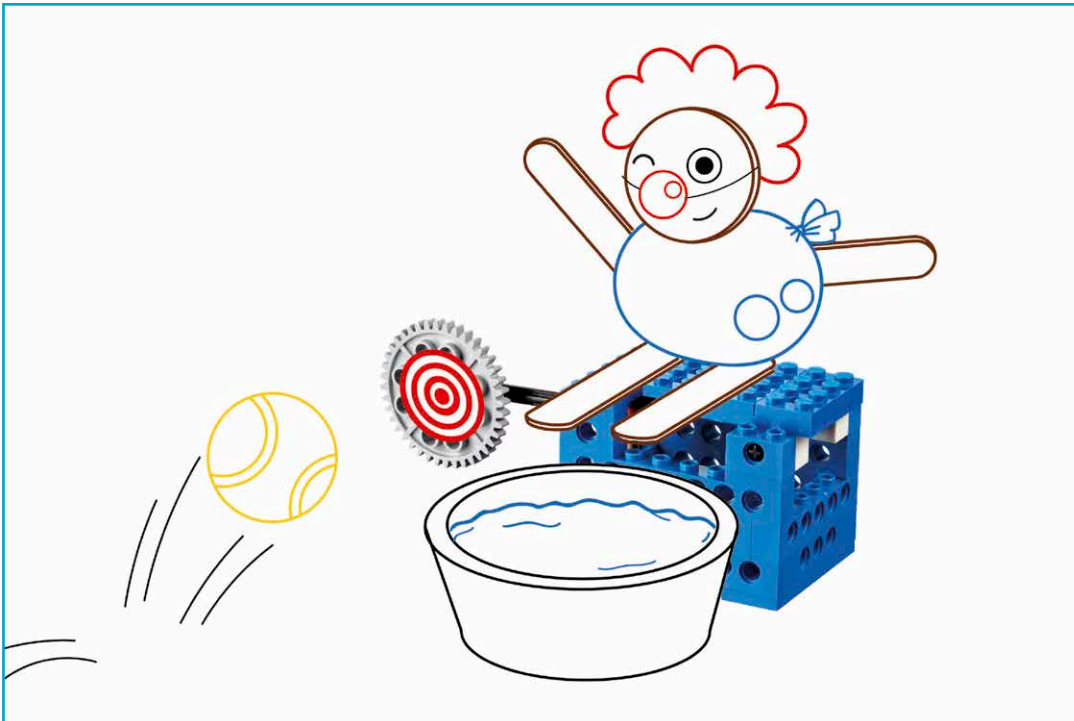

5. Make a Chain Reaction

What is a chain reaction? How many parts does it need to have? How do the parts work together? By gravity? Using a moving element? What type of chain reaction would you most like to see? How many steps would it have? How would it end?

Make a chain reaction that works on its own or together with other classmates' inventions.

Possible Solution

Note: To encourage maximum creativity, you may choose not to share this image with students.

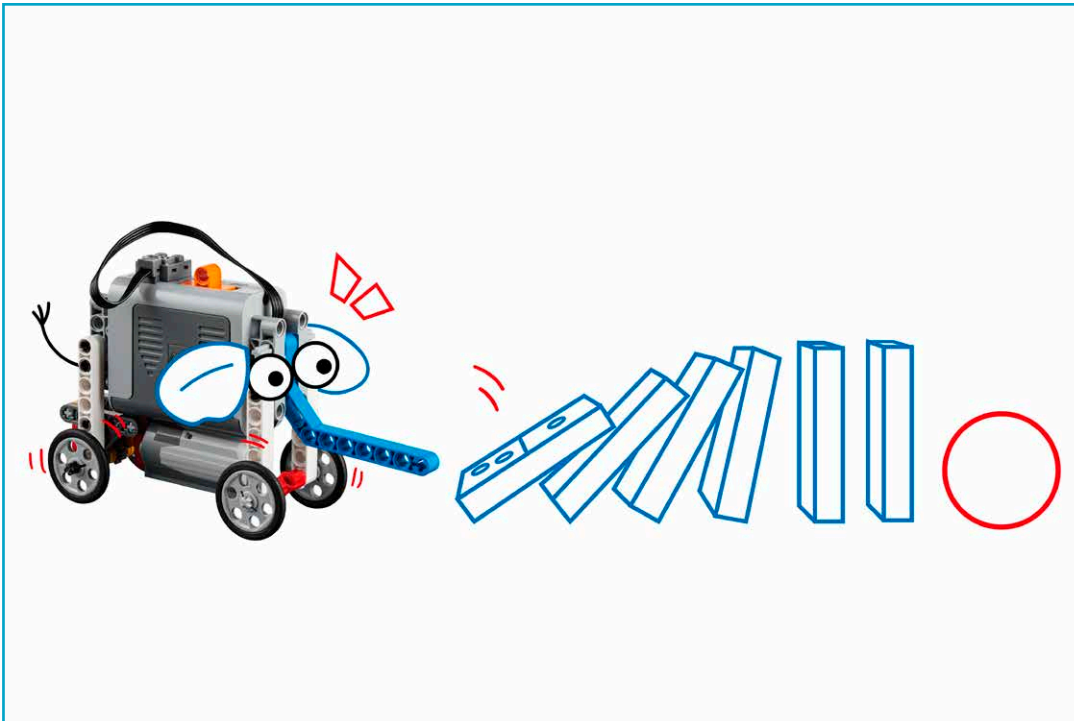

6. Make an Animation Machine

What is an animation? How do you think animations were made before computers? What simple machines can be used to make a moving picture or animation?

Make a machine that can make images move to create an animation.

Possible Solution

Note: To encourage maximum creativity, you may choose not to share this image with students.

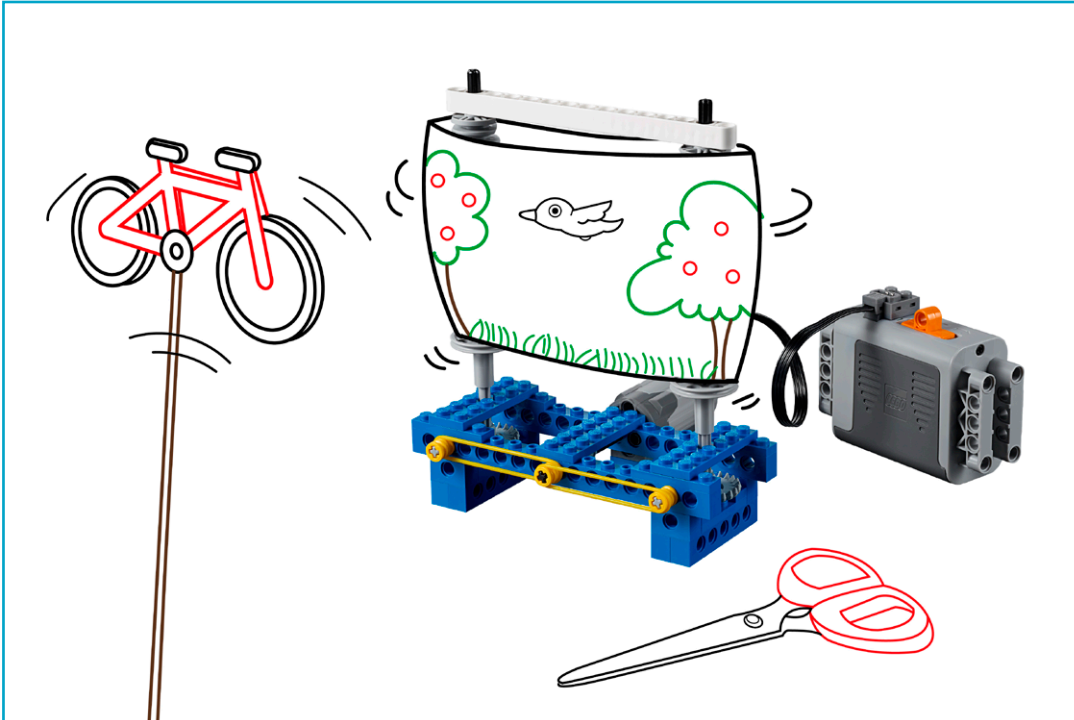

7. Make a Mechanical Toy Animal

Have you ever seen a mechanical toy animal? What type of animal was it? Which parts of the animal moved? How do you think they were made? What type of mechanical toy animal would you most like to see? How would it behave?

Make a mechanical toy animal.

Possible Solution

Note: To encourage maximum creativity, you may choose not to share this image with students.

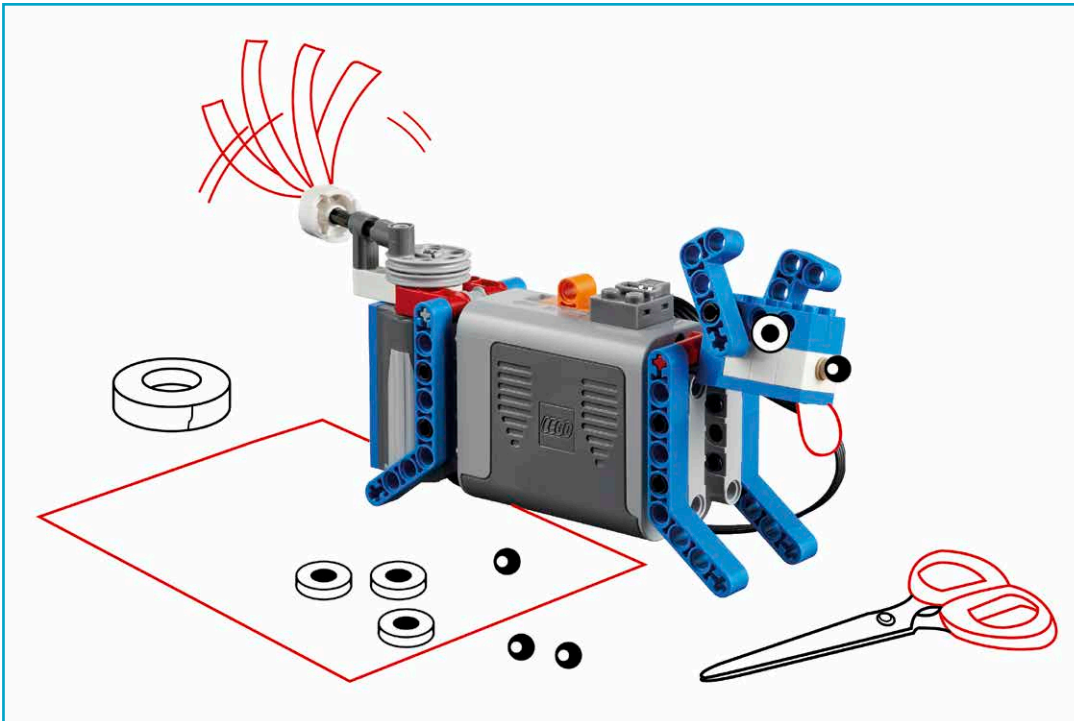

8. Make a Household Helper

What type of invention might make your life easier at home? Do you need help cleaning your room, or washing the dishes? Is your bedroom door not staying open or closed? Do you need more privacy? What else do you need help with?

Make an invention to help you around the house.

Possible Solution

Note: To encourage maximum creativity, you may choose not to share this image with students.

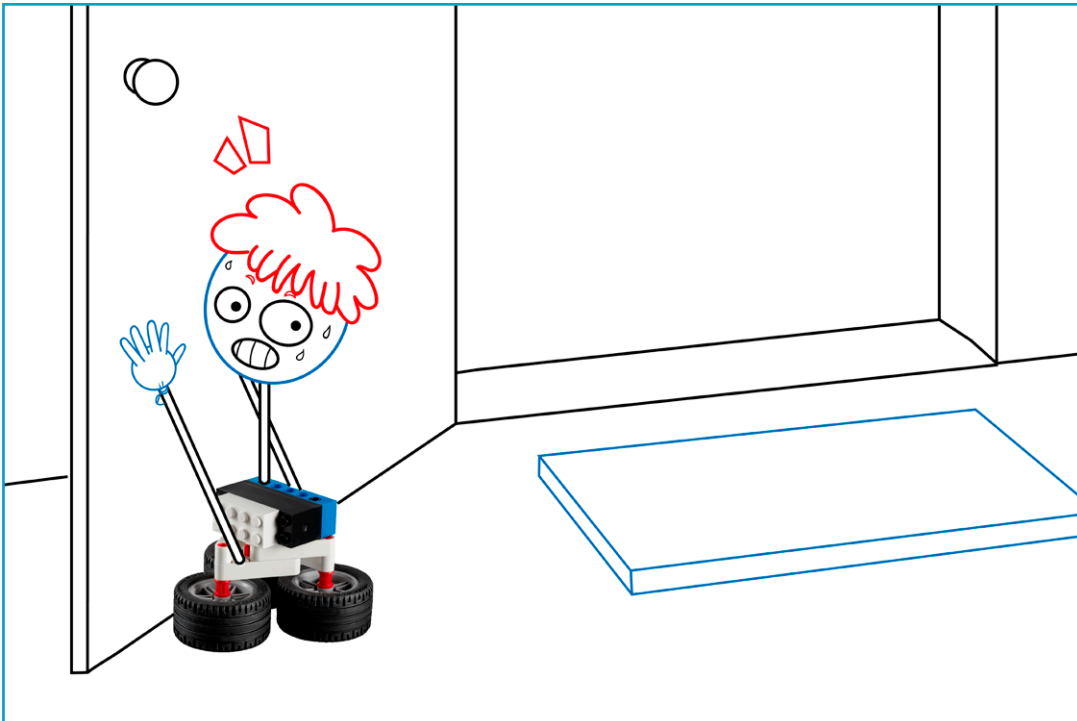

9. Make a Simple Machine to Move Something

How can you safely move heavy things? What are some simple machines that can help you? Have you ever seen or used a wheelbarrow, medical stretcher, or ski-lift?

Make a simple machine that can move things from one place to another.

Possible Solution

Note: To encourage maximum creativity, you may choose not to share this image with students.

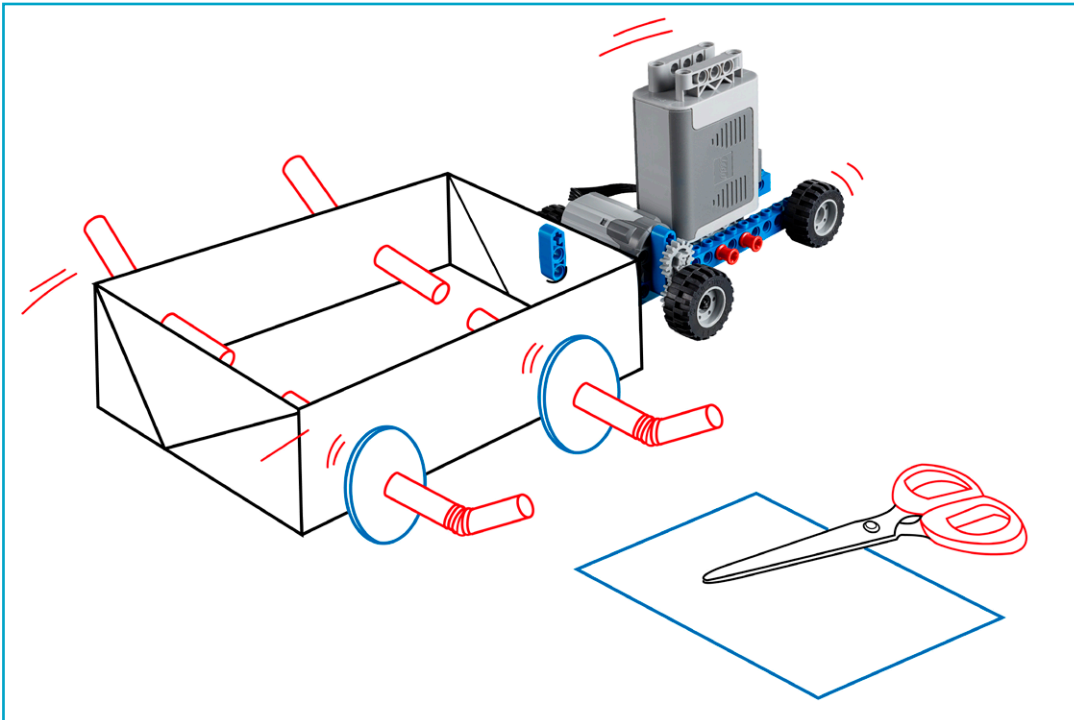



Student Worksheet for your own MAKER project

Name(s): _____ Date: _____

Defining the Problem

What problems can you see in the pictures? Pick one problem and explain it below.

Brainstorm

Individual work: Now that you have defined a problem, take three minutes to generate ideas for solving it. Be prepared to share your ideas with your group.

Group work: Share and discuss your ideas for solving the problem.



Documenting your work is very important during the design process. Record as much as you can through sketches, photos and notes.



Use LEGO® bricks and sketches to explore your ideas.



Sometimes simple ideas are the best ideas.



Define the Design Criteria

You should have generated a number of ideas. Now select the best one to make.

Based upon your brainstorming discussion, write down two or three specific design criteria that your design must meet:

1. _____
2. _____
3. _____

Go MAKE

It is time to start making. Use the components from the LEGO® set to make your chosen solution. Test and analyse your design as you go and record any improvements that you make.

Review and Revise Your Solution

Have you managed to solve the problem that you defined at the beginning of the lesson? Look back at your three design criteria.

How well does your solution work? Use the space below to suggest three improvements to your design.

1. _____
2. _____
3. _____

Communicate Your Solution

Now that you have finished, make a sketch or take a photo of your model, label the three most important parts, and explain how they work. You are now ready to present your solution to the class.

Assessment

				
GOALS	BRONZE	SILVER	GOLD	PLATINUM
MAKER Task: _____ _____	• We successfully built and tested one design based upon a single design criteria and design idea.	• We successfully used two design criteria and ideas to build a solution to the defined problem.	• We met Silver, and refined our idea to improve it further through testing, revising, and retesting.	• We met Gold, and successfully met all three design criteria.
Designing Solutions	<input type="checkbox"/>	<input type="checkbox"/>	<input type="checkbox"/>	<input type="checkbox"/>

Well done! What will you make next?

Design criteria example:
The design must...
The design should...
The design could...



You can use other materials from around the classroom.



Print your photos and attach all of your work to a large sheet of paper or cardboard.



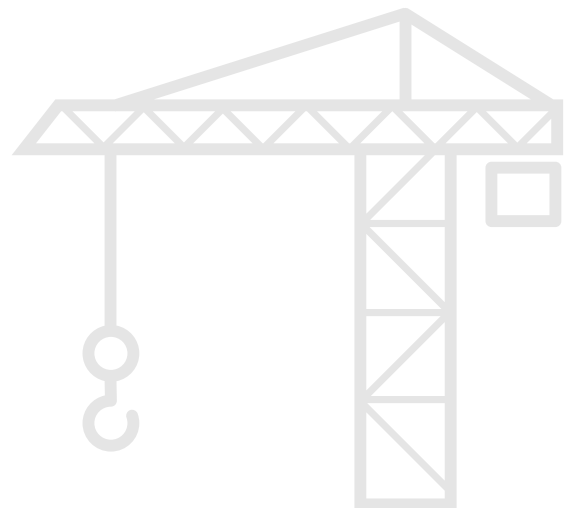

LEGO and the LEGO logo are trademarks of the/son des marques de commerce
du/son marcas registradas de LEGO Group. ©2018 The LEGO Group. 20170510V2

LEGOeducation.com



education