

BYTE

JULY 1988

A MCGRAW-HILL PUBLICATION

REVIEWS

OS/2 Alternatives:
VM/386 and
Concurrent DOS 386
Five Fast ATs
Colorvue SE
ProBas
NewSpace



PRODUCT FOCUS
Fast 40-Mb Hard Disks

Sun's 386i: Workstation performance in a PC box

- 25-MHz speed • "Open Look" Unix
- Multitasking • DOS compatibility
- High-resolution graphics • Network-ready



FIRST IMPRESSION

IBM's OS/2 Extended Edition

PLUS

6 Short Takes
Write Your Own TSRs
Europe's "Viper" Chip
ISDN
Circuit Cellar

IN DEPTH

Multitasking

BORLAND PRESENTS

THE ADVENTURES OF **TURBOMAN**

**“Fastest and most approachable
implementation of that language”**

—Darryl Rubin, AI Expert, on Turbo Prolog

**“Most powerful
version of Basic ever”**

—Ethan Winer, PC Magazine, on Turbo Basic

**And able to leap
onto “new ground in the
price/performance arena”**

*—John H. Mayer, Computer Design,
on Turbo C*



See the technological
excellence of Turbo C,
Turbo Pascal and
Turbo Basic!

Meet Turbo Prolog 2.0:
Artificial Intelligence like
you've never seen it!

BORLAND



Turbo Prolog 2.0: Powerful Artificial Intelligence for your real-world applications!



New Turbo Prolog® 2.0 lets you harness powerful AI techniques. And you don't have to be an expert programmer or artificial intelligence genius!

You get an all-new Prolog compiler that's been optimized to produce smaller and more efficient programs than ever before. An improved full-screen, completely customizable editor with easy pull-down menus. All-new documentation, including a tutorial rich with examples and instructions to take you all the way from basic programming to advanced techniques. Even online help!

System Requirements For the IBM PS/2™ and the IBM® family of personal computers and all 100% compatibles. PC-DOS (MS-DOS) 2.0 or later. 384K RAM.

More new features!

- An external database system for developing large databases. Supports B+ trees and EMS
- Source code for a fully-featured Prolog interpreter written entirely in Turbo Prolog. Plus step-by-step instructions to adapt it or include it as is in your own applications!
- Support for the Borland Graphics Interface, the same professional-quality graphics in Turbo Pascal, Turbo C, and Quattro
- Improved windowing
- Powerful exception handling and error trapping features
- Full compatibility with Turbo C so the two languages can call each other freely
- Supports multiple internal databases
- High-resolution video support

Just \$149.95!

60-Day Money-back Guarantee †

For the dealer nearest you
Call (800) 543-7543

Turbo Prolog Toolbox is 6 toolboxes in one!

More than 80 tools and 8,000 lines of source code help you build your own Turbo Prolog applications. Includes toolboxes for menus, screen and report layouts, business graphics, communications, file-transfer capabilities, parser generators, and more!

Toolbox requires Turbo Prolog 2.0

Just \$99.95

“ If I had to pick one single recommendation for people who want to try to keep up with the computer revolution. I'd say, 'Get and learn Turbo Prolog.' ”

—Jerry Pournelle, *Byte* 1/88

An affordable, fast, and easy-to-use language.

—Darryl Rubin, *AI Expert* ”



The Critics Agree: Borland's

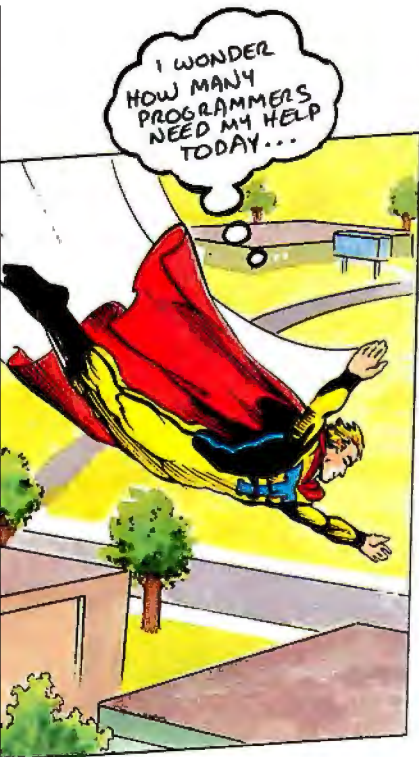

“Turbo C ... will stun you with in-RAM compilations that operate at warp speed.”

—Richard Hale Shaw, *PC Magazine*



Turbo C's® sleek compiler is so fast and powerful, we used it to write our equation solver, Eureka.™ Even better, all that muscle is wrapped in a smooth,

integrated environment with everything you need to make writing, editing and compiling your programs a snap:

- Compiles 10,000 lines per minute*
- Online, context-sensitive help
- ANSI compatible
- Six memory models—tiny to huge
- 450 library functions
- Utilities: Librarian, Make, GREP
- Source code for MicroCalc spreadsheet
- Command-line version of the compiler
- Inline assembly that lets you mix C and assembler

- Professional-quality graphics library supporting VGA, CGA, EGA, Hercules, and IBM 8514
- Interfaces with Turbo Pascal 4.0 and Turbo Prolog

Just \$99.95

“A lightning fast, fully featured C compiler suitable for almost everything ... Borland's Turbo C compiler is flexible, fast and friendly.”

—Peter Feldman, *PC Week* ”

Heap Sort

	<i>Turbo C 1.5</i>	Microsoft C 5.0
Compile time	4.7 sec.	16.3 sec.
Compile & link time	7.4 sec.	19.5 sec.
Execute time	10.5 sec.	15.5 sec.
Object code size	1119	1313
Execution size	6392	7891

Sort benchmark run on a 8 MHz IBM AT using Turbo C version 1.5 and the Turbo Linker version 1.1; Microsoft C version 5.0 and the MS overlay Linker version 3.61.

“Turbo Pascal 4.0 flies 4.0 is ballistic!” —Tom Swan,



Almost from its introduction, Turbo Pascal® has been the world-wide Pascal standard. It's fast. It's flexible. It's affordable. And it

gives you full control.

Compile more than 27,000 lines of code per minute*. And work in a complete, integrated programming environment with pull-down menus and a full-featured editor.

You don't have to swap code in and out to beat the 64K barrier; it's designed for large programs. Break your code into convenient modules and work with them swiftly and separately. If there's an error in one, you can see it and fix it.

System Requirements For the IBM PS/2™ and the IBM® family of personal computers and all 100% compatibles. PC-DOS (MS-DOS) 2.0 or later. 384K RAM.

† Customer satisfaction is our main concern: if within 60 days of purchase this product does not perform in accordance with our claims, call our customer service department, and we will arrange a refund.

System Requirements For the IBM PS/2™ and the IBM® family of personal computers and all 100% compatibles. PC-DOS (MS-DOS) 2.0 or later. 384K RAM.

All Borland products are trademarks or registered trademarks of Borland International, Inc. Other brand and product names are trademarks of their respective holders. Copyright © 1988 Borland International, Inc. BI 123#A

Turbo Languages are Super!

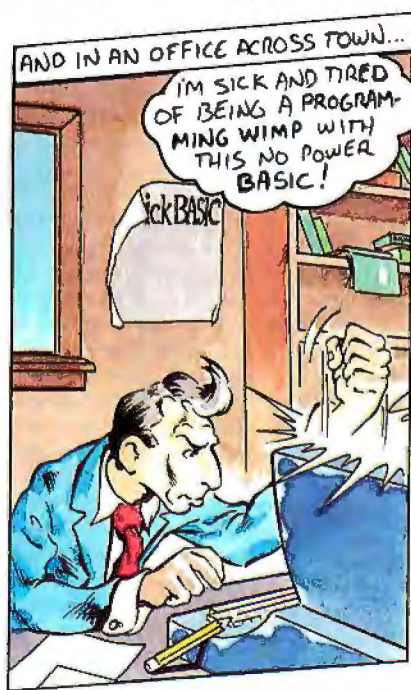

like a rocket ...

“Turbo Basic compiles faster than anything I have seen.” —Ethan Winer, PC Magazine

1987 Programmer's Journal

Powerful features include:

- Producing EXE files
- Separate compilation
- Built-in project management
- Graph unit including support for IBM CGA, EGA, VGA, and 3270, Hercules and ATT 6300
- Online, context-sensitive help

*Run on an 8 MHz IBM PC AT.

Add expertise:

The Turbo Pascal Toolboxes

Start with Turbo Pascal Tutor for just \$69.95 and add the others as your interests and expertise grow:

- Database Toolbox
- Editor Toolbox
- Graphix Toolbox
- Numerical Methods Toolbox
- GameWorks

Toolboxes require Turbo Pascal 4.0

Just \$99.95 each

“Each new Turbo Pascal 4.0 Toolbox is a virtual treasure of programming methods and tips.

—Giovanni Perrone, PC Week”

Circle 34 on Reader Service Card
(DEALERS: 35)



Turbo Basic® is the lightning-fast Basic compiler with a total development environment that puts you in full control. Even novices can

write professional programs with Turbo Basic's full-screen windowed editor, pull-down menus, and trace debugging system. You also get a long list of innovative Borland features like binary disk files, true recursion, and increased compilation control. Plus the ability to create programs as large as your system's memory can hold—not just a cramped 64K.

The choice is basic: Turbo Basic!

Just \$99.95!

“Turbo Basic, simply put, is an incredibly good product . . . Not only is this the most advanced BASIC ever, but Borland has lived up to its Turbo tradition.

—William Zachmann, Computerworld”

Add another Basic advantage:
The Turbo Basic Toolboxes

- The Database Toolbox
- The Editor Toolbox

Toolboxes require Turbo Basic 1.1

Just \$99.95 each.

System Requirements For the IBM PS/2™ and the IBM® family of personal computers and all 100% compatibles. PC-DOS (MS-DOS) 2.0 or later. 384K RAM. 640K to compile toolboxes.

Compare the BASIC differences

	Turbo Basic 1.1	QuickBASIC 4.0 Compiler	QuickBASIC 4.0 Interpreter
Compile & Link to stand-alone EXE	3 sec.	7 sec.	---
Size of .EXE	28387	25980	---
Execution time w/80287	0.16 sec.	16.5 sec.	21.5 sec.
Execution time w/o 80287	0.16 sec.	286.3 sec.	292.3 sec.

The Elkins Optimization Benchmark program from March 1988 issue of Computer Language was used. The Program was run on an IBM PS/2 Model 60 with 80287. The benchmark tests compiler's ability to optimize loop-invariant code, unused code, expression and conditional evaluation.

BYTE

JULY 1988 VOLUME 13 NUMBER 7

PRODUCTS IN PERSPECTIVE

67 What's New

89 Short Takes

Dell System 310, a fast 80386 machine

UR/Forth 1.10, Forth under OS/2
SoftPC, emulates an IBM PC XT
in software

EasyTalk, souping up
the Toshiba laptop

GrandView, for planning
and project managing

Forget-Me-Not, a calendar/timer
TSR program



Cover Story:
Sun 386i/103

FIRST IMPRESSIONS

103 Sun's Newest Workstation: the Sun386i

by Tom Thompson

A microcomputer workstation
that has Unix multitasking with
a window-based interface,
and can run several virtual
MS-DOS PCs.

111 IBM's OS/2 Extended Edition

by Rich Malloy

All the features of the Standard
Edition, plus its own
database manager and an array
of communications interfaces.

REVIEWS

118 Product Focus: Fast Drives for Modern Times

by Stan Miastkowski

40-megabyte hard disks are
becoming standard equipment.

134 Outclassing the AT

by John Unger and Stan
Miastkowski

A look at the strengths and
weaknesses of systems from
Amdek, Arche Technologies,
Epson, Leading Edge,
and PC's Limited.

147 Seeing Colors on the Mac SE

by Don Crabb

With the ColorVue SE, the Mac
SE shows its true colors.

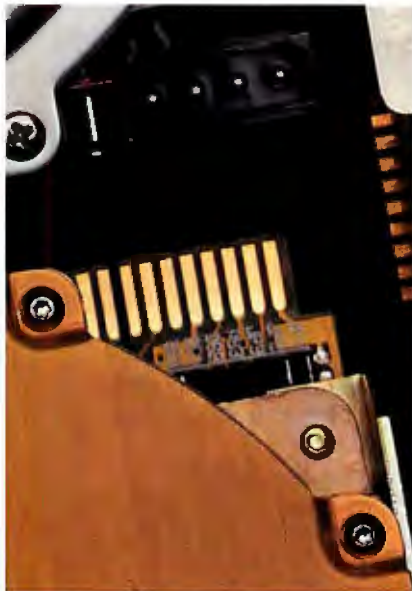

Product Focus/118



Graphic Design for the PC AT/181

155 VM/386: A Virtual Solution

by Namir Clement Shammass

A multitasking program manager
for 80386-based machines.

163 Concurrent DOS 386

by Alex Lane

This multitasking operating
system also supports additional
terminals.

173 A Supercharger for BASIC Compilers

by Namir Clement Shammass

ProBas subroutines add speed
and power to Microsoft BASIC.

181 Graphic Design for the PC AT

by Lamont Wood

Designer bridges the worlds of
drawing and bit-mapped images.

189 Need Some Space?

by Diana Gabaldon

Increase the capacity of your hard
disk with NewSpace.

COLUMNS

197 Computing at Chaos Manor: Dr. Pournelle vs. the Virus

by Jerry Pournelle

Jerry observes the West Coast
Computer Faire and gives
a prescription.

211 Applications Only:

From Shareware to Hyperware

by Ezra Shapiro

Ezra looks at MindReader,
PC-Write, the Pointing Device
Adapter, XHELP, and HyperDA.

217 Some Assembly Required: The Pitfalls of Porting, Part 1

by Rick Grehan

Our newest column illustrates
the programming techniques
that underlie today's and
tomorrow's software, and gives
you lots of useful, hands-on
code besides.



EasyTalk/92

IN DEPTH

- 226 Introduction: Multitasking**
- 229 Fair Share**
by *Jonathan Robie*
However you choose to implement it, resource sharing provides more efficient use of your system.
- 239 It's a Natural**
by *Bud E. Smith*
From virtual memory to virtual machines, the 80386 is designed for the multitasking world.
- 251 Weighing the Options**
by *Brett Glass*
A look at the inner workings of multitasking systems, and a comparison of products currently available.
- 259 First Come, First Served**
by *Michael Benjamin Parker*
With Mailbox, you can write multitasking programs that you can port to many different machines and operating systems.
- 274 Resource Guide**



Multitasking/226

FEATURES

- 278 The Ultimate Link?**
by *Jay Duncanson and Joe Chew*
ISDN—a new technology that could change the way we use computers and telephones.
- 289 Ciarcia's Circuit Cellar: Computers on the Brain, Part 2**
by *Steve Ciarcia*
A look at the system software and some directions for HAL's use.
- 301 A Turbo TSR**
by *Scott Robert Ladd*
Turbo Pascal has everything you need to craft your own TSRs.
- 305 Fast Track vs. Failsafe**
by *Dick Pountain*
It may not be as fast as other RISC chips, but VIPER's error-free design could be a life-and-death matter at Mach 3.



The Ultimate Link/278

DEPARTMENTS

- 6** Editorial: Dribbleware
11 Microbytes
22 Letters
35 Chaos Manor Mail
38 Ask BYTE
51 Book Reviews
351 Coming Up in BYTE

READER SERVICE

- 350** Editorial Index by Company
352 Alphabetical Index to Advertisers
354 Index to Advertisers by Product Category
Inquiry Reply Cards: after **356**

PROGRAM LISTINGS

From BIX: see **298**
From BYTeNet:
call (617) 861-9764
On disk or in print:
see card after **324**

BYTE (ISSN 0360-5280) is published monthly with an additional issue in October by McGraw-Hill Inc. Founder: James H. McGraw (1860-1948). Executive, editorial, circulation, and advertising offices: One Phoenix Mill Lane, Peterborough, NH 03458, phone (603) 924-9281. Office hours: Monday through Thursday 8:30 AM-4:30 PM, Friday 8:30 AM-1:00 PM, Eastern Time. Address subscriptions to BYTE Subscriptions, P.O. Box 7643, Teaneck, NJ 07666-9866. Postmaster: Send address changes, USPS Form 3579, undeliverable copies, and fulfillment questions to BYTE Subscriptions, P.O. Box 7643, Teaneck, NJ 07666-9866. Second-class postage paid at Peterborough, NH 03458 and additional mailing offices. Postage paid at Winnipeg, Manitoba. Registration number 9321. Subscriptions are \$22 for one year, \$40 for two years, and \$58 for three years in the U.S. and its possessions. In Canada and Mexico, \$25 for one year, \$45 for two years, \$65 for three years. \$69 for one-year air delivery to Europe. 31,000 yen for one-year air delivery to Japan, 15,600 yen for one-year surface delivery to Japan, \$37 surface delivery elsewhere. Air delivery to selected areas at additional rates upon request. Single copy price is \$3.50 in the U.S. and its possessions, \$4.25 in Canada and Mexico, \$4.50 in Europe, and \$5 elsewhere. Foreign subscriptions and sales should be remitted in U.S. funds drawn on a U.S. bank. Please allow six to eight weeks for delivery of first issue. Printed in the United States of America.

Address editorial correspondence to: Editor, BYTE, One Phoenix Mill Lane, Peterborough, NH 03458. Unacceptable manuscripts will be returned if accompanied by sufficient postage. Not responsible for lost manuscripts or photos. Opinions expressed by the authors are not necessarily those of BYTE.

Copyright © 1988 by McGraw-Hill Inc. All rights reserved. Trademark registered in the United States Patent and Trademark Office. Where necessary, permission is granted by the copyright owner for libraries and others registered with the Copyright Clearance Center (CCC) to photocopy any article herein for the flat fee of \$1.50 per copy of the article or any part thereof. Correspondence and payment should be sent directly to the CCC, 29 Congress St., Salem, MA 01970. Specify ISSN 0360-5280/83, \$1.50. Copying done for other than personal or internal reference use without the permission of McGraw-Hill Inc. is prohibited. Requests for special permission or bulk orders should be addressed to the publisher. BYTE is available in microform from University Microfilms International, 300 North Zeeb Rd., Dept. PR, Ann Arbor, MI 48106 or 18 Bedford Row, Dept. PR, London WC1R 4EJ, England.



Subscription questions or problems should be addressed to: BYTE Subscriber Service, P.O. Box 7643, Teaneck, NJ 07666-9866.

BYTE

EDITOR IN CHIEF
Frederic S. Langa

PUBLISHER/GROUP VICE PRESIDENT
J. Burt Totaro

OPERATIONS
Glenn Hartwig *Associate Managing Editor*

REVIEWS (Hardware, Software, Product Focus)
Cathryn Baskin *Associate Managing Editor*, Dennis Allen *Senior Technical Editor, Software*, Curtis Franklin Jr. *Senior Testing Editor, BYTE Lab*, Stephen Apiki *Testing Editor, BYTE Lab*, Stanford Diehl *Testing Editor, BYTE Lab*

NEWS AND TECHNOLOGY (Microbytes, What's New, Short Takes)
Rich Malloy *Associate Managing Editor*, D. Barker *Senior Editor*, News and Technology, Anne Fischer *Lent Senior Editor, New Products*
Peterborough: Roger Adams *Associate News Editor*, David Andrews *Associate News Editor*, Martha Hicks *Associate News Editor*
West Coast: Gene Smarte *Bureau Chief*, Costa Mesa, Nicholas Baran *Technical Editor*, San Francisco, Frank Hayes, *Associate News Editor*, Jeffrey Bertolucci *Editorial Assistant*, San Francisco

SENIOR TECHNICAL EDITORS
Ken Sheldon *Features*, Jane Morrill *Tazelaar In Depth*, Richard Grehan *At Large*, Tom Thompson *At Large*

TECHNICAL EDITORS
Janet J. Barron, Eva M. White, Stanley Wszola

ASSOCIATE TECHNICAL EDITOR
Robert Mitchell

CONSULTING EDITORS
Steve Ciarcia, Jerry Pournelle, Ezra Shapiro

CONTRIBUTING EDITORS
Jonathan Amsterdam *Programming Projects*, Mark Dahmke *Video*, Operating Systems, Mark Haas *At Large*, Rik Jadrnick *CAD, Graphics, Spreadsheets*, Robert T. Kurosaka *Mathematical Recreations*, Alastair J. W. Mayer *Software*, Stan Miastkowski *New Technology*, Alan R. Miller *Languages and Engineering*, Dick Pountain *Algorithms*, Roger Powell *Computers and Music*, Phillip Robinson *Semiconductors*, Jon Shiell *High-Performance Systems*, Ernest Tello *Artificial Intelligence*

COPY EDITORS
Lauren Stickler *Chief*, Susan Colwell, Judy Connors-Tenney, Jeff Edmonds, Nancy Hayes, Cathy Kingery, Margaret A. Richard, Warren Williamson

EDITORIAL ASSISTANTS
Peggy Dunham *Office Manager*, Linda C. Ryan, June N. Sheldon, Lynn Susan Valley

ART
Nancy Rice *Director*, Joseph A. Gallagher *Assistant Director*, Jan Muller *Assistant*, Alan Easton *Technical Artist*

PRODUCTION
David R. Anderson *Director*, Virginia Reardon *Senior Editorial Production Coordinator*, Denise Chartrand *Editorial Production Coordinator*, Michael J. Lonsky *Editorial Production Coordinator*

TYPOGRAPHY
Sherry Fiske *Systems Manager*, Donna Sweeney *Applications Manager*, Sellinda Chiquoine, Christa Patterson

ADVERTISING/PRODUCTION (603) 924-6448
Lisa Wozmak *Director*, Lyda Clark *Senior Account Coordinator*, Karen Cilley, Linda Fluhr, Jeanne Gatcombe, Brian Higgins, Rod Holden, Wai Chiu Li *Quality Control Manager*, Julie Murphree *Advertising/Production Coordinator*

ADMINISTRATION
Beverly Goss *Publisher's Assistant*

MARKETING COMMUNICATIONS
Horace T. Howland *Director*, Pamela Petrakos-Wilson *Promotion Manager*, Wilbur S. Watson *Marketing Services Manager*, Dawn Matthews *Marketing Events Coordinator*, Lisa Jo Steiner *Marketing Assistant*, Stephanie Warnesky *Marketing Art Director*, Sharon Price *Associate Art Director*, Julie Perron *Market Research Analyst*

PLANNING AND RESEARCH
Michele Perron *Director*
Faith Kluntz *Copyrights Coordinator*, Cynthia Damato *Sands Reader Service Coordinator*

FINANCIAL SERVICES
Phillip L. Penny *Director of Finance and Services*, Kenneth A. King *Business Manager*, Christine Monkton *Assistant*, Marilyn Haigh, Diane Henry, JoAnn Walter, Jaime Huber

CIRCULATION
Dan McLaughlin *Director*
James Bingham *Newsstand Sales Manager*, Vicki Weston *Assistant Manager*, Karen Desroches *Distribution Coordinator*, Donna Healy, *Direct Accounts Coordinator*, Louise Menegus *Back Issues*

PERSONNEL
Patricia Burke *Personnel Coordinator*

BUILDING SERVICES
Tony Bennett *Manager*, Cliff Monkton, Mark Monkton, Agnes Perry

BIX BYTE INFORMATION EXCHANGE

ACTING DIRECTOR
Edward A. Reno Jr.

EXECUTIVE EDITOR
George Bond

ASSOCIATE EDITORS
Tony Lockwood, Donna Osgood *San Francisco*

MICROBYTES DAILY
D. Barker *Coordinator*, Peterborough, Rich Malloy *New York*, Gene Smarte *Bureau Chief*, Costa Mesa, Nicholas Baran *San Francisco*, Rick Cook *Phoenix*, Frank Hayes *San Francisco*, Martha Hicks *Peterborough*, Anne Fischer *Lent Peterborough*, Larry Loeb *Wallingford, CT*, Brock N. Meeks *La Mesa, CA*, Jeff Marron *Peterborough*, Stan Miastkowski *Peterborough*, Wayne Rash Jr. *Washington, DC*, David Reed *Lexington, KY*

GROUP MODERATORS
David Allen *Applications*, Frank Boosman *Artificial Intelligence*, Leroy Casterline *Other*, Marc Greenfield *Programming Languages*, Jim Howard *Graphics*, Gary Kendall *Operating Systems*, Steve Krenek *Computers*, Brock N. Meeks *Telecommunications*, Barry Nance *New Technology*, Donald Osgood *Computers*, Sue Rosenberg *Other*, Jon Swanson *Chips*

BUSINESS AND MARKETING
Doug Webster *Director (603) 924-9027*, Patricia Bausum *Secretary*, Denise A. Greene *Customer Service*, Brian Warnock *Customer Service*, Tammy Burgess *Customer Credit and Billing*

TECHNOLOGY
Clayton Lisle *Director*, Business Systems Technology, MHI/S, Bill Garrison *Senior Business Systems Analyst*, Jack Reilly *Senior Business Systems Analyst*, Bob Dorobis *Business Systems Analyst*, Fred Strauss *Senior Business Systems Analyst*

ADVERTISING SALES
Dennis J. Riley *Director*, (603) 924-6261
Sandra Foster *Administrative Assistant*

NEW ENGLAND
ME, NH, VT, MA, RI, ONTARIO, CANADA & EASTERN CANADA
John C. Moon (617) 262-1180

ATLANTIC
NY, NYC, CT, NJ (NORTH)
Leah G. Rabinowitz (212) 512-2088
Dick McGurk (203) 988-7111

EAST
PA, KY, OH, NJ (SOUTH), MD, VA, W.VA, DE, DC
Daniel Ferro (215) 496-3633

SOUTHEAST
NC, SC, GA, FL, AL, TN
Carolyn F. Lovett (404) 252-0626

MIDWEST
IL, MO, KS, IA, ND, SD, MN, WI, NE, IN, MI, MS
Bob Denmead (312) 751-3740

SOUTHWEST, ROCKY MOUNTAIN
CO, WY, OK, TX, AR, LA
Karl Heinrich (713) 462-0757

SOUTH PACIFIC
SOUTHERN CA, AZ, NM, LAS VEGAS
Jack Anderson (714) 557-6292
Tom Harvey (213) 460-5243

NORTH PACIFIC
HI, WA, OR, ID, MT, NORTHERN CA, NV (except LAS VEGAS), UT, WESTERN CANADA
Mike Kissberth (415) 362-4600
Bill McAfee (415) 349-4100

TELEMARKETING
L. Bradley Browne *Director*
Susan Boyd *Administrative Assistant*

BYTE BITS (2x3)
Dan Harper (603) 924-6630

THE BUYER'S MART (1x2)
Mark Stone (603) 924-3754

REGIONAL ADVERTISING SECTIONS
MID-ATLANTIC, METRO NY & NEW ENGLAND, SOUTHERN CALIFORNIA, SOUTHEAST
Elisa Lister (603) 924-6630

MIDWEST, PACIFIC NORTHWEST, SOUTHWEST, METRO NY & NEW ENGLAND
Scott Gagnon (603) 924-9261

BYTE DECK MAILINGS
National
Ed Ware (603) 924-6166

A/E/C COMPUTING ENGINEERING COMPUTING FOR ENGINEERS DECK
Mary Ann Goulding (603) 924-9261

INTERNATIONAL ADVERTISING SALES STAFF
See listing on page 353.

EDITORIAL AND BUSINESS OFFICE:

One Phoenix Mill Lane, Peterborough, NH 03458, (603) 924-9281.
West Coast Branch Office: 425 Battery St., San Francisco, CA 94111, (415) 954-9718; 3001 Red Hill Ave., Building #1, Suite 222, Costa Mesa, CA 92626, (714) 557-6292.
New York Branch Editorial Office: 1221 Avenue of the Americas, New York, NY 10020, (212) 512-3175.
BYTEnet: (617) 861-9764 (set modem at 8-1-N or 7-1-E; 300 or 1200 baud). Fax: (603) 924-7507. Telex: (603) 924-7861.
SUBSCRIPTION CUSTOMER SERVICE: Non-U.S. (201) 837-1315; inside U.S. (outside NJ) 1-800-423-8272; (inside NJ) 1-800-367-0218.

Officers of McGraw-Hill Information Systems Company: President: Richard B. Miller. Executive Vice Presidents: Frederick P. Jannott, Construction Information Group; Russell C. White, Computers and Communications Information Group; J. Thomas Ryan, Marketing and International. Senior Vice Presidents—Publishers: Laurence Altman, Data Communications; David J. McGrath, Engineering News-Record. Group Vice Presidents: J. Burt Totaro, BYTE; Frank A. Shinal, Dodge; Vice Presidents: Robert D. Deleo, Controller; Fred O. Jensen, Planning and Development; Michael J. Koeller, Human Resources; Julia Lanard, Systems Planning and Technology.

Officers of McGraw-Hill Inc.: Joseph L. Dionne, Chairman and Chief Executive Officer; Robert N. Landes, Executive Vice President, General Counsel, and Secretary; Walter D. Serwatka, Executive Vice President and Chief Financial Officer; Shel F. Asen, Senior Vice President, Manufacturing; Robert J. Bahash, Senior Vice President, Finance and Manufacturing; Frank D. Penglaese, Senior Vice President, Treasury Operations; Ralph R. Schutz, Senior Vice President, Editorial.

BYTE and BYTE are registered trademarks of McGraw-Hill Inc.

HiWIRE™ Starts the Job that smARTWORK® Finishes

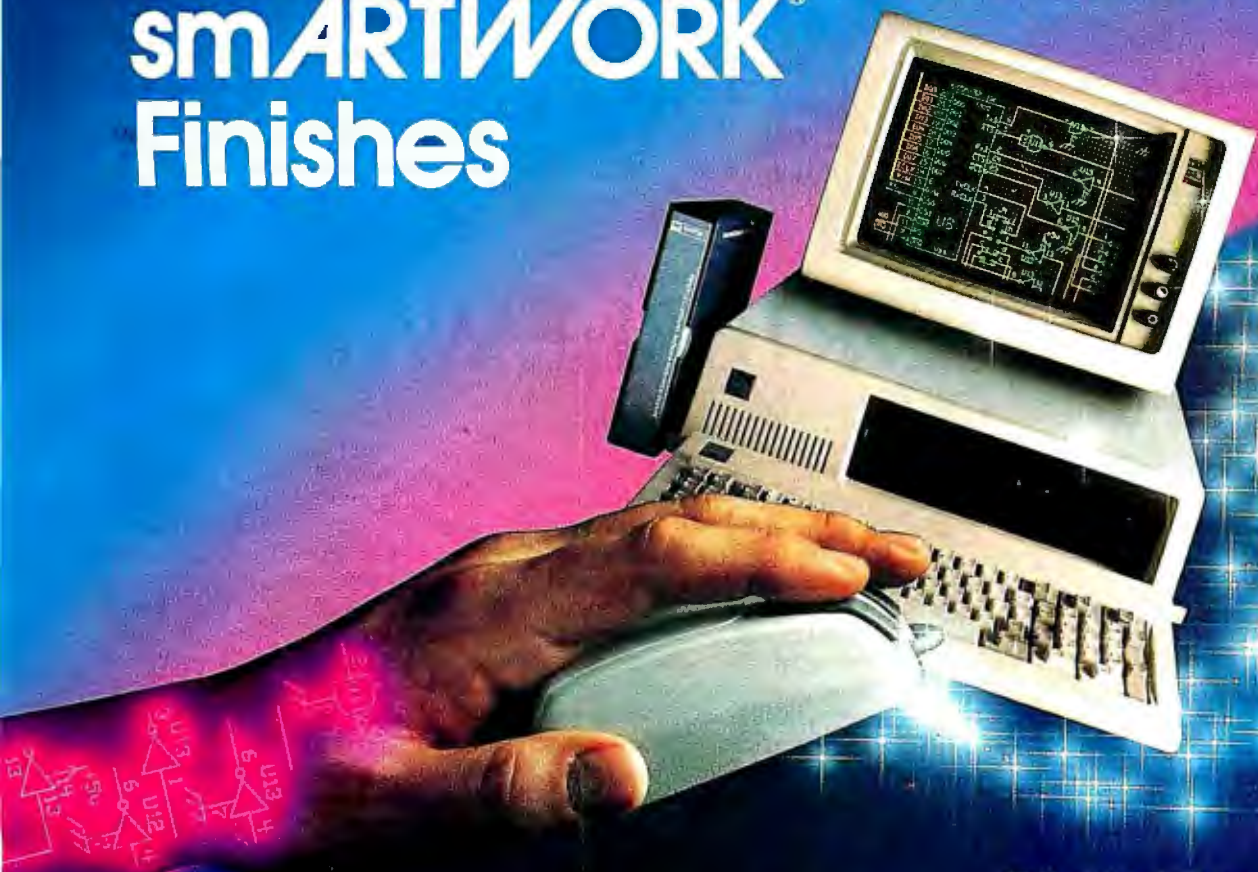

Introducing HiWIRE™

Wintek's smARTWORK® is used by thousands of engineers to design printed-circuit boards. Now Wintek introduces HiWIRE, an electronic-schematic program that is easy to learn and use.

With a click of the mouse button, you can extract symbols from our library of over 700 common components and connect them with wires and buses. You can also easily modify the library's symbols or create your own by combining labels, lines, and arcs.

HiWIRE Advantages

- Easy-to-learn mouse/menu-driven operation
- Complete documentation and tutorial
- Extensive TTL, CMOS, micro-processor, and discrete-component libraries
- Rubberbanding

- Moving, copying, mirroring, and rotating of symbols
- Text-string searching
- Multiple display windows
- High-quality schematics from printers and plotters
- Hierarchical-design support; netlist and bill-of-materials utilities
- Schematic/layout cross checking
- 800 number for free technical support

System Requirements

- IBM Personal Computer, PC XT, or PC AT with 320K RAM, parallel printer port, 2 disk drives, and DOS V2.0 or later
- IBM Color/Graphics Adapter or EGA with RGB color monitor
- Microsoft Mouse
- IBM Graphics Printer or Epson FX/MX/RX-series dot-matrix printer, and/or:

- Houston Instrument DMP-40, 41, 42, 51, 52 or Hewlett-Packard 7470, 7475, 7550, 7580, 7585, 7586 plotter

High Performance at Low Cost

At \$895, HiWIRE delivers quality schematics quickly and easily. You don't need to guess whether or not HiWIRE is right for you. Our money-back guarantee lets you try it for 30 days at absolutely no risk. Call (800) 742-6809 toll free today and put HiWIRE to work tomorrow.

Wintek Corporation
1801 South Street
Lafayette, IN 47904-2993
Telephone: (800) 742-6809
or in Indiana (317) 742-8428
Telex: 70-9079 WINTEK CORP UD



"HiWIRE" is a trademark, and "smARTWORK", "Wintek", and the Wintek logo are registered trademarks of Wintek Corporation.

DRIBBLEWARE

BYTE polls COMDEX attendees on which operating systems will become dominant

While we were at the Spring COMDEX in Atlanta, we asked attendees, "Which operating system will be dominant 5 years from now?" The answer we received was surprising—so surprising, in fact, that newspapers all over the country picked up the story. (You may have seen a brief summary in your local newspaper.) Here's the full story.

The poll was carefully worded to avoid stacking the deck one way or the other. For example, the ballot specifically named several prominent operating systems: the Macintosh's, DOS, OS/2, and two different flavors of Unix (traditional command-line Unixes and the new graphical-interface Unixes like "Open Look"). We also included an "other" category, so that respondents could name a less popular operating system.

We collected over 5000 ballots: OS/2 and DOS each garnered about 1600 votes, the Unixes captured roughly 1300, the Mac got a little over 200, and "other" racked up some 500 votes.

In plain terms, there was no winner. In a random poll such as this, variations of a few hundred votes are meaningless: It's fair to say that DOS, OS/2, and the Unixes finished in a dead heat.

The Mac's poor showing is not significant. Apple didn't exhibit at COMDEX, so I take the Mac's low numbers in the poll to be more indicative of Apple's absence rather than low confidence in the Mac as a viable machine. A poll at a MacWorld Expo would undoubtedly show MultiFinder and A/UX ranking among the contenders.

No Aberration

The poll results were borne out on the show floor, where there was no flood of OS/2 software (a COMDEX joke referred to the few true OS/2 programs as "dribbleware"). All the major software companies are working on OS/2 products, but much of the software being shown was very, very far from finished.

The general feeling at COMDEX was that OS/2 is indeed coming, but that it is likely to be *one of* the dominant operating systems rather than *the* dominant system. Why?

One answer lies in the large number of generally satisfactory alternatives to OS/2. For example, when I asked software developers what they were looking for in OS/2, the almost unanimous answer was "access to big memory," with multitasking a distant second, and Presentation Manager's graphical prowess an even more distant third.

Of course, Unix already offers multitasking and access to major-league memory. Such programs as Phar Lap's 386/DOS-Extender—and even the somewhat clunky Lotus/Intel/Microsoft 4.0 standard—also give you access to large memory; other alternatives like PC-MOS/386, VM/386, and Concurrent DOS 386 (the latter two are reviewed in this issue) let you multitask your current DOS programs. Also, programs like Windows give you a serviceable graphical interface without having to wait for Presentation Manager.

In some cases, you don't even need a DOS alternative, shell, or extender for extraordinary flexibility. As I write this, I'm also simultaneously downloading my morning BIX mail and messages while printing out my daily schedule. Simple multitasking like this is no big deal. All it takes is my word processor, a background telecommunications program, a print spooler, and plain old DOS 3.1.

Even at this point, you probably already can see why there's no clear winner in the operating-system wars. But it

gets even more muddled.

For example, there's the next upgrade of DOS waiting in the wings. It probably will overcome some of the fundamental limitations of the current DOS (like the 32-megabyte cap on hard disk size)—but the new DOS's file structure probably will be incompatible not only with current DOS, but with OS/2 as well.

It's a safe bet that Microsoft will also offer an 80386-specific version of OS/2—one not hampered by the 80286's internal limitations (like the inelegant and time-consuming "soft reboot" it uses to switch from protected to real mode).

Who's on First?

All this is confusing for end users and a nightmare for software developers. Instead of one or two or even three major standards, we're facing a future with up to a dozen viable ways to boot and run an Intel-family machine, plus at least three different ways to boot and run a Mac. And that's not even looking at the many excellent smaller operating systems.

That's why our poll shows no clear winners. For better or worse, you and I are going to have to cope with and sort out more choices, more options, and more incompatibilities than ever before.

Of course, a multiplicity of standards increases the need for objective information on competing standards, and that's BYTE's specialty. You can count on our broad, non-machine-specific coverage to help you sort through this morass of choices and to help you match the right hardware and software to the job at hand, regardless of brand.

For your copy of our COMDEX report, or for reports of PC Expo or the upcoming MacWorld, please send \$3 to: Show Report, BYTE, One Phoenix Mill Lane, Peterborough, NH 03458. Be sure to specify which show report you want and to include a return address.

—Fred Langa
Editor in Chief
(BIX name "flanga")

And then...
Maxell created
the RD Series.

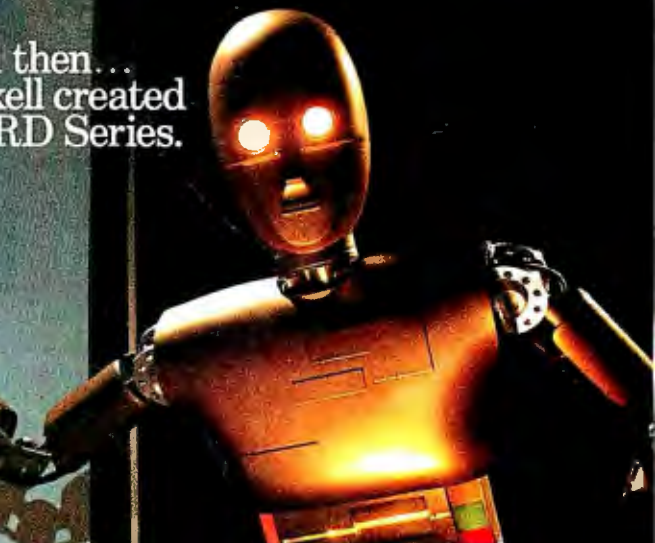

The
Evolution
of the
Floppy Disk

Maxell Corporation of America, 22-08 Route 208, Fair Lawn, NJ 07410

Never before has this level of Reliability
and Durability been available in floppy disks.
Introducing the new RD Series from Maxell.
Twice the durability of the disks you're now using.
Twice the resistance to dust and dirt.
And the RD Series is ten times more reliable
than conventional floppy disks.
The Gold Standard has always meant maximum
safety for your data. Now it means even more.



maxell
THE GOLD STANDARD



Can you cope with fame?

"ALR products make headlines. Broad exposure from trade reviews and national advertising campaigns create public demand. This makes ALR dealers very popular."

**Alan Weinberger - President -
The ASCII Group, a 180 member
nationwide chain**



Can you say goodbye to your middleman?

"ALR only sells through authorized dealers which means you don't get a knife stuck in your back. It also means direct support from the factory. Support from ALR's sales staff, customer service staff and technical support staff. ALR also offers Dealer Incentive Programs such as Flooring, Co-Op Advertising, and some of the highest margins in the industry."

**Tom Diroff - President -
Technology Partners, Ann Arbor, MI**

Do you have what it takes to be an ALR dealer?

Can you be a "Yes Man"?

"We've had to learn to say yes, a lot. Yes to speed, power and affordability. Yes to Novell expandability and a complete variety of networking solutions."



**Sam Woo - President -
Micro Age Computer Store, Dallas, TX**



Can you handle success?

If you think you can live with this kind of success, you may have what it takes to be an authorized Advanced Logic Research Reseller. If you know you can handle satisfying customers with the most advanced computing systems available, **or your looking for an ALR dealer who already is**, call ALR today at

1-800-366-2574 and we'll send you dealer information and a product package. Maybe you do have what it takes.



Advanced Logic Research, Inc.

10 Chrysler, Irvine, CA 92718
714-581-6770
FAX: 714-581-9240
Telex: 5106014525,
Answer back Advanced Logic

Small

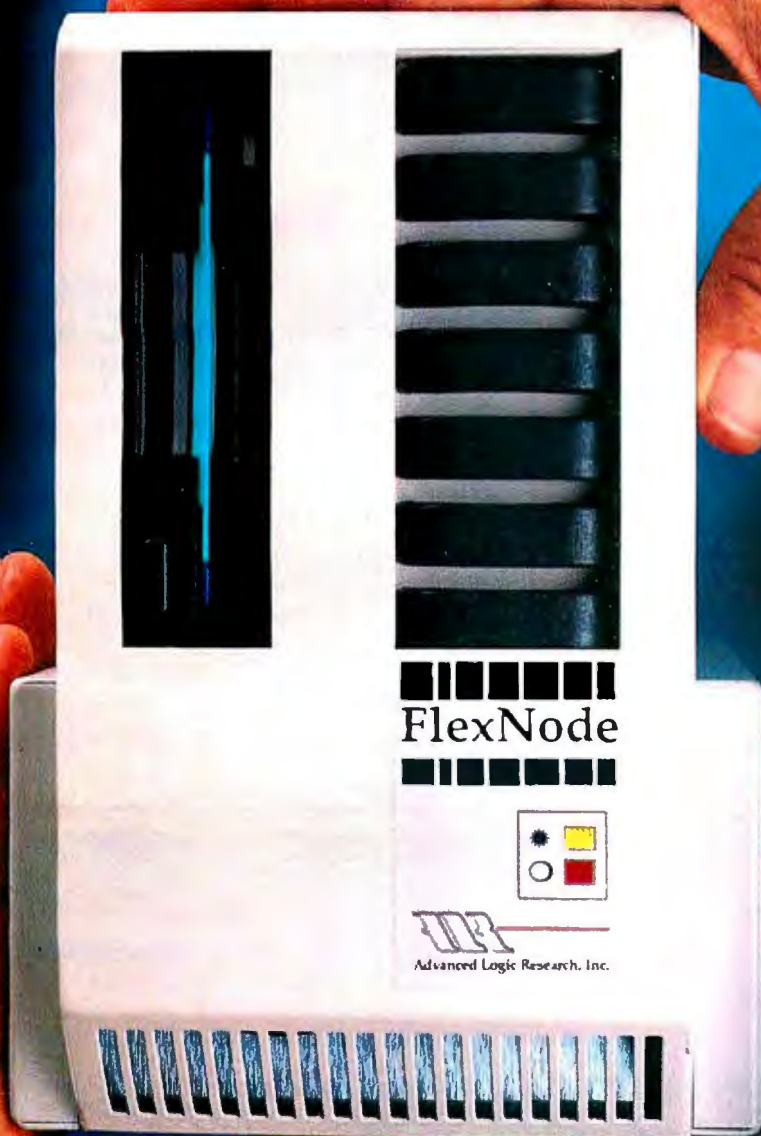

FlexNode

The biggest word
in 20MHz
performance.

The FlexNode from ALR is the ultimate 20MHz workstation. As a workstation or stand alone PC, the FlexNode delivers 20MHz, 286 or 386 performance, with up to 0-wait-states and 50MB of hard disk storage in a very small package.

FlexNode offers pluggable CPU cards designed for high performance and ease of service. With the choice of 286 or 386 speed, FlexNode is available in three basic configurations with pricing beginning as low as \$1990.00. Standard Features include;

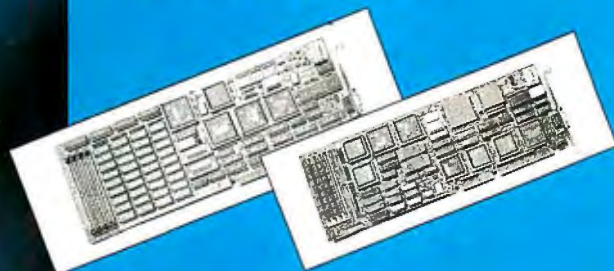

20MHz 286 or 386 CPU
with respective 80287 or
80387 support

3.5" PS/2-compatible,
1.44-MB floppy disk
drive

4-slot backplane with
serial port and floppy
disk controller

101 key enhanced
keyboard

4.5"W x 7"H x 15"D

For more information, or to find the
name of the nearest
ALR Authorized Dealer, give us a call
at;

1-800-444-4ALR



Advanced Logic Research, Inc.

10 Chrysler, Irvine, California 92718 - (714) 551-6770
FAX: (714) 581-9240 - TELEX: 5106014525. Answer back Advanced Logic

Miracle

Circle 7 on Reader Service Card (DEALERS: 8)

Sharpen Your PC Skills While You Build a Great Software Collection— ONLY \$6.65!

Two disks each month filled with lots of great software for your IBM PC™, Apple II™ or Commodore 64/128.™

Learn From the Experts

Draw on the vast experience of our editors to provide you with carefully selected software you can use each month, from spreadsheets to role-playing games, from telecommunications to accounting to recipe programs. With easy-to-use documentation, you will master each new application with confidence and ease.



Become Experienced Inexpensively

Without investing a fortune, our monthly software will help you to see why your personal computer is the most versatile and powerful tool you own. You will know more about your computer, its capabilities, and software for it, than you would have thought possible. At \$6.65 per issue, our monthly software is the best value in software today.

Try our Monthly Software for Three Months

Every month your postman will bring you the latest issue of our monthly software, contained on two unprotected 5¼" diskettes. Each issue is chock-full of our best software, including utilities, games, home and business applications, and educational programs. Order now and receive a special software gift absolutely free

Reviewers Love Our Monthly Software!

Softdisk rating: "■■■■■" (4-stars)INCIDER, APR 1987
"...I highly recommend Loadstar. If you can afford only one disk service, make it Loadstar..."

..... STEVE LEVEN, COMMODORE MICROCOMPUTERS

"...Big Blue Disk offers games, educational programs, product reviews, programming utilities, and even commercial programs. We had more fun than an ant at a picnic, and we're going to subscribe!...RATING: ■■■■■ Value for Money' (4-stars) FAMILY COMPUTING

BIG BLUE DISK (IBM PC version) Contents of Issue #20

- **Crazy Eights** Classic card game with a custom graphic card deck (how else can you get the Eleven of Spades?).
- **Print Utility** Format documents to output on your printer.
- **Directory Label Printer** Generate labels for disks listing filenames.
- **Fireworks Construction Kit** Create your own simulated fireworks shows.
- **PC-Key-Draw** Complete professional drawing program from OEDware.™
- **The "DETAB" Command** Converts tabs to multiple spaces when printing text files.

(Available as a Back Issue)



Apple II, C64/128, and IBM PC, and are trademarks of Apple Computer Inc., Commodore Business Machines Inc., and International Business Machines Inc., respectively. Available at Waldenbooks, B. Dalton Booksellers, and fine bookstores everywhere (cover price \$9.95).

Yes! Please rush my free gift and start my three month subscription for only \$19.95 postage paid. I understand that this is a **trial subscription** and that I am under no obligation to continue beyond three months. (Canada/Mexico \$24.95, Overseas \$27.95) Make checks payable in U.S. funds.

- BIG BLUE DISK™** for IBM PC and compatibles. (5¼" disk)
- BIG BLUE DISK™** for IBM PC and compatibles. (3½" disk)
- SOFTDISK™** for Apple II family & compatibles. (5¼" disk)
- LOADSTAR™** for Commodore 64 & 128 family. (5¼" disk)

Name _____
Address _____
City _____ State _____ ZIP+4 _____
Telephone _____

VISA/MC AmEx Payment Enclosed

Card# _____ Exp. Date _____

Call Toll Free 1-800-831-2694

(Louisiana Residents add 4% Sales Tax)

BY078

SOFTDISK Inc • P. O. Box 30008 • Shreveport, LA 71130-0008

FREE the bonus gift listed below which matches your computer when you order the next three issues of our **monthly software** for your IBM PC, Apple II or Commodore 64/128.

FREE for IBM PC—"Best of **BIG BLUE DISK**" when you order **BIG BLUE DISK**. Nine of the best programs from recent issues.

FREE for Apple II—"The Best of **SOFTDISK**" when you order **SOFTDISK**. Five of the best programs from recent issues.

FREE for C-64/128—"The Best of **LOADSTAR**" when you order **LOADSTAR**. 14 of the best programs from recent issues.

Your Satisfaction Guaranteed

If you are not satisfied with your purchase for any reason, return your first issue for a full \$19.95 refund. The free gift is yours to keep. You can't lose.

MICROBYTES

*Staff-written highlights of developments
in technology and the microcomputer industry*

Look Out, SQL: Here Come Object-Oriented Databases

Although we've been told that the database interface of the future will be based on the Structured Query Language, some experts predict that the relational database model and SQL will be severely challenged within the next 5 years by object-oriented databases. According to professor L.A. Rowe of the University of California at Berkeley, the relational database model is fine for traditional business applications but inadequate for data-

bases used for CAD, scientific, and engineering applications. Relational databases are suitable for applications requiring a small number of data types and a fairly simple set of relations. But they are not well suited for databases involving new data types, such as graphics and other complex objects, and many relations with small numbers of rows, Rowe says.

Rowe and a team of graduate students are working on a different type of database, which they call "Post-

Ingres," that lets users add new data types and customize indexing methods depending on the application. The database will also have forward- and backward-chaining rules for expert-system applications.

Post-Ingres can store "objects," such as a graphics image or a forms specification, as a record in the database, based on an "object ID number." Objects can be shared by multiple databases. The approach Rowe and his cohorts are developing will make it possible to compile frequently used queries and also store them by ID number in the database. Thus, an application program could execute "query #47," which could be a compiled binary record in the database, for example. This would greatly improve performance of complex queries.

Post-Ingres will also give users access to historical data stored on optical disks, researchers say. In fact, the system will support a three-level hierarchy of storage—hard disks, tapes, and optical disks—allowing transparent data access on all three types of media. This capability would be extremely useful for accessing historical data, such as archived medical or legal records.

"Next-generation" database systems will appear within 3 to 5 years and will be developed using object-oriented programming and window interfaces on graphics workstations, Rowe predicts. Alphanumeric terminals eventually will be replaced by graphics workstations for most database applications, he added.

continued

Nanobytes

- Despite being recognized as technologically impressive personal computers, **Atari's ST and Commodore's Amiga** haven't had the kind of market success enjoyed by machines from IBM et al. and Apple. So what's the problem? Part of the problem is that "computers are not powerful enough to be used at home for anything productive," says Neil Harris, director of product marketing at Atari. "I think the ST and the Amiga are in the right direction, but we're still not there yet." Harris also blames the industry press for not covering the Atari machines enough. "The computer press is too busy analyzing its readership," he says. He also cites less malevolent forces, such as the RAM shortage. As for Atari's success in Europe, as opposed to the U.S.: "MS-DOS wasn't entrenched overseas, and there's much less disposable income there, so when a lower-cost alternative was introduced, it was embraced" by the Europeans.

- Researchers at the **National Bureau of Standards (NBS)** are working on tools for measuring the performance and efficiency of multiprocessors. The tools differ from software measurement systems in that they don't affect the program that's being measured. The researchers at the NBS Institute for

continued

Flat-Panel VGA Displays Due Next Year in Portables

By 1989 we'll be seeing portable computers sporting flat-panel VGA displays. One major manufacturer of thin-film electroluminescent displays, Planar Systems (Beaverton, OR), now sells a 640- by 400-pixel electroluminescent screen and plans to introduce a 640- by 480-pixel by 16-gray-scale VGA display in 1989.

Planar's Rolland Von Stroh said the company is working with both domestic and Far East computer manufacturers on a number of new projects involving flat-panel displays. Such screens are not limited to portable applications; some manufacturers plan to use 19-inch flat-panel displays in their engineering workstations.

The next major development in the flat-panel field will be color displays, said Von Stroh. Planar will introduce full-color flat-panel displays in military applications, such as airplane

cockpits, in early 1990, and the first industrial applications of full-color flat-panel displays will follow later that year, he said.

Von Stroh predicted that flat-panel displays will eventually capture a large share of the CRT market. By 1995 they could have 50 percent of the current CRT market, he said. Flat-panel displays have some advantages over CRTs. They are, of course, much more compact, have much less glare because of their flat surface, consume much less power (14 watts versus 50 to 100 watts), and are more reliable (according to Von Stroh, 45,000 hours mean time between failure versus 10,000 hours for CRTs). They cost 3 to 5 times as much to make as CRTs. However, Von Stroh claimed that thin-film electroluminescent displays are already displacing backlit LCDs and gas-plasma displays because of things like better contrast and greater range of viewing angle.

NANOBYTES

Computer Sciences and Technology hope to examine such factors as information flow and processing loads.

- Marlboro Man goes optical: **Optical data processing** is making its way into the commercial world. **Carnegie-Mellon University** and **Philp Morris Corp.** have built a device for inspecting cigarette packs. The system uses pattern-recognition techniques and is considerably faster than digital systems, a CMU spokesperson said.

- "There is **too much piracy** of intellectual property, including computer software," U.S. trade representative **Clayton Yeutter** told the International Computers and Communications Conference in Washington, D.C., recently. There are standards for patents, trademarks, and copyrights, but no enforcement teeth to make these rules effective, Yeutter said. "I want some clarification and effective delineation of fundamental principles to protect intellectual property rights," he said, and he threatened that the U.S. will take an aggressive approach with other governments in order to achieve enforceable agreements.

- Are you budding? Have you written some software but can't find a publisher? A company called **WCE Publishing** (Surrey, BC, Canada) says it's looking for "budding software writers with publishable software" that could sell for between \$50 and \$100. The company thinks "the days of the megabuck software product" are over. You can

continued

New Chip Could Mean Lower-Priced 80386 Machines

In an effort to minimize software compatibility problems across its line of processors, Intel (Santa Clara, CA) has developed a new version of its 80386. The new chip is aimed at "mid-range personal computers," which don't require the high performance offered by the current versions of the 80386 with the 32-bit data bus. The new 386SX runs at 16 MHz and uses a 16-bit data bus and 24-bit address bus, similar to the 80286. However, the 386SX is supposed to be able to run all 80386 software, although at lower performance levels than its full 32-bit brother. Intel rates the performance of the 80386 at 4 to 6 VAX million instructions per second (depending on if the clock speed is 16, 20, or 24 MHz) and the 386SX at 3 MIPS. Intel is planning to release a similar version of the 80387 numeric coprocessor; the 387SX is fully compatible with the 80387.

The 386SX has the po-

tential to make 80386 software accessible on more affordable machines. With the advent of powerful programs such as Windows/386, which runs exclusively on the 80386, the chip has become attractive to a wide range of users. However, current 80386 machines are too expensive for many individuals. The 386SX could be the ticket to 80386-based software for those users.

With the introduction of the 386SX, Intel will discontinue production of the 16-MHz 80386. The chip maker will focus on high performance with the 80386 and on lower-cost computers with the 386SX, said product manager Bruce Schechter. The 80386 will continue to be aimed at high-end personal computers, while the 386SX will become the main processor for midrange machines like today's AT class or PS/2 Models 50 and 60. Meanwhile, the "80286 will move downstream to the lower end of the market,"

said Schechter. Intel expects the 80286 to become the entry-level processor in its product line; the 8088/8086 processors will gradually disappear, Schechter said.

Intel emphasized that the 386SX is not pin-compatible with the 80286. In fact, the 386SX is considerably smaller than its predecessors. With the less complex circuitry required in building a 16-bit bus, the 386SX could be ideal for portable computers and add-in boards.

Several manufacturers already have production units; although Intel won't name names, the most likely candidate is IBM, which plans to introduce 80386-based versions of the Model 50 and Model 60 next year. The chip will be shipped in volume in the fourth quarter. Initially, the 386SX will cost \$212 in quantities of 100 (the 80386 is \$299). But Schechter said that price differential between the 80386 and the 386SX will increase with volume production.

Will Neural Nets Put Patton in a Box?

Depending on the results of the first part of a multiphase contract awarded by the U.S. Department of Defense (DoD), the next generation of battlefield commanders could have pearl-handled Tempest-rated cases around their silicon brains—sort of a cloned Patton on casters. Computer experts don't agree on the potential of neural networks, but the DoD is investing heavily in the new technology and has just awarded a contract to Hecht-Nielsen Neurocomputers (San Diego, CA), one of the first companies to develop commercial neural network products. So far, nearly all the research funding for neural network projects is DoD-related.

The Electronics Technol-

ogy and Devices Laboratory of the U.S. Army Laboratory Command awarded Hecht-Nielsen this contract to "identify Army battlefield problems and develop a design for a battlefield neuro-computer to satisfy the processing requirement." Jacqueline Townsend, a spokesperson for Hecht-Nielsen, said this first \$50,000 phase is for "proof of concept." Assuming that the concept is accepted by the Army, phase two might begin to define the actual system, which, she said, "we probably won't be able to talk about."

Asked if a battlefield computer might consist of one of Hecht-Nielsen's Anza neural network plug-in boards for an IBM PC AT

in a Tempest box, Townsend replied that it is too early to say what, if any, future configurations might be.

While the idea of a swaggering robotic commander is a bit farfetched, the inherent capabilities of neural networks, such as learning, pattern recognition, and associative memory, would lend themselves to defense applications. Performing dangerous and repetitive tasks, radar, sonar, image processing, data manipulation, delivery of defense systems with "humanlike discrimination" capabilities, "opposing force modeling (war-gaming), and weapons aiming and steering" are some of the areas where neural networks might be used, according to Hecht-Nielsen.

continued

If you can see the difference,
you must be looking at the price.

*we never
stop
asking*
"What if..."

Hewlett-Packard Company
18110 S.E. 34th Street
Camas, WA 98607

Dear Reader:

This letter was printed on two of the finest printers available today. One half on a laser printer, the other on the new HP DeskJet Printer. But which one printed which half? Hard to tell, isn't it?

Small and quiet enough for your own desk, our HP DeskJet Printer gives you clean, crisp text and graphics. Just like a laser. You get perfect printing from A to Z. Look for yourself.

AaBbCcDdEeFf JjKkLlMm NnOoPpQq RrSsTtUuVvWwXxYyZz

So which half is from the laser printer and which from the HP DeskJet Printer for under \$1,000? Not sure? That's the point. To see the difference you've got to look at the price. So call for the name of your local dealer and a free brochure on the new HP DeskJet Printer at 1 800 752-0900 Ext. 908A.

Sincerely,

HEWLETT-PACKARD COMPANY

Greg Wallace
Greg Wallace

Laser Printer

HP DeskJet Printer

The New HP DeskJet Printer. Laser-Quality Output for Under \$1000.



NANOBYTES

reach WCE Publishing at 65-13880 74th Ave., Surrey, BC, Canada V3T 2T8, (604) 583-1600.

- IBM hopes to push the "standardization" of its **Micro Channel architecture** by licensing its patents to companies that want to build PS/2-like computers, says **Gordon Campbell**, chief executive of Chips & Technologies (San Jose, CA). "IBM said it will license the patent portfolio. That's very different from licensing the technology. We in the industry have missed what IBM has been saying all along; we've heard only what we wanted to hear." Campbell said that by licensing the IBM patent portfolio, "a company is free to build Micro Channel products, but they have to do all the work." IBM said that licensees will have to pay "a maximum of 1 percent of sales revenue" on a product that uses an IBM patent; the maximum is 5 percent, depending on the number of patents involved.

- Some of the **well-to-do are computing**. Thirty-eight percent of "affluent households" in the U.S. have personal computers, says a study by International Research Associates (Mamaroneck, NY). And what's the machine of choice among the upper crust? This study says 13 percent of the respondents have an IBM PC, 10 percent have Apples, and 7 percent have Commodores.

- **Versacad** (Huntington Beach, CA) has come out with three **HyperCard stacks** for users of its VersaCAD/Macintosh Edition. The hyperware—Bill of Materials, Door & Window Scheduling,

continued

Compromise Brings Hope of High-Speed Modem Standard

There's no standard yet—but it's coming. That's the word from two U.S. companies spearheading the work for a standard modem system that will work faster than 9600 bits per second over regular dial-up phone lines. USRobotics (Skokie, IL) and Telebit (Mountain View, CA) have reached a compromise and asked CCITT, the European standards agency, to give them more time to develop a complete standard.

USRobotics (USR) is proposing a system with one high-speed channel, similar to current lower-speed modems. According to Dale Walsh, USR's vice president of engineering, the main channel would send data at a top speed of 14,400 bps, while a 450-bps back channel would perform error correction and other protocol functions. USR's proposal is supported by Rockwell, Racal-Vadic, and Paradyne.

Telebit's proposed system uses more than 500 channels, each operating at rela-

tively low speed. According to Ted Brown, manager of systems engineering at Telebit, the system normally sends data at up to 18,000 bps, though lab results show speeds of up to 28,000 bps.

Under the compromise, the USR single-channel system would be mandatory, with Telebit's multichannel system as an option, and a system for selecting between the two. Walsh said USR was pleased that work toward a standard would continue. "We've made significant progress, and this way we can work as a team to make more progress," he said. Dwight Decker, Telebit's director of modem engineering, agreed: "The critical thing is that the compromise means there really will be a standard."

Decker said the compromise was supported by eight modem manufacturers and the national standards agencies of Germany, France, Spain, Sweden, and Switzerland. Both he and Walsh

said a draft standard should be ready for examination by the full study group early in the next CCITT plenary session, perhaps as soon as next February.

USR favors a traditional approach, using a single main channel running at up to 14,400 bps. Telebit wants multiple channels running up to 28,000 bps. USR's Walsh said that a multichannel system can't really run that fast. "To achieve the high speeds claimed [by Telebit], they're operating beyond the available bandwidth on a voice line," he said. "As soon as they get interference on a real phone line, it falls back to slower speeds."

Telebit's Ted Brown countered that the slower speeds are still faster than a single-channel system—up to 18,000 bps. In addition, multichannel modems can drop back by as little as 100 bps at a time; traditional modems, on the other hand, must drop by 2400 bps at a time, he said.

Video Could Be the Key to Good Color Printers

Forget that serial or parallel port connection for your printer. To get the state of the art in color printer technology, you may soon be hooking up your computer's video output directly to the printer.

Sony has developed a thermal-transfer color printer that, while designed primarily for broadcasters who want still photos from videos, offers a tantalizing glimpse of where color printer technology is going.

The UP-5000 does have an RS-232C port, but it's used for picture editing and control, not for carrying the actual print data. The printer accepts a wide variety of video inputs, including

standard National Television System Committee (NTSC) video and analog RGB, and other standards like differential R-Y, B-Y and S-video. The interface digitizes 8 bits of video and can print 256 variations of each of the three primary colors (magenta, yellow, and cyan). That amounts to something like 10 million possible colors per pixel.

The printer captures images in an internal buffer and stores up to two frames. You can view the image on a color monitor and adjust the color and tones under computer control. A full-size print from the UP-5000 is 6 by 4½ inches, and the unit will also do overhead trans-

parencies. It takes 67 seconds for it to do its work on each print using special color thermal paper, and you can print multiple copies from the frame buffer.

Print quality is stunning—virtually indistinguishable from a commercial color print, not at all like the muted colors from most of today's color computer printers. As you might expect, though, it's not cheap. The UP-5000, which will be shipped in July, has a retail price of \$7000. But a Sony spokesperson said he expects the cost of the technology will fall dramatically in the next couple of years, bringing this type of color printer within the price range of individuals and small companies.

continued

Are You Floating on an Ocean of Data? You need Navigational Guidance.

IXL The Machine LearningTM S Y S T E M

Discovers Relationships and Knowledge Hidden in Large Databases

Navigate an Ocean of Data

Everyday, all over the world, the number of databases and the amount of data in each database increases. The increasing size of a database makes it harder and harder to understand what the data means. Whether you are part of a government agency, bank, engineering firm, insurance company, hospital or any organization which relies on computers, your database already contains vast amounts of hidden knowledge.

You could, of course, get an overall view of some of the characteristics of your data by using statistics. But IXL, The Machine Learning SystemTM, picks up where statistical techniques leave off. It helps you uncover the knowledge within your database by combining symbolic data analysis, induction and deduction to discover interdependencies and relationships.

Make Better Decisions

If you already use your data for decision making, IXL (Induction on eXtremely Large databases) can help you make better decisions by providing knowledge which may surprise you.

IXL is flexible and allows you to tailor your own ideas, which may involve inexact and compound concepts, by defining rules and frames. It expects inaccuracies

and omissions in your data and allows you to define your own thresholds of error tolerance.

Use a New Technology

IXL relies on a novel and advanced machine learning algorithm specifically designed for dealing with large databases. It is not just another simple implementation of the ID3 algorithm, but combines insight from a number of powerful induction methods such as AQ/INDUCE, RX/Radix, etc.

The induction method can be based on user defined deductive rules, frames and inheritance methods; providing a uniform integration of induction and deduction.

Experience a Higher Level of Versatility

You don't have to be an expert in AI or statistics to use IXL. An intelligent user interface controls your top level interaction and allows you to define your own criteria for induction with a great deal of ease. Our products are known for their efficiency and ease of use.

You may run IXL by itself or use our Intelligence/CompilerTM expert system development environment to define your own forward, backward or inexact rules, calls to

C functions, frames and inheritance structures to be used with IXL.

IXL includes its own data management module and data transfer ability, and accepts data in a variety of formats including dBASE-IIITM, Lotus 123TM and ASCII files.

You Need IXL Now!

If you have a database, you need IXL now. The hidden knowledge you are unaware of today could influence your decisions for tomorrow.

Yes, I would like to discover the knowledge hidden in my database.

Send me IXL at \$490

Send Intelligence/Compiler at \$490

Name: _____

Company: _____

Address: _____

Telephone: _____

Visa Mastercard Number: _____

Expiration Date: _____

Check Money Order is enclosed.

Shipping and handling: US \$9.00, Canada/Hawaii Air \$15.00, Overseas Air \$35.00.

System Requirements: IBM PC/XT, PC/AT or PS/2; 512K memory. Send coupon to:

IntelligenceWare, Inc.
Leading in Artificial Intelligence ApplicationsTM
9800 S. Sepulveda Blvd., Suite 730
Los Angeles, CA 90045 (213) 417-8896

NANOBYTES

and CAD Text Processor—is packaged with version 1.1 of VersaCAD for the Mac.

• It seemed an unlikely fit when Autodesk (Los Gatos, CA) bought into Ted Nelson's Xanadu. But the maker of AutoCAD sees the possibility of using hypertext as a means of managing and sharing CAD drawings generated by AutoCAD. John Forbes, project manager for AutoCAD, said he envisions a distributed drawing management system in which users can connect architectural and engineering drawings to text comments. (For example, a user could point to a location on the drawing and

continued

No More Golden Vaporware: Xanadu Products Next Year, Nelson Says

The first products based on the Xanadu hypertext concept will ship sometime next year, say Ted Nelson and his Xanadu team. Nelson said the time has come to "get this mother out of the closet and onto peoples' desks and into their minds. We're a member of the Gold-

en Vaporware Club, along with Alan Kay's Dynabook."

The Xanadu Hypertext System, said Nelson, would create "a new unification of applications. We're going to create a uniform data structure that developers of all types of applications can use." A preliminary system

will be delivered to developers late this year, according to Xanadu's Roger Gregory. "We're looking at Suns, Macintoshes, and IBM PCs as platforms," he said.

"We have something that's real," Gregory said. "You can see that it's real because it crashes."

Big Changes to the Chip Not Likely, Inventor Kilby Says

Nearly 30 years after he invented the computer chip, Jack St. Clair Kilby says improvements in the memory, performance, and cost of his invention are getting harder to come by. "Nothing goes on forever," he told the new Austin, Texas, chapter of the Ameri-

can Electronics Association recently. "There may not be another 5 orders of magnitude of improvements to be made. Certainly not with the techniques we now use," he said.

The industry needs to focus on improving chip packaging, according to Kilby.

Kilby said he's not pessimistic about the future of the IC, which he invented in 1958. He said he's simply mindful that "30 years is an incredibly long time in the history of electronics for the domination of a single device."

continued

LOOK!
It's Flow Charting™ II+!

The ultimate fast track tool—for internal auditors, public auditors, secretaries, engineers, managers and line leads. Performance power WITH A PLUS, for even faster and easier construction, editing and printing of flowcharts and org charts.

- Text auto centering
- Smart line mode
- Internal mouse driver
- 10 text fonts
- Ega support
- Comprehensive, friendly manual

Give your charts the PLUS for only \$229*. Contact your local software dealer—or call us.

PATTON & PATTON
Software Corporation

81 Great Oaks Blvd., San Jose, CA 95119
1-800-525-0082, Outside California
408-629-5376, California/International
*plus shipping. In California add tax.

Excellence in charting the flow of ideas



The change to a pure language

Now, C programmers can move over to C++ with Zortech C++ – the world's first 'true' C++ compiler for MS-DOS machines.

Zortech C++ is a 'true' compiler and fully conforms to Bjarne Stroustrup's specification as outlined in his book 'The C++ Programming Language'.

Previous implementations of C++ were actually 'translators' – only able to translate C++ source code into C. Of course, this was unacceptable due to the long translating and compiling times.

Now, C++ comes of age with the introduction of the world's first true C++ compiler – from Zortech!

■ **Object Oriented Programming**

C++ is to C what Modula 2 is to Pascal. C++ brings 'classes' to C, so you can create separate modules that contain their own data and data-related operations. These 'classes' then become new types that can in turn be used to create further modules – this allows you to practically create your own language.

■ **ANSI C Superset**

You don't have to throw away your existing C programs – C++ is a superset of ANSI C. Now, you can take your Microsoft C or Turbo C compatible programs and easily migrate to C++ to take full advantage of the new C++ features.

■ **'Codeview' Compatible**

Zortech C++ is compatible with 'Codeview' – Microsoft's industry standard source code debugger.

■ **Improved Program Structure**

As stated in 'The C++ Programming Language', by using C++ "It would not be unreasonable for a single person to cope with 25,000 lines of code!"

■ **Other benefits**

Here's just a few: Operator overloading, overloading function names, default arguments to functions and better type checking.

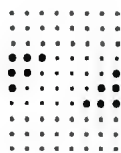

ZORTECH

BOSTON LONDON FRANKFURT GENEVA

Circle 284 on Reader Service Card

YES!
Rush me

UT JW11

below:

Zortech C++ C++ Book
\$99.95 \$29.95
VISA/MC/COD/CHECK ACCEPTED

Name.....
Address.....

Phon.....

VISA or MC..... Exp. Date.....

To: ZORTECH INC. 361 Massachusetts Ave., Arlington,
Tel: 617-646-6703. Fax: 617-648-0603.

CALL THE ORDER HOTLINE 1-800

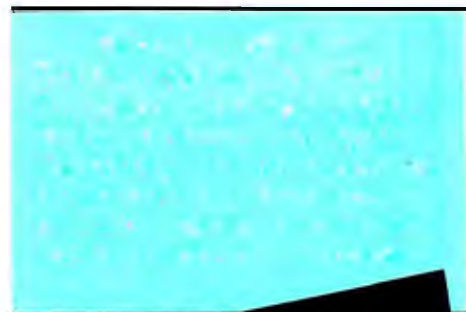

NANOBYTES

retrieve a related description or report on the design characteristics of that piece of the drawing.)

"We see hypertext as a means to manage information in a more intelligent way," said Chris Record, Autodesk vice president of business development and now president of Xanadu.

- The Association of Personal Computer Consultants has formed with the intent of "certifying true professionals" in the field. The group plans to issue credentials and a statement of ethics "to acceptable professionals." If you think you might be acceptable, write to the APCC at P.O. Box 14430, Philadelphia, PA 19115.

Apple Wants Developers to Push Mac into 32-bit World

Apple Computer (Cupertino, CA) and outside developers are working to move the Macintosh into the world of 32-bit computing. And since most current Mac programs operate primarily in the 16-bit realm, this direction is the one that has the most implicit fallout for developers. Some third parties have widened their programs for 24-bit-deep color monitors and cards, but

those are the exceptions.

Apple is encouraging developers to think in 32-bit terms. For its part, the computer maker has suggested revising the system software to accompany the use of a 68030 processor in its machines (Apple officials have hinted at a Mac SE with an 030 in it). Some people at Apple's Spring Developers' Conference said Apple is considering a "fat

slot" (one that addresses more than 24 bits in the slot) and "fat pixels" (up to 32 bits deep).

The move to 32 bits falls in neatly with the closer ties between Apple and DEC; if Apple software runs at the 32-bit level, DEC compatibility is easier. It will mean a total rewrite of Apple printer drivers, for example, to achieve this. It's not clear what that would mean for a company that has existing special drivers to convert QuickDraw into direct printer output, but a complete rewrite of these kinds of drivers is implied by any change in QuickDraw. "Apple is asking a lot in moving to 32 bits. I think they realize they are going to need better error-catching tools if applications are going to get written in a decent time frame," said one developer.

TECHNOLOGY NEWS WANTED. *The news staff at BYTE is always interested in hearing about new technological and scientific developments that might have an impact on microcomputers and the people who use them. We also want to keep track of innovative uses of that technology. If you know of advances or projects relevant to microcomputing and want to share that information, please contact the Microbytes staff at (603) 924-9281, send mail on BIX to Microbytes, or write to us at One Phoenix Mill Lane, Peterborough, NH 03458.*

TAKE A "LOOK" AT THIS DOUBLE HEADER!

Introducing

ROMX-2XL EPROM EMULATOR

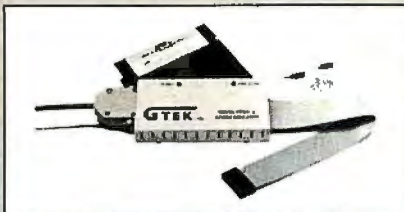

Introducing the **NEW ROMX-2XL Megabit Eprom Emulator!** When GTEK® created the ROMX-2 Eprom Emulator in 1987, a whole new world opened up for engineers. Now GTEK®

has extended the capabilities of the ROMX-2 in the ROMX-2XL. In addition to 2716-27256 sizes, you now have 2532, 2532A, 68764, 68766, 27512, 27010, 271001, 271024, and 27210!

If you are not familiar with eprom emulators, they give you the capability of eliminating the remove eprom/program eprom/insert eprom, steps of program code development.

There are 2 models of ROMX-2 available for your use. The ROMX-2 Eprom Emulator gives you the normal 2716-27256. If 27256 isn't enough, then the ROMX-2XL is what you need! All the models come with communications software for PC/XT/AT type computers, and supports 16 and 32 bit systems.

- Control target system with built in hardware reset lines.
- Auto-Emulation. All commands in conversational format.
- Non-Volatile battery ram up to 128Kx8 (Megabit)
- Baud Rates to 19,200. Free communications software included.
- Access time 150NS. Faster optional.

Compatibly Yours, Dos

PCSS-8X 8 PORT SERIAL BOARD

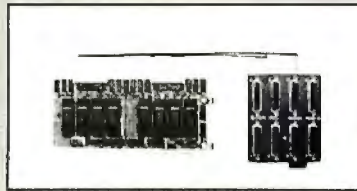

COMMON PROBLEM

Have you ever purchased a serial board only to discover that you've spent your money on a product that wasn't compatible with your system, required device drivers and/or had limited

capabilities? If this is the case, we have a **SURPRISE FOR YOU!**

Finally, a **UNIQUE SOLUTION** to your problem has been developed. GTEK®, Inc. has designed the PCSS-8X an 8 port serial board for your IBM, PC, XT, AT and compatibles that can virtually perform any task you desire. This increases you company's productivity. This unique board was truly made for YOU and your DOS computer in that the PCSS-8X has more maximum number of DOS compatible ports than any of the competing products. In fact, the PCSS-8X surpasses its competitors in terms of input/output functionality, handshaking, maximum port development, price and user application. **READ ON!**

- MUX/DEMUX
- PRINTER SHARING
- CAE/CAD/CAM
- BULLETIN BOARDS
- DATA CONTROL/AQUISITION
- UNIX/XENIX

Still asking "why the PCSS-8X?" Because if you want the **BEST** serial board on the market, GTEK® has it! So order the **PCSS-8X Serial Board** today. It's the multiport serial card that has been signed, "**COMPATIBLY YOURS, DOS!**"

ORDER TOLL FREE 1-800-255-GTEK (4835)
 FAX: 1-601-487-0935 TELEX 315814 (GTEK UD)
 MS & TECHNICAL SUPPORT 1-601-467-8048

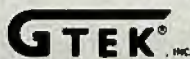

DEVELOPMENT HARDWARE & SOFTWARE
 P. O. BOX 2310
 BAY ST. LOUIS, MS 39521-2310 U.S.A.

Registered Trademarks - PC/XT/AT = IBM; UNIX = AT&T; XENIX = Microsoft; ROMX-2/XL, PCSS-8X = GTEK®, Inc.

More Board for the Buck

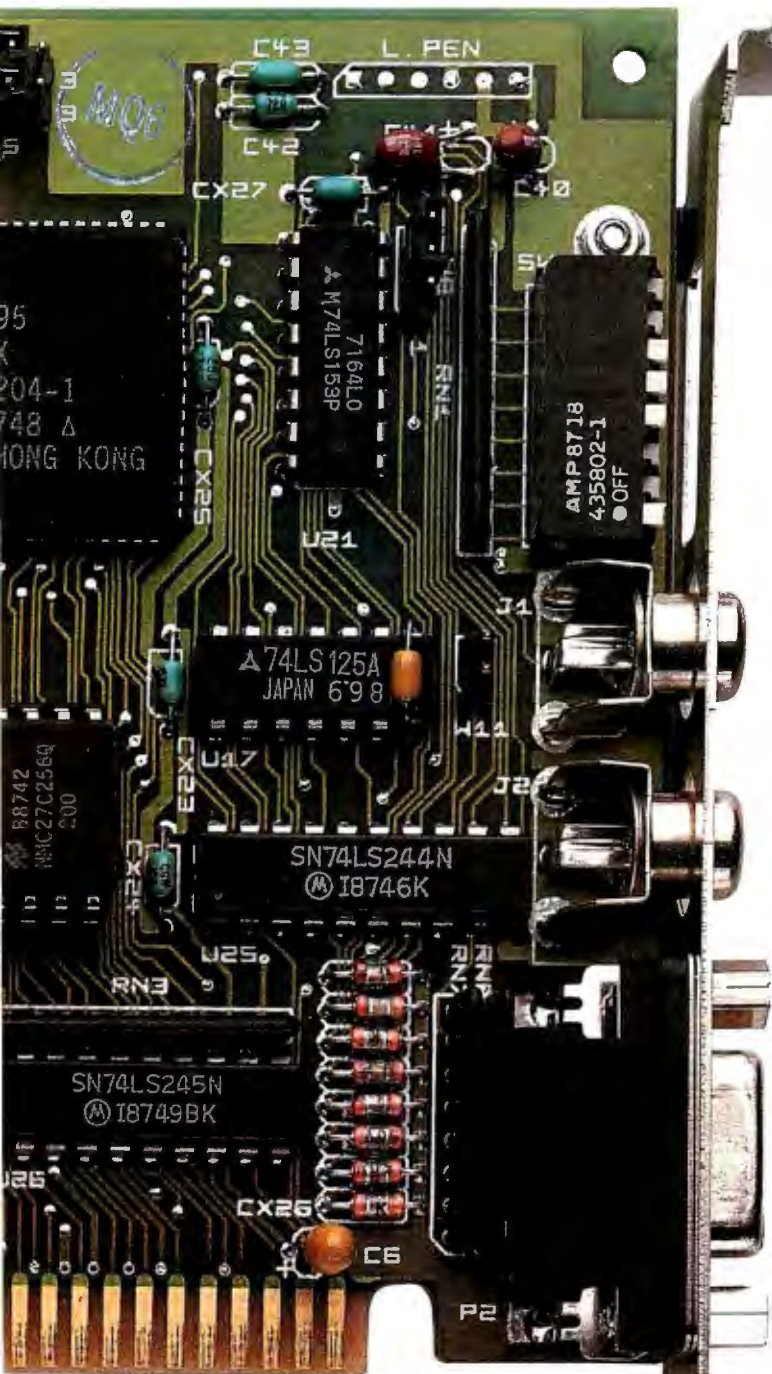

That's what the EGA game comes down to. 100% IBM® EGA compatibility is essential. But today you need more. So what does the Everex Micro Enhancer deliver?

How about extended EGA resolutions like 752 x 410 and 640 x 480, and 132 column text modes. Or the ability to use those resolutions while running Microsoft® Windows, Lotus 1-2-3®, Symphony®, AutoCAD®, GEM®, Ventura Publisher™, PC Paint™ and VersaCAD®.

That's nice. But what if your Hercules® and CGA applications ran on an EGA monitor. And if an autoswitch feature automatically adjusted modes to the software running, so that you wouldn't have to hassle with switch settings. Or if there was an optional parallel port to save money and space. Wouldn't that be better?

This all comes from a leading supplier of EGA cards and costs so little that you wouldn't believe it's made in the United States. That's more board for your buck.

It's simple. More features for less money. **Everex has the answer.**

For more information or the name of your nearest Everex dealer please call:

in USA **1-800-821-0806**

in Calif. **1-800-821-0807**

EVEREX
EVER for EXcellence®

EVER for EXcellence is a registered trademark and EVEREX and Micro Enhancer are trademarks of Everex Systems, Inc. Hercules is a registered trademark of Hercules Computer Technologies, Inc. Lotus 1-2-3 and Symphony are registered trademarks of Lotus Development Corporation. Microsoft is a registered trademark of Microsoft Corporation. AutoCAD is a registered trademark of Autodesk. GEM is a registered trademark of Digital Research, Inc. Ventura Publisher is a trademark of Ventura Software. VersaCAD is a registered trademark of VersaCAD Corporation. PC Paint is a trademark of MSC Technologies, Inc. IBM is a registered trademark of International Business Machines Corp. ©1988 Everex Systems, Inc. All rights reserved.

415-498-1111

48431 Milmont Drive, Fremont, CA 94538

Circle 292 on Reader Service Card (DEALERS: 293)

The Diconix 150 printer. Completes The silent partner

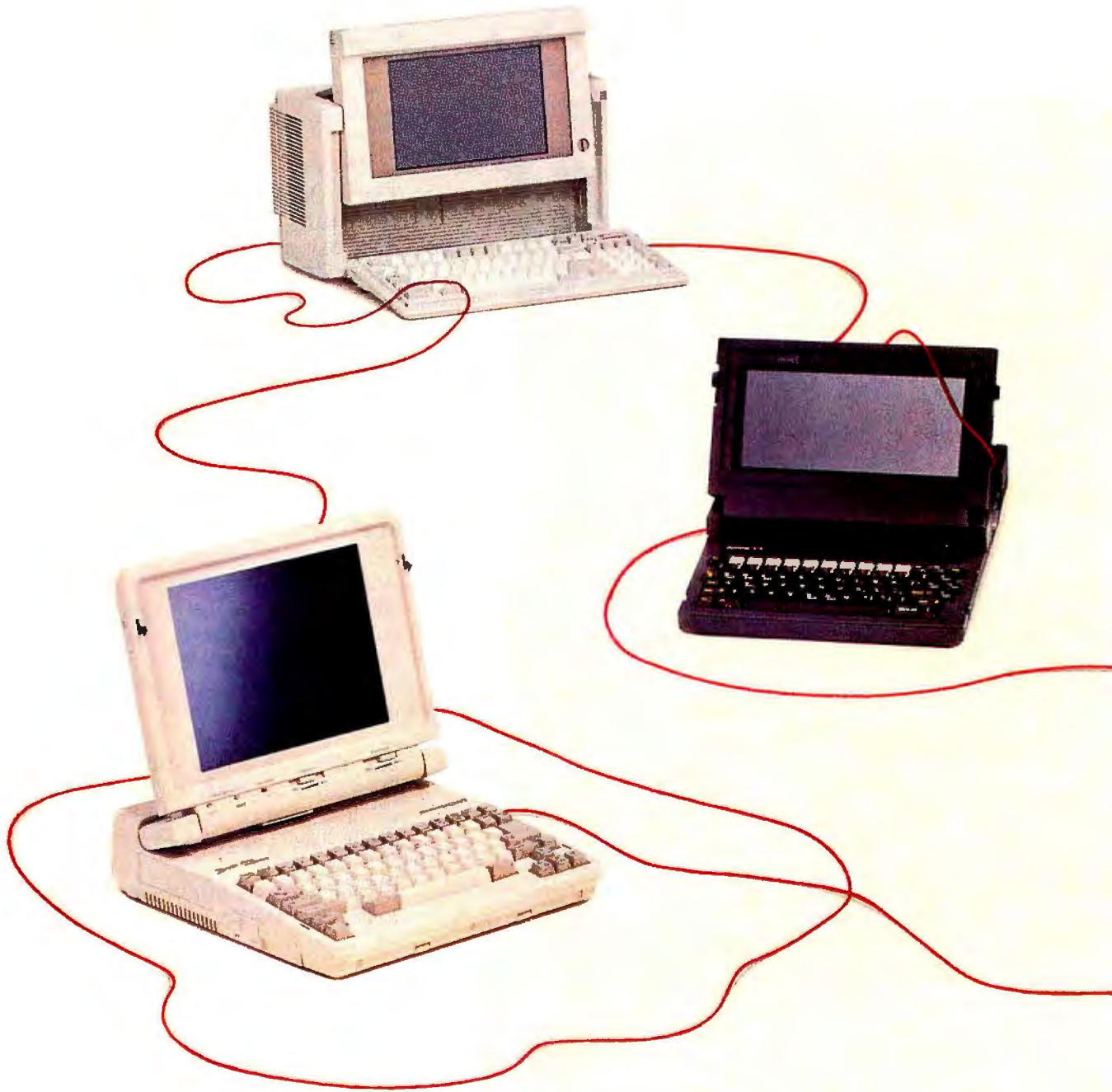

most any system. Quietly.
that fits in a briefcase.



DICONIX
A Kodak Company

3100 Research Boulevard
Dayton, Ohio 45420
1-800-DICONIX

Circle 82 on Reader Service Card

LETTERS

Memory Management

I have a few comments concerning the "Overview of Memory Management" by Randall L. Hyde (April).

The article was instructive, understandable, and well written. I appreciate the effort taken to explain what many users and programmers find to be "black magic" about computers: operating systems and memory management schemes.

Thrashing is not caused by a poor choice of replacement algorithm. A poor replacement algorithm will precipitate thrashing on a loaded system; the fact that so many replacement algorithms are explored in the literature is a testimonial to the importance placed on the subject.

Thrashing is caused by overloading a virtual memory system. A nonthrashing system running at peak load with a poor replacement algorithm will perform better with a good replacement algorithm. An overloaded system will thrash regardless of the replacement algorithm used. The real problem, then, is not the replacement algorithm, but load control.

I think 5 years is too optimistic a time frame for seeing PCs with virtual memory being generally used. Virtual memory systems are useful in the multiuser, multitasking environment that is the current niche for mini and mainframe products. The boundaries between micros, minis, and mainframes are dissolving with today's hardware advances, but before we see "deskframes" throughout the office, several major advances must occur:

- There must still be work on the microprocessor itself before it is capable of supporting the high I/O rates that are necessary to page efficiently. Where is the equivalent of the channel in the future microprocessor market? Traditional preemptive direct memory access won't cut it.

- Memory costs must fall dramatically before the general user can afford a system large enough to need paging. In today's mainframe world, 8 megabytes is tiny. We hear about OS/2 needing 2 megabytes to be functional; what about

the applications that will need 6 megabytes or more?

- Stratospheric prices for high-performance random access devices must fall. When we see a 1-gigabyte hard disk drive with 24-millisecond (innermost to outermost cylinders) seek times for under \$1500, then the personal computer market might afford cost-effective paging devices. Until then, paging will be an expensive and slow toy.

- Finally, and perhaps most important, who will manage the "deskframes"? Then there is the question of the performance adjustments and required maintenance (like backups and spool cleaning).

Soon we'll have to redefine what the terms mainframe, mini, and micro mean. Will there be pico and femto machines, perhaps? You can bet there will always be a niche for the single-user, single-task operating system running on nonvirtual hardware. We all need to keep in mind the hardware and software problems that have already been addressed and occasionally solved in the mainframe world. Let's not make the same mistakes in the micro world.

Jonathan Allan
O'Fallon, IL

LETTERS POLICY: *When submitting a letter for publication, double-space it on one side of the paper and include your name and address. Express your comments and ideas as clearly and concisely as possible. We can print listings and tables along with a letter if they are short and legible.*

Because we receive hundreds of letters each month, we cannot publish all of them. We cannot return letters to authors. Generally, it takes four months from the time we receive a letter until we publish it.

Vindication at Last

I was fascinated to see that your October 1987 issue (which I received in mid-March) has finally caught up with my book *2001: A Space Odyssey*.

It is still not widely known in the com-

puter industry that HAL stands for heuristically programmed algorithmic computer, even though I spelled this out carefully in Chapter 16 of my book. I've spent 20 years trying to disown the legend that HAL is derived from IBM by transposing one letter, and I even had my characters in *2010: Odyssey Two* contradict this canard (see Chapter 35).

So I'll be happy if you can help me stamp it out!

Arthur C. Clarke
Colombo, Sri Lanka

Learning Difficulties

Thank you for publishing Alex Lane's nice review of Trilog ("Trilog: A New Approach to Logic Programming," March). It is difficult to review a new language, and Lane has to be complimented for describing Trilog to your readers quite well. On the other hand, in the short time he had for the review, he did not quite manage to understand the difference between the scopes and programming styles of Prolog and Trilog.

A substantial part of Lane's review concerns the comparison of Turbo Prolog's and Trilog's stack/heap overflows. Using the Tower of Hanoi benchmark, Lane overflowed Trilog's stack with 10 rings, while Turbo Prolog executed OK. The main predicate in Prolog (example #55 from the Turbo Prolog manual) is as follows:

```
hanoi (1,A,B,C) :-inform(A,B),!.
hanoi (N,A,B,C) :-
    N1=N-1,hanoi(N1,A,C,B) ,
    inform(A,B) ,hanoi
    (N1,C,B,A) .
```

The predicate `inform(A,B)` just prints disk moved from A to B. Lane translated this program into Trilog as follows:

```
pred Hanoi
(n:<I,a:<S,b:<S,c:<S) iff
n = 1 &
Inform(a,b)
{Lane called
explicit Print here}
```

continued

Who Says FoxBASE+ is Better than dBASE®?



The Experts!

The Best Just Got Better—Now Shipping New FoxBASE+ Version 2.10!

Nicholas Petreley, *Info* Review Board:

"FoxBASE+ has outdone itself. Once again, FoxBASE+ earns an "excellent" in performance, with kudos for responding to user suggestions. For sheer productivity, there is no other choice." *InfoWorld* "Editor's Choice" for 1987 and 1988!

P.L. Olmstead, *Under & President, National Dbase Users Group / Computer*:

"FoxBASE+ is a supercharged dBASE, with all the features Ashton-Tate forgot. If you're into serious dBASE development and have not tried FoxBASE+, you are living in the dark ages and wasting your company's money."

George F. Goley IV, *Cont. Editor, Data Based Advisor*:

"The product is fast, very compatible, fast, easy to use, fast, relatively inexpensive, and very fast. In every test, FoxBASE+ outperformed the other products. And people who answer the phone at Fox know what they are talking about."

David Irwin, *Former President/CEO, Data Based Advisor*:

"From the dBASE compatibility standpoint, FoxBASE+ is flawless. From the speed standpoint, FoxBASE+ is unbelievable. From the "lazy factor" standpoint, FoxBASE+ is perfect."

Glenn Hart, *Contributing Editor, PC Magazine*:

"Initial tests of FoxBASE+ were simply stunning. In many ways, FoxBASE+ gives you the best of both worlds: all the benefits of interactive development and debugging, plus the speed and code protection of a compiler."

Adam Green, *Contributing Editor, Data Based Advisor, dBASE Author*:

"For the PC, FoxBASE+ has consistently set the performance standard for dBASE compatible languages. For the Macintosh, FoxBASE+/Mac will set standards for innovation and leadership in a new dBASE implementation."

Don Crabb, *Contributing Editor, InfoWorld*:

"You can expect blazing speed on the Mac. FoxBASE+/Mac breezes past tests that have proven stumbling blocks for Macintosh databases in the past. FoxBASE+/Mac combines complete dBASE compatibility with a genuine Macintosh user interface."

This is what they said about Version 2.00 of FoxBASE+. Imagine what The Experts will say about New Version 2.10 with these added features: Menu-Driven Interface, Program Documentor, Screen Painter and Template-Based Application Generator . . . and Version 2.10 is even faster than 2.00!

Join The Experts. Get your copy of the New FoxBASE+ Version 2.10 today! Now available at your nearest, quality software retailer, or directly from us by calling (419) 874-0162 Ext. 320.

Because, when it comes to speed, compatibility and value, nothing runs like the New FOX—Version 2.10!

Fox Software

Nothing Runs Like a Fox.

Fox Software
118 W. South Boundary
Perrysburg, OH 43551

(419) 874-0162 Ext. 320.
FAX: (419) 874-8678
TELEX: 6503040827 FOX

Circle 103 on Reader Service Card

FoxBASE and FoxBASE+ are trademarks of Fox Software.
dBASE and dBASE III PLUS are trademarks of Ashton-Tate.
Macintosh is a trademark of Apple Computers, Inc.

BASIC PROGRAMMING TOOLS

Whether you're a seasoned expert or just starting out...

We'll help you create programs that run faster, work harder, and simply look better. All Crescent Software products include source code, demonstration programs, clear documentation, and a 30-day guarantee.

• **QuickPak** More than 65 essential routines for BASIC programmers including windowing, access to DOS and BIOS, searching/sorting string arrays, Lotus™ and pull-down menus, data input, and more. QuickPak is loaded with examples and tutorial information, and comes with *The Assembly Tutor*—an introductory guide to assembly language from a BASIC perspective. \$69

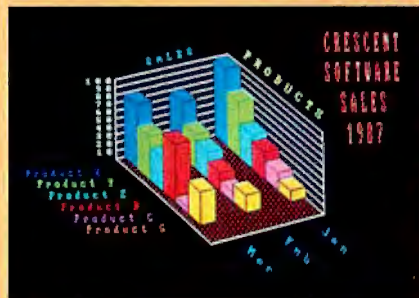

New QuickPak Professional

The most comprehensive set of tools ever developed for BASIC programmers. Hundreds of assembler and BASIC subroutines including array manipulation, pop-up utilities, multiple windows, mouse support, scientific and financial functions, multi-tasking menus, and more. Includes dozens of examples and complete applications. \$149

• **QBase** A superb screen designer and full-featured relational database with BASIC source code to allow customizing. QBase provides a complete database, and is outstanding for creating titles, help screens, and product demos. \$99

• **QBase Report** Enhances QBase by generating reports with multiple levels of sorting, record updating, and browsing. Report comes with a complete time billing application for computer professionals. \$69

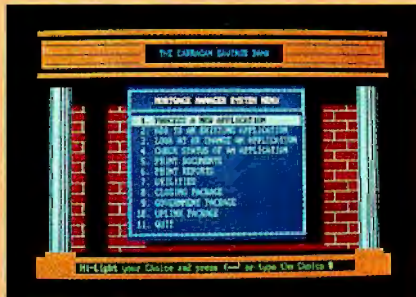

• **GraphPak** A complete collection of BASIC subroutines for displaying presentation quality 3D bar, line, and pie graphs from within your programs. Includes sophisticated font and tile editors. (EGA / VGA recommended) \$69

New GraphPak Professional

All the features of GraphPak plus scientific graphs, 3D surface plots and multiple fonts. Also comes with very fast text-based bar charts. \$149

• **LaserPak** A comprehensive set of subroutines for generating graphics on a LaserJet or compatible. Includes scales, grids, text labeling, Hi-Res pattern editor, and control over all LaserJet commands. \$69

New QuickMenu

A full-featured DOS menu system for novices and experienced users. Define the menu titles and DOS commands for each choice, and they will be executed automatically. QuickMenu is *not* memory resident, and features context-sensitive help and optional password protection. \$49



• **QuickTALK magazine** is our way of saying thank you. The catalog includes feature articles, tips and tricks, and late-breaking news about BASIC. Call or write for your copy. FREE!

LETTERS

```
{should have put n > 1 here}
Hanoi(n-1,a,c,b) &
Inform(a,b) &
{Lane called
  Hanoi(1,a,b,c) here}
Hanoi(n-1,c,b,a)
```

I've modified both programs slightly here so they can be directly compared without affecting their substance. Now Trilogity executes 10 and 11 rings but overflows on 12. Turbo Prolog doesn't overflow.

Unfortunately, Lane did not realize that the programs were not equivalent. Note the cut operator (!) in the Turbo Prolog version. Whenever the recursion comes down to 1 (and it comes there 2048 times for 12 rings), the cut removes the so-called choice point from the stack. Lane's Trilogity program leaves all the choice points on the stack. In other words, Lane has explicitly commanded Trilogity to overflow. If he wanted an equivalent comparison, he should have removed the cut (!) from the Turbo Prolog program—then he would have overflowed its stack/heap with 12 rings as well.

Cuts are features that violate the logic of Prologs. They were introduced as quick hacks in order to improve the execution times. Prologs are sorely missing the IF...THEN...ELSE constructs required here. Trilogity does not contain cuts, and Lane should have used an IF...THEN...ELSE:

```
procHanoi(n:<I,a:<S,b:<S,c:<S)
  iff
  if n = 1 then
    Inform(a,b)
  else
    Hanoi(n-1,a,c,b) &
    Inform(a,b)
    Hanoi(n-1,c,b,a)
  end
```

The execution times for the Tower of Hanoi benchmark as given in the review are irrelevant because they just measure the speed of writing to the screen. I compared this last version with the Turbo Prolog version on 18 rings with the prints turned off. Trilogity executed in 39 seconds (on a 4.7-MHz IBM PC), whereas Turbo Prolog required 77 seconds (this ratio remained the same for any number of rings). By using the IF...THEN...ELSE construct, the stack overflow has disappeared and the program has become more readable to anyone fluent in the procedural style.

We are preparing Trilogity 2.0 for re-

continued



CRESCENT SOFTWARE

11 Grandview Avenue, Stamford, CT 06905 (203) 846-2500

Separate versions available for QuickBASIC and Turbo Basic—please specify when ordering. Trade-ups are available to professional versions—call for information. Add \$3 per order for shipping / \$10 overnight—Foreign \$10 per item / \$35 UPS 2nd day. Visa, M/C, C.O.D. and checks accepted.

\$299 For 3-D CAD

you can't beat by spending thousands more.

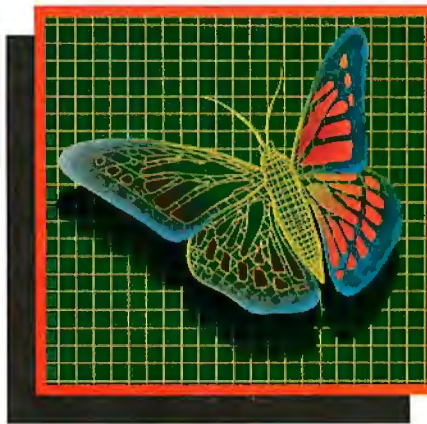
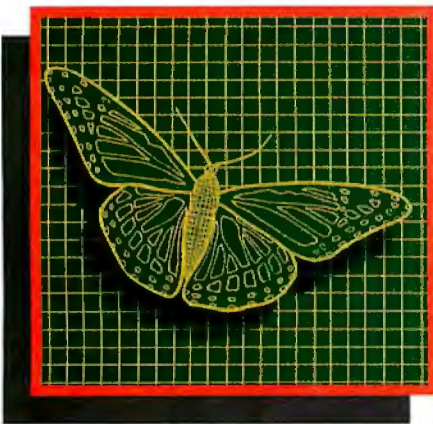

You can spend thousands of dollars for three dimensional CAD software and still not get the power and capability that DesignCAD 3-D offers for a remarkable \$299! DesignCAD 3-D is proof positive that you don't have to spend a fortune for quality.

DESIGNCAD 3-D

The compatibility that DesignCAD 3-D offers you means that it can be used with almost any PC compatible system. It supports more than 200 dot matrix printers, more than 80 plotters and most digitizers and graphic adapters. DesignCAD 3-D can read drawings from most other CAD systems.

DesignCAD 3-D allows you to develop and advance any design in 3 dimensional space, while providing you with features such as shading, hidden line removal, printer and plotter support. DesignCAD 3-D's extensive file transfer utilities allow you to: transfer documents to and from IGES, DXF HPGL, transfer to GEM and Post Script and to read ASCII text files and X, Y, Z coordinate files. It allows up to 4 simultaneous views (any angle or perspective) on the screen. Complex extrusions, extensive 3-D text capabilities, auto dimensioning and a host of other features are all included with DesignCAD 3-D, all at no extra charge.

The best reason to buy DesignCAD 3-D is not the low price, the performance or the compatibility. The best reason is the amazing ease of use. DesignCAD 3-D's powerful commands mean that you can produce professional 3-D drawings in less time than you thought possible. In fact, we think you'll agree that DesignCAD 3-D is easier to learn and easier to use than any 3-D CAD system for IBM PC, at any price!

See your local computer dealer for DesignCAD 3-D, or contact:

**PC Resource Magazine
has listed DesignCAD 3-D
as one of the six
new computer products
worth watching in 1988.**

American
Small Business Computers, Inc.

327 S. Mill St., Pryor, OK 74361
(918) 825-4844 FAX 918-825-6359
Telex 9102400302

OUTSTANDING SOFTWARE

For IBM PC's and Compatibles

\$350 PER DISK**\$300 PER DISK**

Small Quantities

For Ten or More

SHIPPED WITHIN 24 HOURS!**Satisfaction Guaranteed or Money Back!**

- BUSINESS 1**—EZ-FORMS business form generation, completion and printing program.
- CAD 3**—The PC-Flow 1.0 computer aided flow-chart generation program. Color graphics required.
- COMM 4a,b,c,d,e**—(5 disks) Join the world of sysops with RBBS Bulletin Board System 14.1D.
- DATABASE 1a,b**—(2 disks) File Express 3.8 menu driven general purpose database manager.
- EDUCATION 1**—Interactive DOS tutorial for new PC users. Makes learning DOS painless.
- FINANCE 1a,b**—(2 disks) PC Accountant 2.0 personal bookkeeping and finance management.
- GAMES 1**—3-D Pacman, Kong, Spacewar, Janit-Joe, futuristic Nightmare and more. Color required.
- GAMES 2**—Qubert, Pango, Centipede, dungeons and dragons style Zoar, etc. Color req.
- GAMES 3**—Blackjack with customizable rules, Armchair Quarterback (you call plays), and more.
- GAMES 4**—Star Trek, the Castle adventure game, and the original Colossal Caves Adventure.
- GAMES 5**—The Hack adventure game from the universities. Like Rogue, only much richer.
- GAMES 6**—Pinball, Othello, Dragons, Sopwith (fly a Sopwith Camel) and more. Color required.
- INFO 1a,b**—(2 disks) Cooking recipes database with keyword/ingredient retrieval. Add your own.
- MUSIC 2a,b**—(2 disks) PianoMan 3.0 polyphonic music recording and playback program.
- ORGANIZER 1**—Desk Team, a Sidekick clone, and the Judy personal calendar program.
- PRINTER 1**—Resident print control and font utility, intelligent spooler, banner maker, and more.
- SIMULATION 1**—Maze making program, MIT's Life simulation, starfields, etc. Color graphics req.
- UTILITIES 1**—A collection of invaluable general purpose DOS utilities. An absolute must for all.
- UTILITIES 2**—More invaluable DOS utilities including screen burnout, ram disk, and more.
- UTILITIES 3**—A comprehensive set of debugging and diagnostic utilities for monitoring your computer.

NEW RELEASES/UPDATES

- BUSINESS 2**—Expressgraph business graphics. Chart your data and find trends. Color graphics req.
- CAD 1a,b**—(2 disks) Fingerprint 1.2 advanced painting and Altamira object oriented design. Color.
- CAD 2a,b**—(2 disks) DanCad3d, an advanced 2D/3D drafting program w/animation. 640K, color.
- COMM 2a,b**—(2 disks) Procomm 2.42, an excellent modem program with terminal emulation.
- EDUCATION 3**—PC-Fastype 1.20 typing tutor, ideal for beginners and advanced students alike.
- FINANCES 3a,b**—(2 disks) Express Calc 3.12, a powerful and user friendly spreadsheet program.
- GAMES 8**—Striker helicopter attack and Risk, the game of world domination. Color required.
- GAMES 12**—Backgammon (play the computer) and Wheel of Fortune based on the gameshow.
- GRAPHICS 1**—Record and play back screen images! Excellent for demo, etc. Color required.
- GRAPHICS 2a,b,c**—(3 disks) An excellent 3-D surface modelling and shading program. Color.
- INFO 2a,b**—(2 disks) Zip-Phone, national areacode/prefix to zip-code cross reference.
- LANGUAGE 3a,b**—(2 disks) The A86 3.09 macro assembler and debugger for 8088/86/286s.
- SHELL 4a,b**—(2 disks) Automenu and HDM II 4.04 hard disk prog. for custom full-screen menus.
- UTILITIES 5**—Hard disk utilities for verifying, formatting, parking and optimizing your disk drives.
- UTILITIES 6**—Advanced utilities including Mark/Release (remove resident progs w/o reboot!)
- UTILITIES 7**—More advanced utilities including Masterkey (undeletes files from hard disks).
- WORD 1a,b**—(2 disks) PC Write 2.71, a powerful word processing system w/spell checker, laser supt. Most software listed is shareware or user-supported.

3.5" format add \$1 disk. 125 page directory, add \$2.

MicroCom Systems Cost of items _____
 3673 Enochs Street Shipping \$3.00
 Santa Clara, CA CA res tax _____
 95051 Total encl. _____

**(408) 737-9000**

Mon-Fri 7am-9pm, Sat-Sun 8am-5pm



LETTERS

lease in the fall. This update will include incremental garbage collection, a debugger, and the large data model (Trilogy 1.20 already uses the large code model). The price of the update will be \$33.

Although Trilogy 1.20 has a sophisticated relational file system, it cannot yet be characterized as a full database system. We are preparing the B-tree indexes, query optimizer, and form and report generators for release early next year.

Dr. Paul J. Voda
President

Complete Logic Systems
North Vancouver, B.C., Canada

Dr. Voda's letter underscores the difficulty of benchmarking any new language, and, particularly, of attempting to compare benchmark results with those from other languages.

My mention of stack/heap overflow was primarily related to discussions of the list-reversal and disk-read benchmarks in Trilogy. Although I did have a problem with stack/heap overflow while attempting the Tower of Hanoi, my major observation for that benchmark noted that a substantial part of run time was spent writing to the screen. Although the rate of output to the console may be deemed irrelevant since it is not the central focus of the Hanoi test, I thought it did rate a line in the review.

As regards use of Prolog's cut (1) operator, I thought that the benchmarks should reflect the performance capabilities of each language, using all the tools available. Quick hack though it may be, the cut is part of Prolog, so I used it.

I am grateful for Dr. Voda's other comments, and I'm pleased to see that the IF... THEN... ELSE construct allows the Hanoi benchmark to run. However, it would appear that a potential Trilogy programmer must have quite a good understanding of logic programming principles to use the language to best effect. I would have liked to see such information in the user documentation.—Alex Lane

Multiplying Integers

In his letter ("A Tale of Two Integers," April), Peter Crosby asks how to get the QuickBASIC compilers to correctly multiply two integers to get a floating-point result. The problem is a common one when using compiled BASIC for the first time. The answer lies in the conventions used in compiling: Any expression will take on the precision of the highest-precision element. That is, in the program

10 B% = 30
20 A = B% * B%

what actually happens is that B% * B% is calculated as an integer, since both terms in the expression are integers. The result is stored in an integer temporarily, and then the assignment (with accompanying conversion) is made to A, the single-precision variable.

The problem is one that has never affected interpreted BASIC, because it always calculates in single-precision floating-point; however, it is a problem that is addressed in nearly every "changes from the interpreter" section of the manual that I've read. Unfortunately, this section is usually pretty well buried in the back of the manual. I can't seem to find it at all in the QuickBASIC 4.0 documentation. As common as this error is, it seems odd that Microsoft would not mention it prominently in the manual.

In any event, the easy fix for the above program is to change line 20 to read

20 A = 1.0 * B% * B%

Now, since the expression involves a real (single-precision) constant, the calculation must be done in single-precision math so that the result doesn't suffer from integer overflow when B% * B% exceeds the maximum representable integer.

Dan Mick
Newbury Park, CA

Is Hartley Really Faster?

Mark A. O'Neill did a fine job of explaining Hartley transforms ("Faster Than Fast Fourier," April), and BYTE proved itself once again to be a premier forum for the intelligent discussion of technique.

The article is wrong, however, in asserting that the fast Hartley transform is faster than the fast Fourier transform (FFT). This conclusion follows only when the Hartley transform is compared with an entirely naive implementation of its Fourier counterpart. There are two essential and well-known tricks used in modern FFT algorithms that, when combined, actually serve to make the Fourier procedure the faster of the two.

The first trick was published by J.W. Cooley et al. not long after his famous paper that introduced the basic FFT method. It adapts the computation to the important circumstance of real-valued data by transforming a pseudosequence of half length. The even-numbered points in the original sequence of length N are taken to be the real parts, and the odd-numbered points the imaginary parts of the pseudosequence, so that no rear-

continued

Monitors

12 inch TTL green/Mono-Monitor	\$98.
14 inch TTL Amber/green/Paper-white	\$147.
14 inch Flatscreen Mono-Monitor	\$174.
14 inch EGA-Monitor	\$482.
14 inch EGA-Screen	\$622.
EGA-Kit (Card/Monitor)	\$762.

(Coprocessors on request)

Laptops and Portables

XT Portable 8088-2/9 inch Monitor/1 360 K FDD	\$1089.
AT Portable 80286/9 inch Monitor/1 1,2 MB FDD	\$1618.
AT Portable 80386/9 inch Monitor/1 1,2 MB FDD	\$2912.
286 Laptop	\$1941.
Mice up to	\$47.

Hard Disks

20 MB incl. Controller	\$348.
------------------------------	--------

(Others on request)

Add on Cards and Floppy Disk Drives

Hercules	\$73.
Multi I/O	\$92.
Colorgraphic-Card	\$68.
Sega-Card (short)	\$180.
EGA-Card up to	\$153.
Disk Drive 360 K, 5 1/4 inch	\$153.
Disk Drive 3 1/2 inch	on request
Disk Drive 1,2 MB, 5 1/4 inch	\$160.

(other cards on request)

CPU 8088, 10 MHz/W Legal Bios, 8 slots, 256 K installed, 84 Keyboard Power supply 150 Watt, I/O Card, 1360 K FDD, incl. Monitor	\$523.
--	--------

(Extended Models on request)

Turbo AT 286

80286 CPU, 8/10 MHz 0 Wait state, 640 K Ram installed, 7 Slots, Standard AT-Housing, 220 Watt Power supply, 102 Keyboard, 1,2 MB FDD 5 1/4 inch, FDD/HDD Controller, Manuals, incl. Monitor	\$1056.
---	---------

Turbo AT 286 as Towercase	\$1148.
---------------------------------	---------

Uprate for 3 1/2 inch	\$150.
-----------------------------	--------

80386 Computer

CPU 80386, 1-32 Bit Slot, big 6-Layermain-Board, 1 MB Ram (extendable to 16 Ram on board), 16/20 MHz 0 Wait state, 220 Watt Power supply, 102 Keyboard, 1,2 MB FDD 5 1/4 inch, FDD/HDD	\$3486.
--	---------

80386 Computer as Towercase	\$3730.
-----------------------------------	---------

Same System but 2 x 32 Bit Slots, 20/25 MHz 0 Wait state, 2 MB Ram	\$4089.
--	---------

As Towercase	\$4336.
--------------------	---------

Printers offered at	\$1736.
---------------------------	---------

Dealers' requests are welcome!

• Stuttgart

Hense & Partner

Gesellschaft für EDV-Systeme mbH

Windhalmweg 38

7000 Stuttgart 70

Telephone: 0711/451883

Telefax: 0711/451887

We accept
Mastercard
Access, Eurocard

EVEREX

Everex, Ship and Lullu are trademarks of Everex Systems, Inc. All other product names are registered trademarks of their manufacturers.





**"If this is a race, we
are out in front!"**

Steve Hui, President
Everex Systems, Inc.

IBM PS/2 Model 80 (20 MHz)	3.52 MIPS
Compaq DeskPro 386/20	4.59 MIPS
Everex Step 386/20	4.91 MIPS

Power Meter MIPS Version 1.2. The Database Group.

"We created a
monster."

Apparently, we
have surprised a
few people. It's not
every day that
someone builds
the world's fastest
386/20.

Our marketing
people call the con-
cept AMMA—for
Advanced Mem-
ory Management
Architecture.

I don't care what
you call it. This is
the computer that
has left everybody
behind, including
Compaq.

For the moment, we
are overjoyed.
But this is a game
of leapfrog and
we do not intend
to rest.

The Step 386/20
from Everex
is a monster of
a machine.

For price and
performance facts,
call Everex
Computer Systems
Division at 1-800-
356-4283. Everex,
48431 Milmont
Drive, Fremont,
CA 94538.



rangement of the input array is required.

The transformation of this shortened sequence can be carried out by performing $N/4$ "butterflies" on each of $\log_2(N/2)$ levels. This transform is followed by an additional level of $N/4$ butterflies to turn its results into the first half of the Fourier coefficients for the original sequence. The second half is neither calculated nor stored, since the coefficients are known a priori to be the complex conjugates: $X(N-k) = X^*(k)$.

This last level of butterflies involves the same necessity for retrograde addressing that marks all levels of the Hartley transform and reflects the deep relationship between the two approaches.

This trick alone evens the race between the Hartley and the Fourier transforms. Both require $\log_2 N$ levels of computation. On each level, the Hartley procedure requires $N/2$ butterflies, each involving two real multiplications, for a total of $N \times \log_2 N$. The Fourier procedure

has only $N/4$ butterflies on each level (because the transform is of half length), but each requires a complex multiplication. If these were done in the usual way, as Mr. O'Neill suggests, using four real multiplications apiece, then the contest would be a draw.

A second trick, however, can be used to make Fourier transforms the more economical computation on most computers of the present era. Because multiplication instructions typically require much longer to execute than those for addition or subtraction, this trick succeeds by reducing the number of real multiplications at the cost of an increased number of the quicker operations. I learned the technique from a friend who called it "Golub's method," but I am unable to cite a reference duly crediting its originator.

The idea is to compute a complex product $(A + iB) \times (X + iY)$ with only three real multiplications:

$$(A + B) \times (X - Y) + A \times Y - B \times X + i(B \times X + A \times Y).$$

When the products required for Cooley's real-valued FFT algorithm are taken in this way, the number of time-consuming real multiplications is reduced to three-fourths of those needed for the fast Hartley transform. A well-crafted Fourier routine is therefore faster.

Commercial Fourier transform packages also employ other tricks to achieve increased speed and accuracy. Many of these are equally applicable to Hartley and other related transformations. Probably the most important additional notion is to abandon the level-by-level sequence of calculations implicit in the foregoing discussion in favor of an ordering that groups operations involving common multipliers. This allows computations corresponding to angles of 0, 90, 45 degrees, and so on, to be handled by specialized loops that are much faster than the general case.

J. W. Hartwell
Hillsborough, NC

Symmetric Summation

I was pleased to see fuzzy logic featured in "When Facts Get Fuzzy" by Bradley L. Richards (April). Unfortunately, the operations usually used in fuzzy-set theory lead to logical inconsistencies that make it difficult to apply to real situations. To use one of Richards' examples, suppose that a medical diagnostician observes that symptom A indicates a 70 per-

continued

If you think you can buy a better C compiler, don't. We'll buy it for you.

Buy Let's C[®] with *csd*[™] for just \$75. If you're not satisfied, get Turbo C or QuickC. Free.*



Why are we making this incredible offer? Because we're absolutely certain Let's C and *csd* C Source Debugger are the best C programming tools you can own.

Rest assured that, like its competition, Let's C features incredibly fast in-memory compilation and produces extremely tight, high quality code. The differences lie in how much faster you can perform other programming chores.

Our debugger, for example, can cut development time in half. But that's not all:

"csd is close to the ideal debugging environment... a definite aid to learning C and an indispensable tool for program development."

—William G. Wong, BYTE

And comparatively speaking: *"No debugger is included in the Turbo C package... a serious shortcoming."*

—Michael Abrash, Programmer's Journal

Unlike our competition, Let's C includes its own full-featured assembler, features documentation with complete examples and technical support with complete answers—the first time you call.

LET'S C:

- Now compiles twice as fast
- Integrated edit-compile cycle: editor automatically points to errors
- Includes both small and large memory model
- Integrated environment or command line interface
- 8087 sensing and support

LET'S C AND *csd* FEATURES

- Full UNIX compatibility and complete libraries
- Many powerful utilities including make, assembler, archiver
- MicroEMACS full screen editor with source code included
- Supported by dozens of third party libraries

csd:

- Debug in C source code, not assembler
- Provides separate source, evaluation, program and history windows
- Ability to set trace points and monitor variables
- Can interactively evaluate any C expression
- Can execute any C function in your program
- Trace back function

So if you're thinking about buying any other C compiler, think again. But this offer is only available for a limited time. So think fast. And see your software dealer or call 1-800-MWC-1700 soon. (1-312-472-6659 in Illinois.)

To exchange Let's C and *csd* for Turbo C or QuickC, return registration card within 15 days of purchase date. notify Mark Williams Company that you are returning products and receive a return authorization number. Products must be returned within 30 days of purchase date or within 30 days of shipping date on telephone orders.



1430 West Wrightwood, Chicago, Illinois 60614, 312-472-6659

© 1988 Mark Williams Company

Imagine the speed and power of a \$100,000 minicomputer in a desktop PC costing under \$7,000. Now imagine all that power going to waste because the operating system you chose was never meant to take advantage of a computer this powerful. It will take more than just a "window environment" or an outdated operating system to unlock the 80386.

It will take PC-MOS/386™

The First 80386 Operating System. Specifically designed for the 80386 computer, PC-MOS/386™ opens doors. Doors to more memory and multi-tasking. Doors to thousands of DOS programs as well as upcoming 80386-specific software. It's the gateway to the latest technology..., and your networking future.

Memory Management Without Boards. PC-MOS exploits the memory management capabilities built into the 80386. So, up to four GIGABYTES of memory are accessible to multiple users and to future 80386-specific applications requiring megabytes of memory.

Multi-Tasking, Multi-User Support for One, Five or 25 Users. PC-MOS/386™ allows up to 25 inexpensive terminals to be driven by a single 80386 machine. So the features of the 80386 can be utilized at every terminal. And it comes in three versions so you can upgrade your system as your company grows...without having to learn new commands or install new hardware.

**UP TO
25 USERS.**

**MADE FOR
THE 80386.**

**RUNS DOS
PROGRAMS.**

MULTI-TASKING



Software Support for Thousands of DOS Programs. Although PC-MOS/386™ totally replaces DOS, it doesn't make you replace your favorite DOS programs. So you can run programs like Lotus 1-2-3, WordStar, dBASE III, and WordPerfect on the 80386. Best of all, it uses familiar commands like DIR and COPY—so you'll feel comfortable with our system.

The Gateway to Endless Features. Distinctive characteristics like file/system security, remote access, file/record locking, and built-in color graphics support for EACH user set PC-MOS/386™ apart from all previous operating systems.

Open the Doors to Your Future TODAY! Call The Software Link TODAY for more information and the authorized dealer nearest you. PC-MOS/386™ comes in single, five & 25-user versions starting at \$195.

PC-MOS/386™
MODULAR OPERATING SYSTEM



THE SOFTWARE LINK
Developers of LANLink™ & MultiLink™ Advanced

3577 Parkway Lane, Atlanta, GA 30092
Telex 4996147 SWLINK
FAX 404/263-6474

For the dealer nearest you:

CALL: 800/451-LINK
In Georgia: 404/448-LINK

OEM/Int'l Sales: 404/263-1006
Resellers/VARS: 404/448-5465

OEM/Dealer Inquiries Invited

THE SOFTWARE LINK/CANADA CALL: 800/387-0453

**More Than Just Windows,
We've Opened Doors.**

Circle 299 on Reader Service Card (DEALERS: 300)

TRADEMARK ACKNOWLEDGEMENTS: MultiLink™ is a registered trademark of The Software Link. PC-MOS/386™ MultiLink™ Advanced, and LANLink™ are trademarks of The Software Link. Lotus 1-2-3, WordStar, dBASE III, & WordPerfect are trademarks of Lotus Development Corp., MicroPro, Ashton-Tate, & WordPerfect Corp., respectively. Prices and technical specifications subject to change.

cent chance of disease and symptom B indicates a 40 percent chance—then if both symptoms are present, the combined chance is

$$0.7 \text{ p-OR } 0.4 = 0.7 + 0.4 - (0.7 \times 0.4) = 0.82.$$

An optimistic patient might conclude that symptom A means a 30 percent chance of health and symptom B a 60 percent chance, and

$$0.3 \text{ p-OR } 0.6 = 0.3 + 0.6 - (0.3 \times 0.6) = 0.72,$$

or a 72 percent combined chance of health. The numbers do not add up to 100 percent, as they should.

Several years ago, I investigated a class of operations on fuzzy sets

$$(a @ b) + ((1-a) @ (1-b)) = 1,$$

where @ is called the "symmetric sum."

An example of such a symmetric sum is the operation defined by

$$a @ b = ab / (1 - a - b + 2ab).$$

Applied to Richards' medical example, the chance of disease is

$$0.7 @ 0.4 = 0.7 \times 0.4 / (1.0 - 0.7 - 0.4 + 2 \times 0.7 \times 0.4)$$

or 61 percent, while the chance that the patient is healthy is

$$0.3 @ 0.6 = 0.3 \times 0.6 / (1.0 - 0.3 - 0.6 + 2 \times 0.3 \times 0.6)$$

or 39 percent—the two values add up to 100 percent, so both the pessimist and the optimist can agree.

Fuzzy-set definitions are always arbitrary, since for every set there is a complement, and meaningful results should not depend on which one of them we work with. Symmetric summation is the only type of operation that combines fuzzy sets in a way that leads to conclusions that are the same whether we deal with a particular choice of sets (e.g., young @ beautiful) or their complements (old @ ugly).

An interesting feature of symmetric summation is that it applies only to fuzzy sets, and indeed it is the only operation on fuzzy sets that I know of that does not correspond to an operation on normal sets. This is because of the easily proved requirement that $a @ (1 - a) = 1/2$.

William Silvert
Dartmouth, Nova Scotia
Canada

Drawing Lines

There is a problem with the attempt to draw a horizontal line in "A C Interface" by Don F. Ridgway (November 1987). Listing 1 on page 363 of that article is an interesting ANSISYS.H header file (not an ANSISYS.C header file, as the caption states). Also, in the #define WINDOW definition, the horizontal and vertical lines should not be filled.

Harold LeRoy Ling
Jackson, MN

FIXES

In the article "POP Goes the Macintosh" by Dick Pountain (May), the first line of code included in the text on page 290 should have read as follows:

```
pr('That took '><count><'
seconds'); ■
```

California
FREEWARE
ONLY \$2.99 PER DISK ONLY \$2.99 PER DISK

Public Domain & Shareware for IBM and Compatibles - DOS 2.1 or higher Programs and utilities for all your computing needs



BUSINESS

- **EZ-FORMS Rev D15 (66)** - Menu driven forms generator, misc. skeleton forms.
- **BRAB V1.3 (270)** - Small Business Accounting System. Menu-driven. Best avail
- **PRO PC-ACCT V3.0 (526)** - Integrated G/L, A/R & A/P. Menu-driven. Help.
- **EAST PROJECT V1.2 (440)** - Complete project management system. Excellent.
- **REAL ESTATE ANALYST (83)** Menu driven, mortgages, interest, etc.
- **CK - CHECKBOOK V3.1 (79)** - Full featured checkbook program with reports.
- **BIDS 'N' QUOTES V0.9 (463)** - Prepares cost estimates & proposals. Does labor, material, sub-contractor costs, etc.
- **BUSINESS LETTERS (303 & 304)** - (2 disk set) 650 business letters to fit all your needs. Edit w/ any word processor.
- **MIR BILL V3.2 (311 & 312)** - (2 disk set) Time & billing package; costs, credits, reports, audit trail, etc.
- **PC-PAYROLL V2.3 (464)** - Menu driven payroll system: 100 employees or less.
- **RENTAL PROPERTY (318)** - Keeps track of rental activity. Menu driven.
- **BUCWORKS (321)** - Framework clone. Integrated database, spreadsheet, word processor, & communications.
- **PARTS INVENTORY CONTROL (479)** - Tracks inventory of a parts & service business; qty, ordered, supplier, etc.
- **DOCKETINDER V1.2 (448)** - Maintain docket for lawyer or law firm.
- **FINANCE MANAGER V4.0 (77)** - Accounting package for business or personal finances. Double entry system.
- **SOAR V1.92 (448 & 450)** - (2 disk set) Accounts receivable program. Handles a variety of services or products.

COMMUNICATIONS

- **RBBS BULLETIN BOARD V15.1 (290 - 292)** - (3 disk set) Turn your computer into a RBBS. Industry standard.
- **QMODEM V3.1 (283 & 294)** - (2 disk set) Full featured modem program.
- **PROCOM V2.42 (83 & 84)** (2 disk set) Menu driven modem program.

DATABASE

- **FILE EXPRESS V4.14 (33 & 34)** - (2 disk set) Menu driven, easy to use database for beginners to experienced.
- **WAMPUM V3.1B (37 & 38)** - (2 disk set) Menu driven dBase III clone, supports functions of dBase. Knowledge of dBase suggested. Latest update.
- **PC-FILE + V2.0 (493 - 495)** - (3 disk set) Full-featured database; help screens, menus, macros. One of the best.
- **dGENERATE V1.0 (811)** - Screen & source code generator by Tom Rettig. dBase III required.

EDUCATION

- **COMPOSER (3)** - Create, save, edit, play, & print your music. Nice...
- **LETTERFALL V1.1 (118)** - Improve your touch typing skills: 16 levels.

- **THE WORLD 3D (127)** - Display maps of the world. CGA required.
- **FUNNELS & BUCKETS V 2.0 (130)** - Great learning game; add, subtract, multiply, & divide. Ages 5 - 10.
- **ERYN'S ABC'S (131)** - Teaches alphabet & numbers. Computerized Etch-a-Sketch. Ages 2 - 6. Basic required.
- **AMY'S FIRST PRIMER (133)** - Alphabet, numbers, counting, shapes, matching, etc. Ages 4 - 8. CGA & Basic req.
- **POLYLOT V8.01 (139)** - Vocabulary builder. Grades 7 - college. Excellent.

GAMES

- **BLACKJACK (95)** - Advanced blackjack game with tutor, multiple players. Best one yet. CGA or Hercules.
- **MONOPOLY V8.7 (108)** - Just like the board game. 2 to 4 players. CGA req.
- **DUNGEONS & DRAGONS V1.1 (205)** - The Classic Game. Can you survive?
- **LAS VEGAS (118)** - Craps, Roulette, Poker, & more. CGA req. Basic on some.
- **3D CHESS V1.01 (215)** - Excellent chess game. Switch between 2D & 3D.
- **SOLITAIRE (211)** - 4 different games. Nice graphics. CGA required.
- **SUPER PINBALL (212)** - 5 different games. CGA required.
- **WORDPLAY (367)** - Wheel of Fortune clone. You provide the prizes. CGA req.
- **DIGITAL LEAGUE BASEBALL (344)** - Pick your team & players. Nice graphics.
- **MINIATURE GOLF (505)** - 18 hole golf course with graphics.

GRAPHICS

- **FINGERPAINT V2.0 (282)** - Paint program; 6 fonts, 81 sizes - Desktop publishing & slide-show. CGA, EGA, or Hercules.
- **CALENDAR CREATOR (350)** - Create & print your own monthly calendar.
- **DANCAD 3D V2.0B (424 & 428)** - (2 disk set) Advanced 2D/3D drafting program. Stereoscopic 3D wire frame animation. EGA, CGA, Hercules. 640K req.
- **CITY DESK V8.0 (197)** - Desktop publisher with graphics capability.

LANGUAGE

- **TURBO 'C' TUTOR (488 & 490)** - (2 disk set) 14 lesson tutorial; learn to program in "C" language.
- **'C' LANGUAGE V2.1 (299 & 300)** - (2 disk set) Complete programming environment. Source, compiler, samples.
- **TURBO PASCAL TUTOR (20)** - 17 lesson tutorial with samples, etc.

MISCELLANEOUS

- **STRESS & SHRINK (74)** - Stress - stress test. Shrink - personality analysis.
- **FASTBUCKS (191)** - Menu-driven home finance package. Easy to use.
- **HEALTH RISE (331)** - Diagnose your own ailments.
- **LITTLE BLACK BOOK (441)** - Creates pocket sized address book. Prints mini-alphabetized pages.
- **TIMESAVER (442)** - Create daily

monthly calendar of appointments.

SPREADSHEET

- **LOTUS 123 PROGRAMS (28 - 32)** - (5 disk set) Contains as many applications and utilities that we could find. Requires Lotus 123 program.
- **LOTUS LEARNING SYSTEM (458)** - Beginning tutorial for Lotus 123.
- **AS EAST AS V3.0 (302)** - Lotus clone. 52 column sheet, graphing, supports functions of 123. "WKS" files, etc.

UTILITIES

- **DOS HELP (255)** - Help screen for DOS commands, functions & batch files at your fingertips. For DOS 3.XX.
- **DOS TUTORIAL V4.2 (256)** - Menu driven, learn to use your computer.
- **LQ V2.1 (509)** - Produces high quality text on dot matrix printers. Multiple fonts with print spooler.
- **LASERJET FONTS / II (471 & 472)** - (2 disk set) More downloadable fonts for HP Laserjet Plus/II, Helvetica, Script, etc.
- **LASERJET FONTS/UTILITIES (328)** - Contains Pamphlet (slideways printing) & misc. other utilities & fonts.
- **PRINTPRO V1.2 (468)** - Change printer operation from within ANY application at ANY time.
- **DESEMATES V1.01 (278)** - Sidekick like utility plus more features.
- **AUTOMENU V4.01 (280)** - Access programs, batch files, commands, etc.

WORD PROCESSING

- **SIDewriter (6)** - "Sideways" printing.
- **PC-WRITE V2.71 (9 & 10)** - (2 disk set) Full featured word processor; all the features of the expensive one's.
- **LETTERHEAD (69)** - Create and print your own letterhead on letters and envelopes. IBM/Epson comp. printer req.
- **GALAXY V2.3 (11)** - Easy to use word processor, menus & quick keyboard commands. Lots of features.
- **PC TYPE + (373 - 376)** - (3 disk set) A powerful word processor. Buttonware.

ORDER FORM

NAME _____

ADDRESS _____

CITY _____ ST _____ ZIP _____

PHONE _____

of 5.25" disks @ \$2.99 = _____

CA Res. Sales Tax (6.5%) = _____

Shipping & Handling = 3.00

TOTAL = \$ _____

Mail order form & check or money order to:
California FREEWARE
1466 Springline Drive Dept. B7
Palmdale, CA 93550
(805) 273-0300

Call or write for free catalog containing over 500 disks of quality software.
Hours: M-F 9am - 5pm PST
3.5" media - \$3.99 ea.
Sorry, no Credit Card orders.

Ultimate Power. Ultimate Confidence. Ultimate Freedom.



Experience 20 MHz 386 Power, AST Style

The sky's the limit. That's how you might describe the power-packed capabilities of the AST Premium™/386 ...and how far we'll go to provide outstanding products, service and support.

Only the 20 MHz, Premium/386, with its advanced bus technology (SMARTslot™) and uncompromising compatibility, eliminates the traditional restrictions placed on an AT®'s performance and speed while providing future upgradeability.

You also get the comfort that comes from choosing a company with a solid worldwide reputation for reliable,

high-quality technology.

So while others are caught up in compatibility and support problems, you're completely free to enjoy the highest AT-compatible '386 system performance available today...and take advantage of performance-oriented upgrades in the future using SMARTslot architecture.

And because of our many years of working with key leaders in the industry, we're able to maximize the capabilities of the most advanced operating systems and application software available, including MS® OS/2 from AST, IBM®'s OS/2™, UNIX™, Windows™ 386 and MS-DOS®

For more information call **(714) 863-0181** and ask for operator AA15, or fill out the coupon below.

- Please send me more information.
 Please have an AST representative call me.

Name _____

Title _____

Company _____

Address _____

by _____ State _____ Zip _____

Ph _____

AST Rese c., 2121 Alton Ave., Irvi
4992. Attn. M.C. _____

BYTE 7/88

AST markets products worldwide—in Europe and the Middle East call: 44 1 566 435 0; in the Far East call: 852 5 717223; in Canada call: 416 826 7914. AST and AST logo registered and AST Premium and SMARTslot trademarks AST Research, Inc. IBM and AT registered and OS/2 trademark International Business Machines Corp. MS-DOS and MS registered and Windows trademark Microsoft Corp. UNIX trademark AT&T Bell Laboratories. Copyright © 1988 AST Research, Inc. All rights reserved. Screen display courtesy VersaCAD.

AST
RESEARCH INC.

Times Have Changed.

How much would you pay for a device that

- Print Master II lets all your computers easily share all your printers, plotters, and modems, reducing the cost per user of expensive peripherals.
- Print Master II spools print jobs in its smart 256K buffer (field expandable up to 768K), then outputs them in sequence to keep your computers and printers working.
- Print Master II allows computers to select each other so you can share data bases and transfer files.
- Print Master II makes choosing a connection as easy as moving your cursor. You select where you want your data to go from a pop-up menu generated by BayTech's memory resident program.
- Print Master II, Model 808E, features eight flexible ports: six serial and two parallel. You can set *any* port, including both parallel ports, as a computer port or a printer port.
- Print Master II's serial ports operate at *real* speeds up to 9600 baud, even when all

ports are operating at the same time. You can set baud rates, plus other configuration changes, for each port.

- Print Master II handles protocol conversion automatically (i.e. serial/parallel baud rates, handshaking, etc.), so it's compatible with virtually all makes of computers, printers, plotters, modems and peripherals.
- Print Master II can be used in conjunction with the printer server of a LAN to help off-load network traffic by providing port expansion and extra buffer.
- Print Master II features many little extras that make a big difference in performance: shielded connectors, a built-in power supply, easy-to-read configuration menus, fewer parts for higher reliability, sturdy metal case.

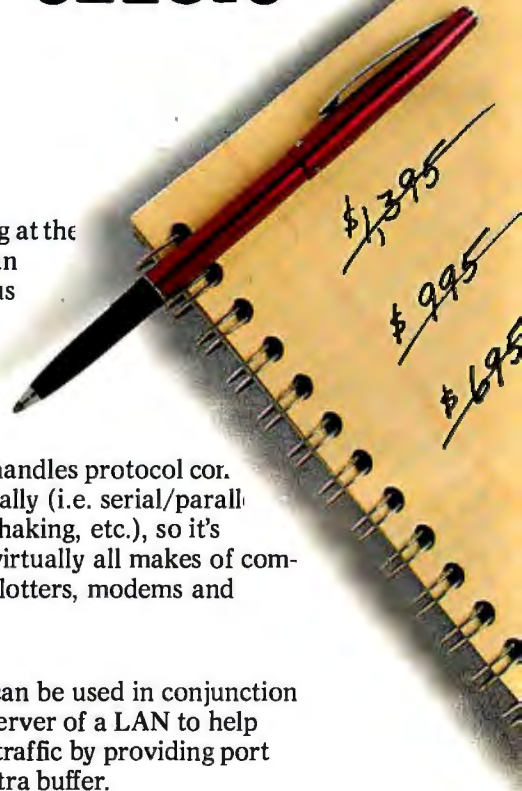

How about \$595? Call us to order direct or for the name of your nearest dealer.

BayTech

Bay Technical Associates, Inc., Data Communications Products Division
200 N. Second St., Bay Saint Louis, MS 39520 USA
Telex 910-333-1618 BAYTECH, Telephone 601-467-8231 or toll-free

800-523-2702

CHAOS MANOR MAIL

*Jerry Pournelle answers questions about his column
and related computer topics*

Kind Words for Multitasking

Dear Jerry,

I've been an avid reader of your column since its beginning. I have generally agreed with your comments—until you blasted multitasking operating systems in the November 1987 issue.

OS/2 is the first glimmer of hope for serious computing at the personal level. Most attempts at multitasking under MS-DOS are serious kludges (e.g., terminate-and-stay-resident programs like SideKick or massive polling loops like Microsoft Windows). These programs make extra efforts to bypass the operating system.

A big problem with IBM PC software is compatibility. Every developer has a different method of bypassing the operating system. Real operating systems (e.g., VMS, Unix, and OS/2) provide standard interfaces and services to support multitasking; therefore, different vendors' software can coexist.

Regarding your comment that "...what everyone wants is not multitasking, with its inevitable slowing of what you're doing in the foreground...": The new generation of 80386 machines has more than 2 million instructions per second of computing power. With this amount of power available and a multitasking operating system, you won't even notice several background processes.

"Real" networking (e.g., electronic mail, transparent file access, and remote procedure calls) cannot be done without true multitasking. Attempts to perform these operations with polling-loop implementations under MS-DOS produce mediocre results.

You say that what we really want is multiprocessing. That's nice in theory, but more processors cost more money. If the operation can be performed with a decent processor and operating system, why throw more hardware at it? Even with multiprocessing, we need multitasking to effectively coordinate the actions of several processors in a system.

I believe your blasting of multitasking is similar to the comment you made sev-

eral years ago regarding type-ahead buffers for keyboards. You didn't think they were necessary until you used a system that incorporated one.

Please don't bad-mouth true multitasking until you've tried it.

Kert H. Jans
Encinitas, CA

I don't recall saying anything about type-ahead buffers; indeed, I do recall insisting on n-key rollover on my early CP/M systems; isn't that what a type-ahead buffer does? Gee.

As to OS/2 on an 80386, I agree: It looks like it ought to be plenty fast and very useful. I'm not so certain about the 80286.

Multitasking is fine, but I'd settle for a really good way to do multiple applications. With luck we'll get both.

As to not knocking something I haven't tried, it's precisely because of the bad memories I have from trying multitasking that I'll remain skeptical until I see for myself that I can type and have my words appear on-screen instantly. Some people stare at the keyboard when they type; me, I watch the screen, and even the tiniest delay is noticeable.

We'll see, and I sure hope you're right.—Jerry

Microsoft Word Macro Delays

Dear Jerry,

I am happy that Microsoft Word 4.0 "is certainly the next program to try," as you said in your column in BYTE. I have used it for 3 years, and think it's the most elegant and versatile writing tool there is.

But you should be warned about its macros. They can emulate Electric Pencil commands just fine. But as your book chapters get bigger, Word's macros get slower. The delay is not noticeable with

continued

Jerry Pournelle holds a doctorate in psychology and is a science fiction writer who also earns a comfortable living writing about computers present and future. He can be reached c/o BYTE, One Phoenix Mill Lane, Peterborough, NH 03458.

Circle 33 on Reader Service Card

Three ways to build better Turbo Pascal programs...

NEW! POWER SCREEN

Screen I/O manager.

Features: ♦ screen painter ♦ virtual screens
♦ data validation ♦ context sensitive help
♦ unlimited screens ♦ definable keys
♦ & much more!

POW TOOLS

\$129

Full featured function library.

Features: ♦ TSR support ♦ direct video
access ♦ VGA and EGA support ♦ windows
and menus ♦ DOS memory allocation
♦ interrupt service routines
♦ & much more!

ASYNCH PLUS \$129

Asynchronous communication manager.

Features: ♦ speeds to 19.2K baud
♦ XON/XOFF protocol ♦ hardware
handshaking ♦ XModem file transfer ♦ I/O
buffers up to 64K ♦ & much more!

We're Blaise Computing, manufacturers of high quality function libraries designed to reduce the time and technical expertise required for serious applications development.

All of these packages include Peter Norton's On-line Instant Access Program, a comprehensive user reference manual with extensive examples, and full sample programs.

Satisfaction guaranteed or return within 30 days for a full refund.

We have a full line of products for C and Pascal. For a free brochure or to order call

800-333-8087!

BLAISE COMPUTING INC.
2560 Ninth Street, Suite 316 Berkeley, CA 94710 (415) 540-5441

small files, but it increases with file size and the cursor's location toward the end of a file (where most writers spend much of their time). On a standard IBM PC, 25 seconds may elapse between the time you hit the macro key(s) and the time the macro starts to execute, if you are at the end of a 35K-byte file. The more you need speed, the less you will get. "Intolerable," as you remarked about Q&A Write.

The only solution is to load ProKey 4.0 along with Word; its macros have no perceptible delay.

Since macros were just introduced in Word 4.0, perhaps it will take another major version for them to be implemented correctly, as is the case with many of Microsoft's other product enhancements.

Allan Fries
Seattle, WA

Gee, thanks for the tip. I expect Super-Key (or, for that matter, DESQview) macros would work the same way. I'll try it.—Jerry

Calling All PX-8 Orphans

Dear Jerry,

Do you have room for a "minority" public service spot?

On a couple of occasions, you've mentioned one of my favorite dinosaurs in your column. It's a small-in-size but big-in-bells-and-whistles CP/M machine called the Epson PX-8 (Geneva). Admittedly, between the advent of MS-DOS and all the reviews that kept saying the Geneva was only for "active computer users" (what does that mean, anyway?), it died out there in consumerland pretty quickly. Nevertheless, there are a lot of PX-8ers around still, and since Epson is out of the PX-8 business, I thought I'd pass on an address or two that might be of

some value to other orphans.

SynderScope International (1594 Hilltop Dr., El Cajon, CA 92020) still provides support, peripherals, and reams of software. The company also runs a bulletin board at (619) 442-3789. DAK Industries (8200 Remmet Ave., Canoga Park, CA 91304) also handles some hardware and software. (It seems prices these days for a PX-8 or peripherals are just a fraction of Epson's original suggested retail. Beware, it's enough to make an early Epson buyer weep!)

Another source of Geneva information is the bulletin board system at (313) 538-6968. By the way, Canadian users might still get some limited support through their local Epson dealers (at least they do in Winnipeg).

Thanks for mentioning CP/M occasionally. There's plenty of life in the old gal yet.

Christopher Lars Arney
Winnipeg, Manitoba, Canada

There sure is a dance in the old girl yet. Toujours gai!—Jerry

Hail the Paper Clip

Dear Jerry,

In Computing at Chaos Manor (October 1987), you mentioned that "Apple should have put a control lever on the Mac so you can eject floppies without begging permission."

Jerry, Apple did; the company just hasn't publicized it for fear of making things too easy for Mac users. There are three ways to eject disks from the Mac:

1. Pull down the window and use the "eject" feature, which you found frustrating.
2. Use the double-infinity Command key near the space bar, simultaneously pressing the Control key and lowercase num-

ber 4 at the top to electronically force a disk out (this won't hurt anything, I promise).

3. Bend the long end of a thick paper clip to a 90-degree angle from the body of the clip and insert into the little ubiquitous hole near the disk slot, located about 1/2 inch from the right-hand corner of the slot, keeping the wire totally at a 0-degree angle to the Mac; insert until you hit the mechanical frog (disk grabber) and press forward 1/4 inch; that will release the tension on the frog, and—bingo—your disk will pop out.

I have done this hundreds of times on all models of Macs and never damaged one in the least, and most of my colleagues forced to suffer Macs all keep a similar paper clip with them at all times and have done this procedure thousands of times with no damage whatsoever.

H. Kent Craig
Raleigh, NC

Well, I guess the solution is to issue a box of paper clips with each Mac!—Jerry

Stamp Out "Turbo"

Dear Jerry,

I am writing to solicit your help in promoting the enactment of federal legislation that would make it a capital offense to use the prefix "turbo" in the name of any product or service not directly and intimately associated with the power-plant industry.

I know I can count on your moral, if not your financial, support in this most worthy of endeavors.

(Embedded command: Remove tongue from cheek in order to lick stamp.)

David Fisher
Scottsville, NY

Hey, I'll join that campaign!—Jerry ■

PC voice mail, now only \$199.



**INCLUDES
HAYES®
COMPATIBLE
MODEM!**

big-system features like auto speed-dial, auto answer, message forwarding, and built-in 300/1200 bps modem. For an ear-opening business applications demo,

Watson®, hailed by one reviewer as "the premier voice mail station" at \$498, is an even better value at \$199. Watson eliminates

telephone tag and gives you

call **1 (800) 6-WATSON** (in Mass., (617) 651-2186). To order, call **1 (800) 533-6120** (in Mass., (617) 655-6066). Credit Cards Accepted.

Watson®

Natural MicroSystems Corporation

11 Important Reasons C Programmers Use Our File Manager

1. It's written in C.

Clearly the growing language of choice for applications that are fast, portable and efficient. All of db_VISTA's source code is written in C.

2. It's fast – almost 3 times faster than a leading competitor.

Fast access that comes from the unique combination of the B-tree indexing method and the "network" or direct "set" relationships between records. A winning combination for fast performance.

3. It's flexible.

Because of db_VISTA's combination of access methods, you can program to your application needs with ultimate design flexibility. Use db_VISTA as an ISAM file manager or to design database applications. You decide how to optimize run-time performance. No other tool gives you this flexibility without sacrificing performance. db_VISTA is also well behaved to work with most any other C libraries!

4. It's portable.

db_VISTA operates on most popular computers and operating systems like UNIX, MS-DOS and VMS. You can write applications for micros, minis, or even mainframes.

5. Complete Source Code available.

We make our entire C Source Code available so you can optimize performance or port to new environments yourself.

6. It uses space efficiently.

db_VISTA lets you precisely define relationships to minimize redundant data. It is non-RAM resident; only those functions necessary for operation become part of the run-time program.

7. Royalty free run-time.

Whether you're developing applications for yourself or for thousands, you pay for db_VISTA or db_QUERY only once. If you currently pay royalties to someone else for your hard work, isn't it time you switched to royalty-free db_VISTA?

db_VISTA™

Features

- ◆ **Multi-user** support allows flexibility to run on local area networks
- ◆ **File structure** is based on the B-tree indexing method
- ◆ **Transaction processing** assures multi-user consistency
- ◆ **File locking** support provides read and write locks
- ◆ **SQL-based db_QUERY** is linkable
- ◆ **File transfer** utilities included for ASCII, dBASE optional
- ◆ **Royalty-free** run-time distribution
- ◆ **Source Code** available
- ◆ **Data Definition Language** for specifying the content and organization of your files
- ◆ **Interactive database access** utility
- ◆ **Database consistency check** utility

File Management Record and File Sizes

- ◆ Maximum record length limited only by accessible RAM
- ◆ Maximum records per file is 16,777,215
- ◆ Maximum file size limited only by available disk storage
- ◆ Maximum of 256 index and data files
- ◆ Key length maximum 246 bytes
- ◆ No limit on number of key fields per record
- ◆ No limit on maximum number of fields per record

Operating System & Compiler Support

- ◆ **Operating systems:** MS-DOS, UNIX, XENIX, ULTRIX, Microport, VMS, Macintosh
- ◆ **C compilers:** Lattice, Microsoft, IBM, Aztec, Turbo C, XENIX, UNIX and LightspeedC

8. SQL-based db_QUERY

is the query and report writing program that provides a relational view of db_VISTA databases. Use ad hoc or link into your C applications. Royalty-free. Source code available.

9. Free tech support.

60 days of free technical and application development support for every Raima product. Of course, extended support and training classes are also available at your place or ours.

10. Upward database compatibility

Start out with file management in a single-user PC environment—then move up to a multi-user LAN or a VAX database application with millions of records. You'll still be using db_VISTA. That's why so many C programmers are choosing db_VISTA.

11. WKS LIBRARY

The WKS LIBRARY PROVIDES THE MOST EFFICIENT WAY FOR C and BASIC programmers to interface with 1-2-3, Symphony and dBASE.

- ◆ Reads & Writes WKS & WK1 Files
- ◆ Reads & Writes DBF Files
- ◆ 1-2-3, Symphony & dBASE compatible
- ◆ Source Included
- ◆ No Royalties

30-day Money Back Guarantee!

Price Schedule

	db_VISTA	db_QUERY
<input type="checkbox"/> Single user	\$ 195	\$ 195
<input type="checkbox"/> Single user w/Source	\$ 495	\$ 495
<input type="checkbox"/> Multi-user	\$ 495	\$ 495
<input type="checkbox"/> Multi-user w/Source	\$ 990	\$ 990
NEW:		
<input type="checkbox"/> WKS LIBRARY for Lotus 1-2-3	\$ 195	

Call Today!

Ordering is easy - simply call toll-free. We'll answer your technical questions and get you started.

1 (800) db_RAIMA

(800) 327-2462 or
(206) 828-4636



For international orders:

In the U.K. call	Systemstar Ltd.:	(0992)500919 FAX: (0992)554261
In Switzerland call	Comptronix AG:	01 725 04 10 FAX: 01 725 87 77
In France call	ISE-CEGOS:	(1) 46 09 2828 FAX: (1) 46 09 2800
In Belgium call	Lemrie S.A.:	(02) 720.96.57 FAX: (02) 721.12.00
In Germany call	ESM GmbH:	07127/5244



3055 - 112th NE, Bellevue, WA 98004 USA
FAX: (206) 828-3131 Telex: 6503018237 MCIUW

© 1988 Raima Corporation

ASK BYTE

Circuit Cellar's Steve Ciarcia answers your questions on microcomputing

Digitizing Live Video

Dear Steve,

Could you point out the proper combination of hardware and software that would permit an IBM PC user to display a full-motion video signal on the PC screen?

There seem to be a number of expensive video capture boards/software around (AT&T's TARGA, for example), but they are overly complex for this simple application. I'd like to be able to call up and view a video signal from a PC menu using my keyboard and return to a menu when done.

In reality, I'd like to go one step further and be able to select one video signal from a menu list of several video sources, using the PC communications port to drive a video switch. My ultimate goal is to be able to window the video into positions on the screen, such positions being controlled by a program.

Ron Van Note
New York, NY

The reason those TARGA boards are so expensive is that they're doing something quite complicated. Let me walk you through the problem.

A standard PC display (everything except the new VGA hardware) uses digital signals to represent the colors for each pixel. EGA displays can handle 64 colors, but the EGA boards can generate only 16 different colors at one time. No matter where your picture comes from, it will have only 64 colors when the EGA is done with it, and that's not enough for what you want to do.

The VGA displays use analog video signals, and the boards can produce 256 colors from a selection of about 250,000 (with 320- by 200-pixel resolution), which is closer to live video. Unfortunately, the screen scanning rates are so different that the monitor can't overlap a video signal on a digital image at the same time.

The TARGA boards sidestep the problem by digitizing the video image and using software to position the pixels in memory. That process just doesn't hap-

pen in real time, if only because the PC isn't fast enough to update the picture that quickly.

Some manufacturers do make a genlock accessory for the EGA display that will superimpose the EGA (in CGA mode) signal on a background of live video. I'm not sure of all the details, but I suspect you need an analog monitor that can handle both standard video and RGB inputs at the same time. The ads showed up in BYTE and PC Magazine a while ago, but I can't track them down again.

In any event, I think it'll be a lot more expensive than you'd like. Maybe having two monitors isn't that awful.—Steve

INASK BYTE, Steve Ciarcia, a computer consultant and electronics engineer, answers questions on any area of microcomputing and his Circuit Cellar projects. The most representative questions will be answered and published. Send your inquiry to

*Ask BYTE
c/o Steve Ciarcia
P.O. Box 582
Glastonbury, CT 06033*

Due to the high volume of inquiries, we cannot guarantee a personal reply. All letters and photographs become the property of Steve Ciarcia and cannot be returned.

The Ask BYTE staff includes manager Harv Weiner and researchers Eric Albert, Tom Cantrell, Bill Curlew, Ken Davidson, Jeannette Dojan, Jon Elson, Frank Kuechmann, Tim McDonough, Edward Nisley, Dick Sawyer, Robert Stek, and Mark Voorhees.

ROM Disk

Dear Steve,

I use a laptop computer quite a bit. I chose the NEC MultiSpeed because it is fast, powerful, inexpensive, and can run on batteries alone for those times when AC is unavailable.

The two built-in 720K-byte floppy disk drives are sufficient for many purposes. Of course, you can never have too much disk storage space. I can usually fit each major application program onto one or two 720K-byte disks, leaving the B drive open to hold the working files. So I

have a disk for Word and a disk full of documents, two disks for Lotus 1-2-3 and a third with spreadsheets and graphs, another pair of disks for Reflex and one for each major database, two for Microsoft C, and one for each major program I'm developing. Get the picture?

While this system is adequate, it tends to involve a lot of disk swapping. Worse yet, the heavy use of the floppy disk drives runs down the battery quickly. While the battery is rated at about 6 hours' use with "minimal" disk access, the NEC service representative told me that it was "normal" for the battery to last only about 2 hours with heavy disk use. And for certain operations (most notably programming), those disk drives are running almost constantly.

An internal hard disk drive, which some of the other laptops have, solves the problem of disk swapping but aggravates the problem of battery life. Besides, it doesn't look as if NEC will offer its hard disk drive as an upgrade option for the existing MultiSpeed machines. The new MultiSpeed HD looks quite a bit different than its predecessor.

I have a solution that I think is actually superior: Why not design and build an external ROM disk for the MultiSpeed? In fact, if I'm not mistaken, you could make the IBM-compatible parallel printer port operate bidirectionally. So you could adapt a ROM disk designed to run from the parallel printer port to all current (and, presumably, future) laptop machines. It would be a silent, low-power, expandable "disk drive" that you could carry easily wherever you went, and it could substitute for a fistful of disks.

I envision a system consisting of multiple circuit boards connected by a bus of ordinary flat ribbon cable. Board #1 would be a simple microprocessor controller board. A low-power Z80, an 82C55 parallel interface chip, a 27C128 EPROM, one or two 6264LP static RAM (SRAM) chips, and some "glue" would probably do the job. Board #2 (one or more copies in parallel on the ribbon-

continued

KNOWLEDGE IS POWER

We're Programmer's Connection, the leading independent dealer of quality programmer's development tools for IBM personal computers and compatibles. We can give you the knowledge to help you make the best software buying decisions possible.

Informative Buyers Guide. The CONNECTION, our comprehensive buyers guide and catalog, contains prices and up-to-date descriptions of over 750 programmer's development tools by over 250 manufacturers. Each description covers major product features as well as special requirements, version numbers, diskette sizes, guarantees, and more. In addition, the CONNECTION features interesting articles by leaders in the programming industry.

How to Get Your FREE Copy: 1) Use the reader service card provided by this journal; 2) Mail us a card or letter with your name and address; or 3) Call one of our convenient toll free telephone numbers.

If you haven't yet received your copy of the Programmer's Connection Buyer's Guide, act now. Increasing your knowledge about these products could be one of the most powerful things you'll ever do.

USA 800-336-1166

Canada 800-225-1166
Ohio & Alaska (Collect) 216-494-3781
International 216-494-3781
TELEX 9102406879
FAX 216-494-5260

Business Hours: 8:30AM to 8:00 PM EST Monday through Friday
Prices, Terms and Conditions are subject to change.
Copyright 1988 Programmer's Connection Incorporated



Established 1984

386 products	List	Ours
386 ASM/386 LINK by Phar Lap Software	495	389
386 DEBUGGER by Phar Lap Software	195	129
NOP C-386 by MicroWay	595	529
NOP ForTran-386 by MicroWay	595	529
PC-MDS/386 Single-User by The Software Link	195	179
PC-MDS/386 S-User by The Software Link	595	539
PC-MOS/386 25-User by The Software Link	995	869
VM/386 by IGC	245	219

blaise products	List	Ours
ASYNCH MANAGER Specify C or Pascal	175	135
C TOOLS PLUS/5.0	129	99
PASCAL TOOLS/TOOLS 2	175	135
Turbo ASYNCH PLUS/4.0	129	99
Turbo C TOOLS	129	99
Turbo POWER SCREEN	129	99
Turbo POWER TOOLS PLUS/4.0	129	99
VIEW MANAGER Specify C or Pascal	275	219

borland products	List	Ours
EUREKA Equation Solver	167	115
Paradox 2.0 by Ansa/Borland	725	525
Paradox 386 by Ansa/Borland	895	639
Paradox Network Pack by Ansa/Borland	995	725
Quattro: The Professional Spreadsheet	247	179
Sidekick Plus	200	125
Turbo Basic Compiler	100	68
Turbo Basic Support Products All Varieties	100	68
Turbo C Compiler	100	68
Turbo Pascal Compiler	100	68
Turbo Pascal Database Toolbox	100	68
Turbo Pascal Developer's Toolkit	395	285
Turbo Pascal Editor Toolbox	100	68
Turbo Pascal Graphics Toolbox	100	68
Turbo Pascal Graphic Toolbox	100	68
Turbo Pascal Numerical Methods Toolbox	100	68
Turbo Pascal Tutor	70	49
Turbo Prolog Compiler	100	68
Turbo Prolog Toolbox	100	68
Other Borland products	CALL	CALL

c language	List	Ours
C talk by CNS	150	129
Eco-CBB Modeling Compiler by Ecosoft	100	69
Lattice C Compiler from Lattice	450	289
Mark Williams Let's C with FREE csd	75	54
Univare 68000 C Cross Compiler by SOS	995	899
Univare Z-80 C Cross Compiler by SOS	995	899
WATCOM C6.0 by WATCOM Group	295	269

database management	List	Ours
Clipper by Nantucket	695	379
dBASE III Plus by Ashton-Tate	695	389
dBFAST dBASE III Plus Comp by dBFAST	99	89
FoxBASE+ by Fox Software	395	249
FoxBASE+/386 by Fox Software	595	399

Geniter by bytel	395	249
Tom Rettig's Library by Tom Rettig & Assoc	100	89

digitalk products	List	Ours
Smalltalk/V	100	84
EGA/VGA Color Option	50	45
Goodies Diskette #1	50	45
Goodies Diskette #2	50	45
Goodies Diskette #3	50	45
Smalltalk/Comm	50	45
Smalltalk/V 286	200	175

golden bow products	List	Ours
Vcache	60	55
Vfeature Hard Disk Utility	80	74
Vfeature Deluxe Hard Disk Utility	120	111
Vopt Hard Disk Optimization Utility	60	55

komputerwerk products	List	Ours
Finally BASIC routines	99	85
Finally Modules	99	85
Finally XGraf	99	85

lahey computer products	List	Ours
F77L-EM/16	695	639
F77L-EM/32	895	799
F77L-FORTRAN Compiler	477	429
Lahey Personal Fortran 77	95	85
with Toolkit	119	99

logitech products	List	Ours
LOGIMOUSE All Varieties	CALL	CALL
LOGITECH Modula-2 Development System	249	199
Modula-2 Compiler Pack	99	75
Modula-2 Toolkit	169	139

microsoft products	List	Ours
Microsoft BASIC Compiler	295	219
Microsoft C Compiler 5 w/CodeView	450	299
Microsoft COBOL Compiler with COBOL Tools	700	465
Microsoft FORTRAN Optimizing Comp	450	299
Microsoft Macro Assembler	150	105
Microsoft Mouse All Varieties	CALL	CALL
Microsoft OS/2 Programmer's Toolkit	350	239
Microsoft Pascal Compiler	300	199
Microsoft QuickBASIC 4	99	69
Microsoft QuickC	99	69
Microsoft Windows	99	69
Microsoft Windows 386	195	129
Microsoft Windows Development Kit	500	329
Other Microsoft products	CALL	CALL

persoft products	List	Ours
SmartMOVE	149	135
SmartTERM 220	195	179
SmartTERM 240	345	309

CALL for Products Not Listed Here

ORDERING INFORMATION

FREE SHIPPING. Orders within the USA (including Alaska & Hawaii) are shipped FREE via UPS. Call for express shipping rates.

NO CREDIT CARD CHARGE. VISA, MasterCard and Discover Card are accepted at no extra cost. Your card is charged when your order is shipped. Mail orders please include expiration date and authorized signature.

NO COD OR PO FEE. CODs and Purchase Orders are accepted at no extra cost. No personal checks are accepted on COD orders. POs with net 30-day terms (with initial minimum order of \$100) are available to qualified US accounts only.

NO SALES TAX. Orders outside of Ohio are not charged sales tax. Ohio customers please add 5% Ohio tax or provide proof of tax-exemption.

30-DAY GUARANTEE. Most of our products come with a 30-day documentation evaluation period or a 30-day return guarantee. Please note that some manufacturers restrict us from offering guarantees on their products. Call for more information.

SOUND ADVICE. Our knowledgeable technical staff can answer technical questions, assist in comparing products and send you detailed product information tailored to your needs.

INTERNATIONAL ORDERS. Shipping charges for International and Canadian orders are based on the shipping carrier's standard rate. Since rates vary between carriers, please call or write for the exact cost. International orders (except Canada), please include an additional \$20 for export preparation. All payments must be made with US funds drawn on a US bank. Please include your telephone number when ordering by mail. Due to government regulations, we cannot ship to all countries.

MAIL ORDERS. Please include your telephone number on all mail orders. Be sure to specify computer, operating system, diskette size, and any applicable compiler or hardware interface(s). Send mail orders to:

**Programmer's Connection
Order Processing Department
7249 Whipple Ave NW
North Canton, OH 44720**

peter norton products	List	Ours
Advanced Norton Utilities	150	89
Norton Commander	75	55
Norton Editor	75	59
Norton Guides 5	100	65
For OS/2	150	109
Norton Utilities	100	59

soft wa	List	Ours
muLISP-87 Interpreter	300	219
muLISP-87 Interpreter &	400	299
muMATH-8C	300	219

other products	List	Ours
DATABACK	70	67
MACK DOS	60	58
Turbo G GRAPHICS Develop	80	75
with Source Code	150	135

actor by The Whitewater Group	List	Ours
Actor by The Whitewater Group	495	439
APL *PLUS PC by STSC	695	529
Brief by Solution Systems	195	CALL
Dan Bricklin's Demo II by Software	195	179
Desqview from Quarterdeck	130	115
Disk Technician by Prime Solutions	100	89
Disk Technician+ by Prime Solutions	130	119
EXTEND FOR 77 Extens by Design Dec	149	129
Flow Charting II+ by Patton & Patton	229	189
GRASP by Paul Mace Software	99	85
HALO 88 by Media Cybernetics	325	CALL
Instant Replay III by Nostradamus	150	129
Mace Utilities by Paul Mace Software	99	85
MathCAD by MathSoft	349	319
Microcompatibles Products All Varieties	CALL	CALL
Microport Products All Varieties	CALL	CALL
MICROSTAT-II Statistics Pack by Ecosoft	395	359
Opt-Tech Sort by Opt-Tech Data Proc	149	99
Peabody by Copia Intl, Specify Language	100	89
PMI Products All Varieties	CALL	CALL
Quinn-Curtis Products All Varieties	CALL	CALL
STATGRAPHICS by STSC	895	699
TLIB Version Control by Burton Systems	100	89
Turbo Analyst 4.0 by TurboPower	75	69
TurboGeometry Library by Disk Softw	100	89
Turbo Professional 4.0 by TurboPower	99	89
XENIX System V All Varieties by SCO	CALL	CALL



SMART CARD EXTENDER

EASY ON \$195⁰⁰ — PC/XT
\$225⁰⁰ — AT

A smart card extender for PC/XT/AT and compatibles

- Allows card insertion and extraction without power on/off cycles
- Saves time by eliminating DOS re-boots
- Reduces wear and tear on hard disk drives
- Extends host interface for hardware and software development and test
- A single switch controls the connection of all signals to and from the computer bus
- Patent pending



DIPROM

RS232 Downloadable PROM

\$175⁰⁰ 32K x 8

\$195⁰⁰ 64K x 8

RS232



- Eprom emulator for 2716 — 27512
- Supports 8, 16, or 32 bit wide busses
- Non-Volatile memory standard
- Up to 19200 Baud
- Accepts Intel Hex and Motorola S formats
- 150ns access time standard

VectorScan 512/640 \$975⁰⁰

Graphic Controller with RS-232 Interface

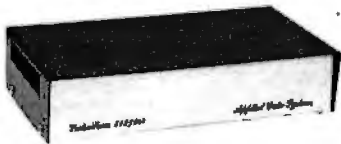

- Interfaces over RS-232 ports
- Drives CGA, EGA, and Multiscan
- Resolution of 512x480 to 640x350
- 4 Bits/Pixel up to 4,096 colors
- Maintains 4 separate images
- Internal 512K byte frame buffer
- PC Version available

Applied Data Systems can customize a product to your specifications.

30 DAY NO RISK EVALUATION

APPLIED DATA SYSTEMS

9811 Mallard Dr. Suite 203

Laurel, MD 20708

For more information call **800-541-2003**

cable bus) would be filled with 27C512 EPROM chips. Each ROM board could hold up to 32 EPROMS, or 2 megabytes, of "disk" space.

With very little additional effort, you could design the system so that it also accepted a third type of board containing 43256LP CMOS SRAM chips instead of EPROMS. Then you could have an external RAM disk that did not reduce the MultiSpeed's working RAM capacity, or a mixture of RAM disk and ROM disk for maximum flexibility.

Loading software and data files into the ROM disk would be the only complicated part of the whole project. A labor-intensive approach would be to use software on a host PC with a hard disk drive to build an image of the ROM disk drive, convert the changed data to an Intel hex file, figure out which EPROM chips need to be removed from the ROM disk board(s), and then dump the hex files to an EPROM programmer one chip at a time.

A hardware approach would be cleaner. You could design a fourth board that would contain EPROM programming circuitry. It could burn the EPROMS in the ROM disk boards; you wouldn't even have to remove them from their sockets. With this programmer board in place, the host PC could simply COPY or XCOPY one or more files to the ROM disk as if it were writing to a real disk.

What do you think about this idea?

John P. Toscano

Apple Valley, MN

Every now and again the subject of an external ROM (or RAM) disk comes up. You've done a good analysis of the project, but you've overlooked one absolutely essential specification: the economics of the project.

The ROM disk you describe uses 32 27C512 EPROMS, which cost about \$10 apiece in moderate quantities. Sockets, bypass capacitors, buffers, and the like add about \$1 to the cost of each EPROM. I think that the support circuitry could be a little simpler than you describe, but let's figure about \$50 in parts for the CPU and other ICs. Just the EPROMS require about 50 square inches of PC board space, so we'll stack two 6- by 8-inch boards in a box; figure \$30, including the board connectors. The board needs a connector to the PC, so add another \$15 or so. Figure that there will be some costs for assembly, test, and rework, and you're up to about \$500 for each unit.

But we haven't allowed for design time, software development, advertising, shipping, or the profit motivator. You can

assign any markup you'd like to cover the cost of running the business that makes the ROM disk possible; I'll use a factor of 2 (which may not be enough).

The bottom-line price to the consumer would be about \$1000, which seems awfully steep for a box that replaces 2.84 floppy disks—and needs a power supply and cable.

Don't feel too bad, though. I've built quite a few projects that didn't make any economic sense; they were just fun to do. If I can figure out any way to make a general-purpose ROM disk workable, I'll be sure to do it. —Steve

Improving Iris after Cataracts

Dear Steve,

My father-in-law was operated on for cataracts a few months ago. Unfortunately, complications resulted in the loss of proper function of the iris of one eye. This makes it difficult for him to cope with wide variations in light intensity and detracts from his enjoyment of his favorite outdoor activities.

I would like to build or procure a simple, lightweight, artificial iris for him. My idea is to overlay one lens of his eyeglasses with some material that can be rendered more or less transparent by a varying electrical field controlled by a light-level sensor mounted on the glasses frame. I know that somewhere, in a discussion of NASA research or similar activity, I read of a material with such properties. In fact, Edmund Scientific markets a liquid-crystal material that might be adapted to the purpose. Unfortunately, it requires a high voltage, and I'm not sure that its clear state is sufficiently transparent.

Are you or is anyone on your staff aware of any material that might be suitable for the purpose?

Robert D. Williams
Mathews, VA

A low-tech solution to your father-in-law's problem may produce better results than a state-of-the-art optoelectronic project. The trouble with the latter is that it's going to be absurdly expensive and probably ugly.

How about a simple polarizer added to a pair of Polaroid sunglasses? If you picked the lenses carefully, they'd have a nearly spherical section so you could mount a polarizer disk against the inside surface. By rotating the polarizer, you could vary the transmission from about 50 percent (more or less) to almost nothing.

You could also use neutral-density fil-
continued

VGA

Princeton's **V**ery **G**ood **A**nswers.

Without question, Princeton's PSC-28 and PSM-03 monitors will bring you the ultimate in VGA performance. Princeton was the first to offer truly compatible VGA dedicated monitors. Our PSC-28 is a 770 × 570, .28mm dot pitch, high resolution analog color monitor that can display an infinite number of colors. The PSC-28 also features a convenient color button for green, amber or cyan text. The PSM-03, a high resolution analog monochrome monitor gives you outstanding 800 × 630 resolution, and the ability to display infinite shades of gray. Plus sharp crisp graphics and character definition from its dynamic focusing circuitry.

Both monitors are compatible with IBM PC*, XT*, AT*, PS/2, Apple Macintosh SE* and compatible personal computers. Each gives you full compatibility with the leading VGA adapter cards including the QuadVGA and VEGA VGA. So if VGA meets all your needs (and you don't require the additional flexibility of our famous ULTRASYN and MAX-15 autosynchronous monitors), investigate the cost/performance value of the

PSC-28 and PSM-03.

Unsurpassed quality, service and performance make it hard to beat Princeton monitors. We offer better value than our competition. We call it the Visible Edge. For answers to all your questions about VGA compatible monitors, contact us at 601 Ewing Street, Building A, Princeton, New Jersey 08540 (609) 683-1660, x 810.

**Requires proper adapter card*

PSM-03



PSC-28



PRINCETON[®]
GRAPHIC SYSTEMS
AN INTELLIGENT SYSTEMS COMPANY

THE VISIBLE EDGE

	MODEL	DESCRIPTION	ANALOG INPUTS			ANALOG OUTPUTS			I/O Lines	
			Channels	Resolution (bits)	Throughput (kHz)	Channels	Resolution (bits)	Throughput (kHz)		
LOW COST	DT2811-PGH	Low Cost A/D, D/A, Interrupt	16SE/8DI	12	20	2	12	50	8 In, 8 Out	
	DT2811-PGL	Low Cost, Low-Level A/D, D/A; Interrupt	16SE/8DI	12	20	2	12	50	8 In, 8 Out	
	DT2814	Low Cost A/D, Int.	16SE	12	25	--	--	--	--	
GENERAL PURPOSE	DT2815	Low Cost D/A	--	--	--	--	--	--	32	
	DT2817	Low Cost DIO	--	--	--	--	--	--	16	
	DT2808	Low Cost, DMA	16SE	10	3.3	2	8	10	14.8	
	DT2801	General Purpose, DMA	16SE/8DI	12	13.7	2	12	29.5	14.8	
	DT2801-A	Higher Throughput, DMA	16SE/8DI	12	27.5	2	12	29.5	14.8	
	DT2801/5716A	High Resolution, DMA	8DI	16	20	2	12	14.8	14.8	
	DT2805	Low Level, DMA	8DI	12	13.7	2	12	14.8	14.8	
	DT2805/5716A	Low Level, DMA	8DI	16	20	2	12	29.5	14.8	
	DT2818	Simultaneous Sample & Hold, DMA	4SE, SS&H	12	27.5	2	12	29.5	14.8	
	HIGH SPEED	DT2821	High Throughput, DMA, Interrupts	16SE/8DI	12	40	2, De-glitched	12	130	16
DT2821-F-16SE, DT2821-F-8DI		Very High Throughput, DMA, Interrupts	16SE or 8DI	12	150	2, De-glitched	12	130	16	
DT2821-G-16SE, DT2821-G-8DI		Ultra High Throughput, DMA, Interrupts	16SE or 8DI	12	250	2, De-glitched	12	100	16	
DT2823		High Throughput, High Res., DMA, Ints.	4DI	16	100	2, De-glitched	16	100	16	
DT2825		High Throughput, Low Level, DMA, Ints.	16SE/8DI	12	40	2, De-glitched	12	130	16	
DT2827		High Resolution, High Throughput, DMA, Int.	4DI	16	100	2, De-glitched	12	130	16	
DT2828		High Throughput, SS&H, DMA, Interrupts	4SE, SS&H	12	100	2, De-glitched	12	130	16	
DT-Connect™		DT2841	High Throughput, DT-Connect™ Transfer	16SE/8DI	12	40	2, De-glitched	12	130	16
		DT2841-F-16SE	Very High Throughput, DT-Connect™ Transfer	16SE	12	150	2, De-glitched	12	130	16
		DT2841-F-8DI	Very High Throughput, DT-Connect™ Transfer	8DI	12	150	2, De-glitched	12	130	16
	DT2841-G-16SE	Very High Throughput, DT-Connect™ Transfer	16SE	12	250	2, De-glitched	12	130	16	
	DT2841-G-8DI	Very High Throughput, DT-Connect™ Transfer	8DI	12	250	2, De-glitched	12	130	16	
	DT2841-L	750kHz Throughput, DT-Connect™ Transfer	4DI	12	750	2, De-glitched	12	130	16	
	DT2847	16-bit Resolution, DT-Connect™ Transfer	4DI	16	100	2, De-glitched	12	130	16	
	DT2848	High Throughput, SS&H, DT-Connect™ Transfer	4SE	12	100	2, De-glitched	12	130	16	
FLEXIBLE I/O	DT2806	ISBX A/D	Up to 80	12	20	Up to 24	12	5	Up to 72	

Subroutine libraries and/or application-specific software packages are available with all boards.



-Fred "Atlas" Molinari, President

Who else could carry all you need in IBM PC data acquisition?

DIGITAL FUNCTIONS		SCREW TERMINAL PANELS		PRICE
Counter/Timer	Programmable Clock	Low Cost	Signal Conditioning	
-	✓	DT707	DT709-Y, DT756-Y, DT760	\$ 745
-	✓	DT707	DT709-Y, DT756-Y, DT760(-T), DT707-T	\$ 845
-	✓	DT757	DT709-Y, DT756-Y, DT760	\$ 395
-	-	(2)DT757	-	\$ 499
-	-	DT758-C	-	\$ 199
-	✓	DT707	DT709-Y, DT756-Y, DT760	\$ 495
-	✓	DT707	DT709-Y, DT756-Y, DT760	\$ 995
-	✓	DT707	DT709-Y, DT756-Y, DT760	\$1,095
-	✓	DT707	-	\$1,970
-	✓	DT707	DT707-T	\$1,095
-	✓	DT707	DT707-T	\$2,070
-	✓	DT707	-	\$1,695
-	✓	DT707	DT709-Y, DT756-Y, DT760	\$1,345
-	✓	DT707	DT709-Y, DT756-Y, DT760 (SE)	\$1,995
-	✓	DT707	DT709-Y, DT756-Y, DT760 (SE)	\$2,995
-	✓	DT707	-	\$2,795
-	✓	DT707	DT707-T, DT760	\$1,445
-	✓	DT707	-	\$2,495
-	✓	DT707	-	\$1,995
-	✓	DT707	-	\$1,450
-	2	DT707	DT709-Y, DT756-Y, DT760 (SE)	\$2,095
-	2	DT707	DT709-Y, DT756-Y, DT760	\$2,095
-	2	DT707	-	\$2,695
-	2	DT707	DT709-Y, DT756-Y, DT760	\$2,695
-	2	DT707	-	\$2,995
-	2	DT707	-	\$2,495
-	2	DT707	-	\$2,095
-	2	DT707	-	\$2,095
(3) 16-bit, cascadable	-	DT757, DT758-E	DT709-Y, DT756-Y, DT756-D, DT760	\$295 to \$1,530

Only one company started the board level data acquisition industry for the PC. And only one company offers everything you need today. Data Translation.

We give you the widest range of data acquisition boards. The most software. The most signal conditioning and screw terminal products.

You get more performance too, with the fastest throughputs in the industry (750KHz), and the option to connect to auxiliary processor boards.

And one thing that the chart doesn't show you: you get the best engineering, quality and support from Data Translation. Including immediate answers to questions, and 5 day delivery from the people who invented these products in the first place.

So next time you need a data acquisition solution, call Data Translation. And get carried away with your choices.

Call (617) 481-3700

Free 1988 Data Acquisition Handbook Set



DATA TRANSLATION®

World Headquarters: Data Translation, Inc., 100 Locke Drive, Marlboro, MA 01752-1192 USA, (617) 481-3700 Tlx 951646
United Kingdom Headquarters: Data Translation Ltd., The Mulberry Business Park, Wokingham, Berkshire RG11 2QJ, U.K. (0734) 793838 Tlx 94011914
West Germany Headquarters: Data Translation GmbH, Stuttgarter Strasse 66, 7120 Bietigheim-Bissingen, West Germany 07142-54025
International Sales Offices: Australia (2) 662-4255; Belgium (2) 735-2135; Canada (416) 625-1907; Chile (2) 25-3689; China (408) 727-8222, (8) 721-4017; Denmark (2) 274511; Finland (90) 372-144; France (1) 69077802; Greece (1) 951-4944, (31) 527.039, (1) 361-4300; Hong Kong (3) 771-8585; India (22) 23-1040; Israel (3) 32-4298; Italy (2) 824701; Japan (3) 502-5550, (3) 375-1551, (3) 355-1111; Korea (82) 756-9954; Morocco (9) 30-4181; Netherlands (70) 99-6360; New Zealand (9) 504759; Norway (2) 53 12 50; Peru (14) 31-8060; Philippines 818-0103; Portugal 545313; Singapore 7797621; South Africa (12) 46-9221; Spain (1) 455-8112; Sweden (8) 761-7820; Switzerland (1) 723-1410; Taiwan (2) 7371896; United Kingdom (0734) 793838; West Germany 07142-54025.
 Data Translation is a registered trademark of Data Translation, Inc. Other brands and products are trademarks of their respective holders.

ters; perhaps you could use two or three levels in various combinations. They might be easier to mount than a polarizer because they wouldn't need to rotate.

Drop into a good camera store and see what they have in the way of filters. You could cannibalize a second pair of sunglasses for a polarizer; that would give you good optical quality for a very low cost.

You might have to drill a few holes in the lens for the filter mount, but that's a mechanical problem and doesn't involve delicate surfaces, high voltages, or complex electronics. While it often seems as though I like high-tech gadgetry for its own sake, you'll notice that many real-world interfaces are brutally simple and reliable—otherwise, they don't work for long.—Steve

Too Much Space

Dear Steve,

I am using an IBM PC with DOS 2.0 and a Brother HR-35 printer with a sheet feeder. A problem shows up when I print from the word processor of MultiMate Advantage II. Specifically: Occasionally, for no apparent reason, extraneous spaces appear in lines of print. In succeeding lines, the left margin is offset the same number of spaces. If I switch the printer off and back on (which clears its buffer), the left margin goes back to its proper setting.

Ashton-Tate's only suggestion was to use TTYCRLF.PAT, but this gave me other troubles with justification and 4-line-per-inch spacing.

Also, the sheet feeder of the printer moves the paper 0.6 inch to the right of its normal position. When I use sophisticated software (e.g., MultiMate, dBASE III Plus, and Norton Utilities), I can adjust for this in the margin specification. But I cannot use the shift-printscreen function. Brother says I cannot do anything with the printer to overcome this. Is there some way I can modify DOS or BIOS to correct this problem?

Russell G. Hill
Princeton, NJ

There are a couple of possibilities, but to figure out what's going on you'll need to do a little experimenting. I'll run through the choices and suggest how to test for them.

Because the offset is consistent from line to line, the Brother HR-35 may be getting a command to set the left margin. I don't know if getting a margin command in the middle of a line would cause additional spacing in that line, but it's worth checking.

The first step is to capture your printer's output so you can see exactly what's going on. The most practical way is to install a resident program that re-directs the printer output to a file so you can look at it. PC Magazine (December 22, 1987) presented a utility called PRN2FILE (print to file) that does the deed.

PRN2FILE will create a disk file containing all the characters going to your printer. You can then use DEBUG or some file dump utility to examine the file in detail. You can also reprint the same file over and over to see if you get different results from the same data; because you use the DOS COPY command to do this, there's less chance for timing problems.

There are two possibilities: (1) either the data file will contain some extra or garbled data, or (2) it won't. If it does, the fault lies in the printer driver software. If it doesn't, then there's a problem in your printer. If you can reprint the same data file with different results, the printer is almost certainly kaput.

Check your cables, connectors, and so forth, even though you're sure they can't possibly make any difference. Often, a 2-day debugging session starts with a flaky connector.

As far as adjusting the margins for printscreen—tinkering with the BIOS code isn't worthwhile. By and large, you'd need to write a replacement routine; this isn't terribly difficult, but it shouldn't be your first whack at assembly language. What may be more practical is to set up a batch file that moves the left margin over 6 or 10 spaces, then do normal printscreens and let the printer handle the margins. Admittedly, that's not too elegant, but it ought to work.

—Steve

Hard Disk Mysteries

Dear Steve,

I have two problems that I've spent considerable time trying to resolve without success, despite reading everything I could find and writing letters to the manufacturers involved.

I built my IBM PC XT clone from components, and to date I have had no problems with hardware failures or software incompatibilities. The following list of my equipment may help you assist me, if you think my problems can be traced to hardware.

I have a DTK 4.77-/8-MHz motherboard with an NEC V20 CPU, Phoenix 2.27 BIOS, and 640K bytes of 150-nanosecond RAM mounted in a steel flip-top case. The display card is the ATI EGA Wonder with 4.02 BIOS. I have a Sam-

sung SM-12SFA7 amber flat-screen monitor and a DTK Multi I/O card with floppy disk drive controller; the card is configured with a game port, a clock, and COM1 enabled (COM2 is disabled). The floppy disk controller is hooked to a Toshiba 360K-byte floppy disk drive (A) and a Toshiba 3½-inch 720K-byte floppy drive (B). My hard disk drive is a Seagate ST251 with a Western Digital WX1 (F300) controller, configured as a 32.6-megabyte hard disk drive (C) and an 8.9-megabyte hard drive (D). A Fujitsu 1.2-megabyte floppy disk drive and a Magitronic PE-510 Super FDC will be installed as drive E after I've resolved the problem. A 150-watt power supply (modified by the internal addition of surge and radio-frequency interference suppression) provides stable outputs. The keyboard is a DataComp DFK-777. Finally, a Zoom 2400-bit-per-second modem operates as COM2.

Now for the problems. Here's the first one. I had two Seagate ST225 21-megabyte hard disk drives with an Everex (which appears to be similar to the Western Digital WX2) controller, formatted with the MS-DOS 3.2 operating system. Wanting to install the 1.2-megabyte floppy disk drive, I installed the Seagate ST251/Western WX1 and formatted everything with MS-DOS 3.30. Now my old CONFIG.SYS file no longer works (the system says unrecognized command).

Furthermore, while I can run a directory of the C drive's root and copy or edit files there, programs such as PC Tools and Menu consistently tell me there are no files in the root directory and will not read the volume name of the hard disk.

The second problem regards formatting the hard disk: Many of the Seagate ST255s (and now my ST251) ignore my interleave specification (I enter a 3) when controlled by a Western Digital WX2 or WX1 controller.

I obtained a program called SPINTEST from a local bulletin board, and it gives the result of 3 revolutions to read a track (with a 174,080-byte-per-second transfer rate) when I use an Omti 5520, Microtek, HDC-1000, or DTC 5150. Occasionally I get a Western Digital WX1 to format with an interleave of 3, but, typically, SPINTEST indicates 17 revolutions to read the track with a transfer rate of 30,710 bytes per second. Is there a fix for this?

Christopher Koch
Buffalo, NY

I think this is one where you've got to be there to make any headway. . .

Here's what I'd do. First, back up the
continued

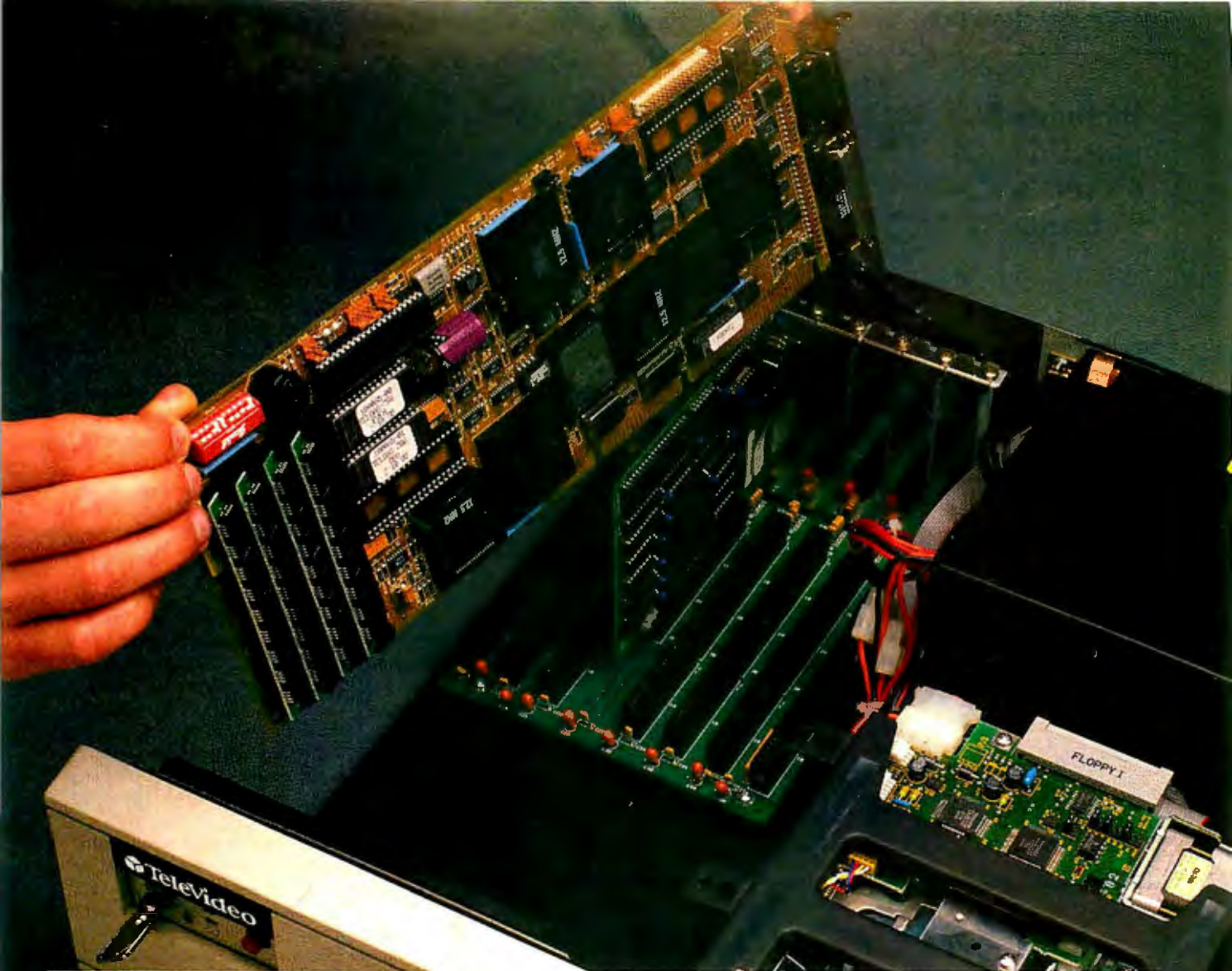

We've Opened Up All Kinds Of Possibilities.

TeloAS™ from TeleVideo® Open Architecture Solutions™ that can be anything you want them to be.

The new TeloAS solutions are entirely new ways of looking at TeleVideo computers. Very flexible systems that give you the choices you need to build the system you need now, then easily expand and upgrade later.

Choose the cabinet with the proper number of slots you need: 4, 8 or 12. Choose the CPU you want: 8088, 80286 or 80386. Choose the drives you want, the monitor you want, the keyboard, the footprint and the price you want. Choose the software to match your needs: MS-DOS™, MS-OS/2™, UNIX® System V.3, NetWare™, and others. With the TeloAS Systems, the choices are all yours.

The TeloAS/I cabinet has a

passive back plane with 4 board slots. It accepts TeloAS 8088 or 80286 boards in a low-profile, small-footprint case that fits anywhere.

The TeloAS/II cabinet has 8 board slots, room for 4 half-height drives, and accepts 80286 or 80386 boards. With the right peripherals, you have an affordable small-footprint workstation that runs both MS-DOS and UNIX System V.3.

The TeloAS/III cabinet has 12 board slots, room for 2 full-height and 2 half-height drives, and accepts 80286 or 80386 boards. With the right peripherals and software, you get a powerful 386 engineering workstation, a LAN fileserver, or a multi-user host system.

The TeloAS Open Architecture Solutions use the most advanced surface-mount technology to reduce

the number of components and make the systems easier to service. The diagnostic features give you extensive tests of hardware. Together with our TeleVideo one-year limited ON-SITE warranty,* you're sure of getting quality products that give you the most for your money.

For more information on the new Open Architecture Solutions that can be anything you want them to be, call toll-free, or write today.

TeleVideo Systems, Inc.
1170 Morse Avenue, Sunnyvale, CA
94088-3568.

Circle 266 on Reader Service Card

 **TeleVideo®**
THE VISION YOU NEED TO SUCCEED

Call 1-800-835-3228

It copies 5¼ and 3½ inch diskettes all by itself.

Just load your diskettes, press one button, and walk away. The Victory Duplicator automatically copies diskettes operating standalone or attached to an IBM/PC, Macintosh, or Mountain compatible system.

Bulk cannisters allow fast, easy loading and unloading. Switching drives takes less than three minutes.

Copy Different Formats, Flawlessly.

Our Auto-Format-Analysis™ feature lets you copy different formats, including PS/2. The system tests for quality and accuracy, sorting disks into one of two output cannisters.

No User-Required Adjustments.

The Duplicator's self-calibration and simple diagnostics for checking drive alignment allow you to maintain the system without outside service.

Call 1-800-421-0103.

And ask about the Victory family of affordable duplication systems — with serialization, copy protection, and custom label printing.



Technology, Inc.

8910 Research Blvd., B2
Austin, Texas 78758
512-450-0801

In Europe call BF1: Paris (33-1) 45330137,
Frankfurt (49-6074) 27051, London (44-1)
941-4066, Milan (39-2) 316716, Stockholm
(46-8) 7547460.

IBM/PC, PS/2, Macintosh, and Mountain are trademarks or registered trademarks of their respective holders.

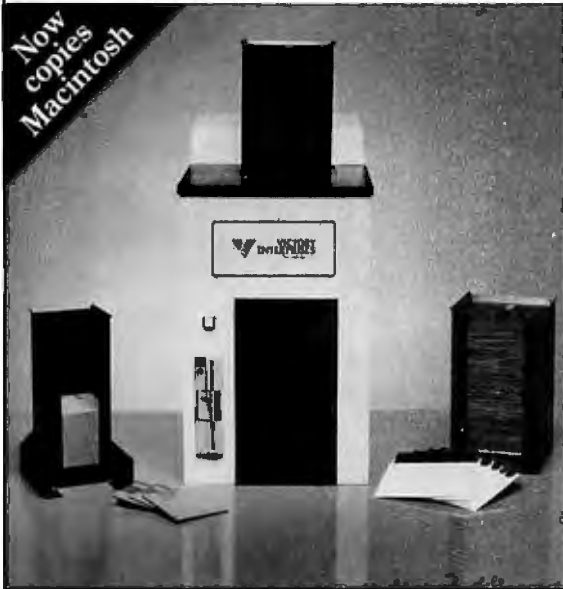

PowerStation™

A Complete VT220 / VT241 Work Station Upgrade for the IBM PC/XT/AT and PS/2

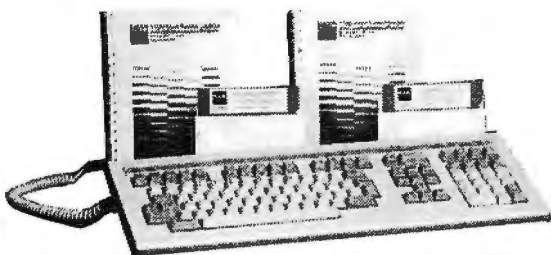

"Now true 800 pixel wide VT241 display and support for VMS Services for MS-DOS."

PowerStation™ 240 **\$435**
VT240 style keyboard and ZSTEM VT240 Emulation Software. Optional WPS labelled keys (GOLD KEY MODEL) add \$30.

ZSTEM pc™ - VT240 Emulator Emulation Software only **\$295**
VT240/241 Emulation Software with all the features of ZSTEM VT220 plus ZSTEM 4014, sixel and ReGIS graphics.

PowerStation™ 220 **\$289**
VT220 style keyboard and ZSTEM VT220 Emulation Software. Optional WPS labelled keys (GOLD KEY MODEL) add \$30.

ZSTEMpc™-VT220 Emulator Emulation Software only. **\$150**
All the features of ZSTEM VT100 plus 8-bit mode, downloadable fonts, user defined keys, full national/multi-national modes. Extended macros/script language. True 132 columns on Hercules, VGAs, Super EGAs, and standard EGAs using the EGAmate option. 128 columns on CGAs. 43 line support on EGAs. Enhanced keyboard support. Ungermann Bass Net/One and VMS Services for MS-DOS support.

EGAmate™ **\$39**
Daughterboard option for 132 columns and true 800 pixel wide ReGIS display on standard EGA adapters.

PS220/2 **\$19**
Keyboard adapter cable for PS200 on PS/2 systems.

ZSTEMpc™-4014 Emulator **\$99**
Use with ZSTEM VT100, VT220, or stand-alone. Interactive zoom and pan. Save/recall images from disk. Keypad, mouse, digitizer, printer, plotter, and TIFF support. 4100 color and line style color mapping. 640 x 400 and 640 x 480 on some adapter/monitors.

ZSTEMpc™-VT100 Emulator **\$99**
High performance COLOR VT100. True double high/wide, smooth scrolling, ISO and attribute mapped color. XMODEM and KERMIT, softkey/MACROS, DOS access.

KEA Systems Ltd.

#412 - 2150 West Broadway, Vancouver, B.C. Canada V6K 4L9
Telephone (604) 732-7411 Telex 04-352848 VCR Fax (604) 732-0715
Order Toll Free (800) 663-8702
30 day money back guarantee AMEX/MC/VISA

hard disks so you don't lose anything in the ensuing melee. Stick the appropriate boards into the PC, cable up the appropriate drives, check everything once, and fire it up. Do a low-level format on the drives and then run DOS 3.3's FDISK and FORMAT /s (you should use the original DOS disks to make sure you get the right version).

If you need device drivers, set up CONFIG.SYS at this point and load the drivers into the appropriate subdirectories. Keep everything else off the disk until you're sure the machinery plays. Once everything is OK, fill up the disk from the backup you make, taking care not to overwrite the boot files with some leftover trash.

Unless that Magitronic floppy disk controller is designed to work with a standard floppy card already installed (presumably using entirely different hardware I/O addresses and its own device driver), neither one will work. Right? So you might want to start the process without that card, just to make sure. Once the rest works, then add the new floppy disk controller and see what breaks.

From what you've told me, I think some of your problems come from mixing versions of DOS and controllers. Remember that there's absolutely no standardization of what the controllers actually slap on the disk, so you can confuse things mightily if you interchange drives and controllers without a low-level format to set things right again.

Setting the interleave often has no effect on cards with clever controllers and internal track buffers. They run with whatever interleave the controller needs to handle the data, so you can't twiddle with DOS or BIOS parameters. Your controllers probably fall into that category, but I'm not sure.

Remember, however, that an interleave of 3 may be too low. If the PC isn't ready when the next sector comes around, it will have to wait another revolution to get the data. That's the penalty you pay for trying to speed it up—it goes slower! If SPINDISK is asking for the sectors in such a way that the controller flushes its buffer, it will take 17 revolutions no matter what the interleave is. Different controllers may react in a different manner.

In cases of mysterious behavior such as this, it often pays to start from scratch and work very carefully through all the steps. I've found that when you're convinced that a particular process is meaningless, you're ready to learn something new. —Steve ■

TALLGRASS BACKS YOU ALL THE WAY.



*Tallgrass makes
internal and external
tape backup systems
for the IBM PC/XT/AT,
PS/2 or compatibles,
and an external
unit for your Mac
Plus, SE or II.*

We've got a whole new family of tape backup systems.

Whether you've got an IBM, a compatible, or a Macintosh, you can count on Tallgrass. We back you with all the storage capacity you could ask for, plus all the features, all the support, and all the speed you'll ever need. And we make it easy to protect your valuable data. Since all operations are automatic

and unattended, you can just set it, and forget it.

Best of all, we stand behind our products with the industry's only 3-year warranty.

But there's one other reason why so many more people are asking for Tallgrass. It's because the competition is asking so much more for their products.

Let Tallgrass start backing you up.
Call 1-800-TAL-GRAS. Or write to:
Tallgrass Technologies, Inc.
11100 West 82nd St.
Overland Park, KS 66214

 **TALLGRASS
TECHNOLOGIES**

When it's worth saving, it's worth Tallgrass

© 1988 Tallgrass Technologies, Inc. "IBM" is a registered trademark of International Business Machines, Inc. "Macintosh" and "Mac Plus" are trademarks of Apple Computer, Inc.

Circle 262 on Reader Service Card (DEALERS: 263)

JULY 1988 • BYTE 47

As your introduction to
The Library of Computer
and Information Sciences

Take Any 3 Books

(Publishers' prices shown)

Programming

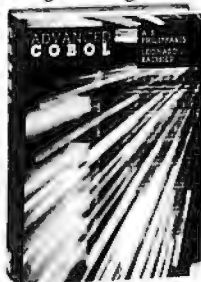

32258-2 \$37.95
(counts as 2 choices)

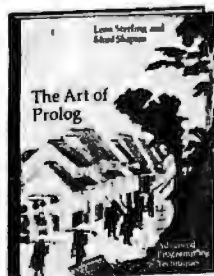

34422 \$29.95



37177 \$24.95
(Softbound)

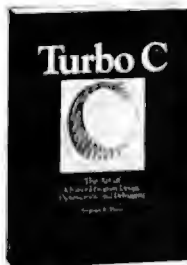

84844 \$24.95
(Softbound)



58700 \$12.95
(Softbound)

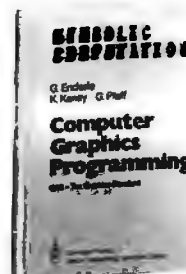

39985-2 \$39.00
(counts as 2 choices)

Professional Tools



70680 \$22.95
(Softbound)

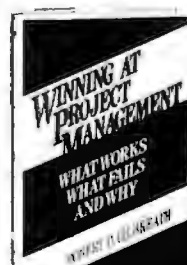

87100 \$29.95

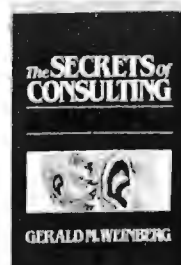

77620 \$25.00
(Softbound)



88018 \$22.95



53920 \$14.95
(Softbound)



59531 \$17.95

Data Base

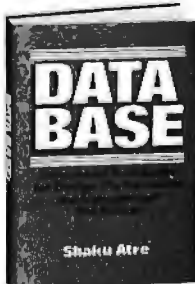

41624-2 \$39.95
(counts as 2 choices)



48441-2 \$38.95
(counts as 2 choices)



37183 \$23.95
(Softbound)

Software Development



41254 \$24.95



79162-2 \$44.95
(counts as 2 choices)



52336-2 \$34.50
(counts as 2 choices)
(Softbound)

Programming in the IBM Environment

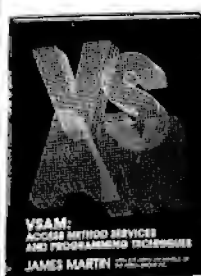

85945-2 \$32.95
(counts as 2 choices)

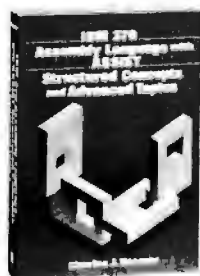

54434-2 \$32.00
(counts as 2 choices)



32269 \$22.95
(Softbound)

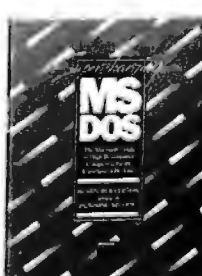

81413 \$18.95
(Softbound)

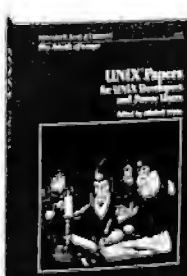

85484 \$26.95
(Softbound)

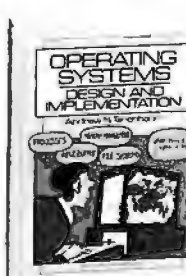

66004-2 \$36.95
(counts as 2 choices)

Operating Systems

The Library of Computer and Information Sciences

(the oldest, largest, and most respected computer book club in the world)

Please accept my application for trial membership and send me the three volumes indicated, billing me only \$1.00 each, plus shipping and handling. I agree to purchase at least three additional Selections or Alternates over the next 12 months. Savings range up to 30% and occasionally even more. My membership is cancelable any time after I buy these three additional books. A shipping and handling charge is added to all shipments.

No-Risk Guarantee: If I am not satisfied—for any reason—I may return my introductory books within 10 days. My membership will be canceled, and I will owe nothing.

3 books for \$1.00 each:

--	--	--

Indicate by number the books you want. A few expensive books (as noted) count as more than one choice.

Name _____

Firm _____
(If you want subscription sent to your office)

Address _____ Apt. _____

City _____

State _____ Zip _____

(Books purchased for professional purposes may be a tax-deductible expense. Offer good in Continental U.S. and Canada only. Prices slightly higher in Canada.)

7-ER3

Byte 7/88

The Library of Computer and Information Sciences

(the oldest, largest, and most respected computer book club in the world)

Please accept my application for trial membership and send me the three volumes indicated, billing me only \$1.00 each, plus shipping and handling. I agree to purchase at least three additional Selections or Alternates over the next 12 months. Savings range up to 30% and occasionally even more. My membership is cancelable any time after I buy these three additional books. A shipping and handling charge is added to all shipments.

No-Risk Guarantee: If I am not satisfied—for any reason—I may return my introductory books within 10 days. My membership will be canceled, and I will owe nothing.

3 books for \$1.00 each:

--	--	--

Indicate by number the books you want. A few expensive books (as noted) count as more than one choice.

Name _____

Firm _____
(If you want subscription sent to your office)

Address _____ Apt. _____

City _____

State _____ Zip _____

(Books purchased for professional purposes may be a tax-deductible expense. Offer good in Continental U.S. and Canada only. Prices slightly higher in Canada.)

7-ER8

Byte 7/88

10-Day
Free Examination!



BUSINESS REPLY MAIL

FIRST CLASS PERMIT NO. 230 RIVERSIDE, NJ

POSTAGE WILL BE PAID BY ADDRESSEE

**The Library of
Computer and
Information Sciences**

Riverside, New Jersey 08075-9889



NO POSTAGE
NECESSARY
IF MAILED
IN THE
UNITED STATES



10-Day
Free Examination!



BUSINESS REPLY MAIL

FIRST CLASS PERMIT NO. 230 RIVERSIDE, NJ

POSTAGE WILL BE PAID BY ADDRESSEE

**The Library of
Computer and
Information Sciences**

Riverside, New Jersey 08075-9889



NO POSTAGE
NECESSARY
IF MAILED
IN THE
UNITED STATES



for only \$1.00 Each

values
to
88.85

You simply agree to buy 3 more books-- at handsome discounts--within the next 12 months.

Micros

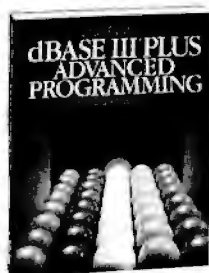

41611 \$22.95
(Softbound)

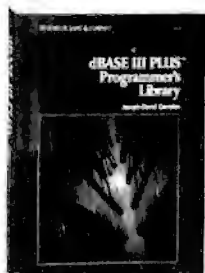

41614 \$21.95
(Softbound)



81405 \$22.95
(Softbound)

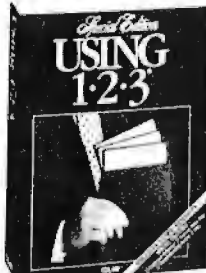

85710 \$24.95
(Softbound)

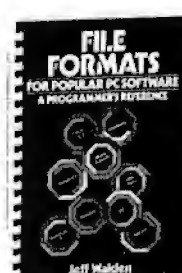

48483 \$24.95
(comb-bound)



61960 \$24.95
(Softbound)



63250 \$24.95
(Softbound)

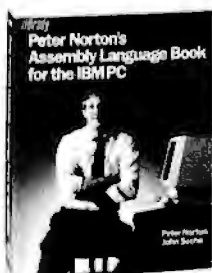

68427 \$21.95
(Softbound)

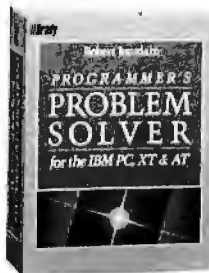

70725 \$21.95
(Softbound)



32284 \$18.95

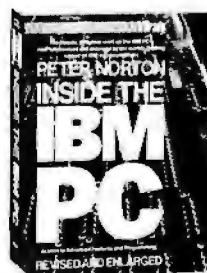

55520 \$21.95
(Softbound)

Computer Science



37517 \$27.50

A.I. and Robotics

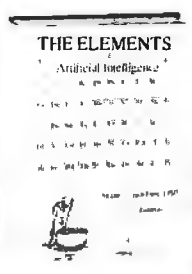

44177-2 \$35.95
(counts as 2 choices)

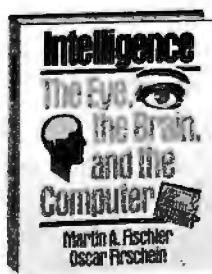

55620 \$27.95

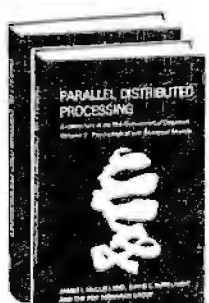

67110-2 \$45.00
(2 books count as 2 choices)



32444 \$24.95

Data Communications

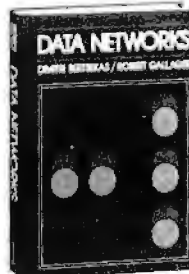

41665-2 \$37.33
(counts as 2 choices)

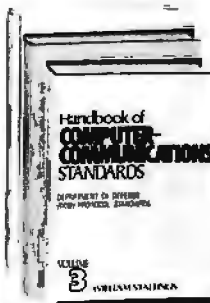

52121-3 \$90.00
(3 books count as 3 choices)

4 Good Reasons to Join

1. The Finest Books. Of the hundreds of books submitted to us each year, only the very finest are selected and offered. Moreover, our books are always of equal quality to publishers' editions, *never* economy editions.

2. Big Savings. In addition to getting three books for only \$1.00 each when you join, you keep saving substantially, up to 30% and occasionally even more. (For example, your total savings as a trial member—including this introductory offer—can easily be over 50%. That's like getting every other book free!)

3. Bonus Books. Also, you will immediately become eligible to participate in our Bonus Book Plan, with savings of 65% off the publishers' prices.

4. Convenient Service. At 3-4 week intervals (16 times per year), you will receive the Library of Computer and Information Sciences News, describing the

Main Selection and Alternate Selections, together with a dated reply card. If you want the Main Selection, do nothing, and it will be sent to you automatically. If you prefer another selection, or no book at all, simply indicate your choice on the card and return it by the date specified. You will have at least 10 days to decide. If, because of late mail delivery of the News, you should receive a book you do not want, we guarantee return postage.

If reply card is missing, please write to The Library of Computer and Information Sciences, Dept. 7-ER8, Riverside, NJ, 08075, for membership information and an application.



16 color VGA Support



RIX SoftWorks, Inc.

EGA Paint 2005 Final Version



Dual Brush Modes

BEFORE



AFTER

Smooth Command



Airbrush Command



Grid Command

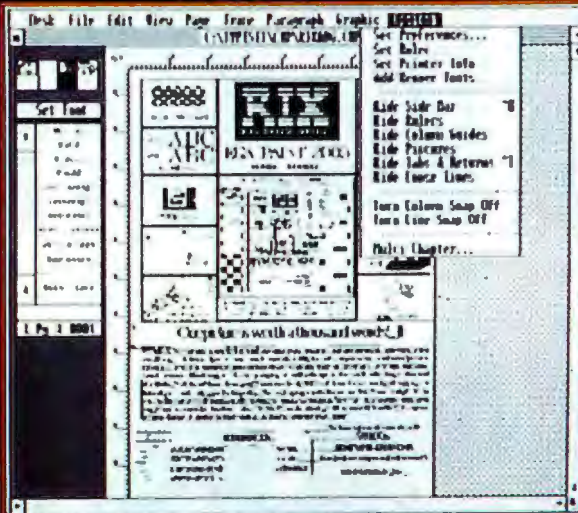

Publish any EGA Paint 2005 Graphics screen!
The Final Version will convert any screen to
.IMG or .PCX files for your desktop system!



360° Rotate Command

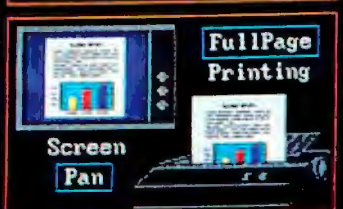

FullPage
Printing

Screen
Pan

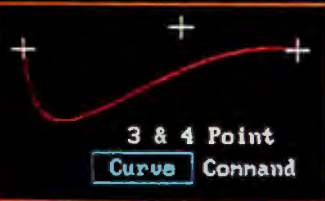

3 & 4 Point
Curve Command



Capture
almost any screen



Area Command

One picture is worth a thousand words!

Kiss those endless upgrade fees goodbye! After well over three years of development, RIX is pleased to announce the Final Version of our EGA specific graphics editor, EGA Paint 2005. RIX was the **first** (and still the only) graphics, software company to introduce an EGA specific graphics editor, the **first** to create a combination TARGA™ image translator and print package, the **first** to release a VGA specific hi-res graphics editor (in July), and now the **first to release a final version of any software program ... ever!** We at RIX had originally planned to release a separate package to implement desktop publishing capabilities but when the release date arrived, we felt our loyal users deserved a fully self-contained graphics package. Now RIX has made it possible for you to make a little history too with EGA Paint 2005 Final Version, At \$129.00, surely the best value in graphics programs ever! Find out why. Order today! RIX SoftWorks, always the best ... for less!

COMING IN JULY

COLORIX VGA PAINT!

ColorIX VGA Paint is the cat's meow for your Hi-Res VGA system! ColorIX supports all modes of VGA, and has time saving features like: Automatic color graduation generation, block palette freeup, image drag for 3D effects, a completely self-contained presentation package which has animation capabilities, and much more. We'll be shipping in July, first come, first served so get your order in now! Only \$199.00!



RIX SoftWorks, Inc.

18552 MacArthur Bl. • Suite 375 • Irvine, CA 92715 • (714) 476-8266

CALL US TOLL FREE:

In CA (800) 233-5983 Outside CA: (800) 345-9059

Euro-Version w/International Character Set

Dieter Beugrand

Beugrand Buerokommunikation GmbH

Otto Han St. 24

6056 Heusenstamm, West Germany

Phone • 49-6-10463092

BOOK REVIEWS

ROUNDUP

Inside OS/2
Gordon Letwin

OS/2 Programmer's
Guide
Ed Iacobucci

OS/2 Features,
Functions,
and Applications
Jeffrey I. Krantz,
Ann M. Mizell, and
Robert L. Williams

Using OS/2
Kris Jamsa

Reader's Guide to OS/2

G. Michael Vose

The first months of 1988 brought us four books seeking to explain OS/2. One attempts only to show how to use OS/2, two others offer lots of detail about the mechanics and internal workings of OS/2, and the fourth tries to explain OS/2's gestalt.

A good place to start learning about OS/2 is *Inside OS/2* (Microsoft Press, Redmond, WA: 1988, 289 pages, \$19.95) by Gordon Letwin, chief architect for systems software at Microsoft. With chapters entitled "History of the Project," "The OS/2 Religion," and "The Future," this book should be the place to discover the vision of what OS/2 will become.

Letwin offers many insights concerning what OS/2 provides as a platform for the computing future. He discusses the electronic office, where all computers are linked together via local-area networks (LANs), sharing data and resources. And he makes implicit comparisons between OS/2 and telephones: When

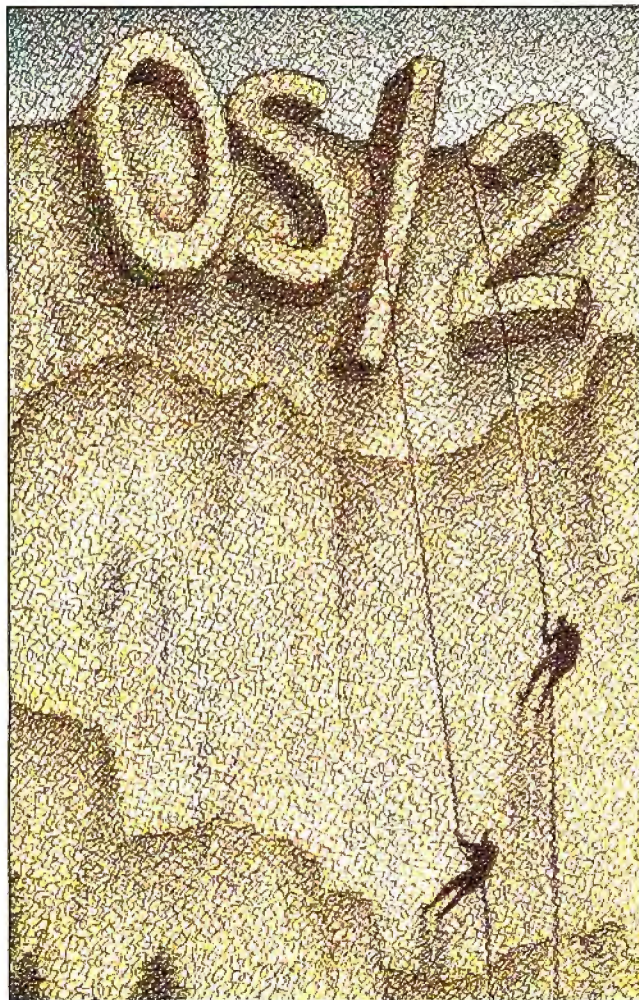

telephones were invented, people scoffed and couldn't see what benefits a phone provided as a communication aid. After all, by the time you wrote out your message, had your secretary call the correspondent's secretary to dictate

the message, and then had that secretary hand the message to its intended recipient, you could have sent a letter by messenger. A change in mind-set had to occur for telephones to catch on as tools. Letwin anticipates a similar lag before peo-

ple really grasp the power of the new paradigm offered by OS/2. That paradigm, of course, is multitasking, with communication among the running tasks.

After extolling the advantages of multitasking, Letwin spends the rest of his book explaining why OS/2 works the way it does. This explanation serves as the mental model a programmer should adopt to write OS/2 programs.

By explaining how the pieces fit together, Letwin provides information that should save programmers time and frustration when they begin writing OS/2 programs. His explanations not only provide a conceptual framework for programmers but actually anticipate the kinds of bugs to which OS/2 programmers might fall prey. His warnings should be heeded.

For example, the chapter on multitasking has three full pages of hints and warnings dealing with parent and child processes and their associated file handles. Here, Letwin details the side effects caused by handle inheritance. He also warns readers not to "follow the standard Unix practice of blindly closing file handles 3 through 20 during program initialization," since OS/2's dynamic link libraries may have previously opened one or more of these handles.

But even after reading all the insider thinking that went into the design of OS/2, I still found myself wondering just what an OS/2 application will do that an MS-DOS application cannot. Maybe this results from the perceptual lag Letwin warns about early on: Maybe you have to see an OS/2 application in action to really appreciate the potential of OS/2.

Letwin's book is definitely thin in source code; the sam-

continued

ALSO REVIEWED

Programming Translation Fundamentals

Programming Language Translation

The IBM Programmer's Challenge and
The Apple Programmer's Challenge

Mind Tools

Elements of Functional Languages

Compact Disk Products, Inc. CD-ROM/WORM

ALL PRODUCTS, LOWEST PRICES, EXPERT ADVICE

INTRODUCTORY OFFERS

Hitachi 1503S or 3500S CD-ROM Drive with your choice of:	
- McGraw Hill Science and Technical Reference Set	\$895
- Grolier Electronic Encyclopedia	\$895
- Microsoft Bookshelf	\$895
- PC-SIG Library (Disks #1 through #1000)	\$895
- Geovision U.S. Atlas and Mapmaker	\$1995
- The Bible Library	\$195

CD-ROM SOFTWARE

Grolier or McGraw Hill or Bookshelf or PC-SIG	\$269
The Bible Library	\$395
Kirk-Othmer Encyclopedia of Chemical Technology	\$845
Registry of Mass Spectral Data	\$2655
Geovision U.S. Atlas and Mapmaker	\$795

TOLL FREE ORDER LINE - 800-MEGABYTE (634-2298)

CD-ROM and WORM DRIVES

Hitachi 1503S External CD-ROM Drive with Audio	\$729
1503S with Digital Audio Output	\$1229
Hitachi 3500S Internal 1/2 Height CD-ROM Drive w/Audio	\$719
Maxtor 800 MB WORM Drive	\$3799
Optotech Laserbank 400 MB WORM Drive	\$2799
Portable 286 with CD-ROM Drive	\$3755

CD-Capture (\$149) Capture Digital Audio information from any CD to RAM or Disk. Also allows playback of music from RAM.

CD-Play (\$69) Pop-up utility that permits user to play all audio CDs on Hitachi and compatible drives. Output to headphones or amplifier.

CD-PlaySampler (\$149) Same features as CD-Play plus the ability to reme two points on an audio CD and loop between them.

CD-AudioFile (\$149) Automatically creates database records of all your audio CDs. Allows you to store a preferred play sequence for each disk. Automatic recognition of CDs. Creates CDBase compatible records.

CDP

217 E. 85th St.
Suite 216
New York, NY 10028
Tel 212-996-6999
Fax 212-439-9109
CompuServe 75530214

Free 3 Month
Subscription to
CD-ROM Review
with orders over
\$300

INTERNATIONAL ORDERS A SPECIALTY

Australian Agent: KEWTEL
145 Cochran Rd.
Kew, Victoria 3101
Tel. (03) 817-5933



Finally! A Keyboard Protector That:

- **PROTECTS CONTINUOUSLY - 24 HOURS A DAY** - Against computer downtime due to liquid spills, dust, ashes, staples, paper clips and other environmental hazards.
- **REMAINS IN PLACE** during the operation of your keyboard. SafeSkin is precision molded to fit each key - like a "second skin."
- **EXCELLENT FEEL** - The unique design eliminates any interference between adjacent keys, allowing smooth natural operation of your keyboard.
- **SafeSkin IS VIRTUALLY TRANSPARENT** - Keytops and side markings are clearly visible. In fact, SafeSkin is so clear, sometimes you may not know it's there!
- **DURABLE - LONG LASTING** - SafeSkin is not a "throw-away" item. Many of our protectors have lasted over 3 years under continuous daily use, without failure.

SafeSkin is available for most popular PC's and portables including: IBM, APPLE, AT&T, COMPAQ, DEC, EPSON, KEYTRONICS, NEC, TANDY, TOSHIBA, WANG, WYSE, ZENITH. Specify computer make and model. Send \$29.95. Check or M.O., VISA & MC include exp. date. Dealer inquiries invited. Free brochure available.

Merritt Computer Products, Inc.

4561 S. Westmoreland / Dallas, Texas 75237 / 214/339-0753

ples he gives rarely, if ever, run more than five lines.

Ed Iacobucci's book, *OS/2 Programmer's Guide* (Osborne/McGraw-Hill, Berkeley, CA: 1988, 1100 pages, \$24.95), promises nearly as much as Letwin's: Iacobucci is Letwin's counterpart at IBM, the OS/2 system architect. And his massive volume on OS/2 provides even more detail than Letwin's on the nuts and bolts of OS/2.

Iacobucci justifies OS/2 mostly by talking about what MS-DOS and Intel 8088-/8086-based machines couldn't do. Then he jumps right into detailed technical discussions about how to write OS/2 programs. In fact, 16 percent of this book is programs—29 different OS/2 programs or program fragments that explain how to use OS/2 features. Many of these programs might be useful to programmers as more than just examples: One displays a file in hexadecimal, and two others allow copying data to and from the standard input and output devices and shared memory segments.

The IBM influence shows through strongly in these example programs. All the code is in assembly language. (Common industry scuttlebutt says that all IBM programmers write in assembly language. One of the reasons put forth for OS/2's long gestation was that IBM's design team first had to learn C.) A disk offered separately contains the assembly code and C versions of the programs. But in a bizarre decision, possibly intended to placate Iacobucci's IBM superiors, Osborne/McGraw-Hill elected to print assembly language instead of C code. The availability of a companion disk with C code remedies this potential deficiency.

I've heard several OS/2 programmers claim they've learned more from Iacobucci's book than from the OS/2 documentation for software developers. One programmer bewails the prohibitive cost (\$3000) of Microsoft's OS/2 Software Development Kit

(SDK) and claims that you can become an OS/2 developer just by buying Iacobucci's book. This programmer learned enough from the book to construct the necessary `doscalls.h` and `subcalls.h` libraries so he could write OS/2 programs. The 159-page appendix A details all of OS/2's function calls.

Iacobucci's book has even helped programmers find bugs in early versions of OS/2. I know of one programmer who was having trouble with a field in the `KbdStatus` structure used by `KbdSetStatus`. The documentation for `KbdSetStatus` in the Microsoft SDK *Programmer's Reference* lists this bit as reserved. This directly contradicts Iacobucci's text. When queried about this discrepancy, Microsoft responded that shift-key reporting, as documented in the Iacobucci book, is part of the OS/2 spec and is safe to use.

OS/2 Features, Functions, and Applications (John Wiley & Sons, New York: 1988, 282 pages, \$24.95) is also written by members of the IBM OS/2 design team. Authors Krantz, Mizell, and Williams try to pass on some of the "tremendous amount of knowledge in the depth and breadth of the product" that they have accumulated. Interestingly, they wrote the programming examples in C code, not assembly language.

This book really shines in its discussions of PS/2 programming, offering some previously little known information on the PS/2s' Advanced BIOS. The authors also provide a good discussion of the difference between the edge-triggered hardware interrupt mechanism in the IBM PC AT environment and the level-sensitive triggering of the PS/2s, and how OS/2 device drivers can use this hardware feature.

The book's drawback, however, is its dense presentation. The writing is passive and academic, making the information hard to access.

continued

9-Track Tape Subsystem

The Data Interchange Solution You've Been Waiting For!

Qualstar's 1/2" 9-track Ministreamers™ bring full ANSI data interchange capability to your PC or Macintosh™ computer system.



With 9-track tape, you are free to exchange data files with any mainframe or minicomputer in the world.

Our affordable Ministreamers come in both 7" and 10 1/2" versions and use less desk space than an ordinary sheet of paper. They can provide 1600 thru 6250 BPI capability and may be used for disk backup as well as data interchange. Complete subsystem prices, including software, start as low as \$2,495 for 7" units and at \$3,670 for 10 1/2" units.

Qualstar has become the market leader in desk-top 9-track systems for a good reason; our tape drives have established an outstanding record for reliability and low cost of ownership.

Discover the many advantages 9-track tape has over other Micro/Mainframe links.

Call us today!

QUALSTAR®

9621 Irondale Avenue,
Chatsworth, CA 91311
Telephone: (818) 882-5822



Macintosh is a trademark of Apple Computer, Inc.

KILA SYSTEMS

SYSTEMS FOR THE REAL WORLD

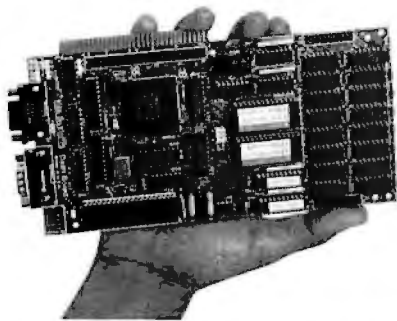

- MS-DOS & PC BUS COMPATIBLE
- CMOS NEC V50 • LOW COST \$249.00

FEATURES • A complete system based on V50, 16 bit CMOS processor • Has core features of a PC • Add PC cards via passive backplane • 512KB or 1mB RAM, upto 128KB ROM • 3 serial ports • floppy, printer, SCSI ports on a piggyback board • Software: CBIOS (MS-DOS compatible), diskless operation, debug monitor • 3.9"x7.8" • 500ma @5v • SI:4.4

CALL NOW 415-692-1448
255 Taylor Blvd., Millbrae, CA 94030

BOOK REVIEWS

Kris Jamsa is a recognized authority on MS-DOS; he wrote *DOS: The Complete Reference*, he presides over the DOS User's Group, and he is the editor of that organization's newsletter. Despite these qualifications, his *Using OS/2* (Osborne/McGraw-Hill, Berkeley, CA: 1988, 757 pages, \$19.95) is the least useful of this bunch.

The first several chapters explain using OS/2 to a novice user—how to care for disks, how to boot the computer, and how to format and back up disks. Even casual MS-DOS users will find these chapters of little use. This section is twice as long as it needs to be. Many of its illustrations are redundant, while others are simply unnecessary. The reference manual included with OS/2 explains these topics as well as this book does.

Next, Jamsa attempts to explain the complexities of OS/2 programming. He was working with early beta software to explore these topics, so his explanations lack depth. Many of his descriptions read like manuals reworded into book style. But they are poorly organized, and the rewording adds little or no additional information.

The book also has many errors. For example, on page 24 an illustration claims that OS/2 has a 4.8-megabyte virtual address space (48 is the correct number), and on page 473 Jamsa asserts, "both the program and the executable code reside in memory." This statement is only a little less confusing than an earlier assertion that "the key to OS/2's success is not necessarily its powerful capabilities, but rather the number of application programs that make use of these capabilities."

Building Your Library

If you plan to write OS/2 programs, the Letwin and Iacobucci books can add substantially to your understanding of OS/2: They function much like the revered Kernighan and Ritchie "white" book that specifies the C language. PS/2

programmers will also find useful information in *OS/2 Features, Functions, and Applications*. Only novices who find themselves in front of a computer running OS/2 might consider Jamsa's book.

For the general-to-advanced reader, I particularly recommend *Inside OS/2*. For readers who will be doing extensive OS/2 programming, *OS/2 Programmer's Guide* is a necessity.

All four books help shed light on the mysterious workings of OS/2. But none succeeds in revealing why or how OS/2 might change the face of personal computing. I suspect that *The Book on OS/2* might be a long time coming. ■

BRIEFLY NOTED

Programming Translation Fundamentals by Peter Calingaert, *Computer Science Press, Rockville, MD: 1988, 366 pages, \$36.95*. This book shows perhaps the best balance of theory and application that I've seen. For his examples, Calingaert uses pseudo-code reminiscent of PL/1 or Modula-2 for high-level code, and for his assembly language examples he uses an assembly language that you could easily mistake for Knuth's MIX. His explanations are clear-cut and readable, not bogged down by abstract notational syntax that can obscure what is actually going on.

The author starts off with an abbreviated exploration of one- and two-pass assemblers. Then, rather than jump immediately into the subject of program translation for higher-level languages, he takes a dip into what he refers to as "program modules." This is a discussion of how routines (modules) are activated during a program's execution (taken, of course, from a high-level-language point of view), including the important issue of variable scoping. Having thus given the reader a good view of what a compiler (or an inter-

continued

Just Released

STATISTICS MADE EASY.

Microstat-II will have you up and running in 5 minutes or your money back.

Loperating Microstat-II couldn't be easier. No matter what your statistical needs are. Simply select the options you need from the menu system with a keyboard or a mouse and your answer is available instantly. No complex command languages to learn. On-line help is only a keystroke away! Plus, it only takes three disks to operate the program. Microstat-II is simple to use and fast!

The #1 Selling Micro Statistical Package is Even Better!

Microstat is by far the most popular micro statistics package of all time. Tens of thousands of satisfied customers have relied on Microstat since 1979 for all their statistical needs. Microstat has been used for every application imaginable from checking the brine content of tuna fish to keeping game statistics for an NFL football team. Already 64 of the Fortune 100 companies have purchased Microstat. Virtually every major university is presently using Microstat and over 10,000 copies have been sold to the US government. Microstat-II is even better!

The Coverage You Need

Microstat-II has the statistical tests you need. Just some of the areas of coverage are descriptive statistics, ANOVA, correlation and regression (with stepwise), time series, hypothesis testing, nonparametrics, crosstabs and chi-square, probability distributions, scatterplots, plus a lot more!

Easier Installation

Microstat-II provides all this power with only 3 disks and can run on a hard disk or a floppy disk system with two drives. Our competitors use up to 21 disks and most require a hard disk. Plus Microstat-II is not copy protected.

Even Greater Flexibility

We have completely redesigned the data management section to include features our users have requested. You can have unequal cases in the same file, aliased variables, missing data, range checking, and built-in scalars on data entry, plus other new features. You can even use a mouse!

Improved Speed and Interface

Microstat-II is 8 times faster than our own Microstat version 4.0 and almost twice as fast as the competition. This exceptional speed was achieved without any loss of accuracy. When running descriptive statistics the results were staggering (can be even faster with a numeric co-processor):

Microstat-II	88 seconds
Leading Competitor	160 seconds
Microstat 4.0	731 seconds

In seconds. Tests on an 8 MHz AT-type machine, (no co-processor). File with 12,800 cases.

The user interface has also been greatly improved. A full-model regression on the infamous Longley data takes only 9 strokes with Microstat-II. One competing package, which claims to have the easiest command structure, requires 88 strokes. Plus, a specifically designed reversible scrolling feature has been added to save you even

more time. You don't have to rerun a test to see output that has scrolled off the screen.

Introductory Price Just \$395 until July 1, 1988

Microstat-II is being offered at the low introductory price of just \$395 complete. Want just a peek at Microstat-II? We'll send you a demo disk and manual for just \$19.95. Also, a generous update program is available for our loyal Microstat customers. Just inquire.

Absolutely Guaranteed

We are so sure that Microstat-II will satisfy all your statistic needs that we will offer a 30-day no risk money-back guarantee.

Make statistics easy, order Microstat-II today!

1-800-952-0472

Ecosoft Inc. Circle 94 on Reader Service Card
6413 N. College Ave., Suite 101,
Indianapolis, IN 46220

Yes!

**1-800
952-0472**

- Please send me ____ copy(s) of Microstat-II and a complete manual at the low introductory price of \$395.00
- Please send me ____ copy(s) of Microstat-II Demo Disk and summary manual for just \$19.95.
Add \$4 per package for UPS shipping charges. Indiana residents add 5% sales tax.
Format: 5¼" IBM 3½" IBM 5½ 1.2 meg
- Please send me a Microstat-II brochure.
- Please send me information on upgrading my Microstat package to Microstat-II.

Name: _____

Organization _____

Address _____

City _____ State _____ Zip _____

Phone _____

Bill my credit card. VISA MC American Express

Account Number _____ Expiration Date _____

ECOSOFT

Introducing Mic for OS/2

Microsoft Pascal 4.0

Compiler

```
File Edit Search Run Help
8) i := 9
1) notprime := -10
14: writeln('
15: prime := 5;
16: repeat
17:   rprime := prime;
18:   sqrt := trunc(sqrt(rprime));
19:   i := 1;
20:   notprime := false;
21:   while (i < sqrt)
22:   begin
23:     i := i + 2;
24:     notprime := (prime mod i = 0);
25:   end;
26:   if (not notprime)
27:     prime := prime + 2;
28: until (prime > 10000);
```

Microsoft BASIC 6.0

Compiler

```
File Edit Search Run Help
Child$ := "dirsort\find " + B$
FileNumber = 5 : 0.000000
' The child process does: D
Child$ = "dirsort\find " +
DIM Directory$(100) ' Stri
FileNumber = FREEFILE ' Ne
OPEN "PIPE:" + Child$ FOR IN
WHILE NOT EOF(1) ' Loop un
LINE INPUT #FileNumber,
NumEntries = NumEntries
WEND
ChildDone:
CLOSE FileNumber
END
```

Microsoft C 5.1

Optimizing Compiler

```
File Edit Search Run Help
8) i := 217
1) p := 233835936
125: int i;
126:
127: set_curs
128: p = screen;
129:
/* Draw top of box.
130:
131:
132: *p = 218;
133: p += 2;
134: for (i = 8;
135: *p =
136: *p = 191;
137: p += 2;
138:
139: /* Draw side of box.
```

The people who co-developed the industry's most powerful personal computer operating system are now proud to announce programming languages to match.

Introducing Microsoft® Macro Assembler 5.1, C 5.1, Pascal 4.0, FORTRAN 4.1 and BASIC Compiler 6.0.

Five industrial-strength, stand-alone languages that combine the implementation flexibility you've enjoyed under MS-DOS® (which, of course, they still support) with the advanced capabilities you've anticipated from OS/2.

Capabilities such as the ability to develop

large, sophisticated applications which go beyond the 640K barrier, taking advantage of up to 16MB of RAM, and utilizing the potential of today's microprocessors.

Just like their MS-DOS predecessors, these five new languages are equipped with powerful, professional features you work with, not around:

Support of direct calls to the operating system, and inter-language calling for mixing multiple languages on the same project.

Access to OS/2 system calls and a full complement of utilities, including an incredibly fast incremental linker and the

Microsoft Languages systems.

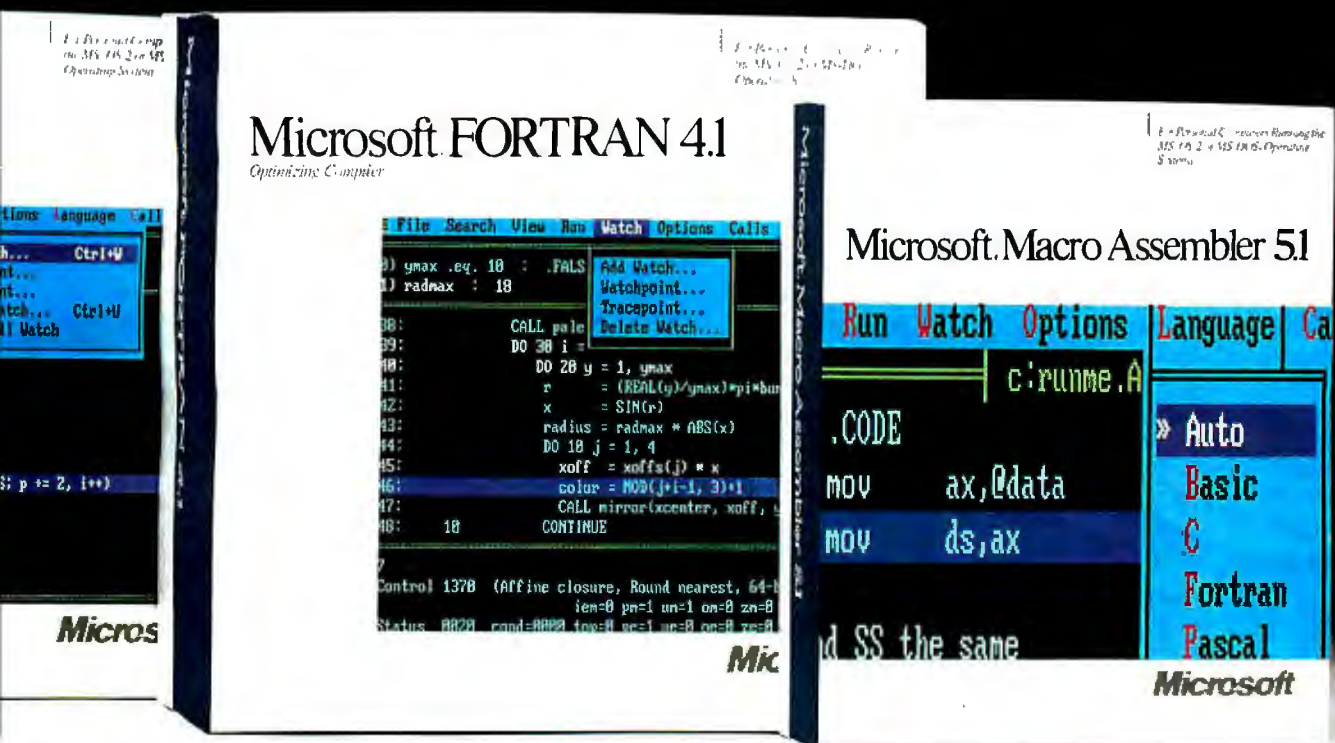

first protected mode programmer's editor that works equally well in real mode.

Microsoft CodeView[®], our popular, advanced debugger that lets you untangle program logic at the source code level, no matter what code you're using.

(It even lets you debug protected mode programs up to 128MB of virtual memory, and larger programs than ever before in real mode.)

As the perfect complement to our new languages, we're also offering the Microsoft OS/2 Programmer's Toolkit.

It contains a parameter-by-parameter

breakdown of all OS/2 system calls and samples to get you started.

All the tools you need for turning out larger, more powerful, more complex OS/2 applications.

(And, incidentally, all the tools we rely on for creating our own commercial software.)

For the name of your nearest Microsoft professional languages dealer, simply call 800-541-1261, Dept. B96.

Ask him for some more information on our OS/2 family.

He'll show you some languages you can really swear by.



RS-422 CONVERTER TO/FROM RS-232

- Up to 100 kilobaud at 4000 feet
- Up to 3 miles at 1200 baud
- Supports eight signals
- Doubles as a high speed short haul modem
- All handshake signals and clock
- Write or call to order or for more information

TELEBYTE

A PUBLIC COMPANY

Remark Division • Teletype Technology, Inc. • 270 E. Pulaski Rd.
Greenlawn, NY 11740 • (516) 423-3232 800-835-3298

**Celebrating
our 10th
Anniversary!**

AMX™ 68000

KADAK's
engineers bring years
of real-time experience
to over 600 installations world-wide.

**This real time
MULTITASKING KERNEL
simplifies real life
product development**

■ No royalties	■ * Dynamic memory allocation
■ Full source code included	■ * Event Manager
■ * C interface	■ * Semaphore Manager
■ Preemptive scheduler	■ * Resource Manager
■ Intertask messages	■ * Buffer Manager
■ Terminal Handler	

AMX 68000 operates on any 68000/10/20 system

Manual only **\$75 US**
AMX 68000 **\$1600 US**
* Options — ask for price list.
(Shipping/handling extra)

Also available for 8080, Z80,
9086/186/286.

KADAK Products Ltd.
206 - 1847 W. Broadway
Vancouver, B.C. Canada V6J 1Y5
Telex: 04-55670
Fax: (604) 734-8114
Telephone: (604) 734-2796

BOOK REVIEWS

preter) seeks to accomplish, the author describes the fundamental steps of compilation: lexical analysis, syntactic analysis, semantic processing, storage allocation, and target code generation.

Though none of the material is attached to a specific machine or language architecture (other than that the book examines only procedural languages), the explanations are lucid enough to make the material worthwhile.

—Richard Grehan

Programming Language Translation by Patrick D. Terry, Addison-Wesley, Reading, MA: 1987, 443 pages, \$26.95. This book is aptly named. It includes more source code than many of the currently popular application toolbox books. "Complete" would be a good word to use: You'll find the complete source code for a macro assembler (for an 8-bit processor that looks like a 6800 with a foreshortened index register), complete source code of an interpreter ("simulator" might be a better word) for a hypothetical stack-based processor reminiscent of the Pascal P-machine, and the complete source code for the compiler/interpreter for a Pascal-like language called CLANG (an abbreviation of "concurrent language"). (Although the compiler generates code for a hypothetical stack machine that the author admits is too idealized, he adheres to his own book's title by discussing code generation for a real processor: the Z80.)

Terry's technique is powerful: He details the problem at hand, follows with an outline of the solution, and rounds off with actual source code. All the high-level-language source code examples are in Pascal. It's refreshing to see algorithms backed by executable source code rather than pseudocode. I found that this made an excellent companion book to *Programming Translation Fundamentals*. Where as the *Programming Language*

Translation volume becomes hazy in theoretical descriptions—choosing to let programs reveal the details—*Programming Translation Fundamentals* could have stood more practical examples.

Not to slight Terry, mind you. Working source code often makes the best computer science textbook, and his book delivers the goods.

—Richard Grehan

The IBM Programmer's Challenge and The Apple Programmer's Challenge by Steven Chen, TAB Books, Blue Ridge Summit, PA: 1987, 225 pages (IBM), 228 pages (Apple), \$14.95. Just how good a programmer are you? This book, which is available in versions for IBM and Apple II computers, will help you find out. Steven Chen presents 10 sets of problems; each set contains 5 specific programming challenges, with time limits and details on input and output required.

After you solve (or attempt to solve) the problems, you use Chen's guide to compute a rating for your work based on the time required to design, code, and test your program; the number of variables you used; and the execution time of your program. You can compare your results with Chen's programs, which are given in C, Pascal, and BASIC.

Programming areas include number theory, conditional statements, repetition statements, overflow problems, and restricted memory programming. The book includes 50 specific programming challenges in all.

In *The IBM Programmer's Challenge*, source code is given in GWBASIC, Turbo Pascal, and Microsoft C. In *The Apple Programmer's Challenge*, source code is given in Applesoft BASIC, Apple Pascal, and Aztec C.

The book is great for recreational programmers, but, more important, it's a good way to polish up your programming skills. And if you

continued



Why build a printer you can stand on, when all it will ever carry is a full office workload?

The answer is reliability.

We built the best track record in the industry by demanding a lot more from our products than you ever will. OKIDATA engineers call this "championship specs." Over 3 million OKIDATA users call it rugged reliability. And it shows in the quality and performance of every printer and modem we make.

You can see it in our new 300 series of 9-pin and 24-pin printers. Their speed, print quality and sheer versatility can carry a ton of paperwork. With day in, day out reliability. OKIDATA wouldn't have it any other way. Why should you?

Call 1-800-OKIDATA for the dealer near you.

Circle 190 on Reader Service Card

OKIDATA is a registered trademark of Oki America, Inc.,
Marque déposée de Oki America, Inc.

OKIDATA[®]
an OKI AMERICA company

We put business on paper.

dBFast™

- VS -

Clipper™

New!
dBase III Plus
Compiler

Faster! dBFast™ compiles and delivers a typical .EXE file in under 5 seconds, while Clipper is still plodding through a 4 minute compile/linking routine. And check out our blistering execution speed . . . We blow away the competition! "Why wait?"

Smaller! With Clipper's lumbering "overhead," the smallest possible execute file is 120KB . . . and it mushrooms from there! dBFast's ultra-efficient "runtime engine" results in amazingly compact code, as small as 1KB!

Smarter! dBFast delivers very high dBase III compatibility. It supports dBase .NDX files and is LAN-capable right out of the box. Its many features include AUTOLOCK, SOFTSEEK, APPEND, BROWSE, CHANGE, EDIT, and dBFast supports external PROCEDURE FILES.

Cheaper! At a fraction of the cost of the competition, dBFast sets the new industry standard for Price-To-Performance. For developers, distribution rights are **Royalty-Free**. And, as an added bonus, dBFast now includes dBEdit, a professional-grade text editor. "Why pay more?"

The new kid on the block!

Operation	dBFast	Clipper
Minimum .EXE file size	1kb	120kb
Compiling/Linking	5 Seconds	4 Minutes
Execution Time	10 Seconds	51 Seconds
PRICE	\$99	\$695



- Now Includes Professional-Grade Text Editor
- Fastest Compilation
- Smallest .EXE's
- Fastest Execution
- LAN-Compatible
- Highest dBase Compatibility

Available through Egghead Discount Software.

60 day Guarantee.

Try dBFast for 60 days. If you're not totally satisfied for any reason, just send it back for a full refund (less \$10 handling fee).

Call today! 1-800-356-6356

Sales information call 1-206-392-0368. Dealer inquiries welcome.

Name: _____ Qty _____ Subtotal _____
 Company: _____ dBFast @ \$99 _____
 Address: _____ Shipping: \$4 U.S., \$25 outside U.S. (add \$4 for each add'l. package)
 City: _____ St: _____ Zip: _____ WA residents add 8.1% sales tax.
 Phone #: _____ Total (U.S. funds only) _____
 Payment (circle one): VISA MC AMX Check
 Card #: _____
 Expires: _____
 Name on Card: _____



dBFast is a trademark of dBFast Inc.
 dBase III Plus and Clipper are registered trademarks of Ashton Tate Corp. and Nantucket Corp. Respectively © dBFast Inc.

1420 Gilman Blvd.
 Suite 2857
 Issaquah, WA 98027-5399

know only one or two of the languages used, the book also becomes a hands-on way to begin learning a new language.
 —Eva M. White

text, you'll find to your possible surprise that you really do understand what it says.
 —Hugh Kenner

Mind Tools: The Five Levels of Mathematical Reality by Rudy Rucker, Houghton-Mifflin, Boston, MA: 1987, 328 pages, \$17.95. The Roman numeral V may be an abstract picture of a hand with thumb outstretched, but "how many fingers?" is only the most obvious of the number-oriented questions you can ask about your hand. Number of hairs? Length of fingernails? Temperature? Salinity? Blood flow rate? . . . On the first page of *Mind Tools*, Rudy Rucker invites you to think of your hand as a "coding up" of such numbers: as a compact record of the information they contain.

Elements of Functional Languages by Martin C. Henson, Blackwell Scientific Publications, Oxford, England: 1987, 434 pages, \$78.75 (hardcover), \$40.50 (paperback). Most programmers, having been raised on imperative programming languages that currently dominate the industry, might find functional languages (e.g., Lisp) a difficult pill to swallow. However, given the rising interest in artificial intelligence applications, some exposure to the fundamentals of functional languages seems necessary. Martin C. Henson's book provides such an introduction.

That is one subtle sign of a revolution that has made our old world of hands, cats, trees, and so on, about which we busily collected information, obsolete. This revolution has also opened up a world that already is the most compact form of all the information we can possibly have "about" it. Obvious phases of the revolution include Claude Shannon's Information Theory of the 1940s, the cracking of the DNA code in the 1960s, and the coming of the microprocessor in the 1970s. Rucker fits in Conway's Game of Life, Mandelbrot's fractals, Universal Turing Machines, Goedel's Incompleteness Theorem, and a good deal more, not just dropping names but really making concepts clear.

Not that the entire book is theory. Later material covers the more practical aspects of language implementation details and gives descriptions of data structures and pseudo-machine architectures on which some functional languages are built. Additionally, the chapters on program verification and transformation offer information and examples useful even in imperative programming. For the novice, *Elements* may be too dense. However, experienced users should find the book a worthwhile map for exploration into the growing field of nonimperative programming languages.
 —Richard Grehan

Unlike many math books for nonmathematicians, *Mind Tools* is much more than a gallery full of curiosities. As Rucker's exposition weaves among the exhibits, they cohere with one another to define a cosmos in which Number, Space, Logic, and Infinity are essentially faces worn by Information; physical systems are information processors; and life itself is "a fractal in Hilbert space." If you'll read up to that statement in its con-

CONTRIBUTORS

G. Michael Vose (P.O. Box 3160, Peterborough, NH 03458) is a former BYTE editor and the current editor of the newsletter *OS Report: News and Views on OS/2*. Richard Grehan is a senior technical editor at large for BYTE. He can be reached as "rick_g" on BIX. Eva M. White is a technical editor for BYTE. She can be reached on BIX as "eva." Critic and author Hugh Kenner lives in Baltimore, Maryland.

Aztec C

*Power to go the distance...
Whatever that distance might be*



From real time embedded applications to comprehensive commercial applications on Macintosh, IBM PC, Amiga, Atari, and others, Aztec C has earned a well-deserved reputation as an innovative, tough to beat, rock-solid C development system.

But don't just take our word for it—try it yourself. We know that the best way to understand what puts you ahead with Aztec C is to use it. That's why Aztec C

systems purchased directly from Manx come with a 30-day, no questions asked, satisfaction guarantee. Call for yours today.

We can also send you information that details the special features and options of Aztec C. Plus information on support software, extended technical support options, and all of the services and specialized support that you may need when you're pushing your software to the limits and ... beyond.

Aztec C Micro Systems

Aztec C is available for most micro-computers in three configurations: The Professional; The Developer; and The Commercial system. All systems are upgradable.

Aztec C68k/Am Amiga
source debugger—optional

Aztec C68k/Mac ... Macintosh
MPW and MAC II support

Aztec C86 MS-DOS
source debugger • CP/M libraries

The following have special pricing and configurations. Call for details.

Aztec C68k/At Atari ST

Aztec C80 CP/M-80

Aztec C65 Apple II & II GS

Standard System \$199

- C compiler
- Macro Assembler
- overlay linker with librarian
- debugger
- UNIX and other libraries
- utilities

Developer System \$299

- all Standard System features
- UNIX utilities make, diff, grep
- UNIX vi editor

Commercial System \$499

- all Developer features
- source for run time libraries
- one year of updates

MS-DOS Hosted ROM Development Systems

Host + Target: \$750 Additional Targets: \$500

Targets:

- 6502 family
- 8080-8085-Z80-Z180-64180
- 8088-8086-80186-80286/8087-80287
- 68000-68010-68020/68881

Components:

- C compiler for host and target
- Assembler for host and target
- linker and librarian
- Unix utilities make, diff, grep
- Unix vi editor
- debugger
- download support

Features:

- Complete development system
- Fast development times
- Prototype and debug non-specific code under MS-DOS
- Compilers produce modifiable assembler output, support inline assembly, and will link with assembly modules
- Support for INTEL hex, S record, and other formats
- source for UNIX run time library
- processor dependent features
- source for startup

C.O.D., VISA, MasterCard, American Express, wire (domestic and international), and terms are available. One and two day delivery available for all domestic and most international destinations.

Circle 157 on Reader Service Card

Manx Software Systems
One Industrial Way
Eatontown, NJ 07724

Aztec C is available on a thirty-day money back guarantee. Call now and find out why over 50,000 users give Aztec C one of the highest user-satisfaction ratings in the industry.

Call 1-800-221-0440

In NJ or outside the USA,

call 201-542-2121

Telex: 4995812 Fax 201-542-8386

HIGH TECH, F

RSCG Equipment



RENCH TOUCH.

One can appreciate the efficiency of the Normerel ATC 12 just by looking at its design.

Extra flat, top of known technology, single board, surface mounted with everything you can dream of on board for greater reliability.

Equipped with a new standard of VGA visualization containing a 256 color palette, its monitor displays "photo" quality images.

Built around a 12.5 MHz processor, its execution speed is from 1.5 to 2 times faster than that of its competitors and it is very user friendly.

Far from the superficial and over-populated world of clones, Normerel ATC 12 offers the well controlled quality, the sure and subtle touch of elegance of traditional french manufacturing. Dealers Wanted.

Technical Specs.	
80286	- 12.5 / 8 Mhz soft switchable.
DRAM	- 640 KB expandable.
ON BOARD	- (Standard)
Video	
	- TTL: MDA, HDA, CGA, EGA, EGA plus
	- Analogous: VGA.
I/O	
	- 2 RS 232 - 1 Parallel Port - Mouse Port
	Controller
	- Floppy - 3 1/2 - 5 1/4 all format
	- Rigid Disk - SCSI
	Dram Socket
	- 2 MB SIMM's Socket
	3 Free Slots
	- 2 AT Format
	- 1 PC Format

NORMEREL BRAIN IS BEAUTIFUL.

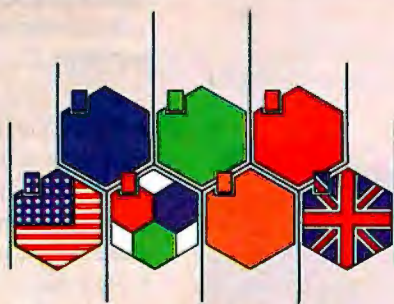

Circle 304 on Reader Service Card

NORMEREL U.S. - P.O. Box 5929 - ORLANDO - FLORIDA 32805
Tél (305) 843.5224 - FL (800) 432.7042 - US (800) 327.9877

NORMEREL U.S. - 16 Crow Canyon Court, Suite 225 - SAN RAMON
CALIFORNIA 94583 - U.S.A. Tél. (415) 8899676

NORMEREL SYSTÈMES - 58 rue Pottier 78150 LE CHESNAY - FRANCE
Tél 33 (1) 39.54.90.06 Télex NRLSYS 699424 F - Fax 33 (1) 39.55.38.13

NORMEREL UK - Pathtrace House - 91/99 High Street - BANSTEAD - SURREY SM7 2NL
ENGLAND - Tél. (0737) 360482/83 Télex 267 597 JSUK Fax (0737) 362813

0 to 60 in 5 seconds



with new UniLab Microprocessor Development Tools

- 64Kbytes from hard disk to emulation memory in 5 seconds. That's moving. But today you've got to be fast just to stay in the race for better microprocessor designs.
- The secret is a new, high-speed parallel interface: the Orion bus. Which zips data between your PC/AT and the 8620 analyzer-emulator, breaking the RS-232 bottleneck.
- The 8620 with O-bus gives you complete program diagnosis — and solutions — in real time. For more than 150 different microprocessors. Using the same command set environment.
- A generous 2730 trace-cycle buffer with selective filtering lets you cut through the clutter and display just the traces you wish. And you get μ sec resolution in program time measurement. Plus continuous InSight monitoring of your program's key functions as they are performed.

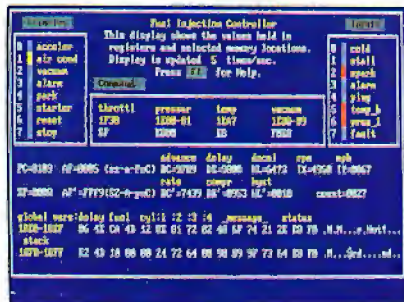

InSight Display. InSight blends analyzer-emulator techniques to give you continuous, real time monitoring of key processor functions. And still services user interrupts. It displays changing register contents, I/O lines, ports, user-defined memory windows. With your own labels.

- On top of that, you get UniLab's trademark ability to debug by symptom, not just by breakpoint and single step. And, to help you complete the job on time, on the spot, a stimulus generator and EPROM programmer are included.
- Ease of use, another Orion trademark, is also built in. So you have all the familiar features and formats you're used to working with. It doesn't matter if your project is a single chip controller or complex 16-bit

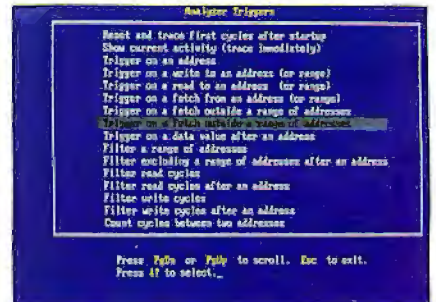

Analyzer Triggers. Commonly used triggers can be selected quickly from a list of standard and user-defined triggers.

microprocessor, the 8620 is the top price/performance analyzer-emulator that does it all. At just \$4380. With processor Personality Paks typically \$550 each.

- UniLab 8620. Fast-lane debugging that gets you to market quicker.

Call toll-free: 800/245-8500.

In CA: 415/361-8883

ORION
INSTRUMENTS

702 Marshall St., Redwood City, CA 94063
TLX 530942 FAX 415/361-8970

Computer Integrated Instrumentation

Circle 193 on Reader Service Card

PRODUCTS IN PERSPECTIVE

- 67** **What's New**
- 89** **Short Takes**
Dell System 310
UR/Forth 1.10
SoftPC
EasyTalk
GrandView
Forget-Me-Not
- First Impressions**
- 103** Sun's New Workstation:
the Sun386i
- 111** IBM's OS/2 Extended Edition
- Reviews**
- 118** Fast Drives for Modern Times
- 134** Amdek System/286A, Arche
Rival 286, Epson Equity II+,
Leading Edge Model D2,
and PC's Limited System 200
- 147** ColorVue SE
- 155** VM/386: A Virtual Solution
- 163** Concurrent DOS 386
- 173** ProBas
- 181** Designer
- 189** NewSpace
- 197** **Computing at Chaos Manor**
by Jerry Pournelle
- 211** **Applications Only**
by Ezra Shapiro
- 217** **Some Assembly Required**
by Rick Grehan



IT'S TIME TO DO SOME SERIOUS 386 BUGBUSTING!

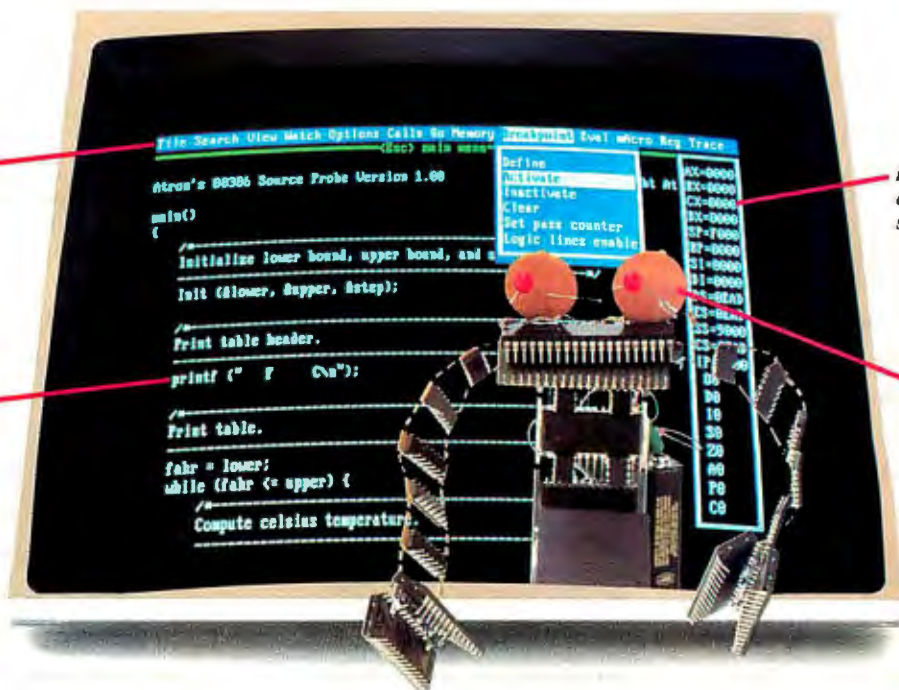

PROBE's menu bar and pull-down menus set a new standard for debugger interfaces.

PROBE has source-level debugging to let you "C" your program.

POP registers up and down with a single key.

This is an out-of-range memory-overwrite bug. Since it is interrupt related, it only appears in real time.

Welcome to your nightmare. Your company has bet the farm on your product. Your demonstration wowed the operating committee, and beta shipments were out on time. Then wham!

All your beta customers seemed to call on the same day. "Your software is doing some really bizarre things," they say. Your credibility is at stake. Your profits are at stake. Your sanity is at stake.

THIS BUG'S FOR YOU

You rack your brain, trying to figure something out. Is it a random memory overwrite? Or worse, an overwrite to a stack-based local variable? Is it sequence dependent? Or worse, randomly caused by interrupts? Overwritten code? Undocumented "features" in the software you're linking to? And to top it off, your program is too big. The software debugger, your program and it's symbol table can't fit into memory at the same time. Opening a bicycle shop suddenly isn't such a bad idea.

THIS DEBUGGER'S FOR YOU

Announcing the 386 PROBE™ Bugbuster,* from Atron. Nine of the top-ten software developers sleep better at night because of Atron hardware-assisted debuggers. Because they can set real-time breakpoints which instantly detect memory reads and writes.

Now, with the 386 PROBE, you have the capability to set a *qualified breakpoint*, so the breakpoint triggers only if the events are coming from the wrong procedures. So you don't have to be halted by breakpoints from legitimate areas. You can even detect obscure, sequence-dependent problems by stopping a breakpoint only after a specific chain of events has occurred in a specific order.

Then, so you can look at the cause of the problem, the 386 PROBE automatically stores the last 2K cycles of program execution. Although other debuggers may *try* to do the same thing, Atron is the only company in the world to dequeue the pipelined trace data so you can easily understand it.

Finally, 386 PROBE's megabyte of hidden, write-protected memory stores your symbol table and debugger. So your bug can't roach the debugger. And so you have room enough to debug a really big program.

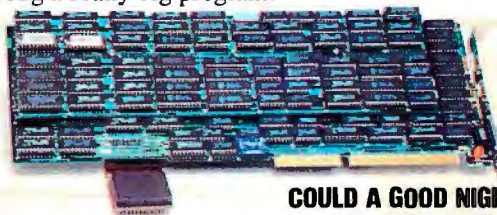

COULD A GOOD NIGHT'S SLEEP PUT YOU IN THE TOP TEN?

Look at it this way. Nine of the top-ten software products in any given category were created by Atron customers. Maybe their *edge* is — a good night's sleep.

Call and get your free, 56-page bugbusting bible today. And if you're in the middle of a nightmare right now, give us a purchase order number. We'll FEDEX you a sweet dream.



Atron
BUGBUSTERS

A division of Northwest Instrument Systems, Inc.
Saratoga Office Center • 12950 Saratoga Avenue
Saratoga, CA 95070 • Call 408/253-5933 today.

WHAT'S NEW

SYSTEMS

Radio Shack Has High-Speed PS/2 Clone

The Tandy 5000 MC is the first available computer that is compatible with the Micro Channel architecture (MCA) on the IBM PS/2 systems. It's also very fast.

Inside the 5000 MC is a 20-MHz 80386 processor with a 32K-byte cache of 35-nano-second static memory. For graphics, a VGA graphics controller is included. Memory ranges from 2 to 16 megabytes. The system also has two 32-bit MCA expansion slots and three 16-bit MCA slots. A video bus connector is available for optional high-resolution MCA video cards.

Externally, the new Tandy machine looks about the same size as the company's older 80386-based system, the Tandy 4000. One difference is that the front panel of the new system has space for four half-height data storage devices (two 3½-inch devices and two 5¼-inch devices). One 3½-inch floppy disk drive comes standard.

Price: \$4999; \$6499 with 40-megabyte hard disk drive.

Contact: Radio Shack, 1700 One Tandy Center, Fort Worth, TX 76102, (817) 390-3011.

Inquiry 751.

Dell's 80286 System Beats Some 80386s

Dell Computer has introduced what may be the fastest 80286 system around. The new Dell System 220 uses an 80286 microprocessor, but it outperforms some



The Tandy 5000 MC is the first Micro Channel compatible.

80386-based systems. The reason? A new 20-MHz CMOS 80286 processor from Harris, which allows the system to run faster than many 16-MHz 80386-based systems. For example, according to a small sample of BYTE benchmarks, the System 220 was 5 percent to 25 percent faster than IBM's 80386-based PS/2 Model 80 with a 16-MHz clock speed.

Although the System 220 is rather small—Dell claims its footprint is smaller than that of the IBM PS/2 Model 30—it includes a number of features as standard. Included on the motherboard, for example, are a VGA and 1 to 8 megabytes of memory.

The System 220 has only three AT-style slots and a power supply of only 85 watts. However, the company

says that the power supply is sufficient for almost all types of add-in boards because of the system's CMOS processor. **Price:** \$1595 with a floppy disk drive only; \$2699 with 40-megabyte hard disk drive and color VGA monitor.

Contact: Dell Computer Corp., 9505 Arboretum Blvd., Austin, TX 78759, (512) 338-4400.

Inquiry 752.

PICK System Network Supports 16 Users

The Zebra 1620 multiuser business system from General Automation represents the company's first venture into the small systems marketplace. This entry-level,

12.5-MHz, zero-wait-state, multiuser business system is based on the 32-bit Motorola MC68020 microprocessor and functions with the PICK operating system.

The system unit (5 by 17 by 17 inches, weighing 35 pounds) comes with 1 megabyte of RAM (expandable to 2 megabytes), one 40-megabyte or 67-megabyte hard disk drive, and a 45-megabyte or 60-megabyte ¼-inch tape drive. It has 8 asynchronous CRT terminal or serial printer ports, expandable to 16, and there is one parallel printer port. Options include a 16.7-MHz microprocessor. Keyboards and monitors are not included in the standard system package.

Standard software includes Accu/Plot II, for business graphics; Compu-Sheet+, a spreadsheet; and Jet, for word processing. While this model of the Zebra series doesn't support the standard PC graphics cards, there are two full-size expansion slots, one of which you can use for optional hardware to support the ARCnet 2.5-megabit-per-second token-passing-ring local area network (LAN).

You can also purchase boards and other equipment to upgrade the 1620 to a Zebra 1820, a 32-user system that runs at 20 MHz with 4 megabytes of RAM and a total of three 140-megabyte hard disk drives. Several other General Automation higher-end systems are also compatible with the Zebra 1620 and 1820. **Price:** \$12,500; \$4000 for 1820 upgrades.

Contact: General Automation, Inc., 1055 South East Street, P.O. Box 4883, Anaheim, CA 92803, (714) 778-4800.

Inquiry 753.

SEND US YOUR NEW PRODUCT RELEASE

We'd like to consider your product for publication. Send us full information, including its price, ship date, and an address and telephone number where readers can get further information. Send to New Products Editor, BYTE, One Phoenix Mill Lane, Peterborough, NH 03458. Information contained in these items is based on manufacturers' written statements and/or telephone interviews with BYTE reporters. BYTE has not formally reviewed each product mentioned.

continued

ModelViewer PC Produces High-Resolution Photos

Two- and three-dimensional slides, prints, and transparencies of computer-generated images are the products of the DI-100 ModelViewer PC, an XT- and AT-compatible digital imaging system that works with a camera. Data Innovations has targeted such applications as marketing presentations and design documentation.

In 3 minutes or less, the ModelViewer produces CAD/CAE solid designs, molecular models, and other scientific images. Consisting of a film recorder, a graphics processor card, interface software, and up to three camera adapters, the ModelViewer has a database of up to 32,768 colors for image resolution of 640 by 480 or 1024 by 800 pixels. **Price:** \$4995; \$495 for 35mm camera adapter; \$95 for automatic slide developing system; \$395 for overhead transparency camera adapter; \$50 each for software interfaces for VersaCAD, Personal Designer, or AutoShade. **Contact:** Data Innovations, Inc., 323 New Boston St., Wilmington, MA 01887, (617) 933-8170. **Inquiry 754.**

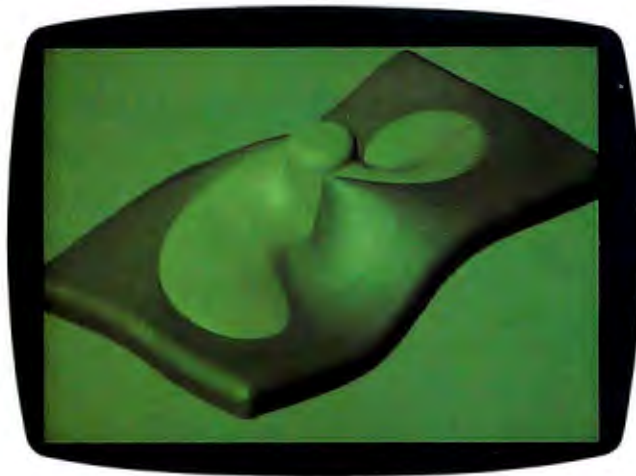

A slide produced by ModelViewer PC.

Keep Your Laptop Data Safe

While there are several companies with hard disk backup equipment for IBM, Macintosh, and other standard-size personal computers, Axonix seems to be the first to offer such equipment for the burgeoning laptop market. Its Thinstream XT/AT is a 40-megabyte streaming tape backup system for laptop storage, which is becoming much more hard-disk-drive-intensive.

Potential markets include intra-office backup, backup of field measurement information, and military information backup.

Double-shielded copper

cabling from the floppy disk drive port permits backup of 20 megabytes of hard disk data from an AT machine in less than 20 minutes, at 500 kilobits per second (250 kilobits per second on the XT). The tape system weighs less than 3 pounds and measures 2 by 5 by 8 inches.

Price: \$849 for the XT model; \$899 for the AT model. **Contact:** Axonix Corp., 2257 South 1100 E, Suite 2C, Salt Lake City, UT 84106, (801) 466-9797. **Inquiry 755.**

Solutions for Mass-Storage Problems

For high-end processing applications with PC compatibles, the N/Hance Systems division of Symphony Systems has introduced 150- and 300-megabyte hard disk drives.

Initial applications include CAD/CAM, office automation, process control, and digital imaging. All the full-height 5¼-inch drives are equipped with a small computer system interface (SCSI) and can be daisy chained for multiple drive configurations. A high-speed enhanced small device interface (ESDI) is also available, with disks for both XT and AT systems.

You can install disks for the XT and AT systems both internally and externally with the Model HCS-pcs150 and Model HCS-pcs300 controller/adaptor boards.

Models HCS-sun150, HCS-mac150, and HCS-mac300 are available for the Sun-3 and Mac Plus, II, and SE. Track-to-track access time is rated at 4 ms.

All drives will run DOS, Xenix, Unix, and Novell. **Price:** \$3699 for HCS-pcs150; \$5299 for HCS-pcs300; \$3999 for HCS-sun150; \$3499 for HCS-mac150; \$4399 for HCS-mac300. (All prices include interface cards and necessary cabling.) **Contact:** N/Hance Systems, 908R Providence Hwy., Dedham, MA 02026, (800) 289-9676; in Massachusetts, (617) 461-1970. **Inquiry 756.**

"Scuzzy" Apples

Apple Crate's new 20-, 40-, and 60-megabyte SCSI drives fit under the Mac Plus, SE, and II, and include ports that let you daisy chain up to seven devices. Utilities for formatting, initializing, testing, and verifying the disks are standard. There's also a help function.

Average access time on the 20-megabyte system is 60 ms. For the 40-megabyte and 60-megabyte systems, access time is 40 ms.

Price: \$560 for the 20-megabyte drive; \$770 for the 40-megabyte drive; \$839 for the 60-megabyte drive.

Contact: Apple Crate, Inc., 6850 Vineland Ave., North Hollywood, CA 91605, (818) 766-4001. **Inquiry 757.**

continued

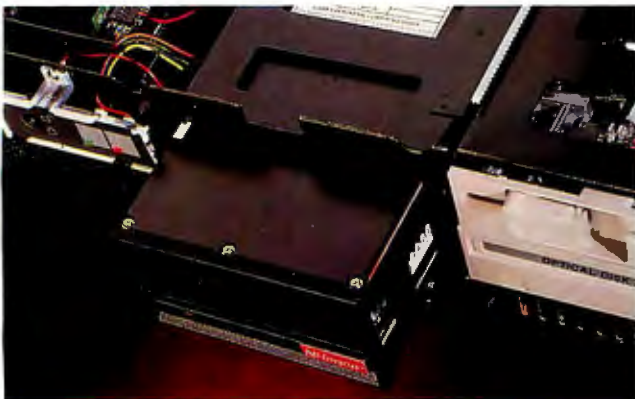

High-capacity hard disk drives from N/Hance.

Why Paradox 2.0 makes your network run like clockwork



Paradox® runs smoothly, intelligently and so transparently that multiple users can access the same data at the same time—without being aware of each other or getting in each other's way.

With Paradox news travels fast and it's always accurate

Paradox *automatically* updates itself with a screen-refresh that ensures that all the data is up to date and accurate all the time. Record-locking, Paradox-style, safeguards data integrity by preventing for example, two different users from making changes to the same record at the same time.

How to make your multiuser network work

To run Paradox 2.0 or the Paradox Network Pack on a network, you need:

- Novell with Novell Advanced Netware version 2.0A or higher
- 3Com 3Plus with 3Com 3+ operating system version 1.0, 1.1 or higher
- IBM Token Ring or PC Network with IBM PC Local Area Network Program version 1.12 or higher
- Torus Tapestry version 1.45 or higher
- AT&T Starlan version 1.1 or higher
- Banyan VINES version 2.10
- Other network configurations that are 100% compatible with DOS 3.1 and one of the listed networks

System Requirements for the Network Workstation

- DOS 3.1 or higher
- 640K RAM
- Any combination of hard, floppy, or no disk drives
- Compatible monochrome, color, or EGA monitor with adapter

*Customer satisfaction is our main concern; if within 60 days of purchase this product does not perform in accordance with our claims, call our customer service department, and we will arrange a refund.

Paradox is a registered trademark of Ansa Software. Ansa is a Borland International Company. Other brand and product names are registered trademarks or trademarks of their respective holders. Copyright ©1988 Borland International. BI 1243

Circle 38 on Reader Service Card (Dealers: 39)

“When I saw the record-locking and autorefresh in action, I couldn't believe it. Here was a true network application, a program that can actually take advantage of a network to provide more features and functions, things that can't be done with a stand-alone PC.

Aaron Brenner, LAN Magazine

With Version 2.0, Paradox becomes a sophisticated multiuser product that boasts an impressive selection of data-production features and password-security levels.

Rusel DeMaria, PC Week ”

Paradox responds instantly to “Query-by-Example”

The method you use to ask questions is called Query-by-Example. Instead of spending time figuring out *how* to do the query, you simply give Paradox an example of the results you're looking for. Paradox picks up the example and automatically seeks the fastest way of getting the answer.

Queries are flexible and interactive. And in Paradox, unlike in other databases, it's just as simple to query more than one table as it is to query one.

“The program elegantly handles all the chores of a multiuser database system with little or no effort by network users.

Mark Cook and Steve King,
Data Based Advisor ”

“Paradox . . . has quickly become the state-of-the-art product among PC database managers . . . Paradox still reigns supreme as the thinking user's DBMS.

Jim Seymour, PC Magazine ”

You don't have to be a genius to use Paradox

Even if you're a beginner, Paradox is the only relational database manager that you can take out of the box and begin using right away.

Because Paradox is driven by the very latest in artificial intelligence technology, it does almost everything for you—except take itself out of the box. (If you've ever used 1-2-3® or dBASE,* you already know how to use Paradox. It has Lotus-like menus, and Paradox documentation includes “A Quick Guide to Paradox for Lotus Users” and “A Quick Guide to Paradox for dBASE users.”) Paradox, it makes your network work.

60-Day Money-back Guarantee*

For a brochure or the dealer nearest you
Call (800) 543-7543



Sony's CAD/CAM Monitor Competes with the Big Boys

Sony Corporation of America has four new XT- and AT-compatible CAD/CAM color monitors to compete against higher-priced CAD/CAM workstations.

Two 19-inch models, with horizontal scan frequencies of 64 and 48 kHz, respectively, will be available next month to complement the two 16-inch monitors (with the same respective horizontal scan frequencies) that will be available in the fall. Each of the monitors will need CAD add-in boards (available from a number of vendors), bringing system pricing to \$15,000.

The 19-inch monitors' specifications include vertical frequencies rated at 60 Hz, a display area of 14½ by 10 inches, dot pitch of 0.31 millimeter, aperture grille resolution of 1280 by 1024 pixels, and a bandwidth of 100 MHz. **Price:** \$4195 for either 19-inch monitor; \$3095 for either 16-inch monitor.

Contact: Sony Corporation of America, Computer Peripheral Products Division, One Sony Dr., Park Ridge, NJ, 07656, (201) 930-1000.

Inquiry 758.

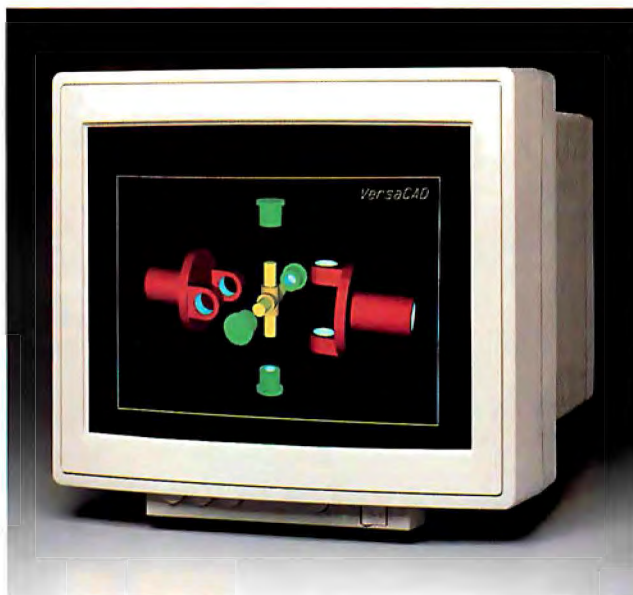

Sony's AT-compatible CAD/CAM monitor.

Acquire and Control Data with Your Mac

Replacing such instruments as oscilloscopes, chart recorders, and voltmeters is the MacPacq, a data acquisition and device-control peripheral designed for the Mac. It is compatible with all Macs from the 512Ke on up.

Modem or printer-port connections from the Mac instruct the MacPacq on how to acquire data from one of up to 16 different devices. The devices can include anything from microphones and solar

cells to speakers and indicator lights. Instructions from the Mac enable the MacPacq to control external devices through eight channels.

MacPacq can run as a stand-alone or connected to the Mac. It can simultaneously control external devices and acquire data. Sampling rates range from 2 samples per hour to 10,000 samples per second.

PacqManager software lets you print the data in a chart recorder format or record and save the data in a word-processing, database, or numerical analysis format. For example, the MacPacq can output

square waves to 500 kHz.

Price: \$995, including software.

Contact: Biopac Systems, 42 Aero Camino, Suite 215, Goleta, CA 93117, (805) 968-8880.

Inquiry 759.

High-Speed, High-Resolution Color Output

The Accel-500, a dot-matrix color printer from Advanced Matrix Technology (AMT), is designed for power users and power computers. AMT, a division of the Singapore-based Lam Soon Group, says speed is rated at 480 characters per second (cps) for 12- and higher-pitch printing of draft documents.

For more important documents, the Accel-500 combines letter-quality text with color resolution graphics and still operates at a sound level of less than 55 decibels. Methods of printing are serial impact, dot matrix, and logic-seeking; movement is bidirectional. During 10-pitch printing, speed is 400 cps. It operates at 200 cps and 80 cps for memo and letter modes, respectively.

Standard features include a 24-pin pinhead, addressable seven-color graphics, a built-in forms tractor, four fonts (each supports six pitches), five coresident printer emulations, and a plug-in Intelli-Card for upgrades.

The 37-pound printer measures 7 by 24 by 17 inches. A Centronics-compatible parallel interface and an RS-232C serial interface are standard.

Price: \$1185.

Contact: Advanced Matrix Technology, Inc., 1157 Tourmaline Dr., Newbury Park, CA 91320, (805) 499-8741.

Inquiry 760.

MusicMaker from Roland

For IBM XTs, ATs, and PS/2s, RolandCorp US has introduced equipment for recording, playing back, and editing up to eight tracks of music. Included in the package is the EASE (editing, arranging, and sequencing environment) Song Maker software, the MT-32 soundmodule, and an MPU-IPC musical instrument digital interface (MIDI) card.

Under EASE, menus and

submenus let you perform general functions such as recording a musical phrase and scoring individual tracks. You can also perform specific functions, such as deleting incorrectly played notes.

Once familiar with the equipment, you can play all of the eight available synthesized sounds and the one rhythm sound simultaneously. Then you can assign functions to each of the syn-

thesized parts: panning, volume, transposition, bender range, and velocity. A built-in reverb section allows you to select up to four reverb modes from the MT-32, process them, and add them to the composition.

Price: \$995.50.

Contact: RolandCorp US, 7200 Dominion Cir., Los Angeles, CA 90040, (213) 685-5141.

Inquiry 761.

continued

When your basic quantum leap is just not enough:

PROBAS™ Professional Basic Programming Library

PROBAS is a library of routines that kicks QuickBASIC and BASCOM into 5th gear and gives you powers and abilities far beyond those of mortal men. It's the greatest thing since sliced bread and if you don't get it today, your hard disk will crash in retaliation. So much for the hype, now down to brass tacks:

- 232 routines (226 in Assembly)
- 600 page 3-part manual
- Full-featured windowing
- Screen snapshots
- Virtual screens in memory
- Lightning-fast file I/O
- Access EMS as files or arrays
- Full mouse support

Plus 200 essential services from directory and equipment routines to handy string, date, time, and input routines.

Sick of running out of string space? Store hundreds of K in numeric arrays or megabytes in EMS arrays. Tired of using a kludgy SHELL to DIR to read a directory? Scan subdirectories using wild-cards and store thousands of file names, dates, and times. Wish you could drag a window containing text or a menu around the screen with a mouse? It's easy!

PROBAS virtual screens allow you to draw full or partial screens to memory, and then snap them on in an eyeblink-- faster and without the limitations of PCOPY. Draw and store hundreds of pull-down menus or help screens, each in its own array, ready to be displayed anywhere on the screen at assembly speeds-- you just can't get any faster.

PROBAS gives you a complete set of blazingly-fast file routines. Read or write up to 64k chunks of data at a clip, with file locking and error handling so that you can even use them in subprograms. You'll never want to use BASIC's file I/O again! No royalty and not copy-protected. For all versions of QuickBASIC and BASCOM including BASCOM 6.0 for OS/2. **Just \$99.00!**

Add \$3.00 per item (\$7.00 Canada) for shipping. Trademarks: ProBas, ProRef, ProScreen: Hammerly Computer Services, Inc. QuickBASIC, BASCOM: Microsoft Corp.

PROBAS™ TOOLKIT

The TOOLKIT is a collection of assembly and BASIC modules that use the PROBAS library to save you even more hours of grunt work. Call a ring, bar, pop-up, or pull-down menu. Pop up a mini-word processor with word-wrap in a window. Make file I/O faster with b-tree indexing. You get:

- Dozens of Menu Generators
- Fast B-tree indexing
- Mini-editor with word-wrap
- Patch .EXE files
- Protected storage areas
- Display text files in windows
- Julian date routines
- Documented BASIC source

Plus dozens of powerful, easy to use routines that help conserve the most valuable asset of all-- your time! **Just \$99.00!**

PROSCREEN™ Professional Screen Management System

PROSCREEN is a full-featured screen generator editor that will save you more design and coding time than you ever thought possible. PROSCREEN works with screens like a word processor works with text to provide complete control over screen characters, placement and colors. Edit up to 3 screens at a time and perform block moves, block copies, merge and cut and paste operations-- even between screens-- with ease.

Use PROSCREEN to prototype designs, create full or partial screens for import via PROBAS, or create input screens that have up to 130 edit fields per screen. You can even take snapshots of other applications, edit them, and produce demos and working tutorials. PROSCREEN comes with subroutine source, extensive on-line help and a 285 page manual with tutorial and reference. **Just \$99.00!**

PROBAS™ TELECOMM TOOLKIT

The PROBAS TELECOMM TOOLKIT is a collection of high-level communications modules that you plug into your code to provide popular file transfer protocols, terminal emulations, auto-dialing, phone data base, login scripts and more. Plug just the routines you need into your programs.

- Xmodem/Modem7/Xmodem-1k
- Ymodem (single and batch)
- CRC-16 and Checksum
- VT52, VT100, ANSI BBS etc.
- Auto Dialer & data base
- Script language support
- Full terminal program
- Documented BASIC source

The TELECOMM TOOLKIT comes with a detailed manual and a full terminal program in BASIC. **Just \$75.00!**

PROREF™ On-Line Help For PROBAS™

PROREF is three products in one-- a pop-up help system for the 232 routines in PROBAS, pop-up help for your routines, and an extension of the QuickBASIC programming environment. See the calling syntax and help for any PROBAS routine, or any of your routines, with just a few keystrokes or mouse clicks. Pop-up an ASCII chart, calculator, keyboard scan code module or almost any DOS program via hot-key. **Just 50.00!**

Our money-back guarantee assures you the highest quality and our technical support staff is always ready to help. Try our BBS at (301) 953-7738 or give us a call at:

(301) 953-2191



HAMMERLY
COMPUTER SERVICES, INC.

8008 Sandy Spring Road • Laurel, Maryland 20707

Transputer Brings 3-D CAD to PCs

Three-dimensional CAD is now possible on IBM PCs and compatibles with the first Transputer-based graphics card, says manufacturer Nth Graphics Display Products. The company claims the Nth 3D Engine can write 40,000 three-dimensional vectors per second or draw 10,000 constant-shaded polygons (with 500 pixels each) per second. In addition, the famous Teapot model (1200 polygons) can be flat-shaded and rotated in 1/4 second.

The board comes with 1 megabyte of video RAM and 2 megabytes of display list RAM. It drives high-resolution monitors with resolutions of up to 1024 by 768 pixels and a 60-Hz noninterlaced refresh rate. The board can display 256 simultaneous colors from a palette of 4096.

There's also an optional full-length expansion card that produces higher resolutions, faster shading speeds, more processing power, and memory for a Z-buffer, the company says.

Power comes from parallel-processing INMOS microprocessors and proprietary graphics coprocessors. One of the microprocessors, a 10-million-instruction-per-second floating-point processor, manages the display list and processes other graphics functions parallel to other on-board processors. Other microprocessors are used in parallel for scan control and complex rendering.

Price: \$5995; \$2000 for optional expansion card.
Contact: Nth Graphics Display Products, 1807-C West Braker Lane, Austin, TX 78758, (800) 624-7552; in Texas, (512) 832-1944.
Inquiry 762.

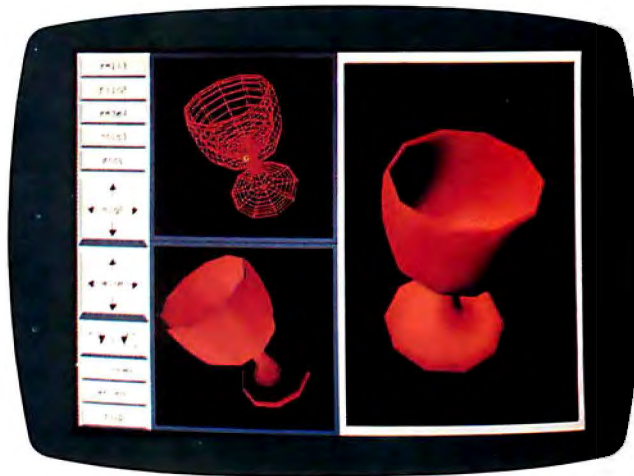

The Nth 3D Engine's model manipulation.

"What Was That, R2?"

Helping the physically handicapped answer telephones and activate appliances are the aims of the voice recognition and speech synthesis equipment from The Voice Connection. But inventory control, assembly-line quality control, and medical data entry are also potential applications.

That's what the IBM-compatible IntroVoice VI system is all about. It's designed to "listen" to one of the 500 commands and data entries and respond by sending keystrokes to the computer and text to the on-board synthesizer for audio output verifications and prompting. According to the company, it recognizes the word on the first try 98 percent of the time. Subvocalaries (with 500 words maximum) are also recognized through the main vocabulary.

Included in the package are a half-length circuit board, a hand-held microphone, a manual, and a speaker. Software includes AutoCAD, Voice Executive, and examples of vocabularies.
Price: \$595.

Contact: The Voice Connection, 17835 Skypark Circle, Suite C, Irvine, CA 92714, (714) 261-2366.
Inquiry 763.

Board Unites Apple and IBM

The Deluxe Option Board, a PC expansion card from Central Point Software, transforms your standard 720K-byte 3 1/2-inch PC AT or PS/2 floppy disk drive into a dual-purpose IBM/Mac drive.

The board fits into a half-length slot and includes software that emulates the Mac's Hierarchical and Macintosh File Systems. When you use a Mac disk, you need only add an *M* before the usual DOS command. You can also create and delete folders, format and copy 400K-byte and 800K-byte disks, and display Mac directories with a tree command.

Central Point says it will introduce a card with Micro Channel PS/2 compatibility next month.
Price: \$159.

Contact: Central Point Software, Inc., 9700 Southwest Capitol Hwy., Portland, OR 97219, (503) 244-5782.
Inquiry 764.

Convert Mac II Images to Standard Video

Now you can save Macintosh II-generated video on standard VCRs and other video peripherals. RasterOps Corp. has introduced a color graphics board featuring video output to televisions meeting National Television System Committee (NTSC) and Phase Alternating Line (PAL) standards.

The ColorBoard 100, a full-size card, provides resolution as sharp as 1024 by 768 pixels, with 8 bits per pixel of color information from a palette of 16.7 million colors.
Price: \$1495 for board and either interface; \$2495 for 16-inch color monitor.

Contact: RasterOps Corp., 10161 Bubb Rd., Cupertino, CA 95014, (408) 446-4090.
Inquiry 765.

AT Engines Rebuilt Cheap

Replacing your AT motherboard with the Absolute 16/0 AT board is like rebuilding the engine on the old car instead of buying a new car.

The new "engines," with three chips from G2 Corp., are comprised of 16-MHz, zero-wait-state motherboards with 1 megabyte of 60-ns RAM. New 80286 machines with 20 ICs do the work that originally took about 150 ICs.
Price: \$975; \$999 installed.
Contact: AdvanTech Corp., 261 Cedar Hill St., Marlborough, MA 01752, (800) 338-3130; in Massachusetts, (617) 481-6009.

Inquiry 766.

continued



Introducing the most agile mouse ever to set foot on a desktop.

The LOGITECH HiREZ Mouse—the only mouse expressly designed for high-resolution screens.

With a resolution of 320 dots-per-inch (as compared with 200 dpi or less for ordinary mice), it covers the same area on your high-res screen, but needs less of your desk to do it. More than 50% less. Saving you valuable desk space, and effort: mouse maneuvers that used to require a sweep of the hand are now reduced to a flick of the wrist.



The LOGITECH HiREZ mouse needs 50% less desk space to cover the same amount of screen area as a 200 dpi mouse.

Which makes this new mouse a hand's best friend. And a more reliable, long-lasting companion—fully compatible with all popular software, and equipped with a Lifetime Guarantee.

Equipped, too, with other advantages exclusive to all Logitech mice: A unique lightweight ergonomic design. Low-angled buttons for maximum comfort and minimum fatigue. An exclusive technology that guarantees a much greater life span. An exceptionally smooth-moving, dirt-resistant roller ball. And natural compatibility with all PCs, look-a-likes, and virtually any software.

So if you've got your eyes on a high-res screen, get your hands on the one mouse that's agile enough to keep up with it.

The LOGITECH HiREZ Mouse.

For the dealer nearest you, call 800-231-7717 (800-552-8885 in California), or write Logitech, Inc., 6505 Kaiser Drive, Fremont, CA 94555. In Europe, call or write: Logitech Switzerland, European Headquarters, CH-1111 Romanel/Morges, Switzerland (++41-21-869-9656).

 LOGITECH

Circle 150 on Reader Service Card (Dealers: 151)

How to pick th



Though most mice out there look pretty much alike, they're not all equal in performance. It pays to be just a little choosy to make sure you end up with the right mouse for your needs.

Starting with software. If you want full compatibility with all of your software, all you have to do is look for a mouse with the Logitech name. There are four in all, each one designed for different hardware needs.

THE HiREZ MOUSE

If you've got your eyes on a high-resolution screen, the mouse to get your hand on is the new LOGITECH HiREZ Mouse.

With a resolution of 320 dots-per-inch (as compared with 200 dpi or less for ordinary mice), it covers the same area on your high-res screen but needs less of your desk to do it. More than 50% less. Saving you valuable desk space, and



The LOGITECH HiREZ Mouse needs 50% less desk space to cover the same amount of screen area as a 200 dpi mouse.



Good instincts run in this family (left to right): the new LOGITECH HiREZ Mouse (\$179), the only mouse designed expressly for high-res screens; the LOGITECH Series 2 Mouse for the IBM PS/2 (\$99, plugs right into mouse port); and the LOGITECH Mouse for standard screens (\$119, in bus and serial versions).

All come with Logitech's own Plus Software, which assures ease of use with virtually any software, mouse-based or not.

effort: mouse maneuvers that used to require sweeps of the hand are now reduced to a flick of the wrist.

Which makes this new mouse a hand's best friend. And a more reliable, long-lasting companion. And, like all Logitech mice, it's fully compatible with all popular software, and equipped with a Lifetime Guarantee.

THE SERIES 2 MOUSE

For those who've chosen the Personal System/2,[™] the most logical choice is the LOGITECH Series 2 Mouse. It's 100% compatible with PS/2, and plugs right into the mouse port, leaving the serial port free to accommodate other peripherals.

e right mouse.

THE ALL-PURPOSE MOUSE: SERIAL OR BUS

Most people find our standard mouse is still the best choice for their systems. It's available in both bus and serial versions, one of which is sure to fit perfectly with your hardware. And with all your favorite software—whether mouse-based or not.

It's hardly an accident that only Logitech offers you such a complete selection—we're the only mouse company to design and manufacture our own products. We make more mice, in fact, than anyone else. Including custom-designed models for OEMs like AT&T, DEC, and Hewlett-Packard.

The three mice pictured to the left come with all this expertise built right in. Which explains an interesting paradox: while you may pay less for a Logitech mouse, you will surely get more performance.



A Logitech mouse plus Logitech application software equals a complete solution (all prices include mouse, Plus Software, and application):

LOGICADD...\$189. Turns your PC into a full-featured CADD workstation. Everything you need for dimensioned line drawing and CADD.

PUBLISHER PACKAGE...\$179. PUBLISHER software lets beginners and experts alike produce professional, high-impact documents. Design templates make page layout easy.

LOGIPAINT SET...\$149. Eleven type fonts and a 16-color palette. Creates files that move easily into both LOGICADD and PUBLISHER documents.

(800-552-8885 in California). Or fill out and mail the coupon below to: Logitech, Inc., 6505 Kaiser Drive, Fremont, CA 94555. In Europe, call or write: Logitech Switzerland, European Headquarters, CH-1111 Romanel/Morges, Switzerland (+41-21-869-9656).



And in comfort. With a unique lightweight ergonomic design. Low-angled buttons for maximum comfort and minimum fatigue. An exclusive technology that guarantees a much greater life span. An exceptionally smooth-moving, dirt-resistant roller ball. And natural compatibility with all PCs, look-a-likes, and virtually any software.

All of which leads to an inescapable conclusion: if you want to end up with the right mouse, start with the right mouse company.

Logitech. We've got a mouse for whatever the task at hand.

For the dealer nearest you, call 800-231-7717

Logitech, Inc., 6505 Kaiser Drive, Fremont, CA 94555.
Logitech Switzerland, European Headquarters,
CH-1111 Romanel/Morges, Switzerland.

Yes! Please send me the name of the nearest Logitech dealer.

Name _____

Company/Title _____

Address _____

Phone _____



LOGITECH

Personal System/2 is a trademark of International Business Machines, Corporation.

Emulation to the Max

A host-independent in-circuit emulator from Microcosm helps you find faults in hardware and software when you're designing 80386-based systems and applications.

The hyperICE-386 consists of a microprocessor-specific probe and a universal chassis and gives you access to trace, registers, and memory during the emulation process.

It gives engineers with a dumb terminal, host, workstation, or mainframe a way to uncover hardware and software problems and to otherwise debug systems at full speed by emulating the 80386 at clock speeds up to 25 MHz. Overlay memory runs with zero wait states at speeds to 20 MHz for real-time firmware debugging.

Key features include three 8000-gate arrays for trigger logic—monitoring address, data, and status lines, as well as the 16 logic probe lines. Four levels of triggering are available.

Another feature is the battery-backed RAM trace collection. When combined with the trigger feature, the trace collection feature is said to simplify debugging. System commands, which can be in a macro form and can be modified, are in C.

Price: \$17,500, including chassis and probe.

Contact: Microcosm, Inc., 15275-E Southwest Koll Pkwy., Beaverton, OR 97006, (503) 626-6100.

Inquiry 767.



Security Is Only a Fingerprint Away

After a 15-second function enrolls your fingerprint on the hard disk with a mathematic characterization system called the TouchSafe, 2 seconds is all it takes for the future access (or denial of access) to your computer.

Identix has been designing such "biometric" products for several years; the company also sells a similar product for access to high-security military establishments.

Processing hardware can be either an internal module (a single-slot board for PC compatibles) or an external module that connects to any computer system with an RS-232C interface. Included software, Safe Word, is designed by Enigma Logic.

Price: \$1795 with internal processor module.

Contact: Identix, Inc., 2452 Watson Court, Palo Alto, CA 94303, (415) 858-1001.

Inquiry 770.

Communications Tester Runs Analog and Digital

Designed to test modems, telephone lines, and computer terminals, the Linktest LT3 combines the functions of a 20-kHz analog test set, a 200K-bps digital bit-error-rate tester, and a digital multimeter. Kapusi Laboratories designed it to test level, noise, and frequency of analog equipment, and volts, ohms, and capacitance of digital equipment.

A built-in intercom allows voice connection between remote testing sites. A front-panel switch allows testing of either CCITT (international

or North American systems. The operating temperature range of the instrument—between -20° and 60°C —facilitates international telephone line testing.

Analog features include frequency measurement to 20 kHz and a transmit-and-receive accuracy of 0.2 decibels, combined. Digital features include data transfer rate measurement of up to 200 kilobits per second (with rated accuracy of ± 1 bit per second) and a built-in link scope that the company says is more accurate than a typical oscilloscope.

Price: \$3950, with battery charger/AC adapter, cables, and carrying case.

Contact: Kapusi Laboratories, 4701 Patrick Henry Dr., Suite 1702, Santa Clara, CA 95054, (408) 496-1086.
Inquiry 768.

Of Neighbors, Locals, and Those Beyond

You can link personal computers and peripherals to other personal computers by using an entry-level Commix 32 file server and some twisted-pair copper wire. Data rates for file transfer, electronic mail, printer sharing, and terminal emulation range from 300 bits per second to 19.2K bits per second.

Data-switching features include up to 32 asynchronous ports (with an optional synchronous channel module with two ports); expandable user I/O in 4-port module increments; speed and asynchronous format conversion; local echo selectable at any port; and camp-on-queue for port contention.

With an optional Ethernet card and some coaxial cable, you can use the Commix 32 to gain access to mainframe information from your personal computer.

If your business needs expand beyond LANs, a statistical-multiplexing wide-area-network (WAN) board links equipment in different cities with leased telephone lines at up to 64K bits per second, or with an X.25 packet network. **Price:** \$2595 for a 16-port Commix 32; \$3995 for 32-port version; \$350 for 4-port cards; \$2995 for Ethernet link and additional \$218 per port; pricing not set for WAN board. **Contact:** Itron, 130 Gaither Dr., Suite 116, Mount Laurel, NJ 08054, (800) 423-8044; in New Jersey, (609) 722-5575.

Inquiry 769.

continued

ORACLE® turns Lotus 1-2-3 into a full function database

ORACLE, the world's best selling relational database, now works from inside your Lotus 1-2-3 spreadsheet program. Familiar 1-2-3 menus guide you through creating, modifying and retrieving data in your database. You can even perform ORACLE database functions automatically using standard Lotus macros and formulas. The point is...



Store unlimited amounts of data in your ORACLE database

Use all the features of Lotus 1-2-3 to analyze, report, and graph data in your ORACLE database.

...If you already know how to use Lotus 1-2-3, then you already know how to use ORACLE, the world's most powerful database.

By putting data into a database, Lotus 1-2-3 spreadsheet's performance is improved, long re-calcs are eliminated and your worksheets are smaller and more manageable.

- Have ORACLE for 1-2-3 build the query automatically for you and retrieve just the data you need.
- A single command automatically creates new database tables from data in any existing worksheet.
- In update mode, changes in your worksheet become changes in your database.

And if you make a mistake, you can...

- Undo changes.
- Or save your changes permanently in your database and worksheet.
- Share the same data in multiple worksheets, or even across a network of different computers with many users.

Act now, get a 30-day moneyback guarantee and we'll pay sales tax and shipping. So fill out and mail the attached coupon, or call today. You can also purchase ORACLE for 1-2-3 at your favorite computer store.

\$199* Yes, this includes the full function ORACLE database.

Dear Oracle,

ORACLE for 1-2-3 • Oracle Corpora
20 Davis Drive • Belmont, CA 94002

Yes, I have an 80286/80386 PC running DOS 3.0+ and Lotus release 2.01. I also have 640KB of RAM, plus either 1MB of extended memory or I will reassign 1MB of my expanded memory as extended memory. Please send me the database I already know how to use — the ORACLE database add-in for Lotus 1-2-3, on 5 1/4" or 3 1/2" disks. Enclosed is my: check, or VISA MasterCard American Express credit card authorization for \$199.*

DATE

SIGNATURE

BYTE

ORACLE®
COMPATIBILITY • PORTABILITY • CONNECTABILITY

Call 1-800-ORACLE1,
ext. 149 today.
For International pricing call (415) 598-8290

*Prices valid in U.S. only. © 1988. ORACLE is a registered trademark of Oracle Corporation. Lotus and 1-2-3 are trademarks of Lotus Development Corporation.

TRBA

Programming in C

C_talk is an object-oriented programming environment for use with C programming languages. It features a Smalltalk-like browser for defining and editing classes of objects. It lets you browse through all the object classes for a particular application, create new ones, modify existing ones, define the application's structural organization, and edit arbitrary text files.

A preprocessor converts the program's object class descriptions into standardized C source files. The source code for the C_talk run-time environment is also included.

A make utility controls the preprocessing, compiling, and linking of an application program. The browser produces a specification for the make utility based on the set of object classes that you are browsing; you can also add other C source files to the make specification.

C_talk runs on the IBM PC and compatibles with at least 512K bytes of RAM. It supports Microsoft C, Turbo C, Lattice C, and Computer Innovations C86.

Price: \$149.95.

Contact: CNS, Inc., 7090 Shady Oak Rd., Eden Prairie, MN 55344, (612) 944-0170. **Inquiry 771.**

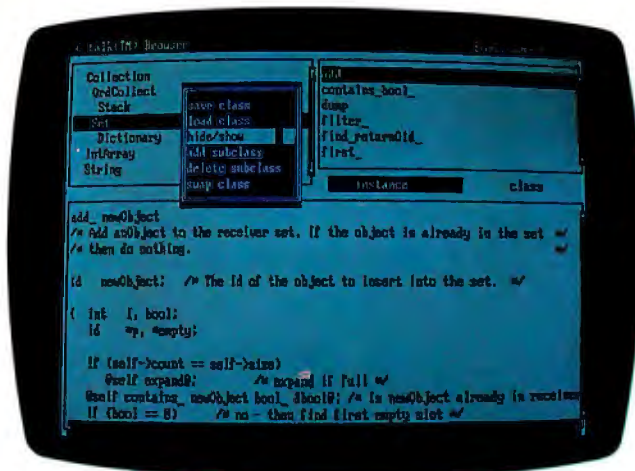

C_talk features a Smalltalk-like browser.

Debug Turbo Pascal 4.0

In an effort to meet the needs of Turbo Pascal 4.0 programmers, TurboPower Software has developed T-DebugPLUS 4.0. With it, you can control your programs at run time, watch the corresponding source code, single-step, and examine and change values using symbolic names. It also gives you the capability to switch between the debug and output screens.

If you have Expanded Memory Specification or AT extended memory, the debugger uses it for additional storage.

T-DebugPLUS 4.0 runs on the IBM PC, XT, AT, PS/2, or compatibles with at least 256K bytes of RAM. **Price:** \$45.

Contact: TurboPower Software, 3109 Scotts Valley Dr., Suite 122, Scotts Valley, CA 95066, (408) 438-8608. **Inquiry 772.**

Professional Prolog

Appplied Logic Systems' Professional Version 1.2 of its Prolog Compiler is now enhanced to assist developers in writing code and distributing applications. It also makes use of virtual code space, letting you create programs larger than available memory.

The ALS compiler is based on Edinburgh-style syntax. **Price:** \$499.

Contact: Applied Logic Systems, Inc., P.O. Box 90, University Station, Syracuse, NY 13210, (315) 471-3900. **Inquiry 773.**

Peabody Helps You Out with Turbo C

If you use Borland's Turbo C 1.5, a pop-up help utility from the Peabody family can give you a hand. Peabody for Turbo C has a database of 560K bytes of information to offer you definitions, examples, and tips on all 563 of Turbo C's functions.

You can place Peabody's help window anywhere on your screen, and a Sticky Key feature lets you post the help message on-screen, return to your program, and copy the syntax of the message. A Hyper Key helps you find definitions, facts, and examples that illustrate keywords in the help windows. And Peabody explains how Turbo C relates to ANSI C, Microsoft C, Lattice C, and other C languages.

The Peabody family is made up of help utilities for Turbo Pascal 3.0 and 4.0 and for Microsoft C 5.0. Copia has plans for an MS-DOS 3.3 utility and one for MASM.

The program runs on the IBM PC and compatibles with at least 256K bytes of RAM and DOS 2.0 or higher. **Price:** \$89.

Contact: Copia International Ltd., 1964 Richton Dr., Wheaton, IL 60187, (312) 665-9830. **Inquiry 774.**

continued

Smalltalk/V: Not So Small Anymore

Smalltalk/V has grown up: Now it's available for 80286 and 80386 systems.

The new version, Smalltalk/V 286, runs in protected mode, can address up to 16 megabytes of RAM directly, and operates under MS-DOS and OS/2. It also supports multitasking, and it is com-

patible with Smalltalk/V.

Smalltalk/V 286 lets you build systems larger than 64K bytes; they can have over 32,000 objects. It also has expanded debugging capabilities, allowing you to inspect and change all objects and correct source program errors, and allowing single-step program execu-

tion. According to Digitalk, the product contains a faster bit block transfer and supports EGA and VGA.

Two extension kits available for Smalltalk/V 286 include Goodies #2—Carleton Tools, which contains a spelling checker and floating-point emulation, and Goodies #3—Carleton Proj-

ects, which provides an application browser and a neural network, among other projects.

Price: \$199.95; \$49.95 each for extension kits. **Contact:** Digitalk, Inc., 9841 Airport Blvd., Los Angeles, CA 90045, (213) 645-1082. **Inquiry 775.**

Take a peek at Genoa's new PC graphics add-ons.



You've known Genoa as a developer of high performance graphics chips, and a leading manufacturer of graphics boards and tape backup. Soon you'll be able to depend on us for all your PC graphics add-on hardware.

Over the next year, we'll be unwrapping a series of graphics products. Each is designed to give you the most reliable, yet innovative engineering features. And above all, the highest performance possible.

Our SuperVGA HiRes family, featured here, is the first in our new product series. SuperVGA HiRes offers breathtaking color and resolution. From 16 colors in 1024x768. Up to 256 colors in 800x600. You'll see more of your spreadsheets at once with SuperVGA HiRes. 132 columns and 60 rows. You'll do Windows or OS/2. In fact, every SuperVGA HiRes feature is designed to turn your IBM PC/XT/AT and PS/2 models 25 and 30 into real graphics engines.

Delivering SuperVGA HiRes™ now!



- 100% IBM VGA compatible
- Advanced features
 - 1024x768 in 16 colors and 800x600 in 256 colors/Model 5200
 - 512x512 in 256 colors/Model 5100
- 132 columns text
- For both analog and TTL displays

If you're looking for PC graphics add-ons, take a look at Genoa first. Our new line of products is starting delivery *now!*

For the Genoa dealer nearest you or to add your name to our mailing list contact: Genoa Systems Corporation, 73 E. Trimble Road, San Jose, CA 95131. Fax: 408/434-0997. Telex: 172319. Or phone: 408/432-9090. In the UK, contact Genoa Systems Limited, phone: 01-225-3247. In the Far East, contact Genoa/Taiwan, phone: 2-776-3933.

Circle 107 on Reader Service Card



Delivering PC Graphics

408/432-9090

AutoCAD Overlay

CAD Overlay eliminates the usual step of automatic vectorization to convert a scanned image into a vector drawing usable in a CAD model, according to Image Systems Technology. In fact, it works as if you were placing a transparent sheet over an existing drawing and working in CAD on the transparent overlay, the company reports. A scanned image becomes another layer in the CAD model but doesn't interfere with the CAD drawing that you overlay.

CAD Overlay lets you zoom, pan, turn the raster image off and on, remove speckles, change color, and manipulate it like other CAD functions.

The program lets you bring a raster image into AutoCAD so you can scan large numbers of drawings. It stores rasterized plots from any CAD or image system in a universal format, so you don't have to translate between incompatible CAD systems.

CAD Overlay also works with desktop publishing systems, such as Ventura and PageMaker, enabling you to import and export information, drawings, and images in either direction.

The program runs on DOS-based CAD systems with at least 640K bytes of RAM, a hard disk drive, an AutoCAD ADI printer/plotter file-supported graphics card, AutoCAD 2.6X or 9, and DOS 3.0 or higher.

Price: \$1000.
Contact: Image Systems Technology, Inc., 251 New Karner Rd., Albany, NY 12205, (518) 452-1147.
Inquiry 776.

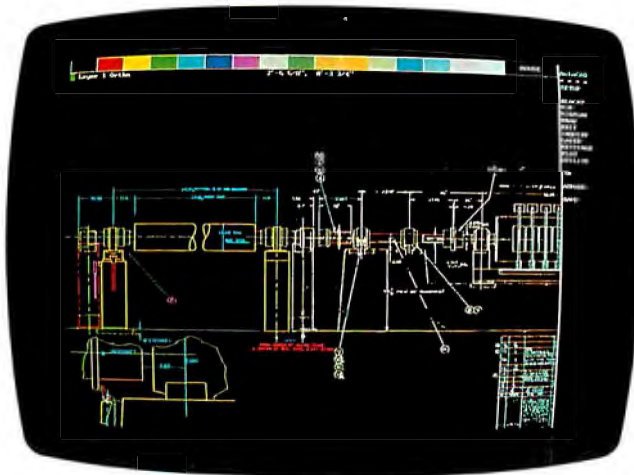

Create CAD designs with CAD Overlay.

Create Fast Fourier Transforms in Two Dimensions

Alligator Technologies has announced Two-Dimensional Prime Factor FFT, a two-dimensional-array fast Fourier transform (FFT) subroutine library. The program includes the two-dimensional forward and inverse FFT for integer, single, and double-precision floating-point complex number sets.

The company reports that the two-dimensional program, an enhancement to its Prime Factor FFT program, is the first PC-based FFT product to calculate rectangular FFTs.

You can call the two-dimensional program from any high-level language, including Turbo Pascal, Microsoft FORTRAN, QuickBASIC, Microsoft C, and more. The program supports arrays of more than 256 by 256 data points. You can perform frequency analysis on data set sizes as small as 2 by 2 data points and as large as 65,520 by 65,520 data points.

The program runs on the IBM PC, XT, AT, and compatibles with an 8087, 80287, or 80387 math coprocessor. You also need Prime Factor FFT to run the two-dimensional program.

Price: \$159 for two-dimensional program; \$159 for Prime Factor FFT.

Contact: Alligator Technologies, P.O. Box 9706, Fountain Valley, CA 92708, (714) 850-9984.
Inquiry 777.

Managing the Lab

If you need a system in the laboratory for tracking, analyzing, and reporting, LSTAR may be just the program for you.

LStar lets you define standard procedures used in studies or lab activities. It then generates a schedule and data slots for the study. You can enter data, generate schedules, and generate standard reports that you can send to a printer or output as an ASCII file.

The program runs on the IBM PC, XT, AT, and compatibles with at least 640K bytes of RAM and a hard disk drive.

Price: \$995.
Contact: American Computer Star, Inc., P.O. Box 108, Belle Mead, NJ 08502, (201) 359-0010.
Inquiry 778.

Scientific Words

With Mathor and Chimix, you can enter mathematical or chemical formulas and let the program calculate the size and position of the symbols. It then displays them on-screen as they will be printed and makes adjustments to text as needed, depending on the size of the formulas.

Mathor is the mathematical word processor. It includes the Latin alphabet with accented letters, Greek in upper- and lowercase and italics, and other special alphabets. The program automatically centers the numerator and the denominator and aligns the elements of a matrix. An editor lets you make changes and see them on-screen as they will appear in print. You can also save formulas to memory, so you can use them again in the same or other documents.

Also available is a T_EX module that you can use with Mathor to translate documents for typesetting.

Chimix is the word processor that draws your chemical formulas. By pressing function keys, you can insert chemical links and the cyclic and polycyclic compounds into your text. When you make changes, you see the formulas automatically rearranged.

Mathor and Chimix run on the IBM PC, XT, AT, PS/2, and compatibles with 512K bytes of RAM, a Hercules or EGA board, and DOS 2.11 or higher.

Price: Mathor, \$595; T_EX module, \$295; Chimix, \$695.
Contact: HiTech Consulting Group, Inc., 1801 Avenue of the Stars, Suite 602, Los Angeles, CA 90067, (213) 556-1628.
Inquiry 779.

continued

FREE DEMO TO DRAMATIZE THE POWER OF IZE.™

Send today for your copy of the IZE demo kit. It's free and full of valuable information about the product that will revolutionize the way you use information.

Please send me my IZE demo kit.

Disk Format: 3.5" 5.25"

Please have a sales person
give me a call.

Name _____

Title _____

Company _____

Address _____

City _____ State _____ Zip _____

Telephone () _____ Extension _____

Persoft, Inc. 465 Science Drive, Madison, WI USA (608) 273-6000 Telex 759491 FAX (608) 273-8227
IZE is a trademark of Persoft, Inc. Patents Pending. Persoft is a registered trademark of Persoft, Inc. © 1988 Persoft, Inc. All Rights Reserved.

BYTE788



NO POSTAGE
NECESSARY
IF MAILED
IN THE
UNITED STATES

BUSINESS REPLY MAIL

FIRST CLASS PERMIT NO. 3704 MADISON, WI.

Postage will be paid by addressee:

persoft[®]

465 SCIENCE DRIVE
MADISON, WI 53791-9147

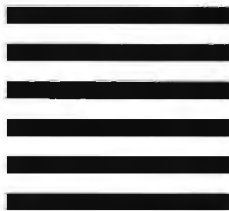

Vision is the power of imagination. Seeing beyond the obvious. Being able to grasp and comprehend the obscure.

Introducing IZE™ to realize greater vision.

The information age has presented virtually every field, from research, education, and government to law, medicine, and business, with powerful resources. Resources that, unlike traditional data-based information, are textual. Lacking structure, this ever-growing textbase is most often unexplored, untapped power.

IZE is software designed to automatically discover the underlying structure of textbase resources and provide users the power to tap, explore, manage, and organize them.

The look of IZE is familiar: a table of contents presented in outline form. Yet the power of this elegant structure is considerable. And transparent in use.

Randomly entered reports, proposals, research abstracts, presentations, and correspondence. Ideas, lists, and notes. Documents you've

Circle 50 on Reader Service Card

© 1987 Persoft, Inc. All Rights Reserved. IZE is a trademark of Persoft, Inc. Patents Pending. IBM is a registered trademark of International Business Machines Corporation.

already created and those you'll generate in the future. Imported information from on-line services. Plus any other text capable of being read by an IBM® PC or compatible system, can now be easily viewed in a different light.

IZE will create a fundamental change in the way you use your computer. And the way you use information.

To gain mastery over new resources. To grasp. To comprehend. To see. To focus. To create. To fully utilize the product of the information age.



The promise of IZE is greater vision to share your vision with the rest of the world.

persoft®

For more information about IZE, please contact your software dealer, phone us at 1-800-273-6000, or write Persoft, Inc., 465 Science Drive, Madison, Wisconsin 53711 U.S.A.

The speed of

Corvus' new Omninet®/4 is the fastest local area network on easy-to-install, easy-to-pay-for twisted pair. What else can you say about a system that has the lowest cost per user of any high performance LAN?

A great deal!

Omninet/4 combines high performance, low cost and ease of installation and use. The result — more networking value for the “more demanding” users in workgroups and businesses.

Maximizing throughput. Omninet/4 has a fast data transmission rate of 4 Mbps and a very efficient collision-avoidance protocol to guarantee transmission accuracy and enhance data throughput. In addition, it utilizes dual port memory on the network card to let your main processor function more efficiently. This combination of greater speed and increased efficiency enables Omninet/4 to outperform many networks, including Ethernet® and Token Ring®, in many system throughput tests.

Adding value — not cost. Corvus pioneered the low cost twisted pair wiring of local area networks with our Omninet/1 system. We have over nine years of experience in supporting an installed base of over 500,000 nodes on 50,000 networks.

During this time we also developed the twisted pair Omninet Cabling System (OCS) to

simplify, economize and improve the reliability of network resource connections. Utilizing these standard OCS products, Omninet/4 operates over distances up to 1,000 feet. And with our affordable Omninet Repeater you can extend your network to 4,000 feet.

Omninet/4 is compatible with Corvus' PC/NOS™ and Microsoft® OS/2 LAN Manager. It also supports Novell Advanced Netware® and can be bridged to an existing Omninet/1 network.

Making networking easy. You can install a four-user Omninet/4 Network Kit in less than an hour. No complicated wiring. No tools. No technicians. It's simply a twisted pair “plug and play” system. As your requirements grow, you can add more workstations (up to 64) by simply plugging a network card into each addition and snapping the OCS cables together.

Connect with Corvus. When you need more throughput for less cost check out Omninet/4 — “the speed of a jet net” on twisted pair. Contact your local dealer or call 1-800-4 CORVUS. Corvus Systems, Inc., 160 Great Oaks Blvd., San Jose, CA 95119-1347.

1-800-4 CORVUS

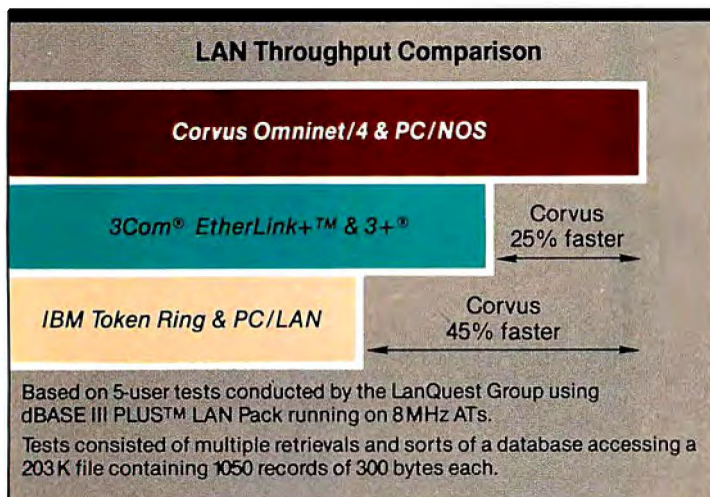

The Corvus Omninet/4 solution proved to be 45% faster than Token Ring and 25% faster than Ethernet in dBASE III PLUS tests.

a jet net.



The Omnet/4 Networking Kit includes four transporter cards, four workstation kits, three trunk cable kits, one termination kit, one software kit and one installation guide.



The Net Works™

Circle 73 on Reader Service Card

Omnet is a registered trademark and PC/NOS is a trademark of Corvus Systems, Inc.
Ethernet is a registered trademark of Xerox Corporation
Novell Advanced Netware is a registered trademark of Novell, Inc.
Microsoft is a registered trademark of Microsoft Corporation
3Com and 3+ are registered trademarks and EtherLink + is a trademark of 3Com Corporation.
IBM and Token Ring are registered trademarks of IBM, Inc.
dBASE III PI.US is a trademark of Ashton-Tate Inc.
© Copyright 1988 Corvus Systems, Inc.

Model Molecular Graphics

ProModeler I is the first professional macromolecular graphics system for the personal computer, according to New England BioGraphics. The program includes large molecule support, interactive rotations, translations and zooming, stereo viewing, high space filling and bond representations, and interactive side-chain substitutions.

In bond or backbone representations, you can rotate, translate, and scale a molecule. The system can produce shaded, colored, and space-filling representations of large molecules at high speeds. You can also use the system to interactively substitute amino acid side chains from a dictionary that's supplied with the system. And you can save modified proteins to disk in any of the file formats that are supported.

During an interactive session, you can load individual molecules from separate files and have more than one on-screen at a time. You can also define subsets of a given molecule, which you can then color, move, or hide from view. You can color all or part of the molecule according to atom name, residue name, and residue range. Predefined color schemes are included that color molecules based on atom type or side-chain hydrophobicity.

ProModeler accepts structure files from the Brookhaven Protein Data Bank, which you can download using standard file-transfer protocols such as Kermit. The system also supports the Hendrickson-Konnert file format.

How many atoms can you display? New England BioGraphics reports that in a 640K-byte system, you can display and manipulate about

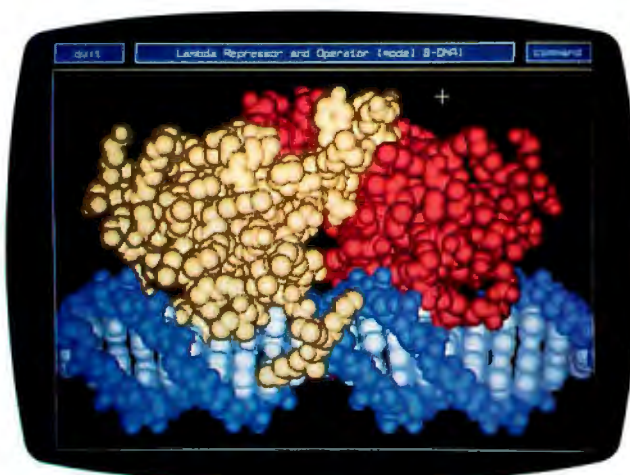

Create macromolecular graphics on an AT with ProModeler I.

5000 atoms simultaneously in any representation, including stereo views. In a 512K-byte system, you can view about 2500 atoms.

The minimum system configuration you need to run ProModeler I is an IBM PC AT or compatible with at least 512K bytes of RAM, an 80287 or 80387 math coprocessor, and a Microsoft or compatible mouse. You also need a Professional Graphics Adapter or compatible; however, the program does not support EGA or VGA boards. Vermont Microsystems offers the Image Manager 640 graphics board, which you can purchase bundled with the ProModeler software.

Price: \$750 for the software alone; \$2000 for the IM-640 board and software.

Contact: New England BioGraphics, P.O. Box 24, Peacham, VT 05862, (802) 633-4344.

Inquiry 780.

Infinite Plotting the MicroMath Way

Whether you need to create x,y plots or develop, evaluate, and plot model equations, MicroMath

has programs to suit your needs. MINSQ 2.3, a program for developing, evaluating, and plotting model equations, is enhanced with PostScript plot descriptions that you can send to a file or print on any PostScript output device.

With MINSQ 2.3, you can plot model equations without data. Or, when you supply data, parameters in the model equations may be optimized by a least-squares procedure. You can read model equations from a file or enter them from a keyboard. A built-in editor lets you modify the models interactively. Built-in operators are also available, including Deriv, Integral, and a Unit step function.

The program also offers graphics capabilities that let you zoom in on regions for annotating plots with text, lines, or arrows. You can move or resize objects.

Graph is another new program from MicroMath. It offers many of the capabilities of MINSQ, except for nonlinear model fitting. Graph lets you prepare x,y plots, plot the data on the screen, and modify it with a built-in editor. You can also send plots from Graph to PostScript printers.

Model-independent curves available include polynomials, cubic splines, rational fractions, and a Stineman interpolating curve. You can also

perform least-squares regression for straight lines, polynomials, or cubic splines.

Like MINSQ, Graph includes a graphics section with zoom capability and the ability to add or delete arrows, text, and lines, and to move or resize objects or change character sets.

MINSQ and Graph run on the IBM PC, XT, AT, or compatible with at least 512K bytes of RAM, DOS 2.0 or higher, and a CGA, EGA, or monochrome graphics board.

Price: MINSQ 2.3, \$179;

Graph, \$79.

Contact: MicroMath Scientific Software, 2034 East Fort Union Blvd., Salt Lake City, UT 84121.

Inquiry 781.

Need a Refresher on Distillation?

Distil Simu is designed to help you brush up on distillation principles.

The program is based on the McCabe Thiele model, which you can bring up on-screen and output to most dot-matrix printers. It allows you to input error checking and generate detailed reports, and it makes use of windowing, file handling, and device error checking.

Also included with the program are the VLE Curve Fit/Plot and several nonlinear regression routines for regressing sets of x,y data and plotting the resulting VLE curve on an x,y equilibrium plot.

Distil Simu runs on the IBM PC and compatibles with 512K bytes of RAM and a CGA or Hercules graphics monitor.

Price: \$79.

Contact: Engrsoft, 1946 Holland, Wichita, KS 67212, (316) 721-1598.

Inquiry 782.

continued

Complete and Easy . . .
and only \$16!



Parsons Technology

MONEY COUNTS[®]

VERSION 4.0

Complete Money Management/ Accounting System . . .

- CPA-designed for home & business
- Manages cash, checking, savings & credit cards
- Smart checkbook balancer — makes short work of the toughest bank statement
- Handles up to 999 accounts & 24000 transactions per year

Prepares & Prints a Wealth of Reports . . .

- Financial statements (4 types including net worth)
- Inquiry reports (3 types)
- General ledger & accountant's trial balance

Now Including . . .

- Automatic transactions
- Financial calculator — computes interest rates, loan payments, prints amortization schedules
- Journal entries
- And more

Plus These Important Additional Features . . .

- Budgeting
- Fast financial data base with 3-way look-up
- Pop-up calculator
- Graphics
- Works great with monochrome & color monitors
- Not copy-protected

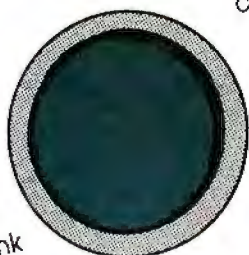

VISA, MasterCard & COD orders call:

1-800-223-6925

(In Canada 319/395-7300)

Here it is. You won't find software that's easier to use:

- Requires no accounting knowledge
- Completely menu-driven with on-line help
- 93-page fully indexed tutorial manual (on disk)

A Proven Track Record. Hard to believe the \$16 price? Don't worry. ManeyCounts[®] has been marketed for three years and is continually receiving rave reviews. There's **no** catch. This is a fully functional system that compares with products selling for \$99 and more.

Same-Day Shipping. Order today and own MoneyCounts[®] for only \$16! Add \$3 shipping and handling (outside North America add \$7). Iowa residents please add 4% sales tax. Send check or money order payable to Parsons Technology. VISA and MasterCard orders welcome.



Parsons Technology

Dept. B
373 Collins Road NE
Cedar Rapids, IA 52402

MONEY COUNTS[®]

\$16 + \$3 Shipping

MoneyCounts[™] requires IBM or compatible computer with two disk drives (or a hard disk drive), 192k or more memory, DOS 2.0 or later and printer.

Name: _____

Address: _____

City/State/Zip: _____

Phone: _____

Check Money Order VISA MasterCard

Card # _____ Exp. Date _____

SuperProject Adds Features for OS/2

The project management tool SuperProject Expert now runs under OS/2. The program retains the features found in the MS-DOS version but has added multitasking, virtual memory management, memory protection, and a feature that lets you toggle between applications without exiting one program and reloading.

SuperProject Expert as-

sists you in planning, tracking, and coordinating projects. It also enables you to create a variety of work schedules. It offers multi-project, import/export, and network capabilities. You can also request reports, including detailed costing information. Other features include graphics and word-processing capabilities.

The OS/2 version lets you

access up to 16 megabytes of virtual memory and runs in protected mode. SuperProject Expert/2 runs on IBM PS/2s and compatibles with at least 320K bytes of RAM and OS/2.

Price: \$795.

Contact: Computer Associates International, Inc., 1240 McKay Dr., San Jose, CA 95131, (408) 432-1727. **Inquiry 787.**

bonds, mutual funds, index options, and commodities. The number of securities that you can monitor is now expanded from 75 to 500 per subdirectory. You can maintain up to 750 days, weeks, or months of data (increased from 250) for each security.

The program runs on the IBM PC and compatibles and supports CGA, EGA, VGA, and Hercules graphics.

Price: \$295.

Contact: Smith Micro Software, Inc., P.O. Box 7137, Huntington Beach, CA 92615, (714) 964-0412.

Inquiry 785.

Maximize Your Sales

Keept track of clients, prospects, and personal data with The Maximizer. This sales support program from Pinetree Software is broken into seven segments: clients, letters, payment analysis, hot-list, telephone, personal records, and utilities.

In managing clients, you can add as many client names to the database as you'd like, with as much information associated with them as you need. You can also search the database using criteria that you've defined, such as occupation, status, source, and interests. You can also keep track of follow-up dates.

The program's letter-writing facility lets you write and store an unlimited number of letters. It comes with a set of standard letters, and you can edit them or create your own using the program's editor.

A set of calculation programs lets you figure out payment schedules, purchase prices, outstanding balances, financing, and more.

The hot-list feature lists all your appointments and the clients you have to contact. A day-at-a-glance feature is available in the calendar utility, and a telephone directory lets

you access your clients' phone numbers individually or in groups.

The Maximizer is written in C and uses Btrieve file access. It runs on the IBM PC, XT, AT, PS/2s, and compatibles with DOS 3.0 or higher and at least 512K bytes of RAM. The program comes on 5¼-inch and 3½-inch disks and is also available in a local-area network version.

Price: \$495.

Contact: Pinetree Software Canada Ltd., 8100 Granville Ave., 9th Floor, Richmond, British Columbia, Canada V6Y 1P3, (604) 270-3311. **Inquiry 783.**

Bill-It on the Mac

If you run a small business, you can do your accounting on a Macintosh with Bill-It. ShopKeeper Software's accounting program integrates accounts receivable, billing, inventory, invoicing, list of services, sales, and point-of-sale modules.

Bill-It is optimized for about 4000 customers and inventory items, although ShopKeeper reports that the program can handle more

than 8000 of each. You can use the inventory section for anything that you can count in units, such as labor charges, lab procedures, golf lessons, and so on. The program is flexible in printing statements, reports, and summaries.

Information is stored as plain ASCII text, so you can transfer data from Bill-It to other programs or export it as SYLK files.

Bill-It runs on a Mac Plus, SE, or II with at least two 800K-byte floppy disk drives or a hard disk drive.

Price: \$159.

Contact: ShopKeeper Software, Inc., P.O. Box 38160, Tallahassee, FL 32315, (904) 222-8808.

Inquiry 784.

More for the Investor

Investors wanting to perform technical analysis of the securities market will find that Wall Street Techniques is now enhanced with access to The Source and increased capacity. It includes a free account to both the Dow Jones News Retrieval Service and The Source. The new interface to The Source lets you automatically access historical data on stocks, options,

Enhancements to Macintosh Business Software

Layered has enhanced a bundle of its business programs. In the Insight Expert Accounting Series, a Time Billing module has been added, as well as multiuser versions of Inventory, Accounts Receivable and Payable, Insight Forms Design, and Insight Export. The Notes product has been expanded to six products. Front Desk has been upgraded and is also available in a multiuser version.

Price: Insight Expert Time Billing module, \$595; Inventory multiuser version, \$895; Accounts Receivable multiuser version, \$895; Accounts Payable multiuser version, \$895; Insight Forms Design, \$149; Insight Export, \$149; Notes for Ready, Set, Go!, \$79; Front Desk multiuser version, \$99 per user.

Contact: Layered, Inc., The Schrafft Center, 529 Main St., Boston, MA 02129, (617) 242-7700.

Inquiry 786.

continued

QNX
OPERATING SYSTEM

REAL TIME

Speed without compromise.

QNX DELIVERS QNX delivers the speed of a dedicated real-time executive as well as multi-tasking, integrated networking and a multi-user development environment as rich and powerful as UNIX.

SPEED The tightly coded QNX kernel performs 3200 task switches/second on an AT, with full pre-emptive prioritized scheduling.

TASK COMMUNICATION QNX is based on a message-passing architecture, radically more innovative than PC-DOS, UNIX, or OS/2. User tasks and system tasks use the same messaging interface. This results in a single unified environment.

INTEGRATED NETWORKING On the QNX network, any task can send messages to any other task anywhere on the network. This direct communication is not available on other networks. The resultant "feel" of the QNX network is that of a homogeneous, tightly connected array of computers, rather than a collection of computing islands strung together on a network with comparatively limited functionality.

DEVELOPMENT ENVIRONMENT QNX comes with a rich set of utilities including a powerful full-screen editor, C compiler, symbolic debugger and multiple full-screen windows.

RUNTIME ENVIRONMENT QNX architecture is modular not monolithic. The

system consists of a set of tasks that provide services. Software developers can easily write tasks that add services to suit their specific application needs. It is straightforward to write tasks that interface to hardware through interrupts, I/O ports, DMA and dual-ported memory.

TECHNICAL SUPPORT Technical support is provided free of charge, and updates can be downloaded 24 hours/day from our online BBS.

QNX is now installed at over 55,000 sites in North America and Europe for manufacturing, process control, process monitoring, point-of-sale and many other applications.

Eliminate compromises in your real-time applications. Call for details today.

THE ONLY MULTI-USER, MULTI-TASKING, NETWORKING, REAL-TIME OPERATING SYSTEM FOR THE IBM PC, AT, PS/2, THE HP VECTRA, AND COMPATIBLES.

Multi-User	10 (32) serial terminals per PC (AT).
Multi-Tasking	64 (150) tasks per PC (AT).
Networking	2.5 Megabit token passing. 255 PC's and/or AT's per network. 10,000 tasks per network. Thousands of users per network.
Real Time	3,200 task switches/sec (AT).
Message Passing	Fast intertask communication between tasks on any machine.

C Compiler	Standard Kernighan and Ritchie.
Flexibility	Single PC, networked PC's, single PC with terminals, networked PC's with terminals. No central servers. Full sharing of disks, devices and CPU's.
PC-DOS	PC-DOS runs as a QNX task.
Cost	From US \$450. Runtime pricing available.

For further information or a free demonstration diskette, please telephone (613) 591-0931.

Quantum Software Systems Ltd. • Kanata South Business Park • 175 Terrence Matthews Crescent • Kanata, Ontario, Canada • K2M 1W8

UNIX is a registered trademark of AT & T Bell Labs. IBM, PC, AT, XT and PS/2, PC-DOS and OS/2 are trademarks of International Business Machines. HP and Vectra are registered trademarks of Hewlett-Packard Company.

Circle 226 on Reader Service Card

A Word Processor That Learns

MindReader is a word processor with artificial intelligence capabilities that teach it how you write, according to Brown Bag Software. It features an expandable dictionary, spelling checker, and calculator, and is distributed as shareware.

To teach MindReader how you write, you switch on the AI Learn feature and leave it on while you write. MindReader will analyze your writing patterns.

WordComplete is a utility that lets you type just the first few letters of a word. It then pops up a window with a list of words, from which you select the one you want with one key-stroke. The FrequentWord option lets you designate the words you want to appear in the pop-up window. Using rule-based artificial intelligence, MindReader reprioritizes the words in the dictionary pop-up menus according to your use.

You can call the calculator up on-screen with just a few keystrokes and use it while you're working on a document. Its functions include addition, subtraction, multiplication, and division, and it's accurate to 12 digits with two decimal places. A paper-tape-type feature keeps a running list of every number you enter.

MindReader 2.0 runs on the IBM PC, XT, AT, and compatibles with at least 256K bytes of RAM and DOS 2.0 or higher. To run it on a LAN, you need a network license. The program supports CGA, EGA, and VGA boards. **Price:** \$49.95 for registration fee.

Contact: Brown Bag Software, 2155 South Bascom Ave., Suite 114, Campbell, CA 95008, (408) 559-4545. **Inquiry 788.**



Version 2.0 of Brown Bag's MindReader.

Moving Data Across Formats

Do you ever need to convert dBASE files into Lotus 1-2-3 spreadsheets? DataPlex 2.0 may be your key to moving data among such formats as 1-2-3, DIF, ASCII, and dBASE. The program's strengths lie in the areas of data entry and conversion. Using AI techniques such as dynamic data dictionaries and pattern recognition, DataPlex learns validation rules from the data and creates field formats, according to Tools & Technology.

Connection to other for-

mats is by way of read/write two-way data paths, and you can sort, select, edit, and reformat data records while the data is in transit. You don't need a copy of your destination package.

DataPlex is written in Microsoft C. Version 2.0 requires an IBM PC, XT, AT, or compatible with DOS 2.0 or higher and 384K bytes of RAM. The program also runs on LANs. The company reports that an OS/2 version is currently in the works.

Price: \$149.

Contact: Tools & Techniques, Inc., 1620 West 12th St., Austin, TX 78703, (512) 482-0824.

Inquiry 789.

The Soft Drum Machine

Adrum is an Amiga software program that acts like a drum machine. The company calls it a rhythm maker with four voices. It is capable of stereo output using sound samples loaded from disk in Interchange File Format.

You can have up to 26 sounds in memory to create a kit from which you produce rhythms. You can alter any of a sound's parameters, such as pitch, volume, length, and number of repeats, and you can assign any sound to any of the 26 instruments.

Once you set up a kit of sounds, you can program Adrum's sequencer. You can define up to 64 measures of variable beats, from 0 to 64 beats per measure.

Pull-down menus let you select removal, replacement, measure copy, and delete/insert editing commands.

Adrum is MIDI-compatible and runs on the Amiga.

Price: \$79.95.

Contact: Haitex Resources, 208 Carrollton Park, Suite 1207, Carrollton, TX 75006, (214) 241-8030.

Inquiry 790.

Create, manipulate, and analyze color maps of areas ranging from 52 feet to 5000 miles wide with MapInfo. Working from information in one or more databases, the program helps you generate maps with boundaries, legends, and text. You can label points with street names, demographic information, notes, or symbols.

The program's Thematic Mapping feature lets you assign different shades to specific map areas. You can pan

and zoom, locate addresses anywhere on the map, and compute the distance between two or more points.

MapInfo comes with its own database management program; you can also use it with dBASE III Plus. Many maps covering U.S. metropolitan areas are available.

The program runs on the IBM PC, XT, AT, and compatibles with DOS 2.0 or higher, 512K bytes of RAM, a graphics board, and a hard disk drive with 3 megabytes

ports various mice, as well as the Summagraphics SummaSketch and Calcomp-9100 and 2500 series digitizers. It also supports dBASE III Plus files

area n
\$2000.

rick Hudson Building, 20C
Broadway, Troy, NY 12180,
(800) 327-8677, in New
York, (518) 2
Inquiry 791.

the Pledge

WOWYW!

6/10, 10/16 MHz
or four speed version
6/8/10/12 MHz



16bits 286 **AT** Compatible

- INTEL 80286 Microprocessor
- 1024Kb dDRAM MotherBoard
- MEMORY allocation 640/384Kb
- RANGE upgradeable to 16Mb
- VLSI six Chips set used
- FULL ONE Year WARRANTY
- CPU virtual Memory Management
- 80287 Math Co-processor socket
- 7 DMA channels & 15 interrupt levels
- 8 I/O expansion slots 2/8 bits, 6/16 bits
- MANY possible options
- FULL Software COMPATIBILITY

\$ 875

512Kb RAM, 6/10MHz speed, 1.2Mb Floppy Drive
Floppy/Hard Disk Controller, 200W Power Supply
101 keys Enhanced AT style Keyboard with 'CLICK'
AT case, Lock, Reset+Turbo button, speed LED

CALL for XT, AT, 386 Desktop, Portable and Laptop Computers.

LAN, File Servers, Workstations, Hard Drives, Tape Backups, Modems, Memory Updates & Software
FAMOUS Brand Computers, Accessories, and Peripherals



COMPAQ



Apple



HEWLETT
PACKARD

AST



EVEREX

Consultants • Dealers • Corporations • Colleges • Universities • Schools • Government

Export and OEM Inquiries WELCOME!

a computer company...Where Quality Counts

WHOLESALE outlet direct from factory

LOCATED in the Silicon Valley

SURAH INC.

45461 Fremont Blvd., Suite #9, Fremont, CA 94538
Telex 5106017247 (ab) SURAH UO

PHONE: TOLL FREE (800) 543-1001
NOW IN CALIFORNIA (415) 651-5101
FAX: (415) 651-5241

OPEN MON. - FRI. 9 AM - 6 PM
SATURDAY 11 AM - 4 PM



• PRICES VALID TILL SUPPLIES LAST SHIPPING & HANDLING NOT INCLUDED NOT responsible for typographical errors

• IBM AT XT AST Premium, Apple, Compaq, Everex, Intel, Hewlett Packard are registered trademarks of respective companies

Circle 519 on Reader Service Card

JULY 1988 • BYTE 88PC-1

WHAT'S NEW

PACIFIC COAST

Toshiba's Colorful Dot-Matrix

You can print color graphics at a resolution of 360 dots per inch with Toshiba's P321SLC 24-pin dot-matrix printer. Orange, green, purple, yellow, cyan, magenta, brown, and black are provided on a custom color ribbon that comes with the printer.

The P321SLC prints 216 characters per second in draft mode and 72 cps in letter-quality mode. It comes with 32K bytes of RAM that you can use as a print buffer or for downloadable fonts. Also included are Toshiba/Qume, IBM ProPrinter, IBM Graphics Printer, and IBM Color Printer emulations.



Toshiba's 24-pin dot-matrix printer comes with color ribbon.

Resident fonts include high-speed draft, Courier, Prestige Elite, condensed, and proportional. You can select font, pitch, emulation, and printer configurations from a 16-digit LCD front-panel display. The printer in-

cludes a built-in tractor feed and a fanfold bypass that lets you print on cut-sheet paper without unloading the fanfold paper.

Options for the P321SLC include a 32K-byte memory card and font cards.

Price: \$949.

Contact: Toshiba America, Inc., Information Systems Division, 9740 Irvine Blvd., Irvine, CA 92718, (800) 457-7777 or (714) 583-3000.
Inquiry 824.

Open Windows

Microsoft has added over 50 new functions and messages in version 2.0 of its Windows Software Development Kit. The new version includes a Snap utility that lets you specify and print portions of the screen. A new Spy utility lets you examine messages sent by Windows to your application. Also added is a floating-point math library

continued

Dare To Compare

8088 4.77/8 MHz Complete System \$499

* XT Compatible

- Turbo XT motherboard (4.77/8MHz) • XT case & 150w power supply
- Floppy disk drive • Monographics w/printer port • Floppy controller
- AT look alike keyboard
- Hi-Res Monitor

80286-6/10 MHz Complete System \$950

* AT Compatible

- 6/10 AT motherboard
- 0 wait state • 200w power supply
- Floppy & hard controller • AT keyboard • Monographics w/printer card • 1.2 Drive
- Hi-Res Monitor

ADD-ON CARDS

384 multifunction card	\$78
Multi I/O card	52
Monochrome graphics W/P	48
Color graphic card	45
Memory expansion card	42
Parallel printer card	20
RS-232 serial card	24
Game I/O card	15
Floppy controller w/cable	20
XT hard disk controller	60
Everex 1200 baud modem	85
Everex 2400 baud modem	170
Logimouse C-7	75

Toshiba Laptops: T-1000	\$739
T-1100	1539
T-1200	2395
T-3100	3125
NEC Multisync	570
Samsung Mono-Amber—12"	72
Samsung RGB—14"	250
Samsung EGA—14"	350*

PRINTERS

Epson EX 1000	\$525
Epson FX 86E/286E	329/469
Epson LX 800/LQ 800	199/389
Citizen MSP 10/40/50	275/309/385
Citizen 120D/180D	159/175
Star NX 1000	199
Okidata 192 +/193+	349/469
Brother 1509/1709	395/565
Fortis 2010	299
Toshiba 321	529
Panasonic 10R0	199
NEC 2200	350

Free cable w/printer purchase.

MISCELLANEOUS

Seagate ST 225/238/251	\$210/230/360
XT keyboard	50
AT/XT enhanced keyboard	65
150W XT power supply	50
200W AT power supply	70
Printer cable	8
360K floppy disk drive (TEAC)	80
(FUJITSU)	70

UNIVERSAL COMPUTER PRODUCTS

951 El Camino Real, South San Francisco, CA 94080
M-F 9 am to 7 pm; Sat 10 am to 5 pm

*XT and AT are registered trademarks of IBM Corp.

CALL FOR PRODUCTS NOT LISTED

Dealers Welcome
Call for Quantity Discount
(415) 583-9736
FAX (415) 583-3457

Great Software for your PC - \$2 per disk (Reg. \$6)

We are making this special offer to introduce you to membership in PC-SIG: The World's Largest Source of Low Cost Software for the IBM-PC and compatibles. PC-SIG disks are normally \$6 each (less with membership) and come packed full of Shareware—software marketed in the revolutionary new way that allows you to try out a program before registering it with the author. PC-SIG provides your gateway to this software with the bimonthly SHAREWARE Magazine, Hot sheets and a 424+ page software directory. All this for a yearly membership fee of \$20 (USA).

Some of the advantages of buying from PC-SIG: We are the oldest and largest Shareware vendor. Our disks are the latest versions. Free technical support by phone. Most complete library of Shareware: over 1000 disks. 48 hour shipping.



Join PC-SIG and receive 424 page directory, bi-monthly Shareware Magazine, Hot sheets and special discounts.

**Take any disk listed in this ad —
\$2 each - when you join today!
Offer expires July 31, 1988.**

- 499 PROCOMM: Extremely versatile telecommunications.
- 310,1022,1023 Q-MODEM: A favorite. Let's your computer talk via phone.
- 212,334,621 RBBS-PC: Set up your own bulletin board.

- 577, 578 CTUTOR: Learn C language.
- 965 PASCAL COMPILER: Full-screen editor, incremental compiler and more.
- 254 PC-DOS HELP: Gives you on-line help to remember those DOS commands.
- 105 PC-PROFESSOR: Learn beginning BASIC.
- 775-778 PSEUDOSAM: Macro assemblers & debuggers for many popular microprocessors, including 8088/86/286s.
- 481 STILL RIVER SHELL: Menued DOS commands. Makes life easier.
- 403 TUTOR.COM: Learn beginning DOS.

- 287,288 FILE EXPRESS: Customize, menu driven data base.
- 5, 730, 1015 PC-FILE+: The most powerful and popular data base.
- 830 WAMPUM: dBase III clone, but easier to use. (Hard disk req)

- 844 ABC FUN KEYS: For ages 2-5. Teaches the alphabet.
- 612 FOREIGN LANGUAGES: Beginning Spanish, French, German & Italian.
- 229 FUNNELS & BUCKETS: Fun game teaches younger children arithmetic.
- 320 PC-TOUCH: Typing tutor. (Color Req)
- 477 WORDGAMES: Stimulates the intellect.

- 164, 773 CASHIAC: Manage checking accounts, track investments.
- 151 FINANCE MANAGER II: Double entry bookkeeping.
- 469,470 MR. BILL: Itemize invoices, age accounts, etc.
- 331 PC-GENERAL LEDGER: Written by a top financial manager.
- 575 PC-STOCK: Track & evaluate stock trends. (Color req)

- 452 AMULET OF YENDOR: Hack, a dungeons & dragons adventure game.
- 708 BACKGAMMON: You against the computer. Also, Wheel of Fortune.
- 780 BRIDGE PAL: Computer plays 3 hands.
- 228 CRIBBAGE: And a few other games as well.

- 457 GREATEST ARCADE GAMES: Flightmare, Jump Joe, Spacewar (Color req.)
- 476 PATRICK'S BEST GAMES: Bugs Centipede, 3-D Packman, Castle, Packgal, Spacevad
- 557 PINBALL RALLY: 3 great games of dexterity and speed. (Color req.)
- 120 PC-CHESS: Your move...
- 791 POKER: Play draw poker head to head. Or try some Blackjack.
- 694 SLEUTH: A murder has been committed...
- 197 TWO TREKS: Beam me up, Scottie!
- 891 WHEEL OF MISFORTUNE: Spin the wheel, win or go bankrupt!

(Most require CGA or EGA Card)

- 701-704 DANCAD 3D (4 disks): Create and animate 3d drawings. (Hard disk req)
- 828 EDRAW: Draw flowcharts, schematics, even printed circuits!
- 763 FINGER PAINT: A 3d wire frame modeling program. (Runs also with Hercules Card.)
- 870 HGCIBM: Run color graphics programs with your Hercules Card!
- 788 IMAGE 3-D (EGA ver.): Create, view, edit 3d objects.
- 762 IMAGE 3-D (CGA ver.)
- 1001 MAC PASTE: Read, save, edit and print Readmac or Mac Paint pictures.
- 344,345,1032 PC-KEYDRAW: Graphics and "slideshow" presentations.
- 244 SLIDE GENERATION: Create slides/transparencies.

- 966 ASTROLOGY 94: Calculate and print charts.
- 361, 632 FAMILY HISTORY: Trace your family tree.
- 929 LOTTO: Will this really help you win the lottery?
- 395 HOME INVENTORY: Keep track of everything you own.

- 127 PC-MUSICIAN: Compose and play your song.
- 279 PIANOMAN: Plays your music or its own in chords.

- 608 AUTOMENU: Create easy access menus for your hard drive.
- 824 DESK COMMANDO: Tools to tame your hard drive.
- 404 EZ-FORMS: Create your own business forms.
- 388 FORM LETTERS: Variety of business letter formats.
- 483 MAILMONSTER: Add, edit, sort and print labels by categories.
- 405 PC-DESK TEAM: In memory calculator, calendar, phone dialer, alarm & more!

- 517 IMAGE PRINT: Letter quality from your dot matrix.
- 718 LQ PRINTER: Print fancy fonts on your dot matrix.
- 523 SIDEWRITER: Print banners or wide spreadsheets.

- 974 BIBLE QUIZ PLUS: Learn the Bible trivia game.
- 766-772 THE BIBLE (7 disks): King James version.
- 581, 582 WORD WORKER: Performs text searches of words in the Bible.

- 598 MASTER KEY: Like Norton Utilities. Recover lost files, etc.
- 414 UNPROTECT/PROTECT: Copy a variety of copy protected disks.

- 524,525 EXPRESS CALC: Powerful but friendly spreadsheet.
- 199,1016,1017 PC-CALC: Like Lotus 1-2-3 but easier.

- 719 LETTER WRITER: Print out "personalized" letters.
- 528 NEW YORK WORD: Allows split screen, mail merge & more.
- 480 PC-OUTLINE: Like ThinkTank. Organize your ideas & thoughts.
- 455,681,682 PC-TYPE: Jim Button's own word processor. Has it all.
- 78, 627 PC-WRITE: Powerful, multi featured, spelling checker, laser support.

Please send the disks I checked above.

_____ disks x \$2 each = _____

1 year PC-SIG Membership = **\$20.00**

3 1/2" - add \$1 per disk = _____

FREE Shipping and Handling

Amount enclosed \$ _____

By: Check Visa M/C

Card No: _____

Exp. _____ Sig. _____

Name _____

Address _____

City: _____ State _____ Zip _____

PC-SIG 734
PC-SIG
 1030D East Duane Ave
 Sunnyvale, CA 94086
 Offer valid in USA only - Dealer Inquiries Invited

Order By Phone:
800/245-6717
 (In Calif. 800/222-2996)

that checks for the presence of and utilizes floating-point math coprocessors.

The kit includes a dialog editor, which enables you to design dialog boxes and save definitions. An icon editor allows you to create icons, cursors, and bit maps. With the font editor, you can create custom fonts.

Windows Software Development Kit 2.0 runs on the IBM PC and compatibles with DOS 2.0 or higher, 640K bytes of RAM, a graphics card, and a hard disk drive. It comes on both 3 1/2- and 5 1/4-inch floppy disks.

Price: \$500.

Contact: Microsoft Corp., 16011 Northeast 36th Way, P.O. Box 97017, Redmond, WA 98073, (206) 882-8080. **Inquiry 822.**

Power Publishing with Panache

More than 35 new features are added in version 3.0 of PageMaker for the Macintosh. The desktop publishing program now automatically flows text across successive pages. You can update source files by exporting PageMaker documents to your word-processing programs.

The program includes style sheets: You can create them in PageMaker, import them from Microsoft Word, or tag text in another program to be automatically converted to a PageMaker style sheet. The program's graphics capabilities now enable you to automati-

cally wrap text around rectangular graphics. You can manually wrap text around irregularly shaped objects.

The program runs on the Macintosh Plus, SE, or II with a hard disk drive.

Price: \$595.

Contact: Aldus Corp., 411 First Ave. S, Suite 200, Seattle, WA 98104, (206) 628-6674.

Inquiry 821.

The Fastest 80386 Around?

If you're looking for the fastest of the fastest, you might want to check out Everex Systems' Step 386/20. According to the company, this 80386-based microcom-

puter operates at 4.91 MIPS (million instructions per second). The microprocessor runs at 20 MHz.

The Step 386/20 comes with 1 megabyte of zero-wait-state RAM, expandable to 16 megabytes. Also included are six 16-bit and two 8-bit expansion slots, openings for five half-height drives, an LED control panel, and a 1-to-1 interleave hard and floppy disk drive controller. Support for the 80387 and Weitek 1167 math coprocessors is provided.

Everex also offers a 16-MHz version of the computer. **Price:** \$4399; 16-MHz version, \$3699.

Contact: Everex Systems, Inc., 48431 Milmont Dr., Fremont, CA 94538, (800) 356-4283.

Inquiry 823.



MERLIN FONTS are available in these typefaces:

American Centum New York
Block MERLIN HeVL
Chancellor Roman Garmon

Point sizes range from 8 to 34 point and 50 point headline. All font packages include the typeface in regular, bold, italic and two distinctive weights, Shadow and Reverse Shadow.

MERLIN MASTER Paks

Over 50 fonts in a variety of sizes and weights, both landscape and portrait and includes FREE DOWNLOAD and DISPFONT font utility programs. All for

only \$149.95

Smaller Paks available, starting at \$79.95

It's time to build your own LaserJet Fonts?

Building your own fonts can be difficult and very time consuming. For Example: Building your own 24 point font could take as much as 59 minutes of your and your computer's valuable time, and that's just one font! To get the same typeface in a different weight (regular, bold, italic, etc.) will take you almost another hour, again, and again, and again. Most business people simply can't afford that much time. Can you?

MERLIN MASTER FONTS

are affordable pre-engineered, easy to use, downloadable fonts for your HP-LaserJet or compatible printer. Our soft fonts are tried and tested, there's no guess work. You know what you're going to get. Best of all, they are ready to use as soon as you open their exclusive "pop-up" storage box.

For more information or to order call toll free:

1 - 800 - MERLIN - 0
(1-800-637-5460)

Use your Visa, MasterCard, AmEx or COD

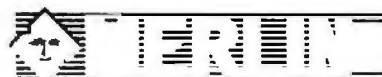

PUBLISHING GROUP™

1240 Johnson Ferry Place • Suite A10 • Marietta, GA 30068

Because you really can't afford to build your own fonts!

This ad was produced using Merlin Master Fonts

Dealer inquiries always welcome.

Authorized Dysan Dealer. Distributing exclusively on Dysan certified diskettes. LaserJet is a registered trademark of Hewlett Packard

SERIOUS DEBUGGING AT A REASONABLE PRICE



All the speed and power of a hardware-assisted
debugger at a software price

Hardware-level break points

REAL-TIME break points on memory locations, memory ranges, execution, I/O ports, hardware and software interrupts. More powerful break points than ANY software-only debugger on the market. Soft-ICE gives you the power of an in-circuit emulator on your desk.

Break out of hung programs

With a keystroke - no external switch necessary. Even with interrupts disabled.

Breaks the 640K barrier

Soft-ICE uses ZERO bytes of memory in the first 1MB of address space. This is especially useful for those subtle bugs that change when the starting address of your code changes. With Soft-ICE your code executes at the same address whether the debugger is loaded or not.

Works with your favorite debugger

Soft-ICE can be used as a stand-alone debugger or it can add its powerful break points to the software debugger you already use. You can continue to use your favorite debugger until you require Soft-ICE. Simply pop up the Soft-ICE window to set powerful real-time break points. When a break point is reached, your debugger will be activated.

Solve tough systems problems too

Soft-ICE is ideal for debugging TSRs, interrupt handlers, self booting programs, DOS loadable device drivers, non-DOS operating systems, and debugging within DOS & BIOS. Soft-ICE is also great for firmware development because Soft-ICE's break points work in ROM.

How Soft-ICE Works

Soft-ICE uses the power of the 80386 to surround your program in a virtual machine. This gives you complete control of the DOS environment, while Soft-ICE runs safely in protected mode. Soft-ICE uses 80386 protected mode features, such as paging, I/O privilege level, and break point registers, to provide real-time hardware-level break points.

"Soft-ICE is a product any MS-DOS developer serious enough to own a 386 machine should have."

Dr. Dobb's Journal -- May 1988

NEW! NEW! NEW! NEW!

RUN CODEVIEW IN ONLY 8K



CodeView is a great integrated debugger, but it uses over 200K of conventional memory. MagicCV uses advanced features of the 80386 microprocessor to load CodeView and symbols in extended memory. This allows MagicCV to run CodeView using less than 8K of conventional memory on your 80386 PC.

Don't let 640K be your limit!

If you are closing in on the 640K limit and would like the power of CodeView, MagicCV is for you.

Don't let the debugger hide the bug!

Even if you're not closing in on the 640K limit, running CodeView with MagicCV makes your debugging environment much closer to the end user's program environment. You can use CodeView to locate subtle bugs that only occur when there is plenty of free memory, or those difficult bugs that only occur when your program is running with a couple of TSRs loaded.

How MagicCV works

MagicCV uses the 80386 to create a separate virtual machine for CodeView. MagicCV uses between 4K & 8K of conventional memory as a bridge between the DOS environment and CodeView.

MagicCV is easy to use

If you are a CodeView user, you already know how to use MagicCV too. Just type MCV instead of CV; everything else is automatic.

Save \$86

MagicCV	\$199
Soft-ICE	\$386
Buy Both and Save \$86	

CALL TODAY
(603) 888 - 2386

30 day money-back guarantee
Visa and Master Card accepted

NU-MEGA TECHNOLOGIES

PO Box 7607
Nashua, NH 03060-7607

Both require 80386 AT compatible or IBM PS/2 Model 80.
MagicCV requires at least 384K of extended memory.
CodeView is a trademark of Microsoft Corporation.

MagicCV with Soft-ICE

Using Soft-ICE with CodeView gives you the features necessary for professional level systems debugging. MagicCV and Soft-ICE can work in concert with CodeView to provide the most powerful debugging platform you will find anywhere. As an extra bonus, by ordering both MagicCV and Soft-ICE together you save \$86.

Breaking the Baud Barrier

Here's how your 2400 baud modem
can send data as fast as a 9600 baud modem
for less than \$90.00

Leigh Tracy

When you got your first modem—that neat little 300 or 1200 baud job—you really thought you had it made, all the power, speed and convenience you'd ever need to move data from PC to PC. *Right?*

Now, of course, if you've got lots of data to move, you've recently bought or are considering switching over to 2400 baud speed. And, in reality, if your company is a power user it would make a lot of sense in saved time and telephone bills to be running at 9600 baud, if it were not for the initial overwhelmingly high modem hardware costs.

Enter *TurboCom* high performance PC to PC modem software by Datran, the clever Southern California based state-of-the-art data compression specialists that brought you the great *dCompressor* short card that triples the dBASE storage capacity of any hard disk.

Modems Run 4 Times Faster

TurboCom turbocharges your Hayes compatible modem to send data files (letters, documents, reports, data bases, spreadsheets, binary files, programs) up to four times faster with your existing 300, 1200 or 2400 baud modems. And it sells for only \$89.00 to connect two PCs.

When the good people at Datran sent me *TurboCom 3.0* for a test run, I was amazed at how simple and well thought out it was for the ordinary person (like me) to use.

TurboCom Facts:

Version 3.0
Each package has software for use with two PCs.
\$89.00

Datran Corp.
Order direct:
1-800-332-0456

Requirements:

IBM PC/XT/AT, 386 or compatible. Minimum 384K RAM, PC-DOS, MS-DOS 2.0 or greater. Internal or external Hayes compatible modem. *TurboCom* at both sending and receiving PCs.

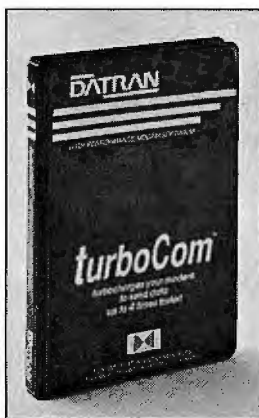

Transfer data files PC to PC up to four times faster.

Easy to Send and Receive

TurboCom is the easiest to learn and use modern software that I've ever tried. No menus are required. It's as simple to use as the COPY command! To send data with *TurboCom*, all you do is type:

C>SEND FILENAME PHONE NUMBER

To program for delayed transmission you type:

C>SEND FILENAME PHONE NUMBER AT TIME

That's all you do. Then, the continuing status of the transmission automatically appears on the screen until file transmission is completed.

Receiving transmitted *TurboCom* messages is automatic and unattended. Simply type **C>RCV** and *TurboCom* does the rest.

Any businessman, insurance broker, accountant, office manager, secretary or salesman on the road that can use a PC can simply operate *TurboCom*. It's that simple.

Unattended Electronic Mailbox

TurboCom is ideal as a fast, low cost mailing system between offices or companies. The sending PC is aware

of how much disk space is available at the receiving end. If a file is transmitted with the same name and extension, *TurboCom* will assign it a unique extension, i.e., !-1, !-2, !-3. If the receiving PC does not have sufficient disk space for the file you are sending, *TurboCom* terminates the phone connection, saving time and wasted money.

Increased modem speed allows you to save up to 75% on your telephone time and costs. Because *TurboCom* can be programmed for delayed unattended transmission for automatic sending, you can transmit data when telephone rates are lowest. PC to PC data is transferred perfectly because *TurboCom* was designed with an advanced error-free high speed protocol.

Because of *TurboCom*'s high speed, cost savings, flawless operation and sensational low \$89.00 price to connect two PCs, I give this product my highest recommendation.

Turbo Your Laptop

Each *TurboCom* package comes with both 5-1/4" and 3-1/2" diskettes, which makes it ideal to run with laptops, too. It is not copy protected.

To order direct from Datran, you can call toll free at 1-800-332-0456. They accept MasterCard and Visa and will ship within 24 hours with a 30-day money-back guarantee.

ORDER TODAY TOLL FREE:

1-800-332-0456

\$89.00



Plus \$5.00 Shipping/Handling

turboCom™



Leadership in Data Compression Technology
Datran Corporation
2505 Foothill Blvd., La Crescenta, CA 91214

Leigh Tracy is a consultant and freelance writer whose columns have appeared in many microcomputer magazines.

UPDATE: dBASE DATA COMPRESSION

Short card for dBase files triples the storage capacity of your existing hard disk

By Leigh Tracy

If your dBASE files are overwhelming the storage capacity of your hard disk, here's a nifty solution

If you bought a 20MB hard disk like I did—thinking it would hold all the dBASE files you'd ever create—were we ever in for a surprise!

Datran Corp., the Southern California based state-of-the-art data compression specialists, have come up with an economical, high performance solution to our problem: the *dCompressor* short card.

The nice people at Datran sent me a *dCompressor* to try, and was I ever impressed. I saw average compression ratios of 3 to 1—and in some cases as much as 10 to 1. I didn't have to be a genius to figure out that my teeni-weeni 20MB disk just became 60MB, and more!

Installation was a snap on my AT. I simply slipped the *dCompressor* into a slot and was up and running after a few minutes of installation. It operates in the background and is completely transparent to the user. I wasn't aware that it was there—except for all the extra data I was able to work with. It even seemed to make my program work faster.

At the heart of the *dCompressor* is a custom designed high-speed parallel microprocessor that uses Datran's powerful high-speed proprietary compression technology. I am told that it allows for an infinite number of compression/decompression cycles with total data integrity.

The *dCompressor* requires no reformatting, as is necessary with RLL con-

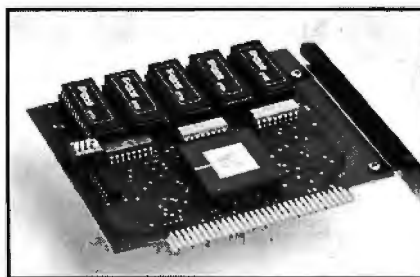

Datran's new *dCompressor* board operates at high speeds that software can't touch.

trollers. It will eventriple the capacity of dBASE files of a disk drive that is using RLL technology.

The *dCompressor* not only increases the performance of an existing disk drive, but also eliminates the need of upgrading the PC's power supply, as would be required if an additional disk drive were added. It requires only 1/2 watt of power, as compared with 15 to 30 watts to accommodate a new drive.

dCompressor is a no nonsense high speed data compression product that incorporates state-of-the-art technology. It operates at speeds that software compression programs can't touch.

It's not a cutesie software product that squishes, squashes, stomps, squeezes, crushes, crunches, munches, mashes—or generally beats your data to a pulp.

In short, it effortlessly compresses your dBASE files quickly and efficiently with no mess or fuss.

This product eliminates the needless hassle and expense of upgrading to a more expensive hard disk to support those expanding dBASE files. And eventually if you must purchase a larger hard disk, your investment will triple the file capacity of your new drive, too. It works with any size hard disk and floppy.

dCompressor works with dBASE III and III PLUS on IBM PC, XT, AT, 386 and compatibles, DOS 2.0 or higher.

And the best part about *dCompressor* is its low price . . . only \$195.00. I can highly recommend this super compression product.

To order direct from Datran you can call toll free to 1-800-332-0456. They accept MasterCard and Visa and will ship within 24 hours. Datran gives a 30-day money-back guarantee.

Datran has another data compression product worth mentioning if you send your dBASE files PC to PC. New *TurboCom* high performance modem software turbocharges your modem to send data up to 4 times faster!

TurboCom sells for only \$89.00 to connect two PCs. Now, your 2400 baud modem can send data as fast as a 9600 baud modem! It also makes 300 and 1200 baud modems perform up to 400% faster.

As a special introductory offer for *dCompressor* at its \$195.00 price, Datran will give you *TurboCom* software free with every unit you buy. The *TurboCom* package comes with 5-1/4" and 3-1/2" diskettes, which makes it ideal to run with laptops, too.

**ORDER TODAY TOLL FREE:
1-800-332-0456**

\$195.00

Plus \$5.00 Shipping/Handling



dCompressor

DATRAN

Leadership in Data Compression Technology

Datran Corporation

2505 Foothill Blvd., La Crescenta, CA 91214

Leigh Tracy is a computer consultant and writer whose pieces have appeared in numerous national publications.

Buy with

Confidence

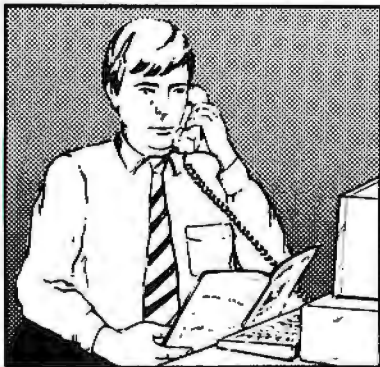

In an effort to make your telephone purchasing a more successful and pleasurable activity, The Microcomputer Marketing Council of the Direct Marketing Association, Inc. offers this advice, "A knowledgeable buyer will be a successful buyer." These are specific facts you should know about the prospective seller before placing an order:

Ask These Important Questions

- How long has the company been in business?
- Does the company offer technical assistance?
- Is there a service facility?
- Are manufacturer's warranties handled through the company?
- Does the seller have formal return and refund policies?
- Is there an additional charge for use of credit cards?
- Are credit card charges held until time of shipment?
- What are shipping costs for items ordered?

Reputable computer dealers will answer all these questions to your satisfaction. Don't settle for less when buying your computer hardware, software, peripherals and supplies.

Purchasing Guidelines

- State as completely and accurately as you can what merchandise you want including brand name, model number, catalog number.
- Establish that the item is in stock and confirm shipping date.
- Confirm that the price is as advertised.
- Obtain an order number and identification of the sales representative.
- Make a record of your order, noting exact price including shipping, date of order, promised shipping date and order number.

If you ever have a problem, remember to deal first with the seller. If you cannot resolve the problem, write to MAIL ORDER ACTION LINE, c/o DMA, 6 E. 43rd St., New York, NY 10017.

This message is brought to you by:

the MICROCOMPUTER
MARKETING COUNCIL
of the Direct Marketing
Association, Inc.
6 E. 43rd St.,
New York, NY 10017

MMC
MICROCOMPUTER
MARKETING COUNCIL
of the Direct Marketing Association, Inc.

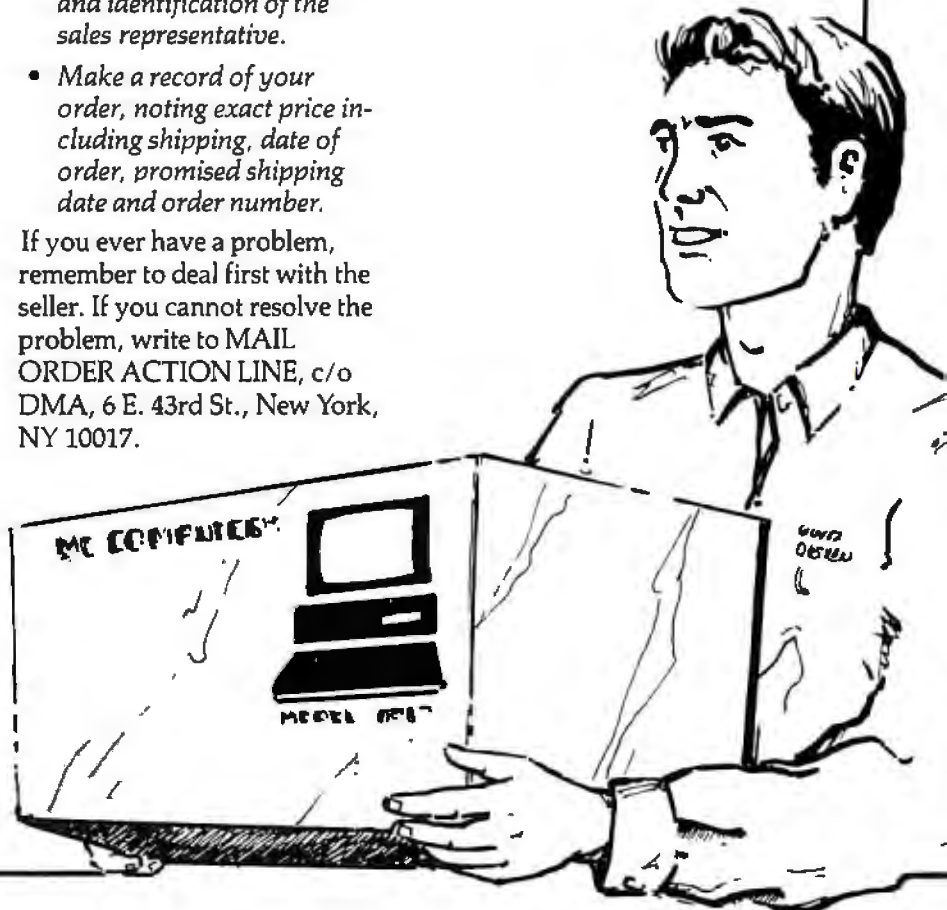

Dealers Call For Complete Confidential Price List

New Reduced Prices



PS II Model 25 Mono/Color . . . \$969/1195
 PS II M.25 Mono/Color + 20MB \$1395/1650
 PS II Model 30 2DR. + 20MB . . . **\$1595**
 PS II Model 30-002/021 . . . \$1195/1645
 PS II Model 50-021 . . . **\$2395**
 PS II Model 60-44MB/70MB . . . *\$3195/3655*
 PS II Model 80-115 20MHZ . . . \$7695
 PS II Model 80-44MB/70MB . . . **\$3995/4695**
 AT 339 (8MHZ, 512K, 30MB) . . . In Stock
 AT 068 (6MHZ, 256K) . . . \$2395
 PC/XT 2DR. 256K . . . \$995/1395
 Mono. Disp. 8503/XT Style . . . \$189/225
 Color Display 8512 . . . \$439
 EGA Disp. 8513/XT Style . . . \$495/595
 Ext. Drive F/PS2 (5¼) . . . \$285
 Pro Printer I/XL . . . \$359/505*
 Pro Printer X24/XL24 . . . \$519/685
 Quit Writer II/III . . . \$895/1095*
 IBM DOS 3.3 (min. 5) . . . \$85
 Call For All Other IBM Products
 Quantity Discount Available



SEAGATE HARD DRIVES

20MB/30MB W/Controller . . . \$259/289
 30MB/40MB (4038/4051) . . . \$385/450
 40MB (ST251)/40MB (4053) . . . *\$349/459
 80MB (4096)/80MB (277R) . . . *\$689/445
MINISCRIBE
 40MB (3650)/40MB (3053) . . . *\$319/535
 40MB (6053) Full Height . . . 495
 80MB Full Height (6085) . . . 699
HARD CARDS
 20MB/30MB for XT . . . 345/399
 40MB Card F/XT 40MSC . . . 499
 20MB/30MB For PS/2 . . . 399/435
MISCELLANEOUS
 130MB MAXTOR 28mlsecond . . . 1495
 COMPAQ Portable 20MB . . . 495
 COMPAQ 40/60MB F/DP386 . . . 745/895
 10/20MB IBM Hard Disk . . . 145/195
 130MB Compaq Hard Disk . . . 1695



DESKPRO MODELS

386/20 MHZ 60 MB HD . . . 5195**
 386/20 MHZ 130 MB HD . . . 6595**
 386/20 MHZ 300 MB HD . . . 8495
 386 40MB 16MHZ Factory . . . 3895
 386 130MB 16MHZ Factory . . . 5495
 286 Model 1 . . . 1645
 286 640K, 20MB/40MB HD . . . 2095/2295
 286 Model 40 (Factory) . . . 2695
 Deskpro 2DR. 256K/20MB . . . 1095/1395
PORTABLES
 **New Portable 386/40MB . . . *5395
 **New Portable 386/100MB . . . 6795
 II Model 4 (Factory/Upgrade) . . . 2595/2395
 II Model 2 2DR., 256K (80286) . . . 1895
 ***II Model 40MB** . . . 3895
 ***II Model 20MB** . . . 3375
 Compaq Amber/Green Monitor . . . 195
 Compaq Color/VGA Monitor . . . 525/555
 Compaq EGA/VGA Adapter . . . 325/425
 C. DOS 3.3/3.2/3.1 . . . 89/79/55
 Call on Memory and Other Compaq Product
 Quantity Discounts Available

Dealers & Consultants Only

Corporate & Retail Customers Call For Quotes

IRWIN TAPE BACK UP

8087-3 XT/80287-6 AT . . . **\$87/160
 8087-2 XT/80287-8 AT . . . \$145/249
 80287-10 AT 10MHZ . . . \$289
 80387-16 for 80386 . . . \$455
 80387-20 Base Systems . . . \$725

10 MB. Inter./External . . . \$255/379
 20 MB. Inter./External . . . \$325/455
 40 MB. Inter./External . . . \$459/535
 Call for PS/2 Tape Back Up Units
 Call for Archive, Tecmar, Sysgen

Laser Series II . . . Very Low
 *Desk Jet New 250 CPS . . . \$689
 1MB F/HP II Compat/HP . . . \$339/369
 2MB F/HP II Compat/HP . . . \$639/669
 HP Plotter 7475A . . . \$1395
 HP Scanjet Scanner w/Int . . . \$1355

182/182S 120CPS, 30nlq . . . \$229/279
 192 + /193 + 200CPS, 40nlq . . . \$329/419
 292E/293E 200cps, 100nlq . . . \$359/489
 393/393 Color 450 cps . . . \$945/1029
 ML294/ML2410 . . . \$737/1695
 Lazer Line 6 . . . \$1299

321SL/341SL (216CPS) . . . \$465/645
 351-SX/351-2 Color . . . \$995/1019
 Toshiba T1000/T1100 . . . \$729/1450
 T1200/T3120 . . . \$2295/2950
 T3200/T5100 . . . \$3675/4695
 Toshiba Modem/Compatible . . . \$279/249

Multispeed EL/HD . . . \$1455/2299
 Multisync II/Plus + . . . \$559/875
 Multisync XL 20 + . . . \$1995
 LC860 + /LC890 . . . \$1899/3195
 P760/P2200 . . . \$599/333

*** LOTUS 1-2-3 — \$289***

*** LOTUS SYMPHONY 3 1/2" — \$259***

D-DATA

American Express



Visa



MasterCard



SALES/SERVICE/REPAIR
 4742 Woodman Avenue
 Sherman Oaks, CA 91423

One stop shopping for dealers & consultants
 We also carry NEC, AST, Hercules, Drams, Modems
 Citizen, Micropolis, Sony, Microsoft, Samsung.

There will be a Charge
 on all credit card purchases

For phone order call:
 (213-859-3410 818-905-0994)
 FAX# 818-905-8869

Now You Have A Friend In The Computer Business[®]

Authorized Autocad and Novell Dealer
5 Good Reasons To Buy

1

ZENITH 181/183-20
 \$1449/\$2229

**ZENITH
 FLAT SCREEN
 MONITOR**
 CALL



TOSHIBA 1000 \$749
TOSHIBA 1200 \$2395
TOSHIBA 3100/20 \$3099
TOSHIBA 3200 CALL
TOSHIBA 5100 CALL
NEC Multispeed EL \$1595
NEC Multispeed 20MG \$2435

2

AST PREMIUM 286/386



512K RAM, 1.2 Floppy,
 40 MB Fast HD,
 hi-res mono card,
 mono monitor, DOS
 3.2, GW Basic

**386 Model
 In Stock**

\$2395
 Call for all
 AST products!

3

WYSE 286 System

512K RAM, 1.2 floppy, 40MB HD
 full monochrome system

\$2179

IN STOCK!
 WYSE 386/WYSE Terminals

4

LEADING EDGE COMPUTERS



Model D Hard Disk Full Mono System

\$1195

Authorized Leading Edge Dealer

5

ACER 710/910 SYSTEMS



(Formerly Multitech)
 512K memory, 20 MB
 HD, 6/10 0 wait state
 full mono system

IN STOCK!
 Call for Best Price

Acer 386 machine

We carry a full line of HP, IBM, Intel, Diconix products at best prices in town.

SOFTWARE SPECIAL

Word Perfect \$194
 Microsoft Word 209
 Lotus 305

Call for any software—delivery in 24 hours!

PRINTER SPECIAL

Epson LX800 \$209
 Epson EX800/1000 415/519
 Epson LQ800/1000 315/519
 Epson LQ500/2500 349/899
 Epson LQ850/1050 529/729
 NEC P6/P7/2200 414/615/379
 Toshiba P321SL/P351SL IN STOCK
 HP Laser Jet Series 2 CALL
 AST Turbolazer P/S 3250
 NEC 890 with P/S 3195
Authorized Repair and Service Center. Fast turnaround, carry-in/carry-out, pick up/drop. Call us for Service Contract information.

AUTHORIZED DEALER FOR

Novell Network
 Epson Computers & Printers
 AST
 Samsung
 Zenith
 Toshiba
 Wyse Computers
 AT&T
 Autocad
 Iomega Bernoulli Box
 Leading Edge
 Okidata
 NEC
 Canon
 Universal Data Systems
 HAYES
 Ashton Tate
 Paradox (Ansa Software)
 MicroSoft
 Ventura
 Aldus (PageMaker)

Computown Pleasant Hill

1527 Contra Costa Blvd.
 Pleasant Hill, CA 94523

(415) 682-TOWN
(415) 682-8696

Computown-Mountain View

2455 M Old Middlefield Way
 Mountain View, CA 94043

(415) 962-TOWN
(415) 962-8696

Computown-San Francisco

760 Market Street, Suite 219
 (Phelan Building)
 San Francisco, CA 94102

(415) 956-TOWN
(415) 956-8696
FAX (415) 989-TOWN

We Sell, Deliver, Install, Service, & Train You

Registered trademark of Minden Enterprise, Stockton, CA
 IBM is a registered trademark of International Business Machines, Inc.
 Samsung is a trademark of Samsung Semiconductor & Telecommunications
 Compaq is a trademark of Compaq
 Epson is a registered trademark of Epson America Inc.

All good-while quantities last.
 All prices subject to change on availability without notice.



COMPUTOWN

3,000,000 PCS

MEANS QUALITY

Quality, others promise, we deliver. The fact we've already delivered over 3,000,000 color monitors is the best proof. Tatung also makes a full line of computers and peripherals. Our reputation for superb quality is well known around the world. And we deliver complete after sales service to you.

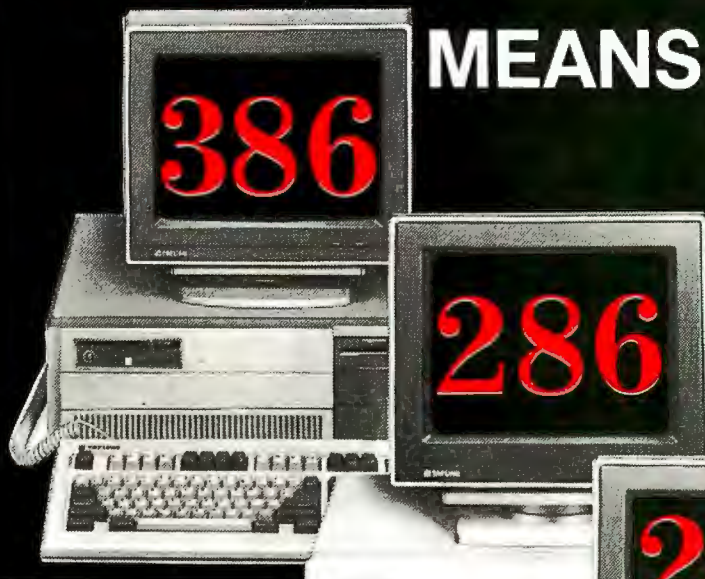

TCS 8000

16 MHZ, O WAIT - STATE
32 BIT, EXPANDABLE 16MB

TCS 7000

6, 8, 10, 12MHZ

TCS 4000 (6/10MHZ)

EQUIVALENT OF 5 EXPANSION SLOTS

OMNISCAN

COMPATIBILITY:
 IBM VGA™, MCGA*
 PGA, EGA, CGA
 AT&T™ PCs
 APPLE IIGS™
 MACINTOSH II™*

14" Color Monitor
 RES: 800 x 560
 4 MULTI-COLOR MODE

12" Mono Monitor
 RES: 800 x 560

* ALL TRADEMARKS ARE PROPERTY OF
THEIR RESPECTIVE MANUFACTURERS

COLOR MONITOR

MODEL RES.

- CM 1322N 640 X 200
- CM 1370A 720 X 400
- CM 1380F 640 X 350
- CM 1495 800 X 560

MONO MONITOR

MODEL RES.

- MM 1222 800 X 350
- MM 1422 800 X 350
- MM 1295 800 X 560

TERMINAL

ET - 10 SERIES

- 14" DARK - TINTED
- ANTI-GLARE FLAT CRT
- H10 (AMBER)
- H17 (PAPER/WHITE)

Circle 520 on Reader Service Card

VAR. DITRIBUTORS. OEM
INQUIRIES ARE WELCOME



TATUNG

TATUNG SCIENCE & TECHNOLOGY INC.

408-435-0140

2060 RINGWOOD AVE., SAN JOSE CA, 95131

MICROMINT'S Gold Standard in Single Board Computers and Industrial Controllers

BCC180 — \$395.00

Multitasking Controller



The BCC180, only 4.5" x 8.5" uses the same 64180 CMOS Z80 instruction compatible processor as Micromint's SB180 and SB180FX single board computers. Configured primarily for process control w/ 384K of memory, 6 parallel I/O ports, console serial port, RS-232/422/485 selectable auxiliary serial port, and an interrupt driven ROM-resident multitasking BASIC-180 compiler, the BCC180 uses the same 44-pin I/O expansion bus as Micromint's BCC52 controller board.

- PROCESSOR**
- CMOS 64084B0, 9.216MHz 8-bit CPU, 68-pin PLCC package
- MEMORY**
- Up to 384K bytes total memory on-board
 - 128K of either static RAM (62256) or EPROM (27256)
 - 256K dynamic RAM (6264)
 - Full-function ROM monitor included
- INPUT/OUTPUT**
- Console RS-232 serial port with auto baud rate select to 19,200 baud
 - Peripheral serial port, 150-19,200 baud, selectable RS-232, RS-422, or RS-485
 - 48 bit bidirectional parallel I/O
 - 64K I/O available through the BCC bus edge connector
- DIMENSIONS and CONNECTIONS**
- Dual 32-pin (0.156") edge connector
 - Compatible with all Micromint BCC-series I/O expansion boards
 - 7-wire-pin headers for bidirectional parallel ports
 - 25-pin DB-25 for RS-232 console I/O
 - 20-pin header for RS-232 auxiliary serial port
 - 4 screw terminals for RS-422/485 connection

BCC180-1-20 9MHz assembled and fully socketed BCC180 Computer/Controller with 32K bytes of static RAM, ROM Monitor, BASIC-180 development software and user's manual
For Additional 256K DRAM add \$100.00

BCC180-1 100 Quantity w/32K RAM w/o ROM Monitor \$209.00

BCC52 — \$189.00

BASIC-52 Computer/Controller

The BCC52 Computer/Controller is Micromint's hottest selling standalone single board microcomputer. Its cost-effective architecture needs only a power supply and terminal to become a complete development or end-use system, programmable in BASIC or machine language. The BCC52 uses Micromint's new 80C52-BASIC CMOS microprocessor which contains a ROM resident 8K byte floating point BASIC-52 interpreter.

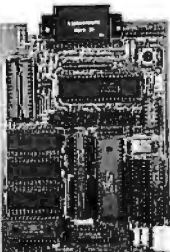

The BCC52 contains sockets for up to 48K bytes of RAM/EPROM, an "intelligent" 2764/128 EPROM programmer, 3 parallel ports, a serial terminal port with auto baud rate selection, a serial printer port, and it is bus compatible with the full line of BCC-bus expansion boards. The BCC52 bridges the gap between expensive programmable controllers and hard-to-justify price sensitive control applications. BASIC-52's full floating point BASIC is fast and efficient enough for the most complicated tasks, while its cost effective design allows it to be considered for many new areas of implementation. It can be used both for development and end-use applications.

Since the BASIC-52 is bus oriented, it supports the following Micromint expansion boards in any of Micromint's card cages with optional power supplies:

- | | |
|---|---|
| BCC22 Smart terminal board | BCC40R 8-Channel relay output board |
| ADP500 User vocabulary, digitized speech board | BCC53 Memory and 6 port I/O expansion board |
| BCC25 LCD display board | BCC13 8-bit and BCC30 12-bit A/D converter boards |
| BCC33 3 port I/O expansion board | BCC18 Dual channel serial I/O board |
| BCC40D 8-Channel optoisolated I/O expansion board | |

BCC52 BASIC 52 Controller Board \$189.00
BCC-SYST-5 "52 PAK" Starter System includes: \$449.00
 BCC52, ROM A&B UTIL., CC01, MB08, UPS10
BCC52 OEM 100 Quantity Price -- \$149.00

BCC52C Lower power all CMOS version of the BCC52 \$199.00
 NOTE: The BCC52 series is available in Industrial Temperature Range, fully tested at temperature. Prices start as low as \$294.00 in single quantities. Be sure to call for a quote on your specific Industrial OEM requirements.

BCC11 — \$139.00

Z8 BASIC Computer



- Features:**
- Uses Z8 single chip microcomputer
 - On-board tiny BASIC interpreter
 - 2 on-board parallel ports & serial port
 - 6 interrupts (4 external)
 - Just connect a terminal and write control programs in BASIC
 - 6K bytes of RAM or EPROM memory on-board
 - Baud rates 110-9600 bps
 - Data and address bus available for 56K memory and I/O expansion
 - Consumes only 1.5 watts at +5, +12, and -12V

BCC11* BASIC System Controller \$139.00

OEM 100 Quantity Price \$89.00

* Now Available In Industrial Temperature Range

Announcing BCC40D — \$139.00

8-Channel Optoisolated I/O Expansion Board

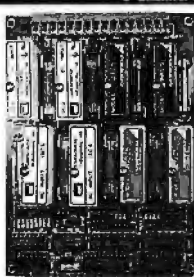

The Micromint BCC40D is an 8-channel optoisolated input/output expansion board designed for use with Micromint's family of BCC-bus Computer/Controllers. Using industry-standard optoisolated I/O modules, the BCC40D provides on/off control and input monitoring of eight 115-230VAC or 5-48VDC devices used in data acquisition and control applications.

Up to 16 BCC40D boards can be used together in a single system to provide a total of 128 input and output channels. Individual channels can be read or updated by reading from or writing to a single I/O address. The BCC40D can be directly controlled from BASIC or it can function completely in the background under an application program using high-speed interrupt-driven ROM C firmware. This firmware sets aside a table in memory which reflects the status, setpoints, and change-of-state flags of the I/O modules. Interaction among programs within a multiboard BCC40x system merely consists of reading or setting these memory table values.

Each optoisolated channel is fused and has screw contacts for direct connection to the controlling device and/or the power source. Both input and output modules, and AC or DC functions can be intermixed on the same BCC40D board.

New

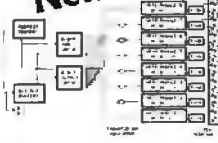

- SPECIFICATIONS**
- Latched outputs
 - Uses industry-standard OACS, ODCS, IACS, IDCS type modules
 - Dual-ported module addressing
 - LED on/off indicator on each channel
 - Can be used concurrently with BCC40R and other BCC-bus peripherals
 - Operates on +5V
 - Operating conditions: temperature: 0-50°C (32-122°F) relative humidity: 10-90% noncondensing
 - 4.5" x 8" board
 - dual 22-pin (0.156") edge connector
 - 16-terminal screw connector (#14 wire)

BCC40D/0 without modules \$139.00
BCC40D/4 with 4 modules \$189.00
BCC40D/8 with 8 modules \$239.00

OEM 100 Quantity pricing starts at \$95.00



Announcing BCC40R — \$169.00

8-Channel Relay Output Board

The Micromint BCC40R is an 8-channel relay output expansion board designed for use with Micromint's family of BCC-bus Computer/Controllers. Using efficient mechanical relays, the BCC40R provides contact-closure on/off control of eight AC- or DC-powered devices for data acquisition and control applications. Up to 16 BCC40R boards can be used together in a single system to provide a total of 128 relay output channels. The relays are controlled by writing to a board-specific I/O address. The relays on a BCC40R board can be controlled either as a set of eight relays at a single I/O address or individual relays at eight separate I/O addresses.

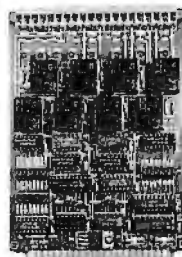

The BCC40R can be directly controlled from BASIC or it can function completely in the background under an application program using high speed interrupt-driven ROM C firmware. This firmware sets aside a table in memory which reflects the status and setpoints of the relays. Interaction among programs within a multiboard BCC40x system merely consists of reading or setting these memory table values.

The eight relay outputs have screw contacts for direct connection to the controlling device and/or the power source. Four of the relays have single-pole-double-throw (SPDT) output connections and four relays have single-pole-single-throw (SPST) output connections.

- SPECIFICATIONS**
- Contacts rated for: 1/10 HP, 3A 120V resistive, or 3A 30VDC
 - Latched relay outputs
 - LED on/off indicator on each channel
 - Power on/off failsafe: No arbitrary closures on power up/down
 - Can be used concurrently with BCC40D and other BCC-bus peripherals
 - Operates on +12V
 - Operating conditions: 0-50°C (32-122°F) relative humidity: 10-90% noncondensing
 - 4.5" x 8" board
 - dual 22-pin (0.156") edge connector
 - 20-terminalscrew connector (#14 wire)

New

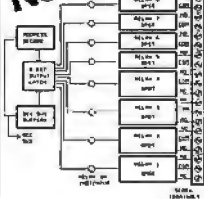

BCC40R 8-Channel relay output board \$169.00
 OEM 100 Quantity price \$124.00

Announcing BCC18 — \$175.00

Dual-Serial Board



The BCC18 is a general-purpose dual-serial-port interface board for use with the Micromint BCC-bus. Optional support software is available for the BCC52 and BCC180 computer/controllers.

The BCC18 Serial Board contains two serial interfaces. Each interface can be either a 110/300/1200-bps modem, or a hard-wired RS-232C/RS-422/RS-485 interface. The modem interface uses a Xecom XE1201/XE1203 MOSART (Modem Synchronous/Asynchronous Receiver/Transmitter), capable of 110, 300, or 1200 bps communication and compatible with Bell 103 and Bell 212A standards. The hard-wired serial interface uses an industry-standard 8251A USART (Universal Synchronous/Asynchronous Receiver/Transmitter), capable of supporting asynchronous serial communications at speeds up to 19.2 kbps and synchronous serial communications at speeds up to 64k bps.

The BCC18 can be configured with two MOSARTs, two 8251As, or one of each. Up to 16 BCC18s can be used in a single system (for a total of 32 serial ports).

- MOSART**
- Connects directly to any phone line
 - DTMF or pulse dialing
 - DTMF reception and decoding
 - Call progress monitoring
 - Parity generation/checking
- 8251A**
- Full-duplex, double-buffered transmitter and receiver
 - Fully programmable with several speed and character modes
 - Error detection for parity, overrun, and framing
 - Fail-safe bit detection: automatic break detect and handling
 - Supports bi-phase
 - Bit rate is software programmable using an on-board 8253 counter/timer
 - RS-232C, RS-422, and RS-485 supported software
- MOSART and 8251A use the same program interface, so most software will work with both. Optional support software for the BCC52 and BCC180 is available that makes it easy to access and use most of the features of the MOSART and 8251A from within user-written programs.**

BCC18S OEM configuration fixed dual 8251 RS-232 only \$175.00 serial port board

BCC18U-1	8251/8251 Dual RS-232/485 serial	\$209.00
BCC18U-2	8251/1201 Modem and serial port	\$359.00
BCC18U-3	1201/1201 Modem/Modem board	\$499.00
BCC52/18	BCC52 serial port utilities software	\$75.00

BCC-BUS

Expansion Products

	Single Qty. Price
BCC08 Single Channel UART Serial Board	\$149.00
BCC13 8-bit, 8 Channel A/D Board	\$129.00
BCC30 12-bit, 16 Channel A/D Board	\$197.00
BCC22 25-line, 80 Character Terminal Board	\$249.00
BCC25 LCD Board (4x20) or (8x40)	\$159.00
BCC55 Fully Decoded & Buffered Prototyping Board	\$79.00
BCCxx X-10 Power Line Controller	\$59.00
BCC53 Multifunction Expansion Board	\$160.00
MB04 4 Slot Mini-Motherboard	\$69.00
MB08 8 Slot Full Motherboard	\$85.00

*Call for current pricing

REPRESENTATIVES
ACCESS TECHNOLOGIES
 1408 Richmond Dr
 Placentia, Ca. 92670 Tel:(714) 996-3917

MICROFUTURE
 41040 Comac Terrace
 Fremont, Ca. 94538 Tel:(415) 657-0264

DISTRIBUTOR
J.B. DESIGNS & TECHNOLOGIES LTD.
 15 Market Place
 Cirencester, Glos. GL7 2PB
 England
 Tel: 0285-68122 Fax: 0285-68859

To order call
1-800-635-3355

TEL: (203) 871-6170
 TELEX: 643331
 FAX: (203) 872-2204

MICROMINT INC.
 4 PARK STREET
 VERNON, CT. 06066





EPSON
(w/Nation-Wide Protection Plan)

EQUITY I+

- 360K Floppy
- 20 Meg Hard Disk
- 640K Ram
- Serial/Parallel Port
- Monochrome Card
- Monochrome Monitor
- MS DOS
- GW Basic

\$1295

EQUITY II PLUS

- 1.2 Meg Floppy
- 40 Meg Hard Disk
- 640K Ram
- Serial/Parallel/C/C
- 80286 CPU
- Monochrome Monitor
- Graphic Card
- MS DOS
- GW Basic

EQUITY III+

- 80286 CPU 6-8 12 MHz
- 1.2 MEG Floppy
- 40 MEG Hard Disk
- DOS 3.2 Mono Monitor & Graphic Card

\$2195

In order to provide the best service, EPSON EQUITY is exclusively sold on location.

**LOW
PRICE
LEADER**



80386

- 16/8/4.77 MHz switchable
- 8/16 MHz, no wait state (Upgradeable to 20 MHz)
- 1 parallel port, 1 serial port with c/c
- Socketed for optional math coprocessor
- 8 layer motherboard/8 full expansion slots
- High-resolution monochrome monitor. Hercules compatible.
- 1.2MB floppy drive
- 3 half-high internal device slots
- 200 watt power supply/101 keyboard
- FCC approved

16 MHz

\$2295

20 MHz

\$2895



80286

- 10/6 MHz switchable
- 0 or 1 wait state
- 8 expansion slots to fill all of your expansion needs
- 512K memory—High quality pre-tested chips (upgradable to 1 MB on the motherboard.)
- FRE amber monitor and Hercules compatible graphics card.
- One high quality floppy drive, 1.2 Meg
- 200 Watt power supply/101 keyboard
- AT style keyboard with 10 function keys
- 1 parallel port with c/c battery backup
- Slot for math co-processor 80287
- FCC Class B approved.

20 MHz

\$1250

12 MHz

\$1350

COMPAQ

386 130 meg/20 MHz	6695
286 40 meg	2395
386 40 meg/16 MHz	4195
386 60 meg/20 MHz	5650
Portable III 40 meg/20 MHz	4195

CARD & MONITOR EXTRA



PS/2 model 30/20 meg	1775
PS/2 model 50/20 meg	2595
PS/2 model 60/40 meg	3250
PS/2 model 60/71 meg	3995
PS/2 model 80/40 meg	5100

MONITOR EXTRA

LAP-TOP

Toshiba 3200-40	3795
Toshiba 3100-20	Call
Toshiba 1000	Call
NEC Multispeed	1395
NEC Multispeed EL	1595
EPSON LT	Call

WE STOCK

CITIZEN
OKIDATA
EVEREX

TOSHIBA
NEC
WYSE
HITACHI

PRINCETON GRAPHICS
SONY
ACER
HOUSTON INSTRUMENTS

AMDEK
HAYES
SAMSUNG
CALCOMP

PC MOUSE
MICROSOFT MICE
LOGITECH
MITSUBISHI

IRWIN & ARCHIVE
TAPE BACK
TAXAN

HARD DISK

Seagate 20 meg	305
Seagate 30 meg	365
Seagate 4096 80 meg	795
Seagate 251	395
Miniscribe	Call
Micropolis	Call

SOFTWARE

Microsoft Word	239
Word Perfect 4.2	215
Lotus 1-2-3	325
dBase III +	385
Microsoft Works	135

AND MANY, MANY MORE!



NOVELL

Authorized Dealer
Netware

AST

AST 386 model 340	4395
AST 286 model 80	1745
AST 286 model 120	Call
AST 286 model 140	2695

CARD & MONITOR EXTRA

**EPSON[®]
PRINTERS**

Epson FX86E	349
Epson 286E	435
Epson EX800	455
Epson EX1000	499
Epson LX800	210
Epson LQ500	365
GQ3500	1395
Epson LQ850	550
Epson LQ1050	749
HP LASER II	1699

WE ACCEPT LC, CASHIER CHECKS, MONEY ORDERS, VISA, MC, AmEx
3% charge on VISA, MC & 5% on American Express

COMPUTER LANE

HOURS:
M-S 9-6

1-800-LANE-402 (Outside CA)
(818) 884-8644 (In CA)
(818) 884-8253 (FAX)

22107 ROSCOE BLVD.
CANOGA PARK
1/2 BLOCK W. OF TOPANGA
CA 91304

CORPORATE ACCOUNTS WELCOME
CALL FOR VOLUME DISCOUNTS
CONSULTANTS CALL FOR PRICING

Prices subject to change without notice

Compaq is a Registered Trademark of Compaq
IBM is a Registered Trademark of International Business Machines

ALTEC ZIP-386

\$2,265

- * Intel 80386 microprocessor
- * 1M high speed memory installed
- * Expandable to 10 MB
- * Phoenix 386 BIOS or Award 386 BIOS
- * 4 speed (4.77/6/8/16 MHz)
- * 200W power supply
- * Case with re-set button
- * Enhanced keyboard
- * Hard disk/floppy disk controller card
- * 1.2M floppy disk drive
- * Monochrome/Graphics card with printer port
- * HI-RES Monochrome Monitor
- * User's manual
- * 1 year warranty

ALTEC-286 Enhanced System

\$1,095

- * Intel 80286-10 microprocessor
- * 640K RAM
- * Dual speed 6/10 MHz
- * 200W power supply
- * AT style case
- * Enhanced keyboard
- * Hard disk/floppy disk controller card
- * 1.2 M floppy disk drive
- * Monochrome/Graphics card with printer port
- * HI-RES Monochrome Monitor
- * Phoenix BIOS
- * User's manual
- * 1 year warranty

ALTEC-XT Turbo System

\$685

- * 8088-1 microprocessor
- * 4.77/10 MHz
- * 640K RAM
- * 150W power supply
- * AT style keyboard
- * Floppy controller card
- * 380K floppy disk drive
- * Monochrome/Graphics card with printer port
- * HI-RES Monochrome Monitor
- * Phoenix BIOS
- * User's manual
- * 1 year warranty

ALTEC-286Jr System

\$1,075

- * Intel 80286-10 microprocessor
- * 640K RAM
- * 200W power supply
- * ATjr style case
- * AT style keyboard
- * Hard disk/floppy disk controlled card
- * 1.2M floppy disk drive
- * Monochrome/Graphics card with printer port
- * HI-RES Monochrome Monitor
- * User's manual
- * 1 year warranty



ADDITIONAL FEATURES	ADD	
Color System	: \$200.00	
EGA System	: \$400.00	
20M hard disk	: \$235.00 (386 & 286)	\$285.00 (XT)
40M harddisk	: \$405.00 (386 & 286)	\$465.00 (XT)
360 K floppy disk drive	: \$80.00	
720K 3 1/2" floppy disk drive	: \$120.00	
1.44 M 3 1/2" floppy disk drive	: \$175.00	

ALTEC Technology Corporation

5751 Rickenbacker Road, Los Angeles, CA 90040

Tel: 1-213-888-9100

Order Desk: 1-800-255-9971

* Intel is registered trademark of Intel Corporation.
 * Phoenix is registered trademark of Phoenix Technologies Ltd.
 * Award is registered trademark of Award Software Inc.
 * AT is registered trademark of IBM Corporation.

**Important TIPS* for BYTE Subscribers:
 Receive Product Information 10 Days Earlier!**



All you need is a touch-tone telephone and your subscriber I.D. number. See instructions facing the Reader Service Index in the back of this issue for outrageous time-saving opportunities!

*BYTE's Telephone Inquiry Processing Service

Summer Savings!*



SF-286	8MHz	10MHz	10MHz (O WS)	12MHz (O WS)	16MHz (386)
Mono System	\$995	\$1119	\$1349	\$1499	\$1950
EGA System	\$1369	\$1569	\$1720	\$1870	\$2315

Basic System Features:

80286-16 bit CPU, 80287 socket, 512K RAM expandable to 1MB, fully compatible AMI BIOS, 1.2Mb Floppy Disk Drive, combined floppy/hard disk controller, Keytronics 101 enhanced keyboard, clock/calendar with battery backup, 195 watt power supply, 48 hour burn-in testing, operations manual, one year limited warranty and optional on-site maintenance agreement.

SF-286-8MHz

20Mb Mono Special.....\$1199

Basic System features plus: Monographics board with printer port, Samsung 12" mono monitor and Seagate 20Mb hard drive.
(40Mb Miniscribe, Add \$100)

SF-286-8MHz

20Mb EGA Special.....\$1569

Basic System features plus: EGA graphics board, Mitsubishi 1410C EGA monitor and Seagate 20Mb hard drive.
(40Mb Miniscribe, Add \$100)

SF-286-8MHz

40Mb VGA Special.....\$1999

Basic System features plus: Everex EVGA graphics board (640x480, 800x600, up to 256 colors), Mitsubishi Diamond Scan multisync monitor and Seagate ST251 40Mb hard drive.

SF-80386

40Mb EGA Special.....\$2599

Basic System features plus: Everex EGA Deluxe autoswitch graphics board (640x480, 752x410), Mitsubishi 1410C EGA monitor and Seagate ST251 40Mb hard drive.

EGA Bundle.....\$479

Everex EGA autoswitch graphics board and Mitsubishi 1410-C EGA color monitor.

Super EGA Bundle.....\$629

Everex EGA Deluxe autoswitch graphics board (640x480, 752x410), and Mitsubishi 1371-A Diamond Scan multisync color monitor.

Super VGA Bundle.....\$769

Everex EVGA graphics board (640x480, 800x600, up to 256 colors) and Mitsubishi 1371-A Diamond Scan multisync color monitor

Hard Disk Specials (for PC)

Seagate ST225 20Mb + Cont.....\$265
Seagate ST238 30Mb + Cont.....\$289
Miniscribe 3650 40Mb + Cont.....\$349

Hard Disk Specials (for AT)

Seagate ST125 20Mb (40ms).....\$269
Seagate ST138 30Mb (40ms).....\$349
Seagate ST251 40Mb (40ms).....\$359
Seagate ST251-1 40Mb (28ms).....\$459
Seagate 4096 80Mb (28ms).....\$759
Miniscribe 3650 40Mb (61ms).....\$309
Micropolis 1335 71Mb (28ms).....\$669

Everex Modems

Everex Evercom external and internal half-card modems (fully Hayes compatible) with Bitcom Communications software.

Internal 1200 Baud Modem.....\$CALL
External 1200 Baud Pocket Modem.....\$139
Internal 2400 Baud Modem.....\$179
External 2400 Baud with Mini I/O.....\$229

Misc. Specials

Mini I/O (PAR, SER, CLK, CAL).....\$49
Mini I/O with Game Port.....\$55
Mini I/O + Logitech C7 serial mouse.....\$119
Mitsubishi 3.5" 720K floppy drive.....\$99
Mitsubishi 3.5" 1.4Mb floppy drive.....\$129
150 Watt Power Supply.....\$49
200 Watt Power Supply.....\$79
2Mb EMS memory board with OK.....\$80
3Mb EMS memory board with OK.....\$99

*Special Prices valid only through 7/31/88

Seagate, Samsung, Miniscribe, Everex, Mitsubishi, Hayes, Micropolis, Bitcom, Logitech, are trademarks or registered trademarks of their respective companies.
SFmicro-04 v.1 5/8/88



1825 Lombard Street
San Francisco, CA 94123

California Orders, Information
(415) 929-1505

National Order Desk (800) 237-5631
Technical Support (415) 929-1607

University P.O.'s and Dealers Inquiries
are Welcome

TERMS: We accept MasterCard, VISA (no surcharge), American Express, COD's (Certified Funds) and approved company P.O.'s (California residents please add sales tax. 10% fee for unauthenticated returns (call for RMA number). Returns must be shipped freight prepaid by customer. Prices are subject to change without notice. We reserve the right to substitute equivalent items.

High Speed Data Acquisition & Arbitrary Waveform Generation

Add Waveform Acquisition and Arbitrary Generator (WAAG) capabilities to your PC or compatible. The WAAG board is a fast waveform capturing device as well as an arbitrary waveform generator on a single card. It is the ideal solution to any need requiring transient or repetitive signal capture. The WAAG... a perfect tool for laboratories, R & D facilities, medical and educational institutions and general industrial use.

PC is a registered trademark of International Business Machines Corp.

Price: **\$895⁰⁰** including software.
VISA and MASTERCARD accepted.

S P E C I F I C A T I O N S

Acquisition

Input: +0.63 to -0.64V
Max. Samples: 16,384
Resolution: 8 bits
Max. Sample Rate: 20 MHz

Generator

Output: $\pm 5V$
Waveform Type: Arbitrary
Resolution: 8 bits
Max. Clock: 20 MHz

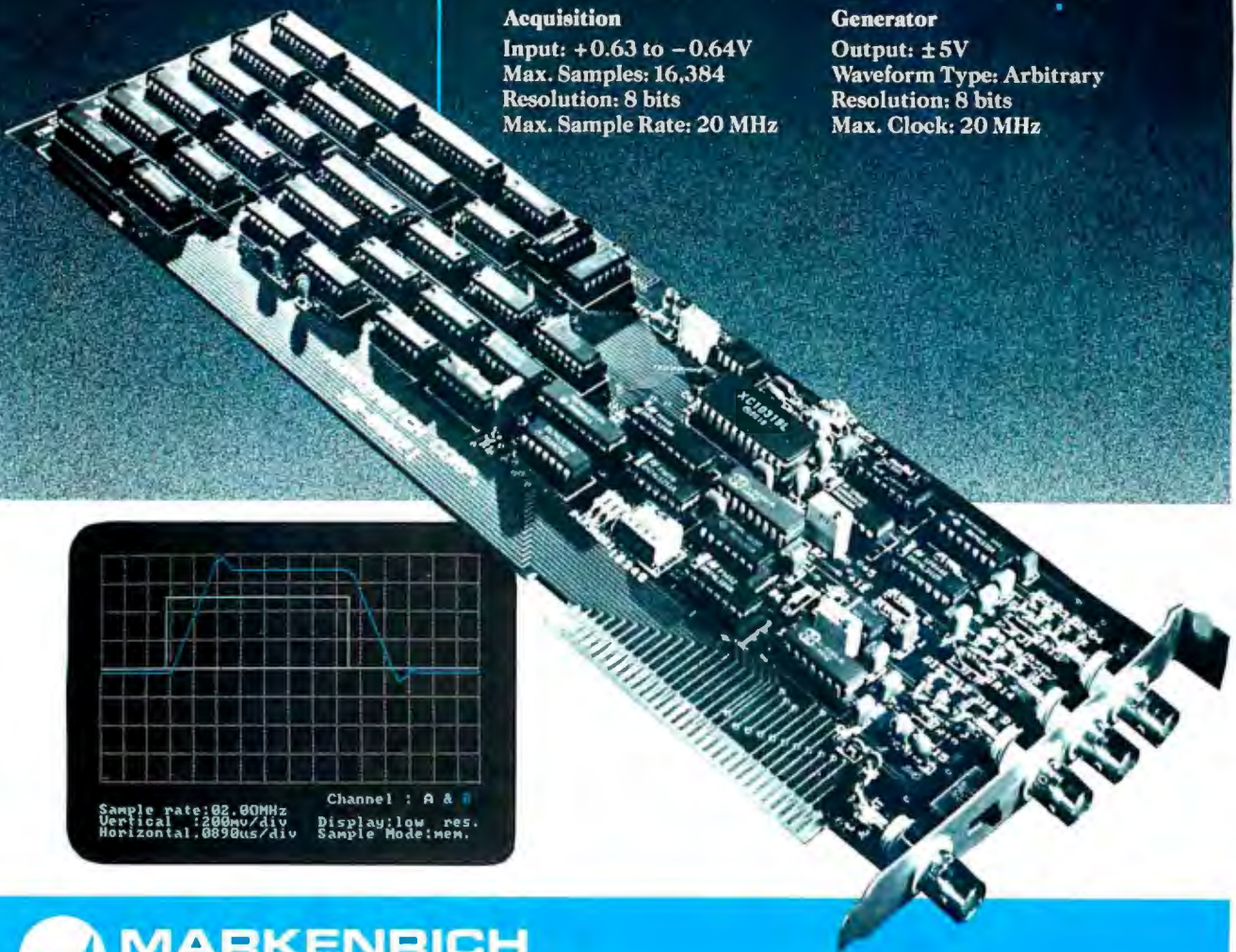

MARKENRICH
CORPORATION

1812 Flower Avenue/Duarte, California 91010-2931 U.S.A.
Telephone (818) 359-9190/Telex: 298727 MRK UR/FAX: (818) 359-5223

SHORT TAKES

BYTE editors offer hands-on views of new products

Dell System 310

UR/Forth 1.10

SoftPC

EasyTalk

GrandView

Forget-Me-Not



THE FACTS

System 310
\$2699

Options:
With VGA, color monitor, and 40-megabyte hard disk drive, \$3999; with VGA color monitor and 90-megabyte hard disk drive, \$4799.

Dell Computer Corp.
9505 Arboretum Blvd.
Austin, TX 78759
(512) 338-4400
Inquiry 856.

Dell's 80386— One of the Fastest

Dell Computer made headlines earlier this year by announcing the first real IBM PS/2 clone. But this groundbreaking system will not ship until later this year. Till then, Dell's most powerful machine will be its new **System 310**, an 80386-based AT-bus system that runs at 20 MHz and may be one of the fastest 80386 systems on the market.

The new Dell system is built on an impressive history. Dell's first 80386 system, introduced under the PC's Limited label in November 1986, was regarded even by some competitors as the fastest machine at that time. That machine used only a 16-MHz processor, but it achieved its high performance through the exclusive use of high-speed static RAM chips.

In the System 310, the static RAM is limited to just a 32K-byte cache. However, the system uses a 20-MHz processor with an Intel 82385 cache controller and paged interleaved

memory. This architecture results in some fast performances. In one small sample of benchmarks, a prototype version of the machine outpaced every other system save one, the ALR FlexCache, which it tied.

The System 310 comes in a standard AT-style case with eight AT-style slots. Up to 8 megabytes can be placed on the system's motherboard. Like most 80386 systems, it uses a proprietary 32-bit slot for memory expansion. Here, though, the slot is arranged in an ingenious way: It shares the

same space as one of the AT slots. When a memory card is inserted into the slot, the AT slot can still be used by a half-length card.

My system had a fast 90-megabyte enhanced-small-device-interface hard disk drive. Copying large groups of files from one directory to another occurred in less time than it took to type the command. The hard disk drive was also very quiet, a welcome change from some other systems.

The system also came with a Mitsubishi analog color monitor, which produced good-

quality VGA color text and graphics. An interesting diagnostics program from Dell lets you test the monitor by creating almost any color you want by varying the red, green, and blue components.

The only thing I didn't like was the keyboard, which seemed a bit too soft. Also, there was no reset button on the front of the system.

One other interesting feature of the System 310 is its price. Although Dell does not publicize it, there are three configurations. The base price—without video adapter or hard disk drive—is only \$2699. Fully equipped, the system lists for \$4799. In any configuration, this is a fast, low-cost system.

—*Rich Malloy*

Forth under OS/2

UR/Forth 1.10 for OS/2 Standard Edition 1.0 will appeal to anyone who wants to learn and experiment with the OS/2 API. While the main purpose of Laboratory Micro-

systems' UR/Forth is to support real-time control applications across a wide range of machines, its designers added the ability to access most API functions directly.

Forth's interactive nature lets you get immediate feedback on what an OS/2 API function call does. You simply

push the necessary parameters onto the stack and type the name of the function call. This eliminates the edit, compile, and run loop of a compiled language like C or Pascal.

The UR/Forth system is a complete applications development system, including an

continued

interpreter/compiler (compatible with the Forth 83 standard), a full-screen editor and assembler, a relocating binary overlay utility, and software floating-point and Intel 80x87 support. It also has a multitasker; a native code optimizer; and graphics support for IBM CGA, EGA, and the Hercules graphics adapter.

UR/Forth uses direct threaded code with the top of the stack in a register, a segmented memory model, an object-compiled nucleus, a completely hashed dictionary, and a uniform file interface across all supported operating systems (i.e., MS-DOS, OS/2, 80286 Xenix, and 68000 Unix).

Much source code is included with the system, for things like the editor, the assembler, the tasker, and the floating-point routines. There are also some demonstration programs for the following: graphics routines, the OS/2 API functions, debugging aids, sample programs, and

THE FACTS

UR/Forth 1.10
\$350

Laboratory Microsystems
3007 Washington Blvd.
Suite 230
P.O. Box 10430
Marina del Rey, CA 90295
(213) 306-7412
Inquiry 855.

Requirements:

A high-density (1.2-megabyte) 5¼-inch or 720K-byte 3½-inch floppy disk drive; Microsoft or IBM OS/2 1.0; 2 megabytes of RAM; a video adapter compatible with IBM MDA, CGA, EGA, or VGA.

miscellaneous utilities.

In the graphics mode, UR/Forth includes routines for reading or setting pixels, line drawing, arcs, ellipses, circles (with clipping), region fill with patterns or solid colors, bit-block moves, custom character sets, and positioning text at any coordinate.

Because the ability to play with OS/2 API functions is an extra you get with UR/Forth for OS/2, there is no description of the OS/2 API calls in the manual. You will thus need some such documentation (e.g., the OS/2 program-

mer's reference from IBM [\$200] or Norton Guides from Peter Norton Computing [\$150]). Also, using the OS/2 API calls will make your application nonportable to Laboratory Microsystems' other Forth systems.

There are some limitations on which OS/2 function calls you can make from UR/Forth. Writing multithreaded applications may cause a problem because not all Forth function calls are now reentrant. This problem is not unique, as many Microsoft C routines are not reentrant either.

Also, because a threaded language is 3 to 4 times slower than a compiled language, the monitor function calls are not available from UR/Forth. But this still leaves many of the 200 or more OS/2 functions to play with. A demonstration program includes calls illustrating the use of queues and semaphores, creating and using shared memory segments, and printing out the global and local information segments.

UR/Forth is the least expensive alternative available so far for getting some hands-on work with OS/2. The closest alternative in price that I know of is the Microsoft Programmer's Toolkit (\$350) and the Microsoft C language (\$450), though I'm sure this will change soon. While UR/Forth is less expensive, the ability to play with the OS/2 API is intended only as a learning tool. But for a programmer with an open mind, it can be very useful.

—Eva M. White

A Real Virtual Machine

Occasionally, a Macintosh user has to handle data supplied from an MS-DOS computer on a 5¼-inch floppy disk. Some vendors supply IBM PC motherboards, which plug into a Mac SE or a Mac II, to let you deal with this problem. Insignia Solutions provides a different solution with **SoftPC**: It emulates a complete IBM PC XT computer in software on either a Mac SE or a Mac II.

The machine emulated has an 8088 CPU, 640K bytes of RAM, a CGA display (presented as a draggable window on the Mac's screen), three hard disk drives (C, D, and E), a Microsoft Bus Mouse, two serial ports (COM1 and COM2), and a parallel port (LPT1). The C and D hard disk drives are emulated as files on the host Mac's hard

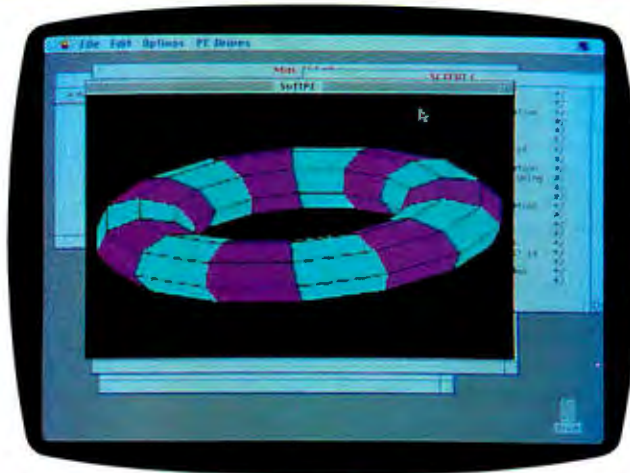

THE FACTS

SoftPC
\$595

Insignia Solutions, Inc.
1255 Post St.
Suite 625
San Francisco, CA 94109
(408) 446-2228
Inquiry 852.

Requirements:

Macintosh SE or II with a hard disk drive; System 4.3/finder 6.0 or higher; at least 2 megabytes of RAM; accelerator card required for the Mac SE.

disk drive. You can configure these two drives in sizes from 1 to 30 megabytes.

The Mac drive itself is treated as hard disk drive E, which lets you copy files to and from the virtual PC drives with the DOS COPY command. If the combination of an Apple PC card and a PC disk drive is connected to the Mac, SoftPC treats it as drive A and allows file transfers to and from it, again using COPY. You can also format floppy disks or run programs in drive A. Printing to a networked LaserWriter is also supported.

SoftPC comes in 2- and 4-megabyte versions. Installation is straightforward: You pick a configuration, place the floppy disk for its first program into the Mac, and double-click on the Install application. Then you supply disks as the application requests them, until you're done.

You get two files: the

continued

The International Preview Society

**3 COMPACT DISCS,
RECORDS OR
CASSETTES \$1**
for just

plus shipping
and handling with
Club membership

With No Obligation To Buy Anything...Ever!

Vivaldi, The Four Seasons The English Concert/Pinnock. Archiv DIGITAL 115356

Horowitz in Moscow Scarlatti, Mozart, Rachmaninov, Liszt, Chopin, Scriabin, others. DG DIGITAL 125264

Perlman: French Violin Showpieces Havanaise, Carmen Fantasy, Tzigane, more. DG DIGITAL 115457

Tchaikovsky, 1812 Overture; Romeo & Juliet; Nutcracker Suite Chicago Symphony/Solti. London DIGITAL 125179

By Request...The Best Of John Williams & The Boston Pops Olympic Fanfare, Star Wars, more. Philips DIGITAL 125360

Brahms, Cello Sonatas Yo-Yo Ma, cello; Emanuel Ax, piano. Grammy Award Winner! RCA DIGITAL 154044

Galway & Yamashita: Italian Serenade Flute & guitar works by Paganini, Cimarosa, Giuliani, others. RCA DIGITAL 173824

Gregorian Chant Schola of the Hofburgkapelle, Vienna. Hauntingly serene. Philips DIGITAL 115434

Slatkin Conducts Russian Showpieces Pictures At An Exhibition, more. RCA DIGITAL 154358

Debussy, La Mer; Nocturnes Boston Symphony Orchestra/Davis. Philips DIGITAL 115068

Beethoven, Symphonies Nos. 4 & 5 Academy of Ancient Music/Hogwood. L'Oiseau-Lyre DIGITAL 115009

André Previn: Gershwin Rhapsody In Blue, Concerto, An American In Paris. Philips DIGITAL 115437

Mozart, The Piano Quartets Beaux Arts Trio; Bruno Giuranna, viola. "Absolutely indispensable."—*Stereo Review* Philips DIGITAL 115271

Teresa Stratas Sings Kurt Weill Surabaya-Johnny, Foolish Heart, 13 more. Nonesuch 124748

Tchaikovsky, Symphony No. 4 Chicago Symphony Orchestra/Solti. London DIGITAL 125038

Dvořák, Symphony No. 9 (New World) Chicago Symphony/Solti. London DIGITAL 115168

Mendelssohn, A Midsummer Night's Dream Neville Marriner, cond. Philips DIGITAL 115546

Ravel, Daphnis et Chloé (Complete) Montreal Symphony/Dutoit. London DIGITAL 115520

Mozart, Requiem Leipzig Radio Choir, Dresden State Orchestra/Schreier. Philips DIGITAL 115039

Pavarotti: Volare Title song, Serenata, 6 more. With Henry Mancini. London DIGITAL 125102

Handel, Water Music Eng. Concert/Pinnock. Archiv DIGITAL 115306

Rossini, Overtures Barber Of Seville, Tancredi, 6 more. Orpheus Chamber Orch. DG DIGITAL 115527

Horowitz Plays Mozart Concerto No. 23 & Sonata No. 13. Giuliani conducts. DG DIGITAL 115436

Eine kleine Nachtmusik Plus Pachelbel Canon, more. Marriner conducts. Philips DIGITAL 115530

The Canadian Brass: High, Bright, Light & Clear Baroque gems. RCA DIGITAL 144529

Bach, Goldberg Variations Trevor Pinnock, harpsichord. "Definitive."—*Stereo Review* Archiv 105318

Rachmaninov, Piano Concertos Nos. 2 & 4 Vladimir Ashkenazy. London DIGITAL 125074

Holst, The Planets Montreal Sym./Dutoit. London DIGITAL 115448

Handel, Messiah (Highlights) Musica Sacra/Wesienburg. Hallelujah Chorus, more. RCA DIGITAL 153586



This remarkable \$1 offer is being made to introduce you to an outstanding classical music membership—with never any obligation to buy.

You'll find hundreds of outstanding albums in each issue of the Society's magazine, which will be sent to you approximately every 3 weeks. That gives you 19 convenient, shop-at-home opportunities a year. But there is no obligation to accept any offering at any time.

You choose only the music you want!

If you'd like to accept the Main Selection, you need not do a thing. It will be sent automatically. If you'd prefer an alternate selection or none at all, just mail back the Notification Card by the specified date. You'll always have at least 10 days to decide.

Substantial savings with our half-price bonus plan.

For every regular purchase you do make, you'll receive bonus certificates good for half-price discounts. A shipping/handling charge is added to each shipment.

3 Compact discs or records or cassettes for just \$1!

Begin your membership now by choosing any 3 albums shown here for just \$1 plus shipping and handling. Send no money now. We want you to judge for yourself before you decide to buy. If not delighted, return your 3 albums at the end of 10 days without obligation.

SAVE

You'll receive bonus certificates for each album you order. Use them to get additional albums at half price!

The International Preview Society

P.O. Box 91406 • Indianapolis, IN 46291

YES! Please accept my membership in The International Preview Society and send me, for 10 days' FREE examination, the 3 albums I have indicated below. I may return them after 10 days and owe nothing, or keep them and pay only \$1 plus shipping & handling. I understand that I'm not obligated to buy anything...ever!

Please send all selections on Compact Disc Cassette Record

Write Selection Numbers Here:

Mr. Mrs. Miss _____
First Name Initial Last Name (PLEASE PRINT)

Address _____ Apt. _____

City _____ State _____ Zip _____

Telephone (_____) _____
Area Code

NOTE: Members who select compact discs will be serviced by the Compact Disc Club. Full membership details will follow with the same 10-day, no-obligation, no-minimum purchase privilege.

Limited to new members; continental U.S.A. only. One membership per family. We reserve the right to request additional information or reject any application. Local taxes, if any, will be added.



IPS 6650 E. 30th St./Indianapolis, IN 46219
IPS 522

New, Expandable Diskette Duplicator

Model 4D delivers 240 copies per hour, using any IBM PC/XT/AT or compatible.

- Multiple Formats, Including PS/2
- On-Screen Production Statistics
- Expandable Up to 8 Drives
- Multi-tasking

\$1,995



New Desktop and high-volume Production Autoloaders also available, for unattended operation. For more information or to order, call 415-651-5580.

Datapath

recision Media Duplication Products
© 1988, Datapath Technologies, Inc., 46710 Fremont Blvd., Fremont, CA 94538.

MAXIT increases your DOS addressable conventional memory beyond 640K

- Add up to 256K above 640K for programs like FOXBASE+ and PC/FOCUS.
- Short card works in the IBM PC, XT, AT, and compatibles.
- Top off a 512 IBM AT's memory to 640K and add another 128K beyond that.
- Run resident programs like Sidekick above 640K.
- Compatible with EGA, Network, and other memory cards.
- Add up to 96K above 640K to all programs.

Break through the 640 barrier. MAXIT increases your PC's available memory by making use of the vacant unused address space between 640K and 1 megabyte. (See illustrations)

Extend the productive life of your, IBM PC, XT, AT or compatible. The MAXIT 256K memory card and software works automatically. If you have questions, our customer support people will answer them, fast.

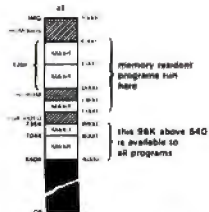

XT class machine (8088, 8086) w/640K and a CGA Color Monitor or a Compaq True Dual Mode Display.

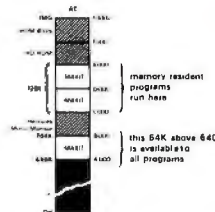

AT class machine (80286) w/640K and a Mono HERC Monitor.

Order toll free 1-800-227-0900. MAXIT is just \$245 plus \$4 shipping, and applicable state sales tax. Buy MAXIT today and solve your PC's memory crisis. Outside the U.S.A. call 1-415-548-2085. We accept VISA, MC, American Express

MAXIT is a trademark of Osborne McGraw-Hill. IBM is a registered trademark of International Business Machines Corporation; Sidekick is a registered trademark of Borland International, Inc; FOXBASE+ is a trademark of Fox Software; Hercules is a trademark of Hercules Computer Technology, Inc; XT and AT are registered trademarks of International Business Machines Corporation; Compaq is a registered trademark of Compaq Computer Corporation.

SoftPC application, and a hard disk file. The hard disk file emulates a 1-megabyte DOS-formatted hard disk drive, complete with MS-DOS 3.30, including the DOS utilities and GWBASIC 3.22.

I tried both versions of SoftPC on a Mac II that was equipped with an Apple PC drivecard and a 5¼-inch floppy disk drive. Screen response, compared to other PC-compatibility products I've seen, was downright snappy: The window was as fast as a real PC's screen, and no lines were lost during scrolling. XyWrite III Plus, one of the most ill-behaved PC programs in existence, ran perfectly and responded accurately to the extended keyboard's function keys.

Printing to the LaserWriter with the Epson FX-80 mode from within XyWrite was slow but reliable. I encountered no problems when issuing DOS commands to drive A.

SoftPC is MultiFinder-compatible, although it does no background processing, and cutting or pasting to and from the PC window is not supported. You won't be able to run under MultiFinder on a Mac with 2 megabytes of RAM: SoftPC uses 1.7 megabytes of RAM. Even if you don't use MultiFinder, this is a tight fit.

If you need to dabble in the realm of MS-DOS once in a while and own or can afford a PC drive card and disk drive, SoftPC is a viable option.

—Tom Thompson



Souping Up the Toshiba Laptop

THE FACTS

EasyTalk
\$299.95

Requirements:
T1100 Plus or T1200.

Megahertz Corp.
2681 Parley's Way
Salt Lake City, UT 84109
(801) 485-8857
Invoice 857.

When I sat down to install EasyTalk from Megahertz on the Toshiba T1100 Plus, I made sure I had some aspirin in the toolbox. It has been a month when everything I've touched has either

continued

We'll Give You Six Solid Reasons Why You Should Be Developing Your Applications In Clarion.



All New Version 2.0

The Clarion Professional Developer Is A Total Programming Environment That Runs On Any IBM PC, PS/2, Or True Compatible With 384K Of Memory And A Hard Disk. The Retail Price Is Just \$695. NOT Copy Protected.

CLARION

PROFESSIONAL DEVELOPER™

Circle 48 on Reader Service Card

Clarion Professional Developer and Clarion Software are trademarks of Clarion Software. Copyright 1988 Clarion Software.

1 Slash Your Total Development Effort... From Prototyping To Completion

You'll get live results fast—even before you write the first line of code. Ideas become running applications in a few hours.

Designer, the front-end application generator, allows you to produce major programs with *no coding*. It eliminates prototyping as a preliminary step because design and source code generation are done concurrently. You can implement a dazzling color screen or a report in minutes. You'll probably never code a screen again!

2 Automatically Generate Commented Source Code For Your Entire Application

The Professional Developer's **Designer** is the most powerful application generator in the industry. It creates structured source code that is fully commented. You can easily add to it, modify it, or just admire it.

And The Professional Developer is a complete development environment with all the tools that you need.

3 Create High-Speed, Bullet-Proof Data Management With Built-In LAN Support

Advanced techniques allow you to tune your data management to fit each application. Use related files, data encryption, memo fields, automatic recovery, and commit and rollback—all without compromising Clarion's high level of performance. And complete LAN features are included so the applications you develop will run on your network without any additional run-time or LAN PACK cost.

4 Interface To Your Own C or Assembler Routines For Special Requirements

The Professional Developer will support special device routines and complex logic written in C and Assembler. You won't have to completely re-write all those existing procedures. You can produce completely open-ended solutions that can grow with your needs or requirements.

5 Produce Executable Programs That Don't Need Run-Time Systems

Compile your application into an .EXE program that will run on a stand-alone computer or workstation so you can distribute your programs without costly run-time systems.

6 Get Started Immediately. You'll Be Productive The First Day.

Although there's a lot of horsepower "under the hood," you'll be producing programs soon after you open the package. You'll find the whole environment friendly and comfortable. PC Week says: "Clarion is easy to learn and easy to use."

And One More.

We'll Give You A Free Preview!

See Your Dealer Or Call Toll Free

(800) 354-5444

For A Free Copy Of Our Tutorial
Diskette And Introductory Material

(Or, simply return this coupon.)

Name _____

Company _____

Address _____

City _____ State _____ Zip _____

Phone (_____) _____

Mail This Coupon To:

Clarion Software

150 East Sample Road, Pompano Beach, FL 33064

*Want to save Time, Money,
& Headaches?*



**GET SUPERSOFT'S
SERVICE DIAGNOSTICS**

All the software, alignment diskettes, parallel/serial wrap-around plugs, ROM POSTs and extensive, professional documentation to provide the most comprehensive testing available for IBM PCs, XTs, ATs and all compatibles under DOS or Stand Alone. No other diagnostics offers such in-depth testing on as many different types of equipment by isolating problems to the board and chip level.

NEW: SuperSoft's ROM POST performs the most advanced Power-on-Self-Test available for system boards that are compatible with the IBM ROM BIOS. It works even in circumstances when the Service Diagnostics diskette cannot be loaded.

NEW: 386 diagnostics for hybrids and PS/2s!

For over nine years, major manufacturers have been relying on SuperSoft's diagnostics software to help them and their customers repair microcomputers. End users have been relying on SuperSoft's Diagnostics II for the most thorough hardware error isolation available. Now versions of Service Diagnostics are available to save everyone (including every serious repair technician) time, money, and headaches in fixing their computers, even non-IBM equipment.

All CPUs & Numeric Co-processors	All Color Graphics & Monochrome
System Expansion & Extended Memory	Monitors
Floppy, Fixed & Non-standard Disk Drives	Parallel & Serial Ports
Standard & Non-standard Printers	Mono, CGA, Hercules & EGA
System Board: DMA, Timers, Interrupt,	Adapters
Real-time Clock & CMOS config. RAM	All Keyboards & the 8042 Controller

Join the ranks of XEROX, NCR, CDC, SONY, PRIME, ... who have bundled SuperSoft's diagnostics with their microcomputers at no risk because of our 30 day money back guarantee.

Service Diagnostics for PC, PC/XT, and compatibles only	\$169
Alignment Diskette for PC, PC/XT and compatibles (48 tpi drives)	\$ 50
Wrap-around Plug for PC, PC/XT and compatibles (parallel and serial)	\$ 30
Service Diagnostics for AT and compatibles only	\$169
Alignment Diskette for AT and compatibles (96 tpi drives)	\$ 50
Wrap-around Plug for AT (serial)	\$ 15
ROM POST for PC, PC/XT, and compatibles only	\$245
ROM POST for AT and compatibles only	\$245
Service Diagnostics: The KIT (includes all of the above—save \$502)	\$495
Service Diagnostics for all other CPUs (386, V20, V30, Harris, etc.)	\$195
Diagnostics II is the solution to the service problems of users of all CP/M-80, CP/M-86 and MS-DOS computers	\$125
ROM POST for PS/2 and compatibles only	\$245
Alignment Diskette for PS/2 and compatibles (3.5 inch)	\$ 50

To order, call 800-678-3600 or 217-359-2112,
FAX 217-359-7225, or write SuperSoft.

your microcomputer repair solution



FIRST IN SOFTWARE TECHNOLOGY P.O. Box 1628 Champaign, IL 61820 (217) 359-2112 Telex 270365

SUPERSOFT is a registered trademark of SuperSoft, Inc.; CDC of Control Data Corp.; IBM PC, AT & XT of International Business Machines Corp.; MS-DOS of MicroSoft Corp.; NEC of NEC Information Systems, Inc.; PRIME of PRIME INC.; Sony of Sony Corp.

crashed, smoked, or simply died. I expected no better from this board. Boy, was I pleasantly surprised.

To install the board, pop off the back plate, slide the board in, tighten two screws, and flip one switch. That's it. The software end is just as easy: Add three lines to your CONFIG.SYS file, and you're ready to go.

Now when you boot up your T1100 Plus, you'll not only find a full-function, 1200-bit-per-second modem, you'll also discover a megabyte of additional memory, a RAM disk, a print spooler, and disk-caching capability. EasyTalk turns your floppy disk-based Toshiba into a laptop you can live with.

It takes some extra time, initially, to copy files over to the RAM disk. In about 40 seconds, my AUTOEXEC.BAT file activated EasyTalk's utilities, loaded Procomm and PC-Write to the RAM disk, and installed SideKick into conventional memory. This freed up my floppies for data or for additional programs. Also, because I was now working directly from RAM, everything accelerated.

Procomm, the communications software that is shipped with EasyTalk, booted from a floppy disk in 19 seconds; from the RAM disk, it booted in less than 2 seconds. It took 25 seconds to boot dBASE III Plus from a floppy disk, and 2 seconds from a RAM disk. Disk caching slashed dBASE in half. Also, word-processing tasks requiring disk access enjoyed hearty speed enhancement, and print spooling keeps you working even when the printer is busy.

Just like the version of Procomm (2.4) included with the package. The screen displays were nicely done, and the beep accompanying each keystroke was unobtrusive. Though I had never used Procomm, I had no problem learning how to use it. Pressing Alt-F10 calls a help file that outlines each feature, along with the keystroke se-

quence required to activate it.

Like PC-Talk, Procomm calls most features by using the Alt key in conjunction with a function key; and, by a simple change of the setup file, you can access your favorite word processor by striking Alt-A. For quicker access, I loaded PC-Write to my RAM disk. However, I could also call WordStar from drive A and use it from within Procomm.

Taking a tour of BIX, I checked many of the modem's functions: auto-dialing, manual dialing, macro log-ins, and multiple file transfers. Of the nine transfer protocols offered from Procomm, I tried five—XMODEM, YMODEM, MODEM7, Kermit, and ASCII—and each worked without a hitch.

EasyTalk adds essential features to a floppy disk-based laptop, and even a hard disk drive's performance will improve with disk caching and a RAM disk. And everything worked flawlessly.

—Stanford Diehl

GrandView: More than an Outliner

Software products that promise to organize your business or your life aren't new. But one that works is. I quickly found that GrandView is much more than a plain old outline program, and that's where its power lies.

Describing GrandView using a standard software category is difficult because, taken as a whole, it pushes the edge of current software development technology. But for simplicity's sake, I'll call it an integrated software package that's quite adept at planning and project managing.

GrandView handles information in three different ways, called *views*: outline, document, and category. Outline view is indeed a state-of-the-

continued

Great Selection + Superior Service + Competitive Prices = Top Value

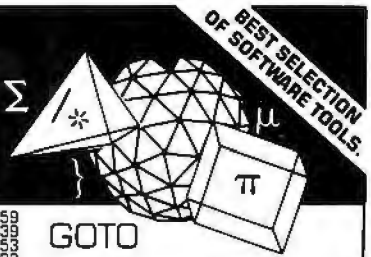

We have the technical expertise to fulfill your specialized needs in software development, circuit design, data analysis, CAD and much more. Call today!

- No one offers you more variety.
- 30-day Money-Back Guarantee*
- Latest versions
- Over 500 name-brand products in stock, if you don't see it — call!

Software Development Tools

ASSEMBLERS	
ADVANTAGE Disassembler, Lifeboat...	\$ 279
Microsoft MASM	99
OPTASM, SLR Systems	172

COBOL	
Micro Focus Products	\$ CALL
MS COBOL, Microsoft	452
Realia COBOL	794
RM/COBOL, Austec	753
SCREENIO, Norcom	382

BASIC	
Flash-up, Software Bottling Co.	\$ 80
MS Basic Comp. 6.0	182
MS QuickBASIC	69
QuickPak, Crescent Software	60
T BASIC, TransEra Corp.	453
Turbo Basic, Borland	69
Turbo Basic Toolboxes, Borland	69

PASCAL	
MS Pascal, Microsoft	\$ 189
Pascal-2, Oregon Software	180
Turbo Pascal, Borland	80
Professional Pascal, Metaware	549

C	
AZTECC-Commercial, Manx	\$ CALL
C-terp, Gimpel	232
Lattice C	239
w/Source	499
Microsoft C	285
Quick C, Microsoft	69
Turbo C, Borland	69

PASCAL LIBRARIES (TURBO)	
Turbo Pascal Dev. Lib., Borland	\$ 289
Metabyte Data Acq. TOOLS, Quinn-Curtis	90
Turbo Pascal S & E Tools, Quinn-Curtis	69
Turbo HALO, Media Cybernetics	80
Turbo MAGIC, Sophisticated Software	90
Turbo ASYNCH PLUS, Blaise	101
Turbo Power Tools Plus, Blaise	101

CLIBRARIES	
CTOOLS PLUS 5.0, Blaise	\$ 101
C Utility Library, Essential	125
Essential Communications	125
Greenleaf C Sampler	69
Greenleaf Comm Library	125
Greenleaf Functions	125
ForC+, Phoenix	249
Timeslicer, Lifeboat	279
Turbo C TOOLS, Blaise	101

MODULA-2	
LOGITECH Modula-2 Compiler Kit	\$ 81
Development System	199
Toolkit	141
SOLID B + Toolbox, Solid Software	89
StonyBrook Modula-2	179

386 DEVELOPMENT TOOLS	
386-Max, Qualitas	\$ 66
ADVANTAGE 386 C, Lifeboat	839

Science & Engineering Software

CIRCUIT DESIGN/SCHEMATIC CAPTURE	
HiWIRE, Wintek Corp.	\$ 849
MICRO-CAP II, Spectrum Software	759
PADS Drill, CAD Software	CALL
PADS PCB	CALL
PADS Router	CALL
Pspice, MicroSim	899
D device Equations Source	309
Probe graphics post-processor	399
Parts parameter estimator	399
Monte Carlo Analysis	309
Digital Files	309
Schema II, Omation	449
SMARTWORK, Wintek Corp.	449
Tango PCB, ACCEL Tech	469
Tango Route, ACCEL Tech	469

MathCAD 2.0, MathSoft	282
Math Mate, MC AE Technologies	89
muMATH, Soft Warehouse	189
SolveIt!, Structured Scientific Software	79
Solver-C, SDDC	79
TK!Solver Plus, Universal Tech Sys.	395

DATA ACQUISITION/SIGNAL ANALYSIS	
Asyst 2.9	\$ 2,179
Asyst Modules 1, 2, 3	1,989
Asyst Modules 1, 2, 4	1,989
Asyst Module 1, 2	1,609
Asystant Plus, Macmillan	849
Asystant, Macmillan	469
DADISP, DSP Systems	749
DADISP-489, DSP Systems	175
Fourier REASPECTIVE II, Alligator Trans	329
HYPERSIGNAL, Hyperception	309
HYPERSIGNAL Plus	439
LABTECH Acquire, Lab Tech. Corp.	179
LABTECH CHROM	709
LABTECH Notebook	759
LABTECH Real Time Access	269
Lotus Measure	445
E.E.D. D.A. and Control, Hart Scientific	799
SNAP-CALC, HEM Data Corp.	350
SNAP-FFT, HEM Data Corp.	269
SNAPSHOT STORAGE SCOPE	495
UnkelScope Junior, Unkel Software	109
UnkelScope Level 1	315
UnkelScope Level 2 +	499

CAD	
AutoCAD, by Autodesk	\$ CALL
Autosketch, by Autodesk	65
Speed Enhanced Version	79
Design CAD, American Small Bus. Comp	21 9
Drafix 1 Plus, Foresight	239
Drafix 3-D Modeler, Foresight	169
EASYCAD, Evolution Computing	139
ECAD, Pelton Engineering	699
FASTCAD, Evolution Computing	1,849
Generic CADD	69
Generic 3-D Solid Modeling	159
3-D Rendering Module	119
InA*Vision, Micrografix	459
Windows Draw w/Clip Art	239
Windows Graph	319
LaserCAD, DSL Link	69
PRD-3D/PC, Enabling Technologies	355
TurboCAD, MSA Group	79

PLOTTING AND GRAPHING	
ChartBuster PC, Interchart Software	\$ 369
Datatap Graph, Milhalsin Assoc.	259
Omniplot, Scientific Endeavors	269
PC MAP III, Peerless Engineering	755
PLOTZ, Curtis Technical Soft.	319
TECH*GRAPH*PAD, binary engineering	259

AUTOCAD ADD-ONS	
AutoESL, Systems Unlimited of CA	\$ 279
AutoSNAPs	189
FSIMPLEX	89
Turbo View, Sublogic Corp.	449

MOUSE PRODUCTS	
LOGITECH HiRez Mouse	\$ 149
LOGITECH Serial or Bus Mouse	99
LOGITECH Others	CALL
LOGITECH Series 2 Mouse	89
Microsoft Ser or Bus Mouse	99
W/Easy CAD	119
W/MS Windows	139
SUMMAMOUSE, Summagraphics	99

APL LANGUAGE	
APL+PLUS/PC, STSC	\$ 499
APL+PLUS PC TOOLS	209
Pocket APL	80

SCIENTIFIC TEXT PROCESSING	
CHEM-TEXT, Molecular Design Ltd.	\$ 1,500
EXACT, Technical Support Software	419

FORBASE +/386	459
High C, Metaware	839
NOF FORTRAN, Microway	559
Pharlap 386/ASM/LINK	422

386 SOFTWARE	
DESQview, Quarterdeck	\$ 115
Microport—Sys W/386 Comp	799
MS Windows/386, Microsoft	130
PC MOS/386, Software Link	181
VM/386, IGC	182
SCO XENIX—Complete	1279

DEBUGGERS	
Periscope II	\$ 141
OTHER Periscope Products	CALL
Advanced Trace-86, Morgan Computing	121
Breakout, Essential	89
Tdebug PLUS V.4.0, Turbo Power Soft	39
w/Source	80
Pfix86plus, Phoenix	215

EDITORS	
BRIEF, Solution Systems	\$ CALL
w/DBRIEF	CALL
EDII, Enging Technology	159
EMACS, Unpress	268
Epsilon, Lugaru	151
KEDIT, Mansfield	120
MULTI-EDIT, American Cybernetics	90
Norton Editor	70
PC/EDIT +, Boston Business Computing	269
Pmate, Phoenix	115
SPF/PC, Command Technology	185
VEDIT PLUS, CompuView	131
XTC, Wendin	80

FILE MANAGERS	
Btrieve, Softcraft	\$ 185
Xtrieve	109
Report Option	109
CBTREE, Peacock System	141
c-tree, Faircom	318
r-tree	241
dbc III, Lattice	172
dbc III/II w/Source	363
dbc III PLUS	599
db VISTA OR db QUERY, Raima	CALL
XOL, Softcraft	599

GRAPHICS	
ADVANTAGE Graphics, Lifeboat	\$ 228

GOTO

Drawbridge, Courseware Applic	111
Essential Graphics	229
Graphic, Software Endeavors	322
GS 9 Graphics Dev. Toolkit, Software Endeavors	399
HALO '88, Media Cybernetics	559
HOOPS, Ithaca Software	554
MetaWINDOW, Metagraphics	162
MetaWINDOW PLUS	232
Turbo WINDOW/C	80
Turbo HALO (Turbo C), Media Cybernetics	80

OBJECT - ORIENTED	
ACTOR, White Water Group	\$ 423
ADVANTAGE C++, Lifeboat	479
ForC+++, Phoenix	219
Smalltalk/V, Daitalk	159
Smalltalk/V286	159

OPERATING SYSTEMS	
Microport DOS Merge	\$ 219
Microport Sys V/AT	599
SCO XENIX System V	999
Wendin-DOS	80
Other Microport, Sco, Wendin Products	CALL

SCREENS/WINDOWS	
Greenleaf Data Windows	\$ 209
MS Windows, Microsoft	69
MS Windows Dev. Kit, Microsoft	319
PANEL Plus, Lifeboat	395
PANEL /QC or /TC	99
Vitamin C, Creative Programming	162
Windows for Data, Vermont Creative	CALL
ScreenStar w/Source, Essential	169
SoftCode, Software Bottling Co	119
Turbo POWER SCREEN	101

OTHER PRODUCTS	
Dan Bricklin's Demo Program, Software Graden	\$ 60
MKS Toolkit	145
MS OS/2 Programmer's Toolkit	229
PC lint, Gimpel	101
Plink 86Plus, Phoenix	279
Polytron PVCS CORPORATE	323
Pre-C, Phoenix	159
SEIDL Version Manager	265
Source Print, Aldebaran Labs	81

EXP, Brook's/Cole Publishing	129
For Math, Shantha Software	379
Lotus Manuscript	445
PC TEX, Personal TEX	229
TC Sci. Word Proc., TCI Software Res.	499

STATISTICS	
ASST, Anderson Bell	\$ 315
CS, StatSoft	469
Microstat, Ecosoft	319
NWA STATPAK, Northwest	749
P-STAT	659
The Scientific Wheel, Dalin Inc.	99
SPSS/PC +	749
StatPac Gold, Walonick Associates	539
STAT S - StatSoft	229
THE SYSTAT	CALL

ADDITIONAL SEE PRODUCTS	
ATLAS*GRAPHICS, STSC	\$ 339
Atoms, Curtis Technical Soft	25
COMPEDITOR, Aveco Inc	155
Engineer's Aide, Eng Prog Concepts	649
LASCAUX 1000 Calculator	55
PC-Matlab, The Math Works	659
Control System Toolbox	375

System ID Toolbox	375
POINT FIVE, Pacific Crags	279
The Professional Wheel, Dalin Inc.	199
Unics, Curtis Technical Soft	25

FORTRAN LANGUAGE	
DIFF-E-O, Microcompatibles	\$ 449
Extend, Design Decisions	131
Grammatic or Plotmatic, Microcompatibles	119
Lahey F77L-EM/32	805
Lahey Personal FORTRAN	89
MathPac, Systolic Systems	445
Microsoft FORTRAN w/CodeView	269
Numerical Analysis, Magus	249
RM/FORTRAN, Austec	279
Spindrift Library, Laboratory LTD	135
SSP/PC, Lattice	279

GAUSS	
GAUSS Prog. Lang., Aptech Sys	\$ 189
GAUSS Math & Stat System	339

X-ASMS/SIMULATORS	
Microtec, Reims, Uniware, Quelo	\$ CALL

Ordering Information

We accept AMERICAN EXPRESS, MC, VISA and PERSONAL CHECKS. There is no surcharge on credit card or C.O.D. New York State residents must add sales tax. Shipping and handling \$3.95 per item within the U.S., sent UPS ground. Rush and international service available. Call for prevailing rates.
• International orders add \$10 for export preparation.
• Prices and policies may change without notice.
• Dealers and Corporate Buyers call for special rates.
• Mail orders must include phone number.
• Ask for details before you buy; some manufacturers won't take returns if disk seals are broken.

Call for your FREE catalog today!

In the U.S. call
1-800-333-3141

International Orders: 914-332-0756

Science & Engineering SOFTWARE CO.

55 South Broadway, Tarrytown, NY 10591

A Drawing Tool...

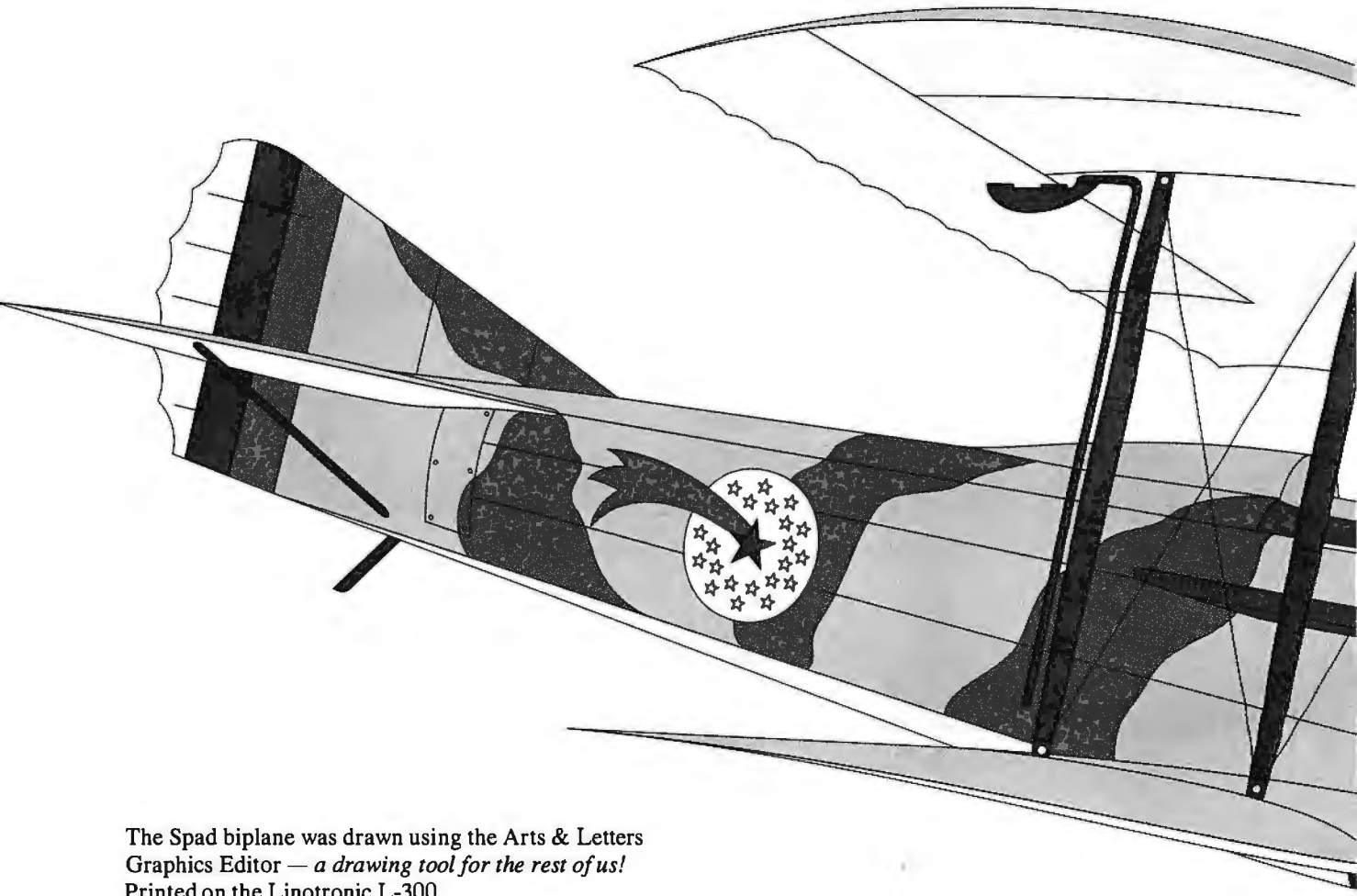

The Spad biplane was drawn using the Arts & Letters Graphics Editor — *a drawing tool for the rest of us!*
Printed on the Linotronic L-300.

Short on Time?

For those of us with little artistic skill, and even less time, the Arts & Letters Graphics Editor offers the ability to modify professionally drawn clip art quickly and easily.

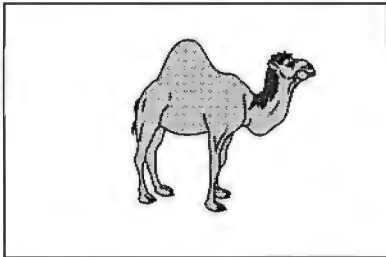

Often you will find the exact drawing you need from among the thousands of clip art drawings available with Arts & Letters. But if you don't, there is usually a drawing you can customize to your requirements.

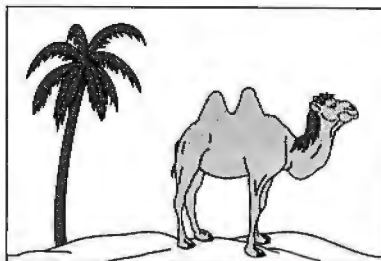

For example, the drawing of a one-hump camel can easily be changed to a two-hump camel. Just place the cursor at the top of the single hump and drag the curve down to form two humps.

Of course you can also split a shape at a point, delete segments, join shapes, snap to points and move a point or group of points. And the lines and curves will be smoothly joined and stay smooth throughout the editing process.

Because you don't need to specify control points when drawing Bezier curves, freehand drawing is greatly simplified. And don't worry if the lines you've drawn appear squiggly — the Graphics Editor will convert them into smooth curves automatically.

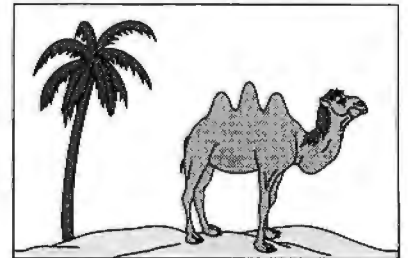

The above drawing was created in about two minutes. If that sounds too good to be true, see for yourself. Order a videotape demonstration of the Graphics Editor today.

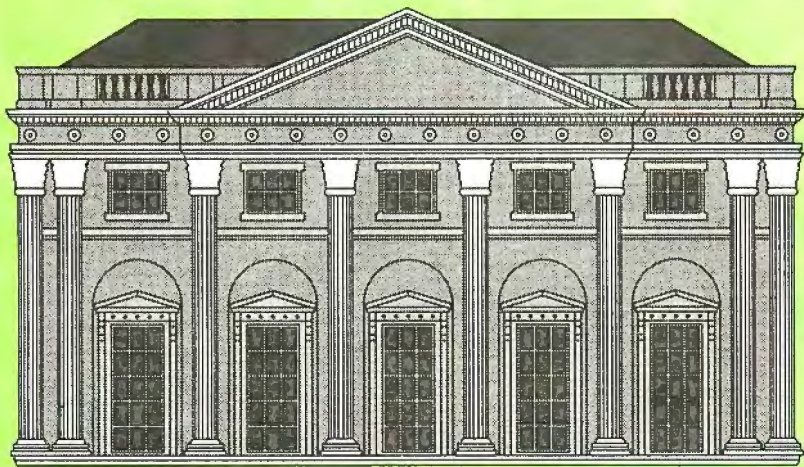

See For Yourself

Whether you're a professional illustrator or can't draw a straight line, we have the graphics solution for you. And it runs on your IBM or compatible personal computer.

For more information about the Arts & Letters family of products, mail this card today or for a video tour, order a demonstration videotape.

Please send me:

- Information about Arts & Letters
- VHS demonstration video (\$9.95)
- Beta demonstration video (\$9.95)

If shipped to a Texas address, please add sales tax. Price includes shipping and handling (U.S.A. only). Add \$5.00 for shipments outside the U.S.A.

Enclosed is my check or money order for \$ _____

For credit card orders, call us at (214) 661-8960.

Offer good through August 31, 1988.

Arts & Letters is a trademark of Computer Support Corporation.
IBM is a registered trademark of International Business Machines Corporation.

The house shown above was drawn using the Arts & Letters Graphics Editor — a drawing tool for the rest of us!
Printed on the Linotronic L-300.

Mr. _____ Mail Stop _____
 Ms. _____

Title _____

Company _____

Street _____

City _____ State/Province _____ Zip/Postal Code _____

Country _____ Telephone () _____

TAPE BUSINESS
CARD HERE



No postage
necessary
if mailed in the
United States

Business Reply Mail

FIRST CLASS PERMIT NO. 312 CARROLLTON, TEXAS

Postage will be paid by addressee

Computer Support Corporation
Attn: Marketing Communications
15926 Midway Road
Dallas, Texas 75244



for the Rest of Us.

No Need to Trade In Your PC

The Arts & Letters Graphics Editor is a freehand drawing tool for IBM and IBM compatible personal computers.

You draw with a mouse using pull-down menus and dialogue boxes or select the most commonly used functions from an on-screen toolbox. Unlike a paint program, your drawing is composed of lines and curves, not pixels, so you can size, stretch, rotate, flip, bend and twist it any which way.

Can't Draw a Straight Line?

We developed Arts & Letters just for you. Depending on your level of artistic ability, there are several ways to create high-quality line art.

Modify Predrawn Clip Art

The Graphics Editor comes with over 1,000 clip art drawings, and thousands of optional drawings are also available. So you can start with most of the work already done for you by a professional artist.

Trace Scanned Images

Trace scanned artwork, logos, blueprints and photos. Use the editing features to fine tune the drawing. Very little artistic skill is required and this approach gives you an unlimited choice of subject matter.

Draw Your Own

Of course if you're a skilled artist, you can draw complex illustrations freehand. But when you're working against a deadline, modifying predrawn clip art can save lots of time.

Perfect For Desktop Publishing

Using cut, copy and paste commands, drawings created using Arts & Letters can be incorporated in any of the popular word processing or desktop publishing applications that support Windows. You can also exchange data with any non-Windows application that supports EPS, CGM or TIFF.

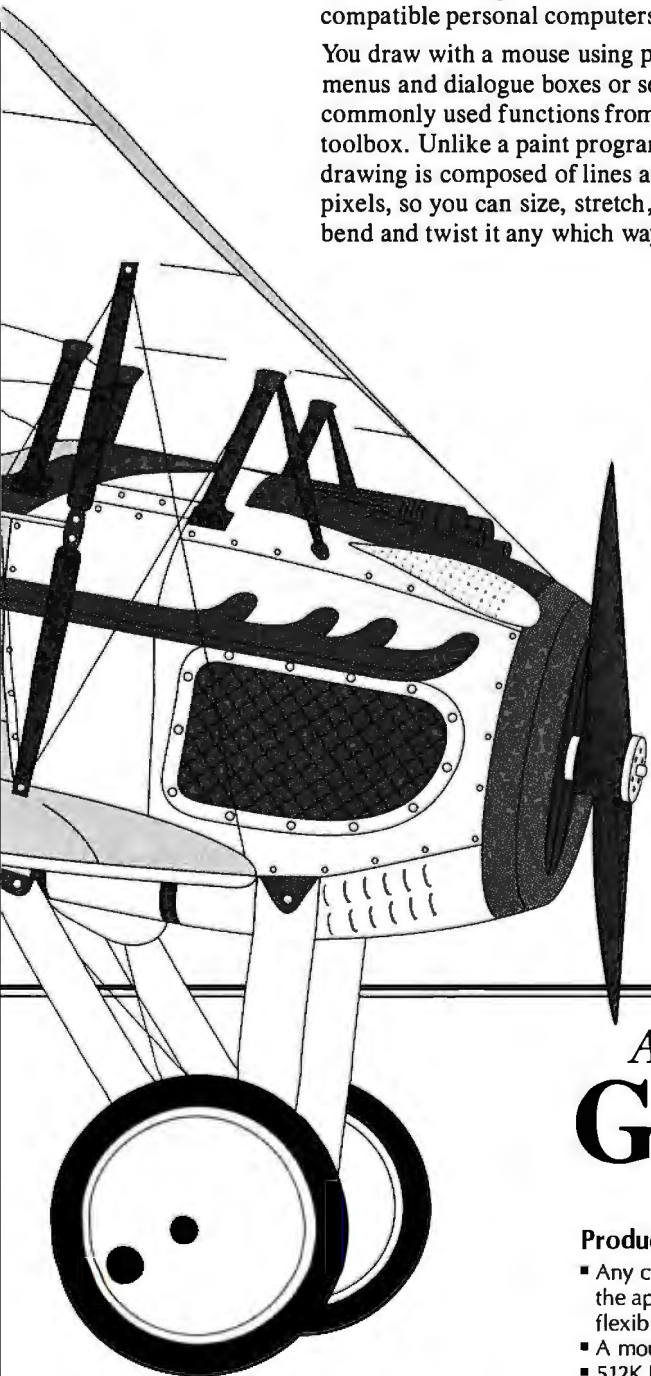

ARTS & LETTERS[™] Graphics Editor[™]

Product Requirements

- Any computer with Microsoft Windows, and the appropriate version of MS-DOS; one flexible disk drive and one fixed disk drive.
- A mouse or other drawing device.
- 512K RAM memory (640K recommended).

\$595
Suggested Retail

Send for your videotape demonstration of the Graphics Editor today.

Computer Support Corporation
15926 Midway Road
Dallas, Texas 75244
(214) 661-8960

Microsoft and MS-DOS are registered trademarks of Microsoft Corporation. IBM is a registered trademark of International Business Machines Corporation. Arts & Letters is a trademark of Computer Support Corporation. Product specifications are subject to change without notice.

C_talk™ Object-oriented Extensions For C

**C_talk, A SERIOUS TOOL FOR
SERIOUS SOFTWARE ENGINEERS:**

- Adds encapsulation, inheritance and dynamic messaging to your C compiler.
- Smalltalk-like **Browser** for building objects.
- Semi-automatic **Make** for building applications.
- Preprocessor** for converting objects to standard C source code.
- Foundation classes to help you get started.
- Professional telephone support from our engineering staff.

**STILL
\$149.95**

Start building software components into your next application. Join the leading edge today.

Order Now:

CNS, Inc.
Software Products Dept.
7090 Shady Oak Road
Eden Prairie, MN 55344
Tel: (612) 944-0170
Fax: (612) 944-0923
30 day money back guarantee
MasterCard, Visa
Shipping: \$ 5 - U.S.
\$ 25 - Int'l.

C_talk is designed for an IBM® PC (or compatible) with: Microsoft® C, Lattice C, Turbo C, or C86. A system with a hard drive and mouse is highly recommended.

IBM is a registered trademark of IBM Corp. MICROSOFT is a registered trademark of MICROSOFT CORP. C_talk is a trademark of CNS, Inc.

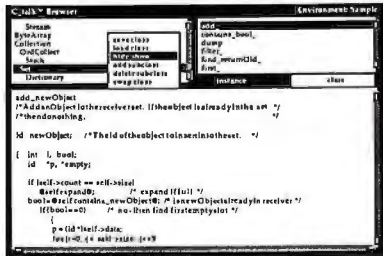

THE FACTS

**GrandView
\$295**

Symantec
Living Videotext Division
117 Easy St.
Mountain View, CA 94043
(415) 964-6300
Inquiry 851.

Requirements:

IBM PC, XT, AT, or compatible, or IBM PS/2; DOS 2.0 or higher and 256K bytes of RAM; hard disk drive recommended.

DP100 MINI-AT ENCLOSURE



\$252.00

Ideal for Plug-In AT CPU Boards:

- MICROMINT CCAT (OEM-286) board (see "Circuit Cellar" Sept '87)
 - SIGMA DESIGNS CPU 386 board set
 - and Others
- Five 8/16 bit full-length expansion slots
 - Three 1/2 height drive slots w/drive mounting rails
 - 100 watt power supply w/high surge capacity & fan
 - Keyboard connector, keylock & speaker
 - Four serial/parallel connector punchouts
 - Dimensions: 6.25" H x 11.75" W x 15.25" D



DISKS PLUS

Microcomputers & Peripherals
DISKS PLUS, INC.
356 Lexington Drive
Buffalo Grove, IL 60089

Trademarks: IBM PC-AT, International Business Machines Corp., CCAT and OEM-286. The Micromint, Inc.: CPU 386, Sigma Designs, Inc.

Telex: 650 249 2139 MCI UW
Fax: (312) 537-8331
Technical and more info:
(312) 537-7888

art outliner, with a host of features that let you expand, contract, and move outline elements around.

Document view is a fancy term for GrandView's word processor. Taken by itself, however, it's a word processor with features that put it nearly on a par with stand-alone word-processing packages with hefty price tags. It's also customized to work seamlessly with the rest of the package.

I found GrandView's category view its most intriguing and potentially most useful feature. It lets you take information from your outline or other document and assign it—as the name implies—to a category. It gathers related information from throughout an outline and displays it on a single screen.

For instance, in a long outline that covered all the aspects of a publishing project, category view let me quickly pull out editorial, circulation, and marketing areas and see their dependencies and schedules.

In category view, an outline or document becomes an effective project manager, though GrandView is far from a full-fledged project-management package.

While it's relatively easy to throw together a quick outline or two, getting the most out of the package's features requires time and dedication. You'll need to learn numerous unfamiliar terms, and I was at first frustrated by key-stroke sequences that seemed strange (e.g., Control-Enter to add a new heading to an outline).

If your outlining needs tend toward simple priority lists, GrandView is much more than you need. But if you have a real need to organize scattered pieces of information into viable projects, GrandView—once you get over the top of the learning curve—will save scads of time and money. Considering this program's power, the \$295 price tag is more than reasonable.

—Stan Miastkowski
continued



Coming from Lotus.

THE COST OF A MEGABYTE HAS JUST GONE DOWN!

- WITHOUT SACRIFICING -

- **HIGH PERFORMANCE** As fast as 17msec
- **HIGH CAPACITY** As large as 319mB
- **RELIABILITY** At Least 1 year warranty

HARD DRIVES

301 mB and Above

MiniScribe 9380E (ESDI)	319mB 17msec fh	\$2659.00
Maxtor EXT4380 (ESDI)	319mB 27msec fh	\$2749.00

101mB to 300mB

MiniScribe 6128 (RLL)	108mB 28msec fh	\$749.00
Maxtor XT2190 ST506	150mB 30msec fh	\$1988.00
Maxtor XT1140 ST506	112mB 27msec fh	\$1845.00

61mB to 100mB

MiniScribe 6085	72mB 28msec fh	\$649.00
MinScribe 6079 (RLL)	66mB 28msec fh	\$599.00
MiniScribe 3675 (RLL)	62mB 61 msec hh	\$339.00
Seagate 4096	80mB 28msec fh	\$699.00
Seagate 277R (RLL)	65mB 39msec hh	\$399.00

41mB to 60mB

MiniScribe 6053-2	44mB 25msec hh	\$499.00
MiniScribe 3650	42mB 61msec hh	\$299.00
Seagate 251-1	42mB 28msec hh	\$449.00
Seagate 251-0	42mB 39msec hh	\$359.00

20mB to 40mB

MiniScribe 8438 (RLL)F	30mB 40msec 3 1/2"	\$249.00
MinScribe 8425F	20mB 40msec 3 1/2"	\$239.00
MiniScribe 8438 (RLL)	30mB 65 msec 3 1/2"	\$225.00
MiniScribe 8425	20mB 65msec 3 1/2"	\$215.00
Seagate 238 (RLL)	30mB 65msec hh	\$225.00
Seagate 225	20mB 65msec hh	\$215.00
Seagate 138-0	30mB 40msec 3 1/2"	\$379.00
Seagate 138-0 (RLL)	30mB 40msec 3 1/2"	\$319.00
Seagate 125-0	20mB 40msec 3 1/2"	\$249.00

XT Kits- Additional \$50 for MFM drives, \$60 for RLL drives
QUANTITY PRICING AVAILABLE

100% SATISFACTION GUARANTEE

Full manufacturers warranty plus 30 days 100% satisfaction guarantee. If you are not completely satisfied with the products that are shipped, simply call to return within 30 days.

COMPUTER PRODUCTS CORPORATION

4657 MacArthur Lane, Boulder, CO 80301 • 303-442-4747

ORDERS ONLY

1-800-338-4273
 MONDAY-FRIDAY 8AM-6PM, MST

What, Me Forget?

Just what I need, an additional terminate-and-stay-resident (TSR) desk accessory program. Well, maybe I don't need this one, but it did save me the embarrassment of forgetting two birthdays.

Forget-Me-Not (FMN) from Sterling Castle Software is a calendar/timer TSR program with a unique ASCII-based engine. (I was working with a prerelease version.) It can pop up reminders on your screen at times and dates you choose. Also, it can activate batch files you create to do tasks, such as sending multiple messages via electronic mail or a network and doing backups or disk maintenance when you aren't using the machine. To do network communications, you need a copy of FMN installed at each node.

Sterling Castle bills FMN as "the first timed-release software." The heart of it is the concept of file accessibility. FMN can read all printable ASCII characters in a file and respond accordingly. If you want to set up a biweekly midnight or lunchtime backup process, just get into your favorite word processor and type in the necessary commands, just as you would if you were going to do the backup manually. You must preface the batch file with an FMN control line that specifies the type of message it is and at what times and on what days you wish it to occur.

Save the unformatted file and copy it to the appropriate FMN message file. You can have up to 16 different message types, each customized to fit your situation. When the conditions you specified are met, the file will activate. When it's done, you'll find a message that indicates success. If there is no message, you know something went awry.

If you're worrying about a

private reminder popping up while someone is looking over your shoulder, FMN covers that, too. You can attach an acknowledgment attribute to your messages so the computer will beep when the reminder is ready to pop up. Unless you hit the appropriate key, which is also selectable, the message won't be displayed.

If you are already using TSRs like SuperKey, Side-Kick, Homebase, ProKey, or others that give you some sort of notepad and keyboard macro capability, you can use them to automate the reminder-writing process. For instance, if you have a "call back" file format for returning phone calls, you can set up keyboard macros to leap from your present application into your word processor or notepad TSR.

Once there, you type in the reminder you need, send the file to FMN's "call back" file, and jump back to your original application with a minimum of keystrokes. If your TSRs work with your other applications software and can produce ASCII files, FMN should work just fine for you.

FMN is written in assembly language and requires 24K bytes and some buffer memory, for a total of 64K bytes. A version that will operate in extended memory is being considered for a later release.

—Gene Smarte

THE FACTS

Forget-Me-Not
 \$79.95

Requirements:
 IBM PC or compatible;
 128K bytes of RAM; DOS
 2.0 or higher.

Sterling Castle Software
 702 Washington St.
 Suite 174
 Marinadel Rey, CA 90292
 (213) 306-3020
Inquiry 854.



Coming from Lotus.

How To Grow A Laser Printer.

At QUME, we know you want a laser printer that grows up strong. *Not grows old fast.*

Which is why our full-line of laser printing products give you the right tools for today's printing needs. Plus they *plant* you firmly in the future by *growing* whenever you do.

HOW'S IT POSSIBLE?

Through our LaserTEN PLUS; the even more advanced ScriptTEN; the new ScriptTEN Upgrade Kit; or PageLINK, our office publishing system.

printer.

BEGIN with the crisp looking text of a LaserTEN PLUS.

THE GRAPHIC DETAILS.

The QUME ScriptTEN makes both you and your work look great through 300 dpi resolution. Not to mention the fact that it speaks fluent Adobe

PostScript® — offering you 35 type styles on either Apple® or IBM® computers. All at a swift 10 ppm, with 3 Mbytes of memory.

Or for general office printing needs, start with our 10 ppm LaserTEN PLUS. It gives you incredible print quality at an incredible value.

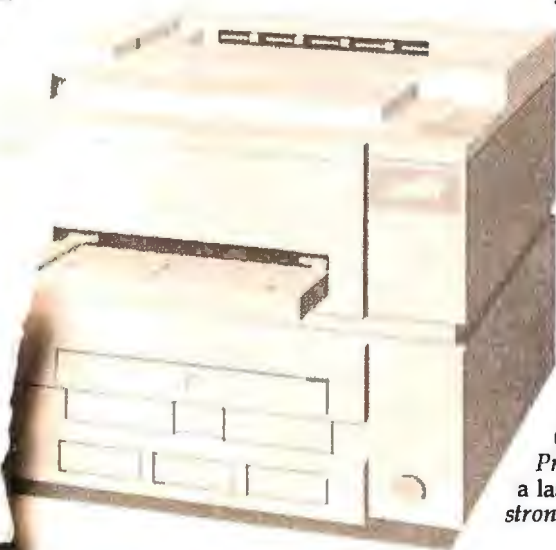

ADVANCE to the superior text and graphics of a ScriptTEN.

IT'LL GROW ON YOU.

Best of all, you'll like the LaserTEN PLUS even more when your demands become more sophisticated. Because through QUME's ScriptTEN Upgrade Kit, you protect your

LaserTEN PLUS investment by upgrading it to full PostScript and ScriptTEN features to meet all your desktop publishing needs.

And if that's not enough to satisfy your *growing* pains, there's also PageLINK. It allows up to 9 PC users to enhance their existing software to true publishing quality.

THAT'S TRUE FAMILY CONNECTIONS.

Which is something we understand. Because QUME's family of printers has been connecting customers with great letter quality printing for years.

TO FIND OUT MORE.

Call today for a demonstration or to receive your free copy of "How QUME Grows Laser Printers". Learn how to get a laser printer that *grows strong* in any business climate.

1-800-223-2479

©1988 QUME Corporation
LaserTEN PLUS, ScriptTEN, ScriptTEN Upgrade Kit, and PageLINK are trademarks of Qume Corporation. Apple is a registered trademark of Apple Computer, Inc. IBM is a registered trademark of International Business Machines Corporation.

Original output from QUME LaserTEN PLUS and ScriptTEN.

Circle 230 on Reader Service Card

Qume®

500 Yosemite Dr., Milpitas, CA 95035

Sun's New Workstation: the Sun386i

A microcomputer workstation that combines Unix multitasking, a window-based interface, and the ability to run several virtual PCs

Multitasking operating systems have been promising to provide microcomputer users with many services that mainframe users enjoy, such as electronic mail and background processing. Unfortunately, the promise has so far remained merely a promise.

The Commodore Amiga came with a multitasking kernel from the start, but its baroque command set, low-resolution display, and lack of hardware memory protection makes using it a chore at best.

Microsoft's OS/2 with the Presentation Manager is slated to be released late this year, and programs that take advantage of its multitasking features will undoubtedly arrive even later.

Apple's A/UX system provides multitasking, but it's literally Unix running on a Macintosh II: Gone is the familiar point-and-click user interface that many Mac users enjoy. Currently, some Mac applications can run under A/UX, but others can't. Like the situation with OS/2, Macintosh applications will be revised to be A/UX compatible, but until then, Mac users, like PC users, will have to wait.

A solution to this hurry-up-and-wait dilemma comes in the form of Sun's newest workstation, the Sun386i, designed around an Intel 80386 processor. Typical of its workstation caliber, it runs Unix, a time-proven multitasking operating system; it supports Ethernet commu-



nications; and it uses Sun's own Network File System (NFS) to provide access to files across networked devices. A point-and-click window-based user interface with icons and buttons simplifies such operations as examining or copying files and answering mail.

But what has attracted the interest of the microcomputer community is the Sun386i's ability to execute MS-DOS programs simultaneously as sessions in separate windows. A sophisticated monitor program also allows them to utilize the workstation's hard disk and memory without conflict. And this ability to run existing MS-DOS programs while reaping the benefits of a workstation is available now.

The Sun386i comes in two models: The Sun386i/150 uses 20-MHz components and has 4 megabytes of 100-nano-

second (ns) fast-CAS (column-address strobe) paged-mode RAM; the Sun386i/250 uses 25-MHz components and has 8 megabytes of 120-ns fast-CAS paged-mode RAM and a 32K-byte cache of 25-ns static RAM.

There are some minor differences, but for the most part the two microcomputers are identical, so we'll concentrate on the Sun386i/250. A Sun386i/250 with a 16-inch monitor and 91-megabyte hard disk costs \$17,990, and a Sun386i/150 with a 15-inch monochrome monitor and 91-megabyte hard disk (available in the third quarter of 1988) costs \$9990.

The Hardware

The Sun386i is a short, floor-standing desk-side unit with a single 3½-inch floppy disk drive. The system comes with a

continued

three-button optical mouse, a 107-key keyboard that has both Sun software-specific function keys (such as Help and Copy) and PC function keys, and your choice of a high-resolution color or monochrome monitor.

The heart of the Sun386i is a single system board that holds an 80386 processor; an 80387 math coprocessor (standard, not as an option); an 82380 DMA controller; an Ethernet interface using the Intel 82586 network processor, and a custom ASIC for the system interface; three slots for Sun 32-bit memory boards; and a video frame buffer slot that accepts three types of video display boards. All these components are connected on a 32-bit high-speed proprietary bus.

Interface electronics attach this 32-bit bus to a 16-bit AT bus and an 8-bit device bus. The AT bus handles the parallel printer port, floppy disk controller, three 16-bit AT-compatible slots, and one 8-bit XT-compatible slot for expansion cards. The device bus handles the SCSI port, serial port, ROM and nonvolatile RAM addressing, and clock.

The system's memory is contained on an expansion board that plugs into one of the memory slots. The memory board uses 1-megabit-density, parity-checked SIMMs (single in-line memory modules) that mount in a rack of sixteen clip-on sockets.

You can add extra memory to the board in 4-megabyte increments up to the maximum of 16 megabytes. An Intel

82385 cache controller chip is mounted on the board and implements a 32K-byte high-speed memory cache. This cache memory board is optional on the Sun386i/150.

Two optional high-capacity SCSI hard disk drives are available for the Sun386i: 91 megabytes and 327 megabytes (formatted). You can mount these drives internally within the system, or externally in an optional peripheral expansion box supplied by Sun. The 3½-inch floppy disk drive serves double duty as a drive for the Unix operating system or as drive A for a single MS-DOS program. Under MS-DOS, the drive can use both 720K-byte or 1.44-megabyte DOS-formatted floppy disks.

An external DB-50 SCSI port and switched power outlet located on the back of the computer allows you to connect the peripheral box, external tape drive, or other SCSI peripherals to the system. Also located at the rear of the computer is a "thick" Ethernet port with DB-15 connector, and two DB-25 connectors for the serial and parallel printer ports.

You have a choice of monitors and display boards to use with the system. A monochrome video board provides a 1152- by 900-pixel display for a 15- or 19-inch monochrome monitor. For color work, you have a choice of either a video board that provides a 1024- by 768-pixel color display for a 14-inch color monitor, or one that provides a 1152- by 900-pixel color display on a 16- or 19-inch color monitor. Both color video boards use a

fixed 8-bit image depth that allows you to display 256 colors on the screen simultaneously from a palette of 16 million colors.

The Software

The core of the Sun386i operating system is SunOS version 4.0, which is a converged version of BSD4.2/4.3 Unix and System V.3 Unix. Besides the usual Unix services, SunOS provides NFS capabilities, a window-based user interface called SunView, and ease-of-use facilities such as the Sun Organizer and Color Editor.

SunView represents active programs as icons, and these icons can be selected (left button) using the mouse. Selecting an icon opens a window, owned by the program, that accepts user commands or displays information. The icons and windows are placed on a desktop image quite similar to the Macintosh desktop display (see photo 1).

These windows allow you to type commands directly into the Unix operating system (the Commands window) or a DOS program (the DOS window). A System Messages window displays error messages issued by SunOS as they occur. A window can also present a specialized display, as determined by the program that owns it. For example, the Organizer program can give you a graphic map of the hierarchy of subdirectories and files in your home directory.

As with the Macintosh, you can open, close, resize, and drag the SunView windows to different parts of the screen using the mouse. The left button of the Sun386i mouse serves as a selector; that is, it selects (or activates) the object you click on the screen.

The middle button is used to move icons or windows about on the Desktop, although you need to place the pointer on a window's name stripe (similar to a Mac window's drag bar) or on its frame (the border) to move it. The right button is used to activate pop-up menus.

Clicking the right button on a window's frame pops up a Frame menu that's used to manipulate the window (for example, resize it) or to terminate the process owning the window. If you click the rightmost button within a window's interior, a program-specific menu pops up (for example, in a DOS window this menu lets you choose the type of PC screen display to use). Clicking on the Desktop itself pops up a Services menu that allows you to start a program not visible on the Desktop, start a copy of a program already running on the Desktop, or log out of the system.

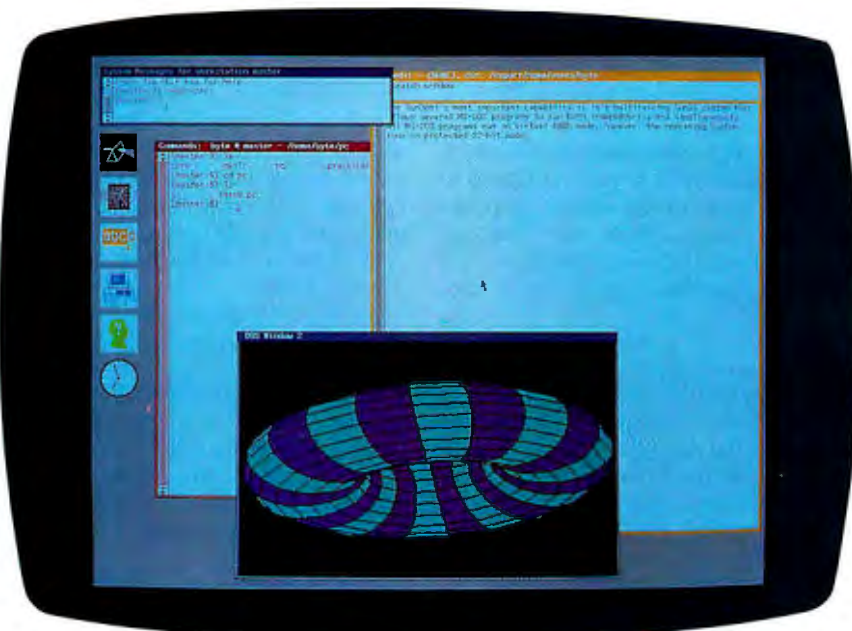

Photo 1: On the SunView Desktop, icons represent active processes, not files.

You don't click on a window to make it the active window, like on the Mac. Positioning the pointer over the desired window causes its frame to be highlighted, indicating that the process is ready to accept typed commands.

Some windows can have scroll bars that allow you to scroll through a long document or large display. Pressing the mouse's left button scrolls the window's contents upward, and pressing the right button scrolls the window's contents downwards. A window's name stripe also shows the name of the process that owns it and the current directory that the process is using.

A Mail program lets you send, receive, file, and print electronic mail. Selecting its postage-stamp icon gives you a window in which to examine or compose letters. All you need to know to send a letter is the system name of the recipient (for example, `byte_mag`), and their log-in name on this system (`editor`), so the mail address becomes `editor@byte_mag`. Once you've composed a letter and addressed it, you simply click on the Deliver button and Mail will transmit it to the appropriate remote system.

If you dislike maneuvering through Unix hierarchies by typing commands like `cd/export/home/users/byte/pc`, you can use the Sun Organizer program. The Organizer works like the Macintosh Finder by presenting a graphic representation of the subdirectories and files in your current directory. You navigate up or down directory levels by simply pointing and clicking with the mouse on icons and buttons in the Organizer's window. Unlike the SunView Desktop, icons in the Organizer program do represent files and directories (see photo 2).

You can also copy, move, or delete files within the Organizer by clicking on the desired file icon and then the appropriate button. The Organizer, like most SunOS programs, uses NFS to provide access to remote systems. From your `/net` directory, the Organizer lets you use the same graphic interface to select any remote Sun386i or NFS-based workstation on the network and then work with its files. This ability to seamlessly examine and copy files from a remote system makes the Organizer one of the most powerful programs on the Sun386i. Professional programmers can still use Unix programs such as `cp` to copy files from remote systems.

It Does DOS

OS/2 runs a single MS-DOS program in a Compatibility Box. SunOS allows you to run multiple copies of MS-DOS ver-

sion 3.3, each in its own window, and each running simultaneously along with other SunOS programs. PC programs can use the Sun386i's hard disk and floppy disk and access PC expansion boards plugged into the AT bus slots. PC programs can also take advantage of the system's networking facilities.

The SunOS DOS Windows program allocates memory and initializes the MS-DOS environment when you open a DOS window. Each PC program runs in the 80386's virtual 8086 mode, letting 8086 program code execute at full speed on the processor. Since the virtual 8086 mode does not support the 80286 protected mode, this type of program won't run on the Sun386i. As the program runs, the DOS Windows program intercepts hardware-specific calls and reroutes them to the appropriate SunOS routines.

For example, a call that writes to the PC's screen is emulated by DOS Windows by using the proper combination of SunView graphics routines. A DOS window can emulate a Hercules, monochrome, or CGA display. An AT-bus expansion card can provide support for EGA/VGA displays. You select the type of display to use by popping up a menu within the window's interior and choosing an item from the Show Screen item.

The DOS monitor allocates 1 megabyte of memory (for a 640K-byte DOS address space) and two megabytes of version 3.2 Lotus/Intel/Microsoft (LIM) expanded memory for a PC program when it starts. DOS Windows redirects LIM

memory accesses to this virtual memory space as they occur. Because the PC program and the LIM memory are located in the Sun386i's virtual memory, they can be swapped to and from the hard disk.

You can install four PC expansion boards within the Sun386i. However, it's not enough to physically install the board into a slot. You have to inform SunOS of the board's characteristics so it can respond appropriately when you access the board. To do this, you must become a Unix superuser and edit the `boards.pc` file in the `/etc/dos/default` directory. In this file, you supply the address space the board occupies and the interrupt levels it uses (if any).

Each user has a separate `/pc` subdirectory. In this subdirectory are four files: `autoexec.bat`, `config.sys`, `setup.pc`, and `C:`. The functions of the first two files are obvious; the other two files need explaining.

`Setup.pc` describes to SunOS which Sun386i devices are assigned to which DOS devices. For example, drive A is directed to the Unix device `/dev/rfd0c`, the Sun386i's floppy disk drive. `C:` is a specially formatted file made to resemble a 20-megabyte MS-DOS hard disk.

A DOS window normally places you on a drive D, which is actually the current Unix directory you're working in. However, programs with copy protection rely on certain PC hard drive characteristics that are missing on the Sun386i hard disk drive, and thus break during instal-

continued



Photo 2: The SunOS Organizer graphically displays the hierarchy of a directory.

Table 1: *On the BYTE benchmarks, the Sun386i/250 did better than the Compaq 386/20. Performance dropped as additional DOS windows were opened. Only benchmarks using algorithms were selected to make the performance comparison, since the DOS window is a process running under Unix. (All times are in seconds.)*

	Sun386i 1 task	Sun386i 2 tasks	Sun386i 3 tasks	Compaq 386/20	IBM PS/2 Model 80	IBM PC AT
Matrix	2.77	5.57	10.17	3.06	4.65	11.69
Sieve	19.33	36.99	54.50	23.18	29.11	40.26
Sort	19.05	39.41	60.28	26.89	33.11	84.39

lation or operation. C: is used to sidestep this problem by emulating an MS-DOS hard disk for this type of software.

PC programs assume that they have exclusive access to a computer's resources. This assumption becomes a problem when such programs are run in a shared environment. In the case of memory and screen I/O, the DOS Window redirects these functions to the appropriate section of virtual memory or to the program's DOS window. MS-DOS files located on the Sun386i hard disk are maintained by the Unix file system via DOS Windows, which can resolve I/O conflicts when more than one copy of MS-DOS attempts to access them. However, for drive C or drive A, Unix can't help. This is because drive C is a disk emulation, and is seen as one file by Unix. MS-DOS drivers must be used to access files within C or on drive A, and are therefore subject to the problems described earlier.

Sun came up with a clever solution for this problem: The first DOS window opened has exclusive write access to both drive A and drive C. You release the exclusive access by terminating the DOS window that owns them, or using a menu selection to modify the drive-access mode. This seems awkward, but if you use your files on drive D, you let Unix provide the shared access to your MS-DOS files.

How It Performs

I had an opportunity to examine two production Sun386i/250 workstations using a beta version of SunOS 4.0. Sun also generously supplied two thick Ethernet cables and an Ethernet multiport transceiver unit so that I could look at the system's networking capabilities. The Sun386i comes with the system software installed on the hard disk, so getting a system started was simply a matter of connecting the parts, turning on the power, and answering several questions about the system. This first system was started as a master server.

Sun claims that adding more 386i systems to the network "is extremely easy and requires no technical expertise." I soon put this statement to the test by connecting the second system's Ethernet cable to the transceiver box, which was connected to the master (first) system. Again, the system was turned on and several questions were answered, this time making the system a slave. After exchanging a flurry of data packets (as indicated by the status lights on the transceiver box), the second Sun386i announced its domain and system name, and the connection was completed. We managed to connect a Macintosh II running A/UX to the network only after we had set the Mac II's internet address and domain name correctly and configured it as a yellow pages client. This, needless to say, took a number of attempts. Compared to the few minutes it took for the second Sun386i to connect itself automatically to the network, I'd have to say Sun's statement about ease of network installation is true.

I tried XyWrite III Plus, Lotus 1-2-3 version 2.01, dBASE III Plus 1.01, Designer 1.0, and a program compiled in QuickBASIC 4.0 in the DOS windows. All programs ran reliably. I had a problem when using the DOS window menu to switch to the CGA mode: Once in it, the window seemed to stop operating. The problem was traced to failing to issue a mode co80 command to switch to the emulated color monitor. Once this command was added to the AUTOEXEC.BAT file, I had no further problems.

Of course, how fast are these PC programs if they run as a process on a Unix workstation? To answer this question, I executed a .BAT file that ran the new BYTE benchmarks several times and recorded the results, which I then averaged by hand. I next ran the benchmark batch file simultaneously in two DOS windows, and then in three. (Bear in mind that this is a multitasking Unix system, so these numbers are only a measure of the

DOS emulation, and not an overall measurement of the workstation itself.) Although I had several SunOS windows open, these processes were idle.

With the system quiescent, one DOS window performs better than a Compaq 386/20 (see table 1). With two DOS windows, you're doing slightly worse than an IBM PS/2 Model 80. With three windows active, performance sags close to that of an IBM PC AT. SunOS doesn't limit the number of DOS windows you can open, but if you expect reasonable performance, you won't use many more than three DOS windows at a time.

Once, while running an AT program on the system, I got an "Unsupported 286 instruction" in the System Messages window, and the DOS window abruptly disappeared. All other processes and DOS windows running were unaffected. A call to Sun got an explanation. The 80386's built-in memory management hardware had trapped the illegal instruction and called the appropriate Unix routine, which then killed the process.

The DOS window's disappearing act was an example of hardware memory protection in action: that is, the ability of the system hardware to isolate a process running amok and leave the other processes intact. This is an important area that shouldn't be overlooked: Multitasking operating systems should not only run processes simultaneously, they should also protect the processes' integrity. Sun has done a good job of implementing this type of protection in SunOS.

Where does the Sun386i fit in the scheme of the microcomputer industry? As an MS-DOS system, it offers good processing power and can provide it as virtual PCs in several DOS windows. You also reap the benefits of a workstation: good graphics, multitasking, and a networking capability that allows you to share files or send mail messages without becoming mired in the intricacies of learning Unix. For those who use Unix, the complete set of standard BSD and System V utilities is included and can be used in the Commands window.

However, a workstation makes demands of its owner in exchange: You need someone with Unix experience to configure the system software and modify it to accept PC expansion boards, and manage the network as it grows. If you're willing to accept the demands of a microcomputer workstation, the Sun386i will deliver ease of use and performance. ■

Tom Thompson is a BYTE Senior Technical Editor at Large. He can be reached on BIX as "tom_thompson."

Insist on a Sysgen 5¹/₄" drive for your PS/2.

Here's why:

A Sysgen™ Bridge-File™ gives a PS/2™ full access to your current data and software, with unparalleled 5¹/₄" disk drive performance and reliability. You get: **A larger capacity drive.** Two modes — a 360Kb and a powerful 1.2 Mb — assure you comprehensive transfer capabilities and convenience for total office needs. Others, like IBM®'s, offer only 360Kb. **Proven reliability.** In fact, Sysgen is the choice of over 100,000 satisfied Bridge-File and tape back-up users. **No slot loss.** The Sysgen 5¹/₄" drive adapter card doesn't take any additional slot space. **IBM's does.** **Built-in flexibility of an external connector.** You can add another Bridge-File drive or Sysgen's high-performance tape back-up system, Bridge-Tape.™ (As a Bridge-File owner, you receive a total savings of \$135 on Bridge-Tape!) **What's more,**

Sysgen's footprint is smaller. A full 50% smaller than IBM's. For the best PS/2 access to 5¹/₄" disks, and the best value at only \$325, insist on Sysgen Bridge-File.

Sysgen offers the only complete family of data transfer products: Including the 3¹/₂" Bridge-File floppy disk drive, for transferring information from any PS/2 to any PC. And the Bridge-Tape subsystem that's

PC and PS/2 compatible, giving you **total** tape back-up and data transfer flexibility.

Call for Sysgen literature or for the location of the Sysgen dealer nearest you.



INFO HOTLINE 1-800-821-2151

SYSGEN
INCORPORATED

Circle 260 on Reader Service Card



“Unlimited.”

un·lim'it·ed, a. [L. *limitus*]: *The ability to expand your personal computer's storage capacity beyond your wildest imagination.*

Up until now, the concept of unlimited PC storage capacity was about as practical as cramming all your office files into your briefcase. Storage capacity could only be stretched as far as the fixed capacity of your hard disk. Or to the limit of your patience for shuffling through stacks of floppies.

But imagine instead that you could insert and remove hard disks as easily as a VCR cassette—your PC's storage capacity would then be virtually limitless.

That's exactly the idea behind the Tandon Personal Data Pac, the world's first and only



number of self-contained, portable Personal Data Pacs that can be inserted and removed as easy as a floppy. Now a whole business worth of software and data can fit neatly into your briefcase. Ready to go anywhere your business will take you.

And when you are done for the

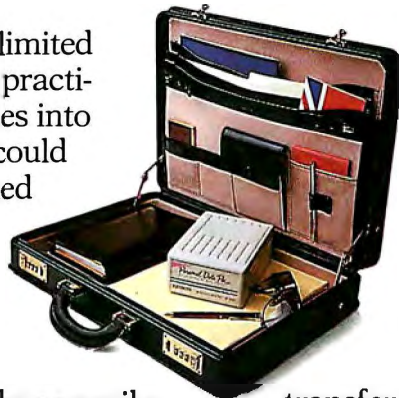

day, your entire information base can be simply locked away where only you can get at it.

If you want to share your software and data with others, the Tandon Personal Data Pac offers you the cheapest and most reliable “network” possible. Simply

transfer what you need from one Pac to another, and turn a shared PC into a dedicated workstation, just for you.

If your travels with the Data Pac take you on a bumpy road, don't worry. Your software and files will be safe and secure inside the Pac's rugged housing. It can even take a trip in the mail or an occasional fall off your desk.

See your Tandon Dealer today or call us at 1-800-556-1234, ext. 171 (in California 1-800-441-2345, ext. 171) and learn the new definition for personal computing.

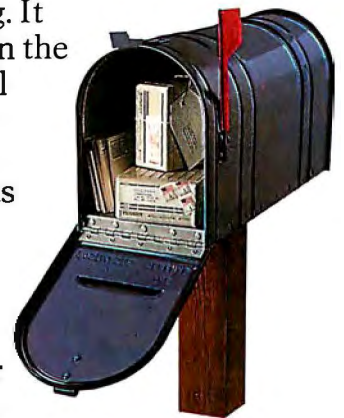

The possibilities are limitless.



Tandon

*We're redefining
personal computing.*



Removable Hard Disks 20 to 100MB

TransPac hard drives are the first removable drives from 20 to 100MB for IBM and compatible PC's, PS/2's and the Apple Macintosh.

The TransPacs can be used for data security - you can remove the drive and lock it up when leaving the office - or for backing up important data on an existing drive.

The 3 1/2" TransPac can be removed from its 5 1/4" chassis to provide you with a means of transferring data between PC's, AT's and PS/2's, or between Macintoshes.

The TransPac can mirror the computer's primary hard drive, providing a ready source of data in the event of a primary disk crash.

The shock-resistant TransPac drives are offered in capacities 20, 32, 45, 60, 80 and 100M bytes, and feature access times between 19 and 35 milliseconds.

Industry-standard interfaces, such as ST506, MFM, RLL and SCSI are also offered as options for the drives.

ProStor's internal TransPac fits in standard 5 1/4" PC floppy drive slots. External units are available for PC's, PS/2's and Macintosh computers, enabling you to transfer data from one machine to another by simply inserting the disk cartridge into its case.

TransPac drives are the only removable media available that can be locked in the machine for security when you are away from your desk for a short period and don't want to remove and lock the drive in a file or safe.

Why buy a removable hard disk?

1. Data security - lock up all your files when you are away from the office.

2. Better back up - skip the headache of tape devices - 3 times faster for backup & 1000 times faster to restore a file.

3. No down time - In the event of disk failure, you just snap in a new module (or your backup module) and you are on line in seconds!

4. Transportable - put a spare chassis in another machine and carry your data with you. We also offer a portable PC with a removable hard disk. Take your office hard disk with you on the road.

5. Archival - when you fill up your disk, you can lock it up and put another one in - no hassle! When you want to work with your archived disk, you're up and making changes in under a minute.

6. Fault-tolerant system - install two with our "Mirror" software & never be down again, or use a TransPac to mirror your existing drive.

ProStor, Inc.

55 Hawthorne St. Suite 530 San Francisco, CA 94105

415.974.6462

IBM's OS/2 Extended Edition

This greatly enhanced version of OS/2 packs its own database manager and an array of communications interfaces

IBM's shipment of OS/2 last December was only the first in a series that will offer progressively more powerful systems. The first version, Standard Edition 1.0, features multitasking and superior memory management that lets you run several applications concurrently and switch back and forth between them at will.

This month, IBM will release the Extended Edition (EE) of OS/2, which includes all the features of the Standard Edition, plus support for communications and a database management program. At a retail price of \$795, the EE may be one of the better values on the market. (Current owners of the Standard Edition can upgrade for \$600.)

Unlike the Standard Edition, which is available from other computer manufacturers, the EE will probably be available only from IBM. Later this year, IBM will replace both editions of OS/2 with free upgrades that will include the Presentation Manager, a graphical user interface similar to Microsoft Windows (see figure 1).

Why include a communications manager and a database manager with an operating system? According to IBM's projections, approximately 75 percent of its PC users will be using both database and communications software on their PCs. In addition, many users will want to run both types of applications at the same time. The ultimate goal of the EE is to allow you to access several databases at several locations at the same time, and to

have the whole process appear as if you were browsing through a single database on your own hard disk. (Unfortunately, this feature—which IBM calls Remote Data Services—is only a “planned enhancement,” meaning that the company will not make it available until some indeterminate date.)

In terms of code size, the EE is probably the most ambitious program to date for personal computers. It will be packaged on approximately 16 3/4-inch disks, with each disk having a capacity of 1.44 megabytes. The system requires an OS/2-compatible PS/2 or AT with 3 megabytes of RAM, and if you load the whole package on a hard disk, it may completely consume a 20-megabyte hard disk drive. Thus, even IBM PS/2 Model 50 users may have to consider purchasing a larger hard disk drive, or implementing only part of the EE. An installation program included with the system will let you save disk space by installing only those parts of the operating system you need.

No doubt a large part of the EE's disk space is taken up by its help facilities. In addition to contextual help screens, the EE also has a feature that lets you place the cursor on a particular word and call up a help screen pertaining to it. It also has a tutorial program that, according to IBM, can be easily modified, depending on your particular configuration.

The new OS/2 will also be the first program to conform to IBM's new Systems Application Architecture (SAA). This is a standard set of interfaces for users and programmers, designed so that users can easily switch between different applications on different types of IBM hardware, and source-level programs can be easily ported to different types of IBM systems and communications facilities.

Communicating with Several Systems at Once

The Communications Manager of OS/2 provides support in three areas: asyn-

chronous communications, which you could use to contact Dow Jones or BIX, or to connect with non-IBM host computers; support for the 3270-style terminals used by IBM's System/370 mainframes; and support for peer-to-peer communications using APPC (IBM's Advanced Program-to-Program Communications). APPC differs from the hierarchical structure of terminal-to-host communication in that it lets any machine communicate with any other machine on the network in an intelligent manner. Unfortunately, network support will not be available until version 1.1 of the EE becomes available in November.

The goal of the Communications Manager is to allow an OS/2 workstation to interact simultaneously with several other systems. With such a workstation you could check a number of things at once—for example, parts inventory on a mainframe database via a 3270 link, a customer database on another OS/2 system on a local network, and stock prices on a COM link to Dow Jones News Retrieval.

OS/2 Standard Version 1.0 provides good support for asynchronous communications via a device driver that supports up to three serial ports. The device driver operates with some high-level function calls that make it relatively easy to write a communications program.

In the EE, IBM provides such a program, an asynchronous communications program that can emulate a DEC VT-100 terminal or IBM's own 3101 terminal and that supports XMODEM file transfers. Unfortunately, this program can be used on only one of the asynchronous COM ports at a time.

Perhaps the most important value of the Communications Manager is its support of 3270-style communication with IBM System/370 mainframes. With the Communications Manager you may still need a coaxial 3270-style interface card (such as those provided by AST, DAC, or

continued

IBM), but you will no longer need to purchase a 3270-emulation program from IBM. One advantage of the Communications Manager on a PS/2 system is that you can mix and match multiple 3270 and asynchronous adapters on the Micro Channel bus. Thus, the EE is perhaps the first program that can take real advantage of the Micro Channel architecture.

The local-area network support of the Communications Manager will, according to IBM, be part of the November release and will support calls to NETBIOS, IEEE 802.2, and IBM's APPC network functions. One notable omission here is support for Ethernet. IBM claims, however, that it may be relatively easy to write an Ethernet driver based on one of the other sets of functions.

SQL and a Query Manager

When IBM announced in April 1987 that the OS/2 EE would feature a built-in database manager with support for Structured Query Language (SQL), the ripples began to be felt almost immediately in the database world. The announcement has spurred a movement toward the use of SQL and, since the EE's database manager is just one part of a \$795 bundle of software, it may initiate

an important downward movement in database prices as well.

The EE's database manager consists of an SQL-based relational database engine, called Data Services, and a front-end application for this engine called the Query Manager. The database engine can also be accessed by embedding SQL code into custom applications. Several companies are expected to modify existing database managers so that they can access this database engine. Until these front ends become available, users may choose to use IBM's Query Manager.

Like other SQL database engines, the EE database divides data into a series of relational tables, with rows (records) and columns (fields). You can construct a VIEW of a database by SELECTing various columns and JOINing tables. You have no knowledge of the physical layout of the data; you have access only to the logical layout.

According to IBM, the database engine is very compatible with the company's DB2 database, which runs under the VM operating system on IBM's 370 mainframes. IBM claims that the database will have about 92 percent to 93 percent of the capabilities of the mainframe system, though it will lack a small num-

ber of features: the GRANT and REVOKE commands, which let network users see certain fields and not others; the UNION relational operator; a FORTRAN pre-compiler; and the ability to do date and time arithmetic.

Managing Catastrophes

One planned area of compatibility between the EE and the larger IBM databases is in transaction management. The goal of transaction management is to ensure that a transaction—a set of changes or additions to the database—is completed successfully even if a catastrophe (such as a power failure) occurs while the transaction is being processed.

This problem is handled by a pair of functions called COMMIT and ROLLBACK. All transactions are first written to a buffer. If the transactions are completed, they are written (or "committed") to the database files. But if a problem occurs before they are completed, the transactions are "rolled back" and executed over again.

The COMMIT and ROLLBACK functions are performed automatically, but a programmer can also have explicit control over them. You can set up a "unit of

continued

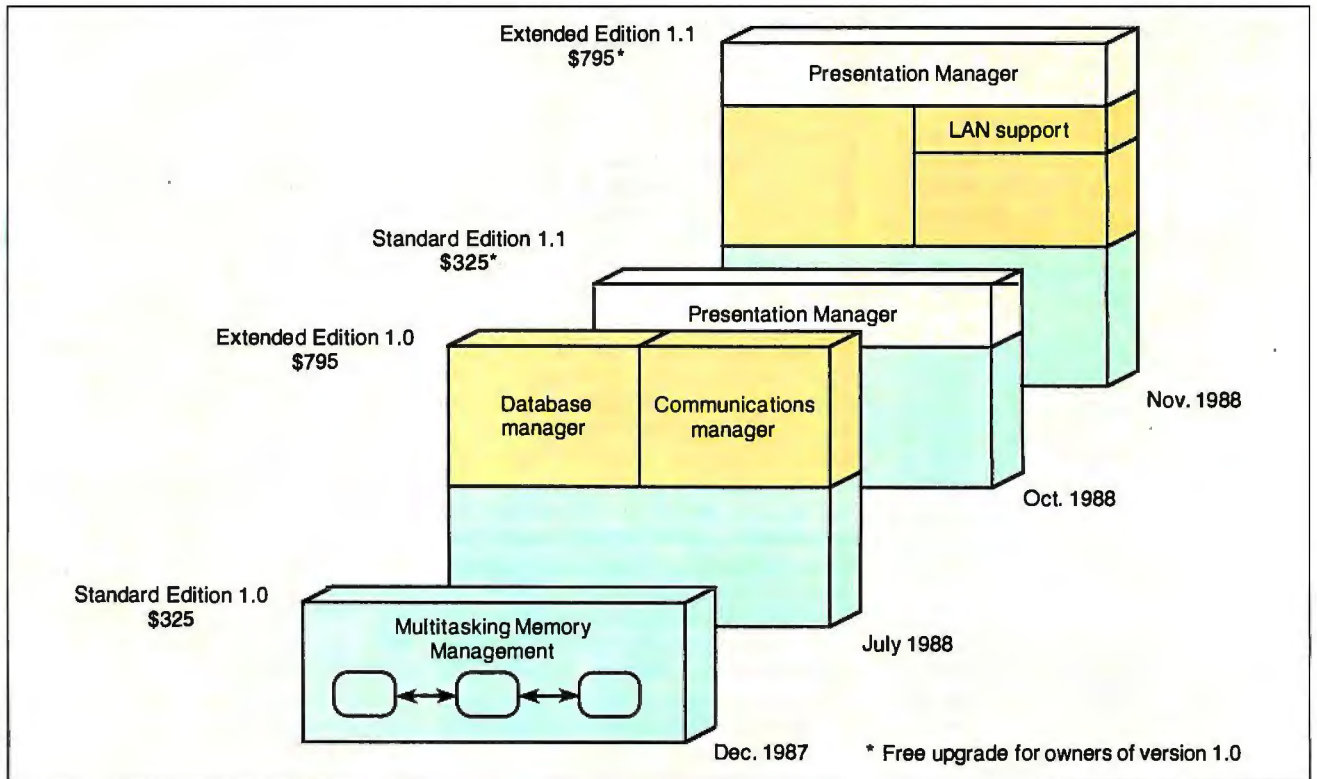

Figure 1: The Extended Edition of OS/2 adds database and communications managers to the base operating system of the Standard Edition. Later this year, both editions will be upgraded to include the Presentation Manager, a Windows-like graphic user interface.



Finally. A programming tool for people who hate manual labor.

Nobody ever said programming PCs was supposed to be easy. But does it have to be tedious and time-consuming, too? Not any more. Not since the arrival of the remarkable new program you see here. Which is designed to save you most of the time you're currently spending digging through the books and manuals on the shelf above.

drawing characters, error messages, memory usage maps, important data structures and more. How much more? Well, the Guides to BASIC, C and Pascal contain detailed listings of all built-in and library functions. The Guide to BIOS/DOS/Assembly delivers a complete collection of DOS service calls, interrupts and ROM BIOS routines.

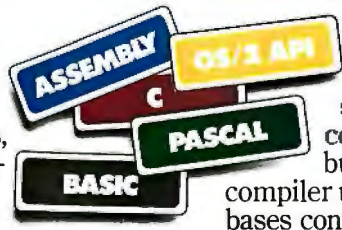

Which is why each version of the Norton Guides comes equipped with a built-in compiler—the same compiler used to develop the databases contained in the Guides. So you can create new databases of your own, complete with electronic indexing and cross-referencing. No wonder *PC WEEK* refers to the Guides as “a set of programs that will delight programmers.” Your dealer will be delighted to give you more information. All you have to do is call. Or call Peter Norton Computing. And ask for some guidance.



A Guides reference summary screen (shown in blue) pops up on top of the program you're working on (shown in green).

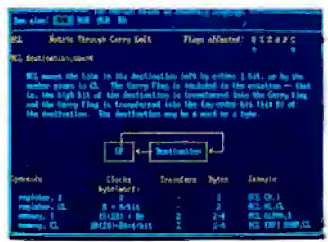

Summary data expands on command into extensive detail. And you can select from a wide variety of information.

While the Guide to OS/2 API packs a handy DOS-to-OS/2 conversion table. You can, of course, find most of this information in the books and manuals on our shelf.

It's one of a quintet of pop-up reference packages, called the Norton On-Line Programmer's Guides, that search for information automatically—in DOS or in OS/2 protected mode. Each package comes complete with a comprehensive, cross-referenced database crammed with just about everything you need to know to write applications. Everything from facts about language syntax to a variety of tables, including ASCII characters, line

—who's written quite a few books himself—figured you'd rather have it on your screen. Instantly. In either full-screen or moveable half-screen mode. Popping up right next to your work. Right where you need it. This, you're probably thinking, is precisely the kind of thinking that produced the classic Norton Utilities. And you're right. But even Peter Norton can't think of everything.

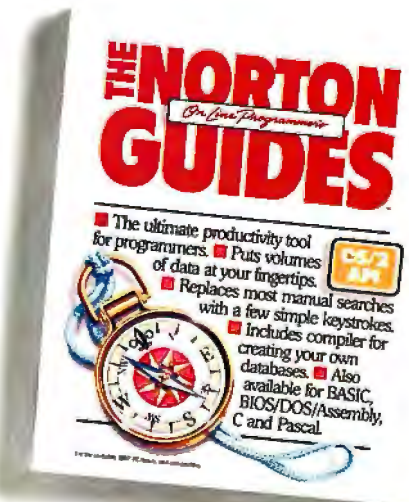

Peter Norton
COMPUTING

Circle 206 on Reader Service Card (DEALERS: 207)

DADiSP..

Lab Data Analysis -
No Assistants Required

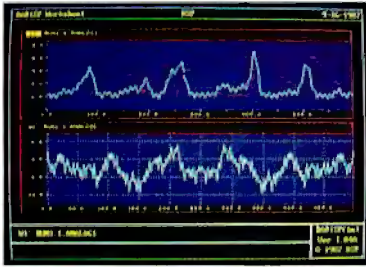

Make Waves...

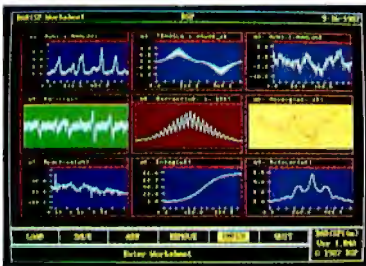

make Sense...

the First Spreadsheet
designed exclusively for
Scientists and Engineers.

Over 150 functions for displaying and analyzing waveforms makes lab data analysis as easy as typing a name. Run external data acquisition software, or *your own analysis programs*; create new functions with *DADiSP Macros*; and, talk to your instruments with *DADiSP-488*.

make a Call.

(617) 577-1133

Order our \$20 Interactive Demo Disk. Ask about DADiSP for IBM-PC/XT/AT, DEC MicroVAX, HP9000, Masscomp 5000, and Sun Workstations. For further information write DSP Development Corporation, One Kendall Square, Cambridge, MA 02139, (617) 577-1133



work" in which, for example, one account is credited by some amount and some other account is debited. Here, again, if the unit of work is completed, you can COMMIT it; if not, you can ROLL-BACK and do it over.

Another feature of the database engine important for transaction management is a Recovery Log. This log lists each new record and the record that was replaced. Also, the Recovery Log is written to disk before the database on the disk is updated. With the log, you can reconstruct the database or complete the updating of the database.

Sharing Performance Features

The data integrity features mentioned above do have a cost in terms of performance. To counter this, IBM has designed the database engine so that it will share some high-performance technology with its mainframe version. IBM claims that as new techniques are developed by the company's research staff, they will be implemented on all the company's database products, including the EE database engine.

One performance feature ported from the mainframe systems is high-concurrency index locking. Many multiuser databases, when they are accessing something, will lock a portion of the in-

dex table to keep out conflicting accesses. For example, if you are using a particular set of records, the database engine locks part of the index table so others can't update those records or any other records in the immediate vicinity. IBM claims that it has come up with a new algorithm that locks not on the index but on the record that it points to. Thus, other users will get their data more quickly since they will get blocked only when they try to access that particular data.

The database engine will also use a query optimizer that decides the best way to access data. In most databases, you set up an index to make it easy to find particular data. But if you have set up several indexes, it may become difficult to decide which indexes to use. The query optimizer can analyze a particular query and choose which index to use, or whether to use an index at all.

According to IBM, the optimizer uses artificial-intelligence techniques to determine the best path to take. Though similar to that of the mainframe database engines, the query optimizer on the EE is more compact and makes greater use of heuristics, or educated guesses, to determine the best path. On mainframes, the queries will probably access larger databases and thus will benefit from a larger, more accurate optimization technique.

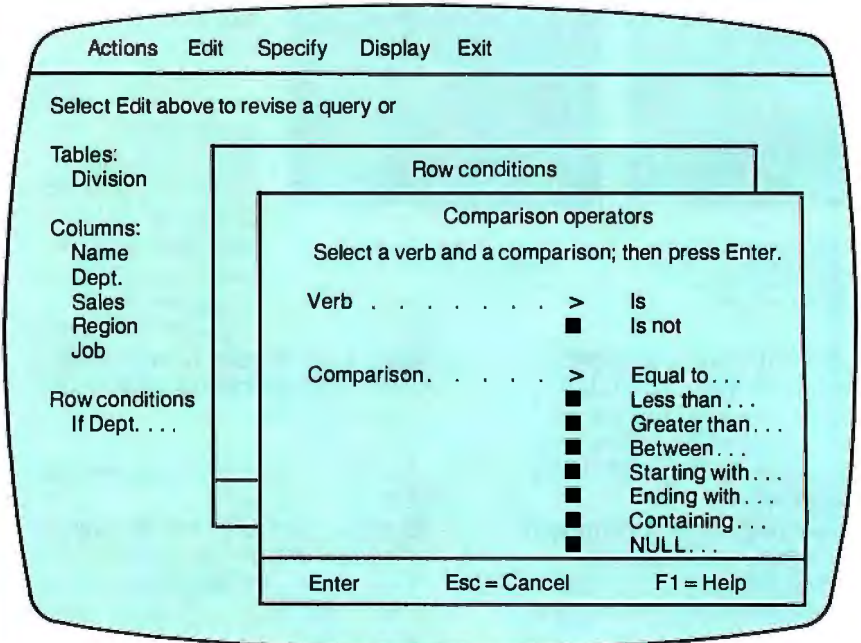

Figure 2: The Extended Edition's Query Manager uses a Prompted Query interface that lets you build valid SQL queries. The left side of the screen shows the query terms already selected, while menus on the right list the possibilities for subsequent terms. Here, the condition "IfDept" could take the verbs "is" or "is not" and the comparison operators "equal to," "less than," and so on.

Reading 1-2-3 Files

In addition to its SQL capabilities, the database engine will also include a number of interesting utilities. The first of these is a utility for importing and exporting Lotus 1-2-3 files and delimited ASCII files. These file-import capabilities can be called from your own applications. Surprisingly, the database manager will not be able to import dBASE III files.

The system's BACKUP and RESTORE utilities let you do short, incremental backups, or restore the database to any prior condition.

Two other utilities let you optimize your data for more intensive applications. A RUNSTATS utility gives you statistics on how data has been accessed. It also updates the access plan to take into account new data that has been added. As a database grows, you may want to run this utility to make the access more efficient. A REORG utility lets you reorganize the data on your hard disk drive for more efficient access.

Writing Applications for the Database Engine

As mentioned earlier, programmers can access the capabilities of the database engine by embedding SQL commands in their code. Currently IBM recommends using its C/2 compiler for this. Eventually IBM will also have available Pascal/2 and COBOL/2. In the meantime, programmers can write external SQL functions in C and call these from their favorite language.

Before compiling a program, you must first run it through a precompiler, which IBM provides free with the EE. The precompiler creates a modified source code file, leaving the C code alone but changing the SQL commands so that the compiler can understand them. The precompiler also places some information in a separate "bind file."

You then run the modified source code through the compiler, which creates an executable file. You provide the executable program to users along with the bind files. At installation, the user of the application must submit the bind file to the database engine, which then stores this information in its "catalogs" and creates an access plan for accessing the data.

The bind file may create some compatibility problems between one SQL database and another. The way one database does binding may be quite different from that of another. Thus, the source code may be similar for different systems but the bind files will be different. For

this reason, applications developers may find it difficult to support a large number of SQL databases.

The database engine supports two types of embedded SQL: static and dynamic. In static SQL commands, the table names are spelled out explicitly in the SQL commands. In dynamic commands, the table names are represented in the commands by variables, the meanings of which can change at run time. Dynamic SQL is a little slower, since the engine cannot prepare an access plan beforehand but has to do so on the spot. The engine does, however, have a PRE-

With the
Extended Edition
of OS/2, IBM has
recognized that an
operating system
should be more than
just a file handler.

PARE command that prepares an access plan once and saves it so that the application can reuse it several times.

Managing More Than Queries

The Query Manager, despite its name, is essentially a complete database system—it can create reports, procedures, menus, and panels (forms) for data entry, as well as manage queries. IBM apparently chose to call it the Query Manager to be consistent with QMF (Query Management Facility), which runs on large mainframe systems.

Since the Presentation Manager is not available yet, the OS/2 EE uses a text-based version of the interface called the Dialog Manager. The Dialog Manager conforms to the Common User Access (CUA) protocol of the SAA (including windows, pull-down menus, mouse support, and so on), but it does not use graphics. When the Presentation Manager becomes available, IBM will port the EE over to it.

The Query Manager has an additional interesting user interface called the Prompted Query interface. This interface, which uses the features of the Dia-

log Manager, lets you build an SQL query term by term, by selecting the next term from a list of possible valid terms (see figure 2).

Once a query is complete, you can look at the result of the query, further modify the query, or save it for later use. For very complex queries with tree-shaped or subquery elements, you may have to use SQL directly. However, most users can accomplish what they want with just the Prompted Query interface.

For data entry, you can set up forms, which IBM calls panels. Behind a panel there may be up to 11 tables. You can have two different tables available for update, and up to nine tables available for looking up data.

The Query Manager can also be automated by creating procedures. Procedures are essentially Query Manager commands and some conditional logic compatible with REXX, IBM's SAA procedural language. The language has variables and lets you do such things as creating your own menus that conform to the Dialog Manager standards, and even designing custom help screens.

A New Standard?

The OS/2 EE is a large, extensive package of software. It has a fairly reasonable price and a lot of functionality, including a large number of capabilities that will be especially handy for IBM's large corporate customers who need to interconnect with IBM mainframes. Indeed, large-volume purchasers will be able to pick up licenses for the package for \$417, just \$214 more than what they would spend for the Standard Edition alone.

The question is, how appropriate will this impressive collection of software be for single users and small network groups? It may simply be too big for many users, who may balk at having to get additional memory and a larger hard disk drive in order to use it.

Nevertheless, the EE is a very important move by IBM. It is a recognition of the fact that an operating system should be more than just a file handler, and that various types of computers should have greater connectivity between them. IBM does not have an exceptionally good track record at selling application software in the volatile personal computer market. But even if the EE does not sell well in the short term, it will probably—if nothing else—establish a standard for a large number of related products. ■

Rich Malloy is an associate managing editor at BYTE. He can be contacted on BIX as "rmlloy."



T1000
80C88
4.77MHz
720KB



T1200F
80C86
9.54MHz
720KB(x2)



T1200H
80C86
9.54MHz
720KB
20MB HDD

Obviously, We Believe In

When it comes to portable PCs, we think that numbers should speak for themselves.

Perhaps that's why we have the largest number of high-powered, highly-portable PCs on the market today. All of which are IBM-compatible. All of which have industry-standard 3 1/2" disk drives, full function keyboards and a vast array of built-in ports. All squeezed into packages as easy to carry as a briefcase.

The T1000, for example, weighs a mere 6.4 pounds, yet boasts MS-DOS® in ROM, a 720KB 3 1/2" disk drive and an optional 768KB memory card which can be configured as

EMS memory or a battery-backed RAM disk.

Our T1200H, on the other hand, has the distinction of packing a 20MB hard disk, a backlit screen and 1MB of RAM into a tidy 11-pound package. We also make an economical dual floppy disk version known as the T1200F that weighs just under 10 pounds.

And thanks to rechargeable battery power, all three are ready to work wherever you go.

For even more computing power, the T3100/20 is one of the smallest PCs with an 80286





T3100/20
80286
8MHz
720KB
20MB HDD



T3200
80286
12MHz
720KB
40MB HDD



T5100
80386
16MHz
1.44MB
40MB HDD

Strength In Numbers.

microprocessor and an easy-to-read gas plasma display. It gives you a wealth of power and a 20MB hard disk in a trim 15-pound package.

Our T3200 goes even further, with two IBM-compatible internal expansion slots, a 40MB hard disk, an EGA plasma display system and up to 4MB of memory. Still, it only weighs a scant 19 pounds.

Finally, there's our powerful T5100, which at less than 15 pounds has all the best features of our other portables, plus an 80386 microprocessor for unmatched versatility and speed. And for a limited time, your T5100 purchase entitles you to buy Paradox 386,[®] Borland's

powerful database software for only \$299 (which is nearly \$600 off the retail price).

And to all those numbers, we'd like to add one more: 1-800-457-7777. With it, you can find out even more about Toshiba's full line of computers and printers.

In fact, it's one call that ought to be your number one priority.

All Toshiba PCs are backed by the Exceptional Care program (no-cost enrollment required). IBM is a registered trademark of International Business Machines Corp. MS-DOS is a registered trademark of Microsoft Corp. Paradox is a registered trademark of Borland Corp.



In Touch with Tomorrow
TOSHIBA

Toshiba America Inc., Information Systems Division



Fast Drives for Modern Times

BYTE selects the top performers from a group of high-speed 40-megabyte hard disk drives

Stan Miastkowski

Hard disk drive performance is second only to system clock speed in affecting the overall performance of your computer. The 10-megabyte hard disk drive with an access time of 85 milliseconds (ms) that did so much for an IBM PC XT—and even the 30-megabyte, 40-ms hard disk drive for an IBM PC AT—seem slow and limited when attached to one of today's high-speed 80286- or 80386-based computers.

As spreadsheets, databases, desktop publishing documents, and engineering drawings grow in complexity and size, many microcomputer users are choosing 40-megabyte hard disk drives as standard equipment in their new computers. Aggressive pricing strategies and ready availability from computer dealers and mail-order houses have also made 40-megabyte drives the first upgrade choice for users trying to improve the performance of their existing systems.

I looked at a group of fast-access hard disk drives, almost all with claimed access times of 28 ms or less and with capacities of approximately 40 megabytes. It is clear that today's buyer has a wide variety of prices, sizes, speeds, and technologies to choose from.

The group that I looked at ranged in price from the \$370 Seagate ST251-1 to

the \$2592 Core AT40F. I worked through full-height 5¼-inch drives, half-height 5¼-inch drives, half-height 3½-inch drives, and hard disk drive cards. While none of these drives are slow, the benchmark results show definite differences in their speeds. The drives I looked at use three distinctly different interfaces: small computer system interface (SCSI), used by the Tandy and Columbia Data Products drives; enhanced small device interface (ESDI), used by the Core AT40F; and the standard ST506, used by the rest of the drives. (For a closer look at SCSI and ESDI, turn to "The Importance of Being Intelligent" on page 120.)

Differences and Similarities

When I started this review, I thought one of the biggest potential problems would be how to differentiate this many drives with specifications that were, at least on paper, quite similar. The drives are indeed similar in size and general performance, but price, ease of installation, and the specifics of performance made it easy to distinguish them from one another. Documentation, cables and other accessories included, and software included also served as distinguishing characteristics.

All the drives I tested came configured for internal mounting. Some of them came to me from the manufacturer; others came from an OEM, like Tandy or Columbia, that made significant additions to the basic drive.

Many of these drives are available from other OEMs and distributors, in a variety of interface, mounting, and software combinations. The broad variety of sources and the widespread presence of discount mail-order vendors mean that prices may vary drastically, depending on your source of supply.

I judged the drives using a combination of objective and subjective measurements. For the objective tests, I used the hard disk drive benchmark programs

from the new BYTE benchmark suite. As these tests show, access time is only one factor in determining a drive's performance, and it's not the measure you should rely on. (For details on these tests, see "Putting the Drives through Their Paces" on page 121.) I made subjective calls on ease of installation and setup, the quality of construction, and how cool and quiet the drive ran.

Since SCSI and ESDI have been getting much attention recently, I was a bit surprised to find that most of the drives I tested still use standard ST506-interface controllers, like Western Digital's venerable 16-bit hard/floppy disk drive controller used in the IBM PC AT.

Developed originally by Seagate Technology, the ST506 interface is one of the uncommon instances in the computer industry where a standard quickly caught on. The interface uses a 3-bit head-select code that allows up to eight heads to be used. When the interface was first developed, many drives used two platters and three heads.

So how do today's ST506-interface drives pack so much data into so little space and access it so fast while maintaining industry standards? The basic answer is to use more platters and more heads.

In addition, the old-style stepper-based head positioning has been largely replaced by the much more efficient voice-coil technology. A stepper does just what its name implies—steps incrementally from track to track on the disk. A voice-coil head positioner moves smoothly and directly to the track where the data you want is located, without having to stop at each and every track on its way. This is largely the reason for access speeds up to 3 times faster than on stepper-based systems.

Speaking of Standards

Most of the controllers for these drives use modified-frequency-modulation

continued



The Importance of Being Intelligent

In the group of drives reviewed for this article, three have moved beyond the basic ST506 interface. The two interfaces that are being used with more and more frequency are SCSI and ESDI. These devices are similar in their use of more powerful logic in their control circuits, but they differ in their approach and capabilities.

SCSI is a microcomputer-oriented serial interface that was proposed as a standard in 1982. It first came to the attention of many computer users when Apple included it as a standard interface on the Macintosh Plus. SCSI offers four main advantages to system designers.

First, SCSI devices can be "chained" together, so that a single bus controller can work with multiple devices of different types. SCSI allows those devices not in current use to go "off-line," so that their mere presence on the bus does not degrade system performance.

Second, the SCSI design allows the individual device controller to be integrated into the device itself, saving money in the design and fabrication processes that, theoretically, can be passed on to buyers. This advantage is already available in Macs that have built-in

SCSI ports; on the MS-DOS side, the Sun 386i, a new Unix/DOS system, has a built-in SCSI port.

Third, SCSI hides the physical layout of the devices from the programmer or user, making them deal only with a standard logical device. In theory, this assures more compatibility between devices, since it is much more difficult for any single device to "break the rules."

Finally, SCSI is fast, with a top speed of 1.5 megabits per second (mbps) in asynchronous modes and up to 4 mbps in synchronous handshaking mode.

ESDI is a low-level serial interface that was initially designed for and used in minicomputer installations. It is similar to SCSI in its level of intelligence, but it differs from SCSI in two important respects, flexibility and speed. Where SCSI was designed from the start as a generalized interface, ESDI has been confined much more to implementation as a disk interface. More important to most users, ESDI has a higher potential speed, up to 24 mbps. Unfortunately, a product with a data transfer rate of 24 mbps is unlikely, given system overhead and the limitations of current microcomputer buses.

(MFM) coding, which uses magnetic flux-field reversals to store data. It's much like FM radio, except the music doesn't change. MFM is a proven technology, prompting most manufacturers to recommend it for their drives. There's a plus for your wallet, too, since you don't need to buy a new controller when you upgrade your drive.

Run-length-limited (RLL) coding is becoming more common, especially for 3½-inch hard disk drives, because it stores more data in a given physical space than MFM coding does. RLL is more correctly called "2,7 RLL encoding," because it uses a *n* algorithm that encodes each byte into new code that's 16 bits long and has from two to seven zeros between each magnetic fluctuation.

The strange thing about RLL is that although it increases the number of bits it takes to store data, the longer RLL bit pattern doesn't need as much space as the shorter MFM pattern. However, RLL requires a very consistent, high-quality medium to handle the higher density of

information. Because of the greater demands of quality placed on the medium, reliability problems crop up with some RLL controller/drive combinations.

Installation: A Trying Experience

If you buy one of the drives reviewed here, you'll find that, unfortunately, the era of the "plug in and play" hard disk drive has not yet arrived. The problem starts when trying to deal with a hard disk drive, a controller, a computer, and setup/installation software. When any component does not recognize the type of any other one, problems quickly begin to mount.

I used an 8-MHz IBM PC AT to test these drives, and the biggest problem came with the requirement of the AT's CMOS memory to "know" what type of hard disk drive was connected. With both ATs and the numerous available clones, you're required to enter a number that corresponds to the type of drive installed. If you don't enter the right number, the hard disk drive just won't work. If the

drive's installation documentation doesn't tell you what drive type to enter, you'll need to determine what it is. Trial and error isn't a recommended method for figuring out drive types, but solutions do exist.

I used two formatting and partitioning programs: Storage Dimensions' SpeedStor and Ontrack Computer Systems' Disk Manager, both of which can determine the drive type. Both can also do low-level formatting, media analysis, and partitioning of hard disk drives. Partitioning is important, since DOS can handle a maximum of only 32 megabytes in each partition.

I used SpeedStor for the majority of drives and Disk Manager for the Mini-Scribe 3053 and the Toshiba MK-54FB. Both Core drives and the Plus Hardcard 40 came with their own custom installation software.

Focusing In

Because the drives differed in the installation and setup procedures, testing them turned out to be a most time-consuming process. Overall, I found that manufacturers have settled on a number of ways to make the performance and features of an individual drive stand out—an important feat for a product that many people consider a commodity item. For a side-by-side comparison of benchmark results and features, see tables 1 and 2.

Standard ST506 Drives

The drives in this section did not come with their own controllers. As a group, they tended to cluster in the middle of the performance results. I tested them with the 16-bit Western Digital ST506 combination hard/floppy disk drive controller present in my IBM PC AT.

CMS F40-K: This full-height 5¼-inch drive carries a suggested retail price of \$995 and a hefty weight of 10 pounds. The 42-megabyte unit ran quietly and kept its cool. Its performance was unexceptional, with a 1-megabyte file read time that ranked next to the bottom of the standard drives and other results that were squarely in the middle of the pack.

CMS rates this drive as a 22-ms-access device. According to the Coretest, however, the average seek time is 29.2 ms. The F40-K comes with a 40-page installation manual and does not include software. Since the documentation included the drive type to enter for the setup program, installation and setup were straightforward.

Control Data Wren II: The Wren II, with 42 megabytes, is Control Data Corp.'s latest incarnation of a well-re-

spected drive that has earned a reputation for being unusually rugged. It's a half-height 5¼-inch drive. Although CDC doesn't sell directly to end users, the company estimates it will cost you in the vicinity of \$900, a relatively steep price for a half-height drive.

But this drive exudes quality. The 3.8-pound unit has a solid, hefty feel, and you hardly know it's running. CDC has built high-capacity drives for large computers for years, so it's a safe bet that this drive would be particularly well suited to full-time, heavy-duty use. When you turn it off, there's a satisfying clunk as the heads are automatically parked.

The Wren II has a rated average access speed of 28 ms, but I found that it actually showed a better speed, 23.6 ms. In the BYTE benchmarks, the drive showed up in the middle of the ST506 pack on nearly every test. In all, a solid, middle-of-the-road performance.

The drive I reviewed came with two manuals. A 16-page OEM manual is well written but is designed for experienced users. If you're into the technical nitty-gritty, a 63-page technical specification will tell you everything you ever wanted to know and more about the inner workings of the drive.

continued

Putting the Drives through Their Paces

BYTE recently unveiled a new suite of total system benchmarks that includes a set of programs to evaluate hard disk drive performance. I used these benchmarks, along with the Coretest, to evaluate the drives for this review. (For more information on the complete suite, see "Introducing the New BYTE Benchmarks" on page 239 of the June BYTE.)

Here is a brief look at the tests and what they are designed to measure.

Hard seek: This makes direct calls to the BIOS to directly manipulate the position of the read/write heads of the drive. This test measures the average track-to-track seek time of the hard disk drive, without adding operating-system interaction. A drawback of this test is its inability to give meaningful results on SCSI drives.

DOS seek and read: This test measures the time required by the hard disk drive to seek to a given location and read

1 or 8 sectors of data. It uses the operating system's most basic level of disk-access functions.

File I/O: File I/O is a reworked version of a longtime BYTE benchmark. This test uses the full file structure support of the operating system to measure the time required by the hard disk drive to seek, write, and read while under the control of the operating system.

1-megabyte file write and read: These are straightforward tests of the time required to first write, then read, a 1-megabyte file. Because I believe these tests offer closer approximations of real-world use than do the others, they were given a predominant position in determining overall performance winners and losers.

Coretest: This test, developed and distributed by Core International, was used to verify average access-time ratings as supplied by the manufacturers of the various drives.

Table 1: The benchmark results show that the Northgate Turbo kit tops the list, followed by the SCSI and ESDI drives. The three hard disk drive cards were the slowest performers. (All times are in seconds, except where noted.)

Hard disk drive	Hard seek (average)	DOS seek and read		File I/O			1-megabyte file		Coretest (ms)	
		1 sector	8 sectors	Total seek	Read 1K byte	Write 1K byte	Write	Read	Average seek	Average trk/trk seek
Northgate Turbo kit	16.6325	12.72	26.42	0.33	0.02	0.019	4.74	3.77	36.47	15.63
Columbia SCSI drive	N/A	N/A	N/A	0.28	0.015	0.018	5.9	4.32	19	6
Core AT40F	4.545	8.35	12.8	0.35	0.014	0.014	4.25	4.48	10.43	2.27
Tandy SCSI drive	N/A	N/A	N/A	0.18	0.016	0.019	5.6	4.65	28	6
Core AT43	7.485	10.61	20.09	0.24	0.017	0.016	5.64	5.55	20.08	4.08
Priam ID45-AT-D2	6.64	9.7	25.75	0.09	0.018	0.016	7.41	6.81	19.88	3.89
Toshiba MK-54FB	7.03	9.96	24.21	0.58	0.015	0.03	16.5	7.74	25.7	4.6
Fujitsu M2242AS2	9.8875	10.66	24.11	0.44	0.016	0.029	16.51	7.76	37.8	5.1
Rodime RO 3055	7.4575	10.67	26.97	0.35	0.016	0.018	8.26	7.78	21.86	6
Seagate ST251-1	7.8425	10.31	26.89	0.59	0.017	0.03	16.74	7.84	N/A	N/A
Control Data Wren II	7.0175	10.65	26.97	0.48	0.016	0.029	16.7	7.87	23.6	4.1
Micropolis 1333A	7.4575	10.54	26.95	0.45	0.016	0.03	16.73	7.87	27.83	5
MiniScribe 3053	7.1775	10.56	26.89	0.4	0.016	0.03	16.83	7.87	29.5	5.4
CMS F40-K	7.4375	10.59	26.86	0.24	0.016	0.029	16.66	7.88	29.2	4.7
Microscience HH-1050	8.2625	10.58	26.78	0.44	0.016	0.03	16.62	7.89	26.5	4
Plus Hardcard 40	10.24	12.39	52	0.14	0.025	0.031	17.21	13.77	39.5	6.88
CompuAdd FlashCard 49	6.9725	10.2	81.34	0.29	0.047	0.045	36.45	36.29	27	7.61
SPC Scorecard 44	8.3125	10.8	81.22	0.31	0.045	0.043	36.58	37.89	24.07	4.77

HARD DISK DRIVES

Table 2: Features and prices vary widely, even among supposedly similar disks.

Hard disk drive	Suggested list price	Formatted capacity (megabytes)	Form factor	Cylinders	Heads	Platters	Interface
CMS F40-K	\$995	42	Full-height, 5¼ inches	1024	5	3	ST506
Columbia SCSI drive	\$995	42	Half-height, 3½ inches	834	3	2	SCSI
CompuAdd FlashCard 49	\$549	49	Plug-in, 1½-slot card	615	6	3	ST506
Control Data Wren II	\$900	42	Half-height, 5¼ inches	989	5	3	ST506
Core AT40F	\$2156	40.4	Full-height, 5¼ inches	564	4	N/A	ESDI
Core AT43	\$876	43	Half-height, 5¼ inches	988	5	3	ST506
Fujitsu M2242AS2	\$1000	43.2	Full-height, 5¼ inches	754	7	4	ST506
Micropolis 1333A	\$799	44	Full-height, 5¼ inches	1024	5	3	ST506
Microscience HH-1050	\$750	44.56	Half-height, 5¼ inches	1024	5	3	ST506
MiniScribe 3053	\$550	44	Half-height, 5¼ inches	1024	6	3	ST506
Northgate Turbo kit	\$695	42	Half-height, 5¼ inches	809	6	3	ST506
Plus Hardcard 40	\$995	42.26	Plug-in, single-slot card	612	4	2	ST506
Priam ID45-AT-D2	\$1050	42	Full-height, 5¼ inches	1166	5	3	ST506
Rodime RO 3055	\$1395	45.5	Half-height, 3½ inches	872	7	4	ST506
Seagate ST251-1	\$370	42.8	Half-height, 5¼ inches	820	6	3	ST506
SPC Scorecard 44	\$795	44	Plug-in, 1½-slot card	753	7	4	ST506
Tandy SCSI drive	\$1799	80	Half-height, 5¼ inches	823	6	3	SCSI
Toshiba MK-54FB	\$1190	49.2	Full-height, 5¼ inches	830	7	4	ST506

N/A—Information not available

Core AT43: The AT43 is a half-height 5¼-inch drive with a fast average access time of about 20 ms. It sells for \$876 (plus \$436 for the optional controller), but it was the fastest standard ST506 drive I tested. It's built like that proverbial tank and remains cool even after hours of hard running.

Even though the AT43 is shipped with extensive setup software and manuals, installation is on the difficult side and time-consuming. Successful installation of the drive was dependent on one key step that was not spelled out: It's vital that you run the AT's setup program before beginning Core's setup. You should

also be prepared to get a floppy disk error at every boot-up for the life of the machine if you also use its controller to control the floppy disks in your system. You can still use the floppy disks with safety, but the computer will have trouble during the post portion of booting.

Fujitsu M2242AS2: This full-height

Recording code	Head positioning	Average power consumption	Weight (pounds)	Controller included/recommended	Software included	Documentation
MFM	Voice coil	0.9 A	10	CMS recommended	None	40-page installation manual
RLL	Stepper motor	22.45 W	1.9	Western Digital 7000-ASC controller included	Installation software	50-page controller, 149-page disk drive, and 30-page owner's manuals
RLL	Voice coil	N/A	1.6	Controller included on card	PC-FullBak	35-page installation, 30-page controller, and 17-page drive manuals
MFM	Voice coil	20 W	3.8	CD-506 recommended	None	16-page manual and 63-page technical specification
MFM	Voice coil	33 W	7.3	Core CNTHCF controller (\$436) recommended	Partitioning software	47-page disk drive, 24-page controller, and 59-page software manuals
MFM	Voice coil	1.5 A	3.8	Core CNTHCF controller (\$436) recommended	Partitioning software	47-page disk drive, 24-page controller, and 59-page software manuals
MFM	Voice coil	29.6 W	6.6	None	None	194-page technical specification
MFM	Voice coil	2 A	6	None	None	31-page installation guide and 30-page technical specification
MFM	Voice coil	N/A	4.2	Adaptec, Data Technology, SCI, Western Digital, or Xebec recommended	None	31-page documentation
MFM	Voice coil	N/A	4.1	None	Disk Manager	34-page documentation
RLL	Voice coil	N/A	3	Adaptec ACB-2372 RLL controller included	Benchmark software	37-page documentation
RLL	Voice coil	0.48 A	N/A	Controller included on card	Partition and install software	74-page manual
MFM	Voice coil	35 W	6	None	Installation software	41-page installation guide and 132-page user's manual
MFM	Voice coil	0.8 A	1.65	Any capable of controlling 872 cylinders with a step rate of 5 μ s to 15 ms	None	29-page documentation
MFM	Stepper motor	12 W	2.75	Any MFM, 5.0 Mbit/sec recommended	Disk Manager	13-page installation guide
MFM	Voice coil	10 W	1.8	Controller included on card	SpeedStor, SpeedCache	6-page manual
RLL	Stepper motor	24 W	3.5	Adaptec AHA-1540 (\$299)	None	13-page manual
MFM	Voice coil	N/A	6.6	None	None	47-page installation guide and 15-page manual

5¼-inch drive—with four platters and seven heads—ranked in the top half of all the drives in overall performance. Despite results that rank it near the bottom of the ST506 group in most of the benchmark tests, it ends up in the middle of the pack because of a relatively strong showing in the 1-megabyte file read and write.

A slow average access time is one of the reasons for its average showing; while Fujitsu rates the drive as a 30-ms-access device, the Coretest gave it a 37.8-ms score—the second slowest among all drives tested. One thing it has going for it is that it runs cool, making it a particularly good choice for a cramped installa-

tion or an environment that isn't always comfort-controlled.

One area where the M2242AS2 falls short is its documentation. With a 194-page technical specification—the biggest manual of any of the drives I tested—you'd think you have it made. But the

continued

BEST PERFORMERS

Core AT40F

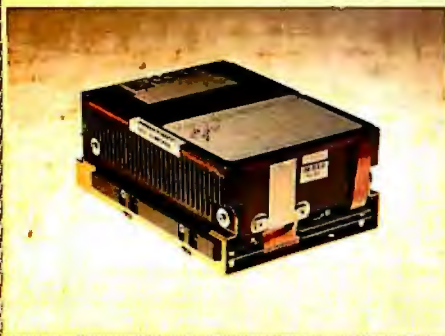

Core AT43

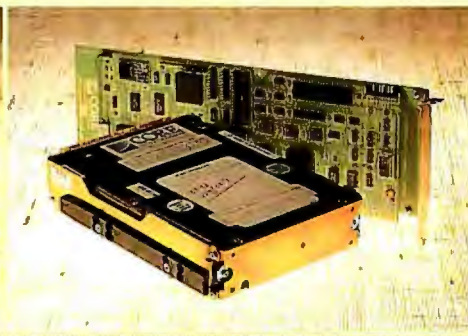

Northgate Turbo kit

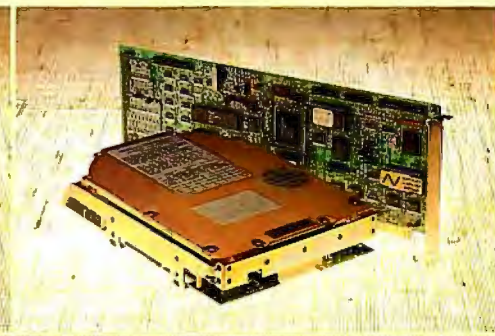

manual is long on technical information and short on practical information.

Because no end-user-oriented material is found in the documentation, the drive was relatively hard to install. After much puzzling, I finally had to call Fujitsu's customer service to find out how to set a jumper for DS2 (Disk Select). It was easy to do—once I knew where the jumper was; it wasn't marked either on the drive or in the manual. This type of problem just shouldn't happen in a \$1000 product of this complexity.

Micropolis 1333A: Another full-height 5 1/4-inch drive, the 1333A, with a price of \$799, is 20 percent less expensive than comparable full-height drives. This 44-megabyte drive is not one of the hotter performers in the group, ranking in the bottom half of the results in every test. With a rated average access time of 28 ms versus a Coretest average access time of 27.83 ms, this was one of the few drives where my results were almost identical to the manufacturer's specs.

After wrestling through the documentation and installation procedures of some of the other drives, the clearly written, well-illustrated installation manual that accompanied this drive made it a joy to install. The 31-page manual is one of the best examples of sparse yet useful technical communications I've ever seen.

Microscience HH-1050: This half-height 5 1/4-inch drive packs 44.56 megabytes of storage into its three platters and five heads. Unfortunately, Microscience wasn't able to pack top performance into the \$750 unit, which ended up resting at the bottom of the standard ST506 benchmark results. The ranking is based on the device's lackluster performance in the 1-megabyte file read and write.

Other tests place the HH-1050 in the middle of the speed curve, but it is the slowest drive in this group on the important 1-megabyte read test. Access time isn't to blame for the problem, since my

26.5-ms average access time Coretest results were even better than the 28-ms rating from the factory.

Like many of the drives here, it came with a very technical manual. But I didn't really need it. There were no surprises or special case instructions needed to install this drive in the AT, so it was easy to install. Its vaned outer case is effective in keeping it cool.

MiniScribe 3053: MiniScribe is another well-respected drive maker whose reputation shows in the sheer number of drives the company has sold. At \$550, this half-height 5 1/4-inch drive is one of the lowest-priced drives I looked at. It's a solid, though not spectacular, performer, with a showing in the bottom half of the results. Its Coretest result, a 29.5-ms average access time, didn't live up to the 25-ms time stated by MiniScribe.

The 3053 was easy to install because it came with a custom version of Disk Manager. I didn't even need the 34-page manual, which was full of technical detail.

A unique feature of the 3053 among the drives I tested is that it has internal diagnostics that flash 32 different error codes when something goes wrong. Telling the service folks that the drive light is flashing "long short long long" is considerably more effective than saying "my drive doesn't work."

This drive shares one unfortunate trait with other MiniScribe units: It gets quite warm after several hours of use. While heat is a frequent problem with 3 1/2-inch drives, most 5 1/4-inch drives get only slightly warm. Not the 3053, although I can't say whether this has any long-term implications for the drive's reliability. One thing is certain—you should use it only in a well-ventilated case.

Priam ID45-AT-D2: Unlike most of the other drives I tested, this full-height 5 1/4-inch drive is designed for end-user installation. At \$1050, it's on the high side of the pricing scale, but it is one of

the fastest standard ST506 drives I tested, with an average seek time for the Coretest that comes in below 20 ms. This drive has no thermal problems and is barely warm to the touch after extended operation.

Installing the 42-megabyte drive isn't a problem, but it is a time-consuming task. You're warned not to do a low-level format of the drive, since you'll destroy special format data that's already on the drive. Installation software is included, and you need to prepare an installation disk with MS-DOS on it. Still, the 41-page installation guide takes you quickly and easily through the installation process.

Last but not least, a particularly nice touch is a 132-page user's manual that covers all the technical bases not contained in the installation manual. Need instructions on installing the ID45-AT-D2 in a Novell Network or under Xenix? You'll find it here.

Rodime RO 3055: This is a quirky little half-height 3 1/2-inch drive that, at \$1395, is quite expensive. The expense may come because of its rated capacity of 45.5 megabytes, using four platters and seven heads packed into a tiny package. But there's a problem: I couldn't format it as a 45.5-megabyte drive because AT setup, Disk Manager, and SpeedStor didn't contain a setup for a drive this large.

I contacted the company and found that Rodime has software for formatting the drive to its full capacity, but none was available in time for this review. It was suggested that I either partition the disk into two logical drives, one of 32 megabytes and one of 13.5 megabytes, or use formatting software from Golden Bow to try and establish a single large partition.

So I formatted it, using type 11 in the AT setup, as a 35-megabyte drive. The 29-page manual that came with it was nicely designed but essentially useless. Between the problems of trying to take

HARD DISK DRIVES

Priam ID45-AT-D2

Tandy SCSI drive

Columbia SCSI drive



advantage of the drive's full capacity and a manual that contains no information on end-user installation, this one was a real pain to install. And to top it all off, it ran hot to the touch (116 °F) after only a few hours.

Seagate ST251-1: Venerable old Seagate is the drive company that almost everybody knows, and one of its latest drives is the half-height 5¼-inch ST251-1. It's a solid, though not spectacular, performer that consistently turned in results that placed it in the middle of the overall grouping. The stated average access time of 28 ms is also a solid speed in the middle of the pack. The drive runs a bit warm, though not uncomfortably so, and it makes strange raspy noises on power-down. The saving grace of all this is its price, \$370, which makes it the least expensive drive in this review.

The ST251-1 comes with Disk Manager, a data cable, and a faceplate. It isn't difficult to install. If you need help, though, you're not going to find it in the 13-page "universal installation" manual that's packed with the drive.

Toshiba MK-54FB: A full-height 5¼-inch drive, the \$1190 MK-54FB has good performance and a large capacity of 49.2 megabytes. The unit I tested was quite noisy on reads and writes, but that's common on some drives and doesn't seem to be detrimental.

The MK-54FB was one of the fastest drives I tested, coming in as the third-best performer among standard ST506 drives. The rated access speed of 25 ms was corroborated by the Coretest. While the price of this unit is high, the performance is also high, and it may be enough of a factor for those users who need very good performance to spend the extra money.

Toshiba recommends Disk Manager for installation but doesn't supply it. The OEM manual shipped with the drive was written for technicians, not end users,

but there were no surprises or particular problems in installation, so I wasn't forced to plumb the depths of the manual too often.

Dedicated-Controller Drives

The drives in this category share one important feature: They come from the vendor with a controller specially designed to work optimally with the drive. This category includes drives that win on performance and lose on convenience, like the Core AT40F and the two SCSI drives.

The difference between the drives in this category and those listed above is like the difference between a tailored suit and one you get off the rack: The dedicated-controller drives, like the tailored suit, will certainly fit better when your needs are special. But the price you pay, either in money or performance, will almost certainly be higher than for off-the-rack standards. The exception to this is the Northgate kit, which turns in top performance for an excellent price.

Core AT40F: Core's drives have a reputation of being "Cadillac" drives, and the full-height 5¼-inch AT40F fits into that category. If you have the need for a very fast hard disk drive, there's little to compare with this one, a 40.4-megabyte drive with a wallet-clearing price of \$2156 (plus \$436 for the optional controller).

Why is it so expensive? For one thing, it comes with its own ESDI card for the IBM PC AT and compatibles. The full-length 16-bit board replaces your current disk controllers. It also offers incredible speed. The benchmarks for the AT40F were, across the board, among the fastest of any drive I tested. We're talking average seek times in the vicinity of 10 ms.

Like its non-ESDI AT43 cousin, the AT40F is obviously designed for heavy full-time use; and if you're going to pay \$2592 for a hard disk drive and controller, that's the type of use you'll be putting

it to. It comes with extensive setup software and three manuals, and the complex setup procedure makes it difficult and time-consuming to install. However, the results are worth it.

Columbia SCSI drive: This drive uses the Western Digital 7000-ASC Host Bus Adapter (which has its own Z80 processor) and the Quantum half-height 3½ inch drive, giving it a capacity of 42 megabytes. It is faster than the Tandy SCSI drive and has documentation and installation software designed for end users. Unlike Tandy's policy for its drive, Columbia ships a friendly setup program and an easy-to-follow setup manual.

This ranked as the second-fastest drive in the review, with a Coretest-established average access time of 19 ms and consistently fast results in the BYTE benchmarks. Its \$995 price tag isn't cheap, but if they follow the trends established by other small computer equipment, SCSI prices will be coming down.

But there's more. Columbia includes extensive technical documentation on the interface and the drive itself. You don't have to read it; but if you're technically inclined, it's an excellent look at how SCSI and ATs manage to fit together.

As I was writing this review, Western Digital announced that it will sell its controller, the 7000-FASST, directly to end users. For a suggested list price of \$485, you get the board alone; for \$495, you get a kit that includes the board, software, manual, and cable.

Northgate Turbo kit: This is an Adaptec ACB-2372 RLL controller coupled with a MiniScribe 3650R drive. The \$695 kit doesn't rely on SCSI or ESDI for throughput, but with its 16-bit RLL controller and a 1-to-1 interleave, it managed to come out on top of the performance chart. The half-height 5¼-inch drive provides 42 megabytes of formatted

continued

space and lets you use that space at a high rate of throughput.

When you look at the testing results for this drive, you'll notice that the average access time is quite slow for this group—36.47 ms. Northgate maintains that it doesn't care about the access time, that it optimizes for throughput. Judging from the overall results, I can't argue with Northgate's point of view.

The kit includes a disk of Northgate's benchmark software and a fairly small (under 40 pages) manual. The disk I got had been low-level formatted, and installation and setup were straightforward procedures.

Tandy SCSI drive: Using a half-height 5¼-inch Quantum SCSI drive that stores 80 megabytes and a 16-bit Adaptec controller, Tandy's high-capacity, high-speed SCSI drive is a good example of where hard disk drives may indeed be headed. To pack 80 megabytes into the drive, RLL encoding is used. The Adaptec controller has a 10-MHz direct-memory-access chip to help speed up performance.

The board is capable of controlling up to three SCSI drives, ranging in size from 40 to 786 megabytes. I had hoped to be able to test this controller with a 40-megabyte drive, but Tandy is currently selling only 80-megabyte SCSI drives.

At \$1799 for the drive and \$299 for the controller, this drive is not cheap, but it's not an unreasonable price for the speed and capacity. And this drive is quite fast. It consistently came in as one of the best performers, ranking fourth overall. Its access time is only average for the group tested, 28 ms. The good performance is

the result of the high (1.5 megabytes per second) data transfer rate possible with SCSI.

Tandy intends this drive to be installed by an authorized Tandy service center, and the documentation does not include clear information for end-user installation. I did not have to lean on the documentation, since I simply plugged the controller and drive in and had a working combination. If you are not so fortunate, the documentation won't help to shorten the troubleshooting time.

Drives on a Card

High-capacity hard disk drives have come to add-in cards, and, like the ESDI and SCSI drives, these cards use dedicated controllers. But while the ESDI and SCSI drives win on performance and lose on convenience, the hard disk drive cards win on convenience but lose on performance.

SPC Scorecard 44: You'll still need a full 8-bit slot and a half in your IBM PC or AT to fit in the \$795 Scorecard 44 from Systems Peripherals Consultants. It uses a Micropolis 3½-inch hard disk drive and is very slow—a common problem with hard disk drive cards. As a matter of fact, this was the slowest drive among all those I tested.

As an idea of its speed, it takes 10 times as long to read a 1-megabyte file from the Scorecard 44 as it takes to read the same file from the fastest drive in the group. The Scorecard 44 comes with SpeedStor for installation and also includes SpeedCache, a disk-caching program that can at least help a bit with the speed.

The Scorecard 44 packs four platters and seven heads into a tiny space, and, surprisingly enough, it runs relatively cool for all this. Since ease of installation and use are large parts of the reason behind this type of drive, it came as no surprise that it's quite easy to install.

CompuAdd FlashCard 49: Like the Scorecard 44, the FlashCard 49 consists of a 3½-inch drive and a card that requires a full 8-bit slot and a half in your IBM PC or AT. As the name implies, it stores 49 megabytes in an incredibly small space. The price is eyebrow raising: \$549 seems too little to pay for all this capacity.

Unfortunately, it joined the other drives-on-a-card at the bottom of the benchmark table. The drive is rated with an average access time of 28 ms, and the Coretest supported this with a rating of 27 ms. But the FlashCard 49, like the Scorecard 44, fell short in the 1-megabyte file read and write times. These two drives had similar times on the test—2 to 3 times slower than the next slowest drive.

The FlashCard 49 uses a Seagate ST157R drive coupled with a Western Digital RLL controller. It comes with a well-written manual that features specific installation instructions and useful illustrations, and it is easy to get up and running. PC-FullBak software was included with the drive.

Plus Hardcard 40: Plus Development was the first company to sell hard disk drive cards. As its competition has grown, the company has branched out to provide cutting-edge technology, often at premium prices. A case in point is the \$995 Hardcard 40. This little drive requires only a single 8-bit full-length add-in slot in your IBM PC or AT and delivers 42.26 formatted megabytes of storage. Truly amazing. There are only two platters and four heads packed into the space, but Plus uses RLL coding (and a few other proprietary tricks) to get it all to work.

The Hardcard 40 was the fastest of the drive cards, and it turned in a performance that placed it third from the bottom of the benchmarks. The rated average access time of the Hardcard was one of the slowest of any drive I looked at, 35 ms, and the Coretest turned in an even slower figure of 39.5 ms.

Installing the Hardcard takes a bit longer than the other drive cards because of the custom installation and partitioning software, but the same software makes the installation relatively easy. It comes with everything you need for in-

continued



The CompuAdd FlashCard 49, SPC Scorecard 44, and Plus Hardcard 40 trade top performance for compact size and ease of installation.

VIDEOTRAX DATA BACK-UP. WE JUST INTRODUCED IT. AND ALREADY 50 MILLION PEOPLE OWN HALF OF IT.

Every human in the hemisphere who owns a standard VCR has half of what's needed to back up data. The rest of what you need is neatly contained on the new Videotrax® controller board by Alpha Micro.

Slip the half-size Videotrax board into the expansion slot of any PC. Meaning any IBM®, PC, XT, AT, Compaq® 386 or true compatible.



High-tech. Open your PC and slide the controller board into any expansion slot. Low-tech. Hook up VCR to computer with standard connector cables.

Connect the computer to a VCR with standard connector cables. And, as of that moment, you are under the protection of a highly sophisticated, stringently reliable, data backup system.

In fact, exhaustive testing and the long term experience of over 20,000 Alpha Micro users have proven Videotrax technology to be more reliable than any other backup option available. More dependable, even, than

the hard disk you're covering for.

QUICK STUDY

Videotrax has been designed to extremely demanding standards. So that it won't put a lot of demands on you. Anyone who can run a VCR knows most of the drill. The rest is covered by our menu-driven software. By clear, concise documentation. And by a range of backup modes that keeps it simple:

Insert a blank video cassette tape and follow the directions which appear on screen. These guide you through the painless steps for copying or restoring an entire hard disk, specific files, or only files modified since the last backup.

Meanwhile, Videotrax rigorously monitors itself for proper functioning.

WE MAKE THE VCR PART OF IT, TOO.

like, opt for Videotrax

ence the automatic, un-

attended backup capabilities. It will be a most prudent investment. Because, for the price of

taping Dallas you can preserve your most precious data. Up to 80MB on a single



Your basic video cassettes. Reliable, inexpensive, easy to find.

cassette, at less than a tenth of the cost of streamer tape.

And now the price is low. Just \$399 for the board and \$1199 for the board and enhanced VCR, suggested retail.

network of factory service centers will provide all the support you need.

For the name of your nearest Videotrax dealer, call Alpha Micro at 1-800-992-9779. In California, call 1-800-821-0612.

The Videotrax System. It's a great leap forward in backing up.

Circle 10 on Reader Service Card (DEALERS: 11)



Corporate Headquarters: 3501 Sunflower, P.O. Box 25059, Santa Ana, CA 92799
© Alpha Microsystems 1988. All rights reserved. IBM is a registered trademark of International Business Machines. Videotrax is a registered trademark of Alpha Microsystems. Compaq is a registered trademark of Compaq Computer Corp. Radio Shack Computer Center is a registered trademark of Tandy Corporation.

Available at **Radio Shack** Computer Centers®/Plus Computer Centers and other fine computer dealers worldwide.

Company Information

CMS

1372 Valencia Ave.
Tustin, CA 92680
(714) 259-9555
Inquiry 898.

Columbia Data Products, Inc.

851 West 436, Suite 1061
Altamonte Springs, FL 32714
(305) 869-6700
Inquiry 899.

CompuAdd Corp.

12303-G Technology Blvd.
Austin, TX 78727
(512) 250-1489
Inquiry 900.

Control Data Corp.

8100 34th Ave. S
Minneapolis, MN 94043
(612) 851-4131
Inquiry 901.

Core International

7171 North Federal Hwy.
Boca Raton, FL 33431
(303) 997-6055
Inquiry 902.

Fujitsu America, Inc.

3055 Orchard Dr.
San Jose, CA 95134
(408) 432-1300
Inquiry 903.

Micropolis Corp.

21211 Nordhoff St.
Chatsworth, CA 91311
(818) 718-5117
Inquiry 904.

Microscience International Corp.

305 North Mathilda Ave.
Sunnyvale, CA 94086
(408) 730-5965
Inquiry 905.

MiniScribe

1861 Lefthand Cir.
Longmont, CO 80501
(303) 651-6000
Inquiry 906.

Northgate Computer Systems

13895 Industrial Park Blvd., Suite 110
Plymouth, MN 55441
(800) 548-1993
Inquiry 907.

Plus Development Corp.

1778 McCarthy Blvd.
Milpitas, CA 95035
(408) 946-3700
Inquiry 908.

Priam Corp.

20 West Montague Expy.
San Jose, CA 95134
(408) 434-9300
Inquiry 909.

Rodime, Inc.

Peripheral Systems Division
29525 Chagrin Blvd., Suite 214
Pepper Pike, OH 44122
(216) 765-8414
Inquiry 910.

Seagate Technology

920 Disc Dr.
Scotts Valley, CA 95066
(408) 438-6550
Inquiry 911.

Systems Peripherals Consultants, Inc.

9747 Businesspark Ave.
San Diego, CA 92131
(619) 693-8611
Inquiry 912.

Tandy/Radio Shack

1800 One Tandy Center
Fort Worth, TX 76102
(817) 390-3700
Inquiry 913.

Toshiba America, Inc.

Disk Products Division
9740 Irvine Blvd.
Irvine, CA 92718
(714) 380-3000
Inquiry 914.

stallation, including a custom device driver.

Which One for You?

When it comes time to buy a hard disk drive, it's important to remember that not all the drives covered here are available to end users directly from their manufacturers. Many are sold by distributors or value-added retailers, or sold only as part of complete systems.

The type of dealer you buy from—and the value of the software, hardware, and support they add to the basic hard disk drive—will have a dramatic impact on the price of the hard disk drive package and its ultimate worth to you. If you're buying a hard disk drive, it behooves you to ask what brand and model you're buying and precisely what is included.

I've also made it clear that few of these drives are easy to install. Some require advanced system knowledge to get them working, and even the easiest require

some knowledge of DOS and computer hardware. If in doubt, go to a reputable dealer who will install the drive for you.

Finally, what about reliability? All the drives reviewed here have a claimed mean time before failure of between 25,000 and 50,000 hours. That's a long time, and most drives haven't been out long enough to prove or disprove the number in the general case. In any case, reliability does seem to be increasing. I wouldn't be reluctant to count on any of these drives for my important data.

But hard disk drives are notorious for being flaky, and many's the computer user who's found months of work lost in a bum hard disk drive. The obvious answer is to make backups. This month's Views from BIX on page 129 looks at the factors that go into purchasing a tape backup system and the reasons behind the choices a number of users have made.

Choosing which drive is best for your system is far from an easy call. As I've

noted, each drive has its own idiosyncrasies. Prices vary widely, from less than \$400 to almost \$2600. Though it's far from the cheapest, my particular favorite is the Priam ID45-AT-D2, which just about anyone can install, given a bit of time and patience. The absolute price leader is the Seagate ST251-1, which, at \$370, sells for a relatively small premium over many 20-megabyte drives.

Finally, if you're looking for the best price/performance ratio, you'll have trouble beating the Northgate Turbo kit. At \$695, it has a better overall performance than some drives, like the Tandy SCSI drive and Core AT40F, costing over \$2000. ■

Stan Miastkowski is a BYTE contributing editor, director of K+S Concepts (a documentation and consulting firm), and editor in chief of the OS Report newsletter. He can be reached on BIX as "stanm."

Views from BIX: Tape Backup Units

When a hard disk drive crash can destroy months of work, a reliable backup method becomes vital. BIX users have turned to tape backup units for many applications and are free with their opinions and recommendations. Speed, ease of use, cost, compatibility, and reliability are the main issues they deal with here.

—Curt Franklin, Senior Testing Editor,
BYTE Lab

NICK BARAN (technical editor, BYTE) [nickbaran]: "I'd strongly recommend the Genoa or a similar tape backup system for disk image backup. It's definitely worth the investment. I've already had occasion to use it after my hard disk drive crashed."

LES TROYER [ltroyer]: "Buy an Irwin for backup and make an image to tape. It takes about 5 minutes (while you drink coffee). The Irwin takes care of bad sectors automatically. Occasionally, do a full file backup and restore to up the performance due to fragmented files."

RUSSELL SCHNAPP [rschnapp]: "We use the Emerald tape drive to back up and archive our IBM PC-based office automation product. We were having problems with tapes seeming to go bad. Since we bought the cartridges from them, Emerald suggested we turn them in, and they'd replace them. We did, and they didn't.

"They just sent them back and said nothing was wrong, once they were re-erased. They had no interest in the cause of the tape failures. Then Emerald came out with a new version of the tape backup software called ASP.

"We purchased ASP and found we couldn't get it to seek to the end of the last backed-up volume on the tape. Rather than trying to diagnose the problem (the drive was only a few months old), they told us to buy a new drive. That cost us \$700 more. On the other hand, when it works, it works well. There are other companies that make you pay through the nose for crud. At least Emerald makes you pay through the nose for useful stuff. They simply don't try to engender any customer loyalty through goodwill."

RAY DUNCAN [rduncan]: "We have been using the Emerald 60-megabyte

tape drive and 60-megabyte hard disk drive unit for about a year on a 3Com Ethernet system as the server. We've had pretty good luck with the hardware. Customer service at Emerald was pretty good a year ago but has been going downhill since they got so 'successful,' it seems. We recently bought an expansion drive for our IBM PC AT. It didn't fit in the box, we couldn't get any reasonable answers on the phone, and we finally just had to stop payment on the check to get their attention."

RUSSELL SCHNAPP: "We use an Emerald 60-megabyte tape drive to back up several servers over our TiaraLink LanWare network. It allows multiple volumes per tape, file by file or image (though we never use the latter). The transfer rate is good, somewhere around 1 or 2 megabits a minute. The only problem is that I don't like Emerald's attitude. When the drive began rejecting tapes right and left, they charged us almost the full cost of a new drive to fix/replace it. It has now begun to reject more and more tapes again. ASP will not archive hidden or system files (and maybe not even read-only files). This is supposedly on purpose."

TED BELZER [bunnyrabbit]: "We just installed an Everex streaming tape in an IBM PC AT with Novell NetWare 86. In order to be able to do both image and file-by-file backups, the tape unit must be co-located with the hard disk drive to be backed up. This means the file server must be booted as a nondedicated file server when doing backups. The Everex software allows for backup of Novell's system files when doing a file-by-file backup should you wish to do so, but for frequent file-by-file backups, the inclusion of system files and executables just wastes tape."

BARRY NANCE [barryn]: "I've used the Tecmar QIC-60 tape backup for the IBM PC AT and the Maynstream tape backup unit. I greatly prefer the Tecmar tape machine; it's quicker and seems to be more reliable."

BRIAN COLLETT [bcollett]: "I have an Everex tape drive (20-megabyte streamer) in my machine, and it seems to be working out very well. It backs up the 10 to 12 megabytes I have on my disk at the moment in under 10 minutes (I think it's closer to 5, but I tend

to go elsewhere).

The Everex tape drive comes with some very easy-to-use menu-driven software that should make backing up pretty nearly foolproof for just about anyone, and it can even be set up so that it knows when you should be doing your backups."

BARRY NANCE: "We used to have the Maynstream tape backup unit at work; we trashed it and got a Tecmar QIC-60 in its place. Sometimes the Maynstream would work, and sometimes it wouldn't. We kept nursing it along, eventually getting a new interface card for it so that it would work with ATs, and one day we just decided it was more work than it was worth in backup/restore situations. We also decided we couldn't trust it any longer. In my opinion, the Tecmar is a much better unit."

TIM FROST [tfrost]: "We have a Cipher 5400 that comes with Sytos software. We use the same box on several machines, with an interface card in each. Sytos is fine for straight backups, but the user interface is a bit impenetrable if you need to do some of the more complex selections and exclusions. If you do a complete DOS disk backup, it can take an age to restore an individual file. And remember to remove all RAM disks, etc., before doing a backup; it doesn't tell you it's short of RAM, just runs very, very slowly.

"I have the Xenix version of Sytos, but I never use it. The Xenix support software also comes with a `/dev/mt` driver, and we simply use `tar` or `cpio`. You can make tapes with AT Xenix (SCO) that are readable on several other systems. Sun and NCR Tower are certainly OK. In some cases, you need to use `dd` with `conv=swab`. Transfer in both directions is OK. I don't know what the QIC number is, but it can use DC600A or DC300XLP tapes. We use the latter."

Editor's note: *Views from BIX presents a variety of informal, diverse opinions from users of a selected class of products. Messages chosen for publication may be edited for length or clarity. The views expressed are those of each message's author and do not necessarily reflect those of BYTE or BYTE's reviewers.*

If our new 286 computer is so terrific, why doesn't it cost more?

This handsome piece of high-tech wizardry is the new Dell System 220.



It's the first 286 computer that runs at 20 MHz.

Which means it's as fast as most 386 computers,

running MS[®] OS/2 and MS-DOS[®] at blistering speed. All from a tiny corner of your desk.

Yet it costs less than half of what most 386 computers sell for.

Which might lead you, quite reasonably, to ask: How can Dell offer so much for so little?

Well, you buy direct from us, the manufacturer. Eliminating computer stores and their salespeople—who can add thousands of dollars to a computer's cost, and the hassle of a middleman.

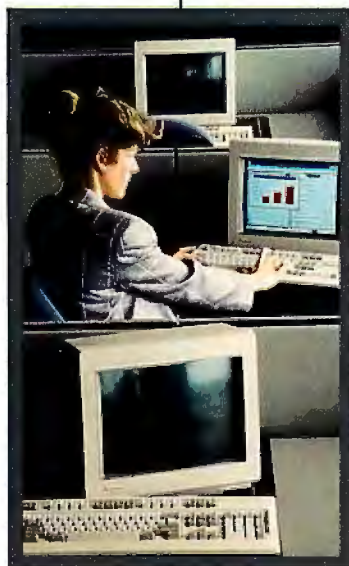

"Speed is a good thing. Safe, reliable, no hassles speed is better still!"—Al Poor, Editor's Choice, PC Magazine

We design and build our computers right here in Austin. Putting a premium on speed, compatibility, and reliability.

We're already shipping our version of MS OS/2, so you can run OS/2 applications, now and in the future.

"...includes a year's on-site support...in the price of the computer. This is the sweetest support deal offered



by any computer vendor in the business?"-Eric Knorr, PC World

And each computer goes through a battery of diagnostic checks, including a comprehensive burn-in before shipment.



In addition, every computer comes with a level of service most computer stores can only envy.

Including expert technical advice before you buy, and free technical phone support after-

wards. Plus next-day on-site repair during the first year.

We also give you a thirty-day money-back guarantee, and a one year limited warranty.

"If your desire for speed is inexhaustible, (this is) the machine for you...it's reassuring when a computer completes some operations even before your fingers leave the keyboard."

-Harry Miller, PC World

As one of the largest personal computer manufacturers in the U.S., we've sold computers to large companies, small companies, and everything in between. Because of this, you can be confident we'll be here to support you now and in the future.

After all, we've been offering better computers, with better service—at better prices.

Now, if you'd like the rest of the details on our hyperfast 286 computer, and the rest of our line, there's only one more thing you have to do.

Turn the page.



The Dell Computer Store.

Welcome to our store. To buy or lease a Dell computer, call (800) 426-5150. We'll help you select the right system.

For service and technical support, call our highly trained technicians at (800) 624-9896. In almost all cases, any problem can be solved over the phone.

These technicians are also supported by Honeywell Bull service engineers who can be dispatched to your office by the next business day, should on-site service be required. This optional service contract is available in over 95% of the United States, with over 1,000 engineers in 198 service locations.*

We are so confident in our quality products that we also provide a Total Satisfaction Guarantee, which says that any system bought from us may be returned within thirty days from the date it was shipped to you for a complete refund of your purchase price.

We also offer a One Year Limited Warranty, which warrants each system we manufacture to be free of defects in materials and workmanship for one full year. During the one year period we will repair or replace any defective products properly returned to our factory.

Call or write for the complete terms of our Guarantee Warranty, and the Honeywell Bull Service Contract. Dell Computer Corporation, 9505 Arboretum Blvd., Austin, Texas 78759-7299.

Dell products are available on a GSA contract. Call us for GSA pricing.

THE NEW 20MHz 386 SYSTEM 310.

The top of the line. It's the highest performance 80386 computer available, faster than the IBM[†] PS/2[†] Model 80 and the Compaq[†] 386/20. It runs at 20 MHz, with the latest 32-bit architecture for maximum performance. And it's completely MS[®] OS/2 compatible. Since it also has Intel's[†] Advanced 82385 Cache Memory Controller, and high performance disk drives, the System 310 is ideal for intensive database management, complex research and development, CAD/CAM, and desktop publishing. As a network file server the system offers an unbeatable combination of price and performance.

Standard Features:

- Intel[†] 80386 microprocessor running at 20 MHz
- 1 MB of 80 ns 32-bit RAM expandable to 16 MB without using an expansion slot
- Advanced Intel 82385 Cache Memory Controller with 32 KB of high speed static RAM.
- Socket for 20 MHz 80387 coprocessor.
- 5.25" 1.2 MB or 3.5" 1.44 MB diskette drive.
- Dual diskette and hard disk drive controller.
- Enhanced 101-key keyboard.
- 1 parallel and 2 serial ports.
- 200-watt power supply.
- Real-time clock.
- 8 expansion slots (6 available with hard disk drive controller and video adapter installed).
- Dell System Analyzer.
- MS-DOS[®] and MS OS/2 compatible.
- Security lock with locking chassis.
- 12 month on-site service contract (Available on complete systems).

Options:

- 1 MB RAM upgrade kit.
- 20 MHz Intel 80387 math coprocessor.
- 2 MB or 8 MB memory expansion boards.

SYSTEM 310	With Monitor and Adapter		
Hard Disk Drives	VGA Mono	VGA Color	VGA Color Plus
40MB-28ms	\$4,099	\$4,299	\$4,399
90MB-18ms ESDI	\$4,899	\$5,099	\$5,199
150MB-18ms ESDI	\$5,399	\$5,599	\$5,699
322MB-18ms ESDI	\$7,399	\$7,599	\$7,699

THE NEW 20MHz 286 SYSTEM 220.

As fast as most 386 computers, at less than half the price—more power for the money than any other system. An 80286 system that runs at 20 MHz, with less than one wait state. Completely compatible for both MS-DOS and MS OS/2 applications (it runs OS/2 faster than IBM PS/2 Model 80), and with a remarkably small footprint, the System 220 is the ideal executive workstation for database management, business, or sophisticated connectivity applications. The system uses page-mode interleaved memory; the page-mode RAM operates at less than one wait state, and inter-leaving results in a performance increase of about 15 percent.

Standard Features:

- 80286 microprocessor running at 20 MHz.
- 1 MB of RAM expandable to 16 MB (8 MB on system board).
- Integrated diskette and VGA video controller on system board.
- One 3.5" 1.44 MB diskette drive.
- Integrated high performance hard disk interface on system board.
- Enhanced 101-key keyboard.
- 1 parallel and 2 serial ports.
- LIM 4.0 support for memory over 1 MB.
- Real-time clock.
- Three full-sized AT[†] compatible expansion slots.
- Socket for 80287 coprocessor.
- Dell System Analyzer.
- MS-DOS[®] and MS OS/2 compatible.
- Security lock with locking chassis.
- 12 month on-site service contract (Available on complete systems).

Options:

- 3.5" 1.44 MB diskette drive.
- Intel 80287 coprocessor.
- 1 MB RAM upgrade kits.

SYSTEM 220	With Monitor		
	VGA Mono	VGA Color	VGA Color Plus
One Diskette Drive	\$2,299	\$2,499	\$2,599
40MB-29ms Hard Disk	\$2,999	\$3,199	\$3,299
100 MB-29 ms Hard Disk	\$3,799	\$3,999	\$4,099

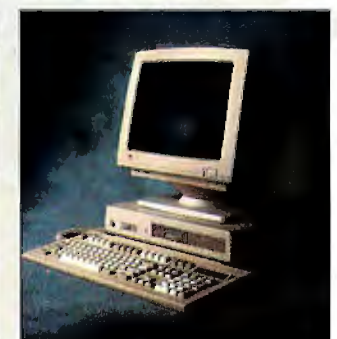

THE NEW 12.5MHz 286 SYSTEM 200.

A great value in a full-featured AT compatible. An 80286 computer running at 12.5 MHz, this system is completely MS OS/2 compatible. It's ideal for general business applications, as well as software development, local area networks, CAD/CAM, and desktop publishing. The System 200 offers high speed drive options, industry standard compatible BIOS, and on-site service. At these low prices, the System 200 is the best value in the 80286 marketplace. As Executive Computing said of this computer's predecessor, "If faster processing speed and low cost are two key issues affecting your purchase decision, this machine might be the ideal choice for your office."

Standard Features:

Intel 80286 microprocessor running at 12.5 MHz.
640 KB of RAM, expandable to 16 MB (4.6 MB on system board.)
5.25" 1.2 MB or 3.5" 1.44 MB diskette drive.
Dual diskette and hard disk drive controller.
Enhanced 101-key keyboard.
1 parallel and 2 serial ports.
200-watt power supply.
Real-time clock.
6 expansion slots. (4 available with hard disk drive controller and video adapter installed).
Socket for 8 MHz 80287 coprocessor.
Dell System Analyzer.
MS-DOS & MS OS/2 compatible.
Security lock with locking chassis.
12-month on-site service contract (Available on complete systems).

Options:

512 KB RAM upgrade kit.
8 MHz Intel 80287 coprocessor.

SYSTEM 200 Hard Disk Drives	With Monitor and Adapter			
	Mono	VGA Mono	VGA Color	VGA Color Plus
20MB	\$2,099	\$2,299	\$2,499	\$2,599
40MB-40ms	\$2,299	\$2,499	\$2,699	\$2,799
40 MB-28 ms	\$2,499	\$2,699	\$2,899	\$2,999
90 MB-18ms ESD1	\$3,299	\$3,499	\$3,699	\$3,799
150MB 18 ms ESD1	\$3,799	\$3,999	\$4,199	\$4,299
322MB 18ms ESD1	\$5,799	\$5,999	\$6,199	\$6,299



THE NEW 8088 SYSTEM 100.

A full-featured, yet economical one-piece computer for office, school, or home. This system is fast, easy to use, and ready to run with Dell Enhanced MS-DOS 3.3, Microsoft® DOS Manager, and Microsoft Works software—more than a \$400 value, included at no extra charge. Complete MS-DOS compatibility means you can run thousands of programs for business, personal finance, education, and entertainment. And the System 100 can grow, with the high quality options listed below. A price leader in 8088 technology, the System 100 boasts an innovative design that allows for more power, speed and convenience than most of its competitors.

Standard Features:

Intel 8088 microprocessor running at 9.54 MHz selectable to 4.77.
640 KB of RAM.
3.5" 720 KB diskette drive.
Diskette drive controller integrated on system board.
Integrated high-quality 84-key keyboard.
1 serial and 1 parallel port.
Two full-sized expansion slots available when video adapter is installed.
One half-sized expansion slot used for video adapter.
Socket for 8 MHz 8087 coprocessor.
Internal speaker with earphone jack and volume control.
Security Tie-Down bracket.
Dell Enhanced MS-DOS 3.3
Microsoft DOS Manager,
Microsoft Works.

Options:

3.5" 720 KB diskette drive.
8 MHz Intel 8087.

SYSTEM 100	With Monitor and Adapter			
	Mono	CGA Color	VGA Mono	VGA Color
720KB Diskette Drive	\$1,099	\$1,199	\$1,299	\$1,499
Two 720 KB Diskette Drives	\$1,249	\$1,349	\$1,449	\$1,649
20MB Hard Disk	\$1,599	\$1,699	\$1,799	\$1,999



PRINTERS.

We now offer a full line of PC-compatible dot matrix and laser printers. Our dot matrix printers range from inexpensive near-letter quality printers to the highest resolution printers available. Our laser printers include some of the fastest, most reliable printers ever made. All are 300 dots per inch, and all support serial and parallel interfaces. And all printers come with our 30-day money-back guarantee and a one year warranty.

LASER PRINTERS

Laser System 150 \$5,995
15 pages per minute, text and graphics
1.5 MB standard memory, expandable to 2.0 MB
Dual 250-sheet input trays
Laser System 80 \$3,195
8 pages per minute text and graphics
1.5 MB standard memory, expandable to 2.0 MB
Laser System 60 \$2,195
6 pages per minute, text and graphics
1.5 MB standard memory, expandable to 2.0 MB
DOT MATRIX PRINTERS
Printer System 800 \$699.95
Highest resolution text and graphics from a 24-wire dot matrix printer
Draft quality at 200 cps

Correspondence quality at 132 cps
Letter quality at 66 cps
Standard parallel and serial interfaces
Wide carriage

Printer System 600 \$499.95

9-wire dot matrix
Draft quality at 240 cps
Near-letter quality at 60 cps
Standard parallel interface
12.6 KB Buffer (expandable to 28.6 KB)
Wide carriage

Printer System 300 \$199.95

9-wire dot matrix
Draft quality at 144 cps
Near-letter quality at 36 cps
Four standard fonts
Paper parking
4 KB buffer
Standard Parallel interface

PERIPHERALS.

With our unique manufacturing capabilities, we can build a system to your exact specifications. We offer monitors, modems, graphics boards, tape backups, hard drives, diskette drives, expanded memory boards, a serial mouse, and more. Call for details.

Operating System Software

Dell Enhanced MS-DOS 3.3 with disk cache and other utilities \$119.95.
Dell MS OS/2 Standard Edition 1.0 \$324.95

SOFTWARE.

Complete your system with software: accounting, communications, desktop publishing, graphics, home, spreadsheet, training, word processing, and integrated packages. Call for more information.

DELL
COMPUTER
CORPORATION

TO ORDER, CALL
800-426-5150
IN THE U.S. AND CANADA

All prices and specifications are subject to change without notice. Please inquire for current details. Dell cannot be responsible for errors in typography or photography. In Canada, leasing is not currently available, and configurations and pricing may vary. *Available on System 100 at extra charge. Microsoft® MS® and MS-DOS® are owned by Microsoft Corporation. †Signifies registered or unregistered trademarks owned by entities other than Dell Computer Corporation. ©1988 DELL COMPUTER CORPORATION.

AD CODE NO. 11EG8



Outclassing the AT

Of these five AT compatibles, Amdek's system ranks tops in performance, and PC's Limited comes in as the best buy

John Unger and Stan Miastkowski



Amdek System/286A



Arche Rival 286

The current crop of PC AT-compatible computers is pushing performance beyond that of the IBM PC AT. Granted, most AT compatibles don't yet have the speed and flash of 80386 machines. But high-speed 80286 systems are more and more closely approaching the performance of 80386 systems, are well-tested and reliable, and still sell for far less than fully equipped 80386 systems. In short, they don't shirk in performance, don't break budgets, and don't break down.

The Amdek System/286A, Arche Rival 286, Epson Equity II+, Leading Edge Model D2, and PC's Limited System 200 are 80286-based computers that run at 10 MHz or higher. While they are all IBM PC AT-compatible, they differ in details: Besides varying clock speeds, internal components such as graphics cards and hard disk drives are different, and the basic design of the motherboards differs significantly from machine to machine. In this review, we'll look at each machine and then do a side-by-side comparison with BYTE's new benchmarks to give you a good idea of where each computer's strengths and weaknesses lie.

Amdek System/286A

The Amdek System/286A is a small-footprint microcomputer built on the same chassis as the Amdek System/386 computer I reviewed in the May *BYTE*. Amdek takes advantage of the modularity built into its system bus design. The CPU, system RAM, and ROM are mounted on a card that fits into one of the standard 16-bit AT-style expansion slots on the system bus. This configuration allows Amdek (or WYSE Technology, Amdek's parent company, which actually manufactures the Amdek microcomputers) to change the computer models by simply replacing the CPU board.

The 12.5-MHz CPU on the System/286A can be switched to run at a slower 8-MHz clock speed for better compatibility. The machine has a convenient 16-character LCD window on the front panel that displays the time or date and CPU clock speed, or a bar graph that shows the amount of CPU activity.

My test system had an EGA monitor, along with a 1.2-megabyte 5¼-inch floppy

disk drive, a 40-megabyte hard disk drive, and 1 megabyte of dynamic RAM (DRAM). The cost for this configuration is \$4345. The review unit was also equipped with the Paradise EGA card.

The View

The combination of Paradise's half-length EGA card and the Amdek Monitor/722 produced excellent color graphics and text. When it's in monochrome text mode, the monitor has the capability to switch from white characters on a black background to either orange or green characters on a black background. All my "serious" software and my CGA games ran perfectly on this display combination.

Hardware and Performance

As the benchmark results show, the System/286A is one of the best-performing 80286-based microcomputers that *BYTE* has reviewed. The system's fine performance is due to the CPU clock's high speed (12.5 MHz) and to the fact that the hardware imposes no wait states on the system. For compatibility with some software and expansion boards, you can



Epson Equity II+



Leading Edge Model D2



PC's Limited System 200

also run the CPU at 8 MHz with one wait state. You switch the CPU speed by pressing a button on the front panel or by invoking a utility program. For mathematically intensive tasks, the system accepts either a 6-MHz or 10-MHz 80287 coprocessor.

The Control Data Corp. (CDC) 40-megabyte hard disk drive in my review system did not degrade the system's performance. It had an average access time of 24 milliseconds and a data transfer rate of 165K bytes per second, as reported by the Coretest program. Using Amdek's disk-caching program increases the speed of some disk-intensive tasks by as much as 20 percent.

The 1 megabyte of system memory is mounted on a piggyback daughterboard that is connected to the CPU motherboard via a special bus. This card combo is mounted in an extra-wide expansion slot on the left-hand side of the computer. Two DB-9 RS-232C male serial ports and a single DB-25 female parallel port are located on a half-length expansion card mounted in one of the 8-bit slots. The full-length disk controller card fills a 16-bit slot and has cabling for two floppy

disk drives and two hard disk drives. The EGA video card takes up a second 16-bit slot.

This configuration leaves you with three 16-bit slots and one 8-bit slot free; the 8-bit slot isn't really usable for some purposes, though, because the second serial port is mounted on the cover of the adjacent empty expansion slot.

Essential Software

For the System/286A, Amdek supplies an enhanced version of MS-DOS 3.20 that includes a number of utility programs. The most useful of these is an on-line HELP command for all the DOS commands and programs. This feature is essential; Amdek's documentation on MS-DOS is skimpy and includes no explanation of EDLIN or Debug.

Fast computers can come in small packages. If you are looking for one of the top-performance AT compatibles and don't need to install more than three half-height storage devices, the System/286A is an excellent choice. Its modular CPU design gives it the added benefit of being easily upgraded—you can simply add a new expansion card.—*John Unger*

Arche Rival 286

Arche Technologies is a new contender in the AT clone sweepstakes, with a distinctive yellow-arch corporate logo that's reminiscent of a certain fast-food chain. The Arche Rival 286 has the rather unusual distinction (for a compatible) of being made in the U.S., although many of its parts, including the floppy disk drive and some of the chips, are, not surprisingly, of Japanese extraction.

The system comes in a rather bewildering array of choices. The entry-level model goes for \$1995 and includes 640K bytes of RAM, a single 1.2-megabyte 5¼-inch floppy disk drive, and a 14-inch diagonal monochrome monitor.

If you have Cadillac tastes, you can equip your Arche Rival 286 with the works: 1 megabyte of RAM, a second 1.2-megabyte 5¼-inch floppy disk drive, a high-speed 80-megabyte hard disk drive, and an EGA monitor. That will set you back \$4395.

The unit I tested had 1 megabyte of RAM, a single floppy disk drive, the

continued

OUTCLASSING THE AT

	Amdek System/286A	Arche Rival 286	Epson Equity II+
Company	Amdek Corp. 1901 Zanker Rd. San Jose, CA 95112 (800) 722-6335	Arche Technologies, Inc. 48835 Kato Rd. Fremont, CA 94539 (800) 422-4674	Epson America, Inc. 2780 Lomita Blvd. Torrance, CA 90505 (800) 421-5426
Components	Processor: 12.5-MHz 80286 with zero wait states, switchable to 8 MHz with one wait state; optional 80287 (6- or 10-MHz) math coprocessor Memory: 1 megabyte of DRAM, expandable to 16 megabytes; 32K bytes of ROM; Phoenix ROM BIOS version 1.83 Mass storage: 1.2-megabyte 5¼-inch floppy disk drive; optional 40-megabyte hard disk drive Display: Optional Amdek color EGA display, 80 characters by 25 lines, 640- by 350-pixel resolution Keyboard: 102 keys in IBM enhanced keyboard layout I/O interfaces: Two DB-9 RS-232C serial ports; one DB-25 parallel printer port; six 16-bit and two 8-bit expansion slots	Processor: 12-MHz 80286 with one wait state, switchable to 8 MHz with zero wait states; socket for 80287 math coprocessor Memory: 640K bytes of 100-ns RAM, expandable to 1 megabyte on system board; diagnostics in ROM Mass storage: One 1.2-megabyte 5¼-inch floppy disk drive; optional 20-, 40-, 65-, 80-, or 140-megabyte hard disk drive Display: Amber-phosphor monochrome; 14-inch diagonal flat screen, 1000-line resolution Keyboard: 101 keys in IBM enhanced keyboard layout I/O interfaces: One DB-9 and one DB-25 RS-232C serial port; one DB-25 parallel port; one DB-9 monochrome monitor port; two 8-bit and six 16-bit expansion slots	Processor: 12-MHz 80286 with one, two, three, or four wait states, switchable to 8 MHz with one wait state; optional 80287 (8-MHz) math coprocessor Memory: 640K bytes of DRAM, expandable to 15.5 megabytes; 32K bytes of ROM Mass storage: 1.2-megabyte 5¼-inch floppy disk drive; optional 40-megabyte hard disk drive Display: Optional Epson Enhanced color display Keyboard: 101 keys in IBM enhanced keyboard layout I/O interfaces: One DB-9 RS-232C serial port; one DB-25 parallel printer port; three 16-bit and three 8-bit expansion slots
Size	6¼ × 15 × 17 inches; 23 pounds	6 × 17 × 17 inches; 52 pounds	6 × 15¾ × 16⅝ inches; 23 pounds
Software	Microsoft MS-DOS 3.20; Microsoft GWBASIC 3.20; custom utilities	MS-DOS 3.3; system setup on hard disk drive	Microsoft MS-DOS 3.3; Microsoft GWBASIC 3.20; custom utilities; hard disk cache
Options	Monitor/432, VGA monochrome: \$245 Monitor/732, VGA color: \$625 Monitor/722, EGA color: \$750	384K-byte memory expansion: \$200 EGA monitor: \$600 1.2-megabyte 5¼-inch floppy disk drive: \$200 20-megabyte hard disk drive: \$300 40-megabyte hard disk drive: \$600 65-megabyte hard disk drive: \$800 80-megabyte hard disk drive: \$1400	Multimode graphics adapter: \$149 EGA card: \$299 Monochrome monitor: \$149 Color monitor: \$449 EGA monitor: \$599
Documentation	64-page Amdek System 286A Installation and Assembly Guide; 110-page Amdek Enhanced MS-DOS 3.2 User's Guide	User's Guide; Microsoft MS-DOS User's Guide and User's Reference; Microsoft GWBASIC User's Guide and User's Reference	User's Guide and Diagnostics; Epson GWBASIC for the Equity+ System; Epson MS-DOS for the Equity+ System
Price	With 1.2-megabyte 5¼-inch floppy disk drive; no monitor or display adapter: \$2495 With 1.2-megabyte 5¼-inch floppy disk drive and 40-megabyte hard disk drive; no monitor or display adapter: \$3595 System as reviewed: \$4345	With 1.2-megabyte 5¼-inch floppy disk drive and monochrome system: \$1995 With two 1.2-megabyte 5¼-inch floppy disk drives, an 80-megabyte hard disk drive, 1 megabyte of RAM, and EGA monitor: \$4395 System as reviewed: \$2595	With 1.2-megabyte 5¼-inch floppy disk drive; no monitor or display adapter: \$1899 With 1.2-megabyte 5¼-inch floppy disk drive and 40-megabyte hard disk drive; no monitor or display adapter: \$2999 System as reviewed: \$3897
	Inquiry 883.	Inquiry 884.	Inquiry 885.

Leading Edge Model D2

Leading Edge Hardware Products, Inc.
225 Turnpike St.
Canton, MA 02021
(800) 872-5323
(617) 828-8150

Processor: 10-MHz 80286 with one wait state, switchable to 8 MHz and 6 MHz with one wait state; socket for 80287 math coprocessor
Memory: 640K bytes of 120-ns RAM, expandable to 1 megabyte on system board
Mass storage: 1.2-megabyte 5¼-inch floppy disk drive; optional 30-megabyte or 64-megabyte hard disk drive
Display: Green-phosphor monochrome; 12-inch diagonal
Keyboard: 101 keys in IBM enhanced keyboard layout
I/O interfaces: One DB-9 RS-232C serial port; one DB-25 parallel port; one EGA monitor port; two 8-bit and four 16-bit expansion slots

6 × 15½ × 16 inches; 46 pounds

MS-DOS 3.20; GWBASIC 3.20; system diagnostics; system setup; Leading Edge Word Processor

None available

Operator's Guide; MS-DOS Reference Manual; Guide to BASIC; Word Processing User's Guide

With single 1.2-megabyte 5¼-inch floppy disk drive: \$1495
With 1.2-megabyte 5¼-inch floppy disk drive and 30-megabyte hard disk drive: \$1995
System as reviewed: \$2495

Inquiry 886.

PC's Limited System 200

Dell Computer Corp.
9505 Arboretum Blvd.
Austin, TX 78759
(800) 426-5150

Processor: 12.5-MHz 80286 with one wait state, switchable to 6.25 MHz with one wait state; optional 80287 (either 6-MHz or 8-MHz) math coprocessor
Memory: 640K bytes of 120-ns DRAM, expandable to 16 megabytes with up to 4.6 megabytes on system board with optional SIMM modules; 32K bytes of ROM; Phoenix BIOS version 3.07 08
Mass storage: 1.2-megabyte 5¼-inch floppy disk drive; optional 1.44-megabyte 3½-inch floppy disk drive; optional 40-megabyte hard disk drive
Display: Optional Mitsubishi XC-1429C color VGA display
Keyboard: 101 keys in IBM enhanced keyboard layout
I/O interfaces: Two DB-9 RS-232C serial ports; DB-25 parallel printer port; four 16-bit and two 8-bit expansion slots

6¼ × 21⅛ × 17½ inches; 41 pounds

Microsoft MS-DOS 3.30; Microsoft GWBASIC 3.22; custom utilities

14-inch VGA monochrome monitor: \$250
14-inch EGA monitor: \$700
VGA card: \$300
20-megabyte hard disk drive: \$370
40-megabyte hard disk drive: \$600
40-megabyte 28-ms hard disk drive: \$900
1.44-megabyte 3½-inch floppy disk drive: \$200
360K-byte 5¼-inch floppy disk drive: \$150
512K-byte RAM: \$200

286 Owner's Manual; MS-DOS 3.30 Enhancement Guide; System 200 Support Manual; MS-DOS User's Guide; MS-DOS 3.30 User's Reference; Microsoft GWBASIC Interpreter User's Reference

With 1.2-megabyte 5¼-inch floppy disk drive, monochrome display adapter and monitor, and 20-megabyte hard disk drive: \$1799
System as reviewed: \$3599

Inquiry 887.

monochrome monitor, and a 20-megabyte Seagate ST225 hard disk drive—a configuration with a list price of \$2595.

Using 100-nanosecond RAM, the Rival 286 runs at 12 MHz with one wait state or at 8 MHz with zero wait states. Speed selection is a simple matter of pressing a button on the front panel of the system unit. There's also a reset switch and a keylock on the front.

Keeping It Small

Inside the case, the Rival 286 has a particularly neat appearance; in fact, it looks almost empty. The motherboard is an incredibly small 8½ by 12 inches; yet, despite its size, it doesn't look crowded. The primary reason for this is that the Arche folks decided to use the whole Chips & Technologies 80286 support set—a group of six application-specific integrated circuits (ASICs) that eliminate a multitude of individual chips. Another reason for the small motherboard is that some functions that are normally supported on an AT-type motherboard, such as I/O ports, are relegated to add-in boards.

The Rival 286 has eight expansion slots: two 8-bit and six 16-bit. A Hercules-compatible monochrome graphics adapter takes up one of the 8-bit slots. A serial/printer/game-port card takes up a single 16-bit slot, as does a hard disk drive/floppy disk drive controller that accepts both 3½-inch and 5¼-inch drives. The hard disk drive is mounted at the very bottom of a drive stack that can take a total of three half-height drives.

Easy on the Eyes

The display of the Rival 286 is most immediately noticeable for its 14-inch diagonal size. It uses the flat-screen technology that Zenith first introduced last year. The Rival's monitor is Taiwan-made and of indeterminate manufacture; the monitor's only internal identification, Zemintron Ltd., is on the neck of the flat-screen tube. Couple the flat display with the large character size, and it's a great monitor for pampering your eyes.

Although the Rival 286 is available without a hard disk drive or with various floppy disk drives of various capacities, the unit I tested came with a venerable, albeit slow, Seagate ST225. The Coretest showed an average seek time of 70.8 ms and a data transfer rate of 159.1K bytes per second—not exactly speedy. In a disk-intensive application such as a database, using a drive this slow can seriously bog down system performance, 12-MHz processor speed notwithstanding.

continued

Outclassing the AT:

Amdek System/286A PC's Limited System 200 Arche Rival 286 Leading Edge Model D2 Epson Equity II+

APPLICATION-LEVEL PERFORMANCE

WORD PROCESSING						DATABASE					
	Amdek	PC's Ltd.	Arche	LE-D2	Epson		Amdek	PC's Ltd.	Arche	LE-D2	Epson
XyWrite III+ 3.52						dBASE III+ 1.1					
Load (large)	:11	:13	:15	:15	:15	Copy	1:01	:56	2:52	1:07	1:17
Word count	:04/:28	:05/:34	:03/:36	:06/:42	:06/:43	Index	:14	:22	:23	:20	:23
Search/replace	:06/:25	:08/:33	:08/:37	:09/:37	:10/:37	List	2:24	2:05	1:56	2:43	3:13
End of document	:02/:11	:03/:22	:02/:24	:02/:23	:03/:22	Append	2:25	1:50	3:27	2:09	2:31
Block moves	:12/:12	:12/:12	:07/:07	:08/:08	:15/:15	Delete	:03	:03	:04	:02	:04
Spelling check	:12/1:29	:15/1:49	:16/1:56	:17/2:16	:18/2:17	Pack	1:02	1:42	2:04	1:48	1:50
Microsoft Word 4.0						Index:					
Forward delete	2:12	:22	:24	:28	:28		1.6	1.4	1.0	1.4	1.1
Aldus PageMaker 1.0a						SCIENTIFIC/ENGINEERING					
Load document	:05	:06	:19	:13	:07	Amdek PC's Ltd. Arche LE-D2 Epson					
Change/Bold	:31	:40	:47	:53	:50	AutoCAD 2.52					
Align right	:26	:31	:37	:38	:38	Load SoftWest	1:34	1:25	1:37	2:06	1:58
Cut 10 pages	:24	:26	:31	:30	:32	Regen SoftWest	1:01	1:06	1:17	1:45	1:39
Place graphic	:07	:07	:09	:09	:08	Load StPauls	:23	:20	:21	:25	:23
Print to file	2:00	2:34	3:19	3:03	3:06	Regen StPauls	:11	:12	:14	:16	:16
Index:						Hide/redraw					
	2.2	1.9	1.8	1.7	1.6		18:41	21:11	24:53	30:01	29:16
SPREADSHEET						STATA 1.5					
Lotus 1-2-3 2.01						Graphics					
Block copy	:05	:05	:06	:07	:07	ANOVA	:27	:24	:21	:30	:31
Recalc	:02	:02	:03	:03	:03	MathCAD 2.0					
Load Monte Carlo	:20	:22	:23	:36	:38	IFS800 pts.	:29	:33	:33	:39	:43
Recalc Monte Carlo	:05	:06	:09	:14	:11	FFT/IFFT 1024 pts.	:32	:36	:35	:41	:47
Load rlarge3	:05	:05	:06	:09	:09	Index:					
Recalc rlarge3	:01	:01	:02	:02	:02		2.1	2.0	2.0	1.5	1.5
Recalc Goal-seek	:04	:05	:09	:07	:08	COMPILERS					
Microsoft Excel 2.0						Amdek PC's Ltd. Arche LE-D2 Epson					
Fill right	:06	:08	:09	:10	:10	Microsoft C 5.0					
Undo fill	2:32	3:13	3:25	4:05	4:04	XLisp compile	5:39	6:50	8:41	7:01	7:56
Recalc	:01	:01	:03	:04	:01	Turbo Pascal					
Load rlarge3	:31	:38	:41	:48	:46	Pascal S compile	:07	:07	:10	:10	:09
Recalc rlarge3	:02	:02	:02	:03	:02	Index:					
Index:							1.7	1.5	1.1	1.2	1.2

All times are in minutes and seconds. Indexes show relative performance; for all indexes, an 8-MHz IBM PC AT=1.

LOW-LEVEL PERFORMANCE¹

CPU	Amdek	PC'S Ltd.	Arche	LE-D2	Epson	DISK I/O	Amdek	PC'S Ltd.	Arche	LE-D2	Epson	VIDEO	Amdek	PC'S Ltd.	Arche	LE-D2	Epson
Matrix	6.06	7.18	7.83	9.00	8.98	Hard Seek⁴						Text					
String Move						Outer track	3.33	3.35	6.66	3.32	3.33	Mode 0	14.86	11.37	N/A	N/A	12.32
Byte-wide	34.07	50.24	53.23	63.49	63.00	Inner track	3.32	3.28	6.68	3.31	3.31	Mode 1	14.88	11.4	N/A	N/A	12.33
Word-wide						Half platter	9.98	9.97	19.94	6.66	9.99	Mode 2	14.52	11.2	N/A	N/A	11.84
Odd-bnd.	34.06	50.26	53.40	63.49	63.00	Full platter	13.33	13.36	33.3	10	13.29	Mode 3	14.54	11.2	N/A	N/A	11.83
Even-bnd.	17.05	25.12	26.53	31.74	32.00	Average	7.49	7.49	16.64	5.82	7.48	Mode 7	N/A	10.18	6.0	9.9	N/A
Sieve	35.65	46.12	48.64	57.70	58.00	DOS Seek						Graphics					
Sort	40.39	52.82	55.58	67.00	66.00	1-sector	10.81	10.78	15.96	12.11	10.68	CGA:					
Index:						8-sector	33.70	24.99	47.45	12.55	26.98	Mode 4	2.74	3.18	N/A	N/A	4.14
	2.11	1.61	1.51	1.28	1.28	File I/O⁵						Mode 5	2.73	3.2	N/A	N/A	4.16
FLOATING POINT²						Seek	0.11	0.19	0.45	0.13	0.27	Mode 6	2.88	3.41	N/A	N/A	4.35
						Read	0.01	0.01	0.0194	0.03	0.0201	EGA:					
						Write	0.02	0.0158	0.025	0.08	0.0231	Mode 13	4.87	5.29	N/A	N/A	6.9
						1-megabyte						Mode 14	5.31	5.86	N/A	N/A	7.52
						Write	8.04	8.06	9.7	4.7	8.4	Mode 16	5.25	5.84	N/A	N/A	7.51
						Read	7.56	7.5	8.1	5.8	7.65	Hercules					
Index:						Index:						Mode225	N/A	N/A	3.24	3.90	N/A
	1.6	1.7	1.5	1.3	1.2		1.3	1.2	0.8	1.3	1.0	Index:					
												1.0	1.1	1.5	1.2	0.9	

N/A=Not applicable; mode not supported by graphics adapter.

¹ All times are in seconds. All figures were generated using the 8088/8086 version of Small-C (16-bit integers). Figures for 80386 machines do not use 80386-specific instructions.

² The floating-point benchmarks use 8087-compatible instructions only.

³ The errors for the floating-point benchmarks indicate the difference between expected and actual values, correct to 10 digits or rounded to 2 digits.

⁴ Times reported by the Hard Seek and DOS Seek are for multiple seek operations (number of seeks performed currently set to 100.)

⁵ Read and write times for the File I/O benchmarks are in seconds per Kbyte.

⁶ For the Livermore Loops and Dhrystone tests only, higher numbers mean faster performance.

CONVENTIONAL BENCHMARKS

	Amdek	PC'S Ltd.	Arche	LE-D2	Epson
LINPACK	633.40	574.19	669.76	803.95	805.48
Livermore Loops ⁶					
(MFLOPS)	0.04	0.0419	0.0355	0.0297	0.0296
Dhrystone (MS C 5.0)					
(Dhry/sec)	3584	2741	2557	2136	2177



Amdek System/286A **9.8***

PC's Limited System 200 **8.9**

Arche Rival 286 **7.4**

Leading Edge Model D2 **7.1**

Epson Equity II+ **7.0**

IBM PS/2 Model 80 **11.3**

IBM PC AT **5**

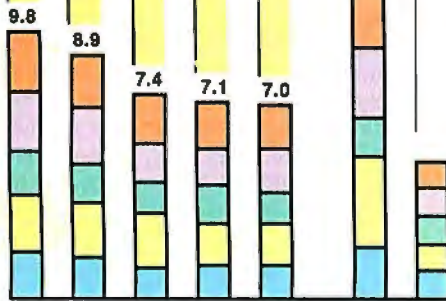

*Cumulative applications index. Graphs are based on indexes at left and show relative performance.

Amdek System/286A

PC's Limited System 200

Arche Rival 286

Leading Edge Model D2

Epson Equity II+

IBM PS/2 Model 80

IBM PC AT

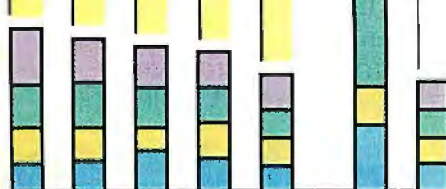

CPU

FPU

Disk I/O

Video

If you buy a Rival 286, you should seriously consider opting for a faster hard disk drive.

All the memory chips in the Rival 286 are socketed, and if you have a 640K-byte machine, it's a simple matter to plug in a few extra chips to bring it up to the full 1-megabyte AT complement.

Between the Covers

The Rival 286 ships with a generic version of MS-DOS 3.3. The excellent Microsoft manuals are included, although the relatively high level of their technical content can be daunting if you're a beginner. The User's Guide is a better place for most folks to start. It's a terse, though well-written, 54 pages of essential information.

Another plug-it-in-and-run machine, the Arche Rival 286 bears all the marks of careful design and construction. And it's frankly a comfortable system to use. On the unit I tested, the slow hard disk drive was a noticeable drag on the system. Arche Technologies has warranted its system for 24 months, and the company was in the process of setting up toll-free help lines as I was writing this review.—*Stan Miastkowski*

Epson Equity II+

The Epson Equity II+ is a big jump forward from the original Equity II. This new model has an 80286 CPU that you can switch between 8 and 10 MHz. The improved performance of this machine is not due only to the new processor: All the critical hardware components have been upgraded. My review unit had a fast 40-megabyte hard disk drive, a 1.2-megabyte 5 1/4-inch floppy disk drive, and 640K bytes of 120-ns DRAM. All this is attractively packaged in a light-gray, small-footprint unit. The price of this system, including Epson's Autoswitch EGA card and EGA monitor, is \$3897.

As in earlier Epson computers, the Equity II+ has a small door on the bottom left of the front panel, behind which you'll find a hardware reset switch, a toggle switch for the 8-MHz and 12-MHz CPU speeds, and another toggle for monochrome and color monitors. The keyboard cable connects to a recessed plug hidden behind another small panel at the bottom left corner of the machine.

An LED power indicator on the front of the Equity II+ glows green when the computer is turned on and running at 10 MHz; it changes to orange when the CPU

continued

is set to its 8-MHz speed. You can change the processor speed only with the switch mentioned above; it cannot be changed with a keystroke combination or by software—an inconvenience compared to other systems with switchable CPU speeds. A second green LED glows when the system's CDC 40-megabyte hard disk drive is active. This hot drive shows an average seek time of 23 ms with a data transfer rate of 169K bytes per second, according to the Coretest program.

Internals

The basic layout of the Equity II+ components is similar to that of most other small-size AT clones. Three half-height storage device bays occupy the right front corner of the computer; behind them sits the 140-watt power supply. The left side of the box contains three 16-bit and three 8-bit expansion slots.

There are a few surprises inside, though. The 640K bytes of RAM are installed on a special memory card rather than on the motherboard. This small card is mounted vertically on its own expansion connector, just to the left of the disk drive enclosures. Also, the computer

uses two separate disk drive controller expansion cards. The floppy disk drive controller is mounted in an 8-bit slot and has connections for two floppy disk drives and the DB-9 RS-232C serial and DB-25 parallel ports. The hard disk drive controller is mounted in a 16-bit slot and has connectors for two drives. Because the video adapter card occupies another of the 8-bit slots, the machine is left with only one 8-bit and two 16-bit slots available for further expansion.

My review computer came with an EGA card and EGA monitor. The half-length Epson Autoswitch EGA card appears to be almost identical to the Paradise Autoswitch EGA card. The monitor and adapter performed perfectly with CGA and EGA software such as Brief 2.0, WordPerfect 4.2, Borland's Quattro 1.0, and my kids' current favorite, Chuck Yeager's Advanced Flight Trainer 1.2.

One peeve I have about this computer is its keyboard. The keys felt loose and somewhat flimsy, and their action was light and uncertain; it did not inspire confidence when typing fast. It's a bothersome component of an otherwise fine computer.

Software and Documentation

The Equity II+ comes with MS-DOS 3.3, GWBASIC 3.20, and an easy-to-use setup and diagnostics disk. The manuals for the operating system and BASIC interpreter are in softcover binders and are quite complete. The Equity II+ user's guide makes setting up the computer straightforward even for novice users. Epson also includes a useful utility program from Storage Dimensions called SpeedStor, which allows you to partition your hard disk drive in a variety of ways, including into DOS partitions that exceed the normal 32-megabyte limit.

Bottom Line

The strengths of the Equity II+ are its convenient size and the fact that it is manufactured by one of the most reputable companies in the microcomputer game. The machine's performance would have been considered outstanding a year ago, but standards change quickly in this business, and a 10-MHz 80286 running with one wait state is a rather ordinary configuration these days. [Editor's note: *Epson has recently announced a new version of the Equity II+ with a clock speed*

INDUSTRIAL STRENGTH OOPS.

You have three options in today's world; lead, follow or get out of the way. You've already taken a leadership position in hardware with the latest 286 or 386 system. Now you can use that triple-digit architecture to blast ahead of the pack with the most powerful new Object Oriented Programming (OOPS) software on the market: Smalltalk/V286.

Smalltalk/V, the original OOPS tool for the PC, gave scientists, engineers, programmers and educators a brand new way to solve problems. And soon they were developing exciting new applications in everything from economics to medicine to space.

Now Smalltalk/V286 gives you true work station performance with industrial strength capabilities like: push-button debugging; multi-processing; portability

between DOS, OS/2 and Presentation Manager operating environments; integrated color graphics; a rich class library; and access to 16 MB of protected mode memory, even under DOS.

The new Smalltalk/V286, which is even easier to learn and use than Smalltalk/V, retails for just \$199.95. Or you can buy Smalltalk/V, still the world's best selling OOPS, for only \$99.95. And both come with our 60 day money-back guarantee.

Check out the new Smalltalk/V286 at your dealer. If he doesn't have it, order toll free, 1-800-922-8255. Or write to: Digitalk, Inc., 9841 Airport Blvd., Los Angeles, CA 90045.

And let us put you ahead of the power curve.

Smalltalk/V286

of 12 MHz. The new version retains the same case design and sells for \$2699 with a 40-megabyte hard disk drive.]

Another possible minus for the Equity II+ is its limited expandability because of the need for two separate disk controllers and for the installation of a memory-expansion card if you want more than 640K bytes of RAM.—*John Unger*

Leading Edge Model D2

Leading Edge is a familiar company in the battle for personal computer users' dollars. Its new Model D2 is a direct descendant of the still-available 8088-based Model D, which I reviewed in the September 1986 BYTE. Like its predecessor, the Model D2 is manufactured in Korea by Daewoo Telecom. With its 16-inch-square footprint, it even looks like the Model D, although it's a bit taller.

The Model D2 comes in three configurations, all with 640K bytes of RAM, a single 1.2-megabyte 5¼-inch floppy disk drive, a 12-inch high-resolution monochrome monitor, and a multimode EGA

card. The basic model lists for \$1495. You can get the same with a 30-megabyte hard disk drive for \$1995, or with a 65-megabyte high-speed hard disk drive for \$2495. The last is the one I tested.

Leading Edge sells no other accessories. If you want a color monitor, or if you want to expand the memory to 1 megabyte (on the motherboard), you'll have to fend for yourself.

The system uses 120-ns RAM and runs at either 10, 8, or 6 MHz, all with a single wait state. You switch the processor speed via the keyboard. There's a reset switch and keylock on the front, and single RS-232C and parallel ports are also standard issue.

Under the Hood

Inside, the Model D2 has a close-to-conventional-size motherboard (11 by 12 inches). The Daewoo folks opted to use most of the Chips & Technologies AT-compatible chip set, although for some reason they didn't use the C&T 82C206, preferring to incorporate their own direct memory access (DMA) controller, interrupt controller, timer, and real-time clock/calendar using discrete chips.

The Model D2 has four 16-bit and two 8-bit expansion slots. The hard disk drive controller takes up a 16-bit slot, and the EGA card takes an 8-bit slot. The floppy disk drive controller and the circuitry for single RS-232C serial and parallel ports are all included on the motherboard. There's space for two 5¼-inch floppy disk drives in the main drive bay, and if you opt for a hard disk drive, it gets mounted vertically to the right of the floppy disk drives—an efficient use of space.

High-Test Hard Disk Drive

The 65-megabyte Microscience HH-1060 hard disk drive that came with my high-end version of the system is a veritable speed demon. The Coretest showed an average seek time of 20.6 ms with a data transfer rate of 716.6K bytes per second. The 16-bit controller coupled with 1-to-1 interleave definitely does the job. If you're doing disk-intensive processing, there's absolutely no question that this is the hard disk system to use.

The Model D2 comes configured with 640K bytes of RAM, 512K bytes of

continued



which is permanently soldered into the motherboard; this can be a real pain if problems develop. Although there's room for the full standard megabyte of AT memory on the motherboard, the Model D2 has one slightly maddening idiosyncrasy: If you want to expand your 640K-byte system to 1 megabyte, you need to buy 512K bytes of RAM, not 384K bytes. The reason for this is that the 128K bytes of RAM from 512K to 640K is configured with 64K-byte chips. To expand the board to 1 megabyte, you need to remove the 64K-byte chips and replace them with 256K-byte chips. And you'll probably never have a use for those leftover 64K-byte chips.

The Model D2 comes with a pile of disks and a pile of manuals. There's MS-DOS 3.20, a diagnostics disk, a setup disk, and the Leading Edge Word Processor thrown in for good measure. The two MS-DOS manuals are full start-from-scratch rewrites of generic MS-DOS manuals. They're particularly effective at explaining some of the vagaries of the operating system. The Operator's Guide is also a joy; it was obviously written by someone sympathetic to the needs of both

new users and the more experienced.

Thoughtful touches abound on the Model D2. There are long keyboard, power, and monitor cables, and even a depression on the keyboard for a pen or pencil. And in keeping with the increased reliability of today's hardware, it has a 20-month warranty.

The Model D2 is a prime example of today's high-quality plug-in-and-run systems: You can take it out of the box, plug it in, and be doing productive work in minutes. In addition, software compatibility just doesn't seem to be an issue anymore. The system's high-speed hard disk drive is a pleasure to use, especially with a disk-intensive application like Paradox. Last but not least, its low price makes it a real value.—*Stan Miastkowski*

PC's Limited System 200

The PC's Limited System 200, manufactured by Dell Computer, is an up-to-date, high-performance system. Except for its size and the general layout of its components, the System 200 bears little resem-

blance to the original IBM PC AT it purports to mimic. This computer can use virtually all the software and hardware designed for the original AT, but it does so with new and better components and much faster.

The CPU runs at a maximum clock rate of 12.5 MHz, more than twice as fast as the first ATs, and Dell makes good use of very-large-scale-integration (VLSI) components, including three Chips & Technologies chips, to keep the motherboard chip count down to a minimum. My review system came with a 1.2-megabyte 5¼-inch floppy disk drive, a 1.44-megabyte 3½-inch floppy disk drive, and a fast 40-megabyte hard disk drive—and it still had room for two more half-height storage units. It was also equipped with a VGA/EGA/CGA video card and monitor and a total of 1.6 megabytes of RAM. The total price for this configuration is \$3599.

Internal Layout and Components

The physical layout of the major hardware components resembles that used in most full-size AT clones. The right rear corner is occupied by a hefty 200-watt

OOPS LITE. LESS FILLING. GREAT TASTE.

Object Oriented Programming (OOPS) is the most refreshing development ever to hit PC computing because it makes programming natural and easy. And if you've got a thirst for the world's best selling OOPS, get your hands on OOPS Lite, Smalltalk/V.

Thousands of scientists, engineers, programmers and educators have chosen Smalltalk/V because it's less filling. Unlike other OOPS which require deep-pocket workstations and a zillion bytes of RAM, Smalltalk/V runs on box-stock PC/XTs and clones with 512K and still has room to develop full-bodied applications.

Thousands more have chosen Smalltalk/V because it's the fastest, easiest way to get a great taste of OOPS. And that taste has led to satisfying results in everything from finance to medicine to space.

These people found that the real value of

personal computing isn't just manipulating a word processor, a spreadsheet or a modern user interface. It is using their PC as a sculptor uses clay. And Smalltalk/V with its unique design clarity, natural parallel between problem and solution, and forgiving nature gets you there with gusto.

Smalltalk/V is only \$99.95 and comes with the best object oriented programming tutorial money can buy. And when you're ready for something even more potent, move up to new Industrial Strength OOPS, Smalltalk/V 286 for just \$199.95. Both come with our 60 day money-back guarantee.

Check out Smalltalk/V at your dealer. If he doesn't have it, order toll free: 1-800-922-8255. Or write to: Digital, Inc., 9841 Airport Blvd., Los Angeles, CA 90045. OOPS Lite. Everything you've ever wanted in a great OOPS. For less.

Smalltalk/V

power supply. In front of the power supply are two storage-device bays; the one on the right is set up to take three half-height devices, and the left-hand bay can be used by one full-height or two half-height hard disk drives. The bottom half-height bay on the right is suitable only for a hard disk drive, because you cannot access it from the front panel.

The System 200 has six expansion slots on the motherboard: four 16-bit and two 8-bit. The hard disk drive/floppy disk drive controller uses one of the 16-bit slots, and the video adapter uses an 8-bit slot. Two DB-9 RS-232C serial ports and one DB-25 parallel port are mounted on the motherboard; you don't have to use up an expansion slot for them.

The computer comes standard with 640K bytes of 120-ns DRAM mounted directly on the motherboard. My review unit had an additional 1 megabyte of DRAM installed in special single in-line memory module (SIMM) sockets, also located on the motherboard. Using SIMMs, you can install up to 4 megabytes of memory on the motherboard.

You can switch the 80286 CPU between 12.5 and 6.25 MHz with either a

keystroke combination (Ctrl-Alt-Backslash) or a utility program. The expansion bus clock rate switches between 8 and 6.25 MHz when you toggle the CPU speed. The system's memory access uses one wait state independently of the clock speed. I had no trouble installing an 8-MHz 80287 math coprocessor on the motherboard.

Storage and Display

My System 200 had a versatile trio of data storage devices installed. The mainstay is a 40-megabyte hard disk drive with an average access time of 25 ms and a data transfer rate of 167K bytes per second, according to the Coretest. For convenience in running software and exchanging data, I had the choice of using either a 1.2-megabyte 5¼-inch floppy disk drive or a 1.44-megabyte 3½-inch floppy disk drive. This drive combination ensures easy compatibility with all MS-DOS systems, including laptops and the new PS/2 computers.

The System 200 also came with a Video Seven Vega VGA card and a Mitsubishi XC-1429C color monitor. This display system is VGA/EGA/CGA com-

patible and ran all my CGA and EGA software flawlessly. I don't have any commercial software that uses color graphics in VGA mode, so I wrote some simple graphics routines to show off the VGA's colors using Borland Turbo C version 1.5. The results were stunning.

Performance

When running my software on the System 200, I never got the feeling that I had to wait for the computer to catch up with me. (And I have built up quite an impatience quotient over the years.) The benchmark results back up my feelings about the machine's performance: It is near the top for 80286 machines. [Editor's note: *Dell Computer has recently announced the Model 220, a 20-MHz 80286 system with a 3½-inch floppy disk drive, 1 megabyte of RAM, and a 40-megabyte hard disk drive. It lists for \$2499.*]

Dell Computer, the manufacturer of PC's Limited computers, deals strictly by mail order. Dell has a toll-free number for technical assistance, and its employees are fast and knowledgeable.

continued



However, if its technicians cannot solve your problem, you can take advantage of free, on-site service provided by Honeywell Bull if you live within 100 miles of one of that company's 180 customer-service dispatch offices. This service is free for one year and can be extended for four extra years with an additional fee.

The System 200 is an ideal choice if you need a full-size, high-performance AT-compatible microcomputer with a large capacity both for extra storage de-

VICES, such as disk drives and tape backup units, and for plug-in expansion boards. —John Unger

Side by Side

We were not surprised by the benchmark results. The fleetest CPU gets the gold medal; in this case, it is the Amdek System/286A with its 12.5-MHz 80286 with

zero wait states.

All the computers had a respectable showing against an 8-MHz IBM PC AT. But when you get further into the benchmark results, the distinctions are less clear.

In the FPU test, the PC's Limited System 200 is the clear leader, leaving the Amdek behind. This is significant if you plan to do intensive number crunching.

A hard disk drive can be a bottleneck for any computer system, and in the Disk I/O tests, the Arche Rival 286 was betrayed by its slow Seagate ST225. All the other reviewed systems had respectable hard disk drive performance.

The lead again changed hands in the Video tests. The Arche Rival 286's EGA card put on a good performance.

The Applications benchmarks give real-world results that reflect how a computer would perform in your home or office. In all these tests, the Amdek System/286A was the leader, consistently outperforming its competition. Its nearest rival was the PC's Limited System 200. The Arche Rival 286, while excelling in the Word Processing tests, was again slowed by its hard disk drive in the disk-intensive Database tests.

In terms of performance, then, the stand-up winner in our benchmark tests was the Amdek System/286A. The only test where it stumbled was in the Video benchmarks, and that has more to do with the function of the graphics adapter card than with the whole computer.

You should, of course, select the system that excels in the categories you work with most. Also, be aware that the prices given here are list prices. Many systems, such as Epson's Equity II+, are sold by independent retailers and may be available at heavily discounted prices in your area. But given our benchmark results and list prices, a couple of clear choices emerge. Top performance goes to the Amdek System/286A, but at a cost of \$4345. At \$3600, a PC's Limited System 200 is close in performance and more fully equipped. And if top-notch performance is not essential, the Leading Edge Model D2 comes in at \$2500, the bargain of this bunch. ■

John Unger is a geophysicist for the U.S. government and lives in Hamilton, Virginia. He writes graphics software and uses computers to study the earth's crust. He can be reached on BIX as "editors." Stan Miastkowski is a BYTE contributing editor, director of K+S Concepts (a documentation and consulting firm), and editor in chief of the "OS Report" newsletter. He can be reached on BIX as "stanm."

SUNDAY 10-5 **PROMPT DELIVERY**

Category	Item	Price
COMPUTERS	Apple II GS	1949.99
	Hypercard for Mac IIcx	2495.00
	Mac SE 2 800K	2325.00
	Mac SE with	1724.99
	Mac Plus	689.99
	70 MB HD Ex	444.99
	40 MB HD Ex	399.99
	Imagewriter II	1999.00
	Desktop 286 12 MB	3995.00
	1 F/D 40 MB HD	3095.00
	Desktop 286 20 HD	3449.99
	1 F/D 60 MB HD	3449.99
	Portable III 20	1180.00
	Portable III 40	1395.00
	IBM System/2	2299.00
Mod 50 20MB	599.00	
Mod 50 40MB	699.00	
Mod 60 40MB	799.00	
Mod 80 70 MB	1099.00	
Mod 90 115 MB	1399.00	
8503 MTR	679.00	
8513 MTR	699.00	
LEADING EDGE		
Model D 5176 Dual Drive	1999.00	
Model D2 2.2	1049.99	
Model D3 40 MB	1099.00	
LASER PRINTER		
Apple Laser II SC	699.99	
Apple Laser II W	699.99	
Apple Laser II NFX	699.99	
HP Laser Jet	699.99	
HP Laser Jet II	699.99	
NEC LC 895	699.99	
Oh Layer 6	699.99	
Oh Layer 8	699.99	
Oh Layer 10	699.99	
Oh Layer 12	699.99	
Oh Layer 15	699.99	
Oh Layer 20	699.99	
Oh Layer 30	699.99	
Oh Layer 40	699.99	
Oh Layer 60	699.99	
Oh Layer 80	699.99	
Oh Layer 100	699.99	
Oh Layer 120	699.99	
Oh Layer 150	699.99	
Oh Layer 200	699.99	
Oh Layer 300	699.99	
Oh Layer 400	699.99	
Oh Layer 600	699.99	
Oh Layer 800	699.99	
Oh Layer 1000	699.99	
Oh Layer 1200	699.99	
Oh Layer 1500	699.99	
Oh Layer 2000	699.99	
Oh Layer 3000	699.99	
Oh Layer 4000	699.99	
Oh Layer 6000	699.99	
Oh Layer 8000	699.99	
Oh Layer 10000	699.99	
Oh Layer 12000	699.99	
Oh Layer 15000	699.99	
Oh Layer 20000	699.99	
Oh Layer 30000	699.99	
Oh Layer 40000	699.99	
Oh Layer 60000	699.99	
Oh Layer 80000	699.99	
Oh Layer 100000	699.99	
Oh Layer 120000	699.99	
Oh Layer 150000	699.99	
Oh Layer 200000	699.99	
Oh Layer 300000	699.99	
Oh Layer 400000	699.99	
Oh Layer 600000	699.99	
Oh Layer 800000	699.99	
Oh Layer 1000000	699.99	
Oh Layer 1200000	699.99	
Oh Layer 1500000	699.99	
Oh Layer 2000000	699.99	
Oh Layer 3000000	699.99	
Oh Layer 4000000	699.99	
Oh Layer 6000000	699.99	
Oh Layer 8000000	699.99	
Oh Layer 10000000	699.99	
Oh Layer 12000000	699.99	
Oh Layer 15000000	699.99	
Oh Layer 20000000	699.99	
Oh Layer 30000000	699.99	
Oh Layer 40000000	699.99	
Oh Layer 60000000	699.99	
Oh Layer 80000000	699.99	
Oh Layer 100000000	699.99	
Oh Layer 120000000	699.99	
Oh Layer 150000000	699.99	
Oh Layer 200000000	699.99	
Oh Layer 300000000	699.99	
Oh Layer 400000000	699.99	
Oh Layer 600000000	699.99	
Oh Layer 800000000	699.99	
Oh Layer 1000000000	699.99	
Oh Layer 1200000000	699.99	
Oh Layer 1500000000	699.99	
Oh Layer 2000000000	699.99	
Oh Layer 3000000000	699.99	
Oh Layer 4000000000	699.99	
Oh Layer 6000000000	699.99	
Oh Layer 8000000000	699.99	
Oh Layer 10000000000	699.99	
Oh Layer 12000000000	699.99	
Oh Layer 15000000000	699.99	
Oh Layer 20000000000	699.99	
Oh Layer 30000000000	699.99	
Oh Layer 40000000000	699.99	
Oh Layer 60000000000	699.99	
Oh Layer 80000000000	699.99	
Oh Layer 100000000000	699.99	
Oh Layer 120000000000	699.99	
Oh Layer 150000000000	699.99	
Oh Layer 200000000000	699.99	
Oh Layer 300000000000	699.99	
Oh Layer 400000000000	699.99	
Oh Layer 600000000000	699.99	
Oh Layer 800000000000	699.99	
Oh Layer 1000000000000	699.99	
Oh Layer 1200000000000	699.99	
Oh Layer 1500000000000	699.99	
Oh Layer 2000000000000	699.99	
Oh Layer 3000000000000	699.99	
Oh Layer 4000000000000	699.99	
Oh Layer 6000000000000	699.99	
Oh Layer 8000000000000	699.99	
Oh Layer 10000000000000	699.99	
Oh Layer 12000000000000	699.99	
Oh Layer 15000000000000	699.99	
Oh Layer 20000000000000	699.99	
Oh Layer 30000000000000	699.99	
Oh Layer 40000000000000	699.99	
Oh Layer 60000000000000	699.99	
Oh Layer 80000000000000	699.99	
Oh Layer 100000000000000	699.99	
Oh Layer 120000000000000	699.99	
Oh Layer 150000000000000	699.99	
Oh Layer 200000000000000	699.99	
Oh Layer 300000000000000	699.99	
Oh Layer 400000000000000	699.99	
Oh Layer 600000000000000	699.99	
Oh Layer 800000000000000	699.99	
Oh Layer 1000000000000000	699.99	
Oh Layer 1200000000000000	699.99	
Oh Layer 1500000000000000	699.99	
Oh Layer 2000000000000000	699.99	
Oh Layer 3000000000000000	699.99	
Oh Layer 4000000000000000	699.99	
Oh Layer 6000000000000000	699.99	
Oh Layer 8000000000000000	699.99	
Oh Layer 10000000000000000	699.99	
Oh Layer 12000000000000000	699.99	
Oh Layer 15000000000000000	699.99	
Oh Layer 20000000000000000	699.99	
Oh Layer 30000000000000000	699.99	
Oh Layer 40000000000000000	699.99	
Oh Layer 60000000000000000	699.99	
Oh Layer 80000000000000000	699.99	
Oh Layer 100000000000000000	699.99	
Oh Layer 120000000000000000	699.99	
Oh Layer 150000000000000000	699.99	
Oh Layer 200000000000000000	699.99	
Oh Layer 300000000000000000	699.99	
Oh Layer 400000000000000000	699.99	
Oh Layer 600000000000000000	699.99	
Oh Layer 800000000000000000	699.99	
Oh Layer 1000000000000000000	699.99	
Oh Layer 1200000000000000000	699.99	
Oh Layer 1500000000000000000	699.99	
Oh Layer 2000000000000000000	699.99	
Oh Layer 3000000000000000000	699.99	
Oh Layer 4000000000000000000	699.99	
Oh Layer 6000000000000000000	699.99	
Oh Layer 8000000000000000000	699.99	
Oh Layer 10000000000000000000	699.99	
Oh Layer 12000000000000000000	699.99	
Oh Layer 15000000000000000000	699.99	
Oh Layer 20000000000000000000	699.99	
Oh Layer 30000000000000000000	699.99	
Oh Layer 40000000000000000000	699.99	
Oh Layer 60000000000000000000	699.99	
Oh Layer 80000000000000000000	699.99	
Oh Layer 100000000000000000000	699.99	
Oh Layer 120000000000000000000	699.99	
Oh Layer 150000000000000000000	699.99	
Oh Layer 200000000000000000000	699.99	
Oh Layer 300000000000000000000	699.99	
Oh Layer 400000000000000000000	699.99	
Oh Layer 600000000000000000000	699.99	
Oh Layer 800000000000000000000	699.99	
Oh Layer 1000000000000000000000	699.99	
Oh Layer 1200000000000000000000	699.99	
Oh Layer 1500000000000000000000	699.99	
Oh Layer 2000000000000000000000	699.99	
Oh Layer 3000000000000000000000	699.99	
Oh Layer 4000000000000000000000	699.99	
Oh Layer 6000000000000000000000	699.99	
Oh Layer 8000000000000000000000	699.99	
Oh Layer 10000000000000000000000	699.99	
Oh Layer 12000000000000000000000	699.99	
Oh Layer 15000000000000000000000	699.99	
Oh Layer 20000000000000000000000	699.99	
Oh Layer 30000000000000000000000	699.99	
Oh Layer 40000000000000000000000	699.99	
Oh Layer 60000000000000000000000	699.99	
Oh Layer 80000000000000000000000	699.99	
Oh Layer 100000000000000000000000	699.99	
Oh Layer 120000000000000000000000	699.99	
Oh Layer 150000000000000000000000	699.99	
Oh Layer 200000000000000000000000	699.99	
Oh Layer 300000000000000000000000	699.99	
Oh Layer 400000000000000000000000	699.99	
Oh Layer 600000000000000000000000	699.99	
Oh Layer 800000000000000000000000	699.99	
Oh Layer 1000000000000000000000000	699.99	
Oh Layer 1200000000000000000000000	699.99	
Oh Layer 1500000000000000000000000	699.99	
Oh Layer 2000000000000000000000000	699.99	
Oh Layer 3000000000000000000000000	699.99	
Oh Layer 4000000000000000000000000	699.99	
Oh Layer 6000000000000000000000000	699.99	
Oh Layer 8000000000000000000000000	699.99	
Oh Layer 10000000000000000000000000	699.99	
Oh Layer 12000000000000000000000000	699.99	
Oh Layer 15000000000000000000000000	699.99	
Oh Layer 20000000000000000000000000	699.99	
Oh Layer 30000000000000000000000000	699.99	
Oh Layer 40000000000000000000000000	699.99	
Oh Layer 60000000000000000000000000	699.99	
Oh Layer 80000000000000000000000000	699.99	
Oh Layer 100000000000000000000000000	699.99	
Oh Layer 120000000000000000000000000	699.99	
Oh Layer 150000000000000000000000000	699.99	
Oh Layer 200000000000000000000000000	699.99	
Oh Layer 300000000000000000000000000	699.99	
Oh Layer 400000000000000000000000000	699.99	
Oh Layer 600000000000000000000000000	699.99	
Oh Layer 800000000000000000000000000	699.99	
Oh Layer 1000000000000000000000000000	699.99	
Oh Layer 1200000000000000000000000000	699.99	
Oh Layer 1500000000000000000000000000	699.99	
Oh Layer 2000000000000000000000000000	699.99	
Oh Layer 3000000000000000000000000000	699.99	
Oh Layer 4000000000000000000000000000	699.99	
Oh Layer 6000000000000000000000000000	699.99	
Oh Layer 8000000000000000000000000000	699.99	
Oh Layer 10000000000000000000000000000	699.99	
Oh Layer 12000000000000000000000000000	699.99	
Oh Layer 15000000000000000000000000000	699.99	
Oh Layer 20000000000000000000000000000	699.99	
Oh Layer 30000000000000000000000000000	699.99	
Oh Layer 40000000000000000000000000000	699.99	
Oh Layer 60000000000000000000000000000	699.99	
Oh Layer 8000000000000		

WARP SPEED



30 Day Risk-Free Trial • On-Site Service Available
The Fastest PC's in the Galaxy, at down to Earth Prices

12 Slot Power 286/386

We put the 80286 on a card so you can upgrade to the 80386 whenever you're ready. Most of our corporate accts. prefer this American-designed, industrial quality machine. Why? 12 slots, 240 watt power supply, 4 drive openings & ruggedized construction. Tower, rack-mounted and motherboard versions available.

50MB, mono, system

386 Speed, 286 Price

12MHz, zero wait states with 1 to 1 controller and Power Optimiser software makes this AT compatible the fastest at any price. Landmark speed Test rates this 286 at 15.6MHz! The data transfer rate is 4 times faster. A complete system with 1MB RAM, monitor and 50MB, 33ms hard disk is only:

50MB

12MHz 1 wait state, 640K, 50MB,

101 Keyboard, 1.2MB

Passport 286 & 386

New large screen.

Micro 1 introduces the Passport 286 & 386 portables that keep pace with the best Compaq has to offer. 12, 16 or 20MHz and up to 8MB of zero wait state memory gives you more power than most desktop computers. Both the 11", 640 x 480 resolution backlit, supertwist, LCD screen and gas plasma screen are far more readable than typical laptop screens. External EGA and VGA output optional. 1 to 1 interleave controllers and 50 to 150MB drives optional. 200 watts, 6 slots standard.

386-16MB, 20MB

286-12 640K, 20MB

"Micro 1's clones are designed for industrial use. . . none are so well made."

Paul Muller, Ford Aerospace, Palo Alto, CA

30MHz Performance

The Power 386 outruns the IBM Model 80 and CompaqDeskpro 386/20. How do we do it? 20MHz, zero wait state with 64K of static RAM cache and ultra-high speed ESDI hard disks with 1 to 1 interleave buffered controllers. Add to this our special Power Optimiser software that accelerates reads and writes by 300% and you've got the best that money can buy, at 2/3 the price! Landmark. Speed Test rating 30MHz.

UNIX systems with DOSMERGE now available. Ask about our Tower!

16MHz (24MHz Landmark) 1MB Complete system with 50MB and monitor.

Call for price on 20MHz and other configurations.

MICRO



557 Howard St.
San Francisco, CA 94105
Tech Support: (415) 974-6997
Fax: (415) 974-6996

Summit Computer System
12A Chapel St. North
Colchester Essex
CO2 7AT UK
(0206) 761950
FAX: (0206) 761941
Telex: 940 11232

Ask our customers about our quality, service and prices:

American Express
Anheuser-Busch
Associated Press
Boeing Aerospace
Clorox
Coca-Cola
Dean Witter
Ernst & Whinney
Federal Communications Com.
Ford Aerospace
Heath Zenith

Honeywell
Intel
IteL
ITT
Lockheed Missiles & Space
Lucas Film
Martin-Marietta
Master-Card
McDonnell Douglas
MCI

NASA
Pacific Bell
Rockwell International
Siemens
Tandem Computers
TRW
United Airlines
University of Calif.
Wells Fargo
Westinghouse

Circle 167 on Reader Service Card

To order call toll free:

1-800-338-4061

In California call

(415) 974-5439



CLEO
 now delivers
3278 coax cards
 at **\$795.00!**

and now coax

CLEO is your SNA or BSC Gateway

Remote Sites Communication

Whatever your industry, your remote computers need to share information with your mainframe. Or, they need to exchange data with other remotes. In either case, you need a total solution at the remote sites. You need software, hardware interfaces and modems that all work together smoothly. You need CLEO!

CLEO software products allow micro-computers to communicate with mini-computers and mainframes, and to emulate their workstations. Since 1981, CLEO has provided remote communications between micros and mainframes for the automotive, insurance, medical and banking industries. Today over 66,000 CLEO users worldwide are running on all major brands of micro-processors. The greatest number of these users run CLEO software on IBM Personal Computers and NETBIOS LANs.

Complete Software/Hardware Package

Every CLEO package contains all the software and hardware accessories needed at the remote site. Your selected CLEO SNA or BSC software is packaged with 1) an internal modem card for dial-up applications, or 2) an interface card and cable for use with your existing modem. There's no waiting for non-CLEO add-ons. And, you get prompt, single-source service.



Package prices range from \$795.00 for most stand-alone packages, up to \$1,995.00 for the 32-user SNA gateway.

Call us today to discuss your application.

CLEO Software
 1639 North Alpine Rd.
 Rockford, IL 61107
 Telex 703639
 FAX 815/397-6535

Headquarters:

USA: **1-800/233-2536**
 Illinois: 1-800/422-2536
 International: 815/397-8110

Sales and Distribution:

Benelux: 31 (71) 215281
 Canada, East: 800/361-3185
 Canada, West: 800/361-1210
 Canada, Montreal: 514/737-3631
 Colombia, S.A.: 12172266
 Denmark: 1628300
 England: 0908667737
 France: 146861136
 Italy: (0331) 634 562
 Mexico City: 596-5539
 Sweden: 8 740 5070





Seeing Colors on the Mac SE



Orchid's ColorVue SE board taps hidden color capabilities

Don Crabb

To the world at large, it's obvious that the Macintosh II supports color. Not so obvious is that both the Mac SE and the Mac Plus, even with their black-and-white displays, also support color. These Mac ROMs use conventional QuickDraw calls to handle eight basic colors: black, red, green, blue, white, cyan, magenta, and yellow.

This limited color capability allows the Mac SE to print in color on an Imagewriter II, Imagewriter LQ, Hewlett-Packard PaintJet, and other devices. But because the Mac SE lacks a way to display these eight colors, achieving good color output is a matter of trial and error. The demand for a way to view color on a Mac SE has grown because of the increasing sophistication of desktop presentation and publishing software and the need to review the output before committing the results to the printer.

Orchid Technology's ColorVue SE provides an add-on solution. The ColorVue SE is a \$695 adapter card that lets the Mac SE display colors on an attached color monitor while still allowing use of the computer's built-in screen.

The ColorVue SE version 1.0 supports a 1024- by 512-pixel virtual screen, with a region of 640 by 480 pixels visible at a given time. The board supports horizontal panning to let you view the entire virtual screen in sections (if your software provides the necessary assistance—via a horizontal scroll bar, for example). The board can display as many as 16 colors or gray scales at a time (the ColorVue software supplies eight additional colors besides the eight that QuickDraw provides) from a palette of 262,144 possible RGB values. The board also supports 2- and 8-color (or gray-scale) modes.

The video output can drive either an Apple RGB analog monitor, such as the Mac II color monitor, or a VGA monitor, such as the IBM 8513 and 8514 color monitors. Many multiscan monitors, such as the Sony Multiscan and the NEC MultiSync, can also be used.

The Hardware of Color

The ColorVue SE is a standard-size SE daughterboard that plugs into the Mac SE's 96-pin Euro-DIN slot. The ColorVue board does not include an extra bus connector, so if you install it in your SE, you will not be able to install other add-on cards. The basic design fault is the Mac SE's, though, with its limited slot space. The SE that I used already had a SuperMac (Levco) Prodigy SE board installed, which I had to remove to test the ColorVue.

The ColorVue SE comes packaged in an antistatic bag and is well protected during shipment by closed-cell foam padding. The package includes a user's manual, a support software disk, two nylon standoffs to help anchor the board, a customer service booklet and warranty card,

continued

an output connector with two sockets for the color monitor connection, and ribbon cable to join the board to the output connector. A color monitor is not included.

The output connector includes both a large-format DB-15 Apple connector and a small-format DB-14 VGA-style connector. The user's manual provides a schematic of the pin-outs for each.

The board has a very clean design, with no engineering afterthoughts (see photo 1). It contains two proprietary Orchid ROMs (version 1.0), 2 megabytes of video RAM, a number of programmable-array-logic (PAL) chips, a couple of oscillators, a connector for the ribbon cable, and some unmarked custom chips. The ROMs are socketed, so the company can upgrade the board's firmware.

Installing the ColorVue board is quite easy. The instructions supplied in the user's manual are sufficiently detailed if you've had some installation and modification experience with Macs before. However, Orchid warns against novices attempting the installation; this advice is warranted because of the high voltage danger presented by the SE's CRT yoke and analog board.

Installation and initial testing of the ColorVue SE took a little longer than an

You can
set the external
display for 2, 8, or
16 colors.

hour from removal of the computer's outer shell to its replacement. You need a Phillips screwdriver, a small flat-blade screwdriver, a long-shafted T-15 Torx driver, and a case-cracker to complete the installation. Orchid does not supply these tools.

After the board is installed, you attach the output connector to the board, using its ribbon cable, and then you mount the output connector in the SE's accessory access port; this process took another 10 minutes. The output connector is fastened by screws to the SE's chassis and fits through the access port after you have popped out its plastic cover. A small metal finishing bracket fits over the

monitor connectors in the port, giving a nice finished appearance to the installation and offering further anchorage for the monitor connectors.

The Software of Color

The software assist for the ColorVue SE comes in the form of a Control Panel CDEV called ColorVue. To install the software, you simply drag the CDEV from the supplied disk to the system folder of your start-up disk. The CDEV lets you set a number of functions, including the number of display colors; a screen saver, which you can activate manually or time to dim the screen within 5 or 30 minutes of inactivity; and the monitor type you have connected (Apple or VGA, color or monochrome).

You can set display colors to 2, 8, 16, or automatic. The 2-color mode turns the external monitor into a monochrome screen. This improves screen performance for noncolor programs, because you're manipulating bits instead of pixels for the display. It also eliminates compatibility problems for software that won't work properly with ColorVue.

The 8-color mode displays the 8 standard colors used in printing on the Imagewriter II and Imagewriter LQ: black, red, green, blue, white, cyan, magenta, and yellow. When you switch to the 16-color mode, the ColorVue board adds 8 more colors to the available palette (dark gray, orange, olive, purple, light gray, gray, brown, and tan). At this writing, current applications don't utilize these extra colors, but Orchid Technology says that 19 programs modified to use this capability will be ready to ship by August. These include PageMaker, Adobe Illustrator, SuperPaint 2.0, MacDraw II, and dBASE Mac.

The recommended mode of operation is the automatic color mode. The automatic setting displays 16 colors if they are present; if no colors are visible, the software treats the screen as a black-and-white display. This improves video performance by using the faster 2-color mode to update the Mac SE desktop until you open an application using color.

Other screen attributes and functions are set with the ColorVue CDEV, including the ability to fine-tune your color choices on-screen to match your own tastes or to match those of your color printer (Imagewriter or PaintJet). The CDEV also lets you activate either or both of the internal and external monitors. If you use the internal monitor, it duplicates the top left (512- by 342-pixel) rectangle of the larger screen.

continued

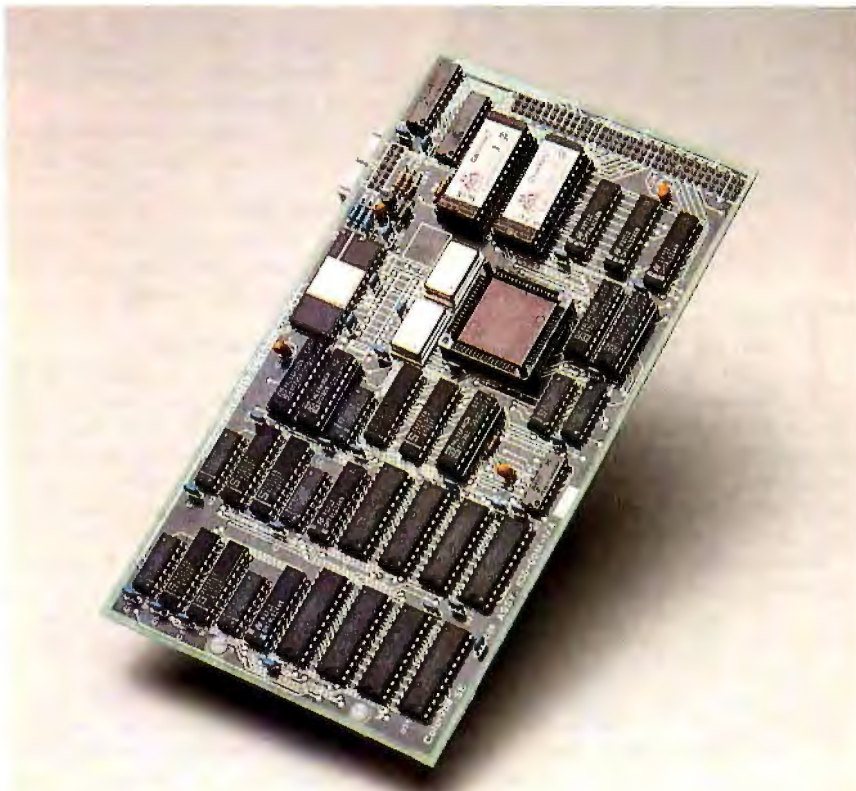

Photo 1: The ColorVue SE add-on board, with 2 megabytes of video RAM.

NEW

THE "DESKTOP PRESENTER PACK"



Everything you need for creating and giving presentations with your PC.

Now, you can make impressive, professional-quality, full-color presentations of any kind right at your desk with The DESKTOP PRESENTER PACK.

Everything you need is included: Colormetric® a high resolution graphics card for your PC, PictureIt™ business graphics software, and PCPrintmaker® desktop printing software.

With The DESKTOP PRESENTER PACK you will turn your personal computer into a full-capability workstation for creating professional-

quality presentations quickly and easily. Then use your PC to give a video presentation in 1000 colors.

Or make high resolution slides, overhead transparencies or hardcopy all in full-color by simply plugging in a SlideMaker® or color printer.

Buy the DESKTOP PRESENTER PACK and make the best presentation of your career.

Call today 800-556-1234, ext. 234.
In Calif. 800-441-2345, ext. 234.

General Parametrics Corporation the makers of VideoShow

Berkeley, CA 415-524-3950

ChiWriter

 NOW
WITH
MICROSPELL

How are you currently producing your scientific documents? Are you using a "golf ball" style typewriter? A regular word processor, hand lettering the special symbols? Are you fighting against a "what-you-see-is-definitely-not-what-you-get!" system with a special command language? Or are you using one of our competitors' expensive and inflexible programs? Find out how ChiWriter can solve your scientific word processing problems.

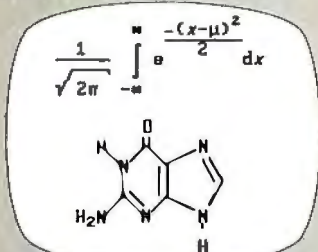

From an actual ChiWriter screen display

Powerful Scientific/Multifont Word Processing at a Reasonable Price

ChiWriter is a complete word processor, designed especially for scientific and foreign language text. Its features include: intuitive formula editing commands, automatic pagination, variable headers and footers, footnotes, box draw mode, a notepad window and an integrated spelling checker.

Best of all, ChiWriter is completely "what-you-see-is-what-you-get". Even complicated formulas can be entered easily because the screen display corresponds exactly to the printout.

ChiWriter runs on an IBM PC with CGA graphics, 2 floppy or 1 hard/1 floppy drive, and an Epson/IBM compatible 9 pin printer. Hi res screen support (Hercules, EGA, VGA, AT&T), 24 pin printer support and laser printer support (HP LaserJet, PostScript) is available.

"ChiWriter is a nifty product with a price I defy you to beat and performance I defy you to snub ... I know of several \$500 programs that will do the job, but for the same money you could buy ChiWriter and a vacation."

Phil Wiswell, PC Magazine



- | | |
|---|----------|
| <input type="checkbox"/> ChiWriter Program | \$99.95 |
| <input type="checkbox"/> Hi Res Screen Support | \$24.95 |
| <input type="checkbox"/> 24 Pin Printer Support | \$24.95 |
| <input type="checkbox"/> Laser Printer Support | \$59.95 |
| <input type="checkbox"/> International Keyboard Support | \$19.95 |
| <input type="checkbox"/> Chemistry Support | \$49.95 |
| <input type="checkbox"/> Word Perfect Converter | \$49.95 |
| <input type="checkbox"/> Conographic Font Set | \$149.95 |
| <input type="checkbox"/> IndexChi Index Generator | \$59.95 |
| <input type="checkbox"/> Shipping & handling | \$ |
| \$5 U.S. & Canada, \$10 Europe, \$15 elsewhere | |

Name _____

Address _____

City _____

State _____ Zip _____ Country _____

Phone () _____

Payment by Check Purchase Order VISA MC

Card # _____ Exp. / _____

R7

Horstmann Software Design Corporation
140 E. San Carlos St./P.O. Box 5039
San Jose, CA 95150-5039, USA
(408) 296-0828

horstmann software

ColorVue SE

Type

Color display board for the Macintosh SE

Company

Orchid Technology
45365 Northport Loop W
Fremont, CA 94538
(415) 683-0300

Features

640- by 480-pixel display in a virtual window of 1024 by 512 pixels; displays 16 colors out of a palette of 262,144; 2-, 8-, 16-, and auto-color modes; prints in color on the Apple Imagewriter II, Imagewriter LQ, and HP PaintJet color printers; automatic or manually triggered screen-saving feature; connector- and signal-compatible with the Mac II monochrome/color monitors or PS/2 series color/monochrome monitors; 2 megabytes of video RAM; Orchid ROM version 1.0; ColorVue SE CDEV

Size

4 9/16 x 8 7/16 inches; conforms to SE daughtercard form factor

Hardware Needed

Macintosh SE; Mac II monochrome/color monitor, VGA-compatible monitor, or multiscan monitor

Software Needed

None

Documentation

76-page ColorVue SE User's Manual

Price

\$695

Inquiry 888.

The ColorVue SE's virtual screen is 1024 by 512 pixels, although you can view only 640 by 480 pixels at once. The documentation makes no mention of how to invoke, control, or use this capability, but I found through trial and error that the horizontal scroll bars on some applications let you move the viewable screen around in that virtual space.

I tested the ColorVue using an AppleColor 13-inch high-resolution RGB monitor (the Mac II color monitor); an IBM 8513 PS/2 VGA monitor; a Zenith 14-inch FTM VGA monitor; a Zenith 13-inch RGB monitor; an Apple 12-inch

high-resolution monochrome monitor (the Mac II monochrome monitor); a Sony Multiscan color monitor; and an NEC MultiSync color monitor. The ColorVue drove each monitor successfully, although I had to adjust the sharpness and focus controls on the Zenith RGB monitor to get a clear picture.

The power connectors of many color monitors use a special power cord that connects them to the switched outlet on a computer chassis. This is true for the AppleColor monitor, which comes with a cord meant to be hooked to the Mac II. Fortunately, this same cable is detachable at the monitor so you can substitute a "generic" power cable. Bear this in mind if you use a different monitor with the ColorVue SE, since the Mac SE does not have a switched power outlet of its own.

A Few Compatibility Snags

I ran virtually every Macintosh application I had on the ColorVue SE-equipped Mac. Nongraphics software, such as word processors, did not have a problem with the ColorVue, since they don't support color anyway. One exception was dBASE Mac 1.01, which produces color on a Mac II. The dBASE database I used to test the ColorVue had color graphics and text in it. Neither color text nor graphics displayed properly with the ColorVue SE. Orchid Technology is aware of this problem and is currently working on a fix.

My software test list naturally included lots of graphics and desktop publishing applications, since presumably the biggest reason for buying the ColorVue board is for color graphics. Among the applications I tested were FullPaint 1.1, SuperPaint 1.0, MacPaint 1.4 and 2.0, Cricket Draw 1.0, Cricket Graph 1.1, MacProject 1.5, MacDraw 1.9.5 and 2.0, PowerPoint 1.0 and 2.0, Quark XPress, GraphicWorks 1.1, VideoWorks 1.0, VersaCAD 1.1, More 1.1c, Mega-Images B6.c, ImageStudio 1.0, MaxWrite 0.80, MapMaker 1.0, Zoomation! 1.5, Color MacStar, PixelPaint 1.0, and Slide Show 1.0.

Of this list, only FullPaint, MaxWrite, and MacPaint would not run properly on the ColorVue in color mode, although they would work in 2-bit monochrome mode. Display problems ranged from menus with multiple ghosts, to invisible menu bars, to confused images. Color MacStar, MegaImages, PixelPaint, and Zoomation! would not work at all in either monochrome or color mode, and the computer required a hard reset to clear. Since these four programs were

continued

Mendelson Electronics Inc.

1-800-422-3525

CONTROL YOUR HOME OR BUSINESS FROM YOUR IBM*PC OR PC/AT COMPATIBLE

This card is what you need to TURN ON & OFF lights, machinery, and other electrical or electronic equipment.

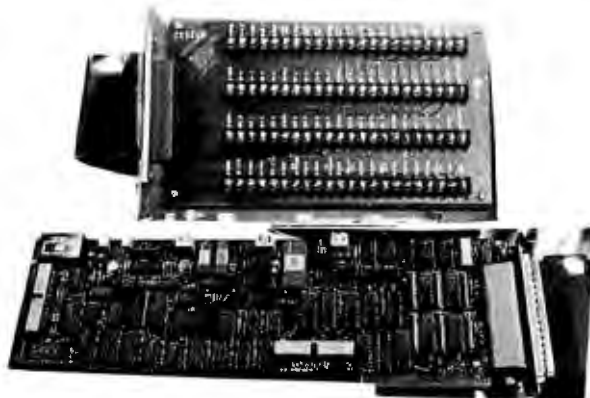

IBM PC* DATA ACQUISITION AND CONTROL ADAPTER & DISTRIBUTION PANEL provides the capability to control and monitor processes within a sensor base system.

IBM PC*DATA ACQUISITION AND CONTROL ADAPTER provides an easy to use interface for accessing the ANALOG and DIGITAL I/O. Integrates analog, binary and time/counter devices on a single adapter card.

THIS IS AN ORIGINAL IBM* PRODUCT !!!

Up to four IBM DATA ACQUISITION AND CONTROL ADAPTERS can be attached to an individual PC or AT Compatible

* The Adapter has:

- Four analog input channels (12-bit resolution)
- Two analog output channels (12-bit resolution)
- 16-channel digital input port
- 16-channel digital output port
- Programmable sampling rates provided by a 32-bit timer
- Event counter, programmable rate generator, or programmable time delay provided by a 16-bit user timer/counter

* The Distribution Panel has:

- Screw terminals provided to attach devices to the distribution panel
- Multiple grounds for twisted pair terminations
- Shielded construction to minimize noise interference

* USES

Chromatography, Electrochemistry, Energy management, Electronic testing, Process control, Data logging, Robotics. Some parameters commonly monitored or controlled include: Pressure, Flow, Displacement, Voltage, Light intensity, Rotational speed.

Some instruments or devices that may utilize the Adapter are Chromatographs, Spectrophotometers, Pressure gages, Relay controls, Thermocouples, Gas analyzers, Humidity sensors, Valve actuators, Level gauges, Load cells, Conductivity cells, pH Meters.

* TECHNICAL DATA

ANALOG INPUT: The analog input functions of the adapter operate in either programmed or interrupting mode. The analog input functions provide 12-bit relative accuracy.

RESOLUTION - 12 bits

INPUT CHANNELS - four differential

INPUT MODES-	unipolar or bipolar, user-selectable
INPUT RANGES:	
unipolar	0 TO ± 10 volts, user-selectable
bipolar	± 5 and ± 10 volts user-selectable
OUTPUT MODE	straight binary
unipolar	offset binary
bipolar	
INPUT IMPEDANCE	> 100 megohms with 100 picofarads
INPUT CURRENT	limited to less than ± 4 mA
INPUT VOLTAGE	
Normal mode	± 30 volts maximum, without damage, power on or power off
Common mode	± 11 volts maximum
COMMON MODE	
Rejection ratio	72 db
Integral linearity	
error	± 1 LSB maximum
DIFFERENTIAL linearity	
Error	$\pm 1/2$ LSB maximum
Stability	± 5 ppm/degrees C of FSR (max)
GAIN:	
Error	$\pm 0.1\%$ between ranges (max) any range adjustable to 0
Stability	± 32 ppm/degrees C of FSR (max)
OFFSET:	
Error	adjustable to 0
Unipolar stability	± 24 ppm/degrees C of FSR (max)
Bipolar stability	± 24 ppm/degrees C of FSR (max)
MONOTONICITY	0 to 50 degrees C
THROUGHPUT to memory	15,000 conversions/second min.

The analog output functions of the adapter operate in programmed I/O mode. The analog output functions provide 12-bit relative accuracy.

RESOLUTION	12-bits
Number of output channels	2
OUTPUT modes	unipolar or bipolar, user-selectable
OUTPUT ranges	
Unipolar	0 to ± 10 volts, user-selectable
Bipolar	± 5 and ± 10 volts, user-selectable
INPUT CODE:	
Unipolar	straight binary
Bipolar	offset binary
OUTPUT Current	± 5 millamps, min. with normal loading and protection from damage with the output shorted to common
OUTPUT Impedance	20 ohm, max
CAPACITIVE loading	0.5 microfarads, max
GAIN	
Error	0.1 between ranges (max), any range adjustable to 0
Stability	\pm ppm/degrees C of FSR (max)
OFFSET	
Error unipolar	± 32 millivolts max
Error bipolar	adjustable to 0
Unipolar stability	± 8 ppm/degrees C of FSR (max)
Bipolar stability	± 24 ppm/degrees C of FSR (max)
MONOTONICITY	0 to 50 degrees C
SETTLING TIME	10 microseconds max, to within 0.1% FSR for a 10 volt step with 1000 ohms
PROTECTION	Protected for short to common
OVERSHOOT	$\pm 1\%$ of FSR max
THROUGHPUT from memory	25,000 conversion/second

OUR LOW! LOW! PRICE FOR BOTH UNITS



IBM* DATA ACQUISITION AND CONTROL ADAPTER
#6451502 ORIGINAL COST \$1275
IBM* ADAPTER DISTRIBUTION PANEL
#6451504 ORIGINAL COST \$245

\$195

PER SET

Shipping & Handling \$6.50

INCLUDES TURBO PASCAL DEMO SOFTWARE W/SOURCE CODES, ADDRESSES, ANALOG & BINARY INPUT & OUTPUT MODULES

MENDELSON'S ADVANCED DEMO IN TURBO PASCAL AVAILABLE FOR \$25

Part No. #200-108 Demo Turbo

Mendelson Electronic Co., Inc.

STORE HOURS 8:30 - 5:00 Monday thru Saturday.
*IBM PC/XT is a registered trademark of IBM corp.
TERMS: MasterCard/Visa/Discover Card, Check or Money order (checks allow two weeks for clearance), C.O.D. add additional \$3.00. Ohio residents add 6% State Tax.
Above shipping/handling are rates for UPS ground in Continental U.S. only
340 East First Street Dayton, Ohio 45402
1-800-422-3525



513/461-3525
FAX 513/461-3391

20% Restocking Fee on Non-Defective Returns

Integrand's new Chassis/System is not another IBM mechanical and electrical clone. An entirely fresh packaging design approach has been taken using modular construction. At present, over 40 optional stock modules allow you to customize our standard chassis to nearly any requirement. Integrand offers high quality, advanced design hardware along with applications and technical support *all at prices competitive with imports*. Why settle for less?

Rack & Desk PC/AT Chassis



Rack & Desk Models

Accepts PC, XT, AT Motherboards and Passive Backplanes

Doesn't Look Like IBM

Rugged, Modular Construction

Excellent Air Flow & Cooling

Optional Card Cage Fan

Designed to meet FCC

204 Watt Supply, UL Recognized

145W & 85W also available

Reasonably Priced

INTEGRAND

RESEARCH CORP.

Call or write for descriptive brochure and prices:

8620 Roosevelt Ave. • Visalia, CA 93291

209/651-1203

TELEX 5106012830 (INTEGRAND UD)

EZLINK 62926572

We accept BankAmericard/VISA and MasterCard

IBM, PC, XT, AT trademarks of International Business Machines.
Drives and computer boards not included.

SEEING COLORS ON THE MAC SE

written for the Mac II, I expected this problem. The rest of the graphics software worked in monochrome mode on the external screen.

I printed color output using Cricket Draw, Cricket Graph, More, and other applications on an Imagewriter II, Imagewriter LQ, and HP PaintJet without a hitch; the pages had the colors that the screen displays led me to expect. I also printed color output on an HP 7475A flat-bed plotter, although the matchup between the displayed color on the screen and the plotted color on the paper usually did not match.

The most noticeable difference between the regular Mac SE screen and the color screen driven by the ColorVue (besides the color) was in screen-drawing performance. Cricket Draw, for example, took at least twice as long (and often much more for complex images) to redraw a color graphic on the ColorVue SE-driven screen, compared to the same image in monochrome on the internal screen of an unmodified Mac SE.

The same was true for other applications working in color (e.g., GraphicWorks, VersaCAD, and Cricket Graph). Of all the other applications I tested, More 1.1c showed the most slowdown when redisplaying an image with color text in it, compared to displaying on the internal monitor. Thus, the price of having color is some screen-drawing slowdown when you use the 8- or 16-color mode. However, you can always switch to monochrome to improve drawing speed, or you can use the automatic-color setting and let the ColorVue switch to monochrome when no color is present.

Skimpy Documentation

The user's manual supplied with the ColorVue board does a good job as an installation guide, but it is anemically thin on other issues. It doesn't mention anything about using the ColorVue SE with actual software. There is no list of compatible software, nor a discussion of which software vendors can be expected to provide ColorVue drivers with their products. The manual also fails to give any information about the card's 1024-by-512-pixel virtual screen and how you're supposed to move around in it (horizontal panning).

From an end user's point of view, Orchid needs to go back to its technical writers for about 40 more pages of software and usage discussion. An updated manual should also include complete technical specifications (such as a detailed board schematic and a discussion of the board's design) and should address

other technical concerns. No on-line help is provided with the ColorVue CDEV.

Orchid is a proven accessory board manufacturer for the IBM PC. This is the company's first Apple-compatible product. I tested the customer-support phone lines by asking some questions about installation and software compatibility. The support technicians dealt with installation problems easily, but those I talked with knew much less about the ColorVue's software compatibility or about the availability of new software releases that would drive the ColorVue properly.

The ColorVue SE has a two-year hardware warranty that you can extend to four years at no extra charge by filling out and returning your warranty card.

The Big Draw: Color Now

The question you have to answer before buying a ColorVue SE is: Do you really need a color Mac SE? And at what price? At \$695, the ColorVue SE isn't cheap, but it's reasonable. However, you have to add the price of a color monitor to your shopping list when you go with SE color. This will add another \$500 to \$900 to the tab, depending on the monitor you buy. That puts the price of SE color at \$1200 and up. Not cheap, but still much less expensive than scrapping (or selling) your Mac SE and buying a Mac II. Besides, you can opt to buy one of Apple's color monitors and then continue to use it when your budget permits you to buy a Mac II.

The main reason for buying the ColorVue SE is that it provides a usable color display for the Mac SE *now*. If you need color for your graphic design, CAD, or publishing work, and you don't want to replace your Mac SE, the ColorVue SE is a reasonable solution. Although the board's color display lacks the subtlety of the 256-color Mac II display, you'll be surprised just how appealing 8 or 16 colors can be. And if you need 16 gray scales for your desktop publishing work, the ColorVue SE does that job nicely, too. The cost of acquiring this capability won't bankrupt you, either.

Finally, the ColorVue SE doesn't tie your Mac SE to your desk. Any time you need to move your Mac or take it on the road, you can disconnect the color monitor cable and go. ■

Don Crabb is the director of instructional laboratories for the computer science department of the University of Chicago and is a lecturer in the department and the college. His articles and reviews have appeared in microcomputer magazines, newspapers, and journals. He can be reached on BIX as "decrabb."

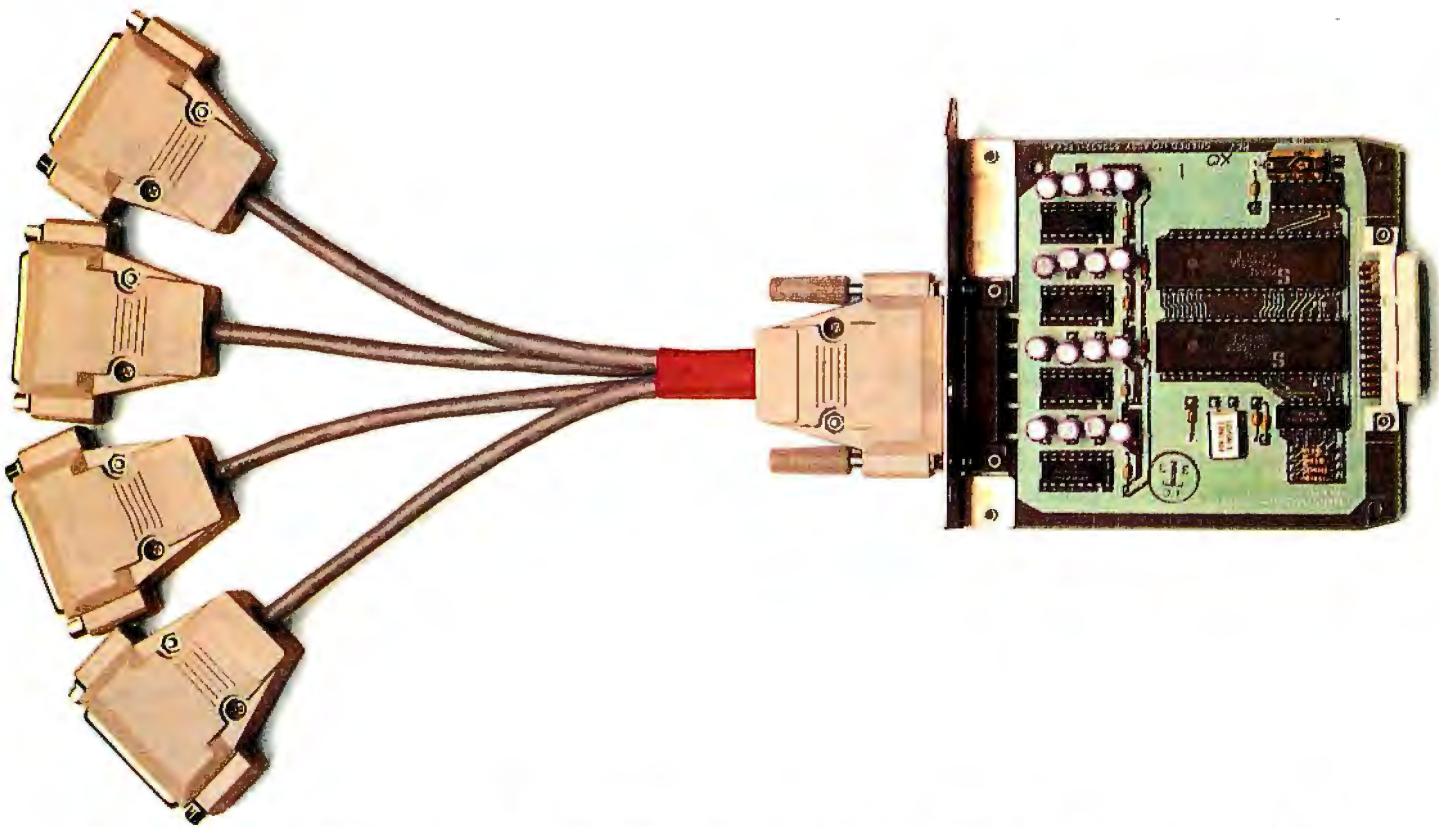

NOW YOU CAN CONNECT FOUR USERS TO ONE LASER PRINTER.

With the Mannesmann Tally® MT910 Laser Printer and its Multiuser Interface option, you can connect four users for just \$1050 each.

Each of you will have your own I/O port, programmable for your own protocol and emulation. Laser-crisp text and graphics at 300 dpi. All the specs you see in the center. And with an optional 5-bin sorter, even your own output bin.

Circle 155 on Reader Service Card (Dealers: 156)



THIS ONE.

- Speed: 10 pages-per-minute
- Dual paper cassettes standard, 250 sheets each.
- Dual output bins standard, 250 sheets each.
- Memory: 500K; 400K available to print graphics or download additional fonts.
- Manual feed handles single sheets, envelopes, transparencies, and labels.
- Emulations: Diablo® 630, Epson® FX, IBM® Proprinter;™ HP® Laserjet Plus;™ and Qume® Sprint II.
- Workload: 10,000 pages-per-month.
- Standard fonts: Courier 10. Prestige Elite 12 Letter Gothic 16.6 bold, italic, condensed, and expanded.
- Options: 4-user I/O extensive library of optional fonts in cartridge or downloadable formats 1.5 Mg RAM upgrade 5-bin sorter.

So call the number below for more information or to connect with your nearest dealer.

And he'll connect you with the only out-of-the-box laser printer on the market today that gives you so much for just \$1050 per user.

A Mannesmann Tally.

**MANNESMANN
TALLY**

1-800-843-1347 Ext. 101

In Washington state, call:
206-251-5524 Ext. 101

COMPLETE 12 MHz ZERO-WAIT 286 SYSTEM WITH 32MB HARD DRIVE!

Can you believe it? *Yes you can!*

32 MB hard drive. 12 MHz ZERO Wait State. Fully AT compatible. Our *complete* '286 system ready to plug in and fly right out of the box! At the amazing price of only \$1,295!

How is it possible? By buying direct from the manufacturer that's how. ZEOS International offers you the finest, best-backed fully AT compatible systems available . . . at *factory direct* prices.

We think you'll agree, this is the very best value you'll find anywhere.

And every ZEOS® system is fully assembled, burned-in and tested in our own laboratories. We would like to build one for you. Give us a call today!

OTHER ZEOS OPTIONS:

- Basic System Only: Everything except HDD/HDC. \$995
- Complete 64 MB hard drive system! Only \$1,595
- EGA Upgrade. 14" EGA color monitor with ZEOS EGA card. Fully tested. Add \$495
- Many other drives and options available. Call Toll Free for details, 800 23-5891.

ZEOS® Customer Assurance Program

Compare not only our features but the ZEOS® Customer Assurance Program as well: 1. Full refund within 30 days of shipment if you are not absolutely satisfied. 2. One full year limited warranty on parts and labor. 3. Federal Express replacement of any failed parts for your first year of ownership.

ONLY
\$1,295⁰⁰

NEW! ZEOS® '386 Tower System

Available now! Zeos® 386 Tower System! Complete with 64 MB HDD; Adaptec 2372 HDC, 1:1 interleave, 800 KB/sec transfer rate; 1 MB RAM, Zero-Wait, cache memory, 1.2 FDD, High Resolution tilt swivel monitor, 101 key keyboard, and more. Complete 20 MHz System \$3,495! 16 MHz \$2,995!

STANDARD FEATURES INCLUDE:

- 12" High Resolution Amber Screen TTL Monitor with Tilt & Swivel base. Easy on the eyes!
- 80286 CPU Zero-Wait State Motherboard with 8 I/O slots and socket for 80287 Math Co-processor.
- 6/12 MHz Dual Speed, Keyboard Selectable, Zero Wait-State. Phoenix BIOS!
- Deluxe AT-style Case, Security Keylock, Reset Button, LEDs.
- Full 101 key AT-style Keyboard, Mechanical Tactile with Pleasant "Click" Feel.

- Heavy Duty 200W Power Supply.
- Real Time Clock/Calendar with Battery Backup.
- 512K, 80ns Memory expandable to 1MB on the Motherboard.
- Hard and Floppy Drive Controller; 1:1, 800 KB/sec!
- Serial and Parallel/Printer Ports.
- 1.2 MB High Capacity Floppy Drive.
- 32MB hard drive.
- High Resolution Monochrome Graphic Card.
- FCC approved.
- Norton SI: 15.3



AT is a registered trademark of IBM Corporation.

Due to currency fluctuations and other factors beyond our control, prices are subject to change without notice.

Call for complete warranty details.

In Minnesota Call: 612-633-4591
FAX Orders Dial: 612-633-2310



**ORDER NOW TOLL FREE
800-423-5891**

ZEOS
INTERNATIONAL, LTD

530 5th Avenue NW, Suite 1000
St. Paul, MN 55112

Circle 282 on Reader Service Card



VM/386: A Virtual Solution

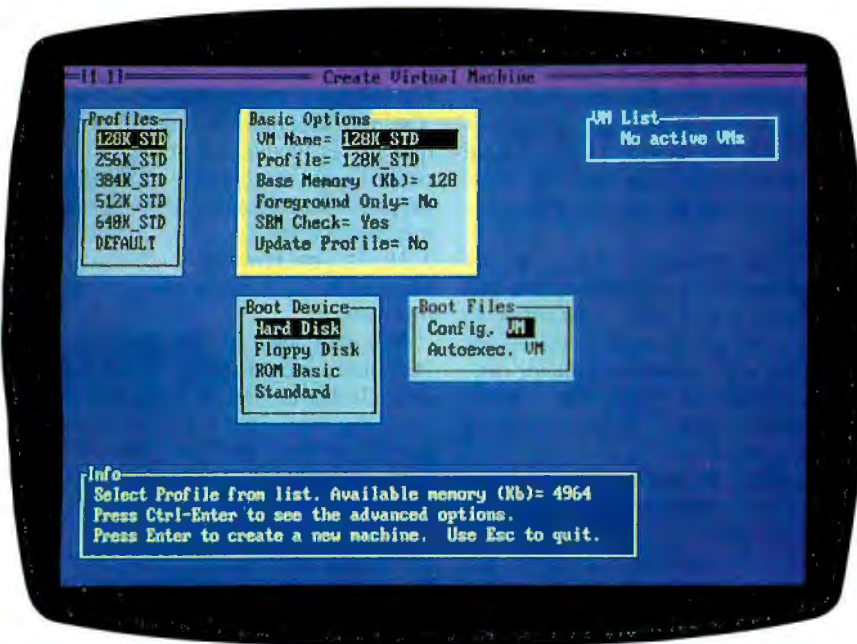

A multitasking program manager for 80386-based DOS machines

Namir Clement Shammass

VM/386 is a control program that lets you run DOS applications concurrently. It uses the virtual 8086 mode of the Intel 80386 CPU chip to create multiple 8086-based virtual machines. The amount of physical memory limits the number of virtual machines.

VM/386 1.1 (\$245) from Intelligent Graphics Corp. requires an 80386-based computer with at least 2 megabytes of RAM. The system requires one high-density floppy disk drive, and the manual

recommends that you use a hard disk drive. VM/386 supports monochrome display adapters and VGA, CGA, EGA, and Hercules-compatible graphics adapters. I used a Compaq Deskpro/20 with 5 megabytes of memory and a 40-megabyte hard disk drive running MS-DOS 3.3.

Multiple Virtual IBM PC XTs

The VM/386 control program takes up 640K bytes of memory, and lets you divide up the rest of the physical memory into virtual machines. It uses a preemptive multitasking scheduler to share the processor among the virtual machines. You can choose to have the System Resource Manager (SRM) adjust and optimize the scheduling of a virtual machine, or you can turn off the SRM and adjust these parameters yourself.

Each machine operates as though it were an independent IBM PC XT, with its own copies of DOS, AUTOEXEC and CONFIG files and memory-resident programs. These virtual machines are pro-

tected from each other; a software crash in one does not affect the others. In fact, you can even reboot an individual virtual machine with the Ctrl-Alt-Del key combination. To move among the virtual machines, you call up a switcher list by pressing SysReq (or Alt-SysReq if you have an enhanced keyboard). From this list, you can choose either to enter the virtual machine manager menu or to go to a virtual machine.

To use VM/386, you first boot up under DOS and then type VM/386, which is the name of a batch file that starts the Virtual Memory Manager (VMM). The VM/386 control program uses multiple text-based windows containing menus and help or status information. The VMM contains six main menus: Virtual Machine Control, Hardware Control, System Options, Status Display, Help Information, and Exit VM/386. All these menus except the last have submenus. It is important that you exit from VM/386 via the menu option so that VM/386 can close any files it has open.

Creating a virtual machine involves two screens, each with a set of options. The first contains basic options, while the second contains advanced ones. You can alter and fine-tune the default values, with the option of storing a new set of default values in a profile file.

The basic options for creating a virtual machine are assigning a virtual machine a name, a profile, and an amount of memory (128K to 640K bytes); as shown in the photo. You can also specify whether this virtual machine will run only while it is in the foreground and whether the SRM will adjust its time slice.

When you estimate the total amount of memory required, you must take into account that the video screen requires 16K bytes and 112K bytes in text and graphics modes, respectively. You can assign foreground-only mode to highly interactive applications that do not perform any task while in the background.

continued

VM/386 1.1

Type

Multitasking environment

Company

IGC
4800 Great America Pkwy.
Santa Clara, CA 95054
(408) 986-8373
(800) 458-9108

Format

One high-density 5¼-inch floppy disk

Language

Assembly

Hardware Needed

IBM AT with an Intel Inboard 386, Compaq Deskpro 386, IBM PS/2 Model 80, or 80386-based computer with at least 2 megabytes of RAM, one high-density floppy disk drive (hard disk drive recommended), monochrome display adapter, and VGA, CGA, EGA, or Hercules graphics adapter

Software Needed

DOS 3.0 or higher

Documentation

200-page user's manual

Price

\$245

Inquiry 895.

The SRM is responsible for adjusting and optimizing the time slice of a virtual machine based on I/O activities. The more I/O a virtual machine performs, the more time slice the SRM will give it. You can turn off the SRM for a virtual machine that is running an important number-crunching application. Such applications tend not to perform many I/O operations and, with the SRM turned on, they are considered idle and are consequently allocated a smaller CPU time slice.

Other basic options for creating a virtual machine let you select the boot device and files. You can start a virtual machine from a hard disk drive, a floppy disk drive, and from ROM BASIC. The boot files are AUTOEXEC.BAT and CONFIG.SYS by default. You can specify other boot files such that the primary filenames are the same, but you have to designate the extension names. The AUTOEXEC.VM and CONFIG.VM filenames are suggested for alternate filenames.

This enables you to customize the configuration during the virtual machine reboot.

Each virtual machine can have its own AUTOEXEC batch file to load RAM-resident utilities and related applications. VM/386 does not support DOS redirection and piping commands placed inside batch files. These commands work fine when issued at the DOS command level.

The advanced options for creating a virtual machine let you adjust parameters that relate to the performance, extended or expanded memory allocation, and hardware device drivers.

The performance parameters are probably the most interesting and most frequently adjusted. With these parameters, you can control the speed of virtual machines relative to each other. The parameters include the queue, priority, time slice, SRM burst, SRM swapout, real-time switch setting, and the I/O privilege level.

The queue parameter designates the interrupt level for a virtual machine and ranges from 1 to 5, with a default of 4. The lower the queue number, the higher the priority of a virtual machine for handling external interrupts. The VMM, with a queue number of 0, has the highest interrupt level.

For virtual machines with the same queue number, you use a second parameter (called priority), which ranges from 0 to 255, to decide which machine has precedence. Low-priority values yield a higher precedence.

The third parameter is the time slice (in milliseconds) that defines the CPU time spent on each virtual machine. The time slice values range from 1 to 255, with a default of 6. The manual recommends that for optimum performance, the sum of the time slices of the virtual machines should be 60 ms.

VM/386 offers an additional level of sophistication in managing virtual machines. You can run a virtual machine for a specific number of seconds and then suspend it, either completely or for a fixed time span. The SRM burst parameter assigns the total CPU seconds before a virtual machine is suspended. The SRM swapout parameter defines the number of seconds before the suspended machine resumes running. A 0 value implies a permanent suspension.

Once a virtual machine profile is defined, you can create one or more virtual machines by pressing the Enter key after a final confirmation message. You then use the switcher to move among the virtual machines.

To automate the systematic creation of

a set of virtual machines, VM/386 supports the creation of start-up files. These files create the preselected combination of virtual machines, but they do not load or launch their applications.

You terminate a virtual machine by selecting an option from the virtual machine manager menu. You should first close any applications that perform file I/O before you terminate them because the selected application is abandoned at once. Updating a virtual machine is another option that permits you to adjust some of its parameters (e.g., the time slice) while it is running. This lets you alter the real-time speed of execution for an application.

Hardware Constraints

VM/386 supports the use of two hard disk drives (connected to the same controller) and two monitors. VM/386 also supports hard disk partitions beyond 32 megabytes if you are using Compaq DOS 3.31. If you have an EGA that auto-switches to CGA mode, you must disable this feature.

You can specify that monitors and hard disk drives be used in either floating or exclusive modes. In exclusive mode, the designated device is tied solely to a specific virtual machine. You can employ exclusive video output to monitor a special application on a secondary monitor. In floating mode, several virtual machines can intermittently access different files located on the same hard disk. Also there is a RAM disk that virtual machines and a VGA can share.

You can also specify the allocation of extended or expanded memory to work with your applications. Using either genre of memory reduces the amount of memory available for virtual machines.

In creating a multitasking environment out of the single-tasking DOS environment, VM/386 must take steps to allocate resources, such as the printer and communications ports, to specific virtual machines. It does this from the device allocation menu by letting you assign these resources to specific virtual machines. The explicit device allocation prevents various applications from simultaneously printing, which could lead to an utterly confusing hard-copy printout. The application allocated to the communications port should have its virtual machine queue parameter set to 1 so it will have a high level of access to external interrupts. This enables the communications software to keep up with the pace of the transmitted characters.

The Status Display main menu permits you to monitor the status of the virtual

Table 1: The time for the primary benchmark essentially increases proportionally with each additional background process.

	Number of operating programs	Time (seconds)	Comparison to DOS performance (percent)
Compaq DOS 3.31	1	10.5	100
VM/386	1	10.5	100
	2	21.8	208
	3	32.8	312
	4	42.5	405
	8	81.7	778

Note: All processes are running at a time slice of 60 ms.

machines. The information is presented in tabular form indicating the queue number, the priority level, the time slice, the remaining time slice (for a running virtual machine), and the total number of unprocessed interrupts. You can also query the status of the total amount of storage: actual, expanded, extended, and virtual. VM/386 also enables you to peek at memory locations, presenting you with a debug-like memory dump.

Testing The Performance

To test the speed of the multitasking feature of VM/386, I wrote two Turbo Pascal 4.0 programs: BEN1.EXE and BEN2.EXE. BEN1.EXE contains the primary benchmark program that runs in the foreground; BEN2.EXE is the secondary benchmark program that runs in a background virtual machine. Both programs loop infinitely and use the Turbo Pascal function KeyPressed to exit.

The primary benchmark program performs integer calculations in a For loop, beeps, and then displays the time required to execute the For-Do loop. The secondary benchmark program performs the same calculations and displays the loop-control variable. Printing the loop-control variable in the secondary benchmark gives you a visual indication of whether or not a copy of the program is actually running. It also gives you a feel for how fast or slow a copy of the secondary benchmark is running.

To run the multitasking benchmark, I first saved the following settings in a 128K_STD profile file: I set the SRM to OFF, queue to 4, priority to 128, and time slice to 60 ms.

I then created a virtual machine using the modified 128K_STD profile and started a copy of BEN1.EXE in that virtual machine and measured the time between beeps.

Once I had the time for BEN1.EXE running alone, I then added copies of the secondary benchmarks to a virtual machine that runs in the background and measured how much subsequent copies of BEN2.EXE slow down BEN1.EXE. I used the switcher to load copies of BEN2.EXE in a virtual machine and then to switch BEN1.EXE back into the foreground. Table 1 shows the effect adding subsequent background virtual machines has on executing BEN1.EXE.

I also tested the effect of running the primary benchmark in a 512K-byte virtual machine with a 60-ms time slice, while four copies of the secondary benchmark ran in four 128K-byte machines with a 15-ms time slice. The results show that the timing of the primary benchmark was 31.2 seconds, instead of the estimated 21 seconds (10.5 seconds × (4 × 15 + 60) / 60). The difference between these two timings can most likely be attributed to the extra size of the virtual machine running the primary benchmark.

The second benchmark program, DSK-BEN1.EXE, examines the ability of VM/386 to support multiple virtual machines that appear to simultaneously or intermittently access different files on the same hard disk. The program repeatedly reads the same text file. It displays the time that each loop iteration takes to read a text file.

The name of the text file read by each running copy of DSKBEN1.EXE is supplied on the argument list. I prepared three 128K-byte text files to be read by three copies of the benchmarks running concurrently. I used the 128K-byte profiles with the SRM setting turned on. Up to three copies of the benchmark programs were run in three different virtual machines. The process used to bring out

continued

Buy one, get one free.

Five productivity enhancers proven by over 300,000 PC users.

Buy any one of these SoftLogic products and get any other one free. Look for these specially marked packages at your favorite dealer. Then just fill out the "FREE Software" coupon you'll find inside and mail it to us. It's that simple.

Coupon contained only in packages marked "FREE Software" and redeemable by users who register by 9/30/88. Void where prohibited.



True multi-tasking that's easy to use.
\$69.95



For instant do-it-yourself data integration.
\$99.95



Switches instantly among programs and files
\$79.95



New release 4.0 with advanced file recovery tools.
\$69.95



Compresses 1-2-3 and all other files.
\$69.95

For more information, call 1-800-272-9900. (603)-627-9900 in NH

SOFTLOGIC SOLUTIONS

SoftLogic Solutions, Inc.
One Perimeter Road
Manchester, NH 03103

Offer Good in USA Only

9516

Table 2: The disk benchmark program, DSKBEN1.EXE, shows that VM/386 allows several applications in virtual machines to access different files on the same hard disk.

Total number of programs	Time (seconds)
1	4.1
2	7.5
3	11.6

Note: All processes are running at a time slice of 60ms.

each virtual machine is basically the same as the one described for the first benchmark program.

Table 2 shows the results that confirm the ability of VM/386 to allow the intermittent access of different files in the same drive. Each of the benchmark copies ran at about the same speed shown in the table. The timings fluctuated more than in the first benchmark. I also investigated the same feature in Microsoft

Windows/386 and discovered that it doesn't support the intermittent file I/O.

Short-Term Solution

VM/386 1.1 is an interim solution to the DOS single-tasking bottleneck that OS/2 is designed to address. VM/386 is like a heart bypass for the current DOS 3.x application base: It gives more life and flexibility to these applications by letting you run two or more of them simultaneously. It also provides you with excellent control for adjusting the performance and operation of each virtual machine and requires practically no effort to learn or use.

VM/386 and Windows/386 are two very similar products (see my review "Microsoft Windows 2.03 and Windows/386," May BYTE). They both let you run DOS 3.x applications in 640K bytes of memory. The main differences are that VM/386 does not allow two or more virtual machines to share the same display. With Windows/386, you can run different applications within the windows on the screen. With VM/386, you have to use the switcher to move from one virtual machine to another, but it does give you control over the multitasking scheduler,

whereas, in Windows/386, you don't have the options of adjusting parameters for the scheduler.

Both VM/386 and Windows/386 are very different from OS/2. Where VM/386 and Windows/386 let you run the current base of DOS 3.x applications concurrently, OS/2 provides only the ability to run one single DOS 2.x application. Most DOS applications must be substantially redesigned to run under the protected mode in OS/2. However, the OS/2 environment removes a lot of constraints that limit DOS applications. Unfortunately, there aren't many OS/2 applications around. In the meantime, VM/386 offers an interim solution while we're waiting for OS/2 applications to appear.

Editor's note: The source code listing for the programs BEN1.PAS, BEN2.PAS, and DSKBEN1.PAS is available in a variety of formats. See page 3 for further details. ■

Namir Clement Shammas is a columnist for several computer magazines and a freelance writer living in Glen Allen, Virginia. He can be reached on BIX as "nshammas."

	1985	1986	1987	1988
Jan.	\$6.00			\$6.00
Feb.	\$6.00	\$6.00	\$6.00	\$6.00
March	\$6.00		\$6.00	\$6.00
April	\$6.00		\$6.00	\$6.00
May	\$6.00		\$6.00	\$6.00
June	\$6.00	\$6.00	\$6.00	\$6.00
July		\$6.00	\$6.00	
Aug.	\$6.00	\$6.00	\$6.00	
Sept.	\$6.00	\$6.00	\$6.00	
Oct.	\$6.00	\$6.00	\$6.00	
Nov.	\$6.00		\$6.00	
Dec.	\$6.00	\$6.00		

BACK ISSUES FOR SALE

SPECIAL ISSUES and INDEX

BYTE '83-'84 INDEX	\$2.00
BYTE 1985 INDEX	\$2.50
BYTE 1986 INDEX	\$2.00
BYTE 1987 INDEX	\$2.50
1985 INSIDE THE IBM PCs	\$4.75
1986 INSIDE THE IBM PCs	\$5.00
APPLICATIONS SOFTWARE TODAY SPECIAL	\$4.00

Circle and send requests with payments to:

BYTE Back Issues
 One Phoenix Mill Lane
 Peterborough, NH 03458
 (603) 924-9281

Check enclosed *Payments from foreign countries must be made in US funds payable at a US bank.*

VISA MasterCard

CARD # _____ EXP. DATE _____

SIGNATURE _____

The above prices include postage in the US. Please add \$.50 per copy for Canada and Mexico; and \$2.00 per copy to foreign countries (surface delivery). Please allow 4 weeks for domestic delivery and 12 weeks for foreign delivery.

European customers please refer to Back Issue order form in International Advertising section of book.

NAME _____

ADDRESS _____

CITY _____ STATE _____ ZIP _____

COMPUTERS FROM IOWA?

“We at Gateway 2000 are often asked how a company located in Iowa can have the best priced IBM Compatible Computers in the nation.

Gateway 2000 is centrally located in order to efficiently serve the entire country. We are honest, hard working, well educated people, committed to succeeding and growing in the highly competitive micro-computer market.

Gateway 2000 is a full-service and support organization that realizes the key to our success lies in a satisfied customer base.

One look at the configuration we have listed below and you will see that we have high quality equipment at an incredible price. We have many different configurations available, so call one of our knowledgeable sales people, if you have any questions.

We look forward to doing business with you, and establishing a long term business relationship.”

OUR MOST POPULAR CONFIGURATION — THE GATEWAY 2000 A12

- 12 Mhz 80286 Processor (Switchable to 6)
- Phoenix BIOS
- 1 Meg Weight State RAM (100 NS)
- 1 - 5 1/4" Floppy Drive (Teac)
- 1 - 3.5" Diskette Drive (Teac)
- Seagate ST251 (40 Meg, 28ms if Partitioned)
- 1 - Parallel and 2-Serial Ports
- 101 Key Enhanced Keyboard (Keytronic)
- 14" Samsung EGA Monitor (640 x 350)
- Sigma Designs Autoswitch EGA Card
- 200 Watt Power Supply
- Battery Backed-up Clock Calendar
- 8 Expansion Slots (6-16 Bit, 2-8 Bit)
- Space for 5 1/4" Storage Devices
- Completely IBM Hardware and Software Compatible
- 1 Year Warranty
- 30 Day Money-back Guarantee

\$1995 COMPLETE (386 SYSTEM ADD \$1000)

Assembled, Tested, 48 Hour Burn-in



Prices subject to DRAM market changes.
Gateway 2000 - P.O. Box 2414 - Sioux City, IA 51107
800-233-8472/712-255-7899

Circle 104 on Reader Service Card



The monitor
that makes obsolescence
obsolete.



MultiSync II

*The world's best-selling color
monitor, compatible with all
leading graphics standards.*

At NEC, we design our products with a simple principle in mind.

What works well today should work just as well tomorrow.

And the MultiSync® II is no exception. It's a monitor that has proven itself compatible with all the leading computer systems.

Including the PC/XT/AT/386 (and their 100% compatibles), PS/2 and Mac II. As well as all the leading graphics boards. So as technology continues to evolve you can be confident that the MultiSync II will be ready to meet the challenge.

The MultiSync II has an advanced ergonomic design that makes computing more comfortable. With a smaller footprint, upfront user controls, tilt-swivel base and a non-glare screen.

Best of all, it's from NEC. The company that not only invented the technology, but that also insures that your investment in

it doesn't become obsolete. For literature or a dealer call

PC/XT/AT and PS/2 are registered trademarks of the International Business Machines Corporation.

1-800-447-4700. For technical details call NEC Home Electronics

Mac II is a registered trademark of Apple Computer, Inc.

(USA) Inc. 1-800-NEC-SOFT.

NEC is a registered trademark of NEC Corporation.

C&C

Computers and Communications

Circle 307 on Reader Service Card

NEC®

JULY 1988 • BYTE 161

COMPUTER WAREHOUSE

CALL TOLL FREE **1-800-528-1054**

FREE FEDERAL EXPRESS
Air Express Shipping
See Details Below

**LOWEST PRICES
FAST DELIVERY**

HARDWARE

PRINTERS

Alps All Models.....	Call
AST TurboLazer.....	\$430
Citizen 120D.....	\$145
180D.....	\$159
15E.....	\$335
MSP-40.....	\$319
MSP-45.....	\$465
MSP-50.....	\$399
MSP-55.....	\$530
Premier 35.....	\$449
Tribute 124.....	\$465
Tribute 224.....	\$635
C. Itoh.....	Call
Diconix 150.....	\$309
300.....	\$480

EPSON

All Printer Models.....	Call
Hewlett-Packard LaserJet II.....	\$1775
DeskJet.....	\$779
NEC P2200.....	\$329
P6.....	\$418
P7.....	\$615
P9.....	\$1035
Silentwriter.....	Call

OKIDATA

All Printer Models.....	Call
Panasonic 1080 Model 2.....	\$165
1091 Model 2.....	\$199
1092 I.....	\$325
1524.....	\$525
1592.....	\$415
1595.....	\$429
3131.....	\$325
3151.....	\$389
Laser P4450.....	\$1635

STAR MICRONICS

All Printer Models.....	Call
Toshiba 3215L.....	\$485
3415L.....	\$665
3515X.....	\$979
Laser Printer.....	\$2415

DISKETTES

Maxell MD2 (Qty 100) 5 1/4.....	\$75
M2S 5 1/4.....	\$68
MD-2 High Density.....	\$149
Sony DS/DD (Qty 100).....	\$69
HD (100's) 5 1/4.....	\$150
DS (100's) 3 1/2.....	\$159

MONITORS

Amdek All Monitors.....	Call
Mitsubishi Diamond Scan.....	\$509
Other Models.....	Call
NEC Multisync II.....	\$599
Multisync Plus.....	\$589
Multisync XL.....	\$2069
Princeton Graphics All Models.....	Call
Ultrasync.....	\$485
Samsung.....	Call
Sony Multiscan w/cable.....	\$535
Thompson Ultrascan.....	\$519
Zenith 1490 FTM.....	\$609
Other Models.....	Call

KEYBOARDS

KB5151.....	\$119
KB5153.....	\$149
KB101.....	\$79

DISK DRIVES

Iomega Bernoulli 10 meg.....	\$909
Bernoulli 20 meg.....	\$1260
Bernoulli 40 meg.....	\$1615
Bernoulli Beta Internal (5 1/4).....	\$909
Bernoulli Beta External (5 1/4).....	\$1645
Miniscribe Drives.....	Call
Teac AT 1.2 Meg Drive.....	\$89
XT 1/2 HT Drive.....	\$79
Toshiba 3.5 720K.....	\$95
3.5 1.4 MB.....	\$115
Magnum Tape Backup.....	Call

SEAGATE

20 meg w/Western I/O.....	\$275
251-1.....	\$469
Other Models.....	Call

\$545



MIT SYSTEMS Turbo PC/XT

640 Memory, One 360K Brand Name Floppy Drive • 135 Watt Power Supply
AT Style Keyboard • 4-10 MHz Clock Speed, (Keyboard Selectable), 8 Expansion Slots

Turbo PC/XT w/640K & 2 Drives.....	\$620
Turbo PC/XT w/640K, 1 Drive, 20 MG.....	\$829
PC/AT 10 MHz w/1024K, 12 Floppy Dr.....	\$1159
PC/AT 12 MHz/1024K, 1 Drive, 40 MG.....	\$1549
PC 386 16 Mz 1 DR.....	\$1979
PC 386 16 Mz 1 DR/40 Meg.....	\$2479
MonGraphics Card w/Parallel PrinterPort.....	\$55
Color Card w/Parallel PrinterPort.....	\$55
Amber Monitor (TTL).....	\$89
Amber Monitor w/Swivel Tilt.....	\$95
Color Monitor (RGB).....	\$255
EGA Monitor.....	\$359
EGA+ Card.....	\$145
I/O Card (Serial/Parallel).....	\$38
I/O Card (Serial/Clock Calendar).....	\$39
Enhanced Keyboard.....	\$69
AT Multi I/O Card.....	\$69
XT Multi I/O Card.....	\$55

BOARDS

AST Six-Pack Plus.....	\$115
Hot Shot 286.....	\$345
Transformer.....	\$545
3G Plus II.....	\$225
Other Models.....	Call
ATI EGA Enhanced.....	\$175
VIP VGA.....	\$265
Hercules Color Card.....	\$145
Graphic Card & Graphic Card +.....	\$175
Intel 80287-6.....	\$175
80287-8.....	\$239
80287-10.....	\$285
8087-2.....	\$149
Above Board AT (4020).....	\$375
AboveBoard PS/AT (4120).....	\$329
Inboard 386 w/Cable PC.....	\$979
NEC Multisync Graphic Board.....	\$275
Orchid Designer VGA.....	\$265
Paradise Autoswitch 350.....	\$130
Autoswitch 480.....	\$145
VGA +.....	\$239
VGA Professional.....	\$355
Plus Development.....	Call
Video-7 Vega Deluxe.....	\$180
VGA.....	\$259

COMPUTERS

AST Model 80.....	\$1715
AST Model 120.....	\$2405
AST Model 140X.....	\$2619
NEC Multispeed EL II.....	\$1495
PowerMate I.....	Call
Toshiba T1000.....	\$785
T3120.....	\$3068
T-1100 Super twist.....	\$1370
5100.....	\$4899
Zenith.....	Call

MODEMS

All Modems.....	HAYES	Call
Incomm.....	Call	
Prometheus 2400B w/Soft.....	\$119	
Other Models.....	Call	
US Robotics Courier 2400.....	\$299	
Password 1200.....	\$149	

VIDEO TERMINALS

Wyse.....	Call
-----------	------

MONEY MANAGEMENT

Dollars & Sensew/Forecast.....	\$92
Tobias Managing Your Money 4.0.....	\$114

COMMUNICATIONS

CompuServe Subscription Kit.....	\$19
Crosstalk XVI.....	\$87
Carbon Copy Plus.....	\$105
Mirror II.....	\$33
Remote.....	\$87
Smartcom III.....	\$136

GRAPHICS

Logi Tech Mice.....	Call
Newsmaster II.....	\$39
Microsoft Buss Mouse 1.0.....	\$92
Microsoft Chart 3.0.....	\$229
Microsoft Serial Mouse 1.0.....	\$92
Newsroom.....	\$30
PC Buss Plus Mouse w/Paint.....	\$85
PFS: First Publisher.....	\$52
OPTI Mouse w/Dr. Halo III.....	\$82
PC Mouse w/Paint.....	\$83
Printmaster Plus.....	\$29
Master Presentation Pack.....	\$315
Turbo Graphix Tool Box 4.0.....	\$58

SOFTWARE

IBM PC and 100% Compatibles

INTEGRATIVE SOFTWARE

Enable 2.0.....	\$352
Framework II.....	\$309
Smart Software System 3.1.....	\$399
Symphony.....	\$435
Ability Plus.....	\$137

TRAINING

MS Flight Simulator.....	\$29
PC Logo.....	\$79
Typing Instructor.....	\$27
Typing Tutor IV.....	\$27
MS Learning DOS.....	\$29

LANGUAGES

C Compiler (Microsoft).....	\$259
Fortran Compiler (Microsoft).....	\$259
Macro Assembler (Microsoft).....	\$86
Pascal Compiler (Microsoft).....	\$175
Quick Basic 4.0.....	\$57
Turbo Pascal Dev. Lib.....	\$229
Turbo Pascal 4.0.....	\$58
Turbo C 1.5.....	\$58
Turbo Basic.....	\$58
Turbo Prolog.....	\$58

PROJECT MANAGEMENT

Harvard Total Project Manager II.....	\$309
Microsoft Project.....	\$287
Super Project Expert.....	\$385
Timeline 2.0.....	\$259

SPREADSHEETS

Lotus 1-2-3.....	\$295
Multiplan 3.0 MS.....	\$113
Twin Classic.....	\$32
VP Planner Plus.....	\$82
Supercalc 4.....	\$269

DATA BASE MANAGEMENT

Clipper.....	\$368
dBase III Plus.....	\$374
Quickcode Plus.....	\$129
QuickReport.....	\$129
Reflex.....	\$68
DB-XL Diamond.....	\$105
PFS: Professional File.....	\$119
R:Base For DOS.....	\$425

WORD PROCESSORS

Word Perfect Executive.....	\$103
Turbo Lightening.....	\$58
Microsoft Word 4.0.....	\$185
Multimate Advantage II.....	\$249
Wordstar w/Tutor.....	\$162
Wordstar Pro Pack 4.0.....	\$179
PFS: Professional Write.....	\$102

**Word Perfect (Ver.4.2) Call
Wordstar 2000 + 3.0 \$189**

UTILITIES

MS Windows 2.0.....	\$57
Copy II PC.....	\$18
1 DIR Plus.....	\$46
Fastback Plus.....	\$87
Norton Utilities 4.0.....	\$46
Printworks For Laser.....	\$67
Sidkick (Unprotected).....	\$48
Sideways 3.2.....	\$37
Superkey.....	\$58
Xtree Professional.....	\$61
SOZ Plus.....	\$53
Brooklyn Bridge.....	\$69
Many other titles available.	

COMPUTER WAREHOUSE

To Place an Order: 1-800-528-1054
To Follow-up on an Order: 602-944-1037
8804 N. 23rd Ave.
Phoenix, Arizona 85021

Order Line Hours: CWF-588
Mon-Fri 7:00 a.m.-6:00 p.m.
Saturday 9:00-1:00
Order Processing:
10:00 a.m.-3:00 p.m. Mon-Fri



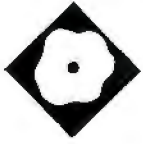

Concurrent DOS 386



A multitasking operating system that also supports additional terminals

Alex Lane

Some people have been quick to sum up the state of 80386-based computers: All revved up with no place to go. They're referring to the inability of MS-DOS (and PC-DOS) to fully exploit the multitasking aspects of the 80386. Concurrent DOS 386 from Digital Research, Inc. (DRI) is one multitasking alternative to MS-DOS for the Compaq Deskpro 386 and compatibles with as little as 512K bytes of RAM.

The basic Concurrent DOS 386 package (\$395) is capable of multiuser opera-

tion, supporting two RS-232C serial terminals in addition to the main console. The console can run up to four tasks concurrently in separate screens, while the serial terminals can run up to two virtual tasks each. DRI also markets a version of Concurrent DOS 386 that supports up to nine serial terminals; it sells for \$495.

I tested Concurrent DOS 386 version 2.0 on an ARC 386i microcomputer with an Award BIOS (version 2.09), but it also runs on systems with the Phoenix BIOS.

Concurrent DOS 386 comes on two 5¼-inch high-density floppy disks and two 3½-inch 720K-byte floppy disks. The accompanying documentation consists of four books that include information applicable to both Concurrent DOS 386 and Concurrent DOS XM—a DRI product for PC XT's and AT's.

Automatic Setup

Installing Concurrent DOS 386 is painless. You just boot your system with the appropriate Concurrent DOS 386 disk in

drive A and then press F10. Once you indicate which drive the software is to be installed on, the installation routine creates a subdirectory on that drive, copies the appropriate files from the distribution disks, and installs the system files in the drive's root directory. Once transferred to a hard disk drive, the files occupy about 1.5 megabytes of storage.

During installation, the AUTOEXEC.BAT file is modified so that each time you boot the system, it asks you whether Concurrent DOS 386 should be loaded in place of DOS. This ability of Concurrent DOS 386 to coexist with DOS on the same drive is a big plus.

Once the software is installed, you must run the Setup program to configure the system for a multiport expansion card, or to connect printers and serial devices such as modems and terminals.

Device drivers are loaded and system parameters are set using the information contained in the Concurrent DOS 386 file CCONFIG.SYS (analogous to the DOS file CONFIG.SYS). Some of the parameters, such as BUFFERS and FILES, will be familiar to DOS users.

Concurrent DOS 386 would not initialize my hard disk device driver, which, when installed under DOS, allows a 20-megabyte partition of my 40-megabyte hard disk drive to be addressed as drive D. In effect, Concurrent DOS 386 recognized only half my hard disk drive. Although this problem is not hard to solve, it does involve a time-consuming reformat. There is no 32-megabyte limit to the size of a partition if Concurrent DOS 386 becomes the only operating system installed on a hard disk drive. The maximum hard disk drive partition that is allowed under Concurrent DOS 386 is 512 megabytes.

According to DRI, you should be able to install and run Concurrent DOS 386 with a minimum of 512K bytes of memory installed, although, admittedly, there'll be little you can do with such a

continued

Concurrent DOS 386 version 2.0

Type

Multitasking operating system

Company

Digital Research, Inc.
60 Garden Court
P.O. Box DRI
Monterey, CA 93942
(408) 646-6464

Format

Two high-density 5¼-inch floppy disks;
two 720K-byte 3½-inch floppy disks

Language

Assembly and C

Hardware Needed

Compaq Deskpro 386 or 100 percent compatible with a hard disk drive and 512K bytes of RAM; the 10-user system requires a multiport card

Documentation

35-page Installation Guide; 170-page User's Guide; 150-page Reference Guide; 26-page Applications Guide

Price

3-user license: \$395
10-user license: \$495

Inquiry 893.

small system other than run a very small application. With a bare 512K bytes of memory, I was unable to install Concurrent DOS 386 on my machine.

The first paragraph of the memory configuration section in the Installation Guide tells you to disregard the rest of the section if you're installing Concurrent DOS 386—a note you may miss (as I did). The rest of the information is for Concurrent DOS XM users, who must use Expanded Memory Specification (EMS) or enhanced EMS (EEMS) with their system. I admit to fiddling a lot with the settings on my memory board, with varying degrees of success, before going back and rereading the chapter from the first word. Even so, it finally took a call to a DRI technical-support representative to convince me that I didn't need to do anything special about memory configuration.

Multitasking and MS-DOS Compatibility

Concurrent DOS 386 performs multitasking using the time-slice technique. Basically, this means that each of the programs residing simultaneously in

memory is given 1/60 second to run, after which control is passed to the next program. In an 80386 environment, this constant switching occurs so quickly that programs appear to run simultaneously.

Without having verified every permutation of every DOS command, I found Concurrent DOS 386 to be substantially compatible with DOS. However, it was missing several commands found in the MS-DOS 3.2 that was supplied with my ARC. Among the missing are CTTY, EXE2BIN, JOIN, SHARE, GRAFTABL, and GRAPHICS. On the other hand, there are over 30 commands that are unique to Concurrent DOS 386, including commands for password maintenance, programming function keys, and rebooting the system. A separate command processor shell, DOS.COM (analogous to the DOS COMMAND.COM), is provided to act as a buffer between troublesome programs, such as SideKick and other terminate-and-stay resident programs, and Concurrent DOS 386.

Concurrent DOS 386 offers several keyboard enhancements, including the ability to program up to 50 function keys using the FUNCTION command. In addition, Concurrent DOS 386 maintains a history buffer of commands entered at the system prompt, which you can recall by using the up and down arrow keys and edit by using a set of WordStar-like commands.

Perhaps one of the most titillating features of Concurrent DOS 386 is the ability to run up to 255 processes simultaneously. To the novice, this may sound like being able to run 255 programs at once. However, by "process" DRI means a specific operating system construct (e.g., one that maintains a text buffer or keeps system time). For example, each virtual terminal has two processes associated with it: a flush process that maintains a DOS video buffer (thereby allowing the terminal to perform pokes into a virtual video RAM), and a command shell process that runs the basic user interface.

About the only concession to systems programming in Concurrent DOS 386 is the inclusion of SID86.COM, a symbolic debugger with roots going back to 8-bit CP/M days. It was included solely to allow the user to incorporate patches that are anticipated as minor bugs in the software surface over time.

Concurrent DOS 386 reads disks formatted under DOS, as well as under other DRI operating systems for the PC architecture (e.g., CP/M-86, Concurrent CP/M-86, and Concurrent DOS 4.1 to 5.2). Concurrent DOS 386 also executes

DOS .EXE and .COM programs, although they cannot take advantage of undocumented DOS functions (Microsoft's Word 4.0, for example, is not executable under Concurrent DOS, although Word 3.1 will run).

Other features that are familiar to DOS users include redirection of I/O using the <, >, and >> symbols, and the use of ? and * characters as wild cards in filename descriptions. One wrinkle that's not found in DOS is the executable .CMD file, which is a contribution from previous DRI products. Another unique feature is the ability to control file access in Concurrent DOS 386 by using password-protected file attributes that can make a file a system file (invisible to the casual user) or a read-only file, or both.

If you've ever used any of DRI's earlier concurrent systems, such as Concurrent CP/M-86 or Concurrent DOS XM, the look and feel of Concurrent DOS 386 will be no surprise to you. Most system utilities like Dskmaint (for disk maintenance) and Setup (for system setup) have a function-key menu interface that involves a minimum of typing. The utility Editmenu lets you build on this interface; you can create, change, copy, or delete a menu, and use special effects such as reverse video and blinking in menu displays. Another menu utility, Runmenu, runs the menu files that you created with Editmenu, while the Copymenu utility lets you copy menu files for editing or backup purposes.

Other Concurrent DOS Applications

The Concurrent DOS package includes several other programs that can be considered applications in themselves: File Manager, Printer Manager, DR EDIX, and Cardfile.

The File Manager is a useful utility program that executes most common commands, which you can select from a menu. The main menu of File Manager consists of three parts: a command panel, which lists important Concurrent DOS 386 commands ranging from obtaining a simple directory to setting up the system; an object panel, which typically offers a list of files, directories, or drives for selection; and a prompt panel, which describes the currently selected command. You can select commands by pressing the up and down arrow keys until the desired command is highlighted, by typing enough of a command to uniquely identify it, or by pressing F10 and entering a complete command from the keyboard.

The Printer Manager is a Concurrent DOS 386 program that allows one or sev-

continued



DOS system running Lotus 1-2-3



SCO XENIX system running SCO Professional

THIS IS AN IBM PS/2 MODEL 80 RUNNING DOS

Under DOS, this PS/2™ is a powerful 80386-based single-tasking, single-user computer that can run thousands of DOS applications. In 16-bit, 8086 mode.

One at a time.

When OS/2™ software becomes available, the PS/2 can become a multitasking, single-user computer running in 16-bit, 286 mode that can also single-task those DOS applications under OS/2.

One at a time.

With DOS or OS/2, the PS/2 will support one user.

	1 user (DOS)	1 user (OS/2)
Cost per system**:	\$12,389	\$12,594
Cost per user:	\$12,389	\$12,594

THIS IS AN IBM PS/2 MODEL 80 RUNNING SCO XENIX

Under SCO XENIX®, this PS/2 becomes a powerful 80386-based multitasking, multiuser computer that can run thousands of XENIX applications. In full-tilt, 32-bit, 386 mode.

Many at a time.

And using SCO VP/ix,™* the PS/2 can multitask DOS applications under SCO XENIX.

Many at a time.

With SCO XENIX, the PS/2 will support one user.

Or 9 users. Or even 33 users.

And it can do all that today because you can get SCO XENIX for the PS/2—*now!*

	1 user	9 users	33 users
Cost per system**:	\$14,559	\$19,726	\$40,402
Cost per user:	\$14,559	\$2,192	\$1,224

SCO XENIX System V and the SCO XENIX family of software solutions are available for all industry-standard 8086-, 80286-, and 80386-based computers, and the IBM® Personal System/2™ Models 50, 60, and 80.



(800) 626-UNIX (626-8649)
 (408) 425-7222
 FAX: (408) 458-4227
 TWX: 910-598-4510 SCO SACZ
 uucp: ...decvax!microsoft!sco!info!

Circle 240 on Reader Service Card

*SCO VP/ix available as separate product.

** Cost comparisons are based on most recently published U.S. domestic suggested list prices. Cost model: Base machine: IBM PS/2 Model 80, 70Mb disk, 1Mb RAM, IBM 8512 color monitor, 1Mb additional IBM RAM, IBM ProPrinter XL. 1-user DOS system: Base machine, plus DOS 3.3, WordPerfect 4.2, Lotus 1-2-3, dBASE III PLUS. 1-user OS/2 system: 1-user DOS system, substitute OS/2 for DOS. 1-user SCO XENIX system: Base machine, plus SCO XENIX 386 for PS/2, SCO VP/ix, SCO 1,rx (word processing), SCO FoxBASE+™ (dBASE III PLUS workalike), SCO Professional™ (1-2-3 workalike). 9-user SCO XENIX system: 1-user SCO XENIX system, plus intelligent 8-user multipoint card, 8 IBM 3151 ASCII terminals. 33-user SCO XENIX system: 9-user SCO XENIX system, plus 3 more intelligent 8-user multipoint cards, 24 more IBM 3151 ASCII terminals, 4 Mb additional RAM, additional 70Mb disk.

IBM and ProPrinter XL are registered trademarks and Personal System/2, PS/2 and OS/2 are trademarks of International Business Machines Corporation. * Lotus and 1-2-3 are registered trademarks of Lotus Development Corporation. * dBASE III PLUS is a registered trademark of Ashton-Tate. XENIX is a registered trademark of Microsoft Corporation. * VP/ix is a trademark of INTERACTIVE Systems, Inc. * 1,rx is a registered trademark and SCO Professional is a trademark of The Santa Cruz Operation, Inc. * FoxBASE+ is a trademark of Fox Software, Inc. 10/87 ©1987 The Santa Cruz Operation, Inc., 400 Encinal Street, P.O. Box 1900, Santa Cruz, CA 95061 The Santa Cruz Operation, Ltd., 18 Noel Street, P.O. Box 4YN, London W1A 4YN United Kingdom. +44 1 439 2911, (FAX): +44 1 637 9381, TELEX: 91732 scops

eral printers to print multiple files (up to 254). You can run the program either from the command line or from a set of conventional DRI function-key menus. Files that are sent to print are each assigned a job number and placed in a queue for processing. The job number can subsequently be used to remove the file from the queue, and the job queue itself can be suspended or erased by the Printer Manager. If you wish, you can specify a variety of options, such as num-

ber of copies, format, margin, and tab length, when you send a file to the printer.

DR EDIX is the editor supplied with Concurrent DOS 386. It is a general-purpose WYSIWYG editor that permits up to four files to be worked on at one time, although you can view only two in the program's two screen windows. An on-line tutorial is provided, as well as four help screens. It amused me to read in the user's guide the suggestion that DR

EDIX is equivalent to DOS's EDLIN facility. While DR EDIX is a basic editor, it is a sleek Maserati compared to EDLIN's staid Model T.

The Cardfile program that comes with Concurrent DOS 386 is a name and address filer that lets you maintain a set of electronic index cards that hold all the usual information about business associates. I was unimpressed with this program because of its limited field size (the business name is limited to 20 characters and the address to 24 characters) and its maddening interface. Specifically, the cursor automatically advances to the next field once the current field is full, and (short of applying grease pencil to your monitor) there is no way to tell how close to the end of the business or address field you are. If you overstep, you must endlessly tap cursor keys to get to where you can make the previous field fit; the Home and End keys are ineffectual.

Using Concurrent DOS 386

For the most part, Concurrent DOS 386 acts the way a proper operating system should and stays out of sight to let you run your applications. Out of the box and freshly installed, the package let me run Word 3.1 in one window, Micro Logic's Tornado Notes 1.8 in another, DRI's File Manager in a third, and Microsoft's Multiplan 1.06 in a fourth. Although there was a perceptible slowdown in Word's performance, it was acceptable. Other programs that ran successfully under Concurrent DOS 386 included Turbo Pascal 4.0, Turbo Prolog 1.1, Framework 1.1, SideKick 1.56A (in conjunction with DOS.COM), and Command Plus.

The Wmenu utility lets you determine the shape, placement, and colors used in each of the four windows available on the console. Another useful utility is Stop, which you can invoke to specifically stop a particular program in a specified window, or to show general system statistics regarding what programs are running and how much of which type of memory remains free.

As I became more comfortable with Concurrent DOS 386, I discovered a number of commands that can optimize program performance, such as MEMSIZE, LIMSIZE, BANK, and SUSPEND. You can use MEMSIZE to restrict the amount of memory allocated to executable files (DOS .EXE or .COM or Concurrent DOS 386 .CMD files). LIMSIZE restricts the amount of LIM (Lotus/Intel/Microsoft) expanded memory allocated to a program. The BANK command controls how a program executes in banked memory.

continued

Everything you see here...

12 MHz 80286
AT-Compatible
1Mb on-board DRAM
Full set of AT-compatible controllers
EGA, MDA, Hercules video
HD/FD controllers
and more

you see here.
THE LITTLE BOARD™/286

Big power for smaller systems.

Little Board/286 is the newest member of our family of MS-DOS compatible Single Board Systems. It gives you the power of an AT* in the cubic inches of a half height 5¼" disk drive. It's a complete AT-compatible system that's functionally identical to the 5-board system above. And it runs all AT software.

Ideal for embedded applications. Its low power requirement, wide operating temperature range, solid-state disk support and tiny form factor make Little Board/286 perfect for embedded applications and harsh environments: controllers, data acquisition, instruments, telecomm, workstations... anywhere small size and complete AT hardware/software compatibility are important.

Better answers for OEMs. Little Board/286 is not only a smaller answer, it's a better answer... with the packaging flexibility, low power, I/O capabilities and pricing OEMs need. For information and the name of your nearest U.S. or international Ampro rep, call us today. Or, write for Little Board/286 product literature.

Compare features. Both systems offer:

- 8 or 12MHz versions
- 512K-1Mbyte on-board DRAM
- 80287 coprocessor option
- AT-compatible controllers and bus expansion
- Floppy disk controller
- EGA/CGA/Hercules/MDA video options
- 5.75" x 8" form factor
- SCSI device support: Hard disk, tape bubble drives, etc.
- Two byte-wide sockets for on-board solid-state disk support
- Single voltage (+5 VDC only, 8W power consumption)
- 0-70°C operating range

*AT is a Registered Trademark of IBM Corp.

408-734-2800

Fax: 408-734-2939 TLX: 4940302

AMPRO
COMPUTERS, INCORPORATED
1130 Mountain View/Alviso Road
Sunnyvale, CA 94089

Reps: Australia-61 3 720-3298; Belgium-32 87 469012; Canada-(604) 438-0028; Denmark-45 3 66 20 20; Finland-358 0 585-322; France-331 4502-1800; Germany, West-49 89 611-6151; Israel-972-3 49-16-95; Italy-39 6 811-9406; Japan-81 3 257-2630; Spain-34 3 204-2099; Sweden-46 88 55-00-55; Switzerland-41 1 740-41-05; United Kingdom-44 2 964-35511; USA, contact AMPRO.

UNLEASH YOUR 80386!

Your 80386-based PC should run two to three times as fast as your old AT. This speed-up is primarily due to the doubling of the clock speed from 8 to 16 MHz. The new MicroWay products discussed below take advantage of the real power of your 80386, which is actually 4 to 16 times that of the old AT! These new products take advantage of the 32 bit registers and data bus of the 80386 and the Weitek 1167 numeric coprocessor chip set. They include a family of MicroWay

80386 compilers that run in protected mode and numeric coprocessor cards that utilize the Weitek technology.

The benefits of our new technologies include:

- An increase in addressable memory from 640K to 4 gigabytes using MS-DOS or Unix.
- A 12 fold increase in the speed of 32 bit integer arithmetic.
- A 4 to 16 fold increase in floating point

speed over the 80387/80287 numeric coprocessors.

Equally important, whichever MicroWay product you choose, you can be assured of the same excellent pre- and post-sales support that has made MicroWay the world leader in PC numerics and high performance PC upgrades. For more information, please call the Technical Support Department at

617-746-7341

After July 1988 call 508-746-7341

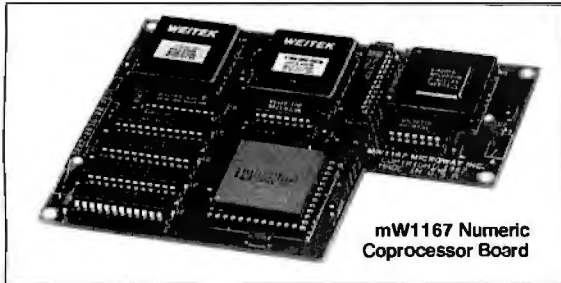

MicroWay® 80386 Support

MicroWay 80386 Compilers

NDP Fortran-386 and **NDP C-386** are globally optimizing 80386 native code compilers that support a number of Numeric Data Processors, including the 80287, 80387 and mW1167. They generate mainframe quality optimized code and are syntactically and operationally compatible to the Berkeley 4.2 Unix i77 and PCC compilers. MS-DOS specific extensions have been added where necessary to make it easy to port programs written with Microsoft C or Fortran and R/M Fortran.

The compilers are presently available in two formats: Microport Unix 5.3 or MS-DOS as extended by the Phar Lap Tools. MicroWay will port them to other 80386 operating systems such as OS/2 as the need arises and as 80386 versions become available.

The key to addressing more than 640 kbytes is the use of 32-bit integers to address arrays. NDP Fortran-386 generates 32-bit code which executes 3 to 8 times faster than the current generation of 16-bit compilers. There are three elements each of which contributes a factor of 2 to this speed increase: very efficient use of 80386 registers to store 32-bit entities, the use of inline 32-bit arithmetic instead of library calls, and a doubling in the effective utilization of the system data bus.

An example of the benefit of excellent code is a 32-bit matrix multiply. In this benchmark an NDP Fortran-386 program is run against the same program compiled with a 16-bit Fortran. Both programs were run on the same 80386 system. However, the 32-bit code ran 7.5 times faster than the 16-bit code, and 58.5 times faster than the 16-bit code executing on an IBM PC.

NDP FORTRAN-386™\$595
NDP C-386™\$595

MicroWay Numerics

The **mW1167™** is a MicroWay designed high speed numeric coprocessor that works with the 80386. It plugs into a 121 pin "Weitek" socket that is actually a superset of the 80387. This socket is available on a number of motherboards and accelerators including the AT&T 6386, Tandy 4000, Compaq 386/20, Hewlett Packard RS/20 and MicroWay Number Smasher 386. It combines the 64-bit Weitek 1163/64 floating point multiplier/adder with a Weitek/Intel designed "glue chip". The mW1167™ runs at 3.6 MegaWhestones (compiled with NDP Fortran-386) which is a factor of 16 faster than an AT and 2 to 4 times faster than an 80387.

mW1167 16 MHz\$995
mW1167 20 MHz\$1595

Monoputer™ - The INMOS T800-20 Transputer is a 32-bit computer on a chip that features a built-in floating point coprocessor. The T800 can be used to build arbitrarily large parallel processing machines. The Monoputer comes with either the 20 MHz T800 or the T414 (a T800 without the NDP) and includes 2 megabytes of processor memory. Transputer language support from MicroWay includes Occam, C, Fortran, Pascal and Prolog.

Monoputer T414-20 with 0 meg¹ ... \$995
Monoputer T800-20 with 0 meg¹ ... \$1495

Quadputer™ can be purchased with 2, 3 or 4 transputers each of which has 1 or 4 megabytes of memory. Quadputers can be cabled together to build arbitrarily fast parallel processing systems that are as fast or faster than today's mainframes. A single T800 is as fast as an 80386/mW1167 combination!

Biputer™ T800/T414 with 2 meg¹\$3495
Quadputer 4 T414-20 with 4 meg¹ ... \$6000

¹Includes Occam

80386 Multi-User Solutions

AT8™ - This intelligent serial controller series is designed to handle 4 to 16 users in a Xenix or Unix environment with as little as 3% degradation in speed. It has been tested and approved by Compaq, Intel, NCR, Zenith, and the Department of Defense for use in high performance 80286 and 80386 Xenix or Unix based multi-user systems.

AT4 - 4 users\$795
AT8 - 8 users\$995
AT16 - 16 users\$1295

Phar Lap™ created the first tools that make it possible to develop 80386 applications which run under MS-DOS yet take advantage of the full power of the 80386. These include an 80386 monitor/loader that runs the 80386 in protected linear address mode, an assembler, linker and debugger. These tools are required for the MS-DOS version of the MicroWay NDP Compilers.
Phar Lap Tools\$495

PC/AT ACCELERATORS

287Turbo-10 10 MHz\$450
287Turbo-12 12 MHz\$550
287TurboPlus-12 12 MHz\$629
FASTCACHE-286 9 MHz\$299
FASTCACHE-286 12 MHz\$399
SUPERCACHE-286\$499

MATH COPROCESSORS

80387-20 20 MHz\$725
80387-16 16 MHz\$475
80287-10 10 MHz\$295
80287-8 8 MHz\$239
80287-6 6 MHz\$155
8087-2 8 MHz\$154
8087 5 MHz\$99

MicroWay

The World Leader in PC Numerics
P.O. Box 79, Kingston, Mass. 02364 USA (617) 746-7341
32 High St., Kingston-Upon-Thames, U.K., 01-541-5466
St. Leonards, NSW, Australia 02-439-8400

Benchmark Results: *A single task took about the same time under Concurrent DOS 386 as it did under MS-DOS.*

	Number of operating programs	Time (seconds)	Comparison to DOS performance (percent)
ALR MS-DOS 3.3	1	32	100
Concurrent DOS 386	1	32	100
	2	72	44
	3	109	29
	4	144	22

Note: SUSPEND was set to OFF in all windows.

If BANK is ON, then the program can be paged in and out of memory; otherwise, the memory taken by the program is no longer available for paging. The SUSPEND command is used either to cause a program that's in the background to execute or to prevent it from doing so. Typically, any program that spends a lot of time waiting for user input should have SUSPEND=ON set before being invoked.

So as not to continually have to issue these commands, there is the Pifed utility

that lets you create or modify Concurrent program information embedded in .EXE and .COM files. Concurrent DOS 386 uses this information to allocate the proper amount of memory for a program, to prevent corruption of interrupt vectors, and to keep other processes from accessing devices that are being directly manipulated. My only complaint about this whole gamut of commands and programs is that it requires some time to become familiar with them.

Comparable Performance

With the minimum 512K bytes of memory in your system, it's not much of an exaggeration to say that about all you can do is sit and admire the system prompt. Unlike DOS, which is relatively small, Concurrent DOS 386 takes up about 200K bytes of the address space available to the typical DOS task. Consider that memory above 640K bytes is pretty much off limits to DOS applications, which leaves about 440K bytes per application running under Concurrent DOS 386. You can adjust this figure somewhat by invoking the Setup utility and enabling 16K-byte chunks of high memory past the 640K-byte address for Concurrent DOS 386 buffers and so forth. However, making these adjustments requires a good working knowledge of what's going on inside your 80386 system, and the added available memory may not be worth the effort. Taking the figure of 440K bytes as a rough measure, 1 megabyte of memory installed in addition to the 640K bytes of base memory gives Concurrent DOS 386 the ability to handle three full-size tasks like Word or Multiplan.

continued

A MESSAGE TO OUR SUBSCRIBERS

FROM TIME TO TIME WE MAKE the BYTE subscriber list available to other companies who wish to send our subscribers material about their products. We take great care to screen these companies, choosing only those who are reputable, and whose products, services, or information we feel would be of interest to you. Direct mail is an efficient medium for presenting the latest personal computer goods and services to our subscribers.

Many BYTE subscribers appreciate this controlled use of

our mailing list, and look forward to finding information of interest to them in the mail. Used are our subscribers' names and addresses only (no other information we may have is ever given).

While we believe the distribution of this information is of benefit to our subscribers, we firmly respect the wishes of any subscriber who does not want to receive such promotional literature. Should you wish to restrict the use of your name, simply send your request to the following address.

BYTE MAGAZINE

ATTN: SUBSCRIBER SERVICE
P.O. Box 7643
TEANECK, NJ 07666-9866



FACT:

"JPI MODULA-2 IS A 'LANDMARK' PRODUCT. THE PROGRAMMING ENVIRONMENT IS BETTER THAN ANYTHING ON OFFER FROM BORLAND OR MICROSOFT."

—Huw Collingbourne, Computer Shopper

The successor of Pascal:
JPI TopSpeed™ Modula-2
produces better code than
Microsoft C, Turbo C,
Logitech Modula, and
Turbo Pascal 4.0.

JPI TopSpeed Modula-2 is a professional Modula-2 development system with full support of memory models, multi-tasking, long data types, structured constants, long and short pointers, 80X87 inline code and emulator, separate compilation, direct BIOS/DOS calls etc. The comprehensive library includes CGA, EGA and VGA graphics support, math functions, sorting, file handling, window management and more. Here is what our users say:

The Compiler Kit includes: High-speed optimizing compiler, integrated menu-driven environment with multi-window/multi-file editor, automatic *make*, fast smart linker. All Modula-2 sources to libraries included. **Bonus:** Complete high-speed window management module included with source.

The TechKit includes: Assembler start-up source code for system, JPI TopSpeed Assembler, TSR module, communications drivers, PROM locator and technical information.

Systems requirements: IBM PC or compatible, 384K available RAM and two floppy drives (hard disk is recommended).

To become part of the excitement, make use of our limited-time introductory price of \$59.95 (after July 4, 1988: \$99.95). 30 days unconditional money-back guarantee.

TO ORDER:
In US & Canada only:
Call 1-800-443-0100.
Ext 255, 24 Hours.
Or mail in the coupon or a letter.



The editor, optimizing compiler, super-fast linker, and automatic make are all seamlessly integrated into a high performance development environment.

"JPI Modula-2 is the Modula-2 we have all been waiting for. JPI Modula-2 will do for Modula-2 what Turbo Pascal did for Pascal."

—K N King
Author of Modula-2:
A Complete Guide

"The code generation is awesome, truly amazing. This is an M2 implementation that swings like Grieg music."

—Bjoern
University of Bergen



Jensen & Partners International
1101 San Antonio Rd., Suite 301
Mountain View, CA 94043
Phone: (415) 967-3200

In England and Europe contact:
Jensen & Partners UK Ltd., 63 Clerkenwell Rd., London EC1M 5NP. Phone: (01) 253-4333. In England call Free Phone 0800 444-143, 24 Hours. Compiler Kit £59.95, TechKit £29.95 (introductory offer only valid in the US).

TopSpeed is a trademark of Jensen & Partners International. Other brand and product names are trademarks or registered trademarks of their respective holders.

Circle 132 on Reader Service Card

Yes, I want to own the compiler that makes the best code. Please rush me:

Compiler Kit \$59.95 (after July 4, 1988: \$99.95) Please add \$5 shipping and handling.

TechKit \$49.95
SEND TO: Jensen & Partners International, 1101 San Antonio Rd., Suite 301, Mountain View, CA 94043
Name: _____
Address: _____
City/State/Zip: _____
Credit Card # _____
Exp. Date _____
 Visa MC Check

The Quick Route to QuickC™ Mastery

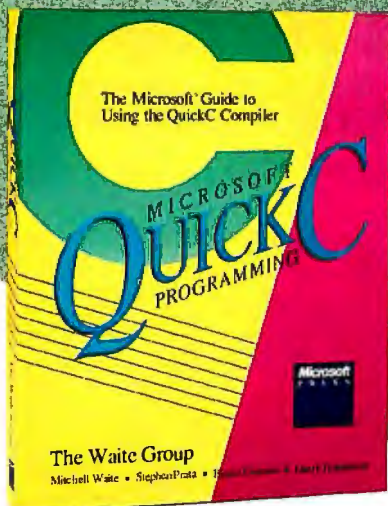

Whatever your programming language or environment—now's the time to discover the Microsoft QuickC compiler. MICROSOFT QUICKC PROGRAMMING—your springboard to the core of this hot new compiler. This book is loaded with practical information and advice on every element of QuickC, along with dozens and dozens of specially constructed listings.

With MICROSOFT QUICKC PROGRAMMING you have the tools to: master QuickC's built-in libraries ■ manage file input and output ■ work creatively with strings, arrays, pointers, structures, and unions ■ use the graphics modes and the built-in graphics library ■ develop and link large C programs ■ and debug your source code.

Your one essential reference. And it's authoritative. From The Waite Group—acknowledged C experts. **\$19.95**

Microsoft® Press Hardcore Computer Books

Available wherever books and software are sold.

Or call in your credit card order. 800-638-3030 (In MD 824-7300). Refer to ad BM78.

Book Code 86-96114.

The BYTE Lab ran the benchmark tests on an ALR FlexCache 386. It was equipped with 2 megabytes of RAM and Phoenix BIOS version 1.00 04.

Concurrent
DOS offers multiuser
support while
Windows/386 does not.

The benchmark program that the lab used to test the speed of Concurrent DOS 386 was the same one used to test Windows/386 (see "Microsoft Windows 2.03 and Windows/386" by Namir Clement Shammas in the May BYTE). This test runs a program that performs integer arithmetic in a FOR-DO loop in each window. The results of running the primary program are shown in the table on page 168. Generally, Concurrent DOS 386 ran a single task in about the same time as did MS-DOS. However, the execution speed of a program under Concurrent DOS 386 is roughly inversely proportional to the number of tasks being executed.

Based on the compute-intensive benchmark tests, Concurrent DOS 386 fared well compared to MS-DOS. In fact, the overhead for running BYTE's benchmark tasks, again compared to MS-DOS, is less than that for Microsoft Windows/386, although as the number of programs increases, Concurrent DOS 386's comparative performance deteriorates. Also, Concurrent DOS 386 proved to be as much as nearly twice as fast as MS-DOS when handling video I/O, and it provides multiuser support while Windows/386 does not.

Much hoopla has been directed up the road, where bigger and better operating systems for the 80386 are expected to roll some time in the future. Concurrent DOS 386 is a multitasking *and* multiuser operating system that is here today and ready to go. And even though it's not the only choice for multitasking alone, the fact that it is a complete operating system may make Concurrent DOS 386 the best choice. ■

Alex Lane is a knowledge engineer with Technology Applications, Inc., in Jacksonville, Florida. He can be reached on BIX as "a.lane."

NEW!

TOOLKITS FOR TURBO C & QUICK C from ZORTECH INC.

HOTKEY

A complete set of Terminate Stay Resident (TSR) functions that help you to write reliable 'pop-up' programs.

Now you can make your programs 'Sidekickable'. Two example programs are included, a 'pop-up Calculator' and a pop-up 'Critical Error Handler'.

The Hotkey toolkit handles all floating point functions in resident mode.

The 32 page manual includes an interesting discussion of the origin and history of undocumented MS-DOS function calls, together with a full explanation of the theory and practical use of TSR's.

Only \$49.95! (State Turbo C or Quick C version.)

COMMS

Do you need to incorporate serial communications into your applications? Yes! Then get this inexpensive but highly professional COMMS toolkit from Zortech Inc.

Look at the list of features: Xmodem, Kermit and ASCII file transfer, Hayes modem control, VT52, VT100 and ANSI terminal emulation, supports up to 8 serial ports, speeds up to 19.2k baud rate and higher.

Two demonstration programs are included, MINICOM and MAXICOM (like Procomm) together with the 120 page manual and full source code FREE!

Only \$49.95! (State Turbo C or Quick C version.)

GAMES

Have you ever wondered how to write a chess program? Now we reveal the secret algorithms and techniques of the masters with this dynamic Games toolkit.

The package comes complete with the full source code to three ready to play games of strategy - Chess, Backgammon and Wari (an ancient African game).

A comprehensive 150 page manual is provided giving an in depth look at the history, structure and program design of such 'Strategy Games'.

Only \$49.95!

(State Turbo C or Quick C version.)

SUPERTEXT

This is not simply an 'Editor' toolkit, but a full-blown, 'WordStar' compatible wordprocessor with the full source code.

As well as all the normal editing functions, you will also find 'dot' commands and full printer control. The SuperText toolkit handles files of any size and allows full on-screen configuration.

Do you need to incorporate a wordprocessor into your application? Yes! Then get the SuperText toolkit complete with full source code and 150 page manual now!

Only \$49.95! (State Turbo C or Quick C version.)

PROSCREEN

Generate high quality data entry screens with the Pro-Screen - Screen Designer and Code Generator.

You can draw the data entry screen, define the input fields, define the input criteria, set screen colors and attributes, draw single or double lines, make boxes - press a few buttons and 'hey presto' Pro-Screen generates the C source code for your application!

Professional applications programmers will find this versatile utility and it's associated functions invaluable.

Comes complete with a substantial 78 page manual and demo programs.

Only \$49.95! (State Turbo C or Quick C version.)

ONLY
\$49.95
EACH

WINDOWS

Add super-fast text screen handling to your applications with the WINDOWS library from Zortech Inc.

Give your applications the professional look - with instant zooming and exploding windows. Incorporate drop-down menus and Lotus style menus with our easy to use functions.

Automatically handles memory saving and buffering of window text. Use any number of overlapping windows in your applications. Write to any window, read from any window, close any window, pull any window to the top.

Over 55 functions together with a big 85 page manual and remember, you get the full source code.

Only \$49.95! (State Turbo C or Quick C version.)

NEW! C VIDEO

- Now learn C the easy way!
- Get the 'Complete C Video Course' from Zortech Inc. together with our big 365 page workbook.
- Ten 1 hour tapes - 36 lessons!
- Easy to follow course, you get an excellent introduction to the C language.
- Takes you step-by-step up to the intermediate and advanced levels.
- Teach yourself at home or the office - at your own speed.

only ~~\$285.00~~ **\$199.95**

Yes!
Rush me
these items!

HOTKEY
 COMMS
 PRO-SCREEN

WINDOWS GAMES
 SUPERTEXT C VIDEO

FREE SHIPPING - VISA/MC/COD/CHECK

Name

Address

Phone

VISA or MC# Exp. Date

ZORTECH Inc. 366 Massachusetts Ave, Arlington, MA 02174
Orders & Enquiries Tel: (617) 646 6703

ORDER HOTLINE 800-848-8408

Circle 285 on Reader Service Card

ZORTECH
LONDON BRISTOL GENEVA

Turbo C is the trademark of Borland Inc. Quick C is the trademark of Microsoft Inc.





Which would you like to see first? The world's fastest dBASE compiler or the most powerful database development language?

Surprise. Now you get both in the same package. New Clipper™ from Nantucket.*

Our latest version — Summer '87 — is still the best-performing compiler ever. It lets users run dBASE® applications up to 20 times faster. But there's a lot more to it than raw speed.

Because new Clipper is one of the most powerful, full-featured development languages ever. And gives you more control over your applications than any release of dBASE ever will. Now or in the future.

Instead of designing Clipper as an add-on, we've structured it as an extended database language that uses dBASE as a subset. In addition to emulating the dBASE language, we've added commands for menus, screens, windows and extended functions. As a result, you get dBASE compatibility and an entirely new level of power and versatility.

And with Clipper's open architecture, you can write functions in Clipper, C, Assembler or other languages, and integrate them into one seamless application. Which helps you create more sophisti-

cated applications in less time. And by using our full-featured debugger, you'll be done even faster.

We also give you source code security that keeps users from damaging your application. And sophisticated record and file locking capabilities that make networking applications easier to create. But no matter what you create, you don't have to buy runtime modules or additional software. You don't even have to pay licensing fees.

If you haven't tried Clipper yet, just call (213) 390-7923 today. We'll send you full information and a free demo diskette. Or the complete program, if you'd rather.

But call today. And see how easy it is to find the best dBASE development language. Just get the fastest compiler. And open the box.

Clipper™

Nantucket, 12555 W. Jefferson Boulevard
Los Angeles, CA 90066 Telex: 650-2574125



© Nantucket Corporation, 1988. Nantucket is a registered trademark and Clipper is a trademark of Nantucket Corporation. dBASE is a registered trademark of Ashton-Tate.



A Supercharger for BASIC Compilers

Over 200 ways to add
speed and power
to Microsoft BASIC

Namir Clement Shammas

ProBas 2.0 is a \$99 collection of over 200 subroutines callable from BASCOM or QuickBASIC programs. Many of the subroutines enable you to tap into the hardware and operating system in ways not afforded by the BASIC language itself; others provide enhanced or speeded-up versions of built-in BASIC routines.

The programs are, for the most part, coded in assembly language and compiled to .OBJ format according to Microsoft conventions for library files. You can integrate them into your programs at link time (when using BASCOM or the compiler of QuickBASIC). ProBas 2.0 works with all BASCOM versions and QuickBASIC 1.0 to 4.0.

Considering the advances made in QuickBASIC 4.0, in particular, the ProBas routines are remarkably compatible with the various levels of compilers from Microsoft. The only areas where you have to use caution are with arrays and communications.

In QuickBASIC 4.0, so-called static arrays are, in fact, dynamic internally: Their location in memory can change during execution of a program. This necessitates a little caution; you may as well declare all arrays dynamic if you intend to pass arrays to external routines such as those from ProBas. A known bug in 4.0 causes QuickBASIC to write zeros to the communications ports during certain initialization conditions such as exiting to the shell; this can lead to problems when you use the communications libraries.

However, in both cases (communications and arrays), ProBas documentation provides the needed workarounds.

A Taste of ProBas

Table 1 lists all the ProBas library routines, arranged by category and alphabetized within categories. Space limitations preclude me from explaining every one, but the library name typically provides a clear indication of the routine's purpose.

Among the most useful routines are those that assist you in setting or querying your hardware and operating system. Thus, you can detect the amount of base, expanded, and extended memory; query the computer and processor/coprocessor types (80x86/80x87); obtain disk space information; query the video display type; and request information about communication status and parameters.

Memory management routines include sorting indexed and unindexed arrays, string to integer-array copy and its inverse, and storing and recalling arrays in expanded memory. ProBas provides two routes to accomplish the latter function. The first family of routines allocates space in the expanded memory area, writes and reads array elements, and deallocates the memory area. To store or recall an element from expanded memory, you employ a Call subroutine and use a memory handle and an array-like index. The second family of routines resembles file I/O routines and transfers data between the expanded memory and entire arrays.

ProBas offers a collection of routines that quickly save, recall, and swap screens. The routines are very flexible. First, you are able to save and recall entire or partial screens to arrays (ideal for creating windowing applications). ProBas permits you to specify the video page number saved, so you are not tied to the visible page number 0 in a CGA or EGA monitor. The second feature is the ability to handle resizable virtual screens (areas of user RAM that operate like the video

memory but are under your own control)—this is also good for windowing applications. In addition, ProBas provides a special version of the screen recall/store routines that can handle screens of any dimension. The third feature is the ability to store and recall a text screen in graphics mode using an array to store the screen image. The ProBas routines handle only text screens.

Putting some speed into screen output requires the ability to write directly to the video display. The BASCOM and QuickBASIC compilers still use calls to the BIOS in compiling print and print using statements. ProBas provides two sets of direct-to-memory screen output routines: one for any video page and the other for the virtual screen. The `xqprint` routine replaces print with the ability to put strings on the screen. The arguments of this subroutine include the cursor location, video page number, display attribute (to control the foreground and background colors), and screen mode. A variation of `xqprint` exists to display a string at a specified screen location using the existing display attributes. Other versions of `xqprint` permit you to write to medium- and high-resolution screens. In addition to writing in text mode, ProBas provides routines to write characters to graphics screens (e.g., large characters used to create eye-catching titles).

A third collection of screen-related subroutines offer support for windows. ProBas offers a couple of routines that let you create windows in which you can place, insert, and delete text in them. You can create windows with titles, exploding effects, and optional shadows. The demonstration program quickly displays 300 colored windows.

For the applications that need to query the files in a directory, ProBas offers a family of related routines. They enable you to obtain the names of the files that match wild cards and specific file attributes. ProBas uses the DOS calls to find

continued

Table 1: Routines included in ProBas, listed alphabetically by category.

Communication	getfattr setcomm	Input	checkkey clrkbd getkbd getkey setkbd sinput sinputset	Mouse	stripchar striprange tinstr upcase xlate	getvidmode gqprint grafprint grafrest grafsave gxqprint inschr insline lscroll mdelchr minschr mprint mwindow printscreen putscreen qprint recolor recolorarea resetpoint rscroll scr2file scr2filess scroll scrrest scrsave scrunch setpixel setpoint setrows testpixel testpoint unscrunch vgetscreen vgetscreens vputscreen vputscreens windowmanager xmprint xqprint
Data Conversion	any2dec date2int daten2s dates2n dec2any doub2long int2date int2time long2doub time2int timen2s times2n	Keyboard	dosinkey getvalidkey keypress	Sort	Time	
Disk	copyfile delfile delsub dfread dfwrite diskstat drvspace drvspacel exist fclose fcreate fgetloc findfirstf findnextf fopen fread fsetend fsetloc fsetofs fsetrec fsize fwrite getattrf getdatef getdrv	Miscellaneous	addmati blockmove breakoff carrier checksum crc crc2 dataseg ddostasks delay delay18th dgetrec dputrec dtr dynptr prtcheck prtswap readbitf reverseptr seterror setmati shiffl shiftr shiftrl speaker	String	Video	
	Equipment					
	Expanded Memory					

the first and next matching files. Other routines enable you to obtain the file size, the time and date stamps, and the attribute. These ProBas routines are a welcome addition to a BASIC programmer's toolbox.

In the category of subroutines that provide improved versions of predefined BASIC routines are the ProBas file I/O routines. While these routines pass information via integer-typed arrays, they offer a form of file I/O that is available in C and Pascal. This includes the ability to read a specified number of bytes; query and set the file pointer; and directly handle file I/O errors by returning numeric error codes.

In the area of console input, the ProBas library offers routines that enhance user input. The highlight of this set of

routines is one that provides a one-line editor with Microsoft and WordStar editing commands. Another routine waits until you enter a single character from a list of valid characters. This is appropriate for menus, letting you select options with a single keystroke.

Another interesting set of subroutines provides support for mouse input devices. They enable an application to check the status of the mouse buttons, to count the number of times you click the mouse buttons, to set and query the mouse cursor, and to define the valid window area for the cursor. These routines empower you to write highly interactive applications.

Error-handling of the subroutines appears to be quite robust. For instance, I experienced a program crash while using

one of the expanded-memory library routines—apparently due to my use of a nonstandard extended memory driver. Upon crashing, ProBas didn't hang the system. Instead, it presented me with an error message and the opportunity to make a graceful exit from the program.

How Fast?

I wrote a number of BASIC programs to test the speed of a few routines. I then performed these tests on an IBM AT with an Intel Inboard 386 running at 16 MHz. The system has 640K bytes of basic RAM and a 2-megabyte RAM disk running under PC-DOS 3.1. An 80387 numeric coprocessor was present, but I did not use it in the testing, since the data manipulated was either integers or characters. I

continued



Leprecard



Leprecards feature components utilizing the latest technology from Seagate & Western Digital. You get a 1 year warranty, & illustrated user's guide. Low power drives mean less strain on the power supply, lower operating temperatures, and longer component life.

FREE SOFTWARE Including **TakeTwo**, the backup utility. PC MAGAZINE Editor's Choice in 1986 & 1987, & PC-KWIK disk cache software from Multisoft.

21MB 85ms \$299	32MB 65ms \$349	32MB 40ms \$389	40MB 70ms* \$449	49MB 28ms* \$549
---------------------------	---------------------------	---------------------------	----------------------------	----------------------------

*Average access speed per partition
TANDY 1000/A/SX/TX Leprecards add \$20

3.5" Floppy Kits



Instant Laptop & PS/2 compatibility. All kits include bracket to mount in 5 1/4" drive bay, black & grey face plates, and AT rails.

Now included: **TakeTwo**, the backup utility PC MAGAZINE named as their Editor's Choice.

\$119 720K Internal for PC/XT/AT Requires DOS 3.2 or optional \$19 driver software.	\$149 1.44 MB Internal for AT only. Includes driver software.	\$249 1.44MB Internal for PC/XT. Includes high speed floppy Controller & cables. Supports two drives.
---	---	---

PC/XT Disk Kits

- Pretested & formatted
- Western Digital short controller
- 30 page installation guide & reference manual
- Cables, mounting screws, full & half-height face plates
- TakeTwo** backup software, PC MAGAZINE "Editor's Choice"
- PC-KWIK** disk cache software by Multisoft
- 1 year Warranty, 30 day Money Back Guarantee
- Optional: 150 watt, UL/FCC approved power supply for IBM PC's **\$69**



TANDY 1000 kits add \$20

20MB kit Seagate ST225 21.4MB/65ms/Half-Height/14.8watts	\$289
30MB kit Seagate ST238 32.7MB/65ms/Half-Height/14.8watts	\$329
40MB kit Seagate ST251 42.8MB/Half-Height/11 watts pre-formatted into a pair of 21MB/28ms partitions	\$459
65MB kit Seagate ST277R 65.5MB/Half-Height/11 watts pre-formatted into a pair of 32MB/28ms partitions	\$549

286¹⁰ Computer

80286 processor at running at 6/10 Mhz with 0 wait states provides a Norton SI rating of 11.5. 8 slots - Room for 1 full height and 3 half - height drives - 200 watt power supply - Clock calendar - Choice of 1.2 or 1.44MB floppy drive - Combination Hard Disk/Floppy drive controller - Maxiswitch 84 or 101 key Keyboard - 512K RAM standard expandable to 1 MB - Award BIOS - 1 year warranty - 30 day money back guarantee.



\$895

COMPLETE SYSTEMS:

Mono/Graphics card & Tilt/Swivel Monitor	\$1095
as above with 65MB Seagate Hard Disk	\$1549
Orchid Designer VGA & NEC Multisync II	\$1995
as above with 65MB Seagate Hard Disk	\$2449

1.5 MB Laser Printer

"One of the Laserjet's strongest competitors."
INFOWORLD October 5, 1987



\$1595

- 100% HP Laserjet, & Laserjet + compatible
- 1.5MB RAM Gives Full Page 300dpi graphics
- Vector graphics capability improves speed on programs like Autocad up to 93%
- 9 resident & 5 downloadable soft fonts standard
- Printer utility software
- Serial & Parallel Interfaces
- 120 day TRW on site maintenance
- 1 year Warranty
- Options: All HP style font cartridges
Toner Cartridge **\$29**

AT Hard Disk Kits

- Includes IBM AT rails & cables
- SpeedStor** or **OnTrack** large drive software
- Formatted, Partitioned & Tested

Size	Model	Speed	Capacity	Price
HH	Seagate ST251	40ms	42.8MB	\$399
HH	Seagate ST251-1	30ms	42.8MB	\$489
FH	Seagate ST4096	28ms	80.2MB	\$749
FH	Micropolis 1333	30ms	44MB	\$555
FH	Micropolis 1335	28ms	71MB	\$699
FH	Maxtor 1140	27ms	117MB	\$1669

Orchid

Designer VGA 1024x768	\$299
Tiny Turbo 286	\$289
Twin Turbo	\$409

1200 Modem

- 300 or 1200 bps speed
- Hayes Smartcom II compatible
- Line-busy detect, auto redial
- FREE MIRROR II software
- Made in USA, 1 year warranty



\$69

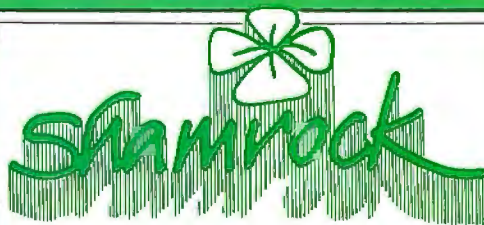

Toll Free 800-722-AT-XT California 805-373-7847

FAX 805-379-9345

2524B Townsgate Road, Dept. B
Westlake Village, CA 91361

- No extra for Visa/Mastercard (AMEX add 3%).
- Prices include UPS surface shipping.
- Federal Express shipping just \$1.50 per pound.
- 30 Day Money Back Guarantee.
- Corporate & Institutional PO's accepted.

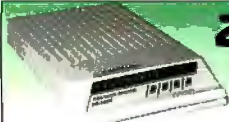

2400 MNP Modems

\$239/\$229

- Hayes Compatible, 300/1200/2400
- MNP level 4 error correction
- FREE MIRROR II** Software, a \$69 value
- Internal model \$229, fits in short slot

2400 without MNP \$179 Ext \$149 Int

Subscription Problems?



We want to help!

If you have a problem with your BYTE subscription, write us with the details. We'll do our best to set it right. But we must have the name, address, and zip of the subscription (new and old address, if it's a change of address). If the problem involves a payment, be sure to include copies of the credit card statement, or front and back of cancelled checks. Include a "business hours" phone number if possible.

BYTE

Subscriber Service
P.O. Box 7643
Teaneck, NJ 07666-9866



ProBas 2.0

Type

Library for Microsoft BASIC compilers

Company

Hammerly Computer Services, Inc.
8008 Sandy Spring Rd.
Laurel, MD 20707
(301) 953-2191

Format

Two 5¼-inch double-sided, double-density disks

Language

Assembly

Hardware Needed

IBM PC, XT, AT, PS/2, or compatible with a hard disk drive

Software Needed

PC-DOS or MS-DOS 2.0 or higher (3.0 is recommended); BASCOM compilers (all versions) or QuickBASIC (all versions)

Documentation

602-page manual

Price

\$99

Inquiry 896.

then used the QuickBASIC 4.0 command-line compiler (BC.EXE) and linker to compile and link the test programs. The benchmark programs were a sorting test, a screen recall test, and a direct screen output test. [Editor's note: *Listings for the four benchmark programs (filenames pbsort.bas, pbqsort.bas, pbsern.bas, and pbprt.bas) are available in a variety of formats. See page 3 for further details.*]

For the sorting test, I wrote two programs to test the `1ptrsort` subroutine used to perform indexed sorting on an array of integers. The first program, `pbsort.bas`, compared the speed of `1ptrsort` with the Shell method coded in BASIC. The second program, `pbqsort.bas`, compared the same ProBas routine with the recursive QuickSort methods written in BASIC. In each program, an array of 1000 integers with indexes were created and sorted, with the entire process being repeated 100 times. The BASIC-coded Shell method sorted the indexes of the array in 34 seconds, compared to the 22 seconds it took the ProBas routine. However, the QuickSort method managed to sort the indexes in

only 5 seconds, versus the 22 seconds it took the ProBas routine.

The `pbsern.bas` screen recall program fills two screens, one at a time, and saves them in an integer array. The program tests the speed of recalling screens from the storage arrays, alternating between the two arrays. The program prompts for the number of iterations used in the timing, as well as the numeric code for the screen mode. It took 48 seconds to recall 500 screens, in screen mode 0 or 1.

To test direct screen output, I wrote the `pbprt.bas` benchmark to compare the speed of compiled `print` statements with that of the `xqprint` subroutine, which is a faster `print` version that writes directly to the screen. In filling 1000 screens, it took the `print` statement 24 seconds, compared with 9 seconds for the `xqprint` subroutine. This is a 266 percent increase in screen output speed.

A Big Manual for a Big Package

The ProBas package includes two distribution disks. If you use a color monitor, one of the disks offers an impressive and very informative demonstration of ProBas's features. You can query the demonstration program about the collections of libraries and their features. The installation of ProBas is fairly easy and includes the use of a batch file to create the appropriate version (i.e., matched to your hardware) of the library file `PROBAS.LIB`.

The 602-page manual is written in a friendly style and consists of tutorial and reference sections that are generally readable and thorough.

The ProBas Advantage

The ProBas library routines bring added power and convenience to programmers who use Microsoft BASIC compilers. Using the routines saves you the trouble of writing your own in BASIC, and, in most cases (sorting being one possible exception), ProBas will far outperform an equivalent routine in BASIC. The manual is thorough and fairly well written, so that you won't have too much trouble learning to use the routines.

If you are involved in developing advanced and well-polished applications using a Microsoft BASIC compiler, the ProBas library can provide you with a time-saving and valuable software toolbox. ■

Namir Clement Shammas is a columnist for several computer magazines and a freelance writer living in Glen Allen, Virginia. He can be reached on BIX as "nshammas."



Embedded systems designers have already used CrossCode C in over 172 different applications.

Introducing CrossCode C for the 68000 Microprocessor Family

Finally, a 68000 C Compiler that's tailor-made for ROMable applications

CrossCode C is designed *specifically* to help you write ROMable code for all members of the Motorola 68000 family.

A ROMable C Compiler?

To get truly ROMable code, you have to start with a truly ROMable compiler. Here are three CrossCode C features that you won't find in any ordinary C compiler:

- Compiler output code is split into five independent memory sections that you can assign into ROM or RAM as you please.
- You can optimize the code for your application because *you* control the sizes of data types. For example, you can optimize for speed by using two byte *ints*, or get maximum versatility by using four byte *ints*.
- You can easily write assembly language routines that call C functions and vice-versa, because the compiler uses simple, well documented parameter passing conventions.

How About Low Level Control?

CrossCode C comes with an assembler that has all the features that assembly language programmers require. In fact, you could write

your whole application with it:

- The assembler features an advanced macro language, conditional assembly, "include" files, and an unlimited size symbol table.
- Detailed cross references show you where you've defined and referenced your symbols.
- After a link, you can actually convert your "relocatable" assembler listings into "absolute" listings that contain absolute addresses and fully linked object code.

Can It Handle The Link?

The CrossCode C linker is designed to handle truly huge loads. There are no limits on the number of symbols in your load or on the size of your output file. And you can always count on full 32 bit target addressability, because the linker operates comfortably in the highest ranges of the 68020's address space.

How Does It Get To ROM?

CrossCode C comes with a *downloader* that puts you in touch with all EPROM programmers and emulators. It can convert your load into Motorola S-Records, Intel Hex, Tek Hex, Extended Tek Hex, and Data I/O ASCII Hex. You can also produce a binary

image and convert that image into any format you might want. In all formats, bytes can be split into EPROMs for an 8, 16, or 32 bit data bus.

Why Wait?

Once you start using CrossCode C, you may just wonder how you ever got the job done before! It's available under MS-DOS for just \$1595, and it runs on all IBM PCs and compatibles (640K memory and hard disk are required). Also available under UNIX & XENIX.

CALL TODAY for more information:

1-800-448-7733

Inside Illinois or outside the United States, please dial

PHONE: 1-312-971-8170

FAX: 1-312-971-8513

SOFTWARE DEVELOPMENT SYSTEMS, INC.
3110 WOODCREEK DRIVE
DOWNERS GROVE, ILLINOIS 60515 USA

CrossCode™ is a trademark of SOFTWARE DEVELOPMENT SYSTEMS, INC. MS-DOS® is a registered trademark of Microsoft. UNIX® is a registered trademark of AT&T. XENIX® is a registered trademark of Microsoft.



V-series Smartmodem 9600™
Throughput to 19,200 bps



V-series Smartmodem 2400™
Throughput to 4800 bps



Smartmodem 2400™
Same AutoSync feature as V-series



Smartmodem 1200™
Established the standard

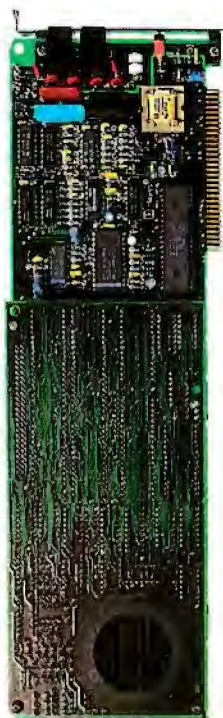

V-series Smartmodem 9600B™
For IBM PCs

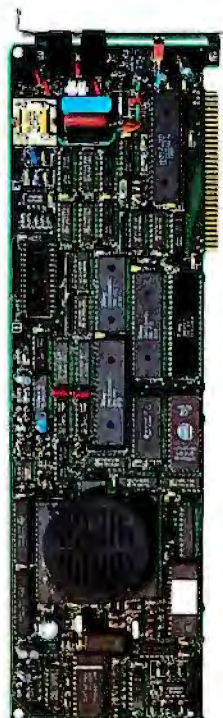

V-series Smartmodem 2400B™
For IBM PCs



Smartmodem 2400P™
For IBM PS/2



Smartmodem 1200A™
For the Apple II series

Over the past decade we've made data communications over ordinary dial-up phone lines as dependable and reliable as a call home. And we did it by offering a total communications solution that combines advanced modem technology with the most powerful software available.

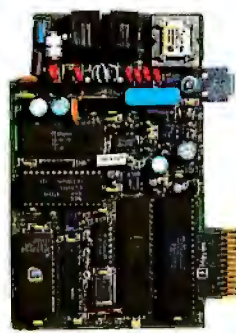

Smartmodem 2400Q™
For Compaq III[®] portables



Smartmodem 2400b™
For IBM PCs

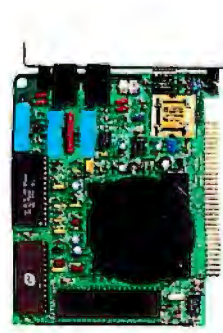

Smartmodem 1200b™
For IBM PCs

YOU DON'T BECOME THE LEADING MO

V-series
Smartmodem 9600



Chronograph
Accurate clock for computers

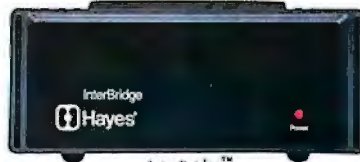

InterBridge™
Connects AppleTalk® networks



V-series Modem Enhancer™
Adds V-series connectivity

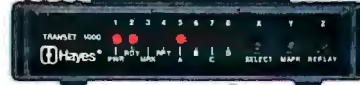

Transet 1000®
Print buffer and electronic mailbox

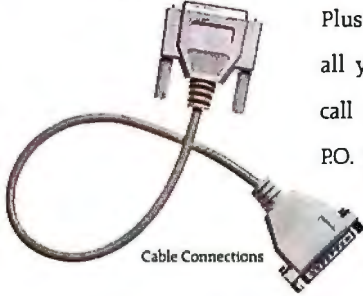

Cable Connections

Plus other enhancement products which provide cost efficiency for all your business communications. For your nearest Hayes dealer, call 1-800-635-1225. Hayes Microcomputer Products, Inc., P.O. Box 105203, Atlanta, GA 30348.

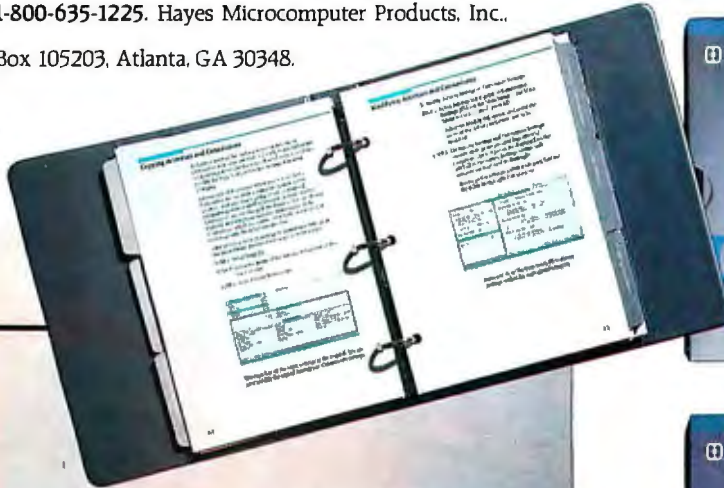

Smartcom III™
For IBM PCs



Smartcom II®
For IBM® PCs or Apple Macintosh™



Smartcom I®
For the Apple® II series



Rack 1A™
Houses nine Hayes modems at host site

© 1988 Hayes Microcomputer Products, Inc.

MODEM MAKER JUST BY MAKING MODEMS.

Circle 114 on Reader Service Card

NEW MENUING
INTERFACE AND
RELIABILITY PROCEDURE

GET SERIOUS



...ABOUT ANALYZING YOUR DATA.

You might be spreading your spreadsheet a little too thin. Or maybe you're starting from scratch. But if you're serious about data analysis, you're ready for SPSS/PC+™ — a full software family that brings you eight high-powered ways to complete any data analysis task.

Enter it. SPSS Data Entry II™ is a fully integrated data entry, cleaning and editing tool.

Analyze it. The SPSS/PC+ base package provides a powerful array of statistical and reporting procedures.

Picture it. SPSS/PC+ Graph-in-the-Box™ featuring New England Software's Graph-in-the-Box™ offers full color "snapshot" graphics.

Examine it. SPSS/PC+ Advanced Statistics™ lets you get more serious with your data.

Predict it. SPSS/PC+ Trends™ — our latest option — is the complete time series analysis/forecasting tool.

Table it. SPSS/PC+ Tables™ produces presentation-ready tables instantly.

Chart it. SPSS/PC+ Graphics™ featuring Microsoft® Chart creates show-stopping graphs and charts.

Map it. SPSS/PC+ Mapping™ featuring MAP-MASTER™ creates maps where vast amounts of data can be summarized and presented in one, simple picture.

SPSS/PC+ products are being put to productive use by serious fact finders in business, government and education. For countless purposes such as market research. Wage and salary studies. Survey analysis. And quality control. Plus each product is superbly documented and supported by SPSS Inc., a leader in statistical software for nearly 20 years. While specially tailored customer support is available through the VALUE PLUS™ plan. And SPSS now offers a SPSS/PC+ version for Novell LANs.

So if you're serious about data analysis, step up to SPSS/PC+. For details, contact our Marketing Department.

CALL 1/312/329-3315

SPSS inc.

SPSS Inc. • 444 North Michigan Avenue, Suite 3000 • Chicago, Illinois 60611

In Europe: SPSS Europe B.V. • P.O. Box 115 • 4200 AC Gorinchem, The Netherlands • Telephone: +31183036711 • TWX: 21019

SPSS/PC+ runs on IBM PC/XT/AT's with hard disk. Contact SPSS Inc. for compatible microcomputers. SPSS/PC+, SPSS Data Entry II, SPSS/PC+ Graph-in-the-Box, SPSS/PC+ Advanced Statistics, SPSS/PC+ Trends, SPSS/PC+ Tables, SPSS/PC+ Graphics and SPSS/PC+ Mapping are trademarks of SPSS Inc. VALUE PLUS is a trademark of SPSS Inc. Chart and Microsoft are trademarks of Microsoft Corporation. MAP-MASTER is a trademark of Ashton-Tate. Graph-in-the-Box is a trademark of New England Software, Inc.

© 1987, SPSS Inc.

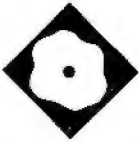

Graphic Design for the PC AT

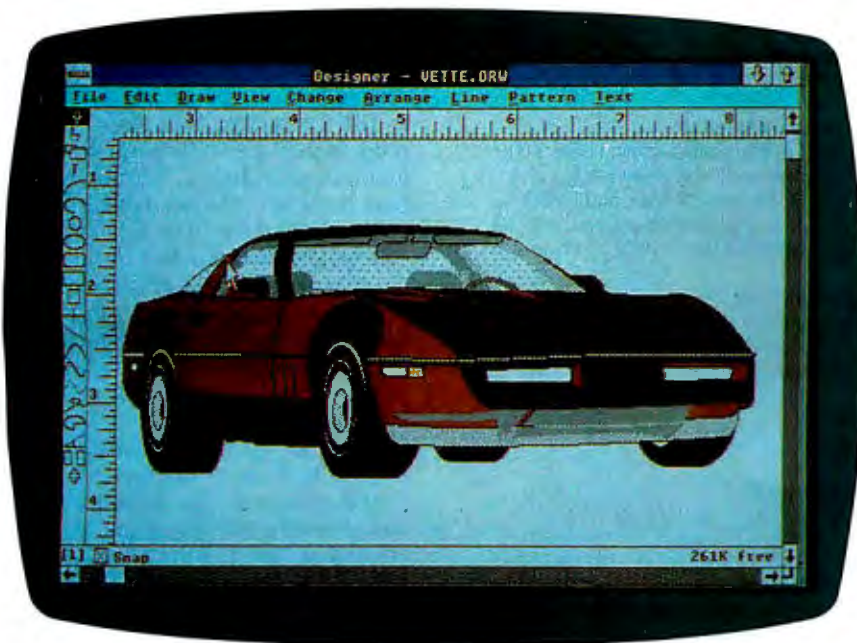

Designer bridges the worlds of drawing and bit-mapped images

Lamont Wood

When you approach the world of graphics for MS-DOS computers, you quickly discover (aside from a swamp of incompatible file formats) that you can draw, or you can paint, but not both. Now there's Designer from Micrografx that can do both.

Designer is a \$695 software package for PC ATs and compatibles with at least 512K bytes of RAM and an EGA, VGA, Hercules, or other graphics adapter compatible with Windows 2.0 or higher.

Micrografx recommends that you use an 80286- or 80386-class machine. While Designer has provisions for using a keyboard instead of a mouse, I tested it with a mouse. Not only does Designer let you bridge the two worlds (with a big assist from Microsoft Windows), but it also offers design tools previously seen only on minicomputer CAD systems.

First, consider the difference between drawing and painting. Drawing packages normally use "primitives" such as circles and lines to compose drawings, much as a draftsman uses a compass, a ruler, and related tools to compose even the most complex blueprint. Freehand drawing (with a mouse or other input device) is used only for special cases, and some drawing packages don't even provide for it.

Such "object-oriented" graphics software produces "line art": The drawing is ultimately just a collage of line and circle segments drawn to precise specifications. The advantage of line art is that the reso-

lution of the final product is independent of the computer screen's resolution. Output devices can follow these specifications using whatever resolution is available, whether it's a laser printer of either 75 or 300 dots per inch, or a 1200-dpi phototypesetting machine.

Meanwhile, painting involves bit-mapped images. The picture is composed of pixels or dots. The device from which the pixels were mapped (i.e., the computer screen on which the original picture was drawn, or the scanner that digitized a picture) sets the resolution of the image. Since laser printer resolution is generally much higher than screen resolution, the quality of bit-mapped printouts on such a device can be disappointing.

Designer's Solution

By merging these two worlds, Designer lets you import bit-mapped images, trace over them using its drawing primitives, and then discard the bit-mapped image. You can add gray scales or colors to the resulting drawing to match the original image, and then print the drawing in the same resolution-independent fashion that you print any drawing.

Designer also imports bit-mapped images by using functions built into the Microsoft Windows environment. An application designed for Windows includes cut-and-paste facilities that load or unload material to a Windows entity called the Clipboard. Having cut an image into the Clipboard, you can load another Windows application and paste the contents of the Clipboard into it. The bit-mapped image that you load into Designer need only be compatible with Windows.

Note, however, that you need other Windows-compatible software besides Designer that can generate or manipulate bit-mapped images; Designer can only paste them from the Clipboard. It has no way to load them into the Clipboard, and certainly no way to generate them. I used Windows Paint for this review.

continued

30% to 60% DISCOUNT on all Mac software, peripherals and supplies!

MacOnly has it all. Over 3,000 Mac related products at discounts of 30% to 60%.

And if that wasn't enough, we also offer:

**HyperCard stacks,
Public Domain Software
and Shareware**

\$ 1.99 per 400K disk!

You read it right: thousands of HyperCard, public domain and shareware programs for \$1.99 per disk. Our catalog lists them all.

Macintosh Typefaces and Clip Art Catalog

A \$29.95 value
FREE!

As part of our catalog, you also get complete LaserWriter and ImageWriter samples of all current Mac typefaces and clip art. See it before you buy!

The Macintosh Bible \$ 9.95

Retails at \$21.00

MacGuide gives it a 95 rating. The New York Times says "It's like having a Macintosh expert at your side whenever you need one". Includes two free updates.

Order your MacOnly catalog package today!

For only \$9.95, you get the MacOnly DISCOUNT catalog, our typeface and art sampler, HyperCard and PD software catalog and a copy of the Macintosh Bible. Send check or money order to MacOnly, Inc., P. O. Box 256, Highland Park IL 60035.

Designer 1.0

Type

Technical illustration software for the Windows 2.0 environment

Company

Micrografx Inc.
1820 North Greenville Ave.
Richardson, TX 75081
(800) 272-3729
(214) 234-1769

Format

Five 5¼-inch floppy disks and five 3½-inch high-density floppy disks; other media available upon request

Language

C and assembly

Hardware Needed

PC AT or compatible running DOS 3.0 or higher with one high-density floppy disk drive, 512K bytes of RAM, and an EGA, VGA, Hercules, or other graphics adapter compatible with Windows 2.0 or higher

Documentation

90-page Installation Guide
320-page User Manual
82-page Clip Art Pictorial Guide

Price

\$695

Inquiry 897.

Designer's image integration lets you scan or trace almost anything and turn it into a powerful illustration. For example, you can add corporate logos to blueprints or design a building plan on top of a site photo. You can combine elements from multiple pictures, since you're not limited to your screen or scanner resolution. Because of this, you can afford to set your scanner to a low resolution (e.g., 75 dpi) and save file space.

You will find that tracing even random blobs is no problem, requiring only a little attention to drafting, especially for the curves. When you finish, you just slide the original image out from under the drafted copy and either discard it or admire its similarities. These similarities evaporate when you print out the images. While they may look the same on the screen, the line-art copy is much snappier, being composed of smooth lines rather than jagged trails of dots. Gray areas are actually gray, rather than bit-mapped grids of dots.

However, with Windows and image integration aside, Designer is primarily a drawing package, so I'll look at its drawing features.

Object-Drawing Features

Like many other drawing packages, Designer gives you a screen that is bordered by rulers as your drawing surface and a selection of tools that is represented by icons along the edge of the screen. The rulers are important, because with the snap command invoked, you can draw lines only to connect the intersections of ruler gradations. Using snap makes it easy to line up and connect objects. You can specify the unit of measure (e.g., inches or centimeters) for use with the picture rulers and the number of gradations per unit (from 1 to 100).

In default mode, the drawing is shown at approximately actual size (see photo). You can zoom in for detail work, with the desired portion of the drawing blown up to fill the screen. How close you can zoom in depends on the setting you give for the coordinate grid, which is separate from the rulers. You can set the grid from 200 to 2900 points per inch, or 100 to 1100 points per centimeter. A finer coordinate grid gives you greater accuracy, but also a smaller drawing surface. The default setting of 480 points per inch provides a 68- by 68-inch area, while 2900 points per inch gives you an 11- by 11-inch area.

Use of the tools is fairly standard. You select a tool, go to the spot where you want it to start on the screen, press the mouse button, and drag a "rubber band" (dashed outlines) of the shape until you get the size you want. If it's not in the right place, you can move it later. The drawing tools include the arc, elliptical arc, circle, ellipse, rounded rectangle, rectangle, square, horizontal or vertical line, diagonal line, parabola, curve, polyline, freehand, and pie.

An elliptical arc is an ellipse with only the part of the circumference that you specify drawn in. Both arcs and elliptical arcs are drawn by designating the two endpoints, with an arc or elliptical arc stretching to connect them. The pie tool is similar, except that lines connect ends of the arc to the center of a circle, creating instant pie chart segments. Parabolas and curves are a different matter. After selecting the tool, you simply draw a line. Next, you go to the middle of the line and "push" it in the direction that you want it to bulge.

You can move objects around or resize them by selecting and then dragging them with the mouse. You select an object by placing the cursor on it and clicking the mouse, or by enclosing it with a dashed line using the block-select tool. Eight black square dots, called "handles," sur-

continued

We Just Made Choosing Your Graphics Card



As Easy As 1,2,4.

You've probably seen our TrueVista products, or you've heard about their powerful features like the real-time frame capture, on-board TI 34010 coprocessor, large frame buffer, NTSC/PAL compatibility and more. Recently, we announced several new products in the series, each with unique potential for your

applications from video to digital pre-press to image processing. So now, whether your choice is an AT-class platform or the Macintosh® II, you only need one source for your graphics needs, the TrueVista series. The chart below outlines several key differences in the 5 products.

TrueVista Series

FEATURES	AT Vista 1M	AT Vista 2M	AT Vista 4M	NuVista 2M	NuVista 4M
BUS	AT	AT	AT	NuBus	NuBus
MAXIMUM ADDRESSABLE RESOLUTIONS	32 bits/pixel 16 bits/pixel 8 bits/pixel	512 x 512 1024 x 512 1024 x 1024	1024 x 512 1024 x 1024 2048 x 1024	1024 x 1024 2048 x 1024 2048 x 1024	1024 x 1024 2048 x 1024 2048 x 2048
VMX EXPANSION	2-10 Mbytes	2-10 Mbytes	2-10 Mbytes	TBA	TBA
PRICE	\$2995.	\$4250.	\$5995.	\$4250.	\$5995.

Now There's Software You Can Count On, Too.

To complete the equation, add in STAGE™, our comprehensive graphics environment for the 34010. Since STAGE is host-independent, it allows you to access the coprocessor directly, regardless of the bus. So your program on the AT can be quickly ported to the Macintosh II. Customers will not be tied to one platform either, as files and programs will be compatible across both hosts. STAGE is currently available for the AT Vista series, and will be available soon for the NuVista as well.

With the new members of the TrueVista family and the release of STAGE, you now have everything you need to develop exciting new products for the next generation of computer graphics. And many applications are already appearing to assist you in your immediate needs. Contact us to learn more about our products or our third-party developer program and the support available to you. You'll soon see how you can count on Truevision to provide all your graphics solutions.



TRUEVISION® INC.

7351 Shadeland Station, Suite 100, Indianapolis, IN 46256 800/858-TRUE

INTERNATIONAL: Canada 416/499-9400 France 33-13-952-6253 Italy 39-2-242-4551 Switzerland 41-1-825-0949
U.K. 44-1-991-0121 West Germany 49-89-612-0010 Other 617/229-6900

Prices quoted are US Domestic suggested retail prices. Macintosh is a registered trademark of Apple Computer, Inc. **Circle 268 on Reader Service Card**

round the selected object. You can resize an object by dragging one of the handles in or out. You can also treat bit-mapped images this way, but the effect is more a distortion than a resizing.

Advanced Features

All the things listed above are fairly standard for a PC drawing package. But Designer also boasts a unique reshape command. You select an object and then invoke reshape from the command

menu. "Reshape handles" then appear at each of the object's "vertices" (i.e., every place a line changes direction). You place the cursor on one of these handles and drag it to a new location. The object is redrawn with the bend, as represented by the handle's new location, with the lines running to and from it curving appropriately. The effect is as if the object was made out of fairly stiff rubber and, by moving the handle, you have dented it in or out with your fin-

ger—a very intuitive way of doing it.

The power of the reshape command becomes apparent when you use the block-select command with the reshape command to select a group of handles and move them all with one nudge of the mouse. Thus, you can proportionally change part of an object in relation to the rest. An example in the user's manual demonstrates using the block-select and reshape commands to make the tail on a drawing of a fish wag up and down.

The connect-closed command is useful while tracing bit-mapped images. This command connects objects made with different elements. If you use a line, a curve, and then a freehand element to trace something, you can use connect-closed to turn them into a single object that you can move, rotate, scale, and so on. If the elements don't quite touch each other, lines automatically link their closest endpoints. I discovered that this command made it much easier to be precise, especially as the snap command was a hindrance during tracing, since I had to place the lines fairly randomly. There's a connect-open command to combine elements without linking them, and a break-apart command to reverse the procedure.

Multiple Layers and Colors

When using a color monitor, you can assign colors to objects, just as you can assign fill patterns and levels of gray when you use a monochrome monitor.

But a graphic artist will be interested not so much in the screen colors as in Designer's layers facility. You can define and give names to up to 64 layers. You can also assign a selected object to a layer and define which layers will be displayed at any one time: one, all, or a combination. The printer command prints only the layers currently displayed.

This last feature is important. If you define three layers and name them red, green, and blue, Designer becomes a tool to do color separations. You would keep objects of a particular color in the appropriate color layer and arrange the objects until you get the desired image on your color monitor. Then you print out the individual layers on a laser printer. Of course, these printouts will be black and white, but a commercial printer uses the correct ink when printing them. By overprinting the various color separations, an accurate copy of your screen image is reproduced. Please realize that this description is a gross simplification. Color printing is fraught with complications that should be left to professionals—al-

continued

WHY SETTLE FOR THIS?...

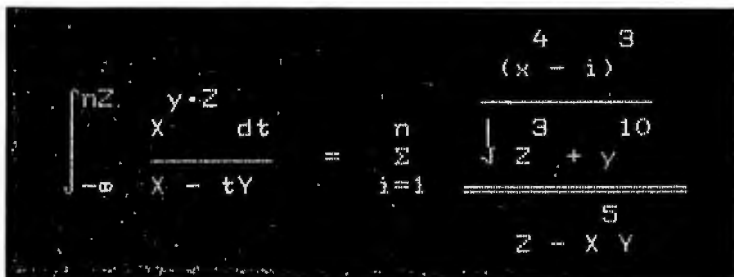

...WHEN WHAT YOU REALLY WANT IS THIS.

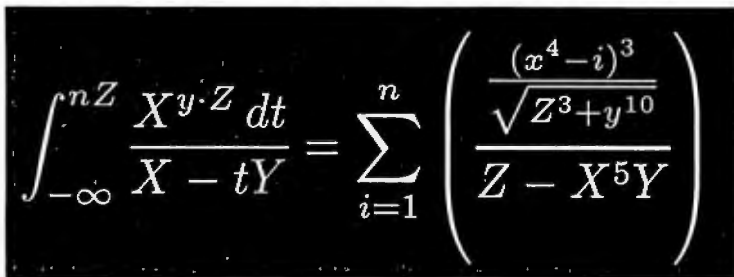

TRY THIS:



Quality work should look high-quality. What better reason to try **PC_TEX[®]**—the full implementation of Prof. D. Knuth's revolutionary **TEX** formatting/typesetting program.

PC_TEX offers professional typesetting capabilities & advantages to PC users. It gives you control—of format, type, symbols, quality—for complex mathematical &

engineering material, statistical tables or straight matter.

So whether you're writing the next starshot manual or a thesis on relativity, you get camera/publisher-ready manuscripts to be proud of, quick & simple. Don't settle for less.

To order or for information, call: **415/388-8853** or write: Personal **TEX**, Inc. 12 Madrona Avenue Mill Valley, CA 94941 USA

From Personal **TEX**, Inc., starting at \$249; **VISA/MC** welcome. Satisfaction guaranteed.

PC_TEX is a registered TM of Personal TEX, Inc. TEX is an American Mathematical Society TM. Manufacturers' product names are their TMs.

PC_TEX FORMATTING/TYPESSETTING SYSTEM • FINE TYPESET QUALITY from dot matrix or laser printers, or phototypesetters. • **A COMPLETE PRODUCT.** Includes • our specially written **PC_TEX** Manual that lets you use **TEX** immediately • custom 'macro package' formats for letters, manuals, technical documents, etc. • the **La_TEX** document preparation system (with user's manual) macro package for article, book, report preparation • **AMS-TEX** developed by the American Mathematical Society for professional mathematical typesetting. • **OUTPUT DEVICE DRIVERS** available for Epson FX, LQ • Toshiba • HP LaserJet Series • Apple LaserWriter • Screen preview, with EGA, VGA or Hercules card. • **REQUIRES:** IBM PC/XT, AT or compatible, DOS 2.0 or higher & 512K RAM; hard disk for printer drivers & fonts.

This ad is typeset & composed using: PC_TEX, Bitstream[®] fonts & laser printer. Logotype & black backgrounds done photographically.

It's not too late for a WYSE decision



WYSEpc 386 SYSTEMS

Standard Features

- INTEL 80386 Processor Running at 16 MHz
- Phoenix Bios 1.2 MB Floppy Drive
- 1 MB of 0 Wait State Static Ram
- Up to 24MB of True 32 Bit RAM
- Socket for 80387 Math Co-Processor
- WYSE Window System Status Display
- 2 Serial and 1 Parallel Ports
- 220 Watt Power Supply
- MS-DOS 3.3*GW-BASIC
- 11 Slots*Real Time Clock
- 102-KEY Enhanced PC-Style Keyboard
- 20 MB 28ms HARD DISK DRIVE

WYSE pc 286 SYSTEMS

Standard Features

- INTEL 80286 Processor
- Model 2108 Running at 8 MHz
- Model 2108 512k RAM Standard
- Model 2112 Running at 12.5 MHz
- Model 2112 1MB RAM Standard
- Phoenix Bios 1.2 MB Floppy Drive
- MS-DOS 3.3 GW-BASIC
- Small Footprint
- 1 Serial & Parallel Port
- 102-Key Enhanced PC-Style Keyboard
- WYSE Window System Status Display
- 20MB 28ms HARD DISK DRIVE

Model 2108

Model 2112



SYSTEM UPGRADES

- | | |
|-------------------------------|--------|
| • 2108 Math Co-Processor | \$185 |
| • 2112 Math Co-Processor | \$350 |
| • 3216 80387 Co-Processor | \$500 |
| • 360k 5.25 Floppy Drive | \$99 |
| • 720k 3.5 Floppy Drive | \$155 |
| • 1.44 3.5 Floppy Drive | \$179 |
| • 1.2 MB 5.25 Floppy Drive | \$155 |
| • 41MB ST 251 Hard Disk Drive | \$210 |
| • 71MB Hard Disk Drive | \$660 |
| • 80MB 4096 Hard Disk Drive | \$660 |
| • 130MB Priam Hard Disk Drive | \$1780 |
| • WY-60 Terminal | \$455 |
| • NEC MULTISYNC II | \$150 |
| • NEC MULTISYNC gs | \$99 |
| • 1200 Baud Modem & Software | \$99 |
| • 2400 Baud Modem & Software | \$199 |
| • PC MOS/386 5 User OS | \$495 |
| • SCO XENIX 286 | \$499 |
| • SCO XENIX 386 | \$599 |

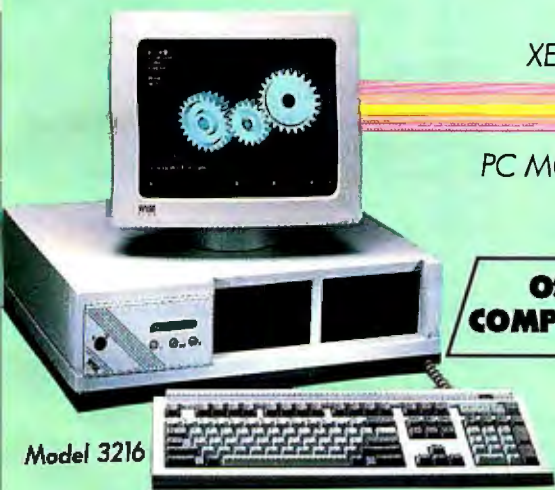

Model 3216

XENIX

PC MOS/386

**OS/2
COMPATIBLE**

WY - 60



EGA COLOR SYSTEM

- Hi Res 640 x 350 EGA Color
- CGA, MDA & HGC Compatible
- 752 x 410 Drivers Included
- Autoswitching with CGA emulation
- WY-640 EGA Color Monitor

Model 2108 System \$2,295

Model 2112 System \$2,745

Model 3216 System \$3,940

MONOCHROME SYSTEM

- Hercules Graphics Compatable
- 1 extra Parallel Port
- 720 x 350 Resolution
- 132 Column by 25 or 44 Line Mode
- WY-530 14 inch Hi Res Monitor

Model 2108 System \$1,795

Model 2112 System \$2,245

Model 3216 System \$3,440

NEW VGA COLOR SYSTEM

- Hi Res 1280 x 600
- 256 Colors from Palette of 256,000
- Implements all 17 VGA modes
- 640 x 400 & 512 x 480
- NEC MULTISYNC II Monitor

Model 2108 System \$2,545

Model 2112 System \$2,995

Model 3216 System \$4,190



B&W Systems, Inc.
7877 Cessna Ave.
Gaithersburg, Md. 20879

To order:
1-800-638-9628
Fax # (301) 258-2753
For information call
(301) 963-5800

Circle 30 on Reader Service Card

Trademarks: WYSE - trademark of WYSE Technology • MS-DOS, OS/2 & XENIX trademark of Microsoft Corporation • Hercules - trademark of Hercules Computer Technology
NEC - trademark of NEC Corporation • PC-MOS/386 - trademark of Software Link. Specifications, configurations, and prices are subject to change without notice. Copyright 1988 B&W Systems, Inc.

IEEE-Z

Our Personal488™ IEEE (GPB) interfaces for PC/AT/386 & PS/2s are packed with these easy-to-use features:

- DOS device driver loads at power-on
- Hewlett-Packard style commands
- Automatic error indication
- BASIC ON SRQ GOSUB capability
- DMA transfers over 300K bytes/s
- 100% IBM PC compatible software
- Serial/Parallel/IEEE port redirection
- DMA and interrupt channel sharing
- Compatible with popular languages (no extras to buy), including BASICA, GWBASIC, Quick BASIC, Compiled BASIC, Turbo BASIC, True BASIC, TBASIC, Turbo Pascal, Microsoft Pascal, Turbo C, Microsoft C, Aztec C, Lotus 1-2-3/Symphony/Measure, ASYST, DADISP, Test Windows, AutoCAD, and many more.

- 30 day money-back guarantee
- 2 year warranty
- Call or send for your FREE Technical Guide

Lotech

(216) 439-4091 Telex 6502820864 Fax (216) 439-4093

25971 Cannon Road • Cleveland, Ohio 44146
London (0734) 86-1287 • Paris (1) 34810178 • Zurich (01) 821 9444
Milan 02-4120360 • Linköping 013 11 01 40 • Amsterdam 01830-35333
Vienna (0222)253626 • Munich, and other European, North African, and Middle East countries not listed (089) 710020.

Circle 125 on Reader Service Card

though professionals can use Designer for this purpose.

Filing Capabilities

Remember that swamp of file incompatibilities? Designer tries to slash a path through it, but unfortunately without enormous success.

Designer has two file formats: DRW and PIC. DRW is Designer's internal format, while PIC is a format inherited from earlier Micrografx products. PIC should not be misinterpreted for the similarly named Macintosh PICT format. Through the Clipboard, Designer also accepts Microsoft Windows bit-mapped images and outputs Windows object-oriented format "metafiles."

Designer comes with a coupon for a free copy of a program that converts between the PIC format and the DXF format used by AutoCAD files. The conversion program lets you use Designer files with Xerox Ventura Publisher and Aldus PageMaker, two desktop publishing programs. You can import Designer files into PageMaker directly through the Clipboard, since the latter also runs under Windows.

Designer also comes with a clip-art library. Micrografx offers about two dozen clip-art libraries, with contents varying from world flags and maps to electrical symbols. Each library costs \$49.95. Designer comes with a general library, with some flowchart and geometrical symbols, symbols suitable for logos, and a world map.

If you don't have Windows, Designer can run stand-alone using a run-time version of Windows that comes with Designer. Most of Designer's distribution disks are, in fact, for the purpose of installing this abbreviated version of Windows. The installation procedure for run-time Windows is the same as for standard Windows, even down to the screen messages. And, of course, there's no way to import bit-mapped images from outside Designer. For those using the run-time Windows and who presumably don't have the Microsoft Windows user manual, Designer's Installation Guide has several chapters of basic Windows information. Expect Windows and Designer to occupy about 1 megabyte on your hard disk drive.

Micrografx gave Designer powerful commands like reshape and connect-closed because it assumed the use of an AT- or 386-class machine, making functions that would have been unacceptably slow on a PC practical. Designer also makes no use of a math coprocessor, since the software uses integer numbers for the

coordinate grid instead of floating-point numbers. Lookup tables are used to speed up the math where necessary.

I reviewed Designer 1.0 with a 4.77-MHz Eagle XT, and I found Micrografx's warnings about performance to be somewhat overstated. Aside from file loading and printing, the only response-time problem with the program was with the reshape command. It took 40 seconds to redraw a reshaped object. Otherwise, the program ran at interactive speeds.

File loading and printing are slow, but usually you have to cope with it only once per session. A sample file that contained a complex rendering of a Ferrari engine took 5 minutes to be displayed on the screen, element by element. As the screen redraws after major changes, you'd think working on such a drawing would be rather sluggish with an AT and unbearably slow with a PC. However, you normally do most of your work zoomed in on a small part of the drawing, where only a couple of elements are on the screen. These elements redraw themselves within moments. The same drawing takes 20 minutes to print on a Hewlett-Packard LaserJet-compatible laser printer, even at a resolution of 75 dpi. Simple drawings take 1 minute at 75 dpi and 4 minutes at 300 dpi.

Obviously, it would be better to have an AT-class machine. You can do simple drawings with no strain on a PC, but if your aims are simple you may as well save your money and stick with Windows Paint or the like.

The Overall Design

Designer has all the attributes of a two-dimensional drafting package: dimensioning, rotation of objects, and control over line width and endings. Three-dimensional features, like selectable points of view and hidden lines, are not present.

But Designer is aimed not so much at architects or mechanical engineers as at graphic artists who have to illustrate technical manuals with detailed drawings. Such drawings have to be not only precise but also based on real objects (possibly by tracing scanned images). The use of color will also be attractive to graphic artists. If you want to turn your MS-DOS machine into a precise yet flexible artist's tool, Designer may be what you're looking for. ■

Lamont Wood is a freelance writer from San Antonio, Texas, in the computer and electronics fields. He can be reached on BIX as "editors."

The best thing next to an IBM PC. Or any PC.



Model 310/360



The economics of IBM ASCII displays.

The affordable Models 310 and 410, when equipped with cartridges, offer PC terminal function for all multi-user PCs. That includes the IBM® RT-PC™ computer and the IBM PS/2™ family.

What's more, Models 310 and 410 offer many popular emulations. Optional cartridges provide features such as concurrent DEC™ and PC connectivity, and auto dial. Both models come with a 3-year warranty. Add an IBM Maintenance Agreement, and you'll get five years of IBM service for just \$54.

The ergonomics of IBM ASCII displays.

They're not only economically attractive, they're easy to look at. Flat 14" screens offer non-glare viewing. Green or amber/gold short-persistence phosphors produce crisp character resolution. And each model uses the advanced 102-key IBM keyboard.



Model 410/460



“Want more information? Just ASCII!”

For a free brochure and to find a distributor near you, call 1-800-IBM-7257 ext. 89. Or call your IBM Marketing Representative.



This Software Won't Run.



Without This.

And that's the way Sea-Land wants it. And a host of other big and not-so-big software developers who use our Software Sentinel. To make sure their successful software is protected. So it stays successful.

We've become used to being seen with top-notch software. A lot of the reason is how our engineers designed the Software Sentinel family. For the developer and the user. To make it the most technologically foolproof yet easiest to use software protection key you or Sea-Land can get.

For users of SEA-TRAC and the thousands of other programs we're protecting, it's a cinch to get up and running. They simply plug the Software Sentinel into the PC's parallel printer port. That's it. How much easier can it get? Users can even make unlimited backup copies. And run them wherever and whenever they need to—as long as they have the Software Sentinel key.

As long as we're talking success, there's something else you should

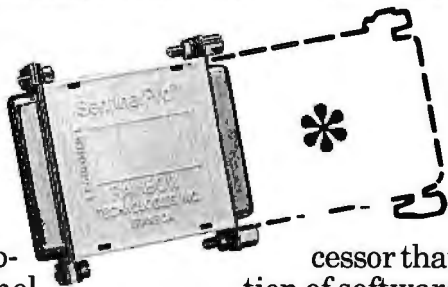

know. Right now, our engineers are putting the finishing touches on a new microprocessor that we'll use in a whole new generation of software and data protection products. With the same high-performance and high-reliability of our past successes but with many new features. Which no doubt is going to make life even easier for you and Sea-Land.

The Software Sentinel. Making sure software developers stay successful with the successful software they've developed.

For more information on the Software Sentinel family, contact Rainbow Technologies, 18011-A Mitchell South, Irvine, California 92714; or call (714) 261-0228.

Software Sentinel Features:

- Runs under DOS and Xenix
 - Uses algorithm technique, never a fixed response
 - Minimal implementation
 - Higher level language interfaces included
 - Transparent operation
-

*** The New SentinelPro™ – Half The Former Size, All The Features.**



RAINBOW TECHNOLOGIES

18011-A Mitchell South, Irvine, CA 92714 • (714) 261-0228 • TELEX: 386078 • FAX: (714) 261-0260

Copyright ©1988 Rainbow Technologies, Inc. Software Sentinel and SentinelPro are trademarks of Rainbow Technologies, Inc.
SEA-TRAC is a trademark of Sea-Land Corporation.

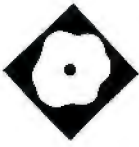

Need Some Space?

NewSpace Release 1.00		Isogon Corporation	
DRIVE C:			
Number of files on disk:		348	
Number of compressed files on disk:		122	
All your eligible files are compressed.			
Physical capacity of disk:	10,584,064 bytes		
Space all files would occupy if uncompressed:	7,529,975 bytes		
Space all files actually occupy:	6,396,398 bytes		
Space remaining on disk:	4,187,666 bytes		
Space remaining for uncompressed files:	4,157,440 bytes		
Space compressed files would occupy if uncompressed:	2,797,568 bytes		
Space compressed files actually occupy:	1,663,991 bytes		
Space saved by using NewSpace:	1,133,577 bytes		
Compression achieved on compressed files:		41 percent	
(Press any key to continue.)			

Increase the capacity of your hard disk with NewSpace

Diana Gabaldon

There's no addiction more pernicious than the lust for more hard disk storage space. Beginning with a deceptively modest craving for 10 megabytes or so, your needs rapidly escalate to 20 megabytes, then 30 megabytes—soon no amount of space is enough. Data files breed like coat hangers in a dark closet. Eventually, subdirectories bulge at the seams, and the hapless space addict looks for a new solution. NewSpace, a hard disk file-compression utility, promises some temporary relief.

NewSpace 1.00 is a terminate-and-stay-resident (TSR) program that automatically loads each time you reboot the computer. The installation routine rewrites your AUTOEXEC.BAT and CONFIG.SYS files, inserting the proper FILES and PATH commands for automatic execution. NewSpace also places itself between DOS and the data files on your hard disk drive. It compresses your data files into a proprietary file format. (For more detailed information on how NewSpace functions, see the text box on page 192.) When DOS or an applications program, such as a word processor, calls for a file, NewSpace intercepts the call, retrieves the compressed file, decompresses it in memory, and sends the file to DOS and the applications program.

DOS stores data files in clusters of 2048 bytes or 4096 bytes, depending on your version of DOS and your hard disk drive. This is a constant, regardless of the actual size of the data file, which means that data files of 2 bytes, 2K bytes, 20K

bytes, or 200K bytes all use hard disk space in the same way. Small files cannot fill an entire cluster, and large files can be broken up into clusters or portions of clusters.

NewSpace compresses data files and reallocates storage space so that each file occupies only the actual number of bytes it really needs, rather than taking up space in whole clusters. This frees considerable wasted space, which can then be used for additional storage.

NewSpace compresses only data files into its own file format. Because compressed files are no longer stored according to standard DOS file format, read and write operations, which are controlled by DOS, are affected. In the case of data files, you'll see a slight slowdown in operation when using NewSpace. Files are automatically decompressed in memory when called by an applications program, such as a word processor.

NewSpace does not compress hidden, system .EXE or .COM files. In the case of program files, the program calls to DOS would be affected by compression, so NewSpace ignores these files.

As an added attraction, NewSpace lets you recover erased files. The program creates compressed copies of the last five files erased. If you want these back, you just use the Recover command. As a convenience, NewSpace keeps a listing of the erased files that are available for recovery, so you can check to see whether the one you want back is still in the lineup.

NewSpace in Action

I tested NewSpace on a variety of IBM PC compatibles, with a variety of DOS versions, hard disk sizes, and software.

Initially, I had a minor problem with installation on the first computer I tried, an IBM PC XT with 540K bytes of RAM, a 10-megabyte hard disk drive, and Orchid Technology's TinyTurbo 286 accelerator board running Microsoft MS-DOS 3.10. The documentation instructs

continued

NewSpace 1.00

Type

Data compression utility

Company

Isogon Corp.
330 Seventh Ave.
New York, NY 10001
(212) 967-2424

Format

One 5¼-inch floppy disk; a 3½-inch floppy disk is available on request with a registration card and a fee of \$5

Language

C and assembly

Hardware Needed

IBM XT, AT, PS/2, or compatible with a hard disk drive, 256K bytes of RAM, and PC-DOS or MS-DOS 2.0 or higher

Documentation

69-page user's manual

Price

\$69.95
(additional \$3.50 for postage and handling)

Inquiry 894.

you to type `a: install` to begin installation. When I tried this, I got an error message stating that one or more files was missing from the installation disk and that the install procedure was canceled. After some experimentation, I discovered that I could get the program installed by logging onto drive A and then typing `install`. However, once installed, the program didn't work; every command resulted in an error message saying invalid function, and the help screens failed to work. A conflict with the accelerator board may have caused the problems with the installation and operation of NewSpace.

I tried NewSpace on five other machines. Two machines had the same type of installation problem, but once installed, the software worked fine. The other three machines had no difficulty with either installation or performance.

Of the five machines I tested, three were IBM PC XTs. With two of these, I ran IBM's PC-DOS 3.30, and the software installed properly. The third computer, an IBM PC XT that was running PC-DOS 3.10 and TOPS software in a local-area network, had problems with the NewSpace software. The NewSpace documentation states that the software

currently doesn't work in a multitasking environment, such as Microsoft Windows or IBM's TopView. It also does not work on the file server(s) in a network, but does work on individual workstations in a network. Once the networking software was disabled and the computer was operating as a workstation and not a file server, the software did install and work correctly.

The other two machines tested were a Zenith Data Systems Z-158, running Zenith's MS-DOS 3.21, and a Phoenix 286 AT clone, running IBM's PC-DOS 3.30. The Zenith was also initially running TOPS networking software. The Zenith exhibited the same installation problem, but once the networking software was disabled, NewSpace ran well. The Phoenix 286 computer had no installation problems, and the software ran fine.

An Isogon technical-support representative said that the software runs on systems that have PC-DOS or MS-DOS 2.0 or higher. The NewSpace program requires 120K bytes of hard disk space. NewSpace itself requires very little RAM: 10K bytes of RAM is the default setting, but it can use up to 99K bytes of RAM, if specified during installation. The technical-support person also said that a few TSR programs might interfere with NewSpace installation; I found no difficulty in using SideKick 1.56 or a prerelease version of an executive organizer program with NewSpace.

Performance

After I installed NewSpace, performance was good. It has only four commands: `Compress`, `Disk`, `Status`, and `Recover`. `Compress` is used to compress eligible files. An eligible file is a data file that does not have one of the prohibited file extensions, such as `.COM` or `.EXE`. Once you install NewSpace, you must use `Compress` to squash all your eligible files; thereafter, new files are automatically compressed when you save them.

The `Disk` command assesses the compression status of the entire hard disk drive and produces a table that tells you which of your files are eligible for compression, how many bytes the files occupy in a decompressed state, how many bytes they actually occupy, how many files you have, and how much space is left on your disk for compressed and decompressed files.

The `Status` command tells you if a given file is compressed, decompressed, erased but recoverable, or not found. If the file is compressed, this command gives you statistics on the compressed versus decompressed size, and the per-

centage compression achieved. You can also use the wild-card characters `?` and `*` to check the status of a group of files.

The `Recover` command is what you use to recover an erased file. If you use the command without specifying a filename, you get a display that tells you which files are available for recovery. When you want to recover a specific file, you just add the filename to the command `newspace recover filename`. The `Recover` command works even if you have another file existing with the same name as the erased file. In this case, the recover routine changes the extension of the existing file to `.)))` and recovers the erased file under its original name.

The `Compress` routine ran to completion on two of the five machines. The results for the first machine's 10-megabyte hard disk drive are shown in the photo on page 189. However, the `Compress` routine ended on the 80286 machine when a Data error reading Drive C: message occurred, presumably as a result of a bad sector on the hard disk drive. The abnormal ending did not abort the compression routine; several subdirectories had been compressed, and these remained in the compressed state. In fact, the `Compress` routine is interruptible; since it may take as long as an hour to compress a very full hard disk drive, you can interrupt the process at any time and resume at the point where you left off.

All the commands worked well on all the machines except, of course, the first XT with the accelerator card. The `Compress` routine ran approximately 3 times as fast on the 80286 clone as on the XT machines.

I tried compressing files of all sorts: word processors (WordStar 4.0, WordPerfect 4.2, Microsoft Word 4.0, XyWrite III Plus, and PC-Write 2.72), spreadsheets (Lotus 1-2-3 version 2.0, Quattro 1.0, and Excel 2.0), databases (dBASE III and dBASE III Plus), and miscellaneous others.

The amount of savings in hard disk space was an average of 35 percent for all the machines I tested, considering all types of data files. Small files (less than 1K bytes) showed proportionally higher percentages of savings than large files, presumably because these files are not taking up most of the space in their original cluster, while the large files are. Overall, word-processing documents, which averaged 8K bytes to 14K bytes in size, showed space savings rates of 40 percent to 50 percent. Spreadsheet worksheet files compressed as much as 50 percent to 60 percent in the case of fairly

continued

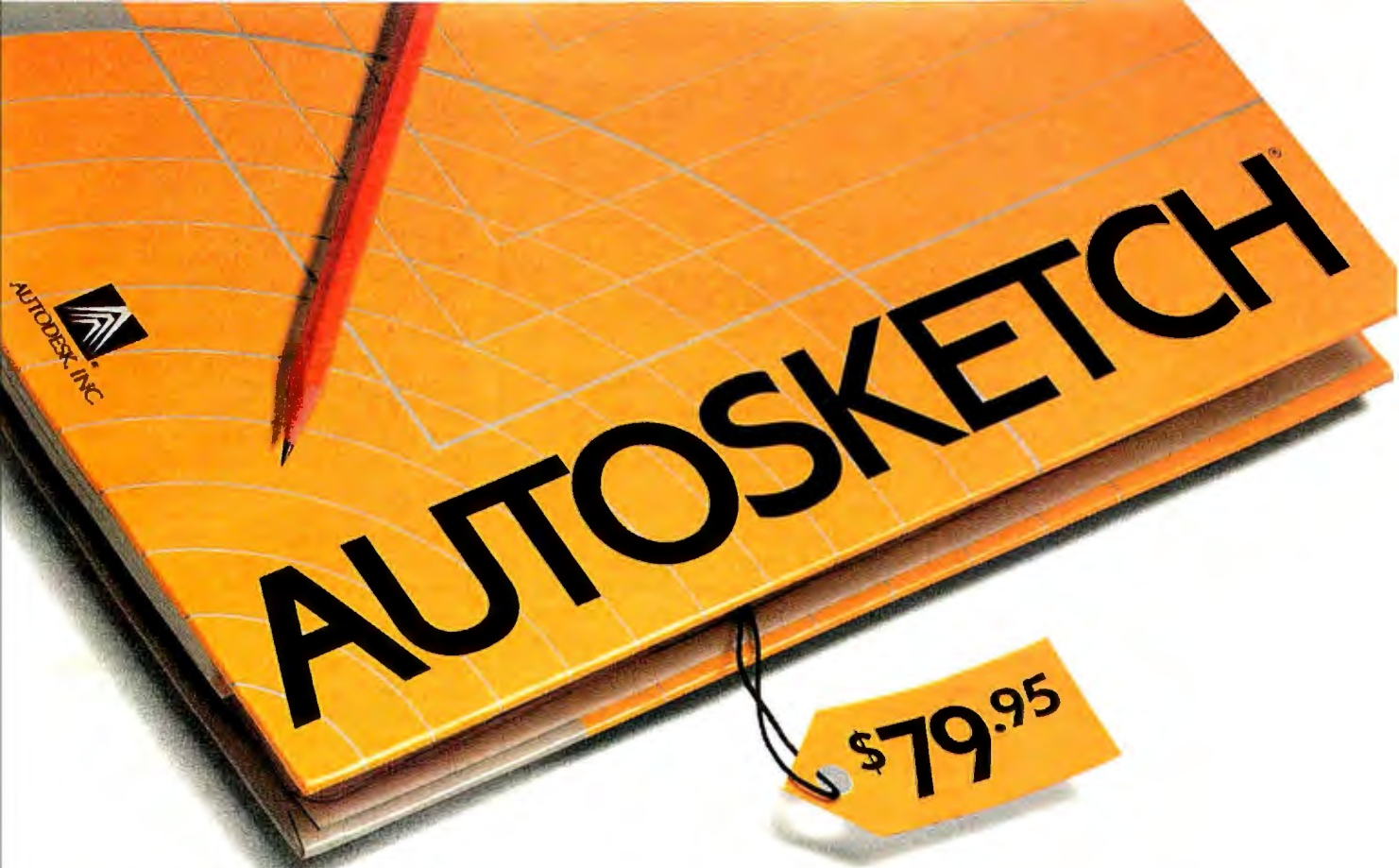

Now that the best name in CAD is this affordable, why settle for a generic brand?

What's in a name? When it comes to the Autodesk name, a lot. In fact, it's the best-selling, most well-respected name in the CAD business. There simply is not another company with the credentials to make that claim.

That's why you shouldn't settle for anything less than AutoSketch[®], the best way to get started in CAD. AutoSketch is the precision drawing tool from the Autodesk family of products. Not only is AutoSketch priced at just \$79.95,* but unlike some entry-level CAD products, you don't have to keep spending more to add the features AutoSketch already has. Standard features like boxes, circles, stretching, mirroring and rotating—to mathematical precision. And advanced CAD capabilities like dynamic PAN and ZOOM and automatic dimensioning and scaling, in up to 10 working layers.

Of course, if you do want to move up from AutoSketch at some point, your files can easily be uploaded into AutoCAD[®].

AutoSketch runs on IBM[®] PC/XT[™]/AT[®] and 100% compatible computers, and supports IBM's PS/2.[™]

So if you're ready for CAD, why not go with the name that rates highest among both critics and users? Anything else is, well, second-rate.

To order your AutoSketch directly, call 1-800-223-2521. For the name of your nearest AutoSketch Dealer or for more information, call 1-800-445-5415 or write to AutoSketch, 2320 Marinship Way, Sausalito, CA 94965.

AUTODESK, INC.



*A speed-enhanced version (9 times faster), requiring a math coprocessor, is available for \$99.95. **Circle 22 on Reader Service Card**

AutoSketch and AutoCAD are registered in the U.S. Patent and Trademark Office by Autodesk, Inc. IBM and Personal Computer AT are registered trademarks of International Business Machines Corporation. Personal Computer XT and PS/2 are trademarks of International Business Machines Corporation.

How NewSpace Works

NewSpace sits in RAM and examines the calls to DOS. When it encounters an interrupt 21 hexadecimal, it intercepts the call to see if it is a file access. If a file is being accessed, NewSpace swings into action and compresses or decompresses the specified file.

The program uses three techniques to compress files: It uses its own file format to store files in sectors (typically 256K bytes to 512K bytes) rather than in clusters (1K bytes to 2K bytes), and reduces wasted hard disk storage space for small files; second, long strings of identical characters (e.g., blank spaces) are handled with a repeat string compression routine; the third method uses a self-adapting Huffman Encoding Binary Tree algorithm.

DOS files are composed of ASCII characters. Each ASCII character is composed of an 8-bit binary string. In essence, the NewSpace program using the Huffman algorithm takes data files composed of ASCII binary strings and translates the ASCII strings into variable-length bit strings. For example, the

letter *E* is represented as 01000101 in binary. NewSpace would translate the *E*, the most commonly used letter in the English language, into a much shorter bit string. The letter *X*, not as commonly used, would be translated into a slightly longer bit string. Each one of the 256 ASCII bit strings is translated into a correspondingly shorter NewSpace bit string, according to the frequency of its use. This is why text files show the greatest degree of compression.

In rare instances, when dealing with a file composed mostly of rarely used characters (e.g., ASCII graphics or control characters), a compressed file may take up more space than the original version. NewSpace compares the compressed version with the original version and will not compress a file if there is no decrease in size.

Files are stored with file-control information to allow random access to a file. NewSpace can retrieve only the portion of the file actually required, not the entire file.

—Stan Wszola, Technical Editor

small (10K bytes or less) files, though larger files had rates of around 20 percent to 25 percent. Database record files compressed about 20 percent to 25 percent, while database index files compressed as much as 90 percent, these being usually quite small files. Graphics files in the .PIC format compressed, though only by about 15 percent to 20 percent. Compression rates for very large files, such as word processor dictionaries and thesauri, which are usually in a compressed format already, were as low as 2 percent to 3 percent. Considering all file types, compression ranged from 25 percent to 35 percent for an entire hard disk drive, which means that, by using NewSpace, you might increase the capacity of the average hard disk drive by an extra one-third.

Data files automatically decompress when programs load or use them and automatically compress again when they are saved. New files are also compressed when they are saved. I didn't notice that much of a difference in storage speed or retrieval between compressed and decompressed files; in cases where it was noticeable (mostly in spreadsheet files), the difference amounted only to 2 or 3 seconds for large files. The negligible

difference in speed is because large files require more time for storage and retrieval. They also show the smallest amount of compression. With small files, which can be substantially compressed, you can generally save or quickly retrieve them even when not compressed.

Operation of NewSpace is very smooth. I noticed no difference in the operation of my normal software when I used NewSpace; normal DOS commands, such as DIR, showed no change. The DIR command still shows data files and available storage space as occupying the same amount of space as before compression; you must use NewSpace's Status or Disk commands to find out how much space a compressed file actually does occupy.

Ease of Use

The documentation consists of a single user's guide in booklet form. It starts out with the disarming statement, "You Don't Have to Read This Manual," followed by a single page of instructions for installation and use. The rest of the manual consists of very clear explanations of the four main NewSpace commands and the ways in which NewSpace does or does

not work with the common DOS commands. The error messages listed in the manual are clear and well documented.

This program couldn't be any easier to use. If remembering the four commands is too complicated, you have the option of using only the initial letter of each command. You can then specify parameters, such as a single filename or a group of files, for each command to operate on. There are excellent help screens that explain the form and use of each command, as well as a general help screen, accessible at any time by typing `newspace /?` from a DOS prompt.

Software Problems

NewSpace can cause problems with the operation of a few software programs that don't make standard calls to DOS, such as Tecmar's tape backup program, or that demand an enormous amount of RAM, such as Xerox's Ventura Publisher, which is so huge that it requires all the available RAM, begrudging even the modest amount needed by NewSpace. Programs known to cause problems are mentioned in a README file on the distribution disk. An Isogon technical-support representative was also helpful in resolving problems.

Some utility programs, such as the Norton Utilities, bypass the normal DOS system calls for accessing data. If you use these programs to look at the contents of your hard disk drive, you will not be able to read compressed files, since the utility program is bypassing the NewSpace program, which acts as an interface between DOS and most programs. The manual warns against using such a utility program to modify data on the hard disk.

Last Words

While there are some freeware/shareware utility programs available that do file compression, these all require the user to manually compress and decompress files as they are saved or retrieved. NewSpace does all this offstage, without interfering noticeably with your normal operations.

Barring the touchiness I encountered in the installation routine, NewSpace is a remarkably smooth and elegant utility, especially for version 1.00. Overall, I would rate its performance as excellent. NewSpace is competent, simple to use, and unobtrusive. ■

Diana Gabaldon is the editor of Science Software and an assistant research professor at the Center for Environmental Studies at Arizona State University, Tempe, Arizona. She can be reached on BIX as "editors."

Now...Exclusively from Northgate OmniKey/102™ Keyboard

With
Function Keys
on the left

THE NEW STANDARD IN PC KEYBOARDS



FEATURES YOU'LL LOVE:

- 1 12 Function Keys where they belong!
- 2 Switchable CTRL and CAPS LOCK Keys
- 3 13-Key Cursor Control Panel
- 4 18-Key Numeric Keypad with separate = Key (the 102nd key)
- 5 12 Notepads to pencil-in Functions
- 6 Keys Color Coded to WordPerfect*

The World's Most Advanced Keyboard

LIMITED INTRODUCTORY PRICE

\$89⁰⁰

FOR IBM PS SERIES MODELS
ADD \$25.00

NORTHGATE put it all together!

A spectacular new keyboard. It has 12 Programmable Function Keys AND THEY'RE ON THE LEFT. Where they belong!

Now, typing speed and productivity return. No more hunting for function keys. They're where your fingers expect. And your standard templates fit. We've even color-coded keys for WordPerfect users.

Other features galore!

You can switch the CTRL and CAPS LOCK keys so CTRL is where typists expect it to be. We supply the key-caps at no extra cost.

Typists love it. Increases in speed and accuracy of up to 30% are reported. It's the touch, the feel and the layout the computer industry has been begging for and it's available now.

► Use OmniKey/102 10 days
Return for FULL REFUND
if not 100% Satisfied!
Unlimited 3-Yea Warranty

Compatible with most XT, AT, and 386 type systems using standard circular DIN connector. If uncertain, contact your computer supplier for connector type.

OmniKey/102™ is a trademark of Northgate Computer Systems. IBM XT and AT are registered trademarks of IBM Corp. WordPerfect is a trademark of WordPerfect Corp. Copyright 1988 Northgate Computer Systems.

Northgate designed it.
Northgate makes it. Exclusively.
Others will copy it, but they won't match the Click/Tactile touch and the solid "sit down to stay on your desk" feel of OmniKey/102.

Order yours now! Initial supply may be limited. And prices are subject to increase with world component supply costs. Best of all—use it for 10 days and return it for full refund if it's not everything Northgate claims!



ORDER NOW TOLL FREE
800-453-1400

Phones answered 24 hours or mail your order ►

Phone Corporate Offices for Dealer and Quantity Prices:
612-553-0111 / FAX 612-553-1695



13895 Industrial Park Blvd., Suite 110
Plymouth, Minnesota 55441

What the Pro's Say...

Gary Ray in PC Week, May 17, 1988

"REVOLUTIONARY AND MUCH NEEDED..."
"Better than any replacement keyboard ever used by this editor. It is also a viable alternative to IBM's own model...places the 12 Function Keys where God intended them to be: vertically along the left side of the keyboard. Other intelligent features make the OmniKey an outstanding buy, but the major facts are these: It's durable, well-designed, sensible and has just the right feel. Best of all, it's relatively inexpensive."

Steve Gibson in InfoWorld, February 8, 1988

"FINDING THE IDEAL KEYBOARD..."
"Imagine my surprise and delight when I found myself facing my dream keyboard...if you want the best keyboard I've ever laid my hands on, check out Northgate's..."

Andrew M. Fried in Computer Shopper, June, 1988

"THE MOST COMFORTABLE KEYBOARD..."
"Once again, I would like to say that the Northgate OmniKey 102 Keyboard is probably the most comfortable keyboard...features good tactile response, they're laid out well, are attractive, and very pleasant to use."

Northgate Computer Systems
13895 Industrial Park Blvd., Suite 110
Plymouth, Minnesota 55441

Ship: _____ (Quantity) OmniKey/102 @ \$89.00
_____ (Quantity) "CT" 101 @ \$99.00
_____ (Quantity) "CT" 84 @ \$79.00
_____ For IBM PS Models add \$25.00

Name _____
Company _____
Address _____
City _____ State _____ Zip _____
Phone _____ Type of Computer _____
Visa/MC # _____
Expiration Date _____
Signature _____

Note: Order processing takes 3-4 days. We ship UPS. For ground shipping add \$7.00 ea. allowing 2-3 weeks for delivery. For second day, after processing time, add \$12.00 ea. For overnight, after processing time, add \$22.00 ea.

**TAKE THE
NORTHGATE
THRUPUT
TEST!**

Find out if your "zippy-fast" hard drive system is REALLY in the fast lane. Send us \$5.00 cash, check or money order and we'll send you the THRUPUT test program. In seconds you'll know how your system compares to Northgate systems. And when you buy a Northgate system, we'll refund the \$5.00!
NO PHONE REQUESTS PLEASE

AND NORTHGATE'S 80286

Now, with Northgate Super 286

Turbo Throughput™



800,000 Bytes Per Second Data
• **Turbo Speed Hard Drive Controllers**

**TRULY A COMPLETE, READY TO USE SYSTEM
YOU GET ALL THESE QUALITY FEATURES:**

65MB Miniscribe Hard Drive, Formatted and Partitioned 32.5MB in C and D Partitions • Turbo Throughput 16-Bit Hard Drive RLL and 1:1 Interleave Controller • 12MHz Intel Processor • 6 16-Bit, 2 8-Bit Expansion Slots • 1.2MB (Reads & Writes 360K Disks) AND 1.44MB Drive (Reads & Writes 720K) • 200 Watt Power Supply • 2 Parallel, 1 Serial Port • Full Size (Not Baby Size) Case with Keylock, Turbo On/Off, Indicator Lights • 14 Inch Tilt/Swivel Flat Screen Amber Graphics Monitor with 1000 Line Resolution Capability for CAD • Hercules Compatible Graphics Card • Latest Version MS-DOS 3.3 with GWBasic including hardbound manuals for both (Northgate is a Microsoft OEM Licensee).

**AND NOW, TO GIVE YOU EVEN
GREATER PERFORMANCE...**

**DRIVE CACHING AND VOPT™
OPTIMIZER ARE INCLUDED!**

Installed on your hard drive is Northgate's exclusive Insta-Cache™ Hard Disk Caching program. Once a file is read it's in cache. Retrieving it again is 0-wait. No hard drive access is needed. This is an \$80.00 value, yours at no extra cost. AND...WE ALSO GIVE YOU THE BEST DISK OPTIMIZER PROGRAM EVER—VOPT™ BY GOLDEN BOW SYSTEMS. CLEANS UP FRAGMENTED SECTORS AUTOMATICALLY EVERY TIME YOU START YOUR SYSTEM. A \$50.00 VALUE, AGAIN YOURS FREE WITH THE NORTHGATE 286.

SYSTEM OPTIONS—PHONE FOR CURRENT PRICING: EGA, EGA+, MFM HARD DRIVES, ESDI & SCSI TO 300MB, STREAMING TAPE BACKUP, HARD DRIVE BACKUP FROM \$389, MEMORY EXPANSION CARDS, CO-PROCESSORS.

400% Faster Performing
WORLD CLASS QUALITY
Features Unmatched Anywhere

The Bottom Line

\$2199⁰⁰ complete
as shown

throughput on all the (21) machines in this review, (Feb. 16, 1988)
WAS THE FASTEST...

65MB Hard Drive System you get:

Computing Power

Transfer Rate • RLL Encoded Hard Drives • 1:1 Interleaving
 • World's Highest Performance AT Class Computer System!

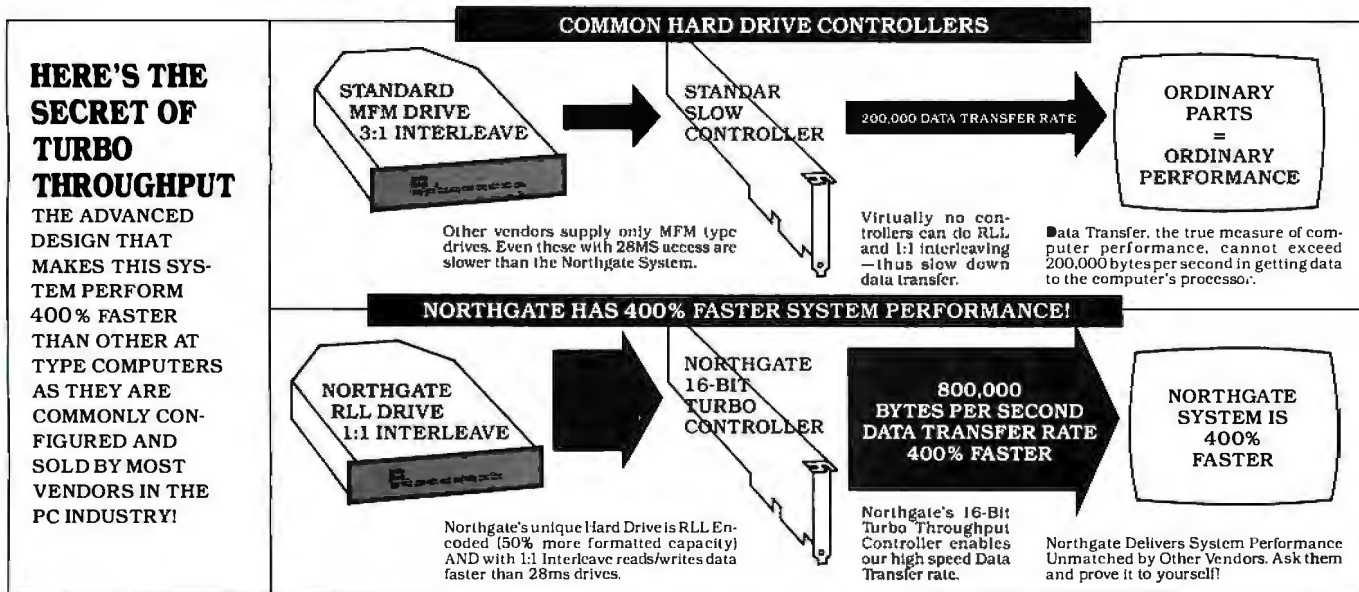

HERE'S THE SECRET OF TURBO THROUGHPUT

THE ADVANCED DESIGN THAT MAKES THIS SYSTEM PERFORM 400% FASTER THAN OTHER AT TYPE COMPUTERS AS THEY ARE COMMONLY CONFIGURED AND SOLD BY MOST VENDORS IN THE PC INDUSTRY!

Most computers look similar. Most vendors advertise processor speed and 28MS hard drive access. There is little to distinguish one from another. Thus everyone tends to assume all computers are alike.

NOT SO. Northgate is truly a different System. And because it is, the computer buyer gets far greater computer value for his money. That's why Northgate has soared in popularity. Those who know choose Northgate.

They know they get value through performance that's demonstrated every time they turn on the system. They know all parts are World Class, not the ordinary "off the shelf" items others use to keep costs down.

Northgate pioneered RLL Hard Drive and 1:1 Interleaving in its 286 systems. To our knowledge, no competitor even offers these vital performance features. Call them. We did. Only Northgate gives you this

unique throughput-enhancement.

If Northgate pricing seems higher, don't be deceived by Bare Bones Prices you see in others' ads. Northgate's System is complete — IT'S THE 286 SYSTEM YOU WON'T OUT-GROW! We encourage you—Shop Around, Call all the Others and Compare.

ALL THIS PLUS...The Computer Industry's Most Meaningful Service and Warranty Policy...

30-Day Compatibility Warranty:

Northgate guarantees its systems will operate any standard, commercially available DOS programs written for use on IBM Compatible Computers. If, on consultation with Northgate, a program cannot be made to operate satisfactorily, owner may return the system, complete and unaltered for a prompt and full refund including all freight costs.

One-Year Overnight AT NORTHGATE EXPENSE Parts Replacement Warranty:

Northgate Computer Systems warrants that all systems sold by Northgate will be free of defects in workmanship and materials for one year from date of shipment.

- In the event of failure of a part that disables the system Northgate will ship, the same day if notified by 12 Noon Central Time, a new replacement part. Customer must phone Northgate Customer Service for diagnosis of the failure.
- Shipment of the replacement part will be by overnight-express service—AT NORTHGATE'S EXPENSE—for next day delivery depending on the carrier's ability to provide such service in owner's geographic area.
- Owner must return any replaced part, complete and unaltered, and pay return shipping costs, to be received at Northgate within two weeks after receiving the replacement part.
- Northgate's Customer Service department will provide full

instructions on making the repair or replacement and will consult with customer on the phone to assure repair is properly completed and the system is again operating.

- In the case of a complete system returned for repair under warranty, customer pays freight to Northgate and Northgate pays return freight by whatever service the system is sent to Northgate.

In the event of a part replaced under warranty, the new part carries a NEW ONE-YEAR GUARANTEE FROM SHIP DATE!
 NOTE: Many computer vendors extend only the parts manufacturer's warranty which may be as little as 30-days. All products sold by NORTHGATE are fully guaranteed by Northgate for one year from date of shipment.



13895 INDUSTRIAL PARK BLVD., SUITE 110
 PLYMOUTH, MINNESOTA 55441

HOURS: Mon.-Fri. 8 A.M.-7 P.M. CST, Sat. 9 A.M.-3 P.M.

USE OUR TOLL FREE ORDER LINE

800-548-1993

VISA MC COD TERMS: Credit Card, Pre-Payment (allow 2 weeks for personal checks to clear) Wire Transfer and Purchase Orders for Rated Accounts. We also ship to APO and FPO. All shipments are FOB Minneapolis, MN

ALL CORPORATION AND BRAND NAMES IN THIS AD ARE THE PROPERTY OF THEIR RESPECTIVE OWNERS. NORTHGATE IS NOT RESPONSIBLE FOR ERRORS OR OMISSIONS IN THIS ADVERTISEMENT. • PRICES ARE SUBJECT TO CHANGE WITHOUT NOTICE. • TURBO THROUGHPUT, INSTA-CACHE AND NORTHGATE ARE TRADENAMES OF NORTHGATE COMPUTER SYSTEMS. COPYRIGHT 1988, NORTHGATE

Circle 189 on Reader Service Card

JULY 1988 • BYTE 195

Train Your PC to Read...

...the Same Things You Read!

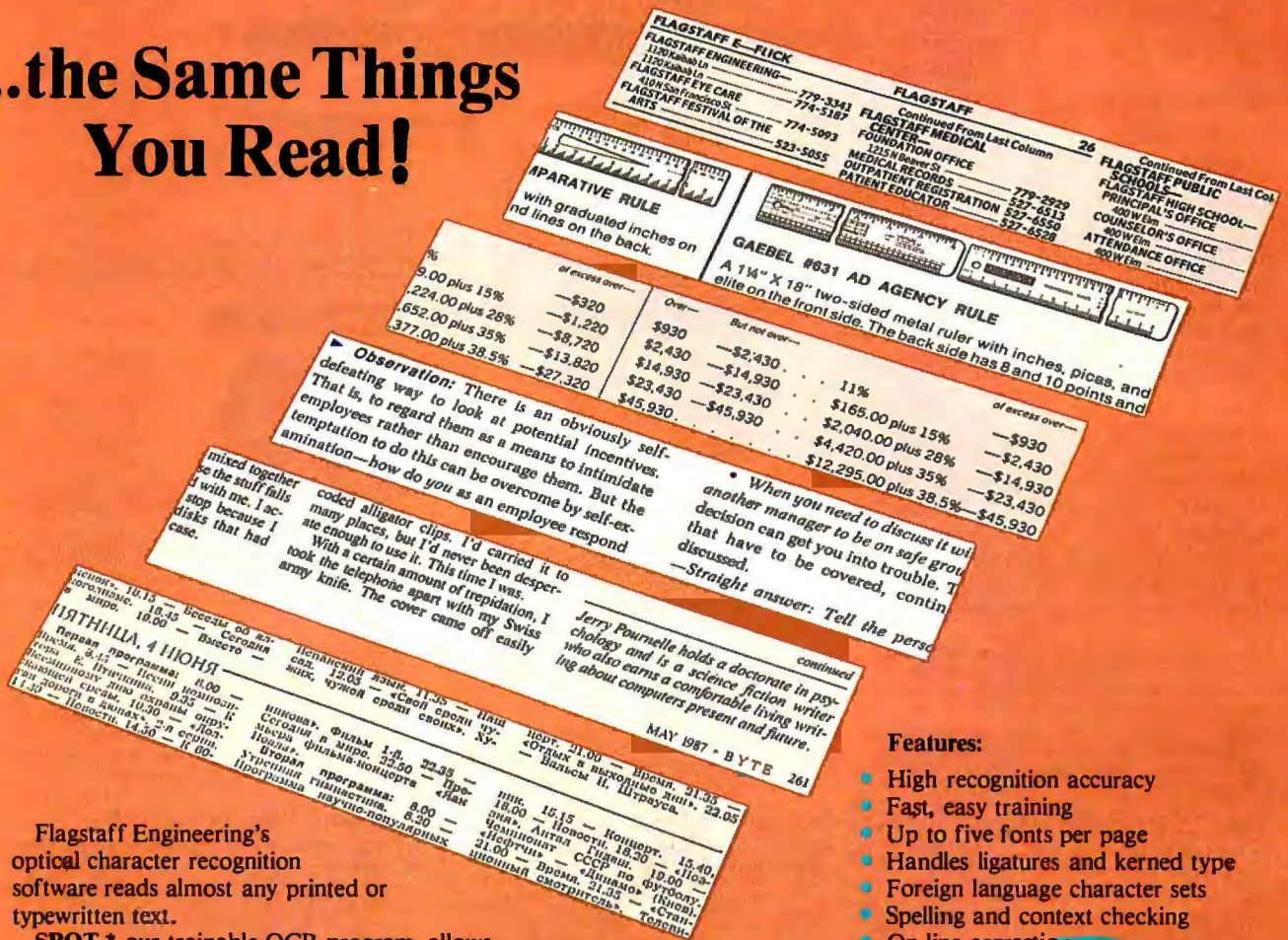

Flagstaff Engineering's optical character recognition software reads almost any printed or typewritten text.

SPOT,* our trainable OCR program, allows you to compile information from books, magazines, typewritten records, genealogical data, directories, catalogs, and public documents, including foreign-language material. The data captured by **SPOT** can be used by database, word processing, desktop publishing and typesetting applications.

SPOT's flexible output options allow you to preserve the original page format, including columns and margins. Reformatting options include the choice of DCA or ASCII output files, with options to generate single-column output from multiple-column text.

Features:

- High recognition accuracy
- Fast, easy training
- Up to five fonts per page
- Handles ligatures and kerned type
- Foreign language character sets
- Spelling and context checking
- On-line correction
- Affordable at \$995.00

Flagstaff Engineering leads the PC industry in desktop conversion systems for 9-track tape and 8-inch diskette data files. We have already supplied thousands of customers worldwide with our OCR systems. Call for the best prices on Panasonic, Hewlett-Packard, and Canon scanners. Dealer and volume discounts are available.

Flagstaff Engineering can modify the software code to meet your custom applications. For details, call us at (602)779-3341.

*Syntactic Pattern Optical Translator

"JOIN" FLAGENG for vendor support on BIXI



1120 Kaibab Lane • Flagstaff, AZ 86001
(602)779-3341 • Telex 705609 • FAX (602)779-5998

Circle 288 on Reader Service Card (DEALERS: 289)



DR. POURNELLE VS. THE VIRUS

Jerry observes the West Coast Computer Faire and gives a prescription

I was late getting to the West Coast Computer Faire this year because William Lowell Putnam, the new sole trustee of the Lowell Observatory, appointed me to the observatory's advisory board. The board meeting was held the same week as the Faire, and while I've never missed a West Coast Computer Faire, I wasn't about to pass up the chance to look through the telescopes that Percival Lowell used to map Mars and Clyde Tombaugh discovered Pluto with.

Incidentally, while those are the best known of the Lowell Observatory's discoveries, the most significant thing done there was probably V. M. Slipher's discovery of the red shift and the recession of faraway galaxies.

Anyway, the meeting was held at the observatory on Mars Hill outside Flagstaff, Arizona, and while it wasn't a lot of trouble getting to Flagstaff, getting out of there in time for my speech at the Faire was a bit more difficult. I wasn't able to get to San Francisco until early Saturday morning.

Even so, I had time to see all the exhibits. I can remember when it just wasn't possible to see everything at the Faire, even getting in a day early and running hard every moment.

On the other hand, I did miss most of the conference sessions, which is a pity, because the Faire continues to attract the best speakers and panelists in the industry. Also, they talk about meaningful subjects rather than just hyping products, the way so many people do at other computer shows.

Although there seemed to be fewer booths, there was no shortage of people.

I'm told that once again there was a record attendance, and from the crowds I can believe it. There were the usual feeding frenzies at Jade, Jameco, and other large discount equipment vendors.

WordPerfect attracted its standard cheering crowds and got the standard complaints from other exhibitors. I have mixed emotions about that. On the one hand, having people cheer and shout in unison is a bit disruptive for those trying to conduct a more serious discussion of their products. On the other hand, WordPerfect certainly adds to the general air of excitement. I'm also curious as to how they get people to *do* it: when I was invited to give "the WordPerfect cheer," I managed one straight out of the Bronx. Oh, well.

Signs of the Times

Early Faires were dominated by Apple, which used it to get acquainted with hackers and end users. Apple now seems more interested in keeping their customers away from the rest of the microcomputer community. They hold their own shows and don't come to the Faire at all.

In the old days, we had serious discussions between CP/M, Radio Shack, and Apple users, and were able to get some cross-fertilization. When the IBM PC and compatibles came in, Apple was still there, and the debates were illuminating. That doesn't happen much anymore. The only Apple presence at the Faire are the stacks of Apple machine boxes at vendor booths.

Meanwhile, IBM, which used to all but ignore end users, comes to the Faire in a big way. Their impressive booth was filled with knowledgeable people, including a couple of genuine programmers, one of whom I actually managed to talk into removing his necktie. I hope they don't fire him.

Borland wasn't at the Faire, which surprised me. Neither was Microsoft, which wasn't a surprise since they haven't been coming for a while. I think both ought to

be there. It can't hurt the big language houses to come to the one place where hackers and language users get together. Neither Borland nor Microsoft has such perfect products that they can afford to ignore their customers.

For years, the biggest question at the Faire was which group would throw the largest and wildest party, Microsoft or *InfoWorld*, and this year neither one was there. I don't know about parties on Thursday and Friday, because I wasn't there.

Saturday evening, Logitech furnished a large open area, tortilla chips and dip, beverages, and no loud noises masquerading as entertainment, a perfect setting for conversations. For me it was the high point of the Faire: a place to sit and talk to everyone. A lot of people showed up, legendary figures from the early days, like Lee Felsenstein, as well as new users and readers. I sure hope Logitech makes that one an annual tradition.

One outfit that I'd as soon have skip the Faire is the FCC. Since they keep bureaucrat hours, they weren't there a good part of the time anyway; but I don't see why taxpayers should pay for them to be there at all. As far as I can see, the FCC's major role in the computer industry is to make it very difficult for start-up companies: it doesn't matter how well your machine is designed, you can't sell it until you get FCC approval, and that takes time and money; meaning that small undercapitalized outfits can't bootstrap their way to success. If the FCC had been around at the first West Coast Computer Faire, there would be few companies other than IBM and the Japanese. Apple wouldn't exist.

My vote for the most spectacular Faire exhibit goes to Koei, producer of two IBM PC games: *Nobunaga's Ambition* and *Romance of Three Kingdoms*. Both are strategic-level multiplayer games, one set in sixteenth-century Japan, and the other in Han dynasty China, which

continued

followed the Warring States period. The booth was decorated with fantastically beautiful Chinese and Japanese armor, and it attracted my attention from the other side of the hall. The games were shown only in demonstration versions; but from everything I can find out, the finished versions will be pretty spectacular, too.

Prodigy

BIX wasn't at the Faire, but several other on-line services, including General Electric's Genie, were.

The oddest one was Prodigy. Prodigy is a partnership of IBM and Sears, and it is supposed to be the on-line information service for the rest of us. You can't (as of April) subscribe to Prodigy just yet, but they did have an on-line demonstration, and they handed out demonstration disks that ape what Prodigy does on your home computer.

The demonstration disks say they can be "copied in whole and given to others solely for use in demonstrating the Prodigy service. Copying for any other use is prohibited by law." I can't conceive of any reason I'd want to copy the disk at all. My guess is that the joint venture got some of the IBM and Sears lawyers as a bonus. . . .

Anyway, Prodigy will shortly be available at a flat rate of \$9.95 a month for unlimited time on-line. They can do that because it isn't a conferencing system like BIX; it's mostly a one-way information service. You get news, weather reports, financial information, *Consumer Reports*, and special newsletters. The demonstration had messages from Sylvia Porter, John Dvorak, and Stewart Alsop.

There is a limited capability for sending messages to information providers (but not to other subscribers). I sent notes to Alsop and Dvorak, but so far neither has acknowledged getting them.

There are also advertisements: on every screen full of information, a significant part is taken up with an advertising blurb. You have the opportunity to expand the ad to a full page if you like. The ads weren't very clever, and I didn't have much temptation beyond curiosity to do that. I wonder how many paying customers will? For that matter, I wonder how many companies will "advertise" in the Prodigy format.

Prodigy is still under development, which is just as well. The demonstrated interface was pretty grim, simplified to the point of near imbecility. There are menus everywhere. No mouse support. It was all very slow. After watching it for a while, Brett Glass struck a pose and pro-

nounced it "Stodigy!" The people in the Prodigy booth were not amused.

We'll just have to wait and see. I wasn't terribly impressed by Prodigy at the Faire, and the demonstration disk hasn't changed my opinion; maybe when it's up for real it will be better. From what I've seen, though, for \$119.40 a year I'd rather have my local newspaper and the *Wall Street Journal*.

Trilogy

The West Coast Computer Faire has long been the spawning grounds for important microcomputer products. Dozens of start-ups—including MicroPro (WordStar), Broderbund, Logitech, and Sorcim (SuperCalc)—got their first real exposure at the Faire. It doesn't happen so often now, but it's still possible. Take, for example, Trilogy from Complete Logic Systems.

Trilogy is a new computer language. Now I know most of us put new languages a long way down on our needs list, but in fact there is room for one. I've written before that I wished I had a language that combined the logic/constraint features of Prolog with the procedural techniques of Pascal and the modularity of Modula-2. I even said it would be nice if the result was a bit faster than any of those.

Trilogy was designed to meet those criteria. It may have done that.

It's pretty easy to get the wrong idea about Trilogy. Indeed, Alex Lane's review in the March BYTE did just that; a Prolog expert, Lane compares Trilogy exclusively to Prolog, which is at least as wrong as my initial impulse to compare it exclusively to Pascal. The fact is that Trilogy combines many of the features of both languages. [Editor's note: *For more information on Alex Lane's review, see the letter on page 22.*]

Trilogy doesn't have the cut (!) operator or any other extra-logical additions put into Prolog to achieve efficiency. Instead, it uses IF...THEN...ELSE and CASE to achieve the same end, and it adds *constraints* to guide the logical solution without endless backtracking. This gives the language an enormous speed advantage in analyzing complex problems.

I haven't had a lot of time to play with Trilogy, but what I saw at the Faire and what I've been able to do with it here have really impressed me. I may use it to write a major program if Complete Logic Systems brings out the graphics and DOS modules in time (they're supposed to be finished before you read this). At my suggestion, they're also adding a number of I/O and string-handling functions that

should also be available when this is in print.

Deciding to adopt a new language is a pretty serious step. If it doesn't catch on, you could find yourself with a useless orphan. On the other hand, if it works but doesn't catch on, you might find yourself with a secret weapon that dramatically improves your productivity; after all, users don't care what language an application program is written in.

My impression of Trilogy is that it's fast and easier for a Pascal programmer to learn than Prolog is. More as I experiment more; but if you're interested in logic programming languages, you might want to look into Trilogy. Incidentally, Peter Grogono, whose *Programming in Pascal* (Addison-Wesley, 1980) is one of the best language books I've ever seen (it has the best explanation of pointers in any book on any language), is doing a book on Trilogy, so I'm not alone in my impression that it may have the potential to be one of the "big" languages like Prolog or Pascal. Recommended for those willing to take a chance.

Virus

The specter of computer piracy stalks the land. One promising new start-up company recently called me to ask my view of yet another copy-protection scheme, this time a hardware device that plugs into the printer port where it is transparent to printing but responds to coded inquiries in a way that enables the software.

Hackers call this a "dongle," and I won't put one on my computer. Leave alone the problem that it's not easy to access the back of my machines, and that if very many companies do this I'll have a train of dongles 2 feet long sticking out of the printer port: the real problem is that I don't know precisely what the thing is doing. If I did know, the dongle would be useless.

For all I know, the gizmo may infect my machine with a virus. Now, sure, no reputable company would do that—but companies don't always know what's going on. Recall that back when Microsoft used copy protection—to their credit they abandoned that a few years ago—a summer hire inserted deep into the Microsoft kernel a worm that, on detecting what it thought was an illegal copy of a Microsoft program, said Illegal Copy. Now trashing your master disk.

In fact, the worm did nothing of the sort, but no one who saw that message was amused, especially since it could be triggered by a bad disk or a power failure. How am I to know that the guy who wrote the dongle PROM doesn't have an even

weirder sense of humor?

Some people do. Someone once took the trouble to make up a board and sent it to me for "evaluation." I forget what the cover letter said it would do, but I got suspicious and wouldn't put it in my machine. I later learned that copies went to several others. One editor turned the thing over to Brett Glass, who disassembled the PROMs and discovered that if the board were in the machine on boot-up, it would change the partitions on your hard disk drive, rendering it unusable until reformatted. I don't know anyone who got burned by this elaborate scheme, but it does show there are some sick people out there.

Anyway, I won't use a dongle for fear of catching a fatal computer virus; but interestingly enough, the fear of a virus may help mitigate the software piracy problem (which, except with games, I think is less severe than most suppose; but leave that for another time).

A computer virus is eerily similar to a real one: what it does is infect a computer program, often the operating system, then await a chance to reproduce itself. A virus can be stupid, like the board I described above, or quite clever. Simple viruses add themselves to programs and can be detected by a check of program size.

More clever ones find empty areas in the program and hide there. Sometimes they hide only a tiny part of themselves in the infected program; that part points to a new file disguised as an ordinary system file that is generally hidden from the user's view. They all try to reproduce themselves by examining susceptible files for hiding places.

What happens next depends on the virus's creator. Some hackers only want to prove they're clever. An example of that was the Christmas Message Virus that went around last year. Even so, adding needless code to a system can have unintended but disastrous side effects.

Many viruses are deliberately destructive. There was the Lehigh Virus, which infected hundreds of disks at Lehigh University. After sitting about harmlessly for days, the virus woke up and erased all data on infected systems. Backup copies were often similarly affected, so that some users were bitten more than once.

I have also heard of the Israeli Virus, although I never met anyone who has actually seen it. This one is supposed to do nasty things on May 13, 1988, the fortieth anniversary of the founding of Israel (and the extinction of Palestine as a sovereign state). It is said to be defused.

The Israeli Virus may be a legend, but

many are not; one bulletin board sysop found that a full 15 percent of the programs posted on his board were infected. If he counted only programs posted by people he didn't know, the percentage went up to about 50 percent. Many sysops are getting scared enough to deny upload capabilities to new users. Recent reports in the *Wall Street Journal* indicate that a number of businesses have infected computers. Viruses can affect Macintoshes as well as PC compatibles.

The best way to avoid computer virus infections is to be careful where you get software. If you don't put strange programs in your system, you can't get strange results. That "free" copy of a program you got from a bulletin board may be more costly than you think. You're not even safe getting pirated software from a friend; even if there have been no signs of infection, some virus programs don't wake up for a long time.

continued

Write Better Turbo 4.0 Programs... Or Your Money Back

You'll write better Turbo Pascal 4.0 programs easier and faster using the powerful analytical tools of **Turbo Analyst 4.0**.

You get • Pascal Formatter • Cross Referencer • Program Indexer • Program Lister • Execution Profiler, and more. Includes complete source code.

Turbo Analyst 4.0 is the successor to the acclaimed TurboPower Utilities:

"If you own Turbo Pascal you should own the Turbo Power Programmers Utilities, that's all there is to it."

Bruce Webster, BYTE Magazine, Feb. 1986

Turbo Analyst 4.0 is only \$75.



A Library of Essential Routines

Turbo Professional 4.0 is a library of more than 400 state-of-the-art routines optimized for Turbo Pascal 4.0. It includes complete source code, comprehensive documentation, and demo

programs that are powerful and useful. Includes • TSR management • Menu, window, and data entry routines • BCD • Large arrays, and more.

Turbo Professional 4.0 is only \$99.

Call toll-free for credit card orders.

1-800-538-8157 ext. 830 (1-800-672-3470 ext. 830 in CA)

Satisfaction guaranteed or your money back within 30 days.



Fast Response Series:

- T-DebugPLUS 4.0—Symbolic run-time debugger for Turbo 4.0, only \$45. (\$90 with source code)
- Overlay Manager 4.0—Use overlays and chain in Turbo 4.0, only \$45. Call for upgrade information.

Turbo Pascal 4.0 is required. Owners of TurboPower Utilities w/o source may upgrade for \$40, w/source, \$25. Include your serial number. For other information call 408-438-8608. Shipping & taxes prepaid in U.S. & Canada. Elsewhere add \$12 per item.

TURBO
Power

TurboPower Software
P. O. Box 66747
Scotts Valley, CA 95066-0747

Vaccine

One possible defense is to use a "vaccine" program.

Obtaining one is a simple matter if you're on BIX: simply download the program called Flushot. This was written by one of the BIX regulars; people I respect say it's very good. Fair warning: I have not tried it yet and know it only by reputation.

You can also get a vaccine from a commercial source.

There were at least two at the Faire. One, called Vaccine, is published by FoundationWare. I didn't get a copy of the program, but that could be because I missed their cocktail party Friday night. I mention them because they had an impressive booth and gave out expensive brochures that contain both hype about their program and some pretty good (if sensorially presented) information about computer viruses.

FoundationWare's brochure says Vac-

cine gives "5 levels" of protection. The first is to write-protect critical system files, like COMMAND.COM, and watch out for unusual disk writes that bypass DOS. The second level is to write-protect the hard disk drive. In both cases, if the program detects a write operation, it asks if you really want to do that.

Their third level is what they call the "Quality Assurance Mode"; it appears to be a checksum program that runs against COMMAND.COM, CONFIG.SYS, and other critical files each time you start up the system or invoke Vaccine. They say this will reduce the odds of virus infection to one in a billion. I hereby offer to bet 10 of my dollars against 10 million of theirs that their program will fail within a year. I might be wrong, but I sure like the odds.

The other virus-protection program I saw at the Faire was Mace Vaccine, from Paul Mace Software. This is a 4K-byte memory-resident program to be installed using AUTOEXEC.BAT. Once invoked, it offers two levels of protection: (1) write protection of vital areas and system files, and (2) protection against all direct writes, things like DOS FORMAT, CHKDSK/F, DEBUG, Vopt, and UNFRAG; other disk optimizers; and, hopefully, viruses.

Whereas FoundationWare says of their program, "The probability of a system 'fully secured' by Vaccine having a disastrous and damaging write-to-disk by an unauthorized or altered software program is less than 1 in 100 million," Mace says, "Understand, the people who make these things are clever and we haven't seen their worst. We're clever too, and will keep on improving the vaccine. We can only hope they will tire of this malicious nonsense before we do." I leave it to the reader to decide which is the more reasonable attitude.

Mace, you'll recall, is the publisher of the Mace Utilities, which I consider to be nearly as essential as DOS.

VP-Planner Plus

VP-Planner Plus, the flagship product of Adam Osborne's Paperback Software, has always offered at least as much bang for the buck as any other spreadsheet. Version 2 is even faster—the fastest spreadsheet around—and adds do/undo keys. There's not a lot that Lotus 1-2-3 and Borland's Quattro can do that VP-Planner Plus can't match, and neither can hold a candle to it when it comes to macro power. Excel can, and with a 386, Excel under Windows is a thing to behold; but it costs a lot more, too. Unlike

continued

HOW TO GIVE YOUR COMPANY A PIECE OF YOUR MIND.

Your company's most valuable resource is the knowledge and expertise of your key people. That's why you want to capture that expertise with 1st-CLASS Expert Systems so you can use it whenever and wherever needed.

The power you need. Without the programming. 1st-CLASS[®] is the expert system development tool you've been waiting for. It's full-featured and flexible, yet exceptionally easy to use. Multiple knowledge representations, and interfaces to windows, graphics, and programs (including Lotus 1-2-3[®] and dBASE[®]) make it powerful enough for technical people, yet simple enough for those with no programming or artificial intelligence experience.

Benefits you'll see right away. Because 1st-CLASS is so easy to use, it starts delivering benefits right away. Accu-

rate and consistent decisions throughout your company. Reduced costs in manufacturing and support. And above all, a chance to apply the expertise of your best people to more situations than ever before.

Whether you're a startup or a Fortune 500, you'll quickly find 1st-CLASS a great help for your entire organization. Just as Du Pont, Travelers, Chrysler, Intel, IBM, and over 5000 others have already found out for themselves.

Priced from \$495 to \$1295. No fancy hardware required (just IBM or compatible PC). And no royalty fees or other hidden charges later on.

Ask for your tutorial package. It has everything you need to get moving fast, including a trial version of our newest release, 1st-CLASS FUSION.[™]

Why wait? Call toll-free today to order your tutorial package: 1-800-872-8812.

1st-CLASS
Expert Systems, Inc.

286 Boston Post Road Wayland, MA 01778 (617-358-7722 in MA).

For the IBM[®]PC. For the DEC VAX[®](with added hardware). Priced from \$495 to \$1295. Tutorial package only \$20.

THE PROGRAMMER'S SHOP

helps save time, money, and cut frustrations. Compare, evaluate, and find products.

SPECIAL PRICES on DBMS Tools

	List	Normal	SPECIAL
• XDB-SQL - DBMS with SQL	\$495	\$449	\$409
• CQL - for c-tree, Btrieve, CBTREE	\$395	\$329	\$309
• XQL - Novell-compatible	\$795	\$599	\$549
• Informix SQL - ANSI Standard	\$795	\$739	\$699
• Informix 4GL - application builder	\$995	\$919	\$879
• R:Base for DOS - latest version	\$725	\$549	\$509
• CLARION Database Development Environment - buy at our normal discounted price, get dBASE III, Finance, or CommLanguage Extension Module FREE.			

Call before July 31, 1988 and mention "BY 788" for these Special Prices.

386 Development Tools

386 Assembler/Linker	PC	\$ 389
386 Debug - by Phar Lap	PC	\$ 129
386/DOS Extender	PC	\$ 919
DESQview PS/2	PC	\$ 109
F77L-EM - by Lahey	MS	Call
FOXBASE + /386	PC	\$ 419
High C - by MetaWare	PC	Call
OS/286 & 386 by AI Architects	PC	Call
Paradox 386	MS	Call

C Language Compilers

AZTEC C86 - Commercial	PC	\$ 499
C86 PLUS - by CI	MS	\$ 359
High C Optimizing Compiler	PC	Call
Instant-C/16M	PC	Call
Lattice C - from Lattice	MS	\$ 259
Microsoft C 5.1 - with Codeview	MS	\$ 289
Microsoft Quick C	MS	\$ 69
NDP C-386 by MicroWay	MS	\$ 529
Turbo C by Borland	PC	\$ 67
Watcom C6.0	MS	\$ 259

C-terp by Gimpel - full K & R	MS	\$ 219
C Trainer - by Catalytic	PC	\$ 89
Interactive C by IMPACC Associates	PC	\$ 189
Run/C Professional	MS	\$ 145
Run/C	MS	\$ 79
Turbo C-terp	PC	\$ 119

C Libraries-Files

BTree/ASAM - Single user	MS	\$ 99
CBTREE - Source, no royalties	MS	\$ 109
c-tree by Faircom - no royalties	MS	\$ 309
r-tree - report generation	PC	\$ 239
dB2C Toolkit V2.0	MS	\$ 259
db_VISTA - Source	MS	Call

Blackstar C Function Library	PC	\$ 99
C Tools Plus - V5.0	PC	\$ 99
C Utilities by Essential	PC	\$ 119
Greenleaf C Sampler	PC	\$ 69
Greenleaf Functions	PC	\$ 129
LIGHT TOOLS by Blaise	PC	\$ 69
Turbo C Tools by Blaise	PC	\$ 99

C-Screens, Windows, Graphics

C Display Manager	PC	\$ 109
C-Worthy Interface Library	PC	\$ 249
dBASE Graphics for C	PC	\$ 69
ESSENTIAL GRAPHICS - fast	PC	\$ 235
Graphic - new color version	PC	\$ 279
Greenleaf Data Windows w/source	PC	\$ 155
Quick Window/C	PC	\$ 259
Terminal Mapping System	PC	\$ 75
TurboWINDOW/C - for Turbo C	PC	\$ 279
VC Screen	PC	\$ 75
View Manager by Blaise	PC	\$ 119
Vitamin C - source, menus	PC	\$ 199
Windows for C - fast	PC	\$ 159
Windows for C - validation	PC	Call
Windows for Data - validation	PC	Call

Note: All prices subject to change without notice. Mention this ad. Some prices are specials. Ask about COD and POs. Formats: 3" laptop now available, plus 200 others. UPS surface shipping add \$3 per normal item.

RECENT DISCOVERY

dBASE IV - features new user interface "Control Center." Multiuser file/record locking, "ANSI + " SQL, Query By Example. 255 field records, 99 files open. Parent-child file relations. DOS shell. PC \$ 499

DataBase & File Management

Advanced Revelation	PC	\$ 779
DataFlex by Data Access	PC	\$ 595
DataFlex multiuser	PC	\$ 1049
Magic PC - visual database	PC	\$ 169
Paradox V2.0 List: \$725	PC	\$ 499
Paradox Network Pack	PC	\$ 719
XDB-SQL Database	MS	\$ 449

Dbase Language

Clipper compiler	PC	\$ 389
dBASE III Plus	PC	\$ 399
dBASE III LANPack	PC	\$ 649
DBXL Interpreter by Word Tech	PC	\$ 99
FoxBASE + V2.0	MS	\$ 259
QuickSilver Diamond	PC	\$ 369

dBASE Tools for C	PC	\$ 65
dBRIEF with BRIEF	PC	Call
dBC III by Lattice	MS	\$ 169
Documotor - dFlow superset	MS	\$ 229
Genifer by Bytel - code generator	MS	\$ 249
Networker Plus	MS	\$ 229
QuickCode III Plus	MS	\$ 189
R&R Report Writer	MS	\$ 139
Seek-It - Query-by-example	PC	\$ 79
Silver Comm Library	MS	\$ 139
Tom Rettig's Library	PC	\$ 79
UI Programmer - user interfaces	PC	\$ 249

ASMLIB - 170+ routines	PC	\$ 125
Back-It by Gazelle	MS	\$ 119
Baler	PC	\$ 459
CO/SESSION - remote access	PC	\$ 229
Dan Bricklin's Demo II	PC	\$ 169
Disk Technician - smart upkeep	PC	\$ 89
Fast Back Plus	PC	\$ 149
Flash-Up	PC	\$ 69
Easy Flow V5.0	PC	\$ 125
Link & Locate	MS	\$ 309
Mace Utilities	MS	\$ 85
MKS RCS	MS	\$ 155
PC/Tools Deluxe-by Custom	PC	\$ 69
Plink 86 PLUS - overlays	MS	\$ 275
PVCS Corporate - by Polytron	PC	\$ 339
PVCS Personal	PC	\$ 135
R-DOC/X	MS	\$ 135
Show Partner F/X	PC	\$ 328
Seidl Version Manager	MS	\$ 269
Source Print - V3.0	PC	\$ 75
TLIB	PC	\$ 89
Tree Diagrammer	PC	\$ 65
Visible Computer: 8088	PC	\$ 65
WKS Library by Tenon	PC	\$ 79

Fortran-C Translator

For_C by Cobalt Blue - complete F77 to C optimizing translator, 99% efficiency, MIL-STD-1753 and common F77 extension support. Runtime libraries with complete C source. MS \$ 659

BRIEF™ Users:
Now you can have fast compilation AND an integrated, productive environment.

Over 5,000 of you were forced to make sacrifices to use BRIEF. The Programmer's Editor. Advanced compilers and new programming environments, like Turbo C and QuickBASIC, took up so much RAM that BRIEF could not fit in the same 640k.

If you wanted to retain BRIEF's uniquely powerful features¹ while working with larger programs, you had to sacrifice speed and continuity. Instead of a tight Edit-Compile-Edit loop, you had to slog through an obsolete Edit-Exit-Compile-Exit-Edit loop.

Now you no longer have to make that sacrifice.

You can enjoy the features¹ that have made BRIEF the best-selling and the best regarded² programmer's editor without sacrificing environment integration.

Version 2.1 of BRIEF can be swapped in and out with a single keystroke — allowing immediate compilation with even the largest compilers: Microsoft C5.0, QuickC, Turbo C, Lattice C, dBXL, FoxBASE+ v2.0, Clipper, etc.

¹ For example: real multi-level Undo (not simply Undo/redo), flexible windowing, unlimited file size, unlimited number of simultaneous files, automatic language sensitive indentation.

² For example: "The quintessential programmer's editor." — *Dr. Dobb's Journal* "Right out of the box, it's a versatile, extremely powerful editor that handles most any programming task with aplomb." — *Computer Language* "Simple to learn and use and extremely sophisticated. Strongly recommended." — *PC Magazine* "Not only the best programmer's text editor I've ever seen, but it is also a tour de force in the way it was conceived and implemented." — *Computerworld* "So far surpasses users' expectations that it is revolutionary." — *MicroTimes Magazine* "BRIEF is truly outstanding." — *Microsoft Systems Journal*

Current BRIEF Users:

Call Ann for details on 4 other important enhancements. Registered users of versions 2.0 or 2.01 update for only \$35.

Haven't tried BRIEF yet?

BRIEF retails for \$195. Call Ann today for a no-risk, 60-day trial with a full, money-back guarantee.

Call toll-free today
800-821-2492

Solution Systems™

541 Main Street, Suite 410
South Weymouth, MA 02190
617-337-6963

THE PROGRAMMER'S SHOP

Your complete source for software, services and answers

5-B Pond Park Road, Hingham, MA 02043
Mass: 800-442-8070 or 617-740-2510 5/88

Call for a catalog, literature, and solid value

800-421-8006

POWER TOOL.

Introducing 4x488™

You get intelligent IEEE-488 and RS232 ports to make instrument programming fast and easy.

You can have up to 4 Mbytes of memory on the same board for your largest programs, RAM disks, and data acquisition tasks.

Compatibility is built-in so you can run your favorite programs or create new ones with our advanced programming tools.

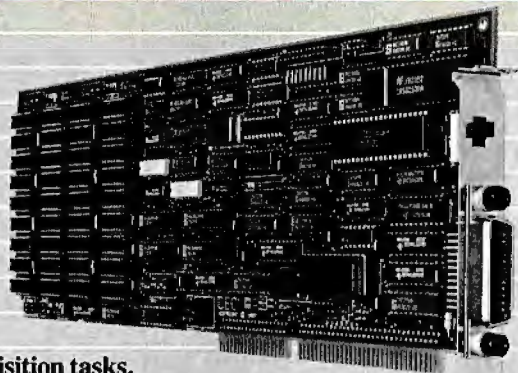

To get your FREE demo disk—call 617-273-1818.



Capital Equipment Corp.
Burlington, MA 01803

The bottom line—IEEE-488, RS232, par. port, 4MB EEM LIM, runs DOS and OS/2.

“IT MAKES PROCOMM LOOK LIKE AMATEURCOM.”

If you talk to a DEC mainframe, no software emulates the VT220, VT100 or VT52 terminal more accurately or professionally than VTERM.

Hot keys. Kermit. Automatic reformatting for spreadsheets and databases. VTERM has it all.

Why not join the 60,000 users of VTERM (many of whom moved up from Procomm). And try the DEC terminal emulation package that's in a totally different league.

FREE EVALUATION KIT.

Yes, send me a free time-limited, full-blown working copy of VTERM/220, which is mine to keep.

Name _____

Title _____

Company _____

Address _____

Telephone (____) _____

I am a user dealer . Mail to:

Coefficient Systems Corporation

611 Broadway, New York, New York 10012 (212) 777-6707 BYP-7/88

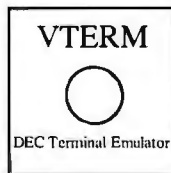

VTERM refers to VTERM/220, VTERM/4010, etc. products from Coefficient Systems Corporation. Procomm is a trademark of Datastorm Technologies, Inc.

Questions? Want faster action? Call (212) 777.6707, ext. 417.

Quattro and 1-2-3, VP-Planner Plus has a handy text editor and report generator. All in all, it's a more-than-just-adequate package.

Paperback Software began with tirades and crusades; I recall Dr. Osborne's speech about "obscenely high retail prices" given the low cost of software production. For all that, his prices have been creeping ever higher. I suspect it's because Osborne, like many others, has run up against a curious fact about the computer market: within wide limits, computer software doesn't obey the classical laws of economic demand.

If you prefer to say it exhibits an unusual demand curve structure, feel free. The bottom line is that lower prices do not necessarily result in more sales. One reason is dealers: unless the list price is reasonably high, there is not enough profit in it to serve dealers and distributors. In any event, the street price of VP-Planner Plus is lower than Quattro, but not all that dramatically so.

Anyway, VP-Planner Plus is a good, solid spreadsheet and limited database program, complete with a text editor, oodles of statistical and mathematical functions, good macro capability, and, as they say, much more. The newest version is a definite improvement over the last one, too. Lotus 1-2-3 remains the "standard" spreadsheet; Quattro is running hard to catch up; Excel under Windows is as nice on the IBM PC as it was on the Mac; but when you come down to it, nearly any job that you can do with the others can be done with VP-Planner Plus. They're all good enough for any job I've needed a spreadsheet for.

The Transfer Game

One perennial visitor to the Faire is Xenosoft. The booth tends to be a hang-out for hackers, which is one reason I spend more time there than most places. Xenosoft's only current product is Xeno-Copy-PC, which is one of those programs you don't need often, but when you do need it not much else will do.

Some of you may not remember the bad old days of 5¼-inch-disk CP/M, when every computer company had its own notion of how 5¼-inch floppy disks ought to be formatted, with the result that you couldn't transfer programs from one machine to another without a great deal of work.

IBM and PC-DOS ended all that. Actually, we still have the problem that high-density IBM PC AT floppy disk drives can read IBM PC XT floppies all right, but they can't write anything the IBM PC can read reliably; still, that's

CHAOS MANOR

nothing compared to the mess we had back in the old days.

Anyway, XenoCopy-PC is a program that will read foreign disks and transfer their files. It will handle about 200 5¼-inch formats and a dozen or so 8-inch formats; it can also format blank disks into those foreign formats, so you can use your PC to, say, read a disk made by a Bondwell 12, then format a disk for the Epson QX-10 and transfer to that.

Just after I got home from the Faire, Norman Spinrad called me. Years ago, partly on my advice, Norman bought a Kaypro 10 CP/M system. He wrote several novels and most of his book review columns on it. The machine still works fine, but Norman kept hearing about all the new software available for PCCompatibles; and when he needed a portable machine to take on location, he decided to change to a PCcompatible.

After consulting with me, he bought a Zenith Z-183. He clearly likes it: he just ordered a second one for Lee Wood, his fiancée and traveling companion. I've always said the best maintenance policy is a second computer, and that's especially true if you're traveling.

The Z-183, like most laptops, uses 3½-inch floppy disks. It's no big deal to transfer files between the Z-183 and a PCcompatible desktop; but Norman just got a contract to turn some of his columns for *Isaac Asimov's Science Fiction Magazine* into a book, and those columns were written on the Kaypro 10.

"No problem," I told him when he called. "We'll use XenoCopy-PC to move them onto my Zenith 386 and then pipe them over to your machine with LapLink."

There was only one problem. When Norman got here, I couldn't find XenoCopy-PC. I still can't imagine what happened to it: I *know* they handed me one at the Faire. In some embarrassment, I called Fred Cisin at Xenosoft and left a message on his machine.

"Well, I've got this CP/M program called Uniform," Norman said. "It's supposed to let the Kaypro write stuff an IBM can read, but it says first you have to format the disks with a PC." (Workman and Associates sell Uniform.)

That was no problem. You can't trust a high-density AT floppy disk drive to format 360K-byte PC disks, but my new Cheetah 386 system has an old-fashioned 360K-byte standard floppy disk drive as the B drive. This would be a good test of the Priam enhanced-small-device-interface controller. The controller's main job is the 330-megabyte hard disk drive, but

continued

LAHEY SETS NEW FORTRAN STANDARDS

LAHEY PERSONAL FORTRAN 77 **\$95**

Low cost, Full 77 Standard, Debugger, Fast Compilation

F77L FORTRAN LANGUAGE SYSTEM **\$477**

For porting or developing, this is the critics' choice.

"Editor's Choice" *PC Magazine*
 "... the most robust compiler tested." *Micro/Systems*
 "... the most efficient and productive FORTRAN development tool
 for the DOS environment" *David W. Burleigh, BYTE 11/87*

F77L-EM/16-bit **\$695** **F77L-EM/32-bit** **\$895**

Break through the DOS 640K barrier. The most powerful PC Fortran Language Systems for downloading or writing large programs.

PRODUCTIVITY TOOLS

Profiler, ULI Mathematical Functions Library, Overlay Linker, Toolkit, Utility Libraries, Windows, Memory Boards, 80386 HummingBoard.

IF YOU DEMAND THE VERY BEST, THEN YOU SHOULD BE USING LAHEY.
 CALL US TO DISCUSS YOUR PC FORTRAN NEEDS.

CALL FOR NEW FEATURES INCLUDING MATH COPROCESSOR EMULATION

30 DAY MONEY-BACK GUARANTEE

FOR INFORMATION OR TO ORDER:

1-800-548-4778

Lahey Computer Systems, Inc.

P.O. Box 6091, Incline Village, NV 89450

TEL: 702-831-2500 TLX: 9102401256

FAX: 702-831-8123



"IT MAKES C-C-CROSSTALK SEEM T-T-TONGUE-TIED."

If you're talking to a DEC mainframe, no communication software emulates the VT220, VT100 or VT52 terminal more accurately, easily, or eloquently than VTERM.

Hot keys. Kermit. Automatic reformatting for spreadsheets and databases. VTERM has it all.

Why not join the 60,000 users of VTERM (many of whom moved up from Crosstalk). And try the DEC terminal emulation package that has everyone in the business buzzing.

FREE EVALUATION KIT.

Yes, send me a free time-limited, full-blown working copy of VTERM/220, which is mine to keep.

Name _____

Title _____

Company _____

Address _____

Telephone (____) _____

I am a user dealer Mail to:

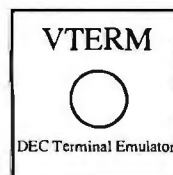

Coefficient Systems Corporation

611 Broadway, New York, New York 10012 (212) 777-6707 BYC-7/88

VTERM refers to VTERM/220, VTERM/4010, etc. products from Coefficient Systems Corporation.
 Crosstalk is a trademark of Digital Communications Associates, Inc.

Questions? Want faster action? Call (212) 777-6707, ext. 418.

I don't know what I'm doing because the Amiga has a goofy operating system. In fact, it has two of them. First, there's the icon-based system based on work done at Xerox's Palo Alto Research Center; it's similar to Windows, Niklaus Wirth's Lilith, or the Mac. Behind that is the command line interface (CLI), which sort of works like DOS.

Now the idea of having both icon command and CLI systems is a very good one; but the Amiga implementation of it leaves a *lot* to be desired. For one thing, the CLI system is harder to learn than DOS, doubly so because the commands are, for some silly reason, just slightly different from DOS. For another, if applications programmers don't create proper icons, you must use the CLI; but the user must deliberately turn on the CLI, and if I don't use it regularly, I forget how it works.

When we first got the Amiga 2000, I invited several Amiga experts, including Joanne Dow ("jdow" on BIX) and David Joyner ("talin" on BIX), to help set it up. One thing we wanted to do was test a number of speedup boards for the PC side since what comes standard is very vanilla (and thus slow). We tried a Sota MotherCard; genuine Intel boards, both 286 and 386; and a few others.

Alas, none of them worked, because Commodore employs the same interrupts to communicate between the Amiga and the PC sides that the PC enhancement boards use. I don't have one, but I understand there are boards, including at least one 386 board, that do work. At the moment, though, the Amiga runs all my PC software exactly as fast as the original 1981 PC. The Atari Mega ST using an emulator runs PC software even slower, about 80 percent of the PC's speed. I don't often use PC software on either machine, but that could change when I get a 386 card.

The Amiga 2000 has a lot more memory than my original Amiga did. Incidentally, I sent that Amiga off to be used in some Lunar Society experiments, and Henry Vanderbilt ("hvanderbilt" on BIX) found that it had a defective mouse: the left mouse button worked most of the time, but it would sometimes fail. That may have been the reason for some of the problems I had; but mostly, I think, I just kept running out of memory. That does not happen with the 2000.

I've had the Amiga 2000 for some months now. In some ways, it's still the most exciting machine I have. It's terrific for games. It's great for artists. There's a lot of fun software for it. It can be blooming frustrating to work with, but the re-

sults are often worth it. If you like computers and know what you're doing, it can be one terrific machine. I would *not* recommend it for people just trying to get some work done.

Dream Machines

When IBM first brought out the Micro Channel bus, I liked it a lot. Now I'm not so sure.

One thing is certain: you don't need the new bus to get a lot of speed from a

PC; at least you don't if you have a Cheetah 386 motherboard.

The Cheetah 386 is the hottest machine here. It has Intel 20-MHz 80386 and 80387 chips, a Priam 330-megabyte internal hard disk drive, an Award BIOS, an Award EGA/VGA board (that at the moment connects as EGA to the Logitech Autosync monitor but works fine as VGA with the Electrohome 19-inch monitor), and a Maximum Systems WORM (write

continued

HOW DO YOU GET A JOB WITHOUT EXPERIENCE? AND HOW DO YOU GET EXPERIENCE WITHOUT A JOB?

Most young people have one answer to this problem. They avoid it until they're out of college. But they could be getting solid work experience while they're still in college. With your company's help. And ours.

We're Co-op Education. A nationwide program that helps college students get real jobs for real pay, while they're getting an education.

But we can't do it without you.

Those real jobs have to come from real companies. Like yours.

For more information on how you can participate in this valuable program, write Co-op Education, Box 775E, Boston, MA 02115.

Not only will you be giving students a chance to earn money and pick up the most valuable kind of knowledge, you'll be giving yourselves a chance to pick up the most valuable kind of employee.

Co-op Education.

You earn a future when you earn a degree.



A Public Service of This Publication ©1987 National Commission for Cooperative Education

once, read many) drive. It also has 8 megabytes of fast Cheetah memory.

My Cheetah 386 is in a "tower" configuration (i.e., it sits on edge on the floor, but the floppy disk drives are horizontal). The tower has a number of advantages. The boards are kept cooler. It doesn't take up space on the desk. The reset button and power switch are on the front, where they're easy to reach. The main disadvantage is that I had to get extension cables for my

video board and the mouse.

Anyway, you don't need to put the Cheetah board in a tower; it's made to drop into any IBM PC AT case. If you replace your 80286 motherboard with the Cheetah 386 board, you'll have a machine as fast as any PS/2, without the expense. The really neat part is that if I get faster Intel chips, I can step up the speed to 25 MHz and maybe faster. There's also software to slow the Cheetah down for real-time programs like games.

The Cheetah has become our major experimental machine: we're setting it up to run Santa Cruz Operations Unix. That's said to run DOS programs. Since I got the American Management Systems' Unix Directory Shell, I'm not so afraid of Unix; indeed, I'm actually looking forward to getting DOS-under-Unix up and running. We'll see.

WORMS

The Cheetah tower has a Priam Inner-Space hard disk drive. This thing is awesome. Not only does it have 330 megabytes formatted, but the access time is 11 milliseconds! It's reliable, too. Priam invented the technique of mechanically lifting the disk head on power-down or power failure and a number of other safety features. I've had several machines with Priam hard disk drives, and so far I have not had a single problem. I don't anticipate any with this one.

I don't anticipate trouble, but I still like to back up my data. The only trouble is that even with Fastback, backing up data takes enough time and trouble that I don't do it often; at least I didn't until I got WORMs.

I already had an Information Storage WORM drive on my Zenith Z-386, and that works fine. The Cheetah tower came with another WORM, the APX-3200 from Maximum Storage. As I understand it, Maximum Storage licenses hardware technology from Information Storage but developed their own WORM operating system.

Whatever they did, this thing is a bloody wonder. It's as simple to use as any drive I have. You can even "erase" files if, like me, you manage to write them onto the wrong subdirectory. Of course, the files aren't really erased anymore than a file is erased if you save another with the same name to the same subdirectory. In both cases, you can use Maximum Storage's XDIR program to find previous versions of a file and CPY to copy any version anywhere you like.

The WORM is a wonderful backup system. Removable WORM cartridges cost about \$100 and hold 300 megabytes, and for all practical purposes, the copies made on the WORM are eternal. I routinely copy everything. With novels, I even copy new work onto a separate cartridge I keep in my box at American Vault.

WORMs are also great for software developers.

Did it ever happen? You did some programming work; tested the new version and liked it; and when you saved it, you erased the old. Later you discover a hid-

ONLY FORTRON COMES WITH ONE FULL YEAR OF SERVICE. FREE. ON-SITE.

When you buy any Fortron 286 and 386-based IBM-compatible, one full year of service at your site is part of the package. Just call the service hotline, and we'll take care of you from a network of 300 service locations throughout the country.

Because we design and build our systems right here, ourselves, you always know exactly who to call for any kind of support you need. And you'll get it. Fast.

Call toll-free for more information, and for the name of your nearest Fortron dealer: 800-821-9771. In California, (408) 432-1191.



Small Footprint 80286



80386, 16 MHz or 20 MHz



80286 12, 16, or 20 MHz

FORTRON

2380 Qume Drive, Ste. F
San Jose, CA 95131

den bug; something that used to work won't work at all. If you had the old code you could compare, but you don't have it.

That won't happen if you back up everything onto a WORM, because you can always go back through the versions and select whichever one you like.

You can also run programs off a WORM drive, meaning that you can put your compilers, editors, and other large programs you never write to on the WORM to save hard disk drive space. If you have a Priam InnerSpace, you may not need to do that for a while, but consider this: since nothing can alter a WORM file, a WORM is the ultimate in protection from virus infections.

I've been using the Maximum Storage WORM for about a month and have 100 megabytes of files on it. I've yet to have a problem.

If you're in the software development business; if you write books on a PC; if you develop valuable data; you have to be nuts not to get a WORM. It's faster and easier to use than any other backup system I've seen, including tape.

Winding Down

I'm completely out of space, and once again my desk is piled high with stuff I meant to tell you about. We're taking another look at Fact Cruncher; Lattice has a new data-encryption system that works like a charm; MacInTax and Excel both work beautifully with the IBM PC, so you don't have to buy a Mac to use those wonderful programs; and if you have any interest in self-replicating systems, you will *love* Cellular Automata, a \$34.95 program from Intelligrafix to create graphics life on your PC. Just be careful you don't spend so much time with it that you don't do anything else.

The book of the month is by Martin van Creveld, *Command in War* (Harvard University Press, 1985). Creveld is a professor of history at the Hebrew University of Jerusalem, and he has a fresh and valuable approach to military history.

The text editor of the month is the newest version of Q&A Write, which fixes most of the problems I mentioned in previous reviews. I'll say one thing about Symantec, they *listen*. The utility of the month is Word Exchange. This thing painlessly translates formatted Microsoft Word text files to and from a number of formats, including DisplayWrite (2, 3, and 4), WordPerfect, WordStar, Wang PC, and a bunch of others. It will even read and analyze an ASCII file to make guesses about page lengths, centering, headers, footers, and so forth. Since it

<h2>Items Discussed</h2>	
APX-3200 \$2675 Maximum Storage 5025 Centennial Blvd. Colorado Springs, CO 80919 (719) 531-6888 Inquiry 935.	Trilogy \$99.95 Complete Logic Systems 741 Blueridge Ave. North Vancouver, BC Canada V7R 2J5 (604) 986-3234 Inquiry 941.
Cheetah 386 Motherboard 16 MHz..... \$1495 20 MHz..... \$1995 Cheetah International 107 Community Blvd. Suite 5 Longview, TX 75602 (800) 243-3824 Inquiry 936.	Unix Directory Shell 80286\$349 80386\$495 American Management Systems Departmental Systems Group 1777 North Kent St. Arlington, VA 22209 (800) 832-8668 Inquiry 942.
InnerSpace \$4890 Priam Corp. 20 West Montague Expy. San Jose, CA 95134 (408) 434-9300 Inquiry 937.	Vaccine\$189 FoundationWare 2135 Renrock Rd. Cleveland, OH 44118 (800) 733-8737 Inquiry 943.
Mace Vaccine \$20 Paul Mace Software 400 Williamson Way Ashland, OR 97520 (503) 488-0224 Inquiry 938.	VP-Planner Plus\$179.95 Paperback Software 2830 Ninth St. Berkeley, CA 94710 (415) 644-2116 Inquiry 944.
Nobunaga's Ambition \$59.95 Romance of Three Kingdoms . \$69.95 Koei Corp. 20000 Mariner Ave. Suite 100 Torrance, CA 90503 (213) 542-6444 Inquiry 939.	Word Exchange \$69.95 Systems Compatibility Corp. 401 North Wabash Suite 600 Chicago, IL 60611 (312) 329-0700 Inquiry 945.
Prodigy \$9.95 per month Prodigy Services Co. 445 Hamilton Ave. White Plains, NY 10601 Inquiry 940.	XenoCopy-PC \$79.95 Xenosoft 2210 Sixth St. Berkeley, CA 94710 (415) 644-9366 Inquiry 946.

translates both ways, you can use it (with Microsoft Word as an intermediate) to translate among any of those and other formats. Alas, it doesn't know about Q&A Write.

The game of the month—and maybe of the year—is FTL Dungeon Master for the Atari ST. Everything you heard about this is true; the graphics are incredible. I'm told there will soon be an Amiga version.

Next month, with luck, I'll look at Unix versus OS/2. ■

Jerry Pournelle holds a doctorate in psychology and is a science fiction writer who also earns a comfortable living writing about computers present and future. Jerry welcomes readers' comments and opinions. Send a self-addressed, stamped envelope to Jerry Pournelle, c/o BYTE, One Phoenix Mill Lane, Peterborough, NH 03458. Please put your address on the letter as well as on the envelope. Due to the high volume of letters, Jerry cannot guarantee a personal reply. You can also contact him on BIX as "jerry."



One Language For V

BB^x[®] Specifications:

Ease-of-use—BB^x is the fastest, most powerful development tool available for business oriented program creation. Programmers can write code in minutes.

Execution time—BB^x's partially compiled format provides enhanced execution speed.

Easy Maintenance—BB^x is an interactive programming language, with a trace facility and a full screen editor which makes program maintenance a snap.

Portability—BB^x runs under UNIX and other operating systems without recompilation.

Compatibility—BB^x is an enhancement of the Business BASIC language, an industry standard, giving you access to thousands of applications.

Supportability—Program maintenance utilities and complete documentation save considerable time and money. It lets you build and support applications easily.

Utilities—A complete set of BB^x utilities are provided for program and file management.

Conversion—A complete set of conversion utilities are provided with every BB^x package.

Features

Math Functions

- 14 place precision and computational accuracy
- Floating point conversion
- Task specified rounding precision
- Binary to decimal conversion
- Long function names
- Dynamic arrays

String Functions

- Numeric to string conversion
- String manipulation
- No string length restriction

I/O Functions

- Windowing
- I/O mnemonics
- Device independent verbs
- X,Y cursor addressing
- Masking
- Soft key loads
- No record length restrictions
- BB^x file sizes are limited only to the size of the available media

File Structures

- INDEX
- KEYED

- MKEYED
- SERIAL
- SORT
- PROGRAM
- STRING

System Structure

- Multi-tasking - which provides record and file level locking
- Program overlay
- Public programming which provides:
 - Local variables
 - Dynamically called sub-programs
 - Argument passing
 - Automatic public program drop from memory at exit
 - Public program in memory lock option

Language Structure

- Interactive program development
- Online syntax checking
- Compound statements
- User defined functions
- Unlimited nesting
- Remote I/O lists
- Program self modification
- Case insensitive console mode
- Various debugging tools

BB^x Utility Set

- File Browse
- Create Data Bundle
- Calculator
- Clear Workspace
- Program Compare
- Copy File
- Define/Redefine File
- Directory Listing
- Erase File
- Generate Filelist
- Program List/Cross Reference
- Move File
- Program Renumbered
- Rename File
- File Resizer
- Execute O/S Shell Command
- Search and Replace Program
- Color & FUNC Key Setup
- Time/Date Examine/Set
- Utility Menu
- Visual Utility Interface
- BXSND/BXRCV conversion utilities

Its portability crosses all operating environments, and now its performance is crossing all oceans.

Around the world, the industry's best and brightest programmers are discovering the astonishing power that BB^x brings to Business BASIC. Write your program once, and have complete movement to MS/PC-DOS, OS/2, UNIX/XENIX, AIX, IX370 and VMS.

This year, over 50,000 copies of BB^x are performing throughout the United States, Canada, Europe, Asia and South America.

Commitment to innovation, development within industry standards and technological leadership have grown BB^x around the globe.

In 1988, aggressive marketing and uncompromising customer support will continue to compliment our success, and expand the BB^x standard among many of the world's most respected companies.

Get in touch with one of our world distributors, and feel the pulse of the power of BB^x!

Die Portabilität schlägt sämtliche, bisher bekannte und unbekannte, EDV-Umgebungen. Die Leistung überzeugt inzwischen die gesamte EDV-Industrie.

Weltweit entdecken die besten Software-Entwickler die erstaunliche Leistung von BB^x, mit der Business BASIC bereichert wird. Die Anwendungen werden nur einmal entwickelt und laufen ohne Änderungen oder Anpassungen auf MS/PC-DOS, OS/2, UNIX/XENIX, AIX, IX370 oder VMS.

Mehr als 50.000 BB^x-Lizenzen stellen die Leistung in den USA, Canada, Europa, Asien und Süd-Amerika unter Beweis.

Zur Innovation nach Industrie-Standard Spezifikationen verpflichtet, und mit dem Ziel nach technologischer Führung, wächst BB^x um die Welt.

Mit aggressivem Marketing ohne Kompromisse im Bereich Kundenservice, wird der Erfolg von BB^x in 1988 fortgesetzt. Es steht auf sämtlichen Systemen namhafter Computerhersteller zur Verfügung und stellt seine Akzeptanz bei den anspruchvollsten Anwendern unter Beweis.

Kontaktieren Sie unsere Vertretungen in aller Welt. Entdecken Sie die Schlagkraft von BB^x!

BB^x PROGRESSION/2[®] is available for Intel Based Computers, Altos, Arete, AT&T, PCS Cadmus, Computer Consoles, Convergent Technologies, Counterpoint/MultiTech, Cubix, Data General, Digital Equipment, Fortune, Honeywell, Hewlett Packard, ICL, Motorola, Nixdorf, Prime, Pyramid, Rexon, Sanyo, Sequent, Siemens, Texas Instruments, Unisys, and the IBM family of products. BASIS is continually adding new systems.



World Class Business.

Portable, il franchit tous les cadres d'opération, et sa performance traverse, maintenant, tous les océans.

Dans le monde, les meilleurs et les plus brillants programmeurs de l'industrie découvrent l'étonnante puissance que BB^x amène au BASIC des affaires. Ecrivez votre programme une seule fois, et accédez totalement à MS/PC-DOS, OS/2, UNIX/XENIX, AIX, IX370 et à VMS.

Cette année, plus de 50 000 copies de BB^x fonctionnent aux Etats-Unis, au Canada, en Europe, en Asie et en Amérique du Sud.

Un esprit constant d'innovation, un développement conforme aux normes de l'industrie, et une position de leader dans le domaine technologique, tels sont les atouts qui ont contribué à la croissance de BB^x dans le monde entier.

En 1988, un marketing dynamique et un appui inconditionnel à notre clientèle continueront à couronner notre réussite, et à étendre le standard BB^x à de nombreuses sociétés parmi les plus respectées au monde.

Contactez l'un de nos distributeurs mondiaux et découvrez la puissance de BB^x!

Su portabilidad traspasa todos los medios de operación y ahora su funcionamiento esta cruzando todos los océanos.

Los mejores y más brillantes programadores del mundo, están descubriendo la asombrosa potencia que BB^x ofrece al negocio BASIC. Escriba su programa una vez y tenga movimiento completo a MS/PC-DOS, OS/2, UNIX/XENIX, AIX, IX370 y VMS.

Este año, más de 50,000 copias de BB^x estan funcionando en Estados Unidos, Canadá, Europa, Asia y América del Sur.

Empeño de innovación, desarrollo en los estandards de la industria y superioridad tecnológica han hecho crecer a BB^x en todo el mundo.

En 1988, mercadotecnia agresiva y apoyo constante a nuestros clientes seguirán complementando el éxito y desarrollo de BB^x entre las compañías más respetadas del mundo.

Comuniquese con uno de nuestros distribuidores mundiales y sienta la potencia de BB^x!

World Distributors:

Edias Hans Kirchhoff & Co. KG
Pflingsbornstr. 25, 6200 Wiesbaden
West Germany
TEL: (06122) 2016
FAX: (06122) 16505
TLX: 418-2563 edia d

Multisys
Torgerv Vraas Plass 5A
3044 Drammen Norway
TEL: (03) 83.86.05
FAX: (03) 89.02.53

J. P. Brown and Associates
780 Gordon Baker Road
Willowdale, Ontario M2H 3B4
TEL: (416) 494-0472

PI Informatique
8, rue Benjamin Constant
75019 Paris, France
TEL: (01) 40.05.10.65
TLX: 214.583
FAX: (01) 40.05.99.63

Softech Pty. Limited
10 Eileen Road, Blairgowrie
Randburg 2194, South Africa
TEL: (011) 787-8839
FAX: (011) 886-3890
TLX: 422669 S.A.

Risegold Pty. Ltd.
678 Paramatta Road
Croydon, N.S.W. 2132
Australia
TEL: (02) 799-6622
FAX: (02) 799-9090

Tempo Computadoras
Av. Americas #670
Guadalupe 44690
Jalisco, Mexico
TELS: 30-28-45
30-28-46
30-28-86

In the United States:
BASIS Incorporated
P.O. Box 20400
Albuquerque, New Mexico 87154
TEL: (505) 821-4407
FAX: (505) 821-1625

West Germany, The Netherlands
Austria, Switzerland
Denmark, Luxembourg, Belgium
England, Italy

Norway, Sweden, Finland,
Greenland, Iceland

Canada

France, Spain, Portugal

South Africa

Risegold Pty. Ltd.
86 Havelock Street
West Perth
Western Australia 6005
TEL: (09) 481-0607
FAX: (09) 481-3162

Infotel, S.A., de, C.V.
Laguna de Mayran
No. 258 3 piso
Col. Anahuac C.P. 11320
Mexico, D.F.
TELS: 05 45 6730 al
05 45 6734

Australia

Mexico



BB^x PROGRESSION/2[®], BB^x and BASIS Incorporated are trademarks and/or service marks of BASIS Incorporated, Albuquerque, New Mexico. All references to computer systems and software products contained within this advertisement recognize the trade and/or service marks of the corresponding manufacturer and holder of the trade and/or service mark.

Circle 31 on Reader Service Card

10% DISCOUNT!
ANY ORDER BY A NEW CUSTOMER ACCOMPANIED
BY THIS ADVERTISEMENT QUALIFIES
FOR A 10% DISCOUNT!
Order Department
Call TOLL FREE directly to our
1-800-423-1394
BJU



WHEN YOUR μ P CODE DEMANDS THIS KIND OF PERFORMANCE, SPEED IS OF THE ESSENCE.

AVMAC™ assemblers can make your high-performance design a winner, too.

In Formula 1 racing, performance is everything. And the sport's μ P-based instrumentation is no exception.

That's why SRD Co., Inc. chose the AVMAC 8096 assembler to develop their state-of-the-art racing dynamometer — a device sophisticated enough to simultaneously calculate every parameter of Formula 1 performance — all before the vehicle has moved 4 inches!

In the critical assembly language phase of development, AVMAC "was a must."

The race is on: in personal μ P development tools, Avocet sets the standards.

AVMAC's standard-setting speed and sophistication were needed to write the complex multi-tasking operating system at the heart of SRD's dynamometer (patent pending). When you need a macro assembler that really performs, AVMAC can give you the *same* advantage.

AVMAC supports all the most popular chip families and offers you enhanced compatibility with Intel, Motorola, Hitachi, and other chip makers.

What's more, every package comes complete with our AVLINK™ linker, AVLIB™ librarian, AVREF™ cross-reference generator, HEXFORM™ object file utility, plus a 250+ page user's guide.

**The last lap:
Compatible simulation/debugging.**

When it's time to test your target code, choose our unique AVSIM™ simulator/debugger. It offers detailed, full-screen CPU simulation that eliminates the need for additional hardware.

Best of all, AVSIM is designed for compatibility with AVMAC and our new Avocet C Compilers—the ideal combination for cost-effective code development —from start to finish.



AVOCET
SYSTEMS, INC.®

THE SOURCE FOR QUALITY PERSONAL μ P DEVELOPMENT TOOLS.

**Our Racy New Catalog
FREE!**

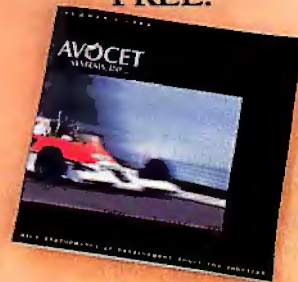

**Call Toll-Free
1-800-448-8500***

For your free catalog, to order, or for more information about AVMAC and other Avocet products.

**Getting to the finish line:
try before you buy.**

When you order AVMAC or AVSIM, we'll include a special demo kit that you can try for 30 days.

If you're not satisfied for any reason, return the unopened software for a full refund—less the \$35 demo/documentation which is yours to keep.

Discover the power of AVMAC and the entire line of Avocet μ P/ μ C development tools. Affordably priced. With comprehensive technical phone support. And delivery in 48 hours, even overnight.

If you're in the development race, we'll get you to the checkered flag in record time.

Avocet Systems, Inc., 120 Union Street
P.O. Box 490AS, Rockport, Maine 04856
*In Maine, or outside U.S., call (207) 236-9055
TLX: 467210 Avocet CI • FAX: (207) 236-6713

©1988 Avocet Systems, Inc. All rights reserved. Avocet logo and name, AVMAC, AVSIM, AVLINK, AVLIB, AVREF and HEXFORM are registered trademarks of Avocet Systems, Inc.



FROM SHAREWARE TO HYPERWARE

Two word processors, MicroSpeed's nifty add-in, and an easy way to read HyperCard stacks

A few weeks ago, I was walking around a fairly large computer show and stumbled across two booths pushing shareware word processors. One was MindReader (Brown Bag, \$49), and the other was PC-Write (Quicksoft, \$89). What a world of difference!

I wrote about MindReader two years ago, before it had become a shareware product; that is, it cost four times as much, and you could get it only from dealers or the manufacturer. It struck me then as an odd but occasionally wonderful piece of software; I always enjoy seeing new ways to do old things, and MindReader was certainly brimming with wacko concepts.

In its earlier incarnation, MindReader gave you an opening screen and sound effects worthy of an arcade game. The program itself featured an as-you-type spelling checker, a truly impressive glossary feature for storing and retrieving chunks of boilerplate text, a decent address book for mail merge, and a process called WordComplete.¹

WordComplete would interrupt you a few characters into every word you typed and present you with a list of alternatives. You'd select the right choice, and the program would finish typing the word for you. This was disconcerting at first, but once I got into the rhythm of it, it wasn't bad. It sure saved me lots of key-strokes. I figured that if a typist could adjust to the WordComplete system, it could be a device that would save time and labor.

My final reaction, though, was mostly negative. Although I urged anyone that

was developing a word-processing program to study MindReader carefully for its innovative features, I recommended against its purchase for day-to-day use. Unfortunately, it just wasn't up to snuff on the fundamentals.

As an example of one problem, you could perform block operations only on complete lines or groups of lines; if you wanted to move or copy a sentence that began in the middle of a line, you were out of luck. I felt guilty about trashing MindReader, but I just couldn't see using it for real work.

So here we are, two years later. How does MindReader stack up these days? Well, it's basically the same program. The block-operation problem has been fixed—you can now manipulate sections of text that start somewhere other than the beginning of a line. WordComplete, the address book, and the glossary are all still as fine as they were the first time around.

But I noticed something that I hadn't reported on in 1986 (probably because I was listing some of its other flaws, like the block problem): Every time you access one of the pull-down menus, MindReader goes off and sucks in the information from disk. On a hard disk drive, this represents a jerky hesitation that might not distract some people. Run from a floppy disk drive, however, it's absolutely unacceptable.

Essentially, MindReader seems to have been dusted off, bandaged a little, and then exiled to the Land of Shareware to live out its twilight years. Which is sad. There are still some great touches in this program, but it's waiting to die. I really wish its authors had looked on "going shareware" as a new beginning rather than as a way to salvage a few bucks and cut their losses from the first go-around. If they had rebuilt MindReader around the good stuff and thrown out the bad, the program could have been a real contender in the low-end word-processor market. *Pity.*

Quite a contrast to PC-Write, which was selling like the proverbial hotcakes. Bob Wallace continues to improve his program, which now boasts a fast spelling checker, and his company has turned out to be one of the biggest success stories in shareware.

Quicksoft is the only firm I know of that actually shares its profits with its customers. If you buy the program from the company and pass a copy to a friend, and the friend proceeds to register the copy by sending in money, Quicksoft will cut you in to the tune of \$25.

After using an unregistered copy every so often (shame on me!), I finally became guilt-ridden enough to register my own copy two years ago. I distributed copies to friends, posted the program on a number of bulletin boards, and waited to see what would happen. To my great surprise, I made money on the deal. So yes, the scheme does work. It's all pretty amazing if you think about it; I'd guess Quicksoft has given away over 10 percent of its revenues up front, and it's going like wildfire.

The difference between PC-Write and MindReader is the difference between a healthy athlete and a zombie. One program is still on the rise; the other is sinking into the sludge of obscurity.

Mice on the Bus

From the gang at MicroSpeed, the trackball manufacturer, comes one of the niftiest IBM PC add-in cards of the epoch. Called the PDA, for Pointing Device Adapter, it started out as a bus card for the company's trackball product, so you'd no longer need to tie up a precious serial port. Purchased with one of the MicroSpeed trackballs, the card adds \$20 to the list price. Purchased by itself, the card is \$69.

However, MicroSpeed didn't stop there. The PDA functions as a bus card for *any* serial pointing device. Not only can you retrofit one of the MicroSpeed

continued

Importers: It's time to change bad habits.

- Don't think Germans offer high quality only at high prices.
- Don't limit your market survey to Asian products.
- Don't forget to order our catalogue.

Printer Buffer inside cable.
For the average user, most buffers are too complicated. So we designed a buffered cable with 64K or 256K inside. Just a cable. As easy to use. Nearly as inexpensive.



Take out your data.
In a battery-operated buffer. Up to 128K with parallel or RS232-input. Battery will hold data for as long as 3 years. Record and play as often as you like. Carry data to a printer or to another computer.



Share your printer.
Forget these boxes that occupy lot of your desk space. Forget the times when you had to switch manually. We have a cable that allows two computers share one printer automatically.



That's how T-switches should look like!
For IBM-compatibles. 2 printers to one computer. Complete set incl. all cables and a small switch-box. No bulky box on your desk!



Isolating line drivers
If a line driver is not optically isolating, you might face problems arising from different mains supplies. That's why our RS232-drivers are 100% isolated up to 1000 volts.

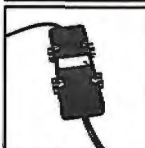

Data Isolators
Transients on the mains supply or electrostatic discharges can cause erroneous data transmissions and even destruction of computers. We offer optical isolators.



Terminal bus.
Connect up to 16 terminals to one 2-wire bus. Save installation costs and gain flexibility and ease of use. MUX-BUS includes optically isolated line drivers.

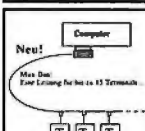

Interfaces.
We have a complete line of interfaces: 20mA, Atari130, C64/128, Centronics, IEEE488, RS232 and RS422.



The following are registered trademarks: Atari, C64, C128, Centronics, IBM

Austria: Zahrer, Wien 0222-347671
France: Neol, Strassbourg (88) 623752
Switzerland: Weber&Co, Zürich 01-9302003
USA: Tectrans, L.A. (818) 2853121

Manufacturer and Exporter:

**wiesemann &
theis gmbh**
MIKROCOMPUTERTECHNIK



winchenbachstr. 3-5 phone: 202-505077
d-5600 wuppertal 2 telex: 859 16 56
west-germany fax: 202-511050

Items Discussed

HyperDA\$69
Symmetry Corp.
761 East University Dr.
Mesa, AZ 85203
(602) 844-2199
Inquiry 947.

MindReader\$49
Brown Bag Software
Telemarketing Resources
2155 South Bascom Ave., Suite 114
Campbell, CA 95008
(800) 523-0764
(800) 323-5335 (in California)
Inquiry 948.

PC-Write\$89
Quicksoft, Inc.
219 First Ave. N, Suite 224
Seattle, WA 98109
(206) 282-0452
Inquiry 949.

PDA (Pointing Device Adapter)...\$69
MicroSpeed, Inc.
5307 Randall Place
Fremont, CA 94538
(415) 490-1403
Inquiry 950.

XHELP\$59.95
Exwells Software Co.
7677 Oakport St., Suite 110
Oakland, CA 94621
(415) 430-1876
Inquiry 951.

time, I thought that the problem was inherent in the weight and other physical properties of the different mice. This is not so.

According to Tim Barry of MicroSpeed, the problem lies in the driver software. The standard Microsoft mouse driver is set up to offer only two rates of speed. Let's say you start off moving the mouse slowly; the motion translates to the screen at a 1-to-1 ratio. When you hit a predetermined speed, that ratio suddenly jumps to 2-to-1, and the mouse flies across the screen. That's all the control you have.

The Apple mouse, on the other hand, is designed for what is called "ballistic" gain. Rather than two speeds, the driver uses a number of speed ratios that fit on an exponential graph; the result is less choppiness in the feel as you speed up or slow down, because the jumps in ratio are less severe.

MicroSpeed has implemented a similar ballistic algorithm for its driver. It uses 10 different speed ratios for nice, even gain. Further, the ratio set is selectable. A command line switch (or a CONFIG.SYS parameter, if you use the device-driver version of the software) lets you choose among steeper and shallower curves for the gain. In other words, you can fine-tune the feel of the pointing device.

If all this is as far over your head as it is over mine, sit down with a Mac and a PC and play with the mice. Imagine how pleasant it would be and how happy you'd feel if the PC mouse moved like the Mac mouse. Then go check out the MicroSpeed product line.

Help, Help

I recently stated that if I saw another pop-up "MS-DOS made simple" program, I'd throw up. There are too many of these things on the market, and most of them aren't worth the price of a blank disk. It's perhaps my least favorite product category, and that's saying a lot. Thus, when I saw a demonstration of XHELP (Exwells Software, \$59.95) that looked suspiciously like a DOS guide, I was tempted to move on. Quickly. I confess I didn't listen too closely to the first few minutes of the pitch, but when I figured out what was really happening I quickly got drawn in.

XHELP is a help authoring system; the demonstration I was watching used a sample database that offered assistance to MS-DOS users, but you can write help or information systems for anything you like. Need a help system for order entry of auto parts? How about a study guide

trackballs, you can plug in any serial mouse from Microsoft or Logitech and mouse off into the sunset. Whatever pointing device you attach, you're still freeing a serial port. The PDA is a universal card for pointing devices.

If that weren't enough, MicroSpeed has developed a magnificent universal mouse driver, distributed with the company's own products or available separately for \$49. It will work with any mouse out there.

Why do I say magnificent? Well, I'm one of those people who frequently move back and forth between a Macintosh and an IBM PC AT clone. The Mac mouse has a well-mannered, smooth feel. The AT mouse seems light and uncontrollable in comparison, and I'm always missing my target on the AT screen. For a long

APPLICATIONS ONLY

for nuclear physics? The awful cliché is "you're limited only by your imagination," but in this case it happens to be true.

The organizing metaphor is the one most people are most familiar with: table of contents, data organized by page number, and index. You look up your area of interest in either the table of contents or the index, enter the page number, and you're on your way. XHELP will take an ASCII document, compress it, and break it into pages for you, or you can insert characters to indicate page breaks and have the screens look pretty when they pop up. Compiling the table of contents and the index is equally simple.

The lookup engine is a straightforward memory-resident program that works as well as any. This is not a supersophisticated package, but it does its job efficiently and it lets you get on with your life.

My only criticism is that the product was still very new when I looked at it, and the company hadn't figured out pricing for site licenses, which is how I think XHELP will be sold. But that's a minor point indeed.

This is a good tool if you need it.

Hyper De-hype-er

Over on the Macintosh, there's HyperDA (Symmetry, \$69), a desk-accessory program that lets you read HyperCard stacks (or programs or applications or databases or whatever you call them) without needing HyperCard itself. Which is fine by me.

For some reason, I've never thought that learning how to program is a revolutionary new idea in computing, and it's the last thing I want to do. Maybe it's neat, but I really don't have the time. With a powerful machine like the Mac, I'm waiting for tools to let me write little Hyper-like programs by sliding pictures or symbols around on the screen.

I'll grant that HyperTalk could easily serve as the underlying language in tomorrow's advanced system for program development—a system that used actual code at only the deepest level—but I don't have much desire to master it in its present form. HyperDA lets me use other people's HyperCard work without having to become an expert.

Written by Bill Appleton, an expert and prolific Mac programmer with such gems as CourseBuilder and some excellent games to his credit, HyperDA is a terrific solution for anyone who wants to read HyperCard stacks but doesn't have the oodles of memory required. It's a

desk accessory, and you can run it on anything from a 512K-byte Mac on up. Note that HyperDA is only a reader; you can't use it to modify programs or add to databases.

The HyperDA implementation is not perfect. You can't see fancy screen dissolves, wipes, or other visual tricks. Playing sounds stored in stacks is impossible. Also missing is the HyperCard flowchart—a visual display of the screens you've viewed, shown in chronological order. But if you're merely flipping through a stack of cards, do you really need all that stuff? HyperDA does have a good "find" function, which will jump you quickly to the right spot.

In my experience, it was easy enough to move from card to card, but it wasn't always possible to pop open a card's windows in the correct sequence. Sometimes I found dealing with HyperCard's hyper-text aspects confusing; HyperDA is better suited for reading stacks that display only full screens of information rather than ones that move you all over the place by presenting large assortments of buttons and hidden text chunks. But even with its obvious flaws, HyperDA is still a quick way to get at data buried in your stacks.

"But wait," you say, "I have MultiFinder. Can't I just run HyperCard as a single application under MultiFinder and gain the ability to modify stacks?" Sure, if you've got a huge amount of RAM and nerves of steel. I'm always edgy about the devastating crashes that can occur when running MultiFinder. And HyperCard is a big program that takes a while to load, particularly annoying if you launch it every time you start work. If all you want is access to information, HyperDA is faster.

Finally, HyperCard stacks seem to want to take over the entire screen on my standard SE (I don't know about third-party big-screen monitors); HyperDA lets me look at stacks in a window that I can resize and reposition. At last I can look at stack data and other data at the same time.

Hooray for this product. My most major problem with it is that I keep wanting to pronounce it as "hyper-dah" rather than "hyper-dee-ay." It is definitely recommended. ■

Ezra Shapiro is a consulting editor for BYTE. You can contact him c/o BYTE, One Phoenix Mill Lane, Peterborough, NH 03458, or on BIX as "ezra." Because of the volume of mail he receives, Ezra, regretfully, cannot respond to each inquiry.

Paul Mace
SOFTWARE

hTEST hFORMAT

... Can double your
hard disk performance.

Experience has shown most hard disks are set up wrong . . . which means the interleave is probably wrong and you are being penalized anywhere from 50 to 600% in performance.

Included in the hTEST · hFOR AT package is an interleave optimizer, HOPTIMUM. It calculates the optimum value for interleave, then resets the disk, automatically, for peak performance.

The second casualty to improper setup is your data . . . because some hardware vendors take the easy route. They skip low-level testing and entry of manufacturer's bad-track information.

hTEST finds those marginal regions on the disk before they cost you time and information. hFOR AT lets you enter the manufacturer's test information and certify for yourself that the disk is properly initialized for reliable service.

When the worst happens . . . and you lose data, hFOR AT will help recover your disk—even from that ultimate disaster: "Invalid Drive Specification."

hTEST · hFOR AT: for IBM PC, XT, AT and compatible computers. Requires 64K, DOS 1.1 or higher.

**Advanced Hard Disk
Diagnostics designed by
Kolod Research . . . \$89.95**

Paul Mace Software, Inc.

400 Williamson Way
Ashland, OR 97520
(800) 523-0258
(503) 488-0224

(COD's, PO's add \$5.00)
(Foreign orders add \$10.00)

CONVINCE YOURSELF!
Send us \$1. We'll send you
an interleave test disk.

Introducing DESQview™ 2.0 API Tools

DESQview API Reference Manual

This is the primary source of information about the DESQview API. It contains all you need to know to write Assembly Language programs that take full advantage of DESQview's capabilities. The Reference manual comes with an 'include' file containing symbols and macros to aid you in development. **AVAILABLE NOW!**

DESQview API C Library

The DESQview API C Library provides C Language interfaces for the entire set of API functions. It supports the Lattice C, Metaware C, Microsoft C, and Turbo C compilers for all memory models. Included with the C Library package is a copy of the API Reference Manual and source code for the library. **AVAILABLE NOW!**

DESQview API Debugger

The DESQview API Debugger is an interactive tool that enables the API programmer to trace and single step through API calls from several concurrently running DESQview-specific programs. Trace information is reported symbolically along with the program counter, registers, and stack at the time of the call. Trace conditions can be specified so that only those calls of interest are reported. **AVAILABLE JUNE 88!**

DESQview API Panel Designer

The DESQview API Panel Designer is an interactive tool to aid you in designing windows, menus, help screens, error messages, and forms. It includes an editor that lets you construct an image of your panel using simple commands to enter, edit, copy, and move text, as well as draw lines and

Bringing new power to DOS

boxes. You can then define the characteristics of the window that will contain the panel, such as its position, size, and title. Finally, you can specify the locations and types of fields in the panel. The Panel Designer automatically generates all the DESQview API data streams necessary to display and take input from your panel. These data streams may be grouped together into panel libraries and stored on disk or as part of your program. AVAILABLE JUNE 88!

DESQview API Pulldown Menu Manager

The DESQview API Pulldown Menu Manager is an interactive tool to aid you in designing pulldown menus. This DESQview API tool assists you in giving your DOS program an OS/2-like look and feel. AVAILABLE JULY 88!



Call for registration information (213) 392-9851

Quarterdeck

Quarterdeck Office Systems

150 Pico Boulevard
Santa Monica CA 90405

(213) 392-9851

MS-DOS and IBM PC-DOS are trademarks of Microsoft Corporation and IBM Corporation respectively.

COMPUTER EXPO

TEXAS #1 IBM COMPATIBLE COMPUTER CENTER



THE 10 MHz 80286

286-10 Monochrome Systems

- Intel 80286 6/10 MHz clock
- 512K RAM (upgradeable to 1MB)
- AT style keyboard 84 key
- 1.2 megabyte floppy disk drive
- Combined floppy / hard disk controller card by WD
- System clock/calendar
- High resolution monochrome monitor
- Monographics printer adapter (Hercules Compatible)
- 200 Watt power supply
- 1 year warranty

• 80386 Available \$ Call

With 20MB Seagate Dr.	\$1395
With 40 MB Seagate Dr.	\$1,495
With 60 MB Seagate Dr.	\$1,695
With 80 MB Seagate Dr.	\$1,995
With 130 MB - 19 ms drive	\$2,695
RGB Color Upgrade	\$195

286-10 EGA Color Systems

- The above system with the following substitutions:
- EGA Hi-resolution enhanced color monitor with tilt & swivel
- Enhanced color graphics (EGA) card

Add Only \$395

THE 12 MHz 80286

286-12 Monochrome Sys

- Intel 80286 at 6/12 MHz clock speed
- 200 watt power supply
- AT style keyboard
- 1.2 megabyte floppy disk drive
- Combined floppy/hard controller card
- System clock & calendar
- Hi-resolution monochrome monitor
- Monographics printer adapter (Hercules Compatible)
- 1 year warranty

With 40 MB Seagate Dr.	\$1,545
With 60 MB Seagate Dr.	\$1,745
With 80 MB Seagate Dr.	\$2,045
With 130 MB - 19 ms drive	\$2,745

286-12 EGA Color Sys

The above system with the following substitutions:

- EGA Hi-resolution enhanced color monitor with tilt & swivel
- Enhanced color graphics (EGA) card

Add Only \$395

Additional 2 meg of HIGH SPEED RAM Add Only \$595

- Upgrade to 386 \$800

THE 20 MHz ALR 80386

386 Monochrome Sys

- Intel 80386 processor 20 MHz
- 1MB RAM
- 200 watt power supply
- AT style 101 key enhanced keyboard
- 1.2 megabyte floppy disk drive
- Comb. floppy/hard disk controller card
- System clock/calendar with battery backup
- Serial/parallel port
- High resolution monochrome monitor
- Monographics printer adapter (Hercules Compatible)
- 1 year warranty

With 40 MB Seagate Dr.	\$3,095
With 60 MB Seagate Dr.	\$3,295
With 80 MB Seagate Dr.	\$3,795
With 130 MB Seagate Dr.	\$4,295

386 EGA Color Sys

The above system with the following substitutions:

- EGA Hi-resolution enhanced color monitor with tilt & swivel
- Enhanced color graphics (EGA) card

Add Only \$395

ALR INTEL U.S. MADE

EXPO PORTABLE LCD IV 286 12MHz

\$1495



- 80286/12 MHz CPU
- 512K RAM (1MB RAM ADD \$195)
- Hi-Res LCD display
- 640 X 200 Pixel (80 X 25 lines)
- Auto select 110/220V
- Five expansion slot
- External RGB/color port
- D: 8 1/4(H) X 9 1/2(W) X 15 1/4(D)
- 386 model also available
- 1 year warranty

With 20 MB Seagate Dr.	\$1695
With 40 MB Seagate Dr.	\$1895
With 60 MB Seagate Dr.	\$2095

AST Premium/386



\$4195

20MHz, 0/1 wait
40 MB System

- 1.2 MB Floppy Drive
- 40 MB Hard Drive
- 1MB RAM
- (Expandable to 13MB)
- Enhanced 101 keyboard
- 7 Expansion Slots
- Serial/Parallel port
- Clock/Calendar
- DOS + BASIC

AST PREMIUM 286 — CALL NOW



\$1395

MODEL 6300
30 MB
COMPLETE SYSTEM

- 360K Floppy Drive
- 640K RAM
- 30 MB Seagate Hard Drive
- Monochrome Display
- Hi-Res Graphics
- Parallel/Serail/Clock/Calendar
- Keyboard

AUTHORIZED AT&T DEALER



brother
PERSONAL FAX

\$985

- 4 Easy Controls
- FCC Approved
- Compatible w/Group 3 Fax Machines
- Hands Free, non-monitored operation
- Fine detail
- FAX - COPIER - PHONE

TOSHIBA T-1000 LAPTOP

\$780



- 80C88 CPU 512K RAM
- 5 Hrs. Battery Charge
- 3 1/2" Floppy 790K
- MS DOS 2.1 1-in ROM
- 6.4 lbs.

T-1200/20MEG	\$2395
T-3200/40MEG	\$4095

Seagate HARD DRIVE SALE!

ST-225 20 MB KIT

- 20 MB Hard Drive System includes
- Controller Cables
- Instructions

\$260

ST-238 30 MB KIT

- 30 MB ALL Hard Drive System includes
- Controller Cables
- Instructions

\$320



40 MB HI-SPEED

- AT Drive
- (Controller is optional)

\$399

ST-4026

- 20 MB AT Drive
- (Full Height 38 MSC.)

\$299

ST-4038

- 30 MB Drive
- (Full Height 38 MSC.)

\$499

ST-4096

- 80 MB Drive
- (Full Height 28 MSC.)

\$845

LASER JET SPECIAL

BROTHER HL8	\$1845
HP SERIES II	\$1845
BLAZER	\$1595
CANON	\$1795

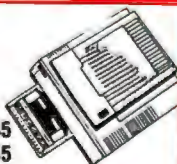

VIDEO CARD

- Mono/Graphics w/Parallel.....\$55
- Color/Graphics Parallel Card RGB or Compatible.....\$60
- EGA (640/400 Res.) MDA/CGA/EGA.....\$149
- Genoa Super EGA & System Super EGA (800x600 Res.).....\$225

MOTHERBOARD

- 8088-2 (4.77/8MHz) OK.....\$99
- 8088-1 (4.77/10 MHz) OK.....\$149
- 80286-10 (6/10 MHz) OK.....\$325
- 80386-16 (6/10/16 MHz) OK \$1695

MODEMS

Everex 1200B	Int. \$ 85
Anchor 1200B	Int. \$ 75
Everex 2400B	Int. \$179
Anchor 2400B	Int. \$179
EVEREX EXTERNAL — CALL	
Practical Peripherals 1200B	Int. \$69

INQUIRY 713 784-0990

TECH-SERVICE 784-7817

HRS: M-F 8-6 SAT. 10-3 SUNDAY CLOSED

Seagate, Hercules, Hayes, Everex, Diamond, IBM, XT, AT & CEI are registered trademarks of their respective companies

TOLL FREE ORDER ONLY 1-800-622-EXPO



Part 1

THE PITFALLS OF PORTING

Introducing a new column that illustrates programming concepts and techniques that underlie the software you use today and will use tomorrow, and gives you lots of useful, hands-on code



Editor's note: "Some Assembly Required" serves a dual purpose: First, it will show you, via concrete examples, the programming techniques that shape the current and future generations of software. For example, once you see how complex a relatively simple port is, you can understand why it's taking so long for DOS-to-OS/2 ports to show up. Information such as this will give you a better understanding of the hows and whys of your software.

Second, this column is the place you can come for working sample code that's useful in its own right, and that serves to define and illustrate larger issues such as those mentioned above. Because the column is geared toward illustrating real-world programming issues and techniques, it will rely on the tools of today's software industry: assembly language for optimum performance, plus lots of C and some Pascal.

The column's author, Rick Grehan, is primary programmer of BYTE's new

low-level system benchmarks, and has programmed everything from a KIM-1 to a building-size mainframe; written everything from accounting software to programs for Schroedinger wave equations; gotten as high as COBOL on a mainframe and as low as toggle switches on an ALTAIR 8800.—FSL

In an industry where new computer systems are rolled out as frequently as new car models, all the major software companies are counting on porting to save their popular programs from landing in the scrap heap.

For example, with the success of the Mac II, companies who previously offered programs only for the DOS machines are porting their software to the Mac and vice versa. And with the release of OS/2, every major software company in the DOS world—including Microsoft, Lotus, and Borland—is scrambling to prepare OS/2 versions of its programs.

Successful porting can ensure the survival of a good program in a world of rapidly evolving CPUs and operating systems. "Effective porting" sounds simple, but, in reality, it's a bloody job.

I know from experience: I recently ported the original incarnation of a C compiler to MS-DOS, and then ported that version to the Macintosh, as part of the task of creating our new benchmarks.

Looking at this specific case—porting a language—can serve in several ways: First, it illustrates the general concepts in porting, and thus can give you some insight into what's happening now in the major software development houses. Second, if you're a programmer, you'll also come away with useful, working code and practical examples of how you can apply the general principles.

High-Level Headaches

One of the major benefits of working with a high-level programming language

continued

is that it insulates you from the system you're programming on; the language handles the intricacies of talking to the hardware and operating system so that you don't have to go gray writing assembly language. Altering a high-level language to deal with a new operating system and different hardware can get pretty hairy.

Sometimes there are ways to make the porting process easier. For example, it is sometimes possible to alter a compiler to port itself—use an existing compiler to write a new compiler. This is exactly what I did when I created the BYTE version of Small-C. In the first two installments of this column, I'll outline some of the problems I had to overcome in porting it to MS-DOS (this month) and the Macintosh (next month).

Here's how the procedure looks broken into an actual step-by-step example. (This example is specific to the Small-C port, but the general steps apply to any similar project.)

Step 1: Modify the source of the 8080 CP/M compiler to emit 8088 code. Compile that, yielding a compiler that runs under CP/M but produces 8088 code.

Step 2: Write the C source code for an MS-DOS-compatible run-time library (the part that talks to the operating system). Pass that through the new compiler to yield 8088 assembly source. Transfer this source to a PC and use MASM (Microsoft's assembler) and LIB (Microsoft's library manager) to create the actual library.

Step 3: Take the modified source of step 1 and send it through the new compiler; you now have 8088 assembly source for Small-C on a CP/M disk. Move that source to a PC, assemble it with MASM, and link it to the library from step 2 to create an 8088 version of Small-C running on the PC.

Now that we see the broad brush strokes of using a compiler to port itself, how about the fine-line definitions that made this specific project work? This demands that we first take a closer look at Small-C.

Small-C

A complete description of the original Small-C would be inappropriate here. Suffice it to say that Small-C executes a subset of Kernighan and Ritchie C, with its most noticeable restrictions being the following:

- The only data types are `int` and `char` (it supports pointers)

- There are no structures or unions
- Arrays may be only one-dimensional
- The only control structures are `for`, `while`, `do`, `if`, and `goto`
- Small-C emits assembly source code; you must have an assembler and linker to execute programs you create with the language

For more details regarding Small-C's external appearance, check the references at the end of this article. As for its internals:

- *The "Small-C Machine":* Much as some languages (e.g., UCSD Pascal) define a hypothetical processor and emit instructions in that machine's repertoire, you can think of Small-C as executing on a theoretical machine. That machine would have three registers (a primary, a secondary, and a stack pointer) and an unspecified amount of memory. (For BYTE Small-C, BX is the primary, DX is the secondary, and SP is the stack pointer.)

All mathematical and logical operations take place in the primary and secondary registers, and results always end up in the primary. The stack holds temporary results during the execution of complex instructions, and also serves as a repository for a function's local variables. The original Small-C ran on a 8080, so all registers (and therefore integers and pointers) were 16 bits.

- *Code, Data, and Stack:* The 8080 had no segment registers, so Small-C views memory as equally available to code, data, and stack. You'll discover later on that it makes things easier if we locate code at the bottom of physical memory, with data and stack space near the top.

- *Support Library:* Small-C possessed a respectable library. It's only real disadvantages were the restrictions its file-handling routines suffered at the hands of CP/M (and even these were minimal).

Making It Work

File-access techniques differ from system to system; a successful port has to deal with this. For example, the original version of Small-C was born within CP/M, an operating system that only accesses files a sector at a time (where one sector is 128 bytes). The original version of Small-C carried this restriction with it; you had to do some extra high-level coding if you wanted to implement Unix-style (files as streams of bytes) file access.

For example, most C language implementations allow you to position a file-pointer to any byte within a file using

`seek()`. In the original Small-C, you would have had to do something like:

```
mode=0;
sect=off/128;
soff=off%128;
cseek(fd,sect,mode)
while(soff!=0) {
    fgetc(fd);
    --soff;
}
```

where `off` is the byte offset to which you intend to position the pointer, and `mode=0` tells `cseek` to treat offsets as being from the beginning of the file. In case you're wondering, the repeated calls to `fgetc()` did not make multiple requests to the operating system in the original Small-C. The language's standard library could optionally buffer sectors. In fact, an easier way to accomplish the above would be to simply read the entire sector and work with its 128 bytes of data as an array.

None of this is unique to my port. For example, Kernighan and Ritchie mention similar contortions they had to go through with a PDP-11 version of C. In that version, to access a given byte in a file, you had to issue two `seek()` function calls: the first call required that `mode` be 3, 4, or 5, which set the file pointer to the start of the n th 512-byte sector; you had to make the second call with `mode` set to its expected value of 0, 1, or 2, which selected the byte within that sector.

To proceed with the port, I therefore rewrote the library for the 8088 version of BYTE Small-C so that it used the MS-DOS file-handling function calls (interrupt 21 hexadecimal, functions 3Ch through 42h). This allowed me to make the `seek()` function more akin to its counterpart in "big" C packages. I say "akin" because BYTE Small-C's `seek()` requires two `int` arguments where most big C packages would use a single long.

As an example, say you have a 128K-byte file, and you want to read the 355th byte into character array `buff`. In BYTE Small-C, you could do this with

```
mode=0;
seek(fd,0,355,mode);
read(fd,buff,1);
```

You can see that this `seek()` function adds at least the overhead of an additional argument. In addition, once you begin working with files bigger than 64K bytes, you have to do what amounts to treating a pair of integers as single 32-bit quantities. So, to access byte number

continued

Order Status,
 Technical & Other
 Info. (602) 246-2222
 FAX # (602) 246-7805
 Call for programs not listed



No Charge for
 MasterCard or Visa



**MICROSOFT PC Excel
 SPECIAL \$295**

TOLL-FREE ORDER LINE 1-800-421-3135 EXT. 200

NOW AVAILABLE

MICROSOFT MACH 20 \$329
MICROSOFT WINDOWS 386 \$119

FREE SOFTWARE!

Purchase over \$100 and receive one of these disks absolutely FREE! Purchases over \$250 get two free disks, over \$400 get three, or get all four disks when your purchase is over \$500! 1) MIXED BAG. 2) PC-WRITE. FONT-SET. 4) ABC-LIST.

- SOFTWARE -

Accounting

Dac Easy Acct.	\$54
Dac Easy Light	39
Dac Easy Payroll	39
Dollars & Sense	94
In House Acct.	112
Managing Your Money 3.0	117

Communication Programs

Brooklyn Bridge Universal	\$72
Carbon Copy Plus	108
Crosstalk XVI	89
Crosstalk MK4	110
PC Anywhere	79
Smartcom II	79

Data Base Managers

Clipper	\$375
Condor 3	325
DataPerfect	266
DBaseIII Plus	375
DB-XL	80
FoxBase Plus	195
Genifer	189
Paradox 2.0 Premium	435
PFS: Pro File	139
Powerbase	169
Q&A	189
Quicksilver Diamond	329
Revelation	464
R Base For DOS	425
Reflex	81
Relate & Report	112
VPInfo	65

Desktop Publishing

Pagemaker	\$479
PFS: First Publisher	59
Ventura Publisher	493

Graphics

Boeing Graphics	\$200
Chartmaster	199
Design Cad 2	148
Diagram Master	199
Easy Cad	109
Generic Cad	49
In-A-Vision	270
Microsoft Chart 3.0	243
Newsroom Pro	65
Printshop	33

Integrated

Ability Plus	\$145
Enable	352
Microsoft Works	120
PFS 1st Choice	79
Smart System	429
Symphony	465

Languages

Lattice C Compiler	\$220
Microsoft C Compiler Ver. 5.0	275
Microsoft Fortran Ver. 4.1	275
Microsoft Macro Assembler	92

Languages

Microsoft Pascal	\$185
Microsoft Quick Basic	59
Microsoft Quick C	59
Ryan McFarlan Fortran	342
Ryan McFarlan Cobol	549
Turbo Basic	59
Turbo C	59
Turbo Pascal	59
Turbo Prolog	59

Multi-User Software

Fox Base	\$299
Microsoft Word	195
Word Perfect	310
Word Perfect Modules	ea 75

Project Manager

Microsoft Project	\$305
Super Project Plus	Low Price
Timeline 2.0	270
Total Harvard Man. 2	355

Spreadsheet

Lotus 1-2-3	\$309
Microsoft PC Excel	295
Quattro	117
Spreadsheet Auditor	82
Suprass	329
VP Planner Plus	88

Utilities

Copy II PC	\$19
Copywrite	39
Cubit	39
Deskview 2.0	72
Direct Access	49
Eureka	95
Fastback Plus	92
Formtools	56
Graph in the Box 2	55
Mace	55
Microsoft Windows	59
Norton Advanced	75
Norton Utilities	48
PC Tools Deluxe	37
Prokey 4.0	70
Q DOS II	49
Rightwriter	75
Sidekick	55
Sideways	39
Sqz	55
Superkey	55
Turbo Lightning	55
XTree	35

Word Processing

Microsoft Word 4.0	\$195
Multimate Advantage II	259
Q and A Write	110
Webster Spellcheck	37
Word Perfect Ver. 5.0	195
Word Perfect Executive	106
Word Perfect Library	59
Wordstar Pro	233
Wordstar 2000+	194

- HARDWARE -

Accessories

Copy II PC Deluxe	\$101
Curtis Ruby	59
Mach III Joystick	36
Masterpiece	88
Masterpiece+	99
150 Watt Power Supply	69

Boards

AST	
Advantage Premium	\$285
Rampage 286	379
Sixpac Plus	129
EVEREX	
2MB Above PC/X7	79
3MB Above AT	89
HERCULES	
Graphics Plus	182
INTEL	
Above PC 64K	225
Above 286	319
Orchid Tiny Turbo	289

COMPUTERS

AZ 386

80386-16 Micro Processor, 1 MB of Ram, Teac 1.2 MB disk drive, 220 watt power supply, 6 layer mother board, RT keyboard **\$2595**

AZ Turbo AT

512K, 6 & 10 MHZ, keyboard, 200 watt power supply, one 1.2 teac drive, Phoenix Bios **\$975**

AZ Turbo XT

135 watt power supply, One 360K drive, 640K, keyboard **\$519**

AZ 10

150 watt power supply, dual 360K drive, 10 MHZ mother board, 640K, keyboard **\$515**

AST 286 or 386

Premium Computer
 512K, expandable to 2MB on the system board, RT enhanced style keyboard, parallel, serial and clock, 1.2 MB floppy disk drive, 7 expansion slots, DOS 3.3 & Basic
 Available Now **Best Prices**

EGA Boards

ATI Ega Wonders	\$195
NEC 1024	855
Orchid Designer	259
Paradise Auto 480	155
Vega VGA	299

EGA Monitors

Casper	\$410
Princeton Ultra Scan	539
Mitsubishi Diamond Scan	486
NEC-Multisync II	619
Zenith 14" Flat Screen	650

Hard Cards

Plus 20 MB	\$529
Plus 40 MB	659

Hard Drives

Seagate 20 MB	\$265
Seagate 30 MB	295
Seagate 40 MB AT	399
Seagate ST-125 w/cont	329
Seagate ST-138 w/cont	399

Modems

AZ 300/1200	\$75
Everex 300/1200	89
Hayes 1200	299
Hayes 1200B	289
Hayes 2400	439
Novation Parrot 1200	89
U.S. Robotics 2400	335

Mice

Genius	\$59
Logitech	68
Microsoft Bus w/Paintbrush	92
Microsoft Serial	92
Optimouse w/Dr Halo	89
Optimouse w/DPE	185

Monitors

AMDEK	
410 Amber	\$145
MAGNAVOX RGB	255
NEC	
GS Amber	190
SAMSUNG	
Flat Amber	82
TTL Amber w/tilt	76
Color w/tilt	249

Printers

CITIZEN	
MSP45	\$415
120 D	Low Price
Premiere 35	Low Price
EPSON	
LQ500	330
LQ850	528
NEC	
P5XLP	815
P960XL	1005
P2200	335
LASSERS	
NEC 890	3300
AST TURBO PS	3199
OKIDATA LASSERLINE 6	1324
OKIDATA	
OKI 390	590
OKI 391	689
STAR MICRONICS	
NX1000	179
NX1000 Color	238

TERMS: Shipping on most software is \$5.00. AZ orders +6.7% sales tax. Personal check/company check—allow fourteen (14) days to clear. We accept purchase orders from authorized institutions for 3.5% more than cash price. All returns are subject to our approval. There will be a 20% restock fee. Minimum phone order \$50. All prices are subject to change. Due to copyright laws we cannot take back any open software.

TOLL-FREE ORDER LINE 1-800-421-3135 EXT. 200
WAREHOUSE DATA PRODUCTS
 2701 West Glendale Ave. • Phoenix, AZ 85051
 We do not guarantee compatibility

Servicing our PC buyers with
 low pricing and technical
 experience since 1979.

Phone Hours:
 Monday thru Friday 7am-9pm.
 Saturday 9am-5pm MST.

Listing 1a: Divide operation for the original Small-C.

```

DIV:
MOV   B,H
MOV   C,L
MOV   A,D
XRA   B
PUSH  PSW
MOV   A,D
ORA   A
CM    CCBNEG ;Negate BC
MVI   A,16
PUSH  PSW
XCHG
LXI   D,0
CCDIV1:
DAD   H
;Rotate DE left 1 bit
CALL  CCRDEL
JZ    CCDIV2
:Compte BC and DE
CALL  CCCMPBCDE
JM    CCDIV2
MOV   A,L
ORI   1
MOV   L,A
MOV   A,E
SUB   C
MOV   E,A
MOV   A,D
SBB   B
MOV   D,A
CCDIV2:
POP   PSW
DCR   A
JZ    CCDIV3
PUSH  PSW
JMP   CCDIV1
CCDIV3:
POP   PSW
RP
CALL  CCDENEG ;Negate DE
XCHG
CALL  CCDENEG
XCHG
RET

```

Listing 1b: Division in BYTE Small-C.

```

MOV   AX,DX
IDIV  AX,BX
MOV   BX,AX

```

65536, you would write

```

mode=0;
seek (fd, 1, 0, mode) ;
read (fd, buff, 1) ;

```

I decided that the additional software (and mental) gyrations you'd have to go through to manipulate integer pairs was worth the reduced number of calls you'd have to make into the library. This be-

came especially important when we decided to use BYTE Small-C as a basis for benchmarks; had I gone with the CP/M version's style of seek(), we would be forced into timing two physical calls to the MS-DOS seek function per one logical seek operation.

Using MS-DOS's Unix-style file I/O also relieved me from having to worry about buffering; I could let the operating system (or any disk-caching terminate-and-stay-resident programs that might be in place) do it. Finally, the MS-DOS file-open call (INT 21h, function 3Dh) returns a handle, and is therefore easier to interface with C's file-handle I/O routines. (BYTE Small-C doesn't support the standard I/O functions that make use of the FILE type; it manipulates all files via handles.)

Adolescent Processors

When you consider Small-C's birthplace, it's obvious that 16-bit math and logic operations there would be nontrivial operations. If you're familiar with the 8080, you might think about what would have to go into a 16-bit divide operation on that processor (I'll show you one in a minute). The original Small-C had to perform all substantial math and comparison operations by making calls into a math/logic library. Space-wise, it was impractical to emit code for a 16-bit division every time a division operation appeared in the C source program. Consequently, the original suffered from the added time overhead of making piles of subroutine calls.

The 8088's instruction set gave me the ability to reduce most of BYTE Small-C's math and logic routines to in-line instructions. As compared to a program written in the original Small-C (as much as we can compare across processors), the same program in BYTE Small-C will certainly have a smaller run-time library, likely include slightly more instructions per operation, and run substantially faster.

As a direct example, compare the code in listing 1a with listing 1b. Listing 1a shows the original Small-C's library routine for performing a 16-bit signed division. Listing 1b is the same operation in BYTE Small-C. Keep in mind that the original Small-C would have generated a CALL to function DIV, and so incurred the additional time for the CALL and RET instructions; BYTE Small-C's three instructions compile in-line.

Life In the 16-bit World

This first version of BYTE Small-C for the MS-DOS machines supports only 16-

bit integers. I'll agree with anyone that this is a less-than-desirable legacy of the language's ancestry, but it made my life easier by orders of magnitude. I could also reasonably argue that since 16 bits is the size of the 8088/80286's primary registers (accumulator and index registers, in particular), it should also be the size for Small-C's integers.

Since Small-C informally defines integers and pointers to be the same size (there is no coercion), it follows that all addressing is restricted to 16 bits. Consequently, the 8088/80286 version of BYTE Small-C runs within a 64K-byte window; if I was making a commercial announcement of the Small-C, I would probably say that "the product supports the small-memory model exclusively."

Integer size is something you should be aware of as you interpret benchmark results obtained in BYTE Small-C. As you'll discover next month, the 68000 version uses 32-bit integers. Therefore, an operation in BYTE's 68000 Small-C—especially an integer math operation—is essentially handling twice the throughput of an equivalent operation in 8088/80286 Small-C.

Getting Logical

Examine the following code fragment:

```

int i, j, k;
i=12;
j=(i==12);
k=(i!=12);

```

Execution of this code would assign to j a nonzero value (typically 1, but officially defined in the standard header file as Yes), and assign to k a value of 0. In essence, Small C does not define a separate, Boolean type (as in Pascal, for example); logical operations yield an integer result.

This produces some problems when you go to translate logical operations to their machine language equivalents on the 8088/80286. Why? Because logical operations on those processors ultimately translate to comparison operations, and comparison operations serve only to alter bits in the flags register. Consequently, you have to somehow map the contents of the flags register to an integer quantity. One way is to move the flags register into the AH register with the LAHF instruction, but I ruled this technique out for two reasons: First, it would resolve into too many instructions per logical operation. Second, different logical operations would yield different results for a true condition.

continued

How fast is *Fast*?

Ten Times Faster*

KONAN'S *TenTime*™ Intelligent Caching Disk Controller

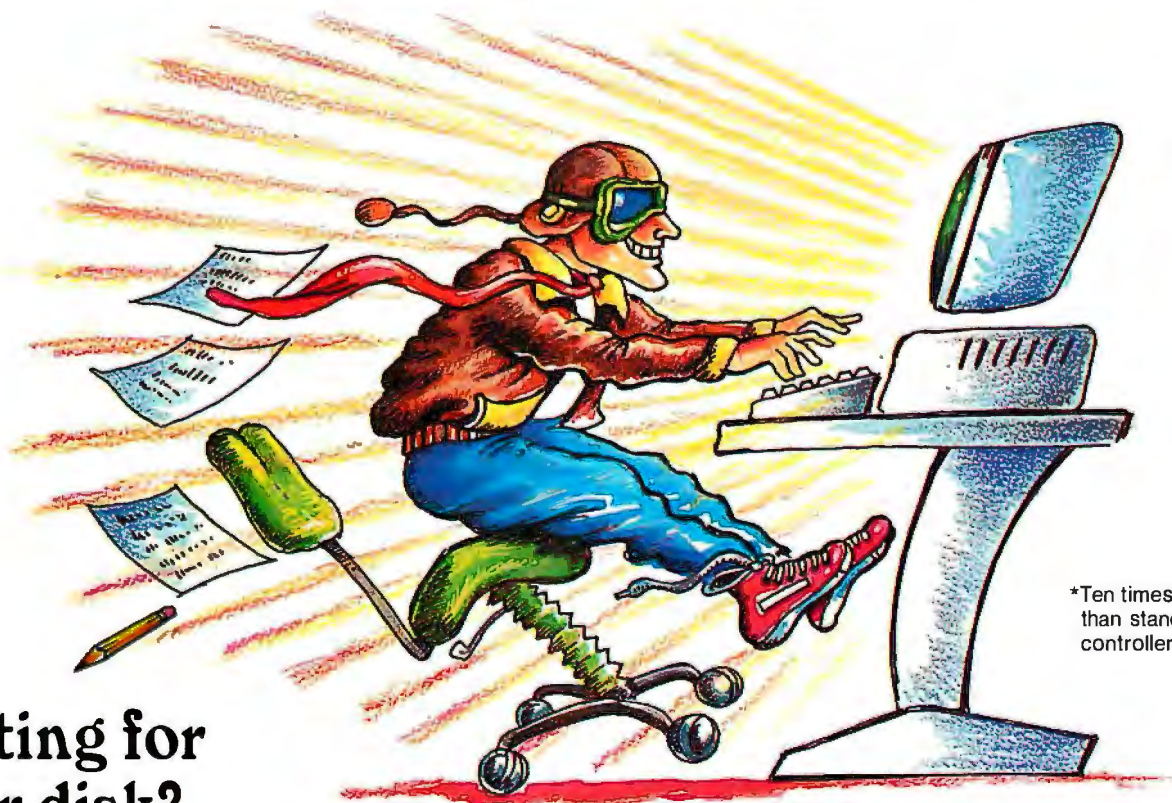

*Ten times faster than standard AT 16 bit controller cards

Waiting for your disk?

The *TenTime*™ Controller eliminates disk bottlenecks.

- Zero Latency Time
- 1 to 1 Interleave
- Elevator Seeks
- Automatic Preread
- Optional Floppy Control

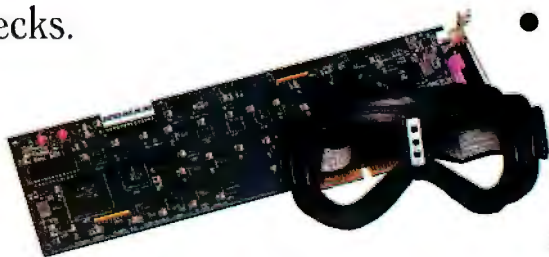

- 10X Faster Access Speed*
- 3X - 10X Faster Throughput
- 4Mb/sec Transfer Rate⁺
 - 16 Bit AT Controller
 - On-board Cache Ram
 - DOS/Unix Compatible
- Intelligent Cache Routine

⁺data transfer from controller to PC

(goggles not included)

Available for IBM AT, Tandy AT and compatibles

Circle 141 on Reader Service Card
(DEALERS: 142)

Leading Innovator Since 1978

KONAN™

1829 West Drake Drive, Suite 103, Tempe, Arizona 85283, FAX 602-345-2829, (602) 345-1300

(602) 345-1300

Instead, I chose to use short conditional branches to control the setting or clearing of a 16-bit register. For example, an equality test in BYTE Small-C emits code like:

```

CMP  BX,DX
MOV  BX,CX
JNZ  L1
INC  BX
L1: ...

```

Here's where I took advantage of two features of the 8088/80286. First, (and I realize this isn't apparent in the above code) BYTE Small-C requires that the CX register always be 0. This requirement saves a few bytes and clock cycles—a MOV BX,CX is one byte and several cycles shorter than a MOV BX,0 instruction—and it doesn't cost us anything because the CX register isn't used to support the "Small-C machine" model. Second, on the 8088/80286, moving the

contents of one register to another does not alter the flags. I couldn't clear the BX register with an XOR BX,BX instruction, as XOR alters the flags register.

Notice how the above code ensures that a TRUE condition always results in a 1 in the primary register (BX), while a FALSE condition leaves a 0 in that register. This brings BYTE Small-C in line with the Kernighan and Ritchie definition of comparison operation results for C (i.e., TRUE is 1, FALSE is 0). All other comparison operations in BYTE Small-C work in this fashion; simply replace the JNZ instruction with the appropriate conditional branch.

Memory

I wanted BYTE Small-C to support the storage allocation functions (alloc() and its ilk), so I had to be careful with the memory layout. Figure 1 shows the scheme I ultimately settled on (which, if you ignore segmentation, actually

looks a lot like the layout of the original Small-C). BYTE Small-C's library defines entry point _Uend as the starting address of any program you create in that language.

Notice that _Uend is in segment SCSEG1, while the remainder of the code is in segment SCSEG. The source code generated by BYTE Small-C includes the preamble instructions shown in listing 2. This preamble ensures the segment SCSEG1 loads higher in physical memory than segment SCSEG (Link controls this), and that _Uend is, therefore, the topmost code routine in memory. BYTE Small-C uses the remainder of memory above _Uend as the stack and dynamically allocated memory.

The _Uend routine sets the stack pointer to near the top of the segment, loads global variable _Umemptr with the offset of _Uend, and transfers control, ultimately, to main(). The initialization routine sits in memory that is claimed as data space the first time the program calls alloc(); this is not a problem since the initialization code will have done its job.

You'll notice things are on a collision course: The stack grows down, and allocated memory grows up, so if the two run into each other, things go bonkers at clockspeed. Small-C does not incorporate stack overflow checking, like its bigger commercial cousins. However, Small-C programs tend to be, at most, modest in size, and none of the many benchmark programs the BYTE lab has run have crashed on account of stack overrun.

So Long to 16 Bits

If you want to discover more about what I had to do to make the port, I encourage you to get a copy of the 8088/MS-DOS version of BYTE Small-C and examine the source code. I've tried to cover the most important points, here; you may find something that's important for you in the actual source.

Next Month

Small-C on the Macintosh. ■

REFERENCES

1. *Dr. Dobb's Toolbook of C*, A Brady Book, New York, NY: Prentice Hall, 1986.
2. Hendrix, James E. *The Small-C Handbook*, Reston, VA: Reston Publishing Company, 1984.

Rick Grehan (bixname: "rick_g") is a BYTE senior technical editor. He has a BS in physics and applied mathematics and an MS in computer science/mathematics from Memphis State University.

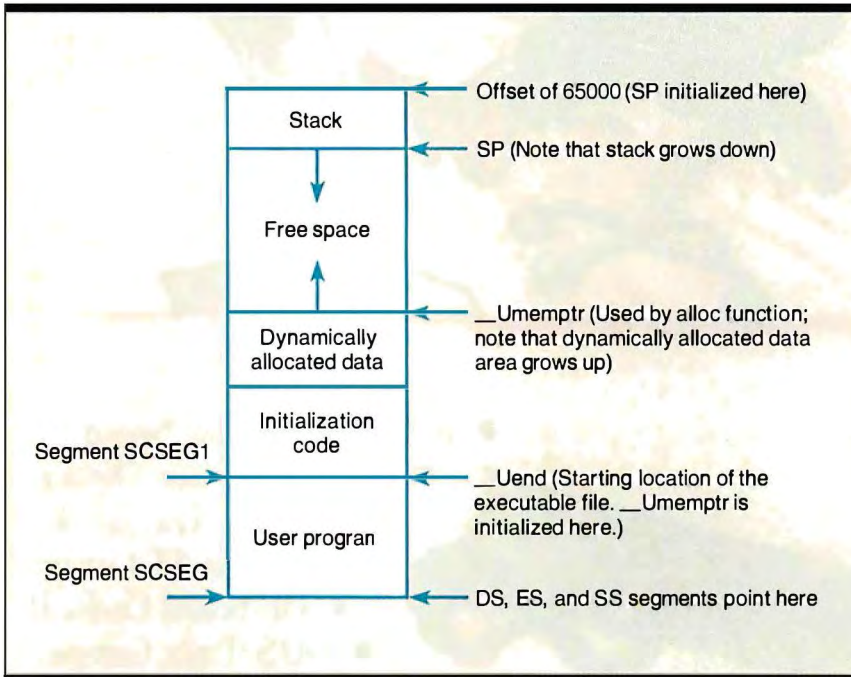

Figure 1: BYTE Small-C's memory map.

Listing 2: This preamble to the source code ensures that segments load into physical memory in the proper order.

```

SCSEG  SEGMENT WORD PUBLIC
SCSEG  ENDS
SCSEG1 SEGMENT WORD PUBLIC
SCSEG1 ENDS
SMC    GROUP SCSEG, SCSEG1
SCSEG  SEGMENT WORD PUBLIC
        ASSUME CS:SCSEG, DS:SCSEG, SS:SCSEG, ES:SCSEG

```

New Prices

OS/2

WINDOWS FOR DATA®

MULTI-LEVEL MENU SYSTEM

NESTED POP-UP FORMS

SCROLLABLE REGION

CHOICE LIST

Invoices: Create Review Print Exit

INVOICE

Invoice No.: 888784 Date: 1/93/87 Time: 16:43:15

Customer: William Jones
Innovative Software
351 Bulletin Avenue
Needham, MA 02194
(617) 394-5512

Search for customer record? (Y/N): N
Enter customer information? (Y/N): N
Enter billing address? (Y/N): N
Enter marketing information? (Y/N): N

No.	PRODUCT	DESCRIPTION	QUANTITY	PRICE	AMOUNT
5	WDMS	Windows for Data Microsoft	10	295.00	2950.00
6	WDLH	Windows for Data Lattice	5	295.00	1475.00
7	WDTC	Windows for Data Turbo C	5	295.00	1475.00
8	UDXE	Windows for Data XENIX	2	795.00	1590.00
9					0.00

Subtotal: 11325.00
Shipping: 0.00
TOTAL: 11325.00
Payment: 0.00

Cursor keys scroll, ENTER selects and ESC exits choice menu

CLOCK

POP-UP WINDOW

RUNNING TOTALS

MESSAGE WINDOW

If you program in C, take a few moments to learn how Windows for Data can help you build a state-of-the-art user interface.

- ✓ Create and manage menus, data-entry forms, context-sensitive help, and text displays — all within windows.
- ✓ Develop window-based OS/2 programs right now, without the headaches of learning OS/2 screen management. Run the same source code in PC DOS and OS/2 protected mode.
- ✓ Build a better front end for any DBMS that has a C-language interface (most popular ones do).

YOU ARE ALWAYS IN CHARGE

Control functions that you write and attach to fields and/or keys can read, compare, validate, and change the data values in all fields of the form. Upon entry or exit from any field, control functions can call up subsidiary forms and menus, change the active field, exit or abort the form, perform almost any task you can imagine.



OUR WINDOWS WILL OPEN DOORS

Our windows will open doors to new markets for your software. High-performance, source-code-compatible versions of Windows for Data are now available for PC DOS, OS/2, XENIX, UNIX, and VMS. PC DOS

versions are fully compatible with Microsoft Windows. **No royalties.**

MONEY BACK GUARANTEE

You owe it to yourself and your programs to try Windows for Data. If not satisfied, you can return it for a full refund.

Prices: PC DOS \$295, Source \$295. OS/2 \$495. XENIX \$795. UNIX, VMS, please call.

Call: (802) 848-7731

Telex: 510-601-4160 VCISOFT

ext. 51

FAX 802-848-3502

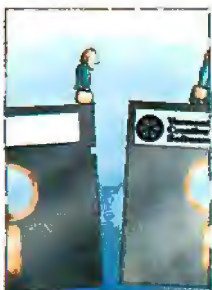

FROM END TO BEGINNING

Windows for Data begins where other screen packages end, with special features like nested pop-up forms and menus, field entry from lists of choices, scrollable regions for the entry of variable numbers of line items, and an exclusive built-in debugging system.

NO WALLS

If you've been frustrated by the limitations of other screen utilities, don't be discouraged. You won't run into walls with Windows for Data. Our customers repeatedly tell us how they've used our system in ways we never imagined — but which we anticipated by designing Windows for Data for unprecedented adaptability. You will be amazed at what you can do with Windows for Data.



Vermont Creative Software

21 Elm Ave.
Richford,
VT 05476



BASIC FEATURES

1.2MB Floppy Drive
 FL/HD Controller
 512K Memory Expands to 1MB
 101 Enhanced Keyboard
 195 Watt Power Supply
 80287 Mathcoprocessor Socket
 Operation Manual
 Clock/Calendar with Battery Backup
 One year Warranty
 FCC, UL, and CSA Approved

Mono System includes 14"
 Flat Screen, Tilt/Swivel base and
 Hercules compatible graphics card.

EGA System Includes 14" Eversion
 with Tilt/Swivel base and EGA card.

MODEL 208

80286-8MHz, 6-16 bit and 2-8 bit expansion
 slots, plus basic features.

Mono System	\$995
Mono System with 20MB	\$1274
Mono System with 40MB	\$1420
Mono System with 70MB	\$1725
For an EGA System add	\$320

MODEL 211

80286-10MHz, 0 wait state with 2 serial and
 1 parallel port, plus basic features.

Mono System	\$1359
Mono System with 40MB	\$1784
Mono System with 70MB	\$2089
Mono System with 130MB	\$3254
For an EGA System add	\$320

MODEL 212

Small footprint chassis with 80286-12MHz,
 0 wait state, 1MB 100ns DRAM, 4-16 bit and
 4-8 bit expansion slots, plus basic features.

Mono System	\$1595
Mono System with 40MB	\$2020
Mono System with 70MB	\$2325
Mono System with 130MB	\$3490
For an EGA System add	\$320

MODEL 316

80386-16MHz, 0 wait state, 1MB 120ns DRAM
 with 64K RAM cache, 6-16 bit and 2-8 bit
 expansion slots, plus basic features.

Mono System	\$1995
Mono System with 40MB	\$2420
Mono System with 70MB	\$2725
Mono System with 130MB	\$3890
For an EGA System add	\$320

CLUB IV V1.1 4/7/88

It's not just another machine. . .
It's the way to America's future.



**MODEL 110
(XT TURBO COMPATIBLE)**

8088 CPU, 4.77/10MHz 0 wait state, 256K RAM
upgradable to 640K, 360K floppy and floppy
controller, 101 enhanced keyboard, 150W power
supply and FCC approved.

Mono System	\$595
Mono System with 20MB	\$889
Mono System with 40MB	\$1049
For an EGA System add	\$320

For Sales Call:
(415) 490-2201

Fax: (415) 490-2687
Customer Service: (415) 683-6580

**Corporate, Government and
University P.O.'s are welcome.
Dealer quantity discounts are available.**

MasterCard, VISA, and American Express cards welcome.

Canadian Distributor
PC Centre Tel: (416) 470-0560
Toronto, Ontario Fax: (416) 470-2644
Pricing in this ad does not match pricing in Canada.

ORDER BY MAIL: Check and Money Order, California add 7% Sales Tax.
ORDER BY PHONE: C.O.D. Cashier Check, VISA (3%), American Express (4%) or
approved Company P.O.
TERMS: All prices are subject to change and quantity may be limited and we
reserve the right to substitute equivalent items. Unauthorized returns are subject
to 10% restocking fee. Call for RMA numbers for returns and repairs. Returning
items must be sent shipping prepaid by customer. Limited warranty: 1 year parts
and 6 months labor.

IBM XT, Hercules, and EVERVISION are trademarks and
registered trademarks of their respective companies.

CLUB

American Technologies, Inc.
3401 W. Warren Ave., Fremont CA 94539

Multitasking

- 229 Fair Share**
by Jonathan Robie
- 239 It's a Natural**
by Bud E. Smith
- 251 Weighing the Options**
by Brett Glass
- 259 First Come, First Served**
by Michael Benjamin Parker
- 274 Resource Guide**

Multitasking is the computer equivalent of walking and chewing gum—that is, the ability to do more than one thing at a time. Minicomputers and mainframes have been multitasking for years, and now microcomputers are gaining ground on them.

The faster and more efficient our machines become, the more impatient we seem to become. Waiting time seems interminable now when it reaches into the minute range—especially when that waiting means we must sit idly by while the computer works. We want to be able to tell our machines what to do, then forget that task and go on to something else while the computer handles both that internal task and the work we are currently doing.

Enter multitasking—the subject of this month's In Depth section. Multitasking involves the sharing of resources; "Fair Share" by Jonathan Robie discusses all the combinations and permutations that this sharing can encompass. Jonathan provides an explanation of the different parts of multitasking, the various means of scheduling tasks, and the communication required between tasks for all this to occur in an orderly fashion. He also deals with some of the problems you can run into when you try to do more than one thing at a time.

Some microprocessor chips are actually designed with multitasking in mind—in fact, with multitasking built in. The 80386 chip is one of these. In "It's a Natural," Bud E. Smith explores some of the internals that give this chip a jump on multitasking, including its hardware support for paging and virtual memory.

The 80386 machines, however, are not

the only option for multitasking—not by a long shot. The Amiga comes with a multitasking system, and the Macintosh's new operating system, MultiFinder, is set up for it as well. In "Weighing the Options," Brett Glass discusses the many different systems available and contrasts and compares them by capability and by how they choose to handle the various functions of multitasking.

And, finally, Michael Benjamin Parker gives you a multitasking system with which you can experiment. In "First Come, First Served," he provides his Mailbox system, a portable multitasking environment written in C. It's user-portable to a variety of systems and operating systems. You'd have to call it a cross between ready-to-use and do-it-yourself, but we think you'll enjoy it.

Once again, microcomputers enter what was once the exclusive realm of minicomputers and mainframes—and once again, we come out the winners.

—Jane Morrill Tazelaar,
Senior Technical Editor, at Large



MIRROR II™

MIRROB II

The Closer You Look... The More You Find!

Like this Russian Doll, a careful inspection of MIRROR II will reveal layer upon layer of carefully crafted features designed to provide you with the best solution to today's and **tomorrow's** data communication problems.

MIRROR II (the Crosstalk® SuperKlone) provides a superior reflection of the best in Crosstalk XVI®, at a fraction of the cost. MIRROR II comes complete with a superset of the Crosstalk XVI® Script language. This Scripting capability and MIRROR II's background communications mode gives you the power to fully automate your PC communications, and the freedom to use your PC for other tasks while sending or receiving data.

- Background communications mode (call or answer)
- File transfer protocols including Xmodem (Batch, CRC or Checksum), Crosstalk®, Hayes®, Ymodem and Kermit
- Terminal emulations for DECVT-100 / 52, IBM 3101 (character or block mode), Televideo 910 / 920 / 925 (character or block mode), Adds Viewpoint, ADM-3A, Data General D210, ANSI and Honeywell VIP7200
- Learn mode for the automatic creation of auto-logon Scripts
- Full screen Wordstar-like text editor
- Site License (the cost effective way to standardize)
- 60-Day, No Questions Asked Money-Back Guarantee

\$69.95 To order, call Toll-Free:
1-800-634-8670

(In Florida call 904-878-8564). Visa / MasterCard / COD. \$5.00 for Shipping and Handling (\$8.00 for COD orders) Florida residents please add 5% sales tax.

MIRROR II and SoftKlone are trademarks of SoftKlone Distributing Corp. / IBM is a registered trademark of International Business Machines Corp. / WordStar is a registered trademark of MicroPro International / Crosstalk and Crosstalk XVI are registered trademarks of Digital Communications Associates Inc. / Hayes is a registered trademark of Hayes Microcomputer Products Inc.

Crosstalk XVI®
Users Call 1-800-634-8670
For A Unique Upgrade Offer



MIRROR II™

A Better Reflection

SOFTKLONE™

336 Office Plaza Drive
Tallahassee, Florida 32301
Telephone: (904) 878-8564
Telex: 6714280 KLON

MIRROR II is designed for use on IBM and 100% compatible microcomputers (including the IBM PS/2 line) running MS-DOS / PC-DOS 2.0 or higher and is not copy protected.

Fair Share

In a multitasking system, resource sharing determines whether your applications fly—or die

Jonathan Robie

Efficiency means different things to different people. Multitasking is a way of using the computer more efficiently by sharing both it and its resources among programs. Many different multitasking strategies have evolved, each of which optimizes those things that were most important to the designer of the system. Some approaches evolved to optimize use of the computer, others to allow certain programming problems to be more easily solved, and still others to let you keep working on the computer even when long jobs are being run.

Multitasking originated on early mainframes as a way of using expensive computer resources efficiently. When a program performed relatively slow I/O operations, it could not continue execution until the I/O operation was complete. This wasted the power of the CPU during I/O. With commercial data processing, this I/O wait time often took between 80 and 90 percent of total run time. A multitasking operating system takes the CPU from the program that's waiting for I/O and gives it to another program that's ready to use it. If enough jobs are in memory, it's pos-



sible to keep the CPU in use most of the time. This form of multitasking, called multiprogramming, provided dramatic improvements in computer throughput. But this improvement came at a cost: Although more programs could run, each one took longer to complete. During this time, most programmers longed for a computer that they wouldn't have to share.

different types of programs make different demands on the computer, it's often possible to combine several programs without dramatically slowing performance. For instance, I have found that I can do background communications with RamNet while I compile and link large programs without significantly changing the time it takes to compile and link.

continued

Many people who have had to share a computer with others are surprised to learn that multitasking can make their work more efficient.

If I May Interrupt...

The simplest form of multitasking is called *serial* multitasking, or simple context switching. This is nothing more than stopping one thing temporarily to work on another. If you have used the Macintosh Desktop or SideKick, then you have

used serial multitasking. While a program is running, you decide that you want to use the calculator, so you pop up the calculator and use it. When you stop using the calculator, the program continues running. This is analogous to how many of us do our work—while I'm programming, I often stop to answer the telephone, drink a cup of coffee, or clean my glasses. Afterward, I continue with my work.

To switch contexts, you need some way

to interrupt the program that's currently executing and to remember everything necessary to continue work on it later—the program and all current data, plus all information that was in the computer's registers when the program was interrupted. This information is called the *process image*. The computer uses one or more of its registers to keep track of which program instruction should be executed next, so this information is also preserved when you save the registers. Therefore, if the program and its data are still in memory (and in the original location), then you can start the program up again by restoring the contents of the registers.

MS-DOS pop-up utilities generally use a DOS call to terminate and stay resident—that is, to remain in memory and update DOS so that it won't try to put another program in the same location. Programs that do this are called TSRs. They install a keyboard interrupt handler that looks for special key combinations. When it detects the appropriate key combination, it saves all the registers and passes control to the TSR. After you are finished with the TSR, the registers are restored and the original program continues where it left off.

Time by the Slice

While serial multitasking can help you work more efficiently, it makes the computer work much less efficiently. If the computer is performing calculations when you interrupt it, then all work on these calculations stops. If you have interrupted it for word processing or to use the calculator, you're using only a small fraction of its power, but none of the surplus capacity is used to continue work on the original program. It would be nice to give the new program only part of the computer's time and use the rest to continue work on the calculations. You could write a program called a *scheduler* to determine which program should run at any given time. But you can do this only if you can find some way to divide up time on the computer.

Virtually all multitasking operating systems run on computers that have some form of timer interrupt, which generates an interrupt at some fixed interval. On the IBM PC and its clones, this interrupt occurs about 18 times per second. On many other computers, it's in the range of 50 to 60 times per second.

You can use this timer interrupt to ensure that the scheduler gets control after each program has run for a specified period of time. This period, known as a

continued

A HOLMES IN EVERY PORT

ARRIVING AT COMM. PORT 2
The Best Laptop Modem
(John C. Dvorak — P.C. Magazine)
...At an Affordable Price. *(P.C. World)*

All Holmes Correspondent™ Modems are fully Hayes™ compatible. They include auto answer, auto dial, and use very little power. These features, along with a two year warranty and a complete software package make Holmes the best value available.

HOLMES
MICROSYSTEMS, INC.
1-800-443-3034

WE'VE GOT THE MODEM FOR YOUR LAPTOP!

1-800-634-0402

Silicon Specialties



\$1095



MIT PC/286 TURBO
 12 MHz, 1024 K Memory,
 200 Watt Power Supply,
 1.2 MEG Floppy Drive,
 Enhanced AT-Style
 Keyboard

FEDERAL
FREE
 AIR EXPRESS SHIPPING
 You Pay the Ground
 We Pay the Air

Hardware

MODEMS

Hayes All Models	Call
Incomm Modems New	Call
Prometheus	
1200B	75
2400 B New	119
Other Models	Call
US Robotics	
Password 1200	149
Courier 2400	299

MONITORS

Amdek Monitors	Call
NEC	
Multisync II	\$ 599
Multisync Plus	889
Other Models	Call
Mitsubishi Diamond Scan	509
Princeton Graphics Monitors	Call
Princeton Ultrasync	485
Sony Multiscan	535
Thompson Ultrascan	519
Samsung	Call
Mitsubishi Diamond Scan	509
Zenith 1490	609

PRINTERS

Alps All models	Call
AST Turbo Laser	\$4310
CITOH	Call
Citizen Printers	
120D	145
180D	159
MSP 40	319
MSP 45	465
MSP 50	399
MSP 55	530
Other Models	Call
Diconix 150	309
300	480
Epson Printers	Call
Hewlett-Packard	
Laser Jet Series II	1775
Desk Jet	779

DISK DRIVES

Bernoulli Box 10 Meg	\$ 909
Beta EXT	1019
Beta INT	909
Magnum Tape Back-up	Call
Seagate 20 MG w WD Controller	275
25-I	469
Toshiba 3.5 720K	95
3.5 1.4 MB	115
Teac Floppy F55 BR	79
AT 1.2 MEG	89

KEYBOARDS

Keytronics KB5151	\$ 119
KB5153	149

NEC Silentwriter	Call
P2200	329
P-6	418
P-7	615
Okidata Printers	Call
Panasonic	
1080I Model II	165
1091I Model II	199
1524	525
1595	429
Lazer P4450	1635
Other Models	Call
Star Micronics	Call
Toshiba	
321 SL	485
341 SL	655
351 SX	979
Page Lazer	2415

COMPUTERS

AST Model 80	\$ 1715
Model 120	2405
Model 340	4345
Model 390	5639
NEC	
Multispeed EL II	1495
Powermate	Call
Toshiba T-1000	785
T-1100 Supertwist	1370
T-3120	3058
T-3200	3789
T-5100	4899
Other Models	Call

BOARDS

AST	
Hot Shot	\$ 345
Six Pack Plus	115
3 G	225
XFormer	545
Other Models	Call
ATI EGA Wonder	175
VIP VGA	265
Hercules	
Color Card	145
Graphics Card Plus	175
Incolor New	209
Intel	
Inboard 386 PC	719
Inboard 386 AT w cable	979
4020	375
80287-6 New	175
80287-20	705
Orchid	
Designer EGA	265
Paradise	
Autoswitch 350	130
VGA - New	239
VGA Professional New	355
Video-7	
VGA	269
Vega Deluxe	180
HARD CARDS	
Plus 20 MEG	\$ 525
Plus 40 MEG	659

Software

SPREADSHEETS

Cambridge Analyst	\$ 79
HAL	89
Lotus 1-2-3 Ver. 2.01	295
MS Excell	285
Multiplan 3.0 (Microsoft)	113
Quattro	116
PFS Pro Plan	52
Supercalc 4	269
Twin Classic	32
VP Planner Plus	82

ACCOUNTING

Accpac	Call
DAC Easy	\$ 52
One Write Plus 2.0	117
Time Slips III	109

LANGUAGES

C Compiler (Microsoft)	\$ 259
Fo tran Compiler (Microsoft)	259
Macro Assembler (Microsoft)	86
Ryan McFarlan Fortran	379
Ryan McFarlan Cobol	609
Pascal Compiler (Microsoft)	175
Quick Basic 4.0	57
Turbo C	58
Turbo Pascal 4.0	58

DESKTOP PUBLISHING

Newsmaster II	\$ 39
Pagemaker	442
PFS: First Publisher	52
Ventura Publishing	489

GRAPHICS

Chartmaster	\$199
Diagram Master	185
Generic CAD w/Dot Plot 3.0	72
Harvard Graphics 2.1	239
In-A-Vision	259
Microsoft Cha t 3.0	229
New Room	30
News Room Professional	42
Printmaster Plus	29
PrintShop	32
Signmaster	132
Turbo Graphix Tool Box	58
Windows Draw! w/clp art	159

PC Mouse

w/paint (Buss or Ser.)	85
------------------------	----

PC Mouse

w/Autoketch (Buss or Ser.)	99
Logimouse	65
Logimouse w/paint	87
Microsoft Buss Mouse 1.0	92
Microsoft Serial Mouse 1.0	92
Optimouse w/Dr. Halo III	82

MONEY MANAGEMENT

Tobias Managing Your Money 4.0	\$114
Dollars & Sense w/Forecast	92

DATA BASE MANAGEMENT

Clipper	\$ 368
dBase III Plus	374
DB-XL Diamond	105
Eureka	88
Fox Base Plus 2.0	185
Genifer	188
Nutshell	75
Paradox 2.0	415
PFS: Professional File	119
Q & A	185
Quickcode Plus	129
QuickRepo 1	138
Revelation	459
R:Base For DOS	425
Rellex	78
VP Expert	56
VP Info	56

PROJECT MANAGEMENT

Harvard Total Project Manager II	\$309
Microsoft Project 4.0	287
Timeline 2.0	259

INTEGRATIVE SOFTWARE

Ability 2.0	\$ 137
Enable 2.0	352
Framework II	309
MS Works	113
PFS: 1st Choice	76
Smart Software System	Best Price
Symphony	435

WORD PROCESSORS

Microsoft Word 4.0	\$185
Multimate Advantage II	249
PFS: Professional Write	102
Volkswriter 3	132
Volkswriter Deluxe Plus	57
Webster New World Writer	53
Webster Spell Checker	32
Webster Thesaurus	37
Word Perfect	Call
Word Perfect Executive	Call
Word Perfect Library	Call
Wordstar Pro Pack 5.0	Call
Wordstar 2000 Plus Personal	205

ACCESSORIES

Copy II Option Deluxe	\$ 99
Masterpiece	79
Masterpiece Plus	92
Masterpiece Remote	107
MousePad by Mousetrac	9
Summasketch 12 x 12 Plus	359

TRAINING

Flight Simulator	\$ 29
MS Learning DOS	29
PC Logo	79
Turbo Tutor II	42
Typing Instructor	27
Typing Tutor IV	27



* No Charge for VISA and Mastercard
 * We Do Not Charge Your Card Until Your Order is Shipped
 * You Pay the Ground Shipping \$6.00
 * We Pay the Air Difference.
 * Free Air applies ONLY to orders up to 10 lbs. & Over \$50.
 * All product carries a manufacturer's warranty. All Guarantees, rebates, trial period privileges & promotional programs are handled by the manufacturer only.

* No APC FPO or international orders, please
 * Call before submitting P.O.'s Ask for National Accounts
 * Personal and Company Checks Will Delay Shipping 3 weeks
 * Prices, Terms & Availability Subject to Change Without Notice
 * Add 5% for C.O.D. Orders
 * We Do Not Guarantee Machine Compatibility

Mailing Address:
 8804 N 23rd Avenue Phoenix, Arizona 85021
 To place an Order 1-800-634-0402
 To follow up on an Order (602) 944-2552
 Order Line Hours: Mon-Fri 7a m-6p m
 Saturday 9a m-1p m
 Order Processing Hours (602) 944-1037
 10a m-3p m Mon-Fri

quantum or a *time slice*, must be a multiple of the interval between timer interrupts so that you have some mechanism for enforcing it. If you give each program enough time slices every second, then it will seem as though all the programs are running at the same time, but each program will run more slowly than it would without multitasking.

Now that you can divide up the CPU time and allocate it to various programs, you have to decide how much time to give to each program and when. This is known as *processor scheduling*, and much has been written on the subject. Since you can't make these decisions without some concrete purpose, let me propose some widely accepted goals for scheduling algorithms.

- Maximize the usage of the CPU.
- Maximize the number of jobs processed in each hour.
- Finish each program as quickly as possible.
- Make sure the time required to run a given program is always consistent.
- Minimize response time for interactive users.

Unfortunately, some of these goals are contradictory. You can minimize response time for interactive users only by giving interactive use more access to the CPU, which means that programs running in the background will run more slowly. Whenever you share the CPU among a variable number of processes, you make it difficult to judge exactly how long a program will take to execute.

Scheduling algorithms are just like everything else—you have to decide what is most important and how much of the other desirable things you can sacrifice. It should come as no surprise that different systems show different sets of values and use different scheduling algorithms. I'll examine two of the commonly used scheduling algorithms, round-robin and simple priority-based scheduling.

It's My Turn

One approach is to have all processes take turns. Each process that's currently

running can run for one time slice. Then it must wait until all other processes have had a turn before it receives its next time slice. This approach, called round-robin, is eminently fair. It is especially well suited for sharing the computer equally among interactive users.

The major design question in round-robin scheduling is the size of the time slice. If it's too large, jobs are forced to wait too long to support interactive use. If it's too short, the overhead of switching between programs becomes greater than the time available to run them.

VIPs Go First

A round-robin scheme assumes that all programs are equally important, but this assumption is not always useful. For instance, you may want to ensure that interactive processes have a very high priority so that you can always work on your computer even if a lot of long programs are running. In multiuser environments, priority schemes are often used to give one class of users priority over another.

In a priority scheme, each program receives a priority code. If there's only one CPU, and one program has the highest priority code, then that program receives the CPU. If several processes have the same priority code, this scheme implements a round-robin scheduling algorithm among them.

This simple priority algorithm is precisely that of the Commodore Amiga. The original implementation of Unix has a similar scheme, but all system processes are guaranteed to have priority over user processes. Unix dynamically changes the priority for user processes to ensure that interactive processes receive precedence. OS/2 uses a slightly more complicated scheme that divides tasks into several classes based on a variety of factors. Like Unix, it also changes user-process priority to favor interactive processes.

Mixing It Up

Regardless of the scheduling algorithm, it almost never makes sense to allow a process to hold the CPU while it's waiting for something to happen. Looping

while waiting for an event is called *busy waiting*. It's considered a cardinal sin in the world of multitasking, because it steals valuable CPU time from other processes that could be using it. Since I/O is generally slow, programs almost always relinquish the CPU while doing I/O.

Most multitasking systems seek to keep the computer's devices busy; those systems favor processes that quickly relinquish the CPU in order to begin I/O. Since I/O can usually be performed while the CPU is doing other things, this increases throughput. If the device isn't currently available, the system remembers that it has a program that needs the device as soon as it's free.

Of course, if all programs are heavily I/O-bound, the CPU can sit idle while the programs are waiting for I/O. Multitasking systems are most efficient when there's a blend of CPU-bound programs and I/O-bound programs. In many batch-oriented systems, another scheduler, called a *long-term* scheduler, seeks to choose an appropriate blend of programs to use the computer optimally.

Block That Run

To this point, I have discussed the handling of programs. But a program may actually consist of a number of tasks that operate "in parallel" and that are scheduled separately (actually, they don't operate in parallel, but multitasking gives the illusion of parallelism). For instance, a word processor might contain one task that accepts user input and another that runs a spelling checker at a lower priority. Each task has its own memory, register image, and resources.

The terms *process* and *task* can be used interchangeably. I'll call the task that currently has the CPU a *running* task. If it's waiting for some event to occur (e.g., for an I/O operation to complete), then I'll call it *blocked*. If it isn't blocked and doesn't have the CPU, I'll call it a *ready* task (see figure 1).

Any task that's capable of running is ready. When it receives the CPU, it runs. The process that's currently running ends either because its time slice is done or because it's blocked when it requests I/O or a resource of some type. In the first case, the process is ready again; in the second, it's blocked. In general, a number of programs will be ready or blocked at any particular time, but only one program will be running. (If the system has more than one processor, it's considered a multiprocessing system, and one task may be running on each processor.)

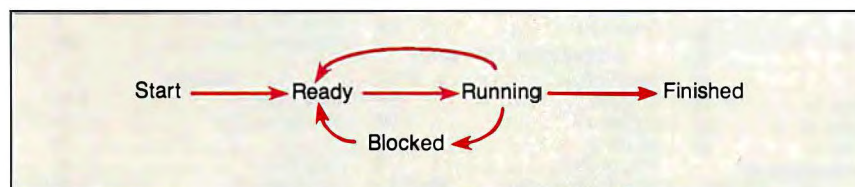
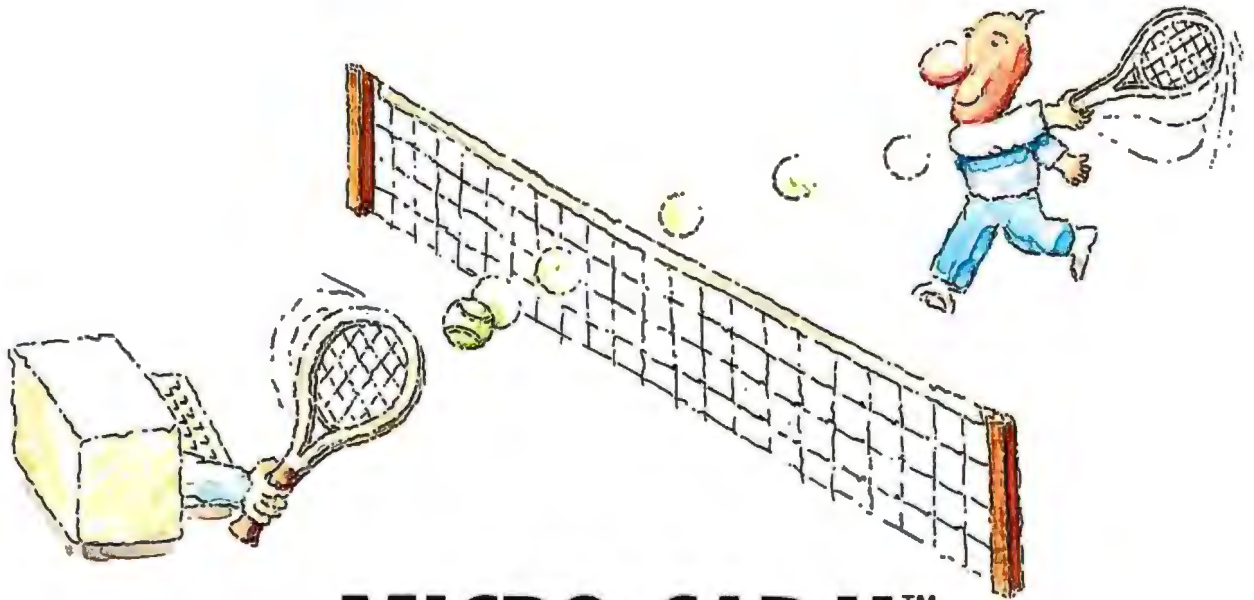

Figure 1: The various state changes that can occur as a task proceeds from start to finish.

continued



MICRO-CAP II.™

The CAE tool with fully interactive analog simulation for your PC.

Spectrum Software's MICRO-CAP II® is fast, powerful, and feature rich. This fully interactive, advanced electronic circuit analysis program helps engineers speed through analog problems right at their own PCs.

MICRO-CAP II, which is based on our original MICRO-CAP software, is a field-proven, second-generation program. But it's dramatically improved.

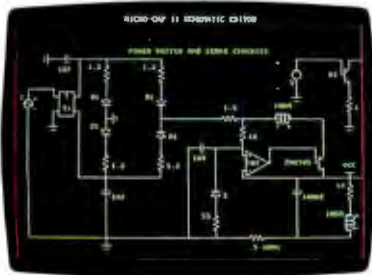

Schematic Editor

MICRO-CAP II has faster analysis routines. Better resolution and color. Larger libraries. All add up to a powerful, cost-effective CAE tool for your PC.

The program has a sophisticated integrated schematic editor with a pan capability. Just sketch and analyze. You can step

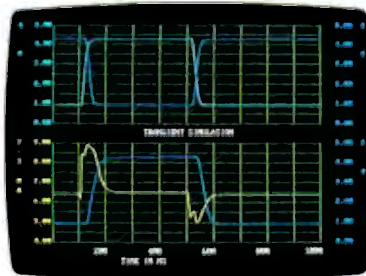

Transient Analysis

component values, and run worst-case scenarios—all interactively. And a 500-type* library of standard parts is at your fingertips for added flexibility.

MICRO-CAP II is available for IBM® PCs and Macintosh.™ The IBM version is CGA, EGA, and Hercules® compatible and costs only \$895 complete. An evaluation version is available for \$100. Call or write today for our free brochure and demo disk. We'd like to tell you more about analog solutions in the fast lane.

- Integrated schematic editor
- Fast analysis routines
- High-resolution graphic output
- Standard parts library of 500* types

*IBM versions only.

- Transient, AC, DC, and FFT routines
- Op-amp and switch models
- Spec-sheet-to model converter*
- Printer and plotter* hard copy



AC Analysis

Spectrum

1021 S. Wolfe Road, Dept. E
Sunnyvale, CA 94087
(408) 738-4387

MICRO-CAP II is a registered trademark of Spectrum Software.

Macintosh is a trademark of McIntosh Laboratory, Inc. and is being used with express permission of its owner.

Hercules is a registered trademark of Hercules Computer Technology

IBM is a registered trademark of International Business Machines, Inc.

Off to the Races

Tom Wagner

When one task starts to write a message to the screen, you want it to finish before another task starts to write its display. This contention is known as a *race condition*: If the first task loses the race, weird things can happen. For example, the single C statement `printf()` initiates the execution of a great many assembly language statements, so it's likely that another task's `printf()` may interrupt them; if it does, the screen will display a garbled mess of characters.

Critical regions are regions of code for which it is critical that they not be reentered by other tasks while they are still active. You have to build some form of protection into your system so tasks will mutually exclude each other from entering a critical region in parallel.

One possible form this protection can take is the use of a lock variable (see listing A). Each task that wants to enter a critical region must first check the lock variable. If it's already set, the task waits (and gives up its time slice) for the task currently using the critical region to clear the lock. Then the task sets the lock and enters the critical region. After processing, the task clears the lock.

When you examine listing A closely, you'll discover another race condition. Suppose the task is interrupted between `while (lock)` and `lock=1`. Both the current task and the waiting task will see the lock as zero, and both will enter the critical region. One remedy to this situation would be that shown in listing B: You first set the lock and then check to see if it was already set. If it was, you

reset the lock to its prior state.

This code might work on the 8086 processor series, which has increment-and-decrement-memory instructions. But the same routine executed on an IBM RT PC or a similar reduced-instruction-set-computer processor will fail, since the `++lock` and `lock--` expressions expand to more than one processor instruction. If the tick interrupt occurs between the `LOAD` and `STORE` instructions, both tasks will again find the lock free and enter the critical region.

A number of complicated solutions have been devised for this, most notably by Dekker and Peterson. They address the problem by providing additional variables to check for interruption and to restrict write access to a variable to a single task. However, these solutions are based on the principle of busy waiting. In a real-world multitasking system, you would never allow busy waiting, due to its inherent shortcomings. The most obvious of these is the waste of processor time; the most serious is the possibility of deadlock. In a prioritized system, the task with the higher priority will run if it's ready. If one of the two tasks vying for a critical region has a higher priority than the other, it will wait forever for the lock to be cleared, since the task that could clear it is never scheduled. (For a further discussion of deadlock, see the text box "A Deadly Embrace" on page 236.)

To solve the deadlock problem, every preempting multitasking kernel that deserves the name provides at least one task-blocking mutual-exclusion con-

struct. Task blocking means that the task no longer receives processor time; it is marked as waiting for a specific event. Only if and when this event occurs is the task awakened.

In CTask, the appropriate construct for this example would be the resource. [Editor's note: CTask is a public-domain multitasking package written in C by Tom Wagner. It is available with full source code in the `ibm.arc` area on BIX under the name `ctask.arc`.] The kernel makes sure that only one task can own a resource at one time. All other tasks that request the resource while it's busy are blocked. When the resource is released, the waiting task with the highest priority is unblocked and assigned the resource (see listing C).

Naturally, race conditions exist in requesting and releasing resources as well. But in all kernel routines, the multitasking system provides the necessary mutual exclusion, so the user doesn't have to worry about it. On the kernel level, this is usually done with interrupt disables, since the time spent in the kernel routines is relatively short. Using interrupt disables in user routines to implement mutual exclusion, however, might prove fatal to overall system operation. If you disable interrupts for too long, overruns, which usually lead to the failure of the system, may occur.

There is an often-overlooked alternative to these mutual-exclusion concepts. Device drivers are commonly used to access peripheral devices, but you can easily expand the definition of a device

Talk to Each Other

Multitasking evolved as an operating-system construct, but it's also an extremely powerful model for building complex software systems. By using multitasking primitives, you can leave the actual intermingling of separate tasks to the programming environment and program at a higher conceptual level.

You might use this capability to write a telecommunications package for commercial bulletin board services like BIX. Since connect time is expensive, it's best to log in and out of the bulletin board as quickly as possible. The program should log in, collect all messages into a file,

download the file, and log out. Unfortunately, downloading tends to be slow, forcing the program to wait. Since reading and commenting to messages is even slower, you'd like to be able to do these functions while the download is occurring. This would give you the feeling of an interactive system with the connect-time charges of a batch download.

Without a multitasking environment, this would be complicated—you'd need to determine when to call the routines for downloading, viewing, and commenting. This kind of program is hard to structure well without multiple tasks.

In a multitasking environment, the

solution is somewhat simpler. You can create two tasks: The first dials the bulletin board, downloads the data, and logs out; the second displays the messages and lets you add responses with a special editor. You can then activate the first task again to post your responses in the appropriate places on the bulletin board.

These two tasks need to communicate if they are to work effectively. For one thing, they'll both be writing information to the status line; if these messages become intermingled, the display will be confusing (see the text box "Off to the Races"). If you establish a semaphore for the status line, you can ensure that only

compass other shared-data problems. *Resource drivers* can enforce mutual exclusion without blocking tasks.

One device driver in CTask is a printer driver. The user task writes data to the driver's input pipe, and the printer-driver task handles the port I/O to actually write the characters to the printer. If you wanted to implement spooling—that is, ensure that a file is completely printed before another task has access to the printer—you could create and request a printer resource. However, this would mean that all other tasks that want to print a file would be blocked while your file prints; this isn't usually desirable. Instead, you can provide a spooler task. Tasks place the names of the files they want to print in the spooler task's mailbox. Only the spooler has direct access to the printer driver; it will wait while the printer's pipe buffer is full, and the other tasks can continue with more useful work.

To ensure that only one task writes to the screen at a time, you may want to delegate screen writing to a screen-resource task. The original tasks no longer call `printf()` directly, but send messages to the screen-resource task telling it what data to write. Thus, the original tasks can continue with other work; they need not be concerned with synchronizing screen usage.

Tom Wagner is a freelance consultant specializing in systems and communications programming and hardware design in Berlin, West Germany. He can be reached on BIX as "twagner."

Listing A: To enter a critical region of code, you first check the lock variable to see if it's already in use.

```
int lock = 0;
...
/* wait for lock release */
while (lock)
    schedule();
lock = 1;
printf (...);
lock = 0;
```

Listing B: To avoid one race condition, you first set the lock variable, then check to see what it was before you set it.

C Code	80x86	RISC Processor
<code>while (++lock > 1)</code>	<code>xx0: INC lock</code>	<code>LOAD REG,lock</code>
<code>{</code>	<code> CMP lock,1</code>	<code> INC REG</code>
	<code> JLE xx1</code>	<code> STORE lock,REG</code>
		<code> COMPARE REG,1</code>
		<code> JLE xx1</code>
<code>lock--;</code>	<code> DEC lock</code>	<code> DEC REG</code>
		<code> STORE lock,REG</code>
<code> schedule ();</code>	<code> CALL schedule</code>	<code> CALL schedule</code>
<code>}</code>	<code> JMP xx0</code>	<code> JMP xx0</code>
<code>printf (...);</code>	<code>xx1: ...</code>	<code> ...</code>
<code>lock--;</code>		

Listing C: Only one task can own a resource at one time, so you request it just before you use it and release it immediately afterward.

```
resource screen_resource;
...
request_resource (&screen_resource, 0L);
printf (...);
release_resource (&screen_resource);
```

one process will use the line at a time.

The second type of communication is more interesting and more complex—the display task must receive all its data from the telecommunications task; this task must tell the display task when new data arrives and how much there is. It might also communicate other information about the status and format of messages.

For this kind of communication, either *mailboxes* or *pipes* would be appropriate. Different systems use these terms somewhat differently, and a full discussion would have to delineate differences in terminology. For my purposes, I'll use the terms generally to indicate a means

of passing messages from one task to another.

The Amiga accomplishes message passing with messages and ports; OS/2 and Unix do it through pipes of various sorts. Any full-fledged multitasking system must provide a way for tasks to exchange messages.

Finally, the telecommunications task must deliver the downloaded messages to the display task. You could do this with a single file, but that could be slow if you're exchanging large amounts of data. You could also do it through a pipe or a mailbox, which would be faster. Or you could use shared memory, which is faster

yet; this is what OS/2 uses. Two processes can share a segment of memory so the display task can have access to a memory buffer used by the telecommunications task.

The task scheduler specifies when to call each task. Since download protocols are time-critical, it's essential to give the telecommunications task a priority that's high enough to execute promptly. You will also want a rapid response time. Balancing priorities is essential to the operation of this system. Using the multitasking system gives you added flexibility—most hard-coded solutions to this kind of

continued

A Deadly Embrace

When tasks are running, they need access to disk drives, memory, printers, and other resources. The operating system grants these resources to a task, which generally holds them until it's done with them. Since each task competes with others for the same resources, it's likely that one task will have the resources needed by another. It's also possible to allocate resources in such a way that it becomes impossible for any task to proceed. This condition is known as *deadlock*.

Suppose two tasks each read images from a scanner into a file on a hard disk. While a task is reading, it has exclusive access to the scanner and to the disk. Now suppose that the first task has the scanner and the second has the disk.

The first cannot proceed until it obtains the disk, and the second cannot proceed until it obtains the scanner. This is deadlock.

The resource allocation graph is one way of showing which processes are holding which resources; computer representations of this graph are used to detect deadlock. It also provides a basic model for discussing the algorithms used to combat deadlock. This graph has two kinds of nodes: Tasks are shown as circles, and resources are shown as squares. Arcs between the nodes indicate requests for resources and the resources being held. A cycle in your resource graph means deadlock is possible (see figure A).

Deadlock occurs only when you let

tasks hog resources even though they can't use them to finish execution. This happens only if some resources are restricted to being held by one task at a time. Also, deadlock can't occur unless you let tasks hold a resource while they wait for additional resources held by others. If you require that a task relinquish all resources when it is denied a resource request, deadlock cannot occur. (Unfortunately, this tends to destroy system performance for many programs.) Further, if your multitasking system preempts resources from some tasks in order to grant them to others, you can always prevent deadlock.

In the detection-and-recovery method, the multitasking system keeps track of the resource-allocation graph. If it finds cycles in the graph, it kills as many processes as necessary to eliminate the deadlock condition.

If deadlock happens quite rarely, many people prefer to do nothing at all. This is known as the *ostrich* algorithm: Put your head in the sand and ignore the problem. This is precisely what most microcomputer multitasking systems do. All deadlock detection, prevention, and avoidance algorithms increase system overhead, and many times you don't want to pay this price. Most computers have special hardware support for the ostrich algorithm—the on/off switch.

Deadlock is guaranteed to bring your entire system to a grinding halt. All the approaches mentioned here impose significant overheads, so when deadlock is rare, some people would rather face the risk than try to find a way to avoid it.

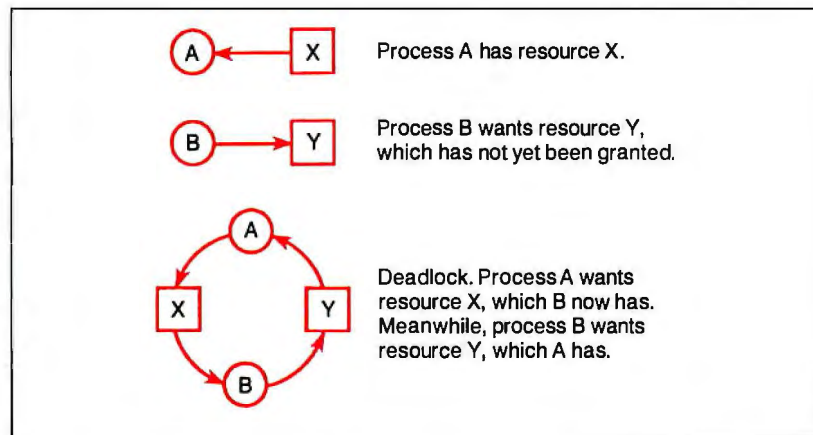

Figure A: Deadlock will occur if and only if a cycle exists in the resource-allocation graph.

problem don't easily let you change priorities or modify the relationships between modules.

Share and Share Alike

When computers were very expensive, multitasking maximized the number of programs you could run. When computers became less expensive, multitasking made programmers more efficient by giving them a better programming environment and a better programming model. In the user-oriented world of microcomputers, multitasking lets you make more efficient use of your time.

With multitasking, you can choose to maximize throughput on the computer or

minimize waiting for the people involved—but you probably can't do both. Or you can use multitasking to provide a convenient programming model for complicated software systems. The kind of multitasking you choose and the parameters you use for that implementation will determine how well your system meets your needs. ■

BIBLIOGRAPHY

- Amiga ROM Kernel Reference Manual: Exec.* Reading, MA: Addison-Wesley, 1986.
- Deitel, Harvey M. *An Introduction to Operating Systems.* Reading, MA: Addison-Wesley, 1984.

DESQview Manual. Santa Monica, CA: Quarterdeck Office Systems.

"In Depth: Memory Management." BYTE. April, 1988.

Letwin, Gordon. *Inside OS/2.* Redmond, WA: Microsoft Press, 1988.

Lions, J. *A Commentary on the Unix Operating System.* Dept. of Computer Science, Univ. of New South Wales, 1977.

Tanenbaum, Andrew S. *Operating Systems: Design & Implementation.* Englewood Cliffs, NJ: Prentice Hall, 1987.

Jonathan Robie is a freelance systems consultant working in Berlin, West Germany. He can be reached on BIX as "jrobie."

How to create high-performance programs without wasting your time or money



C Source Window

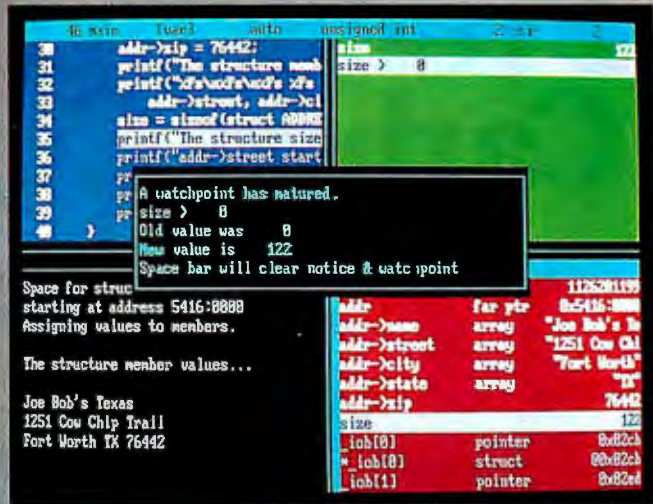

Watch Point Window

Output Window

The structure member values...
 Joe Bob's Texas
 1251 Cow Chip Trail
 Fort Worth TX 76442

Variables Window

addr	far ptr	11262199
addr->name	array	"Joe Bob's Texas"
addr->street	array	"1251 Cow Chip Trail"
addr->city	array	"Fort Worth"
addr->state	array	"TX"
addr->zip	array	"76442"
size		122
job[0]	pointer	0x82c4
job[0]	struct	0x82c4
job[1]	pointer	0x82c4

Power C Trace Debugger

Step 1: The \$19.95 Power C compiler

Power C is the new ANSI compatible C compiler that runs faster than Microsoft C and has more functions than Turbo C®. Power C combines high-performance software with superb documentation, all for less than the price of most C books alone. It's your fast route to fast programs without the fast bucks. Compare Power C to the competition and see how much time and money you'll save.



The Assembly Window

Step 2: The \$19.95 Power C Trace debugger

Power C Trace is the new state-of-the-art C debugger that makes Microsoft's Codeview look like old technology. Power C Trace will reduce the time you spend debugging your C programs by at least a factor of 10. With Power C Trace, you'll be working smarter instead of harder. Actually, you'll be having so much fun that it won't even feel like work anymore.

Unlike other debuggers, Power C Trace lets you debug graphics programs on a single monitor. You can even debug programs that write directly to video memory. However, the major advantage of Power C Trace is simple operation. You won't waste any time trying to understand or remember cryptic commands. With Power C Trace, a single keystroke is all it takes. Help screens show you which key to press and pop-up menus list your options. Invest just 10 minutes with Power C Trace now and you'll save hours from now on.

Technical Specifications

Power C includes: Power C compiler with integrated Make, Power C Linker, Power C Libraries (450 functions), the Power C book (680 pages), and support for...

- ANSI standard
- IEEE floating point
- 8087/80287 coprocessor
- auto-sensing of 8087/80287
- automatic register variables
- unlimited program size
- mixed model (near & far pointers)
- graphics on CGA, EGA, VGA, & Hercules

Optional Products:

- Power C Trace debugger
- Library source code
- BCD business math

Order now by calling our toll free number or mail the coupon to Mix Software, 1132 Commerce Drive, Richardson, TX 75081.

1-800-333-0330

For technical support call: 1-214-783-6001

Minimum System Requirements:
 DOS 2.0 or later, 320K memory, 2 floppy drives or hard drive.
 Runs on IBM PC, XT, AT, PS/2 and compatibles.

Performance/Price Chart (execution times in seconds)			
	Power C	Quick C®	Turbo C®
1) fib	23.8	53.4	26.4
2) sieve	27.6	43.2	25.5
3) tdbl	3.5	9.0	9.6
4) diskio	13.5	14.4	14.3
5) report	11.0	71.7	60.7
6) drystone	36.6	41.6	31.8
Compile/Link	73.9	113.5	81.4
EXE File Size	25120	32092	27184
Compiler Price	\$19.95	\$99.00	\$99.95
Debugger Price	\$19.95	N/C	N/A
Library Source	\$10.00	\$150.00	\$150.00
Total Cost	\$49.90	\$249.00	\$249.95

N/C no charge - N/A not available
 Benchmarks compiled using Make utility, command-line compiler, and medium memory model



60 day money back guarantee

Name _____
 Street _____
 City _____
 State _____ Zip _____
 Telephone _____

Paying by: Money Order Check
 Visa MC AX Discover

Card # _____
 Card Expiration Date _____
 Computer Name _____ Disk Size 5¼" 3½"

Product(s) (Not Copy Protected)

<input type="checkbox"/> Power C compiler (\$19.95)	\$ _____
<input type="checkbox"/> Power C Trace debugger (\$19.95)	\$ _____
<input type="checkbox"/> Library Source Code (\$10.00)	\$ _____
(includes assembler & library manager)	
<input type="checkbox"/> BCD Business Math (\$10.00)	\$ _____

Add Shipping (\$5 USA - \$20 Foreign) \$ _____
 Texas Residents add 8% Sales Tax \$ _____
 Total amount of your order \$ _____

Power C & Power C Trace are trademarks of Mix Software Inc.
 Quick C & Codeview are registered trademarks of Microsoft Corp.
 Turbo C is a registered trademark of Borland International.

Double Your Productivity With Carbon Copy Plus



Carbon Copy Plus™—the industry standard in remote control software—easily lets two PCs share the same application program over ordinary phone lines.

So now you can share the same keyboard, screen and disk with a remote user thousands of miles away, allowing you to give effective product demonstrations, support remote customers or train new users—without ever having to leave your office!

Remote control and much more!

Of course, Carbon Copy Plus offers other advanced remote communications features, including remote printing, remote access to a local area network and remote session capture and playback. But Carbon Copy Plus also offers many of the same features found in "standard" communications programs, such as file transfer, terminal emulation and complete scripting macros. And much more!

Introducing Version 5.0

If you thought Carbon Copy Plus was powerful before—wait until you see the new Version 5.0. Carbon Copy Plus has always been able to transmit text or graphics, but

now our new universal graphics translator merges incompatible graphics formats. So you can jointly update a CAD diagram using your CGA, EGA, VGA or MCGA system with an associate who is using the Hercules™ standard.

Just as important is our new background file transfer capability. This lets you easily send or receive files, at any time, without exiting your current application. Now you can double your productivity by working on one spreadsheet file while an associate sends you another!

Twice as easy

Find out why Carbon Copy Plus has become the industry standard in remote communications and is fast becoming one of the most popular communications programs overall. Call us today. We'll show you how easily you can increase your productivity.

Carbon Copy plus

Fully translated foreign versions now available!

MERIDIAN TECHNOLOGY INC

A SUBSIDIARY OF MICROCOM

7 Corporate Park Suite 100 Irvine, CA 92714 (714) 261-1199

A separate Carbon Copy Plus is required for each PC location.
Carbon Copy Plus is a trademark of Meridian Technology.
All other products referenced are trademarks of their respective companies.

It's a Natural

*The 80386 was designed with multitasking in mind
—and it shows*

Bud E. Smith

The 80386 is a natural for multitasking. With a speed of up to 4 million instructions per second and capabilities like paging and virtual memory support built into the chip, microcomputers built around Intel's 80386 processor have many capabilities of minicomputers and mainframes. And much of the work done to optimize those computers, such as support hardware and efficient, capable operating systems, applies to 80386 machines.

Multitasking

The 80386 allows multitasking of several different operations at once, while still viewing at each application as if it were running on a simple, single-function computer. In a "task switch" on the 80386, program X controls the entire system for a while, then, based on some "trigger" such as elapsed time, the processor (in conjunction with the operating system) saves the values of all program X's registers in an area of memory called a *task-state* segment (TSS). Then, the processor reloads the registers from the TSS of the program that's taking control, program Y. When execution proceeds, program Y is in control, and program X

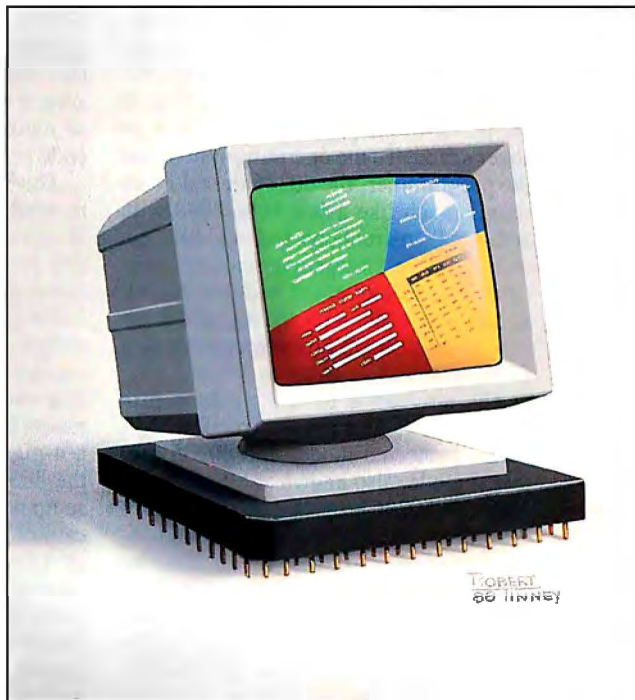

is waiting to be called again.

For multitasking, the 80386 recognizes several data structures, which are stored in a standard form for quick handling, and a special register, the task register (TR), which points to the current task. The TSS, which is a special kind of segment, is always at least 26 double-words long. It has room for copies of all the 80386's registers, including EFlags

and EIP, the instruction pointer. It also contains a 16-bit pointer to the TSS that previously had control in case there is a need to return to it. This pointer is useful when the current task is a subordinate task (like an exception handler) that has been called by the previous task and, when finished, must return control to it.

All segments have descriptors that contain necessary information about them, including location, size, and privilege level. A TSS has a special descriptor. Its limit, or length, must be at least 103 bytes (104 if an I/O permission map is used; the last word of the TSS contains a pointer to it). Longer limits let you use bigger TSSes, but you must define the values in the additional bytes. TSSes are not reentrant; if a task is busy

(based on the available bit in the segment descriptor), you can't start it again.

There is also a task-gate descriptor (see figure 1). The task gate is a short data structure that allows access to a TSS (other gates allow access to other data structures). The descriptor privilege level (DPL) field contains the task gate's privilege level. A procedure must op-

continued

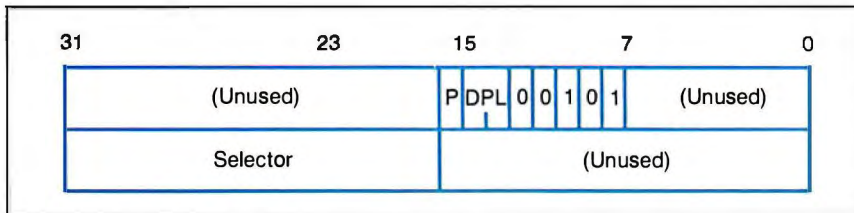

Figure 1: The task-gate descriptor. A procedure may gain access to a task through a task gate rather than the task-gate segment. Once it passes the privilege-level check at the task gate, no further protection checking takes place.

erate at a privilege level as high as or higher than that of the task gate to access it. If a procedure meets this criterion, the selector lets it access the TSS without further protection checking. In other words, a procedure that couldn't normally access a given TSS through the TSS descriptor may be able to reach it via a task gate.

Unlike the TSSes, the task-gate descriptor can be kept in a local data table and be visible to some procedures, such as interrupt and exception handlers. This process allows flexible access to a task, which can have several task gates, each accessible to different procedures and each having a different privilege level, but all sharing the same selector field.

In addition to these software structures, the 80386 has a register dedicated to multitasking—the TR register. Its upper 16 bits are visible and contain a selector that points to the current TSS descriptor. Most of the TR register, however, is invisible. The hidden part holds a 16-bit TSS base and a 16-bit TSS limit. The TR acts as an on-processor cache so the processor can access these fields quickly when a program references the current TSS.

Using these elements, the processor can switch between tasks in 268 clocks (about 17 microseconds on a 16-MHz system). If it did no other work between task switches, this would allow nearly 60,000 of them per second (not counting operating-system overhead). In other words, the processor can make many task switches per second and still have plenty of time left in which to execute programs.

A task switch is triggered when a `jmp` or `call` refers to a TSS descriptor or a task gate, when an interrupt or exception points to a task gate, or when the current task executes an `iret` and sets the nested-task (NT) flag. If the NT flag is set, the processor uses the pointer to the previous TSS, which is stored in the current TSS, to bring back the calling task.

The processor makes several checks for privilege level and for the presence in

memory of the current TSS; if it's "paged out" (stored on disk by a virtual-memory operating system), an exception occurs. If the checks are passed, the processor saves the current task's registers in the current TSS. Then it loads the TR register with the selector of the new TSS and the rest of the registers with the new information. Finally, the task-switched (TS) bit in the machine-status word is set to alert coprocessors that a task change has occurred.

80386 à la Mode

The 80386 operates in one of two modes: *real* and *protected*. In real mode, one operating system and one program run at a time; this system is compatible with PC- and AT-style programs but uses little of the power of the processor other than its sheer speed. To the operating system and the programmer, the 80386 in real mode seems much like a fast 8086/8088 with additional instructions and registers but with the same 1-megabyte memory limit. (To avoid redundancy, I will use "8086" to mean 8086/8088 for the rest of this article.) An 80386 microcomputer running DOS operates in real mode.

The alternative to real mode is protected mode, which has two "flavors": 80286 protected mode, and 80386 protected mode, also known as 80386 native mode. In 80286 protected mode, the processor uses the 24-bit addressing and 16-bit data-element size of the 80286. An 80386 microcomputer running OS/2 operates in 80286 protected mode. 80386 protected mode, or native mode, offers access to all the capabilities of the 80386: multitasking, paging, virtual memory, and so on.

While the processor is in native mode, individual tasks can run in virtual 8086 (V8086) mode, which provides an 8086-style environment just as real mode does. This task can be a single program with or without a copy of its own operating system. Meanwhile, the 80386's operating system and other programs are running in protected mode and thus have access to all its capabilities.

An 8086 operating system, like DOS 2.x or 3.x, can run as a task in V8086 mode. While this task is running, you can start up, run, and exit nearly any program that runs in real mode, such as Turbo Pascal or Lotus 1-2-3. This creates a situation in which an operating system is running as a task under the 80386's own operating system, which handles paging, virtual memory, and priorities among all the tasks running together. To avoid confusion, I'll call the 80386's own operating system a *hypervisor* to differentiate it from any other operating system that may be running under it. The hypervisor lets you set priorities and switch control among the different tasks in a multitasking environment.

Operating Room

Instead of the 64K-byte segments of the 8086, the 80386 allows segments as large as 4 gigabytes each. You have a great deal of flexibility in managing memory, but the operating system determines the possible memory structures. An 8086 operating system (or any 80386-real-mode or V8086 program) running on the 80386 imposes the 64K-byte segment limit of the 8086 on it. Even an 80386 operating system may impose arbitrary restrictions to maintain compatibility with existing code or to simplify its work.

The 80386 can support a totally unsegmented and unprotected memory model. If you set all the segment registers to 0 and give each segment a limit of 4 gigabytes, the instruction pointer, stack base, index pointer, and data pointers can all refer to the same 4-gigabyte area, so you can intermix them at will. This is called a *flat-memory* model. A flat-memory model has only one segment: in this case, a 4-gigabyte segment. It is available on the 80386 only in protected mode. This setup isn't necessarily good for all applications, but it does, for instance, let you port Unix-type operating systems (which generally use a flat-memory model) directly to 80386-based systems. This configuration will attract ports of many operating systems and large programs from minicomputers.

The important difference between operating systems for this processor lies in the amount of access they provide to the potential power of the 80386. Many different levels of capability exist. The simplest level is a *control program*, a hypervisor that lets one or more V8086 tasks run under one or more copies of an 8086 operating system. To extend this initial model, a hypervisor can support virtual

continued

800 X 560

Twice the resolution of EGA
on your Multisync.

NEW

FROM THE
MANUFACTURER
OF THE
EGA WONDER



**Any
Software**

- 800x560 (1)
- 752x410 (1)
- 640x480 VGA (1)
- 640x350 EGA
- 320x200 CGA
- 720x350 MDA
- 720x350 Herc.
- 132 Columns

**Any
Monitor**

- MultiSync
- EGA Color
- RGB Color
- 25 kHz Color
- TTL Monochrome
- Composite Mono
- PC Portable
- Compaq Portable (2)
- Polaroid Palette

**Any
Time**

- Windows
- GEM
- AutoCAD
- 1-2-3
- Symphony
- PageMaker
- Ventura
- VTerm
- SmartTerm
- WordPerfect
- WordStar & more

EGAWONDER800™

Now available from all major computer stores
Call us Today at (416) 756-0711 for more information

ATI Technologies Inc.
3761 Victoria Park Ave.
Scarborough, Ontario, Canada
M1W 3S2
Tel.: (416) 756-0711



Telex: 06-966640
Fax: (416) 756-0720

TECHNOLOGIES INC.

Technology you can Trust.

Circle 20 on Reader Service Card

(1) MultiSync monitors only. (2) Requires Optional Compaq Expansion Module.

Trademarks: ATI, EGA WONDER — ATI Technologies Inc., IBM, VGA, EGA, CGA — International Business Machines Corp.,

Ventura — Xerox Corp., PageMaker — Aldus Corp., SmartTerm — Perisoft Inc., VTerm — Coefficient Systems Corp.,

Compaq — Compaq Computer Corp., MultiSync — NEC Home Electronics Corp., Windows — Microsoft Inc., GEM — Digital Research Inc.,

1-2-3, Symphony — Lotus Development Corp., AutoCAD — Autodesk Inc., WordPerfect — WordPerfect Inc., WordStar — MicroPro Inc., Polaroid — Polaroid Corp.

memory (the 80386 has built-in support for swapping variable-size segments or fixed 4K-byte pages), mixing 80386 native mode and 8086-type programs, and other features. (For more details of the paging process, see the text box "Page By Page.")

This level lets several V8086 tasks run at once. When multitasking, however, the hypervisor may need to trap all accesses to instructions that change the interrupt flag; otherwise, one program can hang the entire system. The operating system can also turn such trapping on and off or offer it as a user option. The hypervisor can be a single-user multitasking system, a multiuser system with each user running one task, or even a multi-user multitasking system. The hypervisor must either require that the computer have enough physical memory to support all tasks, or use virtual memory (which utilizes a hard disk for page or segment swapping). The individual tasks, however, are still V8086 tasks that don't use the full power of the 80386.

A full-featured hypervisor would include multiuser and multitasking support with virtual memory and let 80386 protected-mode programs run along with the V8086 tasks. It would include a full operating system to handle system calls by the protected-mode programs.

Despite the support given by the 80386, an operating system with all these capabilities is difficult to write. There are many decisions to make, such as which pages to have in memory at any given time, and which pages to overwrite first when memory fills up (called "page-replacement strategies"). Debugging such an operating system is also a large task. Only when such a system is available, however, will programmers be able to tap the full power of the 80386.

Virtual Memory ad Infinitum

At this point, we should review virtual memory on the 80386. In general, virtual memory gives programs access to more physical memory than the computer actually has. The amount of free space on the hard disk can be seen as main memory, and RAM can be seen as a holding area for the code and data that the processor is currently using. The number of bits in the largest address that a processor can construct determines the size of its virtual address space.

An advanced processor like the 80386 has two different address sizes: A large address determines the virtual address space, or the amount of memory that you can access; a smaller address determines the real address space, or the amount of

real memory that the processor can support. On the 80386, the address information in paging tables allows a virtual address space of 64T bytes (over 64 trillion bytes). This is equivalent to 64,000 1-gigabyte CD-ROMs. (As a point of reference, one copy of every book ever printed would require fewer than 64,000 CD-ROM disks.)

The real address space on an 80386 can be directly accessed with a 32-bit address, with or without paging, allowing access of up to 4 gigabytes of real memory. However, these limits exceed the reach of current hardware. In practice, real addresses are used to access RAM, and virtual addresses are used to address large spaces for convenient systems and large applications programming.

Some large programs already use a simple form of virtual memory. In this form, a core part of the program remains resident in memory while the rest of it is divided up into sections of about 64K bytes each. As different parts of the program are accessed, these sections, or "overlays," are brought in from disk. However, dividing a program into overlays and managing their swapping in and out of memory is a big chore.

In the 80386's virtual memory, every program, data file, and so on is seen as a series of 4K-byte "pages." The real address space, RAM, is divided into 4K-byte "page frames," and the virtual address space, the hard disk, is divided into 4K-byte "page slots." The paging capability of the 80386 is one of its most interesting and novel aspects, yet it is completely a tool of the operating system and invisible to the application programmer. However, it will probably be the main tool used to access large amounts of actual memory, and it is vital to the operation of V8086 mode. (80286-based operating systems such as OS/2 use segment swapping instead.)

As different parts of a program are accessed, different pages are brought from their page slots on disk to page frames in real memory. When real memory is full and a new page is needed (i.e., the system is "overcommitted"), the processor overwrites an existing page frame so long as it hasn't been changed since it came into memory; if it has been changed, the processor copies the page frame out to its page slot on disk before overwriting it. All this takes place invisibly; the program simply accesses code and data at different virtual addresses, and the processor and operating system cooperate to bring the page into memory when it's actually needed.

The 80386 processor supports virtual

memory with its abilities to access large address spaces, translate virtual addresses into real addresses for accessing real memory, and cause an exception if a "page fault" occurs (a needed piece of code or data is not currently in memory); it also supports virtual memory with instructions that can be restarted if a page fault prevents their completion.

This is a lot for a processor to do, but much of the work is still left to the operating system. When a page fault occurs, the operating system must get the desired page from disk and bring it into memory. When memory is full, the operating system must write an existing page to disk, if necessary, and then overwrite the page frame with the desired page.

How much real memory do you need to support a given amount of virtual memory? Estimates based on existing work vary from 1 megabyte of RAM per megabyte of external storage, to the 80/20 rule: 80 percent of virtual address space must be backed by real RAM. The important issue is the size of the "working set" of each program. If each program in an overcommitted system accesses a large number of pages repeatedly (i.e., has a large working set), the operating system will have to access the disk frequently for more pages, causing "page thrashing." For example, repeatedly recalculating large spreadsheets while doing a large compile or sort at the same time might well cause page thrashing.

Preserving Your Environment

On the 80386, you can run V8086 tasks that duplicate the 8086 environment, and then 8086 programs and operating systems can be run in those tasks, but 80286 and 80386 operating systems can't be run as tasks under an 80386 hypervisor. That is, the 80386 can "virtualize" the 8086, but it cannot virtualize the 80286 or itself.

In other words, the 80386 can run 8086-style operating systems under itself, but not OS/2 or Xenix 286 as guest tasks. However, it can run this type of program as its sole operating system; the processor will emulate an 80286 completely and won't have the capabilities of the 80386, such as paging, multitasking, and so forth. Thus, these operating systems are only stopgaps until the development of true 80386 operating systems.

When the 80386 runs in real mode, it acts like a fast 8086. When it runs an 80286 operating system, it acts like a fast 80286. But when it runs a V8086 task, the operating system and native-mode tasks running concurrently with the

continued

Page by Page

An 80386 page is a 4K-byte piece of memory. Pages are placed at locations, called *page frames*, whose addresses are 4K bytes apart (0, 4K, 8K, and so on). A data item that starts at one of these 4K-multiple addresses is said to be "aligned on a page boundary." Only the first 20 bits of a 32-bit page address are significant; the last 12 are always 0. When virtual memory is in use, pages are swapped between disk and memory as needed. The 4K-byte sections on disk that hold pages are called *page slots*.

Paging doesn't have to be used at all; in real mode, it can't be. A bit in the MSW, which is inaccessible to real-mode and application programs, allows paging to be on or off.

However, paging is an almost irresistible tool for a systems programmer, since it provides an easy way to assign almost any actual address to replace the linear address calculated by a program. Nearly all 80386 operating systems will do at least some paging.

Let's Get Physical

The *physical address* is the address that comes out of the paging unit. (The 80386 is divided up into functional pieces called *units*. Each has its own function, which is described, in brief, by its name: prefetch, instruction decode, control, timing, execution, segmentation, paging, and bus units.) When paging is off (or even sometimes when it's on), the linear address from the execution unit that goes into the paging unit is the same as the physical address that comes out. However, the process of translation is complicated and can affect every aspect of the system.

A physical address has three parts: a 10-bit directory (*dir*) entry, a 10-bit page entry, and a 12-bit offset. They generate a physical address in the following way:

The 32-bit CR3 register holds the address of the current page directory. The low-order 12 bits of CR3 are always 0s, because the page directory always starts on a page boundary. The 10-bit *dir* value from the linear address points to the page-directory entry (PDE).

The high-order 20 bits of the PDE point to a page table (12 low-order 0s are added to make a 32-bit linear address). The 10-bit page value from the middle of the linear address points to the page-table entry (PTE).

The high-order 20 bits of the PTE point to a page frame (12 low-order 0s are added to make a linear address). The 12-bit offset value from the low-order bits of the linear address points to the location in memory.

The PDEs and PTEs are nearly identical. Figure A shows an entry like that found in either table. Bit by bit, this is how it breaks down:

- *Paging address (bits 31 through 12)*. For a PDE, this address points to a page table; for a PTE, it points to a page. The low-order 12 bits of the address are always 0s, since both page tables and pages are aligned on 4K-byte boundaries.
- *Operating system reserved (bits 11 through 9)*. These bits are available for the operating system to use. Typically, it might use them to keep statistics on virtual memory and page swapping—such as the number of times a page has been accessed in a given period.
- *Bits 8 and 7*. These bits are set to 0.
- *D (bit 6)*. This is the "dirty" bit for a PTE; when the page is written to, the D bit is automatically set to 1.
- *A (bit 5)*. This is the "accessed" bit for both a PDE and a PTE; when the page is read from or written to, the A bit is automatically set to 1.
- *Bits 4 and 3*. These bits are set to 0.

- *U/S (bit 2)*. This is the "user/supervisor" bit. If it's set to 1, then user access is allowed, and programs with a protection level of 3 (the lowest level) can access the page.

- *R/W (bit 1)*. This is the "read/write" bit. It works in conjunction with the U/S bit. If U/S is 0, then R/W doesn't really matter: The page can be neither read from nor written to by nonprivileged code. If U/S is 1 and R/W equals 0, then the page can only be read from; if U/S and R/W both equal 1, then it can be written to as well. U/S and R/W are meaningful for PDEs and PTEs. An individual page's protection depends on the *most restrictive pair* of bits from its PDE and PTE.

- *P (bit 0)*. This is the "present" bit that indicates whether or not the PDE or PTE points to a page currently in memory. If the P bit is 1, the rest of the bit fields defined here mean what they say. However, if the P bit is 0, the desired page is on disk, and the remaining 31 bits in this descriptor-type record can be the location of the page slot on the disk that has the page.

Each page directory has up to 1024 entries, allowing that many page tables. Each page table can point to as many as 1024 pages, each 4K bytes long. This means that a single page directory can address $1024 \times 1024 \times 4096$ bytes, or 4 gigabytes (the entire physical address space of the 80386).

While the PTE contains a lot of useful information about a page, it's very hard to get to; you need two memory accesses just to get the address of each page. The translation look-aside buffer (TLB) in the paging unit contains the 32 most recently used PTEs. The TLB often has the desired PTE, eliminating the need to actually look at the memory-based tables over 95 percent of the time.

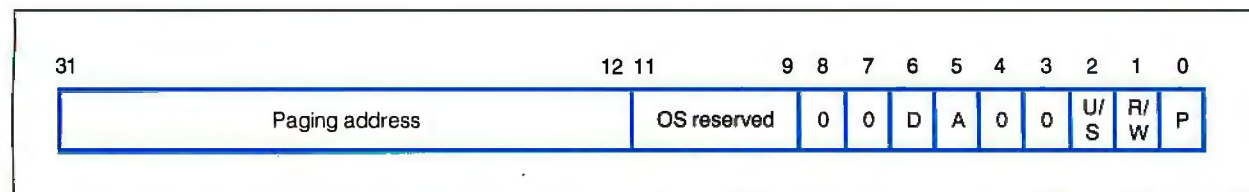

Figure A: Page-directory entry and page-table entry layout. PDEs and PTEs are almost identical, but a PDE points to a page table, while a PTE points to a page.

V8086 task have access to the full power of the 80386. The V8086 task doesn't need all these powers; it just wants to think that it has its own 8086-based computer.

If multitasking is going on, the V8086 task may be slower than it was in real mode, because it's not running all the time. Even if it's the only task running, it is still one more system layer away from the processor. Many DOS calls result in task switches to the hypervisor, which

must determine what has happened and what to do before it returns control to the calling task. Many lines of code outside the task may execute between the call and the return, increasing the time it takes for the application to execute. The exact effect on a particular application depends on which DOS calls the hypervisor traps—and how many of them there are—and which ones it doesn't.

When a hypervisor supports multiple V8086 tasks, it must use paging, because

each task produces addresses in the same range: from 0 to 1 megabyte. Paging remaps most of these addresses to physical addresses beyond 1 megabyte, helps the various tasks share the hypervisor, and protects the I/O areas from direct access by a V8086 task.

The Power of Paging

Operating systems that allow some degree of multitasking on the 8086 have problems with ill-behaved programs. For example, to update the video display, a well-behaved program calls the operating system to write to the screen. However, this is a slow process. An ill-behaved program writes directly to the screen map in memory, which is a much faster process. It can cause problems, however, when two programs run at once, one in the foreground where the user interacts with it, and one in the background. The foreground program controls the video monitor, if running full-screen, or the foreground window in a windowed system.

The operating system can intercept any calls from a well-behaved background program to the monitor. But if the background program writes directly to video memory, its results appear on the foreground screen, or it "crawls out" of its window.

On the 80386, a multitasking operating system can use the paging tables to remap the background task's direct accesses to video memory. Now the background task updates some other area of memory; the operating system controls the actual video memory and thus completely controls what appears on the screen.

A Machine of Your Own

A virtual machine extends the concept of virtual memory to the entire computer: the keyboard, the monitor, the register set, everything. A program acts as if it had the whole machine to itself—in the case of virtual 8086 mode, an entire 8086-based computer. When a program calls on system resources—for example, writes to the video RAM—the 80386's hypervisor can take one of three actions: let the write execute, trap the call and perform some other write itself, or not do the write at all, before it returns control to the calling program.

For example, if a well-behaved 8086 assembly language program (running under DOS 3.1 in V8086 mode) wants to write Hello on the screen, it issues an int 21, and DOS executes a write to the screen. However, DOS is running as a

continued

"Developing my application in C would have taken 6 months to a year, but in Actor it took 2 months."
—Brian Fenske, Boeing Commercial Airplane Company

**"To C
or not
to C..."**



Actually, you don't have to make the choice. Once C was ideal for all PC programming. But it has been complicated by windowing and graphical interfaces. Now windows development with C is difficult, time-consuming and error-prone. You need a new language that simplifies windows programming. Introducing Actor®.

Actor is the first interactive object-oriented language made for commercial development. Its powerful browsers, inspectors and debuggers give you more insight into a windowing environment than C ever will. But your C work is not lost. C libraries can be linked to Actor. Plus, its procedural syntax is easy for C programmers to learn.

Actor comes with windowing classes built in. Customize Actor's classes to create stand-alone windowing applications. And objects give you another layer of independence for a smooth transition to OS/2 and Presentation Manager. It's the quickest and easiest way to write a windowing program.

"You can write Windows programs much faster with Actor than with C or assembly language."
—PC Magazine, June 9, 1987

T e c h S p e c s

- Runs with Microsoft Windows 1.04, 2.0 and 386. Extended memory under 2.0 and 386.
- Pure, single-inheritance object-oriented language, incrementally compiled.
- Dynamic linking to C, Pascal, Assembler, or Fortran libraries. Pass data in C structures.
- Pascal and C-like syntax.
- Programming tools: Browser, Inspector, Debugger, File Editor.
- Full access to MS-Windows systems calls, multitasking, and DDE.
- Fast device-independent graphics: lines, shapes, icons, cursors, bitmaps, metafiles, Turtle graphics, sample control language using YACC.
- 150 classes, 1500 functions, fully extensible.
- Window styles: tiled, overlapping, popup, child, edit, dialogs. Controls: list boxes, scroll bars, buttons, check boxes.
- Data structures: stacks, arrays, queues, lists, dictionaries, sets, sorting, hashing, intervals.
- AI support: frames, symbols, dictionaries, lists, symbolic programming, functional arguments. Parsing and lexical analysis YACC compatible.
- String manipulation: substrings, concat, append, insert, remove, search.
- 643-page manual includes tutorial and reference.
- No license fees. Generates stand-alone applications.
- Fastest interactive OOL available.
- Fast incremental garbage collector.

**New
Release
Version 1.1**

Actor \$495 • Academic price \$99 • Academic site license \$99 • Manuals for site license \$35 • New! Language Extension \$99 • Shipping \$5 US, \$25 Int'l

**The Whitewater Group
Technology Innovation Center
906 University Place, Evanston, Illinois 60201
(312) 491-2370**

Actor is a registered trademark of The Whitewater Group, Inc.

You can rely on your file server for LAN communications...



**All you need is patience.
And faith.**

You're getting the drift of this message already. File servers aren't designed to solve the PC user's communications problem. But now there's a system that is.

Now there's COMMIX™ 32.

It's a general purpose local area network for PCs and minicomputer hosts. It connects you with the host, other PCs, and peripherals such as printers, plotters, or modems through simple, pop-up menu commands.

For file transfer and E-mail as a background task. For printer spooling and sharing directly from your applications programs. For terminal emulation that's automatic. COMMIX 32 will let anyone perform common LAN tasks—without the need for expert assistance.

Install it quickly. Expand it easily.

Almost any PC user can install and connect with COMMIX. With each connection, you're saving time and money. Because each COMMIX connection costs as little as \$125.

Then take advantage of expansion possibilities. With our optional Ethernet® Link Module, you can create larger LANs with thousands of users. And through our optional Wide Area Network Module, distant COMMIX LANs can appear as one network.

If you're lost at sea.

And looking for solid LAN. The COMMIX 32 is available now. Send us a message: ITRON, a Division of Infotron Systems Corporation, 130 Gaither Drive, Suite 116, Mount Laurel, NJ 08054.

TEL: (609) 722-5575 FAX: (609) 234-0451

1-800-423-8044



COMMIX is a trademark of Infotron Corporation. Ethernet is a registered trademark of Xerox Corporation.

V8086 task, which has a privilege level of 3. The I/O area has a privilege level of 0, so the DOS write causes a protection exception.

The interrupt vector initiates a task switch to the hypervisor's TSS, which must decide what the V8086 task is trying to do, emulate it (by doing the actual write or by ignoring the attempt), and then return control to the V8086 task. The more of this intercept-and-decide work there is, the slower the program be-

comes as it tries to perform I/O or use other system resources.

In V8086 mode, addresses are created with the 1-megabyte limit of the 8086. The 8086-style address is sent to the paging unit, which can map it to any page, either in memory or out on disk (in other words, virtual memory). Thus, the operating system can enforce page-based protection whenever a V8086 task is running; it can also support virtual memory for several V8086 tasks at once with the

paging unit and page tables. This type of protection checking and simulation can occur whenever the 80386 runs multiple tasks.

How does V8086 mode fool the program into "thinking" that it's running on a 16-bit 8086 instead of a 32-bit 80386? When a V8086 task begins executing, bit 17 of the EFlags register, called VM, for virtual mode, is set. This bit tells the 80386 to generate addresses and handle segments for this task the same way it would if the whole machine were in real mode. So, the processor generates addresses by shifting the proper segment register four positions to the left, adding the appropriate 16-bit offset, and then using the result as a memory address, exactly as on an 8086. This 20-bit number can address a maximum of 1 megabyte of memory.

The VM bit also tells the processor that the current task can access only the lower 16 bits of the 32-bit registers. This means that a V8086 task cannot access the VM flag in bit 17 of EFlags. Also, the VM bit tells the processor not to accept certain privileged op codes; only 80386 real-mode instructions and address modes, an extended version of those found on the 8086, are allowed to execute.

The 80386's real mode functions in a similar way. When the protection-enable bit in the 80386's machine status word (MSW) is not set, the machine is in real mode, and the 16-bit addressing and op code restrictions described for V8086 mode apply. The difference is that the MSW controls the whole machine, while EFlags controls only the current task. In protected mode, the hypervisor and other protected-mode tasks can use privileged instructions and address modes, while the V8086 task cannot.

Dressed for Success

From virtual memory and paging to virtual machines, the 80386 is designed for the multitasking world. As the operating systems to take advantage of its capabilities are written, we will begin to see not just the already obvious speed increases, but the real power of the 80386. ■

Editor's note: This material is adapted from Programming the Intel 80386 by Bud E. Smith and Mark T. Johnson. Copyright © 1987 Bud E. Smith. All rights reserved. By permission of Bud E. Smith.

Bud E. Smith is technical writing manager for IGC (Santa Clara, California), makers of the VM/386 control program.

DATAPRO Means Accurate.

Information. We base our purchases on it. Formulate opinions from it. Make intelligent decisions with it.

Provided... it is correct. Inaccurate information is oftentimes less useful than none at all. It leads to misinterpretation. And in making a poor choice.

Data pro means accuracy. Our information services contain up-to-date documented reports on products and

services in microcomputers, information processing and data and voice communications. Reports that help you separate truth from fiction. And in today's ever-changing industry, that requires constant research and review. Our product and pricing comparisons are carefully developed. Technology reports are documented. User ratings are statistically analyzed. Competitive reports are scrutinized. And How-to-Advice columns are meticulously edited.

Start making your decisions based on the facts. To receive your free literature pack on Datapro's subscription services, call us today at 1-800-DATAPRO (1-800-328-2776) or use the reader service card.

datapro

COMPUTER DISCOUNT WAREHOUSE™



NEC

NEC Multispeed \$1348.64
 NEC Multispeed EL 1499.76
 NEC Multispeed HD w/20 Meg 2365.77
 NEC Powermate 2, 40 Meg NEW
 NEC Powermate 2, 66 Meg LOWER
 NEC Powermate 386, 66 Meg NEC
 NEC Powermate 386, 130 Meg PRICES

WHY PAY RETAIL?

Nobody Sells For Less

CALL FOR LOWEST CUSTOM QUOTES

PACKARD BELL

Free Sidekick & Tutorial

PB88 (XT Turbo) 512K, 1 Floppy, DOS & GW-Basic, Serial/Parallel, Color/Monochrome Adapter & Keyboard \$645.14
 VT286 (AT Compatible) 10 MHz, 0 Wait State, 640K 1.2M Floppy, Serial/Parallel, F/H Controller, Keyboard \$1299.36



TOSHIBA

T100 Plus \$1484.10
 3100 w/20 Meg 2998.50
 1000 759.41
 1200 2237.55
 3200 SPECIAL BUY
 5100 NEW MODEL

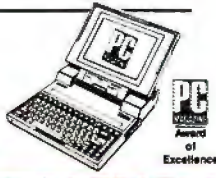

SAMSUNG



S-300 4/8 MHz, 512K, 6 Slots S/P/C, Monographics board, DOS, Keyboard
 S-300, 1 Floppy \$749.50
 S-300, 20 Meg 989.95
 S-300, 40 Meg 1117.82

500 AT Compatible 8/10 MHz, 8 Slots, S/P/C, Monographics Board, DOS, Keyboard
 S-500, 1.2M Floppy \$1095.45
 S-500, 20 Meg 1469.80
 S-500, 40 Meg 1624.45

HARDWARE, SOFTWARE & PERIPHERALS AT DISCOUNT PRICES

COMPUTERS

ASi

MDL 80 \$1619.70 MDL 170 \$2988.36
 MDL 90 1926.15 MDL 300 3490.40
 MDL 120 2260.05 MDL 340 3945.65
 MDL 140 2629.55 MDL 390 5589.40

IBM PS2

MDL 30, 2 dr \$1272.20 MDL 60, 70 Meg \$3469.60
 MDL 30, 20 Meg 1725.17 MDL 80, 40 Meg 4497.87
 MDL 60, 40 Meg 3340.15 MDL 80, 70 Meg 5677.33

COMPAQ™

Deskpro 286, Model 1 \$2095.55
 Deskpro 286, 40 Meg 2580.19
 Deskpro 286, 70 Meg 2895.20
 Deskpro 386, Model 60, 20 MHz 5579.30
 Deskpro 386, Model 130, 20 MHz 7059.92
 Deskpro 386, Model 300, 20 MHz 9168.20
 Portable II, Model 2 1896.10
 Portable III, Model 4 2797.00
 Portable III, Model 20 3577.85
 Portable III, Model 40 4159.33

LASER TURBO

XT Turbo, 512K, 1 floppy, P/S/G, Enhanced keyboard, EMS mem \$699.10
 XT Turbo, 1 floppy, 20 Meg 989.34
 XT Turbo, 1 floppy, 40 Meg 1194.22

PRINTERS

EPSON

EX800 CALL LQ500 ALL
 FX86e COW™ LQ850 EPSON
 FX286e FOR BEST LQ1050 MODELS
 LX800 PRICE LQ-2500 IN STOCK

OKINIX by Kodak

150P/300 \$319.17/479.17

IBM

Pro Printer II \$447.95 Quietwriter III \$1295.62

NEC

Color P6 \$569.74 Color P7 \$722.12
 P660 479.22 P760 639.35
 P560XL 914.75 P960XL 1067.70
 P2200 359.65 8850 1080.75
 3550 744.12 CALL FOR ACCESSORIES

OKDATA

Okimate 20 \$122.74 ML 320 \$336.63
 ML 182S 279.76 ML 321 472.28
 ML 182P 232.50 ML 390 469.96
 LASERLINE 6 1229.30 ML 391 638.48
 ML 292 Plus 377.44 ML 393 949.55
 ML 293 Plus 516.55 ML 393 Color 1067.60
 ML 294 737.10 CALL FOR ACCESSORIES

PANASONIC

1080i \$179.60 1091 \$219.85
 1092i 334.28 1592 433.44
 1595 459.45 3191 274.32
 3151 409.52 3192 579.10

CITIZEN

120D \$169.55 MSP50 \$385.64
 MSP40 318.45 MSP55 489.66
 MSP45 459.20 Premiere 35 477.17

TOSHIBA

P321SL \$494.85 P351-2 Color \$1199.95
 P341SL 634.17 P351SX 1019.45

FLOPPIES, DRIVES & TAPES

1/2 height floppy drive \$99.00
 MINISCRIBE 20 Meg 1/2 height w/cont. 329.14
 MINISCRIBE 30 Meg 1/2 height w/RLL 345.95
 SEAGATE 20 Meg 1/2 height hard drive 295.69
 SEAGATE 30 Meg 1/2 height w/RLL 309.72
 SEAGATE 40 Meg 1/2 height 432.50
 GENOA 60 Meg int. tape 734.60
 GENOA 60 Meg ext. tape 895.10
 GENOA 125 Meg int. tape 995.85
 IOMEGA BERNOLLI 20+20 1629.99
 IOMEGA 20 Meg 1/2 height int. 996.55
 IOMEGA 20+20 External 5 1/4 1795.73
 IRWIN 10 Meg tape backup 259.34
 IRWIN 20 M/40 M Internal Tape 399.10/539.20
 MOUNTAIN 4440 int. 368.80
 MOUNTAIN 4440 ext. 547.75

SANTA CLARA Diskless Workstation \$640.40

SOFTWARE & STARTER KITS

WESTERN DIGITAL 3 Nde LAN kit w/Western Digital software \$720.34
 Entry-level 286 Starter Kit, 4 Users 489.90
 Entry-level 286 Starter Kit, 8 Users SAVE
 NOVELL 286 Software w/Keyboard 1659.09
 NOVELL SFT Network Level I 2148.66
 NOVELL SFT Network Level II V2.1 2757.60
 Nondedicated Network Software 286 w/Keyboard 1495.09

INTERFACE CARDS

ARCNET PC110 LANBoard \$199.27
 ARCNET PC210 LANBoard 249.50
 ETHERNET Interface Connector 329.80
 ETHERNET Plus Board (for 286) 709.74
 G-NET Interface Card w/cable 299.52
 WESTERN DIGITAL Ethernet Cards 269.10

ACCESSORIES

ARCNET Passive Hub \$85.00
 ARCNET Active Hub 499.98
 Ethernet Terminators 37.50
 All Sales People are Novell trained and authorized. Call COW for all your Networking Hardware & Software.

VGA & EGA PRODUCTS

VGA & EGA MONITORS

COMPAQ VGA monitor \$548.68
 MAGNAVOX 943EGA 387.40
 NEC Multisync II / PLUS 609.76/888.10
 NEC Multisync XL 19 inch 197.46
 PACKARD BELL VGA Monitor 389.95
 PGS Ultrasync 515.33
 SONY Multiscan 1303/1302 599.45/649.25
 TAXAN 770 PLUS 499.40
 ZENITH Z-1490 768.31

VGA DISPLAY CARDS

ATI VGA VIP \$307.24
 GENOA VGA 289.70
 PARADISE VGA 297.68
 ORCHID VGA 278.14
 VIDEO-7 VGA 299.15

EGA DISPLAY CARDS

ATI Wonder Card \$199.95
 GENOA Super EGA Hi-Res 800 x 600 234.40
 LOGITECH EGA Card w/mouse 217.18
 NEC MVA 1024 960.50
 NEC GB-1 640x480 239.43
 PARADISE Auto Switch EGA 480 169.65
 QUADRAM Prosync 285.40
 VIDEO 7 Vega Deluxe 249.74

MODEMS & COMMUNICATIONS

AST 5251-11 Plus \$619.04
 EVEREX 1200B/2400B 109.90/199.50
 IRMA 3278/79 695.17
 PACKARD BELL 2400 Int/2400 Ext 169.95/199.22

HAYES

HAYES 1200 \$289.60 2400 \$424.68
 1200B 289.20 2400B 379.65

Robotics

1200B \$108.45 2400B \$199.70
 1200 External 129.10 2400 HST 665.20

Ventel

1200 Int. \$194.50 2400 Int. \$299.10
 1200 Plus 228.88 2400 Ext. 389.44

CHIPS

8087-2/ 8087-3 \$159.33/122.50
 80287-6/ 87-10 174.30/299.55/339.25
 80387-16/ 80387-20 497.68/777.44

MISC. & ACCESSORIES

A-B Switching Box (par or serial) \$39.95
 BASF 5 Pack of 10 DS/DD w/case 49.00
 KENSINGTON Masterpiece 99.99
 KENSINGTON Masterpiece Plus 118.40
 KEYTRONICS 5151 IBM or AT&T 148.95
 KEYTRONICS 101 104.65
 Printer Cable (IBM to Centronics) 6 ft. 18.99
 XT Power Supply 150 Watt 69.95

BATTERY BACKUP & SURGE

PERMA POWER 6 Outlet Surge Supp. \$29.40

TRIPPLITE

BC-450 \$419.78 LC-1200 \$136.85
 BC-1200 748.55 LC-1800 189.75
 4 outlet 44.25

DATASHIELD

500 Watt \$560.05 1200 Watt \$994.75
 800 Watt 638.50 6 Outlet Surge 27.85

MICE

LOGITECH HiRez \$99.95
 LOGITECH G7 / Bus 89.95/109.06
 LOGITECH Logimouse w/w/publisher 116.65
 MICROSOFT Mouse (Bus Version) 116.94
 MICROSOFT Mouse (Serial Version) 131.26
 MOUSE SYSTEMS (Serial Version) 99.55
 MOUSE SYSTEMS (Bus Version) 108.77

AT&T

6300 w/640K 1 Drive \$849.20
 6300 w/640K 1 Floppy, 20 Meg 1159.60
 6300 w/640K 1 Floppy, 40 Meg 1410.90
 6300 WGS 1099.42
 6312/6386 WGS CALL

TOSHIBA

T1100 Plus \$1484.10 T1000 \$749.41
 T3100, 20 Meg 2999.50 T1200 \$2237.55
 T3200 SPECIAL BUY 15100 NEW MODEL

PACKARD BELL

PB88 (XT Turbo) \$645.64
 PB88 w/1 floppy, 20 Meg 956.80
 VT286 1299.36
 VT286 w/20 Meg 1675.50
 VT286 w/40 Meg 1724.10
 VT386 NEW MODEL

WYSE

MDL 2108 \$1082.50 MDL 2214 \$1868.30
 MDL 2112 1568.20 MDL 3216 2658.05

LASER PRINTERS

H-P Laser Jet Model 2 \$1699.40
 AST Turbolaser P/S IN STOCK
 H-P Deskjet 689.00
 NEC LC860/LC890 1982.44/3295.60
 PANASONIC Laser 1605.35
 TOSHIBA PageLaser SAVE

PLOTTERS, DIGITIZERS & SCANNERS

CALCOMP

1023 \$3838.38 1043 \$6535.15
 1042 7539.95 1044 10305.06

SUMMASKETCH

12x12 \$376.30 12x18 \$632.50

HEWLETT PACKARD

HP7440A \$968.30
 HP7475A 1417.44
 HP7550 2926.56
 HP7570 LOWEST PRICE
 HP SCANJET SAVE

HOUSTON INSTRUMENTS

HI DMP-42
 HI DMP-52
 HI DMP-52MP
 HI DMP-56A
 HI DMP-61
 HI DMP-82

MONITOR INTERFACE CARDS

COW™ color card \$ 99.00
 COW™ monographics card w/p 99.00
 GENOA Spectrum (color monographic w/p) 168.75
 HERCULES color card w/p 145.16
 HERCULES monographics plus w/p 179.84
 TAXAN MONOGRAPHIC w/p 99.00

MONOCHROME MONITORS

AT&T Monochrome Monitor \$189.40
 AMDEK 310A/410A 119.99/149.99
 AMDEK 1280 679.78
 COMPAQ monochrome monitor 186.46
 COMPAQ VGA Mono IN STOCK
 IBM PS2 8503 187.90
 NEC Multisync GS 184.52
 PEG MonoGraph 1297.25
 PEG MAX 12E amber color 139.40
 PACKARD BELL Green or Amber 86.95
 TAXAN 123 Green/124 Amber 119.50/124.05

COLOR GRAPHIC MONITORS

AMDEK color 600T/722 \$349.24/444.49
 IBM PS2 8512 Color 428.40
 IBM PS2 8513 Enhanced Color 498.20
 SAMSUNG RGB Com 238.60
 PGS HX-12 Plus 417.15
 TAXAN 650/722 469.90/759.80
 MAGNAVOX 8762 269.05

DRIVE CARDS

MINISCRIBE 30 Meg Flashcard \$425.96
 MOUNTAIN 20 Meg/30 Meg \$49.40/785.80
 PLUS DEVELOPMENT 20 Meg 655.55
 PLUS DEVELOPMENT 40 Meg 765.80
 WESTERN DIGITAL 30 Meg 416.30

DRIVES FOR ATs & 286s

MINISCRIBE 40 Meg 28ms \$609.40
 MINISCRIBE 80 Meg 20ms 649.45
 PRIAM 40 Meg hard disk 669.55
 PRIAM 60 Meg hard disk 777.95
 PRIAM 130 Meg hard disk 1967.68
 SEAGATE 4038 30 Meg hard disk 479.80
 SEAGATE 4053 40 Meg hard disk 589.98
 SEAGATE 4096 80 Meg hard disk 739.59
 360K floppy drive 110.12

FAX MACHINES & PAPER SHREDDERS

From Here to Anywhere in 18 Seconds

SHARP FO-300 \$1720.10
 SHARP FO-500 1559.95
 TOSHIBA 3010 1314.44
 GBC-1656 1459.80
 GBC-1236S 915.44

MONOCHROME MONITORS

AT&T Monochrome Monitor \$189.40
 AMDEK 310A/410A 119.99/149.99
 AMDEK 1280 679.78
 COMPAQ monochrome monitor 186.46
 COMPAQ VGA Mono IN STOCK
 IBM PS2 8503 187.90
 NEC Multisync GS 184.52
 PEG MonoGraph 1297.25
 PEG MAX 12E amber color 139.40
 PACKARD BELL Green or Amber 86.95
 TAXAN 123 Green/124 Amber 119.50/124.05

COLOR GRAPHIC MONITORS

AMDEK color 600T/722 \$349.24/444.49
 IBM PS2 8512 Color 428.40
 IBM PS2 8513 Enhanced Color 498.20
 SAMSUNG RGB Com 238.60
 PGS HX-12 Plus 417.15
 TAXAN 650/722 469.90/759.80
 MAGNAVOX 8762 269.05

MOST ORDERS SHIPPED WITHIN 48 HOURS.

WORDPERFECT 4.2 5 1/4 3 1/2 \$199.90/214.90
 dBase III+ 5 1/4 3 1/2 399.00/424.00
 LOTUS 1-2-3 5 1/4 3 1/2 305.00/327.00
 Paradox Version 2.0 399.00
 Ventura Software Version 1.1 499.00
 MICROSOFT Word V.4/Excel 243.50/319.30

Credit Card charges are not subject until time of shipment. Shipping and handling additional. On all hard drive orders all orders under \$200.00 please add \$5.00 handling fee. Non-refundable returns subject to restocking fee. Prices reflect 9% discount for cash. All in-line business days for shipping when paying by personal check. Software, chips and other electronic components are not returnable. All pricing subject to change. TM - Registered trademarks of IBM and COMPAQ.

HIGH VOLUME BIDS INVITED

730 Anthony Trail, Northbrook, IL 60062 FAX-A-BID (312) 291-1737

WHY WAIT? CALL COMPUTER DISCOUNT WAREHOUSE™ NOW!

Nationwide Toll Free

(800) 233-4426

In Illinois FAX (312) 498-1426 (312) 291-1737

Small card charges are not subject until time of shipment

If you find a better price call us before you buy.

CHARTER MEMBER

MMC

MTC ROCCOMPUTER MARKETING COUNCIL of the Direct Marketing Association, Inc.

MEMBER E718

NEC introduces the
monitor as big as an engineer's
imagination.



MultiSync XL
Breakthrough
MultiSync technology
for CAD.

Whether your big ideas take the shape of skyscrapers or screw threads, you'll find the new MultiSync® XL the perfect monitor to display them. Especially when it's used with the graphics board that was designed to make the most of it: the MVA 1024 from NEC. Together, they give you the brilliant resolution and CAD capabilities your ideas deserve.

The XL gives you a reduced-glare 20" diagonal CRT on a tilt-swivel base, for a larger viewing area and greater comfort. And it works with a wide variety of systems from PC/XT/AT/386 to PS/2 to Mac II. The MultiSync XL automatically adjusts its scanning frequency from EGA to VGA, and on up to even higher standards with our MVA 1024 in AT/386 based machines.

So, to create brilliant CAD ideas, get the MultiSync XL and the MVA 1024. Two big ideas in themselves. For literature or a dealer call 1-800-447-4700. For technical details call NEC Home Electronics (USA) Inc. 1-800-NEC-SOFT.

IBM, PC, XT, AT and PS/2 are registered trademarks of the International Business Machines Corporation.

Apple and Mac II are registered trademarks of Apple Computer, Inc.

NEC is a registered trademark of NEC Corporation.



Computers and Communications

Circle 182 on Reader Service Card

The logo for NEC Corporation, featuring the letters 'NEC' in a large, bold, red font with a registered trademark symbol.

JULY 1988 • BYTE 249

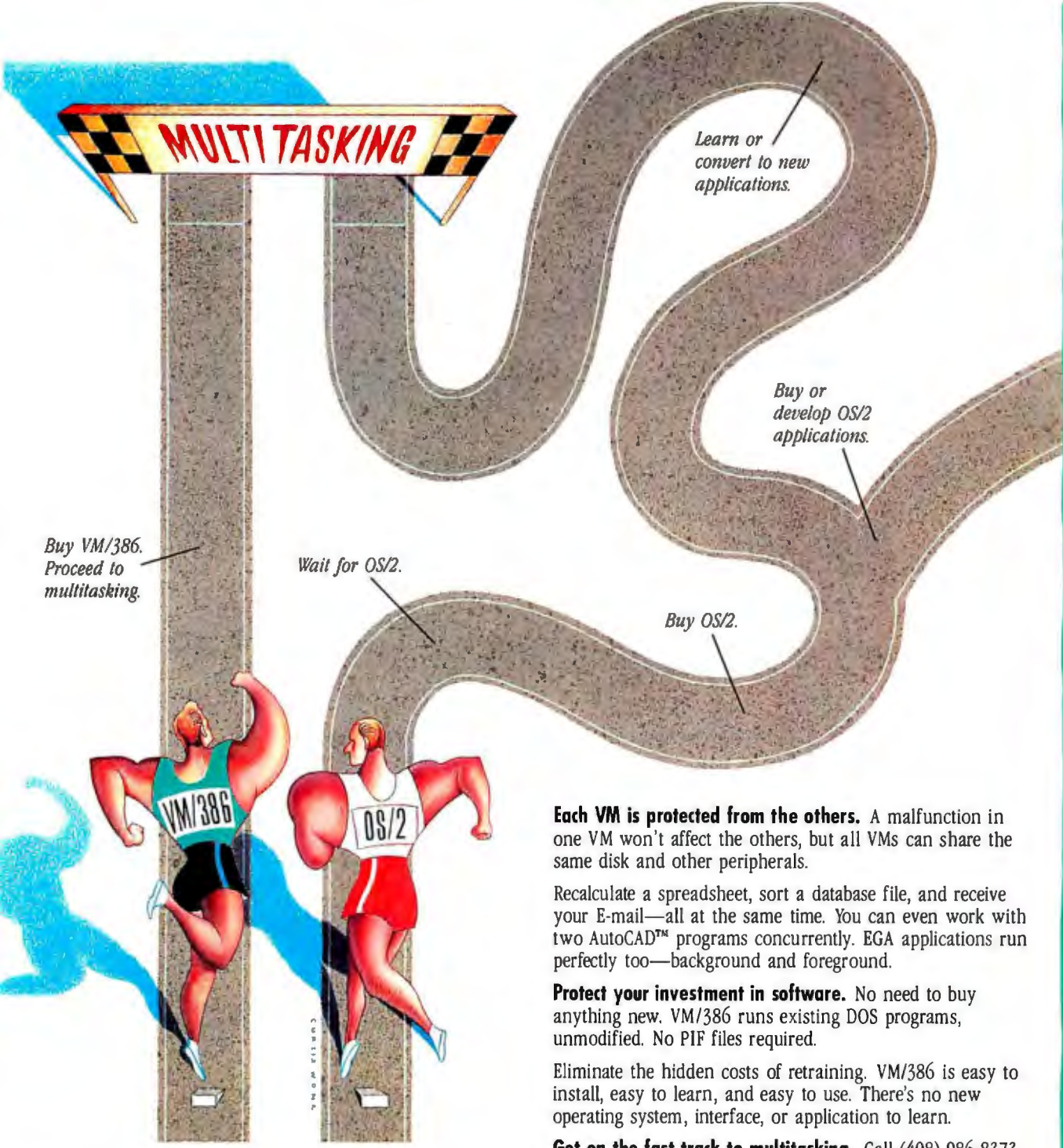

VM/386™. The Fast Track To Multitasking.

Run smart. Run efficient. Run VM/386 on your 386-based PC and start multitasking now! No detours, no waiting, no runaround.

True multitasking. VM/386 uses the virtual 8086 mode of the 80386 processor to create many Virtual Machines (VMs) in one computer.

You can load a different application into each VM. Each VM has up to 640K RAM, plus its own DOS, CONFIG.SYS, AUTOEXEC.BAT and memory-resident programs along with its applications. Tailor each VM to your needs. You have complete control.

Each VM is protected from the others. A malfunction in one VM won't affect the others, but all VMs can share the same disk and other peripherals.

Recalculate a spreadsheet, sort a database file, and receive your E-mail—all at the same time. You can even work with two AutoCAD™ programs concurrently. EGA applications run perfectly too—background and foreground.

Protect your investment in software. No need to buy anything new. VM/386 runs existing DOS programs, unmodified. No PIF files required.

Eliminate the hidden costs of retraining. VM/386 is easy to install, easy to learn, and easy to use. There's no new operating system, interface, or application to learn.

Get on the fast track to multitasking. Call (408) 986-8373 for more information or to order VM/386. Everything else is just the runaround.

System Requirements

- 80386-based computer such as IBM® PS/2™ Model 80 or COMPAQ® DESKPRO 386® or 80286-based computer with Intel® Inboard™ 386/AT.
- One 1.2 Mb (5 1/4") or one 3 1/2" microfloppy disk drive.
- One hard disk drive.
- DOS 3.0 or later.
- 2 Mb RAM recommended.
- Supports monochrome, CGA, EGA, VGA, and Hercules™ monitors.
- Not copy protected.

The Professional MultiTasker™

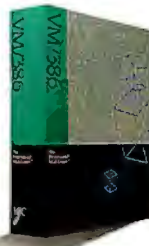

IGC
4800 Great America Parkway
Santa Clara, CA 95054
(408) 986-8373

VM/386 is a trademark of IGC. IBM is a registered trademark of International Business Machines Corporation. COMPAQ and DESKPRO 386 are registered trademarks of Compaq Computer Corporation. Intel is a registered trademark and Inboard is a trademark of Intel Corporation. Hercules is a trademark of Hercules Computer Technology. AutoCAD is a trademark of Autodesk, Inc.

Weighing the Options

Comparing the many flavors of multitasking

Brett Glass

Broadly defined, multitasking is the ability to execute more than one program, or many copies of the same program, at the same time. Long the domain of expensive minicomputers and mainframes, this ability has now become a desirable feature for all computer systems, regardless of size or cost.

Multitasking in mainframe computers was a product of economic necessity: Computing power was too scarce and expensive a resource to be wasted. However, in the microcomputer world, the move to multitasking has been driven primarily by a desire for greater convenience and increased personal productivity. In this article, I'll explore the features and limitations of some of the most popular multitasking environments available for personal computers today.

Contrary to what you might think, multitasking is not a new development on small personal computers. As early as the mid-1970s, vendors offered environments such as Cromemco's Cromix, a Unix-like operating system hosted by a 4-MHz Z80 with bank-switched memory. But the overwhelming majority of

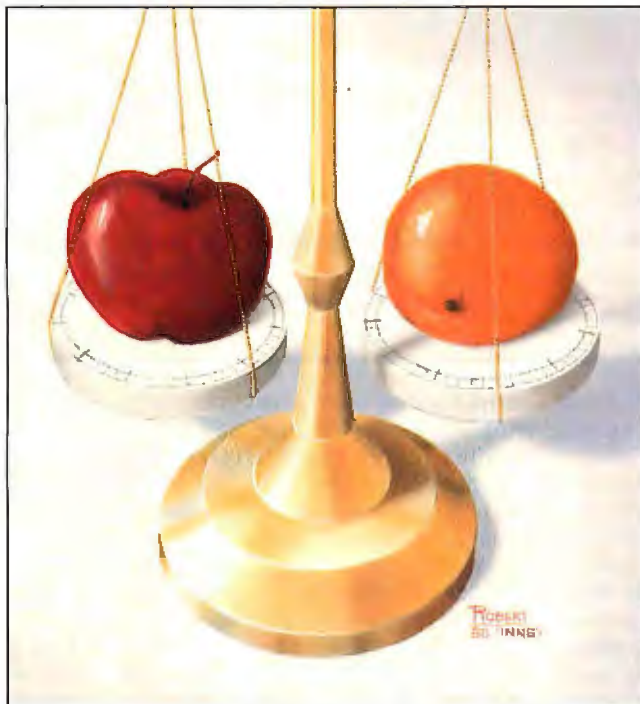

microcomputers available today, such as the IBM PC and the Apple Macintosh, weren't designed originally with full multitasking capabilities in mind.

For these systems, the technology that allowed concurrent use of several programs evolved in three stages: desk accessories (termed TSRs in the IBM PC world from the MS-DOS terminate-and-stay-resident call), program switchers,

and complete add-on multitasking environments. At the same time, manufacturers (and, in some cases, innovative third parties) began to re-engineer existing hardware and software to multitask smoothly by design, rather than as an afterthought.

Add-On Program Switchers

The first personal computers ran a single program at a time. If you were, for instance, running a database program and wanted to make a quick change to a word-processing document, there was no way to do it other than to save your work, quit the database application, enter the word-processing program, and bring up the document. On floppy disk-based computers, this might require a change of disks, and would certainly take enough time to let you forget the inspired idea you were going to add to the document.

Clever developers perceived this problem and began to come up with solutions. The result was a small program called a *desk accessory* that could instantly "pop up" when needed, regardless of what application was running. Examples of these

continued

Table 1: The multitasking environments compared.

Features	"Add-on" multitasking environments			
	Windows 2.0	Windows/386	DESQview	MultiFinder
Scheduling	Cooperative	Preemptive	Preemptive	Cooperative
Run "ordinary" applications?	Yes	Yes	Yes	Yes
In windows?	No	Yes	Any with 80386; some otherwise	Yes
Background execution	Windows applications only	Yes	Any with 80386; some otherwise	Specially written applications
Memory protection	No	Yes	With 80386**	No
Memory management	Purgeable code segments and resources; can swap inactive DOS applications to disk, EMS, and EEMS; dynamic link libraries		Can swap inactive DOS programs to disk, EMS, and EEMS	Purgeable code segments and resources
Interprocess communication				
Semaphores	No	No	Yes	No
Pipes	No	No	No	No
Queues	No	No	Yes	No
Messages	Yes	Yes	Yes	No
Signals	No	No	No	No
Named Pipes	No	No	No	No
Shared Memory	No	No	Yes	Yes
Sockets	No	No	No	No
Other	DDE	DDE		AppleTalk***
Windowing environment?	Yes	Yes	Yes	Yes

* SCO Xenix and Microport Unix for the IBM PC support optional packages that run DOS applications within the Unix environment. Apple's A/UX provides limited support for access to Macintosh tools.

** DESQview requires the use of QEMM (Quarterdeck Expanded Memory Manager) or CEMM (Compaq Expanded Memory Manager) to take full advantage of the 80386 microprocessor.

*** Under MultiFinder, it is possible for tasks on the same machine to communicate with one another via AppleTalk. This mechanism can be used to pass a handle to a block of memory on the system heap, allowing further communications through shared memory.

programs are SideKick for IBM PCs, and the MockWrite desk accessory for the Macintosh.

Although these desk accessories didn't allow the main program to run while they were on the screen, they let you save that inspired thought to a file without quitting your database, or could pop up the day's schedule without leaving your word processor. The limited but useful capabilities of desk accessories made their users ask, "If a small program can be made to 'pop up' when needed, why not a full application of my choice?" Developers once again responded with a new class of utility: *program switchers*.

A program switcher lets you switch quickly between two or more applications without reloading each program or saving your work. Each of these utilities allows switching among several programs, although it's important to note that the program switched in "owns" the

entire machine while it runs, while those programs switched out are inactive. Examples include Andy Hertzfeld's Switcher for the Macintosh, and a number of programs for the IBM PC, such as Jason Loveman's Multiple Choice, Soft-Logic Solutions' Software Carousel, and Quarterdeck's DESQ.

Finally, programmers began to address the formidable task of making multiple programs appear to run not one at a time, but concurrently, on the same system. These environments are called *add-on multitaskers*. Apple's MultiFinder began as a program switcher that simply switched programs repeatedly (and very quickly), and was refined later to perform more "intelligent" multitasking. In the IBM PC world, TopView, Wendin-DOS, Microsoft Windows, and DESQview made some multitasking possible (subject to architectural limitations). The 80386's appearance in IBM-

class machines finally makes multitasking of existing applications possible in environments such as PC-MOS/386, Windows/386 and DESQview.

Multitasking By Design

While some developers struggled to do multitasking with programs that were never written to share a machine with another application, others were developing new and complete environments that were designed from the beginning to run multiple applications concurrently. On the IBM PC were ports of Unix and PICK, two well-established minicomputer multitasking environments, and new systems such as OS/2.

Because of its complexity and the proprietary nature of its internal workings, fewer third parties have attempted to develop new operating environments for the Macintosh. However, the new Mac II, if equipped with the proper resources

"Native" multitasking environments		
Unix	OS/2	Amiga
Preemptive	Preemptive	Preemptive
Some versions*	One at a time (Compatibility Box)	N/A
No	No	N/A
Yes	Yes	Yes
Yes	Yes	No
Full virtual memory; code sharing	Full virtual memory; code sharing; dynamic link libraries	Shared code libraries, fonts, and other resources
Yes	Yes	Yes (signals)
Yes	Yes	Yes (add-on device)
Some versions	Yes	No
No	Presentation Manager only	Yes
Yes	Yes	Yes (software interrupts)
Yes	Yes (LAN Manager)	No
Some versions	Yes	Yes
Yes	No	No
	DDE	
Varies	With Presentation Manager	Yes (Intuition)

and memory management chip, runs a version of Unix supplied by Apple known as A/UX.

Many of the multitasking systems for existing machines support some mechanism for running one or more "old" applications, so that you can migrate gracefully from one environment to the other. Microport's Merge 386 and Phoenix Technologies' VP/ix 386 each let MS-DOS applications run under their respective versions of Unix for the IBM PC. QNX, a Unix look-alike for the PC, supports MS-DOS as a task. The OS/2 Compatibility Box lets you run a single MS-DOS application together with multiple new applications. And Apple's A/UX provides a limited ability to launch conventional Macintosh applications from the Unix environment.

Finally, there are the newest machine/operating-system combinations where multitasking is a feature from the time

the hardware is designed. Most prominent of these in the microcomputer world is Commodore's Amiga. With special graphics hardware tailored to support tasks running in multiple screens and windows, the Amiga is at least partially responsible for the rush to bring multitasking to other PCs.

What's the Difference?

The words *multiprogramming*, *multiprocessing*, and *multitasking* are often confused. Before continuing, I want to draw some distinctions between these similar, but distinct, terms.

The term *multiprogramming* refers to the situation in which a single CPU divides its time between more than one job. Time-sharing is a special case of multiprogramming, where a single CPU serves a number of users at interactive terminals.

In *multiprocessing*, multiple CPUs

perform more than one job at one time. Multiprocessing and multiprogramming are not mutually exclusive: Some mainframes and superminicomputers have multiple CPUs, each of which can juggle several jobs.

Some sources consider multitasking equivalent to multiprogramming. Others define it as any situation that involves multiprogramming, multiprocessing, or some combination of the two. For the purposes of this article, I'll use the term *multitasking* to describe any system that runs, or appears to run, more than one application program at one time.

An effective multitasking environment must provide many services, both to the user and to the application programs it runs. The most important of these are *resource management*, which divides the computer's time, memory, and peripheral devices among competing tasks, and *interprocess communication*, which lets tasks coordinate their activities by exchanging information.

Sharing the CPU

The key resource that all multitasking environments must manage, or schedule, is the use of the CPU itself. While there are many schemes that can be used to distribute CPU time among the different tasks within a system, all fall into two major categories: preemptive and nonpreemptive scheduling.

In preemptive scheduling, a task may lose control of the CPU at any time, and another task is made to run instead. The task that loses control, or is *preempted*, need not know that this has occurred; in fact, it may not even be aware that it's running in a multitasking environment. This is accomplished by system hardware and software that's designed to fool the task into thinking it owns the machine.

Most preemptive-scheduling algorithms give interactive tasks larger and more frequent time slices so that they can respond rapidly to a user's request. Because the level of interaction can vary in different parts of the same program (e.g., a spreadsheet requires a high level of interaction during data entry, but none during recalculation), many environments are designed to monitor the current behavior of each task and adjust its time slice appropriately.

In nonpreemptive scheduling (also called cooperative multitasking), a task that gains control of the CPU continues to do so for any amount of time until it explicitly yields control to the next task. While nonpreemptive schedulers are usually very simple to implement, they

continued

are generally not as robust, or tolerant of errors, as preemptive ones. With non-preemptive scheduling, a task that fails to relinquish the CPU—due to a software bug or a hardware problem—locks up the entire system, destroying all the data used by every task. Also, a task that yields control too infrequently to other active tasks causes the entire system to appear sluggish. In practice, nonpreemptive scheduling works best when enforced either by the compiler that creates the program or by rigorous program design standards.

Last but not least in the area of time management, a scheduler must determine which task is to run next, and for how long. A preemptive scheduler can interrupt a task when there is something more important to be done (say, to service a peripheral device), and both preemptive and nonpreemptive schedulers can determine how often each task is given a chance to run. Generally speaking, it is desirable to give the task that occupies the frontmost window in a windowed environment priority over those in other windows, since this improves the responsiveness of the system as perceived by the user.

At the other extreme, multitasking systems must also prevent "starvation," the condition in which a task never runs because its priority is set too low. OS/2, for example, sets a maximum amount of time for which a task, regardless of priority, can languish without gaining control of the CPU.

Sharing Memory

Besides sharing CPU time, all multitasking environments must help applications share available RAM with one another. The three main functions that an environment can provide include storage allocation (required on all machines), storage overcommitment (also called swapping or paging), and protection (available only where the hardware permits).

In a multitasking system, each task must be relegated to a specific part of memory, and each task must not attempt to manipulate storage belonging to other tasks without permission. In systems designed from the ground up, tasks are expected to ask the operating system for memory before using it. In add-on multitasking environments, the system often "lies" to a task, telling it that the system has less memory than it actually does. Thus, a task that commandeers all available memory still runs correctly. Some systems also provide the ability to temporarily halt a task and copy its memory to disk, which makes room for other tasks

while the first one is dormant.

When a task interferes with others by directly accessing key parts of a machine's hardware (such as the screen), it may not be able to run simultaneously with other applications in a multitasking environment. Both Microsoft Windows 2.0 and DESQview (without an 80386)

Besides sharing CPU time, all multitasking environments must help applications share available RAM with one another.

allow such applications to be "switched" on and off, either swapping them to disk or leaving them inactive in RAM when they are not in use.

Making a task dormant and swapping its memory to disk is a primitive form of storage overcommitment—that is, running more tasks than can fit in RAM at one time. However, to overcommit storage without suspending at least one task usually requires a special piece of hardware known as a memory management unit (MMU). Popular personal computers that contain MMUs include the IBM PC AT, AT compatibles, and the Macintosh II (as an extra-cost option). The IBM PC XT, all Macintosh machines developed prior to the Mac II, and the Amiga do not contain MMUs.

An MMU facilitates storage overcommitment by quickly and automatically detecting when a program tries to access information not in RAM. When it sees such an access, it activates special software that reads the needed information off the disk, then restarts the program where it left off. The program that attempted to make the access isn't aware that anything unusual has happened. Execution continues exactly as if the data had been in RAM all along, although perhaps a bit more slowly.

Some systems without an MMU, such as Windows on a PC and the Macintosh, have a limited ability to overcommit stor-

age. The memory occupied by certain parts of the code ("segments") and by blocks of data that do not change ("resources") can be deallocated, or purged, and reused for other purposes.

Another useful function in multitasking systems is memory protection—that is, preventing programs from reading or modifying RAM that doesn't belong to them. This protection contains the damage done by a crashed program, and usually the information being manipulated by other programs survives intact. An MMU also provides memory protection of this level.

The 80386 microprocessor contains particularly powerful facilities for memory protection. Many "ill-behaved" programs (i.e., programs that take over some or all of the IBM PC's hardware) can safely be contained within a virtual machine and prevented from interfering with other applications. DESQview, Microsoft Windows/386, Merge 386, and VP/ix all use this facility on a single 80386-based machine to multitask IBM PC programs (and, in the latter two, Unix applications).

Finally, multitasking systems also control access to resources such as printers, serial ports, disk files, and the computer's screen. Often, a system spools printer output by saving the information generated by each program and printing it separately rather than enforcing exclusive access. (*Spool*, by the way, stands for "simultaneous peripheral operation on-line.") Parts of disk files can be locked to prevent simultaneous access by more than one task. Also, the screen can be divided into windows so that you can simultaneously view the output of many programs.

Interprocess Communication

A multitasking environment becomes vastly more useful if the tasks, or processes, can communicate with one another. While the number of possible communication mechanisms is infinite, a relatively small number have gained wide acceptance. These include semaphores, pipes, queues, messages, signals, named pipes, shared memory, and sockets.

A semaphore is simply a variable (an integer or a yes/no flag) that can be read, incremented, or decremented by more than one process. Most implementations provide a means to attempt to change the variable and retrieve its original value in a single indivisible operation; this feature is necessary to prevent "race conditions" when two processes attempt to manipulate the semaphore at the same time.

WEIGHING THE OPTIONS

A pipe is a mechanism that allows a stream of characters from one task to be passed to another in order. Pipes are a one-way communication mechanism: Data always flows from the write end of the pipe to the read end of the pipe. Pipes are often used to feed the output of one application directly to another as input; the Unix, MS-DOS, and OS/2 command-line interpreters can connect long strings of applications via pipes to accomplish complex tasks.

Queues allow larger blocks of data, usually records larger than one character, to be passed between applications in order. Queues are often used to implement other interprocess communication mechanisms, such as messages.

Many multitasking environments have facilities through which applications can exchange messages—blocks of data with a format defined by the system or the applications involved. The exact formats and semantics of messages vary widely from system to system.

A signal (sometimes called a software interrupt) tells a task to drop what it is doing and immediately handle an asynchronous event. Usually, this is done by executing a special piece of code called, logically enough, a signal handler. Most multitasking environments that implement signals will terminate an application at once if it receives a signal it is not prepared to handle. In the jargon of some systems (like the Amiga), the term *signal* is used to describe what I have defined earlier as a semaphore.

Named pipes are similar to pipes in that they let tasks exchange data a character at a time. Unlike ordinary pipes, however, they can also support the transmission of larger blocks of data, be used across a network, or carry data in both directions (like a pair of ordinary pipes). In systems that implement named pipes, ordinary pipes are often called anonymous pipes to make a clear distinction between the two.

Most multitasking systems provide a way for two tasks to share a common block of memory, and this is perhaps the fastest form of interprocess communication. When shared memory is used, other mechanisms (such as semaphores) are often useful to arbitrate access to the common area. Shared memory is rarely (if ever) available to processes communicating over a network—a constraint that limits its usefulness in some situations.

Versions of Unix developed at the University of California at Berkeley contain a useful interprocess-communication mechanism called sockets. Similar in some ways to named pipes, sockets let a

process on one networked computer start a program on another, feed that program input, and collect the output. This feature has proved useful enough that it will likely be implemented in all versions of Unix (and perhaps other operating systems) in the future.

Some Real-World Environments

So far, I've covered most of the points required to understand the inner workings of many real-world systems. What products are available, and what are the capabilities of each?

While a thorough description of any one system could (and often does) fill several volumes, I'll survey some of the most popular multitasking environments for personal computers and discuss how they support some of the facilities mentioned above (see table 1).

Microsoft Windows 2.0

Microsoft Windows 2.0 provides a windowed, graphical user interface and limited multitasking capabilities on the IBM PC and compatibles. The interface conforms to IBM's Systems Application Architecture (SAA) standard, which means that it has the same appearance as the forthcoming OS/2 Presentation Manager.

Applications written specifically to work with Windows run in windows and participate in nonpreemptive multitasking. Some other MS-DOS applications—mostly those written to be compatible with TopView—can be run in Windows, but only one at a time. But for poorly behaved DOS applications, Windows 2.0 can serve only as a program switcher. Windows-specific applications can communicate with one another via a message-passing scheme; no other interprocess communication facilities are provided. TSR programs cannot be run in a Window, but a number of "desktop applications" are provided, including the traditional calendar, calculator, notepad, and clock, as well as simple paint and draw programs.

Windows uses message passing to implement a unique high-level protocol called Dynamic Data Exchange (DDE). Using this protocol, applications can send data to one another on the fly, so that a spreadsheet, for instance, could continually be updated with information that enters the system via a communications program.

Microsoft Windows 2.0 uses a number of unique methods to manage storage. Applications can share the code in dynamic-link libraries: routines linked to

continued

The best Modula-2

compilers for PCs and
compatibles

Taylor Modula-2

The professional high-performance compiler for PCs: the fastest compiler in the world!

- * **unrivaled speed of compilation**
7,000–10,000 lines per minute (80286, 8 MHz).
- * **excellent code**
Mini-computer standard global optimisation. Code performs 1580 Dhrystone tests per second! (80286, 8 MHz)
- * **ultra-compact**
high code density and a library of unrivalled compactness (23 modules in a total of 13K!)
- * **completely standard implementation**
Follows the ANSI standard for Modula-2. BIOS independent – uses MS-DOS exclusively.
- * **easy to use**
Straightforward user interface. Comprehensive documentation for system programmers.
- * **Guarantee and support**
One year guarantee. Maintenance contracts available. Swiss quality product.

TaylorModula-2 \$ 900
Demo disk \$ 10

M2SDS \$ 99

The professional Modula-2 software development system M2SDS comprises the following features in an easy-to-use window environment:

- modern, syntax-driven editor
- fast compiler
- linker producing EXE programs
- unique library manager
- comprehensive standard library

There are a vast number of tools, toolboxes, demo disks, public domain programs and books for M2SDS – probably more than for any other development system! M2SDS was used for the writing of the Farsight integrated business software package!

Demo disks \$ 10

JPI-Modula-2 \$ 149

A reasonably-priced Modula-2 compiler with a configurable environment, integrated Make function and highly optimising code generator.

We have Modula-2 compilers for the Amiga, Atari, Commodore, IBM PC, Macintosh, and the Intel 80386. We also have a complete Modula-2 development system.

Texas residents add 8% sales tax. International Orders add \$20 shipping.

The Modula-2 people:

**INTERFACE
TECHNOLOGIES**

3336 Richmond, Suite 323
Houston, TX 77098-9990 (713) 523 8422

Dealer inquiries welcome

International	
Austria: 0222/4545010	United Kingdom: 01/6567333
Belgium: 071/366133	Germany: 02983/8337;
France: 20822662	0731/26932;
Italy: 02/405174	0821/85737;
Scandinavia: +45/3/512014	04106/3998;
Switzerland: 01/9455432	0531/347121



A. L. Meier-Vogt
im Späten 23
CH-8906 Bonstetten/ZH
Switzerland
Tel. (41)(1) 700 30 37

SPECIAL

GENERIC CADD 3.0

- Auto Dimensioning
- Dot Plot
- Drafting ENH 1
- Drafting ENH 2

\$119 LTD. QTY

SAVE UP TO 70%

PRODUCTS NOT LISTED...CALL

SINCE 1984

CAD...etc.
PC & MAC

UPS ShipMate™ Manifest \$295

PRINTERS • LASERS • SCANNERS

AST TurboLaser/PS	Call	10011-M2	\$190
Citizen 1 0-D	\$139	10921	\$280
180-D	\$167	1524	\$524
MSP-15E	\$295	1592	\$350
MSP-40	\$590	1596	\$590
MSP-5	\$380	3131	\$250
MSP-50	\$350	3151	\$385
MSP-55	\$440	3151	\$480
Primera 25	\$430	Personal Laser (Mac)	\$1350
Tribute 124	\$430	Stry Microneer	
Tribute 224	\$570	NX1000	\$160
Diconix 150	\$300	N 18	\$705
N.P. Laser Jet Series W	\$1690	NR15	\$1015
JDL 850	Call	NR10	\$375
NEC P-6	\$425	NR15	\$410
P-7	\$500	Toshiba 321 SL	\$465
P-9	\$1010	341	\$595
3510, 3550	\$710	351 SX	\$930
8810, 8850	\$1 9	351 C-2	\$1010
Panasonic 1000-M2	\$155		
CHPS 64k, 56k, 8087, 80287/387	Call		

MONITORS • TERMINALS • PANELS

Amdek 1280 w/card	\$630	Samsung	Call
Mitachi	Call	Signs Design	Call
Logitech Multiscan	\$440	LaserView 15/18"	Call
Mitsubishi		Sony Multiscan 1303	\$540
Diamond Scan	\$475	Taxim	Call
Others	Call	Viking	Call
NEC Multisync II	\$530	VMI	Call
Multisync II	Call	Zenith 14 Flatcreeen	\$580
Plus & XL	Call		

SOFTWARE

ACT!	\$190	Norton Utilities 4.0	\$45
AutoCad	Call	PageMaker	\$4 9
AutoSketch	\$50	Paradox 2.0	\$398
BoeingGraph 3D	\$195	Pathfinder	\$55
Canvas (Mac)	\$100	PC-Fullback	\$49
Carbon Copy Plus	\$100	Peashire	
CPA for Lotus 123	\$180	Accounting II	\$145
Clipper	\$365	PFS: First Choice	\$79
Copy II PC	\$11	PFS: First Publisher	\$55
rBase III Plus	\$355	PFS: Professional File	\$129
DesQview	\$60	PFS: Professional Plan	\$55
Dratix 1 Plus	\$140	PFS: Professional Write	\$105
Dratix 3D Mod/Options	\$430	Q&A Write	\$177
DS Back-Up Plus	\$33	O&A Write	\$116
Excel Mac/PC	\$176/\$281	Quattro	\$145
FastBack Backup	\$75	RBase for DOS	\$416
Fox Base Plus	\$170	ShipMate	\$240
GEM Draw Plus	\$165	(UPS Manifest)	\$240
Generic Cadd 3.0	\$55	SuperSpool (Mac)	\$30
Generic & Dot Plot 3.0	\$71	Topo (IBM or Mac)	\$101
Generic Editor/Cholice	\$119	Turbo Basic	\$57
Generic Options	\$119	Turbo C	\$57
Harvard Graphics	\$265	Ventura Publishing 1.1	\$484
Harvard Tot Proj Mgr	\$317	VersaCad/Libraries	Call
Lighting HD Speedup	\$293	WordPerfect 4.2	\$187
Lotus 123 2.01	\$293	X-Tree	\$20
MathCad 2.0	\$199	X-Tree Pro	\$33
MS-Dos3.3	\$95		

DIGITIZERS & PLOTTERS

Calcomp 1043-GT	\$61 5	MP Options	Call
1023-G1	Call	Nitachi	
Digitizers	\$580	11x11 Tablet	\$390
Enter Sweet-p600	\$580	15x15 Pro Tablet	\$580
Others	Call	H-P Plotters	Call
Houston Instruments		Indica	Call
DMP 41/42	\$1900	JOL 850	Call
DMP 51MP	\$3550	Kurto IS 12x12	\$290
DMP 51/52MP	\$3150	IS 12x17	\$490
DMP 52	\$2900	Summagraphics	
DMP 55R	\$3295	12x12R Plus	\$344
DMP61	\$3295	18x12 Professional	\$590
DMP62	\$4550		

COMPUTERS

AST Premium 286	Call	T1200	\$2380
& 286	Call	T1100/13100	
NEC Multipress	\$1980	Mediam M.M.	\$179
Multipress Et	\$1545	T3100/20	\$3050
Toshiba T1000	\$750	T3200	\$3760
T1100	\$650	T5000	\$4870

BOARDS & NETWORKS

AST Boards	Call	Paraltek AutoSwitch	
ATI EGA Wonder	\$169	EGA 480	\$145
VIP VGA	\$240	VGA P us	\$220
Central Sys Artist	Call	VGA Pro	\$340
Genus SuperEGA	\$185	Prographics	\$71
VGA 520/800	\$240	Signs Design VGA	\$199
VGA 750/1024	\$240	Topo Flashcard	\$143
Grapple C/Mac/BS	\$71	Ultimate EGA	
Mitrolite Graphics Plus	\$169	Autolow P-port	\$120
net	Call	XT/AT	Call
NEC66-1	\$250	Verticon	\$199
Novell Network 286	Call	Video 7 Vega	\$377
Number 9	Call	Deluxe w/VGA	\$119
		Vega VGA	\$259

DRIVES • MODEMS • FAX

Hayes	Call	2400B & SW	\$145
Mitsubishi 4070 1/2	\$120	3.5" XT/AT	
AT 23-28ms Drive	\$490	72 k Drive	\$95
Seagate ST225		380k Drive 5.25	\$75
20 w/Card	\$280	US Modem	\$199
ST225 30 w/Card	\$290	Coulier 2ND	\$290
SmartModem 1200B & SW int	\$69		

MDUSE

Logitech C7	\$85	Logimouse & Publisher	\$104
Serial/RS	\$85	Microsoft Mouse	\$90
Hi-Res Base	\$85		
Logimouse Bus & Point	\$84		

HELPERS

Logitech Connection 256K	\$340
512k	\$390

MHI Warehouse, Inc.

P.O. Box 10261 • Phoenix, AZ 85064-0261

TOLL FREE credit with order



602-861-1090

Customer Service Hrs 10-3 PT M-F

Ordering Hours 7-5 PT M-F 9-2 SAT

Pre-approved PD's are welcome. Prices reflect each discount and are subject to change without notice. Product compatibility, warranties, & terms are responsibility of manufacturer only. All returns are subject to a restocking fee. Personal checks only shipping. AZ orders only add 7.5%.

IN DEPTH

WEIGHING THE OPTIONS

Because it runs in protected mode, OS/2 can often catch errant applications before they crash the machine.

the application automatically when it is loaded. Parts of Windows applications as small as a single procedure or function can be marked as "discardable" and swapped in or out as needed. In addition, conventional MS-DOS applications can be swapped to and from disk.

Microsoft Windows/386

Microsoft Windows/386 provides the same user interface as Windows 2.0, but it uses the virtual 8086 mode of the 80386 processor to let any MS-DOS application run in a window concurrently with other programs. Multitasking is preemptive. All programs can also run in the background without user intervention.

The 80386 architecture provides memory protection; an application that fails cannot crash the entire machine. As in Windows 2.0, interprocess communication is done via message passing.

DESQview

DESQview, by Quarterdeck Office Systems of Santa Monica, California, is billed as a multiwindow integrator. Designed to run on all members of the IBM PC family and compatibles, DESQview's capabilities vary depending on the features of the specific hardware used.

When running on a non-80386 system, DESQview tries harder than Windows 2.0 to make many ill-behaved programs run in windows. Using loaders to apply special patches to programs such as Lotus 1-2-3, it gains the ability to run them in windows. As with Windows 2.0, any MS-DOS program can be run if it is given the full screen and complete control of the processor.

On an 80386 system, DESQview can join forces with another program from Quarterdeck, QEMM (Quarterdeck Expanded Memory Manager) to run each program in a virtual machine. As with Windows/386, this allows any applica-

tion to run in a window.

Multitasking in DESQview is preemptive, with priority given to the task running in the frontmost window (the foreground task). The DESQview API (Application Program Interface) provides interprocess-communication facilities, including queues, message passing, and signals.

DESQview can use extended or Expanded Memory Specification (EMS) memory to store itself and your application programs, but it works best when as much RAM as possible is EEMS (enhanced EMS, also known as LIM 4.0). However, if you do run out of RAM, you can deactivate an application and swap it out to disk. Some applications, such as communications programs, cannot be reloaded to the disk in this manner.

OS/2

OS/2, developed jointly by Microsoft and IBM, is a multitasking operating system designed from the ground up specifically for 80286-class machines. It provides preemptive multitasking and a vast range of application services, as well as the ability to run a single MS-DOS application in a special environment known as the Compatibility Box. When augmented by the OS/2 Presentation Manager (to be available during the second half of 1988), OS/2 provides a user interface and multitasking capabilities similar to those of Windows/386, plus powerful facilities for networking, all on a standard 80286 machine such as the IBM PC AT.

Scheduling in OS/2 is performed according to a complex, stratified scheme. Each thread, or task, can fall into one of three categories: time-critical, general, or low-priority. Within the general priority category, there are additional sub-levels, the highest of which are assigned to tasks that are interactive and in one of the frontmost (foreground) windows. In addition, there are mechanisms to prevent "starvation" and to boost perceived system throughput.

OS/2 implements a vast assortment of interprocess-communications mechanisms (IPCs), including semaphores, pipes, queues, named pipes, shared memory, signals, messages, and DDE (as in Windows). With the possible exception of Unix, no operating system comes with as many IPC facilities built-in as OS/2.

OS/2 implements storage overcommitment for all applications as needed (except in the Compatibility Box).

Because it runs in protected mode, OS/2 can often catch errant applications before they crash the machine. Unfortun-

WEIGHING THE OPTIONS

nately, because the Compatibility Box does not run in protected mode, a misbehaved DOS application can hang the entire system.

Unix

Unix, the granddaddy of modern multitasking systems, is the only environment in this group that was also designed to be multiuser. Virtually all Unix implementations can accept users at terminals as well as the main console.

Unix and its look-alikes are available for many varieties of machines. Apple's A/UX implements Unix on the Macintosh, while Microport and Phoenix Technologies (among others) are the leading suppliers of Unix for IBM PC AT compatibles.

Unix does scheduling by measuring how long each process in the system runs before it stops to perform I/O. Any task that runs for a full time slice without performing any input or output is considered to be hogging the CPU and is given a lower priority. Conversely, a task that does a great deal of I/O gets a higher priority, not only because it has not used much of each time slice, but because perceived performance improves if the keyboard, screen, and disk appear to respond quickly.

IPCs vary from version to version of Unix. However, those most commonly used include semaphores (implemented through the file system), pipes, and signals. Also available in many implementations are shared memory, sockets, named pipes, and more esoteric facilities such as streams and remote procedure calls (used across networks).

Amiga Exec/AmigaDOS

Multitasking on the Amiga is managed by the Amiga Exec, a high-performance multitasking kernel. Together with AmigaDOS and the rest of the Amiga ROM Kernel, Exec manages tasks on a strict priority basis. The Amiga windowing system, Intuition, provides user interface facilities.

Interprocess communications on the Amiga is based on three mechanisms: signals (which are really semaphores), message passing, and software interrupts (similar to what I called signals above). Because of the "lean and mean" nature of the Amiga systems software, interprocess communications must be done with care; sending a signal or a message to a nonexistent task will crash the machine. If used properly, however, the speed of interprocess communications on the Amiga approaches the theoretical limits of the 68000 microprocessor.

MultiFinder

MultiFinder runs on the entire Apple Macintosh line of computers and performs nonpreemptive multitasking on Macintosh applications. By trapping system calls and carefully managing memory, MultiFinder can allow up to 30 applications to run concurrently in windows on the Macintosh screen. The application that owns the frontmost window has the highest priority. Each task relinquishes control when it calls SystemTask or GetNextEvent. According to the Macintosh programming rules, tasks should call these functions at least 60 times per second. Task switches cannot occur during file operations.

MultiFinder allows only two IPCs: the AppleTalk network (which allows intramachine as well as intermachine communications) and shared memory. Shared memory must be carefully managed so as not to corrupt the system heap space. MultiFinder offers no memory protection, since only the Mac II has an MMU.

Choose Your Environment

The microcomputer world has evolved drastically in the past few years, in terms of both hardware and software. No longer is it merely a matter of higher hardware performance that sells a microcomputer: Hard looks are being taken at how well the computer's operating system performs. Can the software improve your productivity by switching rapidly among several programs all at once? Can you download a lengthy report from the office while working at home in your word processor?

Vendors plan to move slowly so that users can adapt to the powers of the new operating systems and phase out ill-behaved software. Microsoft's OS/2 provides the familiar DOS interface while allowing you access to multitasking capabilities. Apple plans to upgrade MultiFinder and release improvements every 6 months.

Nevertheless, microcomputer multitasking is still in its infancy. Not everyone needs it: You may be content to run in single-user mode, squeezing out every iota of performance from your microcomputer without incurring the penalty in overhead required by multitasking. If you do need the capabilities that multitasking provides, no matter what machine you use, as you can see, you have a choice. ■

Brett Glass is a freelance programmer, writer, and hardware designer residing in Palo Alto, California. He can be reached on BIX as "glass."

A new concept in managing Megabytes of memory

IX-BoX*

Have you ever spent hours

- searching for a letter which you know exists, but can't seem to find?
- looking for an address which you can only remember half of?
- tracking down a variable which was initialised somewhere in your programs, and which is now causing them to crash?
- rummaging through your ultra-modern database, simply because you omitted to define a simple key field when setting it up?
- searching your literature index for an urgently needed article?
- looking and looking, but without success?

Then we can help! IX-BoX will instantly find all your correspondence, addresses, programs, entries, summaries - in fact, anything and everything stored on your computer. IX-BoX delivers the document you require in seconds, and you can carry out any necessary changes to it using the built-in editor. What more could you possibly need?

IX-BoX is much more than a simple information retrieval system, yet it only costs **\$ 275**

Demo disk costs \$ 10

* IX-BoX is a trade mark of Snark AG, Zürich.

Farsight

Once you've used the Farsight integrated software package, you'll know the fun of working with and exploiting Megabytes of memory.

Window manager, word processor and spreadsheet together cost only **\$ 99**

Graphics **\$ 29**

Texas residents add 8% sales tax. International Orders add \$ 20 shipping.

The Modula-2 people:

INTERFACE TECHNOLOGIES

3336 Richmond, Suite 323
Houston, TX 77098-9990 (713) 523 8422

Dealer inquiries welcome

International	
Austria: 0222/4545010	United Kingdom: 01/6567333
Belgium: 071/366133	Germany: 02983/8337;
France: 20822662	0731/26932;
Italy: 02/405174	0821/85737;
Scandinavia: +45/3/512014	04106/3998;
Switzerland: 01/9455432	0531/347121



A. + L. Meier-Vogt
Im Späken 23
CH-8906 Bonstetten/ZH
Switzerland
Tel. (41) (1) 700 30 37

Buy with

Confidence

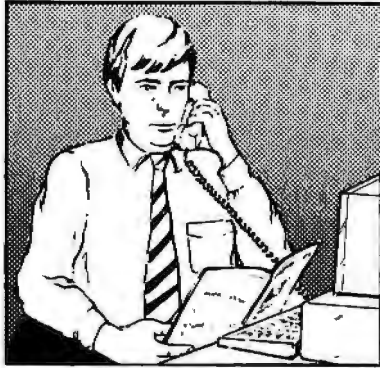

In an effort to make your telephone purchasing a more successful and pleasurable activity, The Microcomputer Marketing Council of the Direct Marketing Association, Inc. offers this advice, "A knowledgeable buyer will be a successful buyer." These are specific facts you should know about the prospective seller before placing an order:

Ask These Important Questions

- How long has the company been in business?
- Does the company offer technical assistance?
- Is there a service facility?
- Are manufacturer's warranties handled through the company?
- Does the seller have formal return and refund policies?
- Is there an additional charge for use of credit cards?
- Are credit card charges held until time of shipment?
- What are shipping costs for items ordered?

Reputable computer dealers will answer all these questions to your satisfaction. Don't settle for less when buying your computer hardware, software, peripherals and supplies.

Purchasing Guidelines

- State as completely and accurately as you can what merchandise you want including brand name, model number, catalog number.
- Establish that the item is in stock and confirm shipping date.
- Confirm that the price is as advertised.
- Obtain an order number and identification of the sales representative.
- Make a record of your order, noting exact price including shipping, date of order, promised shipping date and order number.

If you ever have a problem, remember to deal first with the seller. If you cannot resolve the problem, write to MAIL ORDER ACTION LINE, c/o DMA, 6 E. 43rd St., New York, NY 10017.

This message is brought to you by:

the MICROCOMPUTER
MARKETING COUNCIL
of the Direct Marketing
Association, Inc.
6 E. 43rd St.,
New York, NY 10017

MMCG
MICROCOMPUTER
MARKETING COUNCIL
of the Direct Marketing Association, Inc.

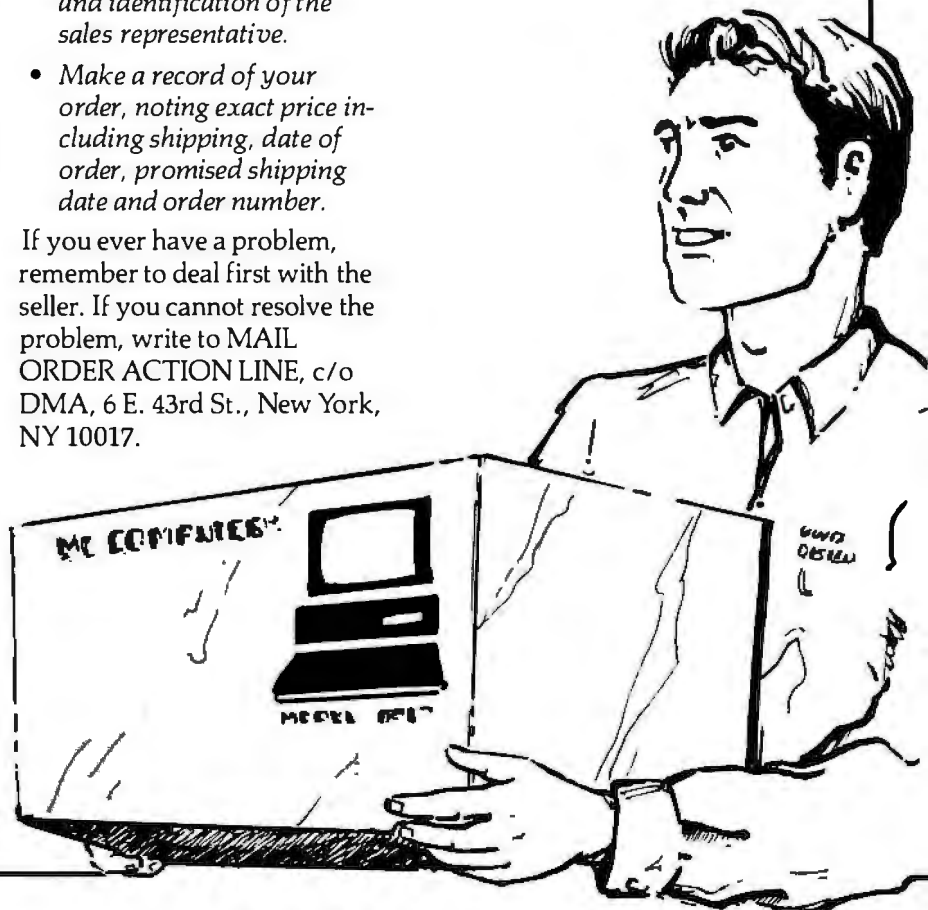

First Come, First Served

*Mailbox is a portable multitasking environment
written in C*

Michael Benjamin Parker

Mailbox is an *environment*, not an operating system. It does not provide the file, memory, and other resource management functions required of a complete operating system. However, it does provide a multitasking environment for the programs that you write with it.

With Mailbox, you can write multitasking programs that are portable to many different machines and operating systems. Because the code for Mailbox is easily ported and its interface is the same on all machines, your own multitasking code can also be portable. What's more, if the machine has multiple processors, your program can take advantage of them.

Traditionally, multitasking, when available, has been a function of the operating system and usually machine-specific. Macintosh MultiFinder, for example, provides some multitasking support, but the programs that use it are limited to the Macintosh. Microsoft's OS/2 provides an impressive library of multitasking functions, but OS/2 is highly IBM PC AT specific. Although Unix provides portable multiprocessing, the operating system is usually



found only on workstations and mainframes; also, its common Berkeley Standard Distribution (BSD) processes are big and "expensive" and cannot share memory. See table 1 for a comparison of the features of some of today's multitasking systems for microcomputers and workstations.

The Mailbox package is built on three layers of portability. Each layer adds a

degree of functionality and machine independence.

- MPTH (context switching): independent threads of execution and simple multiprocessor context switching.
- MPTSK (task organization): prioritized multiprocessor scheduling and "mailbox" message passing, with provisions for user schedulers and communication protocols.
- MPRES (resource management): preemptive concurrent processing; regulated access to the basic resources, with provisions for sophisticated user resources, resource managers, and optimizations.

(All global names in the package are prefixed with my initials, MP, to prevent naming conflicts with other global names your environment may

have.)

The lowest and most device-dependent layer, MPTH, implements the basic context switching required for any multitasking package, it provides threads of execution. The middle layer, MPTSK, implements scheduling and interprocess communication, nonpreemptive multitasking based on MPTH's; it provides

continued

Table 1: A feature comparison of some multitaskers. (Tele is both a programming environment and an operating system.)

Features	Applications Integrators			Prog. Environments		Both	Operating Systems		
	DESC- View 2.0	Multi- Finder 1.0	Windows 2.0	Mailbox 1.0	TimeSlicer 5.0		Tele (Kernel)	OS/2 1.0	Xenix 2.00
"Lightweight" threads (with shared memory)	●	●	●	●	●	●	●	●	○
"Heavyweight" processes (with protected memory)	○	○	○	○	○	○	●	○	●
Low-level resource management (contention management)	●	●	●	●	●	●	●	●	●
Medium-level resource management (I/O waiting, deadlock handling)	●	○	●	*	*	●	●	●	●
High-level resource management (high-level optimized interfaces)	●	○	●	○	○	●	●	*	*
Intertask communication	●	○	●	●	○	*	●	●	●
Preemptive multitasking	●	○	○	●	●	●	●	●	●
Multiprocessor support	○	○	○	●	○	○	○	●	●
Task delay/alarm timers	●	○	●	*	●	●	●	●	●
Task priority levels	○	○	○	●	●	●	●	●	●
Task hierarchies/inheritance	●	○	○	●	○	○	●	●	●
Task suspension/termination (forced)	●	●	●	*	●	●	●	●	●
User context switching	○	○	○	●	○	*	○	○	○
User interrupt handling	○	○	●	●	●	*	●	*	●
User task schedulers	○	○	○	●	○	*	○	○	○
User resource management	*	○	*	●	*	*	●	●	*

● Present
○ Not present
* Can be implemented

independent, communicating tasks. The top layer, MPRES, implements basic resource management for all standard resources and those you may add, and preemptive multitasking based on MPTSK's. Since each layer depends only on the layer below it, you can incorporate only those layers you need.

MPTHD: Context Switching

Essential to any multitasker is the ability to switch the processor's context from one process to another. Traditional multitaskers do this by having interrupt handlers save the state of the processor; they push the state on the stack when they are invoked. This is an efficient but complex and machine-dependent approach. The

MPTHD layer achieves the same effect in an easy-to-understand portable way.

The MPTHD layer introduces the notion of an independent thread of execution. Like a normal process, a thread has its own stack on which it executes. With this stack, you can save the state of the thread so you can resume it later.

To perform this context switch, the thread must call the `mpthd_switch()` function (see listing 1), which is not an ordinary function. Like an ordinary function, `mpthd_switch()` can return to you, but it can also return to anyone else you specify. Indeed, it can return to *any* active `mpthd_switch()` call. You specify as an argument the thread you want the switch to go to, and it returns from

that thread's call of `mpthd_switch()`. In fact, it tells *that* thread (via the switch's returned argument) the thread it switched from (see figure 1).

The `mpthd_switch()` function also works in a multiprocessor environment. If another processor is executing a thread when you switch to it, it will wait until the other processor switches out of the thread before you switch in. If you switch to an invalid thread or one with a corrupted stack, `mpthd_switch()` returns `nil`, indicating the error.

The `mpthd_switch()` interface is also portable. In many cases, you can directly implement it with C's standard `setjmp()` and `longjmp()` functions. In other lan-

continued

SC Systems

Serving Computer Buyers For
Eight Years

1-800-669-9933

Para Asistirle En Espanol
Llame Al Tel 1-800-842-1777

InComm
1200B Int Modem
\$62
w/Software

Samsung
14" RGB Monitor
\$215
640 x 230
.51 Dot Pitch

Color
Graphics Card
\$44
Parallel Printer Port

HARDWARE

SOFTWARE

ACCESSORIES

CopyIIPC Brd \$ Call
Masterpiece + 95

COMPUTERS

NEC
Multispeed \$1429
Multispeed EL 1635
Toshiba
T-1100 S/Twist 1659
T-3100/20 Call

BOARDS

AST Adv Prem 1mb \$ 419
AST 6Pac Prem 1mb 525
AST Sixpac 115
Hercules Grph + 182
Intel Above 286 Call
Intel Inboard 386 960

EGA BOARDS

ATI EGA Wonder \$ 175
Genoa SuperHiRes+ 175
Orchid Designer 249
Paradise 480 155
Paradise VGA +XT 259
Paradise VGA Prof 385
Vega VGA 259

EGA MONITORS

Magnavox \$ Call
Princeton U/Sync 509
NEC Multisync 2 619
Samsung 359

HARD DRIVES

Plus Hardcard 20 \$ 539
Seagate 125 w/cont 321
Seagate 138 w/cont 411

KEYBOARDS

Keytronics 5151 \$ 162
Keytronics 5153 269

MICE

Logitech \$ 68
MS Bus Mouse Call
Optimouse w/DrHalo 92

MODEMS

Hayes 1200 \$ Call
Hayes 1200B Call
Incomm RPC1200 62
Incomm RPC2400 147
Incomm T1200 76
Incomm T2400 167
Incomm T2400EC 224
USRobotics S1200PC 114
USRobotics S2400PC 160

MONITORS

Amdek 410 \$ 145
Princeton MAX15 Call
Samsung RGB 215
Samsung Amber 82

3COM

3C501 ELink \$ 356
3C503 ELink II 359
3C505B ELink Plus 645
3C523 ELink/MC 432

PRINTERS

Citizen
120D \$ Call
180D 199
MSP-15E 319
MSP-40 285
C.Itoh
PW 1550S+NLQ 506
PW 8510S+NLQ 401
ProWriter 310 479
ProWriter 315 586
ProWriter C715 925
ProWriter Jr.+ 255
StarWriter D10 754
JetSetterLaser 1265
NEC P5XLP 819
NEC P2200 335
Panasonic
1080I/M2 179
1091I/M2 199
1092I Call
Star
NX-1000 179
NX-1000 Color Call
NX-15 Call
Toshiba
321SL 500
341SL Call
351SX 1005

ACCOUNTING

DacEasy \$ 54
Dollars & Sense 95
Managing Your \$ 119

COMMUNICATION

Carbon Copy \$ 108
CrossTalk XVI 89
CrossTalk 4 115
SmartCom II 82

DATABASE

Clipper \$ 370
Data Perfect 255
DBase III Call
DBXL Diamond 109
Fox Base + 190
Paradox 2.0 Call
Q and A 188
Relate & Report 100

DESKTOP PUBLISHERS

Pagemaker \$ Call
PFS First Pub 55
Ventura 495

GRAPHICS

Chartmaster \$ 199
Printshop 35
Signmaster Call

INTEGRATED

Ability Plus \$ 139
First Choice 79

LANGUAGES

MS C Compiler \$ Call
MS QuickBasic Call
MS Quick C Call
Turbo Basic 59
Turbo C 59
Turbo Prolog 59

SPREADSHEETS

Lotus 123 \$ Call
Plan Perfect 165
Quattro 119
Surpass 329

UTILITIES

CopyIIPC \$ 19
Desqview 72
Duet 48
Fastback Plus 87
Formtool 55
Mace 52
Norton Advanced 74
PC Tools Deluxe 39
Sideways Print 39

WORD PROCESSING

MS Word v4.0 Call
Word Perfect 5.0 192
Wordstar ProPack Call
Wordstar 2000 Call

No Charge for Mastercard or Visa



Call For Items Not Listed

SC Systems

3000 Mariposa Hwy. Ste. B, Nogales, AZ 85621

Order Line 800-669-9933

Espanol 800-842-1777

Status Line 602-275-1395

FAX No. 602-273-0043

Order Line for Europe & Mexico 602-287-5347

TERMS: No charge for Visa or Mastercard. We do not charge your card UNTIL WE SHIP your order. Manufacturers warranty applies in all cases, all warranties are handled by the manufacturers. We accept Purchase Orders from authorized companies only, for 3.5% above cash price. No COD orders. No refund on opened software. All prices are subject to change. Allow 14 days for personal/company checks. Arizona orders add 6.7% tax.

Listing 1: The `mpthd_switch()` function suspends the current thread of execution and switches into the new thread.

```

MPTHDID mpthd_switch(newmpthd)
MPTHDID newmpthd;

{
  if (newmpthd->stackoverflow) return((MPTHDID)0);

  if (newmpthd!=mpthd_me()) {
    mpsem_critsect(&(newmpthd->mpsem), {

      if (!setjmp(mpthd_me()->state)) {
        newmpthd->oldmpthd= mpthd_me();
        mpthd_me()= newmpthd;
        longjmp(mpthd_me()->state,1);
      }

      newmpthd= mpthd_me()->oldmpthd;
    });

  /* return old thread switched from */
  return(newmpthd);
}

```

guages, you can quickly code the function in assembly language and "link it in." And even if you're not programming in C, most stack-based languages and machines can support an implementation of `mpthd_switch()` (see figure 2 for internal data-type representation). With a few additional support functions, you can easily create and destroy threads.

The initialization function, `mpthd_init()`, requires three arguments: `buff`, the memory buffer used to store the thread; `size`, the size of the buffer; and `mpthdfn`, the function to execute. Since all this is awkward to specify, a default size stored in a global variable would be convenient. However, you're in a concurrent environment: Different tasks may change the default value, and different tasks may want different defaults.

Therefore, a thread maintains its own heap, private to its current task. Instead of a default size, you can set up a global constant containing an offset into the current thread's heap; the default buffer size resides here. This way, each task has its own defaults but refers to them with the same variable name.

MPTHID automatically copies the parent's heap when initializing a new thread, so defaults are inherited. This simple feature can also be used for passing arguments from the parent to the child thread.

If you also don't want to specify `buff`, the buffer storing a thread, you could have MPTHID call `malloc` to dynamically allocate storage for you. But storage is a resource. Not all languages have this resource, so using it would limit portability. More important, dynamic memory allocation sometimes takes time; it

continued

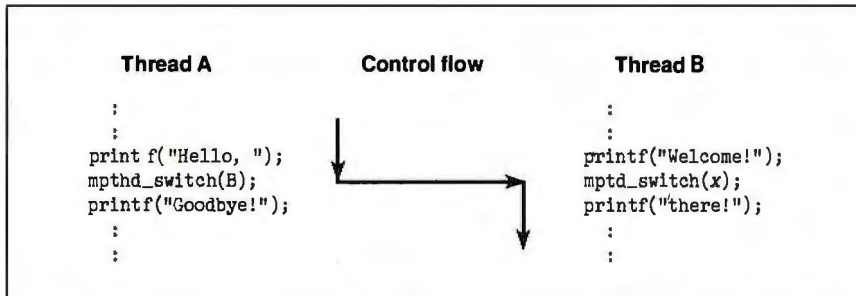

Figure 1: Context switching as performed by `mpthd_switch()`. The output from this context switch would be "Hello, there!"; "Hello," comes from thread A, which switches to thread B for "there!".

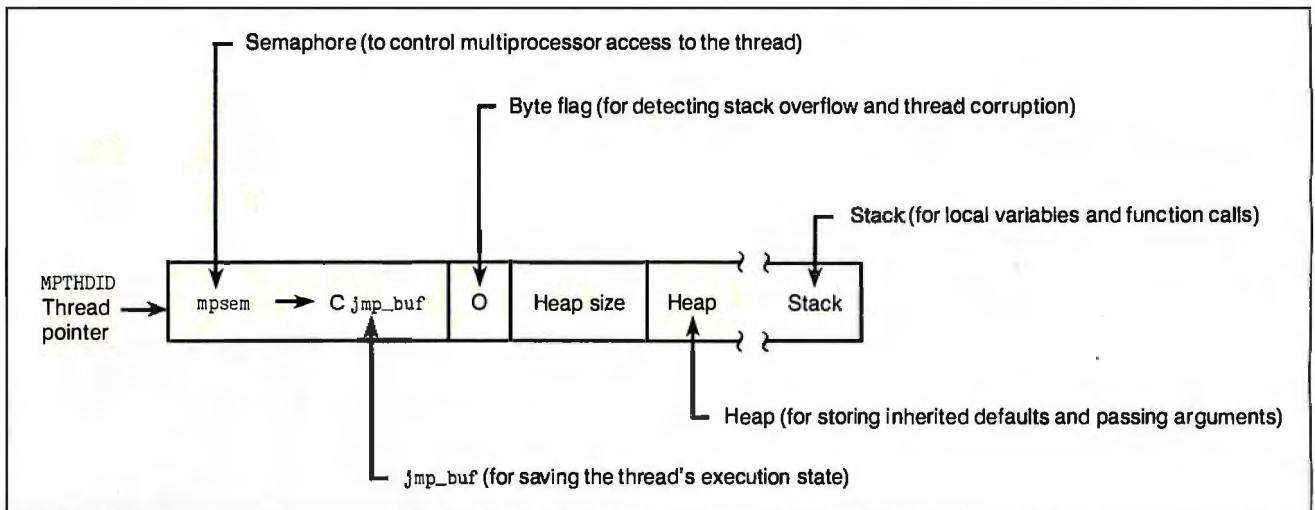

Figure 2: Internal representation of the thread data type.



The Graphics Toolkit for Contemporary Software Developers

Already the fastest and most powerful graphics toolkit on the market, the new HALO® delivers subroutines and device support for exciting, contemporary applications in publishing, office automation, vision, and image processing.

HALO '88 is a device independent library of 190 graphics subroutines. It is compatible with 18 programming languages, and over 140 hardware devices such as image scanners; graphics, vision, and imaging boards; printers and plotters; and mice. HALO '88 is designed for the complete IBM compatible microcomputer line including the PS/2 and VGA.

Today's Tools for Tomorrow's Applications

HALO '88 has new subroutines which control scanners and scanned images — even images which are larger than screen resolution and available memory. Extended character set support enables software developers to address IBM's

full 255 characters in graphics and to design foreign language fonts. Among contemporary HALO '88 applications are CAD, Computer-Based Training, Presentation Graphics, Graphic Arts, Mapping, Machine Vision, Silicon Wafer Manufacturing, Sound System Design, Vehicle Scheduling and Routing, and Real Estate.

Join the HALO Family

HALO has an installed base of 60,000+ end-users, hundreds of site-licensed corporations, government agencies, universities, and national laboratories and most importantly, over 220 Independent Software Developers (ISVs) who market applications written with HALO.

HALO '88 provides the software designer with the richest environment of graphics functions; the programmer with reliable and

well-documented tools, and DP managers with continuity of user interface and database format.

Reach for the Future

If you need high performance graphics development software that provides a migration path to OS/2 and other future technology, follow the industry leaders — call (800) 992-HALO (4256).

HALO '88 is just \$325 and includes all device drivers, 20 fonts, your choice of one compiler binding, completely new documentation, an interactive tutorial and free 800# technical support. Update from HALO for \$150.

Ask about the new HALO Programmers' Workbook which provides C program examples for HALO '88 applications developers.

media cybernetics
8484 Georgia Ave.
Silver Spring, MD 20910
(301) 495-3305, (800) 992-HALO

HALO is a registered trademark of Media Cybernetics, Inc. IBM PS/2, VGA and OS/2 are registered trademarks of International Business Machines Corp.



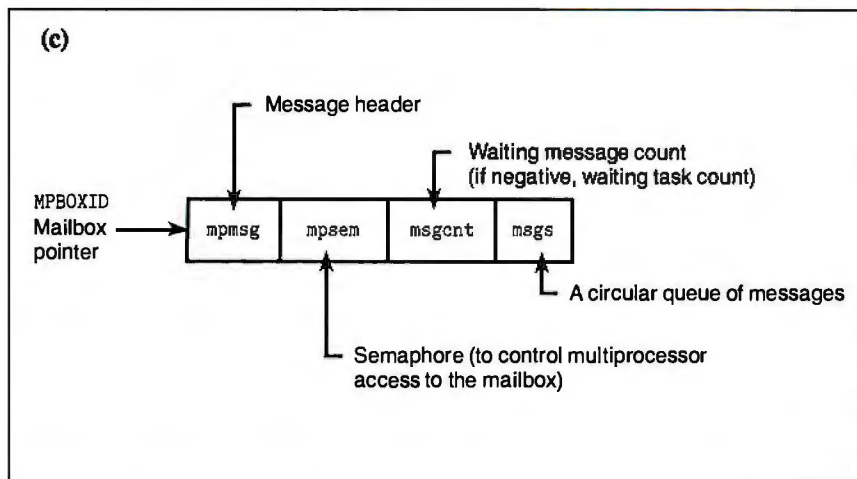
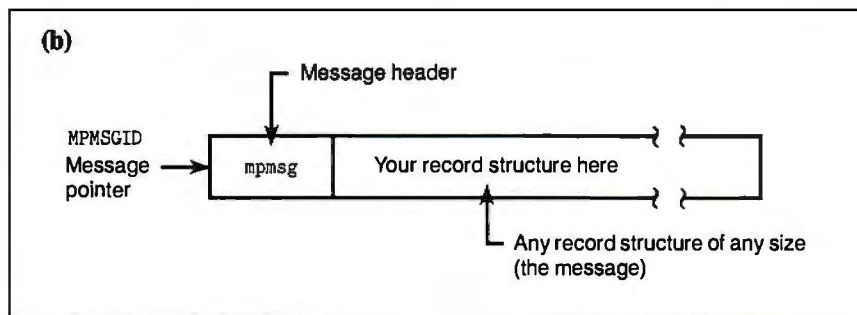
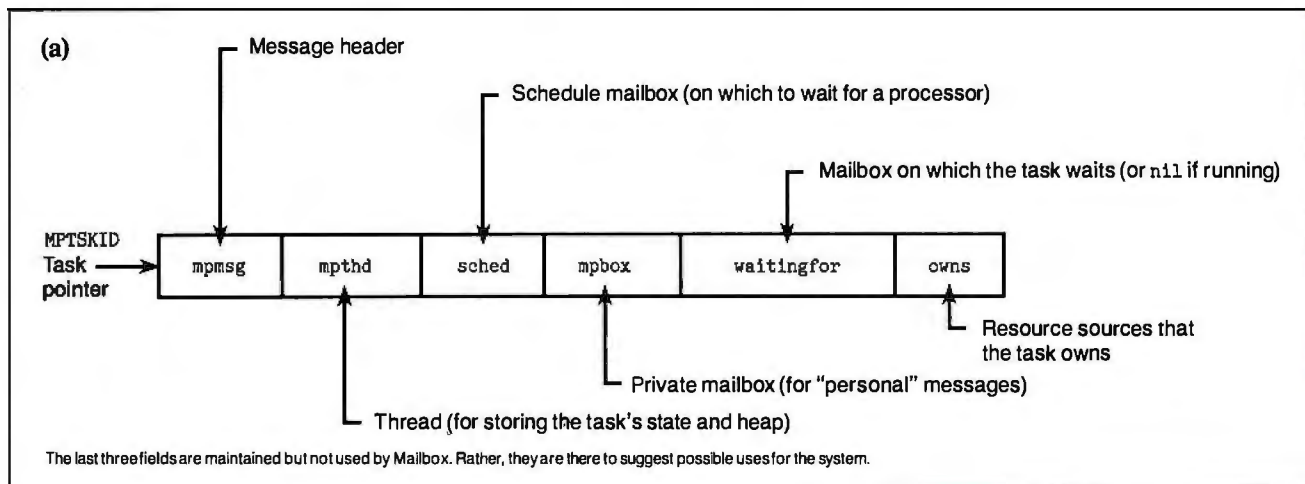

Figure 3: Internal representations of the (a) tasks, (b) messages, and (c) mailboxes data types.

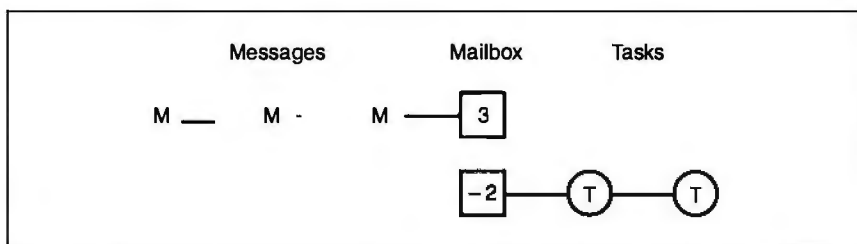

Figure 4: Mailbox "message bank." The upper diagram is of a mailbox with messages waiting for tasks (positive count); the lower diagram is of a mailbox with tasks waiting for messages (negative count).

must be interruptible, so the computer can perform other possible time-critical tasks. But a high-level scheduler may switch into another thread that allocates memory while your thread is doing the same. Since memory allocation is a resource, this feature will have to wait for MPRES. MPTHD is a simple and portable way to do context switching.

MPTSK: Task Organization

It's nice to be able to switch contexts whenever you choose, but you may want more. If, for instance, you reach a point where you have to wait for keyboard input, which thread do you switch to? Or if you want to send a message to another thread to tell it that its printout has finished, how do you pass it the message? What if the other thread is busy?

The MPTSK cluster answers these questions by providing a general-purpose integrated scheduler and message-passing system based on mailboxes (from which the package gets its name). Essentially, MPTSK organizes threads into a powerful (multi)task force.

MPTSK introduces three new data types: tasks (mptsk), messages (mpmsg), and mailboxes (mpbox) (see figure 3). Tasks are essentially enhanced threads. They are automatically scheduled, and you don't need to explicitly switch between them. They can also send and receive messages. Messages can be of any record type for maximum flexibility. Its structure needs only to begin with an mpmsg field (for internal message-management purposes). Indeed, even tasks and mailboxes are treated as messages.

Mailboxes tie tasks and messages together and make the package work. A hybrid of the queue data structure, a mailbox contains either a list of messages or a list of tasks (waiting for messages). If the

count of items in the mailbox is positive, it contains a list of messages; if the count is negative, the mailbox contains a list of tasks (see figure 4).

Tasks can either send or receive messages in a mailbox. If a task sends a message and there are no tasks waiting for it, then the sending task adds it to the end of the list of waiting messages; if there are tasks waiting for it, then the sending task gives it to the first task waiting in line. On the other hand, if a task attempts to receive a message from a mailbox, and there are no messages waiting, then it adds itself to the end of the list of waiting tasks; if there are messages waiting, then it takes the first message and proceeds.

As an analogy, think of a mailbox as a bank account and messages as money. Like a bank account, a mailbox has either a credit or deficit of messages. And messages, like money, can be deposited or withdrawn. Of course, when people come to the bank, they must usually wait in line. Likewise, a mailbox services its tasks and messages on a first-come, first-served basis.

Although it's a simple concept, the mailbox, `mpbox`, is a remarkably versatile structure. It's used not only for inter-task communication, but also for scheduling, resource management, and even message-passing semaphores. For instance, if you view the three messages waiting in the printers mailbox as representing the computer's three printers, when a task wants a printer, it simply receives a printer message from the printer's mailbox. The message tells it which printer to use. If no printers are available, the task is queued; when a printer becomes available, it will go to the next task in line, which will automatically be restarted. Since this first-in/first-out (FIFO) ordering holds for messages as well, the least recently used printer is always chosen, ensuring that the three printers are evenly used.

If you think of a processor as a resource as well, the mailbox abstraction makes a good scheduler. You can imagine a schedule mailbox with tasks waiting to "receive" a processor to run them. Due to the FIFO ordering, tasks are automatically processed in round-robin fashion. For prioritized scheduling, a task receives a priority by assigning a mailbox in which to schedule it whenever it can be run. You list these schedule mailboxes in order of priority. When a processor needs to run a task, it searches this list sequentially—it's a short list—until it finds the highest-priority task (see figure 5).

A key advantage to mailbox multitask-

continued

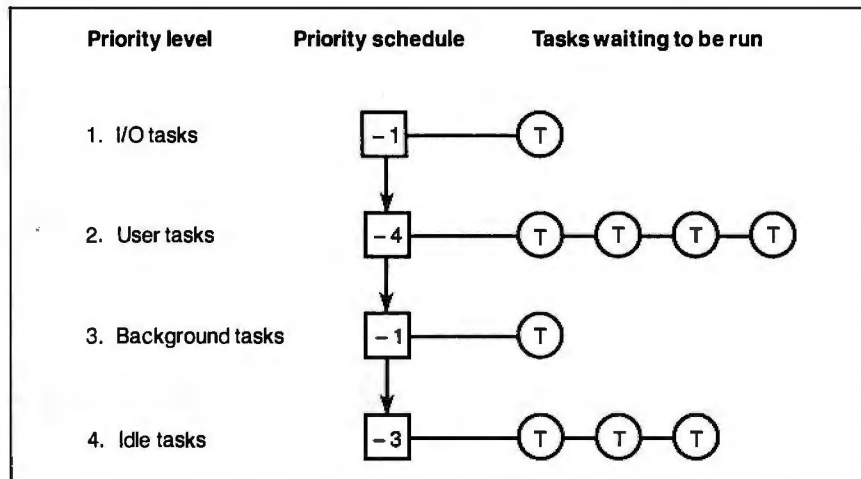

Figure 5: A mailbox scheduler example. To find a new task to run, a processor simply searches down the schedule list until it finds a task.

Listing 2: The `mptsk_xfer()` function contains the routines to send, receive, and schedule messages.

```

MPMSGID mptsk_xfer(MPBOXID mpbox, MPMSGID mpmsg, BOOL block,
MPBOXID sched) {
mpsig_critsect(do { /* disable interrupts */
/*SEND*/
if (mpmsg) { /* if sending a message */
MPTSKID mptsk;
mptsk= mpbox_xfer(mpbox, /* queue msg XOR get task */
mptsk_sendside, block?mpmsg:(MPMSGID)0);
if (mptsk) { /* a task was waiting */
/* transfer message */
mptsk_mpmsg(mptsk)= mpmsg; mpmsg= 0;
/* schedule both tasks */
mpbox_xfer(mptsk_sched(mptsk),mptsk_recvside,mptsk);
mpbox_xfer(mptsk_mysched(),mptsk_recvside,mptsk_me());
} else {
if (block) mpmsg=0; /* message sent */
break; /* return immediately */
}
}
/*RECEIVE*/
} else { /* if receiving a message */
mpmsg= mpbox_xfer(mpbox, /* get msg XOR queue task */
mptsk_recvside, block?mptsk_me():(MPMSGID)0);
if (mpmsg) break; /* message recvd: return immediately */
if (!block) break; /* don't wait for msg: rtn at once */
}
}
/*SCHEDULE*/
{ /* schedule a new task to run */
MPTSKID mptsk;
MPBOXID cursched= sched; /* use user sched list */
/* search from high to low priority until task found */
while (!(mptsk= mpbox_xfer(cursched,mptsk_recvside,
(MPMSGID)0))){
cursched= mprng_next(cursched);
if (cursched==sched) /* if end of user sched list */
cursched= mptsk_topsched(); /* use system list */
}
mptsk_mympmsg()=mpmsg; /* save msg between switches */
mptsk_switch(str2fld(mptsk,mptsk));
mpmsg= mptsk_mympmsg(); /* return result message */
}
} while (0);
return (mpmsg);
}

```

When you want to talk computers..

ATARI COMPUTERS

65XE 64K Computer	99.99
130XE 132K Computer	139.00
520ST-FM Monochrome Syst.	649.00
1040ST Color System	969.00
SF124 Monochrome Monitor	159.00
SF1224 Color Monitor	329.00



Atari 520 Color System \$779

Includes: 520ST-FM, 512K RAM with 3 1/2" Drive Built-In, Basic, RF-MOD, Atari Mouse, and SF-1224 Color Monitor.

AMIGA SOFTWARE

Mimetics	
Amigen Gen Lock	159.00
New Tek Inc.	
Digi-View 2.0	149.00
Digi-Paint	44.99
Sub-Logic Corp.	
Flight Simulator II	39.99
Word Perfect Corp.	
Word Perfect	199.00

MACINTOSH PRODUCTS



CMS 60MB Tape Backup \$799

Hard Drives	
CMS	
MacStack 43	839.00
Everex	
91MB SCSI	1499.00
PCPC	
MacBottom HD45	1149.00
Floppy Drives	
Cutting Edge	
800K External	189.00
Central Point	
800K Floppy External	199.00
Monitors	
Network Specialties	
Big Top 20"	1,549.00
Radius	
Full Page Display Plus	1,499.00
Two Page Display SE	2,199.00
Sigma Designs	
Laser View Display for SE	1,749.00
Memory Upgrades	
Dove Computer	
Mac Snap 548S	429.00
Scanners	
AST	
Turboscan	1,349.00
Datacopy	
730 Flatbed Scanner	1,199.00

MS/DOS SYSTEMS

Ast Premium 286 & 386	Call
Compaq Deskpro and Portbils.	Call
IBM PS/2 25, 30, 50, 60, 80	Call
Leading Edge	899.00

MS/DOS SYSTEMS

NEC APC-IV Powermate	2,399.00
NEC Multispeed Laptop	1,229.00
PC-TOO 80286 1.2MB, 512K	899.00
Toshiba T-1000 Laptop	799.00



TOSHIBA T-1000 LapTop \$749

MULTIFUNCTION CARDS

AST	
6-Pak Plus 576 Board	149.00
Hot Shot 286 Accelerator	349.00
Hercules	
Color Card	129.00
Graphics Card Plus	159.00
Intel	
Inboard 386 Board	799.00
5th Generation	
Logical Connection 256K	339.00
Quadram	
Quad386XT 80386 PC-Upgr.	799.00
Video 7	
Vega V.G.A. Adapter	299.00
Zuckerboard	
Color Card w/Parallel Port	89.99

MS/DOS SOFTWARE

Ashton-Tate	
d-Base III +	389.00
Borland	
Quattro	129.00
5th Generation	
Fastback Plus	84.99
Fox Software	
Fox Base & Development	219.00
IMSI	
Optimouse w/dr. Halo	89.99
Logitec	
Hi-Res Buss Mouse	99.00
Lotus	
Lotus 1.2.3	299.00
Software Publishing	
First Choice	99.99
Word Perfect Corp.	
Word Perfect 5.0	NEW

ATARI ST SOFTWARE

Access	
Leaderboard Golf	24.99
Antic	
CAD 3D	29.99
Avant Garde	
PC Ditto (IBM Emulation)	64.99
Batteries Included	
Degas Elite	39.99
DAC	
Easy Accounting	61.99
Soft Logik Corp.	
Publishing Partner	64.99
Timeworks	
Swiftcalc/Wordwriter	47.99
VIP	
Professional Gem	139.00

AMIGA SOFTWARE

Absoft	
AC Basic	139.00
Aegis Development	
Animator/Images	89.99
Draw Plus	149.00
Sonix	49.99
Discovery Software	
Marander II	31.99
Electronic Arts	
Deluxe Video 1.2	89.99
Gold Disk Software	
Pagesetter w/Text ed.	89.99
Micro Illusions	
Dynamic Cad	349.00

WE SHIP 90% OF ALL ORDERS WITHIN 24 HOURS



SELECT FROM OVER 3000 PRODUCTS

COMPUTER MAIL ORDER

.....When you want to talk price.

MONITORS

Amdek
Video 210A 12" Amber89.00
Video 410 12" A/G/W(ea.) 139.00
Magnavox
7BM623 12" TTL Amber99.00
CM8505 14" RGB/Composite .189.00
CM8515 14" RGB/Composite .269.00
9CM053 14" EGA.....379.00
NEC
GS-1400 14" Monochr. TTL ..219.00
JC-1402 Multisync-II599.00
Packard Bell
PB-1418F 14" Flat TTL A/G/W
.....(ea.) 119.00
PB-1420CG 14" Mid-Res CGA 269.00
PB-1422EG 14" Hi-Res EGA .369.00
PB-8426-MJ Uniscan Monitor .399.00
Princeton Graphics
Max-12 12" TTL Amber149.00
Thomson
450 15" 132 col. TTL Amber .119.00
4120 14" RGB/Composite239.00



**Magnavox CM 8762
14" RGB/Composite \$269**

DRIVES

Atari
AA314 DS/DD ST Disk209.00
SHD204 20MB ST Hard Drive .569.00
C.LTD (For Amiga)
C.LTD 20MB (A2000)769.00
C.LTD 33MB (A2000)879.00
C.LTD 44MB (A2000)1099.00
C.LTD 50MB (A2000)1139.00
C.LTD A500 SCSI Controller ..179.00
Indus
GT Disk Drive Atari XL/XE189.00
GTS-100 ST Drive189.00
Racore
Jr. Expansion Chassis299.00
Seagate Technologies
ST-225 20MB Drive249.00
Supra
Atari ST 20MB Hard Drive ...559.00
Amiga 2000 20MB Hard/Drive .629.00

MODEMS

Anchor
6480 C64/128 1200 Baud99.99
520 ST520/1040 1200 Baud ..129.00
1200E 1200 Baud External ...129.00
Atari
XMM301 XL/XE 300 Baud44.99
SX-212 St Modem89.99
Avatech
1200 Hc External94.99
2400 External189.00
Best Products
2400 Baud 1/2 Card w/software 149.00
Everex
Evercom 2400 Baud External .199.00

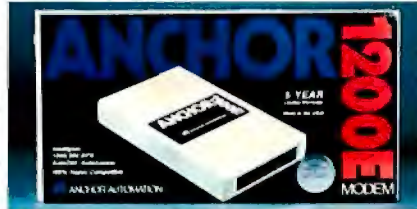

**Anchor
1200 Baud External \$119**

Hayes
Smartmodem 300149.00
Smartmodem 1200279.00
Packard Bell
1200 External89.99
2400 External169.00
Practical Peripherals
Complete Telecom Package ...79.99
2400 Baud Stand-Alone189.00
Supra
2400AT 2400 Baud Atari169.00
U.S. Robotics
Direct 1200 Baud Internal99.00
Direct 2400 Baud External ...199.00

DISKETTES

Maxwell
MD1-M SS/DD 5 1/4"8.49
MD2-DM DS/DD 5 1/4"9.49
MF1-DDM SS/DD 3 1/2"12.49
MF2-DDM DS/DD 3 1/2"18.49
MC-6000 DC-600 Tape23.99
Sony
MD1D SS/DD 5 1/2"6.99
MD2D DS/DD 5 1/2"7.99
MFD-1DD SS/DD 3 1/2"11.99
MFD-2DD DS/DD 3 1/2"16.99

PRINTERS

Atari
1020 XL/XE Plotter35.99
XDM-121 Letter Quality XL-XE 209.00
XM-M801 XL-XE Dot Matrix...199.00
XM-M804 ST Dot Matrix.....189.00
Brother
M-1409 180cps Dot Matrix ...309.00
M-1509 180cps, 132 col.389.00
Citizen
HR-20 22cps Daisywheel369.00
120D 120cps Dot Matrix.....149.00
Premier-35 35cps Daisywheel .479.00
C.Itoh
315-XP Epson/IBM 132 col ...549.00
Epson
LX-800 150 cps, 80 col179.00
FX-286E 240 cps, 132 colCall
LQ-500 180 cps, 24-wireCall
LQ-850 330 cps, 80 colCall
LQ-1050 330 cps, 24-wireCall
Hi-80 4 Pen Plotter279.00
Hewlett-Packard
2225A Thinkjet369.00
NEC
P2200 Pinwriter 24-wire379.00
P660 Pinwriter 24-wire459.00
P760 Pinwriter 132 col679.00
Okidata
Okimate 20 color printer129.00
ML-182 120 cps 80 col229.00
ML-320 300 cps, 80 col379.00
ML-390 24 wire, 270 cps519.00



**Epson FX-86e
240 cps, 80 col. \$319**

Panasonic
KX-P1080i 144 cps, 80 col....189.00
KX-P1091i 194 cps, 80 col....209.00
KX-P1092i 240 cps, 80 col....339.00
Star Micronics
NX-1000 140 cps, 80 col179.00
NX-1000C C64/128 Interface ..179.00
NX-15 120 cps, 132 col319.00
Toshiba
P321-SL 216 cps, 24-wire499.00
P351-SX 300 cps, 24-wire999.00

In the U.S.A. and in Canada

Call toll-free: 1-800-233-8950

Outside the U.S.A. call 717-327-9575, Fax 717-327-1217

Educational, Governmental and Corporate Organizations call toll-free 1-800-221-4283
CMO, 101 Reighard Ave., Dept. A1, Williamsport, PA 17701

OVER 350,000 SATISFIED CUSTOMERS • ALL MAJOR CREDIT CARDS ACCEPTED • CREDIT CARDS ARE NOT CHARGED UNTIL WE SHIP

POLICY: Add 3% (minimum \$7.00) shipping and handling. Larger shipments may require additional charges. Personal and company checks require 3 weeks to clear. For faster delivery, use your credit card or send cashier's check or bank money order. Credit cards are not charged until we ship. Pennsylvania residents add 6% sales tax. All prices are U.S.A. prices and are subject to change, and all items are subject to availability. Defective software will be replaced with the same item only. Hardware will be replaced or repaired at our discretion within the terms and limits of the manufacturer's warranty. We cannot guarantee compatibility. All sales are final and returned shipments are subject to a restocking fee. We are not responsible for typographic or photographic errors.

A107

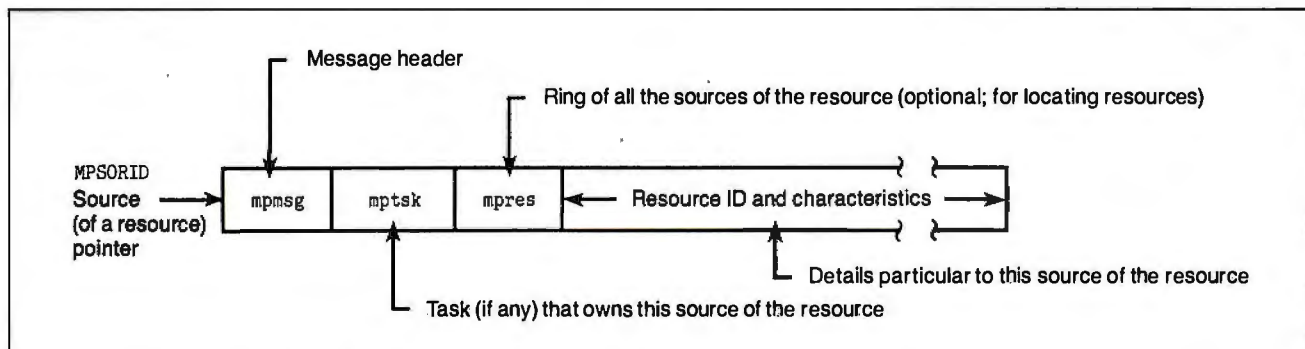

Figure 6: Internal representation of a source (of a resource) data type.

Listing 3: *The one-argument thread-initialization routine. Notice how the resource is claimed before allocating memory and released afterward.*

```
MPTHDID mpthd_create(MPTHDFN mpthdfn)
{
    int mydeftasksize= mpthd_mydef(mpdef_tasksize,int);
    MPTHDID mpthd;

    /* claim memory resource */
    mpres take(mpres_memory);
    mpthd= (MPTHDID)malloc(mydeftasksize);
    /* release memory resource */
    mpres_give(mpres_memory);

    if (mpthd) mpthd_init(mpthd,mydeftasksize,mpthdfn);
    return(mpthd);
}
```

Listing 4: *This Turbo C code will enable preemptive multitasking in Mailbox.*

```
void interrupt (* mpsig_oldclocktick)();
void interrupt mpsig_clocktick()
{
    mpsig_oldclocktick();
    mptsk_yield();
}
/* interrupt 0x08 on IBM PC */
#define MPSIG_CLOCKTICK (0x08)
void mpres_setup()
{
    ....
    mpsig_oldclocktick= getvect(MPSIG_CLOCKTICK);
    setvect(MPSIG_CLOCKTICK,mpsig_clocktick);
    ....
}
```

ing is speed. Many multitasking systems have a single kernel task that schedules all processes and manages all resources. To switch between tasks, or even to send a message, requires at least two context switches (into and out of the kernel). Mailbox requires, at most, one context switch—sometimes none—to send a message, and only one to switch between tasks. This is because it does these kernel

functions simply and within the current task. Mailbox achieves this efficiency at the cost of some intertask protection, an acceptable price since all the memory is shared anyway.

Also, multitasking systems usually let only one processor execute inside the kernel at once. Thus, the kernel scheduler itself becomes the bottleneck as you add more processors. For this reason, it

is unusual to find a shared-memory machine with more than half a dozen processors.

A mailbox can likewise be opened by only one processor. However, a processor can open only one mailbox at a time—and then only momentarily. More important, mailbox multitasking distributes message passing and scheduling between multiple mailboxes. Although its scheduling algorithm is simple, Mailbox is fast and potentially independent of the number of processors. For this reason, Mailbox should be able to make good use of multiprocessing machines.

An apparent disadvantage of mailbox multitasking is that it doesn't come with functions that allow one task to force another to stop or suspend, a feature common in other multitaskers. But this is because Mailbox has been designed to also work in multiprocessor environments, where the scheduler can't automatically assume that other tasks are suspended while it executes a task. Although I don't have a multiprocessor machine at my disposal, I designed Mailbox to take advantage of multiprocessing environments when they become available, and to better understand the issues involved in real concurrent environments.

Actually, Mailbox is easily extended to support sophisticated task-control operations due to its uniformity. Everything, even scheduling, works by sending and receiving messages. More sophisticated operations follow logically and don't need to be tailored. For example, to yield the current task so other tasks can run (useful when polling some condition), the task merely attempts to "receive" a processor "resource" from its schedule mailbox. It's also possible for a task to specify which tasks (which schedule list) it wants to yield to. Thus, when optimizing performance, a task can implement its own scheduler and "break" the strict priority scheduling. Or, for modular program-

ming, it can duplicate (i.e., a task can multitask itself).

Even the send and receive “primitives” are special instances of a general `mptsk_xfer()` function (see listing 2), with flexibility similar to that of `mptsk_switch()`. Since all task switching and message passing go through this single function interface, any sort of performance monitoring, message monitoring, or task control is possible simply by patching the desired instructions into the `mptsk_xfer()` function. Instead of being big and complicated with every possible feature included, Mailbox has been kept simple so you can tailor it to your own needs.

MPTSK implements prioritized multiprocessor scheduling and simple “mailbox” message passing based on threads. It introduces the message, task, and mailbox data types, and a simple set of operations with which you can build many sophisticated scheduling, communication, and monitoring environments. Still, the MPTSK layer only takes into account the tasks’ interaction among themselves, not with the outside world. If two or more tasks want to use the same resource at the same time, you will need the final layer, MPRES, to share resources.

MPRES: Resource Management

The MPRES layer is best viewed as an open-ended extension of the MPTSK environment. Unfortunately, only basic resource management (regulated access) can be defined in a portable fashion

Mailbox
*has been kept simple
so you can tailor it
to your own needs.*

(short of writing an entire operating system). Although all machines have processors and memory, they vary widely in what devices they have. MPRES contains support for a default set of resource types. For other devices, it shows how you can build resource managers tailored to your environment.

MPRES introduces the *resource* and *source* data types. The resource is merely

a mailbox data type, used for storing the available sources of the resource as messages. The source data type is a message with two extra fields. The first specifies the task that owns the source (NIL if none), and the second is a double-pointer structure (the same as the `mmsg` header) that keeps all the sources of a resource in a ring (see figure 6). You can take (`mpres_take()`) and give or release (`mpres_recv()`) a source of a resource (these routines are implemented with `mptsk_send()` and `mptsk_recv()`). MPRES also provides operations to initialize—and to deinitialize—a resource of a particular type.

These two fields in the source data type allow you to locate all sources—and users—of a resource. This feature could be useful for reclaiming resources from crashed or discourteous tasks, although it’s not currently taken advantage of.

By incorporating the knowledge gained from the `waitingfor` and `owns` fields of tasks (see figure 3a), it’s also possible to detect deadlock (a cycle of tasks waiting endlessly for each other) before it occurs. When a task is about to be suspended to wait for a resource, it first checks if any other tasks that have

continued

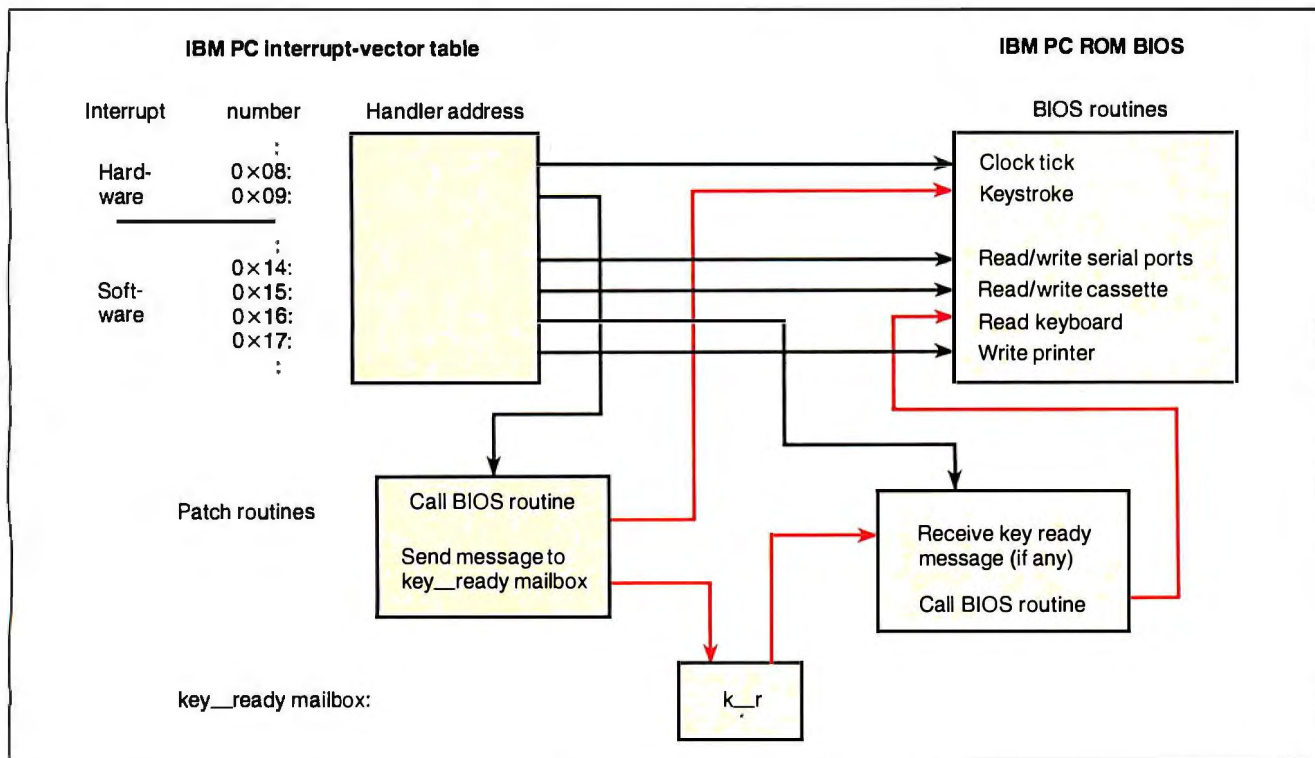

Figure 7: Intercepting interrupts (advanced optimizations). To prevent tasks from wasting processor time waiting for keystrokes, you can intercept the IBM PC’s BIOS interrupt routines to check and signal when a keystroke has occurred. Since you can call Mailbox’s send and receive primitives within interrupts, many such schedule optimizations are possible without rewriting the scheduler.

A Few Rules of Thumb for Concurrent Processing

1. Divide problems into modular tasks, units of highly coupled data and control.
2. Know the order in which things must happen, and the order in which they could be allowed to happen.
3. Know which objects are shared, and which objects are local.
4. Synchronize access to all shared objects.
5. Know the unit of transaction, what operations should be atomic, and when they should commit.

Note: Modular and object-oriented programming styles are also helpful for reasoning about concurrent systems.

the resource are already waiting for it. (Since this check potentially involves a great deal of searching for every access to a resource, it's not implemented, but it could be if deadlock is a serious problem.) You should be wary, however, of the base case of deadlock, where a task requests a resource that it already has.

The MPRES layer also defines a few general resources, the most universal of which is `mpres_memory`. With memory-contention management, you can finally write a one-argument thread-initialization routine (see `mpthd_create()` in listing 3). Notice how the memory resource must be claimed and released around the standard `malloc` memory-allocation call. This ensures that no other task can allocate memory at the same time. Likewise, protection must be provided around `free`, the memory-deallocation call, and other memory management calls.

In general, every C function that accesses resources must be executed within an appropriate resource lock. This is true for any concurrent system. To make the job easier, the MPRES package defines a macro, `mpres_critsect`, which takes as arguments a resource and a block of code. The macro claims the resource, executes the code, and then frees the resource before exiting.

MPRES also duplicates many of the common C function calls with this extra locking added (e.g., `mpres_malloc()`). Operations such as `malloc()`, which are completed in a single transaction, are well suited for this. In contrast, operations such as `printf`, which usually require several calls ("or the," "Hello," "output may not stick," "Goodbye," "together") are best locked explicitly by the caller. Explicit locking is also necessary when calling library functions that use resources and are unaware they are executing in a concurrent environment.

One way to simplify the complexities of having to lock and unlock resources is to assume a single-processor environment, which is often the case, and to have tasks yield control explicitly only when

they're not holding any resources. This may be an acceptable compromise in many circumstances, and Mailbox allows for this style of programming.

MPRES also provides three levels of I/O locking *granularity*. On the high-stream level are the standard streams: `mpres_stdin`, `mpres_stdout`, and `mpres_stderr`. On the middle-component level are standard operating-system components: `mpres_filesystem`, `mpres_network`, `mpres_terminalin`, and `mpres_terminalout`. And on the low-device level are the standard devices: `mpres_harddisk`, `mpres_floppydisk`, `mpres_modem`, `mpres_printer`, `mpres_parallel`, and `mpres_serial`. Locking at a lower granularity level allows for a higher degree of concurrency at a cost of complexity and portability. These locking levels are likely to be incomplete and to overlap; they are merely suggested names for resources and their locks. It is up to you to tailor the locking appropriate to your environment and task.

One optimization you may want is to tap into the power of the hardware and operating-system interrupts. Both the MPTH and MPTSK layers have been carefully designed so you can also call their functions from interrupt handlers with no modifications. For example, if you add the Turbo C code in listing 4, the package becomes a *preemptive* multitasker. Now, 18.2 times a second (the frequency of the IBM PC clock), the current task will yield if another task is waiting to run. You can achieve a similar effect in Unix by using the alarm signal.

Putting Idle Time to Work

In general, you can tailor Mailbox to take advantage of almost any interrupt-driven resource. For example, personal computers waste most of their processing power waiting for keystrokes.

Suppose you wanted to suspend tasks waiting for keyboard I/O, without modifying the standard functions, like `scanf()`, which might access the keyboard. On the IBM PC, the keyboard is

typically read through a ROM BIOS software interrupt. The keyboard also generates a hardware interrupt each time a key is pressed. By intercepting requests to read the keyboard and signaling when a key is available (see figure 7), you can put this idle time to more productive uses—like saving the data you're working on.

You can use a similar trick in Unix with `signal(3C)` and `fcntl(2)`. The calling task must explicitly wait for a mailbox, associated with a particular stream, if an I/O operation exists on the stream `EWOULDBLOCK`; in turn, a signal handler for `SIGIO` would restart the task by sending it a message that the stream was ready. Likewise, you could make optimizations for the other computer resources.

Resource management is a difficult issue. Since computer devices differ and most languages have several wired-in I/O calls, *portable* resource management is nearly impossible, short of writing another operating system. Mailbox provides portable processor (preemptive multitasking) and memory (dynamic allocation) resource management, and contention management for many standard resources. Beyond this, I encourage you to tailor Mailbox to your own particular resource needs.

Thinking Concurrently

Concurrency buys you modularization, the ability to divide your programs into their logical "tasks"—in the full sense of the word. It also buys performance. But the price is high. You must face complex issues of managing resources and ensuring data integrity. You must learn to think concurrently. A few rules of thumb are given in the textbox above.

A major problem with concurrent systems, especially distributed systems, is "getting them right." The concurrency issues introduced here are just the tip of the iceberg. No language extension can provide a complete solution. We need to write new operating systems to take real advantage of concurrency; Microsoft's OS/2 is just the beginning. Nevertheless, Mailbox allows you to explore multitasking and learn to appreciate the pros and cons of concurrent processing. ■

Editor's note: *The source code listing for the Mailbox package is available in a variety of formats. See page 3 for details.*

Michael Benjamin Parker is a computer science major at MIT. Mailbox is part of his larger research project, SHARE, a distributed shared-information operating system for personal computers.

HypertExpert Systems

...something totally new from Knowledge Garden

HYPertext

Hypertext lets you link related concepts, logic or procedures. It adds a whole new dimension to written material like training manuals, help systems and reference works. Hypertext allows users to access information in a non-linear fashion by following a train of thought. Hypertext lets the reader control the level of detail and the type of information displayed. But that's just one side of the coin.

EXPERT SYSTEMS

The other key ingredient to real exchange of knowledge via the computer is control by the author. That's why integration of hypertext and expert systems is such a breakthrough — it lets communication take place between teacher and pupil, author and reader, expert and novice. It lets each side REACT to what the other says.

Announcing KnowledgePro™, a new development environment, from Knowledge Garden. It integrates **hypertext** with **expert systems** to create the world's first **knowledge processor**. KnowledgePro is unlike anything you have seen before.

KNOWLEDGE PROCESSOR

The age of packaged knowledge is upon us. PC's now have the power to manipulate, store and retrieve knowledge using KnowledgePro, **a language for experts**, and **a tool for beginners**. KnowledgePro is the first system to provide an effective, simple and aesthetic medium for the communication of knowledge on disk.

Big corporations can now construct expert systems for internal use quickly and without expensive AI training. Individuals can author knowledge bases for commercial or educational use.

KNOWLEDGEPRO

KnowledgePro is a totally new development environment created by Bev and Bill Thompson. It costs \$495 plus \$5 shipping and handling and runs on IBM PC, XT, AT or PS/2 with 512k memory. KnowledgePro is not copy-protected and there are no run-time fees. A working demonstration disk is available for \$30 with full credit towards purchase of KnowledgePro. Call today **to order** your copy.

A LANGUAGE FOR EXPERTS

KnowledgePro is for experts because it provides a wide variety of structures to work with. It has many advanced features, like inference, list processing, topics, procedural control and inheritance. You can write new procedures in other languages and interface to other programs. You can read DBASE III and LOTUS 123 data directly into the knowledge base.

A TOOL FOR BEGINNERS

KnowledgePro let's you communicate knowledge, easily and without spending weeks on the details. KnowledgePro handles the details for you. It provides easy access to colors, windows and mouse control. It's been called the BASIC of the 80's because anyone can get results quickly — and then grow into more sophisticated features at their own pace.

TO ORDER

Call 518-766-3000 (American Express, Visa, M/C accepted) or mail your **check** today. *check*

Knowledge Garden Inc.
473A Malden Bridge Rd.
Nassau, NY 12123

The run-time version of KnowledgePro is free on the electronic networks or \$15 from Knowledge Garden complete with useful example applications.



Another intelligent tool in the Knowledge Garden family of products.

Published by



IBM is a registered trademark of International Business Machines Inc. KnowledgePro is a trademark of Knowledge Garden Inc. DBASE III is a trademark of Ashton Tate. LOTUS 123 is a registered trademark of Lotus Development Corp. Photo: Tcherevkoff©



Take any 3 books for only \$1⁰⁰ each



UNDERSTANDING & USING dBASE III® PLUS. By R. Krumm. 674 pp., illus., softbound. Widely regarded as the most comprehensive one-volume reference on the subject, it covers everything from basic concepts to advanced programming techniques.
583940-7 Pub. Pr., \$22.95

UNIX UTILITIES. By R.S. Tare. 352 pp., illus., softbound. This practical manual shows how to make the best use of UNIX utilities. It covers more utilities than any other book of its kind and provides numerous examples of real applications.
628/84X Pub. Pr., \$24.95

VSAM: Performance, Design, and Fine Tuning. By J. Ranade. 280 pp., illus. Find out how to adapt VSAM to your particular needs and cut processing time in half! This new work by an authority on VSAM provides the detailed, hands-on assistance you need to design and implement efficient systems.
583963-6 Pub. Pr., \$34.95

TURBO PASCAL PROGRAMMER'S LIBRARY. By K. Jamsa and S. Name-roff. 495 pp., illus., softbound. An outstanding and varied collection of more than 200 routines that you can quickly key into any computer that runs under PC-DOS. Includes some vital math functions not provided in Turbo Pascal's standard package.
583762-5 Pub. Pr., \$18.95

ANALYSIS, DESIGN, & IMPLEMENTATION OF DATA DICTIONARIES. By K.S. Braithwaite. 256 pp., 40 illus. Data dictionaries are becoming increasingly important tools for managing and tracking data within an organization. This practical volume will help you integrate data dictionaries into any information processing environment.
072/485 Pub. Pr., \$39.95

when you join BYTE Book Club® Values up to \$59.95

- Your one source for computer books from over 100 different publishers
- the latest and best information in your field
- discounts of up to 40% off publishers' list prices

A COMPREHENSIVE GUIDE TO AI AND EXPERT SYSTEMS: Turbo Pascal Edition. By R.I. Levine, D.E. Drang, and B. Edelson. 256 pp., 99 illus. A must for everyone who wants to understand and utilize artificial intelligence for commercial, military, scientific, or educational applications. It's all in clear, simple language with many illustrations and sample programs.
374/708 Pub. Pr., \$22.95

32-BIT MICROPROCESSORS. Edited by H. J. Mitchell. 248 pp., 104 illus. and tables. A comprehensive survey of the powerful new microprocessors for large, technically complex projects. Coverage includes: AT&T's WE32100, Inmos' T414 and T424, Intel's 80386, Motorola's 68020, and Zilog's Z80000.
425/85X Pub. Pr., \$45.00

CIARCIA'S CIRCUIT CELLAR, Volume VI. By S. Ciarcia. 224 pp., 75 illus., softbound. More marvelous projects from the incomparable Ciarcia! This new volume contains easy-to-follow plans for a home security system, a serial Eprom programmer, a turnkey bulletin board, an audio-and-video multiplexer, plus 10 more projects.
109/680 Pub. Pr., \$19.95

PROGRAMMER'S CHALLENGE: 50 Challenging Problems to Test Your Programming Skills. By S. Chen. 464 pp. If you enjoy testing your programming skills, then you'll enjoy solving these 50 challenging problems. Solutions are provided in BASIC, Pascal, and C with full explanations and test data.
583883-4 Pub. Pr., \$29.95

RUNNING MS-DOS®. By V. Wolverton. 2nd Ed., 423 pp., 40 illus. Now updated to cover all versions of MS-DOS through 3.1. You'll see exactly how to manage files and diskettes, manipulate display, printer, and telecommunications devices, create your own commands and menus, set up a network to connect several PCs, and much more.
583694-7 Pub. Pr., \$34.95

dBASE COMPILERS. By K. Knecht. 276 pp. Gives you a thorough understanding and comparison of the four major dBase III Plus compilers: Clipper, Quicksilver, OB III Compiler, and Foxbase +. A sample application is used to describe the compilation and linking process for each compiler.
584576-8 Pub. Pr., \$18.95

ARTIFICIAL INTELLIGENCE USING C: The C Programmer's Guide to AI Techniques. By H. Schildt. 412 pp., 37 illus., softbound. This hands-on guide shows you how to create your own AI applications and systems using C. After an introductory overview it provides coverage of expert systems, logic, natural language processing, machine learning, pattern recognition, and more, with ready-to-run programs illustrating each topic.
881255-0 Pub. Pr., \$21.95

PROGRAMMING USING THE C LANGUAGE. By R.C. Hutchison and S.B. Just. 519 pp., illus. Whether you want to understand programs in C written by others, or write better C programs of your own, this practical, authoritative book gives you the tools and guidance you need. Coverage includes program organization, sorting algorithms, recursion, linked lists, and more — with many sample programs.
315/418 Pub. Pr., \$28.95

HARD DISK MANAGEMENT with MS-DOS and PC-DOS. By D. Gookin and A. Townsend. 307 pp., illus. Shows you how to make the best use of your hard disk for all types of programs, with an emphasis on organization, data security, and enhancing performance. Easy enough for novices, yet sophisticated enough for power users, it's packed with helpful hints, proven shortcuts, and clear explanations.
583954-7 Pub. Pr., \$26.95

TRICKS OF THE UNIX MASTERS. By R.G. Sage. pp. illus. Many of UNIX's most interesting features have virtually been kept secret from users — until now! This master guide goes beyond the basics to show you the shortcuts, tools, tips, and tricks it could take years to discover on your own.
584637-3 Pub. Pr., \$22.95

BYTE BOOK CLUB™

Membership Order Card

Please enroll me as a member and send me the three choices I have listed below. Bill me only \$3.00, plus local tax, postage and handling. I agree to purchase a minimum of three additional books during my first year as outlined under the Club plan described in this ad. Membership in the club is cancellable by me any time after the three book purchase requirement has been fulfilled. A shipping and handling charge is added to all shipments.

Indicate below by number the books you want. A few expensive books (noted in the descriptions) count as more than one choice.

<input type="text"/>	<input type="text"/>	<input type="text"/>
----------------------	----------------------	----------------------

Signature _____

Name _____

Address/Apt.# _____

City, State, Zip _____

Corporate Affiliation _____

This order subject to acceptance by McGraw-Hill. All prices subject to change without notice. Offer good only to new members. Foreign member acceptance subject to special conditions.

BYTE BOOK CLUB™

Membership Order Card

Please enroll me as a member and send me the three choices I have listed below. Bill me only \$3.00, plus local tax, postage and handling. I agree to purchase a minimum of three additional books during my first year as outlined under the Club plan described in this ad. Membership in the club is cancellable by me any time after the three book purchase requirement has been fulfilled. A shipping and handling charge is added to all shipments.

Indicate below by number the books you want. A few expensive books (noted in the descriptions) count as more than one choice.

<input type="text"/>	<input type="text"/>	<input type="text"/>
----------------------	----------------------	----------------------

Signature _____

Name _____

Address/Apt.# _____

City, State, Zip _____

Corporate Affiliation _____

This order subject to acceptance by McGraw-Hill. All prices subject to change without notice. Offer good only to new members. Foreign member acceptance subject to special conditions.



NO POSTAGE
NECESSARY
IF MAILED
IN THE
UNITED STATES

BUSINESS REPLY MAIL

FIRST CLASS MAIL PERMIT NO. 42 HIGHTSTOWN, NJ

POSTAGE WILL BE PAID BY ADDRESSEE

McGraw-Hill Book Clubs
P.O. Box 582
Hightstown, NJ 08520-9959

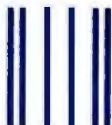

NO POSTAGE
NECESSARY
IF MAILED
IN THE
UNITED STATES

BUSINESS REPLY MAIL

FIRST CLASS MAIL PERMIT NO. 42 HIGHTSTOWN, NJ

POSTAGE WILL BE PAID BY ADDRESSEE

McGraw-Hill Book Clubs
P.O. Box 582
Hightstown, NJ 08520-9959



ADVANCED UNIX: A PROGRAMMER'S GUIDE. By S. Prata
583829-X Pub. Pr., \$17.95

PROGRAMMING WITH TURBO PASCAL. By D. Carroll
852908-5 Pub. Pr., \$39.95

HIGH-SPEED ANIMATION & SIMULATION FOR MICROCOMPUTERS. By L. Adams
583855-9 Pub. Pr., \$19.95

DATABASE MACHINES & DATABASE MANAGEMENT. By E. Ozkarahan
583770-6B Pub. Pr., \$52.33
(Counts as 2 of your 3 books)

PRINCIPLES OF PARALLEL AND MULTI-PROCESSING. By G.R. Desrochers.
165/793 Pub. Pr., \$49.50
(Counts as 2 of your 3 books)

GETTING THE MOST FROM UTILITIES ON THE IBM PC. By R. Krumm
583790-0 Pub. Pr., \$19.95

THE ADA PRIMER. By P. I. Johnson
326/266 Pub. Pr., \$17.95

DATA PROCESSING PROJECT MANAGEMENT. By A. O. Awani
583721-8 Pub. Pr., \$29.95

68000, 68010, 68020 PRIMER. By S. Kelly-Bootle & B. Fowler
583802-8 Pub. Pr., \$21.95

THE DATABASE EXPERT'S GUIDE TO SQL. By F. Lusardi
390/061 Pub. Pr., \$39.95

PRINCIPLES OF ARTIFICIAL INTELLIGENCE AND EXPERT SYSTEMS DEVELOPMENT. By D.W. Rolston
536/147 Pub. Pr., \$39.95

HOW TO WRITE COMPUTER DOCUMENTATION FOR USERS, 2nd Ed. By S.J. Grimm
583783-8 Pub. Pr., \$29.95

DATA STRUCTURES USING PASCAL, 2nd Ed. By A. M. Tenenbaum & M. J. Augenstein
583738-2 Pub. Pr., \$42.67

MICROCOMPUTER LANS: Network Design and Implementation. By M.F. Hordeski
584580-6 Pub. Pr., \$26.95

OPERATING SYSTEMS. By M. Milenkovic
419/205 Pub. Pr., \$40.95

USER GUIDE TO FOCUS. By R. P. Lipton
380/066 Pub. Pr., \$22.95

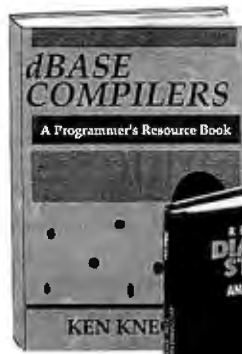

Any 3 books for \$1.00 each ... if you join now and agree to purchase three more books — at handsome discounts — during your first year of membership.

ADVANCED TURBO PASCAL: PROGRAMMING AND TECHNIQUES. By H. Schildt.
583761-7 Pub. Pr., \$18.95

SOFTWARE ENGINEERING: A PRACTITIONER'S APPROACH. By R.S. Pressman.
507/83XB Pub. Pr., \$47.95
(Counts as 2 of your 3 books)

68000 ASSEMBLY LANGUAGE PROGRAMMING, 2nd Ed. By L. Leventhal; D. Hawkins; G. Kane & W. Cramer
583817-6 Pub. Pr., \$28.95

MICROPROCESSOR SYSTEM DESIGN CONCEPTS. By N. A. Alexandridis
583313-1 Pub. Pr., \$37.95

RECOMMENDED DIAGRAMMING STANDARDS. By J. Martin
583597-5 Pub. Pr., \$45.00
(Counts as 2 of your 3 books)

FILE ORGANIZATION FOR DATABASE DESIGN. By G. Wiederhold.
701/334 Pub. Pr., \$40.95

USING TURBO C. By H. Schildt
881279-8 Pub. Pr., \$19.95

More Books to Choose from

FOILING THE SYSTEM BREAKERS: COMPUTER SECURITY AND ACCESS CONTROL. By J. Lobel
383/57X Pub. Pr., \$37.50

IMS (DL/I) DATABASE ORGANIZATION AND PERFORMANCE. By G. Hubbard
583840-0 Pub. Pr., \$32.95

HOW TO BE A SUCCESSFUL COMPUTER CONSULTANT. By A. R. Simon
572/968 Pub. Pr., \$19.95

THE THEORY AND PRACTICE OF COMPILER WRITING. By J. P. Tremblay & P. G. Sorenson
651/612B Pub. Pr., \$46.95
(Counts as 2 of your 3 books)

INTRODUCING PC-DOS AND MS-DOS: A GUIDE FOR BEGINNING & ADVANCED USERS. By T. Sheldon
565/597 Pub. Pr., \$24.95

THE HANDBOOK OF DATA COMMUNICATION AND COMPUTER NETWORKS. By D. N. Chorafas
583713-7B Pub. Pr., \$59.95
(Counts as 2 of your 3 books)

DEBUGGING TECHNIQUES FOR IBM PC BASIC. By J. R. Corsi & W. F. Hills
583693-9 Pub. Pr., \$17.95

CIARCIA'S CIRCUIT CELLAR, Volume V. By S. Ciarcia
109/672 Pub. Pr., \$21.95

HANDBOOK OF SOFTWARE MAINTENANCE. By G. Parikh
583639-4 Pub. Pr., \$35.95

THE C PRIMER, 2nd Ed. By L. Hancock & M. Krieger
259/95X Pub. Pr., \$22.95

DATA TYPES AND DATA STRUCTURES. By J. J. Martin
583689-0 Pub. Pr., \$44.67

TROUBLESHOOTING AND REPAIRING THE NEW PERSONAL COMPUTERS. By A. Margolis
583871-0 Pub. Pr., \$17.95

APPLYING EXPERT SYSTEMS IN BUSINESS. By D. N. Chorafas
108/803 Pub. Pr., \$31.95

STRUCTURED COBOL: A STEP BY STEP APPROACH. By C.R. Litecky and G.B. Davis.
157/88X Pub. Pr., \$30.95

TELECOMMUNICATIONS AND DATA COMMUNICATIONS FACTBOOK. By J. Abbatiello and R. Sarch
606965-6 Pub. Pr., \$39.95

DESIGN OF DISTRIBUTED OPERATING SYSTEMS. By P. J. Fortier
216/215 Pub. Pr., \$42.95

dBASE III PLUS® AND LOCAL AREA NETWORKS. By W. Bates and A. G. Fortino
583751-X Pub. Pr., \$24.95

HANDS-ON-BASIC: FOR THE IBM PERSONAL COMPUTER. By H. Peckham
491/78X Pub. Pr., \$26.95

Here's how Byte Book Club works to serve you:

- **Important information ... we make it easy to get!** Today, professionals who perform best are those who are best informed. For reliable, hands-on information, turn to the Byte Book Club. Every 3 or 4 weeks (12-15 times a year), members receive the Club Bulletin offering more than 30 books — the best, newest, most important books from all publishers.
- **Dependable service ... we're here to help!** Whether you want information about a book or have a question about your membership, just call us toll-free or drop us a line. To get only the books you want, make your choice on the Reply Card and return it by the date specified. If you want the Main Selection, do nothing — it will be sent to you automatically. (A small shipping and handling charge is added to each shipment.)
- **Club convenience ... we do the work!** You get a wide choice of books that

simply cannot be matched by any bookstore. And all your books are conveniently delivered right to your door. You also get 10 full days to decide whether you want the Main Selection. (If the Club Bulletin ever comes late and you receive a Main Selection you don't want, return it for credit at our expense.)

- **Substantial savings ... and a bonus program too!** You enjoy substantial discounts — up to 40% — on every book you buy. Plus, you're automatically eligible for our Bonus Book Plan which allows you savings up to 70% on a wide selection of books.
- **Easy membership terms ... it's worthwhile to belong!** Your only obligation is to purchase 3 more books — at handsome discounts — during the next 12 months, after which you enjoy the benefits of membership with no further obligation. You or the Club may cancel membership anytime thereafter.

Fill out the card and mail today! If the card is missing, write to:

BYTE BOOK CLUB®, P.O. Box 582, Hightstown, New Jersey 08520-9959
For faster service in enrolling, call 1-800-2-MCGRAW

Resource Guide

Amiga Exec 2000 \$1995
Multitasking operating system; runs on the Amiga.

Commodore
Business Machines, Inc.
1200 Wilson Dr.
West Chester, PA 19380
(215) 436-4200
Inquiry 955.

A/UX
Multitasking Unix operating system; runs on the Mac.

Macintosh Toolbox
Windowing system; runs on the Mac.

MultiFinder \$49
Multitasking operating system; runs on the Mac.

Apple Programmers and
Developers Association
290 Southwest 43rd St.
Renton, WA 98055
(206) 251-6548
Inquiry 956.

Concurrent DOS 386
Three-user \$395
Ten-user \$495
Multitasking operating system; runs on 80386-based machines.

Concurrent DOS XM 6.0
Three-user \$295
Six-user \$395
Multitasking operating system; runs on IBM PC, XT, AT, PS/2, and compatibles.

FlexOS 286 \$1995
Multitasking operating system; runs on 80286-based machines.

FlexOS 386 \$2995
Multitasking operating system; runs on 80386-based machines.

Digital Research, Inc.
70 Garden Court
P.O. Box DRI
Monterey, CA 93942
(800) 443-4200
Inquiry 957.

Ctask **Public domain**
Multitasking operating system; runs on IBM PC, XT, AT, and compatibles.

Tom Wagner
BIX ("twagner")
Inquiry 958.

DESQview 1.3 \$99.95
Windowing system; runs on IBM PC, XT, AT, and compatibles.

DESQview 2.0 \$129.95
Concurrent environment; runs on 80386-based machines, IBM PC, XT, AT, PS/2, and compatibles.

Quarterdeck Office Systems
150 Pico Blvd.
Santa Monica, CA 90405
(213) 392-9701
Inquiry 959.

MacScheme + Toolsmith \$395
Concurrent programming environment; runs on the Mac.

Semantic Microsystems
4470 Southwest Hall, Suite 340
Beaverton, OR 97005
(503) 643-4539
Inquiry 960.

Mailbox 1.0 ... \$35 (shareware)
Multitasking programming environment; user-portable to IBM, DEC, Apple; user-portable to MS-DOS or Unix.

Michael B. Parker
BIX
Inquiry 961.

Merge 386
Two-user with Unix \$795
Unlimited with Unix \$1595
Multitasking operating system; runs on IBM PC, XT, AT, and compatibles.

Locus Computing Corp.
3330 Ocean Park Blvd.
Santa Monica, CA 90405
(213) 452-2435
Inquiry 962.

NeWS
Windowing system; runs on the IBM PC.

Sun Microsystems, Inc.
2550 Garcia Ave.
Mountain View, CA 94043
(415) 960-1300
Inquiry 963.

OS/2
Multitasking operating system; runs on the IBM PS/2s.

Windows 2.03 \$99
Windowing system; runs on IBM PC, XT, AT, PS/2, and compatibles.

Windows/386 \$195
Multitasking environment; runs on 80386-based machines under MS-DOS.

Microsoft Corp.
16011 Northeast 36th Way
P.O. Box 97017
Redmond, WA 98073
(206) 882-8080
Inquiry 964.

PC-MOS/386 \$195
Multitasking operating system; runs on 80386-based machines.

The Software Link
3577 Parkway Lane
Atlanta, GA 30092
(404) 448-5465
Inquiry 965.

QNX \$450
Multitasking operating system; runs on IBM PC, AT, PS/2, and compatibles.

Quantum Software Systems, Ltd.
Kanata South Business Park
175 Terrence Matthews Crescent
Kanata, Ontario, Canada
K2M 1W8
(613) 591-0931
Inquiry 966.

RM/FORTRAN with RM/Forte \$595
Multitasking programming environment; runs on IBM PC, XT, AT, and compatibles.

Austec, Inc.
609 Deep Valley Dr.
Rolling Hills Estates, CA 90274
(213) 541-4828
Inquiry 967.

SCO Xenix 386 2.2 \$695
Multitasking operating system; runs on 80386-based machines.

VP/ix
Two-user \$495
Three-user \$995
Multitasking operating system; runs on IBM PC, XT, AT, and compatibles.

The Santa Cruz Operation, Inc.
P.O. Box 1900
Santa Cruz, CA 95061
(800) 626-8649
Inquiry 968.

SideKick Plus \$199
Desktop manager; runs on IBM PC, PC, XT, AT, PS/2, and compatibles.

Borland International, Inc.
4585 Scotts Valley Dr.
Scotts Valley, CA 95066
(408) 438-8400
Inquiry 969.

Tele (Kernel) \$50
Multitasking programming environment and operating system; runs on IBM PC and compatibles.

M&T Books
501 Galveston Dr.
Redwood City, CA 94063
(800) 533-4372; in California,
(415) 366-3600
Inquiry 970.

TimeSlicer 5.0 \$295
Multitasking environment; runs on IBM PC, AT, and compatibles with MS-DOS.

Lifeboat Associates
55 South Broadway
Tarrytown, NY 10591
(800) 847-7078
Inquiry 971.

TopView \$175
Windowing system; runs on IBM PC, XT, Portable, AT, and compatibles.

IBM Corp.
113 Westchester Ave.
White Plains, NY 10604
(800) 447-4700
Inquiry 972.

Unix
Multitasking operating system; runs on 80386-based machines.
AT&T Information Systems
100 Southgate Pkwy.
Morristown, NJ 07960
(800) 247-1212
Inquiry 973.

VM/386 \$245
Multitasking operating system; runs on 80386-based machines.

Intelligent Graphics Corp.
4800 Great America Pkwy.
Suite 200
Santa Clara, CA 95054
(408) 986-8373
Inquiry 974.

Wendin-DOS 2.14 \$99
Multitasking operating system; runs on IBM PC, XT, AT, and compatibles.

Wendin's Operating System Toolbox \$99
Multitasking environment; runs on IBM PC, XT, AT, and compatibles.

Wendin, Inc.
P.O. Box 3888
Spokane, WA 99220
(509) 624-8088
Inquiry 975.

ROAD WARRIORS.



INTRODUCING ZENITH'S NEW BATTERY-POWERED PORTABLES.

ZENITH INNOVATES AGAIN—with a state of the art family of battery-powered portables led by the single most revolutionary portable ever created, TurbosPort 386™.

TurbosPort 386 is breakthrough inside and out. Outside, Zenith's exclusive Page White™ display virtually duplicates printed page clarity. Its sharp black images are refreshed quickly on a fluorescent backlit screen. Plus a fully detachable keyboard (unheard of on any other battery-powered portable).

Inside the compact TurbosPort 386, the breakthroughs continue with a powerful 80386 microprocessor harnessed to a fast access 40MB hard disk. And zero wait state technology for up to 50% greater speed than other 12MHz systems.

Next comes the lightweight SupersPort 286™, the highest performance 286 class machine among all laptops... or

desktops. With a choice of fast access 20 or 40MB hard disk.

The third member of the pack is the SupersPort™ with 20MB hard disk or dual floppy systems and detachable battery packs for optimum flexibility.

All three machines ride on Zenith's Intelligent Power Management System™ for maximum battery life.

Three new portables—three more reasons why Zenith is the battery-powered leader. For the name of your nearest Zenith Data Systems Dealer, call: 1-800-842-9000, ext. 1.

ZENITH | data systems

THE QUALITY GOES IN BEFORE THE NAME GOES ON.*

ALPS

DESIGN OUR NEXT AND WE'LL NAME

The engineers at ALPS aren't the only ones who come up with great printer ideas. Our customers do, too.

And now we've found a way to reward your efforts. The "ALPS Design Our Next Printer Contest."

Just tell us what you'd like to see in a new PC printer. If yours is the best idea selected,

we'll actually use it in our next printer, name the printer after Y-O-U, and give you a free ALPS LPX600 laser printer. Five runners-up will receive free ALPS dot matrix printers.

Now if you're wondering what sort of ideas we're looking for, here are a few we've recently put to good use:

"Why not make a jam-proof 24-pin printer

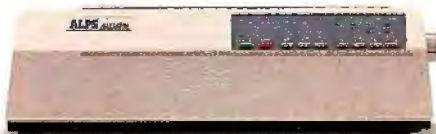

Harold

EXT PRINTER E IT AFTER YOU.

for under \$500?" led to our new Allegro 24 and its unique flatbed design. "How about a 24-pin printer with 9- and 18-pin emulation, paper parking and two built-in type fonts?" resulted in our new enhanced ALQe series. And "Laser printers should have larger memories and greater versatility" inspired our rugged new LPX600, with 2MB of

built-in RAM and over 40 downloadable fonts.

If you've got an idea this good, tell us about it. For your free contest entry package, call 800-828-ALPS. In California, 800-257-7872. Or write to ALPS America, 3553 North First Street, San Jose, CA 95134.

And watch your name go down in printer history.



ALPS

AMERICA

Built by popular demand.

Allegro 24, ALQe and LPX600 are trademarks of Alps Electric Co., Ltd.
© 1988, ALPS America.

THE ULTIMATE LINK?

ISDN—a new communications technology that could change the way we use our computers and telephones

Jay Duncanson and Joe Chew

You are sitting at your desk, first thing in the morning. Your computer downloads several large files from a shared hard disk over the telephone system. Sipping your coffee, you start another download from an information service, then check your electronic mail (E-mail) while the error-free transfers continue.

The telephone rings. A window pops up on your computer, telling you it's your mother calling. In the midst of the conversation with your mother, the window reappears: Your division manager is calling from headquarters. Putting the personal call on hold, you and your manager discuss a new assignment, augmenting the discussion with interactive graphics.

As you return to Mom's call, the pop-up window informs you that a call from a pesky salesman has just been automatically rejected. At the same time as all this, your laser printer has made a hard copy of a facsimile that has come in from one of your remote divisions.

Sound futuristic? It is, but not by much. Even as you read this, functions like these are being demonstrated in field trials and actual commercial implementations of ISDN, the Integrated Services Digital Network. (The grammatically proper usage is "an ISDN" or "the ISDN," as if the acronym were spelled out, but most use it without remorse as a noun in its own right.)

ISDN is a technology that integrates digitized voice and data—not only computer data, but other digital information, such as fax and video. It works over simple twisted-pair wiring such as that currently in use for telephones (see figure 1). At monthly rates from 20 percent to 60 percent higher (depending on the services chosen) than we are now paying for basic telephone services, ISDN will offer high-speed digital transmission and many enhanced communications services.

More Than Just a Service

The keys to understanding the concept of ISDN are in its name. First and foremost, its services are integrated. Voice and data,

circuit switching, and packet switching all come to you on one line from one source. Standards for interoperability are being developed and approved by the CCITT, or International Consultative Committee for Telephone and Telegraph, under the aegis of the United Nations.

Whereas today's conventional networks have islands of modern digital apparatus in a sea of analog technology, ISDN is completely digital (except, of course, for certain parts of the telephone, such as the microphone, speaker, and tone pad). This approach allows performance unheard of in analog days.

With a few local exceptions, these integrated digital services will eventually be provided over existing telephone wiring to all subscribers who want them. The first tentative commercial offerings are already in place, and ISDN lines should be available in most places by the mid-1990s. However, technical and financial problems may slow its progress.

Batteries Not Included

The telephone system uses the complex embedded technology you'd expect from an international network that serves hundreds of millions of people. Fortunately, to understand how ISDN affects end users, we need to deal with only two key elements: the central offices (electronic switchboards that route calls and provide services) and the local loop from the central offices to the customers' premises.

In most of the Western industrial countries, the central offices and the networks connecting them are well on the road to complete digitization, a process that began in the early 1960s. Most circuits from the central office to the customer, though, still use the analog technology that Alexander Graham Bell would have recognized: talking by modulating a continuous DC signal across a loop. A present-day telephone's interaction with the central-office switch is both limited and simple-minded, especially during a call. The burdens of knowing the state of a connection and of providing extra services, such as call waiting, rest entirely upon the switch.

continued

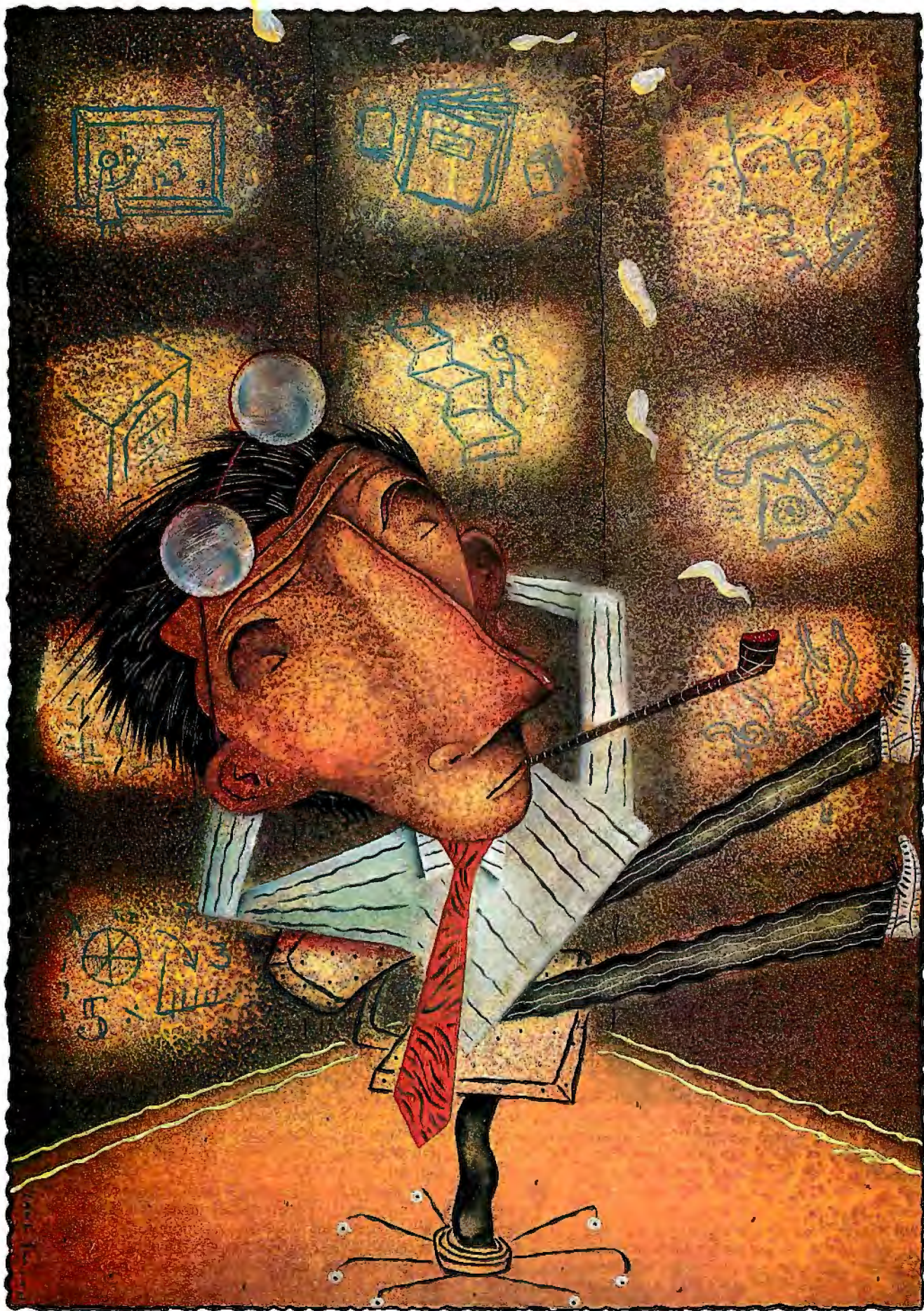

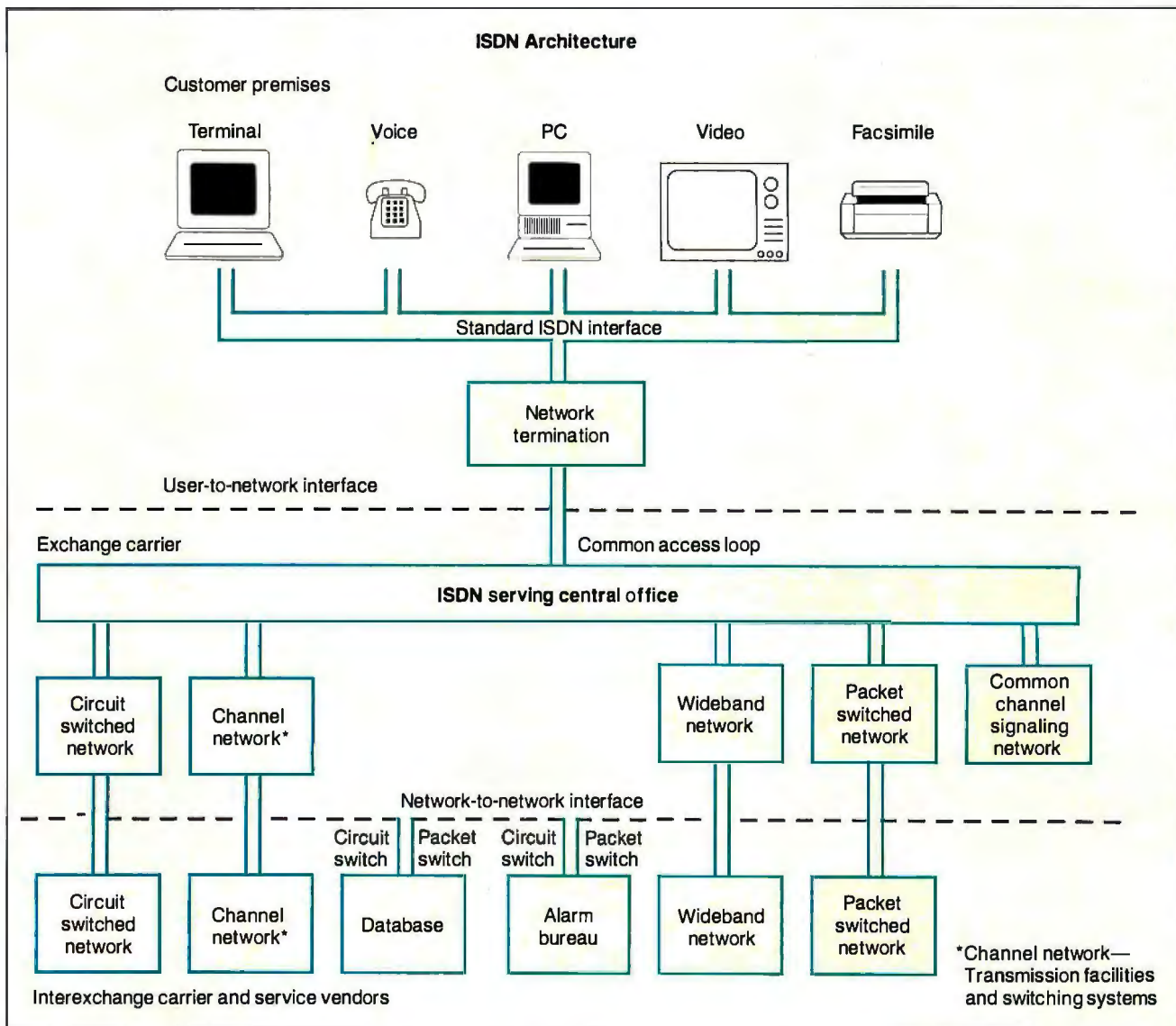

Figure 1: ISDN is an evolving international standard for voice and data communications. Its major features include integrated access of multiple services over a single access line, network transparency via standard customer-to-network and network-to-network interfaces, and end-to-end digital connectivity.

Some interaction can be done with brute force, such as applying voltage to a telephone to make it ring, or interrupting the current loop to send dialing numbers. Modern extensions to this approach, like dialing tones, are more sophisticated and capable, but they still tread upon the bandwidth used for the connection.

ISDN represents a fundamental severing of the ties with Bell's technology. Whereas today's conventional telephone and network services are cost-inefficient and awkwardly configured mixtures of digital and analog technology, ISDN is a completely digital approach. Under ISDN, the telephone is a computer. It sends digital rather than analog information, and it talks interactively with central-office switches that are themselves large, specialized mainframe computers. The difference opens many doors—and creates a few problems as well.

Since ISDN customer equipment can communicate intelligently with the switch, even during a call, it is easier to implement advanced features. Furthermore, features that are cur-

rently implemented only in proprietary ways on private branch exchanges can be provided in standard ways through the telephone companies.

This change in signaling methods has some drawbacks, which will probably be temporary. One is that different manufacturers' ISDN switches now use subtly different signaling methods. As an early ISDN customer, you would have to be aware of what is in the central office and set up your equipment accordingly. This situation will change, but achieving compatibility among products from different manufacturers is always slow and difficult.

Another problem is the huge installed base of "dumb" analog equipment that must be accommodated during the change-over period. Analog telephone sets, for instance, will have to be adapted to ISDN or replaced with ISDN units. Interoperability between ISDN and analog subscribers will also have to be accommodated.

In the new ISDN environment, you will be able to pick and

ISDN to Date

Implementation of ISDN is well under way. Hundreds of millions of dollars have been invested in equipment purchases, research and development, and marketing efforts. The government has given it a vote of confidence by making a smooth migration path to ISDN a requirement for FTS-2000, the new federal telephone system now in the bidding stage. But the odds are slim right now that you'll see workers around your home climbing poles and digging up the street to install ISDN.

For over a year now, all seven regional Bell holding companies (RBHCs) have been conducting ISDN trials through their subsidiaries, the local telephone companies. Only one or two local carriers per RBHC, however, have really gotten involved to this date.

The trials and first implementations so far have generally involved only large companies with considerable telecommunications experience. Southwestern

Bell, for instance, has signed contracts to provide ISDN services to Shell and Tenneco. Illinois Bell is developing a commercial relationship from its ongoing field trial with McDonald's. Lockheed, 3M, and the Lawrence Livermore National Laboratory are among the other companies that have done considerable work with ISDN.

In Atlanta, Georgia, Southern Bell Telephone is offering ISDN as a new class of commercial business service. AT&T, Hayes Microcomputer Products, Contel Corp., Prime Computer, Suntrust Banks, and Digital Equipment Corp. have already begun using the network's services.

Perhaps the most audacious of all early adopters is Boeing. It has just installed the last of five central-office switches of its own as part of a multi-year, \$100 million effort to build a private ISDN system. Boeing's telecommunications needs are so huge and

sophisticated that, in the long run, the company expects to save money with ISDN by building its own ISDN system rather than using the public network.

However, most businesses, followed by residential customers, can expect to wait awhile for ISDN, depending on their proximity to central offices where ISDN-capable equipment is being installed.

As this was being written, AT&T became the first domestic carrier to announce ISDN service supporting the primary rate interface. And Illinois Bell Telephone Company filed a tariff proposing two types of basic rate service. A single circuit-switched voice channel with a signaling-only D channel will carry a one-time installation fee of \$146.50 and a monthly charge of \$16.58 per line. 2B+D service, with circuit-switched data on the other B channel and packet-switched data on the D channel, costs \$246.50 plus \$29.68 a month.

choose the services you want. If, for instance, you are satisfied with your present telephone services, you will be able to use your telephone in exactly the same way after ISDN is installed. In order to take full advantage of ISDN's benefits, though, you will have to learn to live with the new complexity, just as you learned to cope with the esoteric features and moon-mission control panels of today's audio and video equipment.

Two Types of Services

ISDN services will be provided to customers in two classes: the basic rate interface and the primary rate interface. The basic rate is referred to as 2B+D and consists of two 64K-bits-per-second (Kbps) B channels that can carry either voice or data, and one 16-Kbps D channel used for network signaling and control, and user packet data. An additional 48Kbps is also used for other purposes, such as echoing the D channel, synchronizing the terminal units, and conveying other internal network information.

In North America, the primary rate is referred to as 23B+D. It consists of 23 64-Kbps B channels and one 64-Kbps D channel. Primary rate will support 1.544-megabyte-per-second (Mbps) bidirectional transmission rates. It could be used, for example, to interconnect computing facilities and to connect private branch exchanges (PBXes) to the network rather than to directly serve residential end users.

Basic rate access can include various combinations of circuit-switched voice, packet-switched data, and circuit-switched data. The difference between circuit switching and packet switching lies in the way the data is routed through the network. Circuit-switching technology is the closest thing to a traditional telephone connection; it can be compared to a pair of wires dedicated to a particular connection for the duration of the call. In packet switching, data bits are grouped into packets with origin

address, destination address, and error-control information. The packets are routed to their destinations through networks of packet switches at the central offices and elsewhere, taking whatever paths the intelligent network considers best at the time.

Packet switching has several advantages for data transmission. The individually addressed packets can be intermingled; packet switching is more akin to a conveyor belt in the post office than to a conventional telephone connection. Like time-sharing on a large computer or the multiplexing of several terminals onto one communication line, it keeps high-capacity facilities from sitting idle between sporadic bursts of usage.

Packet switching has other advantages as well. With appropriate equipment, the user can maintain multiple simultaneous connections over a single channel. Packet switching also opens the door for services such as remote meter reading, polled security monitoring, and wide-area versions of local area networks (LANs).

Traditionally, circuit switching and packet switching have used different equipment, and in fact have reflected opposing philosophies. ISDN will be the first widely available network to integrate them.

An ISDN switch can also provide supplementary voice services such as call forwarding, conference calling, and hold—all the services now available on office telephones—plus a few more that are not currently feasible, such as prescreening and selective answering. It can provide these services without modification of the twisted-pair wiring scheme used in today's phone service.

This seems like a trivial issue, but it is tremendously important. A substantial fraction of the world's copper production has gone into "last mile" telephone circuits, and the labor costs of

continued

What a Tangled Web We've Woven...

While drafting the ISDN specifications, the CCITT defined five interfaces—R, S, T, U, and V—that are access points into the network (see figure A).

The R interface is an access point for existing, non-ISDN equipment (a TE2 in the CCITT specification), such as an analog telephone or an RS-232C port, which requires terminal adapters to tie into the network. While the other interfaces are associated with ISDN standards and are ISDN-specific, the R interface implements whatever standards are required for a particular piece of customer equipment. For example, the

analog telephone and RS-232C port, which differ greatly in physical, electrical, and logical needs, both meet the network at the R interface.

The S interface connects the ISDN-compatible equipment and the computer side of the network termination (an NT2, such as a PBX or a LAN). The T interface is where the premise-based ISDN switching equipment connects to the carrier's side of the network termination (NT1). The U interface is the connection between the customer premises and the central office equipment, while the V interface connects the central office to the rest of the network.

Both the S and T interfaces use two twisted pairs of wire, for a total of four wires. The T interface uses one pair for transmit and one for receive, to provide full-duplex operation, and it has the capacity to operate at the primary rate.

At the U interface, the use of echo-cancellation techniques permits full-duplex operation over a single twisted pair. It operates at the basic rate. This interface has a greater range (2500 to 6500 meters versus 1000 meters for the S and T interfaces) and doesn't need that extra pair of wires. It allows the existing local loop—a single pair—to be used all the way from the central office to the user.

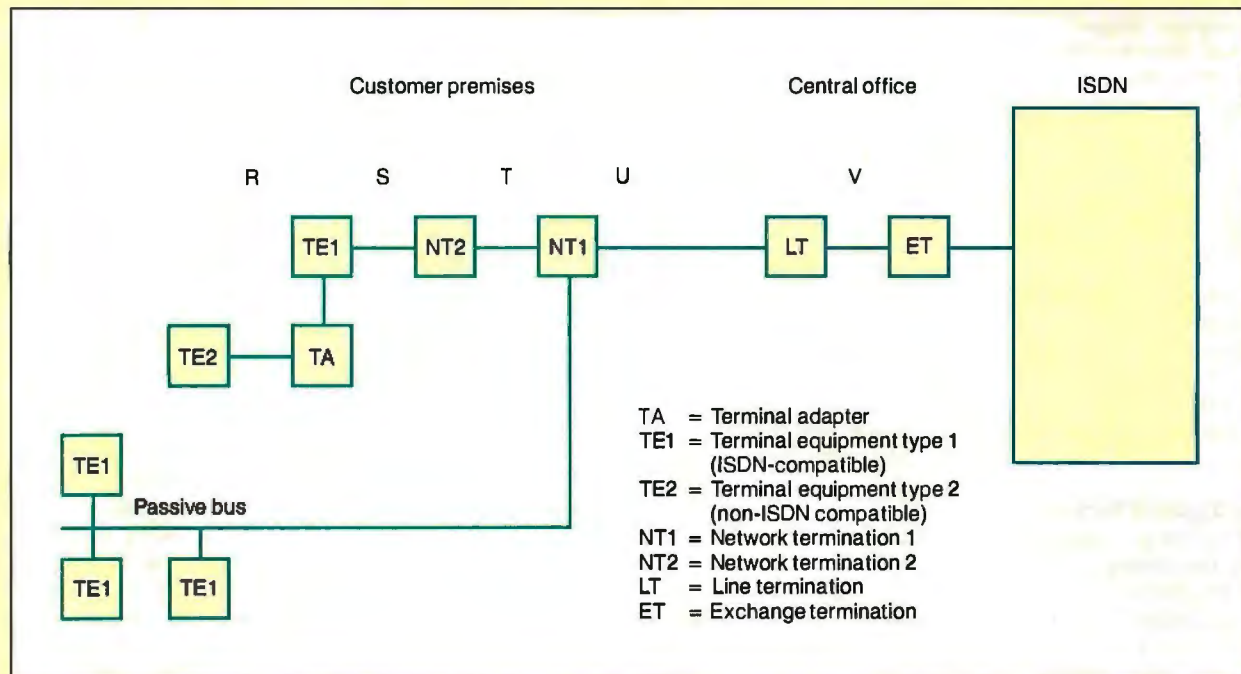

Figure A: The CCITT, a communications governing body of the United Nations, has designated five ISDN reference points: R, S, T, U, and V. These are places in the network where one or more interfaces for specific functions will occur.

replacing it would dwarf the material costs. Despite the best-laid plans of supporters of fiber optics, it is axiomatic that the next generation of the telephone system, whatever its other characteristics, has to work over twisted-pair wiring already in place.

ISDN and Computing

Most of ISDN's impact on the public will come from voice service, which, after all, is the main business of the telephone companies. But ISDN integrates voice and high-speed data. For the first time, data will stand beside voice as an equal partner in the public telephone network.

Establishing data connections over ISDN from a personal

computer can be accomplished with the addition of a terminal adapter (TA). A TA is like a modem in one way: It allows the computer to talk over the telephone network. But the similarity ends there.

TAs are being designed so that existing terminal-emulation programs can work with them after little or no modification. (Generally speaking, TAs and other ISDN equipment will isolate the user from the complexities of dealing directly with ISDN.) But taking full advantage of ISDN's capabilities will call for special software that is just beginning to appear.

Take the wide-area network, or "metroLAN," for instance. When you think of a LAN, you probably think of high performance, great complexity, and someone standing on a ladder in

your office to run coaxial cable through the ceiling. The high-speed packet-switching capability of ISDN makes it feasible to build a LAN that runs over switched connections through the public telephone system.

Such a LAN can interconnect users across the street or across the continent. It doesn't need dedicated cables and adapter cards—just the existing telephone wiring, plus ISDN terminal adapters and software. And you can reconfigure the network without having to call in someone with a ladder.

Multiple simultaneous connections, each fast enough to accomplish something useful, will also become feasible under ISDN. With a personal computer running a multitasking (or at least multiwindowed) operating system, you will be able to exchange information with different parties simultaneously. What's more, you will be able to do so without sacrificing voice quality or capabilities.

Some computers that include ISDN interfaces and features are already on the market; they are often called "integrated voice/data terminals." That term, though, is also used for telephones with small displays, such as a receptionist might use.

One of the major issues of the transition years, a special case of the analog-interoperability problem, will be connecting ISDN-equipped computers to other computers that have modems. This could be done either through centralized modem pools or by digitizing the modem signal at the modem and sending it over a B channel as circuit-switched data.

The Holdup

One obstacle in the adoption of ISDN comes from the financial rather than the technical side. Converting to digital technology is expensive, and the telephone companies, operating under heavy regulation, will have to get their money back somehow.

For the first several years, they will probably get it from business users. Residential users could provide a great deal of revenue, but at present, they don't have much use for ISDN. It has been proven time and again that the celebrated Man in the Street wants nothing more than analog voice (known to the trade as Plain Old Telephone Service, or POTS), and at the lowest possible tariffs.

Should the phone companies force this new, expensive, and perhaps intimidating technology upon residential customers who already have adequate phone service? Or should they resign themselves to a long, long transition period of providing both analog POTS and ISDN while private individuals figure out what to do with their connectivity?

Thus far, ISDN has been used in familiar ways: as a more capable phone and as a faster modem. Only time will reveal the effects of having 144 Kbps of communications power in every home and office. ISDN could be revolutionary, changing the way we live and work. Then again, it could be evolutionary, merely updating the telephone without changing the familiar uses and social rituals surrounding it.

In either case, ISDN will be the hidden engine behind the changes. The changes themselves will come through applications. And therein lies the quandary and the opportunity.

The Pull Forward

In marketing parlance, the telephone companies and equipment manufacturers are pushing ISDN, but, so far, only a few venturesome companies are pulling it with demand. In a classic chicken-or-egg problem, the demand will presumably be increased by applications, but the applications won't arrive until there is a market.

Here's a look at a few of the possible applications that could

continued

PROGRAMMERS FOR IBM PC/XT/AT



- Select Device with vender name & type number directly
 - Enable user to set up Program Pulse Width, Vpp, Vcc, Over-program Pulse Width & Iteration Counts.
 - Capable of set & 8/16/32-bits wide—word programming
- | | | |
|----------|---|-------|
| XP6000A | Adapter & cable installs in PC for connecting programmer externally | \$55 |
| XP6001 | 1-socket 1M-bits EPROMs programmer | \$160 |
| XP6002 | 8-socket 1M-bits EPROMs programmer | \$375 |
| XP6003 | 1-socket MCS-48 micros programmer | \$215 |
| XP6004 | 1-socket MCS-51 micros programmer | \$270 |
| XP6014 | 4-sockets 1M-bits EPROM programmer | \$260 |
| AT-101/A | EPROM Eraser erases 30 24-pin ICs with timer | \$195 |

2 YEARS WARRANTY + 30 DAYS MONEY BACK WARRANTY



Xender

Xender Corporation

2824 KENNEDY BLVD. FL. JERSEY CITY, NJ 07310

TEL: 201-659-8291 TX: 910 240 4444 CHAMPION

Fax: 201-864-9737

Circle 310 on Reader Service Card

Quelo™ 68000 Software Development Tools

Since 1983 professional quality tools for the entire 68xxx family including the 68030. Hosts: MS-DOS, UNIX and VAX.

C Compiler
C Source Level Debugger
Macro Assembler Package
Disassembler
Simulator

AVOCET
Systems, Inc®

Toll free: 800/627-6073
FAX: 207/236-6713
Telex: 467210 AVOCET CI

Circle 301 on Reader Service Card

TurboFlow \$39.95

Flowchart drawing for IBM PC/XT/AT

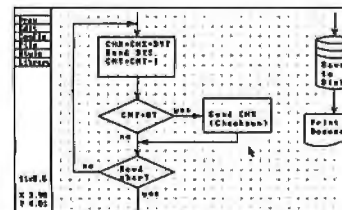

- Curves, ellipses
- User defined library
- Pop-up menus
- Automatic PANning to scan drawing quickly
- Hercules monochrome, CGA, EGA
- IBM/EPSON, NEC, OKIDATA, HP LaserJet
- HP-GL, DM/PL, SweetP plotters
- Any size symbols
- Paper size to 34" x 44"
- WYSIWYG

Daytron Electronics
Add s&h (\$4 USA, \$20 foreign) 610 S. Sherman, #104
Texas residents add 8% sales tax Richardson, TX 75081

CALL 1-214-669-2137

Circle 312 on Reader Service Card

pull ISDN and some of the obstacles that it would face (see figure 2).

- **Telemetry.** If ISDN were ubiquitous, utility companies could install smart meters and read them remotely. But this would not happen overnight. The hundreds of millions of existing meters have no intelligence or communications capabilities.
- **Networking.** We've already mentioned wide-area networks—LANs that use the phone lines to connect to other, more distant environments. They are much less trouble than traditional hard-wired LANs, but there are disadvantages. For one thing, your connectivity habit shows up on the phone bill each month. Furthermore, they have comparatively low performance. The slowest traditional LANs run at about 4 times the speed of a B channel, and many users have become spoiled by the now-commonplace 10-Mbps LANs, such as Ethernet.

Although its performance may not be adequate for every

need, an ISDN LAN would probably serve most users quite well. However, the argument is not entirely technical. Analyzing throughput needs and spotting performance bottlenecks is not nearly as difficult as changing customers' perceptions. Only time will tell if the real price/performance characteristics of these networks can overcome their poky image.

The ISDN wide-area network might also catch on as a personal convenience. Nearly everybody who uses E-mail at work comes to love it, so how about a standard, public, nationwide E-mail system? The catch here is obvious: Although embedded processors are in everything from TVs to thermostats, the computer, per se, has not entered the personal lives of many people. Since home computing has not emerged as a force strong enough to push ISDN, perhaps ISDN will pull home computing.

- **Video.** Even that old science-fiction standby, the videophone, could be born anew. AT&T showed a videophone at the 1964

continued

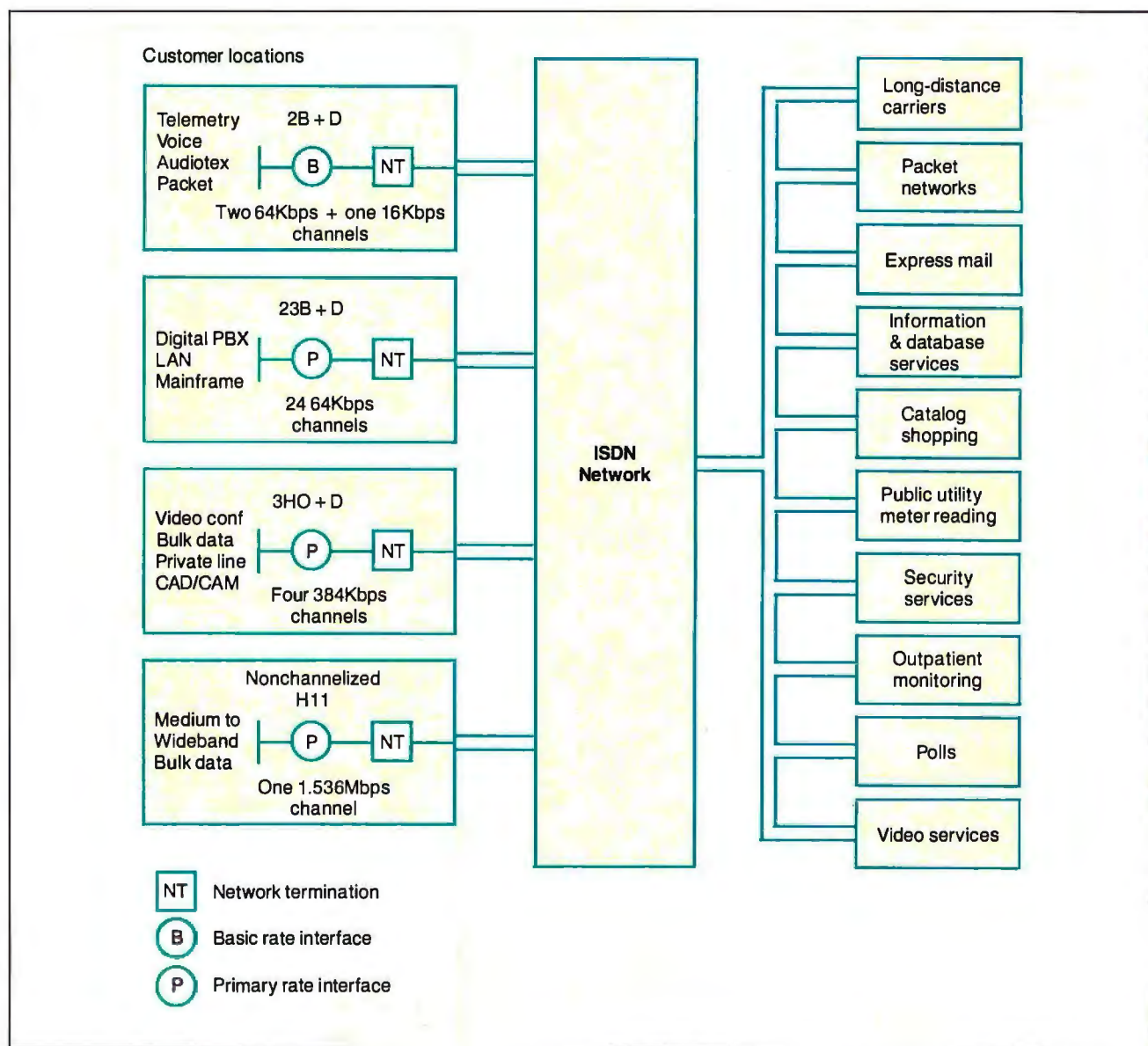

Figure 2: Many services will be available over ISDN's basic and primary rate interfaces when the technology is fully employed. Some of the potential applications are shown here.

**Mitsubishi's diskettes reign supreme in any market,
for they are the very best available!**



Wonders have been created in the field of magnetic recording

A newly developed 3.5-inch high-density micro floppy disks to satisfy every business' most demanding needs. The MF-2HD by Mitsubishi is highly durable and equipped with a three-dimensional binder system. Furthermore, the new disk supporting structure enhances head-to-disk contact no end. It is compact but possesses outstanding features. The double sided disk allow amazing memory capacity of 2 mega-bytes and has an automatic shutter, a hard shell, a thin coating, a slide-on write protect tab and top-level reliability guaranteed to be 100 percent error-free. This is yet another breakthrough in the already advanced field of diskette technology.



 **Mitsubishi Kasei Corporation**
(Formerly "Mitsubishi Chemical Industries Limited.")

Information Storage Products Division
Head Office: 5-2, Marunouchi 2-chome, Chiyoda-ku, Tokyo, 100 Japan Tel: (03) 283-6978 Telex: BISICH J 24901 Telefax: (03) 286-0093

 **Mitsubishi Kasei America Inc.**
(Formerly "Mitsubishi Chemical Industries America Inc.")

Head Office: 81 Main Street (Suite 401) White Plains, NY 10601 Tel: 914-761-9450 Telex: 233570 MCI UR Telefax: 914-681-0760

Circle 174 on Reader Service Card

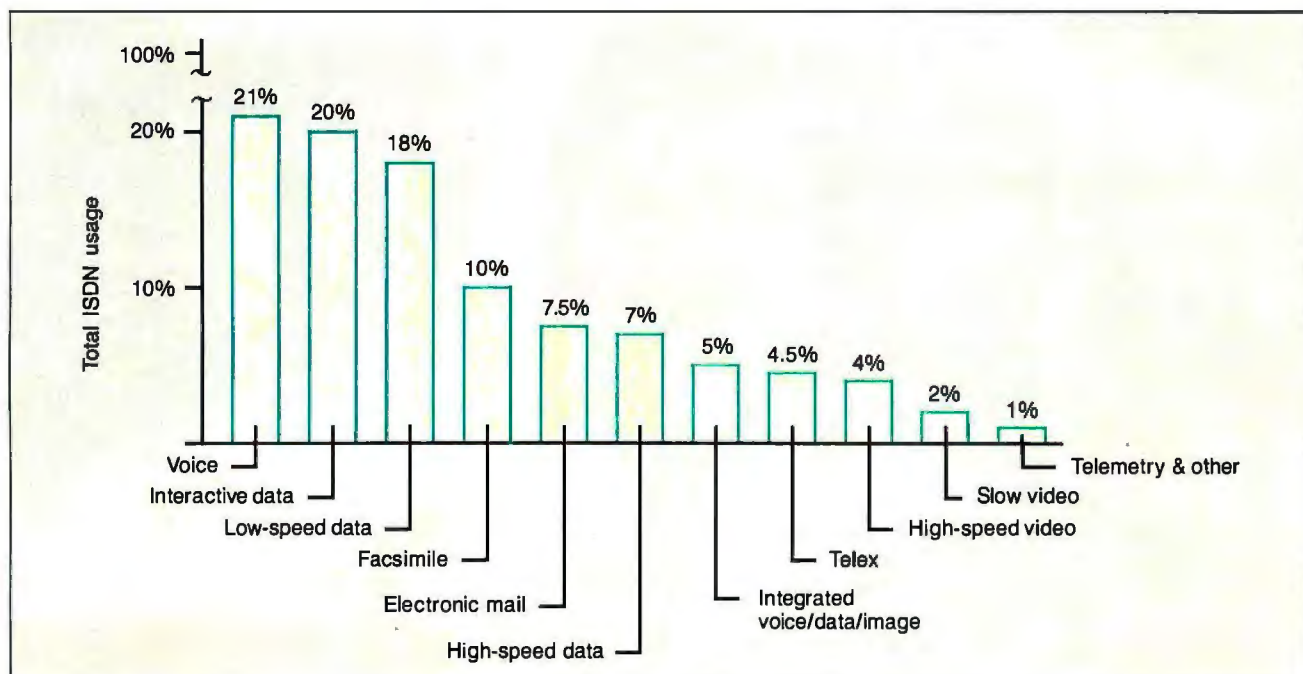

Figure 3: When ISDN is fully implemented, its largest usage will be for voice, interactive data, and low-speed data. As an emerging technology, however, ISDN may take off in directions unpredicted at this stage of the game.

World's Fair, but the technology and economics of the day would not support its commercial adoption. Granted, a 64-Kbps channel will not provide broadcast-quality television images, but it can transmit real-time video with acceptable resolution. Imagine working at home and "sitting in" on a meeting at the office, or showing a document and your honest, trustworthy face to a bank's customer-service representative. Or even sending live images of a heart attack victim to paramedics while they simultaneously transmit a videodisk refresher course on cardiopulmonary resuscitation to you.

But will videophones or nationwide E-mail networks ever really catch on? It depends on ISDN, but ISDN depends to some extent on whether applications become popular.

ISDN is an "enabling technology." Think of it as a highway that enables new cities to spring up. It is more than just a new switch or even a new network; it is a potential revolutionary force for the role of technology in society.

But the revolution requires demand as well as capacity. Fast new chips don't sell personal computers. The ability to process words, calculate finances, keep databases, and so forth sells personal computers. And as others have pointed out, no one foresaw word processing when computers were invented.

Technology for technology's sake is almost never a success. The right applications may not be invented until after ISDN has been around awhile, but the conversion to ISDN will be slow and piecemeal until the applications come about.

This situation leads to much ulceration in the telephone service and equipment businesses. The developing ISDN technology is well on the way to being implemented. Strategic commitments, the momentum of vast equipment purchases, and ever-increasing demands on the network will see that it continues. But fortunes will be made and lost over the details.

ISDN equipment and services will reach businesses first, and then probably residential users in islands of high-tech connectivity, such as new construction, and neighborhoods that are

near facilities being upgraded to serve businesses. While not exactly egalitarian, this approach makes economic sense.

A Taste of the Future?

Though the implementation of ISDN has just begun in earnest, standards committees have begun talking about its successor. A technology known as broadband ISDN will eventually provide individual subscribers with performance in the megabit range—enough for television-grade video and high-performance LANs. Adoption of a broadband ISDN could take place at the beginning of the next century. ISDN might suffice for many years; then again, it might merely whet customers' appetites.

Ben Bova once wrote an essay comparing the Douglas DC-2 with its successor, the DC-3. The DC-3 made air travel safe, reliable, and, above all, profitable. The DC-2 did not have the necessary capabilities, but it gave Douglas Aircraft the technical expertise needed to develop the DC-3. It also gave the fledgling airlines an idea of what the next generation of equipment could do. The DC-2 was an enabling technology.

In all likelihood, the capabilities of the ISDN basic-rate interface will be an embarrassment of riches to residential users. But not long ago, you could have said that about a microcomputer with 64K bytes of memory. If it turns out that what the world wants is packet-switched voice or high-resolution video, ISDN will be a DC-2: merely a tantalizing taste of the future.

Neither regular nor broadband ISDN will take off just because the technology is there. Technology vendors have seen the future, and, much to the chagrin of their planning departments, it consists of yet-unforeseen applications. ISDN is coming, but what shape it arrives in remains to be seen. ■

Jay Duncanson is the ISDN department manager, and Joe Chew a staff information developer, at the San Francisco office of Hayes Microcomputer Products Inc. They can be reached on BIX as "editors." The views expressed in this article are their own and not necessarily those of HMP.

In the engineering business...

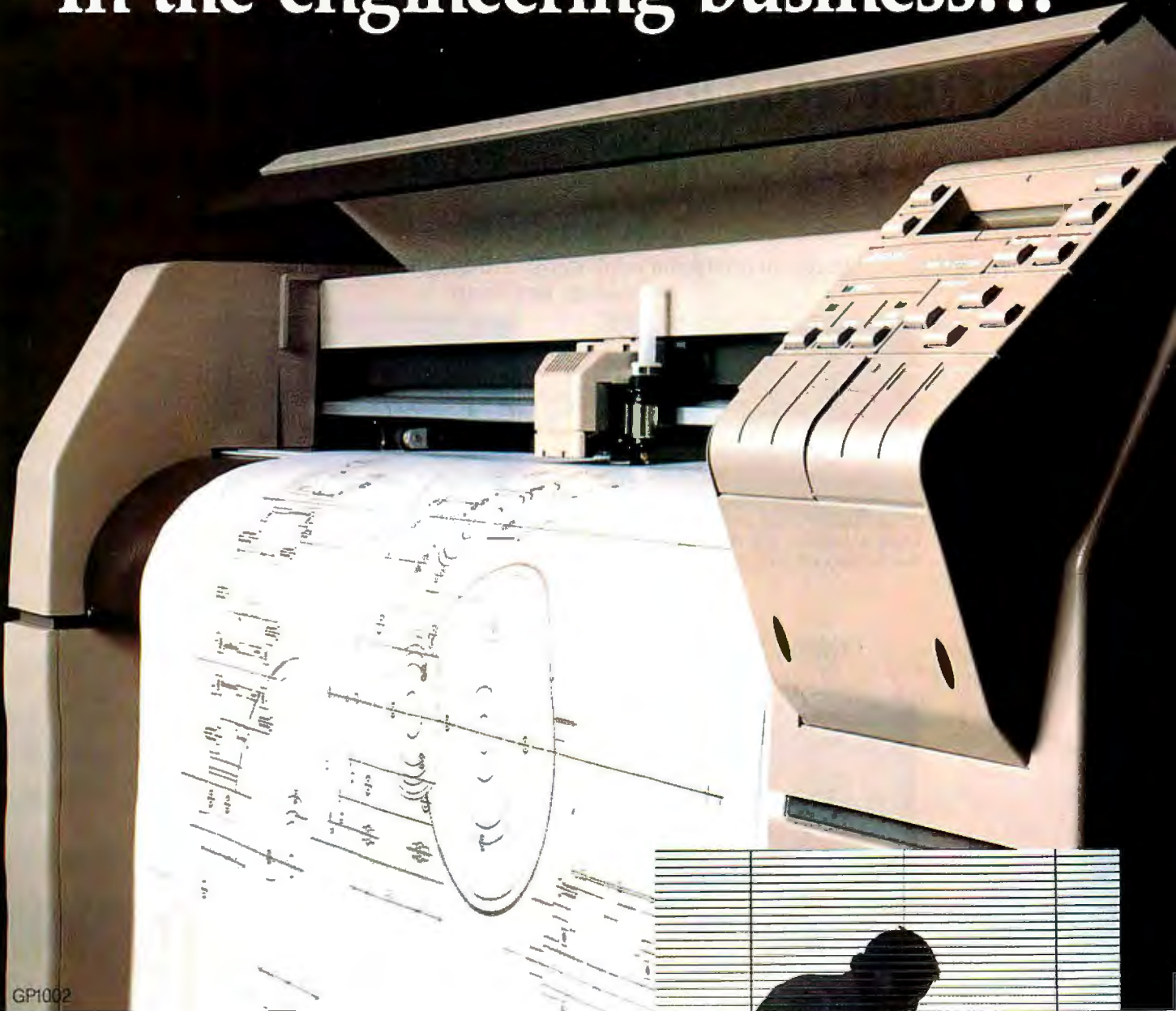

People use a Graphtec.

Engineers who are serious about their work understand the importance of quality and accuracy. That's why they choose Graphtec's new A0-sized GP1002 and A1-sized GP1102. Features that make these large-format plotters so popular include: an 80 cm/s pen speed, vector optimization, 0.005 mm mechanical resolution, HP-GL™ emulation and GP-GL™ command sets, and a long list of automatic functions.

Get serious about your work, get a Graphtec.

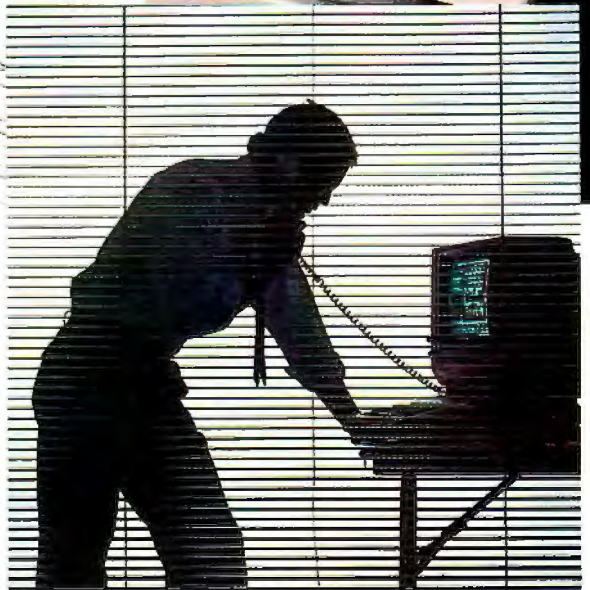

Recording the past... Plotting the future



GRAPHTEC CORPORATION
Mita 43rd Mori Bldg., 13-16, Mita 3-chome,
Minato-ku, Tokyo 108, Japan
Tel: (03) 453-0511 Telex: 02422687 (GRAPH-J)

U.S.A.: Western Graphtec Inc.
11 Vanderbilt, Irvine, Calif. 92718-2067, U.S.A.
Tel: Inside Calif. (800) 624-8396, (714) 770-6010
Outside Calif. (800) 854-8385

Europe: Graphtec Europe GmbH
Borsteler Chaussee 85-99A 2000 Hamburg 61,
West Germany
Tel: (040) 511-5059 Telex: 2165630 (GTEC D)

United Kingdom: Graphtec (UK) Ltd.
Environ House, Welshman's Lane, Nantwich,
Cheshire CW5 6AB, England
Tel: (0270) 625-115 Fax: (0270) 626-733

Circle 110 on Reader Service Card

JULY 1988 • BYTE 287

We've Invented the Future of Instrumentation Software . . . Twice.

With Words

With Pictures

Acquisition

Integrated libraries for GPIB, RS-232, A/D-D/A-DIO plug-in cards, and modular instruments.

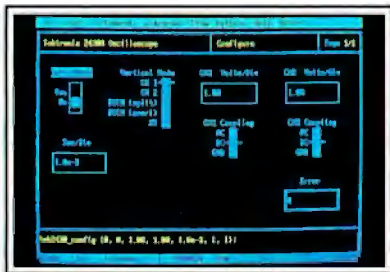

Intuitive character-based function panels that automatically generate source code.

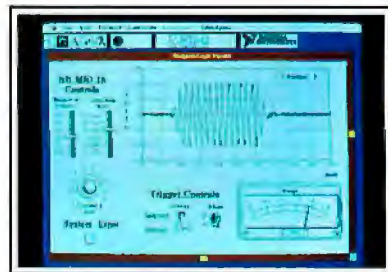

Front panel user interface with virtual instrument block diagram programming.

Analysis

Extensive libraries for data reduction, digital signal processing, and statistical analysis.

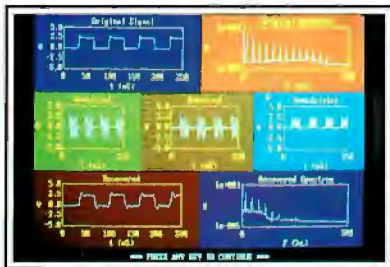

Over 100 analysis functions plus all the built-in functions of your language.

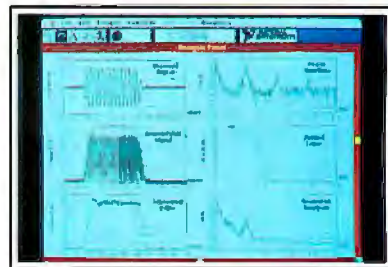

Over 250 icons for computation and analysis.

Presentation

Flexible high-performance graphics and report generation.

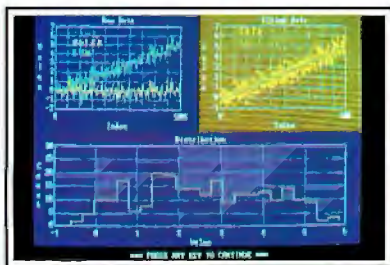

Extensive graphics support for CGA, EGA, MCGA, VGA, and Hercules.

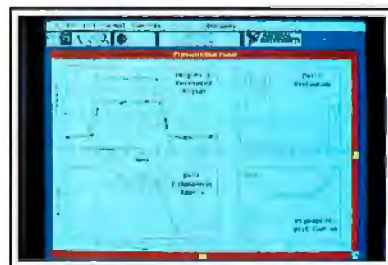

Macintosh Desktop Publishing compatibility.

The Software is the Instrument

LabWindows™
for the DOS-based PC and PS/2,
with Microsoft QuickBASIC or C.



12109 Technology Boulevard
Austin, Texas 78727-6204
800/531-4742 512/250-9119

LabVIEW®
for the Apple Macintosh

SAVE \$19



487TSU-6

Subscribe to BYTE now and save \$19 off the newsstand price — 12 issues for \$22.95 instead of \$42.00! You'll also receive our special IBM PC issue as part of your subscription.

USA \$22.95/1 year Canada \$25.95 U.S./1 year

Bill me

Payment enclosed

Charge to my VISA MasterCard

Account # _____

Expires _____

Signature _____

This is a renewal order.

Name _____
(Please Print)

Company _____

Address _____

City/State _____

Country _____ Code _____

For direct ordering, call toll free 1 800 423-8272 weekdays 9 AM—5 PM EST. In New Jersey, call 1 800 367-0218.

Please allow 6-8 weeks for processing your subscription.



SAVE \$19



487TSU-6

Subscribe to BYTE now and save \$19 off the newsstand price — 12 issues for \$22.95 instead of \$42.00! You'll also receive our special IBM PC issue as part of your subscription.

USA \$22.95/1 year Canada \$25.95 U.S./1 year

Bill me

Payment enclosed

Charge to my VISA MasterCard

Account # _____

Expires _____

Signature _____

This is a renewal order.

Name _____
(Please Print)

Company _____

Address _____

City/State _____

Country _____ Code _____

For direct ordering, call toll free 1 800 423-8272 weekdays 9 AM—5 PM EST. In New Jersey, call 1 800 367-0218.

Please allow 6-8 weeks for processing your subscription.





NO POSTAGE
NECESSARY
IF MAILED
IN THE
UNITED STATES

BUSINESS REPLY MAIL
FIRST CLASS MAIL PERMIT NO. 684 TEANECK, NJ

POSTAGE WILL BE PAID BY ADDRESSEE

BYTE

Subscription Dept.
P.O. Box 7640
Teaneck, NJ 07666-9866

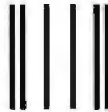
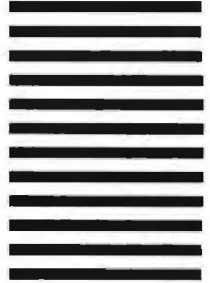

NO POSTAGE
NECESSARY
IF MAILED
IN THE
UNITED STATES

BUSINESS REPLY MAIL
FIRST CLASS MAIL PERMIT NO. 684 TEANECK, NJ

POSTAGE WILL BE PAID BY ADDRESSEE

BYTE

Subscription Dept.
P.O. Box 7640
Teaneck, NJ 07666-9866

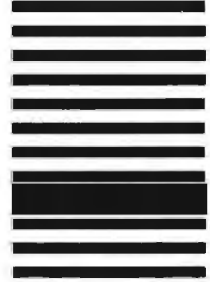

Part 2

COMPUTERS ON THE BRAIN

Making sense out of the data

by Steve Ciarcia



ast month, I introduced you to the Circuit Cellar electroencephalogram (EEG) monitor called HAL (Hemispheric Activation Level Detector) and discussed its hardware design. This month, I'll look at the system software and provide some directions for HAL's use.

Software Overview

The overall operation of HAL is relatively straightforward. It samples four channels of analog brain-wave data 64 times per second and transmits this data serially to a host computer. The host analyzes two channels of the data to determine frequency components, and it then displays the results on a monitor as a series of continuously changing bar charts.

As I mentioned last month, the frequency range of interest in brain-wave detection is 4 Hz to 20 Hz, which includes alpha, beta, and theta waves. I could have designed HAL with many independent band-pass filters to separate each channel's complex waveform into discrete sinusoidal components, but that would have involved much more hardware. Instead, HAL's raw digitized analog data is analyzed on the host computer using a fast Fourier transform (FFT).

An FFT is like a mathematical prism. Just as a prism breaks down light into its component colors, the FFT breaks down a waveform into the sinusoidal components that make up the signal. In this way, I can extract amplitude and phase values for any given frequency in the target spectrum of 4 Hz to 16 Hz (I didn't display frequencies from 16 Hz to 20 Hz because of speed constraints on the IBM PC).

The system software coordinates four major tasks, which are graphically outlined in figure 1. The Intel 8031 microcontroller's task is precise sampling of hemispherical data and transmission via an optocoupled RS-232C link to the host IBM PC (the 8031 firmware is called BIO31). An IBM PC task called COMMO is an interrupt-driven communications routine that receives HAL's incoming data. Being interrupt-driven, COMMO operates independently of the activities of the FFT analy-

sis-and-display routine (and any other tasks that happen to be running on the IBM PC).

As the data comes in, the host loads it into 1024-byte sample queues for left brain and right brain data. The FFT algorithm reads this incoming data, calculates amplitude and phase values per frequency, and updates integer arrays. Finally, the BIO program reads these arrays to continually update the bar graphs on the video display.

Simple—right? Just like using a hammer to make gravel out of a boulder. Simple in theory, at least.

While HAL is technically independent of the host computer (by virtue of its serial interface), I chose to present the demonstration display on an IBM PC for the sake of convenience. (I invite conversion to other computers and will make such conversions available through the Circuit Cellar bulletin board system.)

Because HAL is supposed to be both an educational and a functional presentation, my fundamental goal for the software was to keep it simple and fast. To that end, I used BASIC wherever possible. However, to maintain processing speed, I incorporated certain assembly language routines that are called from BASIC (i.e., the QuickBASIC compiler).

Refer again to figure 1, the overview block diagram of the system. The COMMO and FFT routines are written in assembly language. COMMO is really a group of subroutines; BASIC merely calls the initialization code.

I wrote the FFT block in assembly language for maximum speed in the FFT calculations. Using a BASIC program, a 64-point FFT took about 20 seconds to do. The existing FFT algorithm in assembly language will calculate 64-point transforms for both channels in about 240 milliseconds (ms). More about this later.

HAL's Brain

The 8031 is a remarkably capable processor that I have been using for many stand-alone projects lately. I described the inner

continued

workings of BIO31 last month with the hardware description, since BIO31 works so closely with the hardware. Basically, BIO31 is a simple read-transmit-wait loop (see figure 2). The read portion of the loop samples the switches and the A/D converter. It then places this information in the output buffer and transmits it out the serial port at 4800 bits per second (bps) to the host computer. The transmission is a 5-byte sequential string: switch position/sync, channel 1, channel 2, channel 3, and channel 4.

Once transmission is completed, the program waits for the 8031's internal timer to time out. Since proper sampling of a

continuous waveform requires sampling at a fixed rate, this precise time delay is what provides the host program with data samples that the FFT can successfully analyze.

The IBM PC Communications Interface

The IBM PC's COM1 port is configured as the headset interface port. Recall that the data coming from HAL arrives at 4800 bps in packets of 5 bytes, transmitted 64 times a second. The first byte indicates HAL's switch configuration, and the host computer uses this byte for synchronization purposes.

A switch position/sync byte value of 00000011 binary indicates that both the left and right switches are closed; a value of 00000000 indicates they are both open. The maximum value the switch position/sync byte can have is 3. BIO31, as one of its functions, tests all outgoing data and limits the lowest A/D channel data to a value of 4. Since any incoming data with a value of 3 or less must therefore be the switch position/sync byte, it is possible for COMMO to synchronize easily with the incoming data stream.

COMMO's service routine uses a state machine to synchronize itself with the incoming data (see figure 3). It reads the data byte from the Data Receive register and stores it according to which state the routine is in. If state equals 0, it saves the switch bits and advances to the next state. If state equals 1, it loads the sample data into the left brain sample queue. If state equals 2, it loads the sample data into the right brain sample queue. If a value of 3 or less is encountered, the state will automatically change to 0, and it will save the data as switch parameters.

The Software Prism

After the computer receives HAL's data, the FFT takes over, transforming the collected information into something useful. In this application, I wanted to see what frequencies are active in whatever brain is connected to the EEG and how powerful those frequencies are.

My first impression of the FFT was stated earlier: a mathematical prism. I've read articles that have used the FFT on everything from spectral analysis and digital filtering to biorhythms and random numbers. But what does the FFT do here?

Consider figure 4. The four sine waves on the bottom represent energy levels at four different frequencies plotted with respect to time. The vertical bars represent a 1-second sample window. (The 64 dots on each graph between the two vertical lines represent $\frac{1}{64}$ -second intervals.) The top squiggle is an integrated waveform, the sum of the four waveforms below it at any given point in time.

This integrated waveform is similar to what we find in the real world. I used values generated from this integrated waveform to test HAL's software. The results of the FFT on this waveform appear on the screen shown in photo 1. The bars are read side to side, with their respective frequencies labeled in the middle. Energy levels are defined both above and below the bar charts. Notice that I applied the same test data to both the left brain and right brain sample queues. I will discuss the display in greater detail later.

There is a little more to structuring an FFT than just using an algorithm out of a book. Without getting into any mathematical formulas, I will explain the impact of modifying FFT parameters. The text box "Understanding the Fast Fourier Transform" on page 292 explains the FFT, using a version written in BASIC. The initial lines of code are configuration data, and only the last 11 lines perform the actual transform on the data in the array RAWDATA.

You must address three major factors when building a simple FFT algorithm: the duration of the sample window, the sample

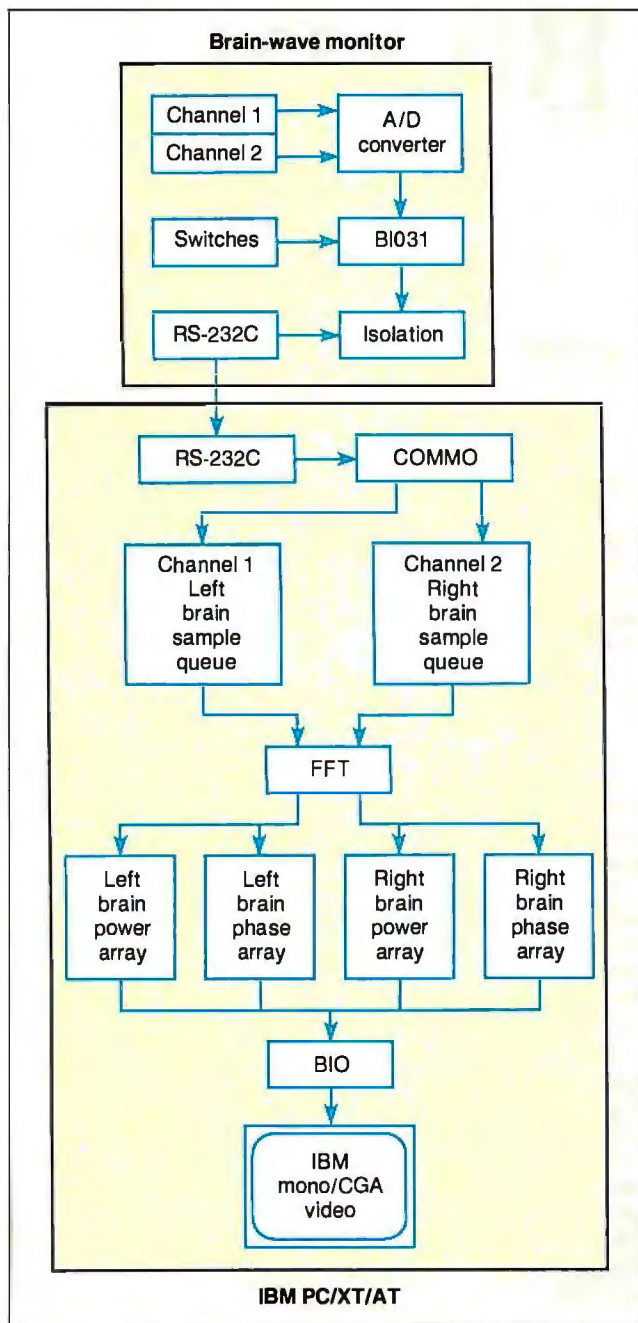

Figure 1: A block diagram of the complete HAL system, showing major components of the brain-wave monitor and the host machine.

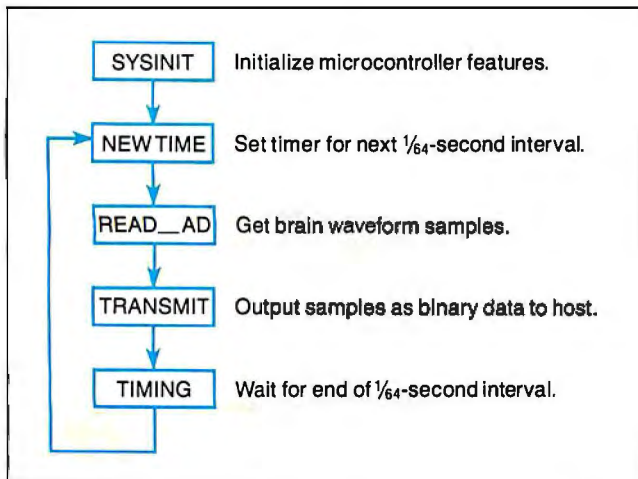

Figure 2: A flowchart for HAL's firmware program, BIO31.

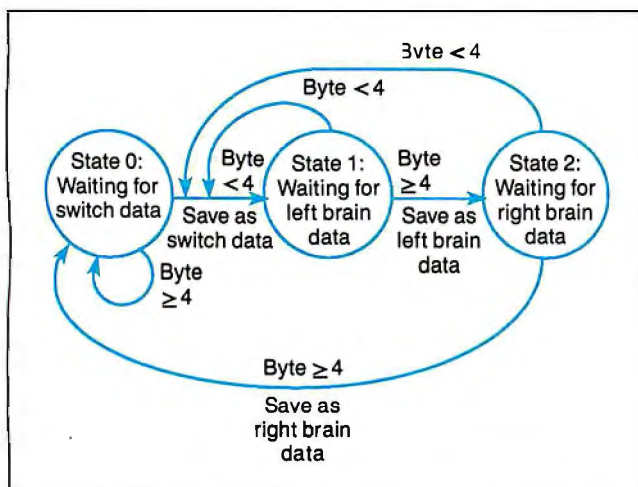

Figure 3: The host computer's receiver routine executes a finite-state machine, shown here graphically. Each circular node of the graph represents a state, and transitions from state to state occur when the system receives a byte.

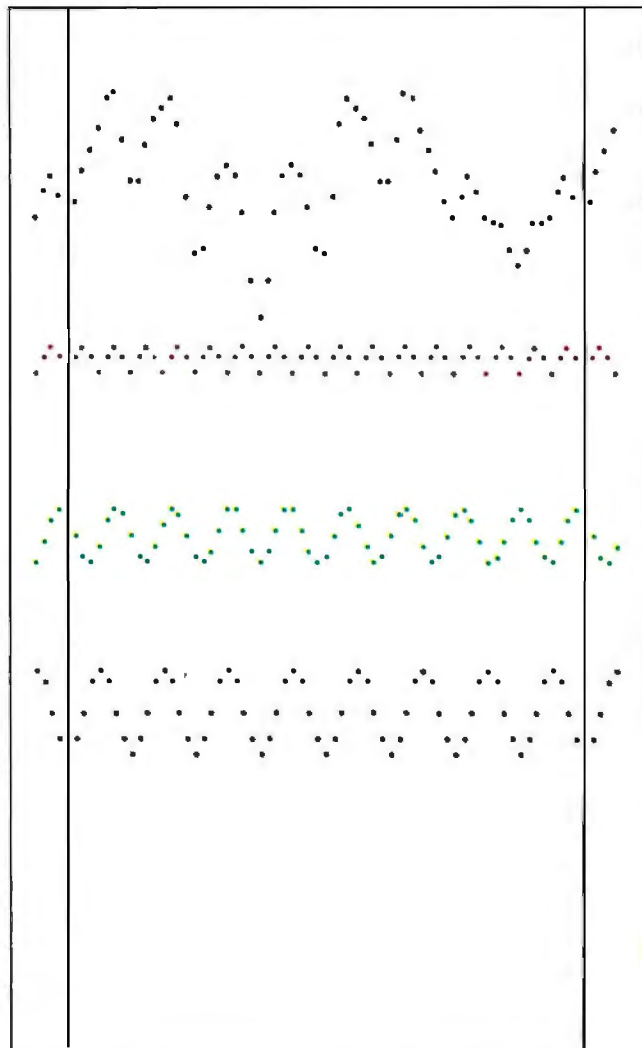

Figure 4: If you add together the lower four sine waves, you get the topmost, random-looking waveform. The FFT does just the reverse: It takes the composite waveform and extracts its components.

rate, and the actual frequencies desired for output. These factors are identified as:

- WDW: The sample window in seconds.
- PT: The number of samples to be taken in the sample window.
- MIN and MAX: Lowest and highest frequencies to be evaluated.

The FREQ array represents the sinusoidal frequencies to be integrated into the waveform I talked about earlier, A represents the peak amplitude of these sine waves, and P serves to introduce a phase offset in a given channel. The variable SM specifies the starting offset of the points of data to be analyzed by the FFT. Graphically, SM locates the vertical bars on the display seen in figure 5.

Faster FFT

Speed was a key issue in this project. For a visual display to be of any value to a user, the software has to analyze and display the brain-wave data as quickly as possible. Ideally, you should

continued

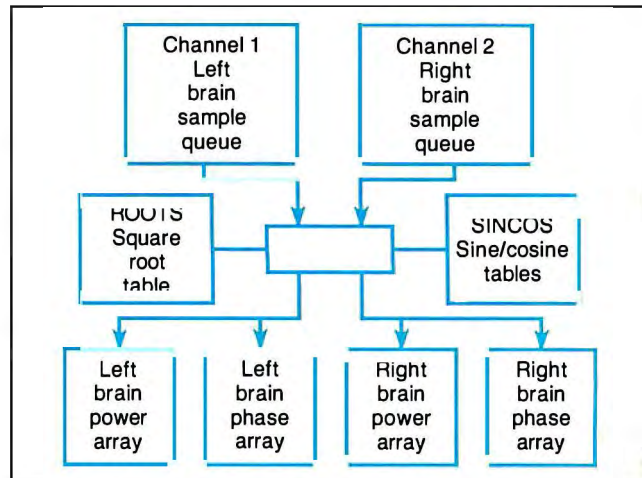

Figure 5: Main components of the FFT.

Understanding the Fast Fourier Transform

Listing A is a heavily commented code fragment in BASIC that performs the FFT on an array of data points (RAWDATA). The following are important program variables and their usage in the program.

WDW, the sample window: The time period over which the sample is taken will affect the resolution you can expect in your output. A period of 1 second will yield 1-Hz intervals of frequency. This is the way the program is set up now. If you reduce the sample window to half a second, the resolution is halved and the frequency output will be in 2-Hz increments. By increasing the sample window to 2 seconds, you get 0.5-Hz intervals.

PT, the sample rate: The number of points taken during the sampling period determines the range of frequency increments (dependent on window period) you can calculate.

According to the Nyquist sampling theorem, you must sample at a frequency of at least twice as fast as the greatest frequency you expect to encounter. If your high end is 40 Hz, you must take at least 81 samples during that sample window. HAL takes 64 samples during a 1-second window, so it should be able to evaluate frequency output up to 30 Hz.

MIN and **MAX**, the output frequencies: The countervariable **HZ** need only be the frequencies desired. The FFT algorithm is really an accelerated version of what is called a discrete Fourier transform (DFT). The DFT calculates frequency output from 0 to the number of points taken. But this output includes something called negative frequencies. These mathematical monkeyshines can be ignored for the purpose of understanding this project. However, FFT.BAS can easily be tweaked to display this graphically, also.

Listing A: This BASIC program performs the FFT on an array of data points.

```
REM FREQUENCY (Hz)
FREQ(0)=16: REM Channel 1
FREQ(1)=9:  REM Channel 2
FREQ(2)=8:  REM Channel 3
FREQ(3)=2:  REM Channel 4

REM AMPLITUDE
A(0)=10: REM Channel 1
A(1)=20: REM Channel 2
A(2)=30: REM Channel 3
A(3)=40  REM Channel 4

REM PHASE (Radians)
P(0)=0: REM Channel 1
P(1)=0: REM Channel 2
P(2)=0: REM Channel 3
P(3)=0: REM Channel 4

WDW=1.0: REM Sample period in seconds
PT=64:  REM Number of sample points
MIN=2:  REM Min freq to evaluate (1 - 25)
MAX=16: REM Max freq to evaluate (MIN - 25)
```

```
SM=040: REM Offset to start of sample period

FOR HZ = MIN TO MAX
REM ** Clear the real and imaginary
REM ** components.
REAL = 0
IMAG = 0
REM ** Begin the frequency analysis
REM ** loop.
FOR X=0 TO PT-1
REM ** Calculate reference angle
G = 2*PI*HZ*X/PT
REM ** Calculate real components
REAL = REAL + RAWDATA(X)*COS(G)/PT
REM ** Calculate imaginary component
IMAG = IMAG - RAWDATA(X)*SIN(G)/PT
NEXT X
REM ** Power calculation
FFT(HZ,0) = 2*SQR(IMAG*IMAG + REAL*REAL)
REM ** Phase calculation
FFT(HZ,1) = ATN(IMAG/REAL)
NEXT HZ
```

be able to see changes in hemispherical activity every half second or sooner.

Clearly, a high-level language was not going to do the trick. (Running the FFT algorithm above in compiled BASIC takes about 5 minutes.) Ultimately, I created a machine language version of the FFT algorithm described in FFT.BAS. Figure 5 shows the flow of sample data from the left and right brain sample queues through the algorithm and into the power and phase arrays defined in the BASIC program. On an IBM PC XT, it takes about 2 seconds to complete the entire feedback cycle; an IBM PC AT processes a cycle in about half a second.

To get the necessary speed, I used a variety of techniques to optimize the FFT:

- **Number of data points:** I chose 64 data points as the sample size for a few reasons. First, you can perform integer division by 64 using shift operations instead of a divide instruction.

When I used the 8088's integer-division instruction, it took about 340 ms to calculate a single 64-point FFT. In contrast, division using shift operations takes about 120 ms to accomplish the same thing.

Second, taking the division by shifting into account, 64 points per second will give the resolution and the range needed to evaluate frequencies from 4 Hz to 20 Hz. The Nyquist sampling theorem dictates that you must sample a waveform at a frequency of at least twice its highest frequency component. Consequently, 32 points would not be enough samples to analyze anything above 15 Hz. On the other end, 128 points would give you a greater frequency range for analysis, but it would take considerably longer to calculate.

- **Table lookup:** The FFT algorithm requires only a fixed number of sine and cosine values. By building these 64 values into a table rather than calculating them on the fly, you can save a lot

continued

SPECIAL TURBO SALE

Get \$5.00 Off Every Turbo Pascal® 4 Book
 Get \$3.00 Off Every Turbo C® & Turbo Basic® Book



Using Turbo C®

by Herbert Schildt

For all C programmers, beginners to pros, this excellent guide helps you write Turbo C programs that get professional results.

~~\$19.95~~ Paperback, ISBN: 0-07-881279-8, 431 pp., 7½ x 9¼
 Borland-Osborne/McGraw-Hill Programming Series
\$16.95

Advanced Turbo C®

by Herbert Schildt

Unveils Turbo C power programming techniques to serious programmers. Covers Turbo Pascal conversion to Turbo C and Turbo C graphics.

~~\$24.95~~ Paperback, ISBN: 0-07-881280-1, 397 pp., 7½ x 9¼
 Borland-Osborne/McGraw-Hill Programming Series
\$19.95

Turbo C®: THE COMPLETE REFERENCE

By Herbert Schildt

Covers Version 1.5

Programmers at every level of Turbo C expertise can quickly locate information on Turbo C functions, commands, codes, and applications—all in this handy encyclopedia.

~~\$24.95~~ Paperback, ISBN: 0-07-881346-8, 850 pp., 7½ x 9¼
 Borland-Osborne/McGraw-Hill Programming Series
\$21.95



Turbo Pascal® THE COMPLETE REFERENCE

Covers Version 4
 by Stephen O'Brien

The first single resource that lists every Turbo Pascal command, function, and feature, all illustrated in short examples and applications. Ideal for every Turbo Pascal programmer.

~~\$24.95~~ Paperback, ISBN: 0-07-881290-9, 814 pp., 7½ x 9¼
 Borland-Osborne/McGraw-Hill Programming Series
\$19.95

Using Turbo Pascal® VERSION 4

by Steve Wood

Build the skills you need to become a productive Turbo Pascal 4 programmer. Covers beginning concepts to full-scale applications.

~~\$19.95~~ Paperback, ISBN: 0-07-881356-5, 546 pp., 7½ x 9¼
 Borland-Osborne/McGraw-Hill Programming Series
\$14.95

Advanced Turbo Pascal® VERSION 4

by Herbert Schildt

The power of Turbo Pascal 4 will be at your fingertips when you learn the top-performance techniques from expert Herb Schildt.

~~\$24.95~~ Paperback, ISBN: 0-07-881355-7, 416 pp., 7½ x 9¼
 Borland-Osborne/McGraw-Hill Programming Series
\$16.95

Turbo Pascal®

PROGRAMMER'S LIBRARY, SECOND EDITION

by Kris Jamsa and Steven Nameroff

Take full advantage of Turbo Pascal, and the newest versions of Turbo Pascal, with this outstanding collection of programming routines. Includes routines for the Turbo Pascal toolboxes.

~~\$22.95~~ Paperback, ISBN: 0-07-881368-9, 600 pp., 7½ x 9¼
 Borland-Osborne/McGraw-Hill Programming Series
\$17.95



Using Turbo Basic®

by Frederick E. Mosher
 and David I. Schneider

Introduces Turbo Basic to novices and seasoned pros alike. Learn about the Turbo Basic operating environment and the interactive editor.

~~\$19.95~~ Paperback, ISBN: 0-07-881282-8, 457 pp., 7½ x 9¼
 Borland-Osborne/McGraw-Hill Programming Series
\$16.95

For A Limited Time Only

ORDER TODAY! CALL TOLL-FREE 800-227-0900

Use Your Visa, MasterCard,
 or American Express

McGraw-Hill Osborne McGraw-Hill
 2600 Tenth Street
 Berkeley, California 94710

Turbo Basic, Turbo C, and Turbo Pascal are registered trademarks of Borland International. Copyright © 1988 McGraw-Hill, Inc.

McGraw-Hill
BORLAND·OSBORNE

You can display
*HAL's output in either CGA or
monochrome.*

of time. Using a table of square roots is similarly much faster than calculating them.

- **Scaling:** When I built the tables, I took care to scale the integer values so power calculations can divide by 256. This magic number lets the software shift bytes instead of bits, giving considerable savings in time.
- **Phase octants:** Because the accuracy of this device is limited to integer calculations—and again because of speed—the pro-

gram reports phase results in 45-degree increments. Instead of using the arctangent to calculate phase results, it is quicker in machine language to determine them using the sign and absolute amplitude of both real and imaginary components. The result is in phase octants.

Finally, the FFT is a much deeper subject than I can possibly cover in this article. I recommend a book entitled *The FFT: Fundamentals and Concepts* by Robert W. Ramirez (Prentice Hall, 1985). It provides an excellent look at the FFT and the theory behind it.

Driving the IBM Video Display

The last major block in the system diagram is called BIO. This module takes calculated output from the power and phase arrays just loaded by the FFT, converts this output into character strings, and writes them to the display. This part of the software displays the window opened by HAL into your brain.

Photo 2 shows a typical HAL display. You can display HAL's output in either CGA or monochrome. The horizontal bars represent the relative energy levels found in the frequencies evaluated. The bars that lead to the left represent the energy in the left hemisphere (channel 1); the bars to the right of center are the right hemisphere (channel 2).

Respective frequencies are labeled down the middle of the display under the "Hz" heading. The numbers 0 to 60 located in the rows above and below the energy bars represent relative energy levels only (pressing F3 changes the scale). They do not necessarily indicate absolute voltage levels that a much more expensive EEG machine might provide.

The phase angle of any given frequency is shown under the "OCTANT" heading for its respective hemisphere. An octant is nothing more than an eighth of a cycle. Octant 0 means the waveform is within the first 45 degrees of its cycle. A value of 1 puts it between 45 and 90 degrees, and so on.

Relative phase is indicated in a box at the bottom center of the screen under the "PHASE DIFFERENCE" heading. This feature selects the frequency from the left hemisphere with the greatest energy level and compares its phase angle with the phase angle of the corresponding frequency in the right hemisphere. The two rows of asterisks represent the position of the right hemisphere relative to the left hemisphere. If the right

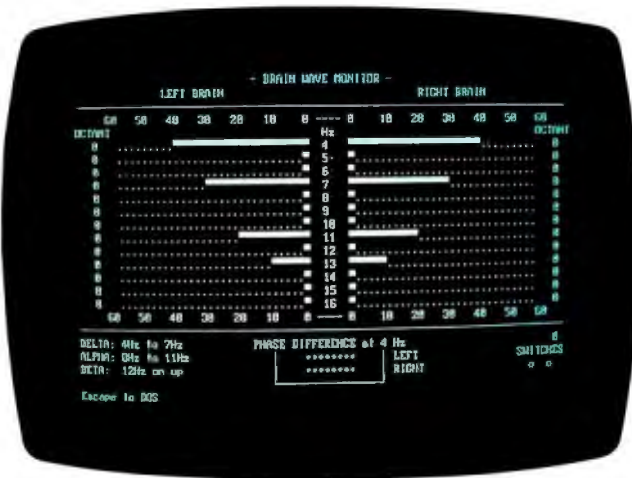

Photo 1: HAL properly unravels the complex waveform shown in figure 4. Note the four long horizontal bars; each corresponds to one of the four component sinusoidal waves.

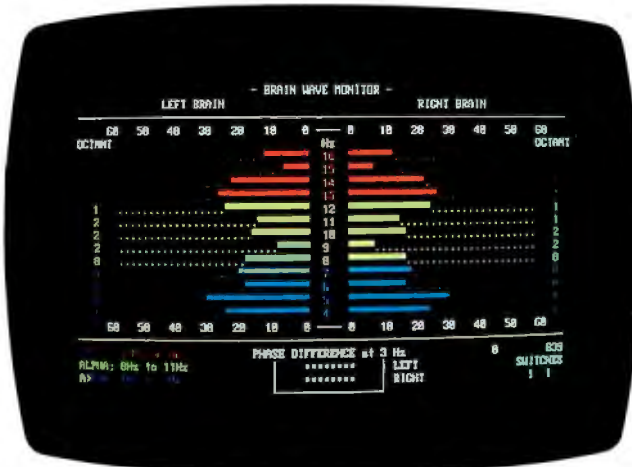

Photo 2: HAL's output can be displayed on an IBM PC using the CGA.

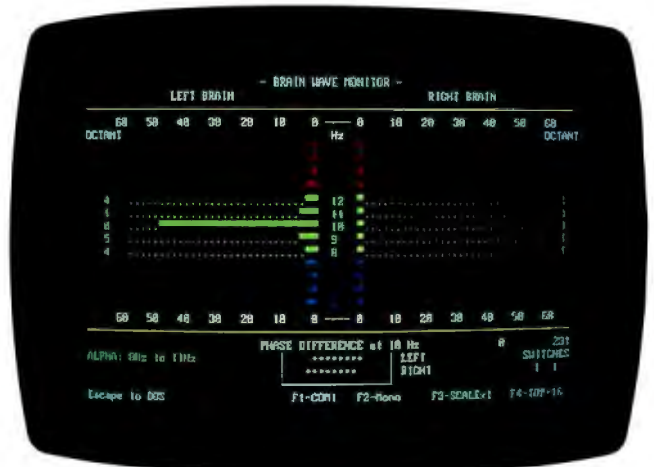

Photo 3: While testing HAL, I injected a 10-Hz sine wave through the headset electronics. The resulting output, shown here, indicates that the system works properly.

hemisphere is one octant ahead of the left hemisphere, the right hemisphere indicator will be advanced one column in front of the left hemisphere indicator.

Yes, But Does It Work?

How do we know that what we see on the display is really what is going on in our head? What makes data from the headset electronics different from a string of random data? Testing, of course.

I've already discussed the first test: Taking a waveform built of known sinusoidal components, passing it through the FFT algorithm, and verifying that the frequency and energy levels coming out are what I put in. The next level of confidence comes from using a sine-wave generator to force-feed the hardware with real data. Photo 3 is a sample of a 10-Hz sine wave being introduced into the headset electronics channel 1 input. Note that all other frequency bands are null.

Once we know how the FFT algorithm works—and we have the confidence that the hardware will deliver the data correctly—the rest is up to interpretation by the users. A sample session using the complete system seems to indicate that many frequencies are active. There also appears to be a difference between the right and left hemispheres in both amplitude and phase. But just what that means will have to be left to a person more involved with biofeedback.

Using HAL

HAL is one of the few Circuit Cellar projects in which the circuitry and software are relatively simple in comparison to the application. While the basic EEG apparatus has been in use for 60 years, we are just beginning to understand the "circuitry" and "software" operating within our own heads. Hundreds of volumes are devoted to clinical and research electroencephalography. I have included some possibilities for further reading at the end of the article; you may find them interesting as you explore this complex and fascinating field.

HAL provides an effective demonstration of how our gross behavior is in some way mirrored in the electrical activity of the brain. To view this behavior, however, you must learn how to connect HAL to your head.

You can purchase disposable EEG electrodes with adhesive pads and conductive gel from medical supply houses. Reusable silver/silver-chloride electrodes are also available. The reusable electrodes are more expensive initially, but you can use them almost indefinitely if you care for them properly.

Five wires are involved in a two-channel HAL connection: common reference, left-channel differential input pair (J1A and J2A), and right-channel differential input pair (J1B and J2B). You should construct the differential pair wires with shielded cable. I found that standard shielded microphone cable—with a male RCA connector at one end and a snap to mate with the electrode at the other end—is quite sufficient. The shield is, of course, grounded only at the RCA jack on HAL. Be careful not to accidentally short the shield to the differential input electrodes or HAL will produce erroneous results.

You can place the common reference electrode on the mastoid, the bony projection just behind the ear. You should first clean the area with soap and water to remove oils from the hair and scalp. Next, rub the area lightly with a piece of alcohol-dampened gauze. Finally, peel the adhesive from a disposable electrode, fill the well with conductive gel (but do not overfill), and place the electrode on the selected spot.

Follow a similar procedure to place the differential-pair electrodes on each hemisphere. One wire (J2A or J2B) goes over the frontal lobe—directly above the eye and just below where your

Warning

HAL is presented as an engineering example of the design techniques used in acquiring brain-wave signals. It is not a medically approved device, no medical claims are made for it, and it should not be used for any medical diagnostic purposes. Furthermore, the safe use of HAL requires that the electrical power and communications isolation described in its design not be circumvented. HAL is designed to be battery-operated only. Do *not* substitute plug-in power supplies.

hairline was before it started receding! The second electrode (J1A or J1B) is more difficult to place (unless you happen to be completely bald). You should put it over the occipital lobe, which in most people is covered with hair.

On the back of your head is a ridge, where your skull begins to bend inward toward your neck. Find a spot about a third of the way from the midline of your head to the common electrode placed on the mastoid and just on or below the ridge. Prepare the scalp as before, taking care to hold the hair carefully away from the site. You might try using a sweatband to hold the electrode in better contact with the scalp, making several small holes in the sweatband to allow easier access to the electrode connector.

Figure 6 shows the general location and nomenclature for commonly used electrode placements. If you build a multichannel model of HAL, you should refer to more detailed literature about electrode placement, monopolar and bipolar placement, and other esoteric subjects.

Assuming that you have successfully placed both channels of electrodes appropriately, it is time to fire up the software supplied with HAL. Remember, to retain its electrical isolation,

continued

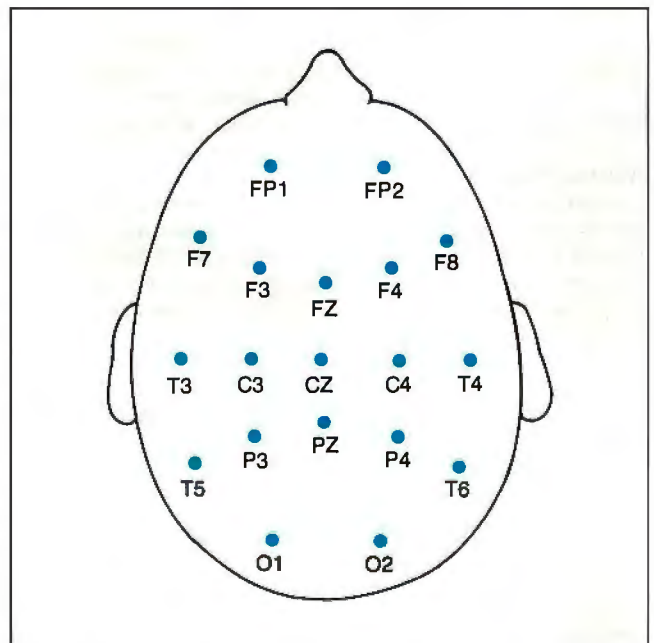

Figure 6: Commonly used locations and nomenclature for electrode placement.

you should operate HAL only on batteries, *exactly* as presented.

Attach the electrode wires to the electrode connectors, connect HAL to the computer's COM1 port, turn on HAL, load BIO.EXE into the computer, and watch your monitor. The sample display illustrated previously will let you see your own brain activity as you produce it. Actually, due to sampling and processing time, you will see it delayed by about half a second.

You may see little high-amplitude activity, and the dominant frequency may drift quite a bit (pressing F3 will change the amplitude range). But if you close your eyes and make your mind less blank than usual, your "lab partner" should see a dominant frequency appear somewhere in the alpha-wave range. Of course, if you open your eyes to see it, it will immediately disappear. Somehow this is reminiscent of the old question about a tree falling in a forest making a sound or not. Since HAL's data is serial, you could store a session to disk and view it "off-line" later.

The display also shows the condition of the two optional switches that can be attached to HAL. The intent here was to provide a way for you to monitor either some external condition or internal state, so you can correlate it with your brain-wave activity. You could use two momentary contact switches, one for each hand perhaps, to see if you can correctly identify from internal cues some aspect of brain functioning (e.g., what band you are producing a dominant frequency in, whether the left or right hemisphere is showing greater power output for different mental tasks, and so forth).

Alternatively, some external source—the presence or absence of music, a strobe light, or other stimulus—could trigger the switches. Since you have two switches, you could test for four different conditions.

You can also modify the BIO code to turn HAL into a standard biofeedback device. In this case, you would want to add threshold controls. That is, the program could provide audio feedback only when you had achieved certain minimum values of relative amplitude within a certain frequency band. You could provide different feedback for each channel, or feedback could be tied into both channels meeting the same (or different) criteria.

A multichannel HAL would need a completely different display to provide meaningful feedback about the brain's activity. An EGA display could be mighty useful here, in some way showing activity in terms of color on a map of the brain.

A Final Thought

As I said earlier, we are only starting to understand the relationship between our brain-wave activity and our mental states. HAL is not intended to take the place of a \$100,000 EEG analyzer in a modern neurologist's lab, but it certainly can provide the serious experimenter a valid vehicle for entry into the fascinating world of neuroscience.

Next Month

I'll present a development system for Intel's 8051 family of microcontrollers using the IBM PC as a base. ■

BIBLIOGRAPHY

- Brown, Barbara. *New Mind, New Body: Bio-Feedback; New Directions for the Mind*. New York: Harper & Row, 1974.
- Kooi, Kenneth. *Fundamentals of Electroencephalography*. New York: Harper & Row, 1971.
- Scientific American Editors. *Altered States of Awareness*. San Francisco: W. H. Freeman & Co., 1972.
- Segalowitz, Sid J. *Two Sides of the Brain: Brain Lateralization Explored*. Englewood Cliffs, NJ: Prentice Hall, 1983.

Special thanks for help provided on this article to Dr. Robert Stek, David Schulze, Rob Schenck, Jeff Bachiochi, and Ed Nisley.

Editor's Note: Steve often refers to previous Circuit Cellar articles. Most of these past articles are available in book form from BYTE Books, McGraw-Hill Book Co., P.O. Box 400, Hightstown, NJ 08250.

Ciarcia's Circuit Cellar, Volume I covers articles in BYTE from September 1977 through November 1978. *Volume II* covers December 1978 through June 1980. *Volume III* covers July 1980 through December 1981. *Volume IV* covers January 1982 through June 1983. *Volume V* covers July 1983 through December 1984. *Volume VI* covers January 1985 through June 1986.

Circuit Cellar Ink

It's virtually impossible to provide all the pertinent details of a project or cover all the designs I'd like to in the pages of BYTE. For that reason, I have started a bimonthly supplemental publication called Circuit Cellar Ink, which presents additional information on projects published in BYTE, new projects, and supplemental applications-oriented materials. For a one-year subscription (6 issues), send \$14.95 to Circuit Cellar Ink, P.O. Box 3378, Wallingford, CT 06494. Credit card orders can call (203) 875-2199.

The following item is available from

CCI
P.O. Box 428
Tolland, CT 06084
(203) 875-2751
Inquiry 934.

Circuit Cellar Hemispheric Activation Level Detector (HAL) complete printed circuit board kit. Comes with printed circuit board and all chips and board-mounted components, including 80C31, IC sockets, 27C64 EPROM, user's manual, and IBM PC demonstration display on PC format disk. Does not include battery holders, batteries, scalp electrodes, or connecting cables. HAL-4-KIT \$179; add \$19 if you want an IBM PC cable.

The Circuit Cellar HAL design is available for licensing to qualified manufacturers. Call for information.

All payments should be made in U.S. dollars by check, money order, MasterCard, or Visa. Surface delivery (U.S. and Canada only): add \$5 for U.S., \$8 for Canada. For delivery to Europe via U.S. airmail, add \$14. Three-day air freight delivery: add \$7 for U.S. (second-day Federal Express), \$15 for Canada (DHL), \$22 for Europe (DHL), or \$30 for Asia and elsewhere in the world (DHL).

There is a multiline Circuit Cellar bulletin board system (running TBBS 2.0M) that supports past and present projects in BYTE and Ink. You are invited to call and exchange ideas and comments with other Circuit Cellar supporters. The 300-/1200-/2400-bps BBS is on-line 24 hours a day at (203) 871-1988.

To receive information about the Circuit Cellar Ink publication for hardware designers and developers, please circle 100 on the Reader Service inquiry card at the back of the magazine.

Steve Ciarcia (pronounced "see-ARE-see-ah") is an electronics engineer and computer consultant with experience in process control, digital design, nuclear instrumentation, and product development. The author of several books on electronics, he can be reached at P. O. Box 582, Glastonbury, CT 06033, or on BIX as "sciarcia."

PUT 420,000 MICRO MENTORS TO WORK.

Advertise in the new BYTE magazine and let the people other people come to for advice help spread your message. We have a total of 420,000 paid readers who are powerful because they're knowledgeable. Each one is a leader in personal computer decision-making at his company. And each one believes that ads in BYTE are a valuable source of information.

- 93% provide advice about *acquiring* micros, peripherals and software, an average of 25 times a month.
- 85% are directly involved in purchasing decisions about microcomputers and related equipment for their company.
- 96% work for a company that currently owns or uses microcomputers.
- 75% of these companies plan to buy an average of 145 microcomputers in the next 12 months.

In short, when it comes to making a purchase decision, people listen to BYTE readers. So if you're not planning on advertising in BYTE, you may be planning an advertising schedule without teeth.

**THE
NEW
BYTE**

PICK BIX BRAINS

... With a 10 Day Trial Membership

If you've thought about joining **BIX** before but weren't sure it was what you needed, now is the time to try it. Because now for a limited time, we're inviting you to try **BIX** for 10 days. If at any time during this 10 day trial period you don't feel **BIX** has made you a more knowledgeable microcomputer user, we'll refund your entire registration fee. You pay only for time spent on the system.* (See log-on instructions for hourly rates).

Explore **BIX** in your home or office. Put its power to work for you and unleash your full microcomputer potential — programming, designing, specifying, researching — and more.

Try **BIX** for 10 full days and see what it can do for you. Explore more than 160 conferences. Access vendor support. Speak to expert consultants. Research new products and systems, and download public domain software.

Prepare yourself for success

It takes a sharp mind and hard work to stay ahead, and having the right tools helps.

Today, you can put one of the most powerful instruments for career advancement to work for you: **BIX**.

- Learn about new products before they hit the market.
- Get quality marketplace feedback on the products you're thinking of purchasing before you invest.
- Research problems and find the solutions that no one else has been able to render.
- Access some of the most advanced public domain software available in the industry.
- Increase your working knowledge of micros to make more confident purchasing decisions and recommendations.

Join **BIX** and arm yourself with the latest in microcomputer-related information

BIX's exclusive *Microbytes* newswire gives you complete, daily, up-to-date computer industry information. You'll gain insight from **BYTE** editors and writers who analyze new products and their potential impact, inform you of the latest mergers and acquisitions, and report late-breaking news from important seminars and conferences.

Talk to colleagues worldwide

You'll stay on top of your company's

business with **BIX**'s electronic mail service.

"Talk" to your east coast, west coast — even European — contacts all in the same day.

Or, simply communicate with other **BIX** users worldwide. Share information and ideas privately, or in conference.

Choose any option for online access with a one time \$39 membership fee

- Use MasterCard, VISA or American Express and begin your 10 day trial use of **BIX** right now.
- The 10 day trial also applies if you open an individual pre-paid account on **BIX**. Trial commences once we open your account and notify you.
- Other billing options including qualified corporate accounts are available. (Sorry, our 10 day trial is not available for these accounts.) Call or write **BIX** for details.

Use credit cards for immediate access or call the **BIX** Helpline for information on any other payment option at, 1-800-227-2983 (from U.S. and Canada) 603-924-7681 (in New Hampshire and elsewhere).

Act now! Our 10 day trial offer is subject to cancellation at any time.

*To notify **BIX** that you wish to discontinue service at any time during the trial period, call the **BIX** Helpline, and your entire membership fee will be refunded.

****BIX** can be accessed via Tymnet throughout the U.S. and Canada. For the Tymnet number nearest you, call the **BIX** Helpline or Tymnet at 1-800-336-0149.

†If your local Tymnet number is a toll call you will receive additional charges from your local phone company at their prevailing rate.

‡Continental U.S. Tymnet rates. Rates from other areas are available from **BIX**.

BIX is easy to join

To log-on to **BIX**, simply:

Set your computer's telecommunications program for full-duplex, 8-bit characters, no parity, 1 stop bit OR 7-bit characters, even parity, 1 stop bit. Use 300 or 1200 baud.

Call your Tymnet number ** and respond as follows:

Tymnet Prompt	You Enter
Garble or request for "terminal identifier"	a
login:	bix<CR>
BIX logo/name:	bix.038 <CR>

Callers outside the U.S. who have a communicating computer or terminal and a packet switching account with their host country phone system

can reach **BIX** by entering 310690157800. To commence registration, enter the code listed at the **BIX** logo/name: prompt.

After you register, you'll automatically be taken to the **BIX** Learn Conference, an online tutorial that will show you how to begin using the system immediately. Time spent in the Learn Conference is FREE. Complete system documentation will be sent to you within a few days.

Access time will be billed at the following hourly rates.†

Off-Peak Time \$11/hr. (\$9 **BIX**, \$2 Tymnet)††
(7 PM - 6 AM weekdays, all day weekends and holidays)

Peak Time \$20/hr. (\$12 **BIX**, \$8 Tymnet)††
(6 AM - 7 PM weekdays)

BIX

BYTE INFORMATION EXCHANGE

One Phoenix Mill Lane
Peterborough, NH 03458

BYTE's Subscriber Benefits Program

Your BYTE subscription brings you a complete menu of the latest in microcomputer technology every 30 days. The kind of broad-based objective coverage you read in every issue. *In addition*, your subscription carries a wealth of other benefits. Check the check list:

BONUSES

✓ **Annual Separate Issues:** In addition to BYTE's 12 monthly issues, subscribers also receive our annual IBM PC issue free of charge, as well as any other annual issues BYTE may produce.

✓ **BYTE Deck:** Subscribers receive five BYTE postcard deck mailings each year—a direct response system for you to obtain information on advertised products through return mail.

✓ **Reader Service:** For information on products advertised in BYTE, circle the numbers on the Reader Service card enclosed in each issue that correspond to the numbers for the advertisers you select. Drop the post-paid card in the mail and we'll get your inquiries to the advertisers.

✓ **TIPS:** BYTE's Telephone Inquiry System is available to subscribers who need *fast response* from advertisers. After obtaining your Subscriber I.D. Card, dial TIPS and enter your inquiries. You'll save as much as ten days over the response to Reader Service cards.

✓ **Free Programs Via BYTENet:** You get access to the BYTENet Bulletin Board Service, which allows you to download, via



modem, valuable program listings. There is no connect charge for this service.

✓ **Subscription Service:** If you have a problem with, or a question about your subscription, you may call our service department toll-free at 800-423-8272 (in New Jersey call 800-367-0218) during regular business hours (Eastern Time). You can also use Subscription Service to obtain back issues. Should you care to correspond, use the following address: P.O. Box 6821, Piscataway, N.J. 08855.

✓ **Editorial Indices:** Available through our customer service department P.O. Box 328, Hancock, New Hampshire 03449.

PAID SERVICES

✓ **BIX:** BYTE's Information Exchange puts you on-line 24 hours a day with your peers via computer conferencing and electronic mail. All you need to

sign up is a microcomputer, a modem, and telecomm software. For further information and cost, call 1-800-227-BYTE.

✓ **Program Listings:** Listings of programs that accompany BYTE articles are now available on BIX, on disks or in quarterly printed supplements (see reply cards in this issue for cost information), or call 1-800-258-5485.

✓ **Microform:** BYTE is available in microform from University Microfilm International in the U.S. and Europe. See Contents page for cost information.

DISCOUNTS

✓ One-year subscription at \$22.95

✓ Two-year subscription at \$39.95

✓ Three-year subscription at \$55.95

✓ One-year group subscription for ten or more at \$18.95 each. (Call or write for details.)

TOLL-FREE NUMBERS FOR YOUR CONVENIENCE:

Subscriptions & Back Issues:
1-800-423-8272
(in N.J., 1-800-367-0218)

BIX: 1-800-227-BYTE

Program Listings Orders:
1-800-258-5485

BYTE



It's indispensable.

A TURBO TSR

*Turbo Pascal 4.0 has everything you need
to craft your own TSRs*

Scott Robert Ladd



Terminate-and-stay-resident (TSR) utilities are popular among users of the IBM PC family of computers, and it's easy to see why. A TSR can fill just about any utilitarian need you have: spelling checker, keyboard macro generator, pop-up calendar and notepad, special device driver, LAN manager, and the list goes on. What's the secret behind the TSR's flexibility?

A TSR performs some sort of task, either automatically (in response to some interrupt) or when you request it. After it has executed, it returns control of the system to MS-DOS but remains resident in the computer's memory. Since MS-DOS is a single-tasking operating system, a TSR can provide a limited level of multiprocessing. Borland's SideKick and Living Video-Text's Ready are two currently successful commercial TSRs.

By their nature, TSRs violate many rules of "proper" programming. They often commandeer system resources that documentation clearly states should *not* be commandeered, and they can interrupt an unsuspecting program. However, with careful planning and design, you can create a TSR that minimizes its impact on the other programs that are running on your computer.

Nearly every programmer I've talked with has had the desire to write a TSR program. Until recently, most TSRs were written in assembly language, which requires some fairly advanced technical skills. With the advent of Turbo Pascal 4.0, you can now write a well-behaved TSR entirely in a high-level language.

The advantage of this is the ease of code creation and maintenance. Turbo Pascal 4.0 (for the remainder of this article, any references to Turbo Pascal will mean version 4.0) provides many facilities applicable to creating TSRs; facilities the programmer would otherwise have to spend hours creating (see the textbox "Turbo Pascal 4.0" on page 303). I believe these conveniences far outweigh the only disadvantage of using Turbo Pascal to create a TSR: larger program size. It adds about 8K to the resident size of a TSR, although this becomes less important as the size of the TSR increases.

Case Study: The Quick Time TSR

The TSR that I designed displays a clock on a PC's CRT when you press a special key sequence known as a *hot key*. Once the clock appears, you can press any key to make the clock vanish and return control to the interrupted application. I call this TSR Quick Time (QT for short), and, although it is not terribly complex, it has all the elements found in more complicated TSR utilities:

- A hot key activates the program.
- Since QT will make changes in the video display, the program saves the current display and cursor of the underlying application, then restores them upon exit.
- QT can determine if it has already been installed and will not allow multiple copies of itself in memory.
- MS-DOS is not reentrant—meaning it must not be interrupted by a TSR when it is in the middle of doing something. QT will not activate during critical MS-DOS activities.
- If QT is already activated, it will not allow itself to be activated "on top of itself."
- You can deinstall QT (remove it from memory) when you no longer need it.

[Editor's note: Pseudocode for *Quick Time* is in listing 1. The complete source for QT is available on disk, on BIX, on BYTEnet, and in the *Quarterly Listings Supplement*. See page 3 for further details.]

Getting Your Toe in the Door

From the user's standpoint, installing a TSR program proceeds in the same way as executing a normal program: You simply enter the name of the program at the MS-DOS prompt. A normal program goes about its business and, when finished, frees the memory it was using. A TSR program, however, does several things before returning control to the system. For instance, QT does the following:

continued

Turbo Pascal 4.0 provides many facilities applicable to creating TSRs; facilities you would otherwise have to spend hours creating.

1. It checks to see if a copy of itself has already been installed. If so, it aborts the installation.
2. It determines the type of video adapter installed.
3. It intercepts required interrupt vectors and reroutes them to its own interrupt handlers. For example, QT captures the keyboard interrupt to watch for the hot key.
4. It locates the INDOS flag. This is an undocumented feature that QT uses to determine if it can interrupt MS-DOS.
5. It terminates using the Turbo Pascal procedure Keep, returning control to MS-DOS and remaining resident in memory.

It is essential that a TSR determine whether or not a copy of itself has already been installed. Unfortunately, MS-DOS has no built-in functions for identifying which programs are in memory. Some TSRs search through the memory allocated for an identifying sequence. This is a slow method that may not

work with all flavors of MS-DOS. Other TSRs check for special codes in and around the entry points to specific interrupts. That method is simple to implement in assembly language, but very difficult to use from a high-level language such as Turbo Pascal.

QT uses an entirely different method. BIOS interrupt 11 hexadecimal returns the equipment status word from a fixed location in low memory. When first installed, QT intercepts interrupt 11h and watches the CX register for a special 2-byte code. If QT receives this code, it places a second (answering) code in CX. In any case, QT will load the AX register with the equipment status word, so that any program calling this interrupt will still get the proper information. The first thing QT does when executed is load CX with the first code, execute an interrupt 11h, and then look for the response code. If CX does not contain the response code, QT knows that it has not been installed, and so it proceeds normally. Otherwise, the installa-

Listing 1: Pseudocode for Quick Time.

```

START:
  Display heading;
  Call INITIALIZATION;
  If INITIALIZATION = TRUE then
    Tell user of successful install;
    Terminate and stay resident (Use
    Turbo Pascal's KEEP procedure).
  else
    Tell user of failure;
    Exit.

INITIALIZATION:
  If QT already installed then
    return FALSE.
  Set display buffer based on video mode;
  Reroute INT 28H vector;
  Reroute INT 11H vector;
  Reroute INT 09H vector;
  Locate the INDOS flag;
  Store location of QT's stack;
  Set BUSY to FALSE;
  Return TRUE.

INT28: {INT 28H handler}
  Clear interrupts;
  Call original DOS INT 28H handler;
(A):
  If BUSY = TRUE and HOTKEY pressed then
    call DEINSTALL.
  If BUSY = FALSE and HOTKEY pressed and
  current video mode is text mode then
    Begin
      Set BUSY to TRUE;
      Save caller's stack;
      Set stack to QT's stack;
      Save current display {SaveScrn};
      call PROCESS;
      Restore display {RestScrn};

```

```

      Set BUSY = FALSE;
    End.
  Restore interrupts;
  Exit.

INT11: {INT 11H handler}
  Call original DOS INT 11H handler;
  If CX register has call code then
    Load CX register with response code.
  Load AX register with equipment list word;
  Exit.

INT09: {INT 09H handler}
  Disable interrupts;
  Call original BIOS INT 09H handler;
  ...
  (Remainder of code identical to (A) in
  INT 28H HANDLER routine.)

PROCESS:
  Turn the cursor off;
  Repeat
    Get current time;
    Position output location;
    Display time;
  Until key is pressed.
  Restore the cursor;
  Exit.

DEINSTALL:
  Save caller's stack;
  Set stack to QT's stack;
  Turn cursor on;
  Restore screen;
  Restore original INT 28H, 11H, and
  09H vectors;
  Deallocate QT's memory;
  Restore caller's stack;
  Exit to DOS {Use Turbo Pascal's

```

tion terminates with an appropriate message. You can use this method for multiple TSRs by just changing the request and response codes (`InstCode1` and `InstCode2` in QT's source code).

QT displays information on the screen, and so must save the display of the current application when activated. QT gets the current video mode using function 0Fh of BIOS interrupt 10h. If the mode is 7, QT knows it is dealing with a monochrome adapter with video memory beginning at segment B000h. Otherwise, QT knows it is dealing with a color adapter (CGA or EGA) whose video memory begins at segment B800h.

Next, the program must intercept several interrupts. You can declare a Turbo Pascal procedure to be an interrupt handler by using the `interrupt` statement in the procedure definition. An interrupt handler must save all registers when called, and return using a special `IRET` (interrupt return) function. The `interrupt` statement tells Turbo Pascal to handle all this automatically.

QT uses the Turbo Pascal function `GetIntVec` to obtain a current interrupt vector address. QT saves the vector (a pointer to the interrupt handler code in the BIOS) and "wires" a new interrupt handler into the interrupt. I used the Turbo Pascal `SetIntVec` procedure, which assigns a Turbo Pascal procedure's address to an interrupt. In this way, any program that calls the old interrupt will pass through QT's new handler code, which transfers control to the saved vector. This keeps other programs that use the same interrupt from being "cut off." When you deinstall QT, it restores the old interrupt vector.

QT intercepts three interrupts: 11h, used for determining the TSR's installation status (see above); and interrupts 09h and 28h, so that QT can watch for its hot key. (Pressing a key invokes interrupt 09h. Interrupt 28h is the MS-DOS "idle" interrupt; the operating system calls this interrupt when the system is at the DOS prompt, waiting for a key.)

An undocumented MS-DOS function, 34h, retrieves the address of what is known as the `INDOS` flag. This counter represents the number of currently active MS-DOS functions. MS-DOS is non-reentrant. Simply put, this means a program cannot interrupt an MS-DOS procedure in progress to call another MS-DOS procedure. QT's `Int09` interrupt handler uses the `INDOS` flag to avoid interrupting MS-DOS when it is busy (e.g., when `INDOS` is greater than 0). The TSR has to be clever, however, because `INDOS` is set to 1 whenever MS-DOS is awaiting input at the DOS prompt. However, since MS-DOS periodically executes an interrupt 28h while waiting, and since QT intercepts this interrupt, the TSR can deduce when it's safe to activate.

Finally, QT sets a `Busy` flag to `FALSE`, indicating that the TSR is inactive. (The `Int09` and `Int28` interrupt handlers check the `Busy` flag to ensure that QT is not activated while it is already active.) It then calls Turbo Pascal's `Keep` procedure, which calculates the program's size and uses MS-DOS interrupt 21h, function 31h to terminate the application and keep it resident. You can use Turbo Pascal's `$M` directive to set the size of a program's stack and heap (where the program keeps dynamically allocated variables); I have set each to 1K bytes. If you're writing a more complex TSR, you'll probably need to set your stack and heap size to some larger value.

Pop It Up

The interrupt-handling procedures `Int09` and `Int28` watch for QT's hot key. When either interrupt is invoked, the handler executes the `CallInt` function (which I wrote in in-line code) to execute the original interrupt handler. Upon return from the original handler, QT compares the hot key code in constant `Ac-`

Turbo Pascal 4.0

Here's a quick list of the Turbo Pascal 4.0 features that relieve some of the burdensome work of writing a TSR:

GetIntVec—This procedure accepts an interrupt vector number (must be in the range 0–255) and returns the address stored at that vector's location.

Interrupt—Not a procedure itself, the `interrupt` directive defines a user-written procedure as being an interrupt handler. Such a procedure automatically saves all registers upon entry and initializes the `DS` register.

PrefixSeg—A predefined word variable that contains the segment address of the Program Segment Prefix.

SetIntVec—Inverse of `GetIntVec`. You pass an interrupt vector number and the address of an interrupt service routine (ISR) to `SetIntVec`. The ISR becomes the new interrupt handler for the vector.

Keep—This procedure calls the DOS terminate-and-stay-resident function (interrupt 21h, function 31h). The program's code, data, and stack segments remain in memory, and control returns to DOS.

Halt—Stops the program and returns control to the operating system.

tivate against the keyboard status byte. Each bit in the keyboard status byte represents the current state of the shift and toggle keys. The 8 bits are mapped as shown in table 1.

QT looks for the value 0Ah in the status byte, which indicates that the user is pressing the Left Shift and Alt keys simultaneously. (If you're going to write your own TSR, you should make sure that different TSRs use different key combinations for activation.) QT then checks the `Busy` flag to verify that it is `FALSE`, proceeds if so, and exits if not. As a final check, the TSR confirms that the video display is in one of the text modes. If not, QT will not activate. (Graphics modes use large amounts of memory—from 4K bytes to 256K bytes on standard PC video adapters—and QT would have to reserve enough memory within itself to preserve the graphics screen, making QT's memory requirements prohibitive.)

Once QT has determined that it can activate, it saves the current value of the stack segment and pointer (the `SS` and `SP` registers). QT then sets the stack to the TSR's own local stack. This is a preventative measure that guarantees there will be enough stack space for QT to execute. Of course, QT will restore the interrupted programs stack at exit time.

QT also saves the current video mode, display buffer, and cursor position using Turbo Pascal's `SaveSern` procedure. Because some programs (e.g., `SideKick`) don't use the BIOS to manipulate the cursor (they talk directly to the 6845 video controller chip), `SaveSern` must save the position in two ways: through the BIOS, and by accessing cursor information internal to the 6845. `SaveSern`'s counterpart is `RestSern`, which restores the original mode, display, and cursor.

QT's `Process` procedure handles the actual visuals. The program simply runs in a loop, retrieving, formatting, and display-

continued

DIGITAL VOICE CARD (DVC)
for IBM PC, XT, AT and compatibles

PC SPEAKOUT
The DIGITAL VOICE CARD from Computer Age Ltd. provides a complete solution for your voice message management.

DIGITAL VOICE CARD (DVC) \$95.00
MICROPHONE (MIC) \$12.00
3" SPEAKER (SPK) \$9.00

Standalone Digital Voice Recorder (DVR) \$89.00 We accept Visa, MasterCard, COD cash. To Order Call Toll-free U.S.

1-800-263-7487

Computer Age Ltd.
P.O. Box 730
Nobleton, Ontario, L0G 1N0
(416) 859-0370

- Store voice data on PC memory at 2K or 4K bytes per second.
- Store up to 170 minutes on hard disk, 900 seconds on floppy.
- Digitize voice at 32K bits per second, 10 bits AD/DA.
- Interrupt and DMA support allows concurrent operation with your normal programs.
- Include software drivers for BASIC, C, PASCAL, and DBASE.
- Include Record and Play Demo, Message Reminder programs. Ready to use.
- APPLICATIONS YOU CAN USE:
 - Voice alarm and reminder for busy executives.
 - Telephone message store and forward.
 - Send your voice mails on a floppy or through a modem.
 - Speech analysis and voice synthesis.
 - Voice message management in store, factory, office and hospital.
 - Computerized security and monitoring system.
 - Sales, exhibit presentation.

Circle 60 on Reader Service Card

Dear Retailer,

Great News!!!

Now you can sell your products to over 20 million potential home personal computer users using our Electronic Home Shopping Network . . .

Nationwide!!!

Personal Computer Owners beginning in June will be able to access our Network Free!!! to purchase products of all types, No \$5.00 per hour charge, plus registration fees. Just buy, buy, and buy. 24 hrs a day, 7 days a week, all from the comfort of their home.

Act Now!!!

Space is Short. *No upfront costs!

*A 5% fee is added to each item ordered.

Call Now!!!

1-800-228-0640

WorldWide Services
6925 Union Park Suite 300
Salt Lake City, Utah 84047

Circle 276 on Reader Service Card

Dear Advertiser,

Great News!!!

Now you can advertise your clients products to over 20 million potential customers Nationwide on our Electronic Home --- shopping service. Also thru our Customer Access Machines. 24 hrs a day, seven days a week. No cost for use by user. Just buy, buy, buy.

Nationwide!!!

Space is short

Cost is \$149.95 per Screen

Regularly \$395.95 per screen.

Send Ad Copy and Check to:

WorldWide Services
6925 Union Park Suite 300
Salt Lake City, Utah 84047

or Call 1-800-228-0640

Circle 277 on Reader Service Card

FEATURE
A TURBO TSR

Table 1: Format of the keyboard status word. If a bit is set to 1, the associated key is activated; if 0, it is not.

Bit	Meaning
0	Right shift
1	Left shift
2	Control
3	Alt
4	Scroll lock
5	Num lock
6	Caps lock
7	Insert state

ing the time. The loop exits when you press any key. I've defined procedures `CursorOn` and `CursorOff` (using BIOS interrupt 10h, functions 1 and 3) to turn on and off the display of the cursor, avoiding a flashing cursor on the screen.

Out! Out! Damned TSR!

Often, you will want to remove (or "deinstall") a TSR once it has become resident. This is usually done to make the memory taken up by the TSR available to other programs.

The `Int09` and `Int28` procedures watch all keystrokes, and if they see that you've pressed the hot key while the Busy flag is TRUE (i.e., while the TSR is activated) they call procedure `DeInstall`.

`DeInstall` first restores the original screen and cursor. Then it reinstalls the previous interrupt handlers for interrupts 28h, 11h, and 09h (saved during the initialization of the TSR).

Finally, the TSR must free the memory blocks it has taken control of. There are two such blocks: one for the program itself and one for its environment. When you execute a program under MS-DOS, the operating system places a program segment prefix (PSP) in the first 256 bytes before the program. The PSP includes several items of information, but there's only one that we're really interested in: the segment program's environment block, located at an offset of 44 bytes within the PSP.

Fortunately, Turbo Pascal provides a predefined variable, `PrefixSeg`, which contains the segment of the PSP. Using `PrefixSeg`, QT creates a pointer to both the environment block and the program block. The TSR then uses MS-DOS function 49h to free a given block of memory beginning at a specific segment. Once QT has released its memory, it exits using Turbo Pascal's HALT procedure. QT is no longer resident.

There is one significant problem you can encounter when you deinstall QT (or any TSR, for that matter). QT does not know if any other programs, TSR or otherwise, are loaded into memory after it. If QT is not the last program in memory when you deinstall it, a hole will be created in memory, causing the operating system to fail with the message "Memory Allocation Error." Your only recourse in this situation is to reboot your PC.

Termination

Using QT, it should be easier for you to develop advanced TSRs like pop-up calculators and notepads. I hope I've helped bring the writing of TSRs down from the rarefied altitude of assembly language to environs frequented by programmers who might feel more comfortable using a high-level language. ■

Scott Robert Ladd owns *Elegant Technologies*, a consulting firm in Denver, Colorado that specializes in IBM PC compatibles.

FAST TRACK VS. FAILSAFE

It may not be as fast as other RISC chips, but VIPER's error-free design could be a life-and-death matter at Mach 3

Dick Pountain

Most microprocessor manufacturers are quite shameless in their pursuit of execution speed. The latest architectures use massive register files, pipelined instruction fetches, on-chip caches, internal concurrency, and many other tricks to get data through the chip as fast as possible. Unfortunately, this pursuit of speed often comes at the expense of accuracy.

By contrast, in the design of VIPER (Verifiable Integrated Processor for Enhanced Reliability), a new 32-bit RISC design microprocessor, speed was of only secondary importance. England's Ministry of Defense plans to use VIPER in control systems for the Royal Air Force's next generation of "fly-by-wire" military aircraft. Such aircraft have no mechanical link to the pilot's control stick, but depend on a microprocessor to move the airplane's control surfaces. These chips must be absolutely correct—any bug could be fatal. In the U.S., NASA is also evaluating possible applications for VIPER.

Designed by the Royal Signals and Radar Establishment (RSRE) in Malvern, England, VIPER is the first microprocessor designed using mathematical correctness proof techniques. These prove that the chip meets its specifications and that it will always function as intended.

Bugs vs. Bucks

In applications where human lives are directly at risk, microprocessor system integrity takes on a special importance. But ever since the first IC microprocessors were invented, chips have had bugs in them that programmers have had to work around. The recent spate of bug reports for the Intel 80386 is typical of the early days of any major new CPU chip.

The reason chip makers don't immediately fix microprocessors with known bugs is simple: The masking process for making VLSI (very large scale integration) chips is so expensive that

it's not commercially feasible to make a new mask and a new chip revision for every minor bug that emerges. However, "minor" bugs are only as minor as their consequences; if they could crash the control program that is the only thing connecting your joystick to your elevator at Mach 3, you have a right to regard them as major.

There's no need to fear bugs that everyone knows about. However, there may be a deep-rooted fault in the logic that becomes apparent only in a rare combination of circumstances. Such bugs can slip through the best-constructed test regimens and remain undetected until Murphy's Law dictates that they surface.

System integrity and safety problems aren't new. For centuries, engineers have had to

continued



create systems where human life is at stake, and they have established many strategies for coping with risk. One of the most effective is to create redundancy by duplicating critical components to reduce the probability of system failure. For example, a truck might have two braking systems, or an aircraft two or more hydraulic systems.

Unfortunately, the introduction of digital computers has created almost intractable problems with this strategy. Computers, especially those using VLSI technology, are so complex that no one can comprehend the entirety of their possible states, interactions, and failure modes. Even designers are wholly dependent on automated aids to create these chips. This complexity can undermine a safety strategy based on redundancy.

Crisis of Confidence

Imagine a control system that uses three identical, independent microprocessors that make all decisions by majority vote. This provides an effective solution in cases where one of the processors fails due to physical damage. But a deep-seated bug is likely to appear in all three processors simultaneously. For genuine redundancy it's better to use processors from three different manufacturers, all running different programs. However, this makes the task of writing the control systems more complex and introduces more opportunities for error.

And that's only the hardware side of the problem. A similar crisis of confidence exists in the software world and has spawned the discipline of software engineering. A few years ago, I attended a seminar where a transport safety engineer described a redundant system he'd designed using Forth on twin Intel 8008 microprocessors. He felt personally responsible for the safety of railway passengers but couldn't guarantee the integrity of an 80286 or a 68000 chip. Instead, he stockpiled 8008s (which have been out of production for 10 years) because he was sure he understood all its bugs. He chose Forth because it was a simple language in which to write his own compiler, and he felt that he could trust no one else's. Even after going to such lengths, however, the engineer will never know for sure whether he provided 100 percent reliability—unless the system fails.

VLSI computers and related software are so complex that de-

signers can't progress without depending upon the work of previous generations of designers and programmers. Unfortunately, this means that, as far as reliability is concerned, designers can have little confidence in the correctness of their work. For the defense industry, it was this potentially deadly paradox that prompted the design of VIPER.

VIPER's Architecture

VIPER's design was completed in 1987, and the RSRE staff first implemented it using a standard gate array. Marconi Electronic Devices has now licensed VIPER and implemented it as the MAS1908 VIPER-1. The company fabricates VIPER-1 chips using both bulk CMOS technology and Silicon on Sapphire for radiation hardness, and packages them as a 120-pin grid array. In redundant systems, designers may use versions of the same architecture implemented using different fabrication technologies. This reduces the chance of bugs appearing as a result of the manufacturing process (i.e., the 80386's temperature-sensitive math bug).

VIPER is a 32-bit processor with a 20-bit address bus and a 20-bit I/O space that can address up to 1 megaword of memory (1 megaword equals 4 megabytes) and 1 megaword of I/O space. It uses a very small instruction set and a minimum of functional units to make the correctness proof feasible. Unlike typical RISC designs, which execute 1 instruction per clock cycle, VIPER's instructions take between 6 and 26 clock cycles to execute, and the number of registers provided is very small. Its performance is rated at 1 million instructions per second (MIPS), which, while far from breaking records, is not to be sniffed at.

A VIPER programmer sees only three 32-bit registers—the accumulator A and the two index registers X and Y—plus a program counter, P. The programmer can use the A, X, and Y registers interchangeably as general-purpose registers, but VIPER uses the Y register to hold the return address during subroutine calls. Only one flag is used, a 1-bit B register that holds the result of comparison operations (see figure 1).

In addition to the B flag, the VIPER's ALU has a "stop" output, which goes out to an external pin. Whenever VIPER computes an illegal operation, arithmetic overflow, or an ille-

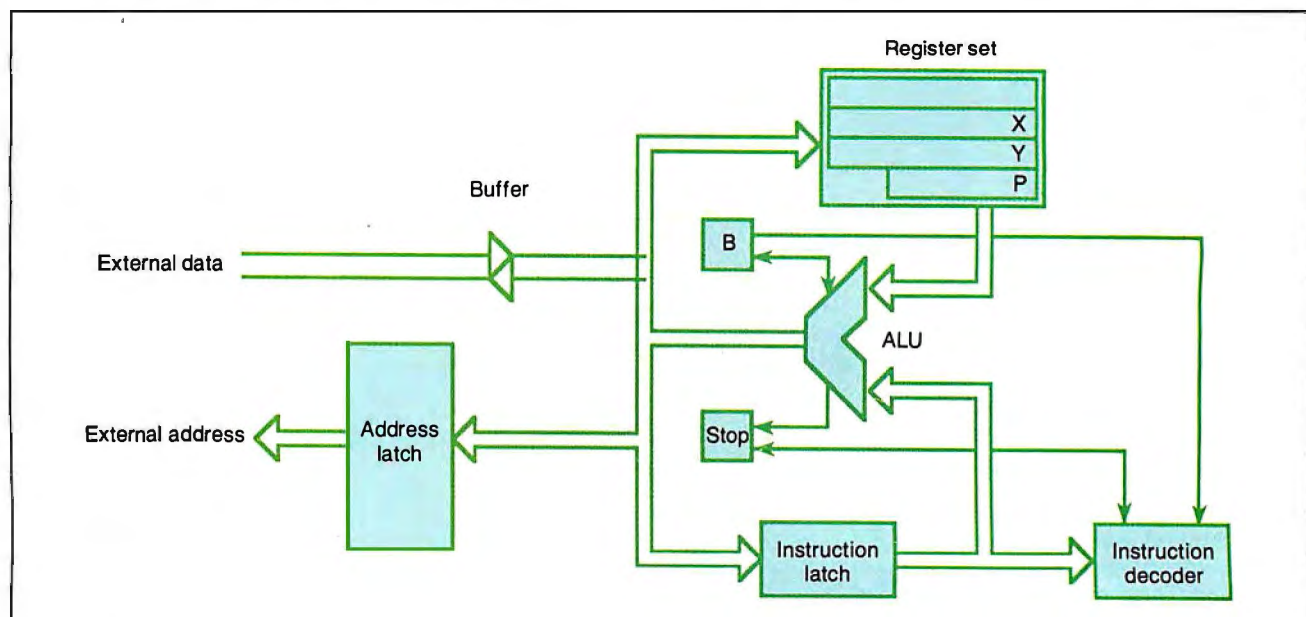

Figure 1: Proving the mathematical correctness of the VIPER-1 microprocessor required a simple architecture, as shown here.

gal address (i.e., more than 20 bits), it stops and raises an exception signal on this pin. The system in which it is embedded then knows that an error has occurred. The only way to continue after a stop is to reset the processor, which clears all registers. The stop condition also occurs when a read from memory or a peripheral device exceeds 63 clock cycles. This stop feature reflects the strict view that when an error occurs, it's dangerous to continue processing. The external system must heed the stop signal and perform some predefined corrective action, like switching to another processor or loading a new program.

Unsafe at Any Speed

VIPER's designers deemed certain hardware features to be so intrinsically unsafe that they excluded them. There's no hardware stack, because overflow and underflow pose insurmountable problems for validation. For similar reasons, there's no interrupt system. Hardware validation is currently possible only for fully synchronous systems, so VIPER avoids the internal concurrency that provides the high performance of the 68030 and most new RISC processors. No refresh circuitry is provided for dynamic RAMs, so VIPER must be used with static RAMs.

All instructions have the same 32-bit-word format, of which 20 bits can hold an immediate constant, an address, or an offset. The remaining 12 bits select source and destination, registers or memory, and the function to perform. VIPER has 32 function codes, 16 of which are comparison operations. The rest are arithmetic, logical, shift, and memory-read operations.

Every ALU operation has a stop condition that can stop the processor and raise an exception. For example, most operations cannot use the P program counter as a destination. For those operations, destination P is a stop condition. Only Read from Memory, Call, Increment, and Decrement can be performed on P, and the latter two cause a stop if an overflow occurs.

Proving Correctness

VIPER's designers chose an extremely Spartan architecture so that a small number of state machines could describe the processor (a finite-state machine is a mathematical device that has a finite number of mutually exclusive states).

When in a particular state, the state machine can perform actions that determine which state it will move to next. A simple analogy is a typewriter, which has uppercase and lowercase states controlled by the Shift and Shift Lock keys. When in the Shift Lock state, pressing any alphabetic key causes an uppercase letter to print, but pressing the Shift key causes a transition back to the lowercase state. A state machine is an attractive model for simple physical systems, because designers can completely define their behavior by describing the states and the allowed transitions between states.

Eleven simple state machines, or *major states*, describe VIPER, and these combine to form the major-state machine in figure 2. The node marked dummy represents the state immediately before an instruction fetch. Any VIPER instruction can be represented by a path through this diagram, starting and ending at dummy. For example, the path dummy->fetch->dummy represents the skip (i.e., do nothing) instruction, because it simply fetches the next instruction. Four of VIPER's pins are called major states 0 to 3. They indicate the processor's current major state to the outside world, for use in debugging and testing.

VIPER's top-down design has four description and documentation levels. The top level is an abstract specification of what the machine is to do. It's written in LCF-LSM (logic of computable functions/logic of sequential machines), a functional logic language based on first-order predicate calculus developed by Dr. Michael Gordon at the Computer Laboratory

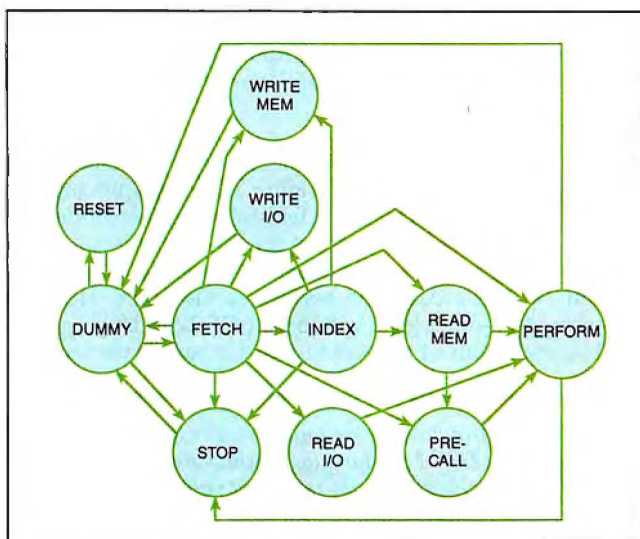

Figure 2: Eleven major states represent the mathematical model of the VIPER microprocessor.

of Cambridge University.

A state vector that holds the contents of the memory, registers, flag, and stop status describes the state of VIPER when resting between instructions:

state: (RAM, A, X, Y, B, stop)

Writing the top-level specification consists of defining a function called next: (state -> state) that describes all possible transitions of this vector when the machine executes a single instruction. Next is itself defined in terms of auxiliary functions, including a function called ALU, which completely specifies the machine's arithmetic. The full specification for VIPER comprises some 240 lines of LCF-LSM and can be printed on a single sheet of paper. By contrast, if the Motorola 68000 had a formal specification, it would probably fill a telephone book. A sample of the specification for ALU is shown in listing 1.

The second description level is the major-state machine itself, which is also written in LCF-LSM. It describes the inner workings of the component state machines. To describe the major states, VIPER's designers concatenated a second vector that contains the values of the control fields in the first 12 bits of a VIPER instruction with the following state vector:

major: (RAM, A, X, Y, B, stop) (T, regselect, memselect, destination, compare, function)

T is an internal register not available to the programmer. This combined vector represents the transient state as an instruction executes. The description of each node in figure 2 now comprises two functions, one defining the exit conditions from this node and another defining the corresponding transformation of its major-state vector.

The third level is the electronic block model, consisting of an ALU, an instruction decoder, and the rest of the units shown in figure 1. This is written in both LCF-LSM and ELLA. A lower-level language, ELLA's advantage is that tools already exist to convert it into input for a VLSI CAD/CAM system. No such tools exist for LCF-LSM. A library of LCF-LSM functions in ELLA provides the bridge between the two languages.

continued

The final description level, a gate-level circuit description, was written entirely in ELLA and converts directly into CAD/CAM input for Ferranti or Marconi's fabrication processes.

Proofs Performed

The task of verifying that VIPER was a correct implementation of the top-level specification in figure 3 involved proving that each level of the hierarchy was a faithful translation of the one above it in every respect. Between the first three levels, from top level to major state, and from major state to electronic block diagram, VIPER's designers performed the proofs algebraically using first-order logic within the LCF-LSM language.

While the details of the proofs used are beyond the scope of

Listing 1: A fragment of the top-level specification of VIPER in the LCF-LSM language, which defines 32-bit addition. This language can represent values either as positive integers, as machine words of various lengths, or as lists of Boolean values (bits). It provides built-in functions like V, TL, EL, WORDn and BITSn to convert between these representations and to manipulate bit lists.

```
TRIM34TO32 :word34 -> word32
TRIM34TO32 (w) == WORD32 (V(TL(TL(BITS34 w))))

ADD32 : (word32 # word32) ->
      (word32 # bool # bool)
ADD32 (r,m) ==
LET sum = WORD34 ((VAL33 (SIGNEXT r))
                  + (VAL33 (SIGNEXT m))) IN
LET opposite = (EL31 (BITS32 r))
               XOR (EL31 (BITS32 m)) IN
(TRIM34TO32 sum, (EL32 (BITS34 sum)) XOR opposite,
 (EL32 (BITS34 sum)) XOR (EL31 (BITS34 sum)))
```

this article, an overview is in order. The first-level proof involves generating a *spanning tree*, which contains all the paths through figure 2 to establish the completeness of the proof. Completeness is extremely important, as unforeseen processor states are more likely to cause hidden bugs than are the well-studied main states.

This use of a spanning tree is valid only for synchronous systems in which transitions occur in a regular time sequence. (This accounts for the design restrictions mentioned earlier.) Chief VIPER designer, Dr. John Cullyer, performed a first informal proof by hand, and the proofs have subsequently been repeated by researchers at Cambridge University using a powerful automatic theorem prover. The automated prover, which had to perform over 1 million primitive inferences, detected three errors in the manual proof.

To prove the correctness of the translation from electronic block diagram to circuit layout, the design team devised the Intelligent Exhaustive Simulation technique. In principle, to verify the circuit for a function block, you would have to prove for every combination of inputs that the block specification and the circuit produce the same results. However, this is often impractical, since for n inputs, 2^n tests are needed.

Intelligent Exhaustive Simulation relies on ELLA's ability to handle multivalued logic where, in addition to true and false, the values don't care and don't know are possible. The programmer can set inputs that, according to the specification, should be irrelevant to don't care. If they're truly irrelevant, the output is unaffected. But if, due to an implementation error, they do have some effect, the output will expose this by delivering a don't know value. With this technique, far fewer than 2^n tests can yield an equivalent level of proof, given that the multi-value logic is first verified as correct. For example, the VIPER instruction decoder has 18 inputs. This theoretically required 262,144 (2^{18}) tests, but 995 tests were sufficient.

VIPER'S designers assumed that the semicustom CAD/CAM system would deliver correct masks from a correct circuit network, and they deemed the final level of proof, from circuit layout to silicon, unnecessary. The grounds for this belief are that the VLSI companies have invested tremendous sums to ensure that this is the case, and the CAD/CAM system itself performs numerous checks on which it's hard to improve. The design team backed up the formal mathematical proofs by conducting extensive simulations of each level. To do so, they wrote a compiler from LCF-LSM into Algol68 and then compiled and executed the actual specifications.

As well as establishing that VIPER contains no fundamental logic errors, the proof process provides complete, unambiguous documentation of the processor's operation at each description level with the LCF-LSM descriptions. This is of great importance, as incorrect or ambiguous documentation of a correct hardware feature can produce bugs in a program just as easily as can a fault in the hardware. Similarly incomplete documentation has plagued microprocessors since their earliest days.

VIPER Software

Although VIPER's designers have established the correctness of the chip's design, the problem of writing correct software for it remains. There has been much research into mathematical software verification techniques, such as Oxford University professor C.A.R. Hoare's work on the laws of programming (see "Mathematics of Programming," August 1986 BYTE), but few such techniques are practical for commercial use. Even so, programmers can apply several methods to improve the prospects of writing correct VIPER programs.

Most programmers will write VIPER programs either in

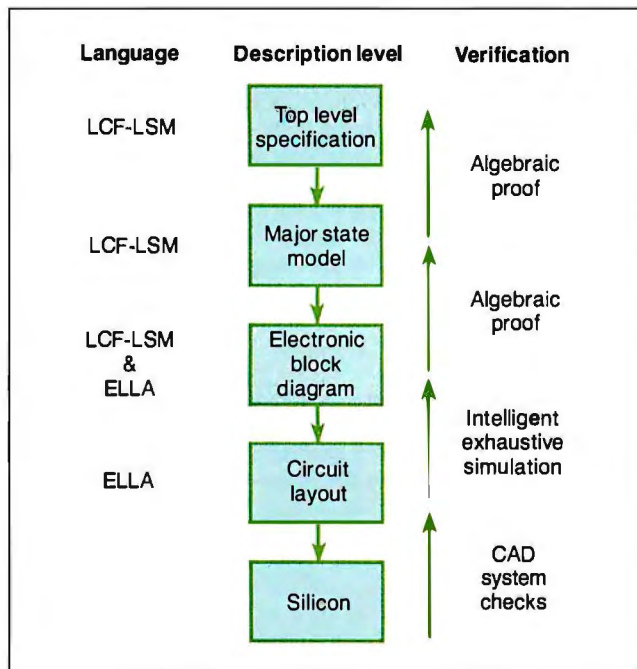

Figure 3: VIPER's hardware validation process uses a hierarchy of description levels.

VISTA (VIPER Structured Assembler), a block-structured high-level assembly language with a Pascal-like syntax, or in SPADE-Pascal. Two sophisticated program-analysis tools are available to handle programs written in these languages. The RSRE staff developed MALPAS (Malvern Program-Analysis Suite) to analyze VISTA programs, while researchers at Southampton University developed SPADE (Southampton Programs Analysis and Development Environment).

Both programs perform static analysis; that is, they investigate the structure of a program from its source text without running it. Both also require translation of the source program into an intermediate language in which the programmer can write the high-level specifications of the program's behavior. Finally, both provide the automated tools to do the translation.

MALPAS performs six different analyses on translated VISTA programs. Control Flow Analysis finds all routes through the program and isolates dead code; Data Use Analysis identifies program inputs and outputs; and Information Flow Analysis checks the dependencies between inputs and outputs. Partial Program Analysis decomposes the program into modules for checking by the Semantic Analyzer, which determines the relationship between inputs and outputs for all paths through the program. Compliance Analysis compares the results of the Semantic Analyzer with the program's intermediate language specification and reports noncompliances. Static analysis can find many deep bugs in a program structure, and programmers can use the results of the analysis further to help design test suites for dynamic analysis of the running program.

SPADE-Pascal is a subset of ISO-Pascal, minus some potentially unsafe constructs, such as variant records and procedural parameters. Soon, SPADE will include translators for Ada and Modula-2 in addition to Pascal. SPADE-Pascal uses formal comments, or "annotations," that SPADE can use to verify programs. SPADE includes a verification condition generator that works on programmer assertions expressed in these annotations, and a proof checker (written in Prolog) that can prove that the conditions are satisfied. Both of these tools, and the language systems they support, run under the VIPSE (Viper Integrated Programming Support Environment) operating environment.

A Failsafe Future?

It will be some time before hardware and software verification impinges significantly on the mainstream of personal computing. One reason is that the technique used to verify VIPER can cope only with chips with a complexity of up to 10,000 gates (VIPER has 5,000, while processors like the 68020 have closer to 100,000). In the interim, while researchers develop more powerful proof methods, it may be possible to use a verified chip like VIPER as a watchdog that checks the inputs and outputs of riskier chips. Marconi intends to use this approach to interface VIPER-1 to an off-the-shelf floating-point coprocessor, since the verification of floating-point arithmetic is currently controversial.

The prospect of a bug-free microprocessor may seem unexciting to those who love to argue over who has the fastest 80386 system and swap stories of bugs in their C compilers. But, sooner or later, hardware and software verification will affect everyone directly. Beyond its application in military aircraft control and weapons arming systems, VIPER may appear in control systems for nuclear power plants and even commercial passenger jets, which are moving toward fly-by-wire technology. ■

Dick Pountain is a BYTE contributing editor, a technical author, and a software consultant living in London, England. You can contact him on BIX as "dickp."

VMEbus Multibus I & II S-100 bus

To achieve performance, you need a performance bus. To find out the latest information on any of the above buses, you need

SUPERMICRO

the magazine for integrators and users of VME, Multibus, and S-100.

SUPERMICRO, PO Box 2089, Provo, UT 84603

To find out how you can receive a trial issue, circle the number below.

Circle 302 on Reader Service Card

RS-422

- RS-422/485
- Selectable Address/IRQ
- Two/Four Wire Operation
- One/Two/Four Port Versions
- Delivery From Stock

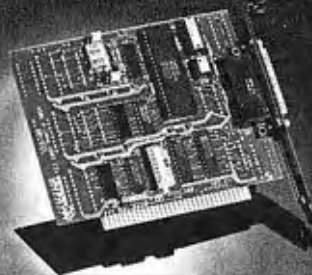

SEALEVEL SYSTEMS INC.
PO BOX 1808
EASLEY, SC 29641
(803) 855-1581

Circle 244 on Reader Service Card

Fix common problems fast!

You don't need to be an expert to diagnose and correct problems involving PC setup. All you need is HELPME™ software! More than 300 tests. On-screen help for understanding and correcting identified problems. Quick identification of system configuration and compatibility. \$99 plus shipping and handling. MC and VISA accepted. California Software Products, Inc., 525 N. Cabrillo Park Drive, Santa Ana, CA 92701 (714) 973-0440.

Circle 44 on Reader Service Card
(DEALERS: 45)

THE BUYER'S MART

A Directory of Products and Services

THE BUYER'S MART is a monthly advertising section which enables readers to easily locate suppliers by product category. As a unique feature, each BUYER'S MART ad includes a Reader Service number to assist interested readers in requesting information from participating advertisers.

RATES: 1x—\$475 3x—\$450 6x—\$425 12x—\$375
Prepayment must accompany each insertion. VISA/MC Accepted.

AD FORMAT: Each ad will be designed and typeset by BYTE. Advertisers must

furnish typewritten copy. Ads can include headline (23 characters maximum), descriptive text (250 characters is recommended, but up to 350 characters can be accommodated), plus company name, address and telephone number. Do not send logos or camera-ready artwork.

DEADLINE: Ad copy is due approximately 2 months prior to issue date. For example: August issue closes on June 9. Send your copy and payment to THE BUYER'S MART, BYTE Magazine, 1 Phoenix Mill Lane, Peterborough, NH 03458. For more information call Mark Stone at BYTE 603-924-3754.

ACCESSORIES

FREE CATALOG

Thousands of parts and new surplus electronic parts at super low prices. FAST ORDER PROCESSING AND SHIPPING (95% of all orders shipped within 48 hours).

CALL OR WRITE FOR A FREE CATALOG. . .

ALL ELECTRONICS CORPORATION
P.O. Box 567, Van Nuys, CA 91408-0567

1-800-826-5432

Inquiry 576.

ACCESSORIES

FREE Source-Book

1988 Industrial Computer Source-Book For Engineers & Scientists

164 page Source-Book Includes • Industrial & Lab Computers • Data Acquisition & Control I/O Cards • NEW 386 CPU Cards • CMOS I/O Cards • NEW PS/2 I/O Cards • Broad selection of Engineering and Scientific Software • And Much More!

Industrial Computer Source

5466 Complex St. #208, San Diego, CA 92123

(619) 279-0084 Ext. 1

The Single Source for Industrial Computer Supplies

Inquiry 581.

BAR CODE

BARCODE BARGAINS

Buy direct and save. We'll beat any written quotes for competing equivalent bar code readers or bar code label generation software. Call or write for brochures. Quantity discounts, warranty, same day shipping. Bar codes are all we do at ITS.

International Technologies & Systems Corp.

1950 White Star Dr., Diamond Bar, CA 91765

(714) 861-7977 Telex 6502824734 MCI

Inquiry 583.

SOFTWARE PACKAGING, DISKS

Cloth binders & slips like IBMs. Vinyl binders, boxes, and folders—many sizes. Disk pages, envelopes & labels. Low qty. imprinting. Bulk & branded disks. Much More! Low prices. Fast service. Call or write for FREE CATALOG.

Anthropomorphic Systems Limited
376-B East St. Charles Road
Lombard, IL 60148

1-800-DEAL-NOW (312) 629-5160

Inquiry 577.

ARTIFICIAL INTELLIGENCE

muLISP™ 87 for MS-DOS

Fast, compact, efficient LISP programming environment. muLISP programs run 2 to 3 times faster & take 1/2 to 1/3 the space of other LISP's. 450 Common LISP functions, multi-window editing & debugging, flavors, graphics primitives, lessons & help, demo programs, comprehensive manual.

Soft Warehouse, Inc.

3615 Harding Ave., Suite 505, Honolulu, HI 96819

(808) 734-5801

Inquiry 582.

BAR CODE MADE EASY

PERCON® E-Z-READER™ keyboard interfaces and multiter RS-232 models make it easy to add bar code to virtually any computer/terminal WITHOUT SOFTWARE MODIFICATION. Immediate shipping. Two year warranty. Bar code printing software available. Call for details on fast, accurate, easy data entry. Substantial reseller discounts.

PERCON®

2190 W. 11th St., Eugene, OR 97402

(503) 344-1189

Inquiry 584.

JOB PROTECTION

If your job depends on your computer, you should have our FREE catalog. Call (800) 356-5794 Ext. 1001 for a FREE catalog from the world's largest manufacturer of single phase uninterruptible power supplies. Call or write today!

BEST POWER TECHNOLOGY, INC.

P.O. Box 280, Necedah, WI 54646

In Wis. (608) 565-7200 Ext. 1001

(800) 356-5794 Ext. 1001

Inquiry 578.

BAR CODE

BAR CODES & BIG TEXT

On EPSON, IBM, OKI dot matrix or LaserJet. Design any format/size on ONE easy screen. 1-120 fields/label, 13 text sizes to 1" — readable at 50 ft. AIAG, MIL-STD, 2 of 5, 128, UPC/EAN, Code 39, etc. Color, Reverses, File Input, FAST—\$279. Other menu-driven bar code programs from \$49. 30 day \$ back.

Worthington Data Solutions

417-A Ingalls St., Santa Cruz, CA 95060

(800) 345-4220 In CA: (408) 458-9938

READ & PRINT BAR CODES

Fast, reliable data entry into your programs as if from your keyboard. Internal unit for PC, XT, AT PS/2-M30. RS-232 unit for DOS & Non-DOS systems (incl. all PS/2). Stainless steel wand and LASER interfaces. Powerful Bar Code and Text printing software.

Seagull Scientific Systems

601 University Ave., Suite 150, Sacramento, CA 95825

(916) 386-1776

RE-INK FABRIC RIBBONS

Cut ribbon costs by using Borg Ribbon Inkers. Do all cartridge ribbons with just one inker. Choose from 3 models. Manual E-Zee Inker — \$39.50

Electric E-Zee Inker — \$89.50

Ink Master (Electric) — \$159.00

1000's of satisfied users in 5 years. Moneyback guarantee.

BORG INDUSTRIES

525 MAIN ST., JANESVILLE, IA 50647

1-800-553-2404

In IOWA 319-987-2976

Inquiry 579.

BAR CODE READERS

From the manufacturer for PC/XT/AT, & PS/2. Attaches as 2nd keyboard, reads as keyed data. External or bus install. With steel wand—\$399. Also Kimtron, Link, Wyse, & RS-232. Portables, Lasers, (hand-held or counter top), slot badge readers, and magnetic stripe tool 30 day \$ back.

Worthington Data Solutions

417-A Ingalls St., Santa Cruz, CA 95060

(800) 345-4220 In CA: (408) 458-9938

BAR CODE READERS

Among the industries best and most widely used barcode reader, reads all major barcode formats (code 39, 2 of 5, UPC/EAN, codabar), connects between keyboard & system, advanced CMOS uses keyboard power supply, connects to all IBM compatibles and DIN terminals, completely OS independent, software independent. Same day ship, 1 year warranty, 30 day satisfaction guarantee. CALL for prices too low to advertise.

Solutions Engineering Sales

8653 Georgia Ave., Silver Spring, MD 20910

800-635-6533

Inquiry 585.

SELF-INKING PRINTER RIBBON

Awarded United States Patent #4710162
Lasts 10-15 times longer than the conventional ribbon
For printers using 1/2" width open spool ribbon:

Okidata-82A-83A-84-92-93 Dec LA 160/120
Teletype-33, 35 Dec LA 300/IBM 1443
Star Gemini 10X Teletype-Model 40
Extel TI 800/810, 820, 880

Contact us by mail, phone or telex and we will forward you a brochure

CONTROLLED PRINTOUT DEVICES, INC.

POB 869, Baldwin Rd., Arden, NC 28704

(704) 684-9044 • TELEX: (FILMON-AREN) 577454

Inquiry 580.

PRINT BAR CODES/BIG TEXT FROM YOUR PROGRAM

Add bar codes and big graphics text to your program. Print from ANY MS-DOS language. Bar codes: UPC, EAN, 2 of 5, MSI, Code 39. Epson, OkI, IBM dot matrix text up to 1/2" LaserJet up to 2". Font cartridges not required. \$159—\$239. 30 day \$ back.

Worthington Data Solutions

417-A Ingalls St., Santa Cruz, CA 95060

(800) 345-4220 In CA: (408) 458-9938

DATA INPUT DEVICES

Bar Code & Magnetic Stripe Readers for microcomputers & terminals, including IBM PS/2 & others, DEC, AT&T, CT, Wyse, Wang. All readers connect on the keyboard cable & are transparent to all software. Low cost bar code print programs & magnetic encoders are also available. GSA contract #GS00K87AGS5346.

TPS Electronics

4047 Transport, Palo Alto, CA 94303

415-856-6833 Telex 371-9097 TPS PLA

Inquiry 586.

THE BUYER'S MART

BAR CODE

BAR CODE SCANNER/READER

For PC/XT/AT and compatibles, and APPLE II. Keyboard emulating model with wand for only \$249. Reads 2 of 5, UPC/EAN/JAN/UPC E, Code 39, CODABAR with 1 yr. warranty.
Also RS-232C and CENTRONICS models with choice of wands, hand-held, and auto scanners.
Call or write for free catalog.

TRADE MATRIX of Silicon Valley
3639 Satinwood Dr., San Jose, CA 95148
(800) 222-4229 Ext. 39, (408) 238-1784

Inquiry 587.

CAD/CAM

New! CADKEY3 (Ver. 3.02) \$2,695

CADKEY CADExpert \$325
New! CADKEY 1 \$425
New! CADKEY Solid Synthesis \$425
We also carry CADJET Input Tablets and Templates and other fine support products for CADKEY. Call or write.

HLB Technology
PO Box 527, Blue Ridge, VA 24064
703-977-6520 MC/VISA

Inquiry 588.

CASE

Affordable CASE

A new concept in Computer Aided Engineering! for developing PC/DOS applications! C Dispatcher generates fast, efficient C code for command and menu driven applications. Develop, document, and change easily. Many features. For many compilers. \$295.00 MC/VISA

Amaryllis Inc.

563 Waitaquadoc Rd., Bolton, MA 01740
(617) 365-5456

Inquiry 589.

FINITE STATE PROGRAM COMPILERS

A Case program that develops complex software programs in minutes instead of hours! The COMPEDITOR forms source Finite State programs in: ADA, BASIC, C, FORTRAN and PASCAL.

IBM PC, XT, AT, PS/2 175K RAM Dos 2.0+
Price: \$175.00 per compiler (With Primer) Sampler \$30

AYECO 5025 Nassau Circle, Orlando
INCORPORATED FL 32808 1-800-537-4753

Inquiry 590.

COMMUNICATIONS

MULTI-LINE PC-DOS BBS

The Bread Board System (TBBS). Secure, reliable, full-featured commercial information system for IBM XT/AT/386/PS2 or compatible. Menu editor allows customization by nonprogrammers. Kermit, X & Y Modem. High performance allows up to 32 simultaneous callers. User audit trail.
300/1200/2400/9600 bps.

eSoft, Inc.

15200 E. Girard Ave. #2550, Aurora, CO 80014
(303) 699-6565

Inquiry 591.

MULTI-USER BBS (FOR IBM PC AT)

TEAMate — a mainframe quality BBS. A mini Compu-Serve. Full screen cursor-controlled interface, topic outline structure, public and private topics, audit trails, xmodem, integrated mail, content retrieval and more. MS-DOS, XENIX and UNIX versions.

MMB Development Corporation

1021 No Sepulveda Blvd., Suite K, Manhattan Beach, CA 90266
1-800-832-6022, In CA (213) 545-1455

Inquiry 592.

COMMUNICATIONS

FAX MACHINES \$395

MURATA FAX 1200/1600 \$795/925
SHARP FAX FO300/FO500 \$1195/1495
TOSHIBA FAX 30100/3300/3700 \$1088/1240/CALL
RICOH 10/20 \$1295/1595
CANON FAX 20 \$1279
PC/XT SYS.Receiver/Transmit FAX+Scanner \$1595
PC/XT Telephone Answer & Voicemail \$1195

Prepay prices Visa/MC 2% cod 2% restock 20%
TELEPHONE PRODUCTS CENTER
23591 #213 El Toro Rd., El Toro, CA 92630 **714/739-9555**

Inquiry 593.

COMPUTER BOOKS

Books! Books! Books!

If it's published and about IBM or compatible computers, we probably have it. Books about applications, programming, operating systems, utilities, hardware and much more. Call today for a free catalogue.

Book Express

Dept. 100, 851 Weikner Ct. South, Buffalo Grove, IL 60089
1-800-234-2620

Inquiry 594.

COMPUTER INSURANCE

INSURES YOUR COMPUTER

SAFWARE provides full replacement of hardware, media and purchased software. As little as \$39 a year provides comprehensive coverage. Blanket coverage; no list of equipment needed. One call does it all. Call 8 am-10 pm ET. (Sat. 9 to 5)

TOLL FREE 1-800-848-3469

(Local 614-262-0559)

SAFWARE, The Insurance Agency Inc.

Inquiry 595.

CROSS ASSEMBLERS

FASTER TMS32020/C25

Macro Assembler
only \$49.95

Ariel Corporation

212-925-4155

110 Greene Street, Suite 404, New York, New York 10012
DSP BBS: 212-925-4131
300, 1200/2400 MNP-5, 9600 UST 8 bits, no parity, 1 stop bit

Inquiry 596.

CROSS ASSEMBLERS

Universal Linker, Librarian

Targets for 36 Microprocessors

Hosts: PC/MS DOS, micro VAX, VAX 8000
Developed and supported at:

ENERTEC, INC.

BOX 1312, Lansdale, PA 19446

215-362-0966 MC/VISA

Inquiry 597.

Professional Series

PseudoCode releases its PseudoSam Professional Series of cross assemblers. All popular processors. Macros, Conditional Assembly, and Include Files. Virtually unlimited size. For IBM PC's, MS-DOS 2.0 or greater. With manual for \$35.00. Each additional \$20.00. (MI res. 4% tax). Visa/MC. (Dealer Inquiries Welcomed.)

Order from distributor:

Micro Kit

6910 Patterson, Caledonia, MI 49316, 616-791-9333.

Inquiry 598.

CROSS ASSEMBLERS

CROSS ASSEMBLERS

8 BIT DEBUG/SIMULATORS

DISASSEMBLERS

EPROM, 8748, PLD Programmers

All run in PC/XT/AT Full featured

MICROCOMPUTER TOOLS

Phone (800) 443-0779

In CA (415) 825-4200

812 Hastings Dr., Concord, CA 94518

Inquiry 599.

680X0 Cross Assemblers

Now, inexpensive quality 680X0 Cross Assemblers that use your IBM PC or compatible. All versions include extensive listing facilities, up to 32 char labels, sorted symbol tables, INCLUDE files, PATH names, ORG, DC, DS, EQU, many other directives (except MACROS), printed manuals. Basic versions create S-records. Linking versions create either S-records or relocatable modules, and include a linker which creates S-records or binary output files. Not copy protected. Minimum requirements are 320K, DOS 2.0X, & 1914" DSD. Basic 6800/68010-\$49.95 Linking 6800/68010-\$89.95 Basic 68020/68881-\$149.95

Check, VISA, MC accepted. MN residents +6% sales tax. No PD's or COD's, please

RAVEN Computer Systems

Box 12116, St. Paul, MN 55112

(612) 636-0365

Inquiry 600.

Z80/HD64180

SLR Systems cross assemblers run on PC and are compatible with Microsoft M80/L80. \$195.00 for assembler and linker. We have CP/M emulator cards for PC. Up to 12.5 mhz Z80 clock speed, starting at \$249.95! Also Z80/HD64180 C compilers.

Z-World

1772 Picasso Ave., Davis, CA 95616 (916) 753-3722
Please see our ad on page 325.

Inquiry 601.

DATA CONVERSION

MEDIA CONVERSION/DATA TRANSLATION

More than just a straight dump or ASCII transfer! Word Processing, DBMS, and Spreadsheet data on Disks or Tapes transferred directly into applications running on Mainframes, Minis, Micros, Dedicated Word Processors, Typesetters, and Electronic Publishing systems.

IBM PS/2 & Macintosh supported

#1 in the translation industry!

CompuData Translators, Inc.

3325 Wilshire Blvd., Suite 1202, Los Angeles, CA 90010
(213) 387-4477 1-800-825-8251

Inquiry 602.

DATABASE MGMT. SYSTEMS

dBASE III WORKALIKE \$39

1 on 1 = 3!! "a programmable relational DBMS... the menu mode is a fancier and more complete version of dBASE's... faster operation in the interactive mode... runs command files slower... at \$39, 1 on 1 = 3!! is a great deal for those who would be glad to have a dBASE III Plus clone!" *PC MAGAZINE 5/17/88.*
SEND CHECK \$39 + \$4 s/h or INQUIRE!!

1 on 1 Computer Solutions

26 Finchwood Dr., Trumbull, CT 06611

203-375-0914

Inquiry 603.

DATA/DISK CONVERSION

Get the Expertise You Need!

Disk/Disk • Tape/Disk • OCR

Over 1,000 formats! 3 1/2, 5 1/4, or 8 inch disks; 9 track mag tape; 10 MB Bernoulli cartridge. Data base and word processor translation. Specialists in Government Security Data. Call for free consultation.

Computer Conversions, Inc.

9580 Black Mtn. Rd., Ste J, San Diego, CA 92126

(619) 693-1697

Inquiry 604.

THE BUYER'S MART

DATA/DISK CONVERSION

DISK CONVERSIONS

Media transfer to or from: IBM, Xerox, DEC, Wang, Lanier, CPT, Micom, NBI, CT, also WP, WS, MS/WRD, DW3, MM, Samna, DEC DX, MAS 11, Xerox-Writer, ASCII.

FREE TEST CONVERSION CONVERSION SPECIALISTS

531 Main St., Ste. 835, El Segundo, CA 90245
(213) 545-6551 (213) 322-6319

Inquiry 605.

DISK & TAPE CONVERSIONS AUTOMATICALLY SAVE TIME AND MONEY

Over 1000 formats from Mini, Micro Mainframe, Word Processors, & Typesetters.

TAPE Conversions as low as \$2300 MB
DISK Conversions as low as \$15.00 per Disk
Call or write TODAY for a cost saving quotation.

CREATIVE DATA SERVICES
1210 W. Latimer Ave., Campbell, CA 95008
(408) 866-6080

Inquiry 606.

DISK INTERCHANGE SERVICE COMPANY

DISC specializes in transferring files between incompatible disk formats, and between disk and 9-track tape.

- Dedicated Word Processors
- Mini, Micro & Mainframe Computers
- 9-Track Tape (800, 1600 and 6250 BPI)
- MSDOS, CP/M, UNIX, DOS, PRODOS, TSX+, RT-11

2 Park Drive • Westford, MA 01886
(617) 692-0050

Inquiry 607.

QUALITY CONVERSIONS

- Disk
- Scanning
- Tape

*TYPEWRITTEN \$33 per page to ASCII
*TYPESET 6-24 point Low Rates
(*WP Formats available)

IMAGES
Logos/Line Art/Glossies

1st Run Computer Services Inc.
1261 Broadway, Suite 508, New York, NY 10001
(212) 779-0800

Inquiry 608.

IBM PC ↔ to ↔ HP

FILE COPY

IBM PC to HP File Copy allows IBM PCs, PS/2, compatibles to read, write files written by Hewlett Packard Series 70, 80, 200, 300, 1000, 9000's. We offer custom work using our file copy utilities and program translators. Call for estimate, catalog, data sheet.

Oswego Software 312/554-3567
507 North Adams St. Fax 312/554-3573
Oswego, Illinois 60543 Telex 858-757

Inquiry 609.

CONVERSION SERVICES

Convert any 9 track magnetic tape to or from over 1000 formats including 3 1/2", 5 1/4", 8" disk formats & word processors. Disk to disk conversions also available. Call for more info. Introducing OCR Scanning Services.

Pivar Computing Services, Inc.
165 Arlington Hgts. Rd., Dept. #B
Buffalo Grove, IL 60089 (312) 459-6010

Inquiry 610.

312 B Y T E • JULY 1988

dBASE III COMPILERS

FREE dBASE III + COMPILER DEMO DISK

Don't buy Clipper™ until you see our FREE dBASE Compiler Evaluation Kit. Includes DEMO DISK with 8 PRG's and results of compiling with Clipper, Quicksilver & Fox-BASE +. Also 15 benchmark tests, complete magazine reviews, and detailed brochures about all 3 compilers. FREE. No obligation. Call 24 hours, 7 days.

dataBASE Specialties (415) 652-2790
P.O. Box 2975, Oakland, CA 94618

DEMOS/TUTORIALS

INSTANT REPLAY III

Build Demos, Tutorials, Prototypes, Presentations, Music, Timed Keyboard Macros, and Menu Systems. Includes Screen Maker, Keystroke/Tme Editor, Program Memorizer, and Animator. Read Great Reviews! Simply the BEST. Not copy protected. No royalties. 60 day satisfaction money back guar. IBM and Compatib. \$149.95 U.S.Chk/Cr. Crd. Demo Diskette \$5.00

NOSTRADAMUS, INC.
3191 South Valley Street (ste 252)

Salt Lake City, Utah 84109 (801) 487-9662

Inquiry 611.

DISK DRIVES

PS/2 DRIVES FOR PC's AT's

CompatiKit/PC\$329

CompatiKit/AT\$309

Built-in floppy controllers—no problem.

Supports multiple drives and formats. Lets your computer use IBM PS/2 1.4M diskettes *plus more!* Call for further information or to place an order.
VISA/MC/COD/CHECK.

Micro Solutions Computer Products
132 W. Lincoln Hwy., DeKalb, IL 60115 815/756-3411

Inquiry 612.

DUPLICATION SERVICES

SOFTWARE DUPLICATION

- One Stop Shopping
- Custom Packaging
- Copy Protection
- Technical Support
- Drop Shipping
- Fast Turnaround
- Competitive Pricing

SATISFACTION GUARANTEED
800-222-0490 NJ 201-462-7628

MEGASoft

P.O. Box 710, Freehold, NJ 07728 See our ad on page 334.

Inquiry 613.

SOFTWARE PRODUCTION

- Disk duplication
- All formats
- EVERLOCK copy protection
- Label/sleeve printing
- Full packaging services
- Warehousing
- Drop shipping
- Fulfillment
- 48-hour delivery
- Consultation & guidance

Star-Byte, Inc.

713 W. Main St., Lansdale, PA 19446

215-368-1200 800-243-1515

Inquiry 614.

ELECTRONIC PROJECTS

BUILD TALKING ROBOT!

- Build B.E.R.T.® the Basic Educational Robot Trainer
- Featured in BYTE April & May 1 87
- Even a child can program this talking Robot, built from off-the-shelf components
- Minimum Kit \$43.00 U.S.
- Complete Kit \$165.00 U.S.
- For further information write to:

GoCo Dist.

Suite 806, 1146 Harwood St.
Vancouver, B.C. Canada V6E 3V1

Inquiry 615.

ENTERTAINMENT

NEMESIS™ Go Master™

Go is a popular Oriental game of intellectual complexity and elegance. NEMESIS, recognized worldwide as the best Go program, is an ideal playmate and tutor. Pournelle's game of the month *twice*. "If you are interested in Go, buy this program." BYTE 7/87

Toyogo, Inc.

100 Fifth Ave., Dept. Y, Waltham, MA 02154
(617) 890-4184

Inquiry 616.

FLOW CHARTS

FLOW CHARTING II+ HELPS YOU!

Precise flowcharting is fast and simple with Flow Charting II+. Draw, edit and print perfect charts: bold and normal fonts, 26 shapes—95 sizes; fast entry of arrows, bypasses & connectors; Fast Insert Line; shrink screen displays 200-column chart; 40 column edit screen for detail work, much more!

PATTON & PATTON

81 Great Oaks Blvd., San Jose, CA 95119

1-800-525-0082 (Outside CA)

408-629-5376 (CA/Int'l)

Inquiry 617.

STRUCTURED FLOW CHART

NSChart creates Nassi-Shneiderman (structured) flowcharts from a simple PDL. Keywords define structures & text strings appear in the chart. Easy to create, even easier to revise! Automatic chart sizing, text centering. Translators from many languages available. For Mac and IBM PC.

SILTRONIX, INC.

P.O. Box 52544, San Diego, CA 92138

1-800-637-4888

Inquiry 618.

HARDWARE

IBM PS/2's Up to 41% off!

	Retail	Your Cost
MODEL 50-386	(New)	\$Call
MODEL 60-041	5,295	3,395
MODEL 60-071	6,295	3,850
MODEL 80-041	6,995	4,395
MODEL 80-071	8,495	4,995
MODEL 80-111	10,995	7,895
MODEL 80-311	13,995	9,995

American Micro Computer Center (305) 985-9406
2690 Griffin Rd., Suite #4, Ft. Lauderdale, FL 33312

Inquiry 619.

DISCOUNT CLONES

- XT Turbo — \$435.
- AT 8/10 MHz — \$995
- Seagate ST225 20MB hard drive with controller — \$300.
- 386 25MHz — \$2,450.
- Hayes compatible 1200 baud modem — \$99.
- Evermix EGA — \$150.
- Seagate 40MB hard drive — \$375.

Automated Business Solutions

516-379-3995

30 day money back guarantee • 1 yr parts & labor warranty
Dealer inquiries invited. Please call for complete price list.

Inquiry 620.

CHIP CHECKER

- 74/54 TTL + CMOS
- 14/4000 CMOS
- 14-24 Pin Chips
- 8000 Nat. + Signetics
- 9000 TTL
- 3" + 6" IC widths

Tests/identifies over 650 digital chips with ANY type of output in seconds. Also tests popular RAM chips. IBM compatible version \$259. C128 + C64 version \$159.

DUNE SYSTEMS

2603 Willa Dr., St. Joseph, MI 49085

(616) 983-2352

Inquiry 621.

THE BUYER'S MART

HARDWARE

INDUSTRIAL STRENGTH SINGLE BOARD COMPUTER
Has optimum features for monitor + control applications: 16 Chan A/D • 4 RS232/422 Ports • 48 Prog I/D Lines • 8 Opto INs • 8 HiDrive OUTs • 4 Timers • Watchdog • 104K Memory • 5.25 x 8.0 Options: Resident FORTH OS with Target Compiler, Editor, Assembler • Auto Load/Start; 5 MHz; 8085 • 4 Chan D/A • Battery Backed Clock/DRAM • Networking • PC Support.
E-PAC 1000 + \$249.00 E-PAC 2000 + \$449.00

EMAC INC.

PO. Box 2042, Carbondale IL 62902 (618) 529-4525

Inquiry 622.

HARDWARE/ADD-ONS

MYRIAD MODEM 2400BPS ONLY \$135

- Hayes compatible
- Free Bitcom software
- For IBM PC/XT/AT & compatibles
- 4 Com ports selectable
- Made in USA
- 2 years warranty

DATA ERA STORE (408) 729-4589

1556 Halford Ave., No. 168, Santa Clara, CA 95051

Inquiry 628.

INVENTORY MANAGEMENT

STOCK-MASTER 4.0

Commercial grade inventory management software at micro prices.

- Supports all 12 transaction types
- Trend Analysis
- Quality Control
- Multiple Locations
- Purchase Order Tracking
- Open Order Reporting
- Serial/Lot # Tracking
- Stock Status Reporting
- Activity History Analysis
- Bill of Materials
- Purchase Order Writing
- Order Entry
- Material Requirements
- On Line Inquiry

Applied Micro Business Systems, Inc.
177-F Riverside Ave., Newport Beach, CA 92663 714-759-0582

Inquiry 634.

LAPTOP COMPUTERS

LAPTOP SPECIALS

Toshiba • Zenith • NEC • DATA/UE • SHARP • LAPTOPS • AFFORDABLE 5 1/4" or 3 1/2" DRIVE UNITS for LAPTOPS & DESKTOPS including Tandy 1400 LT. • DICONIX PRINTERS • 768 card for T1000 • 2400 BAUD MODEMS for Laptops • Laptop software • Hard drives • Fast reliable and friendly service. For Low Pricing call

COMPUTER OPTIONS UNLIMITED
201-469-7678 (7 Days, 9 am-10 pm Eastern time)

Inquiry 635.

FREE CATALOG

Protect your computer power from black-outs, brown-outs, audio/video hash and surge! Complete line of low cost Emergency Power Supply units, Line Conditioners and Surge Suppressors prevent damage and loss of valuable data. Prevent errors, malfunctions and false printouts! Send for money saving catalog today.

INDUS-TOOL

730 W. Lake St., Chicago, IL 60606

Phone 312-648-2191

Inquiry 623.

IBM PC's USE Mac DISKS

MatchMaker lets you plug any Macintosh external floppy drive into an IBM PC. Half size card and software lets you copy to/from, view directory, initialize, or delete files on the Mac diskette. Works with PCs, XT's, AT's, and compatibles. *The easy way to move information!*
\$149.00 Visa/MC/COD/Chk.

Micro Solutions Computer Products

132 W. Lincoln Hwy., DeKalb, IL 60115 815/756-3411

Inquiry 629.

HARDWARE CO-PROCESSOR

DIGITAL SIGNAL PROCESSOR

DSP products for the IBM PC/XT/AT based on the TI TMS32010 and TMS320C25. Designed for applications in communications, instrumentation, speech, and numeric processing. Offered with 12 bit 80 KHz A/D and D/A and continuous data acquisition & playback option. \$650 and up.

DALANCO SPRY

Suite 241, 2900 Connecticut Ave, NW,
Washington DC 20008
(202) 232-7999

Inquiry 630.

L A P - L I N K

The ultimate solution for linking laptop computer with any IBM compatible desktop PC. 115, 200 baud transfer rate—faster than any other product available. No installation necessary, easy to use split screen design. Includes incredible "universal cable" that connects any two computers. Transfer entire disks faster than a DOS copy command! Only \$129.95 including universal cable and both 3 1/2" and 5 1/4" disks. "Bridle" owners can trade in for only \$89.95 w/o cable.

Traveling Software, Inc.
19310 No th Creek Parkway, Bothell WA 98011
1-800-343-8080 (206) 483-8088

Inquiry 636.

87C51 PROG. \$125.00

The UPA 87C51 Programming Adapter lets you use your general purpose programmer to program the 87C51, 8751H, AMD8753H, 87C252, and 8752BH. Also lets you program the 87C51/8751H security bits and the 87C51 encryption array. It's very simple and VERY cost effective.

LOGICAL SYSTEMS CORPORATION

6184 Teal Station, Syracuse NY 13217

(315) 478-0722 Telex 6715617 LOGS

Inquiry 624.

NorthStar

Sales and service. NorthTech Specializes in Horizon and Advantage hardware/software/support. Largest full service distributor of NorthStar products in United States. We buy-sell-trade NorthStar products and peripherals. • complete repair facilities • tech support and training • all hardware and software in stock • same day service available • ten years of customer satisfaction

NorthTech Support Services, Inc.

Oberlin, Ohio / Arlington, Virginia

1-800-426-7898 216-775-0525

Inquiry 625.

PC MINI-SUPERCOMPUTER

Up to 40 MIPS in Your PC!

Fill your PC/XT/AT with 1 to 6 PC4000 boards for a high speed PC-RISC system. The PC4000 uses the NC4016 RISC Engine which executes high level Forth in silicon. Each PC4000 is a general purpose parallel coprocessor that delivers speeds in the 5 to 7 MIPS range...over a 100 times faster than a PC, uses Forth, C or Assembler. From \$1295.

SILICON COMPOSERS (415) 322-8763

210 California Ave., Suite K, Palo Alto, CA 94306

Inquiry 631.

LEGAL

LEGAL DOCUMENT MAKER

All pleadings and documents.
Any word processor software.

Free Brochure.
New! Supra II™.

TSC

The Software Company

P.O. Box 872687, Wasilla, AK 99687

(907) 745-6267

Inquiry 637.

HARDWARE/PERIPHERALS

BUILD SCALE SYSTEMS FOR LESS

For a fraction of your present cost, you can produce professional computerized weighing systems using building-block interface modules and software. They're versatile, easy to use and unbeatable value.

Call or write for brochures, prices and examples taken from our wide industrial experience.

SCALE-TRON INC.

P.O. Box 424, Lachine, Quebec, H8S 4C2 CANADA
(514) 634-7083

Inquiry 632.

INFORMATION

100 TABLES

From the U.S. Statistical Abstract
"The U.S. Statistical Abstract" has a wide variety of public information on (economics, health, education, crime, the world and more.) 100 selected tables of the 1988 Abstract are now available on disk in (CAL, WKS, CSV, or TXT) formats for (PC or MAC or most CP/M)—\$49.95

FAIRFACTS

Box 536, San Rafael, CA 94915
Tel. 415-465-1781

Inquiry 633.

BUY ★ SELL ★ TRADE

Apple • IBM • Compaq • Service Parts
• Accessories • Systems •

PRE-OWNED Electronics, Inc.

30 Clematis Avenue, Waltham, MA 02154

800-274-5343 FAX 617-891-6851

Service Centers and Dealers welcome

Inquiry 626.

SANYO 550/555 USERS

387.2MHZ TURBO BD. W/8088-2.....\$79.95
IBM STYLE CGA VIDEO BD.....\$159.95
IBM STYLE RS-232.....\$79.95
SANYO-RS-232.....\$49.95
768K MEM/CLK/EXPANSION BD.....\$169.95
20 MEG HARD DISK SYSTEM.....\$599.95
COMPOSITE MONO MONITOR.....\$109.95
550 COMMUNICATIONS SOFTWARE.....\$49.95

TAMPA BAY DIGITAL

1750 Drew St., Clearwater, FL 34615

*** FREE CATALOG *** 813-443-7049

Inquiry 627.

MEMORY CHIPS

MEMORY CHIPS

41256-15-12-10.....	Call	51000 (1 Meg).....	Call
4164-15.....	Call	51258 for Compaq 386.6.43	
4164-12.....	Call	8087-3-2.....	96/143
41128 Piggy Back for AT.....	2.63	80287-6-8-10.....	155/233/293
41464-12 (64Kx4).....	3.27	80387.....	Call
414256 (256Kx4).....	Call	NEC-V-20-8.....	Call
2764.27128.27256.27512.....	Call	Mouse.....	\$49

Prices subject to change

ESSKAY 718-353-3353

Inquiry 638.

MUSIC

MIDI — PC/XT \$84.95

Your MIDI instruments can talk with your PC/XT via a MIDIATOR9. Software INCLUDED! MT-8 Sequencer, Performance Splitter/Auto-Chord, & MIDI Monitor. Requires 256K, DOS 2.0+, Std. Serial Port (COM1 or COM2) & std. cables. Needs no modifications, exp. slot, or power sup. Introductory Price \$84.95+5.00 s/h, TX res. add 7.25% tax. MC, VISA Check (allow 10 days).

Key Electronic Enterprises

9112 Hwy. 80 W., Suite 221-B, Fort Worth, TX 76116
(817) 560-1912

Inquiry 639.

THE BUYER'S MART

MUSIC

PC/MIDI Hardware & Software—\$149.95

The new standard in the PC/MIDI world!

- MIDI Interface Card
- Sequencer Software
- MIDI Cables (1 in/3 out)
- 64-track digital recording
- 600 ticks per quarter note resolution
- 60,000 events

Developer's source code \$19.95. Best MIDI offer ever made!

Make check payable to:

MidIMusic

500 E. Arapaho, Suite 609, Richardson, TX 75081

1-800-456-MIDI

214/238-5269

Inquiry 640.

PROGRAMMER'S TOOLS

CLIPPER™ DEVELOPMENT TOOLBOX

Alternative Business Training, Inc. introduces **BOATSWAIN'S MATE**®, a set of over 150 functions, procedures, and DOS Utilities for dBase™ programmers who use clipper as a compiler. Thousands of development hours have gone into this software in order to save you hours of programming time. Whether you are a novice or a serious clipper developer, the **BOATSWAIN'S MATE**® is for you. Free list of library functions available.

Call 1-800-328-7677

In N.H. 1-357-8665

ALTERNATIVE BUSINESS TRAINING, INC.

206 Washington St., Keene, NH 03431

Inquiry 641.

ASCII WILL PAY YOU \$40

for your old screen or application generator when you buy Turbo Programmer (formerly T-GhostWriter) for Turbo Pascal 4.0 or Turbo C. Complete data base T-Pascal or C source code in under 5 minutes from screens you draw. B-Tree indexes & file manager included. Unlimited technical support that our customers brag on.

\$289 (\$249 after rebate).

ASCII 800 227-7681

Inquiry 642.

TLIB™ 4.0 Version Control

The best gets better! They loved TLIB 3.0: "packed with features... [does deltas] amazingly fast... excellent"—PC Tech Journal Sept 87. "has my highest recommendation"—R. Richardson, Computer Shopper Aug 87. Now TLIB 4.0 has: branching, more keywords, wildcards & file lists, revision merge, LAN and WORM drive support, more. MS/PC-DOS 2.x & 3.x \$99.95 + \$3 s&h. Visa/MC.

BURTON SYSTEMS SOFTWARE

P.O. Box 4156, Cary, NC 27519 (919) 469-3068

Inquiry 643.

TURBO PLUS \$99.95

Programming tools for Turbo Pascal 4.0 Screen Painter, Code Generator, I/O Fields, Dynamic Menus, Programming Unit Libraries, Sample Programs, 280 Page Illustrated Manual, 60 Day Satisfaction Guarantee! Brochures & Demo Diskettes avail. Highly Favorable Reviews! IBM & Compatibles.

Nostradamus Inc.

3191 South Valley St. (Suite 252) Salt Lake City, UT 84109
(801) 487-9662

Inquiry 644.

Modula-2

Graphix is the Modula-2 interface to the widely used MetaWindow professional graphics library. Supports multiple fonts, mouse tracking, many printers (incl. PostScript & LaserJet), over 30 display adapters, and hundreds of modes. \$149 (\$189 with source). Includes MetaWindow package. For JPI, Logitech, Stony Brook, ITC, and other compilers. From the creators of Repertoire, ModBase, Macro2, EmsStorage, DynaMatrix, and the Repertoire/Brieve Toolkit. Foreign currencies welcome. MC/VISA/AMEX/COD.

PMI 4536 SE 50th, Portland, OR 97206
(503) 777-8844; TLX: 6502691013

Inquiry 645.

314 B Y T E • JULY 1988

PROGRAMMER'S TOOLS

FREE BUYER'S GUIDE

See Page 39

Programmer's Connection is an independent dealer representing more than 250 manufacturers with over 700 software products for IBM personal computers. Call to receive our FREE comprehensive Buyer's Guide or refer to page 39 of this issue to see a partial list of our software products.

Programmer's Connection

800-336-1166

216-494-3781

Inquiry 646.

DISASSEMBLERS

MPU OBJECT CODE on your PC

Relocatable, symbolic disassemblers are now available for the Motorola, Intel, RCA, TI, Rockwell, & Zilog micro! Automatic label generation, assembly capability and much more. Call and ask for what you need.

RELMS™

P.O. Box 6719, San Jose, CA 95150

(408) 356-1210

TWX 910-379-0014

(800) 448-4880

Inquiry 647.

PUBLIC DOMAIN

\$3.00 SOFTWARE FOR IBM PC

Hundreds to choose from, wordprocessors, databases, spreadsheets, games, lotto, communications, business, music, bible, art, education, language and useful utilities for making your computer easier to learn. Most programs have documentation on the disk.

WRITE FOR YOUR FREE CATALOG TODAY!

BEST BITS & BYTES

P.O. Box 8245, Dept. B, Van Nuys, CA 91409

(818) 781-9975

Inquiry 648.

FREE CATALOGUE PUBLIC DOMAIN/SHAREWARE

• 400 IBM PC & compatibles disks •

• 200 Amiga disks • 125 Atari ST disks

PC disks as low as \$1.25 each, Amiga & ST as low as \$1.60 each! Rent or buy. Free shipping! Call toll free, write or circle reader service for FREE BIG CATALOGUE with full descriptions. Please specify computer—48 hr. turnaround!

Computer Solutions

P.O. Box 354—Dept. B, Mason, Michigan 48854

1-800-874-9375 (M-F 10-6 EST) 1-517-628-2943

Inquiry 649.

RENT SOFTWARE \$1/DISK

Rent Public Domain and User Supported Software for \$1 per disk/full or we'll copy. IBM (3½" also), Apple, C-64, Sanyo 550 and Mac. Sampler \$3. VISA/MC. 24 hr. info/order line. (619) 941-3244 or send #10 SASE (specify computer) Money Back Guarantee!

FutureSystems

Box 3040 (T), Vista, CA 92083

office: 10-6 PST Mon-Sat. (619) 941-9761

Inquiry 650.

QUALITY SOFTWARE IBM/COMPATIBLES

Get a Word Processor, Spreadsheets, Database, Money Manager and 5 arcade games plus our 10,000 program catalog for ONLY \$10.00 (+s/h)

800-992-1992 (National)

800-992-1993 (Ca only)

619-942-9998 (Foreign)

VISA, MC, AMEX Accepted. (COD + 1.80)

The International Software Library

511-104 Encinitas Blvd., Encinitas, CA 92024

Inquiry 651.

PUBLIC DOMAIN

FREE SOFTWARE

The **PUBLIC DOMAIN USERS GROUP** provides public domain software for IBM, CP/M, C64 & C-128 computers. PDUG is one of the oldest (est. 1982) & largest (over 10,000 members worldwide) users groups.

SPECIAL OFFER—Send \$10 and receive not only our 1 year membership but also our new member disk free (contains 21 great programs). Or for more info., send a SASE (specify computer) to:

PUBLIC DOMAIN USERS GROUP

P.O. Box 1442-BM, Orangepark, FL 32067

904-264-3512 (ORDER LINE)

Inquiry 652.

FREE SOFTWARE

Buy or Rent \$1/disk

World's largest Free Software Library of IBM PC & Compatibles and Macintosh. Over 3000 programs for Religion, Utilities, Business, Com., Word Processor, Education, and Games on 5.4" and 3.5" format. Best quality, Lowest rate, and Fastest service. For fast free catalogue write to:

SOFTSHOPPE

P.O. Box 15022, Ann Arbor, MI 48105

(313) 763-8721

Inquiry 653.

\$4.00 SHAREWARE \$4.00

IBM-PC Compatible Software

- Over 700 Disks to Choose From
- Not Half Full Like Some Distributors
- Dozens of Programs in All Categories

Call or Write for FREE Catalog on Disk

— Please specify 5¼" or 3½" Disk —

The Software Kingdom

P.O. Box 358, Manchester, NH 03105-0358

1-800-552-DISK (In N.H.) (603) 627-0444

Inquiry 654.

SECURITY

BIT-LOCK® SECURITY

Piracy SURVIVAL 5 YEARS proves effectiveness of powerful multilayered security. Rapid decryption algorithms. Reliable/small port transparent security device. PARALLEL or SERIAL port. Countdown and timeout options also available. KEY-LOCK™ security at about 1/2 BIT-LOCK cost.

MICROCOMPUTER APPLICATIONS

7805 S. Windemere Circle, Littleton, CO 80120

(303) 922-6410 or 798-7683

Inquiry 655.

COPY PROTECTION

The world's leading software manufacturers depend on Softguard copy protection systems. Your FREE DISKETTE introduces you to SuperLock™—invisible copy protection for IBM-PC (and compatibles) and Macintosh.

- Hard disk support
- Customized versions
- No source code changes
- LAN support

• New upgrades available

(408) 773-9680

SOFTGUARD SYSTEMS, INC.

710 Lakeway, Suite 200, Sunnyvale, CA 94086

FAX (408) 773-1435

Inquiry 656.

SOFTWARE/ACCOUNTING

dBASE BUSINESS TOOLS

- General Ledger
- Accounts Recvbl.
- Order Entry
- Sales Analysis
- Purch Ord/Inventory
- Accounts Payable
- Job Costing
- Job Estimating

\$99 EA. + s&h w/dBASE 2, 3 or 3+ SOURCE CODE

dATAMAR SYSTEMS™ Cr. Crd/Chk/COD

4876-B Santa Monica Ave

San Diego, CA 92107 (619) 223-3344

Inquiry 657.

THE BUYER'S MART

SOFTWARE/ACCOUNTING

FINANCE MANAGER II

Easy to learn, fully integrated, menu-driven book-keeping system for small business and personal use. General Ledger, IBM PC, XT, AT, PS/2 or compat. **Try before you buy!** Fully functional 11 month General Ledger evaluation copy for only \$10!

CALL TODAY! (719) 528-8989
HOOPER INTERNATIONAL: PO Box 62219,
 Colorado Springs, Colorado 80962

Inquiry 658.

SOFTWARE/A.I.

Learn AI Fast

If/then™ is a book and a disk of Lotus spreadsheets. *"A marvelous little AI training package... you'll find it an excellent tutorial... this product is a must!"*

— Ezra Shapiro,
 BYTE, Aug. '87, p.263
If/then is only \$69.95

If/then Solutions

PO. Box 52097 Palo Alto, CA 94303 415-322-3430
 Lotus 1-2-3 rel 2 required, \$3 for shipping N.A., \$8 elsewhere

Inquiry 659.

SOFTWARE/BASIC

XGRAF DRAWS IN BASIC!

FINALLY! XGRAF replaces QuickBASIC's poor drawing commands with assembly language calls that work on Hercules, EGA, VGA, CGA and EEGA screens. Only \$99.00 + \$4.00 S&H. Call us at 1-800-423-3400 (9:00 AM to 8:00 PM EST)

KOMPUTERWERK, INC.

851 Parkview Blvd., Pittsburgh, PA 15215
 For info., call (412) 782-0384

Inquiry 660.

SOFTWARE/BASIC TOOLS

LP88-SPREADSHEET LP

Our best-selling menu driven linear programming system now solves problems with 1000 constraints and 5000 variables up to 30 times faster. New version reads/writes Lotus worksheets. Use 1-2-3/Symphony as a matrix generator or post processor. Many other features including interactive and batch operation, spreadsheet-style display, equation processor, problem/basis storage, file I/O, Simplex restart, report generator, sensitivity analysis. *JENews* says: "The flexibility and features of this program are a bargain at its low price." \$149 with 8087 support and 100-page manual. \$29 for working demo and manual.

EASTERN SOFTWARE PRODUCTS, INC.

P.O. Box 15328, Alexandria, VA 22305 (703) 360-7600

Inquiry 661.

QuickWindows

As seen in the Microsoft Value-Pack Catalog! Create windows, pop-up and pull-down menus, data-entry screens, and multiple-input dialog boxes quickly and easily. Full support of Microsoft mouse. Join the many Fortune 500 companies using QuickWindows and order your copy today. QuickWindows \$79. Advanced \$139. For Microsoft QuickBASIC or BASCOM.

Software Interphase, Inc.

5 Bradley St., Suite 106 • Providence, RI 02908
 (401) 274-5465

Inquiry 662.

SOFTWARE/BUSINESS

DATA ENTRY SYSTEM

Heads-down data entry with two-pass verification for the PC/XT/AT & compatibles. Loaded with features like: Auto dup & skip, verify bypass, range checks, & table lookups. Fully menu driven only \$395. *Call for free 30 day trial period.*

COMPUTER KEYES

21929 Makah Rd., Woodway, WA 98020
 (206) 776-6443 1-800-356-0203

SOFTWARE/BUSINESS

dFELLER Inventory

Business inventory programs written in modifiable dBASE source code.

dFELLER Inventory \$150.00

Requires dBASE II or III, PC-DOS/CPM

dFELLER Plus \$200.00

with History and Purchase Orders

Requires dBASE III or dBASE III Plus (For Stockrooms)

Feller Associates

550 CR PPA, Route 3, Ishpeming, MI 49849

(906) 486-6024

Inquiry 663.

1-2-3® + @RISK = Risk Analysis

Manage risk with @RISK 1-2-3 Add-In! An @RISK simulation automatically reflects thousands of "what-if" scenarios. ■ View full range of possible outcomes ■ Monte Carlo simulation ■ Graphs in .PIC format ■ 30 new probability distribution @functions Now required for all Harvard MBAs

FREE DEMO

Pallsade Corporation

2189 Elmira Road, Newfield, NY 14867
 (607) 564-9993

Inquiry 664.

SOFTWARE/CHURCH

PowerChurch Plus®

Fast, friendly, reliable church administration system. Full fund accounting, mailing lists, membership, contributions, attendance, word processing, accts. payable, payroll, multi-user support, and much more - all for \$695 complete. FREE demo version.

F1 SOFTWARE

P.O. Box 3096, Beverly Hills, CA 90212
 (213) 854-0865

Inquiry 665.

ROMAR CHURCH SYSTEMS™

Membership-61 fields plus alternate addresses; labels, letters, reports any field(s). Offering 256 funds, optional pledge; statements; post to 255/yr. Finance-gen. ledger w/budget; up to 500 subtotals & 99 depts., month & YTD reports anytime for any month. Attendance—8 service times, 250 events per service; 60 consecutive weeks. Available for floppy, 3 1/2 & hard disk. Ad too short! Write for free 48-page guide

Romar Church Systems, Attn: BJB

P.O. Box 4211, Elkhart, IN 46514
 (219) 262-2188

Inquiry 666.

SOFTWARE/CULINARY

Ethnic Recipes

IBM Compatible Floppy
 Greek, Arab, Slav, Ethiopian

Send \$9.11 inc. tax & shipping

Golden Cobra

P.O. Box 25, Palmer, TX 75152

Inquiry 667.

SOFTWARE/EDUCATION

WE CAN MAKE IT TALK!

Talking educational programs from Dataflo Computer Services for IBM® /compat. & Apple® II's support most speech cards or run w/o speech. 3 SPELLING programs share 2000-word files! Create words/files, adjust pronunciation! Spanish versions, too! 2 early MATH programs: MEMORY program; Access speech from compiled BASIC with SONCOM™ All Unprotected! Contact:

U.S.A. DIRECT

Dept. B, HC 32—Box 1, Enfield, NH 03748
 (603) 448-2693

Inquiry 668.

SOFTWARE/ENGINEERING

Affordable Engineering Software

FREE APPLICATION GUIDE & CATALOG

Circuit Analysis • Root Locus • Thermal Analysis • Plotter Drivers • Engineering Graphics • Signal Processing • Active/Passive Filter Design • Transfer Function/FFT Analysis • Logic Simulation • Microstrip Design • PC/MSDOS • Macintosh • VISA/MC

BV Engineering • Professional Software

2023 Chicago Ave., Suite B-13, Riverside, CA 92507
 (714) 781-0252

Inquiry 669.

VERSATILE DSP & DISPLAY

PC DATA MASTER is a DOS shell which integrates a full set of signal processing functions: flexible graphics, data file math, DSP utilities, data sampling/generation, and interactive help. Support for CGA, EGA, VGA, Herc & AT&T. Add custom analysis or graphics functions easily using your favorite compiler. \$115. Toolkit \$45. Demo \$10.

Durham Technical Images

P.O. Box 72, Durham, New Hampshire 03824-0072
 (603) 868-7203

Inquiry 670.

PROFESSIONAL SOLUTIONS

FOR PCs and MS-DOS

DEFLECTION OF BEAMS OF UNIFORM OR VARIABLE CROSS SECTION (not an FE-program): Statically determinate problems & continuous beams
 SIMPLE OR MULTIPLE SHRINK-FITS: Shrinkage pressures, stresses, torsional holding ability etc.
 HERTZ: Pressure between bodies

MICROMIN® — Software

Dan Steurer, P.O. Box 344, Mannford, OK 74044
 Recorded Message: (800) 336-2072, ext. 540

Inquiry 671.

STRUCTURAL ANALYSIS

MICROSAFE: Inexpensive, easy to learn and use Finite Element Analysis for IBM PCs and compatibles. Up to 400 nodes, 600 beams, 500 plates. Graphics. 2-D: \$75, 3-D: \$120, Both: \$160. Overseas add \$20. Evaluation copies. NOT COPY-PROTECTED. Ask for brochure.

MICROSTRESS Corp. (Dep. BM1)

10950 Forest Ave. S., Seattle, WA 98178-3205
 (206) 772-0506

Inquiry 672.

SIMULATION WITH GPSS/PC™

GPSS/PC™ is an IBM personal computer implementation of the popular mainframe simulation language GPSS. Graphics, animation and an extremely interactive environment allow a totally new view of your simulations. Simulate complex real-world systems with the most interactive and visual yet economical simulation software.

MINUTEMAN Software

P.O. Box 1717Y, Stow, Massachusetts, U.S.A.
 (617) 897-5662 ext. 540 (800) 223-1430 ext. 540

Inquiry 673.

Circuit Analysis — SPICE

Non-linear DC & Transient; Linear AC.

★ Version 3B1 with BSIM, GaAs, JFET, MOSFET, BJT, diode, etc. models, screen graphics, improved speed and convergence.
 ★ PC Version 2G6 available at \$95.

Call, write, or check inquiry # for more info.

Northern Valley Software

28327 Rothrock Dr., Rancho Palos Verdes, CA 90274
 (213) 541-3677

Inquiry 674.

THE BUYER'S MART

SOFTWARE/ENGINEERING

FREE ENGINEERING MAGAZINE

Personal Engineering is a monthly magazine sent free of charge (USA only) to scientists/engineers who use PCs for technical applications. Topics each month include **Instrumentation • Data Acq/Control • Design Automation**. To receive a free sample issue and qualification form either circle below or send request on letterhead to:

Personal Engineering Communications
Box 1821, Brookline, MA 02146

Inquiry 675.

EC-Ace ANALOG CIRCUIT ANALYSIS

You can afford to get started with EC-Ace, a subset of the powerful ECA-2 circuit simulator. Includes all the basics and built-in graphics.

- AC, DC, Temperature, Transient
- A full 525 pg. ECA-2 manual.
- Interactive, twice as fast as SPICE.

EC-Ace 2.31 IBM PC or Mac \$145.
Call 313-663-8810 for FREE DEMO

Tatum Labs, Inc.

1478 Mark Twain Ct., Ann Arbor, MI 48103

Inquiry 676.

SOFTWARE/FORECAST

FORECAST PRO

An excellent forecasting package that uses *artificial intelligence* to help both the beginner and the experienced forecaster achieve top-notch results. Time series analysis techniques include exponential smoothing, Box-Jenkins, & dynamic regression.

CALL NOW FOR A FREE DEMO DISK!

Business Forecast Systems, Inc.
68 Leonard Street, Belmont, MA 02178
(617) 484-5050 TELEX #710-3201382

Inquiry 677.

SOFTWARE/GENERAL

US\$5... INCLUDING DISK

Over 2,000+ software titles for IBM-PC Apple][, + a.c.GS, Macintosh, C64/128, Amiga. Latest titles and versions. Lots of hi-quality manuals. Best services.

1200 bps Pocket-size Modem \$159
256K Auto Hi-Res EGA card \$179
16 MHz AT/286 Motherboard/4 Mb \$649
Lots of bargains, ram chips, etc. . . . Specify your computer type. FREE catalog sent to you by air-mail. Write:

IBRAHIM BIN ABU BAKAR, Dept. BYTE
Raffles City P.O. Box 1029, Singapore 9117
REPUBLIC OF SINGAPORE

Inquiry 678.

SOFTW./GEOLOGICAL

GEOLOGICAL CATALOG

Geological software for log plotting, gridding/contouring, hydrology, digitizing, 3-D solid modelling, synthetic seismogram, fracture analysis, image processing, scout ticket manager, over 50 programs in caalog. Macintosh too! Please call, or write, for Free Catalog!

RockWare, Inc.

4251 Kipling St., Suite 595, Wheat Ridge, CO 80033 USA
(303) 423-5645

SOFTWARE/GRAPHICS

TurboGeometry Library (Source & Manual)

Turbo Pascal, C, Mac, & Microsoft C. Over 150 2 & 3 dimensional outlines including: Intersections, Transformations, Equations, Hidden Lines, Perspective, Curves, Areas, Volumes, Clipping, Planes, Matrices, Vectors, Distance, PolyDecomp. IBM PC (Comp.), MAC.

VISA/MC \$99.95.

Disk Software, Inc.

2116 E. Arapaho #487, Richardson, TX 75081
(214) 423-7288

Inquiry 679.

SOFTWARE/GRAPHICS

FPLOTT PEN PLOTTER EMULATOR

Use your dot matrix or laser printer as an HP pen plotter. Fast hi-res output. Vary line width. Includes VPLOT virtual plotter utility to capture plotting commands. Supports NEC P5/P6, IBM P/printer, Epson LQ/IMX/FX, HP Laserjet, Uses Hercules, CGA, EGA or VGA for screen preview. \$64 check or m.o.

HORIZON SOFTWARE

Suite 605, 24-16 Steinway St., Astoria, NY 11103
212-418-8469

Inquiry 680.

GRAPHICS PRINTER SUPPORT

AT LAST! Use the *PrintSc key* to make quality scaled B&W or color reproductions of your display on any dot matrix, inkjet, or laser printer. GRAFPLUS supports all versions of PC or MS-DOS with IBM (incl. EGA, VGA), Tecmar, and Hercules graphics boards. \$49.95.

Jewell Technologies, Inc.

4740 44th Ave. SW, Seattle, WA 98116
800-628-2828 x 527 (206) 937-1081

Inquiry 681.

FORTRAN PROGRAM MER?

Now you can call 2-D and 3-D graphics routines within your FORTRAN program.

GRAF/MATIC: screen routines \$135.
PLOT/MATIC: plotter driver 135.
PRINT/MATIC: printer driver 135.

For the IBM PC, XT, AT & compatibles. We support a variety of compilers, graphics bds., plotters and printers.

MICROCOMPATIBLES

301 Prelude Dr., Dept. B, Silver Spring, MD 20901 USA
(301) 593-0683

Inquiry 682.

CGA→Hercules™ Graphics

Mode-MGA™ allows you to use business graphics, games, BASIC/CGA graphics and other CGA specific software with your Hercules™ Monochrome Graphics adaptor and monochrome monitor. Works with all CGA programs. \$79.95 (+ \$5 s&h) for the 3k-TSR version. 30-day money back guarantee. Call or write:

T.B.S.P. Inc.

2265 Westwood Blvd., Suite 793, Los Angeles, CA 90064
(213) 312-0154

Inquiry 683.

SOFTWARE/HEALTH

FamilyCare™ Software

This comprehensive medical diagnostic program gives parents peace of mind when dealing with health problems of newborns through teenagers. It analyzes hundreds of possible symptoms, injuries, and diseases, offering specific instruction for medical care, home treatment, and medications. It provides answers quickly in life-threatening situations.

FamilyCare™ Software

Lundin Laboratories, Inc.
29451 Greenfield Rd., Suite #218, Southfield, MI 48076
800/426-8426 or 313/559-4561

Inquiry 684.

SOFTW./INVESTMENT

The new **Business Week TOP 1000** and **Mutual Fund Scoreboard** Diskettes use the enormous power of your IBM or compatible PC to select, rate, and compare every equity and fixed income mutual fund on the market (Mutual Fund Scoreboard), and virtually every Business Week 1000 company (TOP 1000)—At the touch of a key.

Mutual Fund Scoreboard Diskettes:
\$49.95 each or \$239.90 for subscriptions to both.
TOP 1000 & TOP 1000 ELITE Diskettes:
\$199 for the TOP 1000 & \$299 for the ELITE version, which offers names & addresses of the top officers too!
Order now or receive more information by calling 1-800-553-3575 (In Illinois, call 1-312-250-9292).
Or write to: **Business Week Diskettes**
P.O. Box 621, Elk Grove, IL 60009

Inquiry 685.

SOFTW./LANGUAGES

INCREASED EFFICIENCY WITH DRUMA FORTH-83? YES!

Strict '83 STANDARD. Ideal for teachers/learners. 1MB+ memory. 64K speed & compactness to 320K. Instant on-line doc/glossary. ASCII & SCR files. Editor, Assembler, FULL file/DOS interfaces. Developers' ideal.

- IBM PC/XT/AT & ALL COMPATIBLES
- BEST VALUE: \$79. S&H \$2, VISA/MC
- 15 day money back. CALL OR WRITE today

DRUMA INC.

6448 Hwy. 290E, Suite E-103, Austin, TX 78723
Orders: 512-323-0403 BBBoard: 512-323-2402

Inquiry 686.

FORTRAN for Macintosh

Language Systems FORTRAN is a full-featured FORTRAN 77 compiler integrated w/MPW. Full ANSI FORTRAN 77 plus VAX-type extensions. SANE numerical calculations & data types incl. COMPLEX*16, 68000, 68020 and 68881 object code. Arrays greater than 32K. Link with Pascal, C, MacApp. \$304 w/MPW via air. MCMISA/Check. MAC+, SE, Mac II. HD req.

Language Systems Corp.

441 Carlisle Drive, Herndon, VA 22070
(703) 478-0181

Inquiry 687.

MULTI-USER DEVELOPMENT PLATFORM

Gain the 80386 edge for your applications with THEOS C, an advanced compiler for the new THEOS 386 multi-user, multitasking operating system. Meets ANSI C standard, plus offers the power of 250 additional functions for VDI graphics, real-time processing and file access. Provides UNIX and DOS source code compatibility. Breaks 64K limitation. Two volume manual set. BASIC Language package also available.
For complete multi-user solutions, call us today.

THEOS Software Corp.

1777 Bothello Dr., Suite 380, Walnut Creek, CA 94596
(415) 935-1118 FAX (415) 935-1177

Inquiry 688.

SOFTWARE/LOTTERY

WIN LOTTO

GAIL HOWARD'S systems have won \$27 million for 9 Lotto jackpot winners! Now available on IBM PC 5¼" diskettes the complete *authentic* Gail Howard Wheeling Systems (*Smart Luck Computer Wheel™* \$29.95 + \$2 s/h); also Gail Howard's *Smart Luck Computer Advantage™* \$39.95 + \$2 s/h (specify Lotto game). VISA/MC welcome.

Smart Luck Computer Systems, Dept. B-1
1271 West Dundee Rd., Suite 16A, Buffalo Grove, IL 60089
312-934-3300 A list of Gail Howard's Lotto books is also available.

Inquiry 689.

THE ULTIMATE LOTTERY PROGRAM

"LOTOSYSTEMS" BY USA-LOTO Rel 3.1 Easy to use, menu driven complete statistical analysis program for any Lotto or Keno Game. Over 100 frequency and selection reports displayed or printed by ball #, pairs, triplets, families, mates, most frequent, and past due in sorted or numeric order. Includes Proven Wheeling Systems. Data for any game also available. IBM PC/XT/AT/LPT/PS. 256K RAM, DOS 2.0, 5.25" & 3.5" disks. \$49.95 + \$4.00 Shipping, VISA/MC

WESTERN EN-COMM, INC.

4909 Stockdale Hwy. #649 Bakersfield, CA 93309
(800) 872-5686 or (805) 831-1633 FAX: 1-805-831-5622

Inquiry 690.

SOFTWARE/MATHEMATICS

What? You've never seen a complex function?

Try *f(z)* - The Complex Variables Graphing Package for PC's with CGA/EGA

"Let our animated screens show you what the printed page cannot."

Lascaux Graphics

(212) 654-7429

Inquiry 691.

THE BUYER'S MART

SOFTWARE/MODELING

MOVING 3-D NAVIGATOR

- Rapid moving natural views of wire-frame objects you create: fly about or through the models in any arbitrary path by easy fingertip control. \$449 + \$4.00 S&H. (Foreign rate \$49.00 + \$11.00 S&H.)
- ◆ Require IBM PC or compatible (256K up, 32 bit recommended.), 5¼" demo-disk \$7.00 + \$1.00 S&H.

bp-Coding Systems

(YOSHINO ENTERPRISES U.S.A., INC.)
2445 University Heights Ave., Boulder, CO 80302
telephone (303) 449-3 40 • facsimile (303) 442-19 7

Inquiry 692.

SOFTWARE/PACKAGING

SAVE SAVE SAVE SAVE LET'S TALK LABELS

We do disk labels (5¼" & 3¼")
• Better • Faster • Cheaper •
Because we specialize in disk labels... Let's Talk
We also have Tyvek Sleeves
Mailers • Binders • Vinyl Pages
We are a complete software packaging service.
Hice & Associates
9303 Cincinnati-Columbus Rd., West Chester, OH 45069
513-777-0133

Inquiry 693.

SOFTWARE/PRODUCTION

ECONOMICAL DISK DUPLICATOR

Automatically formats, verifies, and copies 4 disks, signals for reload. Doubles as a label maker, and disk eraser (software included). Production up to 3,000 disks/week. Only \$1950. Money back guarantee. VISA/MC

Corbin Software

600 Industrial Circle, White City, OR 97503

503-826-6737

Inquiry 694.

SOFTW./SALES & MKTG.

Lead Management System

The next generation in sales management. Follow up, to-do lists, telemarketing, product lists, appointments, mail-merge, word processor, and spreadsheet. Tracks expenses to show cost of sales. Uses your sales cycle and generates top ten lists. Industry specific versions available. IBM PC/XT/AT, compatibles, and laptops. \$99.95 VISA/MC/COD. Demo Disk \$5.00

Powerhouse Systems Inc.

1022 West First St., Suite 104, Winston-Salem, NC 27101

(800) 525-5774 or (919) 721-0241

Inquiry 695.

FOLLOW-UP SOFTWARE FOR SALESPeOPLE

Manage & control all of your sales activities on your desktop or laptop.

\$179.95

XYCAD GROUP

1577 St. Clair Ave., Cleveland, OH 44114

(800) 428-8457 (216) 589-5788 in Ohio

Inquiry 696.

SOFTWARE/SCIENTIFIC

Data Acquisition & Analysis on PC's

- FOURIER PERSPECTIVE II Advanced Digital Signal Analysis.
- PRIME FACTOR FFT subroutines library. Call from Turbo Pascal, C, Fortran, Basic. Up to 65536 data points. 2D interface available. Rectangular FFT's now possible in a multitude of dimensions.
- 2 & 3D Scientific Graphic packages with plotter support from Golden Software.
- Data Acquisition & Control Boards from Metrabyte, Analog Devices, Burr-Brown, Strawberry Tree, National Instruments, Contec, & Tecmar.
- Data Acquisition & Analysis Software—Labtech Notebook, Asys, UnitsScope, Logic Measure with 1-2-3Symphony, & Quinn-Curtis.

Call for FREE Application Assistance & Technical Literature
LOW PRICES—Satisfaction GUARANTEED
Alligator Technologies — (714) 850-9984
P.O. Box 9706, Fountain Valley, CA 92708

Inquiry 697.

SOFTWARE/SCIENTIFIC

FAST FOURIER TRANSFORMS

- Subroutine for integer data: 1024 points in 44mSec on PS-2/Mod 80.
- Subroutine for floating-point data: (with 80387) 1024 points in 220 mS.
- NEW subroutine for double-precision data: 1024 points in 157 mSec!
- Call from FORTRAN, C, BASIC, Pascal. Check or PO: \$175 ea/\$350 all three.

J.W. Hartwell & Associates

Route 4 Box 1540, Hillsborough, NC 27278(919) 732-7951

Inquiry 698.

ORDINARY/PARTIAL DIFFERENTIAL EQN SOLVER

FOR THE IBM PC & COMPATIBLES

MICROCOMPATIBLES INC.

301 Prelude Dr., Silver Spring, MD 20901

(301) 593-0683

Inquiry 699.

SCI-GRAF and SCI-DATA

SCI-GRAF produces huge hires graphics thru easy menus or linkable C libraries. Supports log scales, error bars, screen and printer output.

SCI-DATA performs least squares and normal curve fits, scaling and polar coordinate transformations.

Prices start at \$59.95.

Microcomputer Systems Consultants

Box 747, Santa Barbara, CA 93102

(805) 963-3412

Inquiry 700.

Scientific/Engineering/Graphics Libraries Turbo & Lightspeed Pascal, Modula-2, C

Send for FREE catalogue of software tools for Scientists and Engineers. Includes: Scientific subroutine libraries, device independent graphics libraries (including EGA, HP plotter and Laserjet support), scientific charting libraries, 3-D plotting library, data acquisition libraries, menu-driven process control software. Versions available for a variety of popular languages.

Quinn-Curtis

1191 Chestnut St., Unit 2-5, NewTon, MA 02164

Inquiry 701.

SOFTWARE/SORT

OPT-TECH SORT/MERGE

Extremely fast Sort/Merge/Select utility. Run as an MS-DOS command or CALL as a subroutine. Supports most languages and filetypes including Btrieve and dBASE. Unlimited filesizes, multiple keys and much more! MS-DOS \$149. XENIX \$249.

(702) 588-3737

Opt-Tech Data Processing

P.O. Box 78 - Zephyr Cove, NV 89448

Inquiry 702.

SOFTWARE/TAX PREP.

W-2 (COPY A) ON FLOPPY

The W-2 MAG program makes an IRS/SSA FORMAT floppy from a data entry screen or imported ASCII file. Includes manual and application forms.

- Used nation wide
- Step-by-step data entry
- Free phone support
- Menu, user friendly
- Prints W-2 forms
- PC compatible

Illinois Business Machines Inc.

Department PC
1403 Box 310 Troy Rd., Edwardsville, IL 62025
PH. # (618) 692-6060

Inquiry 703.

SOFTWARE/TOOLS

SCREEN MANAGER

MENU, WINDOW, and DATA ENTRY Support for the Professional Programmer! Interfaces to most languages: BASIC, C, FORTRAN, COBOL, PASCAL, ASSEMBLER. 100 Page Manual. Thirty day money back guarantee. No Royalties.

from \$75. VISA/MC

The West Chester Group

P.O. Box 1304, West Chester, PA 19380

(215) 644-4206

CALL FOR FREE DEMO

Inquiry 704.

STATISTICS

STATA

Statistics and graphics join to make STATA the most powerful package for the PC. No comparable program is as fast, friendly, and accurate. \$20 Demo. Quantity discount available. Call toll-free for more information. AX/VISA/MC.

1-800-STATAPC

Computing Resource Center

10601 National Boulevard, Los Angeles, CA 90064

(213) 470-4341

Inquiry 705.

THE SURVEY SYSTEM

An easy-to-use package designed specifically for questionnaire data. Produces banner format, cross tabs & related tables, statistics (incl. regression) & bar charts. Codes and reports answers to open-end questions. All reports are camera-ready for professional presentations. CRT interviewing option.

CREATIVE RESEARCH SYSTEMS

15 Lone Oak Cir., Dept. B, Petaluma, CA 94952

707-765-1001

Inquiry 706.

RESULTS NOT SIGNIFICANT?

Next time use EX-SAMPLE. Expert program estimates sample size using power analysis for comparisons of means, props, regression, ANOVA, chi-square, log-linear, LISREL, surveys, experiments, many more. Justify sample size to funding agencies, plan sampling budget. Can pay for itself in a single study. IBM/MS-DOS, \$195+sh (50% educ. disc.). VISA/MC/PO, 30 day guarantee. Call now for FREE brochure.

The Idea Works, Inc.

100 West Briarwood, Columbia, MO 65203

Order toll free 1-800-537-4866

Inquiry 707.

NUMBER CRUNCHER STAT SYS

Menu-driven. Multiple & stepwise regression, ANOVA, time series, discriminant cluster and factor analysis, principal components, scatter plots, histograms, t-tests, contingency tables, non-parametrics. Import export data. Spreadsheet, sort, join, merge. \$99. MS-DOS. Graphics program, \$59.

NCSS-B

865 East 400 North, Kaysville, UT 84037

801-546-0445

Inquiry 708.

SOFTWARE/SCIENTIFIC

Data Acquisition & Analysis on PC's

- FOURIER PERSPECTIVE II Advanced Digital Signal Analysis.
- PRIME FACTOR FFT subroutines library. Call from Turbo Pascal, C, Fortran, Basic. Up to 65536 data points. 2D interface available. Rectangular FFT's now possible in a multitude of dimensions.
- 2 & 3D Scientific Graphic packages with plotter support from Golden Software.
- Data Acquisition & Control Boards from Metrabyte, Analog Devices, Burr-Brown, Strawberry Tree, National Instruments, Contec, & Tecmar.
- Data Acquisition & Analysis Software—Labtech Notebook, Asys, UnitsScope, Logic Measure with 1-2-3Symphony, & Quinn-Curtis.

Call for FREE Application Assistance & Technical Literature
LOW PRICES—Satisfaction GUARANTEED
Alligator Technologies — (714) 850-9984
P.O. Box 9706, Fountain Valley, CA 92708

Inquiry 697.

STATISTIX™ II

Comprehensive, powerful and incredibly easy-to-use. Full screen editor, transformations, linear models (ANOVA, regression, logit, PCA, etc), ARIMA, most standard stat procedures. Clear, well organized documentation. Satisfaction guaranteed. \$169 PC DOS, \$99 Apple II.

NH ANALYTICAL SOFTWARE

P.O. Box 13204, Roseville, MN 55113

(612) 631-2852

Inquiry 709.

THE BUYER'S MART

STATISTICS

Spreadsheet Statistics

NEW! 23 comprehensive statistics and forecasting modules for analyzing LOTUS worksheets. Low cost \$24.95 each. Easy to use. Includes tutorial. Basic and advanced statistics with graphics and many user-definable options. Compare. Free brochure.

Walonick Associates, Inc.

6500 Nicollet Ave. S., Minneapolis., MN 55423
(612) 866-9022

Inquiry 710.

UTILITIES

CleanUp the File Management System

FEATURES: global file search, wild card & Attribute file marking, source & target space info, file copy to multiple disks when full, pop up windows, prompted file deleting and many more.

Price: \$49.95

1-800-553-0846

Acme Software Works

1380 156th Ave. N.E. Suite 147, Bellevue, WA. 98007

Inquiry 711.

Enhanced DOS Commands

Get directory listings of all files that *don't* match a template. Search all directories for files matching a template. New commands and new versions of existing commands, all with lots of variable options. Plus all commands accept special codes to reduce repetitive entries. Get the most from DOS with these time-saving routines. For MS-DOS/PCDOS 2.0 and higher. \$29.95

Driscoll Graphics

135 E. Church, P.O. Box 625
Clinton, MI 49236

Inquiry 712.

COPY AT TO PC

The 1.2mB drive has long been known to READ but NOT reliably WRITE on 360KB floppies. With "CPYAT2PC" 1.2mB drives CAN reliably WRITE 360KB floppies saving a slot for a second hard disk or backup tape. "CPYAT2PC" (Not Copy Protected) offers 'the preferable SOFTWARE SOLUTION.' ONLY \$79+\$4 S/H VISA/MC/COD UPS B/R

MICROBRIDGE COMPUTERS

655 Skyway, San Carlos, CA 94070

Order toll free 1-800-523-8777

415-593-8777 (CA) 212-334-1858 (NY)
TELEX EZLNK 62873089 FAX 415-593-7675

Inquiry 713.

UTILITIES

Recover deleted files fast!

Disk Explorer now includes automatic file recovery. You type in the deleted file's name, Disk Explorer finds and restores it. Disk Explorer also shows what's really on disk; view, change or create formats, change a file's status, change data in any sector. MS-DOS \$75 U.S. Check/Credit card welcome.

QUAID SOFTWARE LIMITED

45 Charles St. E. 3rd Fl.
Toronto, Ontario, Canada M4Y 1S2
(416) 961-8243

Inquiry 714.

The SPINDRIFT Library

At last! Now there's a way for FORTRAN programmer to do the things they always wanted to do: Execute other programs via CALL EXEC; edit key control of CURSOR; WINDOWS; POP UP HELP; Wildcard file search; Save/restore screen images: COLOR. 150 subroutines and functions in all. Price: \$149. + S&H Write for DEMO DISK: \$5 credited to purchase. Specify your Compiler.

Spindrift Laboratories, Ltd.

116 S. Harvard Ave., Arlington Hts., IL 60005
(312) 255-6909

Inquiry 714.

HANDS OFF THE PROGRAM®

- Locks Hard Disk. - Restricts Floppy Use.
- Protects Subdirectories.
- Normal Use of DOS Commands and Application Software.
- BM PC, XT, AT and True Compatibles.
- DOS V2.0 and Higher. Hard Disk System.
- Keep Other People's HANDS OFF Your System.

\$89.95 VISA/MC

SYSTEM CONSULTING, INC.

314 Canterbury Dr., Pittsburgh, PA 15238
(412) 963-1624

Inquiry 715.

\$59.95!!

Buy the RED Utilities now! Programs include: Disk cache to speed hard disk. Printer spooler. Batch file compiler. Path command for data files. Wild card exceptions. Protect hard disk from accidental formatting. Sort directories. Over 10 more programs. IBM PC. Visa/MC.

The Wenham Software Company

5 Burley St., Wenham, MA. 01984 (617) 774-7036

Inquiry 716.

WORD PROCESSING

FARSI / GREEK / ARABIC / RUSSIAN

Hebrew, all European, Scandinavian, plus either Hindi, Punjabi, Bengali, Gujarati, Tamil, Thai, Korean, Viet, or IPA. Full-featured multi-language word processor supports on-screen foreign characters and NLO printing with no hardware modifications. Includes Font Editor. \$355 dot matrix; \$150 add'l for laser; \$19 demo. S/H in U.S. incl'd. Req. PC, 640K, graphics. 30 day Guarantee. MC/VISA/AMEX

GAMMA PRODUCTIONS, INC.

710 Wilshire Blvd., Suite 609, Santa Monica, CA 90401
213/394-8622 Tlx: 5106008273 Gamma Pro SNM

Inquiry 717.

CompareRite™

CompareRite saves editing time by comparing two documents and generating a third that shows the differences in an average of two seconds per page. CompareRite highlights changes the way you want to see them. Works with all major word processing programs. Price — \$129.95 + shipping/handling

JURISoft, Inc.

763 Massachusetts Ave., Dept. 11, Cambridge, MA 02139
1-800-262-5656 ext. 11
In MA — 617-864-6151 ext. 11

Inquiry 718.

DuangJan

Bilingual word processor for English and: Armenian, Bengali/Euro/Latin, Greek, Hindi, Khmer, Lao, Punjabi, Russian, Sinhalese, Tamil, Thai, Viet... \$109+\$5 s/h (foreign + \$12 s/h). Font editor included. For IBM with dot-matrix & LaserJet printer. Demo \$6 + \$1 s/h.

MegaChomp Company

3524 Cottman Ave., Philadelphia, PA 19149-1606
(215) 331-2748

Inquiry 719.

PC-Write™ Shareware Ver. 2.71

Fast, full featured word processor/text editor for IBM PC. With spell check, screen clip, mailmerge, split screen, ASCII files, macros. Easy to use. Supports 400 printers - LaserJet+ and PostScript. Software, User Guide, and Tutorial on 2 disks for \$16. Try it, then register with us for only \$89 and get User Manual, 1 year tele-support, newsletter and 2 upgrades. 90-day guarantee. VISA/MC.

Quicksoft 1-800-888-8088 CALL TODAY!

219 First N., #224-BYTC, Seattle, WA 98109

Inquiry 720.

Advertise *your* computer products in **THE BUYER'S MART**. It's easy to get your sales message into print. Just send us typewritten copy or phone in your ad.

And as a unique feature, every **BUYER'S MART** ad is assigned a reader service number which will provide your company with valuable inquiries.

Call Mark Stone for more information at **603-924-3754**

BYTE/McGraw-Hill
One Phoenix Mill Lane
Peterborough, NH 03458

NEC V20 & V30 CHIPS

Replace the 8086 or 8088 in Your IBM-PC and Increase Its Speed by up to 40%! Price

UPD70108-5 (5MHz) V20 Chip. \$ 7.49
 UPD70108-8 (8MHz) V20 Chip. \$ 8.95
 UPD70108-10 (10MHz) V20 Chip. \$24.95 \$14.95
 UPD70116-8 (8MHz) V30 Chip. \$11.95
 UPD70116-10 (10MHz) V30 Chip. \$24.95 \$19.95

7400					
Part No.	1-9	10+	Part No.	1-9	10+
7400	29	19	7485	65	55
7402	29	19	7486	45	35
7404	29	19	7488	2.05	1.95
7405	35	25	7490	49	39
7406	39	29	7493	45	35
7407	39	29	74121	45	35
7408	35	25	74152	55	45
7410	39	29	74125	55	45
7414	49	39	74126	69	59
7416	39	29	74143	3.95	3.85
7417	39	29	74150	1.35	1.25
7420	35	25	74154	1.35	1.25
7430	35	25	74158	1.59	1.50
7432	39	29	74173	85	75
7438	39	29	74174	59	49
7442	55	45	74175	59	49
7445	79	69	74176	99	89
7446	89	79	74181	1.95	1.85
7447	89	79	74189	1.95	1.85
7448	2.05	1.95	74193	79	69
7472	69	59	74198	1.85	1.75
7473	29	19	74273	99	89
7474	39	29	74273	1.95	1.85
7475	49	39	74365	65	55
7476	45	35	74367	65	55

74LS					
Part No.	1-9	10+	Part No.	1-9	10+
74LS00	29	19	74LS165	75	65
74LS02	29	19	74LS166	79	69
74LS04	35	25	74LS173	59	49
74LS05	35	25	74LS174	49	39
74LS06	35	25	74LS189	49	39
74LS07	1.09	99	74LS189	4.59	4.49
74LS08	29	19	74LS191	59	49
74LS10	29	19	74LS193	79	69
74LS14	49	39	74LS221	69	59
74LS27	35	25	74LS240	69	59
74LS32	29	19	74LS243	69	59
74LS32	35	25	74LS244	69	59
74LS42	99	89	74LS245	89	79
74LS47	99	89	74LS259	99	89
74LS73	39	29	74LS273	89	79
74LS74	35	25	74LS279	49	39
74LS75	39	29	74LS322	4.05	3.95
74LS76	55	45	74LS365	49	39
74LS85	35	25	74LS367	49	39
74LS86	35	25	74LS368	49	39
74LS90	49	39	74LS373	79	69
74LS93	49	39	74LS374	79	69
74LS123	59	49	74LS393	89	79
74LS125	49	39	74LS590	6.05	5.95
74LS138	49	39	74LS624	2.65	2.55
74LS139	49	39	74LS629	2.95	2.85
74LS154	1.09	99	74LS629	2.95	2.85
74LS157	45	35	74LS640	1.09	99
74LS158	45	35	74LS645	1.09	99
74LS163	59	49	74LS670	1.09	99
74LS164	59	49	74LS688	2.39	2.29

74S/PROMS*					
Part No.	1-9	10+	Part No.	1-9	10+
74S00	29	19	74S188	1.49	1.39
74S04	29	19	74S189	1.89	1.79
74S05	35	25	74S240	2.49	2.39
74S10	29	19	74S240	1.49	1.39
74S32	35	25	74S244	1.49	1.39
74S74	45	35	74S253	79	69
74S85	1.79	1.69	74S287	1.49	1.39
74S86	4.9	4.5	74S288	1.49	1.39
74S124	2.95	2.85	74S373	1.49	1.39
74S174	79	69	74S374	1.49	1.39
74S175	79	69	74S472	2.95	2.85

CD-ROMS					
Part No.	1-9	10+	Part No.	1-9	10+
CD4001	19	19	CD4076	59	49
CD4008	59	49	CD4081	25	19
CD4011	19	19	CD4082	25	19
CD4013	29	19	CD4093	605	35
CD4016	29	19	CD4094	39	29
CD4017	49	39	CD40103	2.49	2.39
CD4018	79	69	CD40107	49	39
CD4020	59	49	CD40109	79	69
CD4024	49	39	CD4510	69	59
CD4027	35	25	CD4511	69	59
CD4030	49	39	CD4520	75	65
CD4030	65	55	CD4522	75	65
CD4048	29	19	CD4538	79	69
CD4050	29	19	CD4543	79	69
CD4051	59	49	CD4543	79	69
CD4052	59	49	CD4553	4.95	4.85
CD4053	59	49	CD4555	79	69
CD4063	1.49	1.39	CD4559	7.95	7.85
CD4066	29	19	CD4566	2.49	2.39
CD4067	9.95	9.85	CD4567	59	49
CD4069	25	19	CD4584	39	29
CD4070	25	19	CD4585	89	79
CD4071	25	19	MC14411P	8.95	8.85
CD4072	25	19	MC14490P	4.49	4.39

MISCELLANEOUS CHIPS

Part No.	Price	Part No.	Price
7265AC	4.95 3.95	8500/8800/8800 Cont.	
WD9216	6.95 4.95	6845	8.95 2.95
95H90	6.95 4.95	6850	1.95
		6852	1.49 75
		6854	1.49 1.19
		MC68000L8	4.35 9.95
		MC68000L10	4.95 11.95
		MC68010L10	4.95 29.95
		MC68200R12B	169.95 99.95
		8000 SERIES	
		8031	3.95
		80C31	9.95
		8035	9.95
		8037	9.95
		8080A	2.65 2.49
		8085A	2.49
		8086	5.95 4.95
		8086-2	6.95
		8087(5MHz)	9.95
		8087-1(10MHz)	229.95
		8087-2(8MHz)	159.95
		8088	6.49 7.75
		8088-2	6.95 7.75
		8116	4.95
		8155	2.49
		8155-2	3.49
		8156	3.95
		8202	5.95 4.95
		8212	9.95 6.95
		8224	2.25
		8224	2.25

MICROPROCESSOR SALE!

Part No.	Price
8052AHBASIC CPU w/BASIC Interpreter	\$29.95
MC68008L8 32-Bit MPU (8-Bit Data Bus)	\$16.95 \$9.95
MC68701 8-Bit EPROM Microcomputer	\$14.95
MC68705P3S 8-Bit EPROM Microcomputer	\$14.95 \$9.95
MC68705U3S 8-Bit EPROM Microcomputer	\$10.95
80286-10 16-Bit Hi Performance MPU	\$99.95
80287-8 Math Co-processor (8MHz)	\$245.95
80287-10 Math Co-processor (10MHz)	\$309.95
80387-16 Math Co-proc. (16MHz) GRID ARRAY	\$494.95
80387-20 Math Co-proc. (20MHz) GRID ARRAY	\$795.95

COMMODORE CHIPS

Part No.	Price	Part No.	Price
*4116-15 16,384 x 1 (150ns)	1.09	LAG570	40.95 9.95
4128-20 13,107.2 x 1 (200ns) (Pagingback)	9.25 2.75	WD1770	14.95 9.95
*4164-100 65,536 x 1 (100ns)	4.25	SI3052P	2.49 1.25
*4164-120 65,536 x 1 (120ns)	3.75	6502	2.65
*4164-150 65,536 x 1 (150ns)	3.25	6504A	1.95 1.19
*4164-200 65,536 x 1 (200ns)	2.75	6507	4.39 2.95
*TMS4416-12 16,384 x 4 (120ns)	7.49	6510	9.95
*41256-80 262,144 x 1 (80ns)	14.95	6520	1.95
*41256-100 262,144 x 1 (100ns)	14.49	6522	3.95
*41256-120 262,144 x 1 (120ns)	13.95	6525	4.96 2.49
*41256-150 262,144 x 1 (150ns)	12.95	6526	14.95 12.95
*41256-150 262,144 x 4 (150ns) (4A64)	9.95	6529	2.95
*51100P-10 1,048,576 x 1 (100ns) 1 Meg	49.95 39.95	6532	6.49 5.49
*514256P-10 2,621,440 x 4 (100ns) 1 Meg	89.95	6545-1	4.95 3.25
		6551	4.49 2.95
		6560	10.95
		6567	19.95
		6569	24.95 15.95
		6572	8.95 6.95
		6581 (12V)	14.95
		6582 (9V)	14.95 6.95
		8360	14.95
		8501	40.95 8.95
		8502	7.95 4.95
		8563	15.95
		8564	9.95 4.95
		8566	24.95 15.95
		8701	9.95
		8721	44.95 11.95
		8722	9.95 6.95
		*251104-04	40.95 8.95
		310654-05	9.95
		318018-03	40.95 8.95
		318019-03	40.95 8.95
		318020-04	40.95 8.95
		325302-01	10.95
		325572-01	14.95
		*82S100PLA**	15.95
		901225-01	14.95 9.95
		901226-01	11.95
		901227-03	11.95
		901229-05	11.95

Part No.	Price	Part No.	Price
*2016-12 2048 x 8 (120ns)	3.95	LM358N	49
2018-45 2048 x 8 (45ns)	6.95 5.49	LM360N	2.19
2102 1024 x 4 (350ns)	89	LM361N	1.79
2114N 1024 x 4 (450ns)	99	LM380N-8	99 85
2114N-2L 1024 x 4 (200ns) Low Power	1.49	LM388N-3	89
21C14 1024 x 4 (200ns) (CMOS)	1.49	LM387N	39
2566 256 x 8 (150ns) CMOS	1.35	LM393N	2.95
*6118P-3 2048 x 8 (150ns) CMOS	6.49	LF110CN	79
*6116LP-3 2048 x 8 (150ns) LPMCOS	6.95	LM2917N (8pin)	1.95
*6264LP-12 8192 x 8 (120ns) LP CMOS	8.95	MC3419CL	6.95 3.95
*6264LP-15 8192 x 8 (150ns) LP CMOS	8.75	MC3446N	1.69 99
6514 1024 x 4 (350ns) CMOS	3.49	MC3450P	1.95 4.9
*43256-15L 32,768 x 8 (150ns) Low Power	12.95	MC3470P	1.95
		MC3471P	1.95 7.9
		MC3479P	4.79
		MC3488P	1.69
		MC3487P	1.69 99
		MC3900N	1.19
		MC3909N	99
		MC3918N	1.95
		MC3919N	1.95
		MC3920N	1.95
		MC3921N	1.95
		MC3922N	1.95
		MC3923N	1.95
		MC3924N	1.95
		MC3925N	1.95
		MC3926N	1.95
		MC3927N	1.95
		MC3928N	1.95
		MC3929N	1.95
		MC3930N	1.95
		MC3931N	1.95
		MC3932N	1.95
		MC3933N	1.95
		MC3934N	1.95
		MC3935N	1.95
		MC3936N	1.95
		MC3937N	1.95
		MC3938N	1.95
		MC3939N	1.95
		MC3940N	1.95
		MC3941N	1.95
		MC3942N	1.95
		MC3943N	1.95
		MC3944N	1.95
		MC3945N	1.95
		MC3946N	1.95
		MC3947N	1.95
		MC3948N	1.95
		MC3949N	1.95
		MC3950N	1.95
		MC3951N	1.95
		MC3952N	1.95
		MC3953N	1.95
		MC3954N	1.95
		MC3955N	1.95
		MC3956N	1.95
		MC3957N	1.95
		MC3958N	1.95
		MC3959N	1.95
</			

Now Available...Jameco's NEW Summer Flyer #137 with 48 pages of Computer Peripherals, Components & More!

MEMBER
MMCG
MICROCOMPUTER
MARKETING COUNCIL
of the Direct Marketing Association, Inc.

PROTOTYPING PRODUCTS

Jameco Solderless Breadboard Sockets

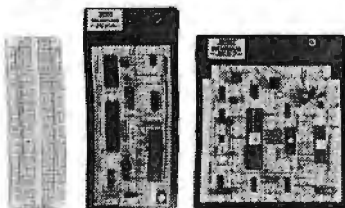

Part No.	Dim. L' x W'	Contact Points	Binding Posts	Price
JE20	6 1/2 x 3/4	200	0	\$ 2.29
JE21	3 1/2 x 2 1/2	400	0	\$ 4.49
JE22	6 1/2 x 1 1/2	630	0	\$ 5.95
JE23	6 1/2 x 2 1/2	830	0	\$ 7.49
JE24	6 1/2 x 3 1/2	1,360	2	\$14.95
JE25	6 1/2 x 4 1/2	1,660	3	\$22.95
JE26	6 1/2 x 5 1/2	2,390	4	\$27.95
JE27	7 1/4 x 7 1/2	3,220	4	\$37.95

Jameco's IBM PC/XT/AT Compatible Motherboards

Award BIOS ROMs included

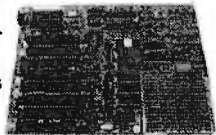

JE1001	4.77/8MHz (PC/XT)	\$ 99.95
JE1002	4.77/10MHz (PC/XT)	\$119.95
JE1007	6/8/10/12MHz (AT)	\$349.95

2 & 3MB Memory Expansion Cards for IBM AT and Compatibles

JE1081	2MB of expanded or extended memory (zero-K on-board) (AT)	\$119.95
JE1082	3MB of expanded or extended memory, parallel printer port, serial port and game port (zero-K on-board) (AT)	\$169.95

Jameco Computer Power Protection

JE1190	Power Base	\$29.95
JE1191	6-Outlet Power Strip	\$11.95

IBM PC/XT/AT Compatible Keyboards

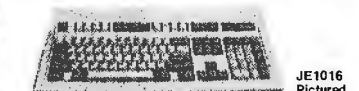

JE1015	Enhanced keyboard layout - illuminated Num Lock, Caps Lock and Scroll Lock - Automatically switches between PC/XT or AT	\$59.95
JE1016	Tactile touch keyswitches - Switch selectable between PC/XT or AT - Illuminated Caps Lock, Num Lock and Scroll Lock	\$79.95

DATA BOOKS

400041	NSC Linear Data Book-Vol. I (87)	\$14.95
400042	NSC Linear Data Book-Vol. II (87)	\$ 9.95
400043	NSC Linear Data Book-Vol. III (87)	\$ 9.95
210830	Intel Memory Handbook (87)	\$17.95
230843	Intel Microsystem Hndbk. Set (87)	\$24.95

U.S. Funds Only
Shipping: Add 5% plus \$1.50 Insurance
(May vary according to weight)

California Residents:
Add 6%, 6 1/2% or 7%
Sales Tax
FAX: 415-592-2503

7/88



Mail Order Electronics - Worldwide
Jameco
ELECTRONICS



1355 Shoreway Rd., Belmont, CA 94002 • 24 HR. ORDER HOTLINE 415-592-8097 • All Other Inquiries (7am-5pm PST) 415-592-8121

IBM AT COMPATIBLE KIT Mini-286 6/8/10/12MHz Kit

JE1007	Baby AT Motherboard (Zero-K RAM - includes Award BIOS ROMs)	\$349.95
JE1015	XT/AT Style Keyboard	\$ 59.95
JE1017	Baby AT Flip-Top Case	\$ 69.95
JE1022	5 1/4" Hi-Density Disk Drive	\$109.95
JE1032	200 Watt Power Supply	\$ 89.95
JE1043	360K/720K/1.2M Floppy Controller Card	\$ 49.95
JE1065	Input/Output Card	\$59.95

Regular List \$789.65

SAVE \$99.70!

JE1059 \$519.95
(EGA Monitor and Card not included)

JE2009*	IBM AT Compatible Kit	\$689.95
JE286M	JE2009 Technical Manual	\$29.95

*RAM not included - Minimum RAM configuration 512K (18 Chips 41256-120, see left)

IBM COMPATIBLE DISPLAY MONITORS

12" Amber Monochrome - TTL Input, High Resolution (PC/XT/AT)
AMBER.....\$99.95

14" RGB Color - CGA Compatible Amber/Green/Color Switchable, 640 x 200 Resolution (PC/XT/AT)
TTX1410.....\$279.95

14" EGA Color - EGA/CGA Compat, 720 x 350 Max. Resolution (PC/XT/AT)
TE5154.....\$399.95

14" Multiscan Color - VGA/PGC/EGA compatible, 800 x 600 Max. Resolution (PC/XT/AT)
CTX1435.....\$549.95

EGA/VGA MONITOR AND CARD SPECIALS

14" EGA Monitor and EGA Card - EGA compatible, 720 x 350 Max. Resolution - displays up to 16 colors (PC/XT/AT)
JE1059.....\$519.95

13" VGA Monitor and VGA Card - VGA compatible, 800 x 560 Max. Resolution - displays up to 256 colors (PC/XT/AT)
JEVGA.....\$649.95

IBM PC/XT/AT COMPATIBLE CARDS

Graphic Display Cards



JE1050	Mono Graphics Card w/Printer Port (PC/XT/AT)	\$59.95
JE1052	Color Graphics Card w/Printer Port (PC/XT/AT)	\$49.95
JE1055	EGA Card with 256K Video RAM (PC/XT/AT)	\$169.95
JE1071	Multi I/O with Drive Controller and Mono Graphics (PC/XT)	\$119.95

Multifunction, I/O and Expansion Cards

JE1060	I/O Card with Serial, Game, Parallel Printer Port and Real Time Clock (PC/XT)	\$59.95
JE1061	RS232 Serial Half Card (PC/XT/AT)	\$29.95
JE1065	I/O Card with Serial, Game and Parallel Printer Port (AT)	\$59.95
JE1078	Expand to 384K (zero-K on-board) Multifunc. w/Serial, Game, Parallel Printer Port & Real Time Clock (PC/XT)	\$69.95

Floppy and Hard Disk Controller Cards

JE1040	360KB Floppy Disk Drive Controller Card (PC/XT)	\$29.95
JE1041	20/40MB Hard Disk Controller Card (PC/XT)	\$79.95
JE1043	360K/720K/1.2MB Floppy Disk Cont. Card (PC/XT/AT)	\$49.95
JE1045	360K/720K/1.2MB Floppy/Hard Disk Controller Card (AT)	\$149.95



COMPUTER PERIPHERALS



ST225	20MB Drive only (PC/XT/AT)	\$224.95
ST225XT	20MB w/Controller (PC/XT)	\$269.95
ST238	30MB Drive only (PC/XT/AT)	\$249.95
ST238XT	30MB w/Controller (PC/XT)	\$299.95
ST238AT	30MB w/Controller (AT)	\$389.95
ST251	40MB Drive only (PC/XT/AT)	\$429.95
ST251XT	40MB w/Cont. Card (PC/XT)	\$469.95
ST251AT	40MB w/Controller Card (AT)	\$539.95
ST277	60MB Drive only (PC/XT/AT)	\$499.95
ST277AT	60MB w/Controller Card (AT)	\$639.95

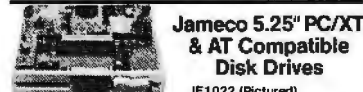

JE1020	360K Black Bzl. (PC/XT/AT)	\$ 89.95
JE1021	360K Beige Bzl. (PC/XT/AT)	\$ 89.95
JE1022	1.2MB Beige Bzl. (PC/XT/AT)	\$109.95

Toshiba 3.5" PC/XT/AT Compatible Disk Drive
352KU 3.5" 720KB (Bazels and Installation Kit incl.) (PC/XT/AT) ... \$129.95

2400/1200/300 Modems

1200H	1200/300 Baud Internal Modem	\$ 69.95
2400S	2400/1200/300 Internal Modem	\$139.95
1200C	1200/300 Baud External Modem	\$119.95
2400E	2400/1200/300 External Modem	\$179.95

Jameco Extended 80-Column Card for Apple IIe

JE864	80 Col./64K RAM - Doubles amount of data your Apple IIe can display as well as its memory capacity - Ideal for word processing - Complete with instructions	\$39.95
-------	---	---------

ADD12 (Disk Drive II, II+, IIe) \$99.95

TEST EQUIPMENT

Digital Multimeters

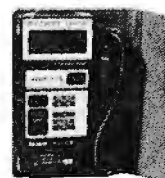

Kingdom KD302:
• Pocket Size in handy carry case
• 3 1/2 Digit LCD
• Auto or manual ranging
• Audible continuity tester
• Tests: AC/DC Voltage, Resistance and Continuity
• One Year Warranty
• Size: 4 1/4" x 2 1/4" x 1 1/4"
KD302 .. \$27.95

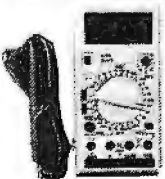

Metex M4650:
• Handheld, high accuracy
• 4 1/2 Digit LCD
• Manual ranging with Overload Protection
• Audible continuity tester
• Tests: AC/DC Voltage, Resistance, Continuity, Capacitance, Frequency
• One Year Warranty
• Size: 7 1/2" x 3 1/2" x 2 1/4" x 1 1/4"
M4650 .. \$89.95

Data Sheets - 50¢ each
Prices Subject to Change

Send \$1.00 Postage for a FREE 1988 CATALOG

Telex: 176043

©1988 Jameco Electronics

CONVERT YOUR PC PARALLEL PORT TO SERIAL

**B&B "Parallel to RS-232
Serial CONVERTER"
Model 232PSC**

Add another serial port on your PC, easily and economically. B&B's Model 232PSC connects directly to most PC compatible parallel ports; gives you a serial output, works with practically any serial printer.

Parallel to serial CONVERTER comes complete with AC power supply; can be programmed for 150-9600 Baud, Parity, 7 or 8 Bits, Number of Stop Bits, and Busy input (pin 4 or pin 20).



\$119.95

**SAME DAY SHIPMENT!
MONEY BACK GUARANTEE
FROM MANUFACTURER!
BUY DIRECT AND SAVE!**



Write or call for FREE B&B ELECTRONICS MFG. CO. CATALOG TODAY! Terms: Visa, MC, cash orders postpaid. P.O.'s from rated firms accepted. (Inmate residents add 6% state sales tax.)

B & B electronics
MANUFACTURING COMPANY

15026 Boyce Memorial Drive • P.O. Box 1040 • Ottawa, IL 61350

815-434-0846

Circle 24 on Reader Service Card

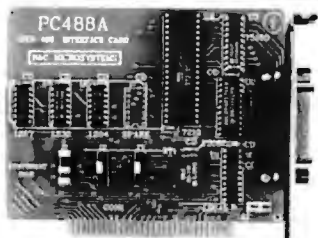

PC488A \$145/195

**LOW COST PC/XT/AT INTERFACE
FOR IEEE-488 (GPIB/HPIB)**

- Includes **INSTALLABLE DOS DEVICE DRIVERS** and software support for **BASIC**
- Optional language support for **C, PASCAL, FORTRAN** and **ASSEMBLY - 350**
- Selectable base I/O address, IRO and DMA
- **CONTROLLER / TALKER / LISTENER** capability
- Customer support via dedicated 24 hours B&C Microsystems **BULLETIN BOARD**
- Quantity discounts available

VISA MC AMEX *Call today for datasheet!!*

B&C MICROSYSTEMS

355 West Olive Ave, Sunnyvale, CA 94086
PH: (408)730-5511 FAX: (408)730-5521 TELEX: 984185

Circle 26 on Reader Service Card

ATTENTION p/cad USERS

Now you can increase the productivity of your software by using the new...

RAPICAD buffer/decoder.

Two buffers in one unit with parallel and serial in/out. Up to 1 Meg total memory.

NO EXTERNAL DECODER needed any more... because RAPICAD is fully p/cad box compatible and software transparent, allowing the use of p/cad and any other software with any printer, plotter, laser, etc.

Prices as low as **\$995.00**



INTECTRA Inc.
2629 Terminal Blvd.
Mtn. View, CA 94043
(415) 964-5018

DATA FLEX™

- Multi-user Database!
 - Powerful!
 - Multiple Operating System Compatibility!
 - Attractive Dealer Pricing!
 - Full Dealer Support!
- Dataflex is a trademark of Data Access
Dealer Inquiries Invited

COGITATE

24000 Telegraph Road
Southfield, Michigan 48034 USA
(313) 352-2345

Circle 56 on Reader Service Card

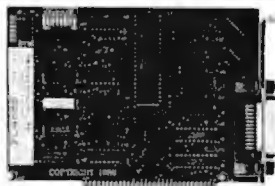

PC488B \$445

**IEEE-488 INTERFACE CARD WITH
BUILT-IN BUS ANALYZER**

- **GPBASIC** package complements IBM/Microsoft BASIC interpreter and compiler to create a programming environment similar to HP desktop computers.
- Additional libraries of over 20 high level 488 dedicated functions for C, Pascal or Fortran available (\$50).
- Powerful menu-driven bus analyzer, which can run in the foreground or in the background while 488 programs or commands are executed, features program stepping, break points and real time bus data capture (4K circular buffer).
- Instant toggling between foreground and Analyzer screen.
- Complete Talker/Listener/Controller capability.
- Dipswitch selectable Base Address, IRO, DMA

VISA MC AMEX *Call today for datasheet!!*

B&C MICROSYSTEMS

355 West Olive Ave, Sunnyvale, CA 94086
PH: (408)730-5511 FAX: (408)730-5521 TELEX: 984185

Circle 27 on Reader Service Card



Presto!
**A Link to
Mainframe
Graphics**

Find out how our whole family of EMU-TEK graphics terminal emulation software makes good sense for the work you do. Call today for more information.

FTG DATA SYSTEMS

(714) 995-3900
(800) 962-3900 (800) 972-3900 (Calif.)
10801 Dale St., Suite M-2
Stanton, CA 90680

Circle 104 on Reader Service Card

DISKS ToGo



100% certified and tested. Error free life time warranty. All disks include generic white box, Tyvek sleeves, labels, write protect tabs, shrink wrapped.

- 5.25 Black Disks, DS/DD36 ea.
- 5.25 Color Disks, 8 Colors Available, DS/DD46 ea.
- 5.25 Black Disks, DS/HD86 ea.
- 5.25 Color Disks, 8 Colors Available, DS/HD94 ea.
- 3.5 Blue or Gray Disks, DS/DD 1.12 ea.
- 3.5 Color Disks, 7 Colors Available, DS/DD 1.28 ea.
- 3.5 High Density, Black only ... 3.80 ea.

BULK MEDIA AVAILABLE

- 5.25 DS/DD32 ea.
- 5.25 DS/DD Colors42 ea.
- 5.25 DS/HD82 ea.
- 5.25 DS/HD Colors90 ea.
- 3.5 DS/DD Blue or Gray 1.07 ea.
- 3.5 DS/DD Colors 1.23 ea.
- 5.25 Tyvek Sleeves03 ea.
- 5.25 Paper Sleeves02 ea.
- 5.25 Label Sheet08 ea.
- 3.5 Label Sheet20 ea.
- 5.25 White Box15 ea.
- 3.5 White Box14 ea.



CONTINUOUS FORM LABELS

Size	Across	Box Qty.	Price Per/1000
2 3/4 x 7/16	1 across	10,000	\$1.95
2 3/4 x 7/16	4 across	20,000	\$1.95
2 1/2 x 15/16	1 across	5,000	\$2.18
2 1/2 x 15/16	3 across	15,000	\$1.98
* 2 3/4 x 2 3/4	1 across	2,500	\$12.00
2 3/4 x 1-7/16	1 across	5,000	\$3.00
3 x 15/16	4 across	20,000	\$2.00
3.3 x 15/16	4 across	20,000	\$2.05
3 1/2 x 15/16	1 across	5,000	\$1.90
3 1/2 x 15/16	2 across	10,000	\$1.90
3 1/2 x 15/16	3 across	15,000	\$1.90
3 1/2 x 15/16	4 across	20,000	\$1.90
4 x 15/16	1 across	5,000	\$3.21
4 x 15/16	3 across	15,000	\$3.21
4 x 1-7/16	1 across	5,000	\$3.25
4 x 1-7/16	3 across	15,000	\$3.25

Prices quoted for full boxes only.

1040 Broadway
Westville, NJ 08093

609-456-6996

FAX# 609-456-7172

All orders F.O.B. Westville, NJ.
COD orders add \$2.20. Visa & MC accepted.
All orders shipped same day.

MICROMINT'S Gold Standard in Single Board Computers and Industrial Controllers

BCC180 — \$395.00
Multitasking Controller



The BCC180, only 4.5" x 8.5" uses the same 64180 CMOS Z80 instruction compatible processor as Micromint's SB180 and SB180FX single board computers. Configured primarily for process control w/ 384K of memory, 6 parallel I/O ports, console serial port, RS-232/422/485 selectable auxiliary serial port, and an interrupt driven ROM-resident multitasking BASIC-180 compiler, the BCC180 uses the same 44-pin I/O expansion bus as Micromint's BCC52 controller board.

PROC SS R
* CMOS HD6-180, 9.2MHz 8-bit CPU, 68-pin PLCC package

MEMORY

- Up to 384K bytes total memory on-board
- 128K of either static RAM (62256) or EPROM (27256)
- 256K dynamic RAM (30M)
- Full-function 8K ROM monitor included

INPUT/OUTPUT

- Console RS-232 serial port with auto baud rate select to 19,200 baud
 - Peripheral serial port, 150-19,200 baud, selectable RS-232, RS-422, or RS-485
 - 48 bit bidirectional parallel I/O
 - 64K I/O available through the BCC bus edge connector
- DIMENSIONS AND CONNECTIONS**
- Dual 22-pin (0.156") edge connector
 - Compatible with all Micromint BCC-series I/O expansion boards
 - Two 2-pin headers for six bidirectional parallel busses
 - 25-pin DIN-25 for RS-232 console I/O
 - 20-pin header for RS-232 auxiliary serial port
 - 4 screw terminals for RS-422/485 connection

BCC180-1 20MHz assembled and fully socketed BCC180 Computer/Controller with 32K bytes of static RAM, ROM Monitor, BASIC-180 development software and user's manual \$395.00

For Additional 256K DRAM add \$100.00

BCC180-1 100 Quantity w/32K RAM w/a ROM Monitor \$209.00

BCC52 — \$189.00
BASIC-52 Computer/Controller

The BCC52 Computer/Controller is Micromint's hottest selling standalone single board microcomputer. Its cost-effective architecture needs only a power supply and terminal to become a complete development or end-use system, programmable in BASIC or machine language. The BCC52 uses Micromint's new 80C52-BASIC CMOS microprocessor which contains a ROM resident 8K byte floating point BASIC-52 interpreter.

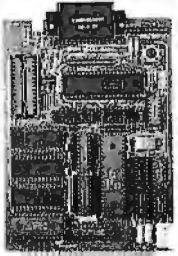

The BCC52 contains sockets for up to 48K bytes of RAM/EPROM, an "intelligent" 2764/128 EPROM programmer, 3 parallel ports, a serial terminal port with auto baud rate selection, a serial printer port, and it is bus compatible with the full line of BCC-bus expansion boards. The BCC52 bridges the gap between expensive programmable controllers and hard-to-justify price sensitive control applications. BASIC-52's full floating point BASIC is fast and efficient enough for the most complicated tasks, while its cost effective design allows it to be considered for many new areas of implementation. It can be used both for development and end-use applications.

Since the BASIC-52 is bus oriented, it supports the following Micromint expansion boards in any of Micromint's card cages with optional power supplies:

BCC22 Smart terminal board	BCC40R8-Channel relay output board
ADP300 User vocabulary, digitized speech board	BCC53 Memory and 6 port I/O expansion board
BCC25 LCD display board	BCC13 8-bit and BCC30 12-bit A/D converter boards
BCC33 3 port I/O expansion board	BCC11 8-bit and BCC30 12-bit I/O expansion board
BCC40D 8-Channel optoisolated I/O expansion board	BCC18 Dual channel serial I/O board

BCC52 BASIC 52 Controller Board \$189.00
BCC-SYST.5 "52 PAK" Starter System includes: BCC52,ROM A&B UTIL.,CC01,MB08,UPS10 \$449.00

BCC52 OEM 100 Quantity Price -- \$149.00

BCC52C Lower power all CMOS version of the BCC52 \$199.00
NOTE: The BCC52 series is available in Industrial Temperature Range, fully tested at temperature. Prices start as low as \$294.00 in single quantities. Be sure to call for a quote on your specific Industrial OEM requirements.

BCC11 — \$139.00
Z8 BASIC Computer

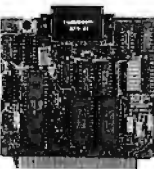

Features:

- Uses Z8 single chip microcomputer
- On-board tiny BASIC interpreter
- 2 on-board parallel ports & serial port
- 6 interrupts (4 external)
- Just connect a terminal and write control programs in BASIC
- 6K bytes of RAM or EPROM memory on-board
- Baud rates 110-9600 bps
- Data and address bus available for 56K memory and I/O expansion
- Consumes only 1.5 watts at +5, +12, and -12V

BCC11* BASIC System Controller \$139.00

OEM 100 Quantity Price \$89.00

* Now Available in Industrial Temperature Range

Announcing **BCC40D** \$139.00
8-Channel Optoisolated I/O Expansion Board

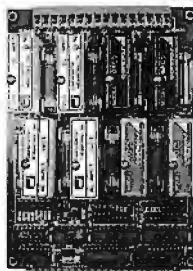

The Micromint BCC40D is an 8-channel optoisolated input/output expansion board designed for use with Micromint's family of BCC-bus Computer/Controllers. Using industry-standard optoisolated I/O modules, the BCC40D provides on/off control and input monitoring of eight 115-230V AC or 5-48VDC devices used in data acquisition and control applications.

Up to 16 BCC40D boards can be used together in a single system to provide a total of 128 input and output channels. Individual channels can be read or updated by reading from or writing to a single I/O address. The BCC40D can be directly controlled from BASIC or it can function completely in the background under an application program using high-speed interrupt-driven ROM C firmware. This firmware sets aside a table in memory which reflects the status, setpoints, and change-of-state flags of the I/O modules. Interaction among programs within a multiboard BCC40x system merely consists of reading or setting these memory table values.

Each optoisolated channel is fused and has screw contacts for direct connection to the controlling device and/or the power source. Both input or output modules, and AC or DC functions can be intermixed on the same BCC40D board.

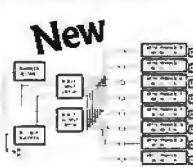

- SPECIFICATIONS**
- Latched outputs
 - Uses industry-standard OACS, ODCS, IACS, IDC3 type modules
 - Dual-ported module addressing
 - LED on/off indicator on each channel
 - Can be used concurrently with BCC40R and other BCC-bus peripherals
 - Operates on +5V
 - Operating conditions: temperature: 0-30°C (32-122°F) relative humidity: 10-90% non-condensing
 - 4.5" x 6" board
 - dual 22-pin (0.156") edge connector
 - 16-terminal screw connector (#14 wire)

BCC40D/0 without modules \$139.00
BCC40D/4 with 4 modules \$189.00
BCC40D/8 with 8 modules \$239.00

OEM 100 Quantity pricing starts at \$95.00



Announcing **BCC40R** — \$169.00
8-Channel Relay Output Board

The Micromint BCC40R is an 8-channel relay output expansion board designed for use with Micromint's family of BCC-bus Computer/Controllers. Using efficient mechanical relays, the BCC40R provides contact-closure on/off control of eight AC- or DC- powered devices for data acquisition and control applications. Up to 16 BCC40R boards can be used together in a single system to provide a total of 128 relay output channels. The relays are controlled by writing to a board-specific I/O address. The relays on a BCC40R board can be controlled either as a set of eight relays at a single I/O address or individual relays at eight separate I/O addresses.

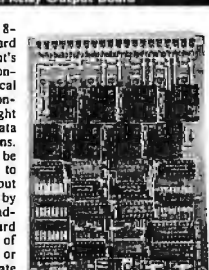

The BCC40R can be directly controlled from BASIC or it can function completely in the background under an application program using high speed interrupt-driven ROM C firmware. This firmware sets aside a table in memory which reflects the status and setpoints of the relays. Interaction among programs within a multiboard BCC40x system merely consists of reading or setting these memory table values.

The eight relay outputs have screw contacts for direct connection to the controlling device and/or the power source. Four of the relays have single-pole-double-throw (SPDT) output connections and four relays have single-pole-single-throw (SPST) output connections.

- SPECIFICATIONS**
- Contacts rated for: 1/10 HP, 3A 120V resistive, or 3A 30VDC
 - Latched relay outputs
 - LED on/off indicator on each channel
 - Power on/off failsafe: No arbitrary closures on power up/down
 - Can be used concurrently with BCC40D and other BCC-bus peripherals
 - Operates on +12V
 - Operating conditions: 0-50°C (32-122°F) relative humidity: 10-90% noncondensing
 - 4.5" x 6" board
 - dual 22-pin (0.156") edge connector
 - 20-terminal screw connector (#14 wire)

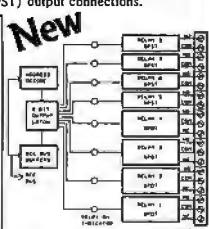

BCC40R 8-Channel relay output board \$169.00
OEM 100 Quantity price \$124.00

Announcing **BCC18** — \$175.00
Dual-Serial Board



The BCC18 is a general-purpose dual-serial-port interface board for use with the Micromint BCC-bus. Optional support software is available for the BCC52and BCC180 computer/controllers.

The BCC18 Serial Board contains two serial interfaces. Each interface can be either a 110/300/1200-bps modem, or a hard-wired RS-232C/RS-422/RS-485 interface. The modem interface uses a Xecom XE1201/XE1203 MOSART (Modem Synchronous/Asynchronous Receiver/Transmitter), capable of 110, 300, or 1200 bps communication and compatible with Bell 103 and Bell 212A standards. The hard-wired serial interface uses an industry-standard 8251A USART (Universal Synchronous/Asynchronous Receiver/Transmitter), capable of supporting asynchronous serial communications at speeds up to 19.2 kbps and synchronous serial communications at speeds up to 64k bps.

The BCC18 can be configured with two MOSARTs, two 8251As, or one of each. Up to 16 BCC18s can be used in a single system (for a total of 32 serial ports).

- MOSART**
- Connects directly to any phone line
 - Sync byte detection/insertion
 - DTRM or pulse dialing
 - Excessive built-in diagnostics
 - Telephone-line diagnostics
 - Call progress monitoring
 - Synchronous and asynchronous operation
 - Parity generation/checking
 - Voice synthesis capability (XE1203 only)
- 8251A**
- Full-duplex, double-buffered transmitter and receiver
 - Fully programmable with several speed and character modes
 - Error detection for parity, overrun, and framing
 - Fake start bit detection; automatic break detect and handshaking
 - Supports biasync
 - Bit rate is software programmable using an on-board 8253 counter/timer
 - RS-232C, RS-422, and RS-485 supported
- MOSART and 8251A** use the same program interface, so most software will work with both
- Optional support software for the BCC52 and BCC18 is available that makes it easy to trace and use most of the features of the MOSART and 8251A from within user-written programs

BCC18S OEM configuration fixed dual 8251 RS-232 only \$175.00 serial port board

BCC18S OEM 100 Quantity Price \$134.00

BCC18U-1	8251/8251 Dual RS-232/485 serial port	\$209.00
BCC18U-2	8251/1201 Modem and serial port	\$359.00
BCC18U-3	1201/1201 Modem /Modem board	\$499.00
BCC52/18	BCC52 serial port utilities software	\$75.00

BCC-BUS
Expansion Products

	Single Qty. Price
BCC08	Single Channel UART Serial Board \$149.00
BCC13	8-bit, 8 Channel A/D Board \$129.00
BCC30	12-bit, 16 Channel A/D Board \$197.00
BCC22	25-line, 80 Character Terminal Board \$249.00
BCC25	LCD Board (4x20) or (8x40)* \$159.00
BCC55	Fully Decoded & Buffered Prototyping Board \$ 79.00
BCCxx	X-10 Power Line Controller \$ 59.00
BCC53	Multifunction Expansion Board \$160.00
MB04	4 Slot Mini-Motherboard \$ 69.00
MB08	8 Slot Full Motherboard \$ 85.00

*Call for current pricing

REPRESENTATIVES
ACCESS TECHNOLOGIES
1408 Richmond Dr
Placentia, Ca. 92670 Tel:(714) 996-3917

MICROFUTURE
41040 Cornac Terrace
Fremont, Ca. 94538 Tel:(415) 657-0264

DISTRIBUTOR
J.B. DESIGNS & TECHNOLOGIES LTD.
15 Market Place
Cirencester, Glos. GL7 2PB
England
Tel: 0285-68122 Fax: 0285-68859

To order call
1-800-635-3355

TEL: (203) 871-6170
TELEX: 643331
FAX : (203) 872-2204

MICROMINT INC.
4 PARK STREET
VERNON, CT. 06066



BYTE LISTINGS YOUR WAY!

It's easy. Now there are three ways to get source-code listings that go with BYTE articles—on disk, in print or on line.

LISTINGS ON DISK

BYTE listings on disk are right for you if you want to compile or run programs quickly. Also included on disk are the month's BIX highlights specific to your machine format.

LISTINGS IN PRINT

This print supplement contains source-code listings described in the issues of BYTE.

LISTINGS FROM BIX

(BYTE Information Exchange) By joining BIX, you can download BYTE source-code listings at standard BIX rates. See BIX informational ad listed in Reader Service index in this issue.



FOR DIRECT ORDERING CALL TOLL FREE: 800-258-5485

Call: M-F, 8:30 a.m. to 4:30 p.m. Eastern Time

(603-924-9281 for New Hampshire residents)

For credit card orders only.

ON DISK - *Including the Month's BIX Highlights Specific To Your Machine Format.

Disks of listings from December 1985 to present are available at the prices stated at right. Please mark the appropriate format and note the issue date below. If you are ordering a subscription, please note the issue date on which you would like it to begin.

Month _____

Year _____

	IN USA:		OUTSIDE USA:	
	Single Month (one disk)	Annual Subscription (13 disks)	Single Month (one disk)	Annual Subscription (13 disks)
5 1/4 inch:	<input type="checkbox"/> \$8.95	<input type="checkbox"/> \$69.95 (Save \$46.40)	<input type="checkbox"/> \$10.95	<input type="checkbox"/> \$89.95 (Save \$52.40)
<input type="checkbox"/> IBM PC*				
<input type="checkbox"/> Apple II				
<input type="checkbox"/> Kaypro 2 CP/M				
<input type="checkbox"/> MS-DOS 8 Sector*				
<input type="checkbox"/> TI Professional				
3 1/2 inch:	<input type="checkbox"/> \$9.95	<input type="checkbox"/> \$79.95 (Save \$49.40)	<input type="checkbox"/> \$11.95	<input type="checkbox"/> \$99.95 (Save \$55.40)
<input type="checkbox"/> Apple Macintosh*				
<input type="checkbox"/> Atari ST*				
<input type="checkbox"/> Amiga*				
<input type="checkbox"/> IBM PS/2*				

IN PRINT

1988 Supplement Issues

January through March \$6.95 in USA \$7.95 outside USA

Monthly supplements replace quarterly supplements starting in April. Indicate the month you're ordering in the space below.

Month _____

Year _____

\$2.50 per issue in USA
\$3.50 per issue outside USA

Annual Subscriptions:
\$19.00 in USA
\$22.00 outside USA

Please note month and year you would like the subscription to begin.

Month _____

Year _____

1987 Supplement Issues

IN USA:

- January through March 1987 for only \$6.95.
- April through June 1987 for only \$6.95. (Includes 1986 Index).
- July through September 1987 for only \$6.95.
- October through December 1987 for only \$6.95.
- 1987 subscription only \$18.00.

OUTSIDE USA:

- January through March 1987 for only \$7.95.
- April through June 1987 for only \$7.95.
- July through September 1987 for only \$7.95.
- October through December 1987 for only \$7.95.
- 1987 subscription only \$21.00.

1986 Supplement Issues

IN USA:

- January through June 1986 for only \$8.95.
- July through September 1986 for only \$6.95.
- October through December 1986 for only \$6.95.
- 1986 Annual Subscription for only \$18.00.

OUTSIDE USA:

- January through June for only \$9.95.
- June through September for only \$7.95.
- October through December for only \$7.95.
- 1986 Annual Subscription for only \$21.00.

FOLD
HERE

COMBINED DISK AND PRINT SUBSCRIPTION

Bundled together, giving you the convenience of disk-based source-code plus the ease of reference of print.

If you are ordering a subscription, please note the issue date on which you would like it to begin.

	IN USA:	
	Annual Subscription	Annual Subscription
5 1/4 inch:	<input type="checkbox"/> \$89.95 (Save \$58.35)	<input type="checkbox"/> \$109.95 (Save \$75.35)
<input type="checkbox"/> IBM PC		
<input type="checkbox"/> Apple II		
<input type="checkbox"/> Kaypro 2 CP/M		
<input type="checkbox"/> MS-DOS 8 Sector		
<input type="checkbox"/> TI Professional		
3 1/2 inch:	<input type="checkbox"/> \$99.95 (Save \$61.35)	<input type="checkbox"/> \$119.95 (Save \$78.35)
<input type="checkbox"/> Apple Macintosh		
<input type="checkbox"/> Atari ST		
<input type="checkbox"/> Amiga		
<input type="checkbox"/> IBM PS/2		

FOLD
HERE

Complete in full. JULY

Name _____

Address _____

City _____ State _____ Zip _____

County or Parish _____ Country _____

Credit Card # _____

Exp. Date _____ Signature _____ Date _____

- Check enclosed
- MasterCard
- VISA
- U.S. Funds enclosed (If ordering from outside the U.S. please remit in U.S. funds drawn on a U.S. bank. Thank you.)

Please allow 4-8 weeks for delivery.

BYTE

FOLD
HERE



NO POSTAGE
NECESSARY
IF MAILED
IN THE
UNITED STATES

BUSINESS REPLY MAIL
FIRST CLASS MAIL PERMIT NO. 10 PETERBOROUGH, NH

POSTAGE WILL BE PAID BY ADDRESSEE

BYTE Listings

One Phoenix Mill Lane
Peterborough, NH 03458-9990

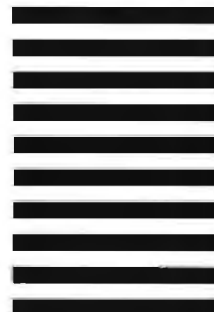

FOLD
HERE

9-TRACK MAG. TAPE SUBSYSTEM* FOR THE IBM PC/XT/AT AND...



For information interchange, backup and archival storage, AK System offers a 9-track, IBM format-compatible 1/2" magnetic tape subsystem for the IBM PC, featuring:

- IBM format 1600/3200 and 800 cpl.
- Software for PC-DOS, MS-DOS, XENIX.
- Also for AT&T, DEC, VAX, VME, S-100, RS-232, IEEE 488.

AKSystems

20741 Marilla St
Chatsworth, CA 91311
(818) 708-6300
TWX 910-493-2071

Formerly IDEX Measurement
Write, phone or TWX for information.

PC-LabCard SERIES

Lab, Industrial and Engineering I/O Cards for IBM PC/XT/AT

- PCL-714 (14 bits) A/D + D/A + D/I + D/O + Timer/Counter Card \$495
- PCL-712 (12 bits) A/D + D/A + D/I + D/O + Timer/Counter Card \$295
- PCL-720 Digital I/O & Counter Card \$160
- PCL-725 Relay & Opto-isolated D/I Card \$240
- PCL-738 Stepping Motor Control Card \$395
- PCL-742 RS-422 Interface Card \$130
- PCL-748 IEEE-488 Interface Card \$395
- PCL-750 Prototype Development Card \$ 70
- PCL-754 PC Slot Extension Kit \$ 50
- PCLS-700 Data Acquisition & Control Software \$195
- PCLS-705 Waveform/Oscilloscope Software \$125

Dealer and OEM inquiries welcome.
Call for free catalog!



1460 Tully Rd. #602
San Jose, CA 95122
TEL: (408) 293-6786
FAX: (408) 293-4697

Circle 9 on Reader Service Card

Circle 15 on Reader Service Card

Intel
RUN **ISIS**
Very Fast

12.5 MHz Clock Speed!



Our co-processor card plugs into your PC or PC/AT. With the included software you can run your ISIS-II development tools, such as ASM80, PLM51, etc. Serial communications program for PC-Intel file transfer included. \$495 gets you a complete 6 mhz system. Clock speeds of 10 and 12.5 mhz also available. We have the best and fastest products in this area.

Z-World

2065 Martin Ave #110
Santa Clara, CA 95050
(408) 980-1678



In Germany: iSystem Tel: 08131/1687

Circle 286 on Reader Service Card

HD64180 Single Board

Prototyping / Control Computer
Get your 64180 project going quickly!

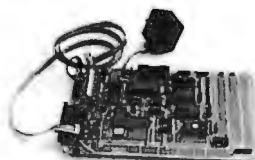

The SBC100 is a complete computer powered by a wall transformer. Available C compiler, assembler, linker and debugger run on a PC. Has battery-backed RAM, battery-backed clock, power fail interrupt, SBX bus connectors, serial and parallel I/O, prototype area for up to 20 IC's. Only \$295 including serial cable, power supply, 32k of battery backed RAM and schematics.

Z-World

1772A Picasso Avenue
Davis, CA 95616



(916) 753-3722

"Z80 Family Specialists"

In Germany: iSystem 08131/1687

Circle 287 on Reader Service Card

Dynamic Electronics

23552
Commerce
Center Dr.
Suite L
Laguna Hills,
CA 92653

Stocking Distributor of Semiconductors

8087 • 5 • 8 • 10

80287 • 6 • 8 • 10 MEG

80387 • 16 • 20 MEG

256K • 64K • 128K • V20 • V30

Fast • Reliable • Everytime

Phone: 714-855-0411

Fax: 714-855-8504

No refund - exchange only - Exchange good for 30 days unless manufacturer warranties merchandise longer

Circle 93 on Reader Service Card

the **LOGIC™ LAB**



the **LOGIC™ LAB** is a complete logic development system

- * Complete System Including Programmer, Sample GAL Devices, Software and all Cabling.
- * Programs GAL Devices Including 16V8, 16Z8, 20V8, & 39V18.
- * Allows Prototyping of 42 different standard PLD's.
- * Includes Updated Equation Assembler Software.
- * Accepts All Standard JEDEC Download Files.
- * Software Updatable.
- * 30 Day Money Back Guarantee.

* Visa and Master Card Accepted *

CALL FOR FREE DEMO DISK

Programmable Logic Technologies, Inc.

R.O. Box 1547
Longmont, CO 80501
Ph. (303) 772-9059

GAL is a registered trademark of Lattice Semiconductor Corporation

Circle 210 on Reader Service Card

"WITH TYVEK SLEEVES" **29¢** ea.

BULK 5 1/4" DISKS
Double Side-Double Den.

100% Tested & Certified Error Free, at "Minimum 55% Clipping Level or Higher" "Lifetime Warranty" With Tyvek Sleeves & Write on Labels

100	200	600
.38¢ each	.35¢ each	.32¢ each

DEALERS WELCOME

Telex #4933362 • Fax #405-495-4598
Shipping Charges Vary With Quantity Call

Delaware 1-800-451-1849
PO BOX 10247 WILMINGTON, DE 19800
Oklahoma 1-800-654-4058
PO BOX 1074 SALEM, OK 73068
Nevada 1-800-621-6221
PO BOX 12396 LAS VEGAS, NV 89112
Minimum Order 2500 - Visa,Master,Card accepted, COD add 30% UPS delivery. US Mail for APO, FPO AK, HI, or PR add 5% additional for PAL



5 1/4"	5 Box	10 Box
D-Side	950	850
D-Den.	1750	1650
HIGH Den.	1600	1600

"Worldwide" Orders Accepted

3.5 S-Side 1195	DATA CARTRIDGES	8 S-Side 1540
35 D-Side 1650	DC 1000 12.95	8 S-Side 1895
3.5 H-Den. 4795	DC 2000 17.50	8 D-Side 2095
	DC 300XP 19.75	
	DC 600A 21.95	

Authorized Distributor
Magnetic Media Division **3M**

Delaware 1-800-451-1849
PO BOX 10247 WILMINGTON, DE 19800
Oklahoma 1-800-654-4058
PO BOX 1074 SALEM, OK 73068
Nevada 1-800-621-6221
PO BOX 12396 LAS VEGAS, NV 89112
Minimum Order 2500 Visa,Master,Card accepted. C.O.D orders add 30% Surface Shipping at 3.5¢/5.25¢ and 5.10¢/6.00¢ per 100 disks. 5¢/6¢ \$1.00 per 100 disks. UPS delivery only. US mail for APO, FPO, HI, or PR add as additional for PAL. Prices subject to change without notice.
Telex #4933362 • Fax #405-495-4598

BASF QUALIMETRIC

5 1/4" D-Side 750	5 1/4" High Den. 995
Min 5 Box	Min 5 Box

ALLSOP
DISK FILE 60
(5.95 EA.) With Each Purchase of 5 Boxes

"INTERNATIONAL ORDERS ACCEPTED"

Delaware 1-800-451-1849
PO BOX 10247 WILMINGTON, DE 19800
Oklahoma 1-800-654-4058
PO BOX 1074 SALEM, OK 73068
Nevada 1-800-621-6221
PO BOX 12396 LAS VEGAS, NV 89112
Minimum Order 2500 Visa,Master,Card accepted. C.O.D orders add 30% Surface Shipping at 3.5¢/5.25¢ and 5.10¢/6.00¢ per 100 disks. 5¢/6¢ \$1.00 per 100 disks. UPS delivery only. US mail for APO, FPO, HI, or PR add as additional for PAL. Prices subject to change without notice.
TELEX #4933362 • FAX #405-495-4598

RS-422 FOR PS/2



MODELS 50, 60, 80

- Two Channel
- Transfers to 256 K baud
- Address Selectable
- Interrupt Selectable

1-800-553-1170



478 E. Exchange St., Akron, OH 44304
TEL: (216) 434-3154 FAX: (216) 434-1409
TLX: 5101012726

Circle 215 on Reader Service Card

MODULAR DATA ACQUISITION



- FOR IBM & Compatibles
 - Flexible and Inexpensive
 - Money Back Guarantee
 - Free Technical Support
- Fast Delivery**
1-800-553-1170



Leaders in Communication Technology
478 E. Exchange St., Akron, OH 44304
(216) 434-3154 TLX: 5101012726

Circle 216 on Reader Service Card

CURRENT LOOP Communications Board

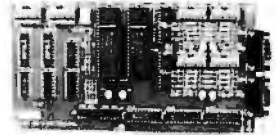

- Dual Channel
- Address Selectable
- Supports 20, 30, 60mA
- Configurable as Active & Passive
- Selectable & Shareable Interrupts

1-800-553-1170



478 E. Exchange St., Akron, OH 44304
TEL: (216) 434-3154 FAX: (216) 434-1409
TLX: 5101012726

Circle 217 on Reader Service Card

RS-422/232 CURRENT LOOP



DS-225

- Single channel async communication board for IBM PC/XT/AT
- Software selectable to be RS/422/485, 232 or Current Loop
- Selectable Address & Interrupt

1-800-553-1170



478 E. Exchange St., Akron, OH 44304
(216) 434-3154 TLX: 5101012726

Circle 218 on Reader Service Card

72 DIGITAL I/O FOR PS/2

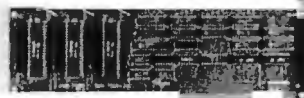

MODELS 50, 60, 80

- Parallel Expansion
- 72 I/O Lines
- Address Selectable

1-800-553-1170



478 E. Exchange St., Akron, OH 44304
TEL: (216) 434-3154 FAX: (216) 434-1409
TLX: 5101012726

Circle 219 on Reader Service Card

WAVEFORM SYNTHESIZER

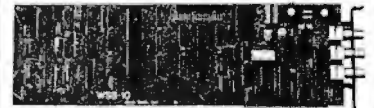

- For IBM PC/XT/AT and compatibles
- Generates user-definable signal
- Up to 2000 points per envelope

\$795.00

1-800-553-1170



478 E. Exchange St., Akron, OH 44304
(216) 434-3154 TLX: 5101012726

Circle 220 on Reader Service Card

SERIAL/PARALLEL Communications Board

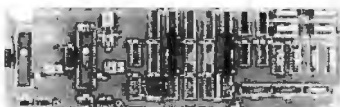

- Two Parallel Printer Ports
- Two 8-Bit Digital I/O Ports
- Two Serial Ports, RS-232, RS-422 or RS-485
- Address Selectable
- Selectable & Shareable Interrupts

1-800-553-1170



478 E. Exchange St., Akron, OH 44304
TEL: (216) 434-3154 FAX: (216) 434-1409
TLX: 5101012726

Circle 221 on Reader Service Card

IEEE-488 CONTROLLER FOR PS/2

MODELS 50, 60, 80

- GPIB Compatibility
- Control Up to 14 Devices
- Selectable Addressing
- Software Included

1-800-553-1170



478 E. Exchange St., Akron, OH 44304
TEL: (216) 434-3154 FAX: (216) 434-1409
TLX: 5101012726

Circle 222 on Reader Service Card

24 DIGITAL I/O

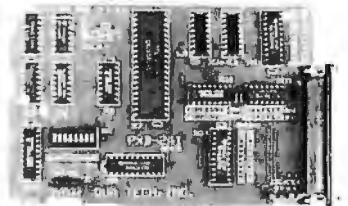

- 24 Bit Digital I/O
- Buffered Output
- Selectable Address

1-800-553-1170



478 E. Exchange St., Akron, OH 44304
TEL: (216) 434-3154 FAX: (216) 434-1409
TLX: 5101012726

Circle 223 on Reader Service Card

Compu\$ave

Call Toll Free: 1-800-624-8949

BOARDS

Above Board 286	319	Arist 1	795
ATI VGA Wonder	SAVE	AST 4 Port	309
ATI EGA Wonder	172	ATI V.I.P	258
AST 5251-11E	595	BOCA RAMAT	142
Genoa VGA	SAVE	Hercules VGA	242
Orchid Tiny Turbo	259	Orchid Designer	299
NEC MVA 1024	789	Metheus 1104	965
Paradise 480 Auto	148	Paradise VGA+	238
Paradise VGA Pro	352	STB VGA EM	299
Tecmar EGA Master	95	VMI IM 1024	2345
Video 7 Vega VGA	252	Vega Deluxe	182
ADC/BNW/Everex/Number 9/Computone	CALL		
Taltree/Quadram/Vericom/Intel/Sigma	CALL		

MONITORS

Amdek 410A	139	Amdek 1280	658
Goldstar TTL	69	Hitachi	CALL
Intercolor 19" VGA	1595	Mitsubishi VGA	462
Mitsubishi 1371A	485	PGS Ultra Synch	499
NEC Multisync II	569	PGS L M 300	539
NEC Multisync +	915	Sigma Laser 19"	1765
NEC Multisync XL	2025	Samsung EGA	349
NEC Monograph	1295	Taxan 770+	515
NEC Multisync GS	179	Wyse 700	678
Vericom 2 Page	1795	Zenith 1490	598

SCANNERS

Panasonic FXRS505	965
Datascopy Model 730	1095
PGS LS-300/iv PC Paintbrush & CCR	965
AST/Hewlett Packard/Taxan/Others	CALL

COMPUTERS

AST Model 286	CALL	AST Model 386	CALL
NEC Multispeed EL	CALL	NEC Multispeed	1299
NEC Multispeed HD	2199	Sharp 4521	1975
Sharp PC 7221	2645	Sharp PC-7000A	1165
Sharp PC-7100	1745	Sharp PC-4502	1165
Samsung Laptop	2149	Toshiba 1000	729
Toshiba 1100+	1339	Toshiba 1200	2285
Toshiba 3100/20	3145	Toshiba 3200	3745
Toshiba 5100	4845	Zenith Laptops	SAVE
Acer 80386:16 MHz/0 Wait/40M Drive	CALL		
Acer 80386:20 MHz/0 Wait	CALL		
NEC Powermate Portable 286/640k/20M	2645		
NEC Powermate Portable 286/640k/40M	3095		
Sperry PC IT 512k/44M HD/Keyboard	2795		
Samsung S500 AT: 10MHz/40M Drive	1565		
Televideo 386: 16 MHz/2m/1.2M Drive	2495		
Wyse 2108: 8 MHz/512k/1.2M Drive	1199		
Wyse 2112: 12.5 MHz/1M/1.2M Drive	1699		
Wyse 2214: 12.5 MHz/0 Wait/1.2 Drive	1895		
Wyse 386: 16 MHz/1M/1.2M Drive	2725		
ITT/Altos/Mitsubishi/Tandon/AT&T/Apple	CALL		

TERMINALS

Altos V	489	IBM 3151	395
Kimtron KT-70 PC	359	Link	CALL
Televideo 965	CALL	Televideo 905	315
Televideo 955	375	Wyse 30	289
Wyse 50	359	Wyse 60	395
Wyse 85G	429	Wyse 99GT	469
Visual/Link/CIE/Adds/Quem/Falco	CALL		

PLOTTERS

Calcomp 1023GT	3785	Calcomp 5902	3395
Calcomp 1043GT	6275	Enter SP 1800	3395
Houston DMP 52	2795	Houston 41/42	2095
Houston 56A	3795	Houston 61	3295
Houston 62	4495	HP 7475	1395
HP 7550 A	2895	HP 7595	7595
Ioline 3700	3045	Ioline 4000	3995
Roland 980	1195	Roland 880	929
Numerics/Taxan/Versatec/JDL/Other Models	CALL		

DIGITIZERS

Calcomp 44 x 60	3745	Calcomp 12 x 12	375
Calcomp 36 x 48	3195	GTCO 24 x 36	1945
GTCO 36 x 48	2395	Hitachi 11 x 11	439
Kurta IS 3	CALL	Kurta IS 8.5 x 11	249
Kurta IS 12 x 12	315	Kurta IS 12 x 17	535
Summa 24 x 36	3095	Summa 12 x 12 +	358
Summa 12 x 18	598	Summa 42 x 60	4195

MODEMS

AST 9600	789	Anchor 2400E	145
Avatec 1200 Ext	95	Hayes 1200	279
Incimm T2400 MNP	245	Hayes 2400	412
Incimm T4800	299	Multitech 224 EH	388
Migent Pocket	109	Multitech 224 EC	329
Prometheus 2400B/2	119	Practical 1200	65
Prometheus 2400G	149	Novation Parrot	85
Racal-Vadic 2400VP	399	USR 2400E	345
USR HST 9600	649	USR Courier 2400	299
Ver-Tel 18000	939	Zoom 2400 HC	139
Avatec/Case/Everex/UDS/Other Models	CALL		

PRINTERS

Alps 224	465	Citizen 120D	142
Citizen 180D	158	Citizen MSP40	282
Citizen MSP50	379	Diconix D150	299
Okidata 390	475	Okidata 320/321	CALL
Okidata 391	649	NEC P6/P7	CALL
NEC P5XL	815	NEC P9XL	1018
NEC P2200	325	Panasonic 1080 M2	175
Star NX1000	169	Panasonic 1091M2	198
Toshiba 321SL	489	Panasonic 1524	549
Toshiba 341SL	645	Panasonic 1595	469
HP Laser Jet II	1689	Cannon 8-11	1545
NEC LC 890	3145	Panasonic 4450	1665
CEI/Data South/OTC/Brother/Epson/TI	CALL		
C.Itoh/Diablo/Data Products/Genicom/QMS	CALL		

SOFTWARE

C Compiler 5.1	279	Carbon Copy+ 5.0	108
DBase III Plus	369	Harvard Graph 2.1	275
Fastback Plus	95	MS Word 4.0	212
Quattro	142	PC EXCEL 2.01	299
WordPerfect 5.0	199	Ventura Publisher	499

DISK DRIVES

Iomega Bernoulli Call	Miniscribe 30M card	385	
Miniscribe 6053	559	Miniscribe 40M	329
Miniscribe 6085	765	PlusCard 20M	525
PlusCard 40M	655	Seagate 20M Kit	265
Seagate 40M	385	Seagate 30M Kit	285
Seagate 4096	765	Toshiba 3.5" Kit	94
AST/Alloy/Everex/Genoa/Maynard/Maxtor	CALL		
Archive/Priam/Talgrass/CDC/Tecmar	CALL		

HOURS: MON-FRI 7AM-6PM/SAT 9AM-2PM
IN ARIZONA CALL: (602)437-4855

CompuSave: 4207 S. 37th St. Phoenix AZ 85040. Prices reflect cash discounts and are subject to change without notice. We do not guarantee compatibility. Major credit cards and selected PO's are accepted.

International orders are welcome.

PACIFIC-286-12

- 80286-12
- 1.2MB Floppy Drive (Option \$120 3 1/4" Drive)
- 640K Ram (Option \$95 for 380K Drive)
- Serial/Parallel
- 101-Key Enhanced Key Board
- SI = 13.3 (1 Wait)
- SI = 15.2 (0 Wait \$150 Option)
- 6/12 MHz Key Board Switchable
- WA2 HD & FD Controller



- MONO SYSTEM**
- W/Mono Monitor
- 20 MB Hard Disk
- \$1195**
- CGA COLOR SYSTEM**
- W/CGA Monitor
- 20 MB Hard Disk
- \$1395**
- EGA COLOR SYSTEM**
- W/EGA Card
- W/EGA Monitor
- W/20 MB Hard Disk
- \$1580**

LCD-286 PORTABLE

- 10 MHz 80286
- 640K Ram
- SI = 10.3
- Key Board
- LCD Screen
- Super Twist Back Lighting
- Serial/Parallel
- 1.2 MB Floppy Drive
- 80287 Socket
- 200W Power Supply
- 20 MB Hard Disk
- 23lbs.
- Size 15 1/2" x 9 1/2" x 8"

\$1595

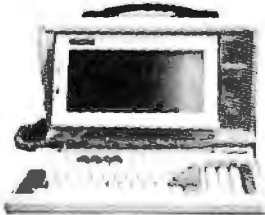

LCD-386

- 20 MHz SI = 23
- 80386-16
- One 1.2 MB Floppy Drive
- 40 MB Hard Disk (ST-251)
- LCD Screen (640x200)
- Key Board
- I/O Card (Serial/Parallel)

\$2795

PACIFIC-386

- 80386-16 (20 MHz)
- SI = 23
- 1 MB Memory
- One 1.2 MB Floppy Drive
- 40 MB (Seagate ST-251)
- 101 Enhanced Key Board
- 200 W Power Supply
- I/O Card Serial/Parallel
- 80387 Socket



MONO SYSTEM

- W/Mono/P Card
- Mono Monitor

\$2395

EGA COLOR SYSTEM

- W/EGA Card (640x350)
- EGA Monitor

\$278!

CRT-PORTABLE 8088

- Compaq Type
- 8088-10 10 MHz
- 2 Floppy Drive
- 150W Power Supply
- TTL Display 9" Amber
- Key Board

\$770



CRT-PORTABLE-286

- Compaq Type
- 80286 (10 MHz or 12 MHz)
- One 1.2 MB Floppy Drive
- 200 W Power Supply
- TTL Display 9" Amber
- At Key Board
- I/O Card Serial/Parallel
- WA2 HD & FD Controller
- 20 MB Hard Disk

\$1389

PRICE SUBJECT TO CHANGE WITHOUT NOTICE

Dealers are welcome
Call For Quantity Price

PACIFIC COMPUTER (818) 571-5548

120 E. Valley Blvd., #H, San Gabriel, CA 91776
 FAX: 818-571-0905

(800) 346-7207 (California)
 (800) 421-1102 (Outside California)



ORDER ONLY

U.S. Robotics

9600 HST

WITH 17,200 BPS
THROUGHPUT AND ERROR
CORRECTION.

NOW ONLY **\$599**

WHILE SUPPLY LASTS.

FAMOUS BRAND

2400 BAUD MODEMS

- Hayes compatible
- 300, 1200, 2400 Baud
- 2 year warranty

NOW ONLY **\$99**

IN PAIRS - SINGLES ADD \$9

FAX

ON-A-CARD

Fully automated FAX now to any Group III FAX machine. Unattended background operation. Send scanned, ASCII, or word processed files. Use any laser or dot matrix printer for output. PC EDITOR'S CHOICE

\$289

Hand Scanners Available

MULTI-LINE INTEGRATED VOICE MAIL TELEPHONE RESPONSE CARD

100s OF USES

THE PROFESSIONAL

IDEALLY SUITED FOR:

- Information & Order Taking
- Voice Mail Answering System
- Mail Forwarding & Pager Alert
- In & Outbound Telemarketing
- Fully Menu Driven by Calling Party. Fits in PC card slot.

FROM ONLY **\$239**

BEST PRICES ANYWHERE!

30 MB HARD DISK SYSTEM

286 AT

- Intel 80286 Processor
- 80287 Co-Processor Slot
- 30 MB Seagate H/D
- VGA/EGA Graphics Card
- Novell, IBM, & OS/2 Compatible System



NOW ONLY **\$995**

Your Choice of Optional Monitors

HUNDREDS OF SALE ITEMS EVERY DAY!

TOSHIBA 130 MB HD	\$999.	VIDEO-7 VGA CARD	\$289.
TOSHIBA 2 MB 3 1/2 IN. FD	129.	ORCHID (1024x768)	319.
TOSHIBA 1.2 MB 5 1/4 FD	99.	ORCHID 286 CARD	389.
MINISCRIBE 43 MB HD	369.	QUADRAM 386/XT	699.
SEAGATE 30 MB HD	299.	GENOA EGA & GEM	199.

VISIT OUR 24 HR BBS (805) 650-0193 (8/1/N)
FOR COMPLETE CATALOG & PRODUCT LISTINGS

ONLINE STORE

BRAND NAMES FOR MUCH LESS!

(805) 650-0188

THIS SUPERCEDES PRIOR ADS • SUBJECT TO SUPPLY ON HAND



Ask About
BBS Software

9-Track Tape Subsystem for the IBM PC/XT/AT



Now you can exchange data files between your IBM PC and any mainframe or mini-computer using IBM compatible 1600 BPI 9-Track tape. Unit can also be used for disk backup. Transfer rate is up to 4 megabytes per minute on PCs and compatibles. Subsystems include 7" or 10 1/2" streaming tape drive, tape coupler card and DOS or XENIX compatible software. Prices start at \$2,995.

QUALSTAR

9621 Iroindale Ave., Chatsworth, CA 91311
Telephone: (818) 882-5822

DYNAMIC RAMS

1MBIT	100ns	\$39.00
51258	100ns	\$13.50
41464	150ns	\$ 9.50
41256	100ns	\$14.50
41256	120ns	\$12.50
✓ 41256	150ns	\$11.75
✓ 41264	150ns	\$16.00
✓ 4164	150ns	\$ 2.95

* For high-speed, Zip, Ploc, Simm Please Call!

PROCESSORS			E PROMS		
80387-16	16MHz	\$495.00	27C101	250ns	\$ 24.00
80287-10	10MHz	\$285.00	27C512	200ns	\$ 15.00
80287-8	8MHz	\$235.00	27S12	250ns	\$ 12.95
80287-6	6MHz	\$159.00	27C256	250ns	\$ 5.50
8087-1	10MHz	\$189.00	27256	250ns	\$ 4.95
8087-2	8MHz	\$145.00	27128A	250ns	\$ 5.25
8087	5MHz	\$102.00	27C64A	200ns	\$ 4.95
V-30	8MHz	\$ 12.75	2764	250ns	\$ 3.50
V-20	10MHz	\$ 17.00	S. RAMS		
V-20	8MHz	\$ 8.50	43256	120ns	\$ 18.95
			4364	150ns	\$ 12.75

I.C. EXPRESS

15358 Valley Blvd. City of Industry, CA 91746 Tel: 818-369-2688
ORDER TOLL FREE (Mon-Fri 9-5 PST)
(800) 892-8889 • (800) 882-8181
Irvine California Irvine California
CALL FOR CURRENT PRICES & VOLUNTARY DISCOUNTS
Price Shown for cash. MasterCard/VISA add 3%. Prices are subject to change.
Minimum order \$10.00. Shipping & Handling: UPS Ground \$5.00. Air \$7.00 (1 lb.)
ALL MERCHANDISE IS 100% GUARANTEED WITH PROMPT DELIVERY.

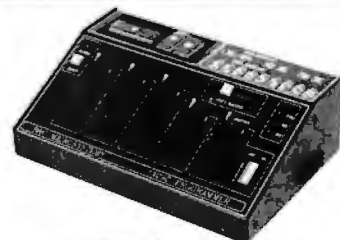

UNIVERSAL E(E)PROM PROGRAMMER \$495 (Kits from \$165)

- No personality modules; Menu driven device selection.
- Built-in Eraser/Timer option (\$50); Conductive foam pad.
- Direct technical support; Full 1 year warranty.
- Stand alone duplication & verify (27XX parts).
- Quick pulse algorithm (27256 under 60 sec).
- 27xx to 1 Mbit; 25xx; 68xx; CMOS; EEPROMS.
- 8741,-2,-4,-8,-8H,-9,-9H,-S1,-C51,-S2,-S5, 9761 & more.
- IBM-PC, Apple, CPM or Unix driver; Autobaud RS232.
- Offset/split Hex, Binary, Intel & Motorola 8,16,32 bit.
- Manual with complete schematics.

VISA MC AMEX Call today for datasheets!!

B&C MICROSYSTEMS

355 WESTOLIVE AVE. SUNNYVALE, CA 94086
PH: (408) 730-5511 FAX: (408) 730-5521 TELEX: 984185

MONTGOMERY GRANT

BYTE
7/88

Warehouse address: 33 34th Street, Brooklyn, N.Y. 11232

FOR ORDERS & INFORMATION
CALL TOLL FREE

1-800-759-6565

OUTSIDE USA---CALL
(718)692-0071

FOR CUSTOMER SERVICE
Call Mon-Fri: 9:30am-5pm
(718)692-1148

OR WRITE TO:
Montgomery Grant
P.O. Box 58 Brooklyn, NY 11230
FAX NO. 2125641497
TELEX-NO. 422132HMOLLER

OPEN 7 DAYS A WEEK FOR ORDERS: Monday-Friday 9:00 am-8pm/Saturday & Sunday 9:30am-6pm (EDT)

The LAPTOP BOX

TOSHIBA 1000
• 512K RAM-720K Floppy Drive
4.77MHz - Super Twist LCD
Screen

\$749

NEC MULTISPEED..... \$979
NEC MULTISPEED EL.II \$1369
NEC MULTISPEED HD..\$2179

TOSHIBA 1200.....\$2199
TOSHIBA 3100/20.....\$2929
TOSHIBA 3200.....\$3695
TOSHIBA 5100.....\$4895
TOSHIBA 1100+.....\$1399

ZENITH 181.....\$1399
ZENITH 183.....\$1999

SPARK by Datavue
640K w/2 720K Drives.....\$989
SPARK EL.....\$1149

MODEMS, EXTERNAL
DRIVES and ACCESSORIES
available for all Laptops!

EPSON

EPSON EQUITY 1+ Package
IBM PC/XT COMPATIBLE
• 640K RAM w/Clock Calendar
360K Drive-KeyBoard-Serial &
Parallel Ports-12" High Resolu-
tion Monitor-Box of 10 Diskettes

\$769

Same Pkg. w/One Floppy
& 20 MB Hard Drive **\$1029**

Same Pkg. w/Two 360K
Floppy Drives **\$849**

EPSON EQUITY III+
40 MB Hard Drive Package
IBM AT Compatible
• Keyboard-80286 Processor
640K RAM-6/8/10 MHz-1.2 MB
Floppy Drive-40MB Hard Drive
12" Monitor-8 Expansion Slots
Serial and Parallel Ports

\$1899

IBM XT

CLEARANCE

Hard Drive Package
• IBM XT Computer • IBM Keyboard 256K
RAM Expandable to 640K • 360K Disk Drive
• 20MB Hard Drive • Package of 10 Diskettes
(Monitor Optional)

\$1299

IBM XT Package with
2 360K Floppy Drives **\$1079**

IBM PERSONAL SYSTEM 2

MODEL 30 Package
• IBM Computer • Two 720K
Drives • 640 K RAM • Built-in
Graphics • Serial and Parallel
Ports-Optional 12" Monitor

\$1199

PS/2 MODEL 30 with 720K
Floppy Drive & 20MB IBM
Hard Drive **\$1599**

MODEL 50
640K RAM 720K Floppy Drive
20 MB Hard Drive

\$2599

PS/II Model 25.....\$1049
PS/II Model 25 w/Color Monitor.....\$1299
PS/II Model 60 w/44 MB & 720K Floppy.....\$3299
PS/II Model 60 w/70 MB & 720K Floppy.....\$3799
PS/II Model 80 w/44 MB & 720K Floppy.....\$4295
PS/II Model 80 w/70 MB & 720K Floppy.....\$4895

5.25 External Drive for PS/II.....\$229

IBM Personal System II Monitors
8503 Monochrome Monitor.....\$209
8512 Color Monitor.....\$459
8513 Color Monitor.....\$519

PACKARD-BELL 386

40 MB Hard Drive System
IBM AT Compatible
• 1 MB RAM - 80386 16 MHz
Microprocessor - 1.2 MB
Floppy Drive-40 MB Hard Drive
8 Expansion Slots-Enhanced
Keyboard - Serial & Parallel
Ports-12" Monitor

\$2699

SANYO

SANYO MBC-675 Package
IBM PC/XT Compatible
• Keyboard-256K Expandable
to 640K • 360K Floppy Drive
Mono Monitor- Free Software

\$399

Same Package with
2 Floppy Drives **\$469**

NEC PowerMate

IBM PC/XT/AT COMPATIBLE
PACKAGE
• 800286 10 MHz Processor
640K RAM-1.2 MB Floppy Drive
12" Monitor

\$1299

Same Package with NEC
20 MB Hard Drive **\$1599**

Powermate II
with Monitor **\$1799**

COMPAQ

DESKPRO 386 MODEL 40
Hard Drive Package
• Keyboard - 80386 16 MHz
Microprocessor-1 MB RAM-40
MB Hard Drive-1.2 MB Floppy
Drive (monitor optional)

\$4495

APPLE PACKAGES

• Apple IIC or IIE Keyboard-
5.25" Disk Drive - 12" Monitor
• All Hook-up Cables &
Adaptors • Pkg. of 10 Diskettes

APPLE IIC \$579

APPLE IIE \$779

Apple IIGS Computer • 3.5" Disk
Drive • Apple RGB Color Monitor
Package of 10 Diskettes • All
Cables & Adaptors • Apple Software

\$1379

MAC PLUS Computer Package.....\$1399
IMAGEWRITER II Printer.....\$449
MAC SE Computer w/Dual Drive.....\$1849
MAC SE Computer w/20MB
APPLE Hard Drive.....\$2599
APPLE MAC II.....CALL

LEADING-EDGE™

MODEL D Package
IBM PC/XT Compatible

\$729

512 K RAM-KeyBoard - 4.7-7.16 Mhz.
360K Floppy Drive - 12" Monitor
8088-2 Processor

Same Package with
20 MB Hard Drive **\$989**

AMSTRAD

IBM PC/XT Compatible
PACKAGE
512K - One 360K Drive-
Clock Calendar- Mono-
graphics Card - Serial &
Parallel Ports - Mono
Monitor - Mono Monitor
Stand

\$569

Includes FREE Mouse
and FREE Software

Same Pkg. with
20 MB Hard Drive **\$839**

VENDEX HEADSTART IBM PC/XT

4.78 MHz; Dual Floppy Drives; 7 Expan-
sion Slots-512K Expandable to 768K
Parallel & Serial Ports-Mouse-Avail-
able in Color or Monochrome System-
Over \$1000 Worth of Software-NO
CHARGE!
Mono System **\$849** Color System **\$999**

HARD DRIVES

SEAGATE
20MB 1/2 Ht. w/Controller.....\$269
30MB 1/2 Ht. w/Controller.....\$319
40MB 1/2 Ht. w/Controller.....\$439

MINISCRIBE
40MB 1/2 Ht. w/Controller.....\$369
CMS 20MB Card.....\$339
CMS 30MB Card.....\$379

PRINTERS

EPSON
FX-86E.....\$299.95
FX-286E.....\$449.95
LQ-800.....\$349.95
LQ-850.....\$489.95
LQ-500.....\$315.95
LQ-1050.....\$659.95
EX-800.....\$419.95
EX-1000.....\$459.95
LX-800.....\$199.95

PANASONIC
1080-II.....\$159.95
1092I.....\$289.95
1091-II.....\$189.95
KX-P 1524.....\$499.95

TOSHIBA
321-SL.....\$479.95
341-SL.....\$649.95
351-II.....\$799.95

PRINTERS

STAR
NX 1000.....\$219.95
RAINBOW.....\$219.95
NX-1000.....\$169.95
NX-15.....\$289.95
NB-2410.....\$409.95
NB-2415.....\$559.95
IBM Pro-
printer II.....\$369.95

OKIDATA
OKI-120.....\$189.95
CKJMATE20.....\$139.95
CKDATA180.....\$219.95
OKIDATA183.....\$289.95

NEC
P-2200.....\$399.95
P-6.....\$419.95

MONITORS

THOMSON 14" CGA Monitor.....\$289
THOMSON TTL Amber 12".....\$69
MAGNAVOX 13" RGB Color.....\$199
MAGNAVOX EGA Monitor.....\$339
with EGA Card.....\$459
NEC Multisync II Monitor.....\$559

Laserjet Series II
\$1599

1 MB Expander.....\$349
HP DESKJET PRINTER.....\$719

commodore

128 PACKAGE
Commodore 128 Computer - Commodore 1571 Disk
Drive-Commodore 1902 Color RGB Monitor
• Commodore 1515 Column Printer

\$699

64c PACKAGE
Commodore 64c Computer - Commodore 1541 Disk
Drive-CompuPrinter
-12" Computer Monitor

\$399

commodore AMIGA

AMIGA 500 Computer
w/1084 RGB Monitor **\$779**

AMIGA 500 Computer
w/1084 Monitor & 1010
3.5" Floppy Drive **\$979**

ALL PERIPHERALS IN STOCK
A-501 512K EXPANSION • A-1010 3.5" FLOPPY
DRIVE-A-1020T 5.25" DISK DRIVE WITH TRANS-
FORMER-A-20880 BRIDGE CARD • A-1084 RGB,
COLOR MONITOR • A-1680 MODEM • A-1080
SIDECAR • A-2080 HARD DRIVE CONTROLLER
FOR A-2000 • A-2010 3.5" INTERNAL DISK DRIVE
FOR A-2000-A-2052 2MB EXPANSION FOR A-2000

AMIGA 2000 IN STOCK

BLUE CHIP

Monitor Package
IBM PC/XT Compatible

\$449

512K Expandable to 640K • 360K Floppy
Drive - 12" Monitor - Box of 10 Diskettes-
Game Disk

Same Package with
20 MB Hard Drive **\$699**

commodore

PC10-1
IBM PC/XT Compatible
PACKAGE

\$499

• PC10-1 Computer -512K RAM Ex-
panded to 640K • 360K Disk Drive
Enhanced Keyboard-Serial & Parallel
Ports - 12" Monitor - AC Adaptors - All
Hook-up Cables-Pkg. of 10 Diskettes

Same Package with
20 MB Hard Drive **\$749**



Deposited Checks, Bank Checks, Money Orders, Credit Cards, Visa, Amex, Diners Club, Carte Blanche, Discover Card, C.O.D. and approved P.O.s accepted. No additional charge for credit card orders. No certified checks must wait 4-6 weeks for clearance. Please add 5% for shipping and handling. APO/FPO orders are shipped first class priority air. NY residents add applicable sales tax. Prices subject to change without notice. Not responsible for typographical errors. Return of defective merchandise must have prior return authorization. Number of returns will not be accepted. IBM/PC/XT/AT are registered trademarks of International Business Machines Corp. All orders can be shipped Air Express. Call for details. For your protection we check your credit card.

NO ADDITIONAL SURCHARGE FOR CREDIT CARD ORDERS WE WELCOME CORPORATE & EDUCATIONAL ACCOUNTS

Circle 117 on Reader Service Card

OPTICAL DISKS



as featured in **PC WEEK 4/26/88**
 • 800MB storage on single disk
 • connecting to any host via SCSI interface
 • Plug'n Play to any operating system
 only **\$4995** Limited time only

PANASONIC LS5000
\$2495 - 200 MB

OPTICAL MEDIA
 For IBM & Panasonic Optical Drives - **\$52**

We carry a full line of
5 1/4" & 12" Optical Drives

SKAN TEKNOLOGIES, INC.
 optical storage systems
 (212) 809-5570 (516)295-2237

Circle 248 on Reader Service Card

SIBEC II



The ideal solution for embedded control applications and stand alone development.

- 8052 Basic CPU
- PROM Programmer
- iSBX* Expansion Bus
- Highest Quality
- 1 Year Warranty

\$228.00 QTY 1

Call Now! (603) 469-3232

Inquire about our 8051 product development kit for the IBM PC/XT/AT.



Binary Technology, Inc.

Main St., P.O. Box 67 Meriden, NH 03770

*iSBX is a trademark of Intel Corporation.

Dealers!

Network-OS LAN Systems - includes Boards, Cabling, Terminators and Software. Two-user hardware and software for under \$1,000 list!

Close-Up Remote Communications - Support your customer without leaving your office. Authored by Cogitate for Norton-Lambert!

Context Sensitive Help for DataFlex, RM/COBOL, Clipper and dBase III - Puts your application's documentation "on line."

DataFlex Database Management - True Multi-User database for MS/PC-DOS, Unix and Xenix. Site licensing available.

Dump/Restore-XT - Seven utilities for the MS/PC-DOS user.

Call or write today for our catalog and pricing!

COGITE, INCORPORATED
 "A Higher Form of Software"
 24000 Telegraph Road
 Southfield, MI 48034
 (313) 352-2345/Telex: 386581
 Visa/MasterCard Accepted

Circle 55 on Reader Service Card



Sure it's insured?

SAFEWARE® Insurance provides full replacement of hardware, media and purchased software. As little as \$39/yr. covers:
 • Fire • Theft • Power Surges
 • Earthquake • Water Damage • Auto Accident

For information or immediate coverage call:
1-800-848-3469

In Ohio call 1-614-262-0559



SAFEWARE, The Insurance Agency, Inc.

Circle 239 on Reader Service Card

IT'S NOT 29¢ PLUS THIS AND THAT, IT'S

29¢

2 for 1 replacement guarantee on bulk 5 1/4" if found initially defective within six months
 With sleeves, tabs, labels

5 1/4" DS/DD (Min. 100)	29¢
DS/DD (Min. 50)	39¢
Color 5 1/4" DS/DD (Min. 50)	49¢
5 1/4" IBM-AT HD (Min. 50)	79¢
Box of 10 5 1/4" DS/DD (Min. 10)	\$4.29
Box of 10 Color 5 1/4" DS/DD	
Free Plastic Case (Min. 5)	\$5.99
3 1/2" DS/DD (Min. 25)	99¢
DS/DD (Min. 25)	\$1.09

Data 205 40MB MiniCartridge		
3m DEI Compatible (Min. 5)	\$15.90
600 120MB DataCartridge (Min. 5)	\$19.20

Immediate shipping - Guaranteed satisfaction
 Call for greater discounts on larger orders. Subject to availability
100% Lifetime Warranty
 Shipping: \$3.50 per min. order \$1.50 each addit. tot. MC/VISA accepted

1-800-537-1600 **MEP**
 Operator No. 227

Dept. No. 1523 P.O. Box 61000, San Francisco, CA 94161

Circle 164 on Reader Service Card

Get the whole story on graphics terminal emulation.



To find out more about software that lets your PC emulate TEKTRONIX™ 4105/6/7/9 and DEC VT100™ terminals, call or write:

GRAFPOINT

4340 Stevens Creeks Blvd., Suite 280,
 San Jose, CA 95129 (408) 249-7951

Circle 109 on Reader Service Card

ZSYSTEM VT240 Smart Terminal Emulator and Communications Program for the IBM XT, AT, PS/2 and compatibles

VT241
\$295*
 *plus your PC or compatible

- Comprehensive VT240 / VT241 emulation at 2-4 times the speed.
- Complete VT240 ANSI emulation including true double-high/double-wide characters, true smooth scrolling, national/multinational support, and downloadable fonts.
- At least 128 columns displayable in 132-column mode on the CGA, EGA, VGA, and Hercules adapters.
- Full Tektronix 4010/4014, sivel and ReGIS graphics support.
- KERMIT and XMODEM transfers.
- Ungermann Bass Net/One and VMS Services for MS-DOS support.

Also available VT220, VT100, D400, 4014 emulators and the **PowerStation™** VT200 style keyboard.

KEA SYSTEMS LTD.

Suite 412, 2150 West Broadway, Vancouver, B.C. Canada V6K 4L9
 Telephone (604) 732-7411 Telex: 04-352848 VCA Fax: (604) 732-0715
 Order Toll Free 800-663-9702
 30 day money back guarantee.

AMEX/MC/VISA

Circle 138 on Reader Service Card

PAL/EPROM PROGRAMMER CARD
 For PC/XT/AT Systems

NEW -- VERSION 2 OF SOFTWARE AND HARDWARE

- Programs 20 and 24 Pin MMI, NS, TL, AMD, ALTERA, CYPRESS, RICOH, and PANATEC PALS. Supports EPLD, polarity, RA, and shared product term types.
- Functions include: Read, Write, Verify, Protect, Edit, Print, and File load and save of program.
- JEDEC supported.
- Software Included

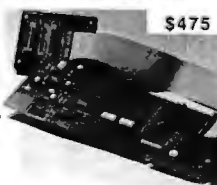

\$475

100MHZ LOGIC ANALYZER CARD
 For PC/XT/AT Systems

\$1199

- 24 Channels at 25KHz-25MHz
- 8 Channels at 100 Mhz
- Internal Clock up to 100 Mhz
- External Clock up to 25 Mhz
- Threshold Voltage TTL, ECL, or variable from -10 to +10v
- Can Stack Multiple Boards
- All Software Included

CALL NOW FOR ORDERS AND TECHNICAL INFO (201) 994-6669

Link Computer Graphics, Inc. 4 Sparrow Dr.,
 Livingston, NJ 07039. TLX: 9102409305 LINK COMPUTER

Circle 145 on Reader Service Card

Schematic to Hardware

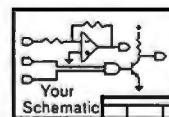

First PCB Assembled

in as little as 3 weeks or as low as \$5 / Component pin + materials

We will take your schematic in Schema™ OrCAD™ or Tango™ format and:

Review for Design Errors • Layout PC Board
 Fabricate Board • Assemble Prototype • Inspect

Also available: Schematic Capture • Test Service
 Engineering Design Service • Volume Manufacturing
 Diagnostic Test Software • PAL/PLD Designs

HTE HiTech Equipment Corporation
 9560 Black Mountain Road
 San Diego, CA 92126
(619) 566-1892

Circle 117 on Reader Service Card

Low Prices, Fast Service.

**Satisfaction
Guaranteed!
Since 1975**

Turbo-XT \$398



- 4.77 & 8 MHz
- 640K Motherboard with 256K
- 8 slots • 8087 socket
- 150W power supply

Turbo-AT \$798



- 1 MB Motherboard with 640K
- 200 watt power supply
- AT-style keyboard
- One year warranty
- Clock/calendar

Option A

- High resolution amber monitor
- Hi-res graphics card add
- Parallel printer port **\$148**

Option B

- Hi-res RGB color monitor
- Hi-res graphics card add
- Parallel printer port **\$298**

Option C

- Hard disk drive
- Dual hard disk controller
- 30 MB for XT 40 MB For PC/XT/AT
- add **\$298** add **\$498**

intel Math Coprocessors

8087 \$98	8087-2 \$138
8087-1 \$198	80287-6 \$178
80287-8 \$228	80287-10 \$268
80387-16 \$438	80387-20 \$728

PC Mouse

LogiTech mouse	\$78
Mouse systems mouse	\$98
Microsoft mouse	\$118
Genius mouse	\$58
Fastrap trackball	\$98
Deluxe joystick	\$24

Place orders toll free!

Continental U.S.A. 1-800-421-5500
 Inside California 1-800-262-1710
 Fax machine 1-213-675-2522
 All others 1-213-973-7707

Prices at our eight store locations will be higher on some items.

California

Torrance, Santa Ana, Woodland Hills
 Kearny Mesa, Sunnyvale

Texas

Addison, Houston
 Georgia
 Smyrna



1200 Baud Deluxe Modem \$58



2400 baud 1/2 card internal ... \$128
 1200 baud external \$88
 2400 baud external \$168

30 MB Hard Disk

Complete kit with controller



CMS \$298

20 MB PC/XT Kit \$248
 20 MB Card \$398
 40 MB for AT \$398
 40 MB PC/XT Kit \$498
 Mountain 40 MB Tape \$398

360K Disk Drive

Half height, IBM compatible
 Direct Drive

\$68



Tandon TM100-2 full height
 for IBM PC or XT \$118
 1.2 MB for AT \$98
 5 1/4" drive for PS/2 \$268

3 1/2" Disk Drive

720K....\$98 1.44 MB....\$128

VGA Package

Monitor & Card **\$648**



- 800 x 560
- Up to 256K brilliant colors

Hi-res EGA card 640x480 \$128
 EGA monitor 640x350 \$378
 NEC MultiSync II 640x560 ... \$598
 RGB color monitor 640x240 . \$258

Amdek 310A \$98

Best selling hi-resolution
 non-glare amber monitor

EPSON 24 Pin \$369

LQ-500

List Price \$529



EPSON Letter Quality Printers
 LQ-850, LQ-1050, LQ-2500 .. Call

EPSON 9 Pin

\$198

LX-800



EPSON Near Letter Quality
 FX-86e, FX-286e, EX-800 Call

HP LaserJet II

\$1698

List Price \$2595



Extra Toner Cartridge \$98
 PDP 4 MB RAM card w/OK .. \$198

1 MB	2 MB	4 MB
\$348	\$648	\$1148

HP DeskJet

\$748

List Price \$995

300 x300 DPI with full
 with full page graphics
 PDP 128K RAM \$98
 Extra ink cartridge \$18

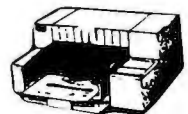

Laser Printer

\$1198

Limited
 Quantity!



1.5 MB RAM card \$198
 Toner cartridge \$58

No Slot Clock \$48

MICROSOFT.

MS-DOS 3.21..... **\$98**



JADE COMPUTER

We accept checks, credit cards or purchase orders from qualified firms and institutions. No surcharge on credit card orders. CA., TX. & GA. residents add sales tax. Prices & availability subject to change without notice. Shipping & handling charges via UPS ground 50¢/lb. UPS air \$1.00/lb. Minimum charge \$3.00.

4901 W. Rosecrans Ave. Box 5046
 Hawthorne, California 90251-5046



DiskMASTER®

The Ultimate Diskette Value ...



Discover the Difference ...

FOR A LIFETIME WARRANTY

- ✓ Pkg'd in 6 different colors, bulk or boxed
- ✓ 100% tested and certified
- ✓ Made to exceed A.N.S.I. specs by 62.5% with a guaranteed clipping level of 65% or above
- ✓ Includes tyvek envelopes (not paper), write protect tabs and user labels
- ✓ Brand-name quality at affordable prices

5-1/4" - 48 TPI DS-DD	DS-HD 96 TPI IBM-AT Compatible
.49	BULK COLOR OR GRAY .90
.59	BOXED COLOR .99

CENTECH

- ✓ TIMELESS WARRANTY
- ✓ 75%+ clipping level guaranteed
- ✓ Performance exceeds A.N.S.I. spec. by 88%
- ✓ Each disk 100% tested and certified
- ✓ 16 COLORS for data organization
- ✓ Pkgs. includes tyvek sleeves, w/tp tabs, & ID labels

5-1/4" - 48 TPI DS-DD	DS-HD 96 TPI IBM-AT Compatible
.84	PLASTIC STORAGE BOX COLOR 1.39
.63	BULK COLOR 1.15
3-1/2" - 135 TPI DS-DD COLOR	3-1/2" - 135 TPI BLACK DS-HD
1.75	PLASTIC STORAGE BOX 4.50

5-1/4" 48 TPI DS-DD	DS-HD 96 TPI IBM-AT Compatible
.75	1.25
	1.42
3-1/2" DS-DD	

TPI	DS-HD 96 TPI IBM-AT Compatible
.50	BOXED * 1.00 *
BULK	
32¢	5-1/4" DS/DD 48 TPI Exceeds ANSI specifications + 6¢ FOR TYVEK

ORDERING INFORMATION

TERMS: P.O. orders accepted, government and schools on net 30. SHIPPING: U.S. orders add \$3.00 per 100 diskettes or fraction thereof, add \$3.00 for COD orders. PRICE PROMISE: We will better any lower delivered price on the same products and quantities advertised nationally.



BISC INTERNATIONAL

AVPAL™

\$395

- Quickly and inexpensively create logic devices — simplify your project design.
- Program from, copy to standard JEDEC files.
- Free PAL starter kit included.
- Ask about our Logic Assembler.



For specs & free catalog, call: **800-448-8500** or (207) 236-9055

AVOCET SYSTEMS, INC.

120 Union St., P.O. Box 490, Rockport, ME 04856

- 2400 + 1200 + 300 BAUD
- IBM INTERNAL
- AT-HAYES COMPATIBLE
- ADVANCED TECHNOLOGY
- 30 DAYS MONEY BACK
- 2 YEAR WARRANTY
- MADE IN USA, FCC certified

Dealers Inquire



Compu Com Corporation

HARD DISK CONTROLLERS

APTEC	
XT Controller ST506/412\$45
1 PC/XT to ST506 RLL (1 drive)\$79
2 PC/XT RLL\$98
0 PC/AT to ST506 RLL\$149
10 SCSI to Tape QIC 36\$76
10 SCSI to ST506/415\$89
10 SCSI to ST506/412 RLL\$96
10 SCSI to ESDI\$96
10 SCSI to ST506/4\$125
10 SCSI to SMD\$175
BEC	
10 SASI Controller\$89
20 SASI to 5 1/4" Floppy & Hard Disk Controller\$99
File II, II+, IIe Host Adapter\$29
HERS	
ITI 20C, L SASI Controller\$99
2 510A SASI Controller\$99
rgart 1610-13 or 4 SASI/SCSI Controller\$79
1 1002-SHD Xebec Compatible SASI Controller\$109

• Call for cable prices.
• Controller manuals \$8 each.



Computer Surplus Store "WE BUY AND SELL"
Phone 408-434-1060
FAX 408-434-0931
Telex 1561447
MC/VISA/Discover/COD's

SAVE ON

9 TRACK SYSTEM

FOR IBM PC/XT/AT



- Mainframe to PC Data Transfer
- High Speed Backup
- All Software, Complete System
- Service and Support, easy Installation

call (818) 343-6505 or write to:
Contech Computer Corp.
P.O. Box 153 Tarzana, Calif. 91356

SMART SWITCHES

... at your command

Master Switch is sophisticated yet flexible. Several computers can access one another or share printers and modems. Use serial or parallel interfaces, up to nine ports. The buffer is expandable up to one megabyte. Access a job control menu from each computer to view the queue or cancel, hold, and release jobs. Many other features.

MasterNet software allows computer networking and electronic mail capabilities for PCs.

Other solutions from ROSE

- Printer Sharing
- Protocol Conversion
- Buffering
- Micro to mainframe
- Multiplexers
- Modems
- Manual Switches
- Cables

We design a variety of quality products for computer networking and data communications solutions guaranteed to work.
Dealer and OEM inquiries are welcome.





- Table based 8/16 bit cross-assembler.
- Uses manufacturer's assembly mnemonics.
- Tables & Example Source files are included for ALL of the following processor families:

1802	3870	64180	6502
65816	6801	6805	6809
6811	68000	7000	8048
8051	8085	8086	8096
COP800	SUPER8	Z8	Z80

- Users may modify or create new tables for additional processors.
- Produces listing, symbol table, and 8/16 bit binary.
- 5" DSDD for PC/MS-DOS 2.0 or greater.
\$99.95 US \$139.95 CDN
- Portable C sourcecode is available.

Worldwide shipping (AIRMAIL) & handling included. Credit Card orders (\$139.95 CDN) please specify: Card number, name, no. card and expiry date.



CAT™ 8MHZ

BASE SYSTEM

- 256K (Opt. 640K) • 150 Watt Power Supply • AT Style Keyboard
- 4.77 or 8 MHz Keyboard Selectable • FDC
- 8087 Socket • 360K Floppy Drive

\$39900

COMPLETE SYSTEM CALL FOR PRICE
1 Year Warranty



CAT™ 286-10

BASE SYSTEM

- 512K Exp. to 1 MEG • 200 Watt Power Supply • AT Style Keyboard
- Western Digital Controller • 1.2 Meg Floppy • Legal Bios w/manuals • Systems Documentation • 1 yr war. • Clock/Calc

\$92900

COMPLETE SYSTEM CALL FOR PRICE
11.3 Nortons SI



30 DAY
IBM COMPATIBILITY
GUARANTEE

OPTION A 12" Mono Amber Monitor Graphics Card w/par port \$51900	OPTION B 640 x 200 Color Monitor Graphics Card w/par port \$75900	OPTION C 12" Mono Amber Monitor Graphics Card w/par port 20 Meg Hard Drive \$81900	OPTION A AT 12" Mono Amber Monitor Graphics Card w/par port \$109900	OPTION B AT 640 x 200 Color Monitor Graphics Card w/par port \$129900	OPTION C AT 12" Mono Amber Monitor Graphics Card w/par port 20 Meg Hard Drive \$139900
---	--	--	---	--	--

PRINTERS

6FT PARALLEL CABLE 149⁰⁰

PANASONIC	CITIZEN
KXP1080I 144CPS 199	180D 180CPS 9 Pin 10" .. 199
KXP1091I 192CPS 229	MSP15E 160CPS 9 Pin 15" 369
KXP1092I 240CPS 379	MSP40 250CPS 9 Pin 10" 369

Tractors — Sheet Feeders — Cables — Ribbons Available

EVEREX MEMORY & IO CARDS

EV138 0-576K For XT	89 ⁰⁰
EV173 Par/Ser/Clock 0-1 Meg XT	109 ⁰⁰
EV173A Par/Ser 0-1 Meg AT	109 ⁰⁰
EV159 RAM 3000 Lotus/Intel 0-3 Meg	119 ⁰⁰
EV170 I.O. Par/Ser/Clock	69 ⁰⁰
EV659 EGA 640 x 350 Auto Switching	149 ⁰⁰

MONITORS

COLOR OR MONO INTERFACE 89⁰⁰ EGA INTERFACE 139⁰⁰

GOLDSTAR	SAMSUNG
EGA 640 x 350	369 ⁰⁰
12" Monochrome Amber	79 ⁰⁰
14" RGB Color 640 x 200	249 ⁰⁰
14" EGA Multisync	449 ⁰⁰

EPSON 3 1/2 DISK DRIVE

• In 5 1/4 Mounting • 720K

\$9900 10 for **\$9200**

DOS 3.2 WITH BASIC 79⁰⁰

150 WATT POWER SUPPLY

• Direct PC Replacement

\$5900

EPSON 1.2 MEG 89⁰⁰ 200 WATT FOR AT 89⁰⁰

EVEREX TAPE BACKUPS

40MB Mini Cartridge, 1.8MB/min, XT	389 ⁰⁰
40MB Mini Cartridge, 3.6MB/min, AT	389 ⁰⁰
40MB Streaming Cassette, 5MB/min w/cont.	539 ⁰⁰
60MB Streaming Cassette, 5MB/min w/cont.	619 ⁰⁰
60MB Streaming Cartridge, 5MB/min w/Full cont.	779 ⁰⁰
125MB Streaming Cartridge, 5MB/min w/Full cont.	989 ⁰⁰

External Add 195⁰⁰

RAM UPGRADES

4164 150 NS, 64 x 1	3 ⁰⁰
4164 120 NS, 64 x 1	3 ²⁵
4164 100 NS, 100 NS, 64K x 1	4 ⁴⁵
41256 150 NS, 256K x 1	12 ⁹⁵
41256 120 NS, 256K x 1	13 ⁴⁵
41256 100 NS, 256K x 1	13 ⁹⁵
4464 150 NS, 64K x 4	12 ⁹⁵
1Meg 100 NS, 1048 x 1	49 ⁰⁰

HARD DRIVES

Seagate

COMPLETE KITS

1 YEAR WARRANTY

ST225 20Meg w/cont. & Cables	279 ⁰⁰
ST238 30Meg w/cont. & Cables	299 ⁰⁰
ST251 40Meg 1/2 HT 40 Mil w/software	399 ⁰⁰
ST251-1 40Meg, 2.8 Mil Sec	489 ⁰⁰
ST4026 20Meg Full HT 40 Mil	279 ⁰⁰
ST4096 80Meg Full HT w/software	749 ⁰⁰

SETUP INSTRUCTIONS

MODEMS

SEVEREX™

EV-920 EverCom 12 300/1200 bps	79 ⁰⁰
EV-940 Internal 300/1200/2400	159 ⁰⁰
EV-945 External 300/1200/2400	239 ⁰⁰

Mead / Hayes Compatible

1200 Baud w/Bitcom 5 yr. Warranty	69 ⁰⁰
1200 Baud External, 5 yr. Warranty	119 ⁰⁰
2400 Baud Internal, 5 yr. Warranty	149 ⁰⁰

INTEL COPROCESSORS

Intel 8087 5Mhz	102 ⁰⁰
Intel 8087 8Mhz	149 ⁰⁰
Intel 80287 6Mhz	179 ⁰⁰
Intel 80287 8Mhz	239 ⁰⁰
Intel 80287 10Mhz	289 ⁰⁰
Intel 80387 16Mhz	498 ⁰⁰
Intel 80387 20Mhz	799 ⁰⁰

LARGE QUANTITIES AVAILABLE

SIMM RAM UPGRADES

256K x 9 120 NS	139 ⁰⁰
1 Meg x 9 120 NS	649 ⁰⁰

BELOW EVERYONE'S COST — CLEARANCE SALE

LETTER QUALITY PRINTER

Why pay \$1149 for a C. Itoh
STARWRITER™ F-10

DAISYWHEEL PRINTER MANUFACTURED BY C.I.TOH

When our 40 cps letter quality daisywheel printer from the same manufacturer is only

\$29900 ea. 100 for **\$249**

These printers were originally priced to sell at over \$1100. Through a special arrangement MEAD has purchased these units from a major computer manufacturer and is offering these printers at a fraction of their original cost.

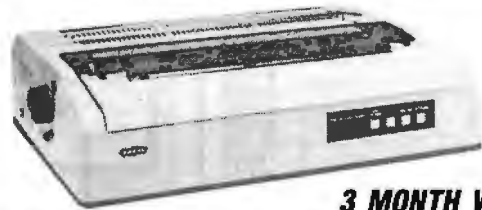

3 MONTH WARRANTY

OPTIONS

- 6 ft. Serial Cable \$ 19⁰⁰
- AT or XT RS232/Serial Interface 39⁰⁰
- Bidirectional Tractor 149⁰⁰
- Cut Sheet Feeder 199⁰⁰

STANDARD FEATURES

- 40 CPS • Accepts Paper to 15 inches
- Form Length and Pitch Set from Control Panel
- Industry compatible ribbon, printwheels and control commands
- RS232 Serial Interface

TANDON

IN ORIGINAL IBM BOXES

360K FLOPPY DRIVE	160K FLOPPY DRIVE
• TM100-2A Full Height	• TM 100-1A • 160K
• Orig. Drive used by IBM	• IBM Pkg & Instructions

List 249⁰⁰ Mead 89⁰⁰ List 199⁰⁰ Mead 39⁰⁰

10 MEG HARD DRIVE

• 1/2 Height
• 65 Mil Sec.

List 299⁰⁰ Mead 129⁰⁰ Add 70⁰⁰ w/controller

EPSON OR IBM PRINTER STANDS

List 39⁰⁰ Mead 19⁰⁰

NEC MONITOR COMPOSITE MONITOR

• 12" Green Screen • JB 1201 New 90 Day Warranty

List 199⁰⁰ Mead 79⁰⁰

MITSUBISHI FLOPPY DRIVE 1.2 MEG

• Black Face • 1 Year Warranty

List 99⁰⁰ Mead 79⁰⁰

DATA CARTRIDGE 3M COMPATIBLE

• DC 300 XLP • 45 Meg or Less • Indiv. Wrapped

List 39⁰⁰ Mead 14⁰⁰

DC1000 • 3M \$9 ea

800-654-7762

SALES: 7 a.m. - 6 p.m. PST

702-294-0204

CUSTOMER SERVICE / ORDER STATUS:
9 a.m. - 4 p.m. PST

FAX 702-294-1168



NO SURCHARGE FOR MC/VISA

TERMS:

MC • VISA • COD • CASH
Purchase Orders from Qualified Firms
Personal Checks • AE add 4%



1000 Nevada Hwy. • Unit 101 • Boulder City, NV 89005

SHIPPING: (min. 6⁵⁵) UPS • Fed Express

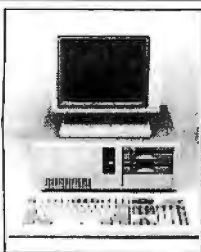

FCC APPROVED!
Sub-Mini AT!
The Space Saver
3-DR. Capability
8-Expansion Slots!

Basic System:

- 8/10MHz Speed, 0 Wait
- 3-LEDs, Reset & Turbo Switch
- 0-1MB on Board With 0K
- 200-Watt Power Supply
- AT Style Keyboard
- 1ea 1.2M Floppy Disk Drive
- 1ea Floppy/H.D. Controller
- 1ea Mono Graphics Card W/Printer
- 1ea 12" TTL Amber Monitor W/Swivel Base
- Assembled & Tested

\$963.00

10MHz XT Turbo Basic System:

- Baby AT Case W/Keyboard
- 4.77/10MHz Hardware Selectable
- 8 Expansion Slots
- 0-640K on Board With 0K
- 150-Watt Power Supply
- XT Style Keyboard
- 1ea 360K Floppy Disk Drive
- 1ea Floppy Disk Controller
- 1ea Mono Graphics Card W/Printer
- 1ea 12" TTL Amber Monitor W/Swivel Base
- Assembled & Tested

\$493.00

10MHz or 12MHz AT-286 Basic System:

- 6/10 or 6/12 MHz Speed, 0 Wait
- 8 Expansion Slots
- 0-1MB on Board With 0K
- Regular AT Slide Case or Digital Display Case
- 200-Watt Power Supply
- AT Style Keyboard
- 1ea 1.2MB Floppy Disk Drive
- 1ea Floppy & H.D. Controller
- 1ea Mono Graphics Card W/Printer
- 1ea 12" TTL Amber Monitor W/Swivel Base
- Assembled & Tested

Regular Case
Digital Case

10MHz 12MHz
938.00 1001.00
959.00 1022.00

PERIPHERALS AT/XT For XT

1. Floppy Disk Controller With Cable **\$22.50**
2. Hard Disk Controller With Cable **\$72.20**
3. 0-384K Multifunction Card, 0K **\$86.30**
4. Monochrome Graphics Printer Card **\$43.80**
5. Color Graphics Card **\$46.30**
6. Color Graphics Printer Card **\$50.00**
7. Enhanced Graphics Adaptor (EGA) **\$131.10**
8. Color/Monochrome Display Card **\$61.30**
9. Parallel Printer Card **\$18.80**
10. Dual Game I/O Card **\$18.80**
11. Serial I/O Card **\$25.00**
12. Dual Serial I/O Card **\$43.80**
13. Mouse For AT/XT W/Driver Software **\$61.30**
14. Multi I/O W/Controller **\$68.80**
15. Multi I/O **\$56.30**
16. No-Slot-Clock **\$28.80**
17. 576K RAM Card, 0K **\$35.00**
18. 4.77/8MHz XT Turbo Motherboard **\$93.80**
19. 4.77/10MHz XT Turbo Motherboard **\$100.00**
20. XT Slide Case **\$35.30**
21. XT Flip Top Case **\$32.90**
22. Baby AT Case, XT **\$47.10**
23. 150-Watt Power Supply **\$48.80**
24. 150-Watt Power Supply (UL) **\$68.80**

For AT

25. Floppy/H.D. Controller W/Cables **\$156.30**
26. 128K RAM Card, 0K **\$68.80**
27. 2MB EMS RAM Card, 0K **\$123.80**
28. Serial/Parallel Card **\$46.30**
29. 6/10MHz AT Motherboard, 0 Wait **\$331.30**
30. 6/12MHz AT Motherboard, 0 Wait **\$393.80**
31. 8/10MHz Mini AT Motherboard, 0 Wait **\$362.50**
32. AT Slide Case **\$64.70**
33. AT Slide Case W/Digital Display **85.90**
34. Mini AT Slide Case **61.20**
35. 200-Watt Power Supply **81.30**
36. 200-Watt Power Supply (UL) **95.00**
37. 200-Watt Power Supply For Mini AT **78.80**

ORDER HOT LINE 1-800-543-5107

Technical Information (714) 990-2097

Hours: Mon. - Fri. 9:00 am - 6:00 pm PST
 Please write for our complete price list.

JAWIN COMPUTER PRODUCTS

565 W. Lambert Rd., #C
 Brea, CA 92621

Terms: Please add 5% (or \$2.00, whichever is higher) plus .25¢ for each \$100.00. CA residents please add 6% sales tax. We accept VISA/MC/Cash. Personal checks please allow 2 weeks to clear. All merchandise is warranted for 1 year unless otherwise stated.

MAXELL
100% CERTIFIED
5 1/4" BULK DISKS

5 1/4" DS/DD **59¢**
 5 1/4" DS/HD **1.59**
 3 1/2" DS/DD **1.09**

Price based on quantity of 300 includes sleeves, labels and tabs.

800-222-0490

In NJ 201-462-7628

• 24 Hour Shipment •

MEGA Soft

P.O. Box 710, Freehold, NJ 07728

Circle 162 on Reader Service Card

GANG EPROM PROGRAMMER

Stand Alone
\$995.00



QUICK PULSE ALGORITHM
FASTEST EPROM PRODUCTION
TO 512K BITS, RS-232 OPTION.

From A Name You Can Trust

LOGICAL DEVICES INC.

1201 N.W. 65th Place
 Ft. Lauderdale, FL 33309

1-800-331-7766 (305) 974-0967
 Telex 383142 Fax (305) 974-8531

Circle 146 on Reader Service Card (DEALERS: 147)

2400 Baud Performance
Incredible \$149 Price!!



- 2400, 1200, 300 Baud Async Modem
- Hayes "AT" Command Set
- CCIT V.22 bis, V.22 & Bell 212A/103 Compatible
- Auto Answer/Auto Dial
- Compact Size
- Programmable non-volatile phone number memory, user configuration & speaker volume
- One year warranty

Order Now
Toll Free

USA: 800-533-8049
 CA: 800-624-5628
 MC/VISA/AMEX Accepted
 (805) 524-4189



330 Central Avenue
 Fillmore, CA 93015

Serving Computer Users Since 1982

Circle 47 on Reader Service Card

IMAGING CARD



DV-01
GRAY SCALE
FRAME GRABBER

Composite video in/out
 256 x 240 resolution
 Digitize/display at frame speed
 256 gray levels in
 16 Meg. color palette out
 PC/XT/AT compatible

\$849.00 Complete with software

Control Vision

P.O. Box 596, Pittsburg, KS 66762
 (316) 231-6647

Circle 71 on Reader Service Card

the **HUSKY™**

EPROM
 PLD
 MICRO
 GANG
 SET



PC based PROGRAMMER
\$599.00*

*modules not included.

From A Name You Can Trust

LOGICAL DEVICES, INC.

1201 N.W. 65th Place, Ft. Lauderdale, FL 33309

1-800-331-7766 (305) 974-0967
 Telex 383142 Fax (305) 974-8531

Circle 148 on Reader Service Card (DEALERS: 149)



! not only a printer buffer !

THIS IS THE MOST SOPHISTICATED
PRINTER BUFFER - MULTIPLEXOR - SWITCH

WITH TWO SEPARATE INPUTS (SERIAL AND PARALLEL) AND TWO SEPARATE OUTPUTS (SERIAL AND PARALLEL), CAN BE USED LIKE STANDARD BUFFER WITH ANY INPUT TO ANY OUTPUT BUT ALSO YOU CAN CONNECT 2 COMPUTERS TO 1 PRINTER, OR 1 COMPUTER TO 2 PRINTERS, OR 2 COMPUTERS AND 2 PRINTERS, AND MORE = 1 COMPUTER TO 3 PRINTERS OR 3 COMPUTERS TO 1 PRINTER
 HIGH CAPACITY - 64 KB TO 256 KB AND - 256 KB TO 1 MB (MODELS A AND B) PAUSE, COPY AND RESET FUNCTIONS
 SERIAL PORTS WITH 7 OR 8 BITS WORD LENGTH, 1 OR 2 STOP BIT, PARITY, XON/XOFF, DTR, RTS

DCB-A-64K \$ 195 DCB-B-256K \$ 255 !!

[*] Power supply and parallel cables are included

ALSO, WE HAVE THE MOST COMPLETE DATA CONVERTER UNIT CONVERTS RS232 SERIAL TO CENTRONICS PARALLEL OR VICE VERSA, JUST BY MOVING JUMPERS BAUD RATE AND PROTOCOL FULLY PROGRAMMABLE FROM 160 TO 19200 BAUDS INCLUDES - DTR, RTS, XON/XOFF, PARITY, etc

DCU \$ 80 !!

[**] Power supply and cables NOT included



serial <-> parallel
 bi-directional converter



INTECTRA Inc.-Dept.222

2619 TERMINAL BLVD
 MOUNTAIN VIEW, CA 94045

(415) 967-8818 TX 345545

The Amazing A-BUS

NEW

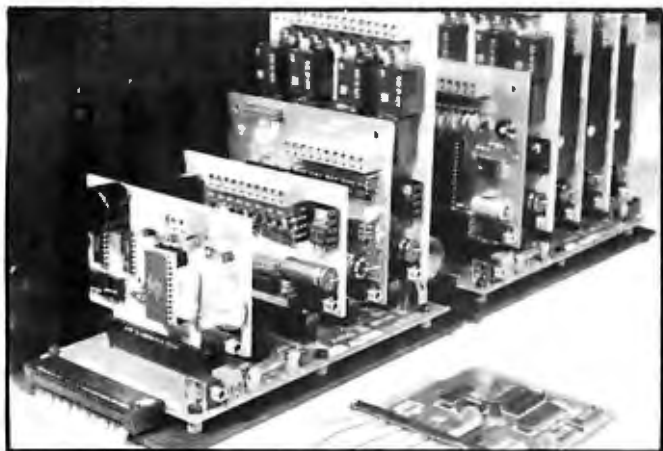

An A-BUS system with two Motherboards
A-BUS adapter (IBM) in foreground

Plug into the future

With the A-BUS you can plug your PC (IBM, Apple, TRS-80) into a future of exciting new applications in the field: of control, monitoring, automation, sensing, robotics, etc.

Alpha's modular A-BUS offers a proven method to build your "custom" system today. Tomorrow, when you are ready to take another step, you will be able to add more functions. This is ideal for first time experimenting and teaching.

A-BUS control can be entirely done in simple BASIC or Pascal, and no knowledge of electronics is required!

An A-BUS system consists of the A-BUS adapter plugged into your computer and a cable to connect the Adapter to 1 or 2 A-BUS cards. The same cable will also fit an A-BUS Motherboard for expansion up to 25 cards in any combination.

The A-BUS is backed by Alpha's continuing support (our 11th year, 50000 customers in over 60 countries).

The complete set of A-BUS User's Manuals is available for \$10.

About the A-BUS:

- All the A-BUS cards are very easy to use with any language that can read or write to a Port or Memory. In BASIC, use INP and OUT (or PEEK and POKE with Apples and Tandy Color Computers)
- They are all compatible with each other. You can mix and match up to 25 cards to fit your application. Card addresses are easily set with jumpers.
- A-BUS cards are shipped with power supplies (except PD-123) and detailed manuals (including schematics and programming examples).

Relay Card

RE-140: \$129

Includes eight industrial relays, (3 amp contacts, SPST) individually controlled and latched. 8 LED's show status. Easy to use (OUT or POKE in BASIC). Card address is jumper selectable.

Reed Relay Card

RE-156: \$99

Same features as above, but uses 8 Reed Relays to switch low level signals (20mA max). Use as a channel selector, solid state relay driver, etc.

Analog Input Card

AD-142: \$129

Eight analog inputs. 0 to +5V range can be expanded to 100V by adding a resistor. 8 bit resolution (20mV). Conversion time 120us. Perfect to measure voltage, temperature, light levels, pressure, etc. Very easy to use.

12 Bit A/D Converter

AN-146: \$139

This analog to digital converter is accurate to .025%. Input range is -4V to +4V. Resolution: 1 millivolt. The on board amplifier boosts signals up to 50 times to read microvolts. Conversion time is 130ms. Ideal for thermocouple, strain gauge, etc. 1 channel. (Expand to 8 channels using the RE-156 card).

Digital Input Card

IN-141: \$59

The eight inputs are optically isolated, so it's safe and easy to connect any "on/off" devices, such as switches, thermostats, alarm loops, etc. to your computer. To read the eight inputs, simply use BASIC INP (or PEEK).

24 Line TTL I/O

DG-148: \$65

Connect 24 input or output signals (switches or any TTL device) to your computer. The card can be set for: input, latched output, strobed output, strobed input, and/or bidirectional strobed I/O. Uses the 8255A chip.

Clock with Alarm

CL-144: \$89

Powerful clock/calendar with: battery backup for Time, Date and Alarm setting (time and date); built in alarm relay, led and buzzer; timing to 1/100 second. Easy to use decimal format. Lithium battery included.

Touch Tone® Decoder

PH-145: \$79

Each tone is converted into a number which is stored on the board. Simply read the number with INP or POKE. Use for remote control projects, etc.

A-BUS Prototyping Card

PR-152: \$15

3 1/2 by 4 1/2 in. with power and ground bus. Fits up to 10 I.C.s

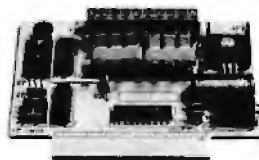

ST-143



CL-144

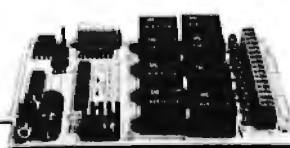

RE-140

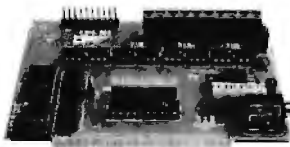

IN-141

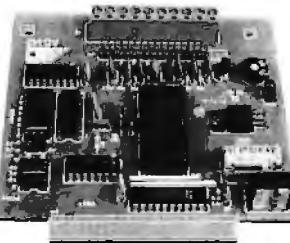

AD-142

Smart Stepper Controller sc-149: \$299

World's finest stepper controller. On board microprocessor controls 4 motors simultaneously. Incredibly, it accepts plain English commands like "Move arm 10.2 inches left". Many complex sequences can be defined as "macros" and stored in the on board memory. For each axis, you can control: coordinate (relative or absolute), ramping, speed, step type (half, full, wave), scale factor, units, holding power, etc. Many inputs: 8 limit & "wait until" switches, panic button, etc. On the fly reporting of position, speed, etc. On board drivers (350mA) for small steppers (MO-103). Send for SC-149 flyer.

Remote Control Keypad Option RC-121: \$49

To control the 4 motors directly, and "teach" sequences of motions.

Power Driver Board Option PD-123: \$89

Boost controller drive to 5 amps per phase. For two motors (eight drivers).

Breakout Board Option BB-122: \$19

For easy connection of 2 motors. 3 ft. cable ends with screw terminal board.

Stepper Motor Driver

ST-143: \$79

Stepper motors are the ultimate in motion control. The special package (below) includes everything you need to get familiar with them. Each card drives two stepper motors (12V, bidirectional, 4 phase, 350mA per phase)

Special Package: 2 motors (MO-103) + ST-143 PA-181: \$99

Stepper Motors MO-103: \$15 or 4 for \$39

Pancake type, 2 1/4" dia, 1/4" shaft, 7.5°/step, 4 phase bidirectional, 300 step/sec, 12V, 36 ohm, bipolar, 5 oz-in torque, same as Airpac K82701-P2

Current Developments

Intelligent Voice Synthesizer, 14 Bit Analog to Digital converter, 4 Channel Digital to Analog converter, Counter Timer, Voice Recognition.

A-BUS Adapters for:

IBM PC, XT, AT and compatibles. Uses one short slot.	AR-133...\$69
Tandy 1000, 1000 EX & SX, 1200, 3000. Uses one short slot.	AR-133...\$69
Apple II, II+, IIe. Uses any slot	AR-134...\$49
TRS-80 Model 102, 200. Plugs into 40 pin "system bus".	AR-136...\$69
Model 100. Uses 40 pin socket (Socket is duplicated on adapter).	AR-135...\$69
TRS-80 Mod 3, 4, 4 D. Fits 50 pin bus. (With hard disk, use Y-cable).	AR-132...\$49
TRS-80 Model 4P. Includes extra cable. (50 pin bus is recessed).	AR-137...\$62
TRS-80 Model I. Plugs into 40 pin I/O bus on KB or E/I.	AR-131...\$39
Color Computers (Tandy). Fits ROM slot. Multipak or Y-cable	AR-138...\$49

A-BUS Cable (3 ft, 50 cond.) CA-163: \$24

Connects the A-BUS adapter to one A-BUS card or to first Motherboard.

Special cable for two A-BUS cards: CA-162: \$34

A-BUS Motherboard

MB-120: \$99

Each Motherboard holds five A-BUS cards. A sixth connector allows a second Motherboard to be added to the first (with connecting cable CA-161: \$12). Up to five Motherboards can be joined this way to a single A-BUS adapter. Sturdy aluminum frame and card guides included.

Add \$3.00 per order for shipping.
Visa, MC, checks, M.O. welcome.
CT & NY residents add sales tax.
C.O.D. add \$3.00 extra.
Canada: shipping is \$5
Overseas add 10%



ALPHA Products

242-B West Avenue, Darien, CT 06820

Technical info: (203) 656-1806
Orders only 800 221-0916
Except in CT
Connecticut orders: (203) 348-9436
All lines open weekdays 9 to 5 Eastern time

Capital Gain.

Time and again, you've heard it said, "To make money, you have to have money."

The truth is, you have to know how to save money before you can think about making more.

That's why more and more people are joining the Payroll Savings Plan to buy U.S. Savings Bonds. That way, a little is taken out of each paycheck automatically.

In no time, you'll have enough Bonds for a new car, your child's education, even a dream vacation.

Whatever you save for, Bonds are the safest, surest way to gain capital.

Take stock in America.



When you put part of your savings into U.S. Savings Bonds you're helping to build a brighter future for your country and for yourself.

DATA ACQUISITION TO GO INTERFACE FOR ANY COMPUTER

FREE IBM SOFTWARE



Connects via RS-232. Fully IBM compatible. Built-in BASIC. Stand alone capability. Expandable. Battery Option. Basic system: 16 ch. 12 bit A/D, 2 ch. D/A, 32 bit Digital I/O. Expansion boards available. Direct Bus units for many computers.

(201) 299-1615

P.O. Box 246, Morris Plains, NJ 07950

ELEXOR

Circle 97 on Reader Service Card

16-BIT RESOLUTION ANALOG-TO-DIGITAL CONVERTER

12,000 SAMPLES/SEC
for IBM PC, XT & AT
SINGLE PIECE PRICE
\$475

We manufacture a broad line of data acquisition and control hardware and software for Apple and IBM computers.

Call for quotes on custom hardware or complete systems.

LAWSON LABS, INC.

5700 RAIBE ROAD
COLUMBIA FALLS, MT 59912
800-321-5355 or 406-387-5355



Circle 144 on Reader Service Card

EPROM PROGRAMMER

\$349



THE EP-1'S A GREAT VALUE AND HERE'S WHY:

- READS, PROGRAMS, COPIES OVER 350 EPROM AND EEPROMS FROM 30 MFG'S INCLUDING 2716, 27513, 2804, 28256, 27011
- READS/Writes INTEL, MOTOROLA, STRAIGHT HEX & BINARY
- OPTIONAL HEADS PROGRAM INTEL 874X, 8751, 87C51, 8755
- MENU-DRIVEN CHIP SELECTION BY MFG & P/N, NO MODULES
- FAST, SLOW, QUICK PULSE PROGRAMMING ALGORITHMS
- SPLITS FILES BY BASE ADDRESS AND ODD/EVEN (16 & 32 BIT)
- ALL INTELLIGENCE IN UNIT; Z80 MICROPROCESSOR BASED
- 5, 12.5, 21.25 V PROGRAMMING FOR CMOS & -A SUFFIX PARTS
- FREE PC-DOS SOFTWARE
- GOLD TEXT TOOL ZIF SOCKET
- MONEY BACK GUARANTEE
- 2 FREE FIRMWARE UPDATES
- CHECKSUMS SUPPORTED
- RS232 TO ANY COMPUTER
- 8 BAUD RATES TO 38,400
- ONE YEAR WARRANTY
- SAME DAY SHIPMENT
- UV ERASERS FROM \$34.95

CALL TODAY FOR MORE INFORMATION

800/225-2102

BP MICROSYSTEMS

10681 HADDINGTON #190, HOUSTON, TX 77043
713/461-9430 TLX: 1561477 FAX: 713/461-7413

Circle 40 on Reader Service Card

UNIVERSAL LOGIC PROGRAMMER

- PROGRAMS, READS, DUPLICATES, TESTS AND SECURES HUNDREDS OF 20- AND 24-PIN DEVICES
- 23 UNIVERSAL P/N DRIVERS WITH INDEPENDENT DAC, ADC & SLEW FUNCTIONS PROGRAM ALMOST ANY LOGIC DEVICE
- MENU DRIVEN OPERATION IS EASY TO LEARN AND QUICK TO OPERATE
- CONNECTS TO ANY IBM COMPATIBLE COMPUTER VIA PARALLEL PRINTER PORT
- EDITS FUSE DATA & TEST VECTORS WITH FULL SCREEN EDITOR
- TESTS WITH VECTORS & SECURES AFTER PROGRAMMING
- SUPPORTS ALL POPULAR PLD DEVELOPMENT SOFTWARE
- GOLD TEXT TOOL, ZIF IC SOCKET • ONLINE HELP FUNCTION
- MONEY BACK GUARANTEE
- TOLL-FREE TECH SUPPORT
- UPDATABLE VIA FLOPPY
- EPROM PROGRAMMERS ALSO

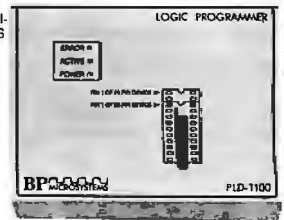

- SELF CALIBRATING
- JEDEC FILE IN/OUTPUT
- ONE YEAR WARRANTY
- SAME DAY SHIPMENT
- JUST \$798

CALL FOR FREE DEMO DISK 800/225-2102

BP MICROSYSTEMS

10681 HADDINGTON #190 HOUSTON, TX 77043
713/461-9430 TLX: 1561477 FAX: 713/461-7413

Circle 40 on Reader Service Card

NEW! INSTANT TERMINAL

"EXACT TERMINAL EMULATION
AND COMMUNICATIONS SOFTWARE"

- PRECISE EMULATION OF THE DEC VT52, VT100, VT102, VT220
- EXPANSION MODULES FOR OVER 40 EXACT EMULATIONS
- 9 FILE TRANSFER PROTOCOLS.
- EASY TO USE, QUICK TO INSTALL, AND MUCH MORE
- IBM PC, XT, AT, PS/2

FOR INFORMATION
800/548-9777

SOFTRONICS
303/593-9540
TELEX 450236

ONLY
\$97.50

Circle 253 on Reader Service Card

6809 Single Board Computer

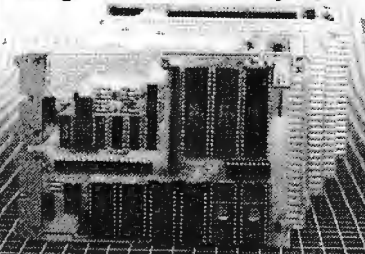

6809 MPU, 2 serial ports, 4 parallel ports, RAM, EPROM, real-time clock, watchdog timer, 44-pin 4.5" x 6.5" PCB
EXPANSION MODULES: RAM, EPROM, CMOS RAM/battery, analog I/O, serial I/O, parallel I/O, counter/timer, IEEE-488, EPROM programmer, floppy disks, cassette, breadboard, keyboard/display



WINTERK

Wintek Corp
1801 South Street
Lafayette, IN 47904
317-742-9428

Circle 279 on Reader Service Card

California Digital

17700 Figueroa Street • Carson, California 90248



Color Monitor
Better Than **EGA**
\$1095 **\$289**

Ideal for CAD/CAM and Desk Top publishing applications. The Roland CD/240 color monitor has a resolution of 720 pixels by 400 lines on a .31mm dot pitch 12" non-glare screen. VGA specifications in text mode EGA in graphic mode.
Comparable monitor and card packages retail at over \$1095. California Digital has made a special purchase and is able to offer the CD/240 and 132 column VGA/EGA graphics card for only \$389.

Also Available: Amdek • Conrac • Hitachi • Magnavox • Mitsubishi • NEC • Panasonic • Princeton • Samsung • Sanyo • Sony • Tatung • Taxan • Thompson • Zenith

20" Analog Color
\$659



Ever try gathering a classroom of students around a 12 inch monitor? This 20 inch analog RGB monitor is the ideal solution. High screen resolution of 1200 pixels by 950 lines allow extra fine detail without the dots looking like golf balls. 256 colors and VGA compatible. Super value originally sold for over \$2000. Only 350 available.



\$2495
\$629

80 Character Daisy Wheel Printer

These Fujitsu Daisy Max 830 were manufactured for Motorola's Computer Division. The purchase order was canceled and Fujitsu was forced to liquidate these 80 character per second daisy wheel printers at "fire sale" prices. Features: bullet proof construction, your choice of either Centronics parallel or RS-232 serial interface, Diablo 630 wheels and commands, programmable line spacing in increments of 1/96" and column spacing of 1/120". The printer is also capable of underscoring, bold overprint, shadow print, centers and justifies along with vector plotting.

Factory suggested price of the Daisy Max 830 was \$2495, California Digital is offering this liquidated special at only \$629. Tractor and sheet feeders available.



	One	Two	Ten
TEC501 1/2 height sgl.sided	49	39	35
TANDON 65L/2 360K, 1/2 ht.	79	75	72
TANDON 101/4 full ht. 96 TPI.	99	89	79
FUJITSU 5/4" half height	95	89	82
MITSUBISHI new 501 half ht.	119	109	105
MITSUBISHI 504A AT comp.	149	139	135
TEAC FD55BV half height	109	99	89
TEAC FD55FV 96 TPI, half ht.	119	109	105
TEAC FD55GF for IBM AT	149	139	135
PANASONIC 455 Half Height	109	99	89
PANASONIC 475 1.2 Meg./96	119	115	109
Switching power supply			49
Dual enclosure for 5/4" drives			59

3 1/4" DISK DRIVES

SONY MP-53W 720K/Byte	129	125	119
SONY MP-73W, 2 Meg.	159	149	call
TEAC 35FN 720 K/Byte	129	119	115
TEAC 35HN/30, 2 Meg.	159	149	145
5/4" form factor kit			20

8" DISK DRIVES

QUME 842 double sided	189	179	175
QUME 841 single sided	119	109	99
SHUGART 851R dbl. sided	319	309	299
REMEX RFD4000 dbl. sided	189	179	165
OLIVETTI 851	189	179	165

40 Meg. Tape Back-up
\$239



This 40 megabyte half height tape pack is manufactured by World America's largest producer of data retrieval equipment. No need to purchase a separate tape controller... the ALL/40 attaches directly to your existing floppy disk controller. Supplied software allows your computer to back up any time **Day or Night**. Come back in the morning and 40 megabytes of irreplaceable data has been stored on one Scotch DC/2000 data cassette. Back up entire hard disk, modified files only, or by file name. Loss of data is a catastrophe.

Hitachi 11 by 17 Plotter
\$695



The Hitachi 672/XD is a four color 11 by 17 (B size) plotter with superior accuracy and repeatability (.3mm). The 672 accepts HPGL 7475 commands and is both Centronics parallel and RS232C compatible. The 672 plots at a fast eight inches per second in axial direction and eleven inches at an angle of 45 degrees. The plotter also features a self contained digitizing function that allows data to be entered into your computer from printed graphs and blue prints.
Four different color pens are supplied with the plotter but a wide variety of technical pens are available.

NEC/8500 Laptop
\$319



The NEC PC/8500 laptop computer crystal display and modem that plugs directly into any RJ/11 wall jack. An auto log/on feature instructs the 8500 to phone the users host computer and automatically send password and log/on information. The computer also includes both serial and Centronics parallel ports packaged in this six pound laptop. This is the ideal computer for Realtors, insurance people or any individual that requires immediate access to remote information. ROM based telecommunication software, spreadsheet and Wordstar also make the 8500 a great computer for students. Files can be transferred from this CP/M computer to any other including the IBM/PC.

Heath H/89 Computer
\$179



Hard to believe... but we found a stash of brand new Zenith/Heath Model H/89 computers. These computers feature the Zilog Z-80 CPU and operate under CP/M. The unit incorporates a 12 inch green screen, three serial ports and one 5 1/4" disk drive. Zenith's original price was \$1895. We have 350 units available for sale, while supplies last we are offering the H/89 at only \$179. Word processing and communication software included.

\$119
2400 Baud Modem



2400 baud with forward error correcting make the Moxon MAX/2400 an unbelievable value at only \$119. Fully compatible with the Hayes command set and CCITT V.22 standards. Error correcting, autobauding and "adaptive equalization" allow the MAX/2400 to maintain reliable data transmission over marginal phone lines. Manufactured by Moxon Systems, one of the World's largest producers of consumer electronics. Originally priced at \$295. While supplies last California Digital is offering the MAX/2400 at only \$119.

Smarteam 2400
\$239



2400 baud

MODEMS

Avalex 1200E external, Hayes compatible	\$89
CTS 1200 baud modem	89
Hayes Smartmodem 2400 baud modem	529
Smarteam 2400 Hayes Compatible	259
Smarteam 1200 Hayes Compatible, 300	119
Smarteam 1200E IBM 1200 baud card	119
UltraLink 1200 data and voice, Bell202	99
Prometheus 1200 super features	289
U.S. Robotics 9600 bps. Courier I	
Signalman Mark VI, 300 baud inte	

21 Megabyte Gold Card

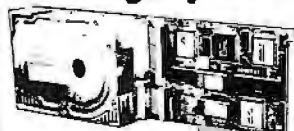

\$379

The Gold Card from Silicon Valley Computers features shock mounted automatic head unloading, 15 watt drive coupled with a 2K/byte sector buffer and advanced OMTI controller for maximum reliability, 30,000 hour MTBF and full 2 year warranty - the best cost per megabyte hardcard available. Also available the 30 Meg. Gold Card at only \$419.

40 Megabyte Hard Disk Kit

Forty megabyte internal hard disk drive, controller and cables all for only \$397. The kit includes the a 40 millisecond Miniscribe 3650 drive and a half slot Western Digital controller.

\$397



Five Inch Winchester Disk Drives

Price does not include controller. each two+

SEAGATE 225 20 Meg. 1/2 Ht.	269	259
SEAGATE 238 30 Meg. RLL	299	289
SEAGATE 251 51 M. 40mS.	419	399
SEAGATE 4051 51 M. 35mS.	695	659
SEAGATE 4096 96 M. 35mS.	795	779
MINISCRIBE3425 25 m 85ms.	279	247
MINISCRIBE3650 50m 61 ms.	419	399
MINISCRIBE 6085 90 meg.	795	779
FUJITSU 2242 55 M. 35mS.	1299	1229
FUJITSU 2243 86 M. 35mS.	1695	1619
RODDIME RD-204E 53 Meg.	895	859
MAXTOR XT1140 140 Meg.	2195	2129
TOSHIBA MK5670 M. 30mS.	1789	1729

Winchester

ADAPTEC 1620 with floppy controller	169
DTC 5150CX	119
OMTI 5520 half card	99
ADAPTEC 2070 RLL controller	129
ADAPTEC 2010A	159
WESTERN DIGITAL W0/1002WX2	89

SCSI/SASI Winchester Controllers

XEBEC 1410A 5 1/4" foot print	219
WESTERN DIGITAL 1002-05E 5 1/4"	289
OMTI 20L	89

Winchester Accessories

Installation Kit with manual	10
Winchester enclosure and supply	139
Dual 20/34 cable set	25
Switching power supply	49

Shipping: First five pounds \$3.00, each additional pound \$.50
Foreign orders: 10% shipping, excess will be refunded.
California residents add 6 1/2% sales tax. • COD's discouraged.
Open accounts extended to state supported educational institutions and companies with a strong "Dun & Bradstreet" rating.



Telefax • (213) 217-1951



TOLL FREE ORDER LINE
(800) 421-5041
TECHNICAL & CALIFORNIA
(213) 217-0500

***FREE 3M Headcleaning Kit**

DS-DD	Quantity Discounts Available	DS-HD
.73*	5.25"	1.49
1.59	3.50"	4.75
DC-1000	12.80	DC-300XLP 19.65
DC-2000	17.40	DC-600A 21.85

WHOLLY KAO World's Finest Professional Quality Color Diskettes

Like from the Surface Scientists
Unlike other "so-called manufacturers" (fabricators, in reality) these color diskettes are Wholly KAO!

- LIFETIME WARRANTY
- 75%+ CLIPPING LEVEL
- 100% Tested & Certified
- 110% of Industry Standards
- Rainbow Color Pack or Solid Pack for organizing your data files
- Sturdy re-usable plastic storage box, includes Tyvek sleeves, ID labels & W/P tabs

DS/DD Color 5.25"	DS/HD Color
.79 in Plastic Storage Box	1.29
DS/DD Color 3.50"	DS/DD Softbox
1.69 in Plastic Storage Box	1.35
3.50" High Density 2MB	3.49

SUMMER SPECIALS

- Box of Ten 5.25" DS/DD-48 TPI Disks (min 10 boxes) **3.50**
- Plastic Storage Box of TEN 3.50" DS/DD Rainbow Color Disks (min 5 boxes) **12.90**
- KAO High Density in Minidex/78 with 60 KAO 5.25" DS/HD "AT" **57.00**
- KAO 3.50" DS/DD in Microdex/25 with 25 KAO 3.50" DS/DD **33.00**
- 3M 3.50" DS/DD in Flip 'n File with 10 3M 3.50" DS/DD (min 5 boxes) **17.50**
- BASF in Minidex/60 with 30 BASF 5.25" DS/DD (min 2 boxes) **19.95**

Verbatim DataLifePlus

5.25" DS/DD	3.50" DS/DD	5.25" DS/HD
.75	1.59	1.49
	(min. 5 boxes)	

BASF *FREE Plastic Library Case

5.25" DS/DD	3.50" DS/DD	5.25" DS/HD
.65*	1.35	.95
	(min. 10 boxes)	

Nashua

5.25" DS/DD	3.50" DS/DD	5.25" DS/HD
.48	1.32	.89
	(min 10 boxes)	

BULK

BLACK DISKS	COLOR DISKS
.29 5.25" DS/DD 48TPI39
.75 5.25" DS/HD 96TPI82
1.05 3.50" DS/DD 135TPI	1.21

*5.25" Bulk Disks with Tyvek, color-coded ID labels and w/p tabs, add 6c

YOUR NAME & LOGO Disks/Envelopes

Put your name on the world's best diskettes! Choose from 3M, BASF, KAO Color or Sony Media. Call for information.

TERMS: VISA, MasterCard or AMEX. CDD only add \$3.00 Prepaid orders deduct 2% cash discount. PD's accepted from recognized institutions and corporations on Net 30 Shipping: \$4/100 or fewer disks

WE BEAT ANY PRICE!

Toll Free Order Line: **1-800-523-9681** Information Line: **1-801-255-0080**
 TLX-9102404712 FAX-801-572-3327

DISK COTECH
 DISKCO TECHNOLOGIES, INC.
 213 Cottage Avenue
 P.O. Box 1339 Sandy, Utah 84091
 338 BYTE • JULY 1988

(E)PROM PROGRAMMER \$395



- No personality modules; Menu-driven device selection.
- Built-in Eraser/Timer option (\$50); Foam pad.
- User friendly software; Complete help menu.
- Direct technical support; Full 1 year warranty.
- Quick pulse algorithm (27256 under 60 sec).
- Programs 27xx to 1 Mbit; 25xx, 68xx; CMOS; EEPROMS.
- Micros: 8741, -2, -8, -9 OR 87(C)51, 87(C)52, 8753, 9761
- IBM-PC, Apple, CPM or Unix driver; Autobaud RS232.
- On/so/split Hex, Binary, Intel & Motorola 8,16,32 bit.
- Manual with complete schematics.

VISA MC AMEX Call today for datasheets!!

B&C MICROSYSTEMS
 355 WEST OLIVE AVE. SUNNYVALE, CA 94086
 PH: (408) 730-5511 FAX: (408) 730-5521 TELEX: 984185

Circle 28 on Reader Service Card

ICs PROMPT DELIVERY!!!
 SAME DAY SHIPPING (USUALLY)
 QUANTITY ONE PRICES SHOWN FOR MAY 10, 1988

OUTSIDE OKLAHOMA: NO SALES TAX

DYNAMIC RAM		
SIMM	1048Kx8	100 ns \$450.00
1Mbit	1048Kx1	100 ns 38.50
41256	256Kx1	60 ns 16.00
41256	256Kx1	80 ns 15.50
41256	256Kx1	100 ns 15.50
51258	* 256Kx1	100 ns 15.95
41256	256Kx1	120 ns 13.95
41256	256Kx1	150 ns 12.50
41264	+ 64Kx4	120 ns 16.95
EPROM		
27C1000	128Kx8	200 ns \$37.50
27C512	64Kx8	200 ns 14.95
27256	32Kx8	250 ns 7.50
27128	16Kx8	250 ns 6.95
STATIC RAM		
43256L-12	32Kx8	120 ns \$16.50
6264P-12	8Kx8	120 ns 10.50

60Kx MOTHERBOARD UPGRADE: Zenith 150, IBM PC-XT, Compaq Portable & Plus, hp Vectra

* * * * *
 + CO. U.S. SHIPPING
 + VIDEO PORT
 80387-2 80287-8 80387-16 80387-20
 \$160.00 \$245.00

OPEN 6 1/2 DAYS, 7:30 AM-10 PM: SHIP VIA FED-EX ON SAT.
 WE EXPORT ONLY TO CANADA, GUAM, PUERTO RICO & VIRGIN ISLANDS

SAT DELIVERY INCLUDED ON FED-EX ORDERS RECEIVED BY: 11:59 AM
 Th: \$24 Air \$8 S/B
 Fr: P1 \$10.25 1 lb

MasterCard VISA or UPS CASH CDD
Factory New, Prime Parts on MICROPROCESSORS UNLIMITED, INC.
 24 000 S Peoria Ave
 BEGGS, OK 74421
 (918) 267-4961

No minimum order. Please note that prices are subject to change. Shipping & insurance extra & up to \$1 for packing materials. Orders received by 9 PM CST can usually be delivered the next morning, via Federal Express Standard Air - \$8.00, or guaranteed next day Priority One - \$10.25!

Circle 169 on Reader Service Card

Satellite Communication
MICROSAT II
 Expansion Board \$700

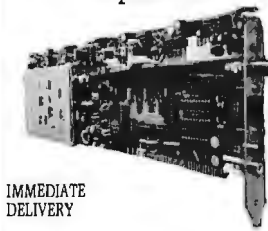

IMMEDIATE DELIVERY

- For IBM PC/XT/AT and compatible.
- Satellite data receiver - 9600 baud.
- Satellite bulletin board.
- Satellite video and audio option - Add \$200

PERSONAL SPACE COMMUNICATIONS
 707 Johnson Road, Blaine WA 98230
 (604)597-6298 TLX 04-508306 FAX (604)597-6214

Circle 187 on Reader Service Card

TANDY ADD-ONS

For Tandy 1000, SX, TX	1000, SX, TX
10 Meg Hard Card	20 Meg Hard Card
	
\$299.95	\$349.95
1000, SX, TX	NEW TANDY 1000, SX, TX
30 Meg Hard Card	49 Meg Hard Card
	32 MS (speed)
\$399.95	\$599.95

TRUE DATA PRODUCTS
 115 So Main Street
 Uxbridge, MA 01569
 Tel. 617-278-6555
 1-800-635-0300
 Hours: 9 a.m.-6 p.m., Sat. 10 a.m.-4 p.m.

Circle 303 on Reader Service Card

MICRO CHANNEL ENGINEERING DEVELOPMENT SUPPLIES

INTRODUCING: The PS/2 Burn-In Board!

For Design and Manufacturing Engineers



- First Passive Backplane For PS/2 Micro Channel
- Test adapters without power cycling computers
- Test adapters without damaging computer
- Optional module and software provides single step bus emulation

CALL now for your FREE Catalog.
 Quality PS/2 compatible products available.

ONTARGET TARGET TARGET
 ON TARGET Associates
 1034 W. Maude Ave., # 602
 Sunnyvale, CA 94086
 (408) 980-7118

PS/2, and Micro Channel are trademarks of IBM Corp.

Circle 191 on Reader Service Card

Everex AT 1800 Basic System 3899
 (MADE IN U.S.A. with quality)

- Intel 80286 CPU
- Fully compatible with IBM AT
- 95 Mhz synchronous, 8 slots
- 512K on 1M mother-board
- 195 watt power supply 110/220
- Color-Center, Evers HMOFO cool
- KCC class "B" approved
- 48 Hour factory high temp dynamic burn-in
- 1.2 MEG Teac Dr., Max. switch AT Keyboard
- Plus: AutoDoc, 1.5mb Xenix, Novell, all prog. Software
- 200 pages of documentation (written in U.S.A.)
- 80287 CD Processor socket
- 40000 unit install with customer report on file
- Made in U.S.A. by Everex with 1 year warranty

Mono System (Basic Sys. + Monographics card w/ptr port, Hi-Res monitor-w/stand) \$100
 Upgrade Options (Call for options not listed)
 A. Everex 20M/40M/72M HardDisk \$250/\$425/\$699 B. 80MHz \$100

System 800 XT \$595	Schwab AT 10MHz, 0" wait \$789
 \$1095 complete system w/20M
Fully IBM XT compatible	80286-10 1010
8088 4.77/9 MHz, 380K Dr.	AMI BIOS, 512K, 1.2 meg Teac
250K on Motherboard	200 w P/S, Maxi-switch KB
Maxi-Switch Keyboard	Hi-Res Mon., Graphics card w/ptr
Hi-Res Mon. w/Stand	8 slots, clock, calendar
Hi-Res. Compat. Graphics Card w/ptr	Free set-up utility, support 1.44 meg dr.

Schwab Computer Center
 "The Everex Store" - Authorized Everex Dealer
 3282 El Camino Real, Santa Clara, CA 95051
 408-241-1210
 M-F 10-7:30 P-7
 Dealer/Consultant Inquiries Welcome
 Prices subject to DRAM market.

Circle 242 on Reader Service Card

FAMOUS MAKER COMPUTER SALE



Standard Features

- 4.77/8MHz Turbo Processor Speed
- **640 Kbyte of RAM memory standard**
- Built-in serial communications port
- Built-in parallel port
- 4 slots for system enhancements
- Hercules compatible display adaptor
- High resolution green TTL monitor
- Clock calendar with battery back-up
- MS-DOS/GW Basic software version 3.2.1
- Integrated productivity software
- One year warranty

Our new computer deal is so good that we can't tell you the manufacturer's name. This is a quality computer manufactured by one of the biggest names in the business. A 14 billion dollar giant who builds the computers from the chips on up! However, because of the low price we're selling them at, the manufacturer won't let us print their name.

These PCs come with 640K memory standard. Most compatibles sold today have only 256K. At today's high RAM prices, the extra memory you need to run most programs adds another \$200 onto the other guy's price—don't be fooled by a lower price on a system that needs expensive upgrades. Our system comes complete.

**Complete System with
1 Floppy, Hi-res Monitor
and Software**

\$699

**Complete System with
1 Floppy, 20Mb Hard Disk,
Monitor & Software**

\$999

Add \$200 for RGB Color System

—NOT AVAILABLE AT PIE RETAIL STORES—

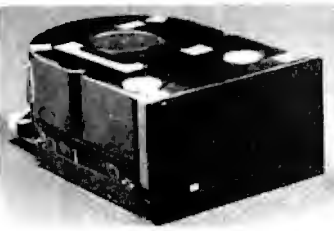

**QUANTUM
Q540
Hard Drive**

- 42.7 Mbytes capacity
- 45ms avg. access time
- 30 day warranty

1 each
\$299

2-4 ea.
\$289

5+ ea.
\$279

**1
PRIORITY ONE ELECTRONICS**

800-423-5922

21622 Plummer Street
Chatsworth, CA 91311

FAX: 818-709-4362



- Same Day Shipping before 2pm PT
- No surcharge on credit card orders
- Prices are subject to change without notice
- Shipping charges added to order
- Retail prices may vary
- Limited to stock

Circle 209 on Reader Service Card

American Semiconductor

Complete units
as low as

\$35.
/mo.



MODELS XT, AT, & 386

Not a Lease—You own it

- ★ 5 Year Warranty Available!
- ★ Instant Credit!
- ★ Technical Support!

Call for Details
1-800-825-SAVE

Circle 16 on Reader Service Card

American Semiconductor

Specializing in Computer Components,
Hardware, and Software

MATH CO-PROC.:	EPROMS:	SIMMS:
8087 \$107.00	27128 \$4.25	1 MB D/RAMS \$29.00
80872 151.00	27256 3.90	
80287 168.00	2764 2.90	1 MB x 9
80287B 238.00	27512 CALL	1 MB x 8
8028710 305.00		256 x 9
8038716 460.00		256 x 8

STATIC COL. RAM \$12.00

DRAMS:		LARGE INVENTORY OF ALL PRIME PARTS. FOR MORE DETAILS CALL 1-800-825-SAVE FAX: 1-813-889-0658
4164-150 \$2.00		
4164-120 2.25		
256-100 12.00		
256-120 11.10		
256-150 10.00		

1-800-825-SAVE

Circle 17 on Reader Service Card

EPROM/PAL Programmer

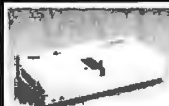

- ★ PAL MODULE \$295
- Programs 20 & 24 pin MMI (A8), NS TI PALS
- Read JEDEC file format
- Security, DIR, LOAD, SAVE, EDIT, READ, WRITE, VERIFY,
- User friendly menu driven SW.

- * EPROM MODULE (1, 4, 8 socket) \$145
- 16K to 1024K EPROM, CMOS EEPROM.
- Read Intel, Motorola, TEK HEX file
- Very fast (Quick pulse), reliable, easy to use
- * BIPOLAR ROM MODULE \$295
- MMI, NS, TI & Signetics parts
- * 8741/42/48/49/50 Module \$195
- 1, 4, 8 socket module available
- 8748 Disassembler included
- * 8751/52/52/44 Module \$245
- Normal, Intelligent programming algorithm
- * TTL & MEMORY IC TESTER MODULE \$195
- Test almost TTL, CMOS, Dynamic, Static IC's
- Auto search for unknown IC part No.
- * INTERFACE CARD & CABLE \$50
- This card is common to all above modules
- Fits in any PC/XT/AT or compatibles
- * UNIVERSAL PROGRAMMER \$545
- Programming Capability for E(E)PROM, BIPOLAR, PAL, 8748, 8751, IC/ROM TESTER in one box
- Includes interface card, cable and software.

473 Sapena Ct., #24 **XELTEK**
Santa Clara, CA 95054 CA residents
(408) 727-6995 add 6.5% tax.
FAX (408) 727-6996 Add \$8 for S/H

Circle 280 on Reader Service Card

"INDISPENSABLE"

Jerry Pournelle, Byte, 8/87

Vopt is the fast, safe disk organizer. It will quickly eliminate the file fragmentation that slows your disk operations.

Vopt includes Vmap for viewing the organization of your disks plus numerous other utilities that test and report on the efficiency of your system.

Call for a free demo disk!

\$59.95 \$3 shipping/handling
CA add 6.5% sales tax.

GOLDEN BOW SYSTEMS

2870 Fifth Ave., Suite 201
San Diego, CA 92103
800/284-3269

Circle 108 on Reader Service Card

"D" SIZE PLOTTER

\$2295⁰⁰
RETAIL

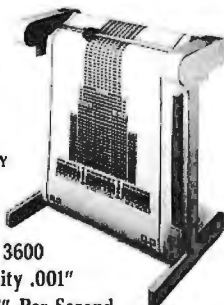

\$1695⁰⁰
INTRODUCTORY
OFFER

- Model PC 3600
- Repeatability .001"
- Speed at 7" Per Second
- Vacuum Paper Hold Down
- High Resolution Circles: Suitable for PCB Artwork

(415) 490-8380 **ZERICON**
STEVENS BUSINESS PARK
BOX 1669, FREMONT, CA 94538

Circle 283 on Reader Service Card

IBM PC/VT220

- EM220** • VT220, VT102 emulation
\$169 • File Transfer
• 132 Column modes
• Color Support
• Hot Key

TEK 4105

- EM4105** • Tektronix 4105 emulation
\$349 • Tektronix 4010 emulation
• VT220, VT102 emulation
• Picture files
• High resolution hardcopy
• VGA and EGA support

Diversified Computer Systems, Inc.

3775 Iris Ave., Suite 1B
Boulder, CO 80301
(303) 447-9251

Trademarks: VT102, VT220 — DEC; IBM PC, XT — IBM Corp.; Tektronix — Tektronics Inc.

Circle 80 on Reader Service Card

Speech Thing™

For all PCs, compatibles, laptops



\$69.95 CLEAR, CLEAN,
DIGITIZED SPEECH &
MUSIC, UNLIMITED
TEXT-TO-SPEECH
Attaches outside
the computer.

Now get popular speech technologies in ONE product! Speech Thing is a full-featured 8 bit D/A sound converter. Easily attaches outside the computer—no slots required. Software includes prerecorded speech vocabularies, synthetic text to speech (speaks any ASCII text), demo programs, and complete editing features. Price only \$69.95. Also available: Voice Master PC plug in board for digital recording, editing, and VOICE RECOGNITION. (Requires Speech Thing for sound output.) Only \$79.95. Patented price/performance breakthrough!

TO ORDER BY MAIL include \$4 shipping & handling (\$6 Canada, \$12 overseas) per order. Visa, MasterCard phone orders accepted. 30 day money back guarantee, one year warranty. Other voice I/O systems available for Apple, Commodore, and Atari computers.

Call or write today for FREE Product Catalog
COVOX INC. (503) 342-1271
675 Conger St., Eugene, Oregon 97402

Circle 74 on Reader Service Card

COMPUTER MUSIC PRODUCTS

for the
IBM PC/XT/AT
and Compatibles

VOYETRA TECHNOLOGIES

333 FIFTH AVE, Dept. B,
PELHAM, NY 10803
(914) 738-4500



Circle 272 on Reader Service Card

REAL WORLD I/O

For PC/XT/ATs

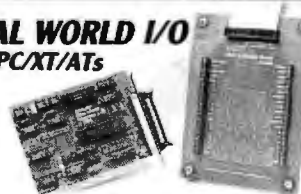

- DC24 • 24-line digital I/O: 10 MHz 8255. \$95
 - AD500 • 8 channel 12-bit (plus sign) integrating A/D; programmable gains of 1, 10, & 100. Hi-Z input and 7 digital lines. \$239
 - AD100 • Single channel version of AD500 with 10 digital lines. \$149
 - AD200 • 4 channel, 125 uS, 12-bit A/D board. \$239
 - ADA300 • 8 channel, 25 uS, 8-bit A/D; single D/A; 24 TTL I/O lines (10 MHz 8255). \$239
 - DA600 • Fast settling dual 12-bit D/A. \$169
 - PD200 • Prototype/development board with address decoder, buffer, 100+ page application/project manual. \$99
 - XB40 • External connection/prototype board with cable. \$99
- All boards include BASIC, Pascal, C, and Fortb drivers. 30 day return; 1 year warranty. Call for "Real World Interfacing" application notes.

Real Time Devices, Inc.
P.O. Box 906 State College, PA 16804
(814) 234-8087

Circle 233 on Reader Service Card

NATURAL LANGUAGE INTERFACE



THE COMPUTER CHRONICLES MAKES KEEPING UP WITH THE INFORMATION AGE EASY

Stewart Cheifet and Gary Kildall are your co-hosts for a weekly half-hour television program aimed at computer users, owners, educators and computer industry professionals. If you're looking for help in finding out what's new and what's news, tune in to THE COMPUTER CHRONICLES every week on your local public television station.

Regular commentators are Jan Lewis, President of Lewis Research Corporation and publisher/editor of

HyperAge magazine, and George Morrow, founder of Morrow Designs.

Topics this season include: CD ROMS — Shareware — Multitasking — Business Graphics — Investment Software — PC Imaging — PC Networks — Decision Support Software — Laser Printers — Hypercard - Input Devices — and MUCH MORE.

Each week THE COMPUTER CHRONICLES looks at the top stories of the week in Random Access, a news segment designed to keep you informed about the latest developments in the computer industry.

THE COMPUTER CHRONICLES, a weekly half-hour of public television that just might be the help you need.



JAN LEWIS



GEORGE MORROW

The Computer Chronicles is funded in part by McGraw-Hill's **BYTE** magazine. The Computer Chronicles is a co-production of WITF/Harrisburg and KCSM/San Mateo.

THE COMPUTER CHRONICLES IS NOW ON BIX

Bix, the Byte Information Exchange, now has a conference for the Computer Chronicles.

Now you can communicate directly with the staff of the Computer Chronicles to suggest topics for future shows or to request information or details on past shows.

Once on Bix, just type "join comp.chron" at the colon (:)
prompt.

IC's, Parts, Components... Shipped Fast!

West Coast's Largest Selection... Call for More

RAM Upgrades!

- ...priced in sets of 9
- 64K/120ns CALL
 - 64K/150ns CALL
 - 256K/100ns CALL
 - 256K/120ns CALL
 - 256K/150ns CALL

DYNAMIC RAMS

4116/200ns	Call	4464/150ns	Call
MK4332/200ns	Call	41256/100ns	Call
4164/200ns	Call	41256/120ns	Call
4164/150ns	Call	41256/150ns	Call
4164/120ns	Call	41264/150ns	Call
4164/PIN ONE	Call	41289/150ns	Call
4166/200ns	Call	81194517	Call
4446/150ns	Call	1 MEG/100ns	Call
4464/120ns	Call	TMS 4161/150ns	Call

STATIC RAMS

2102L/P/450ns	\$.99	6116/120ns	\$2.95
2101/450ns	1.79	6116L/P/150ns	2.45
2112/450ns	2.69	6264L/P/120ns	4.95
2114/450ns	.89	6264L/P/150ns	4.45
21142	1.19	6264/150ns	4.25
21142L	1.99	62256/120ns	12.85
6116/150ns	2.45	62256/100ns	19.95

74 HCT SERIES

74HCT00	\$.25	74HCT161	\$.65	74HCT540S1	1.99
74HCT02	.25	74HCT163	.65	74HCT541	1.99
74HCT04	.25	74HCT164	.65	74HCT563	2.99
74HCT08	.25	74HCT170	.65	74HCT564	2.99
74HCT10	.25	74HCT240	1.29	74HCT573	1.99
74HCT12	.25	74HCT241	1.29	74HCT574	1.99
74HCT17	.49	74HCT244	1.29	74HCT640	1.99
74HCT138	.50	74HCT245	1.29	74HCT646	2.99
74HCT157	.65	74HCT257	.65	74HCT563	2.99
74HCT160	.65	74HCT259	1.10	74HCT564	2.99

LINEAR

CA3086	\$1.19	LM566	\$1.10	LM3900	.45
CA3089	1.19	LM567	.75	LM3909	1.25
CA3030	1.19	LM723	.30	LM3911	1.95
LF347N	1.49	LM733	.30	LM3914	2.75
LF348N	1.49	LM741	.30	LM3915	2.75
LF356H	1.99	LM747	.60	LM3916	2.75
LF441	1.69	LM748	.65	MM4024	3.95
LM301	3.00	LM4144	1.49	MM4034	3.95
LM309K	1.00	LM1886	3.29	MM4136	7.50
LM317K	2.95	LM1320	1.95	MM4558	7.50
LM317T	1.75	LM1350	1.25	MM7555	2.50
LM318	1.15	LM1358	.95	MM7560	2.95
LM319	.95	LM1372	2.25	MM7660	3.95
LM320T-XX	.60	LM1408L	.60	MM7663	2.95
LM320K-XX	1.35	LM1408S	.40	MM7805	6.95
LM323K	4.25	LM1488	.60	MM7812	6.95
LM324	.35	LM1489	.60	MM8303	3.75
LM3502	1.19	LM1889	2.50	MC3452	2.69
LM3502I	1.19	LM2003	.75	MC3453	2.99
LM337H	2.49	LM2206	3.75	MC3480	6.99
LM337K	4.95	LM2111	1.95	MC3480	6.99
LM338K	6.95	LM2211	2.75	MC3486	1.69
LM340T-XX	.60	LM2240	1.75	MC3487	1.69
LM340K-XX	1.35	LM2900	1.19	LM3524	1.99
LM358	.45	LM2901	1.19	DM1170	5.49
LM376	1.69	LM2917	1.29	DM1180	5.99
LM380	.95	LM3045	1.19	TL074	1.65
LM386	.95	LM3054	1.99	TL081	.75
LM393	.65	LM3079	1.49	TL082	.85
LM497	2.50	LM3130	.95	TL084	1.25
LM565	.30	LM3140	.95	ULN2003	1.19
LM565A	.45	LM3160	1.95	ULN2064	1.79
LM569	.85	LM3161	1.95	ULN2074	1.99
LM564	2.75	LM3162	1.95	ULN2081	1.49
LM565	1.50	LM3852	1.49	ULN2981	1.99

74HC SERIES

74HC00	\$.25	74HC125	\$.50	74HC174	\$.65
74HC02	.25	74HC132	.50	74HC175	.65
74HC04	.25	74HC133	.50	74HC240	1.29
74HC08	.25	74HC138	.55	74HC244	1.29
74HC09	.25	74HC139	.55	74HC245	1.29
74HC10	.25	74HC148	.65	74HC368	.65
74HC11	.25	74HC153	.65	74HC373	1.29
74HC14	.25	74HC154	.65	74HC4020	.99
74HC20	.25	74HC155	.65	74HC4060	.99
74HC32	.25	74HC161	.65	74HC4066	.99
74HC34	.25	74HC166	1.15	74HC4075	.89
74HC37	.35	74HC173	.65	74HC4078	1.49

7400 SERIES

7400	\$.18	7474	\$.35	74157	\$.65
7402	.18	7475	.35	74158	.65
7404	.18	7476	.35	74173	.65
7405	.18	7485	.35	74174	.65
7406	.35	7486	.35	74175	.65
7407	.35	7490	.35	74176	.65
7408	.25	7493	.35	74181	1.75
7410	.25	7495	.35	74189	2.95
7414	.35	74121	.35	74193	.65
7420	.25	74123	.45	74195	.65
7426	.25	74125	.45	74198	1.65
7427	.25	74126	.45	74221	.75
7430	.25	74148	.65	74273	.75
7432	.25	74150	1.20	74365	.50
7438	.25	74151	.65	74366	.50
7442	.30	74153	.65	74367	.50
7446	.85	74154	1.20	74368	.50
7447	.95				

74C CHIPS

74C00	\$.25	74C154	\$2.85	74C374	\$1.69
74C02	.25	74C173	.99	74C903	1.19
74C04	.25	74C174	.99	74C906	1.19
74C08	.35	74C175	.99	74C912	6.95
74C10	.35	74C221	1.25	74C922	3.95
74C14	.49	74C240	1.69	74C923	3.95
74C32	.35	74C244	1.69	74C929	4.89
74C90	1.19	74C373	1.69	74C932	14.89

Partial Listing Only!!!
Call us for components...

74LS SERIES

74LS00	\$.19	74LS125	\$.45	74LS241	\$.99
74LS02	.19	74LS126	.49	74LS242	.99
74LS03	.19	74LS138	.45	74LS243	.99
74LS04	.19	74LS139	.45	74LS244	.99
74LS05	.19	74LS153	.59	74LS245	.99
74LS08	.19	74LS154	1.29	74LS257	.69
74LS09	.19	74LS157	.40	74LS258	.69
74LS10	.19	74LS158	.40	74LS259	.69
74LS14	.35	74LS161	.49	74LS273	.99
74LS17	.35	74LS163	.49	74LS322	1.79
74LS30	.25	74LS164	.49	74LS323	1.79
74LS32	.28	74LS165	.49	74LS365	.59
74LS47	.99	74LS166	.99	74LS366	.59
74LS73	.35	74LS173	.49	74LS367	.59
74LS74	.35	74LS174	.49	74LS368	.99
74LS75	.35	74LS175	.49	74LS373	.99
74LS76	.35	74LS189	3.95	74LS374	.99
74LS85	.49	74LS190	.49	74LS393	.99
74LS86	.28	74LS191	.49	74LS624	1.89
74LS90	.45	74LS192	.49	74LS629	1.89
74LS93	.45	74LS193	.49	74LS640	1.89
74LS107	.45	74LS195	.49	74LS641	1.89
74LS109	.45	74LS221	.65	74LS670	.99
74LS123	.49	74LS240	.99	74LS688	1.89

74F SERIES

74F00	\$.35	74F153	\$.59	74F243	\$1.29
74F02	.35	74F157	.59	74F244	1.29
74F04	.35	74F158	.59	74F245	1.29
74F08	.35	74F160	.59	74F251	.79
74F10	.35	74F161	.59	74F258	.79
74F11	.35	74F163	.59	74F280	2.89
74F20	.35	74F174	.69	74F373	1.49
74F32	.35	74F175	.69	74F374	1.49
74F64	.49	74F181	1.99	74F379	1.99
74F74	.49	74F189	2.99	74F399	2.99
74F86	.49	74F219	4.99	74F521	2.99
74F109	.49	74F240	1.29	74F533	2.99
74F139	.49	74F241	1.29	74F534	2.99
74F151	.59				

IC SOCKETS

SOLDER TAIL	HR16S/T	.59	22PIN/W/W 1.29
8PIN/L/P	HR18S/T	.69	24PIN/W/W 1.29
14PIN/L/P	HR20S/T	.79	28PIN/W/W 1.59
16PIN/L/P	HR22S/T	.89	40PIN/W/W 1.99
18PIN/L/P	HR24S/T	.99	HI RES W/W
20PIN/L/P	HR28S/T	1.19	HR8W/W \$.79
22PIN/L/P	HR40S/T	1.49	HR14W/W 1.19
24PIN/L/P	HR64S/T	4.99	HR16W/W 1.29
28PIN/L/P	WIREWRAP		HR18W/W 1.39
40PIN/L/P	28PIN/W/W	.59	HR20W/W 1.69
40PIN/L/P	14PIN/W/W	.59	HR22W/W 1.79
64PIN/L/P	16PIN/W/W	.69	HR24W/W 1.99
HR8S/T	.39	20PIN/W/W 1.19	HR28W/W 2.29
HR14S/T	.49		HR40W/W 3.49

SPECIAL FUNCTION

VOICE RECOGNITION	16450 - 16 BIT	
CHIP SET	USART	\$16.95
YAMAHA DXY	8250 - 8 BIT	
CHIP SET	USART	6.95
TMS 6100	5832 - CLOCK	3.95
SPEECH CHIP	58167 - CLOCK	8.95
TMS 5200 SPEECH CHIP		7.95

CMOS

CD4001	\$.18	CD4017	\$.59	CD4047	\$.65	CD4069	\$.29	CD4510	\$.69	CD4543	\$.89
CD4002	.18	CD4018	.59	CD4048	.75	CD4070	.29	CD4511	.69	CD4555	.99
CD4007	.59	CD4020	.59	CD4049	.29	CD4071	.29	CD4512	.69	CD4556	.99
CD4008	.59	CD4024	.49	CD4050	.39	CD4072	.29	CD4518	.79	CD4584	.69
CD4009	.59	CD4025	.59	CD4051	.39	CD4073	.79	CD4519	.79	CD14409	6.95
CD4010	.29	CD4027	.35	CD4052	.59	CD4076	.65	CD4520	.79	CD14410	7.95
CD4011	.29	CD4030	.29	CD4053	.59	CD4081	.29	CD4522	.79	CD14411	8.95
CD4012	.29	CD4040	.65	CD4060	1.49	CD4082	.29	CD4538	.79	CD14412	8.95
CD4013	.29	CD4042	.65	CD4063	1.49	CD4093	.				

ACP's Break thru Prices!!

Since 1976...The Nation's TOP Computer Supplier

Quantum Theory!

We made a truckload purchase from the factory and while the supply lasts we are offering them at this unbelievable price...

sale

389.

Quantum Q450
42.8Mb

Unformatted, 40ms, perfect for 286 & 386 ATs

ACP...famous since 1976 for delivering the Best Deals!!

TRUE BLUE!!!

REAL IBM®
Internal
1200 Baud
Modem
with diagnostic disc.



Factory Direct! Amdek®

TTL Amber Monitor 88.
12", Model 310A, List \$240.
While Supply Lasts!

New! RAY-O-VAC® 995

AT Replacement
Lithium Battery
Direct replacement for real-time clocks, AT/286/386

MEMORY LOSS?

Don't feel like the Lone Ranger... we are also suffering from loss of memory. ACP sells more Memory Upgrade IC's than other mail order supplier. But...the present shortage is driving us up a wall. We can't get them at the right price, but we are getting them. PLEASE BEAR WITH US...as the market price comes down our price will come down.

SELLING Chips?
Call us, we're buying.

Special Purchase CLOSEOUTS!

- Bulk DS/DD 5 1/4" Diskettes, box of 100 each **32¢**
- Quadram QuadPrint Card upgrade PC/XT to 10 MHz Sale **98.**
- 512xpack Compatible Quadram Silver Board, OK Sale **98.**
- Liberty Card, EMS, OK Sale **93.**
- EPSON Equity II Sale **699.**
- 1200 Baud Internal Modem with software Sale **79.**
- Sharp PC5000 Portable Sale **149.**
- Omnitel 1200 Baud Modem 2 serial/parallels/ems/software Sale **129.**
- Diablo 620 Printer Sale **249.**
- Minidest Personal Computer 360K/floppy/mouse/joy/MS-DOS 2.0 **299.**

PC COMPATIBLE CARDS

ACP Advanced Cards/IBM Monographs/GW/painter port 55.
Colorgraphics w/painter port 55.
SuperEGA, Genoa compatible 169.
SuperVGA, 1024x768 339.
Diamond Multi I/O 2s.p.c./XT 139.
XT 5x-Pak compatible/OK 89.
XT 286 Accelerator card 269.
XT Multi I/O floppy contr. 69.
XT dual Floppy controller 29.
XT Serial I/O card 29.
XT AT Parallel I/O card 29.
XT AT Serial I/O card 39.
XT/AT Game adapter port 29.
XT/AT EPROM programmer 149.
AT 3.5 Mb w/Multi I/O, OK 199.
AT SuperMULTI I/O/floppy 119.
PS/2 Multi I/O 29.
PS/2 Floppy controller 1.4Mb 89.
HP Laserjet 1Mb Ram card 349.

MOTHERBOARDS
XT Turbo w/BDOS, 8MHz 89.
XT Turbo w/BDOS, 10MHz 99.
AT 286 w/BDOS, 10MHz 289.
AT Baby w/BDOS, 12MHz 299.
AT 386 w/BDOS, 16MHz 1499.

HARDWARE
AST Research Xformer/286, 512K, 10MHz 699.
Advantage 2/386, mod 80, 1Mb 725.
Advantage 2/286/PS/2/OK 349.
Advantage Premium 286, 512K 389.
Rampage 2/286/PS/2, 512K 499.
Rampage 286, 512K 489.
AST 5xpackplus, OK 119.

ATI Technologies EGA Wonder 800 199.
VGA VIP 319.
4000c: int. Modem w/MNP-5 189.

GENOA Super EGA call.
Super VGA call.
GULFSTREAM EZ-FAX Board w/software 1189.
HERCULES Color Card/CGA 149.
Graphics Card Plus 174.

INTEL iBoard 386/PC to 386 889.
iBoard 386/AT to 386 299.
Above Board 2/PS/2 mod 50/60 299.
Above Board 286/AT, 512K 329.
Above Board PS/286, mod 30 349.
8087 (5MHz) 102.
8087-1 (8MHz) PS/2 205.
8087-2 (8MHz) 159.
80287-6 (8MHz) 189.
80287-8 (8MHz) 255.
80287-10 (10MHz) 309.
80387-16 (16MHz) 549.
80387-20 (20MHz) 799.

ORCHID Technology Tiny Turbo 286-REDOUCE! 289.
Designer VGA Board 299.
RAMQUEST 50/PS/2, 2Mb 699.

PARADISE Autoswitch 480 199.
VGA Plus 299.

QUADRAM Quad386XT 747.
Prosync 640x480/752x410 269.
Microclavier buffer w/G4K 239.
Quadprint XT accelerator 98.
Liberty EMS XT card, OK 98.
Silver Quadboard, Sotapak comp. 98.

VIDEO 7 VEGA Deluxe 199.
Vega VGA 299.

INPUT DEVICES Advanced PC Keyboards 5160 84key XT/AT switchable 59.
5161 101key XT/AT switchable 79.
CH Products Mach II Joystick-IBM 39.
Mach II Joystick-Apple 39.

COMPUTERS

Advanced 386 Clones
Advanced 386/16base system 1795.
Advanced 386/16 w/40Mb 2195.
Advanced 386/16w/80Mb 2495.
Advanced 286 Clones
Advanced 286/10base system 849.
Advanced 286/10 w/20Mb 1099.
Advanced 286/10 w/40Mb 1299.
Advanced AT Clones
Advanced AT base system 489.
Advanced AT w/mon/20Mb 999.
call for options & details.....
AST Research Premium 286/Model 140 40Mb 2995.
Premium Workstation 2195.
Premium 386/Model 340 40Mb 4699.
call for all AST models.....
COMPAQ Portable II Model 20 call.
Desktop 286 Model 20 call.
Desktop 386 Model 40 call.
Portable 386 Model 40 call.
EPSON Equity II call.
Equity II call.
Equity III call.
HYUNDAI Hyundai 286 call.
Hyundai XT call.
Hyundai PC LAN Terminal call.
NEC MultiSpeed II, 20Mb LCD call.
MultiSpeed HD, 20Mb call.
SHARP 4521 Laptop single floppy 699.
4522 dual floppy, 64K 1295.
4521 Laptop, 20Mb 2195.
PC7100 Portable, 20Mb 2195.
PC7221 Portable, 286, 20Mb 2895.
TOSHIBA T1000 Laptop single floppy 749.
T1100 dual floppy 1420.
T1200 Laptop, 20Mb 2395.
T1300 Laptop, 286, 20Mb 2995.
T2000 286 full keyboard, 40Mb 3995.
T5100 386, EGA, 40Mb 4995.

NETWORKS 3COM Ethernet card 399.
Ethernet II card 399.
WESTERN DIGITAL StarLAN/Novell starter kit 1077.
(network for less than \$400/node)
Ethernet Plus adapter board 239.
NetNet LAN software 120.
Starlink 379.

MODEMS Advanced MODEMS 1200baud w/software (int) 79.
1200baud External 89.
1200baud Pocket MODEM 99.
2400baud w/software (int) 149.
2400baud External 159.
HAYES Smartmodem 1200B w/sw(int) 299.
Smartmodem 1200 External 289.
Smartmodem 2400 External 447.
Smartmodem 2400 External 447.
MIGENT Pocket MODEM 1200 129.
PROMTECHUS 2400B External 199.
2400B/2 w/software (int) 149.
2400PS/2 w/software (int) 299.
1200B/2 w/software (int) sale! 79.

MONITORS AMDEK VIDEO 310A 12" amber TTL 99.
410 12" 12" amber green or white 153.
1200 13" graphics (286/486) 799.
LaserDrive CD ROM/Microsoft 899.
IBM Monitors 8503 12" Mono(640x480) 228.
8512 14" Color/analog 527.

PRINTERS

DICONS/KODAK 150P Portable printer(par) 339.
300P w/wide carriage(par) 539.
EPSON LX800B/Ocolum, 180cps 199.
EX800L/F286/F856/LQ850, LQ1000, LQ1000 call.
ACP is full line Epson dealer
HEWLETT/PACKARD LaserJet Series II 1699.
Deskjet w/laser quality 895.
Scanjet flatbed scanner 1549.
IBM PRINTERS Proprietary II, 240cps 435.
Proprietary XL 24, 240cps 24pin 635.
Proprietary XL24, 240cps 24pin 835.
NEC P2200, 24pin(360x360dpi) 399.
P565XL Color, 100cpsNLD 1095.
P660 Pinwriter, 55cpsNLD 599.
LC890 Silentwriter Laser 3649.
OKIDATA M.393, 180cpsNLD 995.
ML 392, parallel 245.
ML 393, parallel 319.
ML 394, parallel 469.
Laserline 6 (reg. IBM int.) 1399.
PANASONIC KP-X1080, 160cps draft, par 185.
KP-X1091, 192cps draft, par 199.
KP-X1092, 240cps draft, 132 339.
KP-X1094, 24pin, 80cpsNLD 495.
SEIKOSHA S.30A 1 24pin 366.
SL130A1, 24pin 749.
SBP10A1, 18pin, 800cps 3299.
SK3000A1, 9pin, 300cps/s/p 399.
SK3000A1, 9pin, 300cps/132 499.
TOSHIBA P221SL, 24pin, 216cps 579.
P341SL, 24pin, 216cps 699.
P351SX (color ad \$179) 1099.
Pagesize 12, Highvolume call.

PLOTTERS HOUSTON INSTRUMENTS DMP41 or 42 2399.
DMP51 or 52 3099.
SCA-AND 2499.
DMP56A 4399.
ROLAND DX980, 8 pen AB size 1088.
DX980 1488.

ACCESSORIES COMPUTER ACCESSORIES P15 Power Director 89.
P25 4 outlet stand alone 62.
P20 Print Server 289.
A200 PC Data Display Module 888.
KENNINGTON Masterpiece Power Center 109.
Masterpiece Plus 109.

SOFTWARE

System Saver file 69.
System Saver ligs 119.
Printer Muller, 80colum 39.
MICROCOMP ACCESSORIES 51/4" Rolltop Diskette File 29.
51/4" Rolltop Diskette File 22.
PC Vacuum Cleaner 49.
CR1 File (11"x17") 119.
Underdesk Keyboard Drawer 49.
FLIP n' FILE FNF MiniXT, 100 51/4" smoke 10.
FNF MicroXT, 100 31/2" smoke 11.
FNF Maxi 50 8" smoke 15.
FNF Micro 25 31/2" smoke 8.
CGA 14" RGB color 289.
DISKETTES-lifetime warranty 5 1/4" DSDD Diskettes PC/XT/386K Maxell MD2-D 11.
Verbatim Datafile DS/DD 12.
Fujifilm MD2 11.
Advanced Color w/plastic box 8.
5 1/4" DSDD High Density AT/1.2Mb Maxell MD2-D 23.
Verbatim Datafile HD 23.
Fujifilm MD2H 22.
3 1/2" High Density Disk(1.44Mb) Maxell 49.
Verbatim Datafile 49.
Sony 49.
PRINTER BUFFERS Advanced 64K parallel buffer 129.
Advanced 64K AB buffer 169.
SWITCH BOXES Advanced 2-position AB, 3636 29.
Advanced 2-position AB, 2525 29.
Advanced parallel converter 69.
Advanced serial converter 69.
BuffaloSX PC share (up to 7) 499.
Logical Connection 256K 499.
INTELLICOM Longlink-Parallel 199.
Longlink-Serial 199.
Longlink-Par to Ser-64K 149.
Ducklink-Par to Par-64K 149.
Megalink-4prt Buld-Bulk & Ser 299.
TRIPLITE Isobar4 surge supp w/4 outlets 59.
Isobar8 surge/suppr/w/ outlets 69.
Line Conditioner w/4 outlets 149.
Backup Power Supply, 450W 399.
Backup Power Supply, 675W 575.
Backup Power Supply, 1000W 999.
Backup Power Supply, 2000W 1299.
GOLDSTAR DVM/SCOPES DM 6135-3.5 DVM 49.95
DM 6235-3.5 DVM 52.95
DM 6335-3.5 DVM 59.95
DM 6335-3.5 DVM 59.95
DS-7000-20MHz Scope 149.
QS-7040-40MHz Scope 699.
MULTIMEDIA UPGRADES 64K or 256K Upgrades(et of 9) call.
1Mb SIMM's or Ram's call.
SOFTWARE ncp-not copy protected
c-copy protected
ALDU-ncp call.
Alpha-ncp call.
PageMaker/IBM 499.
PageMaker/IBM 499.
PageMaker/MAC 379.
Freehand/MAC call.
ALPHA SOFTWARE-ncp Advanced Keyworks I,0 175.
AlphaThree I,0 232.
AMER. SMALL BUSINESS-ncp Design CAD 30 3.0 168.
ANSA Paradov v1.1 329.
Paradox v2.0 w/EMS&EMS 424.
ASHTON TATE-ncp dbaseII plus 1.1 422.
Rapidity 1.2 219.
Multimate Advantagell 1.0 275.
Appliance Presentation/ompk call.
BORLAND-ncp Sidekick 1.0 139.
Sidekick 1.0 139.
Turbo BASIC 1.0 19.
Masterpiece Power Center 98.
Turbo PASCAL 4.0 69.
Turbo C 1.5 69.
Reflex 1.14 99.
Duetrio 149.
Eureka 149.
BRODERBUND-cp Print Shop 40.
GraphicsLibrary 1.0Z 23.
TopShop 37.
Memory Mail 2.0-ncp 45.
COMPUERVE Subscription kit 29.
Goliath OnlineEncyclopedia 34.
COMPUTER ASSOCIATES-ncp Superical 4 v.1 339.
Superical 4 v.2 339.
CROSSSTALK COMM-ncp Crosstalk XVI v3.61 99.
Crosstalk MK4 v1.01 139.
DAC SOFTWARE-ncp DAC Easy Light v1.0 49.
DAC Easy Accounting v2.0 69.
DIGITAL RESEARCH-ncp GEM Draw plus v2.01 185.
GEM Desktop Plus 270.
EXECUTIVE SYSTEMS-ncp XTREME 2.0 45.
XTRE Professional v1.0 89.
FUNK SOFTWARE-ncp Sideways v3.2 42.
InWord v1.0 59.
5th GENERATION-ncp Fastback Plus 99.
FOX SOFTWARE Foxbase -single user 220.
GENERIC-ncp Generic CAD 3.0 65.
LIFE-ncp 60.
Volkswagen Plus 160.
Total Word v1.0 259.
LOTUS Hal 99.
Lotus 123/ral Bundle call.
Manuscript 349.
MECA-cp Managing your Money/Tobias 129.
MICROLYTICS Golf 45.
Worthing 65.
MICROPRO-ncp Wordstar Professional Rel 4 269.
Wordstar 2000 Rel 3 199.
MICROIM-ncp R-BASE 5000 369.
R Base System V 469.
MICROSOFT-ncp Windows 386 139.
Windows 2.03 69.
Quick C v1.0 66.
Word BASIC 69.
Word v4.0 219.
Excel v2.0/AT 319.
NORTON-ncp Utilities 4.0 69.
Commander 49.
Guides/assem.c base or pascal 59.
PAPERBACK SOFTWARE VP Plannersale! 49.
VP Expert 69.
SURPASS SOFTWARE-ncp Surpass v1.0 299.
SYMANTEC-ncp D & A v2.0 219.
D & A Write 159.
GrandView 175.
TRAVELING SOFTWARE laplink Plus 89.
TURNER HALL-ncp SOZI Plus 65.
Note-It Plus(Lotus 123 notes) 55.
Commander Spreadsheet Artist 75.
4Word (123Wordprocessing) 65.
XEROX Ventura 499.
WORDPERFECT-ncp WordPerfect v5.0 249.
WordPerfect Library v1.1 65.
WordPerfect Executive 125.
DataPerfect v2.0 299.

Advanced Computer Products, Inc.

Mail Order: P.O. Box 17329 Irvine, CA 92713
Retail: 1310-B E. Edinger, Santa Ana, CA 92705

for Fast Service
Order by Phone!

NEW PHONE FOR ALL USA
800-FONE ACP
800-366-3227 • 714-558-8813

\$25.00 Minimum MAIL ORDER
No Surchage for VISA or Mastercard
Volume purchasing agreements available
Pricing subject to change without notice
ACP Retail store pricing may vary. Not responsible for IP types.
Limited warranties and other conditions may apply

OUR POLICY
• Orders subject to availability
• Supply limited on certain items
• Limited warranties and other conditions may apply

Call for our NEW 1988 Catalog...

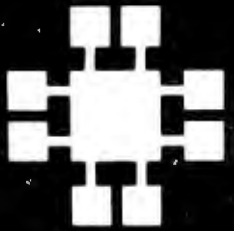

JDR Microdevices®

Complete customer satisfaction... superior service... friendly, knowledgeable personnel
quality merchandise... providing the best values in leading edge technology.

STATIC RAMS

2112	256x4 (450ns)	2.99
2114	1024x4 (200ns)(LOW POWER)	.99
2114L-2	1024x4 (100ns)	1.49
TMM2016-100	2048x8 (100ns)	1.95
HM6116-4	2048x8 (200ns)(CMOS)	3.29
HM6116-3	2048x8 (150ns)(CMOS)	3.95
HM6116LP-4	2048x8 (200ns)(CMOS)(LP)	4.29
HM6116LP-3	2048x8 (150ns)(CMOS)(LP)	4.95
HM6116LP-2	2048x8 (120ns)(CMOS)(LP)	5.49
HM6264LP-15	8192x8 (150ns)(CMOS)(LP)	6.42
HM6264LP-12	8192x8 (120ns)(CMOS)(LP)	6.99
HM43256LP-15	32768x8 (150ns)(CMOS)(LP)	12.95
HM43256LP-12	32768x8 (120ns)(CMOS)(LP)	14.95
HM43256LP-10	32768x8 (100ns)(CMOS)(LP)	19.95

DYNAMIC RAMS

4116-250	16384x1 (250ns)	.49
4116-200	16384x1 (200ns)	.89
4116-150	16384x1 (150ns)	.99
4116-120	16384x1 (120ns)	1.49
MM4332	32768x1 (200ns)	6.95
4164-150	65536x1 (150ns)	2.89
4164-120	65536x1 (120ns)	3.19
MCM6665	65536x1 (200ns)	1.95
TMS4164	65536x1 (150ns)	1.95
4164-REFRESH	65536x1 (150ns)(PIN 1 REFRESH)	2.95
TMS4416	16384x4 (150ns)	3.75
41128-150	131072x1 (150ns)	5.95
TMS4464-15	65536x4 (150ns)	7.95
41256-150	262144x1 (150ns)	12.45
41256-120	262144x1 (120ns)	13.95
41256-100	262144x1 (100ns)	13.45
HM51258-100	262144x1 (100ns)(CMOS)	6.95
1 MB-120	1048576x1 (120ns)	34.95
1 MB-100	1048576x1 (100ns)	37.95

EPROMS

2708	1024x8 (450ns)(25V)	4.95
2716	2048x8 (450ns)(25V)	3.49
2716-1	2048x8 (350ns)(25V)	3.95
TMS2532	4096x8 (450ns)(25V)	5.95
2732	4096x8 (450ns)(25V)	3.95
2732A	4096x8 (250ns)(21V)	3.95
2732A-2	4096x8 (200ns)(21V)	4.25
27C64	8192x8 (250ns)(12.5V CMOS)	4.95
2764	8192x8 (450ns)(12.5V)	3.49
2764-200	8192x8 (250ns)(12.5V)	4.25
2764-250	8192x8 (200ns)(12.5V)	4.25
MCM68766	8192x8 (350ns)(21V)(24 PIN)	15.95
27128	16384x8 (250ns)(12.5V)	4.25
27C256	32768x8 (250ns)(12.5V CMOS)	7.95
27256	32768x8 (250ns)(12.5V)	5.95
27512	65536x8 (250ns)(12.5V)	11.95
27C512	65536x8 (250ns)(12.5V CMOS)	12.95

MEMORY PRICES SUBJECT TO CHANGE DUE TO MARKET CONDITIONS. PLEASE CALL TO CONFIRM PRICES.

HIGH-TECH SPOTLIGHT 1 MB EPROMS

■ 128K x 8 ORGANIZATION ■ 200 NS
■ CMOS DESIGN FOR LOW POWER
\$34.95



8000

8031	3.95
8035	1.49
8039	1.95
8052AH BASIC	34.95
8080	2.49
8085	1.95
8086	6.49
8088	9.95
8088-2	7.95
8155	2.49
8155-2	3.95
8741	9.95
8748	7.95
8749	9.95
8755	14.95

8200

8203	14.95
8205	3.29
8212	1.49
8216	1.49
8224	2.25
8228	2.25
8237	3.95
8237-5	4.75
8243	1.95
8250	6.95
8251	1.29
8251A	1.69
8253	1.59
8253-5	1.95
8255	1.49
8255-5	1.59
8259	1.95
8259-5	2.29
8257	2.25
8272	4.39
8274	4.95
8275	16.95
8275-2	2.49
8275-5	2.95
8282	3.95
8283	3.95
8284	2.25
8286	3.95
8287	3.95
8288	4.95

MATH COPROCESSORS



8087	5 MHz	\$99.95
8087-2	8 MHz	\$159.95
8087-1	10 MHz	\$229.95
80287	6 MHz	\$179.95
80287-8	8 MHz	\$249.95
80287-10	10 MHz	\$309.95
80387-16	16 MHz	\$499.95
80387-20	20 MHz	\$799.95



74LS00

74LS00	.16	74LS112	.29	74LS241	.69
74LS01	.18	74LS122	.45	74LS242	.69
74LS02	.17	74LS123	.49	74LS243	.69
74LS03	.18	74LS124	2.75	74LS244	.69
74LS04	.16	74LS125	.39	74LS245	.79
74LS05	.18	74LS126	.39	74LS251	.49
74LS08	.18	74LS132	.39	74LS253	.49
74LS09	.18	74LS133	.49	74LS257	.39
74LS10	.16	74LS136	.39	74LS258	.49
74LS11	.22	74LS138	.39	74LS259	1.29
74LS12	.22	74LS139	.39	74LS260	.49
74LS13	.26	74LS145	.99	74LS266	.39
74LS14	.39	74LS147	.99	74LS273	.79
74LS15	.26	74LS148	.99	74LS279	.39
74LS20	.17	74LS151	.39	74LS280	1.96
74LS21	.22	74LS153	.39	74LS283	.59
74LS22	.22	74LS154	1.49	74LS290	.89
74LS27	.23	74LS155	.59	74LS293	.89
74LS28	.26	74LS156	.49	74LS299	1.49
74LS30	.17	74LS157	.35	74LS322	3.95
74LS32	.18	74LS158	.29	74LS323	2.49
74LS33	.28	74LS160	.29	74LS365	.39
74LS37	.26	74LS161	.39	74LS368	.39
74LS38	.26	74LS162	.49	74LS368	.39
74LS42	.39	74LS163	.39	74LS373	.79
74LS47	.75	74LS164	.49	74LS374	.79
74LS48	.85	74LS165	.65	74LS375	.95
74LS51	.17	74LS166	.95	74LS377	.95
74LS53	.29	74LS169	.95	74LS390	1.19
74LS74	.29	74LS173	.49	74LS390	2.40
74LS75	.29	74LS174	.39	74LS541	1.49
74LS76	.29	74LS175	.39	74LS624	1.95
74LS83	.49	74LS191	.49	74LS640	.95
74LS85	.49	74LS192	.69	74LS645	.95
74LS86	.22	74LS193	.69	74LS670	.89
74LS90	.39	74LS194	.69	74LS682	3.20
74LS92	.49	74LS195	.69	74LS688	2.40
74LS93	.39	74LS196	.59	74LS783	22.95
74LS95	.49	74LS197	.59	26LS251	2.80
74LS107	.34	74LS221	.59	26LS31	1.95
74LS109	.36	74LS240	.69	26LS32	1.95

7400

7400	.19
7402	.19
7404	.19
7406	.29
7407	.29
7408	.24
7410	.19
7411	.25
7414	.49
7416	.25
7417	.25
7420	.19
7430	.19
7432	.29
7438	.29
7442	.49
7445	.69
7447	.83
7473	.34
7474	.33
7475	.49
7476	.35
7483	.50
7485	.59
7486	.35
7489	2.15
7490	.39
7493	.35
74121	.29
74123	.35
74125	.45
74150	1.35
74151	.55
74153	.55
74154	1.49
74157	.55
74159	1.65
74161	.69
74164	.85
74166	1.00
74175	.89
74367	.65

LINEAR

TL071	.69	LM567	.79
TL072	1.09	NE570	2.95
TL074	1.95	NE552	2.95
TL082	.99	LM723	4.49
TL084	1.49	LM733	.99
LM301	.34	LM741	.29
LM309K	1.25	LM747	.69
LM311	.59	MC1320	1.49
LM311H	.89	MC1350	1.19
LM317K	3.49	LM1458	.35
LM317T	.69	LM1488	.49
LM318	1.49	LM1489	.49
LM319	.19	LM1496	.85
LM320	see 7900	ULN2003	.79
LM323K	3.49	XR2206	3.95
LM324	.34	XR2211	2.95
LM331	3.95	LM2517	1.95
LM334	1.19	CA3046	.85
LM335	1.79	CA3146	1.29
LM336	1.75	MC3373	1.29
LM338K	4.49	MC3470	1.95
LM339	.35	MC3480	1.95
LM340	see 7900	MC3487	2.95
LF353	.59	LM3900	.49
LF356	.99	LM3911	2.25
LF357	.99	LM3909	.99
LM358	.99	MC3480	1.49
LM380	.89	MC4024	3.49
LM383	1.95	MC4044	3.99
LM386	.89	RC4136	1.25
LM393	.45	RC4558	6.95
LM394	5.95	LM13600	1.49
TL494	4.20	75107	1.49
TL497	3.25	75110	1.95
NE555	.29	75150	1.95
NE556	.49	75154	1.95
NE558	.85	75158	.85
NE564	1.95	75189	1.25
LM565	.95	75451	.39
LM566	1.49	75452	.39
NE590	2.50	75477	1.19

H-T-O-5 CAN, K-T-O-3, T-T-O-220

6500

6502	2.25
65C02 (CMOS)	7.95
6520	1.65
6522	2.95
6526	13.95
6532	5.95
6545	2.95
6551	2.95

2.0 MHz

6502A	2.69
6520A	2.95
6522A	5.95
6532A	11.95
6545A	3.95
6551A	6.95

3.0 MHz

6502B	4.25
-------	------

Z-80

2.5 MHz

4.0 MHz

6.0 MHz

8.0 MHz

10.0 MHz

12.5 MHz

15.0 MHz

17.5 MHz

20.0 MHz

22.5 MHz

25.0 MHz

27.5 MHz

30.0 MHz

32.5 MHz

35.0 MHz

37.5 MHz

40.0 MHz

42.5 MHz

45.0 MHz

47.5 MHz

50.0 MHz

52.5 MHz

55.0 MHz

57.5 MHz

60.0 MHz

62.5 MHz

65.0 MHz

67.5 MHz

70.0 MHz

DISK CONTROLLERS

1771	4.95
1791	9.95
1793	9.95
1795	12.95
1797	12.95
2791	19.95
2793	19.95
2797	29.95
8272	4.39
UPD765	4.39
MB8876	12.95
MB8877	12.95
1691	6.95
2143	6.95
9216	6.29

V20 SERIES

CAPACITORS

1.0µf	15V	.12	1.0µf	35V	.45
6.8	15V	.42	2.2	35V	.19
10	15V	.45	4.7	35V	.39
22	15V	.99	10	35V	.69

DISC

10µf	50V	.05	.001µf	50V	.05
22	50V	.05	.005	50V	.05
33	50V	.05	.01	50V	.07
47	50V	.05	.05	50V	.07
100	50V	.05	.1	12V	.10
220	50V	.05	.1	50V	.12

MONOLITHIC

.01µf	50V	.14	.1µf	50V	.18
.047µf	50V	.15	.47µf	50V	.25

ELECTROLYTIC

RADIAL		AXIAL			
1µf	25V	14	1/2	50V	14
4.7	50V	.11	10	50V	.16
10	50V	.11	22	16V	.14
47	35V	.13	47	50V	.19
100	16V	.15	100	35V	.19
220	35V	.20	470	50V	.29
470	25V	.30	1000	15V	.29
2200	16V	.70	2200	16V	.70
4700	25V	1.45	4700	16V	1.25

BYPASS CAPACITORS

.01 µf	CERAMIC DISC	100/\$.50
.01 µf	MONOLITHIC	100/\$.10
.1 µf	CERAMIC DISC	100/\$.60
.1 µf	MONOLITHIC	100/\$.12

VOLTAGE REGULATORS

7805T	.49	7812K	1.39
7808T	.49	7805K	1.69
7812T	.49	7912K	1.49
7815T	.49	78L05	.49
7905T	.59	78L12	.49
7908T	.59	79L05	.69
7912T	.59	79L12	1.49
7915T	.59	LM323K	4.79
7805K	1.59	LM338K	6.95

DISCRETE

1N751	.15	4N28	.69
1N4148B25	1.19	4N33	.89
1N400410	1.19	4N37	1.19
1N5402	.25	MCT-2	.59
KBP02	.55	MCT-6	1.29
2N2222	.25	TIL-11	.99
PN2222	.10	2N3906	.10
2N2907	.25	2N4401	.25
2N3055	.79	2N4402	.25
2N3904	.10	2N4403	.25
4N26	.69	2N6045	1.75
4N27	.69	7P131	.49

SOLDER STATION

- UL APPROVED
- ADJUSTABLE HEAT SETTING WITH TIP TEMPERATURE READOUT
- REPLACEMENT TIPS AVAILABLE \$2.95

\$49.95



WIREWRAP PROTOTYPE CARDS

FR-4 EPOXY GLASS LAMINATE WITH GOLD PLATED EDGE-CARD FINGERS SILK SCREENED LEGENDS, MOUNTING BRACKETS INCLUDED

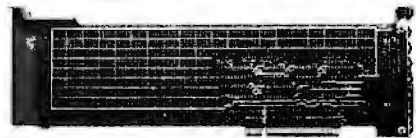

FOR PS/2

JDR-PR32	32 BIT PROTOTYPE CARD	69.95
JDR-PR16	16 BIT CARD WITH I/O DECODING LAYOUT	49.95
JDR-PR16PK	PARTS KIT FOR JDR-PR16 ABOVE	15.95
JDR-PR16V	16 BIT CARD FOR VIDEO APPLICATIONS	39.95

FOR AT

JDR-PR10	16 BIT CARD WITH I/O DECODING LAYOUT	34.95
JDR-PR10PK	PARTS KIT FOR JDR-PR10 ABOVE	12.95

FOR XT

IBM-PR1	WITH +5V AND GROUND PLANE	27.95
IBM-PR2	AS ABOVE WITH I/O DECODING LAYOUT	29.95

RESISTOR NETWORKS

SIP	10 PIN	9 RESISTOR	.69
SIP	8 PIN	7 RESISTOR	.59
DIP	16 PIN	8 RESISTOR	1.09
DIP	16 PIN	15 RESISTOR	1.09
DIP	14 PIN	7 RESISTOR	.99
DIP	14 PIN	13 RESISTOR	.99

SHORTING BLOCKS

51/1.00



EXTENDER CARDS

FOR PROTOTYPE DEBUGGING AND TROUBLESHOOTING

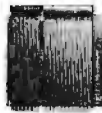

EXT-8088	FOR XT SYSTEM	29.95
EXT-80286	FOR AT SYSTEM	39.95
EXT-16	MICROCHANNEL 16-BIT	69.95
EXT-32	MICROCHANNEL 32-BIT	99.95

SOLDERLESS BREADBOARDS

WBU-D	100 TIE PTS.	2.95	WBU-204	1660 TIE PTS.	26.95
WBU-T	630 TIE PTS.	6.95	WBU-206	2390 TIE PTS.	29.95
WBU-204-3	1360 TIE PTS.	17.95	WBU-208	3220 TIE PTS.	39.95



"SNAPABLE" HEADERS

CAN BE SNAPPED APART TO MAKE ANY SIZE HEADER, ALL WITH .1" CENTERS

1x40	STRAIGHT LEAD	.99
1x40	RIGHT ANGLE LEAD	.49
2x40	2 STRAIGHT LEADS	2.49
2x40	2 RIGHT ANGLE LEADS	2.99



WHY THOUSANDS CHOOSE JDR

- QUALITY MERCHANDISE
- COMPETITIVE PRICES
- MOST ORDERS SHIPPED IN 24 HOURS
- FRIENDLY, KNOWLEDGEABLE STAFF
- 30-DAY MONEY BACK GUARANTEE
- TOLL FREE TECHNICAL SUPPORT
- EXCELLENT CUSTOMER SERVICE

CALL FOR VOLUME QUOTES

IDC CONNECTORS/RIBBON CABLE

DESCRIPTION	ORDER BY	CONTACTS					
		10	20	26	34	40	50
SOLDER HEADER	IDHxxS	.82	1.29	1.68	2.20	2.58	3.24
RIGHT ANGLE SOLDER HEADER	IDHxxSR	.85	1.35	1.76	2.31	2.72	3.39
WIREWRAP HEADER	IDHxxW	1.86	2.98	3.84	4.50	5.28	6.63
RIGHT ANGLE WIREWRAP HEADER	IDHxxWR	2.05	3.28	4.22	4.45	4.80	7.30
RIBBON HEADER SOCKET	IDSxx	.63	.89	.95	1.29	1.49	1.69
RIBBON HEADER	IDMxx	---	5.50	6.25	7.00	7.50	8.50
RIBBON EDGE CARD	IOExx	.85	1.25	1.35	1.75	2.05	2.45
10' GREY RIBBON CABLE	RCxx	1.60	3.20	4.10	5.40	6.40	7.50

FOR ORDERING INSTRUCTIONS, SEE D-SUBMINIATURE CONNECTORS, BELOW

3 VOLT LITHIUM BATTERY

\$1.95

HOLDER \$1.49



SPECTRONICS CORPORATION EPROM ERASERS

Model	Turner	Chip Capacity	Intensity (µW/Cm ²)	Unit Cost
PE-140	NO	9	8,000	\$89
PE-140T	YES	9	8,000	\$139
PE-240T	YES	12	9,600	\$189



D-SUBMINIATURE CONNECTORS

DESCRIPTION	ORDER BY	CONTACTS						
		9	15	19	25	37	50	
SOLDER CUP	MALE	OBxxP	.45	.59	.69	.69	1.35	1.85
	FEMALE	DBxxS	.49	.69	.75	.75	1.39	2.29
RIGHT ANGLE PC SOLDER	MALE	DBxxPR	.49	.69	---	.79	2.27	---
	FEMALE	OBxxSR	.55	.75	---	.85	2.49	---
WIREWRAP	MALE	DBxxPWW	1.69	2.56	---	3.89	5.60	---
	FEMALE	DBxxSWW	2.76	4.27	---	6.84	9.95	---
IDC RIBBON CABLE	MALE	IDBxxP	1.39	1.99	---	2.25	4.25	---
	FEMALE	IDBxxS	1.45	2.05	---	2.35	4.49	---
HOODS	METAL	MH000xx	1.05	1.15	1.25	1.25	---	---
	GREY	HOODxx	.39	.39	---	.39	.69	.75

ORDERING INSTRUCTIONS: INSERT THE NUMBER OF CONTACTS IN THE POSITION MARKED "xx" OF THE "ORDER BY" PART NUMBER LISTED
EXAMPLE: A 15 PIN RIGHT ANGLE MALE PC SOLDER WOULD BE DB15PR

MOUNTING HARDWARE \$9¢

RS-232 BREAKOUT BOX

FOR TROUBLESHOOTING SERIAL COMMUNICATIONS

- OPEN/CLOSE INDIVIDUAL CIRCUITS
- 20 JUMPERS CROSS-CONNECT ANY TWO CIRCUITS
- 10 LEADS SHOW CIRCUIT ACTIVITY



GENDER CHANGERS

FOR 25 PIN D-SUBMINIATURE CONNECTORS

GENDER-FF	FEMALE-MALE	7.95
GENDER-MM	MALE-MALE	7.95
GENDER-MF	MALE-FEMALE	7.95
GENDER-NM	NULL MODEM	8.95
GENDER-JB	JUMPER BOX	8.95
GENDER-MT	MINI-TESTER	14.95



DATARASE

- ERASES 2 EPROMS IN 10 MINUTES
- VERY COMPACT, NO DRAWER
- THIN METAL SHUTTER PREVENTS UV LIGHT FROM ESCAPING

\$34.95



IC SOCKETS/DIP CONNECTORS

DESCRIPTION	ORDER BY	CONTACTS								
		8	14	16	18	20	22	24	28	40
SOLDERTAIL SOCKETS	xxST	.11	.11	.12	.15	.18	.15	.20	.22	.30
WIREWRAP SOCKETS	xxWW	.59	.69	.69	.99	1.09	1.39	1.49	1.69	1.99
ZIF SOCKETS	ZIFxx	---	4.95	4.95	---	5.95	---	5.95	6.95	9.95
TOOLED SOCKETS	AUGATxxST	.62	.79	.89	1.09	1.29	1.39	1.49	1.69	2.49
TOOLED WW SOCKETS	AUGATxxWW	1.30	1.80	2.10	2.40	2.50	2.90	3.15	3.70	5.40
COMPONENT CARRIERS	ICCxx	.49	.59	.69	.99	.99	.99	.99	1.09	1.49
DIP PLUGS (IDC)	IDPxx	.95	.49	.59	1.29	1.49	---	.85	1.49	1.59

FOR ORDERING INSTRUCTIONS, SEE D-SUBMINIATURE CONNECTORS, ABOVE

JOYSTICK

- SET X-Y AXIS FOR AUTO CENTER OR FREE MOVEMENT
- FIRE BUTTON FOR USE WITH GAME SOFTWARE
- ADAPTER CABLE FOR IBM, APPLE II

\$19.95



JDR MICRODEVICES, 110 KNOWLES DRIVE, LOS GATOS, CA 95030
LOCAL (408) 866-6200 FAX (408) 378-8927 TELEX 171-110



RETAIL STORE: 1256 SOUTH BASCOM AVE., SAN JOSE, CA (408) 947-8881
HOURS: M-F 10-7 SAT. 9-5 SUN. 12-4

Terms: Minimum order \$10.00. For shipping and handling include \$2.50 for UPS ground and \$3.50 UPS air. Orders over 1 lb. and foreign orders may require additional shipping charges - please contact the sales department for the amount. CA residents must include applicable sales tax. Prices are subject to change without notice. We are not responsible for typographical errors. We reserve the right to limit quantities and to substitute manufacturer. All merchandise subject to prior sale. A full copy of our terms is available upon request. Items pictured may only be representative.



ORDER TOLL FREE 800-538-5000

COPYRIGHT 1988 JDR MICRODEVICES

CONTINENTAL U.S. AND CANADA



JDR Microdevices®

Complete customer satisfaction... superior service... friendly, knowledgeable personnel
quality merchandise... providing the best values in leading edge technology.

PROMETHEUS 2400 BAUD MODEM

\$129⁹⁵
NEW LOW PRICE!

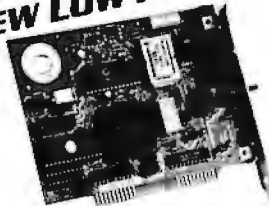

IT'S TIME TO TRADE UP NOW THAT JDR BREAKS THE PRICE BARRIER ON 2400 BAUD MODEMS

- AUTO DIAL ANSWER
- SELF TEST ON POWER-UP
- TOUCHTONE OR PULSE DIALING
- HAYES & BELL SYSTEMS COMPATIBLE
- FULL OR HALF DUPLEX
- MIRROR II COMMUNICATIONS SOFTWARE INCLUDED

MCT-241
MCT-121 1200 BAUD 1/2 CARD **\$ 69.95**

EXTERNAL MODEMS

MCT-12E 1200 BAUD **\$ 99.95**
MCT-24E 2400 BAUD **\$169.95**

COMPUTER CASES

ATTRACTIVE, STURDY STEEL CASES FIT THE POPULAR SIZED MOTHERBOARDS AND INCLUDE SPEAKERS, FACEPLATES, EXPANSION SLOTS, FRONT PANEL KEYLOCKS, LED INDICATORS AND ALL NECESSARY HARDWARE.



XT STYLE FLIP-TOP **\$34.95**
XT STYLE SLIDE-TOP **\$39.95**
AT STYLE SLIDE-TOP **\$89.95**
JR. AT STYLE FLIP-TOP **\$149.95**
■ INCLUDES 150 WATT POWER SUPPLY

POWER SUPPLIES

FOR IBM XT COMPATIBLE **\$59.95**

- UL APP., 135 WATTS
- +5V.15A, +12V 4.2A
- -5V.5A, -12V.5A

PS-135
PS-150 150W MODEL **\$69.95**



FOR IBM AT COMPATIBLE **\$89.95**

- 200 WATTS
- +5V 22A, +12V 8A
- -5V.5A, -12V.5A

PS-200

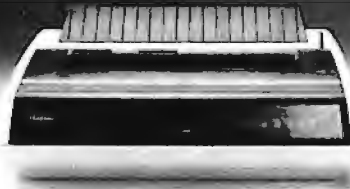

DIABLO PRINTER \$279⁹⁵

- LETTER QUALITY AT 20 CPS, 132 COLS
- 10, 12, 15 PITCH & PROPORTIONAL SPACING
- SERIAL & PARALLEL INTERFACE
- AUTO PAPER LOAD, FRICTION FEED
- FULL XEROX WARRANTY



CENTRONICS LASER \$1195

NEAR TYPESET QUALITY
AFFORDABLE AT LAST

- 8 PAGES PER MINUTE ■ 300 DPI RESOLUTION!
- 1 YEAR WARRANTY ■ CHOICE OF EMULATION BOARDS
- MULTI-PRINTER EMULATION BOARD:**
EPSON FX-80 EMULATION—NOTHING ELSE REQUIRED
IBM PC GRAPHICS, PROPRINTER & DIABLO 630
EMULATION REQUIRES ADDITIONAL FONT CARD
- HP LJ+ EMULATION BOARD:**
HP LASERJET EMULATION—3 RESIDENT FONTS &
2 PITCHES ADDITIONAL FONT CARD AVAILABLE

1.5MB RAM CARD **\$139.95**
EXTRA FONT CARDS **\$199.95**
TONER CARTRIDGES **\$59.95**
PFS FIRST PUBLISHER **\$99.95**



IBM COMPATIBLE KEYBOARDS

FULL ONE YEAR WARRANTY

IBM ENHANCED STYLE LAYOUT **\$79.95**

- AUTONSENSE FOR XT OR AT COMPATIBLES
- LED INDICATORS ■ AUTO REPEAT FEATURE
- SEPARATE CURSOR PAD

MCT-5339 **\$59.95**

IBM AT STYLE LAYOUT **\$59.95**

- SOFTWARE AUTONSENSE FOR XT OR AT COMPATIBLES
- LED INDICATORS ■ AUTO REPEAT FEATURE

MCT-5060 **\$59.95**

MAXI-SWITCH KEYBOARDS **\$84.95**

- ENHANCED STYLE LAYOUT
- STANDARD ENHANCED KEYBOARD LAYOUT
- TACTILE FEEDBACK
- LIGHTED NUM, CAPS, AND SCROLL LOCK
- NUMERIC & CURSOR KEYPADS, 12" F" KEYS

MAX-5339 **\$64.95**
MAX-5060 MAXI-SWITCH, AT STYLE **\$64.95**

VGA COMPATIBLE PACKAGE

\$649⁰⁰

MONITOR
& CARD
TOGETHER



- 600 X 560 MAXIMUM RESOLUTION
- 640 X 480 IN 16 COLORS
- 320 X 200 IN 256 COLORS
- IBM STYLE ANALOG MONITOR
- FULLY VGA, EGA, CGA, HERCULES & MONOCHROME COMPATIBLE



NEC MULTISYNC \$599.95

- ORIGINAL CGA/EGA/PGA COMPATIBLE MONITOR
- AUTO FREQUENCY ADJUSTMENT
- RESOLUTION AS HIGH AS 800 X 560

CASPER E6A \$399.95

- 15.75/21.85 KHZ SCANNING FREQUENCIES
- 640 X 200/350 RESOLUTION ■ .31 MM DOT PITCH
- 14" BLACK MATRIX SCREEN ■ 16 COLORS

CASPER R6B \$279.95

- COLOR GREEN AMBER SWITCH ■ 39MM DOT PITCH
- 640 X 240 RESOLUTION ■ 14" NON-GLARE SCREEN
- RGB/IBM COMPATIBLE ■ CABLE INCLUDED

SAKATA MONOCHROME \$69.95

- IBM COMPATIBLE TTL INPUT
- 12" NON-GLARE SCREEN
- CABLE FOR IBM PC INCLUDED

SAMSUNG MONOCHROME MONITOR \$129.95

MONITOR STANDS

MODEL MS-100 \$12.95

- TILTS AND SWIVELS
- STURDY PLASTIC CONSTRUCTION

MODEL MS-200 \$39.95

- TILTS AND SWIVELS ■ BUILT-IN SURGE SUPPRESSOR
- INDEPENDENTLY CONTROLS UP TO 5 AC OUTLETS

LOGITECH MOUSE \$79⁹⁵



PC MAGAZINE'S EDITORS CHOICE
ALL MODELS HAVE SERIAL SUPPORT (COM1/COM2), 200 D.P.I. RESOLUTION, LOTUS 1-2-3 SHELL, SELF-INSTALLING SOFTWARE AND 'POINT EDITOR'
SERIAL MOUSE W/PC PAINTBRUSH **\$99.95**
BUS MOUSE W/PC PAINTBRUSH **\$99.95**
BUS MOUSE W/PC PAINTBRUSH/CAD **\$149.95**

3.5" FLOPPY DISK DRIVE \$149⁹⁵



1.44 MB 3 1/2" DRIVE

- ULTRA HIGH DENSITY
- ALSO WORKS WITH 720K DISKS
- FDD-1.44 x BLACK FACEPLATE **\$149.95**
- FDD-1.44 x BEIGE FACEPLATE **\$149.95**

720K 3 1/2" FLOPPY DRIVE \$129.95

- FDD-3.5 x (FORXT)
- FDD-3.5 x (FORAT)

Seagate

NEW!
FAST 40MB DRIVE
\$529⁰⁰

THE NEW ST-251-1 DRIVE IS 30% FASTER WITH AN AVERAGE ACCESS TIME OF 28 MS. EASY TO INSTALL HALF-HEIGHT DRIVE.

ST-251-1

WITH MCT-HDC CONTROLLER \$569.00
WITH MCT-ATFH CONTROLLER \$639.00

1 1/2 HEIGHT DRIVES

20 MB, 65 MS, ST-225 \$225.00
WITH MCT-HDC CONTROLLER \$269.00
WITH MCT-ATFH CONTROLLER \$339.00

30 MB RLL, 65 MS, ST-238 \$249.00
WITH MCT-RLL CONTROLLER \$299.00
WITH MCT-ATFH-RLL CONTROLLER \$389.00

40 MB, 40 MS, ST-251 \$429.00
WITH MCT-HDC CONTROLLER \$469.00
WITH MCT-ATFH CONTROLLER \$539.00

60 MB RLL, 40 MS, ST-277 \$499.00
WITH MCT-RLL CONTROLLER \$549.00
WITH MCT-ATFH CONTROLLER \$639.00

FULL HEIGHT DRIVES

30 MB, 40 MS, ST-4038 \$559.00
80 MB, 28 MS, ST-4096 \$895.00

TEAC DISK DRIVE

360K 5 1/4" DRIVE
RELIABLE DIRECT DRIVE MOTOR
DOUBLE-SIDED/DOUBLE-DENSITY FD-55B **\$99⁹⁵**

1/2 HEIGHT FLOPPY DISK DRIVES

5 1/4" TEAC FD-55G DS/HD 1.2M \$129.95
5 1/4" FUJITSU M2551A DS/DD 360K \$89.95
5 1/4" FUJITSU M2553K DS/HD 1.2M \$119.95
5 1/4" DS/DD 360K \$69.95
5 1/4" DS/HD 1.2M \$109.95
3 1/2" MITSUBISHI DS/DD (AT OR XT) \$129.95



INTERFACE CARDS FROM MODULAR CIRCUIT TECHNOLOGY DISPLAY ADAPTORS

MONOCHROME GRAPHICS CARD \$59.95
TRUE HERCULES COMPATIBILITY. SUPPORTS LOTUS 123
PARALLEL PRINTER PORT CONFIGURES AS CPT1 OR LPT2
USES VLSI CHIPS TO ENSURE RELIABILITY
MCT-MGP

ENHANCED GRAPHICS ADAPTOR \$149.95
100% IBM COMPATIBLE. PASSES IBM EGA DIAGNOSTICS
256K OF VIDEO RAM ALLOWS 640 X 350 IN 16 OF 64 COLORS
COMPATIBLE WITH COLOR AND MONOCHROME ADAPTORS
MCT-EGA

COLOR GRAPHICS ADAPTOR \$49.95
COMPATIBLE WITH IBM GRAPHICS STANDARDS
SUPPORTS RGB, COLOR & COMPOSITE MONOCHROME
640 320 X 200 RESOLUTION. LIGHT PEN INTERFACE
MCT-CG

MULTIFUNCTION CARDS

MONOGRAPHICS MULTI I/O \$119.75
TOTAL SYSTEM CONTROL FROM A SINGLE SLOT!
CTRL 2 FLOPPY'S, SERIAL, PARALLEL, GAME PORT, CLOCK CAL
RUN COLOR GRAPHICS SOFTWARE ON A MONOCHROME MONITOR
MCT-MGMIO

MULTI I/O FLOPPY CONTROLLER \$79.95
A PERFECT COMPANION FOR OUR MOTHERBOARDS
SUPPORTS UP TO 2 360K FLOPPIES, 720K WITH DOS 3.2
SERIAL, PARALLEL, GAME PORT, CLOCK CALENDAR
MCT-MIO
MIO-SERIAL—2ND SERIAL PORT \$15.95

MULTI I/O CARD \$59.95
USE WITH MCT-FH FOR A MINIMUM OF SLOTS USED
SERIAL PORT, CLOCK CALENDAR WITH BATTERY BACK-UP
PARALLEL PRINTER PORT ADDRESSABLE AS LPT1 OR LPT2
MCT-IO

AT MULTIFUNCTION CARD \$139.95
ADDS UP TO 3 MB OF RAM TO YOUR AT
USER EXPANDABLE TO 1.5 MB, OR 3 MB WITH OPTIONAL PIGGYBACK BOARD (0 K INSTALLED)
INCLUDES SERIAL AND PARALLEL PORT
MCT-ATMF-MC PIGGYBACK BOARD \$29.95
ATMF SERIAL-2ND SERIAL PORT \$24.95

AT MULTI I/O CARD \$59.95
USE WITH MCT-ATFH FOR MINIMUM OF SLOTS USED
SERIAL, PARALLEL AND GAME PORTS
USES 16450 SERIAL SUPPORT CHIPS FOR HIGH SPEED OPS
MCT-ATIO
ATIO-SERIAL—2ND SERIAL PORT \$24.95

MEMORY CARDS

576K RAM CARD \$59.95
A CONTIGUOUS MEMORY SOLUTION IN A SHORT SLOT
USER SELECTABLE CONFIGURATION UP TO 576K
USES 84K & 256K RAM CHIPS (ZERO K INSTALLED)
MCT-RAM

EXPANDED MEMORY CARD \$129.95
2 MB OF LOTUS INTEL MICROSOFT COMPATIBLE MEMORY FOR AN XT
CONFORMS TO LOTUS INTEL EMS
USER EXPANDABLE TO 2 MB
CAN BE USED AS EXPANDED OR CONVENTIONAL MEMORY, RAMDISK AND SPOOLER
MCT-EMS
MCT-ATEMS AT COMPATIBLE VERSION \$139.95

DRIVE CONTROLLERS

FLOPPY DISK CONTROLLER \$29.95
QUALITY DESIGN FOR SINGLE SLOT CONTROL OF 4 FLOPPY'S
INTERFACES UP TO 4 FDD'S TO AN IBM PC OR COMPATIBLE
SUPPORTS BOTH DS-DD AND DS-OD WITH DOS 3.2
MCT-FDC

1.2 MB FLOPPY CONTROLLER \$69.95
ADD VERSATILITY AND CAPACITY TO YOUR XT
SUPPORTS 2 DRIVES, BOTH MAY BE 360K OR 1.2 MB
ALLOWS DATA TO FLOW FREELY FROM XT'S TO AT'S
MCT-FDC-1.2

FLOPPY/HARD CONTROLLER \$139.95
XT SYSTEM STARVED FOR SLOTS? THIS CARD FREES ONE UP
INTERFACES UP TO 2 FDD'S & 2 HDD'S, CABLING FOR 2 FDD/1 HDD
SUPPORTS BOTH DS/DD & DS/OD WITH DOS 3.2
MCT-FH

ATFH CONTROLLER \$149.95
FLOPPY/HARD DISK CONTROL IN A TRUE AT DESIGN
SUPPORTS UP TO 2 360K/720K, 1 1.2MB FDD'S AS WELL AS 2 HDD'S USING STANDARD CONTROL TABLES
MCT-ATFH

RLL DISK CONTROLLER \$199.95
IMPROVE SPEED AND STORAGE OF YOUR AT COMPATIBLE
SUPPORTS UP TO 2 RLL HARD DISCS AND 2 FLOPPY DRIVES
SUPPORTS 360/720/1.2 MB FLOPPIES IN 5 25" & 3 1/2"
MCT-ATFH-RLL

ARCHIVE XL TAPE BACK-UP \$369⁹⁵

BACK UP 40 MB IN 40 MINUTES!
EASY-TO-USE MENU DRIVEN SOFTWARE
USES STANDARD OIC DATA FORMAT
FULL & INCREMENTAL BACK-UP
PARTIAL & FULL RESTORE
AR 5240 XT —FOR XT'S & AT'S
AR 5540 AT —AT'S ONLY, 2X FASTER
TAPE NOT INCLUDED
TAPE CARTRIDGE—40 MB \$24.95



20MB HARD DISK ON A CARD \$349

SAVES SPACE AND REDUCES POWER CONSUMPTION
IDEAL FOR PC'S WITH FULL HEIGHT FLOPPIES
LEAVES ROOM FOR A HALF LENGTH CARD IN ADJACENT SLOT



JUST A NOTE TO LET YOU KNOW THAT MY SALESPERSON, HELEN MORSE, AT YOUR COMPANY HAS BEEN VERY HELPFUL AND COURTEOUS. THIS IS A PLEASANT CHANGE FROM MOST TELEPHONE SALESPeople I DEAL WITH. PLEASE PASS MY THANKS TO HELEN. I PLAN ON DOING FREQUENT BUSINESS WITH JDR AS MY NEW COMPANY, ODEM INC, GETS GOING, AND HELEN'S ATTITUDE AND HELPFULNESS ARE A MAJOR REASON WHY I LIKE DOING BUSINESS WITH YOU.

R.C.K. BENSALEM, PA

BARGAIN HUNTER'S CORNER 720K FLOPPY DISK DRIVE BY MITSUBISHI

5 1/4" HALF-HEIGHT
96 T.P.I.
100% IBM COMPATIBLE
DOUBLE-SIDED/QUAD DENSITY

ONLY **\$69⁹⁵**
SPECIAL ENDS 8/31/88

intel

INBOARD 386/PC \$895.00

UPGRADE YOUR XT TO A 386 FOR LESS THAN \$1000
16 MHZ PROCESSOR REPLACES 8088
1 MB INSTALLED
EXPAND TO 3MB WITH PIGGYBACK CARD
5 YR WARRANTY

INBOARD 386/AT ABOVE BOARD PS 286 \$1199.95
ABOVE BOARD 286 \$399.95
\$369.95



JDR MICRODEVICES, 110 KNOWLES DRIVE, LOS GATOS, CA 95030
LOCAL (408) 866-6200 FAX (408) 378-8927 TELEX 171-110

ORDER TOLL FREE 800-538-5000

COPYRIGHT 1988 JDR MICRODEVICES

CONTINENTAL U.S. AND CANADA



BUILD YOUR OWN SYSTEM

OVER 20,000 JDR SYSTEMS HAVE ALREADY BEEN BUILT. EASY TO ASSEMBLE IN JUST 2 HOURS WITH A SCREWDRIVER. SAVE MONEY AND LEARN ABOUT YOUR COMPUTER AT THE SAME TIME.

10 MHZ XT COMPATIBLE
\$656.50

- INCLUDES SERIAL PORT, 2 PARALLEL PORTS, CLOCK CALENDAR AND GAME ADAPTOR. RUNS COLOR GRAPHICS ON A MONOCHROME MONITOR
- MOTHERBOARD
- 256K RAM MEMORY
- 135 WATT POWER SUPPLY
- FLIP-TOP CASE
- AT STYLE KEYBOARD
- 360K FLOPPY DRIVE
- MONOGRAPHS I/O CARD
- MONOCHROME MONITOR

16 MHZ 1 MB 386
\$2298.55

- MYLEX 386 MOTHERBOARD
- 1 MB RAM ON BOARD
- 200 WATT POWER SUPPLY
- AT STYLE CASE
- ENHANCED AT STYLE KEYBOARD
- 1.2 MB FLOPPY DRIVE
- AT FLOPPY HARD CONTROLLER
- MONOCHROME MONITOR
- MONOGRAPHS CARD

12 MHZ AT COMPATIBLE
\$1101.70

- 12 MHZ BABY AT MOTHERBOARD
- 256K RAM MEMORY
- MINI-AT CASE W/POWER SUPPLY
- AT STYLE KEYBOARD
- 1.2 MB FLOPPY DRIVE
- FLOPPY/HARD DRIVE CONTROLLER
- MONOCHROME MONITOR
- GRAPHICS ADAPTOR

VIDEO INSTRUCTIONS \$4.95
WITH KIT PURCHASE
IT'S A JDR EXCLUSIVE!
EASY TO FOLLOW 20 MINUTE VHS TAPE SHOWS YOU STEP-BY-STEP HOW TO BUILD AN XT COMPATIBLE SYSTEM.
WITHOUT KIT \$19.95



MOTHERBOARDS

TURBO 4.77/8 MHZ \$99.95 **12 MHZ MINI 80286 \$399.95**

- 4.77 OR 8 MHZ OPERATION WITH 8088-2 & OPTIONAL 8087-2 CO-PROCESSOR
- FRONT PANEL LED SPEED INDICATOR AND RESET SWITCH SET SUPPORTED
- CHOICE OF NORMAL-TURBO MODE OR SOFTWARE SELECT PROCESSOR SPEED

MCT-TURBO
MCT-XTMB STANDARD MOTHERBOARD \$87.95

- 6 MHZ, 10 MHZ (0/1 WAIT STATE), 12 MHZ (1 WAIT STATE)
- USES ZYMOSS ASIC'S FOR LESS CHIPS, GREATER RELIABILITY

- SUPPORTS 256K-1024K MEMORY
- RE-CHARGEABLE HIGH CAPACITY NI-CAD BATTERY
- 6 16-BIT SLOTS, 2 8-BIT SLOTS
- MOUNTS IN STANDARD XT CASE

MCT-BATMB-12
MCT-BATMB 6/10 MHZ MINI 80286 BOARD \$389.95

80286 6/8 MHZ \$379.95 **16 MHZ MYLEX 386 \$1649.00**

- 8 SLOT (2 EIGHT BIT, 6 SIXTEEN BIT) AT MOTHERBOARD
- HARDWARE SELECTION OF 6 OR 8 MHZ
- 1 WAIT STATE
- KEYLOCK SUPPORTED, RESET SWITCH, FRONT PANEL LED INDICATOR
- SOCKETS FOR 1 MB OF RAM AND 80287
- BATTERY BACKED CLOCK

MCT-ATMB

- 1 MB RAM ON BOARD
- 8 SLOTS, 2 8-BIT, 6 16-BIT
- SUPPORTS 80287 MATH CO-PROCESSOR
- SUPPORTS 80387 W/ADAPTOR
- 64 KB CACHE FOR NEAR 0 WAIT STATE
- USES AMI BIOS

MCT-386 MB
MCT-386 MB-4 4 MB MEMORY INSTALLED \$2649.00
MCT-386 MB-MCB MATH CO-PROCESSOR ADAPTOR BOARD \$149.00



10 MHZ SINGLE CHIP XT
\$129.95

- SINGLE CHIP USES LESS POWER, IMPROVES RELIABILITY
- KEY SELECTABLE SPEED, 4.77 MHZ OR 10 MHZ
- 2.3 TIMES FASTER THAN A STANDARD
- RESET SWITCH, KEYLOCK AND SPEED POWER INDICATORS SUPPORTED

MCT-TURBO-10

DEVELOPMENT TOOLS

EPROM PROGRAMMER
\$129.95

- PROGRAMS 27XX & 27XXX EPROMS UP TO 27512
- SUPPORTS VARIOUS PROGRAMMING FORMATS AND VOLTAGES
- SPLIT OR COMBINE CONTENTS OF SEVERAL EPROMS OF DIFFERENT SIZES
- READ, WRITE, COPY, ERASE CHECK AND VERIFY
- SOFTWARE FOR HEX AND INTEL HEX FORMATS

MCT-EPROM
MCT-EPROM-4 4 GANG PROGRAMMER \$189.00
MCT-EPROM-10 10 GANG PROGRAMMER \$299.95
MCT-PAL PAL PROGRAMMER \$269.95
MCT-MP PROCESSOR PROG. \$199.95



- **1 YEAR WARRANTY ON MCT PRODUCTS**
- **30 DAY MONEY BACK GUARANTEE**
- **TOLL-FREE TECHNICAL SUPPORT**
- **NEXT DAY AIR SHIP AVAILABLE**

JDR Microdevices®

JDR MICRODEVICES, 110 KNOWLES DRIVE, LOS GATOS, CA 95030
LOCAL (408) 866-6200 FAX (408) 378-8927 TELEX 171-110



ORDER TOLL FREE 800-538-5000

COPYRIGHT 1988 JDR MICRODEVICES

CONTINENTAL U.S. AND CANADA

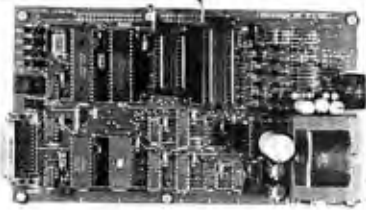

UNIVERSAL E(P)ROM PROGRAMMER KITS FROM \$95

- No personality modules; Menu-driven device selection.
- On board power supply (110/220V AC).
- Direct technical support; Full 1 year warranty.
- User friendly software; Complete help menu.
- Quick pulse algorithm (27256 under 60 sec).
- Programs 27xx to 1 Mbit; 25xx, 68xx, CMOS; EEPROMS.
- Micros: 8741, 8742, 8748, 8748H, 8749, 8749H & more.
- IBM-PC, Apple, CPM or Unix driver; Autobaud RS232.
- Offset/split Hex, Binary, Intel & Motorola 8,16,32 bit.
- Manual with complete schematics.

VISA MC AMEX Call today for datasheets!!

B&C MICROSYSTEMS

355 WEST OLIVE AVE. SUNNYVALE, CA 94086
 PFI: (408) 730-5511 FAX: (408) 730-5521 TELEX: 984185

Circle 29 on Reader Service Card

ROMDISK™

EPROM & SRAM Disk and Drive Emulators for IBM PC, XT, AT and Compatibles

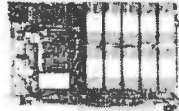

FEATURES

- Disk and drive emulators up to 1.2 MB - using EPROM or battery backed SRAM technology
- Cassette versions available
- Develop programs on a diskette and simply copy directly to ROMDISK with programming utilities provided
- Autoboot and file modes - operate up to four units per computer
- Fast EPROM programming - approximately 180KB/min.

APPLICATIONS

- Industrial control, instrumentation and manufacturing test systems in environments hostile to disks
- Unattended remote site installations
- Diskless PC systems and workstations requiring autoboot capability, reliability and high performance
- Military equipment requiring ruggedization and operational reliability.

List prices from \$329 (PCe-180K) to \$995 (PCe 1.2MB)
CURTIS, INC. • 612/484-5064

10 Anemone Circle
 St. Paul, MN 55127

*IBM is a registered trademark of IBM Corporation

Circle 77 on Reader Service Card

RELAY INTERFACE

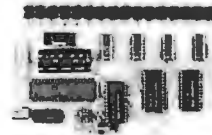

\$ 89.95

- ALLOWS YOU TO USE YOUR COMPUTER AS A CONTROL SYSTEM FOR ENVIRONMENTAL CONTROLS, EQUIPMENT AUTOMATION, EXPERIMENTS, ROBOTICS OR OTHER APPLICATIONS WHICH REQUIRE SOFTWARE CONTROL OF EXTERNAL DEVICES.
- PROVIDES OUTPUT CHANNELS TO CONTROL 16 RELAYS. EXPANDABLE TO 128 RELAYS.
- PLUGS DIRECTLY INTO THE SERIAL PORT.
- USE WITH IBM AND COMPATIBLES, TANDY, APPLE AND MOST OTHER COMPUTERS.

24 HOUR ORDER LINE (614) 464-4470
 VISA, MASTERCARD, AMERICAN EXPRESS, COD

ELECTRONIC ENERGY CONTROL, INC.
 380 S. FIFTH STREET, SUITE 604
 COLUMBUS, OHIO 43215

Circle 96 on Reader Service Card

IEEE-Z

Easiest IEEE 488 (GPIB/HPIB) Interfaces for your PC, PS/2, Macintosh, HP and more!

- Controllers
- Converters
- Extenders
- Buffers
- Boards



Please see our ad on page 186.

Call or send for your **FREE** Technical Guide

Otech (216) 439-4091

25971 Cannon Road • Cleveland, Ohio 44146
 Telex 6502820864 • Fax (216) 439-4093

Circle 126 on Reader Service Card

Motion Control & Data Acquisition

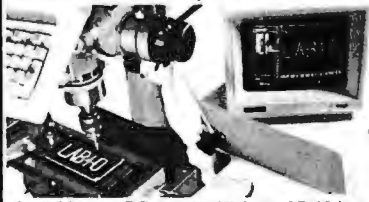

A card in your PC creates the fast LAB 40 bus which supports up to 8 modules.

- *No Programming Packages for PC/XT/AT.
- *Intelligent DC Servo: Joystick, numeric control, motion record/playback, C calls. Up to 16 axes. Two axis package w/motors \$1550 (USA).
- *4-Axis Stepper w/source code & motor \$316.
- *Scope/FFT 650KHz A/D 4 ch. w/source \$525.
- *Modules: 8 & 12 bit A/D, Relay, Stepper, Clock, Servo & Amps, Prog Controller (Forth, A/D, EEPROM, 68HC11, RS-232/422/485, LAB 40).
- *Adapter for RS-232 for Mac and others.
- *Free immediate technical support & literature. Call (415) 755-1978 or our BBS (415) 755-1524.

75 Southgate,
 Daly City, CA 94015

Computer Continuum
 (415) 755-1978 Telex: 3727438

Circle 311 on Reader Service Card

CHIP SHOP

CALL FOR THE LOWEST PRICES

SAME DAY SHIPMENT

4164 8087
 4128 80287
 41256 80387
 1 meg chips
 V20, V30 and more

SABINA INTERNATIONAL, INC.

Phone 1-800-2SABINA
 FAX 714-595-4008

Circle 238 on Reader Service Card

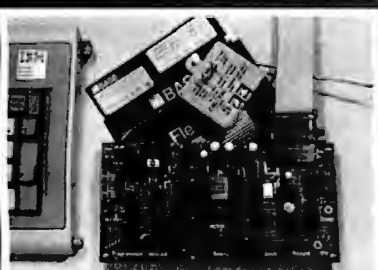

6805/6305 SINGLE CHIP MICROCOMPUTER DEVELOPMENT SYSTEMS

Two systems allow the IBM PC/XT/AT to be used as a complete development system for the MOTOROLA 6805 series single chip microcomputers. Model MCPM-1 supports the MC68705P3, P5, U3, U5, R3, & R5 chips. Model MCPM-2 supports the MC1468705F2 & G2 cmos versions. Both systems are priced at \$495 and include a cross assembler program, a Simulator/Debugger program and a programming circuit board with driver software. A system is also avail. for the HITACHI 63705 ZTAT micro.

THE ENGINEERS COLLABORATIVE
 P.O. Box 53, West Glover, VT 05875
 (802) 525-3458

Circle 98 on Reader Service Card

Advertise your computer products through **BYTE BITS** (2" x 3" ads)

For more information call Dan Harper at 603-924-6830

BYTE
 70 Main St.
 Peterborough, NH 03458

Circle 311 on Reader Service Card



GANG/SET (E)EPROM MULTIPROGRAMMERS™

Model 135-E \$995⁰⁰
 Others from \$345*

- Model 135 is a SET Programmer, GANG Duplicator, & UNIVERSAL Device Programmer.
- Programs virtually all 24, 28, & 32-pin (E)EPROMs.
- RAM expandable to 2MegaByte.
- Optional support for 40-pin EPROMs, Bipolar PROMs, 40-pin Micras, & (E)PLD/GAL/FPLA Devices.
- 18-Month WARRANTY & 12-Month FREE Device Updates.

1-800-523-1565

In Florida: 1-407-994-3520

BYTEK BYTEK Corporation
 1021 S. Rogers Cr., Boca Raton, FL 33487
 FAX: (407) 994-3615 Telex: 4998369 BYTEK

* U.S. Prices only

Circle 43 on Reader Service Card

EDITORIAL INDEX BY COMPANY

Index of companies covered in articles, columns, or news stories in this issue
Each reference is to the first page of the article or section in which the company name appears

INQUIRY #	COMPANY	PAGE	INQUIRY #	COMPANY	PAGE	INQUIRY #	COMPANY	PAGE
	ADDISON-WESLEY	51	753	GENERAL AUTOMATION	67	780	NEW ENGLAND BIOGRAPHICS ..	67
760	ADVANCED MATRIX TECHNOLOGY	67	790	HAITEX RESOURCES	67	907	NORTHGATE COMPUTER SYSTEMS	118
766	ADVANTECH	67	896	HAMMERLY COMPUTER SERVICES	173	762	NTH GRAPHICS DISPLAY PRODUCTS	67
777	ALLIGATOR TECHNOLOGIES	67		HECHT-NIELSEN	11		OSBORNE MCGRAW-HILL	51
883	AMDEK	134	779	HITECH CONSULTING GROUP	67	944	PAPERBACK SOFTWARE	197
778	AMERICAN COMPUSTAR	67		HOUGHTON-MIFFLIN	51	938	PAUL MACE SOFTWARE	197
	AMERICAN ELECTRONICS ASSOCIATION	11	962	IBM	11, 111, 251, 259, 274	783	PHILIP MORRIS	11
942	AMERICAN MANAGEMENT SYSTEMS	197	972	IDENTIX	67	908	PINETREE SOFTWARE CANADA ..	67
	ANDY HERTZFELD	251	770	IMAGE SYSTEMS TECHNOLOGY ..	67	909	PLANAR SYSTEMS	11
956	APPLE COMPUTER ..	11, 251, 259, 274	776	INSIGNIA SOLUTIONS	89	937	PLUS DEVELOPMENT	118
757	APPLE CRATE	67	852	INTEL	11	940	PRODIGY SERVICES	197
773	APPLIED LOGIC SYSTEMS	67	895	INTELLIGENT GRAPHICS ..	155, 274	966	QUANTUM SOFTWARE SYSTEMS	274
884	ARCHE TECHNOLOGIES	134	974	INTELLIGRAFIX	197	955	QUARTERDECK OFFICE SYSTEMS	251, 259, 274
	ASSOCIATION OF PERSONAL COMPUTER CONSULTANTS	11		INTERNATIONAL RESEARCH ASSOCIATES	11	959	QUICKSOFT	211
973	AT&T	274	894	ISOGON	189	949	RADIO SHACK	67
	ATARI	11	769	ITRON	67	751	RASTEROPS	67
967	AUSTEC	274		JASON LOVEMAN	251	910	RODIME	118
	AUTODESK	11		JOHN WILEY & SONS	51	761	ROLANDCORP US	67
755	AXONIX	67	768	KAPUSI LABORATORIES	67		SCO	251
	BIOPAC SYSTEMS	67	939	KOEI	197	911	SEAGATE TECHNOLOGY	118
	BLACKWELL SCIENTIFIC PUBLICATIONS	51	855	LABORATORY MICROSYSTEMS ..	89	960	SEMANTIC MICROSYSTEMS	274
969	BORLAND INTERNATIONAL	274	786	LAYERED	67	784	SHOPKEEPER SOFTWARE	67
788	BROWN BAG SOFTWARE	67, 211	886	LEADING EDGE HARDWARE PRODUCTS	134	785	SMITH MICRO SOFTWARE	67
948				LIFEBOAT ASSOCIATES	259, 274	758	SOFTLOGIC SOLUTIONS	251
	CARNEGIE-MELLON UNIVERSITY	11	959	LOCUS COMPUTING	274	854	SONY	11, 67
934	CCI	289	971	M&T BOOKS	259, 274	963	STERLING CASTLE SOFTWARE ..	89
764	CENTRAL POINT SOFTWARE	67	962	M. B. PARKER	259, 274	963	SUN MICROSYSTEMS	111, 274
936	CHEETAH INTERNATIONAL	197	970	MAPINFO	67	851	SYMANTEC	89
	CHIPS & TECHNOLOGIES	11	958	MARCONI ELECTRONIC DEVICES	305	947	SYMMETRY	211
898	CMS	118	961	MARCONI ELECTRONIC DEVICES	305	945	SYSTEMS COMPATIBILITY	197
771	CNS	67	791	MARCONI ELECTRONIC DEVICES	305	912	SYSTEMS PERIPHERALS CONSULTANTS	118
899	COLUMBIA DATA PRODUCTS	118		MARCONI ELECTRONIC DEVICES	305		TAB BOOKS	51
955	COMMODORE BUSINESS MACHINES	11, 274	935	MARCONI ELECTRONIC DEVICES	305	913	TANDY/RADIO SHACK	118
	COMPLETE LOGIC SYSTEMS	197		MARCONI ELECTRONIC DEVICES	305		TELEBIT	11
900	COMPUADD	118	857	MARCONI ELECTRONIC DEVICES	305	968	TEXAS INSTRUMENTS	11
787	COMPUTER ASSOCIATES INTERNATIONAL	67	767	MARCONI ELECTRONIC DEVICES	305	965	THE SANTA CRUZ OPERATION ..	274
	COMPUTER SCIENCE PRESS	51	897	MARCONI ELECTRONIC DEVICES	305	763	THE SOFTWARE LINK	274
901	CONTROL DATA	118	781	MARCONI ELECTRONIC DEVICES	305	958	THE VOICE CONNECTION	67
774	COPIA INTERNATIONAL	67		MARCONI ELECTRONIC DEVICES	305	789	TOM WAGNER	274
902	CORE INTERNATIONAL	118	904	MARCONI ELECTRONIC DEVICES	305	914	TOOLS & TECHNIQUES	67
	CROMEMCO	251		MARCONI ELECTRONIC DEVICES	305	772	TOSHIBA AMERICA	118
754	DATA INNOVATIONS	67	905	MARCONI ELECTRONIC DEVICES	305		TURBOPOWER SOFTWARE	67
752	DELL COMPUTER	67, 89, 134	957	MARCONI ELECTRONIC DEVICES	305		U.S. ARMY LABORATORY COMMAND	11
856			961	MARCONI ELECTRONIC DEVICES	305		U.S. DEPARTMENT OF DEFENSE UNIVERSITY OF CALIFORNIA AT BERKELEY	11, 259
887			964	MARCONI ELECTRONIC DEVICES	305		USROBOTICS	11
	DIGITAL EQUIPMENT	11		MARCONI ELECTRONIC DEVICES	305		VERSACAD	11
893	DIGITAL RESEARCH	163, 274		MARCONI ELECTRONIC DEVICES	305		WCE PUBLISHING	11
957			950	MARCONI ELECTRONIC DEVICES	305	975	WENDIN	274
775	DIGITALK	67	906	MARCONI ELECTRONIC DEVICES	305		XANADU	11
	ENGRSOFT	67	756	MARCONI ELECTRONIC DEVICES	305	946	XENOSOFT	197
885	EPSON AMERICA	134		MARCONI ELECTRONIC DEVICES	305			
951	EXWELLS SOFTWARE	211		MARCONI ELECTRONIC DEVICES	305			
	FORESTER RESEARCH	11		MARCONI ELECTRONIC DEVICES	305			
943	FOUNDATIONWARE	197		MARCONI ELECTRONIC DEVICES	305			
903	FUJITSU AMERICA	118		MARCONI ELECTRONIC DEVICES	305			

COMING UP IN BYTE

PRODUCTS IN PERSPECTIVE:

We are rounding up 14 state-of-the-art communication packages for August's **Product Focus**. These programs are made for the IBM PC and compatibles, and they all have advanced features that take some of the frustration out of telecommunications. We'll test them for their ease of use. Then we'll check their performance when working with varying file sizes and with batch tasks.

System review: Since Compaq and Advanced Logic Research released the first 20-MHz 80386-based computers several months ago, many companies have announced such systems. They offer levels of performance higher than 16-MHz 80386-based systems, usually for higher prices. We'll look at computers from Everex, Proteus, and Tatung.

Hardware review: Alternate input devices for the IBM PC are back in the news. We'll compare several and let you know what we think of their prospects.

Software reviews: When it's time to talk languages, what you won't find in most computer magazines is Ada. However, it has finally made its way to the Macintosh in the form of Meridien's AdaVantage.

We'll also review Apple's A/UX system for the Mac II. A/UX is a hefty implementation of Unix that is sold only on its own hard disk drive.

Application reviews: First up is VersaCAD's Macintosh Edition. Next, we've slated Tornado, a memory-resident "random information processor" from Micro Logic. Finally, we'll look at Dataplex from Tools and Technologies, a new data-entry and format-conversion program.

IN DEPTH:

Our August spotlight will fall on **the C language**, which has a commanding position in the micro-computer industry. While BASIC is what most people learn first—and other languages have their proponents—C is where you find the heaviest concentration of attention.

Within broad boundaries, C is considered to be the most portable language. The advantages for the program developer rest on the reduction in time it takes to make an IBM PC program, for example, operational on a Macintosh. With complex programs, this translation time can be both time-consuming and costly if a language is too rigidly identified with a particular micro-computer family. Not only will the programs be prone to erratic behavior, their performance will likely be much slower—if they can be made to perform at all.

FEATURES:

A few years from now, you may be able to interact with your computer using your eyes, your voice, and even your whole body. Our lead feature will discuss some of the **innovative technologies** that are already working in research centers around the country.

Will there be a glut or a dearth of new programs to run under OS/2? We've lined up top programmers, who will discuss **porting** their popular programs from MS-DOS to OS/2—and what that process means for OS/2 users.

BASIC, the language that everyone owns and loves to pick on, has grown up. We'll talk about features of several **new versions of BASIC** that make it a serious programming language.

Steve Ciarcia's **Circuit Cellar** will be a construction project on an 8051 development system. He'll demonstrate how to build a controller development tool that can be guided, instructed, and manipulated from your IBM PC.

MACINTOSH SPECIAL COVERAGE

August has other surprises as well. It's the advent of a special Macintosh supplement. The topics will run the gamut of what matters most in the Mac community. This actually is a "daughter" publication carried within the same binding as the normal August BYTE. It will include Short Takes, columns, and features. Jerry Pournelle and Ezra Shapiro will both provide bonus Mac columns. Also, Bruce Webster returns with a special column.

Features will cover local-area networking with Macintoshes, inside MultiFinder, working with NuBus, effective programming on the Macintosh, color on the Mac II, writing HyperCard applications, and programming in Apple's version of Unix.

READER SERVICE

To get further information on the products advertised in BYTE, fill out the reader service card by circling the numbers on the card that correspond to the inquiry number listed with the advertiser. This index is provided as an additional service by the publisher, who assumes no liability for errors or omissions.

* Correspond directly with company

Alphabetical Index to Advertisers

Inquiry No.	Page No.	Inquiry No.	Page No.	Inquiry No.	Page No.	Inquiry No.	Page No.
3	1ST CLASS EXPERT SYSTEMS 200	74	COVOX 340	149	LOGICAL DEVICES 334		
4	A + L MEIER VOGT 255	76	CRESCENT SOFTWARE INC. 24	150	LOGITECH 73		
5	A + L MEIER VOGT 257	77	CURTIS INC. 349	151	LOGITECH 73		
6	ADVANCED COMP. PROD. 342,343	308	DATAPATH TECH 92	152	LOGITECH 74,75		
7	ADVANCED LOGIC RESEARCH 8,9	309	DATAPATH TECH 92	153	LOGITECH 74,75		
8	ADVANCED LOGIC RESEARCH 8,9	305	DATAPRO 246		* LOTUS DEVELOPMENT CORP. 99		
15	ADVANTECH 325	78	DATA TRANSLATION 42,43		* LOTUS DEVELOPMENT CORP. 101		
9	AK SYSTEMS 325	312	DAYTRON ELECTRONICS 283	154	MACONLY, INC. 182		
10	ALPHA MICRO 127	79	DBFAST 60		* MACMILLIAN BOOK CLUBS 48,49		
11	ALPHA MICRO 127	80	DCS (DIVERSIFIED COMP.) 340	155	MANNESMANN TALLY 153		
12	ALPHA PRODUCTS COMPANY 335	290	DELL COMP. (N. AMERICA) 130-133	156	MANNESMANN TALLY 153		
13	ALPS AMERICA 276,277	291	DELL COMP. (INT'L) 130-133	157	MANX SOFTWARE SYSTEM 61		
14	* AMERICAN DESIGN COMP. 322	82	DICONIX 20,21	158	MARK WILLIAMS 30		
16	AMERICAN SEMICONDUCTOR 340	83	DIGITALK 140,141		* MAXELL DATA PRODUCTS 7		
17	AMERICAN SEMICONDUCTOR 340	84	DIGITALK 140,141	159	MEAD COMPUTER 333		
18	AMERICAN SMALL BUSINESS 25	85	DIGITALK 142,143	160	MEDIA CYBERNETICS 263		
	* AMPRO 166	86	DIGITALK 142,143	161	MEDIA CYBERNETICS 263		
19	APPLIED DATA SYS 40	87	DISC INTERNA L 332	162	MEGASOFT 334		
	* AST RESEARCH 33	88	DISKCO TECH 338	163	MENDELSON ELECTRONICS 151		
20	ATI TECHNOLOGIES 241	89	DISKETTE CONNECTION 325	164	MEP(MICRO ELECT. PROD) 330		
21	ATRON 66	90	DISKS PLUS 98	165	MERIDIAN TECH 238		
22	AUTODESK 191	91	DISKS TO GO 323	166	MERRITT COMPUTER PROD 52		
	* AVOCET 332	92	DSP DEVELOPMENT CORP. 114	167	MICRO 1 145		
23	AVOCET SYSTEMS INC. 210	93	DYNAMIC ELECTRONICS 325	168	MICROCOM SYSTEMS 26		
24	B & B ELECTRONICS 323	94	ECOSOFT 55		* MICROCOMP. MKTG. COUNCIL 258		
25	B & C MICRO 328	96	ELECTRONIC ENERGY CTRL 349		* MICROMINT 324		
26	B & C MICRO 323	97	ELEXOR 336	169	MICROPROCESSORS UNLTD. 338		
27	B & C MICRO 323	98	ENGINEERS COLLABORATIVE 349		* MICROSOFT 56,57		
28	B & C MICRO 338	292	EVEREX SYSTEMS 19	171	MICROSOFT PRESS 170		
29	B & C MICRO 349	293	EVEREX SYSTEMS 19	172	MICROSOFT PRESS 170		
30	B & W SYSTEMS INC. 185	294	EVEREX SYSTEMS 28,29	173	MICROWAY 167		
31	BASIS 208,209	295	EVEREX SYSTEMS 28,29	174	MITSUBISHI CHEMICAL 285		
32	BAY TECHNICAL ASSOC. 34	288	FLAGSTAFF ENGINEERING 196	175	MIX SOFTWARE 237		
	* BINARY TECH 330	289	FLAGSTAFF ENGINEERING 196	177	MONTGOMERY GRANT 329		
450	BIX 298,299	296	FORTRON CORP. 206	178	M.H.I. 256		
33	BLAISE 35	297	FORTRON CORP. 206	179	NANTUCKET 172		
34	BORLAND CI	297	FOX SOFTWARE 23	180	NATIONAL INSTRUMENTS 288		
35	BORLAND CI	104	FTG DATA SYSTEM 323	181	NATURAL MICROSYSTEMS 36		
36	BORLAND 1	105	GATEWAY 2000 159	182	NEC HOME ELEC. DIV. 248,249		
37	BORLAND 1	106	GENERAL PARAMETRICS 149	307	NEC HOME ELEC. DIV. 160,161		
38	BORLAND 69	107	GENOA SYS. CORP. 79	186	NEC INFO SYSTEMS CIII 188		
39	BORLAND 69	108	GOLDEN BOW 340	304	NORMEREL 62,63		
40	BP MICRO 336	109	GRAFFPOINT 330	188	NORTHGATE COMP SYSTEMS 193		
41	BP MICRO 336	110	GRAPHTEC 287	189	NORTHGATE COMP SYS. 194,195		
42	BUS COMPUTER SYSTEMS 319	111	GTEK INC. 18	190	OKDATA 59		
	* BUYERS MART 310-318	112	GTEK INC. 18	191	ON-TARGET ASSOC. 338		
	* BYTE BACK ISSUES 158	113	HAMMERLY COMPUTER SERV. 71	192	ON-LINE STORE 328		
311	BYTE BITS 349	114	HAYES MICROCOMP. PROD. 178,179		ORACLE 77		
	* BYTE BOOK CLUB 272,273	115	HENSE & PARTNER 27	193	ORION 64		
	* BYTE CIRCULATION 300	116	HEWLETT PACKARD 13	194	OSBORNE/MCGRRAW-HILL 293		
	* BYTE MARKETING 297	117	HITECH EQUIPMENT 330	195	OSBORNE/MCGRRAW-HILL 92		
	* BYTE SUB MESSAGE 168	118	HOLMES MICROSYSTEMS 230	196	PACIFIC COMPUTER 327		
	* BYTE SUB SERVICE 176	119	HOLMES MICROSYSTEMS 230	197	PACIFIC COMPUTER 327		
43	BYTEC 349	120	HORSTMANN SOFTWARE 150	198	PARSONS TECHNOLOGY 85		
	* CALIFORNIA DIGITAL 337		* IBM CORP. 187	199	PATTON & PATTON 16		
44	CALIFORNIA SFTW. PRODS. 309	121	IC EXPRESS 328	200	PAUL MACE SOFTWARE 213		
45	CALIFORNIA SFTW. PRODS. 309	122	IGC 250	201	PC PLUS 32		
46	CAPITAL EQUIPMENT 202		* INECTRA 323	50	PERSOFT INC. 81		
47	CENTRAL COMP PROD 334		* INECTRA 334	187	PERSONAL SPACE COMM. 338		
48	CLARION SOFTWARE 93	123	INTEGRAND 152	203	PERSONAL TEX 184		
	* CLEO SOFTWARE 146	124	INTELLIGENCEWARE 15	206	PETER NORTON 113		
298	CLUB AMERICAN TECHN. 224,225		* INT'L PREVIEW SOCIETY 91	207	PETER NORTON 113		
51	CNS 98	125	IO TECH 186	208	PRINCETON GRAPHIC SYS 41		
52	CNS 98	128	IO TECH 349	209	PRIORITY ONE 339		
53	COEFFICIENT SYSTEMS CO 202	127	ITRON 245	210	PROGRAMMABLE LOGIC 325		
54	COEFFICIENT SYSTEMS CO 203	128	JADE COMPUTER 331	211	PROGRAMMERS CONNECTION 39		
55	COGITATE 330	129	JAMECO 320,321	212	PROGRAMMERS PARADISE 53		
56	COGITATE 323	130	JAWIN COMPUTER 334	213	PROGRAMMERS SHOP 201		
57	COMPACT DISC PRODUCTS 52	131	JAWIN COMPUTER 334	214	PROSTOR INC. 110		
58	COMPU COM CORP. 332	132	JENSEN & PARTNERS 169	215	QUA TECH 326		
59	COMPUSAVE 327	134	J.D.R. MICRODEVICES 344,345	216	QUA TECH 326		
60	COMPUTER AGE LTD 304	135	J.D.R. MICRODEVICES 346,347	217	QUA TECH 326		
	* COMPUTER CHRONICLES 341	135	J.D.R. MICRODEVICES 348	218	QUA TECH 326		
	* COMPUTER CONTINUUM 349	136	KADAK 58	219	QUA TECH 326		
61	COMPUTER DISCWAREHOUSE 247	137	KEA SYSTEMS 46	220	QUA TECH 326		
62	COMPUTER EXPO 216	138	KEA SYSTEMS 330	221	QUA TECH 326		
63	COMPUTER MAIL ORDER 266,267	139	KILA SYSTEMS 54	222	QUA TECH 326		
64	COMPUTER PRODUCTS CO 100	140	KNOWLEDGE GARDEN 271	223	QUA TECH 326		
65	COMPUTER SUPPORT GRP. 96,97	141	KONAN 221	224	QUALSTAR 54		
67	COMPUTER SURPLUS STORE 332	142	KONAN 221	225	QUALSTAR CORP. 328		
68	COMPUTER WAREHOUSE 162	143	LAHEY COMPUTER SYSTEMS 203	226	QUANTUM 87		
69	COMPUTER WAREHOUSE 162	144	LAWSON LABS 336	227	QUARTERDECK 214,215		
70	CONTECH 332	145	LINK COMPUTER GRAPHICS 330	228	QUARTERDECK 214,215		
71	CONTROL VISION 334	146	LOGICAL DEVICES 334	301	QUELO 283		
73	CORVUS SYSTEMS 82,83	147	LOGICAL DEVICES 334	230	QUME 102		
		148	LOGICAL DEVICES 334	231	RADIO SHACK CIV		
					* RAIMA 37		
					232 RAINBOW TECHNOLOGY 188		
					233 REAL TIME DEVICES 340		
					234 RIX SOFTWARE 50		
					235 RIX SOFTWARE 50		
					236 ROSE ELECTRONICS 332		
					237 ROSE ELECTRONICS 332		
					238 SABINA INT'L 349		
					239 SAFEWARE 330		
					240 SANTA CRUZ OPERATIONS 165		
					261 SC SYSTEMS 261		
					242 SCHWAB CORP. 338		
					243 SCIENCE & ENGINEERING S/W 95		
					244 SEA LEVEL 309		
					245 SHAMROCK 175		
					246 SILICON SPECIALTIES 231		
					247 SILICON SPECIALTIES 231		
					248 SKAN TEKNOLOGIES 330		
					250 SN'W ELECTRONICS 144		
					251 SOFTDISK 10		
					252 SOFTKLONE 228		
					* SOFTLOGIC SOLUTIONS 157		
					253 SOFTRONICS 336		
					254 SOFTWARE DEV. SYS. 177		
					299 SOFTWARE LINK, THE 31		
					300 SOFTWARE LINK, THE 31		
					256 SOLUTION SYSTEMS 201		
					257 SPECTRUM 233		
					258 SPSS 180		
					302 SUPER MICRO 309		
					259 SUPERSOFT 94		
					260 SYSGEN INC. 107		
					262 TALLGRASS TECH 47		
					263 TALLGRASS TECH 47		
					264 TANDON 108,109		
					265 TANDON 108,109		
					306 TELEBYTE 58		
					266 TELEVIDEO 45		
					* TINNEY, ROBERT GRAPHICS 204		
					* TOSHIBA AMERICA INC. 116,117		
					303 TRUE DATA PRODUCTS 338		
					268 TRUEVISION 183		
					269 TURBO POWER 199		
					270 UNIVERSAL CROSS ASSBL. 332		
					* VERMONT CREATIVE SFTW. 223		
					271 VICTORY ENTERPRISES 46		
					272 VOYETRA TECH 340		
					* WAREHOUSE DATA PRODS. 219		
					273 WISEMANN & THEIS 212		
					275 WHITEWATER GROUP, THE 244		
					278 WINTEK CORP. 5		
					279 WINTEK CORP. 336		
					277 WORLDWIDE SERVICES 304		
					278 WORLDWIDE SERVICES 304		
					280 XELTEK 340		
					310 XENDERCORP. 283		
					281 ZENITH DATA SYSTEMS 275		
					282 ZEOS INT'L 154		
					283 ZERICON 340		
					284 ZORTECH 17		
					285 ZORTECH 171		
					286 Z-WORLD 325		
					287 Z-WORLD 325		

INTERNATIONAL SECTION 88IS-1-40
No North American Inquiries please.

READER SERVICE

Advertising Supplement included with this issue:
Jameco Electronics (U.S. and Canada Subscribers)

* Correspond directly with company.

Inquiry No.	Page No.	Inquiry No.	Page No.	Inquiry No.	Page No.	Inquiry No.	Page No.
387	GAMMA PRODUCTIONS . . . 88IS-18						
388	GAMMA PRODUCTIONS . . . 88IS-18						
389	GREY MATTER . . . 88IS-17						
390	GTCO . . . 88IS-21						
391	HOPE CIRCUIT . . . 88IS-33						
392	IES . . . 88IS-24						
393	INES . . . 88IS-33						
394	KIRIN COMPUTERS . . . 88IS-31						
395	MAYFAIR MICRO . . . 88IS-25						
	* MCGRAW-HILL BOOKS . . . 88IS-39						
396	MICRO TECHNOLOGY . . . 88IS-19						
	* MICROMINT . . . 88IS-40						
397	MICROPROCESS ENGR. . . 88IS-33						
398	NOVELL DEVELOPMENT . . . 88IS-29						
399	OLIVETTI . . . 88IS-13						
400	PRECISION DATA . . . 88IS-20						
401	PROCOM . . . 88IS-2						
402	PROCOM . . . 88IS-2						
403	RHV . . . 88IS-23						
	* ROBT. TINNEY S. . . 88IS-34,35						
404	SOFTTECH . . . 88IS-30						
	* SOFTLINE CORPORATION . . . 88IS-15						
405	STONE COMPUTECH LTD . . . 88IS-26						
406	STONE COMPUTECH LTD . . . 88IS-26						
407	STONE COMPUTECH LTD . . . 88IS-26						
408	SUPERVIEW INVTMT. LTD. . . 88IS-32						
409	S-100 . . . 88IS-7						
410	S-100 . . . 88IS-7						
411	TRIANGLE DIGITAL SERV. . . 88IS-30						
412	TRIANGLE DIGITAL SERV. . . 88IS-30						
413	USA SOFTWARE . . . 88IS-9						
413	WARREN POINT INT'L . . . 88IS-33						
REGIONAL SECTIONS							
Midwest . . . 88 MW 1-8				Southwest . . . 88SW 1-8			
481	ALTEX ELECTRONICS . . . 88MW-5	529	COMMUNICATNS RES.GRP. . . 88NE-15		* MICROMINT . . . 88PC-12	516	NU-MEGA TECHNOLOGIES . . . 88PC-5
	* BYTE TIPS . . . 88MW-6		* COMPARE COMPUTERS . . . 88NE-21	517	PC SIG . . . 88PC-3	517	PC SIG . . . 88PC-3
	* COMPARE COMPUTERS . . . 88MW-3		COMP. FORTHEBLIND . . . 88MAT-18	518	SF MICRO . . . 88PC-15	518	SF MICRO . . . 88PC-15
483	HARD DRIVES INT'L . . . 88MW-1	530	COMPUTER AGE . . . 88NE-23	519	SURAH . . . 88PC-1	519	SURAH . . . 88PC-1
484	HARD DRIVES INT'L . . . 88MW-1		* DATRAN CORP. . . 88NE-6,7	520	TATUNG SCI. & TECH. . . 88PC-11	520	TATUNG SCI. & TECH. . . 88PC-11
485	KEITHLEY DAC . . . 88MW-2	531	F & W COMM. . . 88NE-14	521	UNIVERSAL COMP. PROD. . . 88PC-2	521	UNIVERSAL COMP. PROD. . . 88PC-2
488	KORE, INC. . . 88MW-4	532	FIRST MICRO . . . 88NE-17				
	* MICROCOMP.MKTG.COUNCIL . . . 88MW-7	533	LOWELL CORP. . . 88NE-16				
	* MICROCOMP.MKTG.COUNCIL . . . 88MW-8	541	MANZANA . . . 88NE-1				
488	Y.E.S. MULTINATIONAL . . . 88MW-6	542	MANZANA . . . 88NE-1				
			* MICROCOMP.MKTG.COUNCIL . . . 88NE-20				
			* MICROMINT . . . 88NE-12				
			* MICROSART . . . 88NE-10,11				
			* MICROCOMP.MKTG.COUNCIL . . . 88NE-13				
			534	NEURALWARE . . . 88NE-13			
			535	PC LINK . . . 88NE-4,5			
			536	PIONEER . . . 88NE-24			
			537	POWER COMPUTERS . . . 88NE-19			
			539	PROSPERO SOFTWARE . . . 88NE-2,3			
				* ROBT. TINNEY GRAPHICS . . . 88NE-2,2			
Mid-Atlantic . . . 88 MAT 1-8				Pacific Coast . . . 88 PC 1-16			
	* BYTE TIPS . . . 88MAT-4	509	ALTEC . . . 88PC-14				
50	COMMUNICATNS RES.GRP. . . 88MAT-3		* BYTE TIPS . . . 88PC-14				
50	COMPUTERLANE . . . 88MAT-7	51	COMPUTERLANE . . . 88PC-13				
	* COMPUTERS FOR THE BLIND . . . 88MAT-2	51	COMPUTOWN . . . 88PC-10				
	* MICROCOMP.MKT.COUNCIL . . . 88MAT-8		* DATRAN CORP. . . 88PC-6,7				
503	OWL COMPUTER . . . 88MAT-6	512	D-DATA . . . 88PC-9				
504	SF MICRO . . . 88MAT-1	513	MARKENRICH . . . 88PC-16				
505	SURAH . . . 88MAT-5	514	MARKENRICH . . . 88PC-16				
		515	MERLIN PUBLISHING . . . 88PC-4				
			* MICROCOMP.MKTG.COUNCIL . . . 88PC-8				
Northeast . . . 88 NE 1-24							
526	APPLIED PROG. ELECT. . . 88NE-8,9						
	* BYTE TIPS . . . 88NE-16						
528	C.H.A.S. MICRO . . . 88NE-18						

BYTE ADVERTISING SALES STAFF:

Dennis J. Riley, Director of Sales, One Phoenix Mill Lane, Peterborough, NH 03458, tel. (603) 924-9281

NEW ENGLAND
ME, NH, VT, MA, RI, ONTARIO
CANADA & EASTERN CANADA
John C. Moon (617) 262-1160
McGraw-Hill Publications
575 Boylston Street
Boston, MA 02116

ATLANTIC
NY, NYC, CT, NJ (NORTH)
Leah G. Rabinowitz (212) 512-2096
McGraw-Hill Publications
1221 Avenue of the Americas—
36th Floor
New York, NY 10020

Dick McGurk (203) 968-7111
McGraw-Hill Publications
Building A—3rd Floor
777 Long Ridge Road
Stamford, CT 06902

EAST
PA, NJ (SOUTH),
MD, VA, W.VA, DE, D.C.
(215) 496-3833
McGraw-Hill Publications
Three Parkway
Philadelphia, PA 19102

SOUTHEAST
NC, SC, GA, FL, AL, TN
Carolyn F. Lovett (404) 252-0626
McGraw-Hill Publications
4170 Ashford-Dunwoody Road
Suite 420
Atlanta, GA 30319

MIDWEST
IL, MO, KS, IA, ND, SD, MN,
KY, OH, WI, NB, IN, MI, MS
Bob Denmead (312) 751-3740
McGraw-Hill Publications
Blair Building
645 North Michigan Ave.
Chicago, IL 60611

**SOUTHWEST,
ROCKY MOUNTAIN**
CO, WY, OK, TX, AR, LA
Karl Heinrich (713) 462-0757
McGraw-Hill Publications
7600 W. Tidwell Rd.—Suite 500
Houston, TX 77040

SOUTH PACIFIC
SOUTHERN CA, AZ, NM,
LAS VEGAS
Jack Anderson (714) 557-6292
McGraw-Hill Publications
3001 Red Hill Ave.
Building #1—Suite 222
Costa Mesa, CA 92626

Tom Harvey (213) 480-5243
McGraw-Hill Publications
3333 Wilshire Boulevard #407
Los Angeles, CA 90010

NORTH PACIFIC
HI, WA, OR, ID, MT,
NORTHERN CA,
NV (except LAS VEGAS), UT,
W. CANADA
Mike Kisseberth (415) 362-4600
McGraw-Hill Publications
425 Battery Street
San Francisco, CA 94111

Bill McAfee (415) 349-4100
McGraw-Hill Publications
951 Mariner's Island Blvd.—
3rd Floor
San Mateo, CA 94404

BYTE BITS (2x3)
Dan Harper (603) 924-6830
BYTE Publications
One Phoenix Mill Lane
Peterborough, NH 03458

The Buyer's Mart (1x2)
Mark Stone (603) 924-3754
BYTE Publications
One Phoenix Mill Lane
Peterborough, NH 03458

Regional Advertising
(So. CA, Mid-Atlantic,
New York/New England)
Elisa Lister (603) 924-6830
BYTE Publications
One Phoenix Mill Lane
Peterborough, NH 03458

Regional Advertising
(Southeast, Southwest)
Denise Vernier (603) 924-9281
BYTE Publications
One Phoenix Mill Lane
Peterborough, NH 03458

Regional Advertising
(Pacific NW, Midwest,
New York/New England)
Scott Gagnon (603) 924-6830
BYTE Publications
One Phoenix Mill Lane
Peterborough, NH 03458

BYTE Deck Mailings
National
Ed Ware (603) 924-6166
BYTE Publications
One Phoenix Mill Lane
Peterborough, NH 03458

A/E/C Computing Deck
Computing for Engineers
Mary Ann Goulding
(603) 924-9281
BYTE Publications
One Phoenix Mill Lane
Peterborough, NH 03458

International Advertising Sales Staff:

Mr. Hans Csokor
Publimedia
Reisenstrasse 61
A-1039 Vienna, Austria
222 75 76 84

Mrs. Gurit Gepner
McGraw-Hill Publishing Co.
PO Box 2156
Bat Yam, 59121 Israel
3 866 561 321 39

Ros Weyman
McGraw-Hill Publishing Co.
Liebigstrasse 19
D-6000 Frankfurt/Main 1
West Germany
69 72 01 81

Mrs. Maria Sarmiento
Pedro Teixeira 8, Off. 320
Iberia Mart 1
Madrid 4, Spain
1 45 52 891

Michael Karnig
Andrew Karnig & Associates
Finnbodavagen
S-31 31 Nacka, Sweden
8-44 0005

Mr. Alain Faure
McGraw-Hill Publishing Co.
128 Faubourg Saint Honore
75008 Paris
France
(1) 42-89-03-81

Karen Lennie
Ros Weyman
McGraw-Hill Publishing Co.
34 Dover St.
London W1X 4BR
England 01 493 1451

Emilio Zerbini
McGraw-Hill Publishing Co.
Via Flavio Baracchini 1
20123 Milan, Italy
(2) 89010103

Seavex Ltd.
400 Orchard Road, #10-01
Singapore 0923
Republic of Singapore
Tel: 734-9790
Telex: RS35539 SEAVEX

Seavex Ltd.
503 Wilson House
19-27 Wyndham St.
Central, Hong Kong
Tel: 5-260149
Telex: 60904 SEVEX HX

Hiro Morita
McGraw-Hill Publishing Co.
Overseas Corp.
Room 1528
Kasumigaseki Bldg.
3-2-5 Kasumigaseki,
Chiyoda-Ku
Tokyo 100, Japan
3 581 9811

Mr. Ernest McCrary
Empresa Internacional de
Comunicacoes Ltda.
Rua da Consolacao, 222
Conjunto 103
01302 Sao Paulo, S.P., Brasil
Tel: (11) 259-3811
Telex: (100) 32122 EMBN

READER SERVICE

To get further information on the products advertised in BYTE, fill out the reader service card by circling the numbers on the card that correspond to the inquiry number listed with the advertiser. This index is provided as an additional service by the publisher, who assumes no liability for errors or omissions.

* Correspond directly with company

Index to Advertisers by Product Category

Inquiry No.	Page No.	Inquiry No.	Page No.	Inquiry No.	Page No.	Inquiry No.	Page No.		
HARDWARE									
315 ADDINS									
15	ADVANTECH	325	111	GTEK INC	18	533	LOWELL CORP.	88NE-16	
12	ALPHA PRODUCTS COMPANY	335	112	GTEK INC	18	395	MAYFAIR MICRO	88IS-25	
20	ATI TECHNOLOGIES	241	486	KORE, INC.	88MW-4	167	MICRO 1	145	
21	ATRON	66	145	LINK COMPUTER GRAPHICS	330		* MICROSMART	88NE-10, 11	
26	B & C MICRO	323	146	LOGICAL DEVICES	334	304	NORMEREL	62, 63	
27	B & C MICRO	323	147	LOGICAL DEVICES	334	399	OLIVETTI	88IS-13	
29	B & C MICRO	349	148	LOGICAL DEVICES	334	495	OMEGA MICRO SYSTEMS	88SE-4	
46	CAPITAL EQUIPMENT	202	149	LOGICAL DEVICES	334	536	PIONEER	88NE-24	
60	COMPUTER AGE LTD	304	210	PROGRAMMABLE LOGIC	325	231	RADIO SHACK	CIV	
71	CONTROL VISION	334	280	XELTEK	340	504	SF MICRO	88M/AT-1	
77	CURTIS INC	349	310	XENDER CORP.	283	518	SF MICRO	88PC-15	
78	DATA TRANSLATION	42, 43	318 INSTRUMENTATION				405	STONE COMPUTECH LTD	88IS-26
96	ELECTRONIC ENERGY CTRL.	349		* COMPUTER CONTINUUM	349	406	STONE COMPUTECH LTD	88IS-26	
292	EVEREX SYSTEMS	19	97	ELEXOR	336	407	STONE COMPUTECH LTD	88IS-26	
293	EVEREX SYSTEMS	19	191	ON TARGET ASSOC.	338	266	TELEVIDEO	45	
107	GENOA SYS. COMP.	79	216	QUA TECH	326		* TOSHIBA AMERICA INC.	116, 117	
111	GTEK INC	18	220	QUA TECH	326	279	WINTEK CORP.	336	
112	GTEK INC	18	222	QUA TECH	326	281	ZENITH DATA SYSTEMS	275	
393	INES	88IS-33	319 KEYBOARDS/MICE				282	ZEOS INT'L	154
125	IO TECH	186	386	DIETRICH	88IS-33	287	Z-WORLD	325	
126	IO TECH	349	150	LOGITECH	73	328 TERMINALS			
485	KEITHLEY DAC	88MW-2	151	LOGITECH	73	137	KEA SYSTEMS	46	
493	KEITHLEY DAC	88SE-2	152	LOGITECH	74, 75	SOFTWARE			
477	KEITHLEY DAC	88SW-2	153	LOGITECH	74, 75	329 APPLE2/MAC APPLICATIONS			
141	KONAN	221	320 MASS STORAGE				Scientific/Technical		
142	KONAN	221	9	AK SYSTEMS	325	258	SPSS	180	
144	LAWSON LABS	336	10	ALPHA MICRO	127	330 IBM/MS-DOS APPLICATIONS			
513	MARKENRICH	88PC-16	11	ALPHA MICRO	127	Business/Office			
514	MARKENRICH	88PC-16	57	COMPACT DISC PRODUCTS	52	3	1ST CLASS EXPERT SYSTEMS	200	
163	MENDELSON ELECTRONICS	151	483	HARD DRIVES INT'L	88MW-1	31	BASIS	208, 209	
173	MICROWAY	167	484	HARD DRIVES INT'L	88MW-1	38	BORLAND	69	
191	ON TARGET ASSOC.	338	491	HARD DRIVES INT'L	88SE-3	39	BORLAND	69	
193	ORION	64	492	HARD DRIVES INT'L	88SE-3	56	COGITATE	323	
187	PERSONAL SPACE COMM.	338		* MAXELL DATA PRODUCTS	7	385	DAWICONTROL	88IS-24	
215	QUA TECH	326	174	MITSUBISHI CHEMICAL	285	79	DBFAST	60	
217	QUA TECH	326	401	PROCUM	88IS-2	92	DSP DEVELOPMENT CORP.	114	
218	QUA TECH	326	402	PROCUM	88IS-2	103	FOX SOFTWARE	23	
219	QUA TECH	326	214	PROSTOR INC.	110	104	FTG DATA SYSTEM	323	
220	QUA TECH	326	224	QUALSTAR	54	108	GOLDEN BOW	340	
221	QUA TECH	326	225	QUALSTAR	328	124	INTELLIGENCEWARE	15	
222	QUA TECH	326	248	SKAN TEKNOLOGIES	330		* LOTUS DEVELOPMENT CORP.	99	
223	QUA TECH	326	262	TALLGRASS TECH	47		* LOTUS DEVELOPMENT CORP.	101	
233	REAL TIME DEVICES	340	263	TALLGRASS TECH	47	179	NANTUCKET	172	
244	SEA LEVEL	309	303	TRUE DATA PRODUCTS	338	398	NOVELL DEVELOPMENT	88IS-29	
302	SUPER MICRO	309	* MISCELLANEOUS					* ORACLE	77
411	TRIANGLE DIGITAL SERV.	88IS-30	32	BAY TECHNICAL ASSOC.	34	195	OSBORNE/MCGRAW-HILL	92	
415	TRIANGLE DIGITAL SERV.	88IS-30	308	DATAPATH TECH	92	198	PARSONS TECHNOLOGY	85	
303	TRUE DATA PRODUCTS	338	309	DATAPATH TECH	92	199	PATTON & PATTON	16	
268	TRUEVISION	183	90	DISKS PLUS	98	50	PERSOFT INC.	81	
286	Z-WORLD	325		* INECTRA	323		* RAIMA	37	
316 DRIVES									
541	MANZANA	88NE-1	123	INTEGRAND	152		* SOFTLOGIC SOLUTIONS	157	
542	MANZANA	88NE-1	166	MERRITT COMPUTER PROD.	52	331 IBM/MS-DOS APPLICATIONS			
260	SYSGEN INC.	107	259	SUPERSOFT	94	Scientific/Technical			
264	TANDON	108, 109	321 MODEMS/MULTIPLEXORS				312	DAYTRON ELECTRONICS	283
265	TANDON	108, 109	47	CENTRAL COMP PROD.	334	92	DSP DEVELOPMENT CORP.	114	
317 HARDWARE PROGRAMMERS									
	* AVOCET	332		* CLEO SOFTWARE	146	120	HORSTMANN SOFTWARE	150	
25	B & C MICRO	328	58	COMPU COM CORP.	332	173	MICROWAY	167	
28	B & C MICRO	338	114	HAYES MICROCOMP. PROD.	178, 179	180	NATIONAL INSTRUMENTS	288	
40	BP MICRO	336	118	HOLMES MICROSYSTEMS	230	534	NEURALWARE	88NE-13	
40	BP MICRO	336	119	HOLMES MICROSYSTEMS	230	203	PERSONAL TEX	184	
43	BYTEK	349	322 MONITORS						
	* MICROMINT	88MW-8							
307 NEC HOME ELEC. DIV. 160, 161									
182 NEC HOME ELEC. DIV. 248, 249									
208 PRINCETON GRAPHIC SYS 41									
520 TATUNG SCIENCE & TECH 88PC-11									
323 NETWORK HARDWARE									
24 B & B ELECTRONICS 323									
55 COGITATE 330									
127 ITRON 245									
173 MICROWAY 167									
181 NATURAL MICROSYSTEMS 36									
187 PERSONAL SPACE COMM. 338									
215 QUA TECH 326									
217 QUA TECH 326									
218 QUA TECH 326									
221 QUA TECH 326									
236 ROSE ELECTRONICS 332									
237 ROSE ELECTRONICS 332									
306 TELEBYTE 58									
273 WIESEMANN & THEIS 212									
324 PRINTERS/PLOTTERS									
13 ALPS AMERICA 276, 277									
14 ALPS AMERICA 276, 277									
82 DICONIX 20, 21									
110 GRAPHTEC 287									
116 HEWLETT PACKARD 13									
* INECTRA 334									
155 MANNESMANN TALLY 153									
156 MANNESMANN TALLY 153									
186 NEC INFO SYSTEMS CIII									
190 OKIDATA 59									
230 QUME 102									
283 ZERICON 340									
325 SCANNERS/DIGITIZERS									
288 FLAGSTAFF ENGINEERING 196									
289 FLAGSTAFF ENGINEERING 196									
390 GTCO 88IS-21									
257 SPECTRUM 233									
408 SUPERVIEW INVTMT. LTD. 88IS-32									
326 SOFTWARE SECURITY									
15 ADVANTECH 325									
377 ALADDIN 88IS-16									
74 COVOX 340									
216 QUA TECH 326									
232 RAINBOW TECHNOLOGY 188									
327 SYSTEMS									
7 ADVANCED LOGIC RESEARCH 8, 9									
8 ADVANCED LOGIC RESEARCH 8, 9									
* AMPRO 166									
* AST RESEARCH 33									
* BINARY TECH 330									
42 BUS COMPUTER SYSTEMS 319									
298 CLUB AMERICAN TECH. 224, 225									
383 CUBIX 88IS-11									
290 DELL COMP. (N. AMERICA) 130-133									
291 DELL COMP. (INT'L). 130-133									
98 ENGINEERS COLLABORATIVE 349									
294 EVEREX SYSTEMS 28, 29									
295 EVEREX SYSTEMS 28, 29									
296 FORTRON CORP. 206									
297 FORTRON CORP. 206									
105 GATEWAY 2000 159									
* IBM CORP. 187									
139 KILA SYSTEM 54									

READER SERVICE

Advertising Supplement included with this issue:
Jameco Electronics (U.S. and Canada Subscribers)

* Correspond directly with company.

Inquiry No.	Page No.	Inquiry No.	Page No.	Inquiry No.	Page No.	Inquiry No.	Page No.
332	IBM/MS-DOS APPLICATIONS Miscellaneous	285	ZORTECH 171	384	DATRONIC 88IS-20	344	EDUCATIONAL/INSTRUCTIONAL
94	ECOSOFT 55	339	IBM/MS-DOS—COMMUNICATIONS	87	DISC INTERNATIONAL 332	416	BLYTH 88IS-38
391	HOPE CIRCUIT 88IS-33	53	COEFFICIENT SYSTEMS CO . 202	88	DISKOTECH 338	*	BYTE BACK ISSUES 88IS-28
333	IBM/MS-DOS APPLICATIONS Word Processing	54	COEFFICIENT SYSTEMS CO . 203	89	DISKETTE CONNECTION 325	*	BYTE BOOK CLUB 272,273
387	GAMMA PRODUCTIONS . 88IS-18	500	COMMUNICATINS RES.GRP. 88M/AT-3	91	DISKSTOGO 323	*	BYTE CIRCULATION 300
388	GAMMA PRODUCTIONS . 88IS-18	529	COMMUNICATINS RES.GRP. 88NE-15	93	DYNAMIC ELECTRONICS 325	*	BYTE CIRCULATION 88IS-38
334	IBM/MS-DOS—CAD	*	DATRAN CORP 88NE-6,7	512	D-DATA 88PC-9	*	BYTE SUB MESSAGE 168
18	AMERICAN SMALL BUSINESS . 25	*	DATRAN CORP 88PC-6,7	531	F & W COMM 88NE-14	*	BYTE SUB MESSAGE 88IS-22
22	AUTODESK 191	80	DCS (DIVERSIFIED COMP.) . 340	532	FIRST MICRO 88NE-17	*	BYTE SUB SERVICE 176
392	IES 88IS-24	109	GRAFFPOINT 330	389	GREY MATTER 88IS-17	*	BYTE TIPS 88MW-6
403	RHV 88IS-23	138	KEA SYSTEMS 330	115	HENSE & PARTNER 27	*	BYTE TIPS 88M/AT-4
278	WINTEK CORP 5	160	MEDIA CYBERNETICS 263	121	IC EXPRESS 328	*	BYTE TIPS 88NE-16
335	IBM/MS-DOS—LAN	161	MEDIA CYBERNETICS 263	128	JADE COMPUTER 331	*	BYTE TIPS 88SE-7
73	CORVUS SYSTEMS 82,83	165	MERIDIAN TECH 238	129	JAMECO 320,321	*	COMPUTERS FOR THE BLIND 88M/AT-2
336	IBM/MS-DOS—GRAPHICS	252	SOFTKLONE 228	130	JAWIN COMPUTER 334	*	COMPUTERS FOR THE BLIND 88NE-18
65	COMPUTER SUPPORT GRP. 96,97	253	SOFTRONICS 336	131	JAWIN COMPUTER 334	305	DATAPRO 246
106	GENERAL PARAMETRICS 149	340	OTHER APPLICATIONS Miscellaneous	134	J.D.R. MICRODEVICES . 344,345	140	KNOWLEDGE GARDEN 271
234	RIX SOFTWARE 50	272	VOYETRA TECH 340	135	J.D.R. MICRODEVICES . 348,347	*	MACMILLIAN BOOK CLUBS 48,49
235	RIX SOFTWARE 50	341	OTHER APPLICATIONS Languages	135	J.D.R. MICRODEVICES . 348	*	MCGRAW-HILL BOOKS . 88IS-39
337	IBM/MS-DOS—LANGUAGES	301	QUELO 283	394	KIRIN COMPUTERS 88IS-31	168	MICROCOM SYSTEMS 26
4	A + L MEIER-VOGT 255	254	SOFTWARE DEV. SYS. 177	494	KNAPCO 88SE-1	397	MICROPROCESS ENGR. 88IS-33
23	AVOCET SYSTEMS INC 210	342	OTHER APPLICATIONS Utilities	154	MACONLY, INC. 182	171	MICROSOFT PRESS 170
34	BORLAND CII	270	UNIVERSAL CROSS ASSBL. . 332	*	MCGRAW-HILL BOOKS . 88SW-3	172	MICROSOFT PRESS 170
35	BORLAND CII	343	MAIL ORDER/RETAIL	159	MEAD COMPUTER 333	194	OSBORNE/MCGRAW-HILL . 293
36	BORLAND 1	6	ADVANCED COMP. PROD. 342,343	162	MEGASOFT 334	517	PC SIG. 88PC-3
37	BORLAND 1	509	ALTEC 88PC-14	164	MEP(MICRO ELECT. PROD) . 330	251	SOFTDISK 10
83	DIGITALK 140,141	481	ALTEX ELECTRONICS 88MW-5	*	MICROCOMP.MKTG.COUNCIL 258	345	DESKTOP PUBLISHING
84	DIGITALK 140,141	476	ALTEX ELECTRONICS 88SW-5	*	MICROCOMP.MKTG.COUNCIL 88MW-7	515	MERLIN PUBLISHING 88PC-4
85	DIGITALK 142,143	*	AMERICAN DESIGN COMP. . 322	*	MICROCOMP.MKTG.CNCL . 88M/AT-8	*	MISCELLANEOUS
86	DIGITALK 142,143	16	AMERICAN SEMICONDUCTOR 340	*	MICROCOMP.MKTG.COUNCIL 88NE-20	117	HITECH EQUIPMENT 330
94	ECOSOFT 55	17	AMERICAN SEMICONDUCTOR 340	*	MICROCOMP.MKTG.COUNCIL . 88SE-5	*	INT'L PREVIEW SOCIETY 91
132	JENSEN & PARTNERS 169	378	ANALYTICAL ENGINES . 88IS-33	*	MICROCOMP.MKTG.COUNCIL 88SW-1	*	ROBT. TINNEY GRAPHICS . 88IS-34,35
143	LAHEY COMPUTER SYSTEMS 203	19	APPLIED DATA SYS 40	*	MICROMINT 324	*	ROBT. TINNEY GRAPHICS 88NE-22
157	MANX SOFTWARE SYSTEM 61	526	APPLIED PROG. ELECT. 88NE-8,9	*	MICROMINT 88IS-40	*	ROBT. TINNEY GRAPHICS 88SE-7
158	MARK WILLIAMS 30	30	B & W SYSTEMS INC 185	*	MICROMINT 88PC-12	*	ROBT. TINNEY GRAPHICS . 88SW-6,7
*	MICROSOFT 56,57	379	BCL 88IS-33	*	MICROMINT 88SE-8	*	ROBT. TINNEY GRAPHICS . 204
175	MIX SOFTWARE 237	*	BUYERS MART 310-318	*	MICROMINT 88SW-8	239	SAFWARE 330
539	PROSPERO SOFTWARE 88NE-2,3	*	CALIFORNIA DIGITAL 337	169	MICROPROCESSORS UNLTD . 338	404	SOFTTECH 88IS-30
413	WARREN POINT INT'L . 88IS-33	48	CLARION SOFTWARE 93	177	MONTGOMERY GRANT. 329	271	VICTORY ENTERPRISES 46
275	WHITEWATER GROUP, THE . 244	*	COMPARE COMPUTERS . 88MW-3	178	M.H.I. 256	346	OPERATING SYSTEMS
284	ZORTECH 17	*	COMPARE COMPUTERS 88NW-21	188	NORTHGATE COMP SYSTEMS 193	122	IGC 250
338	IBM/MS-DOS—UTILITIES	381	COMPUADD 88IS-5	189	NORTHGATE COMP SYS. 194,195	226	QUANTUM 87
5	A + L MEIER-VOGT 257	59	COMPUSAVE 327	192	ON-LINE STORE 328	240	SANTA CRUZ OPERATIONS . 165
33	BLAISE 35	530	COMPUTER AGE 88NE-23	503	OWL COMPUTER 88M/AT-6	299	SOFTWARE LINK, THE 31
*	CALEND 88IS-27	61	COMPUTER DISC WAREHOUSE 247	196	PACIFIC COMPUTER 327	300	SOFTWARE LINK, THE 31
44	CALIFORNIA SFTW. PRODS . 309	62	COMPUTER EXPO 216	197	PACIFIC COMPUTER 327		
45	CALIFORNIA SFTW. PRODS . 309	501	COMPUTER LANE 88M/AT-7	535	PC LINK 88NE-4,5		
51	CNS 98	510	COMPUTER LANE 88PC-13	201	PC PLUS 32		
52	CNS 98	63	COMPUTER MAIL ORDER 266,267	537	POWER COMPUTERS 88NE-19		
382	CREATIVSOFT 88IS-33	64	COMPUTER PRODUCTS CO . 100	400	PRECISION DATA 88IS-20		
76	CRESCENT SOFTWARE INC . 24	67	COMPUTER SURPLUS STORE 332	209	PRIORITY ONE 339		
113	HAMMERLY COMPUTER SERV. 71	68	COMPUTER WAREHOUSE 162	211	PROGRAMMERS CONNECTION 39		
136	KADAK 58	69	COMPUTER WAREHOUSE 162	212	PROGRAMMERS PARADISE . 53		
516	NU-MEGA TECHNOLOGIES 88PC-5	511	COMPUTOWN 88PC-10	213	PROGRAMMERS SHOP 201		
200	PAUL MACE SOFTWARE 213	70	CONTECH 332	261	S C SYSTEMS 261		
206	PETER NORTON 113	528	C.H.A.S. MICRO 88NE-18	238	SABINA INT'L 349		
207	PETER NORTON 113	*	DALLAS SOFTSTORE . 88SW-4	242	SCHWAB CORP 338		
227	QUARTERDECK 214,215			243	SCIENCE & ENGR. SFTW. . 95		
228	QUARTERDECK 214,215			245	SHAMROCK 175		
269	TURBO POWER 199			246	SILICON SPECIALTIES . 231		
*	VERMONT CREATIVE SFTW. . 223			247	SILICON SPECIALTIES . 231		

FREE Information Retrieval Service

To assist you in making your evaluations, purchasing decisions, or recommendations, you can request further information directly from the manufacturer or service company on products and services advertised in this issue. There is no charge, no obligation. Just complete and mail the attached post-paid, self-addressed reply card, and we'll do the rest.

- 1** Circle numbers on reply card which correspond to numbers assigned to items of interest to you.
- 2** Check all the appropriate answers to questions "A" through "F".
- 3** Print your name and address and mail.



NO POSTAGE
NECESSARY
IF MAILED
IN THE
UNITED STATES

BUSINESS REPLY MAIL
FIRST CLASS MAIL PERMIT NO. 176 DALTON, MA

POSTAGE WILL BE PAID BY ADDRESSEE

BYTE
READER SERVICE
PO Box 298
Dalton, MA 01227-0298
USA

Fill out this coupon carefully. PLEASE PRINT. Requests cannot be honored unless the zip code is included. This card is valid for 6 months from cover date.

A. What is your primary job function? (Check one only)

- 1 Business Owner, General Management, Administrative
- 2 MIS/DP, Programming
- 3 Engineering/Scientific, R&D
- 4 Professional (law, medicine, accounting)
- 5 Other

B. How many people does your company employ? (Check one only)

- 1 25 or fewer
- 2 26-99
- 3 100-499
- 4 500-999
- 5 1000 or more

C. Reason for request: (Check all that apply).

- 1 Business use for yourself
- 2 Business use for your company
- 3 Personal use

D. Your next step after information is received:

- 1 Purchase order
- 2 Evaluation
- 3 Specification/Recommendation

E. Please indicate the product categories for which you influence the selection or purchase at your (or your client's) company or organization. (Check all that apply).

- 1 Microcomputers
- 2 Peripherals
- 3 Software
- 4 Accessories and supplies

F. For how many microcomputers do you influence the purchase of products at your (or your client's) company or organization?

- 1 1
- 2 2-4
- 3 5-9
- 4 10 or more

CIRCLE FOR FREE INFORMATION

JULY 487RSU

1	2	3	4	5	6	7	8	9	10	11	12	13	14	15	16	17	18	19	20	21	22	23	24	25	26	27
28	29	30	31	32	33	34	35	36	37	38	39	40	41	42	43	44	45	46	47	48	49	50	51	52	53	54
55	56	57	58	59	60	61	62	63	64	65	66	67	68	69	70	71	72	73	74	75	76	77	78	79	80	81
82	83	84	85	86	87	88	89	90	91	92	93	94	95	96	97	98	99	100	101	102	103	104	105	106	107	108
109	110	111	112	113	114	115	116	117	118	119	120	121	122	123	124	125	126	127	128	129	130	131	132	133	134	135
136	137	138	139	140	141	142	143	144	145	146	147	148	149	150	151	152	153	154	155	156	157	158	159	160	161	162
163	164	165	166	167	168	169	170	171	172	173	174	175	176	177	178	179	180	181	182	183	184	185	186	187	188	189
190	191	192	193	194	195	196	197	198	199	200	201	202	203	204	205	206	207	208	209	210	211	212	213	214	215	216
217	218	219	220	221	222	223	224	225	226	227	228	229	230	231	232	233	234	235	236	237	238	239	240	241	242	243
244	245	246	247	248	249	250	251	252	253	254	255	256	257	258	259	260	261	262	263	264	265	266	267	268	269	270
271	272	273	274	275	276	277	278	279	280	281	282	283	284	285	286	287	288	289	290	291	292	293	294	295	296	297
298	299	300	301	302	303	304	305	306	307	308	309	310	311	312	313	314	315	316	317	318	319	320	321	322	323	324
325	326	327	328	329	330	331	332	333	334	335	336	337	338	339	340	341	342	343	344	345	346	347	348	349	350	351
352	353	354	355	356	357	358	359	360	361	362	363	364	365	366	367	368	369	370	371	372	373	374	375	376	377	378
379	380	381	382	383	384	385	386	387	388	389	390	391	392	393	394	395	396	397	398	399	400	401	402	403	404	405
406	407	408	409	410	411	412	413	414	415	416	417	418	419	420	421	422	423	424	425	426	427	428	429	430	431	432
433	434	435	436	437	438	439	440	441	442	443	444	445	446	447	448	449	450	451	452	453	454	455	456	457	458	459
460	461	462	463	464	465	466	467	468	469	470	471	472	473	474	475	476	477	478	479	480	481	482	483	484	485	486
487	488	489	490	491	492	493	494	495	496	497	498	499	500	501	502	503	504	505	506	507	508	509	510	511	512	513
514	515	516	517	518	519	520	521	522	523	524	525	526	527	528	529	530	531	532	533	534	535	536	537	538	539	540
541	542	543	544	545	546	547	548	549	550	551	552	553	554	555	556	557	558	559	560	561	562	563	564	565	566	567
568	569	570	571	572	573	574	575	576	577	578	579	580	581	582	583	584	585	586	587	588	589	590	591	592	593	594
595	596	597	598	599	600	601	602	603	604	605	606	607	608	609	610	611	612	613	614	615	616	617	618	619	620	621
622	623	624	625	626	627	628	629	630	631	632	633	634	635	636	637	638	639	640	641	642	643	644	645	646	647	648
649	650	651	652	653	654	655	656	657	658	659	660	661	662	663	664	665	666	667	668	669	670	671	672	673	674	675
676	677	678	679	680	681	682	683	684	685	686	687	688	689	690	691	692	693	694	695	696	697	698	699	700	701	702
703	704	705	706	707	708	709	710	711	712	713	714	715	716	717	718	719	720	721	722	723	724	725	726	727	728	729
730	731	732	733	734	735	736	737	738	739	740	741	742	743	744	745	746	747	748	749	750	751	752	753	754	755	756
757	758	759	760	761	762	763	764	765	766	767	768	769	770	771	772	773	774	775	776	777	778	779	780	781	782	783
784	785	786	787	788	789	790	791	792	793	794	795	796	797	798	799	800	801	802	803	804	805	806	807	808	809	810
811	812	813	814	815	816	817	818	819	820	821	822	823	824	825	826	827	828	829	830	831	832	833	834	835	836	837
838	839	840	841	842	843	844	845	846	847	848	849	850	851	852	853	854	855	856	857	858	859	860	861	862	863	864
865	866	867	868	869	870	871	872	873	874	875	876	877	878	879	880	881	882	883	884	885	886	887	888	889	890	891
892	893	894	895	896	897	898	899	900	901	902	903	904	905	906	907	908	909	910	911	912	913	914	915	916	917	918
919	920	921	922	923	924	925	926	927	928	929	930	931	932	933	934	935	936	937	938	939	940	941	942	943	944	945
946	947	948	949	950	951	952	953	954	955	956	957	958	959	960	961	962	963	964	965	966	967	968	969	970	971	972
973	974	975	976	977	978	979	980	981	982	983	984	985	986	987	988	989	990	991	992	993	994	995	996	997	998	999

Name _____
 Title _____
 Company _____
 Address _____
 City _____ State _____
 Zip _____ Telephone _____

OUR SILENTWRITER IS CREATING HEADLINES ON SEVERAL FRONTS.



Our Silentwriter™ LC890 is the first desktop publishing printer that gives you both popular standards for creating graphics and type: true Adobe PostScript® and LaserJet Plus emulation.

That alone would be enough to cause headlines. But we also added many more features to simplify desktop publishing. Like both Apple and IBM compatibility. *PC Week* stated, "the LC890 is actually better than having both an Apple LaserWriter Plus and an HP LaserJet Plus on your desk." Equally impressed, *PC Magazine* awarded it an "Editor's Choice." And cited it in their "Best of 1987" issue.

EDITOR'S CHOICE

PC MAGAZINE

NEC's SilentWriter Printer Boasts PostScript, HP LaserJet Plus Emulation

The new NEC SilentWriter LC-890 laser printer breaks new ground on several fronts. Until now, buyers of laser printers have been faced with a fundamental decision between...
 NEC's LC-890 printer, however, makes that issue a moot point—and adds new meaning to the term "full featured!" NEC combines the support of Adobe Systems...
 ...language w...
 ...ele l-

And because the Silentwriter has a simple, trouble-free printing mechanism, it will be creating headlines for years to come. In fact, it's twice as reliable as ordinary lasers, with an average life of 600,000 pages.

If you don't require the power of our LC890, consider the rest of the family. The LC850 for text applications and the LC860 Plus for text and less complex graphics.

To start producing your own headlines, call 1-800-343-4418 (in MA 617-264-8635). We'll send you reprints of all the great reviews and the name of the NECIS dealer nearest you.



NEC PRINTERS. THEY ONLY STOP WHEN YOU WANT THEM TO.

NEC

Circle 186 on Reader Service Card

**Tandy Computers:
Because there is
no better value.™**

The New Tandy® 5000 MC



**Our most powerful
80386 based computer
... made in America.**

The new Tandy 5000 MC Professional System is strictly business, from the look of its 256,000-color VGA graphics to the tactile feel of its keyboard.

Inside is pure performance, from the 80386 processor operating at 20 MHz to the fast memory with cache that provides RAM-fast access to your data.

The 5000 MC comes with a built-in 1.44MB 3 1/2" floppy drive. There's room inside for a second 3 1/2" drive (or hard drive) and two 5 1/4" floppy, hard or tape drives. Choose from ST-506 or ESDI—and SCSI support is coming.

Add a 20-MHz 80387 math coprocessor. Expand the memory to 16MB using two dedicated expansion slots, and you can still add up to five IBM® Micro Channel compatible expansion adapters.

And with its high-speed performance, the 5000 MC is a natural as the hub of a multiuser system or as a file server in a 3Com® office workgroup.

A Tandy 5000 MC with an 84MB hard disk drive is only \$6999. Check out the new alternative in personal computing.

- 20 MHz Intel® 80386 microprocessor
- 2MB RAM, expandable to 16MB
- Intel 82385 Memory Cache controller
- Built-in VGA graphics, as well as MCGA, CGA, and EGA
- Displays 256 colors, 64 shades of gray
- Five IBM Micro Channel™ expansion slots, plus two dedicated memory slots
- Built-in 1.44MB 3 1/2" disk drive plus three front-panel device slots
- High-speed/high-capacity disk options
- 80387 co-processor socket
- Supports MS-DOS®, MS® OS/2 and multiuser SCO® XENIX® operating systems

Send me a Tandy 5000 MC brochure.

Mail to: Radio Shack, Dept. 89-A-200
300 One Tandy Center, Fort Worth, TX 76102

Name _____
Company _____
Address _____
City _____ State _____
ZIP _____ Phone _____

Radio Shack®
COMPUTER CENTERS

A DIVISION OF TANDY CORPORATION

Price applies at Radio Shack Computer Centers and participating stores and dealers. Monitor sold separately. Intel/Reg. TM Intel Corp. IBM/Reg. TM and Micro Channel/TM IBM Corp. MS, MS-DOS and XENIX/Reg. TM Microsoft Corp. SCO/Reg. TM The Santa Cruz Operation. 3Com/Reg. TM 3Com Corp.

Circle 231 on Reader Service Card