

FALL EDITION

DEFENDER

DEFENDER



CAN-AMOFFROAD.COM

716001776

©2019 Bombardier Recreational Products Inc. (BRP). All rights reserved. ®, ™ and the BRP logo are trademarks of BRP or its affiliates. Printed in Canada.



can-am

ACCESSORIES, RIDING GEAR
& GENUINE PARTS

YOUR SEARCH FOR THE PERFECT ACCESSORIES STARTS & ENDS HERE

YOUR GUIDE TO ESSENTIAL FACTORY DEVELOPED AND APPROVED ACCESSORIES FOR YOUR CAN-AM.



FIT & COMPATIBILITY

Innovative accessories that are simply better, together. Fit, function and looks—right out of the box—with the peace of mind that the accessories you pick will work perfectly with hundreds of others.



QUALITY & RELIABILITY

Quality and reliability so good, it comes with a 1-year warranty. We stand strong behind our Genuine Can-Am accessories... because we can. Install them yourself or at an authorized dealer and immediately upgrade your off-road vehicle without worry.



STYLE & VISION

Can-Am designers develop vehicles and accessories that look and perform right because they're for riders, period. Everything in this guide is here to benefit your experience—nothing else made the cut.

BRP 1-YEAR LIMITED WARRANTY*

For new Can-Am accessories, genuine parts, and co-branded products sold through BRP¹. Includes items installed by you or an authorized BRP dealer.

can-am

¹Use other than which the product is designed for will void the product lifetime warranty. ²Applies only to BRP-made products or co-branded products made by accredited BRP partners (Lonestar Racing for Can-Am, S3 for Can-Am, Baja Designs for Can-Am, etc.). Purchased at an authorized BRP dealership / distributor or on a BRP-authorized online store. Other exclusions may apply, see complete limited warranty or contact your Can-Am off-road authorized dealer. ³Includes only BRP-approved aftermarket products and products made by currently accredited BRP partners. ⁴Unless otherwise stipulated or required by law. This limited warranty does not apply to factory installed accessories. This limited warranty does not apply on Evinrude parts and accessories. This limited warranty is effective as of March 1st, 2016.

OUTFIT YOUR PERFECT
DEFENDER WITH
HUNTING ACCESSORIES
P.6-7



PROMOUNT
— PLOWS

THE POWER TO PUSH FORWARD

Designed to work as efficiently as possible, Can-Am reimaged the plow from frame to blade.
P.71



APACHE
TRACK SYSTEMS

TERRAIN IS NO LONGER THE LIMIT

Get the most out of your Can-Am Defender this winter for all your endeavors.
P.68

4 ACCESSORIES

4 Built Inspirations

11 Roofs

14 Hard Cabs

15 Soft Cabs

16 Windshields & Mirrors

20 Doors

22 Rear Wind Protection

24 Skid Plates

25 Bumpers & Guards

33 LinQ: Easy On

Easy Off Cargo

39 Cargo & Storage

44 Racks & Holders

48 Lights

52 Audio & Communication
Systems

54 Electrical & Electronic
Accessories

59 Winches & Hitches

62 Seats

63 Performance

68 Track Systems

71 Promount Plows

75 Covers & Add-Ons

76 Tires

77 Rims

78 RIDING GEAR

80 Can-Am Sportswear

81 Mud Gear

82 Helmets

83 Dust Masks /

Communication Systems

84 Goggles / Gloves / Junior

85 Bags / Sizing Chart

86 Branded Merchandise

88 PARTS & MAINTENANCE

88 Genuine Can-Am Parts

94 XPS Oils & Maintenance



SIDE WIND DEFLECTORS

Fully redirect airflow to where it's needed with versatile wind deflectors.

P.19



LinQ
SYSTEM™

NO MORE BUNGEE'S & ROPES

P.33



Look for this logo throughout the catalogue for Expert recommendations on innovative, must-have, enthusiast-ready parts and accessories that will help you customize your perfect off-road machine.

ENGINE OIL CHANGE KIT

Want to save time and money? Use the ultra-convenient "all-in-one" DIY Engine Oil Change Kit

P.95



PLAY

STRENGTH AND STYLE, ALL IN ONE BOX:
DRAGONFIRE AND CAN-AM ACCESSORIES
FOR GROWN-UP FUN



DEFENDER PRO

Take your pick: Expertly-chosen STARTER, ADVANCE, and PEAK utility packages to take your Can-Am build to another level. Or simply mix and match and create your own package.

STARTER	715005276	ProVent Windshield	P.19	\$749.99
	715002922	Rear Polycarbonate Windshield	P.22	\$359.99
	715005754	Front Bumper	P.26	\$269.99
	715005777	Xtreme Front Bumper Plates	P.26	\$239.99
	715005774	Front Corner Protector	P.26	\$179.99
	715006012	Rear Bumper	P.28	\$244.99
	715002459	Side Mirror	P.19	\$99.99
	+			
ADVANCE	715006325	Soft Doors	P.21	\$989.99
	715006001	Fender Flares	P.29	\$259.99
	715003873	Headache Rack	P.40	\$229.99
	715005415	Cargo Bed Protectors & Tie Rails	P.28	\$269.99
	715003870	Adventure Roof Rack	P.44	\$514.99
	715004778	LinQ 8 Gal Cooler Box	P.36	\$359.99
	+			
PEAK	715006697	Skid Plate Kit	P.24	\$1,769.95
	715002019	Complete Overhead Audio System	P.53	\$844.99
	715004007	39" (99 cm) Double Stacked LED Light Bar (270W)	P.50	\$724.99
*Note that price does not include installation requirements and that part numbers may vary depending on vehicle model.				\$8,109.80



YOU CAN FINANCE THE PURCHASE OF ACCESSORIES

with the purchase and financing of your Defender. Ask your dealer for all the details.

HARD WORK

YOUR WORK STARTS HERE:
OUTFIT THE CAN-AM DEFENDER
TO HAUL, CARRY, AND DO EVEN MORE



DEFENDER MAX

Take your pick: Expertly-chosen STARTER, ADVANCE, and PEAK play packages to take your Can-Am build to another level. Or simply mix and match and create your own package.

STARTER	715003038	Sport Roof	P.11	\$714.99
	715002433	Half Windshield	P.17	\$239.99
	715006316	Half Doors (Max)	P.20	\$1,444.99
	715002423	Deluxe Headache Rack	P.39	\$359.99
	715002464	LinQ Tailgate Extension/Divider	P.36	\$229.99
	+			
ADVANCE	715005754	Front Bumper	P.38	\$269.99
	715005777	Xtreme Front Bumper Plates	P.25	\$239.99
	715006012	Rear Bumper	P.27	\$244.99
	715002421	Bed Wall Extenders	P.39	\$724.99
	715003665	3.5" (9 cm) Flood LED Lights	P.48	\$209.99
+				\$4,679.90
PEAK	715006064	LinQ Front Rack	P.38	\$379.99
	715004282	LinQ Low Profile Basket	P.35	\$169.99
	715006037	Rear Cargo Light	P.50	\$149.99
	715004905	Rear View Mirror & Camera Monitor	P.55	\$419.99
	715003095	Overhead Front Audio System	P.52	\$684.99
715006416	Can-Am HD 4500 Winch	P.59	\$309.99	
*Note that price does not include installation requirements and that part numbers may vary depending on vehicle model.				\$6,919.84



YOU CAN FINANCE THE PURCHASE OF ACCESSORIES

with the purchase and financing of your Defender. Ask your dealer for all the details.

HUNTING

YOUR ULTIMATE HUNTING RIG IS WITHIN REACH—IT'S JUST A MATTER OF OUTFITTING IT TO YOUR NEEDS



LinQ GUN AND TOOL HOLDER
2-IN-1 DESIGN EASY TO LOAD OUT & ADAPT FOR THE HUNT OR THE JOBSITE
P.45



CARGO BED WINCH
EASILY LOAD HEAVY GAME INTO THE CARGO BOX
P.60



DUAL GUN HOLDER
KEEP YOUR WEAPONS WITHIN REACH AND PROTECTED IN THE CABIN
P.45

STRONGHOLD GUN BOOT IMPACT[®] BY KOLPIN[®]
THE WORLD'S MOST POPULAR HARD GUN CASE SINCE 1973
P.46



DOUBLE GUN BAG
STRENGTH & PURPOSE: HEAVY-DUTY BAG BUILT STRONG AND MADE TO PROTECT
P.47



DEFENDER

Take your pick: Expertly-chosen STARTER, ADVANCE, and PEAK hunting packages to take your Can-Am build to another level. Or simply mix and match and create your own package.

STARTER	715002430	Sport Roof	P.12	\$429.99
	715002442	Flip Windshield - Hardcoated	P.18	\$884.99
	715006314	Half Doors	P.21	\$824.99
	715002851	Rear Wind Screen	P.23	\$94.99
	715002423	Deluxe Headache Rack	P.40	\$359.99
	715005466	LinQ Tool & Gun Holder	P.45	\$414.99
	715005449	Hanging Storage Box Kit	P.39	\$134.99
715005409	Fender Flares	P.29	\$309.99	
	+			\$3,454.92
ADVANCE	715005410	Rancher Front Bumper	P.27	\$499.99
	715004698	LinQ 8 Gal Cooler Box	P.36	\$359.99
	715003870	Adventure Roof Rack	P.44	\$514.99
	+			\$4,829.89
PEAK	715006696	Skid Plate Kit	P.24	\$1,374.96
	715003617	Front Rancher Body Side Protectors	P.28	\$164.99
	715002569	Rock Sliders	P.30	\$309.99
	715002935	4" Round LED Lights	P.49	\$369.99
715006037	Rear Cargo Light	P.51	\$149.99	
				\$7,199.81

*Note that price does not include installation requirements and that part numbers may vary depending on vehicle model.



YOU CAN FINANCE THE PURCHASE OF ACCESSORIES

with the purchase and financing of your Defender. Ask your dealer for all the details.

WINTER

THRIVE IN THE DEEPEST SNOW—
FOR WORK OR PLAY. YOUR
CAN-AM WAS BORN TO BE A
WINTER WARRIOR.



DEFENDER



Take your pick: Expertly-chosen STARTER and ADVANCE packages are the best way to quickly add cold-weather upgrades—plus plow and track kits for even more winter use. Or mix and match to create your perfect snow-ready Defender.

STARTER	715002432	Full Windshield - Hardcoated	P.18	\$559.99
	715006325	Soft Doors	P.21	\$989.99
	715002922	Rear Polycarbonate Window	P.22	\$359.99
	715005904	Defrost, Heat & Ventilation System	P.57	\$1,449.99
	+			\$3,229.96
ADVANCE	715006821	Fender Flares	P.29	\$214.99
	715003873	Headache Rack	P.40	\$229.99
	715003028	Bed Tool Box	P.43	\$329.99
	715002934	15" (38 cm) Double Stacked LED Light Bar	P.48	\$369.99
	715002456	Light Rack	P.51	\$159.99
	715003665	3.5" (9 cm) Flood LED Lights	P.49	\$209.99
	715004905	Rear View mirror & Camera Monitor	P.55	\$419.99
	715003837	Heated Steering Wheel	P.57	\$394.99
715005112	Heated Seat Cover (Driver)	P.58	\$124.99	
				\$5,809.87
TRACKS	715005103	Apache 360LT Tracks	P.70	\$4,639.99
	715005492	Apache 360 LT Tracks Mounting Kit	P.70	\$549.99
				\$10,999.85
PLOW	715006111	Warn VRX 45-S Winch	P.59	\$629.99
	715006301	Can-Am ProMount Flex2 72" Plow Kit	P.72	\$1,134.97
				\$12,764.81

*Note that price does not include installation requirements and that part numbers may vary depending on vehicle model.



YOU CAN FINANCE THE PURCHASE OF ACCESSORIES

with the purchase and financing of your Defender. Ask your dealer for all the details.

OPEN AIR COMFORT

Well-designed, effective **NEW** accessories that ensure comfort in the cabin and versatility for any task, drive, or adventure.

PROVENT WINDSHIELD

Complete ventilation control with factory fit and finish.

SEE P.19



UPPER VENT CHANNELS AIR INTO THE CABIN

LOWER VENTS DEFOG WINDSHIELD

HANGING STORAGE BOX KIT

3-Position mount and included crate to keep anything at hand.

SEE P.39



SIDE WIND DEFLECTORS

Get as much airflow as you need with simple, effective deflectors.

SEE P.19



CAN-AM ROOFS

Made with high-quality materials designed in concert with your Can-Am, our roofs create a strong, light, resilient barrier from the elements.



FIT & COMPATIBILITY



QUALITY & RELIABILITY



STYLE & VISION



BUILT FOR YOUR VEHICLE

Designed for perfect fit and finish and made with the same built-to-last quality found across our lineup.

100% integrated

into the design of all Can-Am cab components.



Make it **YOURS**

Compatible with other accessories to make your vehicle as unique as you are. Lights, windshields, doors, rear windows and more.



BIMINI ROOF WITH SUN VISOR

SPORT ROOF

- Robust injection-molded polypropylene construction.
- Provides added protection for rider and passenger from the elements.

Defender	Defender MAX
715002430	715003038
\$429.99	\$714.99



DELUXE SPORT ROOF

- Complete roof kit provides extra driver and passenger protection and also diminishes noise within the cab.
- Perfect fit and finish thanks to the seal kit and the liners included.
- Rear Roof Liner is not compatible with Rear Wind Protection.

Defender	Defender MAX
Kit includes:	Kit includes:
• Sport Roof	• Sport Roof
• Sport Roof Seal Kit	• Sport Roof Seal Kit
• Front Roof Liner	• Front Roof Liner
• Rear Roof Liner	• Rear Roof Liner
715002511	715003039
\$931.96	\$1,421.96

SPORT ROOF SEAL KIT

- (Not illustrated)
- Necessary when installing individual cab components with Sport Roof or when installing the Front and Rear Roof Liners.

Defender	Defender MAX
715003126	715003583
\$31.99	\$31.99

BIMINI ROOF WITH SUN VISOR

- Heavy-duty canvas made of UV-resistant polyester.
- Innovative soft top comes with a hard visor that allows for storage of rolled-up soft top and mounting of Light Rack.
- Quick and easy installation.

Defender	Defender MAX
• Not compatible for use with soft and rigid full doors.	■ 715003030 • Black
■ 715003418 • Black	\$494.99
\$309.99	



FRONT ROOF LINER

- Vehicle enhancement.
- Integrates seamlessly with roof-mounted light switch.
- Required for installation of roof mounted lights and of the audio systems.
- Allows a better integration of Windshield Wiper & Washer Kit.
- Seal Kit necessary when installing with Sport Roof (715003038 or 715002430).

Defender, Defender MAX
715003098
\$209.99



REAR ROOF LINER

- Quick and easy vehicle enhancement.
- Allows better integration of other accessories installed on the roof.
- Seal Kit necessary when installing with Sport Roof.

Defender	Defender MAX
• Needs to be installed with Sport Roof (715002430).	(Not illustrated)
715006334	• Needs to be installed with Sport Roof (715003038).
\$259.99	715006391
	\$464.99



Versatile Sport Roof options completely adapt your Defender for the elements.



DESIGN YOUR OWN HARD CAB OR SOFT CAB.

PICK THE ACCESSORIES OF YOUR CHOICE AND BUILD OR COMPLETE YOUR OWN CAB.



100% modular components designed to work together:

- ROOFS** P.12
- WINDSHIELDS** P.17
- DOORS** P.21
- REAR WINDOWS** P.22



↔

PICK YOUR PERFECT CAB WITH CAN-AM EXCLUSIVE INTERCHANGEABLE ENCLOSURE ACCESSORIES

CAB ENCLOSURE

- Rigid cab enclosure ideal for Defender XT vehicles that come stock with a roof, but also fits on Base and DPS models with the addition of a roof.
- Offers good driver and passenger protection from the elements.

- Included:**
- Flip Glass Windshield
 - Full Doors with Power Windows
 - Rear Window, Insulation Acoustic Kit
 - Window Harness
 - Roof Power Cable Kit
 - Hard Enclosure Roof Seal Kit

Defender XT
715006333
\$4,959.99

PREMIUM RIGID CAB ENCLOSURE

- Provides driver and passenger with the best protection from the elements and the cold, and features the most complete top-of-the-line accessories our product lineup has to offer.

- Included:**
- Deluxe Sport Roof Kit
 - Flip Glass Windshield with Wiper and Washer Kit
 - Full Doors with Power Windows
 - Rear Glass Window with Sliding Panel
 - Thermal Insulation Kit
 - Rear Full Doors
 - Wiper and Powered Windows Cable
 - Roof Power Cable
 - Rigid Cab Seal Kit

Defender MAX
715006332
\$9,694.99

- Included:**
- Deluxe Sport Roof Kit
 - Flip Glass Windshield with Wiper and Washer Kit
 - Full Doors with Power Windows
 - Rear Glass Window with Sliding Panel
 - Thermal Insulation Kit
 - Wiper and Powered Windows Cable
 - Roof Power Cable
 - Rigid Cab Seal Kit

Defender
715006330
\$6,079.99

SOFT CAB ENCLOSURE

- Protection for rider and passenger from the elements.

- Included:**
- Bimini Roof with Sun Visor (715002918 - Not sold separately / 715003030)
 - Full Windshield - Hardcoated
 - Soft Doors
 - Soft Rear Panel

Defender (2019 & prior)
■ 715002917 • Black
\$1,914.99

Defender MAX (2019 & prior)
■ 715003032 • Black
\$3,079.99

HYBRID CAB ENCLOSURE

(Not illustrated)

- Included:**
- Sport Roof
 - Full Windshield - Hardcoated
 - Soft Doors
 - Rear Polycarbonate Window
 - Rear Wind Protection Installation Seal Kit

Defender
■ 715006722 • Black
\$1,944.99

Defender MAX
■ 715006723 • Black
\$3,079.99

CAB INSULATION KIT

(Not illustrated)

- Neoprene insulation kit: A must for cold riding conditions.
- Helps keep the cold outside the cabin and the heat inside when the vehicle is equipped with a complete cab enclosure (soft or rigid).
- Standard on XT Cab models 2018 and up.

Defender (2019 & prior)
715004911
\$99.99



CAN-AM WINDSHIELDS

Enhance the fit, look, and comfort of your Defender with a factory-developed windshield to protect from the elements, the dusty trails, deep mud holes, and rocky terrain.



FIT & COMPATIBILITY



QUALITY & RELIABILITY



STYLE & VISION



FLIP GLASS WINDSHIELD

Allows you to quickly adapt to changing conditions by adjusting the windshield as you go.



100% integrated
Your Can-Am's standard profiled cage allows our accessories to install easily, with a perfect fit.



NEW

PROVENT WINDSHIELD

Add complete & effective airflow into the cabin that keeps every passenger comfortable while riding or working.

p.19



Makrolon[®] Coating

Our Full Windshield - Hardcoated is made of high-impact-resistant Makrolon[®] hardcoated polycarbonate to ensure a long life.



COMPLETE AIR FLOW CONTROL

3-position laminated FLIP GLASS WINDSHIELD

FLIP GLASS WINDSHIELD

- Curved and laminated glass full windshield in metal frame.
- Provides excellent optical clarity.
- Seals firmly against the cage and protects rider and passenger from the elements while allowing for controlled air flow.
- 3-position flip can be set at fully closed, ¼ open, or fully open.
- Gas-shock-assisted operation and pivots on 2 hinges located at the top of the windshield.
- Ideal for muddy conditions.
- Can be used with Windshield Wiper & Washer Kit (715001638).
- Not EC compliant.

Defender, Defender MAX
715002942
\$1,229.99



EXPERT CHOICE

Protection from the elements combined with 3-way flip convenience for controlling air flow.

FLIP GLASS WINDSHIELD WITH WIPER & WASHER KIT

- Curved and laminated glass full windshield in metal frame.
- Provides excellent optical clarity.
- Seals firmly against the cage and protects rider and passenger from the elements while allowing for controlled air flow.
- Flip windshield can be set fully closed or fully open according to your preference.
- Ideal for muddy conditions.
- Gas-shock-assisted operation and pivots on 2 hinges located at the top of the windshield.
- Single-speed wiper with washer fluid dispenser.
- Requires Wiper & Power Cable (710004462) and Power Cable (715003094).
- Not EC compliant.

Defender, Defender MAX
715002441
\$1,704.99



WINDSHIELD WIPER & WASHER KIT

- An ideal way to keep your windshield clear in rain, or while riding through mud and water.
- Includes single-speed wiper, washer fluid dispenser and windshield frame mount.
- Must be used with the Glass Windshield (715001303) or Flip Glass Windshield (715002942).
- Requires Wiper & Power Windows Cable (710004462) and Power Cable (715003094).
- Not EC compliant.

Defender, Defender MAX
715001638
\$574.99



WIPER & POWER WINDOWS CABLE

- (Not illustrated)
- Required to install Full Doors with Power Windows (715006331) and/or Windshield Wiper & Washer Kit (715001638).
- Necessary if you want to build your own cab enclosure from modular components.

Defender, Defender MAX (2019 & prior)
710004462
\$61.99



FLIP WINDSHIELD - HARDCOATED

- High-impact-resistant Makrolon[†] hardcoated polycarbonate full windshield in metal frame.
- Provides excellent optical clarity and better abrasion resistance.
- Seals firmly against the cage and protects rider and passenger from the elements while allowing for controlled air flow.
- 3-position flip can be set at fully closed, ¼ open, or fully open.
- Gas-shock-assisted operation.
- Ideal for muddy conditions.

Defender, Defender MAX

715002442

\$884.99



GLASS WINDSHIELD

- Curved and laminated glass full windshield in metal frame.
- Seals firmly against the cage and protects rider and passenger from the elements while providing excellent optical clarity.
- Must be used with Windshield Wiper & Washer Kit (715001638) to maintain clear visibility during severe riding conditions.
- Not EC compliant.

Defender, Defender MAX

715001303

\$929.99



FULL WINDSHIELD - HARDCOATED

- High-impact-resistant Makrolon[†] hardcoated polycarbonate full windshield.
- Provides excellent optical clarity and better abrasion resistance.
- Protects driver and passenger from the elements.
- Quick and easy tool-less installation or removal.

Defender, Defender MAX

715002432

\$559.99



FULL WINDSHIELD

- High-impact-resistant durable polycarbonate full windshield.
- Formulated to be non-yellowing, non-crazing, non-cracking with excellent UV resistance and optical clarity.
- Protects driver and passenger from the elements.
- Quick and easy tool-less installation or removal.

Defender, Defender MAX

715002431

\$369.99



HALF WINDSHIELD

- High-impact-resistant durable polycarbonate half windshield.
- Formulated to be non-yellowing, non-crazing, non-cracking with excellent UV resistance and optical clarity.
- Protects driver and passenger from the elements.
- Features reverse angle lip to deflect air flow.
- Quick and easy tool-less installation or removal.
- Not compatible with Soft Doors.

Defender, Defender MAX

715002433

\$239.99

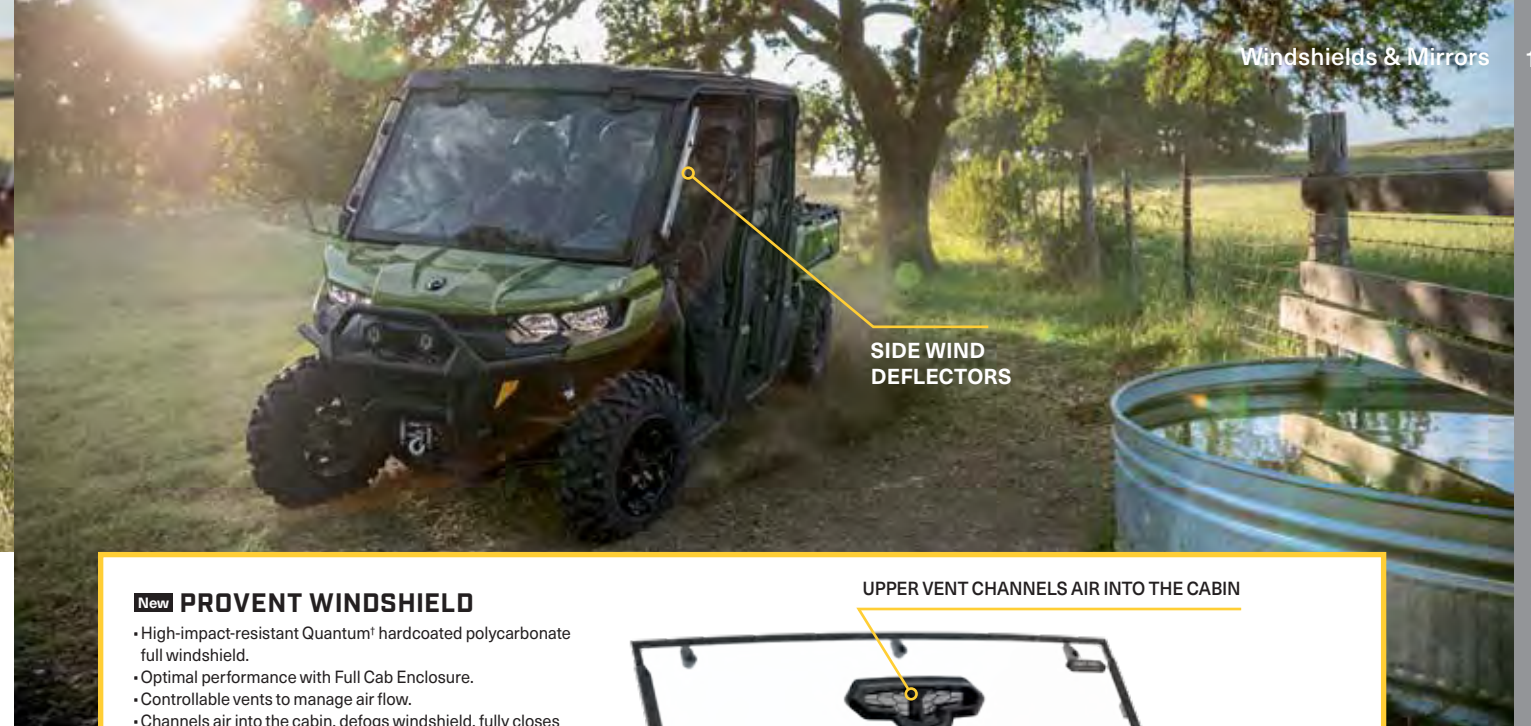

SIDE WIND DEFLECTORS

New PROVENT WINDSHIELD

- High-impact-resistant Quantum[†] hardcoated polycarbonate full windshield.
- Optimal performance with Full Cab Enclosure.
- Controllable vents to manage air flow.
- Channels air into the cabin, defogs windshield, fully closes to eliminate air flow.
- 2 lower vents and one upper vent (pre-filter installed).
- Provides excellent optical clarity and better abrasion resistance.
- Protects driver and passenger from the elements.
- Quick and easy tool-less installation or removal.
- Not compatible with wiper kits.

Defender

715005276

\$749.99

New SIDE WIND DEFLECTORS

- Clear polycarbonate air deflectors mount on each side of the cage.
- Not compatible with Full Doors.
- Sold in pairs.
- Compatible with all windshields.

Defender, Defender MAX

715005081

\$179.99

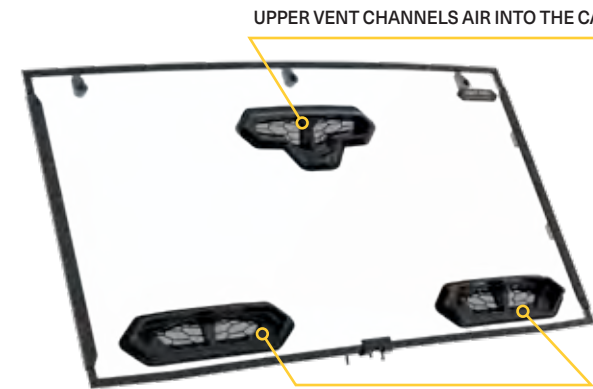

UPPER VENT CHANNELS AIR INTO THE CABIN

LOWER VENTS DEFOG WINDSHIELD

- Can be adjusted at three different positions for cabin air flow control when a full windshield is installed:
- 1) Outside deflection to reduce cabin air flow and turbulence.
- 2) Inside deflection to increase air flow in the cabin.
- 3) Windshield ventilation to reduce fog



1



2



3

EXPERT CHOICE

The shortcut to four-season comfort and versatility is combining the Provent Windshield with Side Window Deflectors for less fogging and remarkable cabin airflow.

SIDE MIRROR

- Molded heavy-duty aluminum mirror.
- Stays in place on rough trails.
- Ball-joint design for steady multi-angle adjustment and outstanding vision.
- Can be used with or without roof, windshield or door.
- Not for road use.
- Fits either side.
- Sold individually.

Defender, Defender MAX

715002459

\$99.99



PANORAMIC CENTER MIRROR

- Wide-angle convex mirror.
- Offers enhanced visibility.
- Can be used with or without roof or windshield and with cab enclosures.

Defender, Defender MAX

715003638

\$79.99



CAN-AM DOORS

Enhanced utility, looks, and protection from the elements on jobsites and trail rides alike.



FIT & COMPATIBILITY



QUALITY & RELIABILITY



STYLE & VISION



Perfect-fit reinforced half doors

Protect against the elements and cabin intrusions wherever you roam

100% integrated

Your Can-Am's standard profiled cage allows our accessories to install easily, with a perfect fit.

Tool-less removability

Once installed, our doors are easy to remove on hot and sunny days.

FULL DOORS WITH POWER WINDOWS

- Made from robust high-density polyethylene.
- Offer excellent protection from the elements.
- Easy to remove on hot and sunny days.
- Lockable doors with convenient integrated storage areas.
- Doors' curved-design provides even more roominess.
- Rear hinge wide opening for ease of ingress/egress in the cockpit.
- Power window delivers added ventilation.
- Compatible with all BRP windshields.
- Require Wiper & Power Windows Cable (710004462), Roof Power Cable (715003094) and Seal Kit (715003126).

Defender
715006331
\$3,719.99



REAR FULL DOORS

- Made from robust high-density polyethylene.
- Offer excellent protection from the elements.
- Easy to remove on hot and sunny days.
- Lockable doors with convenient integrated storage areas.
- Curved design provides even more roominess.
- Rear hinge opens wide for ease of ingress/egress in the cockpit.
- Pop-out window delivers added ventilation.
- Require Front Doors (715006331), Wiper and Power Windows Cables (710004462), Power Cable (715003094) and Sport Roof Seal Kit (715003583).

Defender MAX
715006329
\$3,469.99



HALF DOORS

- Half doors made of plastic.
- Metal frame for a higher level of fit and finish and rigidity.
- Rear hinge wide opening for ease of ingress/egress in the cockpit.
- Interior pockets and liners for more protection.

Defender (2 doors) (2019 & prior)
715003029
\$859.99
Defender (2 doors) (2020)
715006314
\$824.99
Defender MAX (4 doors) (2019 & prior)
715003031
\$1,479.99
Defender MAX (4 doors) (2020)
715006316
\$1,444.99



EXPERT CHOICE

Half Doors instantly transform your Defender for all-round use, including mud riding.

SOFT DOORS

- Bestop designed soft doors for Can-Am Defender.
- Weather-resistant soft doors reinforced with steel frame offer good protection from the elements.
- Made of heavy-duty UV-resistant canvas for excellent resistance to tear and abrasion.
- Rear hinge wide opening for ease of ingress/egress.
- Zip-down windows made of laminated polished vinyl material for added ventilation.
- Easily removable on hot sunny days.
- Compatible with roofs and mirrors.
- Soft Door Installation Kit (715006238 / 2X for MAX) is required for installation of 2019 & prior doors, on 2020 Defender models.

Defender (2 doors) (2019 & prior)
■ 715002919 • Black
\$974.99

Defender (2 doors) (2020)
■ 715006325 • Black
\$989.99

Defender MAX (4 doors) (2019 & prior)
■ 715003033 • Black
\$1,954.98

Defender MAX (4 doors) (2020)
■ 715006322 • Black
\$1,944.98

Defender, Defender MAX (Front passenger door only) (2020)
■ 715006676 • Black
\$544.99

Defender, Defender MAX (Front passenger door only) (2019 & prior)
■ 715006300 • Black
\$544.99





REAR GLASS WINDOW



SOFT REAR WINDOW

REAR GLASS WINDOW WITH SLIDING PANEL

- Made of high-strength tempered glass.
- Ideal for preventing backdraft of dust or rain in harsh environments.
- Sliding panel for enhanced ventilation.
- Quick and easy tool-less installation.
- Sport Roof (715002430 or 715003038) required for installation.
- Rear Wind Protection Installation Seal Kit (715006705) is required for installation on 2020 Defender models.

Defender, Defender MAX

715002440

\$724.99

REAR GLASS WINDOW

- Made of high-strength tempered glass.
- Ideal for preventing backdraft of dust or rain in harsh environments.
- Quick and easy tool-less installation.
- Sport Roof (715002430 or 715003038) required for installation.
- Rear Wind Protection Installation Seal Kit (715006705) is required for installation on 2020 Defender models.

Defender, Defender MAX

715003009

\$464.99

REAR POLYCARBONATE WINDOW

- High-impact-resistant polycarbonate window.
- Ideal for preventing backdraft of dust or rain in harsh environments.
- Quick and easy tool-less installation.
- Sport Roof (715002430 or 715003038) required for installation.
- Rear Wind Protection Installation Seal Kit (715006705) is required for installation on 2020 Defender models.

Defender, Defender MAX

715002922

\$359.99

REAR WIND SCREEN

- Full rear mesh screen reduces windshield backdraft for added cabin comfort.
- Installs quick and easily on roll cage.
- White Can-Am logo at top, to help maintain clear view.

Defender, Defender MAX

715002851

\$94.99

SOFT REAR WINDOW

- Clear, flexible window made of see-through vinyl.
- Resists cold cracking to -4°F (-20°C).
- Blocks windshield backdraft or dust and rain from entering, for added cabin comfort.
- Installs quick and easily on roll cage.
- White Can-Am logo at top, to help maintain clear view.

Defender, Defender MAX

715003249

\$109.99

SOFT REAR PANEL

- Weather-resistant soft rear panel with steel frame offers good protection from the elements.
- Made of heavy-duty UV-resistant canvas for excellent resistance to tear and abrasion.
- Tinted window made of laminated polished vinyl material.
- Resists cold cracking to -22°F (-30°C).
- Installs quick and easily on roll cage.
- Not compatible with the Bimini Roof with Sun Visor (715003418) (sold separately).

Defender, Defender MAX (2019 & prior)

715002920 • Black

\$209.99



REAR WIND PROTECTION INSTALLATION SEAL KIT

(Not Illustrated)

Defender, Defender MAX (2020)

715006705

\$15.99

ALUMINUM SKID PLATES

For ultimate durability and strength, all our Aluminum Skid Plates are made with High Strength 5052 H32 Aluminum 3/16" (4.5 mm) thick.

- ✓ Ultimate durability
- ✓ High strength

SKID PLATES

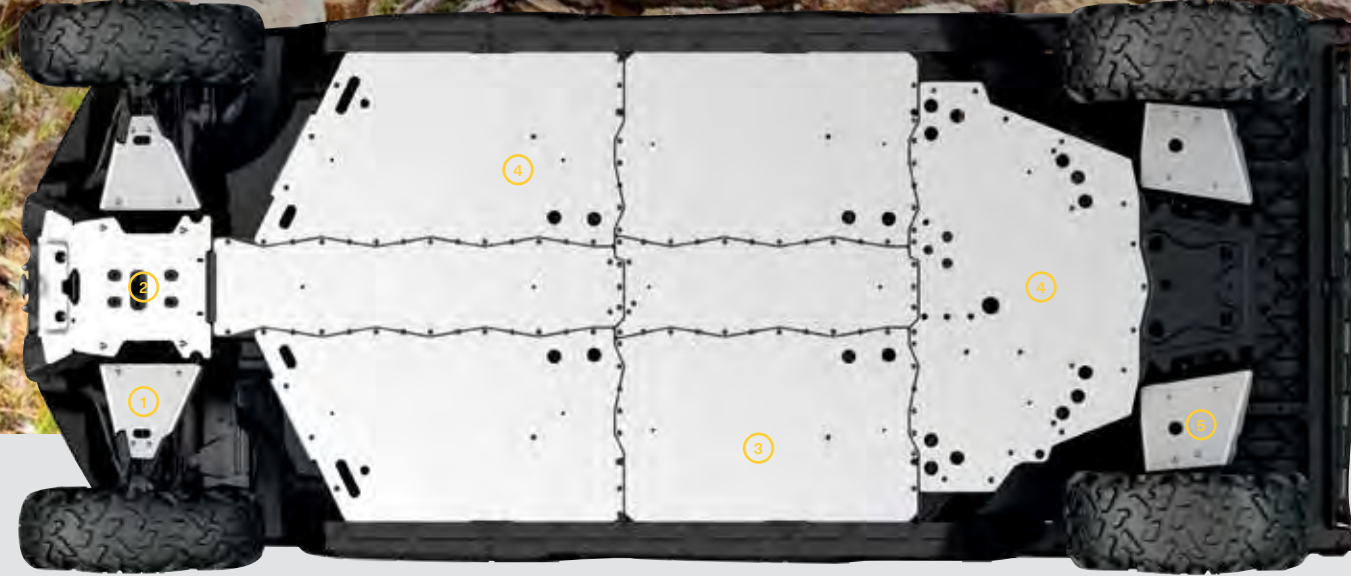

ACCESSORIES

Offer your Defender the full protection kit or get them individually	Defender, Defender MAX				
	2019 & PRIOR		2020		
	Base, DPS, XT, XT-P, XT Cab 2017 & prior & Hunting Edition	XT Cab 2018-2019, Lonestar Edition & X mr	Base, DPS (HD5 & HD8), XT (HD8) & PRO (HD8)	DPS 6x6, DPS PRO, XT PRO, DPS (HD10), XT (HD10) & XT-P	XT Cab, Hunting Edition, Lonestar Edition, Limited, & X mr
ALUMINUM SKID PLATE PROTECTION KIT	715003711 (Except MAX) \$1,284.96 715003712 (MAX only) \$1,679.95	715006977 (3up) \$1,469.96 715006978 (MAX) \$1,864.95	715006694 (Except MAX) \$1,284.96 715006695 (MAX only) \$1,679.95	715006696 (3up & 6x6) \$1,374.96 715006697 (MAX & PRO) \$1,769.95	715006979 (3up) \$1,669.95 715006980 (MAX) \$2,064.94
INDIVIDUAL ALUMINUM SKID PLATES					
1 FRONT A-ARM PROTECTORS • Extra underside protection for your vehicle's steering mechanism and suspension (A-Arm). • Sold in pairs. • Not compatible with Apache Track Systems.	715002444 \$154.99	715006975 \$199.99	715002444 \$154.99	715004387 \$154.99	715006975 \$199.99
2 FRONT SKID PLATE • Protects the front underside of your vehicle when riding in rough terrain conditions. • Adds style to the front of your vehicle.	715002447 \$194.99	715002447 \$194.99	715002447 \$194.99	715002447 \$194.99	715002447 \$194.99
3 CENTRAL SKID PLATE • Central skid plate kit includes central and lateral skid plates. • Ultra-durable protection for the underside of your vehicle. • Makes work easy in more demanding terrain. • Must be used with Underbelly Skid Plate Kit (715002446). • For MAX models only.	715003467 (MAX only) \$394.99	715003467 (MAX only) \$394.99	715003467 (MAX only) \$394.99	715003467 (MAX & PRO only) \$394.99	715003467 (MAX only) \$394.99
4 UNDERBELLY SKID PLATE KIT • Ultra-durable protection for the underside of your vehicle. • Makes work easy in more demanding terrain. • Kit includes lateral and rear skid plates.	715002446 \$774.99	715002446 \$774.99	New 715006197 \$774.99	New 715006197 \$774.99	New 715006197 \$774.99
5 REAR A-ARM PROTECTORS • Extra underside protection for your vehicle's suspension (A-Arm). • Sold in pairs. • Not compatible with Apache Track Systems.	715002445 \$159.99	715006976 \$299.99	715002445 \$159.99	715004388 \$249.99	715006976 \$299.99

CAN-AM BUMPERS

The strength to endure and the character to wear well—our bumpers are ready for it.

- FIT & COMPATIBILITY
- QUALITY & RELIABILITY
- STYLE & VISION

BUMPERS & GUARDS



HEAVY-DUTY LOOKS

Real capability—with a durable fit and finish you'll just have to age yourself

ACCESSORIES



Built for big lights

Fully-integrated bumper mounting plate gives rigid mounting and solid protection for multiple accessory lights.



Better corrosion protection

Can-Am bumpers are E-Coated for supreme corrosion protection inside and out.

100% integrated

Designed to seamlessly integrate with the style, fit, finish, and capability of your Defender.



FRONT BUMPER

- Heavy-duty 1.5" (3.8 cm) diameter steel-tube construction.
- Provides enhanced protection.
- Inside and outside anti-corrosion coating with durable powder coat finish.

Defender, Defender MAX (2019 & prior)
715002418
\$234.99

- Light-kit compatible.
- Required to install the Xtreme Front Bumper Plates, Front Rack and the Front Corner Protectors.

Defender, Defender MAX (2020)
715005754 **New**
\$269.99



Ready to lead you anywhere & compatible with auxiliary LED lights



XTREME FRONT BUMPER PLATES

- Made of high-strength heavy-gauge steel with rubber pads for increased protection.
- Inside and outside anti-corrosion coating with durable powder coat finish.
- Provide additional front-end protection.

Defender, Defender MAX (2019 & prior)
• Require Front Bumper (715002418) for installation.
715003005
\$194.99

Defender, Defender MAX (2020)
• Require Front Bumper (715005754) for installation.
715005777 **New**
\$239.99

FRONT CORNER PROTECTORS

- Heavy-duty 1.25" (3.2 cm) diameter steel-tube construction.
- Provide enhanced protection for front corners.
- Inside and outside anti-corrosion coating with durable powder coat finish.
- Sold in pairs.

Defender, Defender MAX (2019 & prior)
• Require Front Bumper (715002418) for installation.
715002833
\$169.99

Defender, Defender MAX (2020)
• Require Front Bumper (715005754) for installation.
715005774 **New**
\$179.99



715005774

RANCHER FRONT BUMPER

- The low front end protection and plates allow you to use your vehicle within cattle herds and guard the safety of both the vehicle and the animals.
- The flat front portion facilitates gently prodding cattle or pushing light objects, e.g. closing a fence.
- The full frontage coverage extends to provide an extra layer of defense to your headlights and radiator.
- Inside and outside anti-corrosion coating with durable powder coat finish.



Defender, Defender MAX (2019 & prior)
715002834
\$459.99



Defender, Defender MAX (2020)
• Improved approach angle.
• Compatible with front rack, snow plows, tire and track kits, winches.
715005410
\$499.99

XT FRONT BUMPER

- 1.5" (3.8 cm) diameter steel-tube construction.
- Provides light-duty protection.
- Inside and outside anti-corrosion coating with durable powder coat finish.
- Light-kit compatible.
- Standard on XT and XT Cab models 2018 and 2019.
- Not compatible with Xtreme Front Bumper Plates, Front Corner Protectors and LinQ Front Rack.

Defender, Defender MAX (2019 & prior)
715004407
\$164.99

XT-P FRONT BUMPER

- Heavy-duty 1.5" (3.8 cm) diameter steel-tube construction.
- Inside and outside anti-corrosion coating with durable finish.
- Provides additional front body protection.
- Integrated mount plate for auxiliary light installation.
- Winch Support Plate (705206371) is required for winch relocation at a higher position for easier access in muddy conditions (sold separately).
- Standard on XT-P models.

Defender, Defender MAX (2019 & prior)
715004408 · Can-Am Red **\$234.99**

Defender, Defender MAX (2019 & prior)
715006145 · Silver **New** **\$234.99**

X MR FRONT BUMPER

- Heavy-duty 1.5" (3.8 cm) diameter steel-tube construction.
- Inside and outside anti-corrosion coating with durable finish.
- Provides additional front body protection.
- Integrated winch support plate for winch relocation at a higher position for easier access in muddy conditions or for auxiliary lights.
- Includes a front tow hook.
- Standard on X mr models.
- Winch sold separately.

Defender, Defender MAX (2019 & prior)
715004405 · Black **\$264.99**

715004406 · Sunburst Yellow **\$284.99**

Defender, Defender MAX (2020)
715006143 · Black **New** **\$264.99**

715006144 · Green **\$284.99**





FRONT BODY SIDE PROTECTORS

New CARGO BED PROTECTORS & TIE RAILS

- Heavy-duty 1.5" (3.8 cm) diameter steel-tube construction.
- Reliable cargo box protection and tie-down attachment point to secure large loads.
- Anti-corrosion coating with durable powder coat finish.
- Designed to stay in place when cargo bed side walls are removed.

Defender 6x6 & PRO models

715005415

\$269.99



FRONT BODY SIDE PROTECTORS

- Heavy-duty 1.25" (3.2 cm) diameter steel-tube construction.
- Front side protection for farm, ranch and forestry applications.
- Offer complete front body protection.
- Inside and outside anti-corrosion coating with durable powder coat finish.
- Sold in pairs.



FRONT BODY SIDE PROTECTORS

- Require Front Bumper (715002418 or 715005754) with Front Corner Protectors (715002833 or 715005774) and Rock Slider (715002569 or 715003040 for MAX models) for installation.

Defender, Defender MAX

715003450

\$129.99

FRONT RANCHER BODY SIDE PROTECTORS

- Require Rancher Bumper (715002834/715005410) and Rock Sliders (715002569 or 715003040 for MAX models) for installation.

Defender, Defender MAX

715003617

\$164.99

REAR BUMPER

- Heavy-duty 1.5" (3.8 cm) diameter steel construction and integrated tubular design.
- Increased protection of rear box and lower box corner while allowing normal tailgate function.
- Anti-corrosion coating with durable powder coat finish.
- Required to install Rear Body Side Protector (715003055).
- Rear bumper Adapter (715006060) is required for installation on the Defender 6x6 & PRO models.

Defender, Defender MAX

715006012

\$244.99



REAR BUMPER ADAPTER

- (Not illustrated)
- Required to install the Rear Bumper on Defender models with the long box.

Defender 6x6 & PRO models

715006060

\$39.99

REAR BODY SIDE PROTECTORS

- Heavy-duty 1.5" (3.8 cm) diameter steel-tube construction.
- Reliable cargo box protection.
- Inside and outside anti-corrosion coating with durable powder coat finish.
- Compatible with fender flares.
- Integrated brush and low-lying branch deflector.
- Require Rear Bumper (715006012 or 715002419) for installation.
- Sold in pairs.

Defender, Defender MAX (except 6x6 & PRO)

715003055

\$174.99



AGGRESSIVELY PROFILED TO KEEP MUD, DEBRIS, AND SNOW OUTSIDE THE VEHICLE

FENDER FLARES

- Robust injection-molded polypropylene construction.
- Perfect for keeping mud and debris outside the vehicle.
- Include front and rear extension, and all mounting hardware.
- Ideal for track equipped vehicles.

Defender Defender MAX (2019 & prior)

715002424

\$209.99

Defender (except 6x6 & PRO), Defender MAX 2020

715006821

\$214.99

Defender 6x6

715005409 **New**

\$309.99

Defender PRO

715006001 **New**

\$259.99



SPORT FENDER FLARES

- Sleek fender flares just the right size to reduce mud and debris kick-up from your tires.
- Robust injection-molded polypropylene construction.
- Include front and rear extension, and all mounting hardware.

Defender (except 6x6 & PRO), Defender MAX

715003898

\$209.99





S3
FOR *can-am*

WHEN IT COMES TO MUD-MASTERING ACCESSORIES, **S3** HAS THE EDGE IN DELIVERING PERFECT-FIT WINCH-READY BUMPERS FOR WORK, PLAY, AND RECOVERY

Closed course dedicated for mud riding.

ROCK SLIDERS

- Heavy-duty rock sliders made of painted 3/16" (5 mm) aluminum with an integrated step for elevated cargo box access.
- Protect vehicle's sides and undercarriage against large obstacles.
- Lodge tight up against vehicle body for better clearance from obstacles.
- Not compatible with other rock sliders.
- Sold in pairs.
- Standard on Defender X mr, Defender MAX X mr and Defender XT-P models.

Defender (2019 & prior)	Defender 2020
■ 715004409 · Black	■ 715006671 · Black <small>New</small>
\$389.99	■ 715006675 · Green <small>New</small>
■ 715004410 · Sunburst Yellow	■ 715006672 · Red <small>New</small>
■ 715004411 · Can-Am Red	■ 715006674 · Silver <small>New</small>
\$399.99	■ 715006673 · Yellow <small>New</small>
Defender MAX (2019 & prior)	\$399.99
■ 715005020 · Black	Defender MAX 2020 & Defender PRO
\$579.99	■ 715006721 · Black
	\$579.99



715006675

ROCK SLIDERS

- Protect vehicle's sides and undercarriage against large obstacles.
- Made of heavy-duty 1.5" (3.8 cm) diameter steel tubing.
- Inside and outside anti-corrosion coating with durable powder coat finish.
- Integrated step for easy cargo box access.
- Sold in pairs.

Defender, Defender 6x6	Defender MAX, Defender PRO
■ 715002569 · Black	■ 715003040 · Black
\$309.99	\$369.99



MUD FLAPS

- Keep mud and debris out of cargo area and protect trailer or vehicles behind you.
- Add aesthetic appeal to your vehicle.
- Made of EPDM rubber.
- Require Rear Bumper (715006012 or 715002419) for installation.
- Sold in pairs.

Defender, Defender MAX
715003041
\$129.99



S3 FRONT WINCH BUMPER

- Made of 1.5" (3.8 cm) diameter steel tubing with durable powder coat finish.
- Specifically developed for mud riding enthusiasts.
- Integrated mounting plates accommodate all winches.
- Allows higher winch position to avoid winch immersion in mud.
- Added body protection.
- Not compatible with LinQ Front Rack, Removable Winch Mounting Kit, Super-Duty Plow Push Frame Extension and Plow Pulley.
- "S3 for Can-Am" branded.
- Winch not included.

Defender, Defender MAX (2019 & prior)
■ 715003779 · Black
■ 715005092 · Sunburst Yellow
\$589.99



S3 REAR WINCH BUMPER

- Made of 1.5" (3.8 cm) diameter steel tubing with durable powder coat finish.
- Specifically developed for mud riding enthusiasts.
- Integrated mounting plates for winches and towing anchor points.
- Added body protection.
- Not compatible with Apache 360 LT Track System and Removable Winch Mounting Kit.
- Compatible with Defender winches (Rear Winch Electrical Harness required).
- "S3 for Can-Am" branded.

Defender, Defender MAX (2019 & prior)
■ 715003782 · Black
■ 715005123 · Sunburst Yellow
\$589.99



REAR WINCH ELECTRICAL HARNESS

- (Not illustrated)
- Required for the installation of a winch on the S3 Rear Winch Bumper.
- Compatible with complete Defender winch lineup.

Defender, Defender MAX (2019 & prior)
715004233
\$169.99

S3 NERF BARS

- Made of 1.5" (3.8 cm) diameter steel tubing with durable powder coat finish.
- Specifically developed for mud riding enthusiasts.
- Protect vehicle's lower sides without affecting ground clearance.
- Integrated step makes ingress easier.
- Not compatible with Front Body Side Protectors, Front Rancher Body Side Protectors and Apache 360 LT Track System.
- "S3 for Can-Am" branded.

Defender, Defender 6x6	Defender MAX, Defender PRO
■ 715003783 · Black	■ 715004349 · Black
■ 715005094 · Sunburst Yellow	■ 715005124 · Sunburst Yellow
\$399.99	\$579.99





EASY ON EASY OFF CARGO

A BRP exclusive, LinQ is a tool-less system for near-instant installation of accessories. Quickly, easily install and remove LinQ accessories to transform your machine to fit the moment.

- FIT & COMPATIBILITY**
- QUALITY & RELIABILITY**
- STYLE & VISION**

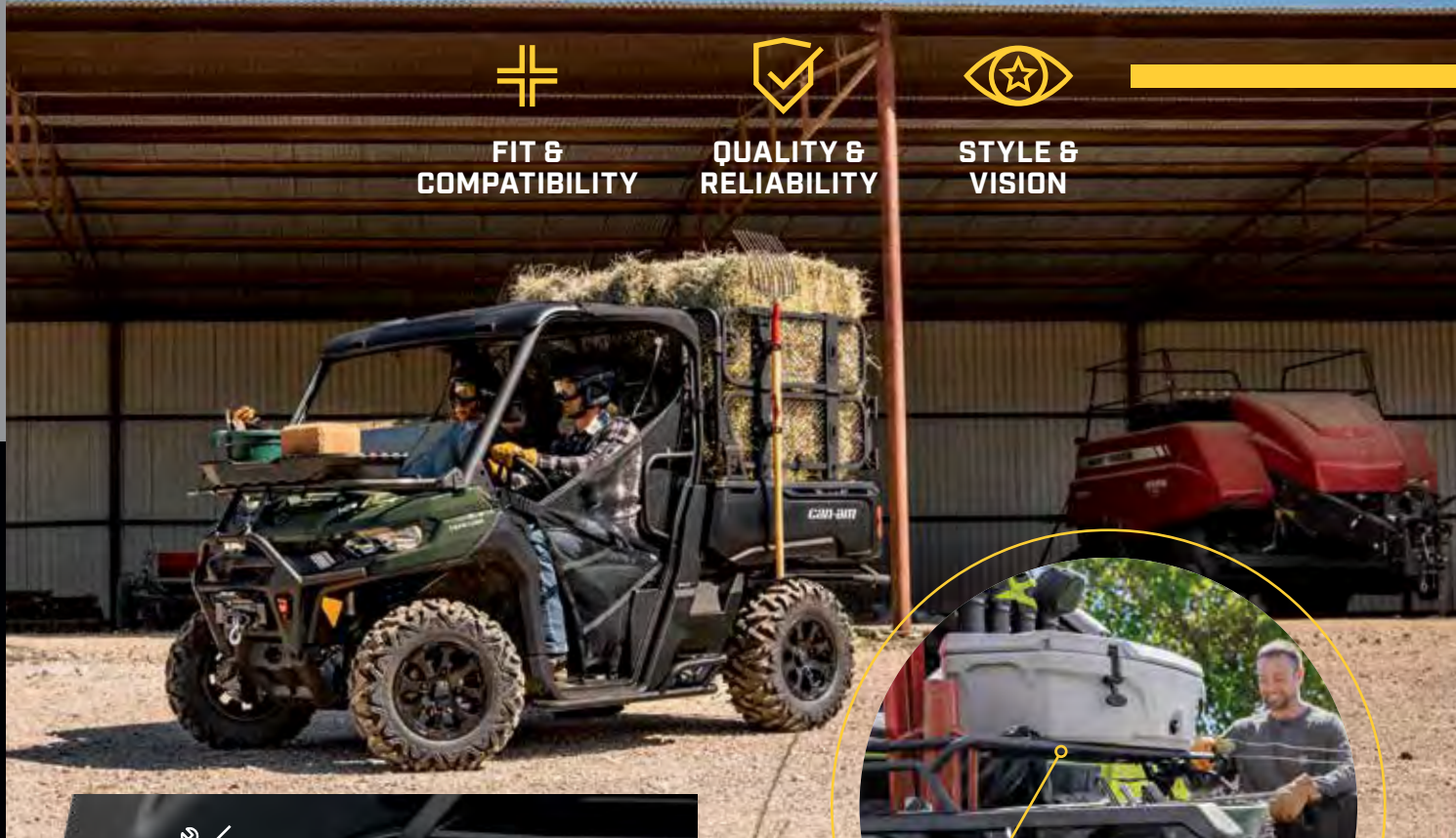

HELP FOR A HARD DAY'S WORK

LinQ trunk boxes, rack extensions, bags, baskets, and gear grips attach quickly to help you get the job done.

TOOL-LESS

Twist LinQ fasteners and go!



LinQ ACCESSORY TYPES

- **LinQ** with 16" base accessories are mounted with LinQ anchors 16 inches apart, ideal for Can-Am ATV and SSVs, Sea-Doo watercraft, and Ski-Doo snowmobiles.
- **LinQ** with 36" base accessories are most commonly used as part of LinQ racks for Can-Am Off-Road vehicles.

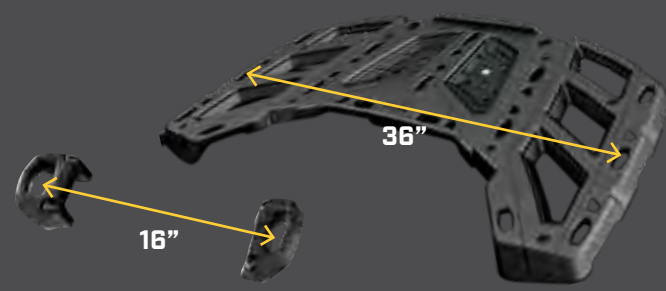

LinQ ACCESSORIES

- No tools needed: Quickly install and remove accessories by hand
- Equip your Can-Am for specialized tasks in no time
- Sturdy mounting system that holds up to the roughest terrain

Mounting location and requirements

Cargo Bed (long box bed LinQ)	LinQ Cargo Rack 715004281	Adventure Roof Rack 715003870 / 715004391

LinQ ACCESSORIES WITH 16" BASE P. 34

- LinQ anchors mounted 16 inches apart, center-to-center.
- Lower loading capacity than the 36" base accessories.
- Can be used on Can-Am ATV and SSV vehicles, Sea-Doo watercraft and Ski-Doo snowmobiles.

	LinQ 4.2 GAL (16 L) COOLER 295100698	LinQ Cargo Base Kit 860201806 + LinQ Base Installation Kit 860201812	LinQ Cargo Base Kit 860201806	Not compatible
	LinQ TOOL BOX 715004301	LinQ Base Installation Kit 860201812	No further requirements	No further requirements
	LinQ SR 5.5 GAL (21 L) BAG 860201740			
	LinQ 4.5 GAL (17 L) SPORT BAG 860201678			
	New LinQ DRY BAG 715002875			Not compatible

LinQ ACCESSORIES WITH 36" BASE P. 35-36

- Mounts on LinQ racks often used by Can-Am ORV vehicles.
- Higher loading capacity than the 16" base accessories.
- Usage is limited to Can-Am ORV vehicles.

	LinQ 12 GAL (45L) CARGO BOX 715003879	Not compatible	No further requirements	No further requirements
	LinQ 23 GAL (86L) TRUNK BOX 715004923			
	LinQ 11.5 GAL (43L) AUDIO CARGO BOX 715003018			
	LinQ 8 GAL (30L) COOLER BOX 715004778 • Black / 715004698 • Grey		No further requirements	Not compatible
	LinQ PREMIUM STORAGE BAG BY OGIO 715002923 • Black / 715003248 • Camo			
	LinQ HEAVY-DUTY BASKET 715001215			No further requirements
	LinQ LOW PROFILE BASKET 715004282			

LinQ RACKS & HOLDERS P. 41

	LinQ TOOL HOLDER 715003059	No further requirements	No further requirements	Side wall installation: LinQ Adapters 715003058
--	--------------------------------------	-------------------------	-------------------------	--

EQUIP YOUR DEFENDER FOR ADDED CARGO CAPACITY AND IMPROVED RIDE OFF-ROAD



LinQ DRY BAG



LinQ 12 GAL (45L) CARGO BOX

SHOWN HERE WITH:
 ADVENTURE ROOF RACK (P.43),
 SPARE TIRE WITH TIE-DOWNS (P.43)
 LinQ TOOL HOLDER (P.40) &
 4" (10 CM) LED LIGHTS (P.48)



LinQ ACCESSORIES WITH 16" BASE

LinQ 4.2 GAL (16 L) COOLER

- LinQ-mounted weather-resistant 4.2 Gal (16 L) cooler.
- Rotomolded construction for exceptional rigidity and durability.
- Premium-quality foam insulation for optimal ice retention.
- Sea-doo: marinized LinQ for salt water uses.

See table for installation location and requirements.

Defender, Defender MAX
 295100698
\$304.99



One of the most versatile and popular coolers on the market made for rugged use.

LinQ TOOL BOX

- High precision injected HDPE construction provides rigidity and durability.
- 5 Gal (19 L) maximum capacity.
- Weather-resistant, sealed and lockable cover.
- Sea-doo: marinized LinQ for salt water uses.

See table for installation location and requirements.

Defender, Defender MAX
 715004301
\$144.99



LinQ SR 5.5 GAL (21 L) BAG

- Semi-rigid expandable bag.
- 5.5 Gal (21L) capacity.
- LinQ Cargo Base Kit (860201806) included.

See table for installation location and requirements.

Defender, Defender MAX
 860201740
\$189.99



LinQ ACCESSORIES WITH 36" BASE

LinQ 12 GAL (45L) CARGO BOX

- Holds cargo safely and securely while riding.
- See table for installation location and requirements.

Defender, Defender MAX
 715003879
\$219.99



LinQ 23 GAL (86L) TRUNK BOX

- Lockable and weather-resistant.
 - Holds cargo safely and securely while riding.
- See table for installation location and requirements.

Defender, Defender MAX
 715004923
\$XX.XX



LinQ 4.5 GAL (17 L) SPORT BAG

- 4.5 Gal (17 L) capacity.
- Rigid bottom, semi-rigid top.

See table for installation location and requirements.

Defender, Defender MAX
 860201678
\$174.99



New LinQ DRY BAG

- Fully waterproof roll-top dry bag will securely store and confine your equipment.
- LinQ mounted using heavy-duty rigid plastic base.
- High capacity storage solution (40L).
- Bottom foam liner for additional equipment protection.
- Integrated handle for easy transportation on/off the vehicle.
- LinQ Cargo Base Kit (860201806) included.
- Sea-doo: marinized LinQ for salt water uses.

See table for installation location and requirements.

Defender, Defender MAX
 715002875
\$189.99





LinQ ACCESSORIES WITH 36" BASE

LinQ 11.5 GAL (43L) AUDIO CARGO BOX

- An affordable and quick solution for adding music and storage to your next ride. The rear installation does not use up any cab space and allows easy listening at an average speed.
- Mounts on/off easily to hold/carry cargo safely and securely.
- The Bluetooth enabled receiver and 6.5" (16.5 cm) speakers are smartly concealed and integrated in the cover.
- Automatic shut-off function protects your battery by turning the system off after 10 minutes of inactivity.
- Backlit control panel perfect for night riding.
- Water-resistant speakers.

See table for installation location and requirements.

Defender, Defender MAX

715003018

\$574.99



LinQ 8 GAL (30L) COOLER BOX

- Installs without vehicle modification.
- Rotomolded construction provides exceptional rigidity and durability.
- Premium-quality foam insulation for optimal ice retention.
- Integrated, fully-removable compartment protects food.
- Robust rubber latches keep the cover tightly closed.
- Weather-resistant
- Convenient drain plug.

See table for installation location and requirements.

Defender, Defender MAX

715004698 • Grey

715004778 • Black

\$359.99



LinQ PREMIUM STORAGE BAG BY OGIO

- 17.2 Gal (65 L) capacity semi-rigid cargo bag ideal for carrying anything you need on your vehicle.
- Buckle and elastic closure with a rubber seal that protects dust from entering the bag.
- 3-section lid for partial or full access to your bag.
- Inside separators for optimal bag organization.

See table for installation location and requirements.

Defender, Defender MAX

715002923 • Black

\$394.99

715003248 • Mossy Oak

Break-Up Country Camo

\$464.99



Inside separators for optimal bag organization

LinQ HEAVY-DUTY BASKET

- Made of high-strength, low-alloy steel.

See table for installation location and requirements.

Defender, Defender MAX

715001215

\$219.99



LinQ LOW PROFILE BASKET

- Low profile, open basket increases cargo space.
- Perfect for easy access to tools, rope, winch and plow accessories.
- Multiple bungee cord and tie-down anchor points.
- Made of impact-resistant injected polypropylene.

See table for installation location and requirements.

Defender, Defender MAX

715004282

\$169.99



LinQ TAILGATE EXTENSION FOR LONG BOX

- Adds rear cargo capacity when the tailgate is open.
- Steel-tubing-system-style barrier mounts on top of the bed walls using the easy, tool-less LinQ System.
- Can be mounted to serve as cargo divider at different locations along the bed wall while preventing larger items from falling off the back.
- Stores neatly out of the way and offers additional cab area protection since it can be mounted upside down on the front bed wall as a mini headache rack.
- Inside and outside anti-corrosion coating with durable powder coat finish.

Defender, Defender MAX (except 6x6 and PRO models)

715002464

\$229.99

Defender 6x6 & PRO

715005412

\$249.99



Cargo divider



Headache rack



EXPERT CHOICE

Stretch your cargo capability where it counts with the versatile tool-less twist LinQ fasteners.

LinQ TIRE HOLDER

- Cargo box spare-tire holder.
- Heavy-duty steel construction.
- Inside and outside anti-corrosion coating with durable powder coat finish.
- Mounts on top of the bed walls using the easy, tool-less LinQ System.
- Compatible with Bed Wall Extender.
- Uses BRP standard wheel bolt pattern to mount tire (nuts included).
- Accommodates BRP tires up to 28" (wheel not included).
- Quickly allows installation in multiple positions thanks to the LinQ System.

Defender (except 6x6 & PRO models), Defender MAX

715003448

\$179.99





LinQ FRONT RACK

- Rugged looking front rack mounts on top of vehicle hood and provides additional storage.
- Heavy-duty 1.25" (3.2 cm) diameter steel-tube construction.
- Inside and outside anti-corrosion coating with durable powder coat finish.
- Flip-up configuration provides easy access to service area.
- Allows the installation of LinQ accessories (especially for use with LinQ Low Profile Basket (715004282)).
- Kit includes LinQ Base.
- Multiple bungee cord and tie-down anchor points.
- Requires Rancher Bumper (715002834/715005410) or Front Bumper (715002418 or 715005754) for installation.
- A great place to store tools while working in the field.

Defender, Defender MAX (2019 & prior)

715004312

\$379.99

Defender, Defender MAX (2020)

715006064

\$379.99



Allows the installation of LinQ Low Profile Basket, see p.36

LinQ CARGO RACK

- Strong, durable steel rack.
- Easy and tool-less installation thanks to the LinQ System.
- Allows the installation of LinQ accessories.
- 2 racks can be installed at the same time.
- Allows multi-level storage on cargo bed, accommodates 5 Gal (19L) bucket.
- Helps keep cargo securely in place.
- Multiple bungee cord and tie-down anchor points.
- Kit includes LinQ Base.
- Provides more usable space in the cargo box.
- Extends vehicle cargo options.

Defender, Defender MAX

715006140

\$319.99



LinQ CARGO BASE KIT

- Unique mounting fastener usable on any LinQ System accessory.
- Included: 2 LinQ Cargo bases and hardware.

Defender, Defender MAX

860201806

\$29.99



LinQ REPLACEMENT PART

- Unique mounting fastener usable on any LinQ System accessory.
- Tool-less installation and removal.
- Sold in pairs.

Defender, Defender MAX

715001707

\$21.99



LinQ BASE INSTALLATION KIT

- Required to install LinQ Cargo Base Kit on the cargo bed.

Defender 6x6, Defender PRO

860201812

\$XX.XX



New HANGING STORAGE BOX KIT

- Versatile rack designed to hold a standard storage box.
- Fully adjustable, the rack can be tailored to hold the crates in multiple positions: Headache rack position, inside the box along the sidewall, and outside the box along the side wall.
- Includes Can-Am branded storage box.

Defender, Defender MAX

715005449 • Black

\$134.99



New CAN-AM STORAGE BOX

- (Not illustrated)
- Conventional 13" x 13" plastic storage box with Can-Am branding.
- Perforated bottom allows water and debris to escape.

Defender, Defender MAX

708303237 • Black

\$12.99

New EXTERIOR CARGO REINFORCEMENT PANEL

- (Not illustrated)
- Plate that attaches to the bed side to further support and protect bed wall when in outward position.
- Recommended use of the Hanging storage box and/or gun & tool holder when installed outside of the bed wall (Except Defender 6x6 & PRO).

715006198

\$49.99



PROTECTION AND CAPABILITY READY FOR THE ROUGH STUFF



RACKS & HOLDERS

DELUXE HEADACHE RACK

- Protects cab components from cargo load.
- Increases box capacity when used in tandem with the Bed Wall Extender (715002421).
- Required to install the Bed Wall Extender (715002421).
- Compatible with gear rail.

Defender, Defender MAX

715002423

\$359.99

HEADACHE RACK

- Full rear roll cage coverage offers a heavy-duty steel protective line of defense between your head or cab's components and the load in your cargo bed.
- Rack's open design helps maintain a clear rear view.
- Not compatible with Bed Wall Extender.
- Compatible with gear rail.

Defender, Defender MAX

715003873

\$229.99



Work and haul more without worry: our Heavy-Duty Headache Rack adds more than just protection.



BED WALL EXTENDER

- Increases box capacity.
- Quick and easy tool-less modularity.
- Easily-removable rear door can be latched open.
- Variable full or half height settings.
- Foldable top panels come off in seconds.
- Requires Deluxe Headache Rack (715002423).

Defender, Defender MAX (except Defender 6x6 & Defender PRO)

715002421

\$724.99

Defender 6x6 & PRO models

715005411

\$1,314.99



Top panels fold down instantly



Sturdy steel extenders built to handle whatever you're able to load up and carry in your Defender.

LinQ ADAPTER

- Allows the installation of the LinQ Tool Holder to the Bed Wall Extender or the Deluxe Headache Rack.
- Sold in pack of 4.

Defender, Defender MAX

715003058

\$25.99

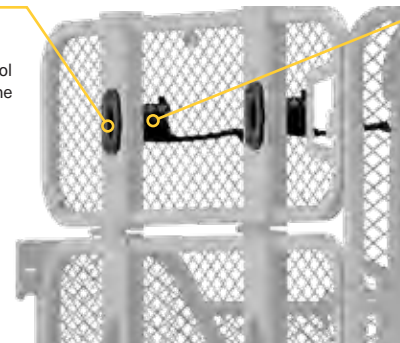

LinQ TOOL HOLDER

- Ultra-versatile tool holder.
- Convenient swivel-latch allows tools to be stored in any orientation.
- Suitable for installation onto the cargo walls, Deluxe Headache Rack, or Bed Wall Extender.
- If mounted on the Deluxe Headache Rack or the Bed Wall Extender, LinQ Adapter is required for installation.
- Sold in pairs.

Defender, Defender MAX

715003059

\$49.99



TONNEAU COVER

- Fitted to cover all of the items in your cargo box thoroughly.
- Prevents splash from entering the cargo box.
- Rolls up to the front.
- Easily removable for quick access.
- Not compatible with accessories that exceed the box height.

Defender 2018 & up (except 6x6 & PRO, Mossy Oak Break-Up Country Camo model), Defender MAX

■ 715006011 • Black

\$239.99

Defender, Defender MAX (2017 & prior)

■ 715003048 • Mossy Oak Break-Up Country Camo

\$309.99



REMOVABLE STORAGE BIN

- Handy, removable on-dash toolbox will make sure you have your critical equipment where you need it.
- Provides 1.7 Gal (6.3 L) of storage, and clips on and off in a snap.
- Water-resistant to ensure your contents remain safe and dry.
- Standard on all models except Base.

Defender, Defender MAX

715004344

\$69.99



DRIVER UNDERSEAT STORAGE BIN

- Polypropylene-injected 4 Gal (15L) capacity bin fits securely under the driver's seat.
- Front opening for quick and easy access.
- Ideal for storing weather-resistant items, such as ropes, tow straps and winch accessories that are needed at a moment's notice.

Defender, Defender MAX

715003399

\$99.99



REMOVABLE STORAGE BIN - PASSENGER

- Convenient passenger-side underseat storage polypropylene-injected 3.7 Gal (14L) storage capacity bin.
- Bin installs and removes in a snap and comes with an integrated handle.
- Water-resistant.

Defender, Defender MAX

715003314

\$69.99



CENTER UNDERSEAT STORAGE BIN

- Polypropylene-injected 2 Gal (8L) capacity storage bin.
- Watertight design keep ice and drinks cold.
- Easy to drain and wash by removing it with integrated handle.
- Accessible by lifting center seat section.

Defender, Defender MAX

715003446

\$79.99



CARGO
BED RAILS**CARGO BED RAILS**

- Add integrated tie-down area to your cargo box while enhancing the look.
- Added cargo box protection.
- Inside and outside anti-corrosion coating with durable powder coat finish.
- Heavy-duty 1" (2.5 cm) diameter steel-tube construction.
- Add height to the bed side wall and serve as a tie-down anchor for ropes, straps or bungees.
- Not compatible with Bed Wall Extender.
- Sold in pairs.

Defender (except 6x6 & PRO), Defender MAX

715003444

\$99.99

**CARGO BED NET**

- Solid net designed to hook to the bottom of the cargo box for secure and compact confinement of your cargo.
- Keeps items tightly against the bed floor.

Defender (except 6x6 & PRO), Defender MAX

715003445

\$69.99

**DASH STORAGE
COMPARTMENT NET
FOR HEATING SYSTEM**

- Perfect for securing items in the dash storage area.
- To be installed when Lower Dashboard for Heating System is installed.

Defender, Defender MAX

715003544

\$25.99

**DASH STORAGE
COMPARTMENT NETS**

- Perfect for securing items in the dash storage area.
- Not compatible with Defrost, Heat & Ventilation System.
- Sold in pairs.

**Defender, Defender MAX
(except XT Cab models)**

715003129

\$25.99

**LOWER DASHBOARD
FOR HEATING SYSTEM**

- Replaces the dashboard that comes stock with the vehicle, and features a tablet that makes it possible for driver and passenger to conveniently store small items in the dash.
- To be installed when the Defrost, Heat & Ventilation System is installed.
- Use together with the Dash Storage Compartment Net for Heating System (715003544) to prevent the items placed in the dash storage compartment from falling.

Defender, Defender MAX (2019 & prior)

715003441

\$69.99

**BACKREST
REAR STORAGE**

- Netting installs easily.
- Made from polyester that won't discolor.
- Sold in pairs.

Defender MAX

715003019

\$49.99

**BED TOOL BOX**

- Large 40 Gal (150L) multifunction weather-resistant tool box designed for cargo beds.
- Rotomolded construction provides exceptional rigidity and durability.
- Features cup holders and integrated groove for pipe or 2x4 cutting.
- Sized to give you the option of installing 2 tool boxes in the cargo bed (quick bolt-on installation).
- Double side openings with lockable covers and rubber latches.

Defender, Defender MAX

715003028

\$329.99



**EXPERT
CHOICE**

Multifunction tool box and work platform adds lockable storage. The largest weather-resistant storage option on the Defender.

SOFT STORAGE BAG

- 11.8 Gal (45L) capacity soft cargo bag designed with vehicle's rear in mind to maximize potential storage.
- 3 sections.
- Weatherproof.

Defender, Defender MAX

■ **715003759** • Black

\$149.99



Vehicle shown is a Can-Am Outlander.

STORAGE 2.6 GAL (10L) BAG

- Roll-top dry bag for fully protecting your cargo from the elements.

Defender, Defender MAX

269502121

\$31.99



RUGGED RACKS THAT MAXIMIZE & SECURE YOUR CARGO CAPACITY FOR ADVENTURE



BUILD YOUR OWN ADVENTURE ROOF RACK!

Shown here with:
SPARE TIRE WITH TIE-DOWNS
LinQ CARGO BOX, LinQ TOOL HOLDER
& 4" (10 CM) LED LIGHTS

ADVENTURE ROOF RACK

- Ideal cargo solution for packing everything you need to live your off-road experience fully and completely.
- Built with heavy-duty 1.25" (3.2 cm) diameter steel tubing.
- Modular LinQ support plates allow for installation of most LinQ cargo accessories.
- Integrated mounting points for lights can hold up to 8 pod-type LED lights (6 front and 2 back) or a 39" (99 cm) LED bar (front)—see table for compatibility.
- Features anchor points for spare tire attachment.
- Spare Tire Tie-Downs sold separately.
- Add the Cargo Box Net or the Cargo Box Elastic Net to secure and confine your cargo in the rack.
- Not compatible with Bimini Roof.

Defender

- Loads of up to 40 lb (18 kg).

715003870

\$514.99

Defender MAX

- Loads of up to 75 lb (34 kg).

715004391

\$619.99



SPARE TIRE RATCHET TIE-DOWNS

- 3-way ratcheting tie-down strap with loop ends.
- Designed to securely hold spare tires on accessories equipped with integrated spare tire attachment points.
- Adjustable to accommodate most common UTV tire sizes.
- Ratchet and junction ring made of durable zinc-plated steel.
- Required for spare tire attachment on Adventure Roof Rack.

Defender, Defender MAX

280000606

\$26.99



New LinQ TOOL & GUN HOLDER

- 2-in-1 holding rack can be used both on the job or on the hunt.
- Includes 5 locations to securely hold tools and guns using rubber grips and retention straps at the top and a rubber mat with gunstock shaped molding at the bottom.
- Easy to remove, install or reposition using our simple and secure LinQ System.
- Can be attached at multiple positions along the cargo bed walls, facing inside or outside the bed.
- Recommended to use with the Exterior Cargo Reinforcement Panel (715006198) when installed outside the bedwall.

Defender, Defender MAX

715005466

\$414.99

EXPERT CHOICE

Secure open storage for the freedom to carry what's needed & keep it close at hand.



GUN BOOT 6.0 IMPACT BY KOLPIN

- Extra room for pistol-grip-type weapons and small bipods.
- Easily fits firearms up to 51" (1.3 m) in total length.
- Provides ample room for 2.4" (60 mm) scopes.
- Hatchback design allows easy access.
- Snap-close cover with locking capability.
- Ergonomically designed handle and molded attachment points for sling.
- Designed to accommodate left and right hand bolt-action rifles and shotguns.
- Requires Gear Rail and Gun Boot Mount by Kolpin for installation.
- Includes removable, shock absorbing foam and nylon Impact liner for superior interior protection.
- Compatible for dual mount with Additional Gun Boot Mount.

Defender, Defender MAX

715001419

\$79.99



New DUAL GUN HOLDER

- Accommodates shotguns, rifles or muzzleloaders.
- Mounts in the cab, on floor board between driver and passenger.
- Rubber pads provide gun protection.
- Can be removed to allow a center passenger.
- Anti-corrosion coating with durable powder coat finish.
- Comes with all hardware for easy installation.
- Keeps your weapons within easy reach and protected within the cab area.
- Refer to your local regulations governing the transportation of firearms before purchase.

Defender, Defender MAX

715005265

\$169.99

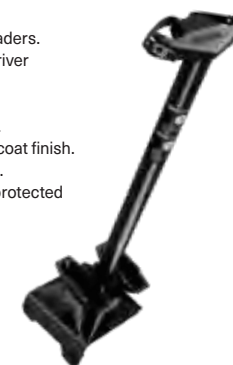

GUN BOOT MOUNT BY KOLPIN

- Fits one Kolpin Gun Boot 6.0 Impact.
- Lightweight and extremely durable.
- Easily adjustable without the use of any tools.
- Offers precision gun angle adjustability.
- Requires Gear Rail for installation.

Defender, Defender MAX

715001420

\$79.99



ADDITIONAL GUN BOOT MOUNT

(Not illustrated)

Defender, Defender MAX

715001586

\$124.99



4-SEASON FIREARMS PROTECTION WITHIN REACH, WITH TOUGH & DURABLE GUN BOOTS FROM KOLPIN

STRONGHOLD GUN BOOT IMPACT⁺ BY KOLPIN⁺

- Compact low-profile design with Kolpin Stronghold styling securely holds up to 52" (132 cm) long rifles and shotguns with optics.
- Includes a removable, shock absorbing foam Impact⁺ liner.
- Single-handed opening with an attached lid for quick access along with an integrated closure strap.
- For use with the Kolpin Stronghold Auto-Latch Mount System.

Defender, Defender MAX

705011442

\$97.99

STRONGHOLD AUTO-LATCH MOUNT BY KOLPIN

- Auto-latching design provides quick and secure gun boot attachment to your vehicle.
- Bracket is made from rugged high-impact, reinforced nylon and coated steel.
- For use with Stronghold Gun Boot.
- Requires Gear Rail For Stronghold (715004089).

Defender, Defender MAX (except X mr models)

715003899

\$69.99

GEAR RAIL FOR STRONGHOLD

- Designed for the Stronghold Auto-Latch Mount by Kolpin.
- Can hold up to two Stronghold Gun Boots (two Latch Mounts required).
- Deluxe Headache Rack (715002423) or Gear Rail Adapter (715003392) required.

Defender, Defender MAX

715004089

\$149.99

GEAR RAIL ADAPTER

- Allows the installation of gear rails directly onto the cargo box without the need for a headache rack.

Defender, Defender MAX (except X mr models)

715003392

\$149.99

GEAR RAIL

- Stationary rail system specially designed for your side-by-side vehicle.
- Universal mounting options for many Kolpin accessories like Gear Grips, Gun Boot 6.0, Gun Boot Mount and Universal Saw Press.
- Rail is made with heavy-duty 7-gauge extruded anodized black aluminum.

- Mounts on roll bar.
- Includes one versatile Gear Rail Mount by Kolpin.
- Requires Deluxe Headache Rack (715002423), Headache Rack (715003873) or Gear Rail Adapter (715003392).

Defender, Defender MAX (except X mr models)

715003391

\$259.99



GEAR RAIL MOUNT BY KOLPIN

- Accessory bracket for mounting additional accessories to the Gear Rail.
- Includes C-clamp and metal mounting brackets.

Defender, Defender MAX

715001422

\$39.99



STRENGTH FOR A PURPOSE: PERFECT-FIT HEAVY-DUTY GUN BAG KEEPS FIREARMS SECURE

DOUBLE GUN BAG

- Shell constructed with heavy-duty, weather-resistant polyester to shelter guns from dust and other outdoor elements, while the thick interior padding protects the guns from shocks.
- Fits perfectly on rear cage, and guns are readily accessible from both sides of vehicle.
- Design features include a removable center pocket that can be mounted on both sides of the bag, and extra front storage pockets for hunting gear.
- Solid, quick installation.
- Not compatible with rear wind protection, headache racks and gear rails.
- May interfere with the tilt function of the Defender 6x6 or Defender PRO models' bed.

Defender (except XT Cab, X mr models),

Defender MAX (except XT Cab)

■ 715003133 • Black

\$149.99

■ 715003134 • Mossy Oak Break-Up Country

\$179.99



UNIVERSAL SAW PRESS BY KOLPIN

- Specially crafted for transporting your chainsaw securely and safely aboard your side-by-side vehicle.
- Heavy-duty, black powder-coated metal bracket designed to attach any chainsaw model with up to a 20" (51 cm) bar.
- Rubber pads provide cushion and tight fit.
- Hinged design for quick removal.
- Holds saw in vertical position or 45° angle in either direction.
- Requires Gear Rail.
- Protective sheath included.

Defender, Defender MAX

(except X mr models)

715001423

\$109.99

DURABLE MOUNT & HOLSTER KEEP YOUR CHAINSAW READY TO WORK



Vehicle shown is a Can-Am Commander.



GEAR GRIPS BY KOLPIN

- Durable, flexible grips cushion and protect while providing a custom fit for a variety of items from 1" to 4" (2.5 cm to 10 cm) in diameter.
- Heavy-duty design for carrying bows, fishing poles, rakes, farm tools and more.
- Quick-release button opens grip quickly for easy access to gear.
- Heavy-duty base system built for the toughest adventures.
- Easy installation on tubular racks, extension racks, brackets or bumpers.
- Sold in pairs.

Defender, Defender MAX

715001421

\$69.99



FUEL PACK BRACKET BY KOLPIN

- Easy, quick and secure bracket for your fuel pack that leaves plenty of room for your other gear.
- ¼-turn-action knob allows quick and easy removal of fuel pack from bracket.
- Not EC compliant to attach fuel packs.

Defender, Defender MAX

715001427

\$54.99





15" (38 CM) DOUBLE STACKED LED LIGHT BAR (90 WATTS)

- Equipped with 18 5W Cree LEDs.
- 8,400 lumens.
- Rugged and waterproof.
- EC compliant.

See table for installation location and requirements.

Defender, Defender MAX

715002934

\$369.99



8,400 LUMENS

Lights up to more than 1900 ft (580 m) in front of the vehicle and around 65 ft (20 m) wide on each side.

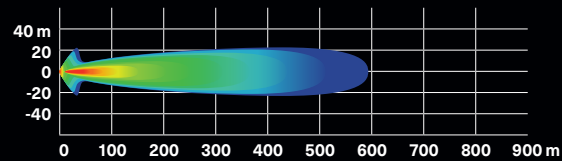

10" (25 CM) DOUBLE STACKED LED LIGHT BAR (60 WATTS)

- Equipped with 12 5W Cree LEDs.
- 5,400 lumens.
- Rugged and waterproof.
- Packs a big punch for its size.
- EC compliant.

See table for installation location and requirements.

Defender, Defender MAX

715002933

\$299.99



5,400 LUMENS

Lights up to more than 1500 ft (460 m) in front of the vehicle and around 65 ft (20 m) wide on each side.

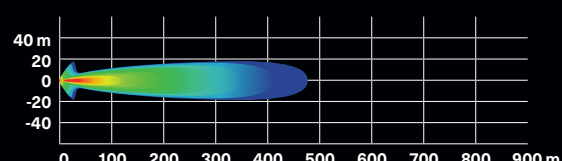

4" (10 CM) ROUND LED LIGHTS (2 X 25 WATTS)

- 25W LED spotlights.
- 1,800 lumens.
- Rugged and waterproof.
- Includes basic wiring and switch.
- Can-Am branded grill.
- Sold in pairs.
- Not EC compliant.

See table for installation location and requirements.

Defender, Defender MAX

715002935

\$369.99



1,800 LUMENS

Perfect fit with the Light Rack and most bumpers.

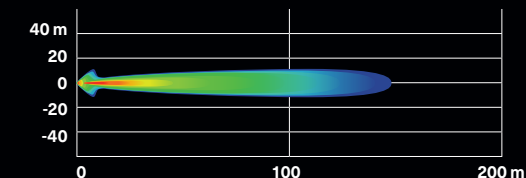

New 3.5" (9 CM) LED LIGHTS (2 X 14W)

- 14W LED lights producing 1,260 lumens each.
- Equipped with 6 high power LEDs in a heavy-duty die cast aluminum housing.
- Features 2 attachment points — if one attachment point fails due to a collision, rotate to the next channel point and re-mount the light.
- Sold in pairs.
- EC compliant.

See table for installation location and requirements.

Defender, Defender MAX

LED DRIVING LIGHTS

- Spot lens for a narrow and long light beam spread, ideal when driving at higher speeds.

715003666

\$209.99

LED FLOOD LIGHTS

- Flood lens for a wide light beam spread, ideal for working applications like plowing or for cornering, dusty or foggy riding conditions.

715003665

\$209.99



1,260 LUMENS

LED DRIVING LIGHTS

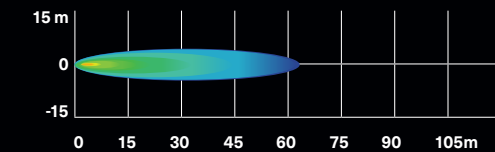

LED FLOOD LIGHTS

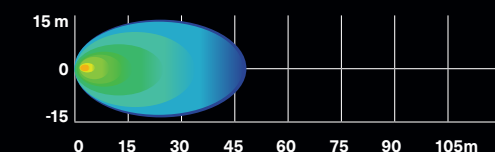

BUILD YOUR LIGHTING SYSTEM IN 4 EASY STEPS

2 CHOOSE YOUR MOUNT POINT

1 CHOOSE YOUR LIGHTS

	10" [25 CM] DOUBLE STACKED LED BAR	15" [38 CM] DOUBLE STACKED LED BAR	39" [99 CM] DOUBLE STACKED LED BAR	4" [10 CM] ROUND LED LIGHTS [SOLD IN PAIRS]	3.5" [9 CM] LED LIGHTS [SOLD IN PAIRS]
DEFENDER, DEFENDER MAX 2019 & PRIOR	FRONT BUMPER RANCHER BUMPER XT FRONT BUMPER	715002933 PLUS 715002454 (Light Power Cable)	715002934 PLUS 715002454 (Light Power Cable)	N/A	715002935 (4" Round), 715003665 (3.5" Flood) or 715003666 (3.5" Spot) PLUS 715002454 (Light Power Cable)
DEFENDER, DEFENDER MAX 2020	X MR FRONT BUMPER [W/O WINCH] X-TP FRONT BUMPER	715002933 PLUS 715006034 (Light Power Cable)	715002934 PLUS 715006034 (Light Power Cable)	N/A	715002935 (4" Round), 715003665 (3.5" Flood) or 715003666 (3.5" Spot) PLUS 715006034 (Light Power Cable)
DEFENDER, DEFENDER MAX 2019 & PRIOR	LONE STAR EDITION FRONT BUMPER	715002933 PLUS 715002454 (Light Power Cable)	N/A	N/A	N/A
DEFENDER, DEFENDER MAX 2020		715002933 PLUS 715006034 (Light Power Cable)	N/A	N/A	N/A
DEFENDER & DEFENDER MAX (EXCEPT XT CAB)	LIGHT RACK <small>*Roof Power Cable and Front Roof Liner may not be required if already installed with other accessories.</small>	715002933 PLUS 715003094 (Roof Power Cable) & 715003098 (Front Roof Liner)	715002934 PLUS 715003094 & 715003098 (Front Roof Liner)	N/A	715002935 (4" Round), 715003665 (3.5" Flood) or 715003666 (3.5" Spot) PLUS 715003094 (Roof Power Cable) & 715003098 (Front Roof Liner)
DEFENDER, DEFENDER MAX XT CAB		715002933	715002934	N/A	715002935 (4" Round), 715003665 (3.5" Flood) or 715003666 (3.5" Spot)
DEFENDER & DEFENDER MAX (EXCEPT XT CAB)	ADVENTURE ROOF RACK <small>*Roof Power Cable may not be required if already installed with other accessories.</small>	N/A	Front only: 715002934 PLUS 715003417 (Power Cable) & 715003094 (Roof Power Cable) & 715003098 (Front Roof Liner)	Front only: 715004007 PLUS 715005822 (Power Cable) & 715003094 (Roof Power Cable) & 715003098 (Front Roof Liner)	Front or Rear: 715002935 (4" Round), 715003665 (3.5" Flood) or 715003666 (3.5" Spot) PLUS 715003417 (Power Cable) & 715003094 (Roof Power Cable) & 715003098 (Front Roof Liner)
DEFENDER, DEFENDER MAX XT CAB		N/A	Front only: 715002934 PLUS 715003417 (Power Cable)	Front only: 715004007 PLUS 715005822 (Power Cable)	Front or Rear: 715002935 (4" Round), 715003665 (3.5" Flood) or 715003666 (3.5" Spot) PLUS 715003417 (Power Cable)

4 ORDER

ORDER ALL PART NUMBERS IN INTERSECTING BOX

*NOTE: When installing more than one light kit, additional Light Power Cable or Mounting Kit is required.

PERFECT MOUNT SOLUTION FOR THE LIGHTS OF YOUR CHOICE



4" (10 CM) ROUND LED LIGHTS



15" (38 CM) DOUBLE STACKED LED LIGHT BAR

LIGHT RACK

- Rugged steel construction serves as both mount and protection for accessory light systems.
- Lights not included.
- Front Roof Liner is required for installation on the roof (except Cab models or with Deluxe Sport Roof (715002511)).
- Power Cable (715003094), Sport Roof (715002430), Bimini Roof with Sun Visor (715002849), Deluxe Sport Roof (715002511) or Sport Roof for MAX (715003038) required for installation (except Cab models).
- Integrates elegantly and seamlessly into our roof products.

Defender, Defender MAX

715002456

\$159.99



REAR CARGO LIGHT

- Powerful 55W H3 illumination for rear cargo area.
- Convenient in-dash switch.
- Wiring included.
- Sport Roof (715002430), Deluxe Sport Roof (715002511) or Sport Roof for MAX (715003038) is required for installation.
- Not EC compliant.
- Not compatible with headache rack on Defender 6x6 and Defender PRO.

Defender,

Defender MAX (2020)

715006037

\$149.99

Defender, Defender MAX

(2019 & prior)

715002422

\$134.99



RAM⁺ LED SPOTLIGHT

- 540 lumens LED light (9 Watt) heavy-duty spotlight standard-equipped with 1" (2.5 cm) diameter rubber-coated double ball and socket system.

Defender, Defender MAX (2019 & prior)

710005423

\$124.99



DOME LIGHT

- LED array integrates perfectly with vehicle.
- Wiring included.
- Can be installed on cage or roof, with or without roof liner.

Defender, Defender MAX

715002455

\$69.99



ROOF POWER CABLE

(Not illustrated)

- Brings power from the battery.
- Required for installation of some electrical accessories.

Defender, Defender MAX

715003094

\$39.99

LIGHT KIT POWER CABLE

(Not illustrated)

- Power cable for installation of compatible Can-Am light kits at front bumper location.

Defender, Defender MAX (2019 & prior)

715002454

\$42.99

Defender, Defender MAX (2020)

715006034

\$39.99



AUDIO & COMMUNICATION SYSTEMS

Stay entertained on jobsites and long rides with complete Bluetooth music integration.

- 
FIT & COMPATIBILITY
- 
QUALITY & RELIABILITY
- 
STYLE & VISION



RUGGED. WATERPROOF. POWERFUL.

Add up to 4 ultra-sturdy outdoor speakers, designed to be Can-Am tough. Our Overhead Audio System will rock with high-fidelity sound... everywhere.



Make 'em say "What!?"

Powered to be heard, even over power tools. A punchy 4x40W amplifier projects strong, crisp sound.



STAY CONNECTED

Our Rugged Radios Car-to-Car System is perfect for communicating with friends and family on group rides.



BRING YOUR FAVORITE MUSIC WHEREVER YOU ROAM

OVERHEAD AUDIO SYSTEM

- Rugged waterproof Jensen® Bluetooth Stereo Audio System offers multi-source input: AM/FM/WB and USB (iPod® and iPhone® ready).
- Convenient white LED-backlit LCD display and buttons.
- Stream from any Bluetooth-enabled device (smartphone, MP3 player).
- Powerful 4x40W amplifier with remote turn-on.
- Voice-control of AVRCP-active device.
- 30 programmable AM/FM stations with auto-store/pre-set scan.

- Separate RCA audio output and input.
- UV-resistant finish / corrosion-resistant components.
- Requires Sport Roof (715002430 (except on XT and Mossy Oak Hunting Edition models)), Front Roof Liner (715003098) or Deluxe Sport Roof (715002511) and Power Cable (715003094) (except if you already have a Hard Cab Enclosure (715001966 or 715003482)).

COMPLETE OVERHEAD AUDIO SYSTEM

- Complete with 4 ultra-sturdy outdoor speakers (2 front and 2 rear) and 4 black speaker boxes.

Defender, Defender MAX
715002019
\$844.99



Factory-made fit and engineering for quality sound outdoors.



OVERHEAD FRONT AUDIO SYSTEM

- Complete with 2 ultra-sturdy front outdoor speakers and black speaker box.

Defender, Defender MAX
715003095
\$684.99

RUGGED RADIOS CAR-TO-CAR SYSTEM

- Perfect for communicating with friends and family on group rides.
- Push-to-talk button conveniently mounted on the steering wheel.
- Includes radio mounting bracket, helmet speaker, mic kit and base charger.
- 2-4 mile range.

- This kit includes:**
- RH-5R Rugged Radios 5-Watt Dual Band Handheld Radio
 - Helmet Speaker / Mic Kit
 - Push-to-talk buttons
 - Mounting bracket
 - Base station charger

Defender, Defender MAX
715003440
\$349.99



New REAR VIEW MIRROR & CAMERA MONITOR

- Fully waterproof rearview camera and monitor kit.
- Multiple camera feeds can be seen with the rear view camera, to see what you need.
- Unit replaces stock rearview mirror (screen is integrated in the unit's replacement rearview mirror).
- Camera uses infrared light for night vision capabilities.

Defender, Defender MAX

715004905 • Black

\$419.99**EXPERT CHOICE**

Replace your rearview mirror with an integrated daytime / infrared night vision rear camera to see all the action & friends behind you.

BACK-UP MONITOR AND CAMERA KIT

- Fully waterproof rear view camera and monitor kit.
- The camera is one of the clearest and sharpest available on the market, with 250,000 pixel image resolution and a 2.1 mm lens with 130° viewing angle.
- Features 18 infrared lights that allow up to 50 ft. (15.24 m) visibility in complete darkness, an auto iris sensor that adapts to light intensity changes and an adjustable sunshade.
- 7" (17.78 cm) digital TFT LCD color monitor comes with power harness and can support up to two camera inputs.
- The camera can be roof mounted to monitor your cargo load or to see farther behind, and it can be mounted under the cargo box for hitching purpose.

Defender, Defender MAX, (2019 & prior)

715003834

\$544.99**QUICK CONNECT BATTERY CABLE**

- Quickly and easily connect and charge different items with your charger.
- Included in the Battery Charger/Maintainer.
- Sold individually.

715005408

\$8.99**New QUICK CONNECT CABLE WITH BATTERY INDICATOR**

- Quickly and easily connect and charge different batteries with your charger.
- 3-color LED indicator provides constant battery health indication.
- Sold individually.

715006055

\$19.99**AUXILIARY BATTERY INSTALLATION KIT**

- Allows you to add a second 30Ah battery for that dual battery setup that will give you the extra juice you'll need to power auxiliary electrical components like a sound system or winch.
- Additional battery sold separately (515176151).
- Equipped with an integrated smart battery isolator that will prevent your auxiliary electrical components from draining your starting battery.
- Kit includes an additional battery junction block, all necessary wiring and the battery holder.

Defender, Defender MAX (2019 & prior)

715003758

Defender, Defender MAX (2020)

715006035

\$309.99**EXPERT CHOICE**

The right way to add a second battery for more on-the-go power—complete with wiring and smart isolator.

3-MODE SWITCH

- Switches quickly and conveniently between normal/work/eco modes.
- Work mode: Reduced throttle sensitivity for smoother acceleration and reduced load impact.
- Eco mode: Increased fuel economy.
- In-dash plug-and-play mount.
- Standard on 2020 models.

Defender, Defender MAX

715004445

\$31.99**REAR 12V POWER OUTLET**

- Kit brings power source to the cargo box area.
- Installs into the rear cab firewall.
- Easy plug-in harness included.

Defender, Defender MAX (2019 and prior)

715003846

\$49.99**USB POWER OUTLET KIT**

- Recharges your electronic devices while riding* (smartphone, MP3, heating gear, etc.).
- Dual port USB connectors.
- *The power outlet is not capable of recharging all device types while riding.

Defender, Defender MAX

219400510

\$31.99**DIGITALLY ENCODED SECURITY SYSTEM (D.E.S.S.™) KEYS**

- Top-security anti-theft protection for your vehicle.
- Encrypted chip technology restricts access to your vehicle's electronic ignition system.
- One vehicle / One code.
- A vibration / shock-resistant ball-and-socket design that ensures a reliable connection.

Comes with 3 programmable keys:

- Work key: Limits vehicle speed to 40 kph (25 mph) but does not limit engine torque.
- Normal key: Limits vehicle speed to 70 kph (44 mph) and 10% torque reduction.
- Performance key: No restrictions.

Defender, Defender MAX

715002458

\$209.99**JUMP STARTER**

- IPX3 water-resistant and enclosed output ports.
- 4 LED battery indicators for easy read on battery charge level.
- Compact design, will conveniently fit in your backpack, glove box or any other storage compartment.
- 2.4A + 1A/5V USB ports for fast charging of all USB devices.
- Smart cable provides protection against reverse polarity, short circuit, low voltage, high temperature and reverse charging.
- Built-in LED light (3 modes).
- Content: 300CA jump starter, SA858 smart cable clamp, MC-USB to USB charging cable, travel bag, user manual.

715005062

\$119.99**GARMIN MONTANA® 680T GPS**

- Rugged and waterproof, the Montana 680T is element-proof.
- 4" dual-orientation, sunlight-readable touchscreen and glove-friendly touchscreen display, to give you vivid colors and high-resolution images.
- 8-megapixel autofocus camera automatically geotags photos.
- Tracks both GPS and GLONASS satellites for improved positioning and typically faster fixes.
- Preloaded TOPO maps, plus 1-year BirdsEye Satellite Imagery subscription.
- 3-axis compass with barometric altimeter.
- Specific GPS cradle included (vehicle mounting kit required).
- Includes a preloaded map for US.

Defender, Defender MAX

715002830

\$664.99**European Version**

- EC compliant.
- Includes preloaded European recreation map.

715003456

**CANADIAN MAP FOR GARMIN MONTANA 680T GPS**

(Not illustrated)

- Additional and readily-programmable Canadian basemap for Garmin Montana 680T GPS system.
- Requires Garmin Montana 680T GPS (715002830).

Defender, Defender MAX

710005065

\$134.99**RAM GPS MOUNT**

- Allows for GPS integration onto vehicle.
- Standard AMPS hole pattern for Garmin Cradle.

Defender, Defender MAX

715003325

\$59.99**CGX3 CAMERA**

- 160° wide angle lens.
- Resolution options: From 3MP up to 20MP and VGA.
- Video resolutions available: 2.7K at 30 frames per second (FPS), 720P at 120/60/30 FPS, 1080P at 60/30 FPS and VGA at 240 FPS.
- Record videos in 4K UHD at 24 FPS, 2.7K QHD at 30 FPS and 720P at 120 FPS.
- Memory: Class 10 32GB Micro SD card.
- 2" (5 cm) capacitive touchscreen.
- Li-ion battery capacity of 1050mAh, working time of 1/1.5 hours and charging time of 3 hours (2 batteries included).
- WiFi function remotely operates up to 10-15 meters with mobile devices and Cyclops app for Android and iOS.
- Waterproof up to 10 meters without a case.
- Features modes such as invert, time lapse, high speed and loop recording, motion detection, capture (while recording a video), burst and anti-sharing.
- Comes with 8 mounting accessories.

9700130090

\$349.99**CGX3 GIMBAL CAMERA STABILIZER**

(Not illustrated)

- 3-axis full 360-degrees precision: Eliminates shaky video and allows you to easily shoot pro-quality, cinematic-like footage with your Action Camera.
- Independent APP to control the gimbal.
- Built-in Bluetooth 4.0.
- Compatible with iOS 8.0 and Android 4.4 or above.
- Rechargeable battery.
- Rugged, full aluminum alloy.
- 5-way joystick and multi-function button for flexible operations and convenient switch.

9700160090

\$299.99**CGX3 LED LIGHT**

(Not illustrated)

- Wide-Angle 300 Lumen Max. (5500K-6000K) by 3 LEDs.
- Waterproof, attachable light
- Three modes of light: High, Low, Flashing.
- Rechargeable battery: 1050mAh.

9700200090

\$49.99**CGX3 POWER STICK MOUNT**

(Not illustrated)

- 5200mAh of continuous power in your hand, when you need it.
- Rubberized silicone handle for comfort and grip.
- Power indicator light to let the user know when the battery is running low.
- Includes power hand grip, long screw, convert tripod mount, phone clip mount, USB mini cord, USB micro cord and adjustable strap.

9700100090

\$49.99**CGX3 SELFIE STICK**

(Not illustrated)

- Easily take photos or record videos with the CGX3 Selfie Stick.
- This selfie stick is made tough for any sport or activity.

9700170090

\$19.99

HEATED ACCESSORIES

Our heated accessories work hard to keep you comfortable in the coldest weather.



**FIT &
COMPATIBILITY**



**QUALITY &
RELIABILITY**



**STYLE &
VISION**

GET TOASTY

Flick the switch and warm up:
All Can-Am heated accessories
are built for your Defender
and include wiring with easy
on/off control.



LET THERE BE HEAT

The Defrost, Heat &
ventilation System offers:

- 3 Ventilation speeds
- Dashboard temperature controls
- Vents strategically positioned

**FOR MAXIMUM DEFROST AND
COMPLETE PASSENGER COMFORT**

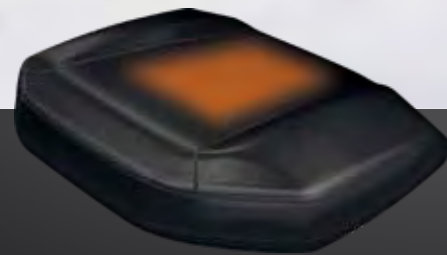

SEAMLESS WARMTH

HEATED SEAT COVER



Simple installation

Once the wires are passed, you just need
to slip the cover over the seat cushion.



Best fit & finish

Nothing else fits, looks, performs, and lasts
like Can-Am factory-designed accessories.

DEFROST, HEAT & VENTILATION SYSTEM

- Best integrated system on the market with 3-ventilation speed and in-dash adjustable temperature.
- Adjustable/directional vents.
- 10 vents specially positioned for better windshield and side windows defrosting/deicing, foot and hand heat.
- Easy-service air filter.
- Once installed, you might want to add storage space with the Lower Dashboard for Heating System and Dash Storage Compartment Net for Heating System.

Defender, Defender MAX 2019 & prior (not compatible with HD5 Motorization)
715004917

\$1,319.99

- Best integrated in-dash system on the market with 3 fan speeds and adjustable temperature.
- Adjustable/directional vents can be closed to concentrate heat at specific areas.
- A total of 8 vents specially positioned for windshield and occupant heating.
- Easy-to-service air filter.
- Includes the replacement lower dashboard compartment for the heating system.
- Dash Storage Compartment Net for Heating System is recommended.

Defender, Defender MAX 2020

715005904

\$1,449.99



HEATED STEERING WHEEL

- Ruggedly-constructed steering wheel designed to withstand cold conditions while channeling heat directly to your hands.
- Perfect for making hand mobility and grip readily available, e.g. hunting, manual farming.
- Replaces stock steering wheel.
- This kit includes the heated steering and in-dash switch.
- Heated Accessories Wiring Harness (710005757) is required.
- Draws a maximum of 45W and 3.2A at 13.5V.

Defender, Defender MAX

715003837

\$394.99



**EXPERT
CHOICE**

Get a grip:
Here's the ultimate comfort
in cold conditions.

HEATED GRAB BAR COVER

- Made tough to hold up to the stresses of rough riding, this heated cover will keep your passenger's hands warm and securely gripped during long cold outings.
- Easy to install and remove.
- This kit includes the heated grab bar cover and in-dash switch.
- Heated Accessories Wiring Harness (710005757) is required.

Defender, Defender MAX

715003835

\$209.99





HEAT AT THE PUSH OF A BUTTON:
STAY WARM ON EVERY CHILLY
RIDE, WITH OR WITHOUT A CAB

New HEATED SEAT

- 30W seat heater delivers chill-free riding comfort.
- Hi/Low temperature settings allow you to control the desired degree of warmth.
- This kit includes one carbon fiber seat heater, foam sheet and in-dash switch.
- Installs directly in the original seat cushion.
- Heated Accessories Wiring Harness (715005757) is required for installation on front seat.
- Heated Accessories Wiring Harness (715006036) is required for installation on Defender XT Cab and Limited models.
- Heated Accessories Wiring Harness (715006004) is required for installation on rear seats on MAX models.

Defender, Defender MAX

715005112

\$124.99

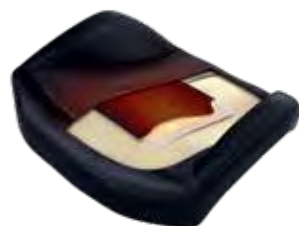

HEATED SEAT COVER

- Made of rugged vinyl, this heated seat cover delivers chill-free riding comfort.
- Ergonomically designed to fit snugly over the seat, it is also easy to install and remove.
- Hi/Low temperature settings allow you to control the desired degree of warmth.
- This kit includes the heated seat cover and in-dash switch.
- Heated Accessories Wiring Harness (710005757) is required on all models except XT Cab 2020, which requires Heated Accessories Wiring Harness (715006036).
- Harness (715006004) is required for rear seats installation.

Defender, Defender MAX

715003836 • Driver

\$209.99

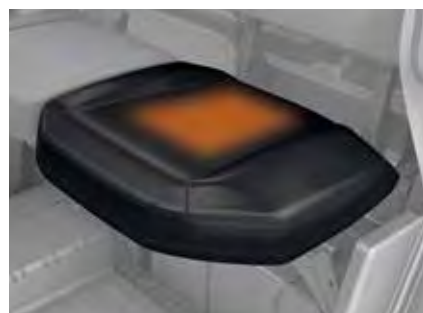

715004296 • Passenger

\$209.99



New HEATED SEAT HARNESS FOR MAX MODEL

(Not illustrated)

- Electric harness required to hook up and operate rear heated seats.

Defender MAX

715006004

\$XX.XX

HEATED ACCESSORIES WIRING HARNESS

(Not illustrated)

- Electric harness required to hook up and operate heated accessories.
- Power up to 4 accessories: 2 hand accessories (grab bar/steering wheel) and 2 seat covers.

Defender, Defender MAX (2020 XT CAB & Limited models)

715006036

\$169.99

Defender, Defender MAX (except 2020 XT CAB & Limited models)

710005757

\$99.99

RADIATOR WINTER FRONT

- Allows you to get higher heating temperature out of the Defrost, Heat & Ventilation System in extremely cold conditions.

Defender (2019 & prior)

715005108

\$39.99



HEATED VISOR OUTLET

- Strategically positioned on vehicle to maintain your agility.
- Optional visor outlet that delivers fog-free riding.
- Quick and easy installation.
- Sold individually.
- Heated Visor not included.

Defender, Defender MAX

715001246

\$49.99



BATTERY CHARGER/MAINTAINER

- Keeps stored lead-acid batteries charged.
- Charges and maintains small batteries.
- Microprocessor controlled multi-stage charging for added precision, safety and battery life.
- Reverse hook-up protection helps protect battery and charger from damage.
- Automatically detects 6 or 12 volt batteries.
- Press the display button to show the charge progress.
- Content: 3 amp battery charger, clamp adapter, DC adapter, 24" (61 cm) fused ring leads harness with weather cap, owner's manual.

715005061

\$54.99



EXPERT
CHOICE

Keep your
batteries charged
and ready to go,
automatically
and efficiently.



WARN[†] VRX WINCH

- Extreme IP68-rated waterproof sealing keeps the elements out.
- Durable all-metal construction.
- Black powder-coated finish and stainless steel fasteners for corrosion resistance.
- Robust new clutch design based on 70+ years of WARN 4WD hub lock know-how.
- Load-holding brake for great control.
- Smooth and reliable all-metal three-stage planetary gear train.
- Dash-mounted rocker control and corded remote.
- Limited lifetime warranty (mechanical), 3-year warranty (electrical).
- Pulling strength capability of 4,500 lb (2,041 kg).
- Winch Electrical Harness (715006032) required for installation.

New WARN VRX 45 WINCH

- 50 ft. of 1/4" (15 m of 6.3 mm) wire steel cable.
- Roller fairlead.

Defender, Defender MAX

715006110

\$529.99



New WARN VRX 45-S WINCH

- 50 ft. of 1/4" (15 m of 6.3 mm) synthetic rope.
- Cast aluminum hawse fairlead.

Defender, Defender MAX

715006111

\$629.99



CAN-AM HD WINCH

- Ergonomic clutch handle.
- Rugged all-steel gears and bushings for more torque and durability.
- Automatic 100% load-holding brake.
- Sealed solenoid for all-weather protection.
- Weather sealed corded remote and dash mounted switch.
- Winch Electrical Harness (715006032) required for installation.
- EC compliant.

New CAN-AM HD 4500 WINCH

- Pulling strength capability of 4,500 lb (2,041 kg).
- 43 ft. of 15/64" (13.1 m of 6.3 mm) wire steel cable.
- Heavy-duty 4-way roller fairlead.

Defender, Defender MAX

715006416

\$309.99



New CAN-AM HD 4500-S WINCH

- Pulling strength capability of 4,500 lb (2,041kg).
- 50 ft. of 1/4" (15.2 m of 6.35 mm) synthetic rope.
- Corrosion-proof aluminum hawse fairlead.

Defender, Defender MAX

715006417

\$419.99





PULL HEAVY LOADS
AND LARGE GAME INTO
THE BED WITH EASE

CARGO BED WINCH FOR LONG BOX

- Allows you to pull heavy loads into the cargo box easily.
- Perfect for hunting applications when it comes to loading game.
- Includes support base made of heavy-duty 2" (5 cm) steel tubing, winch and weather-sealed corded remote.
- 750 lb (340 kg) maximum pulling capacity.
- Electronic security module to prevent vehicle damage that could occur if loaded vehicle exceeds manufacturer's gross weight rating.
- Adapter Kit (715004709) required for installation with Gear Rail Adaptor.

Defender, Defender MAX (2019 & prior)

715003268

\$579.99

SYNTHETIC WINCH CABLE*

- 50' of 1/4" (15.2 m of 6.35 mm) synthetic cable for Warn winch.
- Warn Hawse Fairlead is required when upgrading to a synthetic cable to avoid damage and premature wear of the cable.

With Warn winch
705015070



- 50 ft. of 1/4" (15.2 m of 6.35 mm) synthetic cable for Can-Am HD winches.
- Hawse Fairlead (715006426) required when upgrading to a synthetic cable to avoid premature cable damage and wear.

With Can-Am HD winch
715006430
\$129.99



SYNTHETIC CABLE EXTENSION

- Lightweight 1/4" (6.35 mm) diameter, easy to handle and won't rattle in cargo box.
- Easily attaches to winch cable to provide additional 50' (15.2 m) of distance.
- 4,500 lb (2,041 kg) single line capacity.

715001120
\$144.99

REPLACEMENT WIRE ROPE*

- 55' of 1/4" (16.8 m of 6.35 mm) wire rope for Warn winch kit.
- 4,500 lb (2,041 kg) pulling strength.

With Warn winch
715006699

- 43' of 15/64" (13.1 m of 6.3 mm) wire rope.
- 4,500 lb (2,041 kg) pulling strength.

With Can-Am HD winch
705014978
\$19.99



WARN HAWSE FAIRLEAD*

- Double-powder-coated construction.
- Required to use the Synthetic Winch Cable (705015070) on Warn winches.
- To be used with synthetic winch cables only.

With Warn winch
705208797



CAN-AM HD HAWSE FAIRLEAD

- A must when upgrading your winch with a synthetic cable, this corrosion-proof aluminum hawse fairlead will prevent the cable from snapping in a corner of a roller fairlead and from wearing prematurely due to the rough surface of the worn roller guide.
- Must be used with synthetic cables only.

With Can-Am HD winch
715006426
\$49.99



* Ask your dealer or visit canamoffroad.com for price details



ROLLER FAIRLEAD

- Suggested when changing the wire rope.
- Heavy-duty replacement fairlead for winches.

With Warn winch

715001119

\$54.99

With Can-Am HD winch

715007082

\$XX.XX



WIRED REMOTE CONTROL

- This kit allows winch owners to add the hand-held remote to vehicles with a stock winch.
- Works in conjunction with the mini-rocker switch.
- Remote control (715007050) and connection socket are included with Can-Am HD winch.
- EC compliant.

With Can-Am HD winch

715006504

\$21.99

With Warn winch

710001002

\$59.99



WIRELESS REMOTE CONTROL

- The system is quick and easy to install, thanks to a wiring harness with an integrated antenna and all necessary mounting hardware.
- Allows you to operate your winch from anywhere within a 50' (15.2 m) radius, increasing your recovery options.
- All components are weatherproof.

With Warn winch (Defender 2019 & prior)

715002542

\$184.99



REMOVABLE WINCH MOUNTING KIT

- Allows to remove your winch when needed.
- Use in combination with the Multimount Winch Harness to quickly and conveniently relocate a front-mounted winch to the rear of the vehicle.
- Not compatible for use with the Lower Front Receiver Hitch.
- Requires Higher Front Receiver Hitch (715003109).

Defender, Defender MAX (except Limited models)

715001652

\$304.99



LOWER FRONT RECEIVER HITCH

- Heavy-duty 1,500 lb (680 kg) towing capacity 2" (5 cm) receiver hitch.
- Expand and enhance functionality by pairing it with Higher Front Receiver Hitch and Removable Winch Mounting Kit (need to relocate winch from its standard mounting position).

Defender, Defender MAX

715002519

\$99.99



HIGHER FRONT RECEIVER HITCH

- Heavy-duty 1,500 lb (680 kg) towing capacity 2" (5 cm) receiver hitch.
- No need to relocate winch from its standard mounting position.
- Does not fit on Defender CAB 2020.

Defender, Defender MAX

715003109

\$99.99



DROP TOW BAR

- Sturdy 2" (5 cm) ball-less tow bar.
- Conveniently set at standard trailering height.
- Requires Higher Front Receiver Hitch (715003109).

Defender, Defender MAX

715002521

\$99.99



WINCH ELECTRICAL HARNESS

(Not illustrated)

- Required to install a winch on a Defender without a factory-installed winch.

Defender, Defender MAX (2019 & prior)

715003093

\$49.99

Defender, Defender MAX (2020)

715006032

\$99.99

MULTIMOUNT WINCH HARNESS

(Not illustrated)

- Converts Removable Winch Mounting Kit into a practical multimount winch kit.

Defender

710004869

\$49.99

Defender MAX, Defender 6x6

710005082

\$84.99

RUBBER RECEIVER PLUG

- Rubber cap for 2" (5 cm) Receiver Hitch.

705204503

\$10.99



FRONT & REAR HITCH DRAWBAR

- Standard on 2" (5 cm) receiver hitch.
- It offers 1,500 lb (680 kg) of towing capacity.
- Hitch ball not included.

Defender, Defender MAX

715000972

\$79.99

European Version

- Drawbar with 2" (50 mm) hitch ball.

715001473

705206264 (T Homologated)



New CENTRAL HEADREST

- Headrest for front center seating position on 3-seated models and for rear center seating position on MAX models.
- Front Headrests are available separately for front passengers on MAX models.
- Headrests are required for all passengers on some regulated trails.
- Not EC compliant.

Defender, Defender MAX

715005163

\$134.99**New FRONT HEADRESTS**

- Additional headrest for all three front seating position on MAX models.
- Central Headrest is available separately for rear center seating positions on MAX models.
- Headrests are required for all passengers on some regulated trails.
- Not EC compliant.

Defender MAX

715005164

\$209.99

HEADRESTS ARE REQUIRED FOR ALL PASSENGERS ON SOME REGULATED TRAILS.

X MR / XT-P BOLSTER SEATS

- Bolster seat upgrade gives occupants additional support and comfort for recreational riding.
- Features added side padding and redesigned profile to help you control and enjoy your side-by-side vehicle to the fullest.
- Reinforced seat skin.
- Compatible with rear seat on MAX models.
- Not compatible with Heated Seat Covers.
- Standard on Defender X mr and XT-P models.

Defender, Defender MAX

■ 715004363 • Black / Can-Am Red

■ 715004678 • Black / Brown

\$824.99**ADJUSTABLE DRIVER'S SEAT**

- Driver seat upgrade that delivers an added 3 in. (8 cm) of forward/rearward adjustability for increased comfort and facilitated ingress/egress.
- Standard feature on XT, XT Cab and Mossy Oak Hunting Edition models.

Defender, Defender MAX

715005519

\$309.99

Increase comfort with 3 extra inches (8 cm) of to and fro adjustment



S3 FRONT HIGH CLEARANCE A-ARM

S3
FOR *can-am*

MASTER ROUGH TERRAIN—INCREASE THE SPACE BETWEEN LOWER A-ARMS FOR MORE CLEARANCE OVER LARGE OBSTACLES.

S3 FRONT HIGH CLEARANCE A-ARM

- Prevents A-Arm damage over rough terrain.
- Preserves factory ride quality and turning radius without reducing performance.
- Not compatible with Apache 360 LT Track System and Front A-Arm Protectors.
- "S3 for Can-Am" branded.

Contact your authorized dealer or visit our online store at can-amoffroad.com

■ 715003784 • Black

■ 715005116 • Sunburst Yellow

\$389.99**S3 REAR HIGH CLEARANCE A-ARM**

- Prevents A-Arm damage over rough terrain.
- Preserves factory ride quality and turning radius without reducing performance.
- Not compatible with Apache 360 LT Track System and Rear A-Arm Protectors.
- "S3 for Can-Am" branded.

Contact your authorized dealer or visit our online store at can-amoffroad.com

■ 715003785 • Black

■ 715005118 • Sunburst Yellow

\$389.99



GRIP LIKE NEVER BEFORE

Can-Am exclusive: Respond to off-road conditions like never before with 4WD powered by Smart-Lok Technology.

Smart-Lok is the most advanced off-road differential at your command. It's a fully lockable on-the-fly front differential with electronically-controlled automatic modes that always returns maximum traction in every condition, period.



Closed course dedicated for mud riding.



PERFORMANCE

PERFORMANCE

ACCESSORIES

ACCESSORIES

1 START WITH THE SMART-LOK DIFFERENTIAL

SMART-LOK™ DIFFERENTIAL

- Can-Am-exclusive Smart-Lok™ technology constitutes a true full lockable on-the-fly front differential with electronically-controlled automatic modes.
- Choose your differential settings according to your riding need: "2x4" for rear wheel traction only, "4x4 Front Diff Lock" for a fully locked 4 wheel drive, and "4x4 Smart Modes" that offer preset, intelligent calibrations for your type of riding.
- Using multiple input sources, "Smart Modes" will instantaneously engage locking with the right load at the right moment to procure maximum traction while retaining low-speed maneuverability, allowing for optimal placement and a feeling of confidence.
- The Smart-Lok Kit comes standard with the Trail Mode.
- Mud, Rock and Trail Activ modes can be added by installing an additional Smart Mode Module (sold separately) to fine-tune your riding environment.
- Requires Performance Half Shafts (2x) and Front Differential Kit for installation.

Defender, Defender MAX 2019 & prior

705402371

\$1,489.99

2 GET THE SMART-LOK INSTALLATION KIT & PERFORMANCE HALF SHAFT

Both are required to install the Smart-Lok™ Differential Kit.

SMART-LOK™ INSTALLATION KIT

(Not illustrated)

- Includes all necessary hardware and wiring for Smart-Lok Differential installation.

Defender, Defender Max 2018 & prior

715005331

\$329.99

Defender, Defender Max 2019

715005332

\$329.99



PERFORMANCE HALF SHAFT

- High-performance design ideal for off-road use, with superior wheel power and acceleration for racing, dunes and desert riding.
- Includes CVs, Shaft and Boots with the best suited geometry for your Can-Am vehicle.

Defender and Defender Max (2019 & prior - except X mr, XT-P and XT CAB 2018 & up)

705402353

\$204.99

Defender, Defender MAX XT Cab 2018-2019, Lone Star Edition 2019 & prior

705402458

\$204.99



THE SMART-LOK KIT COMES WITH THE TRAIL MODE MODULE.

3 FINE-TUNE YOUR RIDING ENVIRONMENT WITH A SMART MODE MODULE (OPTIONAL)

These modules allow you to add the Mud, Rock or Trail Activ Smart Mode to vehicles equipped with the Smart-Lok™ Differential Kit. Only one Smart Mode Module can be installed at a time.



POWER THROUGH DEEP MUD

DRIVE WHERE IT ROCKS

LET THEM TRAIL BEHIND

- Designed to deliver superior traction in the deepest mud holes.
- When high engine torque and/or slippage is detected, Smart-Lok™ will fully lock the front end.
- The system will stay locked until throttle release.

MUD SMART MODE MODULE

Models with Smart-Lok™ Differential

715005282

\$149.99

- Designed to help cross challenging rocks.
- When high engine torque is detected at low vehicle speed, Smart-Lok™ will progressively lock the front end and will stay engaged until throttle release to prevent wheel slippage and provide optimal traction.
- The progressive engagement allows for easier steering when maneuvering the vehicle.

ROCK SMART MODE MODULE

Models with Smart-Lok™ Differential

715005283

\$149.99

- Designed for aggressive riding delivering the ultimate cornering precision.
- When high engine torque and/or an increase in vehicle speed is detected, Smart-Lok will progressively engage the front end and maintain it engaged until throttle release or vehicle speed reduction.
- The progressive engagement allows for lower smooth steering effort.

TRAIL ACTIV SMART MODE MODULE

Models with Smart-Lok™ Differential

715005284

\$149.99



Closed course dedicated for mud riding.



SNORKEL KIT

- Raises point of engine and CVT air intakes so vehicle can be semi-submersed in water / mud without taking in water to the engine.
- Not compatible with Headache Racks, Gear Rail equipment, DragonFire Cargo Bed Roll Bar and Windshield Wiper & Washer Kit.
- Snorkel Extension Kit is available for roof level air intake and CVT exhaust.
- Adapter for Snorkel Kit (715004414) and Sealed Air Box (707800714) are required for installation on 2017 and prior models.
- Standard on Defender X mr models.

Defender, Defender MAX

715003727

\$619.99



SNORKEL EXTENSIONS

- Extend the Snorkel Kit for roof engine and CVT air intake.
- Add aggressive look to your vehicle and help keep your intakes clear from mud, snow, dust, etc. in severe riding conditions.
- Not compatible with all rear panels and windows, Rear Cargo Light and roof-mounted Rear View Camera.
- Snorkel Kit (715003727) is required, except for X mr models.

Defender, Defender MAX

715004415

\$209.99



ADAPTER FOR SNORKEL KIT

(Not illustrated)

- Required for the installation of Snorkel Kit (715003727) on Defender 2017 and prior models.
- Includes rear firewall for Snorkel Kit and hardware.
- Standard on Defender 2018 and up models.

Defender and Defender MAX 2017 & prior

715004414

\$89.99

SEALED AIR BOX

(Not illustrated)

- Required when installing the Snorkel Kit (715003727) on Defender and Defender MAX 2017 and prior models.
- Standard on Defender 2018 and up models.

Defender, Defender MAX 2017 & prior

707800714

\$159.99

BELIEVE IT: YOUR DEFENDER IS A FEW MODS AWAY FROM BEING A TRUE MUD-READY MONSTER

CVT AIR INTAKE PRE-FILTER

- Adds extra protection to your engine in harsh riding conditions.
- Helps keep air filter cleaner.
- Filter blocks particles larger than 0.007" (0.19 mm).
- Easy, tool-less installation.
- Necessary to maintain vehicle warranty when tracks are installed.
- Required to install the Apache and Backcountry Track Systems.

Defender (except X mr models), Defender MAX

715003483

\$39.99



EMERGENCY KIT

- Complete emergency kit provides all essential equipment and supplies to get out of most unfavorable situations powersport enthusiasts can find themselves in.
- Includes: Jumper Cables, Air Compressor, Tire Repair Kit, First Aid Kit, Ratchet Tie-Down, Duct Tape, Tow Strap 3,300 lb (1,500 kg), Zip-Ties, Cloth Rags.

Defender, Defender MAX

715006102

\$124.99



New SNORKEL PRE-FILTER

- Pre-filter specifically for snorkels.
- Adds extra protection to your engine in harsh riding conditions.
- Helps keep air filter cleaner.
- Filter blocks particles larger than 0.005" (0.13 mm).
- Necessary to maintain vehicle warranty when tracks are installed.

Defender, Defender MAX

715005597

\$74.99



New HEAVY-DUTY SPRING KIT

- This set of heavy-duty springs will stiffen your suspension.
- Perfect for reducing vehicle overall sag when shocks are under heavy demand: heavy loading and hauling or for snow clearing.
- Complete kit of 4 springs.
- Not compatible with Defender HD5, XT CAB, Mossy Oak Edition & X mr models and Defender Max.

Defender, Defender MAX (2019 & prior)

715005084

\$269.99

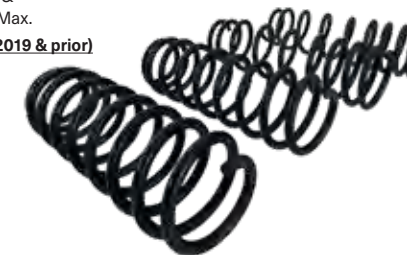

FRONT HEAVY-DUTY SPRINGS

- This set of heavy-duty springs will stiffen your suspension.
- Perfect for reducing vehicle sag on heavy jobs like snow clearing or heavy load hauling.
- Sold in pairs.

Defender (2018 & prior, Base, DPS & XT models only)

715002450

\$154.99

Defender MAX (2018 & prior, Base, DPS & XT models only)

715004280

\$174.99



FOAM AIR FILTER BY TWIN AIR®

- The best choice for the harshest conditions.
- Multiple staged oiled filtering foam for superior dust retaining capacity with high air flow.
- Washable and reusable.

Defender, Defender MAX

715003630

\$99.99





Each track has a specific purpose and is designed without compromise for work and play. Whether it's for deep snow riding, trail riding or for heavy loads, Apache tracks are akin to floating across the terrain.

- FIT & COMPATIBILITY
- QUALITY & RELIABILITY
- STYLE & VISION



WINTER TRACKS

YEAR ROUND TRACKS

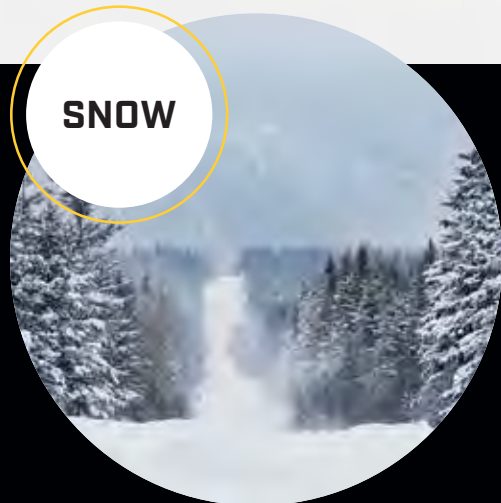

SNOW



MIXED CONDITIONS

APACHE BACKCOUNTRY LT

Finally explore winter with no traction limitations and no compromise, thanks to the unmatched performance of Apache Backcountry track kits. Engineered to thrive in the deepest snow—for work or play. Don't let winter stand in the way.

P.69

APACHE 360 LT

These track kits improve your vehicle's ground clearance and increase its contact patch with the terrain. Adapt your track setup to the conditions you'll be riding in and the purpose of your ride, with the Apache 360 LT system: all-terrain masterpiece.

P.70

WINTER TRACKS APACHE BACKCOUNTRY

GET THE MOST OUT OF YOUR CAN-AM VEHICLE THIS WINTER FOR ALL YOUR ENDEAVORS.

Explore without compromise. Ride on untouched trails, traveling deep into winter's embrace and you'll know: The same technology behind our world-renowned snowmobiles is at your command. With a larger contact patch, and more aggressive track design, travel beyond what you thought possible with the best snow performance.

COVERED BY A 1-YEAR WARRANTY

EFFICIENT FRAME AND RAIL DESIGN ENSURES WEIGHT IS EVENLY DISTRIBUTED ON SNOW

ADDED GROUND CLEARANCE OF 6.4" (16.2 CM)

AGGRESSIVE TRACK DESIGN WITH A 2" (5 CM) LUG HEIGHT FOR MAXIMUM TRACTION



LARGEST CONTACT PATCH ANYWHERE: 37% MORE THAN THE APACHE 360 LT

New APACHE BACKCOUNTRY LT TRACK KIT

- Tracks designed to deliver the best snow performance on the market with unmatched flotation level and traction on snow surface.
- Large contact patch, 37% bigger than the Apache 360 LT.
- Impressive added ground clearance of 6.4" (16 cm) helps keep the vehicle over the snow.
- Lightweight snowmobile-inspired rail design.
- Aggressive track design with 2" (5 cm) lug height for maximum traction on snow.
- Apache Backcountry LT Mounting Kit, Track DPS Module and Engine & CVT Pre-Filter are required.
- Fine-tune your track system using extra Idler Wheels, Sliders with Vespel Inserts and Rail Ice Scratcher.
- For winter use only.

Defender, Defender MAX (except 6x6)

715005891

\$6,499.99

AVAILABLE IN NOVEMBER 2019

New APACHE BACKCOUNTRY LT MOUNT KIT

- (Not illustrated)
- Required for installation of the Apache Backcountry LT Track System.
- DPS module and Pre-Filter are required and sold separately.

See table below for fit, compatibility and requirements.

715005888	715005493	715006196
\$599.99	\$524.99	\$649.99

AVAILABLE IN NOVEMBER 2019

Quick Reference Fitting Guide

Track System	Model Year	Model	Track	Track Mount	DPS	Prefilter without snorkel	Prefilter with Snorkel
APACHE BACKCOUNTRY LT	2019 & Prior	Defender Base, DPS, XT, XT Cab 2017 & Hunting Edition	715005891	715005888	715004707	715004183 CVT intake relocation kit	715005597
	2019 & Prior	Defender XT Cab 2018-2019, Lonestar Edition & X mr		715006196			
	2020	Defender Base, DPS (HD5 & HD8), XT(HD8), HD8 PRO		715005888			
	2020	Defender DPS (HD10), XT(HD10), XT-P		715005493			
	2020	Defender XT Cab, XT Cab Limited, Hunting Edition, Lonestar Edition, X mr		715006196			
APACHE 360 LT	2019 & Prior	Defender Base, DPS, XT, XT Cab 2017 & Hunting Edition	715005103	715004831	715004707	715004183 CVT intake relocation kit	715005597
	2019 & Prior	Defender XT Cab 2018-2019, Lonestar Edition & X mr		715004832			
	2020	Defender Base, DPS (HD5 & HD8), XT(HD8), HD8 PRO		715004831			
	2020	Defender DPS (HD10), XT(HD10), XT-P		715005492			
	2020	Defender XT Cab, XT Cab Limited, Hunting Edition, Lonestar Edition, X mr		715004832			

Vehicle width and length will be affected by tracks installation

YEAR ROUND TRACKS APACHE 360 LT

WORK & PLAY YEAR ROUND THROUGH MUD, SNOW, & ALL TYPES OF TERRAIN.

Rise above terrain, weather, and whole seasons with the Apache 360 LT track kits — the upgrade that takes the Can-Am experience to another level. Designed for superior traction and carrying heavier loads in soft terrain, it can be used with your Defender year round for exploring and completing tough tasks.

COVERED BY A 2-YEAR WARRANTY

ADDED GROUND CLEARANCE OF 4.5" (11.4 CM)

QUICK & EASY INSTALLATION



UNIQUE ADJUSTABLE CONTACT PATCH SYSTEM TO TACKLE THE TOUGHEST YEAR-ROUND CONDITIONS



RUBBER OVER MOLDED HEAVY-DUTY DOUBLE BEARING WHEELS AND OFFSET WHEEL SPACING REDUCE FRICTION AND VIBRATION WHILE ENSURING RELIABILITY

TOTAL GROUND SURFACE AREA OF 2291.5 IN² (14,784 CM²)

APACHE 360 LT TRACK SYSTEM

- Multifunctional tracks designed to support heavy loads and to fit on most Can-Am off-road vehicles.
- Extra contact patch adjustment for better performance over rough terrain.
- Contact patch is 7 to 9% bigger than the Apache 360's.
- Average ground clearance increase of 4.5" (11.44 cm).
- 1" (2.5 cm) lugs in the front and 1.25" (3.2 cm) in the back.
- Apache 360 LT Mounting Kit is required.

Defender, Defender MAX (except 6x6)

715005103

\$4,639.99

APACHE 360 LT MOUNTING KIT

- (Not illustrated)
- Required to install Apache 360 LT Track System (715003064).
 - Track DPS Module and Air Intake Pre-Filter not included.

See table p.69 for fit, compatibility and requirements.

715004832	715004831	715005492
\$449.99	\$424.99	\$549.99

AVAILABLE IN NOVEMBER 2019

TRACK DPS MODULE

- (Not illustrated)
- An innovative DPS module that ensures speedometer accuracy and optimized steering assist, which make for perfect track control and riding ease.
 - Required to install the Apache and Backcountry Track Systems.

715004707
\$124.99

CVT AIR INTAKE PRE-FILTER

- Adds extra protection to your engine in harsh riding conditions.
- Helps keep air filter cleaner.
- Filter blocks particles larger than 0.007" (0.19 mm).
- Easy, tool-less installation.
- Necessary to maintain vehicle warranty when tracks are installed.
- Required to install the Apache and Backcountry Track Systems.

Defender (except X mr models), Defender MAX

715003483
\$39.99



NEW SNORKEL PRE-FILTERS

- Pre-filter specifically for snorkels.
- Adds extra protection to your engine in harsh riding conditions.
- Helps keep air filter cleaner.
- Filter blocks particles larger than 0.005" (0.13 mm).
- Necessary to maintain vehicle warranty when tracks are installed.

Defender, Defender MAX

715005597
\$74.99



CVT AIR INTAKE RELOCATION KIT

- Relocates the CVT air intake protected in the cab area.
- Keeps the CVT air intake away from snow splashing from wheels or tracks.
- Highly recommended for track-equipped vehicles.
- Not compatible with CVT air intake pre-filter.

Defender (except X mr models), Defender MAX

715004183
\$44.99



PROMOUNT PLOWS

The new ProMount lineup was created for both professional operators and enthusiasts looking to take their tool kit to the next level. Designed to work as efficiently as possible, Can-Am reimagined the plow from frame to blade.

- FIT & COMPATIBILITY
- QUALITY & RELIABILITY
- STYLE & VISION

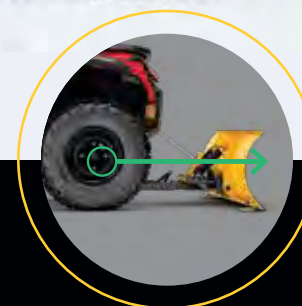

Underbelly mounting plate provides the optimal angle of attack for best pushing capacity.

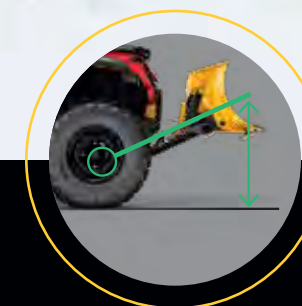

The forward mounted push frame provides industry leading lift height.



Low profile mounting plate has little impact on ground clearance and can be left installed year round.

MOST EFFICIENT MOUNTING SYSTEM

CONNECTS WITH A CLICK

Attachable in **FOUR EASY STEPS**, the Can-Am ProMount plow system is the fastest, easiest way to start plowing and get the job done—minimal effort for maximum result.



1 Drive straight toward the plow.



2 Attach the winch cable to the plow using a guiding hook/roller.



3 Lift the plow until it clips onto the mounting plate.



4 Remove the winch cable from the guide. You're ready to plow.

New

CAN-AM PROMOUNT STEEL PLOWS

Made from 12-gauge steel and designed for efficient plowing, the ProMount steel blades are offered in multiple sizes to fit jobs large or small.

CAN-AM PROMOUNT STEEL PLOW KITS

These kits include:

- Can-Am ProMount Steel Blade
- Push Frame with Quick-Attach System
- Mounting Plate

72" BLADE

Defender, Defender MAX

- 715006302 · Black
- 715006303 · Yellow

\$1,024.97

CAN-AM PROMOUNT STEEL BLADES

- Blades available individually to create your own kit.
- Compatible with Can-Am ProMount Blade accessories to further enhance plow versatility.
- Not compatible with S3 Front High Clearance a A-Arm (715003784 & 715005116).

72" BLADE*

- Clears 66" (168 cm) when plow is fully angled.
- Blade height of 17" (43 cm).

ProMount Push Frame

- 715004474 · Black
- 715006021 · Yellow

\$394.99

66" BLADE*

- Clears 60" (152 cm) when plow is fully angled.
- Blade height of 17" (43 cm).

ProMount Push Frame

- 715006337 · Black
- 715006338 · Yellow

\$329.99



New

CAN-AM PROMOUNT FLEX2 PLOWS

HMWPE (High Molecular Weight Polyethylene) technology gives immunity to Flex2 greater reliability, resistance to impact, and is unaffected by rust or deformation. Tough on jobs but flexible in the face of obstacles, the Flex2 blade simplifies work.

CAN-AM PROMOUNT FLEX2 PLOW KIT

These kits include:

- Can-Am ProMount Flex2 Blade
- Push Frame with Quick-Attach System
- Mounting Plate

72" BLADE

Defender, Defender MAX

- 715006301 · Black

\$1,134.97

CAN-AM PROMOUNT FLEX2 BLADE

- Blades available individually to create your own kit.
- Compatible with Can-Am ProMount Blade accessories to further enhance plow versatility.

72" BLADE*

- Clears 66" (168 cm) when plow is fully angled.
- Blade height of 17" (43 cm).

ProMount Push Frame

- 715004485 · Black

\$504.99



CREATE YOUR OWN KIT

by choosing any plow type/length that you'd like for your push frame. ProMount Push Frames are compatible with all the blades.

YOUR JOB, YOUR CHOICE

Get a custom solution that truly fits the task at hand—with quality components and no cut corners. The ProMount mounting plate, push frame, and blades are a universal system that can be adapted to your specific Can-Am and jobsite.

CAN-AM PROMOUNT PUSH FRAME WITH QUICK-ATTACH SYSTEM

- Heavy-duty steel tubes designed to withstand the roughest use.
- Mid-mount carriage provides ultimate push strength and traction.
- Designed for maximum plow lift height.
- Features a self-aligning quick-attach system, an easy foot release pedal and an ergonomic handle for plow angle adjustment.
- Plow Roller Fairlead and Plow Limit Switch recommended to extend winch cable lifespan.
- Can-Am ProMount Mounting Plate required for installation.
- Blade swivels left or right, 5 positions.
- Large pin designed for easy blade rotation to eliminate dirt and snow buildup at pivot point.

Defender, Defender MAX

715003910

\$494.99



Compatible with all ProMount plows

CAN-AM PROMOUNT MOUNTING PLATE

- Required to install the Can-Am ProMount Push Frame with Quick-Attach System.
- Mounting plate precision-designed to stay on year round without compromising ground clearance.
- Not compatible with S3 Front High Clearance A-Arm (715003784 and 715005116)

Defender, Defender MAX

715004484

\$134.99



Required when plow is installed with Apache Track systems



CAN-AM PROMOUNT PLOW ACCESSORIES

CAN-AM PROMOUNT EDGE MARKERS

- Help locate the edges of your plow.
- Height: 24" (60 cm).
- Sold in pairs.
- Compatible with Can-Am ProMount Steel and Flex2 Blades with or without Blade Extensions (except for the Can-Am ProMount Steel 54" (137 cm) Blades).

Defender, Defender MAX

715004206

\$39.99

CAN-AM PROMOUNT DRIFT CUTTERS*

- Help keep snow in the plow.
- Dimensions: 17" x 13" (43.2 cm x 33 cm).
- Sold in pairs.
- Compatible with Can-Am ProMount Steel and Flex2 Blades with or without Blade Extensions (except for the Can-Am ProMount Steel 54" (137 cm) Blades).

Defender, Defender MAX

715006258

\$134.99

CAN-AM PROMOUNT PLASTIC WEAR BLADE*

- To help prevent scratches on smooth driveways and markable surfaces.

Defender, Defender MAX

66" (168 cm)

715004482

\$79.99

72" (183 cm)

715004483

\$134.99



CAN-AM PROMOUNT BLADE EXTENSIONS

- Add 3" (8 cm) each side.
- Compatible with Can-Am ProMount Blades (except for Can-Am ProMount Steel 54" (137 cm) Blade).
- Longer Wear Blade can be installed to further extend the extra length already provided by the extensions.
- Compatible with Can-Am ProMount Steel and Flex2 Blades (except for the Can-Am ProMount Steel 54" (137 cm) Blades).

Defender, Defender MAX

■ 715004205 · Black

■ 715005319 · Yellow

\$99.99

PLOW ANGLING SYSTEM*

- Converts your plow system into an easy-to-control unit from the driver's seat.
- Allows you to have full up/down and left/right plow control at your fingertips by using the supplied joystick.
- Using one hand to control all plow motions will allow you to easily concentrate and manage your plowing tasks.
- Push Frame Extension (715006257) is required for installation with the Front Rancher Bumper.
- Not compatible with Apache Backcountry Track System.

Any ProMount Push Frames and Blades

715006022

\$979.99



PLOW ROLLER FAIRLEAD

- Larger diameter lower roller reduces wear on wire rope for plow application.
- Can be used with all ProMount plows.

Defender, Defender MAX

705009222

\$59.99



PLOW LIMIT SWITCH

(Not illustrated)

- For controlling the cable tension when over raising your plow system.
- Prevents winch, plow push frame and vehicle damage.
- Sensor relocated for optimal lift height.

Defender, Defender MAX

715006259

\$114.99

SUPER-DUTY PLOW SYSTEM

The Super-Duty plow system and attachments are built to maximize your Defender's capabilities. Built to be extremely robust, efficient at tackling heavy jobs, and resistant to regular use—we call it "super" for a reason.

SUPER-DUTY PLOW KITS

- A comprehensive plow system with manual lift and angling.
- Ultra-durable 72" (183 cm) blade made of 12-gauge steel with integrated reinforcement and heavy-duty push tubes to tackle the most demanding jobs.
- Requires a winch for raising and lowering.
- Convenient disconnect system for quick and easy installation or removal.
- Front mount provides minimum 11" (28 cm) lift distance.

This kit includes:

- 72" (183 cm) Super-Duty Plow
- Super-Duty Plow Push Frame
- Super-Duty Plow Mounting Kit

72" [183 CM]

Defender, Defender MAX

715003416
\$1,274.97



Shown with the following accessories:
Plow Rubber Flap (715001219)
Plow Drift Cutter (715001218)
Plow Edge Markers (715001216)

SUPER-DUTY PLOW HYDRAULIC ANGLING KIT

- Allows you to have full up/down and left/right plow control at your fingertips.
- Pre-assembled, it comes with everything you need to turn your Super-Duty Plow into a quick, easy-to-control unit from the driver's seat.
- Using one hand to control all plow motions with the supplied joystick will allow you to easily concentrate and manage your plowing tasks.
- With this commercial grade kit, you will send snow exactly where you want reliably all winter long.
- Winch and plow sold separately.

Defender, Defender MAX (2019 & prior)

715002840
\$1,339.99

Defender, Defender MAX (2020)

715006038
\$1,339.99



Cylinders hydraulic



Electric hydraulic unit

SUPER-DUTY PLOW PUSH FRAME EXTENSION

(Not illustrated)

- Extension to use the Super-Duty Plow with the Apache 360 LT Track System.
- Comes with Plow Magnetic Switch and Plow Pulley.
- Requires Front Bumper or Front Accessory Bar for installation.

Super-Duty Plow

715001221 • Black
\$299.99

PLOW BLADE EXTENSIONS

- Side extensions for widening your plow blade by 6" (15 cm) on each side.
- Include rubber flaps for extension parts.
- Sold in pairs.

Super-Duty Plow

715001217
\$284.99



WARN⁺ PLOW ROLLER FAIRLEAD

- Larger diameter lower roller reduces wear on wire rope for plow application.
- For use with Super-Duty Plow.

Super-Duty Plow

715001223
\$69.99



PLOW EDGE MARKERS

(Not illustrated)

- For a more accurate view of the width of your plow.
- Allows you to cut a cleaner pass.
- Allows you to work closely around objects.

Super-Duty Plow

715001216
\$39.99

PLOW DRIFT CUTTER

(Not illustrated)

- Keeps snow securely in the plow.
- Allows you to cut a cleaner pass.
- Sold individually.

Super-Duty Plow

715001218
\$99.99

PLOW RUBBER FLAP

(Not illustrated)

- Keeps snow away from the driver and helps snow to roll in front of the plow.

Super-Duty Plow

715001219
\$99.99

PLOW PULLEY

(Not illustrated)

- For use with the Super-Duty Plow.
- Helps winching efficiency.
- Requires Front XT Bumper.

Super-Duty Plow

715002042
\$49.99

PLOW MAGNETIC SWITCH

(Not illustrated)

- Magnetic switch that stops the winch to prevent cable, winch and frame damage.
- For use with Super-Duty Plow.

Super-Duty Plow

715001995
\$109.99

TRAILERING COVER

- Heavy-duty canvas made of UV-resistant solution-dyed polyester.
- Inner soft liner protects windshield and colored panels from abrasion.
- All high-abrasion areas are reinforced with a double canvas layer.
- Weather-resistant trailering cover protects your vehicle during storage and transportation.
- Opening for fuel cap and cabin access on passenger side.
- Quick and easy installation.
- Designed to perfectly fit your vehicle with or without Can-Am accessories.

Defender, Defender 6x6

715004453
\$259.99

Defender MAX, Defender PRO

715004454
\$414.99



BOLT-ON⁺ RETRACTABLE RATCHETING TIE-DOWNS

- Perfect for transporting your powersport vehicle or securing loads.
- Mounts easily: Bolts on any flat surface (e.g. truck bed or frame).
- 1" x 6' (2.5 cm x 1.8 m) tie-down strap with heavy-duty stitching that delivers a 500 lb (226 kg) working load strength and 1,500 lb (680 kg) break strength.
- Convenient retractable push button automatically slackens, spools and stores away strap, while the ratchet mechanism tightens the strap snugly to secure your vehicle or load into place.
- Rubber ratcheting handle provides firm grip, and the hook is vinyl coated to protect whatever surface it hooks into.
- Sold in pairs.

295100737
\$30.99



RATCHET TIE-DOWNS

- 400 lb (181 kg) safe working load.
- 1" x 10' (2.5 cm x 3 m) strap with Sea-Doo, Ski-Doo and Can-Am logos.
- Deluxe ratchet with rubber handle.
- Coated S hooks.
- Pack of 2.

860200447 • Black/Grey
\$17.99



SCS WRAP KITS: PERFECTLY-SIZED AND **EXCLUSIVE WRAP DESIGNS*** THAT WILL COMPLEMENT YOUR DEFENDER AND REFRESH ITS LOOK. YOU'RE UNIQUE. YOUR RIDE SHOULD BE TOO.

Available at participating Can-Am dealers and scscanamgraphics.com

SCS wraps are of the highest quality, made with 0.004" (0.01 cm) engineering-grade vinyl overlaid with a 0.008" (0.02 cm) UV-protective laminate. That means vibrant colors, easy installation and a wrap that will hold up to the rigors of the off-road. SCS can even customize the color combinations, adding names, numbers and logos according to your exact specifications. Available for both 2-seat and 4-seat Defender models.



WITHOUT TRACTION,
THERE'S NOTHING—
FIT THE BEST TIRES
AND WHEELS ON YOUR
DEFENDER AND SEE
ALL IT CAN DO

ACCESSORY TIRES

ZILLA TIRE BY MAXXIS*

• Sold individually.

Front
27" x 10" x 14"
705401302
\$164.99

Rear
27" x 12" x 14"
705501703
\$179.99



REAR TIRE CHAINS

• Improve your traction in mud and snow.
• Sold in pairs.

27" x 11" x 14" 29" x 9" x 14"
715003839 715000225
\$94.99 \$79.99



OEM TIRES

ITP CRYPTID

• Graduated lug height and paddle-like shoulder configuration provide maximum side bite for climbing in and out of the mud without compromising ride comfort on trails and hard pack.
• 6-ply rated.

Defender X mr
Front
705402096 • 30" x 9" x 14"
\$194.99
Rear
705502621 • 30" x 11" x 14"
\$229.99



MAXXIS BIGHORN 2.0 TIRE

Defender (XT, XT Cab)	Defender	
Front - 27" x 9" x 14"	Front - 27" x 9" x 12"	Front - 28" x 9" x 14"
705401377	705401385	705401592
\$134.99	\$174.99	\$174.99
705400961 • (C)	705401386 • (C)	Rear - 28" x 11" x 14"
Rear - 27" x 11" x 14"	Rear - 27" x 11" x 12"	705502144
705502019	705501817	\$169.99
\$169.99	\$159.99	
705501295 • (C)	705501818 • (C)	



MAXXIS CORONADO

• Compliant with European T regulations.
Defender Convenience & PRO

Front
27" x 9" x 14"
705402058
\$184.99
Rear
27" x 11" x 14"
705502576
\$184.99



MAXXIS M923J / M924J

Defender (Base & DPS models only)

Front - 25" x 8" x 12"
705401658
\$114.99

Rear - 25" x 10" x 12"
705502215
\$149.99



*Consult your operator's guide/owner's manual for proper tire type and rim sizing. Improper tire type and rim selection may affect vehicle handling. Check with your local authorities for proper regulation.

OEM RIMS & BEADLOCKS

14" RIM

• Black with clear coat aluminum rim.
• Choice of beadlock color (not included).
• Needs 16 bolts (250000435) for installing the beadlock.

Defender, Defender MAX
Front - 14" x 6.5" offset = 41 mm
705401594
\$239.99
Rear - 14" x 8" offset = 51 mm
705502146
\$239.99



12" RIM

• Black with clear coat aluminum rim.
• Choice of beadlock color (not included).
• Needs 16 bolts (250000435) for installing the beadlock.

Defender, Defender MAX
Front - 12" x 6" offset = 41 mm
705401678 • Black
\$199.99
Rear - 12" x 7.5" offset = 51 mm
705502244 • Black
\$204.99



14" BEADLOCK

• Cast aluminum beadlock.
• Must be installed on Front Rim (705401594) and Rear Rim (705502146).

Defender, Defender MAX

705401586 • Manta Green
705401702 • Octane Blue
705401837 • Can-Am Red
705401840 • Black
\$76.99

NOTE: Matching Nuts - 250100100 / Matching Cap - 705400928

12" BEADLOCK

• Cast aluminum beadlock.
• Must be installed on Front Rim (705401678) and Rear Rim (705502244).

Defender, Defender MAX

705401445 • Can-Am Red
705401543 • Orange Crush
705401329 • Yellow
705401695 • Octane Blue
\$71.99

NOTE: Matching Nuts - 250100100 / Matching Cap - 705400928

OUTLANDER X MR AND DEFENDER RIM

• Cast aluminum rim with trend setting explosive styling so you can ride - and look - like a trailblazer.

Defender, Defender MAX (front wheels)
Front - 14" x 6.5" offset = 10 mm
705401848 • Black and machined
705401849 • Black
\$134.99
Defender, Defender MAX (rear wheels)
Rear - 14" x 8.5" offset = 23 mm
705502397 • Black and machined
705502398 • Black
\$134.99



NOTE: Matching Nuts - 250100100 Black, 250100082 Chrome Matching Cap - 705401541

LIMITED 14" RIM

• Premium cast aluminum rim.
• Black with machined face.
• Sold individually.

Defender, Defender MAX
Front - 14" x 7" offset = 41 mm
705401380 • Silver/Black
\$134.99
Rear - 14" x 8.5" offset = 51 mm
705501813 • Silver/Black
\$149.99

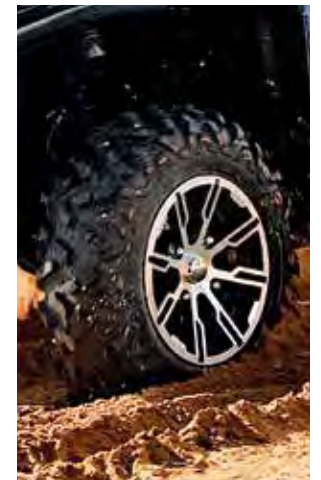

DEFENDER RIM

(Not illustrated)

Front - 14" x 7" offset = 41 mm	Rear - 14" x 8.5" offset = 51 mm
705401564 • Black	705502103 • Black
\$139.99	\$144.99
705401559 • Silver and machined	705502101 • Silver and machined
705401563 • Black and machined	705502102 • Black and machined
\$144.99	\$149.99

NOTE: Matching Nuts - 250100100 Black, 250100082 Chrome / Matching Cap - 705401541

ACCESSORY RIMS

LOCKOUT 393 14" RIM BY VISION*

• Sold individually.
• Matching Cap (705401362), Matching Nuts (250100100).

Front - 14" x 7"
Bolt circle pattern: 4/136 mm
Wheel offset: 4 + 3
705401363
\$104.99
Rear - 14" x 8"
Bolt circle pattern: 4/136 mm
Wheel offset: 4 + 4
705501787
\$104.99



NOTE: Matching Nuts - 250100100 Black & 250100082 Chrome / Matching Cap - 705400680 Black

*Consult your operator's guide/owner's manual for proper tire type and rim sizing. Improper tire type and rim selection may affect vehicle handling. Check with your local authorities for proper regulation.

RIDING GEAR



CAN-AM OFF-ROAD RIDING GEAR LIMITED WARRANTY*

1-YEAR LIMITED WARRANTY ON SPORTSWEAR AND RIDING GEAR**

4-YEAR LIMITED WARRANTY ON HELMETS**

*Purchased at an authorized BRP dealership / distributor or on a BRP-authorized online store. Other exclusions may apply, see complete limited warranty or contact your Can-Am off-road authorized dealer.
**Unless otherwise stipulated or required by law.



New ZIPPED HOODIE

60% Cotton,
40% Polyester Fleece
286709 • S-3XL
Heather Grey (27),
Black (90)
\$74.99

**New CAN-AM PULLOVER HOODIE**

60% Cotton,
40% Polyester Fleece
286708 • S-3XL
Khaki (05), Black (90)
\$69.99

**CAN-AM SHIRT**

60% Cotton,
40% Polyester
454074 • S-3XL
Khaki (05), Black (90)
\$64.99

**New LONG SLEEVE ORIGINAL TEE**

100% Cotton
286717 • S-3XL
White (01), Green (70)
\$34.99

**New ORIGINAL TEE**

100% Cotton
286712 • XS-3XL
Heather Grey (27),
Black (90)
\$24.99

**New X-RACE TEE**

100% Cotton
286714 • XS-3XL
White (01),
Black (90)
\$24.99

**New INTRUSION TEE**

100% Cotton
286716 • XS-3XL
Heather Grey (27),
Green (70), Black (90)
\$24.99

**New LADIES' ORIGINAL TEE**

95% Cotton, 5% Spandex
286715 • XS-2XL
White (01), Black (90)
\$24.99

**New LADIES' X RACE TEE**

95% Cotton,
5% Spandex
286713 • XS-2XL
Green (70), Black (90)
\$24.99

**ADVENTURE TEAM JERSEY**

- Quick-dry, antibacterial, moisture-wicking fabric.
- Extended back for coverage while riding.
- Mesh fabric for extra ventilation underarms.
- Non-fading sublimated graphics.

100% Polyester
454072 • S-3XL
Sunburst Yellow (96),
Red (30)
\$49.99

**New X-RACE JERSEY**

- Ultralight, quick-dry, antibacterial and moisture-wicking fabric.
- Mesh fabric for maximum breathability.
- Extended back for coverage while riding.
- Non-fading sublimated graphics.

100% Polyester.
286710 • S-3XL
Orange (12), Green (70)
\$49.99

**New LADIES' TEAM JERSEY**

- Semi-fitted cut specifically designed for ladies.
- Quick-dry, antibacterial, moisture-wicking fabric for maximum comfort.
- Mesh fabric for extra ventilation underarms.
- Non-fading sublimated graphics.

90% Polyester, 10% Spandex
286711 • XS-2XL
Orange (12), Green (70)
\$49.99

**MUD GEAR****MUD JACKET**

- 100% waterproof PVC.
- Electronically-welded seams.
- Underarm and rear vent panels.
- 2 hand pockets.
- Elastic cuffs.
- Drawstring hood and hem.

Polyvinyl Chloride (PVC)
286676 • S-2XL
Clear (00), Matte Black (93)
\$29.99

**MUD PANTS**

- Oversized pants made of 100% waterproof PVC.
- Electronically-welded seams.
- Strategically placed ventilation.
- Side openings at bottom leg.

Polyvinyl Chloride (PVC)
286128 • S-2XL
Clear (00), Matte Black (93)
\$14.99

**New ORIGINAL CAP**

- Plastic adjustment strap at back.

100% Cotton
286707 • One size • Khaki (05), Black (90)
\$24.99

**New CLASSIC CAP**

- Plastic adjustment strap at back.

100% Cotton
447702 • One size • Charcoal Grey (09), Black (90)
\$24.99

**New X RACE CAP**

- Mesh at back.
- Plastic adjustment strap at back.

55% Cotton, 45% Polyester
286705 • One size • Orange (12), Green (70), Black (90)
\$24.99

**New INTRUSION FLAT CAP**

- Mesh at back.
- Plastic adjustment strap at back.

100% Cotton
286706 • One size • Black (90)
\$24.99





ENDURO

Designed for long rides and high adventure.

FEATURES & BENEFITS

- Offers the dual experience of riding with a visor helmet plus the look and advantages of an MX helmet.
- Advanced plastic composite shell.
- Lockable, multi-positions and anti-scratch visor.
- Interchangeable retractable sun visor.
- Removable aerodynamic peak.
- Ultra-comfort and washable Dri-Lex¹ linings.
- Oversized and vented chin deflector.
- Adjustable air vents and exhausts.

EX-2 ENDURO HELMET

Shell: Polycarbonate Composite
448466 • XS-2XL • Black with graphics (94)

\$199.99

DOT ECE22.05



XP-3

Superlight cross-style helmet: Feature-packed for exceptional performance, protection and comfort.

FEATURES & BENEFITS

- 4-year limited warranty.
- Weight: ±1380 grams for size Large.
- Premium shell construction using superlight fiberglass and impact absorbing EPS liner.
- Aero-tuned fully adjustable visor system.
- Custom stainless grill design.
- Front and rear hi-max air vent system to maximize cooling.
- Removable, washable and replaceable CoolMax[™] moisture-wicking liner.
- Lightweight double-D chin strap.
- Triple certified: DOT, ECE and SNELL M2015.

New XP-3 PRO CROSS X-RACE HELMET

Shell: Fiberglass
448612 • XS-2XL
Charcoal Grey (07), Green (70)

\$239.99

DOT Snell ECE22.05



XC-4

Motocross style that combines lightweight construction, comfort and features beyond its price range. Value you can't ignore.

FEATURES & BENEFITS

- 4-year limited warranty
- Weight: ±1420 g for size Large.
- Front and rear hi-max air vent system to maximize cooling effect.
- Shell construction is superlight polycarbonate with impact absorbing liner.
- Fully adjustable visor system.
- Removable, washable and replaceable moisture-wicking liner.
- Winter breath deflector (sold separately).
- Lightweight double-D chin strap.

New XC-4 CROSS TEAM HELMET

- Durable multi-colored clear coated graphics.
- Can-Am branded.

Shell: Polycarbonate Composite

448608 • XS-2XL
Charcoal Grey (07), Red (30)

\$149.99

DOT ECE22.05



DUST MASKS

- Easily replaceable filters remove 99.9% of airborne dust, particles, pollen and odors.
- Made from soft yet durable neoprene material that fits snugly under helmets and goggles.
- XS/S fits most kids 12 and under, M/L fits most riders and XL/2XL fits larger frames (235+ lbs).
- Includes 2 replacement filters and a small storing pouch.
- Replacement filter (447719) available.

CAN-AM ORIGIN DUST MASK

448524 • XS/S, M/L, XL/2XL • Black with graphics (94)
\$34.99



CAN-AM VENTED DUST MASK

448525 • XS/S, M/L, XL/2XL • Black (90)
\$36.99



COMMUNICATION SYSTEM

SENA 30K BLUETOOTH COMM SYSTEM

- Bluetooth headset that operates on Sena's Mesh Intercom[™] technology.
- The 30K has a new quick charge feature meaning just 20 minutes of charging gets riders an impressive 5 hours of Bluetooth intercom use, or 3 hours Mesh Intercom use.
- 2.4 GHz frequency, connecting to other riders in an entirely new way.
- Should one of the group's riders go out of range, the Mesh Intercom intelligently keeps the rest of the group in seamless communication, while actively searching to reconnect, should that rider come back within range.
- Using the private group mode, the 30K can pair in full duplex communication with up to 16 riders at a range up to 1.2 miles (2 km).
- Sena 30K Audio Multitasking technology allows you to have a conversation via Adaptive Mesh-Networking technology while simultaneously enjoying Bluetooth operations such as streaming smartphone music, taking or making phone calls, or listening to turn-by-turn GPS navigation.

SINGLE PACK

448610 • One size • Black (90)
\$329.99

DUAL PACK

448611 • One size • Black (90)
\$579.99



*Some models and accessories shown may not be available or homologated in your country. Contact your BRP dealer or local authorities for information.



GOGGLES

CAN-AM RACE SAND GOGGLES BY SCOTT

- Dust catcher vent foam.
- Custom painted frame and strap graphics.
- UV protected Lexan® lens with No Fog™ anti-fog lens treatment.
- Hypoallergenic multi-layer face foam.
- Durable and anti-slip full strap attachment.
- Extra clear lens in the box.
- Storing pouch included.
- Speed Strap attachment system compatible (sold separately).
- Tear-off and roll-off compatible (sold separately).

448638 • One size • Black (90)
\$78.99



CAN-AM TRAIL GOGGLES BY SCOTT

- UV protected Lexan® lens.
- Hypoallergenic super-soft face foam.
- Speed Strap attachment system compatible (sold separately).
- Durable and anti-slip full strap attachment.
- Tear-off and roll-off compatible (sold separately).

448616 • One size • White (01), Red (30), Black (90)
\$34.99



GLOVES

New X-RACE GLOVES

- Air mesh panels for ventilation and mobility.
- Double Clarino® layer at palm and thumb for extra durability and comfort.
- Pre-curved design.
- Silicone fingertip for better grip.
- Hook-and-loop wrist closure system.

Shell: Air Mesh, Spandex, Clarino®



MEN'S
286718 • XS-2XL • Orange (12), Green (70)
\$39.99



LADIES'
286719 • S-2XL • Orange (12), Pink (36)
\$39.99



ADVENTURE TEAM GLOVES

- Spandex construction for flexibility.
- Chamude palm.
- Pre-curved design.
- Slip-on gloves.
- Silicon print at inner fingers.

Shell: Spandex, Chamude, Polyester

446305 • S-3XL • Red (30)
\$26.99



JUNIOR

JUNIOR X CRUSH HELMET

- Multi-density EPS liner.
- Ultra-plush removable/washable liners.
- Adjustable visor to protect from the elements.
- Multiple air vents help keep you cool and dry.
- Lightweight double-D chin strap.
- Ski-Doo and Can-Am stickers in the box.
- Optional breath deflector (sold separately).

Shell: ABS

448506 • S, M, L • Black with graphics (94)
\$99.99



New CAN-AM BUZZ GOGGLES BY SCOTT

- UV protected Lexan® lens.
- Hypoallergenic super-soft face foam.
- Durable and anti-slip full strap attachment.
- Speed Strap attachment system compatible (sold separately).

448620 • One size • Black (90)
\$34.99



BAGS

CAN-AM CARRIER DRY BACKPACK BY OGIO

- Completely waterproof rolltop construction.
- Reflective screen print.
- Airflow back panel keeps the rider cool.
- 2-way adjustable sternum strap.
- Dual-density shoulder straps for maximum comfort.
- Removable inner liner to allow bigger storage.
- Laptop and tablet sleeves.
- Organization panel with 2 zippered pockets.
- Dimensions: 20.5" H x 10.5" W x 6.75" D (52 cm x 27 cm x 17 cm).

100% Polyester
469544 • One size • Black (90)
\$139.99



CAN-AM SLAYER GEAR BAG BY OGIO

- Large main compartment with easy access to all gear.
- Large separated boot pocket.
- Zippered accessory pocket.
- Easy grab handles for transport.
- Detachable shoulder strap.
- Heavy-duty reinforced base.
- Dimensions: 32" H x 16" W x 18" D (81 cm x 41 cm x 46 cm).

100% Polyester

469294 • One size • Black (90)
\$104.99



CAN-AM URBAN BACKPACK BY OGIO

- Airport security friendly protective laptop compartment.
- Padded iPad™/tablet/e-reader pocket.
- Dual side water bottle/accessory holders.
- Fully adjustable ergonomic shoulder straps.
- Front pocket with 2 padded accessory compartments and slip pocket.
- Dimensions: 19.5" H x 13.5" W x 9.5" D (50 cm x 34 cm x 24 cm).

100% Polyester

469293 • One size
Black (90)

\$89.99



HOW TO MEASURE

- For best results, have someone else take measurements.
- Measure body in underwear.
- Tape must be snug but not tight.
- If measurements fall between two sizes, order the larger size.

- HEAD** Around your head, from the center of the forehead, above the ears and over the natural bump at the back of the head.
- ARM LENGTH** Let the hands hang down on the side in a slightly bent position. Measure from the center of the back of your neck, along the length of your arm, to the wrist.
- CHEST/ BUST** Measure under your arms, around the fullest part of your chest.
- WAIST** Measure around your natural waistline, keeping one finger between the tape and body.
- HIPS** Across the fullest part of the seat.
- INSEAM** Without shoes, from crotch to the floor.

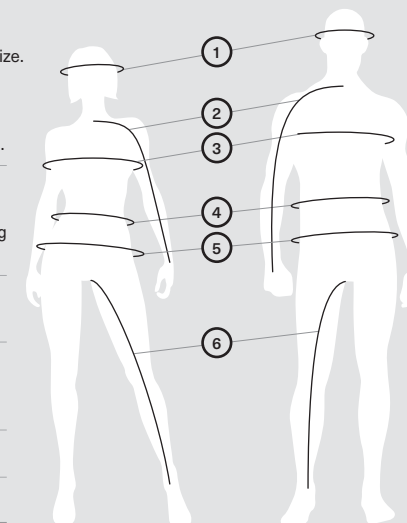

WHAT CODE REPRESENTS YOUR SIZE?

1. Find your size.
2. The corresponding code is **THE CODE** you use to complete the part number on your order.
Example: 440227__90 Size: M = Code "06", therefore 4402270690

SIZE	CODE	SIZE	CODE	SIZE	CODE	SIZE	CODE	SIZE	CODE	SIZE	CODE
One Size	00	XL	12	4XL	19	6	25	13	33	7-8	54
XS	02	XLT	13	5XL	88	7	27	14	34	10-12	49
S	04	2XL	14	1	20	8	28	16	35	14-16	50
M	06	2XLT	15	2	21	9	29	18	78	S/M	72
MT	07	3XL	16	3	22	10	30	3-4	79	M/L	91
L	09	3XLT	17	4	23	11	31	5-6	52	L/XL	73
LT	10	4XL	18	5	24	12	32	6-8	48		

RIDING GEAR & SPORTSWEAR

MEN'S-5'7"- 6'0"

	XS	S	M	L	XL	2XL	3XL
Chest	34-36	36-38	38-41	41-45	45-49	49-53	53-57
Waist	28-30	30-32	32-35	35-39	39-43	43-48	48-52
Hips (seat)	34-36	36-38	38-41	41-45	45-49	49-53	53-57
Arm length	30	31	32	33	34	35	35
Inseam	31	31½	32	32	32	32	32

LADIES'-5'3"- 5'8"

	XS	S	M	L	XL	2XL	3XL
Chest	32-34	34-36	36-39	39-42	42-46	46-50	50-54
Waist	26-28	28-30	30-33	33-36	36-40	40-44	44-48
Hips (seat)	35-37	37-39	39-42	42-45	45-49	49-53	53-57
Arm length	30	30	30½	31	31½	32	33
Inseam	30	30	30	30	30	30	30

GLOVES (measure palm width)

MEN'S	S	M	L	XL	2XL	3XL	LADIES'	S	M	L	XL	2XL
Palm (inches)	3¼	3½	4	4½	5	5½	2¾	3	3½	4	4½	
Palm (cm)	8	9	10	11.5	13	14	7	8	9	10	11.5	

HELMETS

MEN'S & LADIES'

	XS	S	M	L	XL	2XL	3XL
Head (inches)	20 7/8 - 21 1/4	21 1/8 - 22	22 1/8 - 22 3/4	23 1/8 - 23 3/8	24 - 24 1/2	24 3/4 - 25 1/8	25 1/2 - 25 7/8
Head (cm)	53-54	55-56	57-58	59-60	61-62	63-64	65-66

JUNIOR

	S	M	L
Head (inches)	19 1/4 - 19 3/4	20 - 20 1/8	20 1/2 - 21 1/4
Head (cm)	49-50	51-52	53-54



1



2



6



7

TAKE YOUR CAN-AM PRIDE FARTHER THAN EVER BEFORE ALL-NEW CAN-AM LIFESTYLE COLLECTION

MORE THAN 100 PRODUCTS FOR HOME, GARAGE, OFFICE,
TRAVEL, AND MOBILE DEVICES!

Explore them all online at CAN-AMOFFROAD.COM or check out the selection instock
at your favorite **Can-Am dealer!**



3



5



8



9

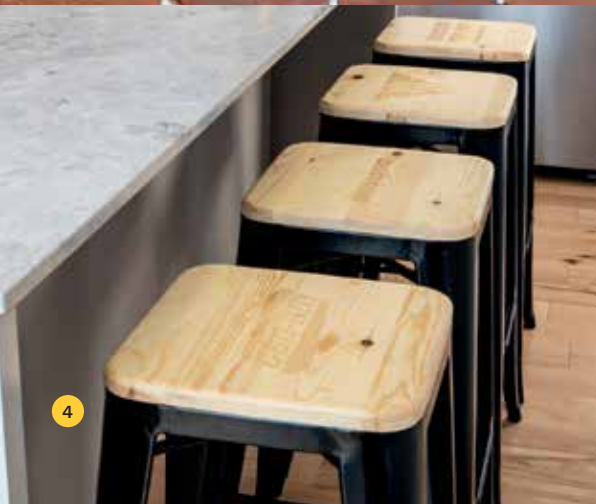

4

1. Golf Bag - \$219.99 2. Versatile Carry-On Suitcases - \$99.99 3. Parking Only Sign (8" x 12") - \$21.99 4. Metal Bar Stools - \$119.99 5. Versatile Backpack - \$96.99
6. Cargo Backpack - \$65.99 7. 24-Can Cooler Bags - \$149.99 8. Jacquard Throws - \$59.99 9. Aprons - \$14.99

KEEP YOUR CAN-AM VEHICLE PERFORMING AT ITS BEST

Remember what made you fall for a Can-Am vehicle? Precisely engineered. Rigorously tested. Factory approved. The ultimate off-road experience continues with Genuine Can-Am Parts, whether installed by our trusted network of trained dealers—or Do-It-Yourself installed in the comfort of your garage.

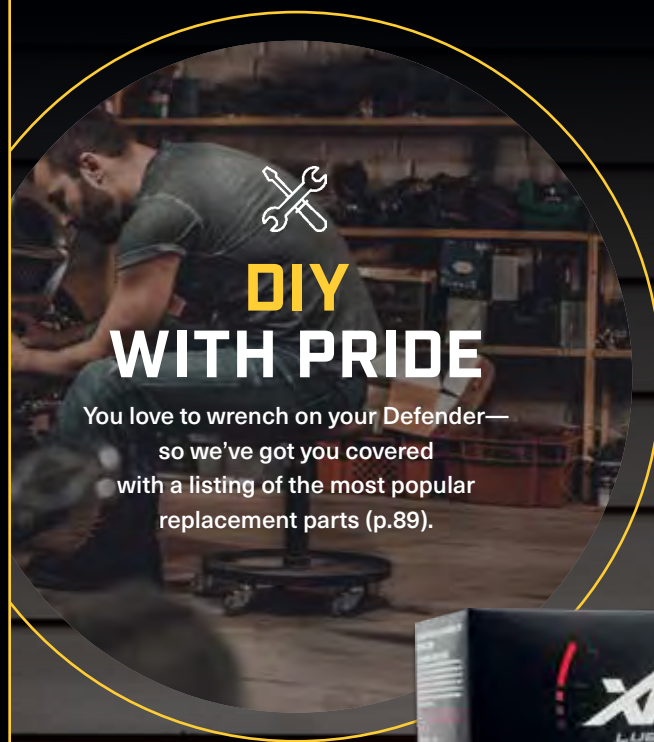

DIY WITH PRIDE

You love to wrench on your Defender—so we've got you covered with a listing of the most popular replacement parts (p.89).



*For new genuine parts sold through BRP. Includes items installed by you or authorized BRP dealer. Other exclusions may apply, see complete limited warranty or contact your Can-Am off-road authorized dealer.

ENGINE OIL CHANGE KIT

All-in-one solution that saves time and money. (p.95).



Visit the can-amoffroad.com Parts & Maintenance section to see the full line of Genuine Can-Am Parts.



REGULAR MAINTENANCE ENSURES YOUR DEFENDER PERFORMS AS YOU EXPECT

KEEP AN EYE ON THESE COMPONENTS*

- ✓ **OIL FILTER** 420256188
- ✓ **ENGINE OIL** SEE P.95
- ✓ **FUEL FILTER**
- ✓ **AIR FILTER** 715900394
- ✓ **CVT AIR FILTER** 706600156 (EXCEPT XMR)
- ✓ **DRIVE BELT** 422280654/422280280
- ✓ **BRAKE PADS** SEE P.90
- ✓ **BOOT KITS** SEE P.90
- ✓ **WHEEL BEARINGS** 293350118
- ✓ **A-ARM BUSHINGS** 703500875
- ✓ **BALL JOINTS** 706202044/706202045
- ✓ **SPARK PLUG**
- ✓ **BATTERY** 410301203

*Refer to periodic maintenance chart for proper intervals.



GENUINE CAN-AM MAINTENANCE PARTS

OIL FILTER

All Engine Types
420256188



O-RING (DRAIN PLUG)

(Not illustrated)
All Engine Types
420552280

O-RING (OIL FILTER COVER)

(Not illustrated)
420230920 • HD8, HD10
420230921 • HD5

Complete Engine Oil Change Kit also available—See page 95.

SPARK PLUG

707000246 • HD8, HD10
715900352 • HD5



FUEL FILTER

(Not illustrated)
Defender, Defender MAX
709000330 • HD5, HD8, HD10
Defender (EVAP Models)
513033719 • HD8, HD10

PREMIUM AIR FILTER

- The best filter on the market, it prevents airborne contaminants from reaching your engine.
- Protects internal components against premature wear.
- Genuine BRP air filters ensure absolute compatibility and a perfect fit.

All Engine Types
715900394



CVT AIR FILTER

(Not illustrated)
706600156 (Except XMR)

Note: Please contact your dealer or visit our online store at can-amoffroad.com for suggested retail prices regarding Genuine Can-Am Parts.

PREMIUM DRIVE BELT

- High-performance design ideal for off-road use.
- BRP-specific calibration adjusted to best suit your Can-Am vehicle.

422280654 • HD8, HD10
422280280 • HD5 Only



METALLIC BRAKE PAD KIT

- Built strong to last long – heavy-duty construction stands up to hard braking.
- Designed to handle demanding riding conditions with challenging braking environments such as mud and dunes.
- Created specifically for use with Can-Am vehicles.

Defender, Defender MAX
715900379 • Front Left
715900380 • Front Right
Defender HD8, HD10
715900381 • Rear Left
715900382 • Rear Right

Defender HD5
715900387 • Rear Right
Defender MAX HD8, HD10
715900386 • Rear Left
715900387 • Rear Right



CVT GASKET COVER

(Not illustrated)
420450400 • HD8, HD10
420630292 • HD5

DRIVEN PULLEY EXTRACTOR

- Spreads the secondary clutch open for easy belt replacement.
- Locks engine at TDC for maintenance tasks.

529036352 • HD8, HD10
708200686 • HD8, HD10

PULLER/LOCKING TOOL

- Allows to spread the secondary clutch open for easy belt replacement.

529036098 • HD5

CV BOOT KITS

- Come with clamps and grease.
- Genuine BRP CV Boot Kits ensure absolute compatibility and a perfect fit.

705401345 • Front Wheel Side
705401355 • Front Differential Side
705501864 • Rear



FRONT A-ARM BUSHING KIT

- This bushing kit includes 2 bushings, a sleeve and a wearplate, as illustrated.
- All you need to renew your suspension A-Arms.

703500875



YUASA¹ BATTERIES

- Top of the line models from the leading preferred original equipment battery supplier in North America.

410301203 • 18 Amps. Wet • (YTX20L-BS)



30 AH BATTERY UPGRADE

- Defender and Defender MAX (Base and DPS models only) require 30ah Battery Holder (715004431).
- Please refer to your user manual for removal and installation.
- Base and DPS models only.

515176151



PREMIUM HALF SHAFT

- Premium quality design ideal for off-road, heavy-duty and low speed torque usage.
- Includes CVs, Shaft and Boots with the best suited geometry for your Can-Am vehicle.

Defender HD5
705502478 • Rear Left
705502479 • Rear Right
Defender, Defender MAX
705401937 • Front Left
705401936 • Front Right

Defender (XT-P Models)
705402353 • Front
Defender HD8, HD10 (Including X-TP Models)
705502451 • Rear

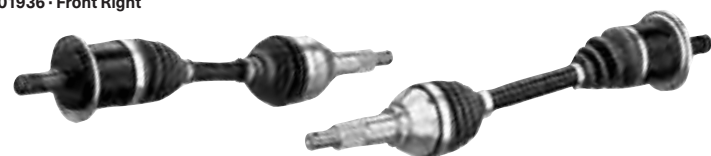

PERFORMANCE HALF SHAFT

- High-performance design ideal for off-road use with superior wheel power and acceleration for racing, dunes and desert riding.
- Includes CVs, Shaft and Boots with the best suited geometry for your Can-Am vehicle.

Defender X mr
705402420 • Front

WHEEL BEARINGS

- (Not illustrated)
- Sealed bearings for additional protection from water and dirt.

293350118

BALL JOINTS

- Robust design for off-road usage and sealed for prolonged durability.

706202044 • Upper
706202045 • Lower



WHAT MAKES CAN-AM BELTS STAND OUT?



"I'VE TESTED EVERY BELT OUT THERE, AND CAN-AM'S DRIVE BELTS ARE WHAT I RELY ON TO WIN RACES."

PHIL BLURTON

2017-2018-2019 UTV World Championship Winner
2017-2018 BITD UTV Pro Production Turbo Champion



CAN-AM BELT CONSTRUCTION VS. COMPETITORS

MODULUS & TENSILE STRENGTH

Based on Dynamometer testing, PBO surpasses Kevlar and Carbon Fiber materials in every way.

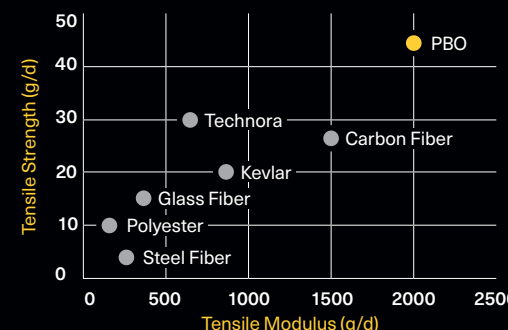

DURABILITY COMPARISON

Compared to Can-Am's Performance Drive Belt.

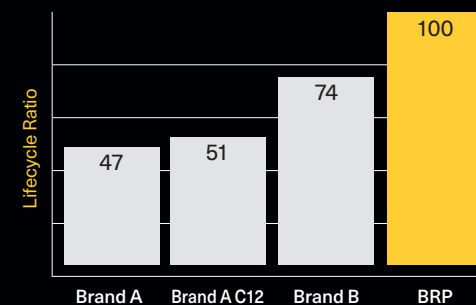

Consistent quality

We partner with the best manufacturers in the powersports industry to offer you unique drive belts with consistent quality.

Prolonged durability

The 100% cutting-edge PBO high-tensile strength polymer fiber construction offers high-temperature robustness and prolonged durability.

Tested performance

Our engineering teams have perfectly integrated and tested each drive belt to provide quick throttle response, powerful acceleration, top speed and consistent shifting performance.

Custom calibration

We aim at delivering the highest levels of performance and longevity based on your vehicle's specific end-use and calibration.

Note: Please contact your dealer or visit our online store at can-amoffroad.com for suggested retail prices regarding Genuine Can-Am Parts.



Hunter Miller
2018 GNCC XC1 PRO TURBO UTV CHAMPION
Multiple-time short course champion
Hunter Miller has won with XPS in all conditions.



Kyle Chaney
2017 TORC PRO MOD UTV CHAMPION
AND MULTI-TIME GNCC CHAMPION
Experienced short course and cross country
champion racer Kyle Chaney relies on XPS
to hold up to extreme race conditions.



Phil Blurton
2017-2018-2019 UTV WORLD CHAMPIONSHIP WINNER
2017-2018 BITD UTV PRO PRODUCTION TURBO CHAMPION
XPS lubricants are what get a naturally-gifted driver
like Phil Blurton to the top of the podium.

XPS oil undergoes rigorous worst-case scenario testing, and as a result is the trusted lubricant of many Can-Am racers.



WHY XPS OIL IS THE PERFECT FIT FOR YOUR ROTAX ENGINE?

Just like you count on Can-Am to help you make the most of every terrain, you can trust XPS to ensure the long-lasting performance and durability of your Rotax engine.

ULTIMATE PERFORMANCE

Engineered to match the advanced performance of Rotax engines.

UNMATCHED RELIABILITY

Get the most out of every mile on every ride.

MADE FOR THIS

Developed with Rotax engines to deliver the best performance and lubrication in all conditions.



<https://can-am.brp.com/off-road/xps.html>

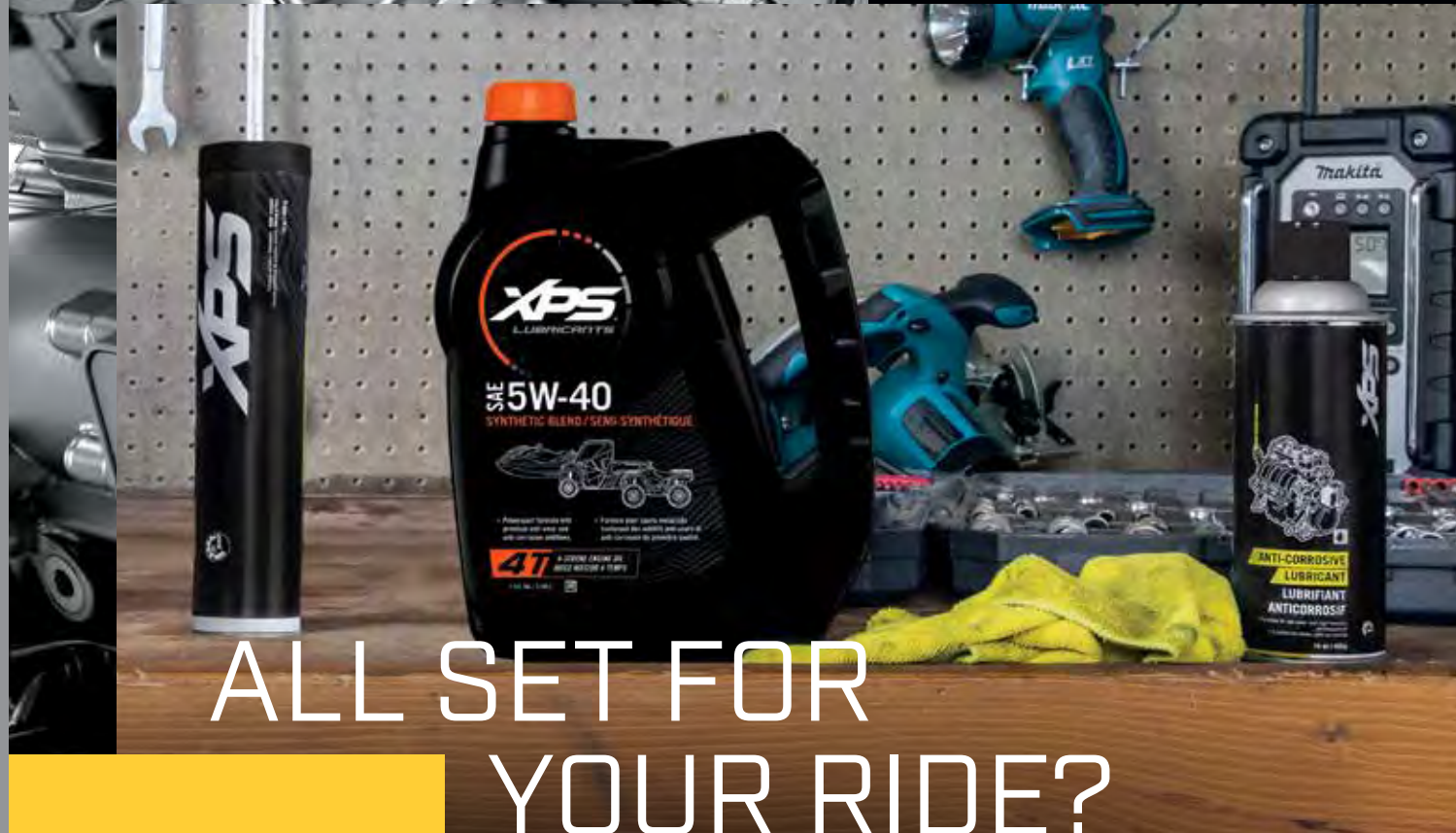

ALL SET FOR YOUR RIDE?

GET THE OIL CHANGE KIT THAT KEEPS YOUR ROTAX ROARING

Protecting your investment by changing your engine oil at regular intervals should be at the top of your maintenance to-do list. To make the task easier, we developed the XPS Engine Oil Change Kit for an all-in-one solution that saves time and money.

<https://can-am.brp.com/off-road/xps.html>



ENGINE OIL CHANGE KIT

- Ultra-convenient "all-in-one" Engine Oil Change Kit saves time and money.
- Includes XPS Synthetic or Synthetic Blend Oil, oil filter, o-rings and washer.

- 779256 • Synthetic Blend (5W-40 450 cc or less (except Rally and DS ATVs))
- 779257 • Full Synthetic (0W-40 450 cc or less (except Rally and DS ATVs))
- 779258 • Synthetic Blend (5W-40 500 cc or more V-twin engine)
- 779259 • Full Synthetic (0W-40 500 cc or more V-twin engine)
- 779252 • Full Synthetic (10W-50 500 cc or more V-twin engine)
- 779260 • Synthetic Blend (5W-40 900 ACE)
- 779261 • Full Synthetic (10W-50 900 ACE)



Love to DIY? Save money, time, and effort: everything you need for an oil change is in this box.

XPS 4T 10W-50 SYNTHETIC OIL

- Engineered for heavy-duty and high-performance 4-stroke engines, including turbocharged, supercharged and racing engines.
- Formulated using carefully selected and strenuously tested base stocks and custom additives.
- Offers thick film strength to protect bearings, and a proven high-temp detergency to minimize deposits, prevent shear, provide thermal stability, and combat fuel dilution to ensure maximum performance from your engine.

779234 • 1 quart / 946 ml
779235 • 1 US gallon / 3.785 L

XPS 4T 0W-40 SYNTHETIC OIL

- Powersport formula with premium anti-wear and anti-corrosion additives.
- The best choice for high-performance snowmobile, ATV and SXS 4-stroke engine used in cold weather.
- Provides superior engine and transmission protection against heat, rust and corrosion.
- Delivers optimal performance in high and low temperature.

779139 • 1 quart / 946 ml
779140 • 1 US gallon / 3.785 L

XPS 4T 5W-40 SYNTHETIC BLEND OIL

- Off-road formula with premium anti-wear and anti-corrosion additives.
- Designed for high-performance off-road, on-road and PWC 4-stroke engines, including turbo or supercharged powersports engines.
- Provides superior engine and transmission protection against rust and corrosion even in extreme conditions.

779133 • 1 quart / 946 ml
779134 • 1 US gallon / 3.785 L

SYNTHETIC GEAR OIL

- Uses custom additives to provide the best performance in Visco-Lok & Smart-Lok differentials.
- Allows higher loads, superior shear stability and reduced oxidation.
- Exceptional wear protection and superior performance at all operating temperatures.

75W-90
779158 • 1 quart / 946 ml
75W-140
779160 • 1 quart / 946 ml



SYNTHETIC GREASE SUSPENSION

- Designed to work specifically with the components found in Can-Am vehicle suspensions.
- It is highly stable and offers optimal lubrication at both extreme cold and high temperatures while protecting suspension components from dirt and moisture, as well as corrosion under extreme washout conditions.

779163 • 14 oz. / 400 g



ANTI-CORROSIVE LUBRICANT

- Multipurpose lubricant that can also be used to prevent rust, corrosion and moisture intrusion.
- It contains extreme pressure additives that work as an all-around lubricant for just about anywhere lubrication is needed.

779168 • 12 oz. / 340 g



EXTENDED LIFE PRE-MIXED COOLANT

- XPS Antifreeze/Coolant contains the correct dilution and the necessary additives to prevent corrosion and inhibit cavitation in BRP cooling systems.
- Long-life, 5-year formula specially formulated for BRP vehicles.
- Superior heat transfer.
- Ideal replacement for vehicles that normally use a 2-year antifreeze/coolant (green).

779150 • 1 quart / 946 ml



Note: Please contact your dealer or visit our online store at can-amoffroad.com for suggested retail prices of XPS products.

Note: Please contact your dealer or visit our online store at can-amoffroad.com for suggested retail prices of XPS products.



DOT4 BRAKE FLUID

- Meets or exceeds all DOT3 and DOT4 brake fluid requirements.
- High-temperature formula resists fade, and also conditions seals and o-rings in braking system.

779151 • 12 oz. / 355 ml



RACING BRAKE FLUID

- Exceeds DOT4 brake fluid requirements for extreme conditions and competition use.
- Extreme, 579-degree boiling point temperature is ideal for high-demand competition conditions to combat brake fade.
- Will not harm seals or braking system components.
- Should be added only to a clean/unfilled system to avoid dilution and diminished performance.
- Low-moisture formula slows water vapor absorption through multiple heat cycles.
- Recommended for use in Ski-Doo and Can-Am racing applications.

779152 • 12 oz. / 355 ml



HIGH PERFORMANCE SUSPENSION FLUID

- A synthetic, fade-free formula for servicing FOX® shocks.
- Specially formulated for high-demand or racing application.
- Ultra high VI shock oil.
- Engineered viscosity for optimized performance with FOX® shocks valving.

779153 • 1 quart / 946 ml



FUEL STABILIZER

- Ethanol-compatible and will stabilize fuel in your tank to keep it from breaking down and causing hard starting, throttle hesitation and poor run quality.
- Ethanol attracts moisture, and this product contains powerful anti-corrosion additives to protect fuel system components.
- Prevents problems associated with E10 fuels.

779171 • 8 oz. / 236 ml



CARBON FREE FUEL TREATMENT

- Combination of a fuel treatment and a fuel system cleaner that can be used periodically to restore lost starting or throttle performance, as well as maintain fuel system integrity and keep internal engine parts clean.
- It treats fuel for storage and addresses the moisture problems inherent in today's Ethanol-blended fuels, keeping ferrous and soft metal parts clean and free of corrosion.
- Uses patented, state-of-the-art additives.
- Cleans valves, sticky rings and combustion chamber.

779169 • 12 oz. / 355 ml



FUEL TREATMENT CARBURETOR CLEANER

- Complete fuel treatment specially formulated to prevent small engine problems caused by Ethanol-blended fuels.
- It removes fuel system gum and varnish that may have accumulated during storage, stabilizes fuel against breakdown for 12 months or more, and adds corrosion protection from moisture for short- and long-term storage.
- It also helps restore throttle response and easy starting.
- It can be used periodically to maintain fuel system integrity, keep carburetor jets clean, and also combat moisture problems caused by Ethanol-blended fuels to keep ferrous and soft metal parts clean and free of corrosion.

779172 • 12 oz. / 355 ml



EXPLORE AN ENTIRE WORLD OF ADVENTURE WITH ALL OF OUR BRP PRODUCTS. BRP.COM



ski-doo LYNX SEA-DOO can-am ROTAX ALUMAcraft Manitou Evinrude

Note: Please contact your dealer or visit our online store at can-amoffroad.com for suggested retail prices of XPS products.