

1947 JULY

RADIO
& Television
RETAILING

CALDWELL-CLEMENTS, INC.

TELEVISION •

RADIO • FM

ELECTRICAL

APPLIANCES

PHONOGRAPHS &

RECORDS

SOUND &

SERVICE

Premium

Quality



You expect more and get more from Mallory
APPROVED PRECISION PRODUCTS

Preferences are built on experience. And the experience of the past fifteen years has shown that Mallory parts have premium quality—*deserve* to be called "Approved *Precision* Products." No line gives better performance. None is more complete. None is backed by a network of distributors who are more willing and able to serve you.

What it all boils down to is that you expect more and get more from Mallory products. But you aren't asked to *pay* MORE! Small wonder that more Mallory-made vibrators are in use today than all other makes combined. Small wonder that Mallory capacitors and replacement controls have a nationwide reputation for longer life, greater dependability.

P. R. MALLORY & CO., Inc.
MALLORY

VIBRATORS . . . VIBRAPACKS* . . . CAPACITORS . . . VOLUME
CONTROLS . . . SWITCHES . . . RESISTORS . . . FILTERS
. . . RECTIFIERS . . . POWER SUPPLIES.

*Reg. U. S. Pat. Off.

APPROVED PRECISION PRODUCTS

P. R. MALLORY & CO., Inc., INDIANAPOLIS 6, INDIANA

RADIO & Television RETAILING

Including RADIO & Television TODAY

ORESTES H. CALDWELL

Editorial Director

M. CLEMENTS

Publisher

JOHN L. STOUTENBURGH

Executive Editor

DARRELL BARTEE

Managing Editor

HAROLD R. ELLIS

Technical Editor

RUTH MORRIS

Records Editor

M. R. LABATT-SIMON

Assistant Editor

CHARLES F. DREYER

Art Director

BUSINESS DEPARTMENT

LEE ROBINSON

Sales Manager

M. H. NEWTON

Business Manager

EDWIN WEISL, JR.

R. A. WHITE

BEN MORRIS

Promotion Manager

BETTY HALL

Production

CIRCULATION DEPARTMENT

B. V. SPINETTA

Circulation Manager

W. W. SWIGERT

Credit Manager

BRANCH OFFICES

CHICAGO 6

R. Y. FITZPATRICK, Manager

S. GASKINS DAVID J. O'ROURKE

201 N. Wells St. RAN. 9225

LOS ANGELES 5

THE ROBERT W. WALKER CO.

684 S. Lafayette Park Pl.

Drexel 4388

SAN FRANCISCO 4

68 Post St. SUtter 5568

RADIO & Television RETAILING

July 1947, Vol. 46, No. 1. 25 cents a copy. Published monthly by Caldwell-Clements, Inc. Publication Office 1309 Noble St., Philadelphia 23, Pa. Editorial, Advertising and Executive Offices 480 Lexington Ave., New York 17, N. Y. M. Clements, President; Orestes H. Caldwell, Treasurer. Subscription rates United States and Latin American countries \$1.00 for one year, \$2.00 for three years. Canada \$1.50 for one year, \$3.00 for three years. All other countries \$2.00 for one year, \$4.00 for three years. Printed in U. S. A. Entered as second class matter March 20, 1947, at the Post Office at Philadelphia, Pa., under the act of March 3, 1879. Member of Audit Bureau of Circulations. Copyright by Caldwell-Clements, Inc., 1947.

*Trade-Mark Reg. U. S. Pat. Off.

IN THIS ISSUE

JULY, 1947

★ *Radio, FM, Television*

COVER—The Big Four
 EDITORIAL—Stop This Fear Psychology 27
 WHAT'S AHEAD!—IN RADIO, APPLIANCES, RECORDS AND TELEVISION 28
 AFTER SALE FOLLOW-UP IS BUSINESS BUILDER 32
 4-WAY-WISE MAKES PROFIT RISE 34
 FARM SALES IN EARLY AUTUMN 36
 INSURANCE PROTECTION FOR RETAILERS 38
 NEW SETS FOR THE NEW SEASON 40
 SALES-PLUS-SERVICE WINS CUSTOMERS 42
 MORE NEW LINES SHOWN 46
 NEW LINES CONTINUE 48

★ *Records, Phonographs, Accessories*

RECORD COVER—Platter Profit-Pointers 51
 PEP UP SUMMER SALES 53
 VARIETY OF PLATTERS OFFERED 54
 NEW PHONO LINES 60
 NEWS OF THE RECORD INDUSTRY Begins on page 62

★ *Electrical Appliances*

APPLIANCE COVER—Sell in the Showroom 69
 HOW TO RUN THE SALES CONTEST 71
 SIGNS HELP TO SIGN 'EM UP 72
 SPEEDING UP REPAIRS ON ELECTRICAL APPLIANCES 74
 NEW ELECTRICAL HOME APPLIANCES 76
 WHAT'S NEW IN LIGHTING 80
 NEW APPLIANCE ITEMS 82
 DO KIDS GET YOUR GOAT 84
 NEWS OF THE APPLIANCE INDUSTRY Begins on page 111

★ *Service and Sound*

SERVICE COVER—Quick Checks for New Set Troubles 87
 NEW PROSPECTS FOR SOUND 89
 SERVICING NEWEST RADIOS 90
 HOW TO INSTALL BOAT RADIOS 92
 MAKES TELE STUDY EASY 94
 NEWEST PRODUCTS FOR PA INSTALLERS 96
 BENCH AIDS CUT SERVICE TIME 100
 NEW PRODUCTS RAISE REPAIR PROFITS 102
 SALES TIPS AND PROFIT POINTERS 106
 FM SALES HIGHLIGHTS 108
 TELEVISION TOPICS 110

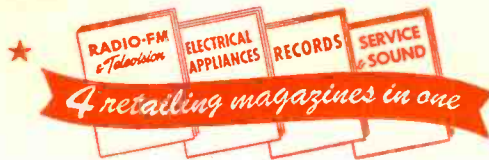

**29,000 COPIES
THIS ISSUE**

Member of
**AUDIT BUREAU
OF CIRCULATIONS**

CALDWELL-CLEMENTS, INC.

Publication Office 1309 NOBLE ST., PHILADELPHIA 23, PA.
 Editorial, Advertising & Executive Offices 480 LEXINGTON AVE., NEW YORK 17, N. Y.



1948

**Back to
Normal**

1948

**the Year of
Production**

PHILCO
Radios and
Phonographs
for 1948
are here!

Philco, the industry
leader for 17 years,
is ready for 1948

*the year of selling . . . with a sensational
line of radio and phonograph values!*



1948
the Year of
Selling

Philco
the Leader...
Stronger than
ever!

Again for
1948... your
major source
of profits!

The news is out . . . Philco dealers all over America are getting the full story now . . . again, for the season of 1947 and '48, the radio dealers' greatest opportunity for sales and profits lies with *Philco, the Leader!*

Philco for 1948 is here, bringing you the sensational post-war developments from the Philco laboratories in a complete array of record-breaking radio and phonograph values . . . every model a *sales leader* in tone, performance, features and quality . . . superbly styled for every shade of modern public demand. And *merchandised* to give you volume sales in the profitable price brackets, to put power in your promotions and sell-up on your floor.

Selling gets back to normal in the year of 1947 and '48. And Philco is ready again to set the pace for the

industry in advertising, merchandising and promotion. In every medium . . . broadcasting, magazines and newspapers . . . the strongest national and local campaigns in Philco history will tell the story of Philco quality and value to the radio and phonograph buyers of every market.

Yes, Philco for 1948 gives you the line, the merchandise and the promotion you need for your biggest year of selling and profits!

PHILCO

Famous for Quality the World Over

INDEPENDENCE from transformer worries is *also* celebrated by users of Merit Transformers. Get the "Constitution" of Merit Transformers. The flag is Merit Quality.

MERIT COIL AND TRANSFORMER CORP.
 MERIT COIL AND TRANSFORMER CORP.

MERIT COIL & TRANSFORMER CORP.
 TELEPHONE
 4427 North Clark St. Long Beach 6311 CHICAGO 40, ILL.

The DIRECTORY ISSUE Will List "Big Four" Products

This will be a crucial Fall for many manufacturers. Increasing consumer sales resistance is forcing dealers to concentrate on more desirable lines. Thus, in many cases, if manufacturers fail to maintain their toe-holds in stores throughout the nation, they may lose out in competitive selling for years to come. That is why it is so necessary that manufacturers *continue* to resell their dealers and distributors on their products and lines—now.

Buyers' markets are normal. Each sale has to be earned. Every product must be backed up with sufficient trade promotion before consumer selling begins.

The largest number of dealers and distributors selling the Big Four products in this trade are the ABC paid subscribers to RADIO & Television RETAILING—total circulation over 29,000. They read the magazine because it gives them each month full information on all their selling needs.

The Big Four DIRECTORY issue in September will be used as a buying index for 12 months ahead. As a Fall 1947 re-appraisal of this ever-changing market, it will tell the trade where to buy.

The Directory will list manufacturers of radio in the following classifications: home sets (AM and FM), television, combinations, auto radio, amateur and commercial. It will list appliance makers who produce refrigerators, freezers, laundry equipment, vacuum cleaners, electric ranges and traffic appliances. There will be a full listing of manufacturers of phonograph records, phonographs, needles, albums and accessories. Replacement parts, tubes, sound and test equipment will be featured in the service section of the Directory.

Supplement this up to date editorial information with product advertising on your full line. Here is the most important issue of the trade's most important publication. Postwar competition needs prewar selling methods: spreads, inserts, color. Tell, sell—loud and often. And whatever else you do, don't miss this issue. Deadline for September is August 1.

The Publishers



YOU GET ALL THREE FROM

Admiral



in the . . .

New

MIRACLE Tone-Arm

*The greatest advance in high fidelity record reproduction
since the invention of the automatic changer!*

Now . . . based upon a wartime secret formula, Admiral engineers have developed an ultra sensitive energy converter. Encased in a permanently sealed all-plastic cartridge, which snaps into Admiral's "Miracle" Tone Arm, this record playing sensation requires no coil, crystal, filament or special tube. Reproduces complete bass to treble tone range with amazing fidelity at both high and low volume. Bans needle scratch, hiss, "talk-back." See and hear it, today . . . ask your Admiral distributor.

Admiral Corporation

{ World's Largest Manufacturer of Radio-Phonographs
with Automatic Record Changers

The great feature thousands are asking for...

Strobo-Sonic Tone

— only Stewart-Warner has it!

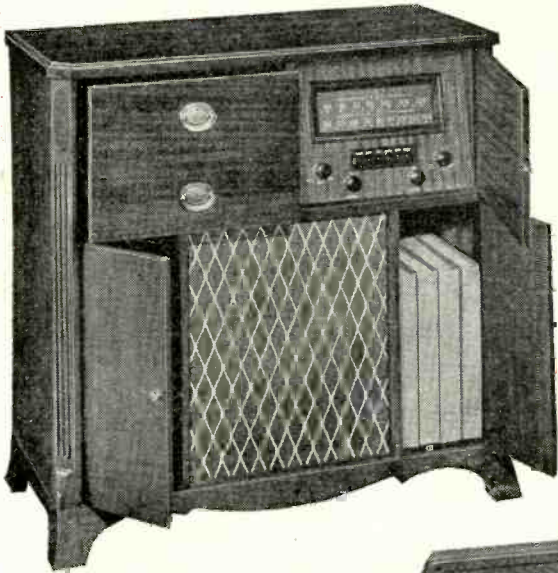

THE MUSIDORA—today's superior FM-AM console combination. Two models: the De Luxe with intermix changer and 2 album compartments; the Master with standard changer and one compartment. Full-cycle AC tonal range.

THE CONSOLETTES—the new AM radio-phonograph that performs like a big console! Smooth AC performance, so important for fine records. Automatic changer handles up to 12 discs. Detachable legs quickly convert this set to a table model.

AM TABLE RADIC—never has so much pure enjoyment been engineered into a set this size! Radair Antenna, 5 tubes plus rectifier, tone control, powerful reception. Ivory plastic with ruby-red controls.

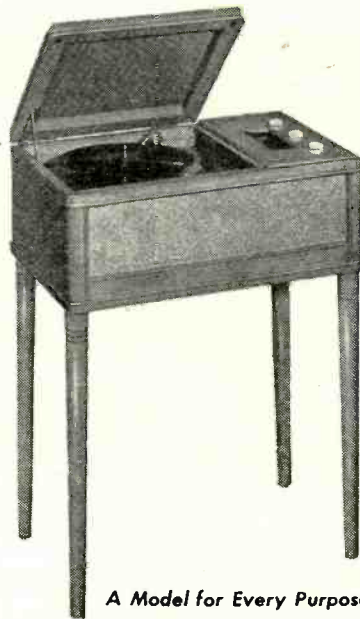

A Model for Every Purpose—a Radio for Every Room

Stewart-Warner dealers alone can answer the demand for "the tone that's picture-clear." In both AM and FM-AM sets, Stewart-Warner is winning customer preference everywhere with the tone so faithful you can understand each word . . . distinguish every instrument . . . hear music in its true dimensions, picture-clear. True quality—priced for the buyers' market!



THE BALLADEERS—today's superior FM-AM table sets. Full depth Strobo-Sonic Tone! AC-DC, 7 tubes plus rectifier, PM dynamic speaker, 2 built-in Radair Antennae. Handsome in both walnut and desert tan.



AIR PAL—built like a watch, smaller than a phone, yet it's a full-power AC-DC radio that plays anywhere you plug it in! Beautiful jewel-box display . . . gold and satin . . . sets it off for what it is—a console in a jewel case!

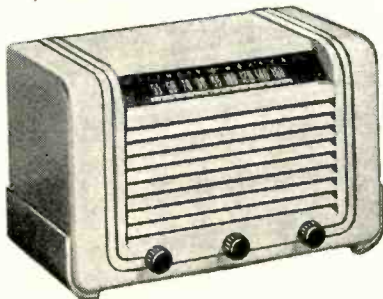

Stewart-Warner

FM Radios AM Radio-phonographs Television

CHICAGO 14



ILLINOIS

SEE US AT THE FURNITURE MART, JULY 7-19, SPACE 55-56, ON THE 17TH FLOOR



TAKE A LEAF FROM THE OLD-TIME RIVER PILOT'S BOOK... AND LET THE CURRENT HELP CARRY YOU!

PROFITS? SUCCESS? ... You'll gain them faster—and with a lot less effort—if you keep your business craft in the swift-flowing current of G-E product-popularity.

It's smart to install and sell G-E radio tubes because they're top-quality *and the world knows it*. That's the impelling force that backs up your efforts as a G-E tube dealer—helps bring you new customers, leads present clients to recommend your shop to their friends.

Plenty of muscle, too, in the "lift" you're given by General Electric along promotion lines! The finest tube dealer-aid material in the industry is supplied for 1947. Also, your prospects see G.E.'s full-color national electronics advertis-

ing in magazines read by millions—advertising that guides buyers straight to your shop door.

Quality, reputation, strong and continuous promotion—these are high cards in any business. They're yours for the asking, when you install and sell G-E radio tubes. They will make your sales hand a winning one, with steady, ever-growing volume and profits. *Electronics Department, General Electric Company, Schenectady 5, New York.*

You want and need Sales-helps Booklet ETR-51, describing G.E.'s complete line of displays and other promotion material available to service-men and tube dealers. Send for your free copy TODAY.



RADIO TUBES



GENERAL ELECTRIC

176-F7-8850

FIRST AND GREATEST NAME IN ELECTRONICS

COLLIERS' WRAPS UP



AMERICA'S RICHEST MARKET



Collier's for Action

LOWEST RATE OF THE "BIG 3" WEEKLIES

Collier's lower rates put additional "impact" into your advertising budget. You get more sell per advertising dollar through Collier's than through either of the other "Big 3" weeklies.

MORE BUYERS

Of the "Big 3" weeklies, Collier's reaches the greatest percentage of the 25 to 45 year age group . . . the "Age of Acquirement" . . . the men and women who know what they want and are out to buy.

MORE SALES MESSAGES

You can "say it" more often in Collier's than in either of the other "Big 3" weeklies. You can penetrate the market deeper with more insertions . . . more sales messages . . . more weeks of national coverage.

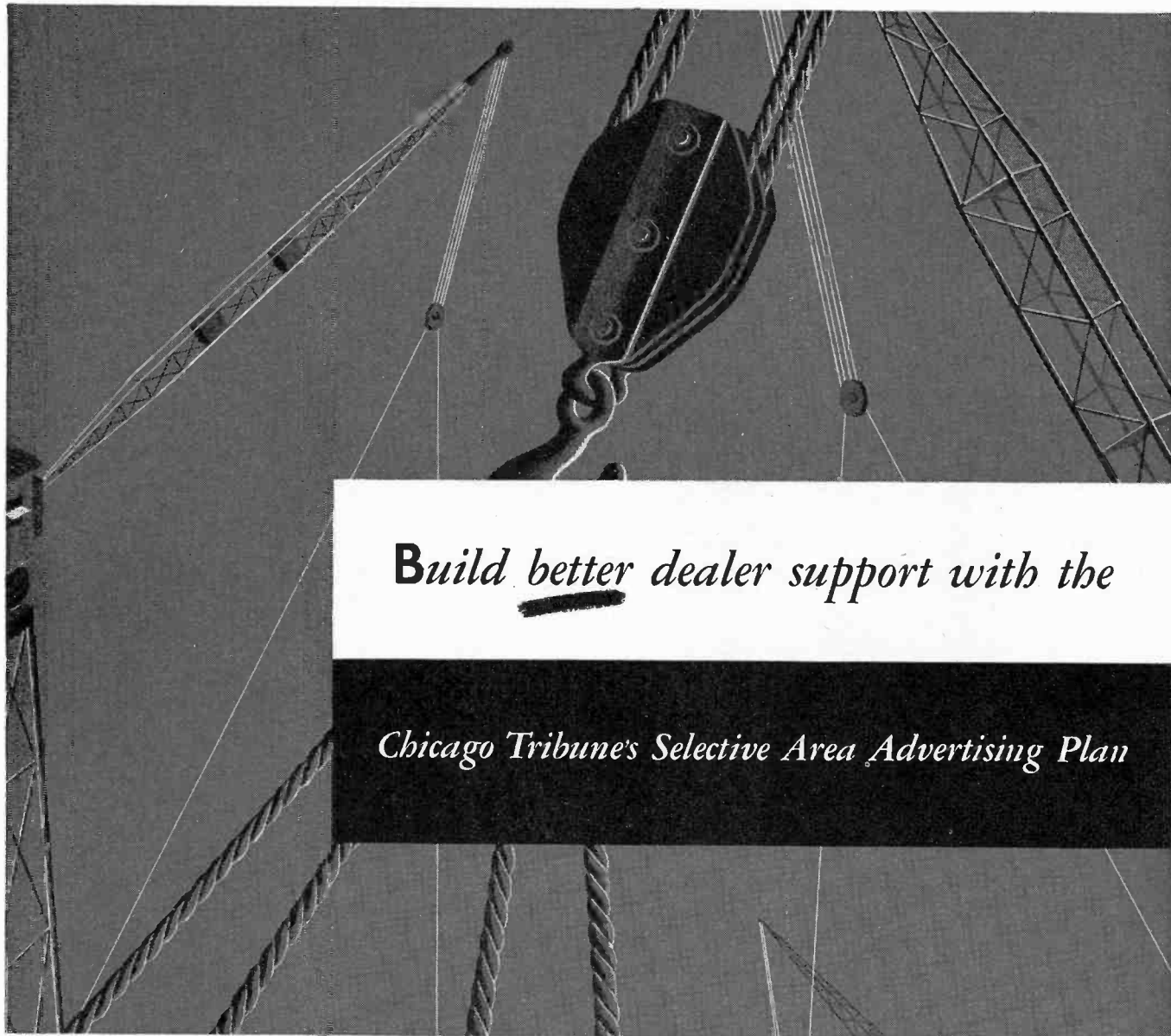

Build better dealer support with the

Chicago Tribune's Selective Area Advertising Plan

No wonder dealers like the Tribune's Selective Area Advertising Plan. Through this plan, each of your dealers gets the benefits of a hard-hitting advertising campaign in his own area . . . he gets faster results from his own prospects . . . and it costs him but 2½c per line.

When you put the plan to work for all of your dealers in this area, it's easy to see why ultimate results should be more sales for you in the Great Chicago Market . . . a market so large it can take all or the greater part of the production of many manufacturers. Here's what happens under the plan—

EACH DEALER GETS:

- 1** Selective coverage of his local market.
- 2** Prominent display of his name and location.
- 3** The low rate of just 2½c a line!

YOU GET:

- 1** Better identification of your local outlets.
- 2** Enthusiastic dealer support.
- 3** Advertising that pays off right away!

This plan will make more valuable to you the exhaustive findings of the Tribune's Durable Goods Study among consumers and dealers. To learn how it will meet your specific needs, contact your nearest Tribune representative as shown below.

Capitalize on the Tribune's plan to drive your sales message home in the Great Chicago Market. No other advertising plan localizes your story so effectively. And no medium penetrates this rich area like the Tribune. Tribune rates per line per 100,000 circulation are among the lowest in America.

Chicago Tribune

The World's Greatest Newspaper

April average net paid total circulation:
Daily, over 1,040,000 • Sunday, over 1,500,000

MEMBER: AMERICAN NEWSPAPER ADVERTISING NETWORK, INC., FIRST 3 MARKETS GROUP, AND METROPOLITAN SUNDAY NEWSPAPERS, INC.

A. W. Dreier, Chicago Tribune
810 Tribune Tower, Chicago 11
E. P. Struhsacker, Chicago Tribune
220 E. 42nd St., New York City 17
Fitzpatrick & Chamberlin
155 Montgomery St., San Francisco 4
W. E. Bates, Chicago Tribune
Penobscot Building, Detroit 26



ELECTRONIC REPRODUCER
Most Dramatic
DEMONSTRATION FEATURE
ANY PHONOGRAPH EVER HAD

RISE STEVENS,
 star of the Metropolitan
 Opera Company, and the
 Prudential "Family Hour,"
 Sunday afternoon over CBS.

• Wonderful FM plus
 standard and short-wave
 broadcasts, and the sensa-
 tional new G-E Elec-
 tronic Reproducer. Push-
 button tuning. Sure-ac-
 tion automatic record
 changer. 9 tubes plus
 rectifier. 18th Century-
 inspired mahogany cabi-
 net. See Model 417A.

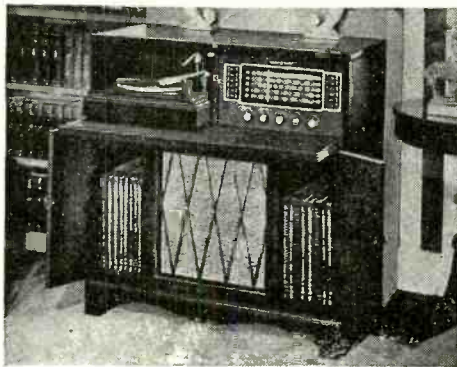

**In every General Electric
 automatic radio-phonograph**

Let your customers' own ears discover the thrill of the
 finest record reproduction they ever heard.

Play the same record with the amazing new G-E Elec-
 tronic Reproducer, and then on any other phonograph.
 The difference is startling. This dramatic demonstration
 clinches sale after sale because the G-E Electronic Re-
 producer—against a background of velvety silence—
 recreates every recorded note in all its glorious beauty.
 For full information, write your General Electric radio
 distributor or Electronics Department, General Electric
 Company, Bridgeport, Conn.

LEADER IN RADIO, TELEVISION AND ELECTRONICS

GENERAL  ELECTRIC
179-77

PORTABLES • TABLE MODELS • CONSOLES • FARM SETS • AUTOMATIC PHONOGRAPH COMBINATIONS • TELEVISION



• A magnificent per-
 former is Model 326 with
 its natural color tone
 from both radio and
 records. G-E Electronic
 Reproducer. Sure-action
 record changer. Storage
 for 118 records.

• General Electric's
 finest table radio-
 phonograph —
 Natural color
 tone from radio,
 and from records
 played by the
 amazing G-E
 Electronic Re-
 producer. Ask to
 see Model 304.



• Master craftsmen
 fashioned this superb
 French Provincial
 cabinet of genuine
 Honduran mahog-
 any. The wonders of
 FM, standard, and
 short-wave radio
 plus the G-E Elec-
 tronic Reproducer.
 Push-button con-
 trols. 12 tubes plus
 rectifier tube and tun-
 ing indicator tube.
 Model 502.



MEISSNER

*For Your
Discriminating Clientele*

For those of your customers who are content with only the finest, you will want Meissner. The choice of artists and music-lovers alike, these superb instruments are acknowledged everywhere as the finest of the new higher-priced, higher-quality radio phonographs. Fashioned for pleasure, surpassing in charm, they represent true perfection in fine music and authentic cabinet design.

In a few areas a number of Meissner dealerships are still open.

For full information on these exclusive franchises write;

Meissner, 936 N. Michigan Avenue, Chicago II, Illinois.

A sales executive will contact you at once.



THE MEISSNER CHIPPENDALE

An authentic reproduction in finely figured swirl mahogany, richly carved and hand finished. As advertised in *Fortune*, *House Beautiful* and *National Geographic*.



Export—Scheel International, Inc.,
4237 No. Lincoln Ave., Chicago, Ill.
Cable—Harscheel.

MEISSNER MANUFACTURING DIVISION OF MAGUIRE INDUSTRIES, INC.

MAKING TUBES IS EASY... IF YOU KNOW HOW!

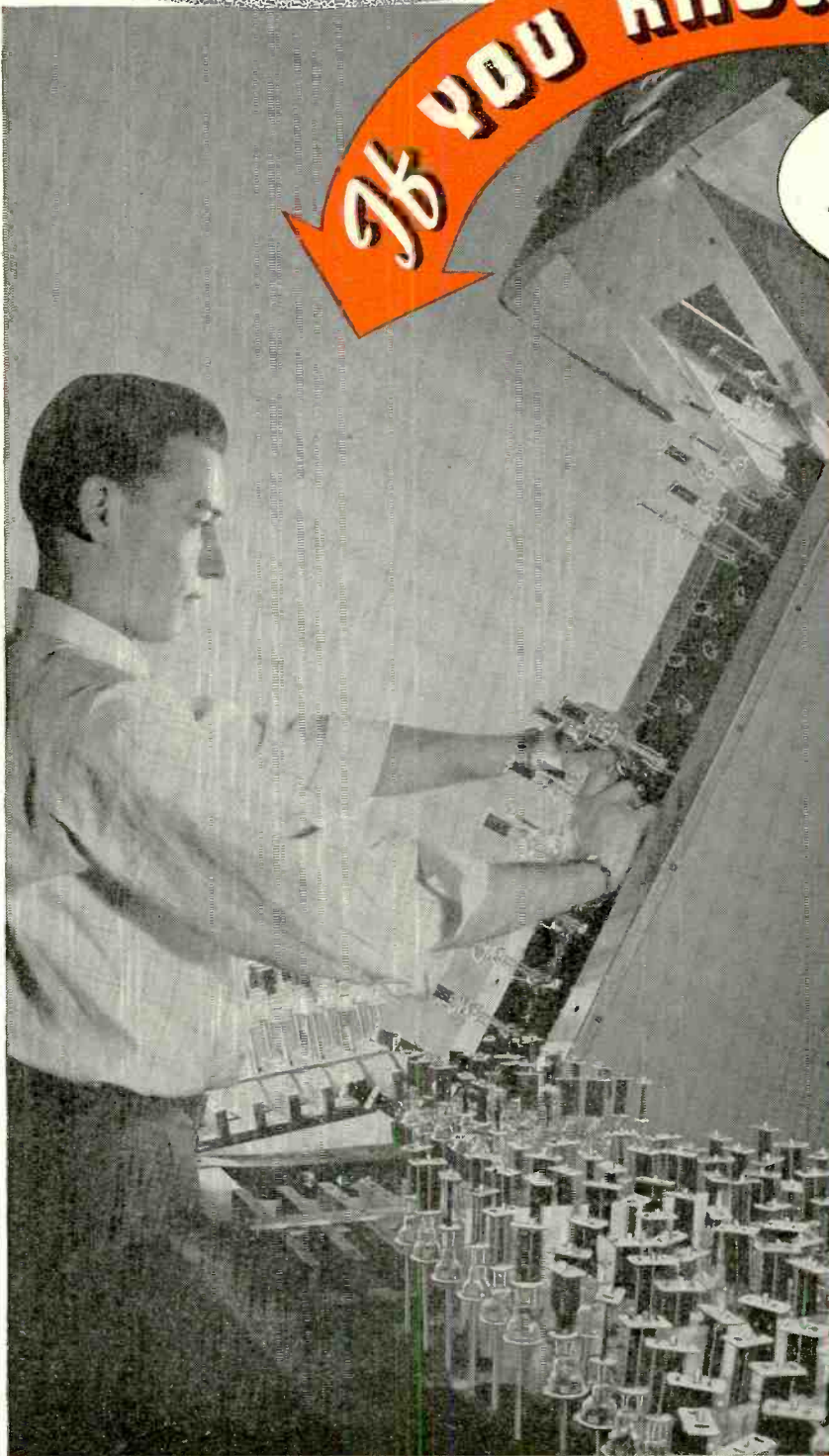

WASHING OUT THE BLACK MAGIC

Tubes are funny critters. Years ago Hytron engineers had this puzzling experience. Production of a certain tube was running beautifully. Without warning, control over emission was lost and rejections skyrocketed. The exact cause could not be pinned down. Finally an engineer suggested washing the mount assemblies in distilled water just before sealing. What a radical idea! Moisture on tube parts had always been shunned. But washing—followed by thorough drying—was tried. As with the snap of one's fingers, the trouble vanished—tube performance became normal.

Parts had already been degreased, hydrogen fired, handled and stored with painstaking care. Just before sealing-in, the mounts had been blown out with clean compressed air. All that fussiness had not been enough. Why? Human handling during assembly had been necessary and had introduced minute traces of salts and fatty oils from the operators' hands. For some types of tubes mount washing is worse than useless. For others, however, Hytron engineers have proved it a must.

The illustrated mount washing machine symbolizes a determination to insure you from trouble. A formidable looking gadget, it is merely an endless belt carrying the mounts through distilled water, alcohol for quick drying, and then past a bank of infrared lamps. Like many an effective manufacturing device, it is simple as pie—if you know how. But what a difference in tube satisfaction such little Hytron extras in cleanliness can make for you!

SPECIALISTS IN RADIO RECEIVING TUBES SINCE 1921



HYTRON

RADIO AND ELECTRONICS CORP.



MAIN OFFICE: SALEM, MASSACHUSETTS



SPARTON

...every radio dealer,
new Spartons in

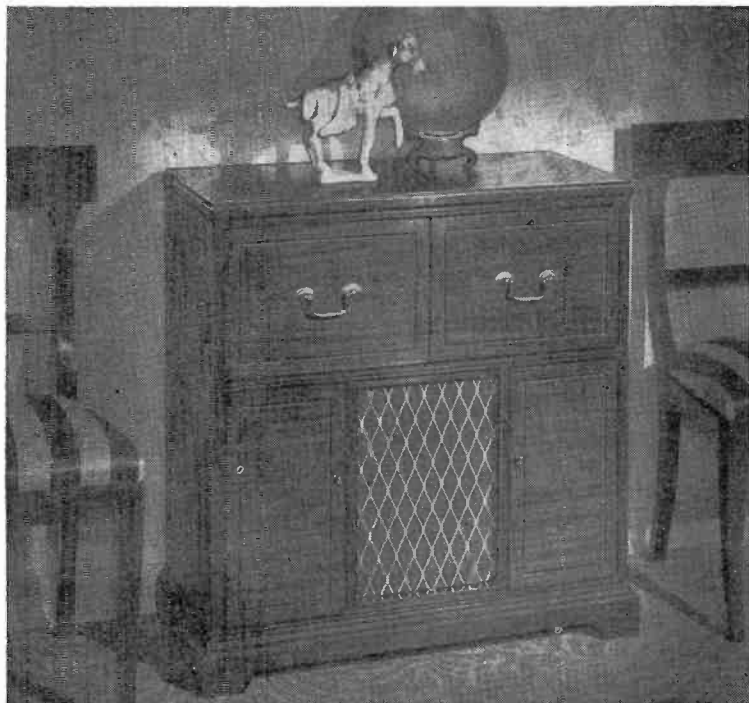

SPARTON PERIOD MODEL NO. 1007

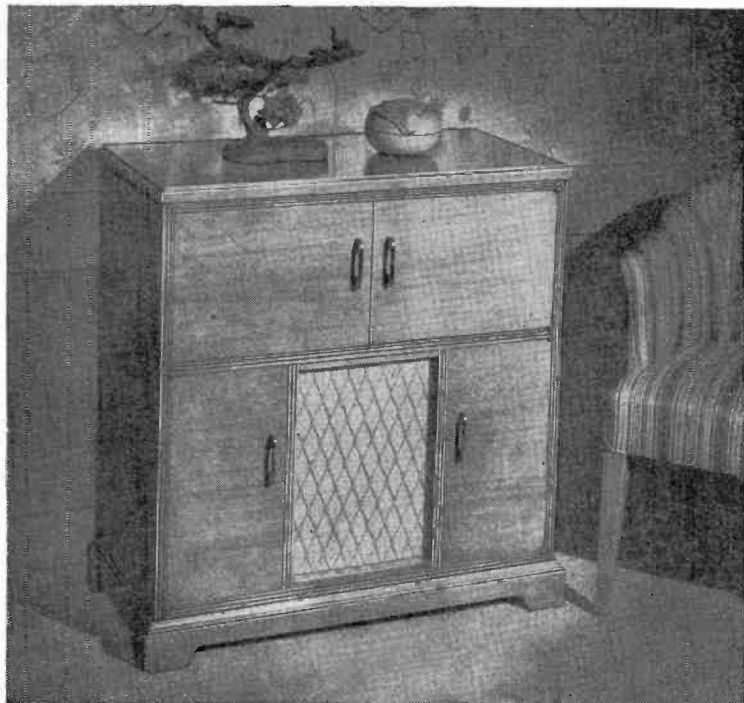

SPARTON MODERN MODEL NO. 1005

*Check these Spartons
for engineering,
cabinets, styling!*

Futura dial
Exclusive Giantenna (longest built-in aerial on market both AM and FM)
Two built-in record storage cabinets
Dual purpose tubes
Two-post record changer (plays twelve 10-inch or ten 12-inch recordings)

AM and FM (no extra charge for FM)
Continuous tone control
Enclosed, dust-proof backs
Eterna-Gem Ruby needle (guaranteed forever!)
Hand-rubbed finishes, rare wood veneers (Mahogany for period and Contemporary; Golden Wheat for Modern)

Compare this stunning Sparton automatic table combination, Model No. 201



SEE IF you can match this styling, the tone, features. Rich mahogany finish. New Sparton ready-tone circuit gives big set performance, *eliminates all warm-up time*. Vacuum-lift lid can't slam, bang, drop. Console tone reproduction with big sound chamber. Record changer handles records with care. Light-weight—easily carried. AC.

\$79⁹⁵

Compare these exciting Sparton utility models



YES, CHECK these Sparton utility models against any comparable sets on the market. Gleaming, sturdy plastic cabinets house the finest of engineering. Sleek, wide dial and trim, smart lines. Listen to the tone! Solid as a console with high-powered performance. Two colors: ebony and polished ivory.

EBONY MODEL
NO. 101

IVORY MODEL
NO. 100 (Shown)

\$19⁹⁵

\$20⁹⁵

CHALLENGES YOU...

manufacturer and the public to match these performance, style, features... **PRICE!**



SPARTON CONTEMPORARY MODEL NO. 1006

SEE WHY we say it's impossible to equal the features of the new Sparton Challengers at anywhere near a comparable price? By all means put these new Spartons to the test—check AM and FM reception—check the smoothest working record player you've ever seen. Look closely at the beautiful cabinet design and workmanship. In every way you'll find Sparton Challengers offer *more* selling features.

SEE NEW SPARTONS AT PERMANENT SHOW ROOM NO. 509-B AMERICAN FURNITURE MART

LOOK at any radio!

LISTEN to any radio!

COMPARE . . . point for point, tone for tone! Yes, the radio world was ripe for a challenge and here it is—the new Sparton Challenger Line. We invite you to try and beat these Sparton beauties—*anywhere*—at a comparable price.

Inspect these handsome AM-FM radio-phonograph combinations—the Period, The Modern, The Contemporary. Here's standard broadcast reception clear as a summer dawn . . . and FM with its high fidelity, static-free reception, an *essential sales feature these days*. Check the smooth working, two-post record changer—*no complaints* from this precision changer that pampers records. Look at those expensively hand-rubbed cabinets of the very finest veneers. Check *all* the many exclusive Sparton features . . .

You'll see why these new Sparton Challengers are taking the radio world by storm.

Now, ETERNA-GEM Ruby Needle at no extra cost!

Typical of the built-in value of every Sparton, all Challenger AM-FM combinations are equipped with a genuine Eterna-Gem Ruby Needle—*guaranteed forever!* (retail price \$4.00). This is a solid gem-shank needle, approximately one full carat—not a chip! Every needle backed by Registered Certificate. This is an unconditional guarantee against wear, breakage, defects. *What a selling feature!* Check the *many other exceptional value features* of the Sparton Challengers.

CHOICE OF CABINET

Even the Sparton price is sweet listening . . .

\$229⁹⁵

and sweet selling, too!

(ALL PRICES ZONE ONE)

Sparton

RADIO'S RICHEST FRANCHISE

THE SPARKS-WITHINGTON COMPANY

Radio & Appliance Division • Jackson, Michigan

SCMP* gives Sparton dealers greater VALUE

*Sparton Cooperative Merchandising Plan makes it possible to pack the new Sparton Challengers with post-war features and keep the price *competitive with mail order houses!* Check the features of SCMP that make such value . . . *such selling power* . . . possible.

- One exclusive dealer in each area
- National advertising that works locally
- Direct factory-to-dealer shipments
- Low consumer prices
- Factory prepared and distributed promotion helps
- Seasonal promotions
- Uniform retail prices
- Products styled by outstanding designers

Jensen

Bass Reflex

CABINETS

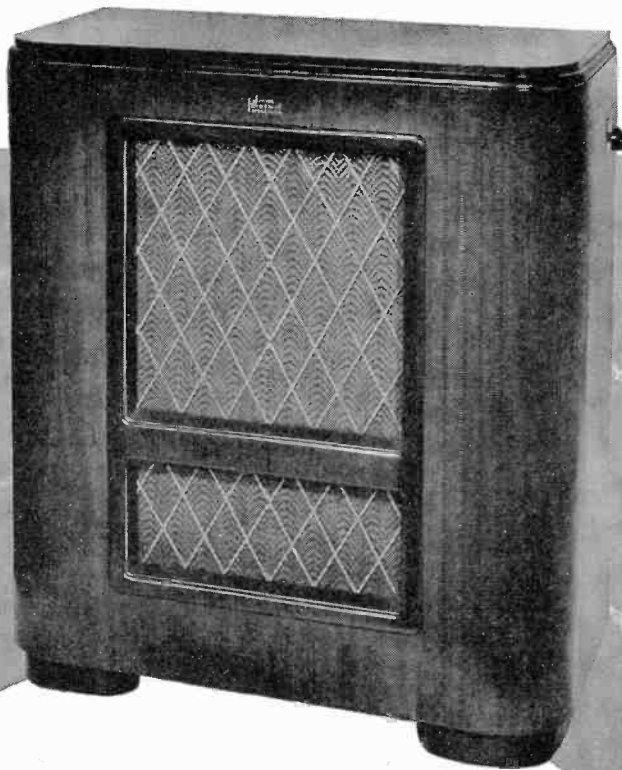

Three types—six models to accommodate 6", 8", 12" and 15" speakers

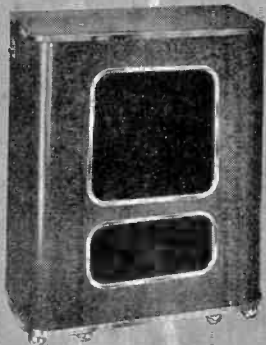

TYPE B Bass Reflex Cabinets are manufactured in sizes for 8", 12" and 15" speakers. A superior new wood composition in outer walls and panels assures distinguished appearance at a modest price. Finish is an attractive, baked-on hazelwood, trim is of chromium and aluminum.

BASS REFLEX PRINCIPLE: Through exact acoustical proportioning of the completely enclosed cabinet, and the use of an auxiliary port, the port is made an auxiliary radiator at low frequencies. This controlled use of what otherwise would be waste energy increases efficiency.

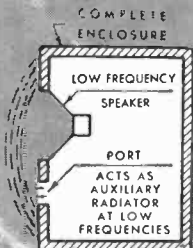

*TYPE I PERI-DYNAMIC (Model J-61) CABINET is a wall-mounting style which takes any standard six inch speaker. Exceedingly styled of a textured composition material, it is complete with mounting bracket. A five-lug terminal board facilitates installation.

Meeting the high engineering and appearance standards which for years have been a Jensen hallmark, these new Bass Reflex cabinets provide acoustically correct enclosures for Jensen speakers. They are particularly suitable for Jensen Coaxials.

All of them (except the J-61) employ the widely heralded Jensen Bass Reflex principle. This, together with special acoustical treatment, assures maximum extension of low frequency response, and freedom from objectionable "boom" or resonance.

See these new cabinets today at your dealers—or write for full information and prices.

ABOVE RIGHT: New Type D Deluxe Bass Reflex Cabinets are available for either 12" or 15" speakers. Exterior styling is by a noted designer; construction by one of the nation's foremost furniture manufacturers. All hard woods are of selected striped walnut. Finish is natural walnut rubbed to a satiny smoothness.

JENSEN MANUFACTURING COMPANY

6625 SOUTH LARAMIE AVENUE • CHICAGO 38, ILLINOIS

In Canada: Copper Wire Products, Ltd.,
137 Oxford St., Guelph, Ontario



Jensen

Designers and Manufacturers of Fine Acoustic Equipment

WORLD'S MOST COMPLETE TELEVISION LINE!

IMMEDIATE DELIVERY ON EVERY UST SET!

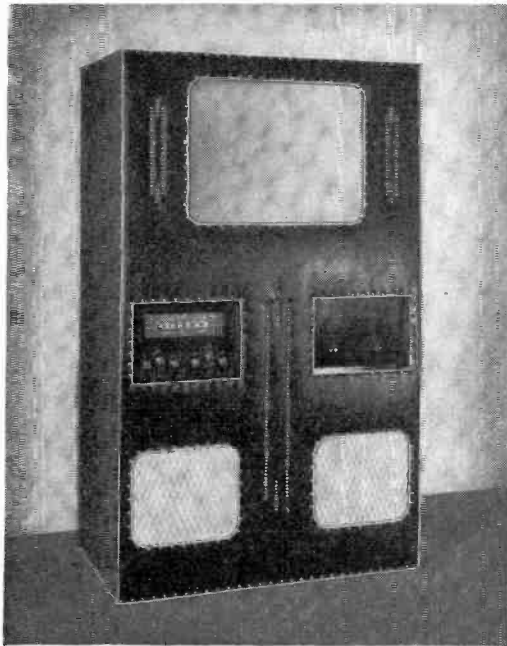

UST TAVERN TELE-SYMPHONIC

There's a terrific demand for this bar set featuring the largest pictures in the world, fully $3\frac{1}{2}$ square feet. Dealers have been making big profits with this sensational money-maker, without even stocking the set. Giant projection screen, 25" x 19". A natural for bars, grills, restaurants. Includes radio. Available in wood mahogany finish or rich leatherette (wine, green, blue, cream, or brown). Including tax \$1,995



UST TELESONIC

A beautiful five-in-one console offering complete entertainment in television, radio, and recorded music. Includes FM. Brilliant 10" direct-view telepictures. Available in distinguished modern or graceful period cabinetry. An outstanding value. Compares with other sets selling for \$1500. Including tax only \$895



UST DEALERS
Keep
"One Full Year Ahead"
and Reap
BIG PROFITS
WITH UST



UST TELE-SYMPHONIC

The complete entertainment instrument for the home. Includes FM, standard, and short-wave radio, plus automatic phonograph. Available in exquisite period cabinetry as shown, or in distinguished modern style. Projection screen as big as standard newspaper page. Including tax! \$2,275

Represent the television industry's most profitable leader! Even small dealers have earned gross profits of as much as \$10,000 a month on just one UST tavern model alone. Now UST has a set for every home . . . for every bar, grill or restaurant . . . for every club and institution. And every set is available NOW for immediate delivery! Cash in on the tremendous demand for television. You'll reap big profits by representing UST—offering the finest biggest pictures in television. (All prices protected under Feld-Crawford Act.)



UST DUMBARTON

latest addition to the UST radio line. Graciously styled console. Includes Seeburg automatic record changer, 12" Magnavox speaker, 8 tubes, including rectifier. \$239

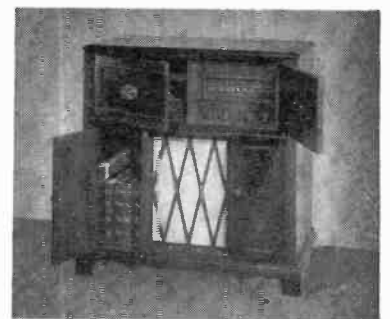

"One Full Year Ahead"



UNITED STATES TELEVISION

MFG. CORP.

3 WEST 61st STREET, NEW YORK 23, N. Y.

Telephone Circle 6-4255

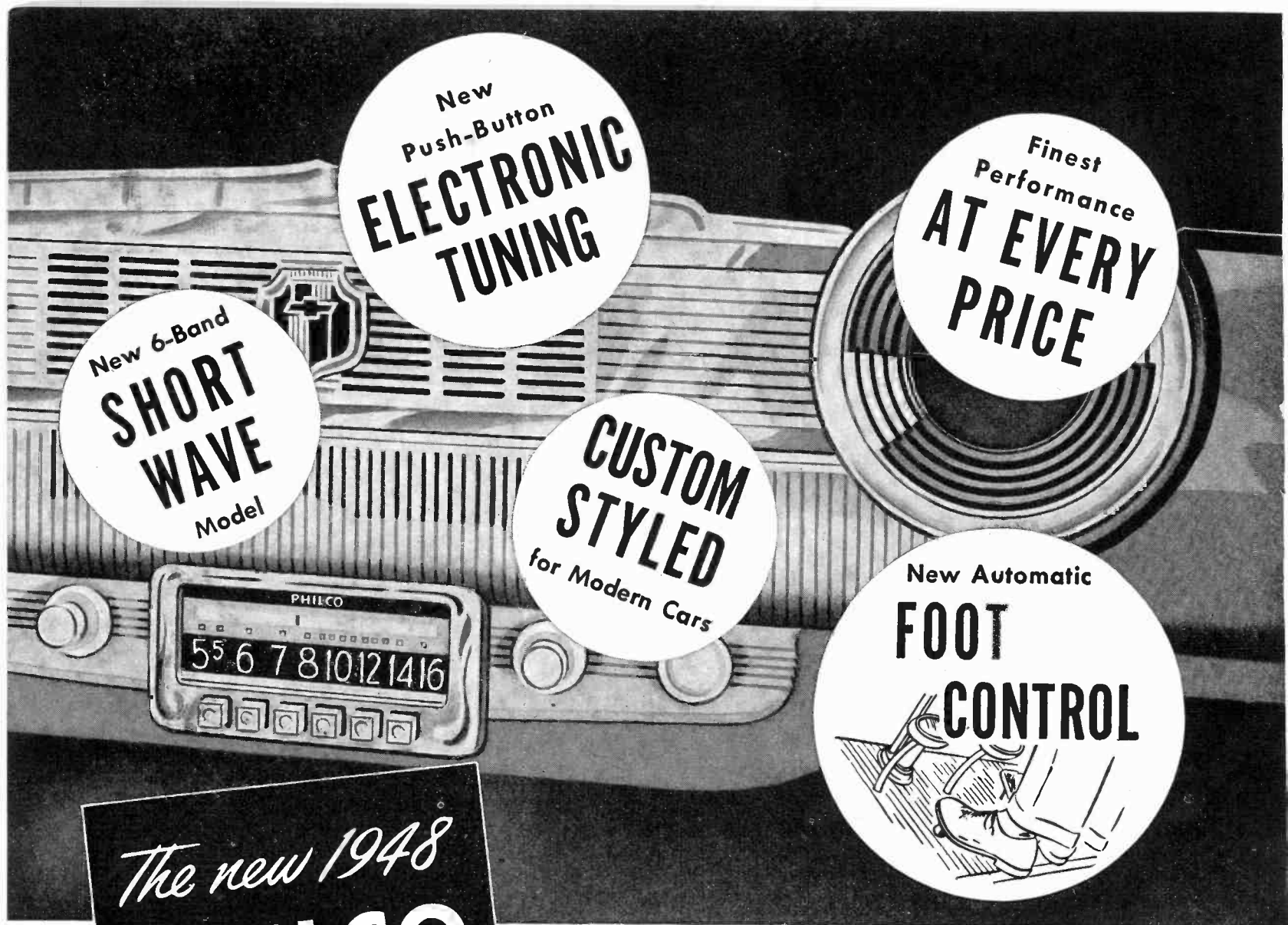

The new 1948
PHILCO
AUTO
RADIOS
are here!

See what's new! See Philco, and get up-to-date on the new Auto Radio style trends ... new tuning conveniences... new war-sparked improvements! See the sensational new Philco Automatic *Foot Control!* Get

ready to boost your Auto Radio sales and profits ... with Philco 1948 models ... covering every price bracket with better values, extra features, more sales-appeal ... backed by Philco's greatest Auto Radio promotional campaign!

SEE YOUR PHILCO DISTRIBUTOR TODAY!



Recordio[®]

T.M. REG. U. S. PAT. OFF.

presents

The
Coronet

MODEL 7D42



THE WORLD'S FINEST HOME RECORDING INSTRUMENT

The Sensational, New Automatic Home Recorder

SEE YOUR RECORDIO DISTRIBUTOR

WILCOX - GAY CORPORATION • CHARLOTTE, MICHIGAN

127-M



Best Lady...



wanta buy a Pig in a Poke?

.. THOSE PIGS AREN'T SELLING SO FAST THESE DAYS!

Production is butchering pig-in-a-poke merchandise. Instead of being snapped-up quickly by desperate shoppers, appliances of unknown quality are gathering dust on shelves.

In short, the we'll-take-any-

thing-to-get-something days are over. That critical gleam in buyers' eyes means a show-down is coming on merchandise of all kinds. And here's what shows up for Crosley dealers:

The Shelvador* is a Featured Attraction

Women love that extra front-row space! And why not? Put yourself in the place of a gal who opens the refrigerator door countless times every day. Then imagine the convenience, the downright joy of opening a door that puts 28 feet of front row food storage space right at your fingertips! And when that *exclusive-with-Crosley* feature is backed up by the finest home refrigeration advantages you'll find anywhere, it's a tough combination to beat.

Crosley dealers don't have to beat it . . . *they have it!* Yes sir, they have the outstanding feature in the field. So naturally they give it top billing on their floor show. And just as naturally, they find that in addition to being a best seller, the Shelvador* is a whale of a traffic-builder. There's no pig-in-a-poke here . . . it's an open and shut case of a sales feature that's way out in front.

The Supporting Cast Includes

— everything an enthusiastic home-maker needs to furnish her kitchen with step-saving, work-saving, time-saving beauty. For example, take a quick peek at the Crosley ranges:

A waist-high broiler, over-size oven and four fast-surface cooking units are just a few of the be-kind-to-women features which distinguish Crosley gas and electric models. Smart styling? Absolutely... these ranges are the center of attraction in the most modern kitchen.

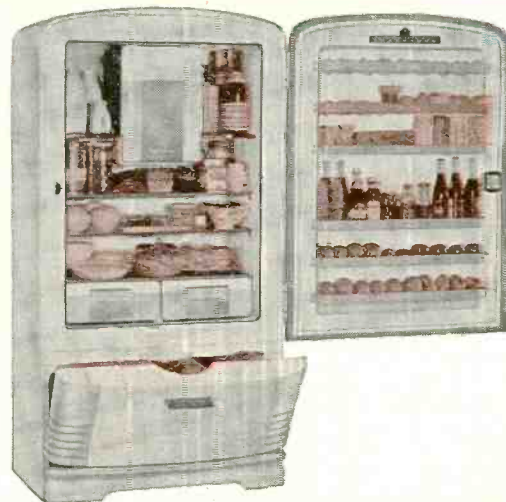

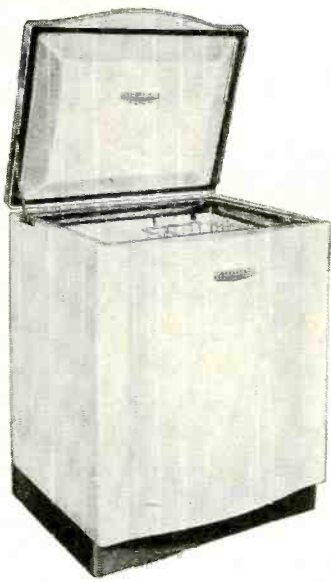

Did Someone Say "Frozen Foods"?

You bet! More and more people are saying that every day, as the swing continues to this modern, efficient method of food storage. And when they mention it to a Crosley dealer, he has the answer. It's the new Crosley Frostmaster . . . the compact, kitchen-size cabinet that holds 100 pounds of frozen foods, answers smart housewives' needs for a thrifty home freezer unit. Look it over *here*; that's exactly what shoppers are doing at their nearest Crosley dealer's.



Of Course, Musical Entertainment is Part of the Main Show

Your customers want radio entertainment. They get it, at its finest, in a complete line of Crosley radios that feature the best in electronic engineering and precision manufacturing. Your customers want recorded music. They get it, at its finest, in Crosley Radio-Phonos that feature the famous Crosley Floating Jewel† Tone System. (The permanent sapphire stylus floats on the sides of record grooves, virtually eliminates s-c-r-a-t-c-h-i-n-g.) Your customers want smart styling in radios and consoles. They get it, in every Crosley model from the luxurious Carrollton down to the smallest table model.

Right . . . Crosley dealers are ready to give musical-minded shoppers what they want . . . with readily-demonstrated features and advantages. The three models shown here are but a small part of a complete line of Crosley radios for every room in the home.

● **NATURALLY**, this food-preparation picture wouldn't be complete without the Crosley Servisink. Here's a gleaming beauty that sets new standards of serviceability. Knee-recessed for working comfort, full of built-in space for utensils, the Servisink (with companion cabinets) rounds out that dream-kitchen so many women will make a reality NOW. It's one more reason Crosley dealers are ready for the ready-est market that ever existed.

THE CROSLY PorTABLE



THE CROSLY RONDO



THE CROSLY CARROLLTON

So —IF YOU REALLY WANT TO BRING HOME THE BACON—

—be sure that shoppers for home appliances find the known-quality merchandise they want, in your store. With the passing of pig-in-a-poke selling days you're going to be dollars ahead with a name line, a *feature* line, a complete line . . . yes, a line like the Crosley line.

Crosley dealers are ready now for the return of what economists call "a buyers' market." (Meaning ya gotta give 'em what they want!) Are *you* ready?

*Trade-mark Reg. U. S. Pat. Off. †Patented.

Shelvador® Refrigerators • Frostmasters
Kitchen Sinks and Cabinets • Ranges
Radios • Radio-Phonographs • FM—Television
• Short Wave • Home of WLW.

CROSLLEY

Division—*AVCO* Manufacturing Corporation
Cincinnati 25, Ohio

A Masterpiece of the Cabinetmaker's Art

The New
DELCO RADIO
Combination



LOOK at it as a piece of furniture and you'll see that the new Delco Radio Combination is outstanding in the field. The grace and distinction of its 18th-Century design . . . the superlative materials and workmanship . . . make it a handsome addition to the finest home.

Listen to it as a musical instrument and you'll find that the new Delco Radio Combination lives up to all the promise of its appearance. It brings a new richness and clarity of tone to both recordings and radio broadcasts.

This new Combination has 14 tubes plus rectifier . . . automatic tuning on *both* AM and FM . . . three short-wave bands . . . a 15-inch speaker . . . 12 different bass and treble combinations . . . and advanced engineering throughout. The record player handles fourteen 10-inch or ten 12-inch records, and shuts off automatically after the last record plays. A special lightweight tone arm with *jeweled-point* pick-up makes recordings sound better and last longer.

The new Delco Radio Combination is available in two models: R-1251 in walnut, and R-1252 in mahogany. Until you've seen them and the other popular Delco radio models, you haven't seen *the best of all that's new in radio!*

DELCO RADIO
A GENERAL MOTORS PRODUCT

Delco radios are distributed nationally by United Motors Service. See your United Motors distributor about the Delco radio line.



GET MORE OUT OF LIFE WITH TELEVISION

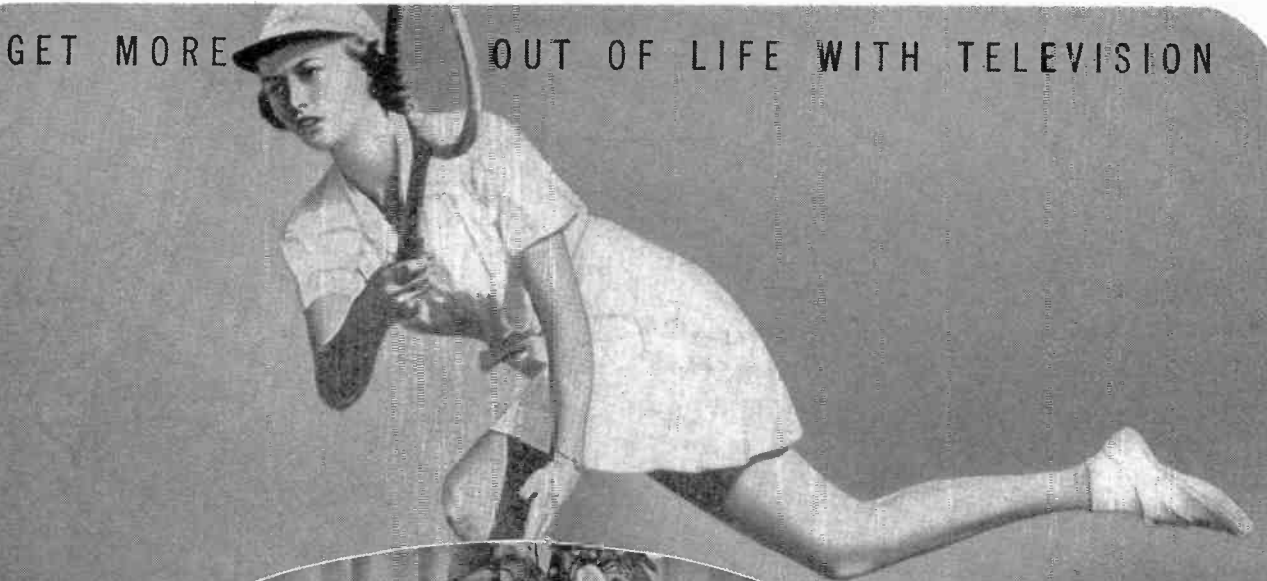

Illustrated—The Sherwood with AM-FM Radio; Automatic Phonograph—one of seven Du Mont Models. Cabinets designed by Herbert Rosergren. Interior by W. & I. Sloane.

Get the most out of television with Du Mont prestige

Far-sighted dealers realize that to achieve leadership in the field of television they must carry the leading line. That is why the Du Mont dealership is the most-sought franchise in the field today—and why Du Mont is able to restrict its distribution to a very few outstanding stores in each market.

DU MONT

First with the finest in Television

DU MONT'S
NEW YORK TELEVISION STATION
WABD
is broadcasting all the home games of the
NEW YORK YANKEES
FOUR DAY AND NIGHT

ALLEN B. DU MONT LABORATORIES, INC. • GENERAL TELEVISION SALES OFFICES AND STATION WABD, 515 MADISON AVE., NEW YORK 22, N. Y.
DU MONT'S JOHN WANAMAKER TELEVISION STUDIOS, WANAMAKER PLACE, NEW YORK 3, N. Y. • HOME OFFICES AND PLANTS, PASSAIC, NEW JERSEY
Copyright 1947, Allen B. Du Mont Laboratories, Inc.

no summer sales slump with this

**LIFE-SIZE
DISPLAY**

Full-color girl display
and 6 separate
pieces.

have fun
in the sun...



RADIO'S FIRST NAME IS

Westinghouse portable promotion

Summer sales slump? Not for dealers handling these two new Westinghouse Portables and tying-in with this powerful promotion program . . . here's a money making formula for summer sales—THE RIGHT PRODUCT . . . PLUS A HARD HITTING NATIONAL AND LOCAL PROMOTION PACKAGE that Westinghouse has provided to make your portable summer selling job easier . . . and more profitable. Order this Promotion Package from your Westinghouse Distributor today.

NATIONAL ADVERTISING

LIFE—July 21, SATURDAY EVENING POST—July 12.
—plus—
Free counter cards of this ad.

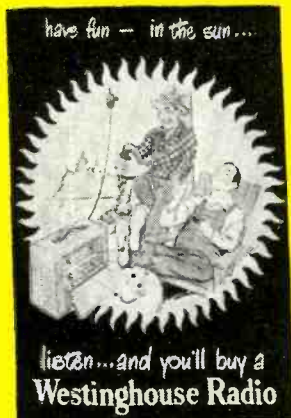

NETWORK RADIO

Ted Malone program, Mon. thru Fri., ABC Network of 197 stations.



LOCAL NEWSPAPERS AND RADIO

Free cooperative newspaper mats and radio spot announcements.

Smartly styled air stream case clad in simulated pigskin, makes the 165 a good-looking lightweight luggage companion piece. Performance matches appearance. This deluxe 3-way portable will be another outstanding Westinghouse sales leader.

DIRECT-BY-MAIL

A new 2 color consumer folder featuring both portables.

Westinghouse

RADIO TELEVISION

Here's an ASSURANCE POLICY that really benefits your business!

● **Never before have your customers** been so conscious of real quality and full dollar value! And that's just the reason Stromberg-Carlson's three-fold policy means greater sales and profits for you.

TAKE A LOOK AT THE FACTS:

1 Stromberg-Carlson quality continues today in the great tradition which the public has come to associate with the highest standards of design, engineering and manufacturing.

2 Stromberg-Carlson prices are competitively pitched to give you some of the most outstanding values in the industry.

3 Stromberg-Carlson consumer demand is reaching new highs with the impetus of the greatest nation-wide advertising campaign in our history.

It's a mighty sound business equation! Put the points all together and they add up to *continued demand* from your customers . . . *continued profits* for every Stromberg-Carlson dealer . . . an "Assurance Policy" that can't be beaten!



THE AUTOGRAPH



THE NEW WORLD

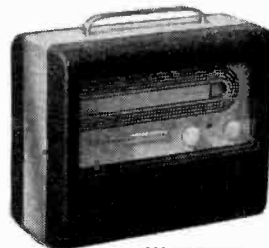

THE VAGABOND

For the main radio in your home
There is nothing finer than a

STROMBERG-CARLSON

ROCHESTER 3, N. Y.

- RADIOS,
- RADIO-PHONOGRAPHS,
- TELEVISION,
- SOUND EQUIPMENT AND
- INDUSTRIAL SYSTEMS,
- TELEPHONES, SWITCHBOARDS, AND
- INTERCOMMUNICATION SYSTEMS

RADIO & Television RETAILING

Including Radio and Television Today

O. H. CALDWELL, Editorial Director ★ M. CLEMENTS, Publisher

Stop This FEAR PSYCHOLOGY!

For some months buying has been slowing up, all over the nation.

Dealers and distributors have been issuing stop-orders because of certain stagnant inventories. It is significant that the dealer buying-rate appears to be slower than the consumer buying-rate.

Consumers have merely stopped buying what they do not want, in addition to not buying what they *would* want if the right kind of salesmanship had been used.

All too many dealers and distributors have stopped buying *anything*.

A typical example is seen in one of the country's largest retail stores. Having on hand a considerable stock of merchandise in our field—merchandise which is priced out-of-line, and more or less unacceptable to buyers at this time—one of the top buyers issued a stop-order to the department head. This buy-nothing decision was made in spite of the fact that the salesmen had back-orders for a considerable number of certain models. The jobber-salesman went away without the order. The salesmen were unable to satisfy their customers' needs. "Sell what you have in stock," was the advice given the salesmen.

While it's bad business to over-buy, it is equally poor practice to starve one's business, or to go along with any of the business-is-shot theories too many people are bandying about.

A look at the situation in its true light is encouraging. At random, we can think of at least ten large companies in the radio and appliance fields whose products, in part or in full, will be *allocated* all the rest of this year. The products include radio, FM, television, refrigerators, automatic toasters, hand-irons (automatic and steam), food mixers, washing machines, ironers, clothes dryers, dish washers, sewing machines, room coolers, electric fans — to mention a few.

Six months from now the unwanted surplus inventories — the "drugs on the market" will be exhausted. Business will have settled away to a normal pattern.

While it is true that the "drive" to reduce prices at the consumer levels—in the face of peak-high wages and material costs—has caused a lot of customers to adopt waiting tactics—goods can be sold now, and they are being sold.

The trick is to banish fear-psychology from our minds. And to substitute aggressive salesmanship and result-getting merchandising methods.

What's Ahead!—in Radio,

NATIONAL RADIO WEEK will be observed Oct. 26 to Nov. 1. RMA and the National Association of Broadcasters, sponsors of the event, will get cooperation from set manufacturers and leading retailers as well as from a number of associations including National Association of Music Merchants, FM Association, and groups in the dry goods and furniture fields.

TOO MUCH OR NOT ENOUGH GOODS AND MATERIALS gives a peculiar touch to the present merchandising and production picture. Some buyers representing manufacturers, jobbers, retailers are out hell-bent and wild-eyed in search of things they need. Certain others aren't buying a dime's worth of anything.

\$632,000,000 BACKLOG DEMAND for electric motors exists, says National Electrical Manufacturers Association. Ninety-four per cent of the total fractional horsepower motor demand in units is needed for use on consumer appliances such as washers, refrigerators, vacuum cleaners, oil burners and fans. Unfilled orders for fractionals amount to \$292,600,000.

FEDERAL TRADE COMMISSION considers it improper to include rectifiers in the tube count in representations "that a set contains a designated number of tubes or is of a designated tube capacity." The Commission does not object to description of a receiver, for example, if represented as "An Eight Tube Set—This receiver in addition contains a rectifier."

USE OF REFRIGERATION IN HOME INCREASED from 50 percent in 1924 to 85 percent in 1947, according to U. S. Department of Commerce. Says a report by that agency: In 1947, about six million families will not use any form of refrigeration, 11½ million will use ice, and 21 million mechanical refrigeration.

HOW TO SPEED VACUUM CLEANER SALES was discovered by one large dealer and his salesman. Having noticed that customers took a long time to make up their minds which cleaner they wanted, it was discovered that the array of different makes all over the demonstration carpet in the store confused the customer. The merchant adopted a new plan. He kept all of the cleaners in a row alongside the carpet; demonstrated but one at a time. Result: Time between looking and buying shortened.

"ALERT, WIDE-AWAKE SALESMEN always demonstrate the features and advantages of whatever they are selling. In addition to selling, they show what they are talking about. It's the first principle of salesmanship, as far as they are concerned because it dramatizes and visualizes what they are talking about much more effectively than words can ever do it."—H. L. Clary, Norge general sales manager.

COMPETITIVE SELLING ON AUTOMATIC WASHERS growing in intensity in most sections of the country. However in some locations dealers cannot get enough stock to warrant advertising immediate delivery. In the meantime, some large manufacturers who haven't been able to get production of automatics much beyond the dealer-sampling stage are doing handsprings in trying to increase their production rates.

HEAVY SUMMER BREAKDOWN RATE OF REFRIGERATORS of ancient vintage has been needling the already large demand for new ones. Dealers are finding, though, that competitive selling is here—that salesmanship must be employed in order to sign up the "just looking around" shopper even in instances where immediate delivery can be made.



NEW FARM FIGURES show that as many as 60,900 farms have been recently electrified in a single state. Nearly all areas are being thickly laced with new power lines, although only about 60% of the total ruralists are hooked up. It makes a "powerfully" interesting market for radio and appliance men, as per the "Farm Sales in Early Autumn" discussion in this issue.

SHORTAGE OF CERTAIN PHOTOFLASH LAMPS continues. In some cities, the situation is described as being "worse" than it was a year ago.

LOW-PRICED FM MODEL, AND A TELEVISION set, "tailored to the purse of the mass consumer" will come off Tele-tone's New York production line by the end of the year, company officials announce.

"MRS. BELLING—YOUR G. E. AUTOMATIC iron has arrived. Please come in before 9 p. m. Wednesday. Fairbanks Radio Co." That's the way an Alaska retailer notifies his customers when he's able to fill their orders—via the "personal" ad columns in a local newspaper.

TO OPERATE IN THIS PRESENT MARKET, the dealer should improve his salesmanship, increase his sales promotional activities, buy wisely, and hang on to his profits. He should not permit himself to be upset or discouraged by the apparent contradictory aspect of today's merchandising picture.

Appliances, Records and Television

92% ARE "BIG FOUR" MERCHANTS! Based on the results of a survey, it is estimated by this publication that 92 percent of RADIO & Television RETAILING'S dealer-subscribers sell electrical home appliances in addition to merchandising radios, records, etc., and the rendering of top-flight service.

THIS IS A WACKY MARKET! It's a feast or famine affair for the consumer, the manufacturer, the wholesaler and the dealer. There are slews of one product; scarcities of another. There is price-cutting going on, but, remarkably enough, there is also plenty of under-counter selling, goods-allocation and priority ordering being transacted.

SHORTAGE OF SOME ELECTRIC FANS BEFORE the summer is over looked for by dealers and jobbers. In spite of the fairly large supply, many numbers will be exhausted before the end of this month, merchandisers believe. Smart retailers are urging customers to buy without delay.

RECORDERS FOR INVENTORY-TAKING offer a new speed-up technique when busy retailers have to count stock items. Radio-electrical dealers can inventory their own stocks in this way, or can lease or sell machines to other business firms or to accounting specialists who make a feature of rapid inventories, with minimum inconvenience to store's regular hours. Later, from playback of the recorded discs, the complete stock list can be typed out and priced.

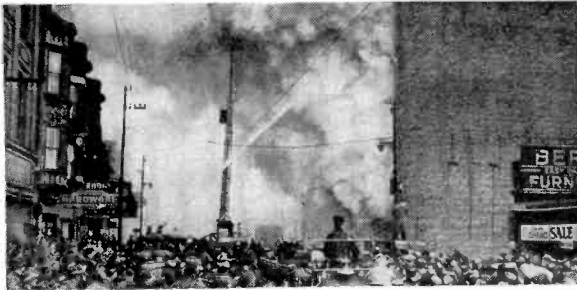

ADEQUATE INSURANCE COVERAGE is necessary to protect the retailer from losses arising from various causes. All types of policies are described in an article in this issue, entitled: "Insurance Protection for Retailers."

WINCHESTER MAKING BATTERIES FOR personal and camera-type radios at its New Haven, Conn., plant. Winchester, a division of Olin Industries, Inc., is already a large producer of flashlight batteries.

THOR CORPORATION IS NEW NAME of Electric Household Utilities Corp., Chicago, makers of Thor home laundry equipment. No changes will be made in personnel or method of operation. John R. Hurley is president of the firm which was founded in 1906.

REFRIGERATOR, WASHER, IRONER and RANGE demand continues strong according to leading retailers. Many dealers are avoiding trade-ins via suggestion that customer can make more money selling his old equipment through a newspaper want ad.

RADIO TUBE INDUSTRY EXPECTS STEADY high-level demand for its products during balance of year, according to M. F. Balcom, chairman of RMA's radio tube committee and vice-president and treasurer of Sylvania Electric Products, Inc. Stating that while the industry does not expect to maintain the first quarter production rate, he said that the increased demand for FM and television sets and the unusually active export demand will tend to stabilize the industry at relatively high production rates.



GOOD SERVICE BUILDS PERMANENT BUSINESS, increases sales too, alert dealers know. How a Wilkingsburg, Pa., firm capitalizes on its expert maintenance facilities is described in an article, "Sales-Plus-Service Wins Customers," appearing in this issue.

"DUPLEX" NAME BACK ON CLEANER. The new Premier Model 12 vacuum cleaner carries the name "Premier Duplex"—which was first used 25 years ago. The "12" has many new features.

PRICE ADJUSTMENTS ON CERTAIN LAMPS being made by GE. Some numbers being lowered in price; others being raised because of abnormally increased costs. The firm no longer absorbs the 5% excise tax which has been passed along to the consumer. "Apart from the excise tax, the average price of General Electric lamps, will . . . be 5% under our prewar prices," a spokesman for the firm says.

FISHERMEN'S LUCK has been sharply improved amongst the boats off Long Island, N. Y., via the use of the new radio telephones. Anglers keep reporting their results to each other across the bays and inlets—if there are any hungry fish in the place, their location is reported on the new 2-way communication units and everybody catches more. All this takes place on the 2100 to 2738 kc band. Both pleasure and commercial operations are much safer, too, with ship-to-ship contact established.

Only

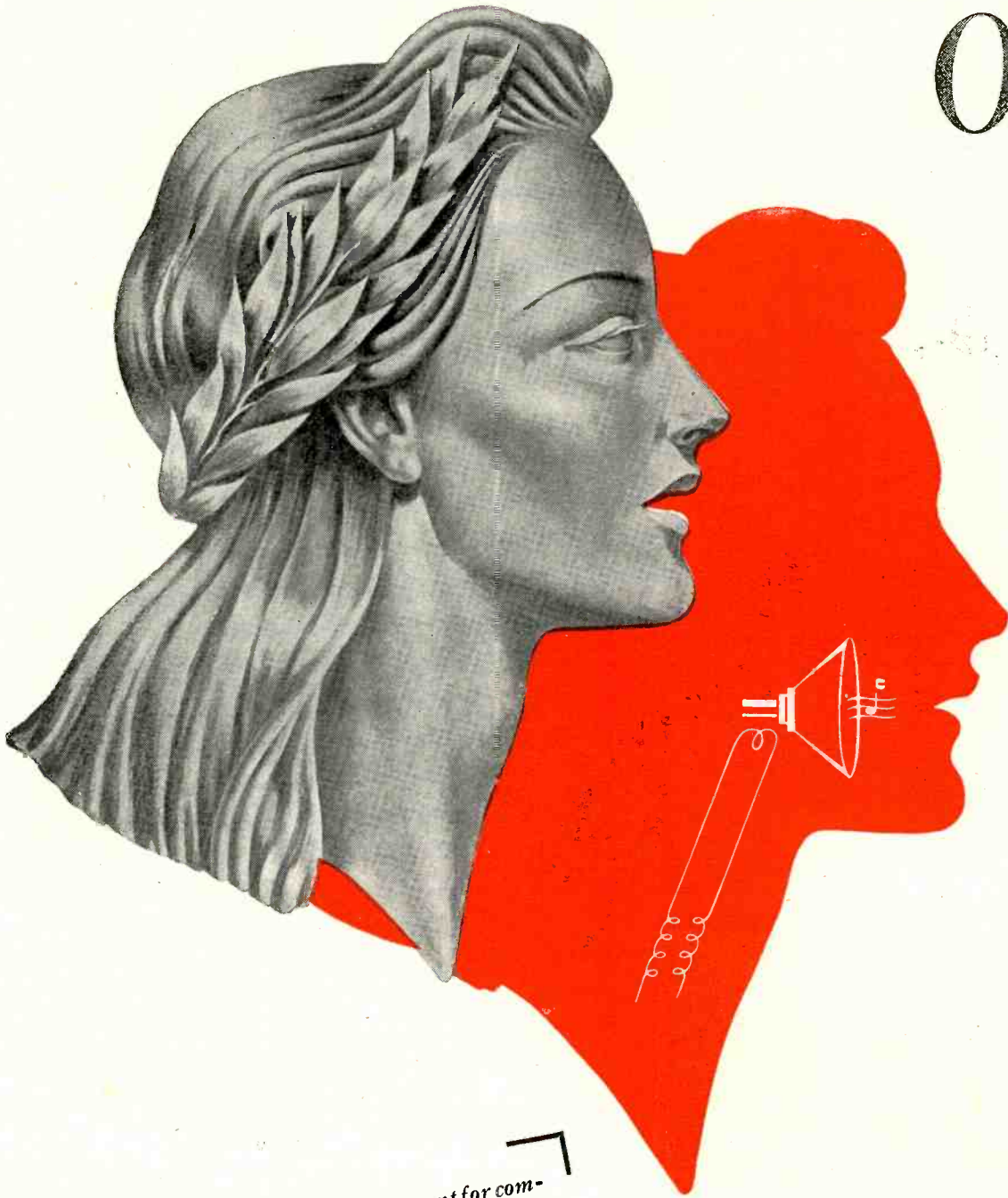

See the August RCA Victor advertisement for complete details on the Golden Throat Demonstration that amazed the N. A. M. M. Convention.



The finest tone system in the

RCA VICTOR has the

“Golden
Throat”



Only RCA VICTOR
makes the
VICTROLA



“Victrola” T. M. Reg. U.S. Pat. Off.

history of RCA VICTOR



After- Is a

Live Leads Come From

● In these hectic days, when things are becoming tougher, the most foolish thing a merchant can do is to spend valuable time on a sale, and, having gotten it, blissfully forget the customer and the newly-sold equipment.

If anything, follow-up is more important today than it ever was before. For one thing, the public has been pushed around from pillar-to-post, and is therefore more than ever conscious of the sort of treatment it gets. The buyer is deeply appreciative of after-sale interest.

Follow-up is smart psychology on the part of the dealer who practices it. It always was smart business. It always will be. There is a psychological let-down to any deal wherein the seller works up the purchaser's interest to a high-pitch; gets the sale and then lets the whole thing cool off.

The neglected customer has every right to feel that such merchant is after one thing primarily—the customer's money. While it is perfectly true that the customer's money is what makes the mare go—what pays the dealer's overhead; sends his kids to college and permits him to eat three square meals a day, it isn't the whole story.

The dealer needs to make genuine friends of his customers. They will not continue to do business with him unless he gives the buyer something else in addition to the merchandise he sells.

That something is a sincere interest in the customer's welfare. A genuine interest in seeing that the equipment purchased is functioning properly.

Even the hard-boiled merchant who feels that money is everything, knows that he must maintain good-

will. Such merchant knows that he cannot neglect his after-sale duties because he realizes that future sales will come only from thoroughly satisfied customers.

No good merchant is in business for his health, but he is in business to keep his business healthy. Follow-up is a good method to use in insuring profits for a long time to come.

Visits Pay



Those who are on the inside in retail merchandising circles know it to be a fact that certain numbers of merchants hesitate to follow-up sales on the premise that such calls help to originate imaginary troubles in the mind of the customer. Of course, too, the good-will follow-up call also uncovers some real trouble in equipment. This latter sort of "discovery" is of actual benefit to the dealer in many cases, because, if neglected, it might develop into a more serious and more costly condition.

In this discussion it must be granted that follow-up calls often result in the dealer being forced to render some "unnecessary" service. On the other hand, if the complaint is not a justifiable one, the dealer can often explain away the necessity for a call by his servicer.

Granted then that follow-ups help to originate complaints, it is still good business to make after-sale calls. At every hand we see the most successful dealers and salesmen in this field as the men who are carrying the most burdens. We see the least successful dodging responsi-

bility; operating on the premise that a sale is finished when the order has been secured from the customer.

All in all it seems to make sense—good common sense—to say that follow-up is a must; that it needs to be practiced as a merchandising technique just as important as that pursued in making the sale itself.

Follow-up performs several valuable services. (1) It makes the customer feel pleased with the purchase, and with the store. (2) Follow-up can uncover need for real service, or can eliminate costly "imaginary" service calls. (3) More sales are made via the satisfied customer route than any other method. Leads furnished by the pleased user result in more sales with less expense and less effort than by any other sales procedure.

As business gets tougher, more and more pressure must be exerted in obtaining sales. Even though the trend is away from knock-'em-down-and-drag-'em-out tactics, as the sledding gets harder, the pressure on customers will increase.

Every radio/appliance salesman can count numbers of difficult, protracted sales he has made. He can look back on the occasions when both he and the customer have wound up a sale in exhausted conditions; the customer finally succumbing, but not entirely satisfied with the wisdom of the purchase.

Keep 'Em Sold



After-sale calls can take the sting out of such transactions; make the customer feel happy, and "re-sold" on the purchase. "Keeping customers sold" was a familiar phrase before the War. Such practice helped to prevent needless repossessions of financed purchases, and kept the customer coming back to the store. It will be just as important in the months and years ahead.

Sale Follow Up **Real Business Builder**



the Satisfied User, and From the Customer Who Bought Elsewhere Too

There is a psychological something or other in the make-up of all humans which urges them to perform certain extraneous services without hope for compensation. Just as Tom Sawyer's friends white-washed the fence, so most folk are willing to volunteer their services in recommending a merchant to their friends and relatives.

Friendly Help



Many customers will go out of their way to demonstrate a fine radio, washer or an electric range in their own homes, and they will get a big bang out of calling the salesman and giving him a hot lead which has resulted from their unselfish effort.

If the obtaining of live leads was the only good feature associated with following-up the customer, it would be a worthwhile sales function. But, it is not the only one. The merchant who displays an after-sale interest in his customers will keep them coming back to his store.

In these days, when merchants carry numbers of large and small appliances, radios and records, and usually stock selection of brands, there is more opportunity than ever before to interest customers in coming in often. The "one-shot" selling method is out. It's out even in stores which formerly counted heavily on doing business with transients—persons they never hoped to see again.

As business tightens up, and buyers continue to increase the habit of "shopping around," it goes without saying that it will be necessary to follow-up not only the purchaser after the sale has been made but the "prospect" as well.

Most salesmen know that it is necessary to follow prospects. Too many do not know the value of following the person who changed from a prospect to a purchaser. The salesman can get as much business from

AFTER-PURCHASE CALLS ON BUYERS

- .. Keep Customer
Coming Back**
 - .. Supply Dealer
With Live Leads**
 - .. Cut Down on
Free Service**
-

leads of satisfied users as he can get from any other source.

When he has devoted a lot of effort to a sale (usually a large one), and has lost it to a competitor, the smart salesman finds that it's good business to call on the person who eventually bought elsewhere.

He calls to express the hope that the customer is satisfied with the

purchase, to thank the person for giving him the opportunity to present his product, and to ask the customer to keep him in mind when in the market for something else.

Business can be derived from "lost sales." A sincere salesman can make a real friend and a real customer of the person who for one reason or another, bought from the competitor.

It just doesn't make sense to work like a Trojan on a sale, becoming acquainted with the prospective purchaser to a considerable extent, then to drop the whole affair. Many a purchaser who has been pushed hard by the salesman feels that the latter may be sore because he didn't buy from him. A call by the losing salesman is a gracious gesture. It will be appreciated by the customer, and will often result in sales to that particular person or to prospects he recommends.

After-sale follow-up is a profitable procedure. It is a merchandising must, and if handled skilfully, will contribute greatly toward building a stable business.



4 Radio Appliances Records Service

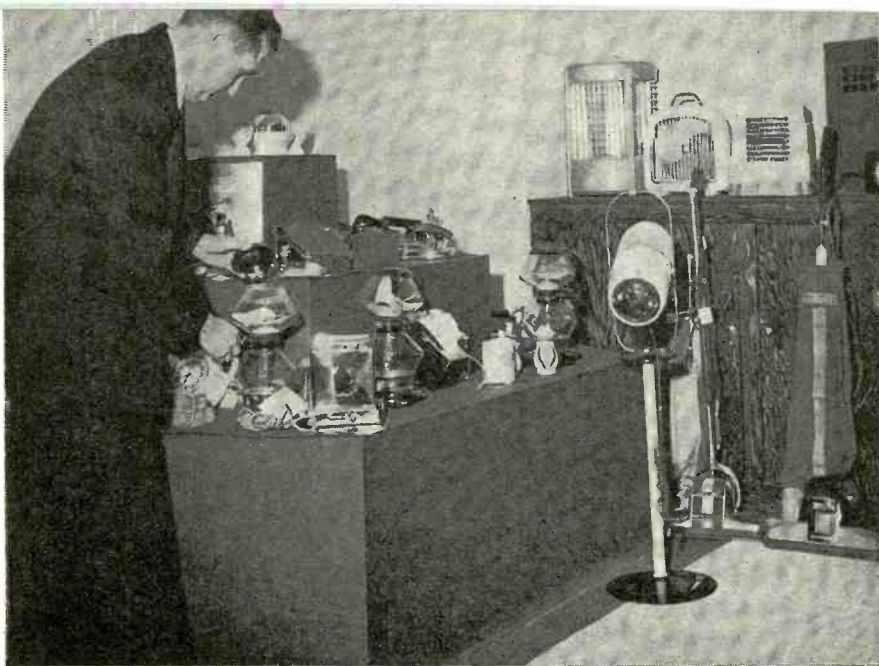

Small appliances are constantly re-arranged and cleaned in order to present an attractive display.

-WAY-WISE makes

Philadelphia Merchant Keeps Volume on the Upgrade—

• Building a sales program designed to draw a specific type of customer, and concerting every effort to make each new purchaser a permanent account is the formula used by one of Philadelphia's leading "Big-Four" dealers.

Catering to a conservative, discriminating type of patron, the owners of the centrally located Hepe Company have adapted their entire program to

this kind of customer. The proprietors are H. B. MacWhorter, John Macklin, and Marcellus Hepe. With its staff of twenty-five, the organization combines conservative appearance with progressive methods.

Courtesy to the customer is an essential to good sales. This is one of the factors on which the Hepe merchandisers base their customer approach policy. The sales-force is re-

strained from the use of any approach which might smack of high-pressure, or an obviously resistance-breaking technique.

Composed mainly of returned veterans, the sales staff of the store, as well as the six outside salesmen, gather weekly for informal sales-meetings. During the course of these orientation sessions, sales problems are ironed out, the personnel familiarized with new products, and new sales methods discussed. Many members of the staff are also augmenting their experience by taking correspondence courses in selling, sales psychology, and similar pertinent topics. During these meetings the latest lessons are discussed.

Other Factors

However, it would be difficult for a dealer to base an entire sales program on the element of personal salesmanship alone. Other action must be taken to draw customers to the store. The Hepe Company, like a majority of radio/appliance dealers uses regular newspaper advertising. But its activity in this direction, once more due to the character of its customers, is confined almost exclusively to institutional presentation, in the newspapers and special-events programs. Product ads are limited, chiefly, to direct mail.

An important "drawing-card" is the Haly ticket agency, which occupies space on the ground floor of the store,

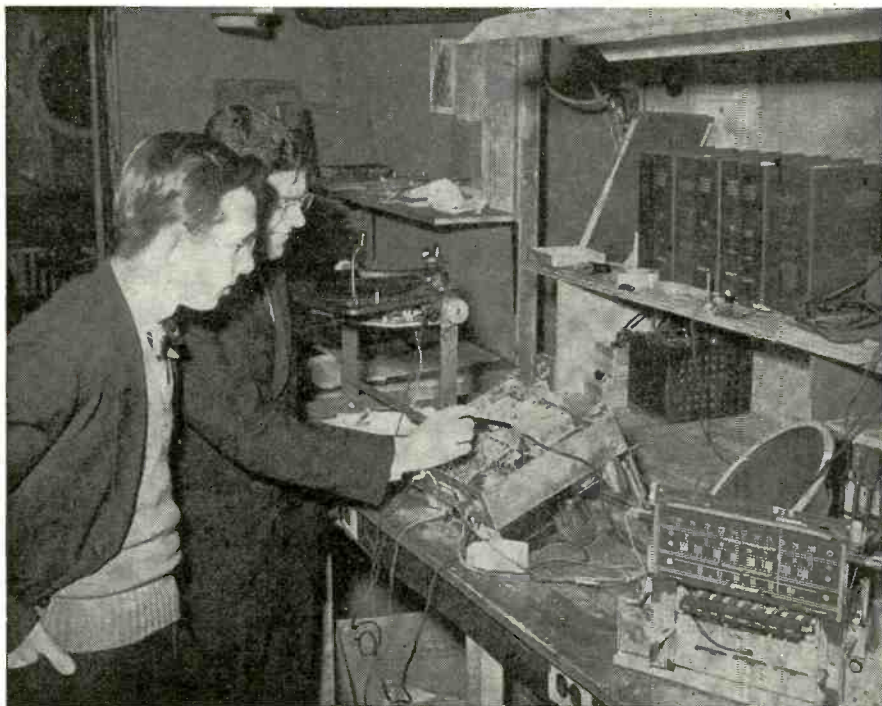

Repair work is done by experts, aided by the latest in servicing aids.



A view, left, of the record counter. Self-service island displays are visible in the left background. To right: Looking from the front of the store. Note the ticket office to the right of the small radio island displays.

PROFIT RISE

Seeks to Make Every Customer a Permanent One

immediately opposite the record department. The only agency in the city of Philadelphia handling tickets to performances at the Academy of Music, and exclusive representatives for tickets to the Philadelphia Orchestra concerts, the Haly office brings in on an average of from 350 to 500 persons daily, all of whom must walk through a major part of the store, past the well-appointed refrigerator and radio displays, and ultimately line up along side the strategically-placed record shelves.

Many of these ticket purchasers eventually leave the store not only with the concert tickets in their pockets, but with records under their arms. Or with receipts in their pockets for appliances or radios.

Large Record Volume

Not surprising, then, is the fact that a large volume is done in records, or that almost ninety percent of the disc sales are of classical or semi-classical types. Browsing and listening to the recordings is encouraged, and the staff finds nothing unusual in the customer who arrives shortly after opening time, selects a stack of records, relaxes in one of the comfortably furnished sound-proof listening booths, and, interrupting himself only for lunch or to select a new group of records, finally leaves at closing time. Such a customer will rarely leave, it has been found, without making a large purchase.

Only the finer quality merchandise is stocked. Console and table radios are all nationally advertised brands; most of the consoles have FM bands. The Hepe staff members believe that they act entirely in the interests of their patrons when they recommend sets with FM.

Unusual Stock

Other products merchandised by the Hepe Company, not often handled by the regular radio and appliance dealer, are the ship-to-shore radio telephone, and the vehicular telephone. The latter, which concerns the fast-developing radio-telephone equipment for private autos is regarded as a rich field. The store owners are working closely with one of the leading manufacturers of this equipment and have obtained sole area distributorship for the merchandise.

Appliance Demonstration

The appliance department is currently undergoing remodeling. Located in the basement, it is a rapidly expanding function of the business. When finished, it will appear to be a complete kitchen, ready for use. Appliances will be demonstrated here to best advantage in homelike surroundings designed to illustrate how the item will be used in the customer's own home.

Again handling only quality and

name-brands, this division markets a wide range of products from glassware and coffee-makers, through vacuum cleaners, health lamps, to large home freezers and washers. With the expansion of this department, there has been a noticeable increase in profits. When alterations have been completed, profits should double.

The store has fitted out its service department as one of the finest in the area. The service personnel employ the latest in oscilloscopes and testing equipment as aids in diagnosing radio ills. The Hepe experts realize that efficient servicing plays a part equal in importance to that of any other department; the policy is rapid and effective repair. The three men of this section work in a spacious, well-lighted room, where the equipment is arranged for maximum convenience.

The imposing facade on Walnut street which marks the location of this store belies the modernity of the policies under which it operates. The severely Gothic front, with its one large window, conforms in dignity with the type of customer it has been designed to draw. This two-story window is framed by drapes with a deep valance hanging almost a full floor. In the window, placed in such a manner as to catch the eye, are one or two small items and a console. Progressive conservatism is the key-note of the entire program of this "Four-Way-Wise" company.

Farm

Prosperous Season

have introduced none at all, (3) The battery replacement business is a continuous source of sales and can be made to offer regular contacts with the RFD customers, and (4) In this era of modernized farms, there's a good chance for selling more radios per farm home, batteries and all.

The number of recently electrified farms—those which were linked to either the utility or the REA power lines during 1945 and 1946—is 714,800. Many of these are still buying electric-line radios and appliances to do the many jobs in running an up-to-date farm. This figure also gives retailers an idea as to the rate at which rural America is being electrified, indicating the enormous merchandising opportunities for dealers among the agriculturists of the country.

Expanding Opportunities

Since rural electrification hit its stride, it has been estimated that some 250 different uses for electricity on the farm have been developed. This does not mean that the farmer could use that number of separate units to do his work, because some of the gadgets have a multiple usefulness. But it does indicate that the farm family has a remarkable number of tasks for electrical equipment to do—work which electricity does so efficiently and economically that it adds importantly to the profit, health, pleasure and comfort of farm life.

Recent surveys reveal that most farmers agree on what appliances they have included in immediate buying plans. The top items among the smaller products are power-line radios, toasters, mixers, floor lamps, irons, waffle irons, table lamps and clocks—not particularly in that order. This list does not take into account the very popular major appliances such as refrigerators and food freezers.

As can be seen in the accompanying list, the jumbo state of Texas has more of the recently electrified farms than any other state. The other states



Illustrating the broadcasters' on-the-scene interest in farm subjects—here's Donald Lerch of the "Country Journal" network feature, interviewing farmer D. R. Walker on his big dairy farm in Maryland.

● For the average retailer, the 5,859,169 farms of the U. S. are first-rate bets for extra sales in the early autumn.

It's the fall of the year when the crops are in, the cash on hand reaches a healthy level, and the rural family is settling down to more time spent indoors. The farm family is attending the county fairs, spending money that rolled in from the harvest, and getting all the farm equipment lined up for the colder months.

It is a period when many alert dealers will decide to dust off the "rural department" and make a renewed appeal to the families who live outside the town. The agricultural prospects, whose modern farms actually have more use for radio and appliances than other types of customers, will certainly respond to dealers who want to be of service.

The total farm market is a 250 billion dollar business. Agricultural

production has increased an estimated 40 per cent. The newest count on the farms now on power lines is 3,335,700, which means that there are still 2,523,469 without electricity. In other words, about 60 per cent of the U. S. farms are electrical ones, and a retailer can figure that in his local area, about six out of every ten farmers are hooked to the lines.

Getting Results

For selling the non-electrified farmers, the retailer now has a number of market factors working for him. These may be counted as (1) Farmers are good pay, though they are cautious buyers, (2) The competition in merchandising battery sets is by no means as keen as in other lines because each manufacturer offers only a limited array of farm receivers and many suppliers

Sales in Early Autumn

Means Profits for Rural Retailers

of the 10 leading ones are, in order: Iowa, Missouri, North Carolina, Alabama, Ohio, Georgia, Arkansas, Mississippi, and Oklahoma. Retailers in these areas have special chances to make extra sales.

It has been noted that the progress in electrified areas has a definite influence on the buying habits of un-electrified sections of the country. For instance, the farmers without power lines are constrained to buy newer and more battery radios, because a general "modernizing and streamlining" has taken place in the farm picture, partly as a result of the widespread distribution of electric power. So whether farmers get the power or not, they are influenced by its over-all impact on agricultural life.

A farmer who keeps up with these trends begins to understand how electricity has radically changed the standards of rural living. He is aware that great changes are being made in his business. Then he starts to be discontented with the old-time battery radio which he had previously thought to be adequate.

Sales Areas Named

An analysis of the figures to the right shows that the Pacific area (Washington, Oregon and California) has the highest percentage of electrified farms. In this area 89.8% of the farms are hooked to lines, which is reaching pretty close to the limit, although a single state (Washington) boasts 95.1% electrification.

The lowest percentage of electrified farms occurs in the East South Central group of states, (Kentucky, Tennessee, Alabama and Mississippi) where the percent is only 36.2. It will be noted, however, that Alabama ranks fifth in the U.S. for the number of recently electrified units.

These figures include both private and REA types of electrification; the basic count comes from Edison Electric Institute, which linked its figures with the U. S. Census of Agriculture.



STATUS OF THE FARM MARKET, BY STATES

	Farms Electrified During Past 2 Years	Total Electrified	Non- Electrified
Maine	3,400	30,000	12,184
New Hampshire	1,400	16,500	2,286
Vermont	5,800	23,600	2,890
Massachusetts	1,800	34,500	2,507
Rhode Island	200	3,300	303
Connecticut	1,700	21,100	1,141
New York	17,200	137,200	12,290
New Jersey	1,400	24,700	1,526
Pennsylvania	18,800	139,700	32,061
Ohio	29,000	189,400	31,175
Indiana	22,700	141,200	34,770
Illinois	25,100	139,800	64,439
Michigan	14,900	157,500	17,768
Wisconsin	25,000	141,700	36,045
Minnesota	23,500	108,700	80,252
Iowa	40,200	159,900	49,034
Missouri	35,700	107,400	135,534
North Dakota	2,300	8,800	60,720
South Dakota	2,300	10,100	58,605
Nebraska	7,700	43,500	68,256
Kansas	10,500	53,600	87,592
Delaware	900	6,400	2,896
D. C. and Maryland	6,400	29,800	11,515
Virginia	23,000	84,300	88,751
West Virginia	10,600	48,000	49,600
North Carolina	34,500	141,300	146,112
South Carolina	16,200	67,900	79,845
Georgia	27,600	103,100	122,797
Florida	8,400	30,400	30,759
Kentucky	25,900	90,500	148,001
Tennessee	18,900	88,000	146,431
Alabama	30,100	94,300	129,069
Mississippi	26,500	75,100	188,428
Arkansas	26,700	68,300	130,469
Louisiana	23,700	54,700	74,595
Oklahoma	25,700	69,000	95,790
Texas	60,900	210,400	174,577
Montana	3,400	14,100	23,647
Idaho	12,500	35,400	6,098
Wyoming	1,700	6,300	6,776
Colorado	6,900	29,700	17,918
New Mexico	3,500	10,400	19,295
Arizona	2,300	10,900	2,242
Utah	1,300	20,400	5,922
Nevada	0	1,700	1,729
Washington	9,800	76,000	3,887
Oregon	10,200	56,600	6,525
California	6,600	120,500	18,417
Total U. S.	714,800	3,335,700	2,523,469

Insurance Protection

Adequate and Proper Coverage Should be Obtained to Guard Against Loss

Edwin A. Muller, author of the accompanying article, is a well-known insurance advisor with offices at 151 William St., New York City. He's been in the field for 24 years, and has done extensive work for retailers. Mr. Muller is a frequent contributor to financial and insurance publications.

● As a contribution in assisting retail businesses to develop insurance to adequately cover the various hazards encountered, the following is dedicated. Not only should the insurance be sufficient, but it should be coordinated into a comprehensive program which will serve best the interests of all concerned.

While the functions of insurance are generally well known it requires careful planning in order to adopt the best program. No matter how careful you are you cannot prevent mishaps, losses, etc., but fortunately you can insure against them. There are all types of losses which may be sustained and which the most careful and painstaking business man can suffer, and for which he can obtain insurance.

Among the components of a business are a good location, stock or merchandise in trade, good will, personnel and insurance. The efficiency of personnel heightens the element of good will by exceptional services, and thus promotes the welfare of the business. Insurance similarly pro-

pects and promotes the welfare of the business by providing indemnity for various losses.

Property loss or damage may be sustained by various perils, among which are fire, windstorm, explosion, burglary, theft and others. Fire insurance is almost universally accepted as such.

Not only may the building or premises be insured, but the contents as well. Proper fire insurance will require a basic knowledge of the co-insurance clause for the business man. He should know that by reason of a reduced rate he will carry insurance for at least 80% or 90% of the property value to be insured all the time. This must be maintained very definitely, otherwise he runs the risk of loss—here is where a good insurance adviser can be of specific help.

Use of this co-insurance clause entails burdens, particularly for those retail shops where inventories fluctuate, either periodically or seasonally. Where necessary a reporting form of insurance is desirable and can be arranged. A modern way of insuring store contents for the small business man or mercantile risk is the "contents form." It affords all the benefits of blanket coverage and describes the insured's contents specifically; and finally costs no more since the regular contents rate is applicable.

Employers Liability

Workmen's Compensation Insurance provides payment of compensation benefits as established by state law to individual employes injured while at work. Under the terms of the policy the company agrees to pay medical, surgical and other benefits in accordance with the Workmen's Compensation act of the state. It also insures and includes Employers Liability protection for the employer in the event an employe brings suit for damages under common law, on the grounds of alleged negligence. This type of insurance is mandatory in New York State as well as some others.

Where the compensation law is not applicable, Employers Liability coverage is available to cover the liability of the employer to his em-

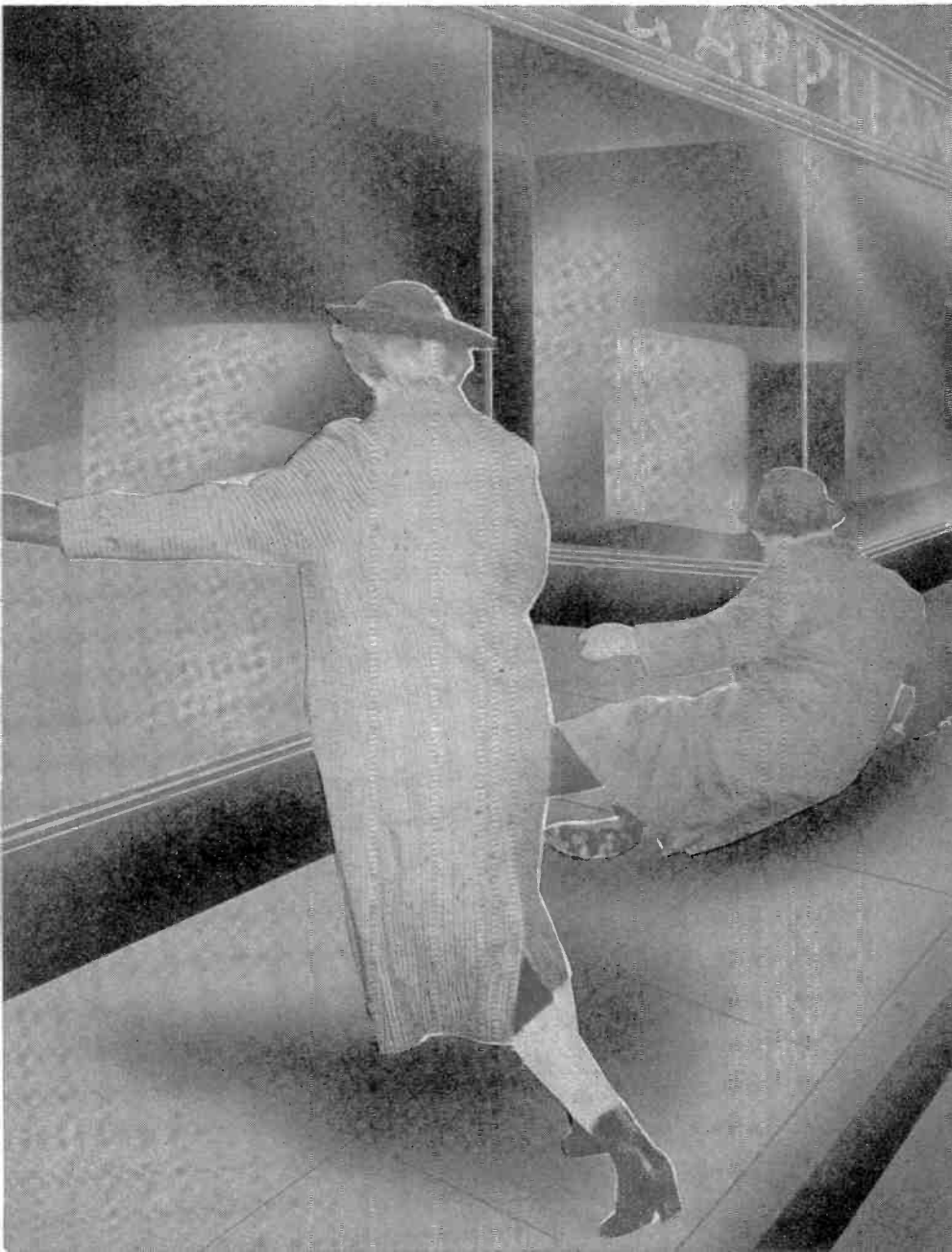

for Retailers

Through Various Causes

ployes. In addition Public Liability and Property Damage Insurance protects the dealer's business against loss arising from his legal liability for injury or damage to the persons or property of others in his establishment caused by his negligence.

Another form of liability is that of Products Liability. It covers the liability of the insured for damages resulting from the consumption or

be obtained covering all known hazards and will protect against the unknown hazard also.

Business Interruption Insurance pays indemnity to a business for loss of profits resulting from a cessation of business as a result of fire or other named peril. And also pays all continuing expenses, such as salaries of valuable employes, also contracts such as rent, light and power, tele-

from burglary, theft, larceny, robbery, forgery, fraud, vandalism, malicious mischief, confiscation or wrongful conversion, and against loss or damage to money and securities and other valuable papers, resulting from any cause.

Should an automobile be used in conducting the business, naturally automobile insurance, including Fire and Theft, Liability and Property Damage should be obtained. In a number of states while the insurance is not compulsory, it is mandatory following any accident to comply with the state's financial responsibility laws, also insurance to cover use of non-owner automobiles utilized by members in the conduct of business.

Did You Know That - - -

- 43% of firms having fires do not stay in business
- 17% no longer give financial statements
- 14% have drastic reduction in credit ratings
- 23% only are not affected

The above are reasons why many firms carry Business Interruption Insurance. Other forms of insurance available to retailers are described in this article.

Automobile Insurance

The standard automobile policy covering cars of owners who hire their use to others include as an additional insured any other person or company who are liable for their use.

It is therefore important that in addition to Employers Non-ownership Insurance the business should also effect the Hired Coverage as well. Of course, the best coverage to obtain would be a Comprehensive Liability contract, since it just about covers all contingencies.

Among other coverages are Plate Glass Insurance and Water Damage. The latter provides insurance for loss or damage caused by water or

use of any product sold or distributed by the insured. Owners and Contractors Protective Public Liability may also be necessary.

In a lease covering the occupied premises are contained provisions by which the lessee agrees to hold harmless the lessor, as a tenant assumes liability, which is passed on by the owner. The lease should be studied by a competent insurance adviser in order that he may ascertain the need for additional insurance. A Comprehensive Liability Policy may

phone, advertising and others. The importance of this special coverage is emphasized by the following statistics:

- 43% of firms having fires do not stay in business.
- 17% no longer give financial statements.
- 14% have drastic reduction in credit ratings.
- 23% only are not affected.

The answer is obvious. Burglary or Theft Insurance provides protection for loss or damage resulting

(Continued on page 114)

Property loss or damage may be sustained through various perils among which are fire, windstorm, explosion, or via an accident such as that seen in left-hand picture on this page. The various types of insurance policies which are available to radio/appliance merchants are described in this article.

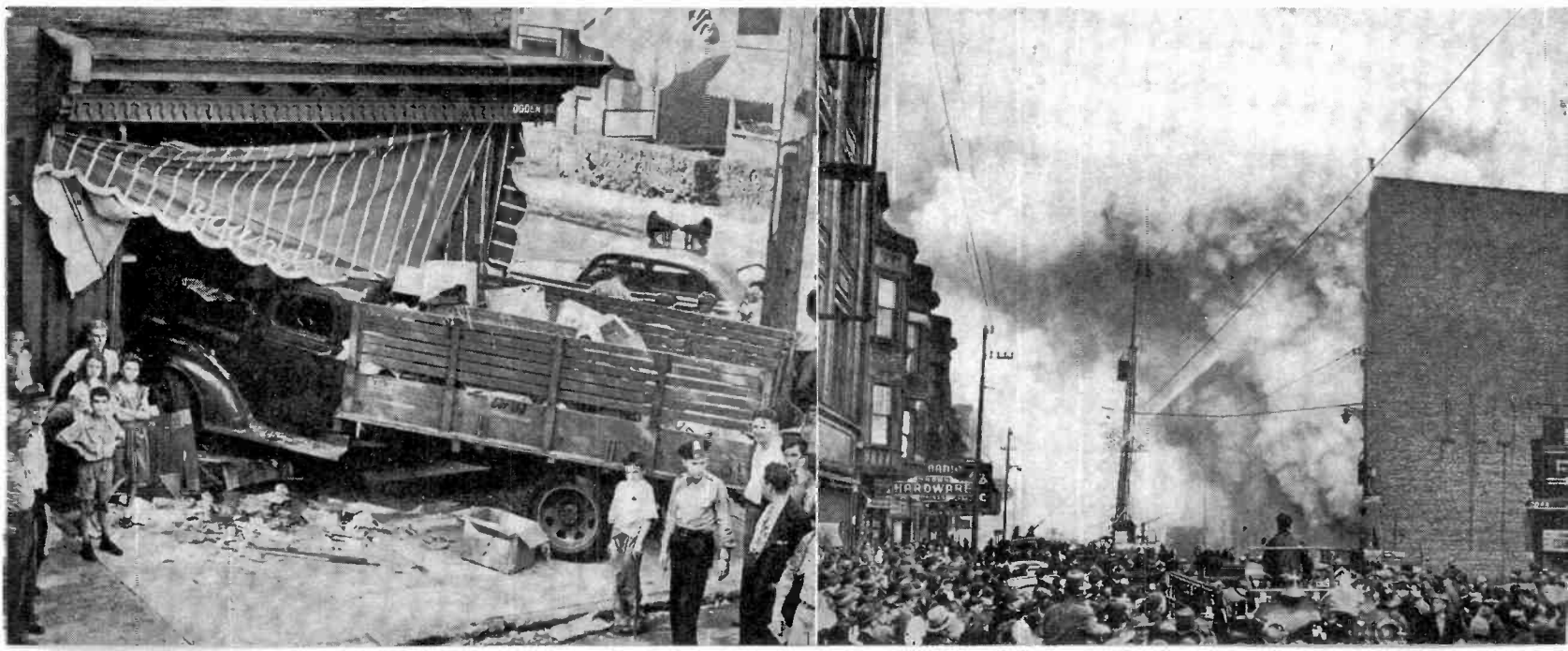

Philco FM-AM RADIO

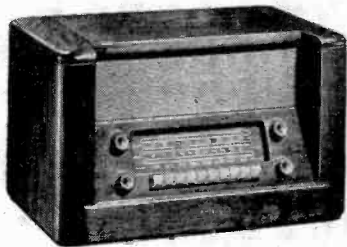

Model 482 table superhet, covering FM, shortwave and standard broadcast. Beam power pentode audio system, 3 watts undistorted volume. Ten push buttons, separate controls for treble and bass. Built-in triple aerial system, 8 tubes plus rectifier. Duotone cabinet of solid walnut and birds-eye maple-grained hardwood with gold-and-tan open-weave grille. \$149.95. Philco Corp., Tioga & C Streets, Philadelphia, Pa.—RADIO & Television RETAILING.

GE PORTABLE RADIO

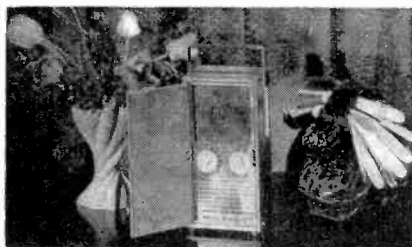

Model 140 3-way personal portable receiver, ac, dc or self-contained batteries. Four tubes plus selenium rectifier, 3½" Alnico 5 PM speaker. Door turns set on and off; all controls on aluminum front panel. Uses Eveready 467 or equivalent battery and two "D" flashlight cells. Beam-a-scope built in plastic door. Steel case, finished in grey or blue-green hammertone. Weighs 5½ lbs. with batteries. Measures 8 1/3" high by 4¼" wide by 3 1/3" deep. \$49.95 including batteries, eastern region. Receiver Division, General Electric Co., Bridgeport, Conn.—RADIO & Television RETAILING.

RCA-Victor COMBO

Model 641-TV "complete home entertainment" console with 5 services—AM, FM, television, shortwave and automatic record player. Picture area is 52 sq. in.—on 10" direct-view tube, automatic brilliance control. Tilt-out radio controls and slide-out record player. Eye Witness picture synchronizer, automatic station selector switch permitting tuning to any of 13 tele chan-



nels. Ten-watt output push-pull amplifier, four positions of tone control. Single external tele antenna also works for FM, shortwave and standard. Four rectifiers, plus 36 other tubes, plus picture tube. Period design cabinets in walnut, mahogany or blonde mahogany. Measures 33¼" wide by 46" high by 21½" deep. \$795 exclusive of tax and owner's policy fee of \$79. RCA Victor Division, Radio Corp. of America, Camden, N. J.—RADIO & Television RETAILING.

Clarion RADIO

Model 11801-V table superhet receiver tuning 540 to 1630 kc, 5 tubes including rectifier. Automatic volume control, 4½" Alnico 5 PM speaker, loop antenna. Metallic-faced dial with red pointer, two controls. Ivory plastic cabinet of modern design. Measures 6¼" high by 9" wide

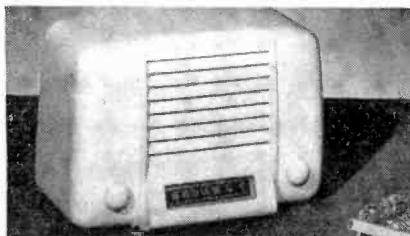

by 5¼" deep. \$19.95. (Other colors at \$17.95). Warwick Mfg. Corp., 4640 W. Harrison St., Chicago, Ill.—RADIO & Television RETAILING.

Sonora RADIO

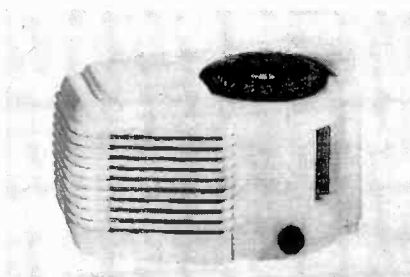

Model WAU-243 ac-dc superhet table unit tuning 535 to 1620 kc. Giant rotor dial in maroon color. Push button tuning for 4 stations, 5" dynamic speaker, automatic volume control, 5 tubes. Circuit operates without aerial or ground. Streamlined ivory plastic-molded cabinet, measures 11¼" long by 6¾" deep by 6¼" high. Shipping weight is 9 lbs. \$29.95. Sonora Radio & Television Corp., 325 N. Hoyne Ave., Chicago 12, Ill.—RADIO & Television RETAILING.

New Sets for

Andrea COMBO



Model CO-VJ12 "Sharp Focus" television console combination with 12" picture tube, screen 7½" by 10". Full 13 TV channels, plus 88 to 108 mc for FM band and 540 to 1650 kc on standard. Station Lock tele selector, Saftee Glass in front of tube, 31 tubes including picture and 3 rectifiers. Ten-inch speaker, automatic disc player in sliding drawer playing ten 12" records or twelve 10" discs. Cabinet of selected mahogany grains, hand-rubbed. List, \$995. Two other lower-priced models. Andrea Radio Corp., 27-01 Bridge Plaza North, Long Island City 1, N. Y.—RADIO & Television RETAILING.

Admiral PORTABLE RADIO

Model 7P34-5H1 "Thin Man" portable superhet ac, dc or battery. Tunes 535 to 1620 kc, beam power output, tuned rf circuit, automatic volume control, selenium rectifier. Equipped with Aeroscope antenna; detachable Travelscope aerial available at slight extra cost. Automatic battery change switch, 4" by 6" oval PM dynamic speaker of Alnico 5. Embossed slide rule dial. Speaker grille in modern design plastic. "Water thin" style cabinet, covered with saddle-stitched leatherette; streamlined plastic handle. Measures 15⅞" wide by 10¾" high by 5¼" deep. Ship-



ping weight is 13½ lbs. Black unit is \$49.95; maroon is \$54.95. Admiral Corp., Chicago 47, Ill.—RADIO & Television RETAILING.

the New Season

Hallicrafters COMBO



Handcrafted custom-built radio console, with time-control wire recorder, automatic record changer, interchangeable receiving unit. Recorder may be set to record automatically any radio program, to be played back at will. Adaptable for use as ham equipment. Space for albums and recording microphone. Changer intermixes 10" and 12" discs. Selection of speakers for wide frequency range reproduction. Low distortion, high fidelity volume expansion. Choice of radios includes unit covering 540 kc to 110 mc.—broadcast bands, new FM and all shortwave bands to 110 mc. The Hallicrafters Co., 2611 S. Indiana Ave., Chicago 16, Ill.—RADIO & Television RETAILING.

Arvin RADIO

Model 140-P portable receiver operating on ac, dc or self-contained battery pack. Tunes 540 to 1600 kc, superhet with cold cathode rectifier to give instant starting and less heat. Enclosed antenna shielded from set. 5" Alnico 5 speaker, 4 miniature tubes plus rectifier. Slide rule dial protected by Acetate nonbreakable crystal, visual in-

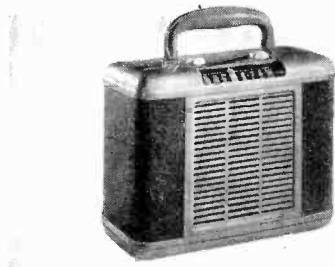

indicator at left. Plastic control knobs recessed in top of case. Top, bottom and grille of sheet steel, hammered silver grey effect. Laminated plastic wrap-around in simulated brown leather finish. Handle of genuine leather. Measures 9 $\frac{3}{4}$ " high by 12 $\frac{1}{4}$ " wide and 5 $\frac{1}{4}$ " deep. Weighs 15 lbs. complete with batteries. \$34.95. Noblitt-Sparks Industries, Inc., Columbus, Ind.—RADIO & Television RETAILING.

Crosley RECEIVER

Model 641-TV "complete home entertainment with picture reproduction of 8 $\frac{1}{2}$ " by 6 $\frac{3}{8}$ ". All 13 video channels (44 to 216 mc). Seven front panel controls for tele sound and pictures, 27 tubes plus 3 rectifiers, 5" speaker. Automatic frequency control on horizontal synchronizing circuits and multi-stage sync separators. Tube face protected by safety glass. Picture space framed by solid walnut, dark finish to improve viewing. Cabinet of striped walnut,

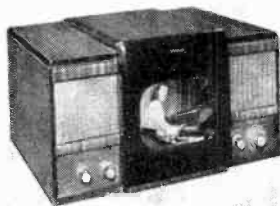

measures 25 $\frac{1}{2}$ " long by 14 $\frac{11}{16}$ " high by 19 $\frac{1}{16}$ " deep. Crosley Division, The Aviation Corp., Cincinnati 25, Ohio.—RADIO & Television RETAILING.

Trav-Ler PORTABLE RADIO



Model 5019 superhet three-way midget portable set "no bigger than a woman's vanity case." Full vision dial, 3 $\frac{1}{2}$ " Alnico 5 PM dynamic speaker, built-in loop antenna, 4 tubes—two of them dual purpose. Simulated leather cabinet; leather handle. Measures 6 $\frac{1}{8}$ " high by 7 $\frac{1}{8}$ " wide by 3 $\frac{3}{4}$ " deep. Weighs about 4 lbs. with batteries. \$19.95. Trav-Ler Radio Corp., 571 W. Jackson Blvd., Chicago 6, Ill.—RADIO & Television RETAILING.

Air King RADIO

Model A-600 "Duchess" table receiver, ac-dc superhet with 5 tubes plus rectifier (two dual purpose ones). Automatic volume control, die-cut antenna, 5" Alnico 5 PM speaker. Edge-lighted slide rule dial, full-



floating tuning drive system. Cabinet of two-tone catalin. Air King Products Co., Inc., 1523 63rd St., Brooklyn, N. Y.—RADIO & Television RETAILING.

Remler CONVERTIBLE COMBO



Scottie table model, billed as "world's smallest radio phonograph." Plays 10" or 12" discs with lid up; appears as conventional set with lid down. Five tubes plus selenium rectifier, output of 3 watts, single volume control for radio and phono. Constant-speed motor with worm-gear drive, rubber mounted, crystal pickup, permanent needle. Loop antenna in lid. Phono shuts off automatically as lid closes. Plastic case in ivory and ebony; measures only 6 $\frac{3}{4}$ " by 7" by 10". \$64.95. (De luxe all-ivory model with silent tone arm is \$69.50) Remler Co., Ltd., 210 Bryant St., San Francisco 10, Calif.—RADIO & Television RETAILING.

Temple PORTABLE RADIO

"Vacationer" model portable two-band receiver with 6" Alnico 5 PM speaker. Dry-disc rectifier, 5 tubes, automatic bass tone compensation. Collapsible whip antenna plus built-in loop antenna. Operates on ac-dc or batteries. Completely enclosed aluminum chassis, adjustable strap for carrying by hand or slung over the shoulder. Plastic roll-back curtain to protect controls and dial window. Automatic vol-



ume control. Case of simulated leather. \$64.95 less batteries. Templetone Radio Mfg. Corp., New London, Conn.—RADIO & Television RETAILING.

(Continued on page 46)

What you should know about SEX to sell portable radios

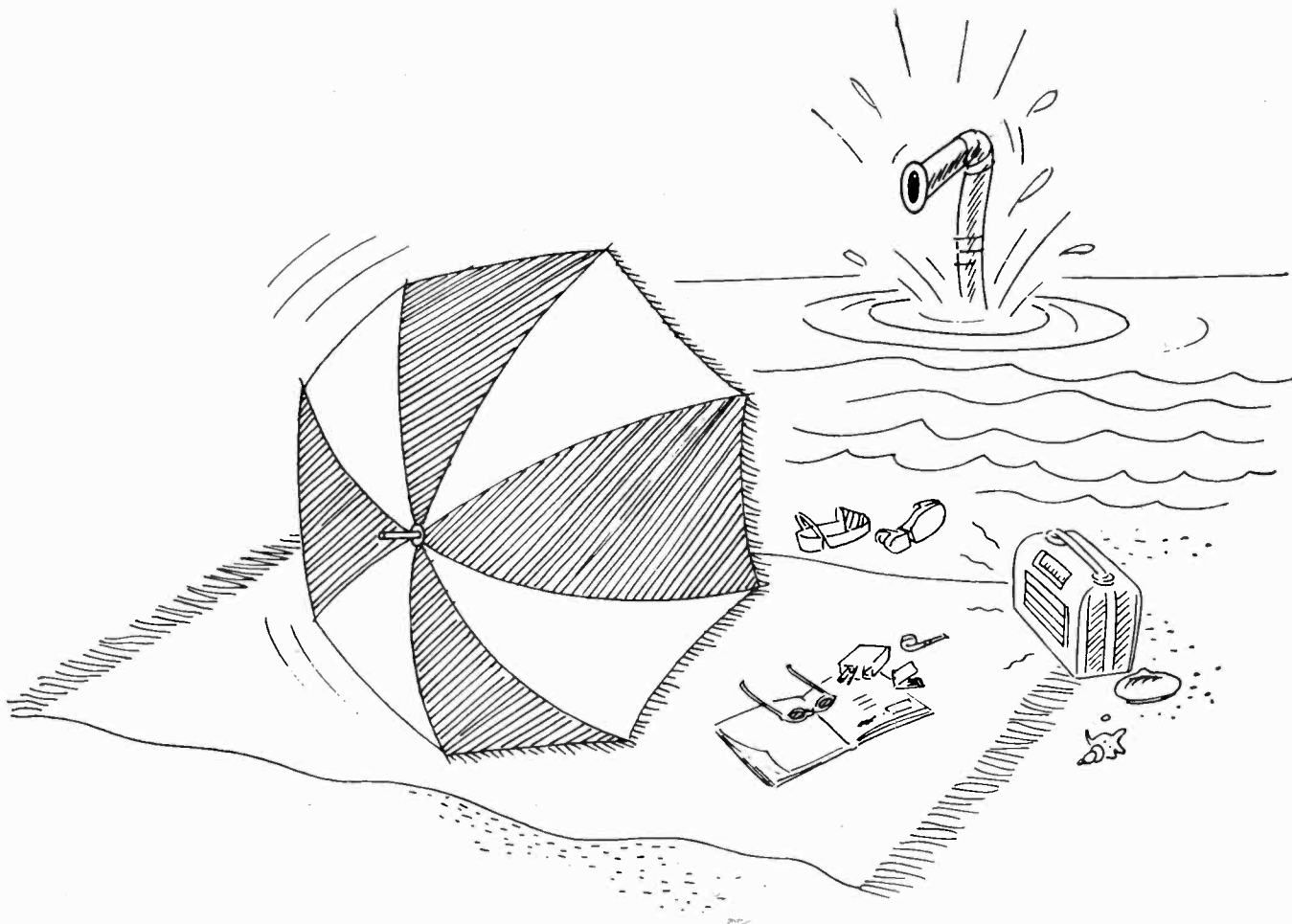

Any submarine captain worth his salt knows that beaches are inhabited by *males* and *females*. And any advertising man worth *his* salt knows that this country is one vast beach.

Now a *few* male and female inhabitants of this vast beach are too inhibited to appreciate each other. But most males and females *instinctively understand* the significance of the opposite sex. And by a simple legal procedure their understanding becomes *permanent*—at which time sundry merchants become very interested.

The portable radio is fast becoming an essential piece of male-female luggage—whether their trip is to the beach or the backyard. *Males* are buying portable

radios . . . *females* are buying portable radios . . . and *males and females* are buying 'em *together* (like they pick out a new refrigerator or washing machine).

But *no one else* ever buys portable radios (or refrigerators, etc. either). Just *males* and/or *females*. You've got to sell *both* sexes—either *together* or *separately*.

And who can woo males and females like THE AMERICAN MAGAZINE!

Dollar for dollar, page for page, *no other* magazine can match the multimillion male-female circulation delivered by . . .

*The American
Magazine*

Sales-Plus-Service

(Continued from page 42)

it up we find it was purchased in 1938. It's easy for anyone to forget. In the case of a service job, when a customer is checking on the 90-day guarantee, these cards are also very valuable."

"The difficult we do immediately; the impossible takes a little longer," has been the motto of Community in regards repair work. Most jobs are completed within a few minutes to within a few days, depending on what's wrong. The store has managed to corral a lot of customers through repair clients who in turn have recommended Community to others. Three men take care of the two repair rooms and all work is done as promptly as possible. The best policy with repair work, believes Community, is to operate it on a strictly cash basis.

The Face Is Lifted

In June, 1945, the store was completely remodeled. It took a long time to complete it, but now it is finished and it's a bang-up job! The all-glass front door didn't arrive until Spring of 1946. Now windows extend from sidewalk to ceiling and a complete glass front gives a clear view of the interior.

"When we had our store remodeled, people wanted to know if this was a new place. They had never even seen us before!"

To take the hurried shopper's eye, the store windows have been backed up in dark blue, which greatly enhances the shining white beauty of refrigerators. Lamps in the center aisle of the store also attract attention.

All of the well-known merchandise is selling well at present, but if Community were going to select the fastest-moving items, they would name certain brands of table model combinations, electric irons and automatic washers.

Community looks forward to rich sales in FM, as soon as the local broadcasters get their problems settled.

A Critical Moment

The store advertises regularly in the local paper. A highly valuable advertising schedule had been used in pre-war days, and this program is being resumed. Community also makes extensive use of handbills, particularly when the store is ready to make special offerings.

But whatever the extent and pace

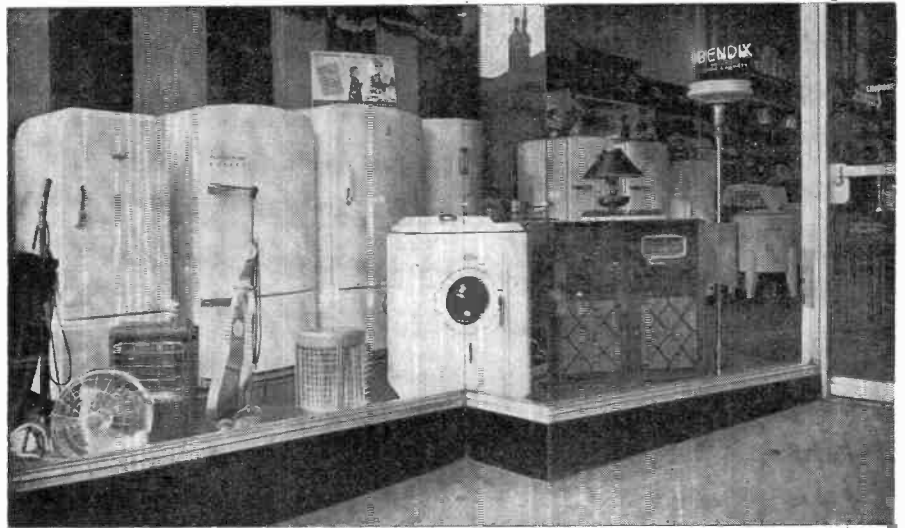

One of the display ideas at Community Radio is to show the "white goods" against a permanent background of dark blue. It shows the merchandise off in a clean-cut, simple, effective manner.

of the promotion, this dealer sticks to the policy, "treat the customer right when you finally get him into your store—or all your effort is lost."

"And remember that competition is back. You have to be on your toes, and you have to back up your promises with action!"

To take these principles seriously and to apply them to the many lines handled at the Community store, is no small job. It takes a lot of extra

energy and thought. But the Pennsylvania retailer gets considerable satisfaction out of getting a lot of merchandise into a lot of homes in such a way that the homemakers become friends of the store.

To say that Community has intensified its efforts thus means that the store re-emphasizes sales-plus-service, rather than just turning on the sales pressure. It's the store's answer to competitive conditions.

A customer, sold on the conveniences of electric ranges, hears about the Community finance plan.



More New Lines Shown

Stewart-Warner RADIO

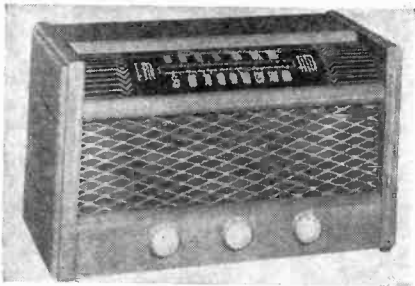

Model A72T3 table AM-FM receiver tuning 88 to 108 mc for FM and 540 to 1600 kc for standard. Seven tubes plus selenium rectifier, ac-dc, built-in antenna for both AM and FM bands. Five-inch PM dynamic speaker. Walnut wood cabinet. (Model A72T4 is desert tan wood.) Stewart-Warner Corp., Chicago 14, Ill.—RADIO & Television RETAILING.

Garod RADIO

Model 5A1 "Ensign" table ac-dc superhet tuning 540 to 1650 kc. Four multi-purpose tubes plus rectifier. Built-in loop antenna, slide rule dial, Alnico speaker. Walnut plastic cabinet, measures 5 $\frac{3}{4}$ " high by



4 $\frac{3}{4}$ " deep by 10 $\frac{3}{4}$ " wide. \$19.95 including federal tax. (Ivory plastic cabinet slightly higher.) Garod Radio Corp., 70 Washington St., Brooklyn, N. Y.—RADIO & Television RETAILING.

Industrial RECEIVER

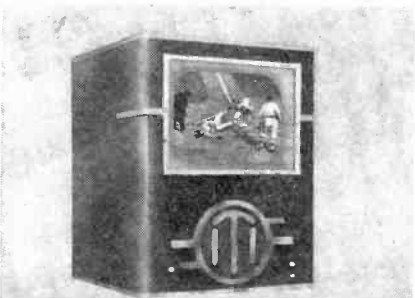
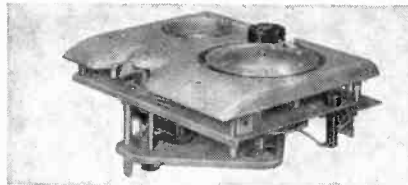

Table television model including FM radio. Features remote control unit, allowing screen and controls to be conveniently placed—provision for controlling a number of screens and sound systems from one central point (has microphone connection). Engineered for continuous duty, rather than for intermittent use. Industrial Television, Inc., 34 Franklin Ave., Nutley 10, N. J.—RADIO & Television RETAILING.

Webster-Chicago RECORDER

Model 79 wire recorder foundation unit—basic device around which complete wire recorder is built—for experimenters, amateurs, etc. Consists of wire transporting mechanism equipped with triple-purpose recording head which records, erases and plays back. Powered by 4-pole, shaded pole, self-starting induction-type motor. Records at 2 ft. per sec.; rewinds at 7 times that speed. Uses standard size spool of wire permitting continuous record-



ings one hour long—smaller spools available. Webster-Chicago Corp., 5610 Bloomingdale Ave., Chicago 39, Ill.—RADIO & Television RETAILING.

DetectoMaster ALARM

Electrical alarm system which warns of fire and indicates its location. Wall-mounted, permanently sealed control unit is connected to 15 master thermostats located in areas to be "guarded." Dial is marked with areas 1 to 15; when any one of 15 thermostats detects abnormal temperature (either fire or cold), the green "on-guard" light goes out, a red light flashes, Klaxonette horn sounds, and indicator needle points to number of trouble area. Control unit also has reset button, adjuster knob (to compensate for voltage loss in batteries) and test button. Non-corrosive silver con-



tact points. Pre-set at factory for 20 to 200 degrees F, other ranges available. Lord-Taber Co., Inc., Canandaigua, N. Y.—RADIO & Television RETAILING.

Signal RADIO

"Empress" model portable 3-way receiver, "Signalloop" antenna. Four tubes plus selenium (no warm-up time) rectifier,



5" Alnico 5 speaker (1.47 oz.), Ac-dc or 5 flashlight cells and 6 $\frac{1}{2}$ v. battery. Slide rule dial, carrying handle and shoulder strap. Simulated leather cabinet measures 10" by 3 $\frac{1}{2}$ " by 5 $\frac{3}{4}$ "; weighs 5 $\frac{1}{2}$ " lbs. \$29.95 less batteries. Signal Electronics, Inc., 114 E. 16th St., New York 3, N. Y.—RADIO & Television RETAILING.

Commercial RADIO

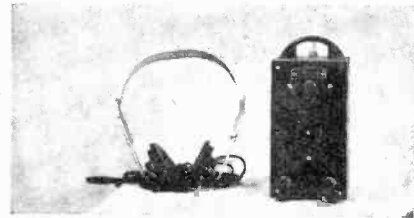

Portable model police & fire call receiver, battery operated. Sturdy case with black plastic front panel, measures only 6 $\frac{1}{8}$ " by 3 $\frac{3}{8}$ " by 3 $\frac{3}{8}$ ". Weighs about 2 lbs. \$17.95. (With earphones, battery and plug-in antenna, \$19.50.) Commercial Radio, 36 Brattle St., Boston 8, Mass.—RADIO & Television RETAILING.

Fada RADIO

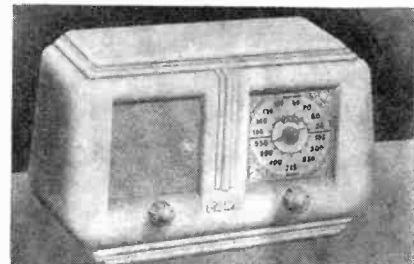

Model 1005 table receiver tuning 528 to 1680 kc. Five tubes, Alnico 5 dynamic speaker, 6 tuned circuits, automatic volume control. Franklin "Aero-Loop" antenna. Golden Glo dial. Poli-Styrene cabinet available in ivory, maroon or mottled blue. Measures 10 11/16" wide by 6 $\frac{3}{4}$ " high by 5 $\frac{1}{2}$ " deep and weighs 4 $\frac{1}{2}$ lbs. Fada Radio & Electric Co., 525 Main St., Belleville, N. J.—RADIO & Television RETAILING.

Rauland FM ANTENNA

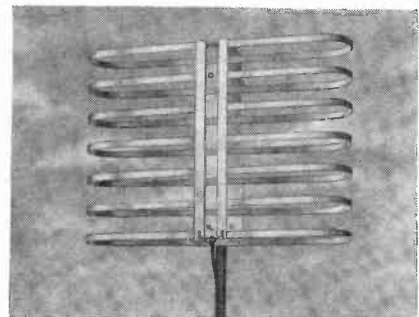

Model 150 all-aluminum receiving antenna designed specifically for 88 to 108 mc. band. Small size for low wind resistance. Omni-directional pickup pattern, designed to require no special orientation. Rauland Corp., 4245 N. Knox Ave., Chicago 41, Ill.—RADIO & Television RETAILING.

VALUE

WILL SELL IN *any* MARKET!

ARVIN
Radios
MOST for the money



Model 444
Arvin "Nifty Mite"
Today's lowest-priced
nationally advertised
superhet!

\$14⁹⁵



Model 140P
Arvin Portable
Sales are terrific!

\$34⁹⁵
less batteries



Model 151T2
Quality-built combo-
changer. Irresistible value!

\$89⁹⁵

Now comes proof for Arvin dealers of the soundness and real worth of the Arvin Radio Franchise. The return to normal market conditions only emphasizes the rightness of Arvin policy in pricing for the long-pull mass-market.

It stresses the top-flight values built into the Arvin line. The well-known Arvin name wins greater recognition among dealers and consumers alike . . . for, Arvin Radios sell at normal prices and regular discounts.

Arvin Radios sell today and are still selling fast because they are our front in quality, in line on price.



. . . the name on many profit-building products of

NOBLITT-SPARKS INDUSTRIES, INC., Columbus, Indiana

Arvin Values include—Arvin Top Flight Radios • Arvin Automatic Electric Irons • Arvin Electric Cook Combination Grill and Waffle Baker • Arvin Fan-Forced Electric Heaters • Arvin Radiant Electric Heaters.

New Lines Continue

Packard-Bell FM TUNER



Model 872 plug-in FM tuner unit, to adapt any radio to receive FM broadcasts. To install on radio-phonos, the phono plug is removed and plugged into tuner, then tuner cord is plugged into phono socket. Uses ratio detector, tunes 88 to 108 mc. Used with 52" dipole antenna. Packard-Bell Co., Inc., 3443 Wilshire Blvd., Los Angeles 5, Calif.—RADIO & Television RETAILING.

DeWald RADIO

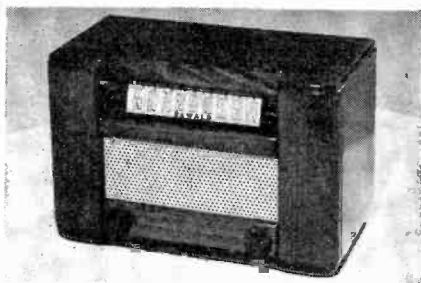

Model A503R table ac-dc superhet, with standard and police reception. Built-in "looptenna," Alnico dynamic speaker. Streamlined cabinet of hardwood. Measures 6¾" by 10½" by 5¾". DeWald Radio Mfg. Corp., 35-15 37th Ave., Long Island City 1, N. Y.—RADIO & Television RETAILING.

Sound-On-Wire RECORDER

Magnetic recorder designed for use as dictating machine. Foot-pedal control, jack for telephone recording; will record for one hour continuously. Operator can revise dictation by re-dictating over old material as demagnetizer clears the wire ahead of new recording. Selector dial to control recording, play-back, rewind, etc. Rewind speed 10 times play-back speed; automatic stops. Wire magazines fitted with "counters" for "logging" dictation. Also



recommended for recording conferences, business meetings, etc. Standard Business Machines Co., 720 S. Dearborn St., Chicago 5, Ill.—RADIO & Television RETAILING.

UST RECEIVER

1948 model direct-view tele receiver, with 10" picture tube. Designed into cabinet about half the size of the 1947 model. Interior space provided for choice of any record changer on the market, including the Garrard. Two cabinet styles—Georgian or modern bleached mahogany. \$895 plus \$45 tax. United States Television Mfg. Corp., 3 W. 61st St., New York 23, N. Y.—RADIO & Television RETAILING.

Stromberg-Carlson RADIO

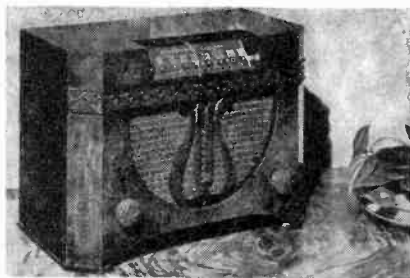

Model 1101-HM—"The Sonnet" table receiver, ac-dc, tuned r-f. Electrodynamic speaker, lighted slide-rule dial, built-in antenna. Automatic volume control plus manual. Mahogany cabinet featuring classic simplicity of design. Measures 8 9/16" high by 12¾" wide by 7" deep. Stromberg-Carlson Co., Rochester 3, N. Y.—RADIO & Television RETAILING

Tele & FM ANTENNA

Model FMTV44216 wide band, high gain television and FM receptor. Covers 44 to 216 mc (13 video channels and all FM bands). Featherweight, polished aluminum construction, all-weather design, engineered for easy installation. Pretuned

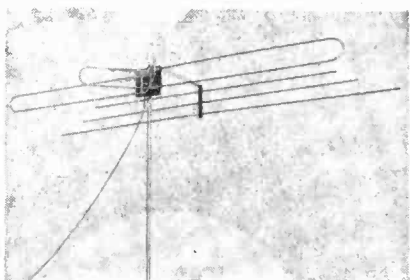

at factory—no adjustments required in field. Normally broadband and non-directional—reflectors available for unidirectional pattern. Interstate Mfg. Corp., 138 Sussex Ave., Newark 4, N. J.—RADIO & Television RETAILING.

EAM TOY ALARM

Battery-operated "Dick Tracy" toy burglar-alarm kit, complete with batteries and wire. Has practical uses in addition to entertainment value. Comes in 7-color package. \$2.98 list. E. A. M. Corp., Brooklyn 17, N. Y. (National sales rep is Bernard Funk, 200 Fifth Ave., New York, N. Y.)—RADIO & Television RETAILING

DENchum RADIO

Model W-446 lightweight "portable" superhet receiver, ac-dc, with handle that folds out of the way, attached bracket on bottom of cabinet for mounting in kitchen,

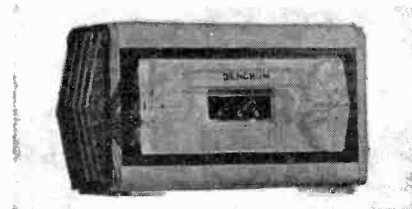

bathroom, library, sunporch, etc.; two wall brackets supplied with each set. Sound comes from grilles in both ends. Four miniature tubes, selenium rectifier. Built-in loop antenna, 3¼" Alnico 5 PM speaker. Rubber mounted feet. Cabinet of natural finish 3-ply walnut veneer, solid maple corner posts and grille bars. Plastic handle and medallion. Measures 8" by 4¾" by 4¾", weighs 3½ lbs. The Wilmak Corp., 139 Harrison St., Benton Harbor, Mich.—RADIO & Television RETAILING.

R-MC TRANSCRIPTION PLAYER

Model TP-16C portable transcription player for schools, ad agencies, transcription services, radio stations, etc. Plays records up to 16", two speeds, compact and light weight. Constant-speed motor with oversize bronze bearings. Drive wheel and idler have special formula neoprene "tires" precision ground for concentricity. Supplied with or without professional broadcast station reproducers. Radio-Music Corp., East Port Chester, Conn.—RADIO & Television RETAILING.

Kellogg Select-O-Phone

Automatic telephone and paging system up to 36-line capacity. Provides unlimited number of simultaneous conversations. Power supply automatically furnished from alternating city current; no batteries used. "Name touch" executive station in neat cabinet. Designed to "grow" with user's needs—no previous telephone experience required for installation. Automatic central station switching eliminates need for



multi-wire cables. Kellogg Switchboard & Supply Co., Select-O-Phone Division, 310 W. 6th St., Kansas City, Mo.—RADIO & Television RETAILING.



IS STILL THE

HOTTEST LINE IN THE INDUSTRY

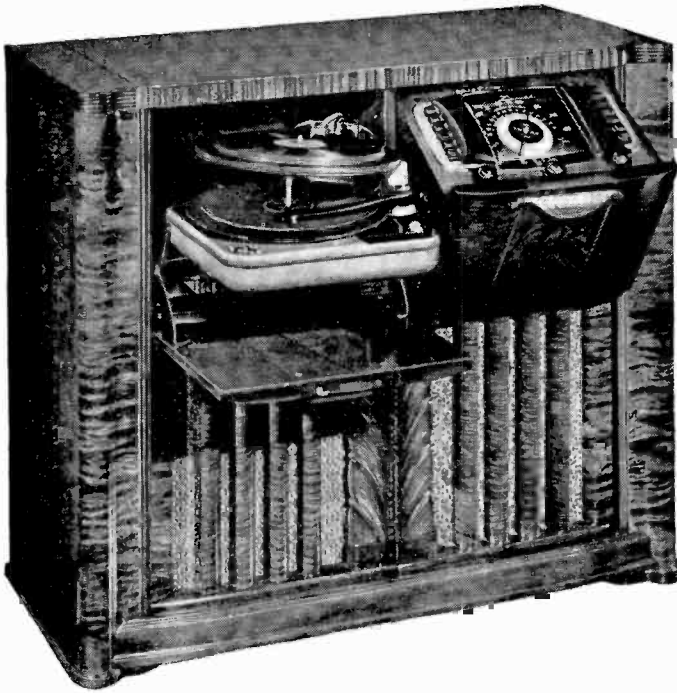

*That's Because of the
Value-Giving, Sales-Making
Features Made Possible By
Zenith's Policy of*

**RADIONICS
EXCLUSIVELY**

FIRST IN FEATURES

Watch shoppers on any radio sales floor. What set catches the interest of the crowds?—a Zenith, of course! That's because *every* model in the Zenith line is packed with features that actually *mean* something—features that reflect the design and engineering "know-how" developed during Zenith's years in the industry—features that insure *value*.

FIRST IN DEMONSTRABILITY

Zenith radios and radio-phonographs are *easy* to sell, because their features are the kind that you can actually *demonstrate*. The Cobra Tone Arm, for example, permits the most dramatic tone arm demonstration ever made. The Zenith "Radiorgan," the Silent-Speed Record Changer, the big, black dial, the Zenith Wavemagnet—all these are features you can show . . . features your customers will notice and want.

FIRST IN PERFORMANCE

From the original engineering blueprint to the finished sets that come out of the final testing booth, every Zenith is built to *work* . . . built with all the skill, the knowledge, the *pride of achievement* that marks this organization. The final test of every radio is how it *performs* . . . and Zeniths are built to pass that test with flying colors. Hundreds of thousands of well-satisfied Zenith owners attest to *that*.

ZENITH RADIO CORPORATION
6001 W. DICKENS AVENUE • CHICAGO 39, ILL.

ONLY ZENITH OFFERS SALES FEATURES LIKE THESE



RADIONIC
COBRA TONE ARM

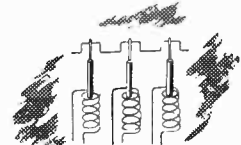

ARMSTRONG F-M

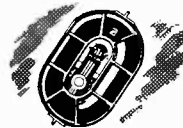

WAVEMAGNET



RADIORGAN



SILENT-SPEED RECORD CHANGER

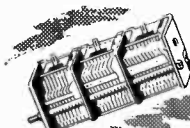

3-GANG CONDENSERS

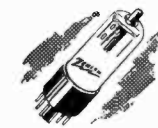

NEW SUPER-SIX TUBE



80% MORE POWERFUL
PHONOGRAPH MOTOR

JACK BENNY

Calling

DAVID ROSE

(Collect)



"DAVID ROSE, I'm really overwhelmed... that you've dedicated your wonderful new M-G-M Record, 'WAUKEGAN CONCERTO', to me. But, Dave, I've always known that my violin playing would inspire great music. I've sold... I mean I've sent hundreds of copies to my friends, and they all say it's swell."

"Thanks a million... (Ulp!) JACK BENNY! Even if I have to pay for this call myself, it's music in my ears to hear such praise from you. I couldn't have dedicated it to a nicer guy!"



5 MORE GREAT M-G-M RELEASES

ART LUND

sings
ON THE OLD SPANISH TRAIL
PEG O' MY HEART
M-G-M 10037

SAM NICHOLS

and the Melody Rangers
THAT WILD and WICKED LOOK in YOUR EYE
YOU'LL LIVE TO REGRET IT (WAIT AND SEE)
M-G-M 10038

JOHNNIE JOHNSTON

sings
AIN'TCHA EVER COMIN' BACK
YOU'RE NOT SO EASY TO FORGET
M-G-M 10036

THE CLARK SISTERS

sing
TIP TOE THROUGH THE TULIPS
I'M JUST WILD ABOUT HARRY
M-G-M 10039

LAURITZ MELCHIOR

lends his famous tenor to
EASY TO LOVE
YOU ARE MY HEART'S DELIGHT
M-G-M 30014

DAVID ROSE

Dedicates M-G-M Records'

WAUKEGAN CONCERTO

to

JACK BENNY

M-G-M 30013



Jack Benny and David Rose will sell this M-G-M Record for you! Jack Benny listeners (23,000,000 each week!) have enjoyed his hilariously funny violin solos. In "WAUKEGAN CONCERTO" David Rose has woven these famous themes into a colorful, fully orchestrated modern masterpiece. And David Rose will conduct the first radio performance of "Waukegan Concerto" on June 26th, when he takes over the Eddie Cantor show (with 12,000,000 listeners) for the summer.

M-G-M RECORDS

THE GREATEST NAME  IN ENTERTAINMENT

RECORDS

Section of **RADIO Television RETAILING**

Platter Profit-Pointers

\$ DEALERS FIND many other non-competitive retail outlets advertising their best-selling artists. Agencies whose clients sponsor big recording names on radio shows, have prepared posters, streamers and other display material for display in food, drug, and ready-to-wear stores. Therefore, popular crooners, orchestra leaders, as well as symphony conductors and opera stars, will receive publicity in their sponsor's retail outlets. Local merchants can capitalize on this additional artist publicity.

\$ NOVEL WINDOW DISPLAY that will arouse much customer comment and encourage automatic changer sales can be built around a contest to find the oldest record player in the neighborhood. Display of old-fashioned players in comparison with modern record changer (in motion) can be shown in window, with winners receiving prizes of a record, an album, or new changer.

\$ SHAKESPEARE is always good business. Dealers are overlooking a bet if they do not keep up with current recordings of plays, poetry, and other dramatic recordings which will appeal to students in school as well as out. Recordings bring the richness of the English language alive to an extent that written pages never could reach, and more and more people are realizing this.

\$ BACKLOG OF REQUESTS for standard records which dealers have been piling up for years, will be filled more readily

from now on. Manufacturers are re-issuing many catalog singles and albums to satisfy long-standing demand.

\$ OTHER BUSINESSMEN in the community are frequently a good source of record sales, if approached properly. Some personnel offices are using records in their waiting rooms to "ease" the minds of prospective employees; small funeral parlors utilize discs for playing of background organ music or hymns; dentists, doctors, or neighborhood retail establishments might welcome the use of music in their business. In addition, people will eventually learn that the records they are hearing all over town, came from Dealer X's store.



\$ NOW THAT OUTDOOR selling is coming back—but fast, alert retailers are planning to give salesmen a couple of albums to take along on visits to established customers. Even if the home-owner doesn't buy, such practice will help advertise the store as a record headquarters.

\$ A GOOD WAY to get folk into the habit of looking at show-window displays is to operate a local bulletin board listing all amateur plays, musicals and other neighborhood functions.

\$ FAST-MOVING DISCS sell, whether they are prominently displayed all over the store or not. It's good business practice to keep certain shelf-warmers in the public view. The disc dealer will be surprised to find how many people are actually looking for platters that are alleged to be sales-proof.

\$ NIGHT CLUBS are new disc-selling grounds. One night-spot operator has made a counter at his club available to record dealers, for the sale of discs. He feels that artists who appear at his place will be more in demand, if their discs are popular. Therefore, he wants to do everything possible to further platter sales. A local distributor names the dealers who are to man the record counter on different days of the month.

\$ ONE OF THE BIGGEST record firms divides its "sales" year into two periods, of five months and seven months each. The idea being that the returns from November through March should be equal to the seven-month period of April to October. Business peak is reached at Christmas-time.

\$ FOLK MUSIC, which has always been a South-West specialty, has made profitable inroads in the Big City stores. "Sophisticate" markets are going in for this basic American music—with everything from square dances to old hill country songs finding their way into the family record collection. Dealers in every locality are missing a bet if they don't emphasize their stock of folk favorites.

6 TOP ITEMS will be featured in your August RCA VICTOR ADS!

3 on "POP"

There's appeal for everybody in your "pop" ads next month, featuring operetta, hot jazz, and Vaughn Monroe's dreamy magic. Plan displays to nab the easy sales... made for you in "LOOK" and 6 of the best fan and teen-age magazines!



AL GOODMAN and his Orchestra in a sparkling new performance of the ever-popular *Student Prince*, co-starring Earl Wrightson, Baritone; Mary Martha Briney, Soprano; Donald Dame, Tenor; Frances Greer, Soprano; and The Guild Choristers. Album P-180, \$3.75.

VAUGHN MONROE'S

sensational *Dreamland Special*. Did You Ever See a Dream Walking?, I've Got a Pocketful of Dreams, Drifting and Dreaming, Meet Me Tonight in Dreamland, I'll See You in My Dreams, Dream, My Isle of Golden Dreams, My Dreams Are Getting Better All the Time. Album P-160, \$3.15.



ERSKINE HAWKINS and his Orchestra's sizzling new *Tuxedo Junction* album... giving their extra special delivery to a prize package of hot jazz: *Tuxedo Junction*, *Don't Cry, Baby*, *Tippin' In*, *I've Got A Right To Cry*, *After Hours*, *Cherry*, *Sweet Georgia Brown*, *Song Of The Wanderer*. P-181, \$3.15.



3 on RED SEAL

Your August Red Seal release—plus headline promotion on 3 big sellers—appears in "LIFE" Aug. 4. "TIME," Aug. 11, features the new Iturbi single. For quick and simple selling, team your displays with the ads!



HEIFETZ: *Modern Violin Transcriptions*—Bax, Poulenc, Ravel, Debussy, Medtner, Rachmaninoff, Halffter, and Castelnuovo-Tedesco. Emanuel Bay at the piano. RCA Victor Red Seal Album M-1126, \$3.75. In "LIFE" August. 4.



JOSÉ ITURBI, Pianist: *Allegro Appassionato*, Op. 70—Camille Saint-Saëns. RCA Victor Red Seal Record 10-1315, 75¢. To be featured in "LIFE" August 4 and full page in "TIME" August 11.

Prices are suggested list, exclusive of taxes.



BLANCHE THEBOM, Mezzo-soprano: *Cradle Song*—Brahms—Westbrook, and *The Virgin's Slumber Song*—Reger—Teschemacher. RCA Victor String Orchestra conducted by Macklin Marrow. Red Seal Record 10-1173, 75¢. To be featured in "LIFE," August 4.

You'll make extra sales by pushing your radio-advertised merchandise. On the popular RCA Victor Show items from your recent stock are picked for extra promotion. Tune in (2 PM Sundays over all NBC stations) and follow up with a profitable tie-in display!



Your RCA VICTOR DISTRIBUTOR



Pep Up Summer Sales

Warm-Weather Merchandising Calls for Extra Effort by Retailers.

● Advertising, promotion, and sales-stimulating window displays are the basic methods to be used for increasing summer volume—and this is especially true of the sale of records. Many record retailers complain that the summer slump is as inevitable as “death and taxes.” Be that as it may, something is being done about both these things; and in the same manner, definite action can be taken to bolster dipping disc sales.

Stimulate Appeal

The record retailer who is located in a year 'round residential and business trading area will obviously have to exert extra effort to garner his share of the platter business. He will continually have to keep reminding people that the record companies are issuing new releases; he will have to advertise these new recordings in local papers, club publications or on the radio. To build up a “desire” for the new release is the object; once that is accomplished the customer will come into the store to buy.

Sales promotion for Dealer X's store can be obtained free of charge, with just an outlay of some time and equipment. Summer is a hey-day for outdoor carnivals, fairs, musical events, amateur and professional sports, etc. Traveling tent shows will often welcome a local dealer's offer of free music for the PA system, in return for placards or an announcement telling who provided the musical entertainment.

The potential audience that the

dealer can reach through this medium is quite large; the expense involved is small, and the returns well worth it.

The extra sales activity which takes place outside of the store proper is important in that potential customers are encouraged to come into the dealer's establishment. At this point, store layout and appearance assumes an all-important place in the selling scheme, with particular stress on the display windows. A perspiring passer-by will not enter a store that looks “as hot as he feels.” Even if a dealer is lucky enough to have air-conditioning, his windows still have to give a “cool appearance.” The displays should be clear, uncluttered, and inviting looking.

Windows All-Important

Department stores are masters in the art of visual display, and local retailers can learn a lot from studying the windows the “experts” feature during the summer months. The same psychological principles that apply to the sale of clothes, furniture, or cosmetics can and do apply to records. Summer settings, women in colorful beach clothes, or a few “icy-looking” drinks properly placed in the store window will help the retailer do a better selling job.

Materials and props needed for a simple, but effective summer window might include: a life-size woman dummy, beach chair, garden table, “make-believe” frosted drink, portable player, and record display pieces. All may be borrowed “with credit”

from non-competitive merchants. One complete window should be utilized for this life-sized display of a woman sitting in a beach chair, relaxing with a cool drink, listening to her favorite records. A fan can be placed in one corner to provide motion to the scene by gently blowing the woman's dress or ribbons, thus giving the effect of a cooling breeze. Such a display is extremely easy to set up in any window, and can be elaborated upon according to the individual dealer's desires and ingenuity.

The opposite approach might be taken in setting up a miniature display. Equally striking, and simple, such a display might consist of a beach scene, set on the floor of the show window, with records, carrying cases, accessories, albums and other point-of-sales devices placed in the window. The beach scene can be simulated easily by utilizing a mirror for the “water effect” and surrounding it with sand, pebbles, small potted “trees” or plants, etc. An electric fan may be used to blow a promotional streamer across the display.

Plan Colors

Color used in these summer display windows should be wisely planned. Cool colors such as blue and emerald green, sprinkled liberally with white and silver should be used in warm-weather windows.

Dealers can take steps to combat the “summer slump.” Warm-weather inertia can be stimulated by promotional activities and smart merchandising techniques for more sales.

A simple life-sized set-up for a summer window.



Miniature beach scene, surrounded by albums, is another idea.

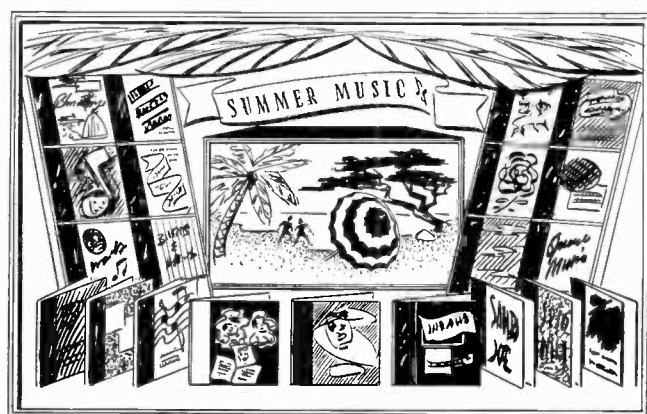

Variety

Manufacturers Present Ample Choice of Tunes, Artists, and Specialty Discs

CLASSICAL WORKS

ADAM: *Giselle, Ballet Music,* arranged by Constant Lambert. Orchestra of the Royal Opera House, Covent Garden, conducted by Constant Lambert. Columbia X-MX-277

Famous to all lovers of the ballet, excerpts recorded for this *Giselle* ballet music album include: "Opening Scene," "Giselle's Dance," "Mad Scene (Act I)," "Pas De Deux," "Closing Scene (Act II)."

BACH: "*Brandenburg Concertos No. 2 in F and No. 5 in D,*" Boston Symphony Orchestra, Serge Koussevitzky, conductor. RCA Victor DM-1118

Like the third and fourth concertos formerly released by RCA Victor, the present concertos were recorded at Tanglewood, Lenox, Mass., during the Berkshire Music Festival. Dealers in the Tanglewood vicinity will find ample promotion opportunities during the summer months.

CHOPIN: "*Les Sylphides,*" Boston "Pops" Orchestra, Arthur Fiedler, conductor. RCA Victor M or DM-1119

Album features a new arrangement by Anderson and Bodge, but still maintains quality of the Chopin original.

HANDEL: "*Twelve Concerti Grossi,*" performed by the Busch Chamber Players, Adolf Busch

New releases by favorite musical personalities include: 1) Gladys Swarthout's Victor album entitled "Gladys Swarthout Sings"; 2) numbers from "The Student Prince" recorded in a new Columbia album by Marek Weber; 3) a follow-up Art Lund disc of "On The Old Spanish Trail," and "Peg O' My Heart," by MGM Records; 4) "Monica Lewis Sings" in a current Signature set; 5) Charlie Barnet's hot waxings on the Apollo label; 6) The Andrews Sisters' new Decca platter coupling with Bing Crosby; 7) Edgar Bergen and his "two voices" are featured in one of the Top-Ten comedy albums; 8) Freddie Stewart, youthful new Capital artist.



of Platters Offered

conducting. Columbia three-volume special album edition

This release marks the first American recording of the "Concerti" in their entirety, and is classified as a "companion" piece to the "Messiah" albums formerly issued. The works cover forty-nine sides; a special booklet analyzing each concerto accompanies the three albums. Music lovers who purchased the "Messiah" sets are definite prospects for this release, as well as students, music teachers, local schools, etc.

HEIFETZ, JASCHA: "Modern Violin Transcriptions." RCA Victor M-1126

This year marks Heifetz' 30th anniversary as a concert artist in the U. S. Album might well be used to tie-in with other Heifetz recordings on this basis. Eight works from repertoire of contemporary and near-contemporary musicians were chosen for this album.

KREISLER: "Rondino on a Theme by Beethoven"—GLUCK: "Orpheus, Melodie," arranged by Fritz Kreisler." Nathan Milstein, violin; Artur Balsam, piano. Columbia 17408-D (single)
Milstein's talent re-creates a by-gone age in musical charm.

SCHUBERT: "Symphony No. 9 in C Major," Bruno Walter conducting the Philharmonic-Symphony of New York. Columbia M-MM-679

This year is 150th anniversary of Schubert's birth, and dealers can plan an eye-catching and interesting display around this celebration. Bruno Walter presents a new interpretation of Schubert's last work.

SHVEDOFF: "The Exchange of Diplomatic Notes Between the Turkish Sultan and the Zaporozsky Cossacks" (Two Parts), Don Cossack Chorus, Serge Jaroff, conductor. Columbia 7493-M (single)

Stirring song of Cossack band which refused to submit to a Turkish Sultan.

SIBELIUS: "Karelia Suite, Op. 11, 'Intermezzo' and 'Alla Marcia,'" Sir Thomas Beecham conducting the B.B.C. Symphony Orchestra. RCA Victor 119568 (single)

The English conductor wields his baton masterfully, doing a good job of popularizing the Sibelius music.

STRAVINSKY: "Symphony in Three Movements," Philharmonic-Symphony of New York, conducted by Igor Stravinsky. Columbia M-MM-680

Of interest to music-lovers is fact that Stravinsky composed this "modern symphony" while living in Hollywood. "Sacre Du Printemps" and earlier ballet music good tie-in sales.

LIGHT CONCERT FAVORITES

"BRIGADOON": Featuring members of the original Broadway cast, including: David Brooks, Marion Bell, Pamela Britton, Lee Sullivan. RCA Victor Musical Smart Set, P-178.

Quality of this old-fashioned operetta in modern style "impressed on wax" in Victor's initial venture in using original members of a show cast for recording. Records include overture music, hit tunes, and some of the ballet music from flourishing Broadway hit.

LYMAN, ABE: "Waltz Time." Columbia

Eight sides included in this melodic collection: "Charmaine," "La Golandrina," "Down by the Old Mill Stream," "Meet Me Tonight in Dreamland," "Jeannine," "Missouri Waltz," "I'm Falling in Love With Someone," and "Valse Huguette."

SCOTT, RAYMOND: "Raymond Scott Album." Columbia C-133

The Raymond Scott quintet and orchestra are featured in the various Scott specialties, "Get Happy," "A Girl at the Typewriter," "The Quintet Plays Carmen," "A Little Bit of Rigoletto," "Manhattan Minuet," "Moment Musical," and "At an Arabian House Party."

WALLENSTEIN, ALFRED: "Tchaikovsky Waltzes." Decca A-483

The Philharmonic Orchestra of Los Angeles is featured with Wallenstein in a melodic collection.

WEBER, MAREK: "The Student Prince." Columbia C-134

Medley of tunes from beloved operetta, which had a successful Broadway run several seasons back. Dealers will find many local operetta groups still putting it on the boards.

VOCAL ARTISTS

MELCHIOR, LAURITZ: "Easy to Love"—"You Are My Heart's Delight." MGM 30014

Melchior has gained a new following, because of his "down-to-earth" roles in movies. Cash in on "pop" audience, and watch for Met tenor's movies to hit neighborhood.

STEVENS, RISE: "Songs of Victor Herbert," with male chorus and orchestra conducted by Sylvan Shulman. Columbia M-MM-682

Tried and true Victor Herbert favorites are sung by the Met Opera star, including: "Ah, Sweet Mystery of Life," title ballad from "Sweethearts," "Kiss Me Again," "A Kiss in the Dark," and "Thine Alone."

SWARTHOUT, GLADYS: "Gladys Swarthout Sings." RCA Victor M-1127

Follow-up to initial "Musical Show Hits" album featuring the popular mezzo-soprano. In this album Miss Swarthout sings six popular songs.

FOLK MUSIC

ALBUMS

"AMERICA'S FAVORITE SONGS, VOL. I." Smokey Mountaineers. Disc Album

Album of traditional songs and dance tunes of the Southern Appalachians.

"COWBOY SONGS": Cisco Houston. Disc 608

Accompanying himself on guitar, Cisco sings the tales of the people, for the people.

LEAD BELLY, with Cisco Houston and Woody Guthrie: "Midnight Special." Disc 726

Album of old favorite southern songs, for listening, and for dancing.

"LISTEN TO OUR STORY." Decca B-1024

This Folk Music album featuring a variety of artists, was supervised by Alan Lomax and is accompanied by the "Sing-Along-Book."

ROTH, ALLEN: "Roll, Jordan" (Spirituals in Rhythm), with the

(Continued on page 56)

Variety of Platters Offered

(Continued from page 55)

Carolina Choristers. *MGM Album 2*

Traditional rhythms of the spiritual are combined with modern jazz idiom for unique album of eight widely known folk spirituals.

TUBB, ERNEST: "Souvenir Album." *Decca A-529*

Melodic music in the true "folk" cowboy tradition.

SINGLES

BRITT, ELTON, and the Skytoppers: "Candlelight and Roses"—"I Wish You the Best of Everything." *RCA Victor 20-2269*

"Candlelight" is a famous hill-billy song of nostalgia, Skytoppers do guitar and fiddle accompaniment.

DEXTER, AL, and his Troopers: "Who's Gonna Love You When I'm Gone"—"Am I to Blame." *Columbia 37352*

Al does the vocals for the two plaintive tunes.

HERMAN THE HERMIT: "Hitler Lives"—"Big Sue." *Capitol 421*

First side is hill-billy song with a moral that folks are beginning to catch onto; reverse was written by the singer.

JIMMIE and LEON SHORT: "Old Indians Never Die"—"No Forgiveness." *Decca 46046*

Singing with instrumental accompaniment.

MANNERS, ZEKE: "I'm A-Goin' Sue, I'm A-Goin'!"—"You'll Get Used to It." *RCA Victor 20-2247*

Some breezy balladeering and some down-to-earth fiddling characterize this platter.

SONS OF THE PIONEERS: "You Don't Know What Lonesome Is"—"Tear Drops In My Heart." *RCA Victor 20-2276*

Typical sage-brush saga of lonesome and broken-hearted cow-boy told on these two sides.

WHITLEY, RAY: "Jukebox Cannonball"—"Between the Lines." *Cowboy C-301*

"Jukebox" is a novelty tune; flip-over, a cow-boy tear-jerker. Santa Fe Rangers, musical support, give out with Western fiddles.

Reading from the top down, are: Ginny Simms, star of Sonora's "celebrity series" of discs; Jerry Cooper, Diamond recording artist; Dick Farney, featured on the Majestic roster; and Ray Whitley, sagebrush crooner of Cowboy Records.

WILLS, BOB, and his Texas Playboys: "Rose of Old Pawnee"—"Bob Wills Boogie." *Columbia 37357*

McKinney sisters do vocal on first side; flipover is an instrumental.



ALBUMS

BRISSON, CARL: "International Favorites." *Apollo*

"Crooner" in the Continental manner, has established his reputation in swanky clubs across the country. Sophisticated songs for a sophisticated audience.

CUGAT, XAVIER: "Xaviar Cugat," *Columbia*

That "South American Way" is featured on eight Cugat sides, in the famed Cugat stylings.

D'ARTEGA: "Latin American Rhythms." *Sonora MS-492*

Time-honored Latin American classics performed by D'Artega, with a distinctive beat.

ELLINGTON, DUKE: "Ellington Special." *Columbia C-127*

This collection contains eight previously unreleased sides which the Duke recorded in the middle thirties, with the band he led at that time.

"ESQUIRE'S ALL - AMERICAN HOT JAZZ, VOL. II." *RCA Victor HJ-10*

Following success of the '46 All-American Esquire Jazz Album, Victor has released another collection of sides featuring top instrumentalists selected this year in the magazine's annual poll. Represented are such artists as: Coleman Hawkins, Duke Ellington, Charlie Shavers, Lionel Hampton, The King Cole Trio, Louis Armstrong, and Benny Goodman.

LEWIS, TED: "When My Baby Smiles at Me." *Decca A-353*

Ted Lewis recently celebrated the 20th anniversary of his first Broadway appearance, and this album was brought out to "commemorate" the occasion. Oldtimers will love it.

"MANHATTAN AT MIDNIGHT," featuring Dean Martin, Vera Massey, Nick Lucas, and Brooks Bros. *Diamond Album D-7*

Album features the named New York night club entertainers, singing the songs they featured in personal appearances.

(Continued on page 58)



La Traviata

A magnificent
FIRST
by
Columbia
Masterworks

First complete
opera recording
since the war

Columbia's leadership scores again — with a superb recording of Verdi's much loved opera, La Traviata, performed in its entirety by a distinguished cast. A memorable event for music lovers—one which you will be proud to present in your locality. Your best customers will be the first to welcome this superb addition to their Columbia Record libraries.

With Artists, Chorus
and Orchestra of the
Opera House, Rome.
Conducted by Vincenzo
Bellezza. Two volumes
with descriptive book-
let, attractively boxed.
Columbia Masterworks
Set OP-MOF 25 \$18.00
(exclusive of tax)



CONTACT YOUR
COLUMBIA RECORDS
DISTRIBUTOR FOR STOCK

Trade-marks "Columbia" and  Reg. U. S. Pat. Off.

Variety of Platters Offered

(Continued from page 56)

PANCHO, and his Orchestra: "Ten Famous Tangos." Decca A-455; "Sambaa." Decca A-457

Strictly for dancing, these Pancho collections should appeal to south-of-the-border addicts.

STANLEY: "Waltz Album." Sonora MS-495

Eight sides of favorite waltzes recorded with a lilt; some songs feature vocals.

WARING, FRED: "Cole Porter Songs." Decca A-499

Waring and his Pennsylvanians do eight top Porter tunes: "Night and Day"; "A Little Rumba Rumba"; "What Is This Thing Called Love?"; "Ev'ry Time We Say Goodbye"; "I've Got You Under My Skin"; "Ev'rything I Love"; "You'd Be So Nice to Come Home To"; "I Love You."

WILLIAMS, MARY LOU: "The Four Strings." Disc 707

Jazz quartet, featuring the Williams arrangements. Personnel comprises Joe Kennedy, violin; S. E. Johnson, piano; Roy Crawford, guitar; Edgar Willis, bass.

SINGLES

BARNET, CHARLIE: "Caravan"—"Dark-Town Strutter's Ball." Apollo 1070

This is Barnet's second release under the Apollo label.

BENEKE, TEX, with the Miller orchestra: "My Young and Foolish Heart"—"Moonlight Serenade." RCA Victor 20-2273

Mellow tune, with Gary Stevens on the vocals, is coupled with band's theme song.

CARROLL, JACK: "Mam'selle"—"I Wonder, I Wonder, I Wonder." National 9032

Romantic singer Carroll does two hit tunes.

THE CHARIOTEERS: "Chi-Baba, Chi-Baba"—"Say No More." Columbia 37384

Good pairing of tunes; "Say No More" is a slow ballad.

COMO, PERRY: "Chi-Baba, Chi-Baba"—"When You Were Sweet Sixteen," with The Satisfiers. RCA Victor 20-2259

Italian lullaby receives the melodic Como treatment; coupling is the old standard, currently being featured in the film "The Great John L."

CROSBY, BING, and THE ANDREWS SISTERS: "Go West, Young Man!" — "Tallahassee." Decca 23885

When the crooner and the three swingin' sisters get together to do two movie tunes, the first side from "Copacabana," the reverse from "Variety Girl," dealers should have no trouble in planning tie-ins.

CROSBY, BING; HAMPTON, LIONEL and orchestra: "On the Sunny Side of the Street"—"Pinetop's Boogie Woogie." Decca 23843

First side has Crosby vocalizing with Hampton's boys, with the Hamp commenting between choruses; reverse is a Crosby field-day, with der Bingle doing a straight talking job throughout the boogie-woogie instrumental.

DAVIS, BERYL: "I Want to Be Loved"—"If My Heart Had a Window." RCA Victor 2-2268

Outstanding British girl vocalist, Beryl Davis, makes her U. S. debut on initial RCA Victor waxing. She has a warm and tender voice.

DAMONE, VIC: "Ivy"—"I Have But One Heart." Mercury 3063
"Ivy" tune is from flicker; Jerry Gray is the orchestra accompanying Damone.

DOREY, RAY: "Je Vous Aime"—"Tallahassee." Majestic 7239

French-titled tune is featured in "Copacabana" movie; reverse, is from the picture, "Variety Girl."

DOUGLAS, LARRY: "Almost Like Being in Love"—"I Kiss Your Hand, Madame." Signature 15117
"Being in Love" tune from the Broadway success musical, "Brigadoon." Reverse is from film, "The Emperor Waltz."

EBERLY, BOB, and The Song Spinners: "Don't Cry, Little Girl, Don't Cry"—"I Wish I Could Say the Same." Decca 23945

First tune is an oldie, currently being picked up.

FARNEY, DICK: "Too Marvelous for Words"—"Tenderly." Majestic 7246

First side tune is featured in film, "Dark Passage." Paul Baron, newly appointed musical director, does orchestrations for both sides.

HERBIE FIELDS QUINTET: "Rainbow Mood"—"Dardanella." RCA Victor 20-2274

Evidence of quintet's musicianship furthered by fact that group recently completed two successful follow-up

engagements at a noted Chicago hotel.

FORREST, HELEN: "All of Me"—"S'posin'." MGM 10029

Torchie ballad, "All of Me," and flipover, "S'posin'," perfect foils for the Forrest blues style.

GIBBS, GEORGIA: "As Long as I'm Dreaming"—"Ballin' the Jack." Majestic 12010

"Dreaming" side is from "Welcome Stranger." Flipover is an oldie, that Her Nibs gives the rhythmic treatment of today.

GOODMAN, BENNY: "I Want to Be Loved"—"Mahzel." Capitol 416

Initial side marks debut of Lillian Lane as Benny's vocalist. Reverse features novelty "Mahzel," as an instrumental, with an unusual arrangement.

HAYMES, DICK, with Gordon Jenkins and orchestra: "Stranger Things Have Happened"—"Je Vous Aime." Decca 23899

Two sides are from "Copacabana" movie.

HERMAN, WOODY, accompanied by the Four Chips: "Can You Look Me in the Eyes"—"Pancho Maximilian Hernandez." Columbia 37355

Continuing his career as a straight vocalist, Woody offers a nostalgic tune coupled with a clever novelty about "the best president we ever had"—until they shot him.

HOWARD, EDDY: "On the Old Spanish Trail"—"Ragtime Cowboy Joe." Majestic 1155

"Spanish Trail" is a follow-up to Howard's "Adobe Hacienda" waxing; reverse is a cowboy classic.

INK SPOTS: "Ask Anyone Who Knows"—"Can You Look Me in the Eyes." Decca 23900

Vocals are done with instrumental accompaniment in typical Ink Spots style.

JAMES, HARRY: "Moten Swing," two sides. Columbia 37351

Swing format and Harry's trumpet goes back to days of swing maestro Benny Moten. Addicts and collectors will go for this waxing.

JOHNSTON, JOHNNIE: "Aint'cha Ever Comin' Back"—"You're Not So Easy to Forget." — MGM 10036

Johnston's fans, who originally knew him through the radio, are increasing, due to recent recordings.

JORDAN, LOUIS: "I Know What
(Continued on page 62)

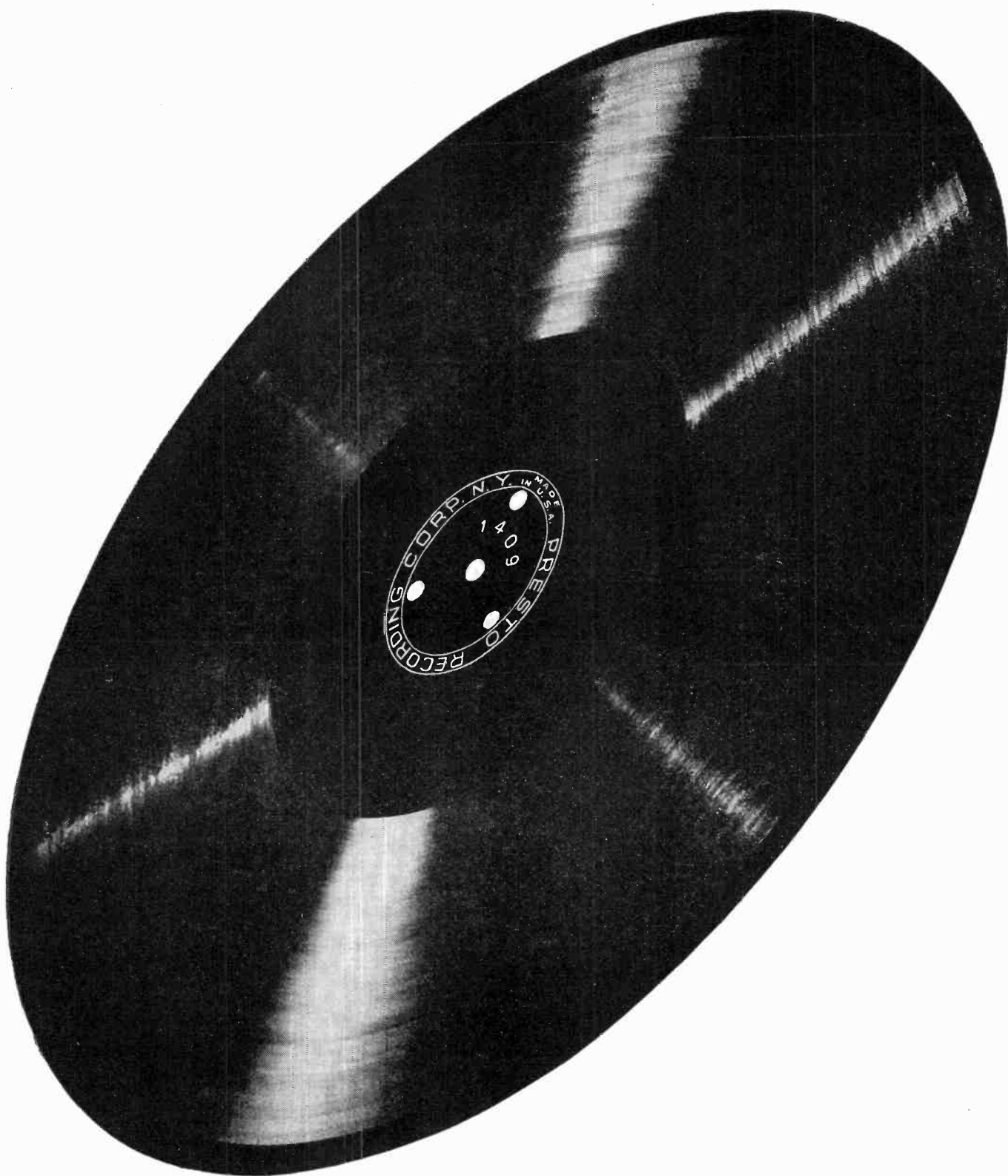

For true to life recording there has never been anything better than Presto Green Label Discs.



RECORDING CORPORATION • 242 WEST 55TH STREET • NEW YORK 19, N. Y.

Walter P. Downs, Ltd., in Canada

World's Largest Manufacturer of Instantaneous Sound Recording Equipment & Discs

New Phono Lines

Latest Disc-Playing Equipment & Accessories

Musitron PHONOGRAPH

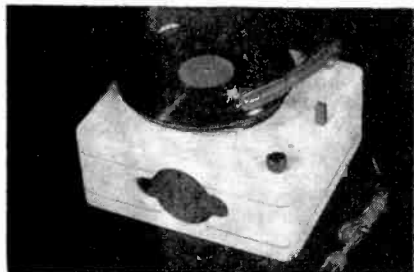

Model 202 table style record player with 2-tube amplifier, playing 10" and 12" records. New Astatic crystal pickup, 4" Alnico 5 PM speaker, 9" flocked turntable. Self-starting ac, 78 RPM constant speed, 60-cycle noiseless synchronous motor. Cabinet of grooved design with two strips on contrasting plastic piping, patterned speaker cut-out. Available in two-tone or solid colors of simulated leather covering. Measures 12" by 11 1/4" by 6 3/4". \$24.50. Musitron Co., 223 W. Erie St., Chicago 10, Ill.—RADIO & Television RETAILING.

CCA PHONOGRAPH

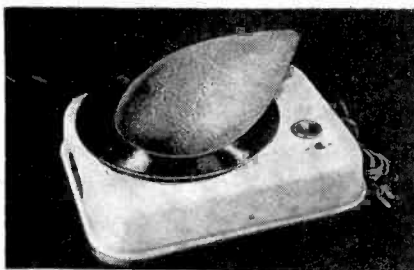

"Jewel-Box" model electric record player, for 10" and 12" discs. "Stratosphere" streamlined head for unidirectional flow of sound. No tubes; noiseless motor operates rim-drive turntable, uses 110-120 volts ac, 60 cycle. Lightweight reproducer. Streamlined modern design finished in ivory and brown. \$14.85. Electric Division, Compressor Corp. of America, St. Joseph, Mich.—RADIO & Television RETAILING.

Webster-Chicago CHANGER

Model 65 portable automatic record changer, to be used either with radio or external speaker system. Plays twelve



10" discs or ten 12" records with lid closed. (This is Model 56 in luggage case.) Lid provided with dividing hinges for easy removal if desired. Burgundy leatherette covered case, with turntable and changer in matching color. Power and pickup cords supplied. Weighs 24 lbs. \$49.95. Webster-Chicago Corp., 5610 Bloomingdale Ave., Chicago 39, Ill.—RADIO & Television RETAILING.

Portofonic RECORD PLAYER



Model 22A electric phonograph with 2-tube amplifier. Volume and tone controls, 5" Alnico speaker. \$27.50. Portofonic Mfg. Corp., 54 Franklin St., New York 13, N. Y.—RADIO & Television RETAILING.

Walco DIAMOND NEEDLE

Phonograph needle with genuine diamond tip. Aluminum alloy metal bent and shaped to produce maximum frequency response with lowest surface noise. Design based on the fact that controlling factors in record wear are (1) pressure of pickup on the needle (2) degree of polish on needle point and (3) shape and contour of point. Jewel point shaped and polished to conform to grooves of modern records. Diamond polishing supervised by Belgian expert. \$12.50. Electrovox Co., Inc., 31 Fulton St., Newark, N. J.—RADIO & Television RETAILING.

Furniture Specialties RECORD CABINET



Model 450 large sized de luxe record storage cabinet with top equal to largest radio-phonograph. Hardwood construction; walnut or mahogany finish. Weighs 39 lbs. packed. Measures 24" wide by 18" deep by 32" high. Minimum shipment—4 pieces. Furniture Specialties Co., 15th St. and S. Penn Sq., Philadelphia, Pa.—RADIO & Television RETAILING.

Trylon PHONOGRAPH

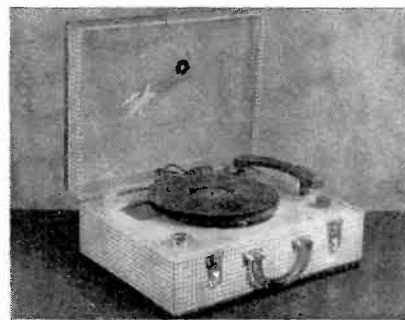

Model 80 portable electric record player, with 2-tube amplifier, Alnico alloy PM speaker, feather-weight Shure "Glider" crystal pickup. Built-in scratch filter, bass compensation, closed needle cup. Plays 10" and 12" discs. Plywood cabinet—Dupont coated-fabric covering resists water, sun and stain. Plastic handle, plated hardware. Trylon Radio Laboratories, 3955 N. Broad St., Philadelphia 40, Pa.—RADIO & Television RETAILING

Ultratone PHONOGRAPH



Model TA-7 table style record player with Milwaukee-Erwood automatic disc changer. Tone control, 3-tube amplifier, 5" PM speaker. Mahogany cabinet. Audio Industries, Michigan City, Ind.—RADIO & Television RETAILING.

Pix-O-Fone PHONOGRAPH

Portable kiddie moving picture electric phonograph with illuminated pictures that move across front panel. Plays 10" or 12" discs—simple operation for youngsters. On-off switch; film stops automatically. Extra picture rolls at \$1.50 a set. Carry-

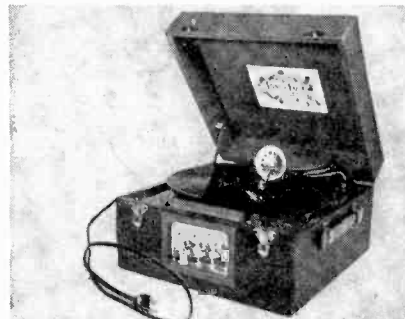

ing case in bright pastel colors. \$19.95. Tech-Tone Products Co., 211 E. Main St., East Gloucester, Mass.—RADIO & Television RETAILING.



the needle with Spring in its heart

Fidelitone Supreme

FLOATING POINT NEEDLE

Like a soaring sky-scraper, the recently introduced Fidelitone SUPREME is a "stand-out" . . . Ever since 1929 — when the first precious-metals tipped long-life phonograph needle was introduced by PERMO — its leadership in the field of good needle construction has never been challenged . . . There always have been more PERMO needles sold than all other long-life needles combined. Fidelitone SUPREME is the crowning achievement of PERMO'S research and engineering. Dealers nation-wide proclaim the SUPREME "the greatest" ever.

STAND OUT

\$2.50



Beautifully packaged in a useful record brush.

PERMO, Incorporated
CHICAGO 26

More Permo Needles sold than all other long-life needles combined

Platter Variety

(Continued from page 58)

You're Puttin' Down — "Jack, You're Dead." Decca 23901

Decca's latest addition to the "million-record-club" continues to wax hot, with his Tympany Five.

KAYE, SAMMY: "Ask Anyone Who Knows" — "Would You Believe Me." RCA Victor 20-2239

Don Cornell renders the lyrics on the "Ask Anyone" tune. Title tune from flicker, "Would You Believe Me," sung by Johnny Ryan, is on the reverse.

KING COLE TRIO: "Come in Out

of the Rain"—"Can You Look Me in the Eyes." Capitol 418

Trio has a coast-to-coast air-show, and will soon be featured in a forthcoming movie. Ample promotion opportunities.

KRUPA, GENE: "Dreams Are a Dime a Dozen" — "Yes, Yes, Honey." Columbia 37354

Tom Berry does "Dream" vocal; Carolyn Grey sings "Yes, Yes . . ." Krupa beat is good for dancing in this discing.

LEE, PEGGY, with Dave Barbour's orchestra: "Aint'cha Ever Comin' Back?"—"Chi-Baba, Chi-Baba." Capitol 419

Barbour's guitar accompanies Peggy in these two top tunes.

LUND, ART: "On the Old Spanish Trail" — "Peg o' My Heart." MGM 10037

Coupling of two oldies that are becoming best-sellers sure to entrance Art Lund fans. Lund, incidentally, is scheduled for many personal appearances.

McINTYRE, HAL: "There's That Lonely Feeling Again" — "My Young and Foolish Heart." MGM 10032

McIntyre is on a tour of the mid-west, so good tie-ins may come your way.

MacRAE, GORDON: "I Want to Be Loved"—"Old Devil Moon." Apollo 1067

MacRae is getting a big press build-up, in conjunction with his sponsored air-shows. "Old Devil Moon" from stage hit, "Finian's Rainbow."

MARTIN, FREDDY: "Things Are No Different Now"—"I Won't Be Home Anymore When You Call." RCA Victor 20-2267

First side is a romantic melody, lush and rhythmic. Turnover is unique for Martin, having a "country-style homespun" element.

MARTIN, TONY: "Passing By"—"Oh! My Aching Heart," with Victor Young, orchestra and chorus. RCA Victor 20-2252

The first side popularly identified as Jean Sablon's theme song (Sablon, incidentally, has signed to record for RCA Victor); platter coupling is a frothy number with emphasis on rhythm.

MARTINEZ, CHUCHO: "Say No More"—"Roses in the Rain"; "La Paloma"—"Ay, Ay, Ay!" Apollo

(Continued on page 64)

Webster-Chicago Needle



Package for Webster-Chicago Corp.'s nylon needle is attractively designed with red plastic base and snap-on polystyrene hood. Styled for effective display.

NOW...ALL... SUN JEWISH RECORDS 80¢ LIST plus tax

JEWISH RECORDS OF DISTINCTION RECORDED BY ARTISTS OF DISTINCTION

HERMAN YABLOKOFF
MAX KLETTER
VELVILLE ROTHSTEIN
BEN ZION WITTLER
MICHEL MICHELESKO
CANTOR BENJAMIN SIEGEL
GEORGE TOULLER
FEDER SISTERS
JACOB ZANGER
VERO ROZANKA
SARA GINGOLD
PESACHKE BURSTEIN

Dealers and Distributors
write:
SUN RECORDING CORP.
260 EAST 161st STREET, BRONX, NEW YORK, N. Y.

Heritage Series Albums

A special ten-pocket storage album to house RCA Victor's Heritage Series records, has been announced by J. M. Williams, advertising manager of the RCA Victor record department.

The album, bound in Roxite cloth, with Cordoba fabrikoid backbone, and gold embossing on the front and backbone, will house ten 12-inch plastic re-issues of original masters made by singers from the Golden Age of Opera.

Birge Returns from Tour

John Birge, director of advertising for Columbia Records, Inc., returned from a tour of the middlewest, accompanied by Arthur Kemp, of McCann-Erickson, Inc. The tour included visits to St. Louis, Chicago, Milwaukee and Indianapolis.

Principal purpose of the trip was to give distributors and salesmen of Columbia Records an intimate picture of the company's national advertising and promotion policies, which have evolved from a series of surveys of the record business.

Capitol Introduces New Label, "Americana" Discs

Capitol Records, Inc., is offering its host of folk artists in a new series of releases to be known as Capitol Americana, Red Label records. Records will be of the same quality as the other records in the Capitol catalog, and the price will be the same as for black label platters.

Decision to present this specialized material on an individual label came after months of studies, which showed a strong demand for a powerful media definitely identified with that particular type of material, the Capitol announcement said.

Capitol pointed out that releases under the Americana label will not affect the frequency or quality of regular Black Label releases. The Americana series will be released every two weeks, on an alternating schedule with Capitol popular releases, which also appear every two weeks.

New Apollo Branches

Apollo has opened its Washington, D. C., office at 730 Ninth St., N. W. It is managed by John F. Delaney. The Blue Bonnet Music Co., 3235 Ross St., Dallas, Texas, has been appointed as exclusive distributor in the Southwest area. Herbert T. Rippa will direct the new Texas operation.

To completely reorganize its New Orleans distributing office, Apollo has appointed George W. Waguespack, new branch manager.

**We are no longer
"Hiding Our Light
under a bushel"**



The **MILWAUKEE** Record Changer

Heretofore unadvertised, is the fact that leading manufacturers of radio-phonographs have specified and installed MILWAUKEE RECORD CHANGERS as *standard equipment* in their sets. And for good reasons . . . which include these:

- FOOLPROOF PICKUP ARM can be "manhandled" by careless operators without damage or danger of throwing it out of adjustment.
- PATENTED TURNTABLE SPIRAL completely eliminates gears, castings, belts and pulleys. Actuates change cycle with speed and certainty.
- JAM-PROOF CLUTCH makes it impossible to throw unit out of cycle.
- FEATHERWEIGHT, RESONANCE-FREE ALUMINUM PICKUP ARM for light needle pressure, and longer record life.
- FAITHFUL, TRUE-TONE REPRODUCTION of the most sensitive recordings, free from disturbing mechanical noises and needle scratch. In operation it's as quiet and serene as a moonlit winter's night!
- EXCEPTIONAL VALUE — PROVEN PERFORMANCE.
- THE PERFECTED RESULT of 53 years precision engineering and manufacturing experience.

These are just a few of many reasons why the MILWAUKEE RECORD CHANGER deserves your fullest consideration . . . as a replacement, or as original equipment. Write for full details.

MILWAUKEE STAMPING COMPANY

807 SOUTH 72nd STREET, MILWAUKEE 14, WISCONSIN

Our 53rd Year of Quality Production



1. AMPLE POWER AT CONSTANT SPEED

2. SUPERIOR IDLER ARRANGEMENT

3. LOW RUMBLE LEVEL

MX Rim Drive Constant Speed Electric Phonograph Motor

4. ANTI-FRICTION BEARING CONSTRUCTION

5. NO EXTERNAL MOVING PARTS

Smooth Power FEATURES

FOR SMOOTH PERFORMANCE

You'll gain highly pleased customers when you equip your phonographs with Smooth Power MX Motors. That's because of finer performance given by:

1. AMPLE POWER AT CONSTANT SPEED . . . eliminates instantaneous speed variations.
2. SUPERIOR IDLER ARRANGEMENT . . . permits idler pulley to move smoothly and quietly in any horizontal direction with no vertical wobble.
3. LOW RUMBLE LEVEL . . . obtained by scientific noise elimination, accurate balancing and adequate cushioning.
4. ANTI-FRICTION BEARING CONSTRUCTION . . . precision-cast bearing brackets maintain accurate centering of shaft in bearing and rotor in field.
5. NO EXTERNAL MOVING PARTS . . . internal fan provides adequate cooling, simplifies shipping and installation.

Plan now to give your customers that smoother, finer performance that's a "natural" with Smooth Power Motors.

Send for details on the complete Smooth Power line of phonomotors, recorders and combination record-changer recorders. They'll make friends for your products.



GI-RM4 Rim Drive, Heavy Duty Electric Recording Motor

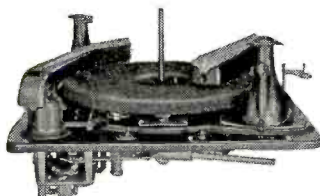

GI-RC130 Combination Record-Changer Recorder

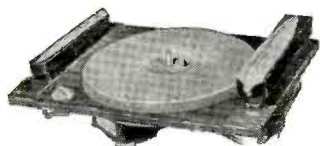

GI-R90 Dual Speed, Home Recording and Phonograph Assembly

THE GENERAL INDUSTRIES CO.

DEPT. MV

ELYRIA, OHIO

Platter Variety

(Continued from page 62)

This is a new Apollo artist, known for his Latin rhythms in night clubs, stage, and radio.

MONROE, VAUGHN: "Say No More" — "Ivy." RCA Victor 20-2275

The first side is styled for dancing, with flipover catchy title tune from "Ivy" film. Singing maestro does the vocals.

MOONEY, ART: "You Should Have Told Me"—"As Long as I'm Dreaming." MGM 10034

"Dreaming" tune is from "Welcome Stranger" flicker. Good dance music.

MOONEY, JOE, QUARTET: "Meet Me at No Special Place" — "I Can't Get up the Nerve to Kiss You." Decca 23909

This is the quartet's third record release. They are currently on a night club tour.

NOBLE, RAY: "You'll Know When It Happens"—"My Heart Is a Hobo." Columbia 37356

"My Heart" number is from new film, "Welcome Stranger," highlighted by clever whistling theme.

OLIVER, SY: "I Want to Be Loved" — "Dit Dot Dit." MGM 10030
Ballads done by Harry Wells and Sy Oliver on the two sides, respectively.

O'NEIL, DANNY: "Peg o' My Heart"—"I'll Take You Home Again, Kathleen." Majestic 7238
Two appropriate ballads for an Irish tenor.

Recoton Ultra Needle



Popular-priced, sapphire-tipped needle, retailing at \$1.50. Fitted with Sapphire point, highly polished, and designed to give up to 6,000 and more plays. Colorful display shown is available for counters and windows.

At Columbia Session



Columbia Records' executives James Hunter, left, and Monic Sacks, join with "the Leprechaun," David Wayne, in listening to a playback during recording session of "Finian's Rainbow."

(Continued from Page 64)

PAGE CAVANAUGH TRIO:
"Walkin' My Baby Back Home"
—"Heartbreakin'." RCA Victor
20-2246

Numerous radio and night club appearances are giving this talented group a nationwide popularity.

PRIMA, LOUIS: "Cecelia" —
"There's That Lonely Feeling
Again." Majestic 1145

Cathy Allen and Prima share vocal spot-light on this platter.

ROSE, DAVID: "Gay Spirits" —
"How High the Moon." MGM
30012

First side is a Rose original; reverse features hit tune from B'way show, "Two for the Show."

RUSSELL, ANDY: "As Long as I'm
Dreaming" — "Je Vous Aime."
Capitol 417

First side is from movie, "Welcome Stranger." Reverse is sung by Russell in film, "Copacabana."

THE RAVENS: "Mahzel" — "For
You." National 9034

Vocal quartet recently completed New York vaude engagement; original styling.

SHERMAN, FLOYD, with the
Chickering Four: "Peg o' My
Heart" — "Don't Cry, Little Girl,
Don't Cry." Signature 15119

Irish tenor voice of Sherman takes the lead in revival of two oldies.

SMITH, KATE: "Tallahassee" —
"Ask Anyone Who Knows."
MGM 10028

Backed by Four Chicks and Chuck, Kate sings out the praises of this Southern city in a lilting style; reverse is a romantic ballad.

STEWART, FREDDIE: "Sincerely
Yours" — "There's That Lonely
Feeling Again." Capitol

(Continued on Page 67)

Permo Plans New Sales Aid Helps

E. C. (Gene) Steffens, vice-president and general sales manager, Permo, Inc., Chicago, is planning a series of dealer sales helps that are calculated to still further expand the sales of Fidelitone needles.

Mr. Steffens expressed deep appreciation for the many letters and personal visits he received from trade members during his recent siege of illness.

MGM Records Air Show

"MGM Record Roundup," a 15-

minute record show featuring MGM discs, is being broadcast over a local New York station each Saturday. The show offers MGM records exclusively, and airs personal tid-bits about MGM artists, songs and new plans.

New RCA Victor Artists

The signing of opera singers Marilyn Cotlow, coloratura soprano, and Thomas Hayward, Metropolitan Opera tenor, to exclusive RCA Victor recording contracts was announced by James W. Murray, vice-president in charge of RCA Victor record activities.

DUOTONE

THE GREATEST NEEDLE LINE IN THE WORLD

THESE world-beating Duotone needles are examples of the painstaking research and technical skill of Duotone engineers. They characterize the superiority of the entire Duotone line of record accessories.

When you sell Duotone, you're sure of enthusiastic customer approval and higher profit margins.

Stock Duotone and watch it pull! There's a Duotone product for every customer.

OTHER WELL-KNOWN DUOTONE PRODUCTS

- Miropoint Needles
- Transcription Needles
- Cactus Needles
- Chromium Needles
- Coin Machine Needles
- Recording Heads
- Steel Cutting Needles
- Sapphire Cutting Needles
- Duodiscs
- Record Preserver

The Duotone Diamond
The world's finest needle for the world's finest phonographs. A jeweler's masterpiece. \$50.00 retail.

The "Star" Sapphire
Completely handmade with a sapphire point. Cherished by record collectors. \$5.00 retail.

The Duotone Ruby
Brilliant achievement of the jeweler's art. A ruby tipped needle that's really new. \$3.50 retail.

The Regent Sapphire
Outstrips competition in any demonstration. Affords the kind of profit margin you like. \$2.00 retail.

DUOTONE COMPANY
799 Broadway, New York 3, N. Y.

The Filter Point
Filters surface noise and reproduces with high fidelity. Plays longer. Package of 35—25¢ retail.

The Durpoint
Fast-moving, high-profit needle with excellent tonal reproduction. Attractively packaged. \$1.00 retail.

The New Lifetone
This superb osmium tip needle surpasses any other needle in its immediate price range. \$1.50 retail.

FOR RECORD ENJOYMENT ONE NAME STANDS OUT-



Quality-built and conservatively priced, Webster record changer units move fast—stay sold. Their plus-value features are easy to demonstrate—help make your sales easier.

Best of all, Webster units are built for lasting service—service that gains customer good will for you. If you are an accredited music or radio dealer, see your distributor today.

WEBSTER MODEL 60

AUTOMATIC PHONOGRAPH

Youngsters love this one! Complete in itself, this model has fine tone, handles records gently—features a "Manual" play position. \$49.95 Retail.



WEBSTER MODEL 55

PLAYS THRU THE RADIO

A proved best seller. Simply plugs into most radios—gives outstanding service. \$35.00 Retail.

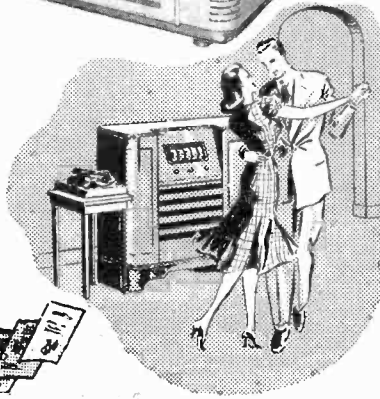

THESE WEBSTER SALES HELPS BUILD BUSINESS FOR YOU

DISPLAY CARDS

Attractive window or counter displays compel valuable attention—help build business for you.

CONSUMER PAMPHLETS

For mailing or counter distribution. A big help in your selling job.

FREE NEWSPAPER MATS

Complete ads—photos of Webster machines—all are yours for the asking when you tie in with Webster.



The Choice of Music Lovers

WEBSTER CHICAGO

5610 BLOOMINGDALE AVENUE



CHICAGO 39, ILLINOIS

"Top-Ten" Dealer Aids

Audience Records, Inc., New York City, has sent dealers a complete merchandising kit for its line of "Top-Ten" Records. The initial release includes albums by Amos 'n' Andy, Eddie Cantor, Jack Benny, Ed (Archie) Gardner, Edgar Bergen, Fibber McGee and Molly, and Burns & Allen. The albums contain material specially designed for these recordings, recorded before an actual audience, and retail at \$4.50, plus tax, per album.

The selling kit contains one broadside, two window streamers, 5 complete window display suggestions, 7 posterettes with about 15 consumer pieces of each artist, using the same color scheme; two re-prints of the double page Life magazine ad; several suggestions for radio "spots"; strips of gummed paper to use in pasting up window streamers, re-prints, etc.; two proof sheets of proposed dealer ads.

Herb Allen to Head Signature Sales Staff

Bob Thiele, president, Signature Recording Corp., New York City, confirmed his belief in the future of the record industry by announcing a three-point expansion program. Herb Allen, formerly with RCA Vic-



Herb Allen

tor, was appointed vice-president in charge of sales; a new compound and pressing plant was acquired by the firm; a music publishing subsidiary, called R-T Music Publishing, Inc., was formed.

Mr. Thiele explained that his firm was operating under a conservative, long term policy. The acquisition of the new record plant will augment output of Signature records.

Stuart Disc Cabinet

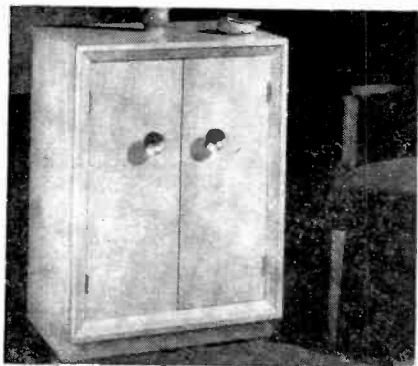

Stuart Mfg. Co., Brooklyn, N. Y., is offering a hand-rubbed record cabinet, made of mahogany plywood. Outside dimensions: height 32", width 24", depth 16". Finished in bleached mahogany, it is priced at \$37.50, and in Sheraton mahogany at \$35.00.

RCA Victor Names Fielding

The appointment of Richard M. Fielding as advertising and promotion manager of the RCA Victor record department was announced by David J. Finn, general sales manager of the department. Mr. Fielding, formerly assistant advertising and promotion manager of the department, succeeds J. M. Williams, who was named advertising manager of the company's home instruments department.

Duotone Window Display

A survey of 500 dealers has revealed that the use of counter displays in show windows increased phonograph needle and other accessory sales by 50%, it was disclosed by Stephen Nester, president of the Duotone Co., Inc., 799 Broadway, New York, producers of a full line of phonograph needles.

The survey was made of those dealers who had already utilized the new Duotone "Show Window," in an effort to discover the value of a counter display of this sort. Comments from dealers reveal that customers not only were attracted to potential needle sales, but were further interested in record accessories as a result.

Discs by Sun Recording

Abe Lyman, president of Sun Recording Corp., 260 E. 161st St., Bronx, N. Y., announces the presentation of a complete line of "Jewish records of distinction." The line of new releases includes theatrical, folk songs, cantorial, and instrumental discs. Artists who record on the Sun label include: Max Kletter, Pesachke Burstein, Herman Yabloukoff, Sara Gingold, Velvella Rothstein, George Touller, Feder Sisters, and Cantor Benjamin Siegel.

Hammond Launches New Policies for Keynote

With John Hammond as president, Robert McKinney, treasurer, and Max Lipon, executive vice-president in charge of sales, Keynote Recordings has begun a new phase of development.

First step taken has been to revise the previously established policy of placing complete emphasis on jazz. Instead, the firm will give equal priority to previously unrecorded classical and contemporary compositions, folk music and children's albums.

On the basis of the planned additions to Keynote's new catalogue, twenty-one distributors have already been engaged with more franchise grants to follow.

Platter Variety

(Continued from page 65)

Singer has been featured in a series of teen-age movies which will make his name "familiar" to younger set.

THE THREE SUNS: "Peg o' My Heart"—"Across the Alley From the Alamo." RCA Victor 20-2272

"Peg" rendition instrumental accentuated by use of an echo chamber; other side features Artie Dunn's vocals backed with guitar, accordion, organ combo.

WEEMS, TED: "Peg o' My Heart"—"Violets." Mercury 5052

Weems picks up "Peg" tune for a snappy side. "Violets" due for a popular revival.

WELK, LAWRENCE: "Red Silk Stockings and Green Perfume"—"I Won't Be Home Anymore When You Call." Decca 23946

The "Champagne Music" maestro is back in his Chicago stamping grounds, after a successful New York stay.

CHILDRENS

"GOLDILOCKS AND THE THREE BEARS": David Allen, narrator, with orchestra. Columbia J-MJ*36

Each of the three bears plus the young lady who eats the porridge, is clearly characterized by voice changes. Youngsters will have no trouble in following the story.

"THE GINGERBREAD BOY": David Allen, narrator, with orchestra. Columbia J-MJ*37

Good musical back-ground aids story of adventures in ginger-bread-land.

NEW . . .

Watch for announcement of the new Audax TUNED-RIBBON reproducers—soon.

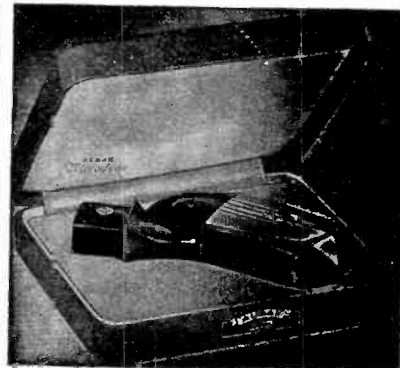

Audax* REPRODUCERS

"The Standard
by which
Others
Are Judged
and Valued"

AUDAX has mastered wide-range so thoroughly that, today, even the lowest priced AUDAX has a range to 7000 cycles—(other models over 10,000 cycles). True,—wide-range makes for naturalness but,—it is highly objectionable if without quality. For example, of two singers, each capable of reaching high C, one may have a pleasing voice—the other, not at all.

It is the same with pickups. To achieve EAR-ACCEPTABILITY, all other factors must be satisfied. Of these, VIBRATORY-MOMENTUM is most important. The only way to test EAR-ACCEPTABILITY of a pickup is to put it to the EAR-TEST. The sharp, clean-cut facsimile performance of AUDAX—regardless of climatic conditions—is a marvel to all who know that EAR-ACCEPTABILITY is the final criterion.

AUDAX COMPANY

Dept. R.

**500 Fifth Avenue
New York 18, N. Y.**

"Creators of Fine Electronic-Acoustical Apparatus since 1915"

*Trademark

New Gibson Program Aims at More Sales Action

Distributors for the Gibson Refrigerator Co. are now holding dealer meetings in their areas to present a new and complete sales promotion program which was announced by the firm along with its three new refrigerators (See "New Appliances" section of this issue).

Gibson is re-establishing its co-operative localized advertising program, which will be used in connection with Kookall electric ranges and home freezers as well as the new refrigerator line. A new refrigerator sales training film, with sound, is being released to all distributors.

New illuminated displays and back-grounds are now being shipped, along with new catalogs, folders and broadsides and a series of sales educational bulletins for dealers. The Gibson advertising program, which consists entirely of full-color full pages in *Saturday Evening Post*, *Good Housekeeping*, *Liberty* and *Ladies' Home Journal*, is continuing into its 5th consecutive year.

Perkins Heads GE Musaphonic Sales

G. S. Perkins is the new sales manager of General Electric's deluxe line of receivers, the Musaphonic, according to Paul L. Chamberlain, manager of receiver division sales in the company's electronics department.

Mr. Perkins was previously receiver representative for northern California and

Nevada. He will have his headquarters at the GE Bridgeport, Conn., plant until the receiver division moves to its new location at Electronics Park, Syracuse, N. Y., later in the year.

Sales Promotion for 1947 Recordio

C. S. Blakslee, sales promotion manager for Wilcox-Gay Corp., Charlotte, Mich., has announced the national promotion plans for the 1947 Recordio line.

Recordio advertising is being carried in a list of top national magazines to an audience numbering three hundred nine million readers. The Recordio advertising theme will stress the educational and entertainment advantages of recording in the home.

Music Institute of America Organizing

A coast-to-coast program to expand the market for musical instruments is now being launched, Louis G. LaMair, president of the National Association of Music Merchants, has announced.

Plans for the Institute were one of the features of the NAMM trade show held June 2-5 at the Palmer House, Chicago, at which Mr. LaMair was re-elected president of the association. The annual event attracted almost 7,400 guests this year, and interest in industry promotion activities ran high.

Proctor Promotion Clicks in a Big Way

Over fifty dealers throughout the state of Oklahoma participated in an eight-week statewide promotion called the "Big Boy Proctor" toaster promotion for Proctor.

According to Walter Engard, sparkplug of the activity and recognized as one of the most progressive distributors in his territory, dealer testimony confirms the fact that the entire state is now Proctor-conscious and is good-naturedly awaiting the company's products even though merchandise is not immediately available. Mr. Engard is sales manager of Tom P. McDermott, Inc., Oklahoma distributor for Proctor.

"Big Boy Proctor" is a midget with an engaging personality who posed in store windows along with a jumbo Proctor toaster and conducted actual demonstrations on the company's new "Color-Guard" toaster.

Store Modernization Show July 7-12

A group of forty retail executives, architects, engineers, designers and educators are conducting the first conference on store modernization at the Store Modernization Show at Grand Central Palace, New York, July 7-12, it was announced by John W. H. Evans, managing director.

The **FASTEST** Selling Album
in the United States today
ACCLAIMED

by **GLENN MILLER** Fans Everywhere as the
SENSATION Album of the Music World

"A Tribute to GLENN MILLER"

8 famous tunes played in the immortal Glenn Miller style by original Miller musicians—Rainbow Album No. 304—List \$3.75.

The millions of fans of Glenn Miller, America's Musical Hero, are all potential customers for this **UNUSUAL** album. Proper display assures its quick sale. In hundreds of shops, the dealers supply was exhausted within 24 hours.

Every important disc jockey in the country is giving heavy play to this album. "Downbeat" lists it the "Best Bet" and both "Billboard" and "Downbeat" give it rave reviews.

For quick turnover, **ORDER TODAY**, and order heavy.

RAINBOW Records, Inc.
156 West 44th Street, New York 18, N. Y.

Keynote
MANUSCRIPT
SERIES PRESENTS

The First of Its Classics for Moderns
Stravinsky Conducts His
DUMBARTON OAKS Concerto
Keynote Album, Two 12"
Records, 4 Sides
On Extended Frequency
Range Recordings
Never Before Available Domestically

★
VIVALDE CONCERTO GROSSO in D-MINOR
Alexander Schneider, Conductor
12" Single

ORDER THESE HIGH FIDELITY, UNBREAKABLE VINYLITE RECORDS
AND PROMOTION MATERIAL FROM YOUR DISTRIBUTOR TODAY!

ELECTRICAL APPLIANCES

Section of *RADIO & Television* RETAILING

Sell IN the Showroom and Make MORE Money!

The customer wants to "try" the appliance to make sure it's what he wants, and because he wants to learn how to operate it. In-store demonstration will answer the buyer's questions IF facilities are adequate

● Every time a merchant makes a sale *in the showroom* he's saved himself real money.

Demonstrations in the home are costly, and while it will have to be admitted that they are extremely effective, it is still better for both the customer and the dealer if such sales can be concluded in the store.

The in-store sale saves the customer time, and it results in a normal profit for the dealer.

The store which is well equipped with demonstration models and is staffed with experienced salespeople, is in a good position to bypass the need for sending out merchandise on trial.

In-store selling is good salesmanship medicine too. The dealer who specializes in this technique will help his staff to stay out of former line-of-least-resistance selling tactics which prevailed before the war—namely, the all-out attempt to get the merchandise into the customer's home without even attempting to sell it in the store.

There is a vast difference between outside soliciting for business and the demonstration of appliances in the home *before* the sale is made.

The former technique is coming back, and will be practiced once again by the nation's leading merchants, but more and more dealers are balking at the resumption of sending out a lot of washers, ironers, vacuum cleaners and what-have-you on approval to a lot of people, many

of whom are bound to be just the merest "suspects."

However, the dealer who doesn't have the proper in-store demonstration set-up cannot hope to compete with the outfits who will go all-out for "try-before-you-buy" tactics in his territory. It isn't as simple as all that. It cannot be done with mirrors or via wishful thinking. But the merchant who sets up the proper facilities, and keeps them working in apple-pie order, can do away with most of the expensive outside groundwork.

In casting about for the answer to the question of whether such store facilities will pay profits, the dealer

must realize that when he sends *one* model to a customer's home, the prospective purchaser may often feel that, after all, the *other* one or ones seen in the store should be tried out too.

Moreover, other dealers are quite likely to bring in their products, which will serve further to bewilder the would-be purchaser. In such cases, the dealer's salesman who gets the last word in often makes the sale.

There are still other sales hazards associated with placing appliances out on approval. Too many times some well-meaning neighbor or relative will drop in to "pan" the prod-

(Continued on page 116)

When he sells in the store, the dealer makes more.

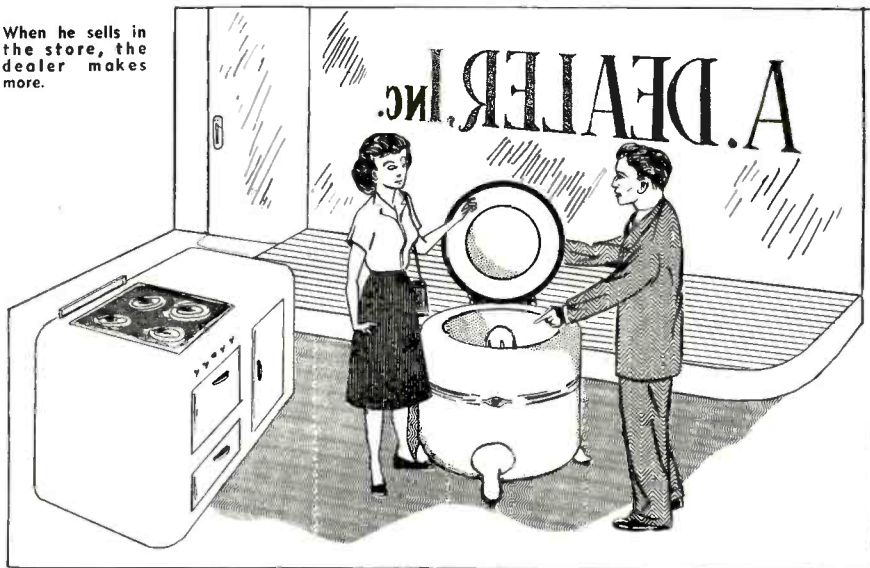

AT LAST!

A PORTABLE
DISHWASHER
THAT RETAILS

FOR \$**9.75**
ONLY FAIR TRADED

DEALER'S DISCOUNT 40%



HANDI-MITE*

SURE-FIRE!!!

FOR PROFIT AND VOLUME!

Here's a household "must" that every housewife will want immediately! HANDI-MITE . . . cleans and rinses dishes — pots — pans — in one easy, quick operation. Efficient, hygienic . . . dishes are washed in detergent mix, rinsed in fresh, clear water.

Dependable . . . safe . . . HANDI-MITE . . . contains no motor, uses no electricity.

Smartly styled, sturdily built, HANDI-MITE is an eye-catching profit maker that's *easy to sell!* It fulfills the universal desire to take the "chore" out of dishwashing. Get your share of this natural market now! Order today to assure prompt delivery of the sensational HANDI-MITE. Individually boxed — 8 to a carton.

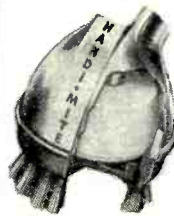

Easy to use!

Hose Attachment fastens to any size faucet.

Trigger button is pressed to send water through "Brite-Wash" detergent chamber into brush for washing and scouring. (Bar soap may be used if desired.)

Button is released to send clear water through spray chamber for non-splash rinsing.



HANDI-MITE BRITE-WASH

is a special detergent formula in cake form, designed to fit detergent chamber. Six cakes included with each HANDI-MITE. Costs less than 1¢ per average dish washing. (Bar soap may be used if desired.)



Attractively packaged



HANDI-MITE is equipped with 2 detachable brushes: one with nylon bristles for washing dishes, the other with fine brass wire for scouring pots and pans.

The entire assembly is attractively packaged for maximum display of this eye-appealing appliance.

Watch for national advertising for HANDI-MITE. Advertising and merchandising cooperation available to dealers.

L. K. FRANKLIN CORP.

1241 SOUTH HILL STREET • LOS ANGELES 15, CALIFORNIA

*PAT. PENDING

HANDI-MITE
"BRITE-WASH" TRADEMARKS REGISTERED

How to Run the Sales Contest

The Fairly-Operated Event Can Be Both Profitable and Pleasant

● With enlarged sales staffs and new emphasis on salesmanship, retail organizations are planning to resume inter-staff contests as a means for upping volume.

Dealers know through experience that sales contests can be pleasant and profitable. Or they can be unprofitable and troublesome. It's all the way they're run.

The first rule for a successful contest is that it must be run fairly. The second rule is that goal quotas must be realistic—capable of attainment. The third rule is that prizes must be worthwhile. The fourth is that customer good-will must be maintained.

A contest which does not give each salesperson an equal chance will prove to be nothing more or less than a morale-lowerer and a money-loser. In an organization where the distribution of floor-time and the allocation of sales territories is in an unsettled state, a contest will not be a battle of sales wits, but will be a battle, period. It is important, therefore, that each contestant knows which customers belong to him, and under what sort of conditions.

It is also important that territories and floor-time be divided in such manner that each man has approximately the same potential—an equal opportunity with his fellow-salesmen. Where this cannot be done, contestants having less chance should be allotted lower quotas.

No "Favorites"

Many sales contests have gone sour because the sales manager or some other official played "favorites." This usually happened in the larger organizations. The firm's fair-haired boy was often given the choicest leads, and in other cases he was handed "house sales" on a silver platter. The results of such biased contests were always unfavorable to the dealer and to the sales force. They ended up with a bunch of grumbling salesmen who proceeded to operate on a dog-eat-dog basis.

In setting quotas, if such plan is to be used, they should be high enough to stimulate real effort, but not so high as to discourage contestants who may feel they're licked before they start.

Many sales contests are run on the basis of "high man" wins, without setting any particular quotas. This sort of affair lends itself well in those organizations where many types of products are sold, and where, for instance, all salesmen handle numbers of radios in various price brackets, small and large appliances.

In the quota contests, prizes are usually announced for sales in various volume brackets. In the "straight" contest, first, second and third prizes are offered. Whatever plan is used, prizes must be worth working for. A good contest cannot be staged if the salespeople are not satisfied that they have something real to compete for. Money, of course, always brings out top effort, but electrical appliances, radios, etc., are good prizes

too, as are expense-paid trips to factories.

A sales contest bulletin board is a must. It keeps the contestant posted, and prevents suspicion that any sort of "rigging" is going on. It also serves to spur greater effort on the part of both the laggard and the top-man.

A sales contest between genuine salesmen can become a most interesting affair. There is a certain amount of pride associated with being a leader; a feeling which is apart from the prospects of material reward. Thus a good contest actually stimulates salesmanship, and brings financial gain to the merchant and the salesman.

There are two possible sales contest pitfalls to avoid. The contestants must be prevented from giving away everything and the kitchen sink in making sales. Splitting commissions with customers, urging trade-ins, and "throwing in" various sorts

(Continued on page 117)

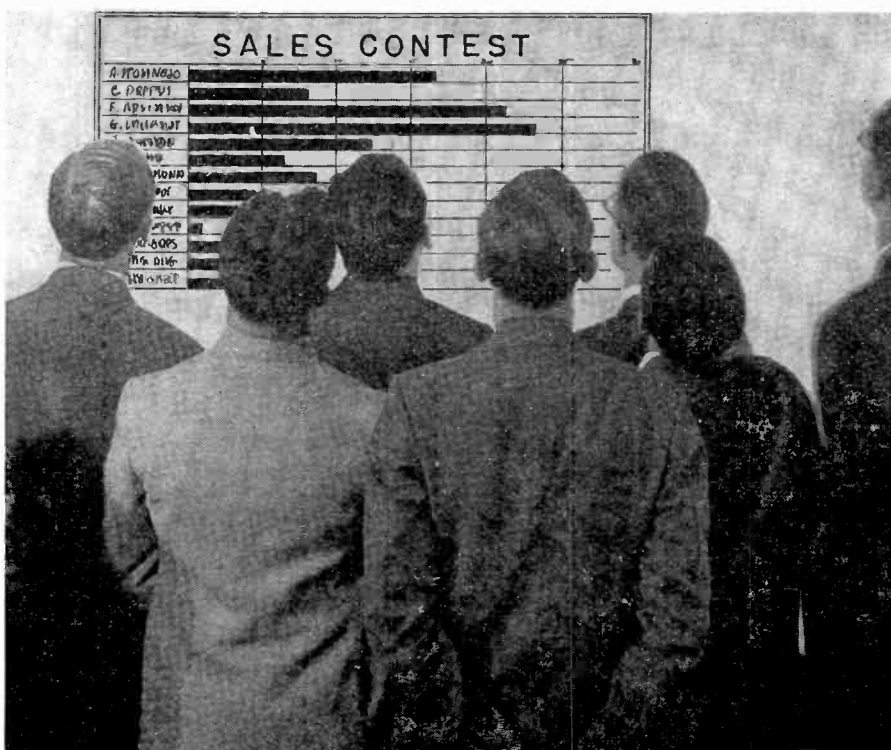

Signs Help

Short Time Between Bare Show Windows and Present Mass Displays Proves Need for Messages Via the Printed Word

● Informative signs, showcards and the top-ranking silent salesmen no dealer can afford to be without.

Telling the story via a sign is more than ever necessary today because many thousands of young would-be home-makers are unfamiliar with household products; are scanning them for the first time. Moreover, during the War, and for the long period of postwar famine, established customers saw few if any radios and electrical appliances in the nation's showrooms.

Big, readable and informative signs, inside and out, can do a really important merchandising job.

In other words, many of the persons who pass your show-windows or visit your store, don't know exactly what certain of the products are be-

USE DISPLAY MATERIAL TO

- ... Identify Maker
 - ... Tell Price
 - ... Describe Use
- and to

Sell Service

Sell Terms

Sell Rebuilt Products

cause they've never seen them before.

Still others may not obtain the necessary information because they've forgotten what the articles looked like or are unfamiliar with them because of design changes.

Using the term sign to mean almost any display piece used to tell the customer at a glance as much information as possible, such sign should flash the following data: 1. What the product is (FM radio, automatic toaster, food freezer, etc.). 2. The brand-name. 3. Outstanding features. 4. Price.

It is just as important for the merchant to tag his displayed products with information as it is for him to use large signs to identify his store name.

Two sorts of signs are used in radio/appliance stores. One is the kind furnished by the manufacturer and the other is made to order for the dealer, either by an "outside" man or by one of his employees.

Because there is a growing trend toward the general use of price signs on *all* merchandise displayed, and



to Sign 'Em Up on the

Dotted Line

since due to the uncertain list price situation which has prevailed, many manufacturers' pieces are coming through without prices, merchants must often make their own tickets or show-cards to be used as adjuncts to the printed or lithographed piece.

Never before in the history of merchandising in this field has there been a greater or better supply of display material available from manufacturers. The trick is to make the best use of all such material, not let it get stuck in some out of the way place, or alongside the wrong product.

They Sell Constantly

Good displays may be a more powerful selling tool than personal salesmanship. Informative signs enable your merchandise to create an immediate reaction in the minds of your customers. Personal selling uses words which develop the same impressions but does so in a roundabout rather than direct way.

Though the need for using manufacturer advertising pieces is quite apparent, the merchant sometimes overlooks the necessity for making signs of his own. For example, in displaying a combination waffle iron and sandwich grill, a sign is a must. If this small appliance is shown closed, with the waffle grids alongside it, many shoppers will think it's nothing but a waffle-maker. If shown open, the passerby will want to know whether the price includes the "extras."

Let's look at a few more examples:

Picture the young ex-GI and his wife out window shopping. While she was in the WAVES, she'd heard of steam irons, but if she's never seen one she may be telling her husband that that iron on display in your show window certainly looks heavy. A neat sign labelling the product a steam iron, and advising that it's feather-weight—three pounds when filled with water—will be a potent sales message and valuable information.

It doesn't pay to permit the window-shopper, in search for a gift for his mother, to stand out in front wondering whether that de luxe broiler is a hair-dryer or a room heater.

A de luxe radio, having FM and a changer, displayed with a price ticket, will seem to be unduly expensive in cases where it is shown without display material explaining its worth-more features.

Unless the shopper knows in advance, a hair dryer, shown without descriptive material, may look like an electric drill or other tool; an automatic washer may be considered to be a food-freezer, and a range without an informative sign could be considered to be made for gas, electricity or oil by the passerby.

Signs are often used to good advantage to call attention to the fact that the store stocks merchandise not shown in the windows. For example, a neatly lettered card listing a number of well-known hand-iron makes, will bring in many a customer.

A great many people take electric clocks to the jeweler for repairs. Actually the electric clock is as different from a spring-wound model as an automobile is from a horse-drawn vehicle. The dealer who displays a sign stressing efficient electric clock repair will get much business which otherwise would be lost to him. Signs listing products serviced in the store are business-getters.

Half the Battle

Signs giving information about credit terms are valuable too, and they prevent the necessity for customers having to ask whether installment purchases may be made.

One of the most effective ways of moving used merchandise is achieved through the use of signs which state original price, sales price, condition and guarantee terms.

In these days when most customers

believe that all prices are sky-high, even those in the radio and appliance field, dealers can make effective and startling denial of this belief by the use of signs comparing price of present models with pre-war lists. In most cases, the rises are not unduly high, and when the improvement value of the newer type is thrown in for good measure, the results will be most convincing.

For the dealer who does not want to hire outside talent for making signs and showcards, one of the many lettering devices on the market is just what the doctor ordered. With such lettering devices even the rankiest novice can produce acceptable work.

Tell the Store's Story

Made-to-order signs are a definite necessity at times when the dealer installs a special seasonal window, or displays to tie in the certain local events.

Signs advising store hours, evenings open, etc., eliminate the possibility of aggravating customers. When a couple drive down town one evening to buy a refrigerator from Dealer Brown, only to find his establishment closed up tighter than a drum, and no sign giving an inkling as to what nights he's open, they're justified in feeling put out about it. More importantly, they may drop in at a competitive merchant's store to make their purchase.

Signs are particularly necessary where stores maintain showrooms on more than one floor. Such signs need to be prominently lettered and conspicuously displayed near entrances to such other floors.

MANY PROSPECTIVE CUSTOMERS have never before seen some of the new things in radio and electrical appliances. . . .

STILL OTHERS have forgotten what they look like. . . .

SO, BE SURE TO TELL 'EM WITH SIGNS!

Speeding Up Repairs

Operation of Proctor Model 965 Steam Iron

The Model 965 Proctor Never-Lift automatic iron is equipped with a steam tank. In many cases, complaints of steam being too moist, too dry, etc., are due to improper operation of the thermostatic control. The accompanying illustrations show the correct way.



Turn pointer on Iron to "Steam" and Speed Control to medium. This is important. Switch on Steamer should always be at "Off" when steam is not being used. Steam going into cold Iron becomes water.

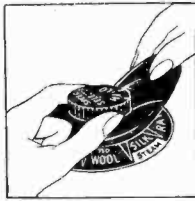

Should steam from the iron be too moist, the Speed Selector on the iron may be turned to "Hi". Should steam be too dry, the Speed Selector may be turned to "Lo". Keep Iron at proper temperature.

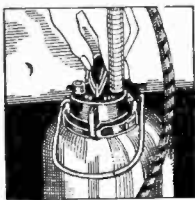

Steam is controlled by switch on top of Control Cap. When this switch is at "Off", steam escapes through vent. When switch is at "On", steam goes to Iron. Safety valve releases any used steam.

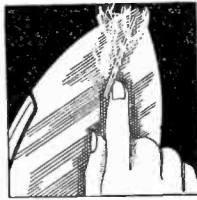

Moisture-laden steam issues from steam-conditioning chamber in the Proctor Iron through the slot in the toe of the sole plate. Steam is always clean—steam passages in iron are rust-proof.

position of the dial (which must not be at OFF) at the time of removal, so that it can be replaced in the same position with minimum risk of disturbing the thermostat adjustment.

1. Remove dial knob by loosening the small set screw, which you will find underneath the knob handle, and lifting straight up from spline—being careful to support dial from both sides as illustrated in Fig. 2.

CAUTION: Do not pry off knob or apply leverage from one side as this risks breaking plastic dial.

2. Remove hood by unscrewing the two clamping screws on each side of thermostat adjusting sleeve. The hood and handle now come off as a single unit.
3. Test lead wires by cross and end-to-end check. If no circuit is found, remove and install new set of lead wires and check to see if iron heats. If the lead wires show circuit, then the reason for no heat must be either the thermostat or the element.
4. Test for circuit at the two terminal studs. If no circuit is found, a new pressure pad with embedded heat unit must be installed.
5. If you do get a circuit across the two terminal studs, the trouble is in the thermostat

assembly. Remove and replace thermostat assembly.

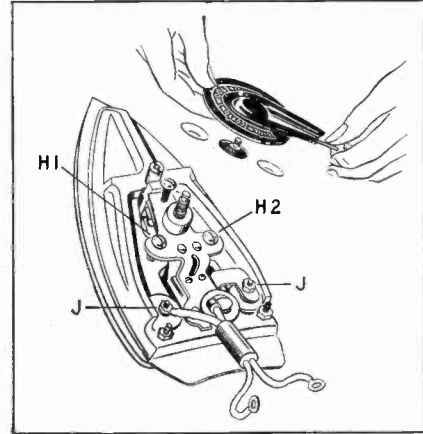

- To remove thermostat assembly:
1. Remove terminal stud nuts "J."
 2. Remove thermostat assembly retaining screws H1 and H2 and lift out complete. To install thermostat assembly, reverse procedure outlined above.

Knowledge Pays Off

The dealer who learns the characteristics of the water supplied to his customers' homes is equipped to render better service in selling and servicing washers and other appliances. In certain localities, for instance, it may be well for the merchant to recommend that his customers use distilled or rain water to prevent rust or lime crust from forming in steam irons.

Ironer Service

In servicing ironers, where complaint is lack of pressure, and where tests show that tension-regulating devices are OK, padding should be removed and fluffed. If covering is badly scratched, it should be replaced. Use shellac to attach burlap section of padding to roll.

Checking "No-Heat" Trouble Inside Samson Hand Iron

If a test for circuit at lead wires, with cord removed, fails to complete a circuit, then the reason for the iron's not heating must be found under the hood.

In order to remove the hood, you must first remove the dial knob, noting carefully beforehand the exact

COMMON CAUSES OF TROUBLE AND HOW TO CORRECT THEM.

BE SURE APPLIANCE HAS NOT BEEN ABUSED	Surface May Be Dirty — Clean Thoroughly	Cord Set May Be Broken — Check Electrical Outlet	Switch Too Wet — Ironing Speed Too Slow	If Non-Automatic, Suggest Customer Buy a Switch Cord Set	Has Appliance Been Dropped or Damaged?	If Automatic, Turn to lower or Higher Setting	Before Using, Allowed to Stand Too Long	If New, Small Amount of Sinter Is Normal	Small Metal Object, May Have Dropped Between Terminal Posts	Switch in Cord May Be Defective	On Appliances Having Indicator — Regulate Heat As Indicated	Butter Outside of Sandwiches on Both Sides	Butter Poured Before Iron is Hot Enough	Washers — Customers Washed with Olive Oil	Against Washing with Water, Regulate with Olive Oil	Has Appliance Been Immersed in Water?	Appliances Having Switches Can Be Damaged by Turning Switch Wrong Way For Too Long	Do Not Use Pins — Do Not Fold — Do Not Allow to Get Wet.	If Terminals Are Dirty or Fitted, Clean with Emery Cloth.	Check Terminals for Proper Fit in Terminals on Appliances	Check Terminals on Appliances — Tighten if Loose	Has Appliance Been Used on Wrong Current? (Automatic Appliances Operate on A. C. Only.)	Is Voltage Too High or Too Low? Check Voltage on Appliance	Check Correctly If Appliance Wrongly Used or Abused. If So, Guarantee Is Not Valid and Charge Will Be Made for Repair — Return for Repair to Authorized Service Station. Charges Prepaid.	
Does Not Heat		X							X	X															
Not Hot Enough			X																						
Sticks to Cloth	X																								
Gets Too Hot				X																					
Handle Too Hot							X																		
Appliance Smokes	X				X			X									X								
Heating Pad Fails to Operate		X					X			X							X	X	X		X				
Toast Burns			X			X	X				X														
Toast Too Light						X					X								X	X					
Waffles Stick	X					X	X				X		X	X	X										
Sandwiches Burn or Stick	X					X	X				X	X				X									
Element Burns Out					X					X												X	X		

Corn Poppers, Curling Irons, Heaters, Heating Pads, Infra Red Lamps, Irons (Automatic and Non Automatic) Sandwich Toasters, Stoves, Toasters, Vaporizers, Waffle Irons.

Chart Courtesy of the Knapp-Monarch Co., St. Louis, Mo.

on Electrical Appliances

Disassembling Gear Box on Universal 26" Ironer

Following information applies to Landers, Frary & Clark Universal ironers, current models WM 4502 and WM 4503, and old models E 55 and E 92:

Remove gear box cover. Remove large pulley by driving out taper pin that holds it to the shaft. Remove pin at the bottom end of the connecting rod. Take off the round plate on the wooden eccentric by removing the two screws holding it in place.

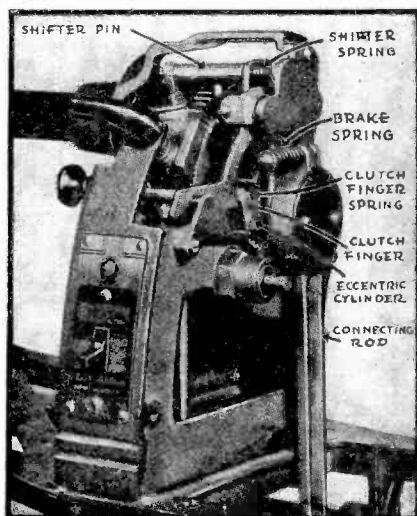

The connecting rod can then be removed by placing a screw driver in the slot at the top of same which will spread it somewhat, enabling removal. Next remove the eccentric

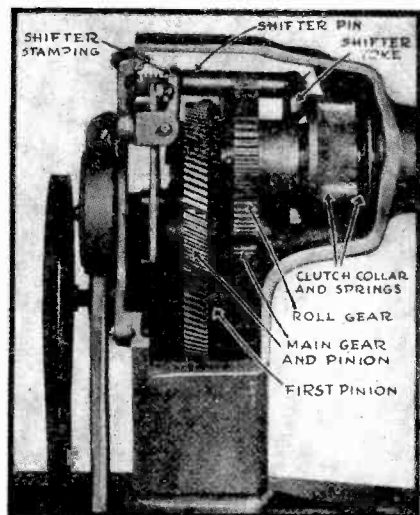

which is held in place by two slotted head set screws, passing down a tapped passage through the larger

portion of the eccentric. There are two such set screws, one on top of the other, the top one locking the bottom one in place.

To remove the large gear, pull the shaft passing through it with a pair of pliers. The first reduction pinion bearing has been made threaded so that it may be unscrewed and removed next in operation. To remove the roll shaft assembly, the shifter yoke must be removed. To do this remove the two screws that hold it in place. Remove the old grease by washing parts and gear box with gasoline or other solvent. Replace old grease with new factory grease which is supplied in correct amounts for each ironer.

To Assemble Gear Box

First see that the clutch spring and ratchet are in place in the large gear, then place eccentric cylinder over the spring making sure that the clutch finger spring is in place and that the finger is engaged in the ratchet and not between the ratchet and end of the eccentric cylinder. If this happens, the finger will lock the clutch and ironer will not operate. Next put cover on, and with a screw driver start shifter pin into the rectangular hole in the shifter stamping mounted on cover. Next reverse the procedure followed in disassembling.

Two Reasons for Keeping Data With the Repair Job

There are two good reasons why the dealer should list the items the customer complains about when he brings in a repair, and why he should keep such data with the appliance until it has been repaired. First, unless such information is written down, the person accepting the repair job may forget what needs to be done, and waste valuable time looking for the trouble. Second, when customer asks if specific things were fixed, the dealer should be able to tell him readily. The owner of the appliance will lose confidence in the repairer who doesn't know exactly what service was performed.

Timely Tips on Repairing Electric Fans

When blades get out of adjustment, a fan "walks." Correct this condition by bending blades carefully.

The peak season for fan repairs is at hand. Many fans which have been stored by householders are brought in for service with the complaint that they won't

run. First step is to check electrically by plugging into tester and moving blades by hand. If motor, switches and supply cord are OK, look for dry bearings, caked grease, etc. Disassemble fan, clean thoroughly, then lubricate.

Before doing anything else, examine fan data plate to see whether it's AC or DC or both.

Complaint of "rattling" noises in window exhaust fans is frequently due to wearing away of rubber separators between fan housings. These should be replaced, and wing nuts or other fastening devices should be tightened to prevent play.

Multi-speed fans which do not run at all, or operate only on "high" or "low" should be examined for improper contact across rheostat contacts. The latter should be burnished, and the repairer should make sure that there is sufficient pressure between the contacts on the movable arm and those on the stationary plate.

Money in Lamp Repairs

There is a lot of floor and table lamp repair business floating around, and good profits may be realized by the retailer who is set up to perform such work. A good stock of parts, such as clusters, teakwood bases, sockets, etc., is needed as well as supplies of tubing, threaded pipe, bushings, nipples, etc. One of the most profitable angles of this sort of service is the conversion of various kinds of vases, jars, bottles, etc., to decorative table lamps.

Repairs on Heat Pads

The dealer who believes in rendering safe and efficient service refuses to open up and work on elements inside the heating pad. Safe work on such appliances includes the plugs, thermostatic switch and service cord as far as the element terminals.

Lauderall Transmission

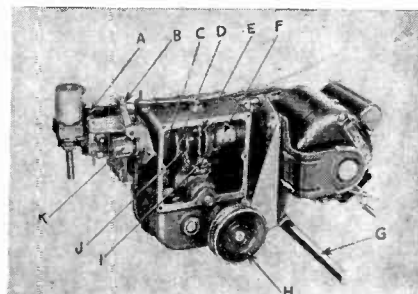

Shown above is the Jacobs' Lauderall "Mechanical Brain" transmission. (A) Water mixing valve; (B) hot and warm water temperature control lever; (C) water valve cam; (D) switch cam; (E) synchronizing cam; (F) stationary gear; (G) motor rod support; (H) output pulley; (I) reverse cam; (J) high speed cam; (K) water mixing cam.

Refrigerators ★
 ★ Washers
 Ironers ★
 ★ Ranges
 Vacuum Cleaners ★
 ★ Food Freezers

New Electrical

Universal ELECTRIC RANGE

Bantam electric range, has large oven, fast broiler action, and two units for surface cooking. Plugs in on any appliance circuit, and features imbedded coils wrapped around the all-steel, insulated, porcelain enamel oven lining to provide maximum input wattage of 1650 watts thermo-



statically controlled for baking and roasting. Two units are interchangeable for broiling or surface cooking. Also features two sliding shelves which can be manipulated in six positions, a permanently attached 6 ft. cord, two-shelf cabinet for storing utensils. Size: 22½ inches wide, 14 inches deep and 42 inches high. Landers, Frary & Clark, New Britain, Conn.—RADIO & Television RETAILING.

Eureka WASTE DISPOSER

Electric food waste disposer for home kitchens; for installation beneath the drain of the average sink. Unit pulverizes the refuse into small waste particles that flush down the drain with water from the faucet. Inside the disposer are two impellers that are whirled around when in use; centrifugal force swings them outward against a slotted ring. As the impellers force the food waste through the slots, it is pulverized into a fine mash. The disposer operates only when the cover is in operating position, and will not run when the drain is open. Eureka Williams Corp., Bloomington, Ill.—RADIO & Television RETAILING.

Westinghouse REFRIGERATOR

Model MF-7-47, 7 cu. ft. two-temperature refrigerator, will hold 56 lbs. frozen food in freeze chest and ice storage tray. Freeze



chest has capacity of 1¼ cu. ft., and the ice storage tray is rated at ¼ cu. ft. of storage space. Dimensions are: 30¼ in. wide, 57⅞ in. high, 25¾ in. deep. Equipment includes two 14-cube "select-o-cube" ice trays, two vegetable crisper containers, with covers of ribbed glass. Main food compartment arrangement is flexible. Westinghouse Electric Corp., Mansfield, O.—RADIO & Television RETAILING

Rittenhouse DOOR CHIME

Newport model, electric door chime. "Short-tube" design, with two notes for



front door and single note for rear door. Housing is ivory plastic, tubes have brass finish. Approx. size: 14¼ inches high by 9 inches wide. A. E. Rittenhouse Co., Honeoye Falls, N. Y.—RADIO & Television RETAILING.

Gibson REFRIGERATOR

Model SF-797, net capacity 7.2 cu. ft. Shelf area is 14.4 sq. ft. New, larger Freez'r Locker has a capacity of 1.12 cu. ft., and provides space for 39.2 pounds of frozen foods. Exclusive Fresh'ner Locker, provides high humidity and just-above-

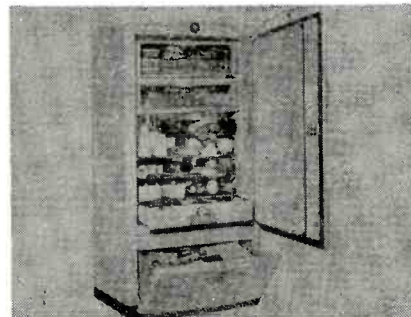

freezing temperature for foods. Basic Freez'r shelf design, and unobstructed, wall-to-wall shelves used throughout. Dry crisper tilt bin at bottom. Exterior dimensions: 61 15/16 inches high, 30⅞ inches wide, 26 13/16 inches deep. Gibson Refrigerator Co., Greenville, Mich.—RADIO & Television RETAILING.

Proctor ROAST-OR-GRILLE

Model 122, thermostatically controlled portable electric oven, features a broiler in the lid. Designed in baked white enamel and chromium with gray acid-resisting inset pan and 3-piece acid-resisting black enamel pan set, its capacity is 18 quarts liquid measure. Broiler lid is easily in-

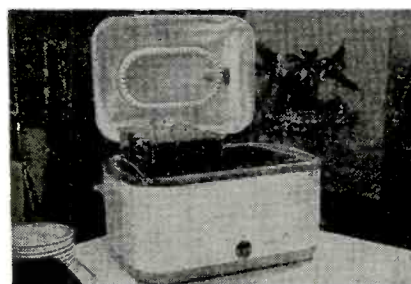

serted and removed. Roaster lid is self-basting and the broiler self-cleaning. Complete combination to retail at \$39.95. Proctor Electric Co., Philadelphia, Pa.—RADIO & Television RETAILING

Home Appliances

★ Toasters
★ Roasters
★ Hand Irons
★ Mixers
★ Clocks
★ Coffee Makers

GE COMBINATION CLEANERS

Housecleaning combination consisting of upright, floor-type vacuum cleaner, and a 6½ pound portable tank-type cleaner with



five slip-on attachments. Called the "Tidy and Tall" combination. Portable cleaner is 14 inches long by 6 inches high and wide. Upright floor cleaner is restyled version of standard, single-speed GE cleaner. Weighs 14 lbs. and adjusts beating and cleaning action automatically to type of rug. Both cleaners finished in brown and tan. General Electric Co., 1285 Boston Ave., Bridgeport 2, Conn.—RADIO & Television RETAILING.

Kaiser DISH-WASHER

Dishwasher powered by water pressure direct from home hot water line. Venturi jets, which the manufacturer claims multiplies water pressure four times, perform



the dual operation of spraying the dishes clean and spinning the basket in which they are carried. Available in deluxe model, embodying a hydraulic lift which, with the turn of a knob, raises the basket out of the finished aluminum basin. The standard model lacks this hydraulic lift. Both models are furnished either in a white, enameled cabinet or a chassis to be built into the sink cabinet of the home. Kaiser Fleetwings, Inc., Kaiser Bldg., Oakland, Calif.—RADIO & Television RETAILING.

Monitor IRON

Steam and electric iron, can be used for wet and dry ironing. Iron steams only when in use, and in a horizontal position; can be refilled without disconnecting; automatically regulates temperature; made of aluminum, with plastic handle. Weighs 4¼ lbs. Monitor Home Appliances, Riverdale, N. Y.—RADIO & Television RETAILING

Fowler WATER HEATER

Electric water heater, streamlined porcelain enamelled, built with recessed tem-

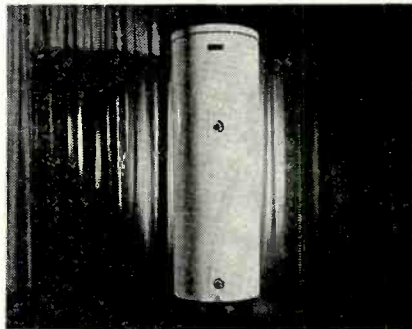

perature dial controls, an inside aluminum heat reflector jacket, and glass-lined tank. Fowler Mfg. Co., Portland, Ore.—RADIO & Television RETAILING.

Yorkaire ROOM CONDITIONER

Console model room conditioner, offers air conditioning for rooms ranging up to 20 by 25 feet with normal ceiling height.

Cabinet dimensions: 39¾ inches high, 32½ inches wide, 19⅞ inches deep. Features: quiet operation; universal air direction

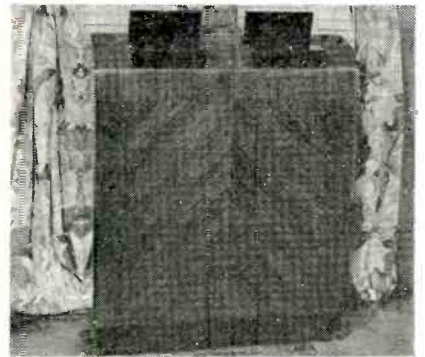

grille; fingertip control; filter; portability. York Corp., York, Pa.—RADIO & Television RETAILING

Coolerator REFRIGERATOR

Model DR-70, 7¾ cu. ft. size. Designed for apartments and small kitchens. (Can be used first as an ice-conditioned refrigerator.) 25 lb. built-in frozen food locker, special shelf for ice-cube trays. Vegetable crisper. The Coolerator Co., Duluth 1, Minn.—RADIO & Television RETAILING.

Bersted COFFEE-CHEF

Model No. 57N. Coffee-maker has heat-resisting glass bowls, porcelain filter, chrome-plated cover, 8-cup capacity. Fast



boiling stove with wide base and cool feet. (Stove may be purchased separately.) Bersted Mfg. Co., Fostoria, O.—RADIO & Television RETAILING

PROOF OF A

LEADERSHIP THAT

The Leader



NEW "SPEEDLINER" RANGES

The nation's fastest Ranges . . . out in front by two full years. They're new . . . they're dramatic . . . they're completely automatic. They have beauty to catch the eye . . . performance unexcelled for completely automatic cooking. Packed with features for extra sales!

- | | |
|---------------------------------|--------------------------------|
| 1. New Super-Heat Surface Units | 4. New Tru-Bake Automatic Oven |
| 2. New Multi-Heat Control | 5. New Tel-A-Switch Panel |
| 3. New Thermo-Chef Oven | 6. New Automaticcook |

NEW BRUSH-TYPE VACUUM CLEANER

Exclusive "Suction-Regulator" assures efficient cleaning action for all types of rugs . . . eliminates sealing and dragging of lightweight rugs.

8 BIG ALL-STAR FEATURES!

- | | |
|-----------------------------------|-------------------------------|
| 1. Exclusive "Suction-Regulator" | 3. Rubber Pistol-Grip Handle |
| 2. Automatic Rug-Adjusting Nozzle | 6. "Touch-Toe" Handle Control |
| 3. All-Metal Construction | 7. "Day-Glo" Headlight |
| 4. Oversize "Vibro-Brush" | 8. "No-Mar" Bumper |



No. 5 in the Universal Product Parade

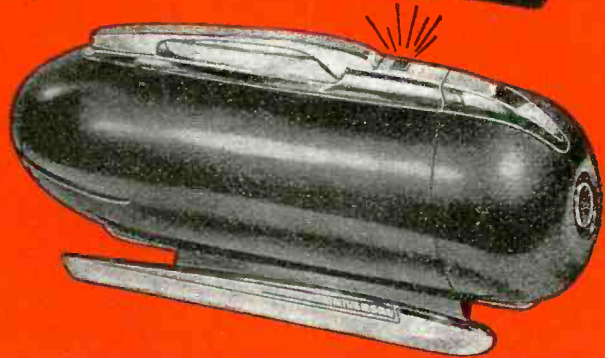

NEW CLEAN-AIR TANK TYPE VACUUM CLEANER

Exclusive "Tattle-Tale" Light shows when dirt bag needs emptying. 13 specially designed attachments for thorough cleaning everywhere . . . "A Special Knack for Every Cleaning Act" . . . demoths, polishes, sprays, shampoos, deodorizes.

UNIVERSAL FEATURES SELL ON SIGHT!

- | | |
|---|---|
| 1. Exclusive "Tattle-Tale" Light | 3. Exclusive "Thread-Picking, Self-Cleaning Nozzle" |
| 2. Exclusive "Instant-Seal" Hose Connection | 4. Exclusive New "Super-Power Motor" |

BUILDS YOUR DEALERSHIP!

Leads The Field!

FIRST WITH THE FINEST... '48 MERCHANDISE IN '47

Universal leads the parade with the first really new post-war line of appliances and housewares. No need to wait 'til '48... these new Universal products are out in front by two full years. No need to worry about their being outmoded or outsold...

each appliance is outstanding in eye-appeal... feature-perfect for top-flight performance.

See your Universal distributor today for full information about the new Universal post-war line!

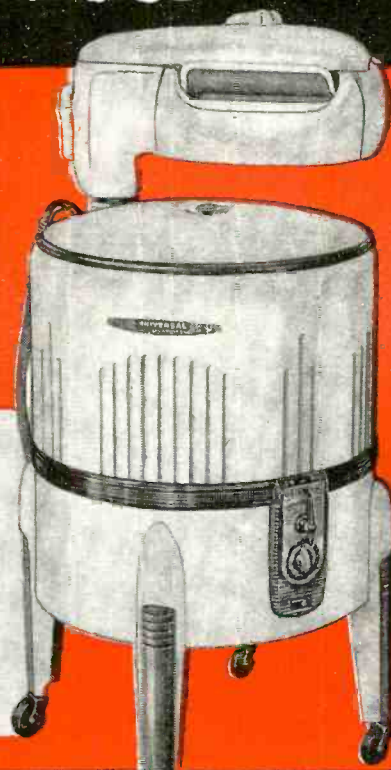

NEW TWO-SPEED WASHER

One speed for the rough stuff and a slow gentle action for the fluff stuff. The first major improvement in a Wringer-Type

Washer in 20 years... plus new Super-Safe Wringer with Control-O-Roll for complete protection.

5 SENSATIONALLY DIFFERENT FEATURES

- 1. Two-Speed Washing Action.
- 2. Super-Safe Wringer with Patented Control-O-Roll Feature
- 3. Time-A-Matic Timer
- 4. Safe-T-Switch
- 5. Red Plastic Sterilator

New Coffeematic
Completely automatic electric Coffee Maker with Multi-Strength Control for coffee as-you-like it.

New Automatic Toaster
With the exclusive See-Vue feature which enables you to look at the toast without interrupting toasting cycle.

New Minute-Savor Pressure Cooker
With the "3 Seals to Safety" — Good Housekeeping Guaranty Seal, Underwriters' Laboratories Seal and exclusive Safe-T-Seal Cover.

New Electric Blanket
With the exclusive Slumber-Sentinel Control for perfect all-weather sleeping comfort. Easy to launder. Plenty of spread for double bed.

New Electric Iron
The Hand-I-Set Fabric Dial, Beveled Point, Cool Plastic Handle and Wrinkle-Proof Heel make ironing easier and faster.

AMERICA'S COMPLETE... REALLY NEW... POST WAR LINE

UNIVERSAL

LANDERS, FRARY & CLARK • NEW BRITAIN, CONN.

Look for No. 6 in the Universal Product Parade Next Month

What's New in Lighting

Latest Product Developments—Timely Sales Tips

Sylvania's Rapid Growth

In a seven-page feature article, *Fortune* magazine printed the story of the spectacular growth of Sylvania Electric Products Company, an organization which has set its sights on a \$100 million dollar business in 1947. The article points out that although Sylvania is well established in the incandescent and radio tube industries, fluorescent lighting played a big part in putting the company on the map. Sylvania's Fluorescent sales jumped from 200,000 tubes in 1938 to 60 million today.

Wiremold Has New Fluorescent Line

The Wiremold Company, Hartford, Conn., is manufacturing a line of single and multiple 15-watt fluorescent units, low power factor, 110-125 volt, 60 cycle.

Wired and ready to install (lamp not furnished), these 21A units are extremely compact, the single units being 20", 21", and 21 $\frac{1}{4}$ " overall, and the double units, 40" and 41 $\frac{1}{4}$ " long overall. The cross section is small—1 $\frac{1}{4}$ " wide by 1 $\frac{15}{16}$ " deep.

Units are furnished in the following variations: with 6-foot cord and plug for plugging in to existing outlets; with 6-inch conductor leads coming from end; with manual starting switch or with conventional type FS-2 starter switch; with provision for two lamps mounted in tandem.

Attractively finished in white enamel, units are furnished with two 2103A clips for permanent or portable mounting. Cloverleaf holes at back permit the use of the unit as a pin-up.

The company states these units are fully approved by Underwriters' Laboratories, and are useful in homes, stores, offices, schools, garages, factories, workshops, laboratories, theaters, libraries—wherever a modern, compact, inexpensive fluorescent utility unit is needed.

Use Lamp Catalogs

Use manufacturers' lamp catalogs in selling. You can often speed up the transaction by showing the customer just what sort of bulb the maker recommends for a specific fixture.

Verd-A-Ray's Aladdin



Milton J. Grosse, vice-president in charge sales, Verd-A-Ray Corp., Toledo, Ohio, appeared in the above striking costume while presenting the firm's Insect Repellent lamp to jobbers.

Bright Store Profitable

The dealer who wants his store to be known as a headquarters for light needs to make his own store an example. In addition to attractively lighting his store interior and exterior, he should install a time-clock which will permit show-window lights to be on those evenings when the store is closed.

Lustra Corp. Has New Fluorescent Folder

"A Miracle of Light" is the title of a new folder on fluorescent lamps issued by Lustra Corporation of America, 40 West 25th St., New York 10, N. Y., describing the four classes of Daylight, 3500° White, Soft-White and 4500° White Lustra fluorescent tubes respectively. Newest of the four is the 4500° White Lustra tube combining the blue-white of daylight

with the warmth and liveness of white light; providing a proper balance of both for display and interior store illumination.

For food store showcases and illumination in restaurants, cafeterias, beauty shops, theatres, etc., the Soft-White tube is recommended and described as slightly tinged with a warmth of tone that is exceedingly flattering to foods such as meats, meat products, coffee, etc., as well as to the human complexion.

The Daylight is recommended for use where color correction and blending with normal daylight is necessary, while the 3500° White, reported as having a higher light output than the previous three types, is stated as the standard tube most commonly used for all general and commercial illumination. Sizes range from 14 up to 100 watts in all four types, and in blue, green, pink, gold and red colors from 15 to 40 watts. Two types of Lustra fluorescent starters are also described in this folder.

Money in Sales to Fellow Merchants

Non-competing retailers in the territory are a good source of business for light bulbs. The merchant who carries a good assortment of large-size lamps can do a good year 'round business among his fellow retailers. Fluorescents are now widely used in various stores, and the dealer stocking them finds this to be a profitable line. In addition to the tubulars, the lamp merchant should stock starter-buttons and other fluorescent accessories for the convenience of his customers. A good assortment of floods and spots, plus a stock of various sorts of flasher-buttons, flasher-sockets, etc., are money-makers, too.

Westinghouse Illuminated Display



Available from the company's Bloomfield, N. J., office is the above illuminated display. 31 $\frac{5}{8}$ " long and 6 $\frac{7}{8}$ " high, stand is lighted by a 20 watt fluorescent lamp. This model X-279 is \$1, F. O. B. shipping point.

These... are the
Passkeys to Profits!

REFRIGERATORS



GAS RANGES

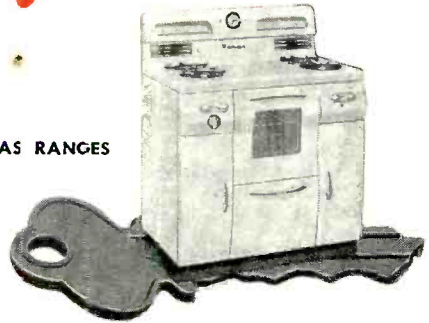

WASHERS

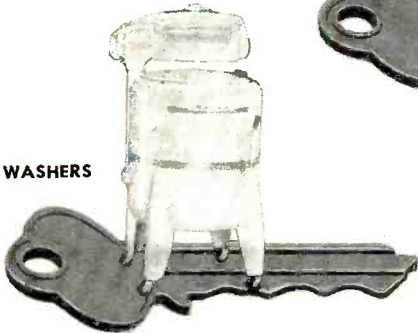

ELECTRIC RANGES

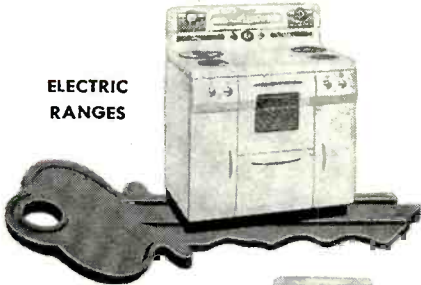

ELECTRIC WATER HEATERS

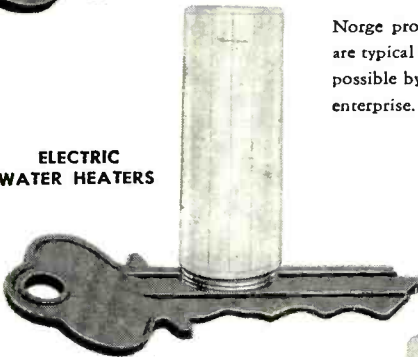

HOME & FARM FREEZERS

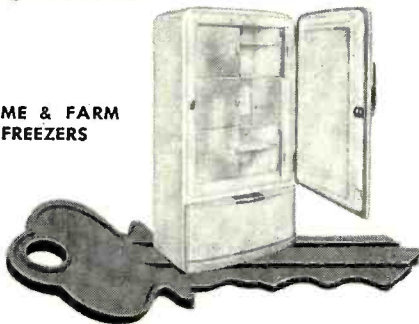

HOME HEATERS

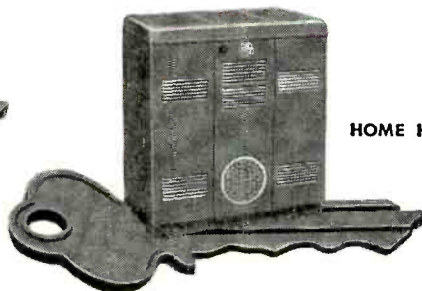

Which is better: *one* source of profit, or *seven*? And seven products with one good name are easier to promote. Norge retailers *know*, because Norge retailers *have* the answer: *seven* traffic-building products—*seven* passkeys to profits! Norge Division, Borg-Warner Corporation, Detroit 26, Michigan.

"THE BEST DEALER IN TOWN SELLS NORGE"

Norge products, distributed worldwide, are typical examples of the values made possible by the American system of free enterprise.

SEE
NORGE
BEFORE YOU BUY

Products of
BORG-WARNER



New Appliance Items

American FREEZER

Model ARB-8. All-aluminum, push-button freezer with an automatic-opening top door. Features are: large storage and utility bin at base; visual control panel with

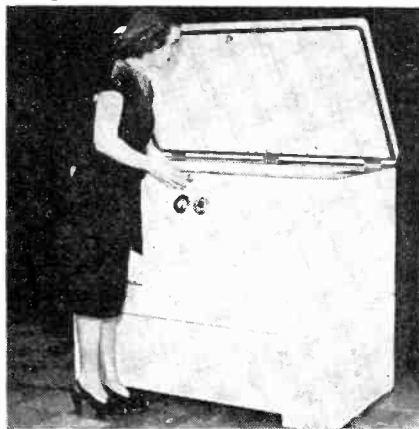

temperature indicator and thermostat dial; wire baskets and inside dividers; 8 cu. ft. capacity. American Refrigerator & Machine, Inc., Minneapolis, Minn.—RADIO & Television RETAILING

Dome Turbo KITCHEN VENTILATOR

Model C package unit of electric kitchen ventilation. Range-length intake of polished aluminum unit; located about 28 inches from burner level. Duct is concealed in wall back of range. Ranges



equipped at the back with damper-operated vent can be direct-connected with this vertical duct; else the oven and broiler are served by the intake over the range. Electro Specialty Mfg. Co., Inc., Minneapolis, Minn.—1900 Third St., N. E., Minneapolis 18, Minn.—RADIO & Television RETAILING.

Morton SINGETTE

Designed to be used in singeing poultry, browning of casserole dishes, grilling sandwiches, or removing paint. Composed of a high temperature heating element shield-

ed with a bright chrome plated hood, and insulated handle. Can be plugged into



any electric outlet. Stand for the unit is nickel plated and made in one piece. Henry J. Morton Associates, Inc., Detroit, Mich.—RADIO & Television RETAILING

Mermaid STEAM IRON

Wet or dry electric steam iron, can be used either way. Features: lightweight, made of cast aluminum; heat control; modern design; polished chrome steel sole

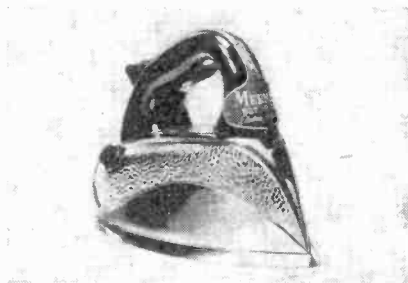

plate; grooved sole plate for spreading steam; hammered aluminum finish. (Cardinal Mfg. Co., St. Louis, Mo.) Smith-Benny Sales, 11 W. 42 St., New York, N. Y.—RADIO & Television RETAILING.

Princess WAFFLE IRON

Features: expansion hinges to assure waffles of uniform thickness; one-piece, seamless waffle molds; one-piece chrome

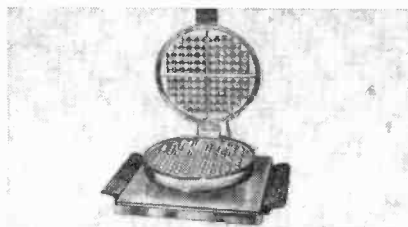

tray-type base; wood handles; built-in heat indicator. Newark Appliance Corp., Inc., Newark 7, N. J.—RADIO & Television RETAILING

Dolly Madison ICE CREAM FREEZER

Features northern pine tub; cast main frame with aluminum finish; induction type motor; special steel ring on drive shaft; prime tin plate, or stainless steel, cream



can of double seam construction; cast aluminum cover with positive stop; finished in ivory enamel. J. E. Porter Corp., Ottawa, Ill.—RADIO & Television RETAILING.

Duo-Therm FURNACE

Deluxe fuel oil furnace. Available in three sizes and eleven different models. Range of models offer choice of gravity or blower types with either manual or thermostatic controls. New line features

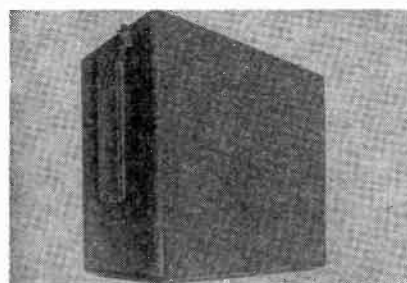

a new heating principle said to provide steady, uniform heat. Features: dual chamber burner; comfort selector; heat-anticipating thermostat; and transfer heat chamber. Duo-Therm Div., Motor Wheel Corp., Lansing, Mich.—RADIO & Television RETAILING.

Kitchen Maid SINK UNIT

Sink unit with porcelain top and "appliance-styled" cabinetry. Available as a



single unit or to be built-in with other cabinets. Kitchen Maid Corp., Andrews, Inc.—RADIO & Television RETAILING.

FOR LATEST RADIO MERCHANDISE, SEE PAGES 40, 41 and 46

Heat Control
where it Counts —

at the Fabric



Low
THE SHELL IS JUST
1 INCH HIGH

Light
ONLY 3
POUNDS

Fast
HEAT IN
30 SECONDS

Durabilt's exclusive thermostatic control guarantees the right temperature at the right place — on the soleplate surface. Here is the only iron in the world in which the soleplate controls the ironing temperature. The new Durabilt Automatic Iron Model 10 offers a full heat range with the exact temperature for every fabric — quickly, evenly. Light — only three pounds, Durabilt assures easier, faster ironing. Low—the shell is just one inch high, Durabilt provides all around visibility in ironing. Fast—Durabilt reaches ironing heat in less than 30 seconds.

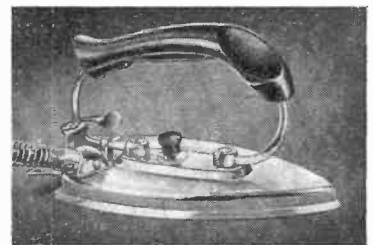

Companion on your shelves is the famous Durabilt all-purpose Folding Iron. Place your order with your distributor now for both Durabilt Automatic Irons!

Manufactured by WINSTED HARDWARE MANUFACTURING COMPANY, WINSTED, CONNECTICUT

DURABILT *Fully Automatic* **IRON**

Do Kids Get Your Goat?

**It's Good Business to Keep on the Right Side of
the Juveniles Even Though It's Difficult at Times**

● Philoprogenitiveness is a highfalutin' word which means not only love of one's offspring but love of children in general.

The philoprogenitive radio/appliance merchant is usually a guy who has slews of adult friends among his customers.

The merchant who may love his own children a whole lot better than he loves the customers' young ones who visit his store, but, who none-the-less, is willing to practice forbearance and "take" a lot from kids is classified as "regular." He's willing to overlook the actions of youngsters who rub noses and dirty fingers on show window and show case glass, handle and drop things on display in the store, and who get in his hair in a hundred and one other ways. Such a dealer is a "good guy" in the eyes of the parents and the young fry.

Even if the antics of the juveniles are merely tolerated via a mask of pseudo-graciousness on the part of the merchants, he's still "all right."

Perhaps he takes comfort in the thought that he was once young. Perhaps he forces himself to be a martyr to good business ethics when he smiles, however falsely, while junior unwinds a few hundred feet of

lamp cord from the display reel, or little sister draws pictures on the newly-painted wall.

But, brother, the dealer who genuinely dislikes children in his store, and makes no bones about showing it, is in line to lose customers! The dealer who waits on adults ahead of the youngsters, robbing them of their rightful "turns" is building up ill-will for himself and his establishment.

The grouch who barks at juveniles who "forgot" what is was that mother wanted, who ask foolish questions or otherwise annoy him, is lining himself up for some hardships because the kids are more than likely to report him as an old crab to their parents. Moreover, they will remember him as a contrary old grouch when they grow up to customer-size themselves.

Catering to kids is not only good business but it's often good fun. While it's not necessary for the dealer to put up with downright maliciousness and costly damage on the part of the youngsters, he certainly should laugh off the small things the tots and teen-agers do.

The importance of making friends of youngsters is well known to many dealers who do all sorts of things to

entertain them and to make them feel at home in their stores.

One merchant displays electric trains in his show windows which can be operated via a pushbutton on the outside frame of the show window. In the course of a year only two of these buttons were pried off by vandals, while hundreds of youngsters, and grown-ups too, respected the dealer's property in handling the equipment carefully.

A dealer who specialized in selling sunlamps found that parents were as tickled as their young ones were when he installed a sand-box in his show window, and invited the kids to get into it, play with the toys, and get a "sun-bath" at the same time.

Some merchants have made hits with kids by serving them ice cold soft drinks out of display refrigerators, passing out souvenirs, etc.

Be a "Regular"

The phono record retailer who is "allergic" to the mannerisms of today's young people has two merchandising strikes on him any way he wants to look at it.

Selling and demonstrating records to teen-agers, bobby-soxers and other youth groups is a specialty business which requires patience, fortitude and understanding.

The dealer who blows his top when he finds that "Kilroy" has been in each of his listening booths, is, to paraphrase radio's Ajax Cassidy, "not long for this world"—the record business world, that is.

Summing the whole thing up, the merchant who really likes other people's children—children at large—has no problems. He's a "natural" who'll find no difficulty in dealing with the offspring of the customers he makes his living from.

The guy who knows that the youngster-visitors can make him "take it" but not necessarily *like it*, but who's able to put up with them and do a good job of making them *like him*, is a smart operator. But the dealer who's a dyed-in-the-wool kid-hater and shows it in his every action is in for some tough-sledding—which is the sort of sleigh-ride most of us like to feel he deserves.



IT TAKES MORE THAN A SINGLE HEAT



... to reveal tomorrow's champs

... whether the competition is among runners or radios or irons. Neither the experience of a single dealer nor a trial in today's market is enough to prove the mass-appeal and *long-range saleability* of a radio or appliance line.

Comparing competing lines — new and old — and selecting those that will sell best ... be most profitable ... year in and year out, is a job that calls for long experience with a variety of lines under all market conditions.

Such experience is Graybar's. Equally important,

Graybar is *free* to select and recommend lines according to their reliability and saleability. For Graybar, a long-established national distributor, has the confidence of leading manufacturers — yet is an independent, self-directing organization.

Those are the fundamental reasons why Graybar dealers can act with confidence upon the recommendations of Graybar Merchandising Specialists. *Merchandising Department, Graybar Electric Company ... offices and warehouses in over 90 principal cities.*

4774

When a product is recommended by Graybar, you can be sure it is (1) easy to sell, (2) honestly advertised, (3) backed by a warranty which protects both dealer and consumer.

recommended by
Graybar

RADIOS AND COMBOS • MAJOR APPLIANCES • TRAFFIC APPLIANCES

Four Out of Five Auto Radios Have It*

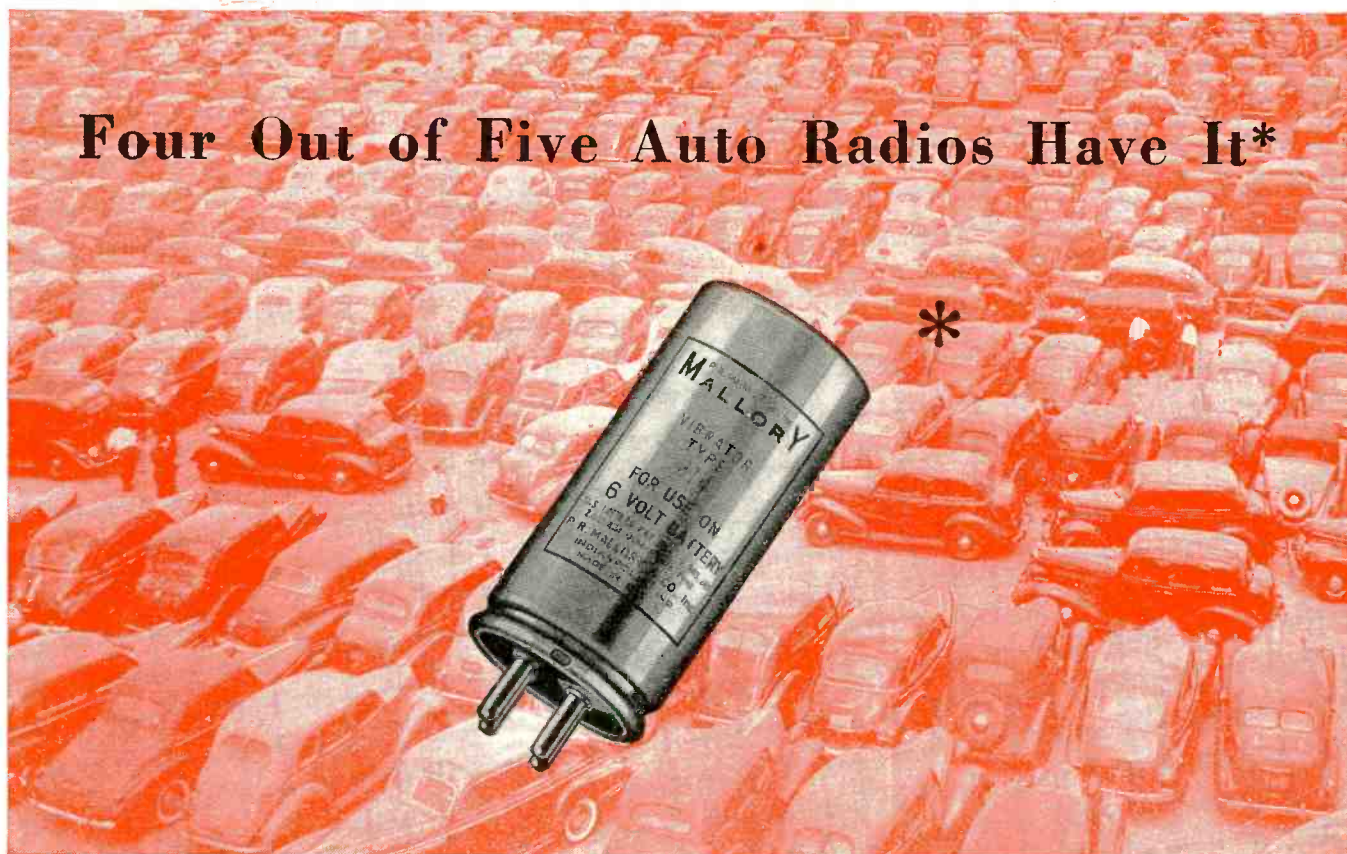

That's Why the Mallory Vibrator Makes the Best Replacement

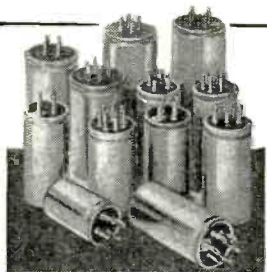

Mallory Has the Most Complete Vibrator Line

The 12 basic vibrators illustrated above answer 90% of your replacement requirements. But Mallory offers 50 vibrators in all so that every need can be instantly met. The Mallory line is the most complete in the business.

More Mallory vibrators are in use today than all other makes combined. In the field of auto radio alone, four sets out of every five carry Mallory vibrators *as original equipment*. Why?

Because Mallory is the world's largest producer of vibrators—has learned the "hard way" how to make vibrators. Because Mallory has introduced many vibrator "firsts" . . . has patented more than 50 improvements . . . adheres to the strictest production standards in the vibrator industry.

These are good and sufficient reasons, too, why Mallory vibrators make *the best replacements*. You can't do better, when you service a set than to use a Mallory replacement.

See Your Mallory Distributor for a free copy of the 1947 Replacement Vibrator Guide

P. R. MALLORY & CO. Inc
MALLORY

VIBRATORS . . . VIBRAPACKS* . . . CAPACITORS . . . VOLUME CONTROLS . . . SWITCHES . . . RESISTORS . . . FILTERS . . . RECTIFIERS . . . POWER SUPPLIES.

*Reg. U. S. Pat. Off.

APPROVED PRECISION PRODUCTS

P. R. MALLORY & CO., Inc., INDIANAPOLIS 6, INDIANA

SERVICE & SOUND

Section of **RADIO & Television RETAILING**

Quick Checks for New Set Troubles

● Since the publication in our January and April, 1947, issues of the first and second pages of advice from factory service managers, new material has been received from virtually every manufacturer in the industry. Their accompanying comments have been warm and encouraging, and as a result radio servicers throughout the country will be enabled to benefit from more of these "inside" service tips.

While, as a rule, the changes indicated below have already been made in current set production, servicers are advised to incorporate the modifications in previously-made receivers

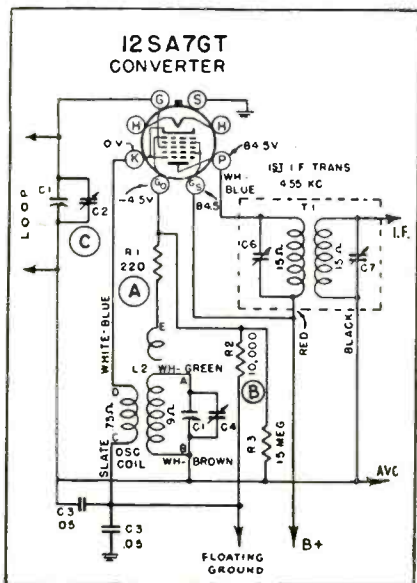

Fig. 1. Greater stability for Zenith oscillators.

ers only when necessary to accomplish adequate reception, since in many specific installations the added performance ability is not required.

Zenith chassis 5C01, 5C02, 5C04,

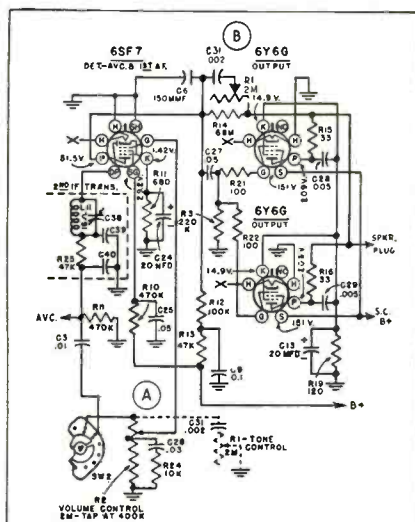

Fig. 2. Westinghouse tonal range is increased by moving control from position A to point B.

series 5D0 and 5R0, says Frank E. Smolek, General Service Manager, may be found to have an oscillator which shifts in frequency. This is cleared by replacing the 220 ohm oscillator grid coupling resistor (R8 in chassis 5C01 and R1 in chassis 5C02 and 5C04), letter A in figure 1, with a 1,000 ohm resistor. If the oscillator drops out at the low end of the band, remove the 10,000 ohm oscillator automatic bias resistor (R1 in chassis 5C01 and R2 in chassis 5C02 and 5C04) from the common return, as shown at letter B in the diagram, and connect it instead to the converter tube's cathode terminal. Hum and microphonics in the same chassis may be caused by the tuning capacitor frame grounding to the cabinet ventilator plate (letter C).

In the same chassis, in case of audio oscillation, disconnect the first audio .005 mf plate bypass capacitor

(C13 in chassis 5C01, and C14 in chassis 5C02, 5C04) from the negative return and connect it instead to the cathode of the 50L6GT output tube. If a 250 mmf bypass is found between plate and cathode of the 50L6GT (C20 in the 5C01 diagram) remove it.

Delco household radios R-1408 and R-1409, according to C. A. Koppe, product supervisor for United Motors Service, have a tendency to overheat the 47 ohm 1 watt resistors found between the plates of the two 35Z5GT tubes and the line cord, in cases where the line voltage consistently runs over 120 volts.

In such cases, replace the resistors (Delco #1215570, shown as numbers 27 and 28 on page 99 of the April 1947 issue of RADIO & Television RETAILING) with 22 ohm 1 watt resistors (Delco #1215566). Some sets above serial number 5,000 will have two 47 ohm units in parallel at each location, instead of single 22 ohm resistors.

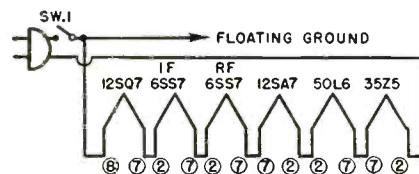

Fig. 3. New Arvin wiring prevents 6S57 burnouts.

To provide greater tonal range in Westinghouse models H-104, 5, 7 and 8 (chassis #V-2102), indicates an advice from John Sloane, of that company's technical press service, a modification was made according to the illustration. R1 and C31, shown dotted at A, were moved to their new position at B, across resistor R14.

(Continued on page 104)

More Proof...

that RCA Batteries MEAN BUSINESS!

These new Sales Aids help YOU sell more batteries

Here is a line-up of sales tools that are designed to catch the attention and the dollars of battery-set owners. Arresting counter cards, streamers and self-service cartons remind vacationers . . . and the stay-at-homes . . . to renew the pep of their radios and flashlights with fresh RCA Batteries.

There is also a handy Quick Selection Chart. It tells at a glance which types of RCA Batteries to use for more than 1000 portables and home radios. And . . . there's an equally useful chart that shows what RCA battery type replaces the corresponding number in more than twenty other brands!

These dealer aids bring the customers your way . . . do a continuous selling job for you . . . save you time.

RCA means business with this great line of radio-engineered batteries. You'll find it means good business for you, too! Ask your RCA Distributor.



COLORFUL DISPLAYS—counter cards, window cards and streamers, in a variety of attractive layouts. Get these "salesmen" working for you! They're free.



QUICK MERCHANDISING CHARTS. Save you time by telling exactly which RCA Battery to use for over 1000 replacement jobs, and giving comparative type numbers of over 20 makes of batteries.



HERE'S YOUR NEW
RCA CATALOG!

The most complete battery buying guide ever published. It's hot off the press. Get yours from your RCA Distributor.



SELF-SERVICE COUNTER CARTONS. For flashlight and small A batteries. You'll appreciate the way these colorful displays sell batteries!

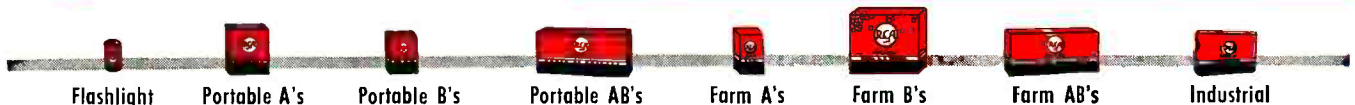

TUBE DEPARTMENT

RADIO CORPORATION of AMERICA

HARRISON, N. J.

New Prospects for Sound

How the PA Field Shapes Up for the Months Ahead

● As sound dealers know, since the end of the war the PA business has been at a stable, profitable level. Aside from the great market in component replacements of existing sound installations, large new fields have been opened which did not exist to any great extent before the war.

Among the fields for PA which are "hot" at this time, are installations in department stores, for music and announcements, and in chain stores. State legislature rooms have seen several very recent installations, and churches are still getting a heavy play.

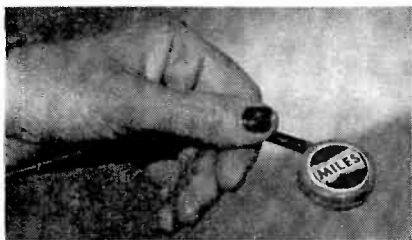

Telemike inductive telephone pickup for PA "remotes."

Due to the recent calamities in mines and hotels, both of those fields are wide open to centralized systems combining safety-promoting features, while schools of every type are beginning to look upon a centralized sound system as a necessity.

While most of these big installations are beyond the facilities of the smaller sound dealer, he, too, has been experiencing the opening of

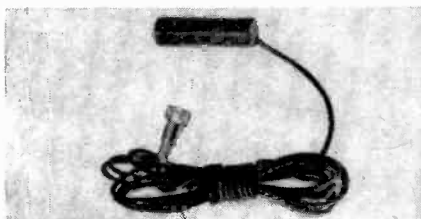

Speak-O-Phone pickup slips between twisted pair. new fields, both for rental and sales.

Systems which are based on intercoms, particularly in warehousing and other industries with spread-out facilities, are in big demand, and are within reach of any technically competent dealer. Outdoor rentals of mobile amplifiers with turntables are more popular than ever.

Along with the increasing interest

in national affairs on the part of the public and civic organizations, has come an increase in PA rentals for meetings. An interesting application in this line, although used by some men before the war, should see widespread application before long. Several manufacturers market an induction device which is used to pick signals off a telephone wire without a direct connection.

By means of these devices, and without objection from the telephone companies, sound dealers are enabled to make profitable rentals of equipment for spill-over meetings. When it is expected that a given rally, meeting, lecture, or assemblage will draw a greater crowd than can be accommodated in the hall, the sound dealer might wisely suggest that the



overflow crowd be directed to another auditorium nearby.

For a small fee, the local telephone company will keep a wire free from interruption, between the halls, for re-amplification and projection by means of the dealer's own equipment.

At the transmitting end, the telephone may be placed close to a good quality speaker, part of the main hall's system, or a 250-500 ohm line may be connected into the telephone wire. The connection, in that case, is performed by a telephone company man for a moderate fee. The company also supplies line equalization or tone balancing.

At the receiving end, use is made of the inductive pickup. This unit, consisting of several thousand turns of extremely fine wire with an appropriate core, is very compact, and yet capable of pickup of a fair signal strength without any sort of direct connection. Fed into a high impedance amplifier input, it provides the program for the spill-over hall.

At the left, are two types of inductive pickups. The small, disc-type unit, made by Miles Reproducer Co., Inc., 812 Broadway, New York 3,

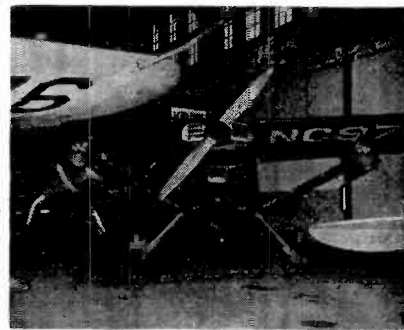

▲ Something new in plane PA installations. Two University 4-unit speakers fit close under wing, hung from 4-point mountings; ← two side straps anchor on struts, and two rings on overhead bar, welded to plane's frame.

▼ Dealer Shulman makes final pre-takeoff check. Story on Page 104.



N. Y., is placed within a foot of the telephone input transformer. This is often found at the ringer box or in the base of the instrument. When possible, the Telemike, as it is called, should be wedged or taped in place against the core of the transformer itself.

Measuring $1\frac{1}{4}$ " in diameter and $\frac{3}{4}$ " thick, it is supplied with 25 feet of shielded cable and a connector, plus instructions. It is also designed for use with the same company's Filmgraph, for recording of speeches and two-way business telephone conversations. For speech recording, the

(Continued on page 104)

Servicing Newest Radios

Circuit Diagrams, Parts Values and Alignment Information
Condensed for Quick Troubleshooting of Popular Receivers

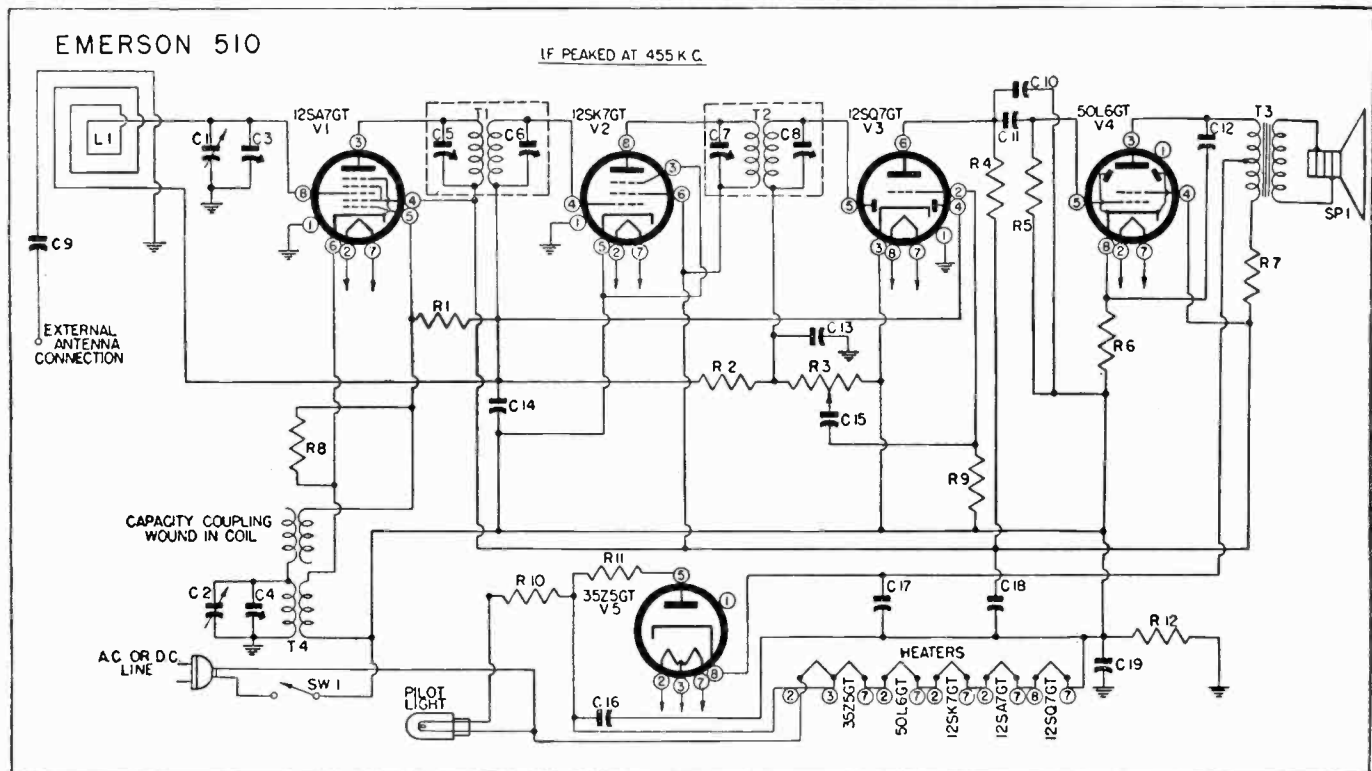

C1, C2 Two-gang variable
C9, C15 0.002 mfd., 600 volt
C10 0.001 mfd., 600 volt
C11, C12 0.02 mfd., 400 volt
C13 0.00022 mfd. mica
C14 0.1 mfd., 200 volt
C16 0.05 mfd., 400 volt

C17, C18 150 V. dual dry-electrolytic
(C17—30 mfd., C18—50 mfd.)
C19 0.2 mfd., 200 volt
R1, R9 15 meg., 1/4 watt
R2 3.3 meg., 1/4 watt
R3 0.5 meg. volume control
R4, R5 470,000 ohms, 1/4 watt

R6 150 ohms, 1/2 watt
R7 1000 ohms, 1 watt
R8 22,000 ohms, 1/4 watt
R10 10 ohms, 1/2 watt
R11 15 ohms, 1 watt wire-wound
R12 220,000 ohms, 1/4 watt

EMERSON MODEL 510 is a five-tube single-band superhet covering the band from 540 to 1620 kc.

For a straightforward alignment, connect the 455 kc i-f signal generator to the converter grid (the stator of the variable capacitor) and adjust the four i-f trimmers C5, C6, C7 and C8 atop the two i-f transformers, for maximum output on a meter connected across the primary or secondary of the output transformer.

For the broadcast band alignment, radiate a signal at 1425 kc, set the dial indicator to the same frequency, and adjust both trimmers on the variable capacitor for maximum signal output. The trimmer C3 for the antenna is located on the rear side of the variable, and trimmer C4 for the oscillator is at the front.

For the low frequency adjustment of the broadcast band, radiate a 600 kc signal and pick it up on the re-

ceiver. Adjust the loose outside turn of the loop antenna for maximum response. This loose turn may be moved to either side of the center. Fasten it in the position which gives maximum response. Repeat the broadcast band alignment until no further improvement is evident.

TEMPLE MODEL G-521 is a two-band ac-dc-battery portable, giving coverage from 535 kc to 1620 kc, and from 5.6 mc to 18.5 mc. Both a built-in loop and a collapsible whip antenna are employed, as well as provision for external antenna and ground. A completely enclosed aluminum chassis helps secure a light weight radio with low shock hazard.

The simulated leather covered set has a plastic roll-back curtain to protect the dial window and controls. Using 5 tubes plus a dry-disc rectifier and two pilot lights in a floating ground arrangement, the set draws

13 watts on line voltage operation.

As shown in the diagram, two i-f amplifiers, both 1LN5 tubes, are used, with double tuned transformer coupling on the input and output of the circuit, and resistance coupling between the stages. AVC is used in both converter and first i-f amplifier on the broadcast band, and in the i-f stage alone on short wave.

Tapped on to the volume control is an automatic bass tone compensation circuit which deepens the tone at low volume. A 6-inch Alnico V PM speaker is used.

CROSLY MODEL 56TY is a five-tube single band superhet, covering from 540 kc to 1600 kc. The i-f stage is aligned on 455 kc with the modulated output of the signal generator fed to the external antenna connection through a 200 mmf dummy antenna, and the ground lead through a .1 mf capacitor to the receiver's

How to

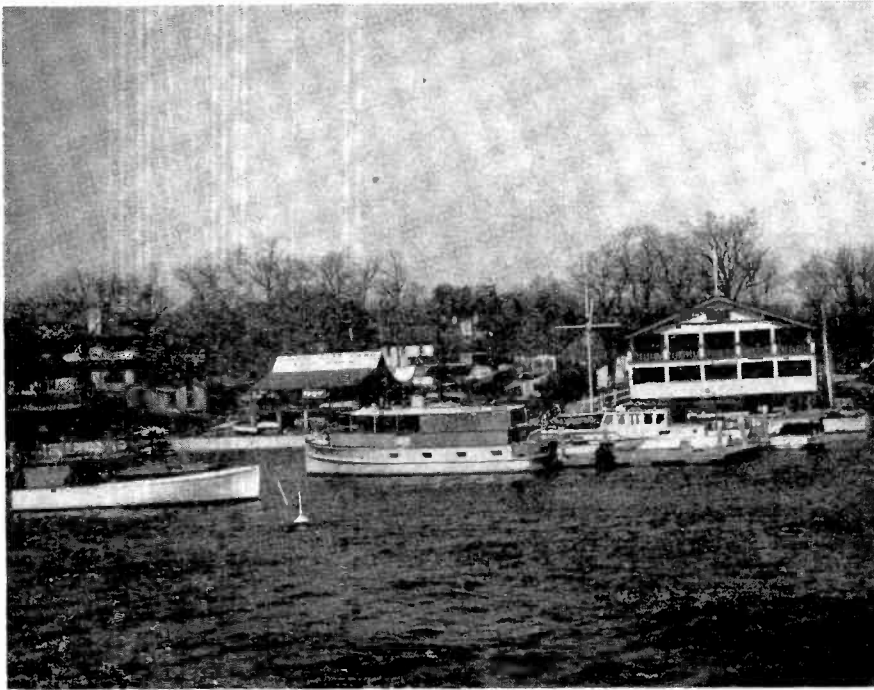

Activity is at full tide in the marine radio business. Hardly a boat does without an entertainment receiver.



Hudson American Corp. "Buccaneeer" receiver.

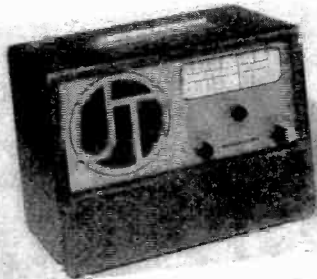

Jefferson-Travis marine portable model MR-3.
Soundview Marine Co. "Sea Mats" portable.



● The radio service man who goes down to the sea this summer is going to find things just a-swimmin'. Yachting is enjoying a boom, which boat yard men predict will last for several years to come. Marine radios are increasingly popular among boatmen and fishermen. Everything from land-lubber portables to two-way crystal control jobs are being sold and installed for the reception of entertainment programs, ship-to-ship and ship-to-shore calls, Coast Guard weather reports and time signals.

The ordinary portable set, while performing fairly satisfactorily on ship-board, has several drawbacks. If it hasn't been treated against moisture and salt air, it is, as a result, sometimes short lived when brought on board ship. The usual loop is not best suited for the reception of the almost entirely vertically polarized radio waves received at sea, and its directional qualities sometimes make it a bother in a small boat that may turn frequently.

These failings may be corrected to some extent. The choke and output transformer can be protected by immersion in hot sealing compound until the bubbles stop forming, and then "flash" dipped after it has cooled to thicken the coating.

The solder joints are particularly subject to corrosion as solder is composed of lead and tin, with which moist salt air sets up an electrolytic action. They should be painted with clear lacquer or some similar substance for protective purposes.

The same consideration holds for the chassis, which is ordinarily cad-

mium on steel. The paper capacitors, if not completely sealed, should be replaced with metal tub or moulded bakelite units.

The directivity of the loop can be lessened and its pick-up increased by the addition of a vertical rod antenna fastened to the cabinet and coupled by means of a 10-20 mmf capacity directly to the tuned circuit associated with the r-f tube. Or, a single turn of wire near, but not close enough to detune the loop, may be connected to an external antenna.

Seagoing portable receivers that have these anti-corrosion features plus a marine band are available. They usually have larger battery compartments. In general, any radio which is fully "tropicalized" is suitable for salt-water use.

Incidentally, most boat owners are unaware of the many radio dead spots that exist on inland waters. The sea is wide open, but rivers and lakes, both small or wide, are often plagued by shifting and fading points of no radio reception.

Where to Place Radio

The portable is usually used up on deck, away from the source of ignition noise. The permanently installed radio receiver, however, is mounted in-board, and of course is powered by the ship's power supply. Thus two additional problems arise.

Marine voltages are, as a rule, 6V, 12V, 32V or 110V. In the smaller boat, like the automobile, the storage battery must provide starting current. In small boats, rarely is there an auxiliary engine generator arrangement for this purpose, although it is frequently found in larger boats.

The power used by the cabin and running lights, and now the radio, is taken from the starter battery and is replenished only when the boat is under way. A boat is rarely used the way an automobile is. A car's lights and radio are seldom on when the car is parked. A boat, however, may run an hour, and anchor for several days. If occupied, its electrical equipment is used continually.

A dead battery at sea is no joke.

Install Boat Radios

Are You Located Near a River, Lake or Sea? You'd Be Surprised at the Amount of Marine Service Business Done. Check Into It Now.

You cannot simply resign yourself to getting your feet wet, and then get out to push the boat. And you just don't handcrank a large marine engine.

Before selling and installing that radio, check the boat's storage battery capacity against its lights and contemplated radio drain. Additional storage batteries, in some cases, may not be the best solution.

Weight is important aboard ship. The deeper in the water the boat sits, the harder it's going to be to move her. If this factor is not too important, however, an additional battery may be installed, and the generator's rate of charge stepped up correspondingly. Otherwise, a dry-battery portable receiver may be needed.

Connecting the radio to the boat's power supply will introduce ignition noise, and probably auxiliary motor noise. This interference may be treated in the same fashion it would be treated ashore with one basic difference . . . don't use spark plug suppressors!

Why Suppressors Are Out

Suppressors should never be installed in a marine engine. In most cases, the inclusion of a resistance in the spark circuit will *ruin the engine*. The number of times suppressors may be used with impunity are so few that suppressors may be considered non-existent aboard ship.

The reason is this: suppressors will not interfere with the starting and running of an engine. However, at full load, or close to full load, the resistors will cut down the amount of spark and prevent *complete* combustion.

The unburnt gasoline will foul the combustion chamber and eventually dilute the crankcase oil to the point where the bearings and associated parts will burn up. The gasoline is not readily detected on the oil gauge stick or pressure gauge. However, the tachometer will show low RPM.

Suppressors can be used without ill effect on most cars, since they are very seldom, and then for a short

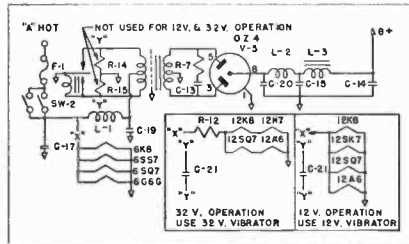

"Buccaneer" power supply for 6V, 12V, 32V., showing vibrator used off boat's starting battery.

period only, operated at full power. The modern car engine is "revved up" to full power only when the car pushes ninety, or when it is raced up a steep hill in second gear. These periods are too short to permit the gasoline to accumulate dangerously in the crankcase.

However, when a boat owner installs a hundred horse motor in his boat he uses that full hundred a great deal of the time he is under way. To double the speed of a boat you have to square the power. From this, derives the natural tendency to open the throttle and let it run.

Ignition interference, a major problem only in 2-way radiotelephone jobs, may safely be suppressed by means of complete metal shielding. A wall of metal as heavy and of as low electrical resistance as is practical is thrown around the entire ignition system, and is grounded to the engine at one, or as close to one point as possible. The high tension

primary is filtered. The plugs, distributor, ignition coil are all inside the shield.

Commercial suppressor "packages," designed to be easily installed on a variety of standard marine engines, are available. They run about \$150. installed. Care must be exercised in the design to include plenty of insulation and ventilation. The instantaneous voltages run upwards of fifteen thousand volts, and the ozone generated by the electric arcing across the points induces corrosion and needs to be let out.

Copper screening tacked to the inside of the engine box and bonded to form one continuous wall will sometimes help enormously. A ground plate has been found to be very ineffective so far as reception and noise suppression is concerned. It should not be resorted to except as a final measure or when needed to counterpoise a transmitting antenna.

The generator may be filtered by means of a bypass capacitor and filter choke. The same holds true for the water closet bowl, sump pump, ventilating and other auxiliary motors aboard the ship. It is almost all cut and try work. No two ships, even sister ships, built by the same company on the same day have been found to respond exactly alike. The fact that most of the smaller boats

(Continued on page 104)

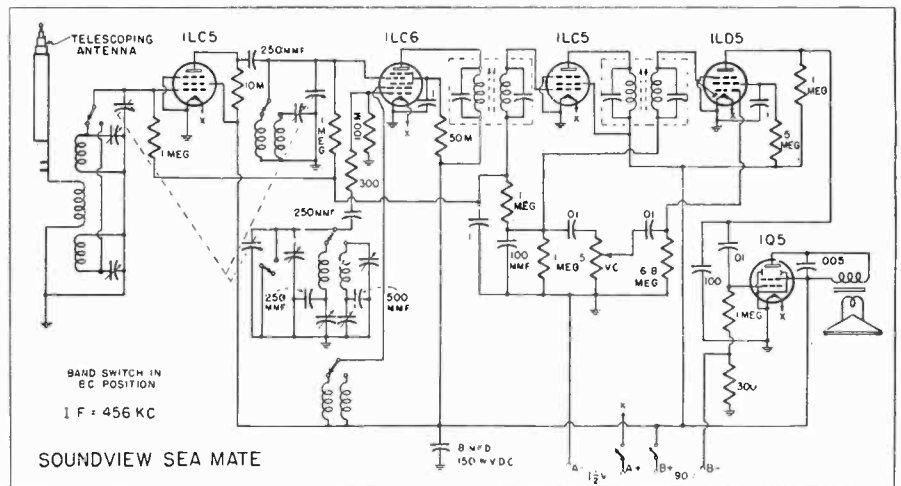

Typical marine dry battery portable, with broadcast band and 2000 kc to 6600 kc maritime band.

Makes Tele Study Easy

It's Not Too Late to Become the Television Expert in Your Area

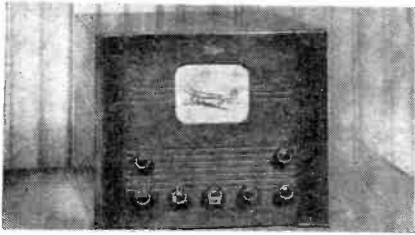

Transvision viewer, supplied with dipole antenna.

● One of the facts of life which people learn as they grow, is that practice without theory is barren, and theory without practice is sterile . . . an observation directed, in this instance, to radiomen who wish to catch the television express before it finally leaves the yards.

The long-term policy of this publication has always been to advise radiomen to study television, and to waste no time doing it. Schools, textbooks, magazine articles, service lectures and discussions . . . these are the traditional methods.

Television, however, is one of the most complicated mechanisms designed by man. As many an engineer has jokingly remarked, "the dern thing is so complicated, theoretically it can't possibly work." For the practical servicer to get on intimate terms with such a creation is, obviously, more than a casual proposition. In a word, it takes practice as well as theory.

Learn by Starting Now

In view of the current installation and servicing restrictions, and the shortage of sets, perhaps the best way to learn tele at this time is through the construction of a home-made viewer. For this purpose, several complete kits are marketed, of which the Dynamic, Transvision and Republic are illustrated here.

In each of these cases, the drudgery of laying out, drilling and punching the metal chassis and panel or cabinet is taken care of by the kit manufacturer, all parts, including tubes, are supplied and exactly identified, and complete instructions are given.

At this writing, about 6,000 Transvision television kits have been sold, according to Herbert D. Suesholtz, general manager of *Transvision, Inc.*, 385 North Ave., New Rochelle, N. Y., to persons ranging from those whose

experience has never included the handling of a soldering iron, to full-fledged radio engineers.

The Transvision kit, which includes a dipole antenna with 60 feet of lead-in and a front panel, encloses each part in its own envelope or package, and refers to it by number, rather than by value. In this way, by the use of extremely detailed wiring and layout diagrams, even a raw beginner can assemble the set, without the need of any technical knowledge of importance. For the radio-man, of course, a schematic diagram with all parts values is also included, although no reference is made to it during actual construction.

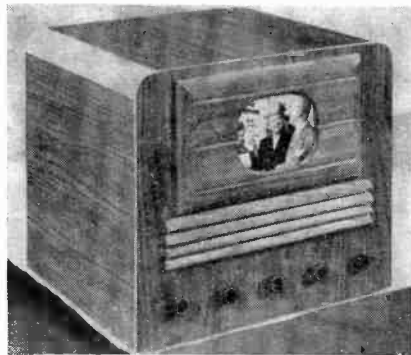

Dynamic, with wood cabinet, uses FM sound.

The video bandpass, designed to achieve a $3\frac{1}{2}$ mc width, is used with a 7" type 7EP4 kinescope. The entire r-f unit, with its two tubes and three sets of components for three television station channels, is completely pre-assembled and prewired, with all tuned amplifier circuits, including the i-f transformers, pre-aligned.

Three video i-f amplifier 6AC7 tubes, of which the first acts also as a sound i-f amplifier; a 6H6 sync clipper and video detector; a 6AG7 video amplifier; a 6AC7 sync separator; 6N7 cathode-coupled multivibrator saw-tooth oscillators and 6SN7 balanced saw-tooth amplifiers; a 2X2 high-voltage rectifier; a 5U4G low-voltage rectifier; another 6AC7 sound i-f stage; a 6SQ7 slope-detector and 1st a-f amplifier, and a 6V6 2nd a-f amplifier, complete the tube line-up.

A chart of typical voltage and resistance readings are supplied as an aid in troubleshooting. However, all parts are guaranteed for 90 days, and in each television center of the coun-

try a service agency has been appointed, to aid constructors in rectifying errors and getting the set in operation. A cabinet is supplied at additional cost.

Dynamic Television Associates, Inc., of 155 Prince St., Brooklyn 1, N. Y., manufacture a television kit, with 7" picture tube and $3\frac{1}{2}$ mc video band width, which comes with a fully complete leatherette cabinet (model TU7A) or the hand-rubbed blond-birch, walnut or mahogany wood cabinet illustrated (model TU7DL). According to Sid Teich, who, with Dr. M. Berinsky, a television pioneer, heads the company, a kit using a 12-inch kinescope will soon be in production.

Designed particularly for training purposes, aside from household use, several hundreds of these units have been constructed by students on the Veteran Training Program of the Board of Education of the City of New York, as well as by radio servicers. It is not suggested for construction by the non-technical layman.

Parts are referred to by value, rather than by number, and complete circuit breakdowns and layouts are given for study simultaneously with the progress of assembling and wiring. Coil detail sketches, wiring suggestions and precautions, and complete alignment instructions are given, including antenna information. No antenna is supplied, however. Critical portions of the 6C4 oscillator and 6AC7 mixer circuits in the r-f tuner are pre-wired.

The balance of the Dynamic kit tube line-up consists of three 6AC7 video i-f amplifiers; 6SN7 video detector and 1st video amplifier; 6SN7 2nd video amplifier and sync separator; 6N7 cathode-coupled multivibrator

(Continued on page 104)



Republic, dipole supplied, has FM sound.



available NOW

THE NEW 1947
RADIART
VIBRATOR
GUIDE
AND CATALOG

FREE

The very finest Vibrator Guide ever offered to the service field. Head and shoulders over any similar handbook, this new 1947 edition is crammed with every conceivable fact relative to the efficient servicing of auto radio power supplies. The most complete vibrator cross index ever compiled; a 23 page replacement list by brand names, buffer circuit diagrams, complete vibrator installation instructions, a six page article on the theory and use of the vibrator written by a leading authority; vibrator indexes by types, by numbers and by base diagrams... all this and much more is contained in the pages of this valuable manual. Designed to simplify the present-day problems of vibrator servicing, this handbook is an invaluable addition to any service library. Send for your free copy today.

Radiart

ELECTRONIC DISTRIBUTOR & INDUSTRIAL SALES DEPARTMENT
 MAGUIRE INDUSTRIES, INC. • 936 N. MICHIGAN AVE. • CHICAGO 11, ILLINOIS
 EXPORT DIVISION • SCHEEL INTERNATIONAL, 4237 N. LINCOLN AVE., CHICAGO 18, ILL. • CABLE HARSHEEL

ELECTRONIC DISTRIBUTOR & INDUSTRIAL SALES DEPARTMENT
 MAGUIRE INDUSTRIES, INC. • 936 N. MICHIGAN AVE. • CHICAGO 11, ILL.

PLEASE SEND MY FREE COPY OF THE NEW RADIART VIBRATOR
 GUIDE AND CATALOG, POSTPAID, TO THE ADDRESS BELOW:

NAME _____
 STREET _____
 CITY _____ STATE _____

Newest Products for PA Installers

Western Electric LOUDSPEAKER

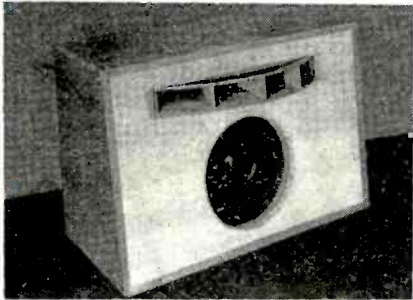

The 757A loudspeaker utilizes a 728B low frequency cone speaker and a 713B high frequency unit used in conjunction with a sectoral horn giving a horizontal sound distribution of 90 degrees. Also included is a dividing network and a four-step compensating control. A power handling capacity of 25 watts and a frequency response from 60 to 15,000 cycles are achieved. Western Electric Co., Inc., 195 Broadway, N. Y. 7, N. Y.—RADIO & Television RETAILING.

Sound Apparatus Co. TWIN-RECORDER

Two records of the same or different actions can be made simultaneously with the Twin-Recorder. Suggested uses include testing of radio and sound equipment for many qualities, especially contrasting ones, or those of two systems which are to be compared. Sound Apparatus Co., 233 Broadway, New York 7, N. Y.—RADIO & Television RETAILING

Speco MIKE CABLE

This retractable single conductor shielded microphone cable has a coiled section which is about 5' long when retracted, but stretches to 25'. The coil back is accomplished by vulcanizing the rubber covering into permanent coiled form. Besides the coiled part, there is a 4½' straight portion for running within the mike stand. Available also for desk stands. Special Products Co., Silver Spring, Md.—RADIO & Television RETAILING

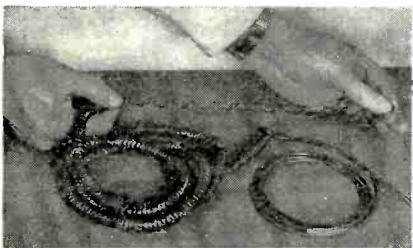

Masco MUSICAL AMP

Model MAP-105 is a self-contained light weight system in a fabricoid covered carrying case to meet the needs of small halls, dance and entertainment spots and the requirements of solo instrumentalists or small musical groups. Two inputs for mike

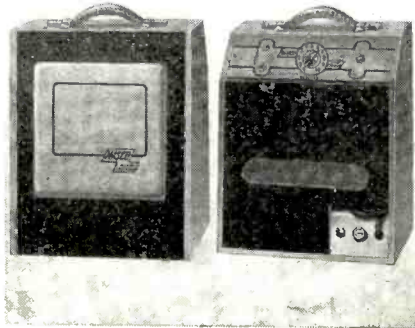

or instrument drive the 8" Alnico V PM speaker with 5 watts of power. Mark Simpson Mfg. Co., Inc., Long Island City, New York—RADIO & Television RETAILING

GE VARIABLE RELUCTANCE PICKUP

A magnetic type of pickup, General Electric's new Model DL 1RM 6C variable reluctance type reproducer provides high fidelity dependent more on the characteristics of the records than on the pickup. Hum pickup is reduced by a shielded case and balanced double coil construction. The built-in permanent sapphire needle tip is mounted in a soft spring suspension; with



the light and small stylus assembly, sensitivity only to lateral vibrations, low record pressure and the elimination of resonant response, low distortion, needle scratch, needle talk, and record wear are achieved. A preamp and equalization circuit is suggested in the data sheet which comes with the unit. General Electric Co., Syracuse, N. Y.—RADIO & Television RETAILING

Recordio MIDGET MIKE

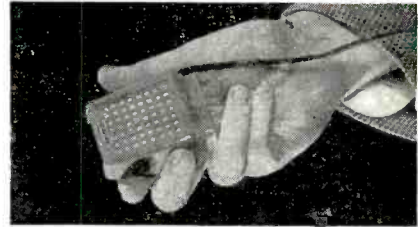

The Recordio Midget mike is light and compact, fitting into the palm of the hand. The diaphragm type crystal unit is housed in a die cast case, with a glass cloth grill. Wilcox-Gay Corp., Charlotte, Mich.—RADIO & Television RETAILING

Webster TONE ARM

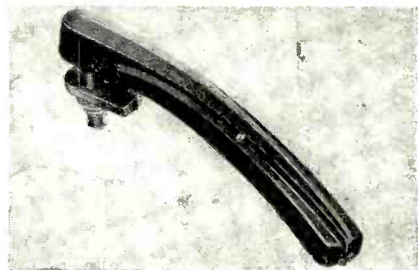

Series S Tone Arm is designed for use with F series cartridges, giving very low tracking pressure. The die cast zinc alloy arm is currently produced with cartridge Models F2 and F5. Webster Electric Co., Racine, Wisc.—RADIO & Television RETAILING

Allied 4W PHONO AMP

The Knight 4-watt phono amplifier is ready to install in record players. For use with high impedance crystal pickup and 110 volts a-c or d-c power, the amplifier measures 4"x5¼"x4¾" with tubes inserted. The inverse feedback circuit for wide frequency response provides sufficient power for an 8" or 10" speaker. Allied Radio Corp., 833 W. Jackson Blvd., Chicago, Ill.—RADIO & Television RETAILING

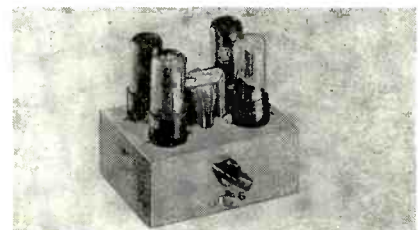



A SIGN OF SUCCESSFUL SERVICING

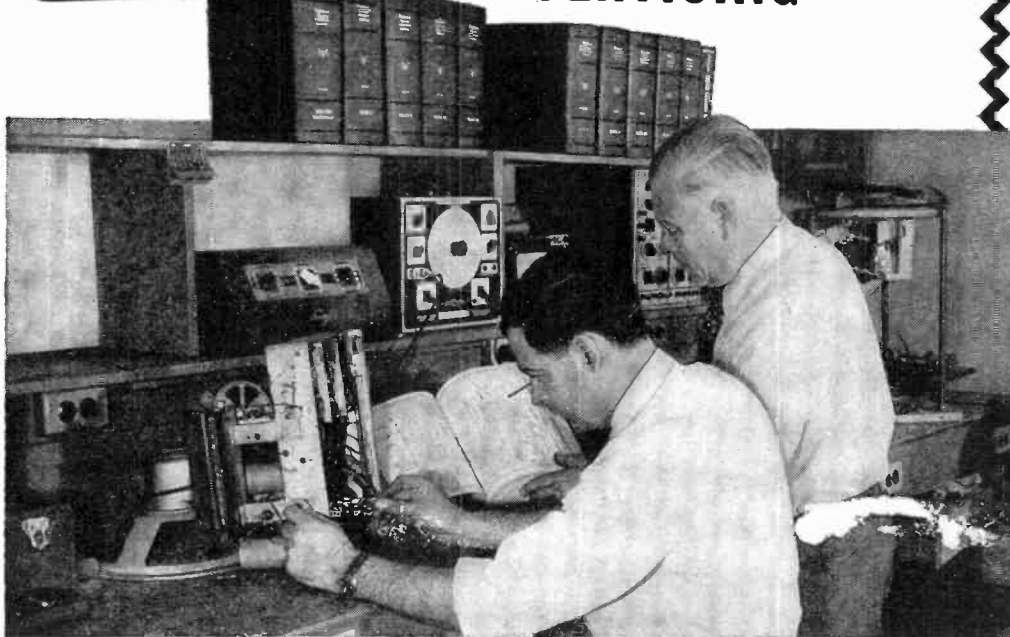

Witte has all fifteen RIDER MANUALS

Anyone in Philadelphia's radio-service circles can tell you of the high reputation and efficiency of the servicing department of Witte Radio and Television Co. And, Witte has one thing in common with other successful shops; it recognizes the time-saving value of Rider Manuals, by maintaining a set of all fifteen volumes.

You, too, need this servicing data on American made receivers made between 1920 and 1947. You, too, need the facts to quickly diagnose troubles in any and all receivers that come to you for repair. You, too, need all fifteen Rider Manuals. For, from no other single source is this complete service available; receiver schematics, voltage data, alignment data, resistance values,

chassis layouts and wiring, and trimmer connections. Dependable, authoritative information.

Volume XV, covering sets issued during 1946 and some unpublished pre-war models, is full of features resulting from "Sixteen Years of Continuing Service for the Radio Servicing Industry." For example, "clarified-schematics", which break down the composite diagrams of hundreds of complicated multiband receivers into individual schematics of each circuit as it exists with each turn of the wave band or equipment switch.

With each copy of Volume XV is the 181 page "How It Works" book, a guide to the theory of operation of the new technical features in the latest receivers. Volume XV, also includes all popular "Ham" communication receivers, Scott receivers, Magnavox RA combinations and record player combinations.

Rider Manuals are an investment which keeps pouring out profits for you. Those who bought Volume I, 17 years ago, are still benefiting from it. Be sure your shop has the Sign of Successful Servicing—be sure it has all fifteen Rider Manuals.



VOL. XV JUST OUT!

2000 pages, plus
181 page "How
It Works" Book.
\$18.00 complete

Volumes XIV to VII (each volume).....	\$15.00
Volume VI	11.00
Abridged Manuals I to V (one volume).....	17.50
Record Changers and Recorders	9.00

RIDER MANUALS MEAN SUCCESSFUL SERVICING

ENTER THE RIDER MANUAL CONTEST

224
OPPORTUNITIES
TO WIN!

\$4,325.00
WORTH OF
**CASH
PRIZES**

AND
SERVICING
EQUIPMENT

JUST TELL WHY
(in 100 Words or Less)

**"RIDER MANUALS
MEAN
SUCCESSFUL SERVICING"**

That's all you need do. Nothing to buy. Nothing difficult. No need for fancy writing. Write your entry on official blank, obtainable from your parts jobber, in plain everyday English. The first thing you write may win you one of the 224 valuable prizes.

**DON'T PUT IT OFF.
WRITE IT DOWN!**

Send in your entry
NOW!

**JOHN F. RIDER
Publisher, Inc.**

404-4th AVE., N. Y. 16, N. Y.

Export Division,
Rocke International Corp.,
13 E. 40th St., New York City
Cable ARLAB

GET THESE PERSONAL BUSINESS FORMS AND STATIONERY...

\$1

The SYLVANIA
Simplified - Week by Week
BUSINESS RECORD
FOR INCOME TAX PURPOSES
Including Withholding Tax Provisions
for the Radio Serviceman

Prepared under the direction of
Rodman L. Modra
Former Chief Deputy Collector U. S. Internal Revenue
NEW YORK, N. Y.

A Timely Bookkeeping System
Easy to Understand - Easy to Follow - Easy to Keep

Prepared especially for
Sylvania Electric Products Inc.
Emporium, Pa.

START AT ANY TIME
COMPLETE RECORD
FOR A FULL YEAR

Copyright 1945, The Tax Digest, New York, N. Y.

Wonderful Business Record Book—simplified for accurate daily records and tax information. Complete record for a full year! Only \$1.00.

YOUR IMPRINT HERE
250 - \$0.75
500 - 1.00

SYLVANIA TOP QUALITY RADIO TUBES
EXPERT SERVICE . . . PARTS

CUSTOMER'S RECEIPT

JOE MOD
Your Radio has been repaired. We guarantee it for 90 days. No charge for parts.

Radio: _____ Model or Serial: _____
When Ready: _____ Will Call: _____ Will Deliver: _____

TERMS CASH
YOUR IMPRINT HERE

SET OWNER'S WARRANTY

JOB NO. 6 **KEEP THIS WITH RADIO**

Owner: _____
Street: _____
City: _____
Date Job Accepted: _____ Delivered: _____
Radio: _____ Model or Serial: _____

NUMBER AND CONDITION OF TUBES

Good	Bad	Doubtful
YOUR IMPRINT HERE		
100	-	\$1.00
250	-	1.75
500	-	3.00

We Guarantee Sylvania Radio Tubes

JOB RECORD NO.

Signature: _____	Owner's Name: _____
City: _____	Street: _____
Radio: _____	Model or Serial: _____
Complaint: _____	Date Delivered: _____
Tubes and Material Replaced, Mounted on Service Side: _____	Date Accepted: _____
Check-up Service: _____	Repair Service: _____
Alignment Service: _____	Grand Total \$ _____
Signature (Customer's Signature): _____	Total: _____
_____	Sales Tax: _____

Job Record Cards (with your imprint)—customer's record and receipt for cash payment, and a complete job record for your files. 100—\$1.00; 250—\$1.75; 500—\$3.00.

Personal cards—essential to all businessmen—(with your imprint) 250—\$.75; 500—\$1.00.

SYLVANIA

MAKERS OF RADIO TUBES; CATHODE RAY TUBES; ELECTRONIC DEVICES;

...FOR TIME- AND MONEY-SAVING EFFICIENCY!

The special business forms shown on these pages are items essential to a carefully planned, systematic radio service department.

Sylvania's aim in the preparation of this material was simply this: to offer radio retailers with service facilities the advantage of these time- and money-saving helps at the lowest possible cost.

Now is the time to stock up. While you're using these neat, impressive forms and stationery on the home front, Sylvania's big advertising is boosting you, your products and your service from coast to coast!

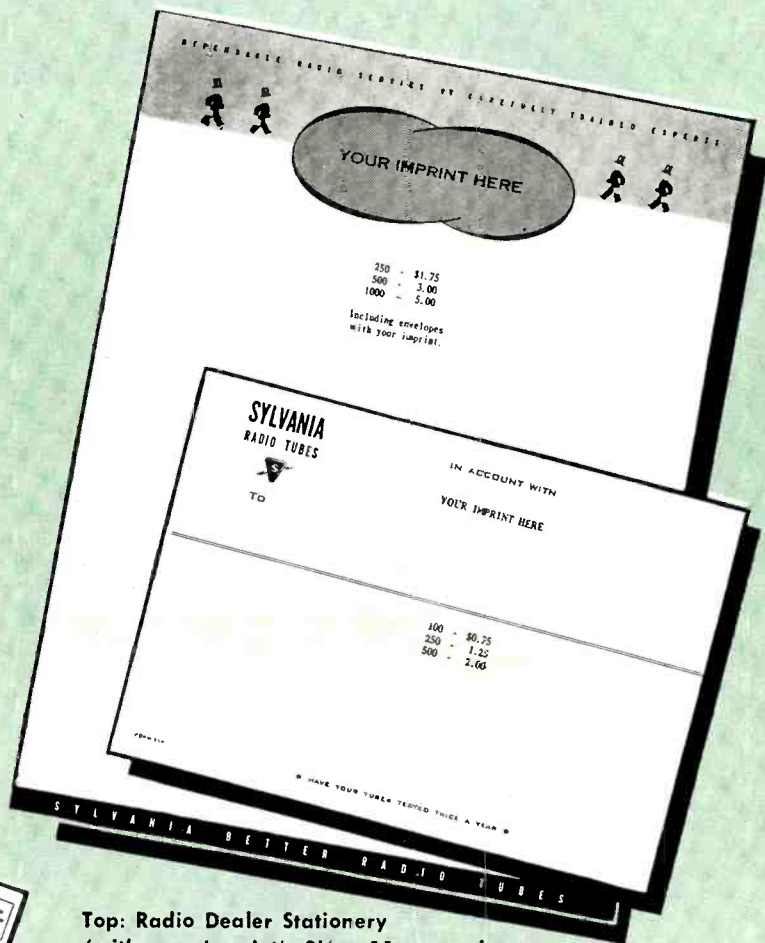

Top: Radio Dealer Stationery (with your imprint): 8½ x 11, two-color, with envelopes. 250—\$1.75; 500—\$3.00; 1000—\$5.00. **Above: Service Billheads** (with your imprint): 100—\$.75; 250—\$1.25; 500—\$2.00.

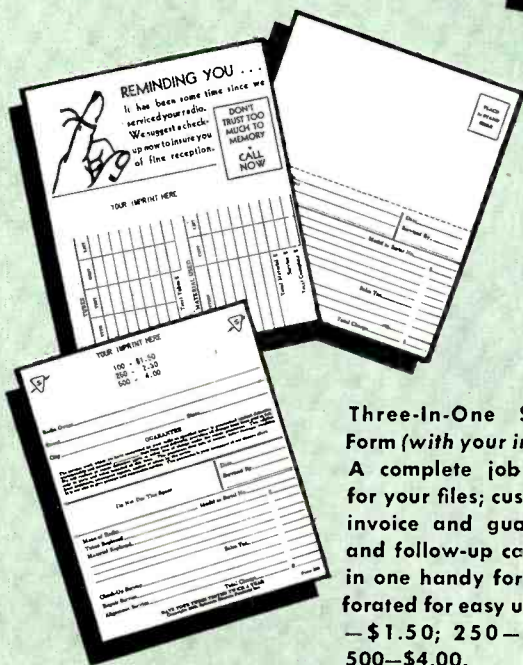

Three-In-One Service Form (with your imprint): A complete job record for your files; customer's invoice and guarantee, and follow-up cards; all in one handy form, perforated for easy use. 100—\$1.50; 250—\$2.50; 500—\$4.00.

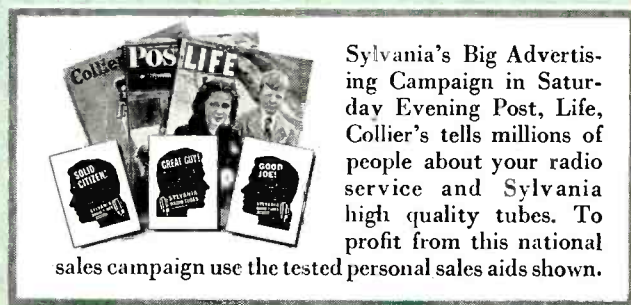

Sylvania's Big Advertising Campaign in Saturday Evening Post, Life, Collier's tells millions of people about your radio service and Sylvania high quality tubes. To profit from this national sales campaign use the tested personal sales aids shown.

Order from Sylvania Distributors or write Sylvania Electric Products Inc., Emporium, Pa.

ELECTRIC

FLUORESCENT LAMPS, FIXTURES, WIRING DEVICES; ELECTRIC LIGHT BULBS

Bench Aids Cut Service Time

General Electric SIGNAL GENERATOR



Type YGS-3 offers eight types of generated signals: unmodulated r-f, r-f plus crystal, fixed audio, variable audio, modulated r-f, modulated crystal, FM (100 kc to 200 mc) and unmodulated crystal. Fundamental range of the variable r-f oscillator is 100 kc to 150 mc, while the FM oscillator operates with center frequencies of 1, 20 and 50 mc and deviations of 20, 300 and 750 kc respectively. An internal mixer develops any desired FM frequency with the beat frequency range of the r-f and FM oscillators, while two-step r-f attenuation with level control and separate audio attenuator are provided. The r-c audio oscillator covers from 100 to 12,000 cycles. General Electric Co., Syracuse, N. Y.—RADIO & Television RETAILING

DRC TUBE TESTER

Model 410 checks tubes having 17 different filament voltages from .75 V to 117 V at recommended leads and voltages. The 4 1/2" reads POOR and GOOD, while separate scales for the two voltage ranges (to 1000 V) and the two resistance ranges (to 400,000 ohms) are provided. Three spare sockets and spare switch positions permit adaptation to new tube types, while all elements may be checked for shorts and leaks. Dayco Radio Corp., 915 Valley St., Dayton 4, Ohio.—RADIO & Television RETAILING.

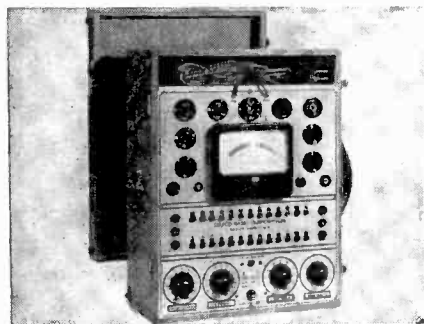

RCA PLUG-IN SCOPE

Type WO-60C permits the quick interchange of three different types of cathode-ray tubes through the front panel by means of plug-in connections. Furnished with a medium-persistence tube for general applications, a long-persistence tube for avoiding flicker at low frequencies, and a short-persistence, highly actinic screen for photographic recording without blurring are available at additional cost. Cathode coupled vertical and horizontal amplifier inputs, with a .5 to 300,000 cycle response, a sweep variable from 3 to 10,000 cycles, and an ability to handle signals input voltages as high as 850 volts peak to peak are featured. RCA Victor Division, Camden, N. J.—RADIO & Television RETAILING

RCP POCKET GENERATOR

Model 710 is a pocket-size supplementary signal generator for quick checking and alignment of repair jobs in the home. Weighing 2 lbs. in its metal case it measures 3"x6"x2 3/4". Variable attenuation and



recalibration trimmers are available, with four fixed frequencies of 1500 kc, 550 kc, 456 kc and 465 kc. The case and chassis use a floating ground, preventing shocks and shorts. Radio City Products Co., Inc., 127 W. 26 St., New York 1, N. Y.—RADIO & Television RETAILING

Federal LOOP WIRE

A small diameter, polyethylene insulated wire for the winding of small radio loop antennae, type K-1044 is of bare soft #24 copper. The Q of a 6"x9" receiver loop made of the wire reaches 200. After winding a loop, it is heated between plates, melting the polyethylene slightly. When cooled, the insulation reforms in a unit which does not require coil supports, and is resistant to water, acids, alkalis and oils. Federal Telephone & Radio Corp., Newark, N. J.—RADIO & Television RETAILING

Kwikheat KORDLESS IRON

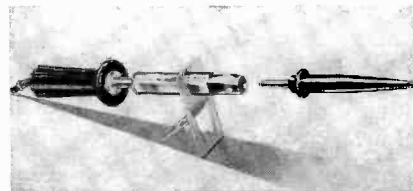

The Kwikheat Kordless soldering iron is a pencil-type tool for work in tight spots and on delicate equipment. The forged tellurium copper alloy tip holds approximately 680° temperature for nearly one minute, and reheats in about 20 seconds by re-inserting like a desk pen-set into the heater-receptacle which is plugged into the 110 volt line. The heater receptacle and the normal soldering tip are interchangeable. Sound Equipment Corp. of Calif., Glendale, Cal.—RADIO & Television RETAILING

Bruno BORING TOOLS

The new Boring Bar Set and Holder Kit contains a 1/4 in., a 3/8 in. and a 1/2 in. boring bar, plus a heavy duty holder for installation on any 9 or 10 in. swing lathe. Bruno Tools, 9330 Santa Monica Blvd., Beverly Hills, Calif.—RADIO & Television RETAILING

Simpson POCKET SIZE APPLIANCE TESTER

Model 390 is a light, rugged pocket-size appliance tester measuring to 300 volts a-c in two ranges, to 15 amperes a-c in two ranges, and to 3000 watts a-c in four ranges. Furnished with a break-in plug, the four color-coded leads are attached to the instrument, the plug placed into an electrical outlet, and the appliance to be tested plugged into it. Voltage readings will register immediately. For current or power readings, one of two buttons is pressed. Simpson Electric Co., 5200-18 W. Kinzie St., Chi. 44, Ill.—RADIO & Television RETAILING



ENGINEERING...



SERVICING...

is easier with SNC quality transformers

Here's Why!

Comprehensive research done by SNC in the field of transformer requirements has produced a line outstanding for its sturdy quality, superior design, simplicity and wide range of usefulness.

Both engineers and servicemen, particularly those in the radio field, find their work made easier due to the absence of duplication or overlap in SNC transformer specifications. And balanced design, skilled workmanship, and finest materials practically eliminate the problem of rejects.

It will pay you to investigate SNC! Write for free catalog, today.

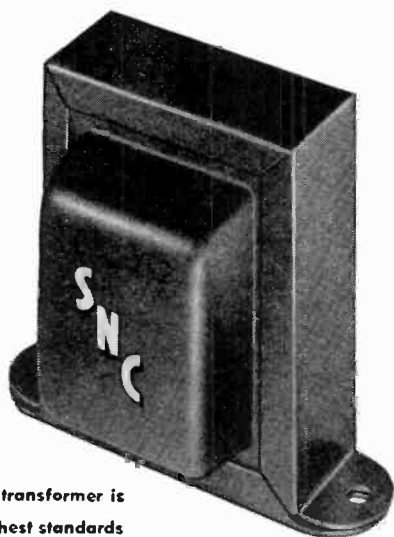

Every SNC transformer is built to highest standards for finest performance.

Remember! SNC gives MORE applications with SMALLER inventories for GREATER profits!

SNC MANUFACTURING CO., INC.
Quality Transformers
WEST LAKE AVE. NEAR LEHIGH • GLENVIEW, ILLINOIS

New Products Raise Repair Profits

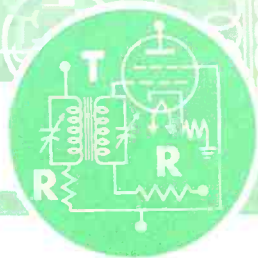

Simpson TUBE TESTERS



Models 305 RC and 330 RC are new versions of previous models. The former is a standard type tester for all receiving tubes, ballasts, gaseous rectifiers, acorn tubes, Christmas tree bulbs and many others. The latter, Model 330 RC tests tubes in terms of percentage of rated dynamic mutual conductance. Both colored zone and micromho ratings are indicated on the 4½ in. rectangular meter, while ten push-button switches and nine rotating switches of six positions each permit the testing of every type of tube. Both testers use the "No Backlash" roll chart. Simpson Electric Co., 5200-18 W. Kinzie St., Chicago 44, Ill.—RADIO & Television RETAILING

ATR AUTO RADIO VIBRATORS

This new line of replacement vibrators features 3/16" diameter tungsten contacts with wiping action, a spring steel reed, a magnetic circuit with a formed base, mica-ceramic and metal stack spacers with 2-bolt stack construction. American Television & Radio Co., 300 E. 4th St., St. Paul 1, Minn.—RADIO & Television RETAILING.

Thermador SOLDERING TOOL

Model ST-1 soldering tool uses 3/16 in. carbon tips, drawing operating current only through actual contact with metal to be soldered. No preheating is required and the work need not be grounded. A line-to-6-volt transformer with 6 feet of rubber covered primary cord and 4 feet of flexible cotton covered secondary heater cord is included. The tool weighs 3 ounces, using a total of 96 watts during operation. Thermador Electrical Manufacturing Co., 5119 District Blvd., Los Angeles 22, Calif.—RADIO & Television RETAILING

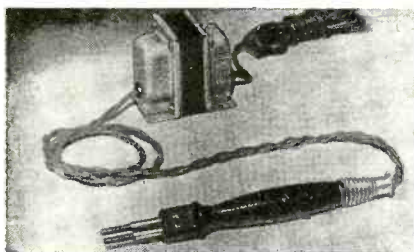

Supreme SET TESTER

The model 574 electronic set tester measures to 2500 volts a-c or d-c on six scales, at low frequencies. For r-f measurements up to 100 mc, a hand probe incorporating a high frequency diode may be used to measure up to 250 volts, in five ranges, at a minimum impedance of 20,000 ohms. Four d-c milliampere scales cover to 50 ma, and two additional ranges measure to 10 amperes. The ohmmeter has seven ranges going to 1,000 megohms, while four decibel scales are available. Supreme Instruments Corp., Greenwood, Miss.—RADIO & Television RETAILING

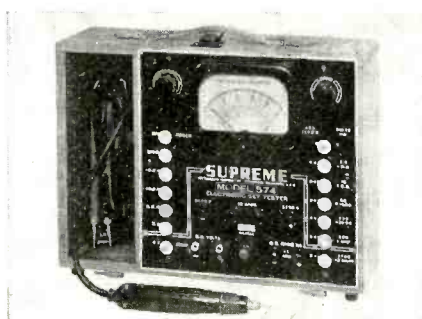

Superior VOLTBOX

This AC power supply is a compact, portable source of metered, continuously adjustable AC voltage and current. Three ranges of output voltages to 300 volts and two ranges of output current to 20 amperes are electrically isolated, independently varied and separately metered. Measures starting currents of motors, relays and other electrical appliances. Superior Electric Co., 206 Church St., Bristol, Conn.—RADIO & Television RETAILING

Polarad VOLTASCOPE



This is a small, self-contained instrument which provides three sine-wave line-frequency signals of .1, 1.0 and 10.0 volts peak to peak, for calibrating the oscilloscope at a given setting of the gain controls, and for comparing the magnitude of another signal under observation. Polarad Electronics Co., 135 Liberty St., New York 6, N. Y.—RADIO & Television RETAILING

Electronic Manufacturing SPOT FREQUENCY GENERATOR

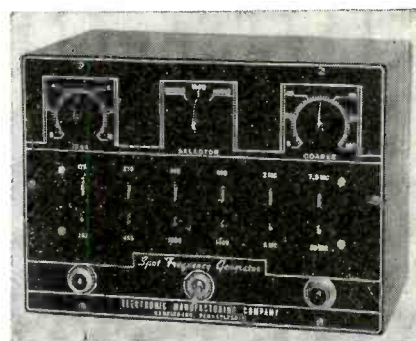

Model 200 spot frequency generator contains 12 pre-set frequencies chosen to cover all standard alignment frequencies for all-wave radios, selected by the flip of one of 6 switches. Double shielded two-unit attenuators cut the modulated or unmodulated output to less than one micro-volt, while audio test signal is also available through the same output jack. Electronic Mfg. Co., 714 Race St., Harrisburg, Pa.—RADIO & Television RETAILING

Triton PRES-TO-HEAT

This new soldering tool using a 6-volt transformer and a heating unit about the size and shape of an electric razor, operates off the AC line. A spring-actuated lever, when compressed, closes two plier-like carbon electrodes on the parts to be soldered. By further compressing the actuating lever, the current is switched on for the short period required to melt the solder. Slightly releasing the lever turns off the current and permits the work to be held between the jaws until the solder has cooled. Current is consumed only when the actual soldering operation is being performed. Triton Manufacturing Co., Inc., East Haddam, Conn.—RADIO & Television RETAILING

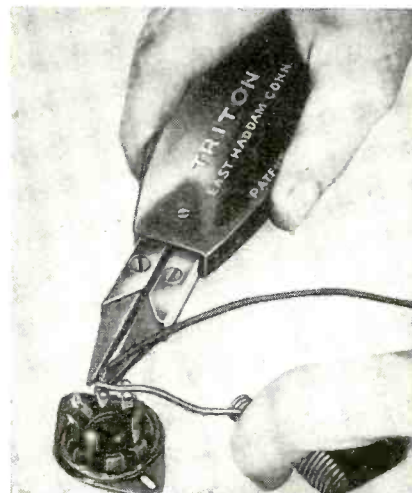

"I find by comparison there is no comparison—"

PHOTOFACT* is
by far superior
in all ways"

—E. S. Worthington, Jr.
Maplewood, Missouri
(In Radio Servicing Since 1929)

Hundreds of OLD TIME Radio Service Men have made the same comparison, and like Mr. Worthington they've found helpful, time saving, profit making, exclusive advantages in PHOTOFACT that no other service can provide.

It's like trying to compare an encyclopedia with a dictionary.
Make the test for yourself.

**You'll find these EXCLUSIVE
PHOTOFACT ADVANTAGES**

● **MOST ACCURATE**

Based on study of the actual equipment in our own laboratories.

● **MOST COMPLETE**

Gives you all the data you need.

● **MOST UNIFORM**

Data is always in the same place—easiest for fast reference.

● **DIAL CORD DRAWINGS**

For EVERY receiver.

● **PRODUCTION CHANGES**

The only service that is always up-to-date.

● **CODED SCHEMATICS**

For every receiver, keyed to complete parts lists and photographs.

● **PHOTOGRAPHS**

Top—bottom and other views of EVERY instrument—LARGE—CLEAR with each part coded.

*Reg. U. S. Pat. Off.



Ask to see PHOTOFACT VOLUMES I and II. Notice these points. The same complete data always in the same easy-to-find location! BIG, CLEAR, ACCURATE PICTURES—each with its simple coding system—keyed for instant reference to complete parts lists. Full alignment and circuit data! DISASSEMBLY INSTRUCTIONS! DIAL-CORD DRAW-

INGS! And even RECORD CHANGERS are completely diagrammed.

Put any other service beside PHOTOFACT and compare. Use PHOTOFACTS once—you'll use them forever.

Individual Set #21—available July 15 at the same low cost of \$1.50. Order Volumes I and II and the current set from your nearest distributor, or mail directly to us.

COMPARE . . . and You'll Buy PHOTOFACT

HOWARD W. SAMS & CO., INC.

INDIANAPOLIS 6, INDIANA

Export—Ad. Auriema—89 Broad St., New York 4, N. Y.—U. S. of America

Canada—A. C. Simmonds & Sons, 301 King St. East—Toronto, Ontario

PHOTOFACT SERVICE

"The Service that pays for itself over and over again"

HOWARD W. SAMS & CO., INC.
Indianapolis 6, Indiana

My (check) (money order) is enclosed.

Send _____

Name _____

Address _____

City _____ State _____

PHOTOFACTS are based on OUR actual study of the equipment covered. We ORIGINATE information—WE DO NOT COPY IT. Every fact is quadruple checked for accuracy. NO OTHER SERVICE COMPARES WITH PHOTOFACT.

PHOTOFACT VOLUMES I and II—the first 20 sets of PHOTOFACT Folders—are now available. Think of it! Almost 3800 pages, covering approximately 1800 NEW 1946 and 1947 models and chassis designations—yours for only \$18.39 for each volume. If you prefer drawer filing, order any or all of the 20 individual sets of folders at \$1.50 per set. Less than two cents a model brings you this complete, up-to-the-minute service.

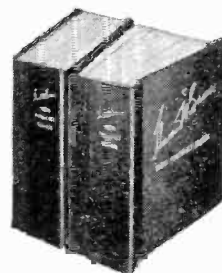

New PA Prospects

(Continued from Page 89)

Telemike is placed flat against the speaker output transformer. For two-way telephone conversations, a stage of amplification with AVC circuits having a suitable time constant, is sometimes desirable.

The Speak-O-Phone Recording & Equipment Co., of 23 W. 60th St., New York 23, N. Y., manufacture a somewhat similar device, illustrated here, which is used to pick signals off a telephone line at any point, without connections. Slipped between the twisted pair, the induction coil is used for the purposes already mentioned. It is the same unit sold by Speak-O-Phone, with concealment type and vibration-sensitive contact type microphones and a 3-stage amplifier, for investigational work.

Also of interest to the smaller PA dealer is the increasing use of sound projection from small airplanes. Illustrated here is an installation by Louis Shulman, of White Sound, 145 W. 63rd St., New York City, in a light Stinson operating in California. A relatively new technique for powering the amplifier uses a 110-volt generator powered by the airplane's motor through a take-off attached to the shaft.

A flexible drive runs through the cockpit into the rear seat compartment, where the generator is secured. This seems to be a great improvement over the usual method of employing a wind-driven generator or a bank of storage batteries.

Another new feature is the use of two reflex speakers mounted close under the wing between the struts, supported by the struts as well as by a pipe welded to the inner frame of the wings. A low drag was experienced, practically eliminating this serious drawback in airplane installations.

Outdoor taverns, picnic pavilions, park restaurants, and roadside eating places are excellent bets for new small-sized installations, as in the case of the attractive outdoor dance floor and bar shown below.

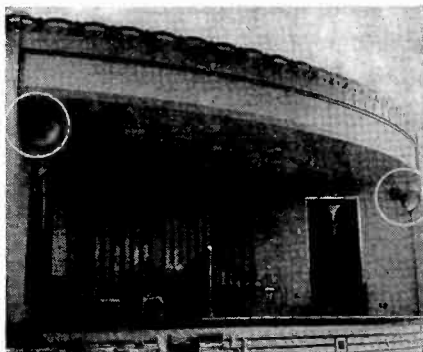

Install Boat Radio

(Continued from Page 93)

are wooden doesn't make noise removal any easier, either.

Four-hundred volt metal cased capacitors should be used, and along with the choke coils should be fastened securely on the motor frame.

While no license of any sort is needed by the service man to install and repair marine radio and electrical equipment on small boats, his work should be ship shape. Not only has he his conscience to face (a break-

down or fire at sea can have tragic consequences), but the Federal Maritime Commission periodically inspects all boats, of any size, that carry passengers for hire, and the insurance companies also inspect ships.

The service man may install and service transmitters, but he may not tune up a transmitter on the air. A non-radiating dummy antenna is permissible. This is true, of course, unless he carries a 2nd class commercial radio and telephone operators license, or better. A "ham" license, any grade, does not apply.

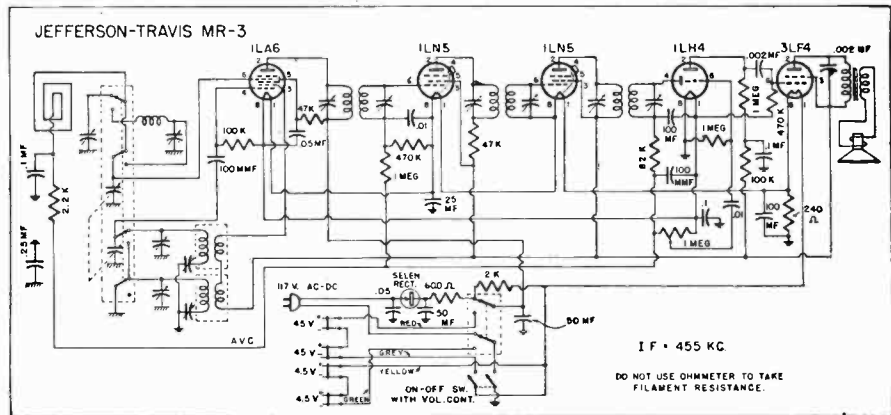

Jefferson-Travis model MR-3 is an example of an ac-dc-battery portable designed for shipboard installation.

Quick Checks

(Continued from Page 87)

Changed chassis are numbered V-2102-1.

Occasionally an Arvin model 665 (chassis RE-229) radio-phono combination will be found with the early production filament string arrangement. According to the maker, the original order was: 35Z5, 6SS7 i-f, 12SA7, 6SS7 r-f, 50L6, and 12SQ7. If frequent burnout of the 6SS7 i-f tube is encountered, rewire the filaments as shown in Fig. 3, p. 87.

On the same company's model 558 radio-phono combination (chassis RE-204), if a set is found to be microphonic when playing records, check for the presence of 4 felt washers under the chassis and a wood block 3 3/4" x 8" x 3/4" glued under the phono motor board, against the front side of the center brace.

A letter commenting on the time-saving tips appearing on page 95 of our April, 1947, issue points out that the change recommended for Stewart-Warner's models 9001-C, D, E and F and 9003-B applies AVC voltage to the r-f stage as well as the converter stage when the set is used for push button operation. The early production models had a circuit arrangement that did not utilize AVC action on the converter tube during push button operation.

Easy to Learn Tele

(Continued from Page 94)

tor saw-tooth oscillators and 6SN7 balanced saw-tooth amplifiers; 2X2 high-voltage rectifier; 5U4 low-voltage rectifier; 6AC7 sound i-f amplifier; 7X7/XXFM frequency-modulation discriminator and 1st a-f amplifier; and a 6V6 2nd a-f amplifier.

Republic Television, Inc., of 7 East Madison Ave., Dumont, N. J., market a television kit model TL-4. According to Donald P. Nelson, of that company, anyone who can use simple tools and who possesses an average mechanical aptitude, can easily assemble the receiver.

Twenty tubes are used, including a 7" kinescope, and with the kit comes a finished hardwood veneer front panel and an antenna with 60 feet of lead-in and mounting brackets. The i-f transformers are permeability tuned, and the can is mounted with internal coupling and wiring preassembled and tuned.

The r-f tuning unit is supplied fully wired and three of the five sets of television station channel components are pre-tuned to the channels available to the buyer's locality. The sound channel uses an FM discriminator and limiter, while the picture channel is designed to have a 3 1/2 mc band width. A walnut wood cabinet is supplied at an additional cost.

NOW *One* INSTRUMENT FOR ELECTRONIC MEASUREMENTS

WESTON ELECTRONIC ANALYZER

Incorporating:

- 1. A conventional Volt-Ohm-Milliammeter with self-contained power source.**
- 2. A high impedance electronic Volt-Ohmmeter using 115 volt, 60 cycle power.**
- 3. A stable, probe-type, Vacuum Tube Voltmeter, for use to 300 megacycles.**

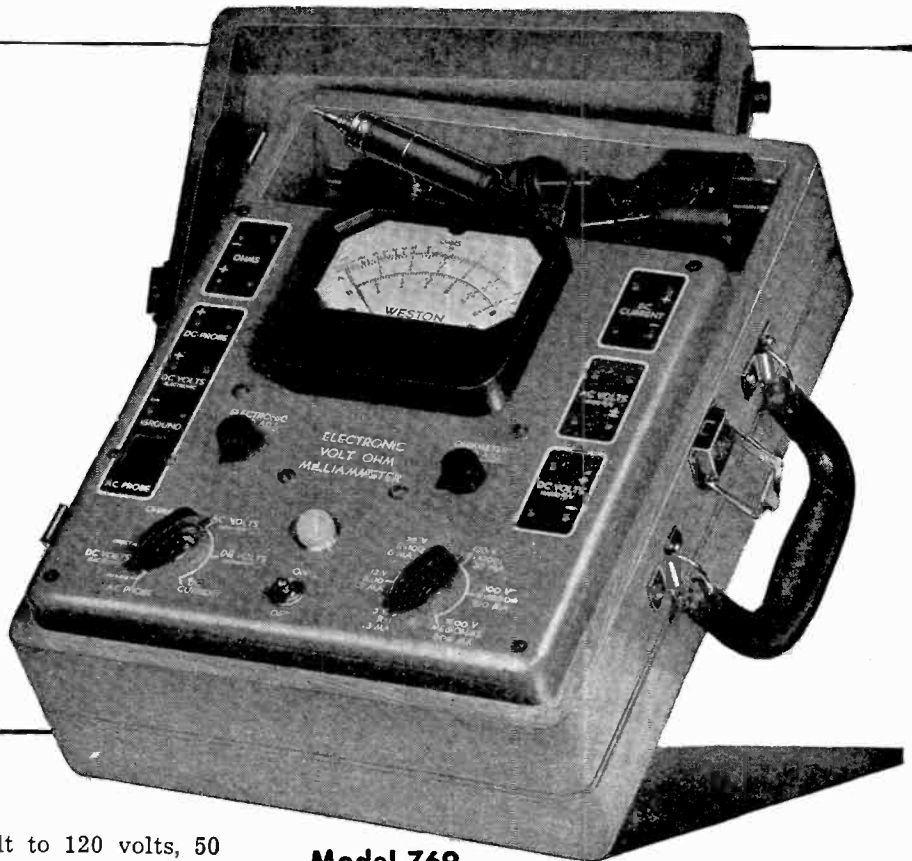

Model 769

Accurate a-c measurements .25 volt to 120 volts, 50 cycles to 300 megacycles.

Extremely small R.F. Probe (3½" x ¾" dia.). Probe constants, 5 megohms paralleled by 5 mmfd., approx.

New unity gain d-c amplifier provides absolute stability with line voltage variations from 105 to 130 volts.

D-C Electronic amplifier ranges 3 to 1200 volts at 15 megohms, resistance ranges 3000 ohms to 3000 megohms.

Conventional 10,000 ohm per volt d-c ranges 3 to 1200 volts, 1000 ohm per volt a-c rectifier ranges 3 to 1200 volts.

Resistance ranges 3000 to 300,000 ohms where a-c power is not available.

Entire Model 769 protected from external RF influences.

Uses standard commercial types of tubes replaceable without recalibration.

Size only 10" x 13" x 6⅛".

Full details from your jobber or local WESTON representative. Literature available... Weston Electrical Instrument Corporation, 581 Frelinghuysen Avenue, Newark 5, New Jersey.

WESTON

Instruments

ALBANY · ATLANTA · BOSTON · BUFFALO · CHARLOTTE · CHICAGO · CINCINNATI · CLEVELAND
DALLAS · DENVER · DETROIT · JACKSONVILLE · KNOXVILLE · LITTLE ROCK · LOS ANGELES
MERIDEN · MINNEAPOLIS · NEWARK · NEW ORLEANS · NEW YORK · PHILADELPHIA
PHOENIX · PITTSBURGH · ROCHESTER · SAN FRANCISCO · SEATTLE · ST. LOUIS
SYRACUSE · IN CANADA, WORTHER® ELECTRIC CO., LTD., POWERLITE DEVICES, LTD.

Sales **Tips and** Profit **Pointers**

In order to speed up sales and to gain confidence of customers, the merchant should make certain that all large and small appliances and radio sets on display are price-tagged. Such procedure helps customers to make buying decisions, and eliminates the possibility that one of the salesmen will have to "look up the price," in the meantime keeping the customer cooling his heels.

Praise is a powerful stimulus to better work. Give the men who get the sales contracts frequent public praise. Stop short, however, of the point where it creates arrogance.

Most prospective buyers can sense whether or not a salesman likes his job. A good salesman is a guy who *loves* his profession—an actor who *lives* the part he plays and, therefore, doesn't "ham" up his roles.

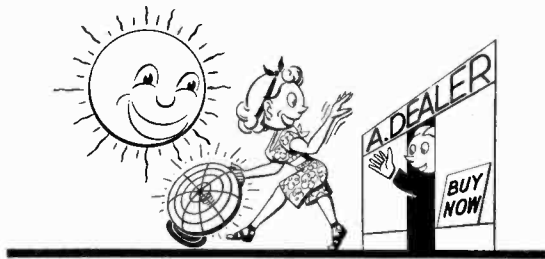

When your customer hesitates to buy, overcome the time factor by capitalizing on seasonal reasons or any other advantage of immediate purchase. Show that if the product is worth buying, it is worth buying now.

The daily record of sales and of cash payments is the basis of accounting control. From the basic records you can make monthly and yearly summaries which enable you to plan operations and control expenses.

The only way the employer can find out whether the would-be salesman applicant will turn out to be a good salesman is to put him at the job of selling. Unless the person comes to the merchant with a good selling record back of him, it's next to impossible to peg his capabilities accurately on the basis of his appearance, speech, mannerisms, etc.

The retail salesman has a good pattern to follow in the wholesale salesman who's built a following because he *services* his accounts—makes after-sale follow-ups.

The Guest Experts of the Month Say—

Proof in selling makes sales simple. When a prospective ironer purchaser walks into your store and asks a leading question, make your answer convincing enough to make the sale. For example — when a housewife inquires if shirts can be ironed satisfactorily on an ironer, don't give a weak reply of "Yes" or "Sure" because that would only be a statement which invariably is discounted. But instead—be emphatic, say, "Yes, ma'am, I will show you how it is done," and you will make the sale. Remember, in selling, there is nothing more convincing than proof.—*Joseph Groshans, general manager, American Ironing Machine Co., Algonquin, Ill.*

In preparing for the highly competitive days ahead, it seems obvious that the smaller retailers, even one man shops, cannot afford to be without the services of an outside man. Appliance sales are direct sales of the most fundamental type. As long as the retailer must depend on over the counter sales, he will never realize his true sales potential. The good will which he can build through having a representative of his business visit with the homes of his area, will be worth far more to him than the expense of the commission paid to either a full-time man or a part-time man. Broaden your horizons with more outside men.—*Harry E. Harris, vice-president and sales manager, Bell Sound Systems, Inc., Columbus, Ohio.*

Timeliness of advertising and display programs is important to sales success. A good merchandiser learns to know the proper time for the appearance of a particular advertisement, setting it neither prematurely nor too late, and carefully determines *when* as well as *how* a special display can be most economically and effectively tied in with a product he wishes to move. — *John Garceau, manager of advertising and sales promotion, Farnsworth Television & Radio Corp., Fort Wayne, Ind.*

When the buyer's market comes, as it will sooner with some items, later with others, the dealer who thoroughly knows the product he handles will cash in on the sales.

The dealer must be able to convert the various features built into the product to points of usefulness to the purchaser and indicate in understandable terms just why these features are of definite value to the user. Knowledge of the merchandise and its adaptability to the user's need is paramount.—*H. M. Parsons, vice-president in charge of major appliances, Landers, Frary & Clark, New Britain, Conn.*

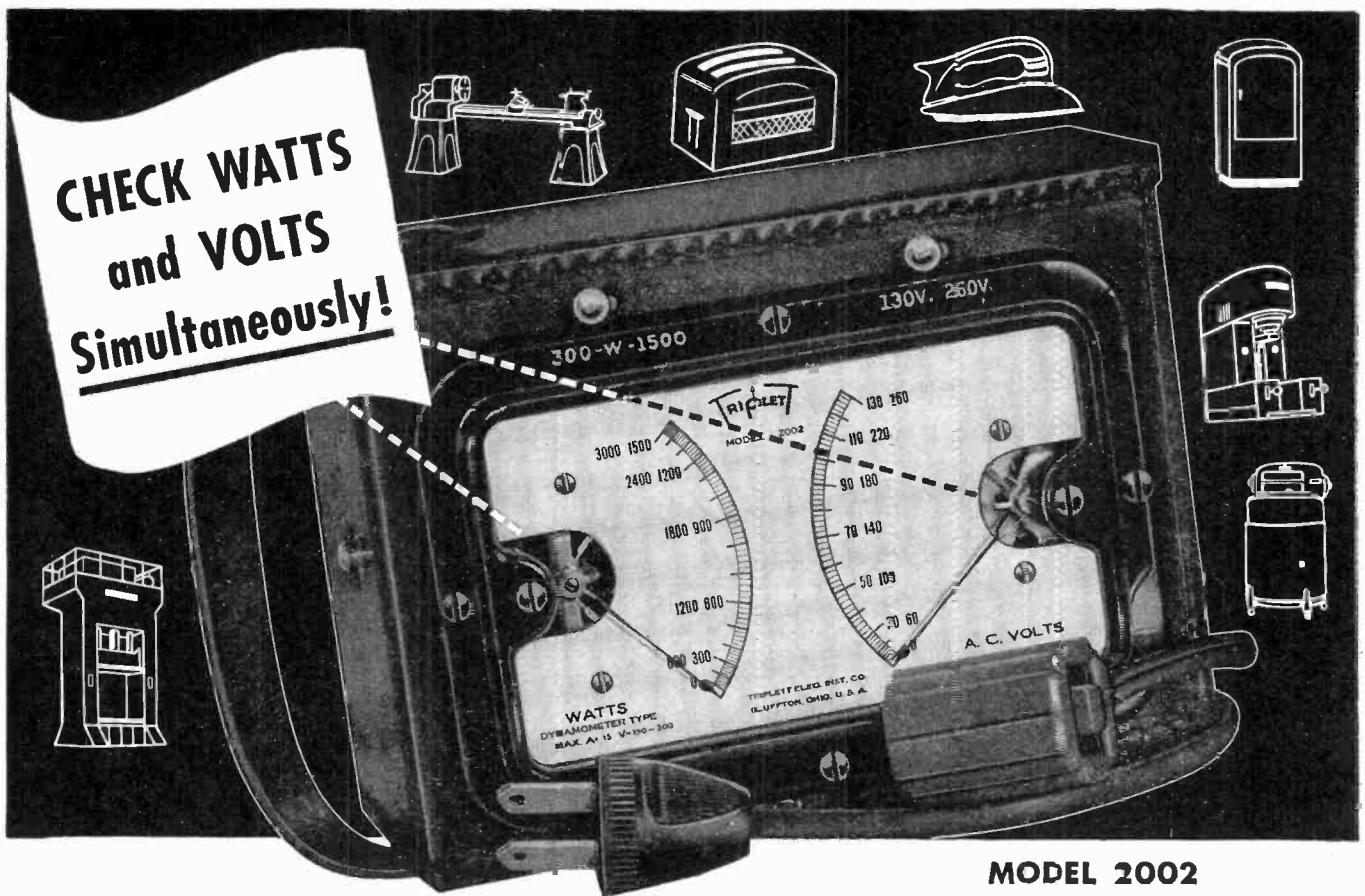

MODEL 2002

APPLIANCE MEN SAY...

"You can't beat it for Installations and Service Calls"

You, too, will find Model 2002 Triplet Appliance Tester one of the best little helpers you have ever had for installations and service calls. Weighs only two pounds but saves time and speeds the day's work. Tests power consumption of radios, industrial equipment, and household appliances under actual running conditions, on either D.C. or A.C., between 25 and 133 cycles. CHECKS WATTS AND VOLTS SIMULTANEOUSLY! Shows faulty power lines. *Heavy inner construction assures ample current capacity for momentary tests on motor starting over-loads.* Easy reading and simple operation because of wide open meters and clearly marked toggle switches. Heavy leather carrying case with strap handle has flap to protect meter window, and provides storage space for leads. Use Model 2002 *once* . . . and you will never want to be without it! Ranges: 0-1500-3000 A.C.-D.C. Watts at either 130 or 260 volts; and 0-130-260 A.C.-D.C. Volts.

SEE YOUR DISTRIBUTOR OR WRITE FOR FULL DETAILS
ADDRESS YOUR INQUIRY TO DEPARTMENT Q77

ANOTHER TRIPLET TRIUMPH!

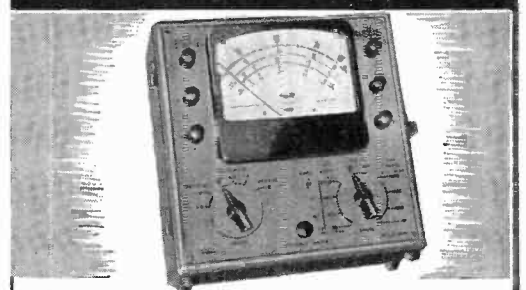

MODEL 2470 APPLIANCE TESTER

• Wattmeter, ammeter and voltmeter tester measures wattage consumption, current, and line voltage of all household appliances. Smallest appliances readily checked on extremely low scale range of 0-20 watts (fused to prevent damage from accidental overload). Ranges: 0-20-500-1000-2000 at 130 volts; 0-40-1000-2000-4000 at 260 volts; 0-0.26-6.5-13-26 Amperes; 0-130-260 AC-DC Volts.



Triplet

ELECTRICAL INSTRUMENT CO. BLUFFTON, OHIO

FM Sales Highlights

Production Hiked 47% on FM Receivers

In the latest count on FM receivers now being produced, the Radio Manufacturers Association reported that FM-AM radio set production during April spurted 47% over that of March.

An estimated 98,625 radio sets with FM reception facilities were manufactured by RMA member-companies in April as compared with 67,264 in March. Actual production during a five-week period, March 31-May 2, inclusive, was 112,256, whereas the March report covered only four weeks, March 3-28, inclusive. RMA reports are made on a weekly basis.

The Pace Increases

April's estimated production of all types of radio receivers by RMA companies was 1,548,540 as compared with 1,377,269 in March. Actual production during the five-week period, March 31-May 2, inclusive, was 1,759,723.

Television receiver production in April showed a slight gain over March, reaching 7,886 for the five-week period as against 6,639 for the four-week March period.

April's television output was classified as follows: 3,971 radio table models, 2,242 direct viewing radio consoles, 87 projection consoles, 686 direct viewing radio-phonograph combinations, 40 projection radio-phonograph combinations, and 860 converters.

The April figure brings the total television receiver output for 1947 to 26,205

as of May 2, while FM-AM sets produced during the same four-month period totalled 284,432.

Freed Revises Prices on Two Combo Units

Announced as "the first price reduction in the quality radio-phonograph field," the Freed Radio Corp., has reduced prices on its two leading FM-AM combinations from \$795 to \$695. The cut on the two Freed-Eisemann high-fidelity units was made "in the spirit of President Truman's suggestion to reduce consumer prices."

No change was made in dealer discounts. In addition to the price revision, Freed also announced that the firm is launching a new cooperative newspaper advertising plan.

Speaker Requirements for Quality FM

Altec Lansing Corp., in a series of trade announcements is now emphasizing the danger of overselling the benefits of frequency modulation if dealers provide radios that are incapable of delivering the full benefits of FM.

The firm whose headquarters are at 250 W. 57th St., New York 19, N. Y., points out that to be true, the speaker system in an FM set "must be capable of reproducing the full FM range, which is from 50 to 15,000 cycles per second, without distortion." Altec Lansing, long-time manufacturer of theatre loudspeakers, is now making the Duplex speaker for the home.

Singing Star Okays a New Combination



Opera star Lily Pons, who's naturally inclined to be critical about matters of tone, plays a favorite recording for Paul L. Chamberlain, sales manager for GE's receiver division. She said that this Model 417 AM-FM radio-phonograph delivers "the most perfect record reproduction I have ever heard."

Dipole with Reflector

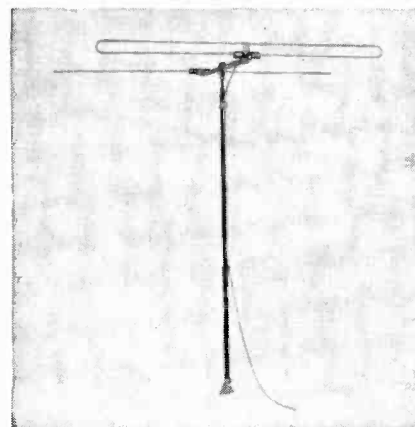

Here's the folded dipole FM antenna offered by Ward Products Co., 1523 E. 45th St., Cleveland 3. The firm also has a straight dipole available, with or without reflector kit.

Variety of FM Models Offered by RCA

RCA Victor is now showing "the largest number of FM receivers ever to be presented by a single company." The firm offers a full line of home instruments incorporating FM, which includes four table models, two new television receivers, and a wide variety of consoles.

Among the consoles is the versatile new five-in-one television-radio-phonograph console (Model 641TV), a complete home entertainment unit combining a direct-view 52-inch-square television screen with FM, standard broadcast, and international short-wave radio and a Victrola phonograph with automatic record changer and silent sapphire permanent point pickup.

Also there's the new Crestwood series of FM-AM-shortwave-Victrola phonograph consoles, the lower-priced Model 711V2 console incorporating the same four services, and a new FM-AM Victrola phonograph console (Model 610V2), at a suggested list price of \$325 to \$340, according to cabinet finish.

The first RCA Victor FM table model announced was the 68R3 unit. This set is the first of a series of RCA Victor table model FM receivers in cabinets of plastics and selected woods, with others soon to be introduced. All will feature the Golden Throat tone system. (Suggested retail price of the initial set is \$95. Suggested prices for others in the series will range from \$79.95 to \$95.)

The 68R3, combining FM with standard broadcast, and housed in a modern cabinet of walnut veneers and other selected woods, is now in quantity production at the company's Bloomington, Ind., plant, and initial shipments have been made to distributors. The new set is equipped with 7 tubes plus rectifier, and a special radio-frequency chassis sub-assembly.



...the new line of

WEBSTER ELECTRIC Pickup Tone Arms

LOW TRACKING PRESSURES

DEPENDABLE PERFORMANCE

PRECISE CONSTRUCTION

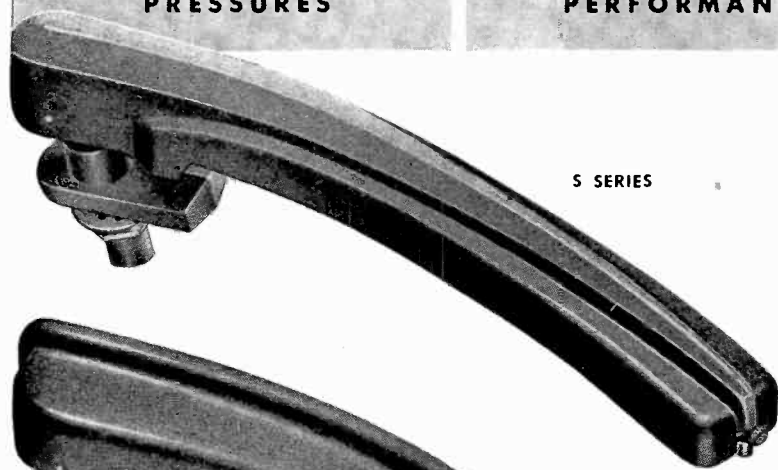

S SERIES

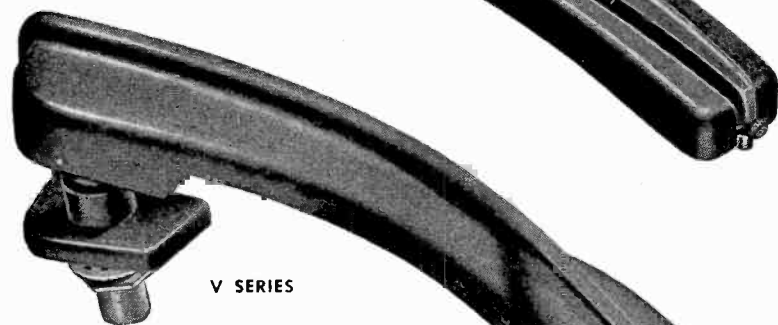

V SERIES

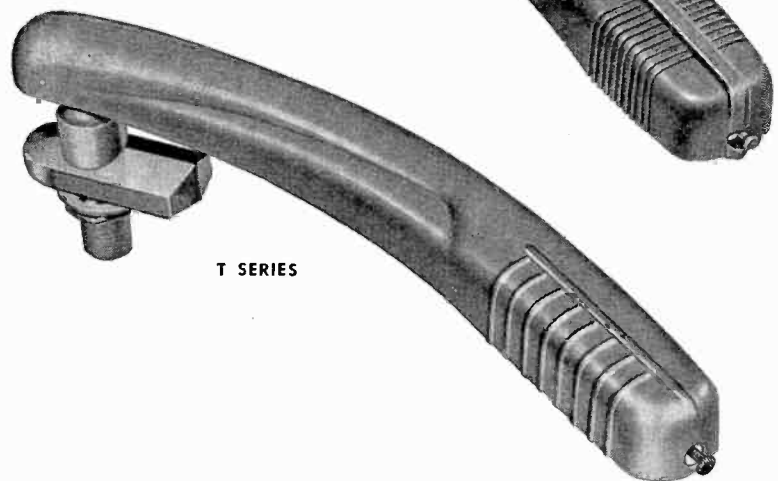

T SERIES

Here is another step forward—New Designs—and improved performance in the new line of Webster Electric Pickup Tone Arms.

Among the many outstanding features are their low tracking pressures, attractive appearance, and freedom from resonance distortion.

Additional points that describe their merit are as follows:

- Perfect Response
- Modern Styling
- Low Record Wear
- Easy to Install
- Feather-light Tracking
- High Needle-point Compliance
- Accommodate Various Needles
- All Voltage Requirements
- Negligible Surface Noise
- Correct Tracking Angle

Already adopted by many leading record player manufacturers for new models, they offer the finest in styling and performance for modernization and repair of existing equipment.

In addition to this new line of complete pickup tone arms, a complete selection of cartridges is available for universal replacement in all makes of tone arms.

Send for your copy of New Cartridge Replacement Chart that shows which cartridge to use for correct replacement purposes.

SERIES "S"—Sturdy die-cast zinc alloy construction with spring counterbalance maintains tracking pressure at only one ounce. Meets majority of requirements.

SERIES "T"—Stamped aluminum construction without counterbalance or springs. Internally braced to give maximum rigidity and freedom from resonance distortion. Tracking pressure 1.25 ounce.

OR SERIES "V"—Aluminum die-cast construction, a deluxe model with high lateral ridge to assure absolute minimum in resonance distortion. Tracking pressure .75 ounce.

(Licensed under patents of the Brush Development Company)

WEBSTER ELECTRIC
RACINE WISCONSIN



Established 1909

Export Dept. 13 E. 40th Street, New York (16), N. Y. Cable Address "ARLAB" New York City

"WHERE QUALITY IS A RESPONSIBILITY AND FAIR DEALING AN OBLIGATION"



Texans Crowd Around the New Pictures

"Traffic jam" is always the result of television showings in new areas. This is part of the crowd which flocked around the Stewart-Warner booth at the Ft. Worth, Tex., show where The Texas Electric Co. exhibited new postwar electrical products. The "Videorama" console was a feature of the exhibit; it grabbed the attention of many of the 140,000 show guests at the week-long event. This receiver comes in custom-built cabinet with a choice of three finishes.

Middle West Gets First Link of Tele Network

The first television relay link between two cities in the Middle West—the beginning of a new network in a new area—goes into action between the WBKB transmitter in Chicago and a terminal station at South Bend, Ind. While the chief aim of the new relay was to be able to televise the football games of the famous Notre Dame team, it was seen by Chicago radio men as the first step toward a local video web capable of picking up many sports classics in Middle West towns.

The hook-up between South Bend and Chicago is made by means of two control towers as relay points in Indiana. One is located at New Carlisle and the other at Michigan City.

Video fans in the area are now looking forward to when the expanding network will pick up the Columbian yacht races at Michigan City and the well known auto races at Indianapolis.

Television Topics

New Video Markets in Thirty-Eight Cities

The list of broadcasters whose television licenses are now on file in one form or another, at the FCC, shows that 38 different cities are involved. These towns, which either are, or will soon be, television markets, are located in 25 different states, coast to coast. They are as follows:

Albuquerque, N. Mex.	Ames, Iowa
Baltimore, Md.	Boston, Mass.
Cincinnati, Ohio	Buffalo, N. Y.
Cleveland, Ohio	Chicago, Ill.
Columbus, Ohio	Dayton, Ohio
Ft. Worth, Tex.	Dallas, Tex.
Indianapolis, Ind.	Detroit, Mich.
Los Angeles, Calif.	Miami, Fla.
Louisville, Ky.	St. Paul, Minn.
Milwaukee, Wis.	New Orleans, La.
Minneapolis, Minn.	New York, N. Y.
Philadelphia, Pa.	Newark, N. J.
Pittsburgh, Pa.	Portland, Ore.
Providence, R. I.	Richmond, Va.
Riverside, Calif.	St. Louis, Mo.
Salt Lake City, Utah	Seattle, Wash.
San Francisco, Calif.	Stockton, Calif.
Schenectady, N. Y.	Toledo, Ohio
Washington, D. C.	Johnstown, Pa.

Philco Ready With First Video Model

Philco is now showing its first commercial television receiver, Model 1000—a unit with a 10-inch picture tube and "many new and exclusive Philco features" in a modern mahogany cabinet. It was announced by James H. Carmine, vice-president in charge of merchandising for Philco. The company is concentrating the sales and installation program in the Philadelphia television area for the pres-

ent. The firm intends to utilize the Philadelphia television area as a "training ground" both for its entire local dealer sales and service organization, and for representatives from Philco distributors in other television areas.

The Philco television training program covers (1) training all dealers with qualified service organizations, as well as independent service men, in installation and maintenance, and (2) an integrated sales training plan to prepare Philco dealers and their salesmen to sell the new receivers intelligently.

The new television sets are now being sold by dealers to their customers without demonstration, as "most sales are readily made by telephone because of the widespread interest with which Philco receivers have been awaited."

One feature of the Model 1000 is the Philco Electronic Control, which brings the user a clear, steady picture in sharp focus the moment he switches the tuning control to the channel he wants. Pictures are automatically synchronized and focused.

There are only five manual controls: a station selector; brightness and contrast for picture; volume and tone control for sound. All other adjustments are automatic for the user. The receiver is housed in a new type mahogany table cabinet, with "a streamlined flow around the cathode ray picture tube that expresses the spirit of television to the consumer."

More Brilliant Pictures on Bigger Screens

"Doubling the picture brilliance and increasing the contrast through a modification of our optical system" has been announced by Hamilton Hoge, president

of United States Television Mfg. Corp., 3 W. 61st St., New York 23.

"Big picture projection television sets showing pictures larger than a full newspaper page with this improvement added are being delivered by UST," Mr. Hoge said. "UST expects to increase this brilliance to 2½ times the present level in the near future. This will be accomplished without curved screens, key-stoning, electronic aberration, slanting mirrors, and other methods by which other companies are understood to be attempting to reach such brilliancy standards in projection sets about to be introduced."

"Sharp Focus" Receivers Shown by Andrea

First showing of its 1947-48 "Sharp Focus" television sets have been held by Andrea Radio Corp., 27-01 Bridge Plaza North, Long Island City, N. Y. Three units, all with AM and FM radio, were shown at the Andrea plant. These were the table model T-VJ12 at \$695, the console model C-VJ12 at \$795, and the CO-VJ12 console combination model with automatic record changer at \$995. (See "New Products" section.) Andrea will show a projection model at a later date.

All three units have the same chassis—with 13 telechannels, a 12" picture giving "daylight brightness" on a screen 7½" by 10". Features include the "Station Lock TV Selector", new circuits designed to minimize electrical interference and to insure picture clarity and steadiness, quality-styled cabinets, and several safety devices.

The company will leave the field installation and service work to qualified dealers, although it will help to train retailers in the proper procedure.

Featherlite Antennas for Television and FM

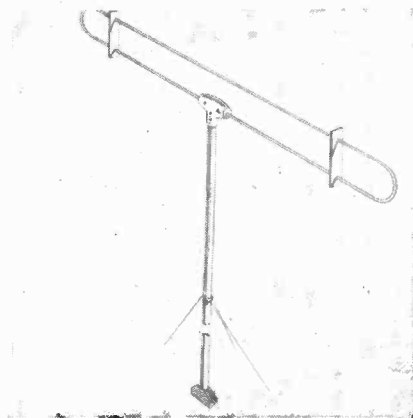

Camco "Featherlite" folded dipole, Model F22 for 88 to 108 mc FM band, with or without twin lead. Model T32 covers 44 to 216 mc for tele.

The new line of "Featherlite" antennas for television, FM and amateur use, now being featured by Camburn, Inc., 32-40 57th St., Woodside, L. I., includes 9 different models. These are of five types—dipole, dipole and reflector, folded dipole, folded dipole and reflector, and the amateur units. Each is available with or without transmission lines.

The FM and tele units are designed to operate with standard 300-ohm transmission lines, or they can be used with coaxial cable or twisted pair. They can be rotated to eliminate ghosts, they can be tilted, and are equipped with guy wire supports. The antennas are pre-tuned—no length adjustment required. They are all metal construction, easily installed.

Radio Service School

At the first of a district-wide series of radio service schools, held at the Rochester, N. Y., Westinghouse Electric Supply Co., was host to 35 radio servicemen from the area.

FM was the feature subject, with Robert Douglas, Fred Bartley and John MacKenzie on the program.

Promotion Package



Complete package of promotional aids, with something new for each month, is part of Universal's big "Point O' Sales" program for dealers' and jobbers' year 'round merchandising. It ties in with increased national advertising of Landers, Fray & Clark, New Britain, Conn.

America's *Most Convenient*
Radio-Phonograph

NOTED FOR TONE!



The Beautiful New

HOWARD
FM · AM CHAIRSIDE

This great new Howard provides thrilling musical reproduction on both FM and AM radio and automatic phonograph.

It may be conveniently placed on either side of a chair. Roomy record storage compartment is accessible regardless of position. Radio or phonograph may be operated without disturbing the cabinet top.

The hand-rubbed cabinet of rare Primavera and mahogany woods, with finish available in blonde or dark mahogany, is a fitting companion to the finest surroundings.

**No Top to Lift... Roll-Out Changer
Child-Proof Lock**

HOWARD RADIO COMPANY

CHICAGO 13, ILLINOIS

America's Oldest Radio Manufacturer

Twelfth Annual Dinner Meeting of the New York Reps



Nearly 150 guests were on hand at the Hotel New Yorker, N. Y. C., for the annual dinner festival of the New York Chapter of The Representatives. The event attracted leading radio men among distributors and manufacturers who were guests of the "Reps." Leo Freed, chapter president, presided at the meeting.

Philco Unveils New Models at Atlantic City

Philco jobbers and field men were guests, 1,200 strong, at Convention Hall in Atlantic City, N. J., June 16-18 when the company introduced its 1948 lines. The guests came from all parts of the U. S. to the big conference, and with Philco's top executives as hosts, were shown 38 new radios and combos plus a new "multi-feature" refrigerator.

On the program, which also outlined the company's extensive sales and advertising program, were Philco officials Larry E. Gubb, John Ballantyne, William Balderson, Thomas A. Kennally, James H. Carmine, Larry F. Hardy, W. Paul Jones, David B. Smith, Robert F. Herr and John M. Otter.

A feature of the meeting was the appearance of a number of celebrities from Philco's radio programs. These included Don McNeill, Burl Ives, Paul Whiteman

and other well known radio stars.

Descriptions and photos of the new products will appear in forthcoming "New Lines" sections of RADIO & Television RETAILING.

Keeping Your Iron in the Fire

A big-scale sales-and-service program has been launched in the interests of the radio serviceman by International Resistance Co., 401 N. Broad St., Philadelphia 8, Pa. The campaign is aimed at improving the position of the serviceman in general, and helping him to earn more regular profits from repair jobs.

The drive includes one-minute spot announcements which are recorded and broadcast on a wide scale. The announcements were released by IRC distributors and have the effect of boosting service business for local radio men.

Part of the program is the distribution, also through IRC jobbers, of a booklet called "Keep Your Iron in the Fire"—the "iron" referring to the soldering iron used so continuously by repairmen. Included in the booklet is the news of promotion pieces and sales helps made available by IRC.

Booklet on Operating Film Rental Library

Official Films, Inc., 25 W. 45 St., New York 19, N. Y., has available to dealers a booklet telling how to set up and operate a film rental library. There are chapters on how to determine the market, investment necessary, selection of titles, sizes, etc., rental charges and storing methods, as well as sections on life of film, promotional aids, etc.

Commenting upon the possibilities for profit in operating a film library, an official of the film company says: "If operated as an independent unit, the film library can provide a profitable source of revenue. However, when coupled with a line of movie equipment and other photographic accessories, it becomes an integral part of a business that highly affects the income on these other related lines, with the profits of the library and other departments of the store, reflecting one upon the other.

Official Films offers dealer aids in the form of national advertising, newspaper mats, a 32-page catalog for distribution to customers, window displays, etc.

Leaders of Distributors Group for 1947-48



Newly elected officers of the National Electronic Distributors Association are, left to right, Guy B. Paine, Portland, Ore., second vice-president; Lealis Hale, Monroe, La., secretary; Aaron Lippman, Newark, N. J., president; Louis W. Hatry, Hartford, Conn., first vice-president; and Arthur Stallman, Ithaca, N. Y., treasurer.

Honored by Cory

N. H. Schlegel, advertising manager of Cory Corp. for the past year, has been named director of advertising and sales promotion. He will now head all public relations and sales promotion of Cory in addition to continuing as advertising head.

Jack Williams Honored



Jack M. Williams, with the RCA Victor division of RCA for over 20 years, has been appointed advertising manager for the firm's home instrument dept. Mr. Williams was formerly ad manager for RCA Victor Records, where he developed "the largest national advertising program in the history of the industry."

Offers Speaker Line to Jobber Trade

Permoflux Corp. has now launched the Permoflux line of speakers, transformers, pickups and microphones to the jobber trade. The firm has an Eastern plant at 4900 W. Grand Ave., Chicago, and a Western plant at 236 S. Verdugo Road, Glendale, Calif.

"Permoflux has decided to enter the jobber field," president L. M. Heineman stated, "because we feel that we have the



L. M. Heineman

most complete line of loudspeakers ever offered to jobbers. We are able to supply this complete line due to the variety of speakers which Permoflux designs for and supplies to radio manufacturers."

Permoflux, in addition to the standard line of permanent magnet and electro magnet speakers, is offering a hi-fidelity de luxe line and a complete stock of matching output transformers.

Florida Firm for Howard

Howard Radio Co., Chicago, has announced the appointment of a new distributor in Florida—Dade Distributors, Inc., 136 N.E. First St., Miami 32, Fla. S. F. Potter is president of the firm.

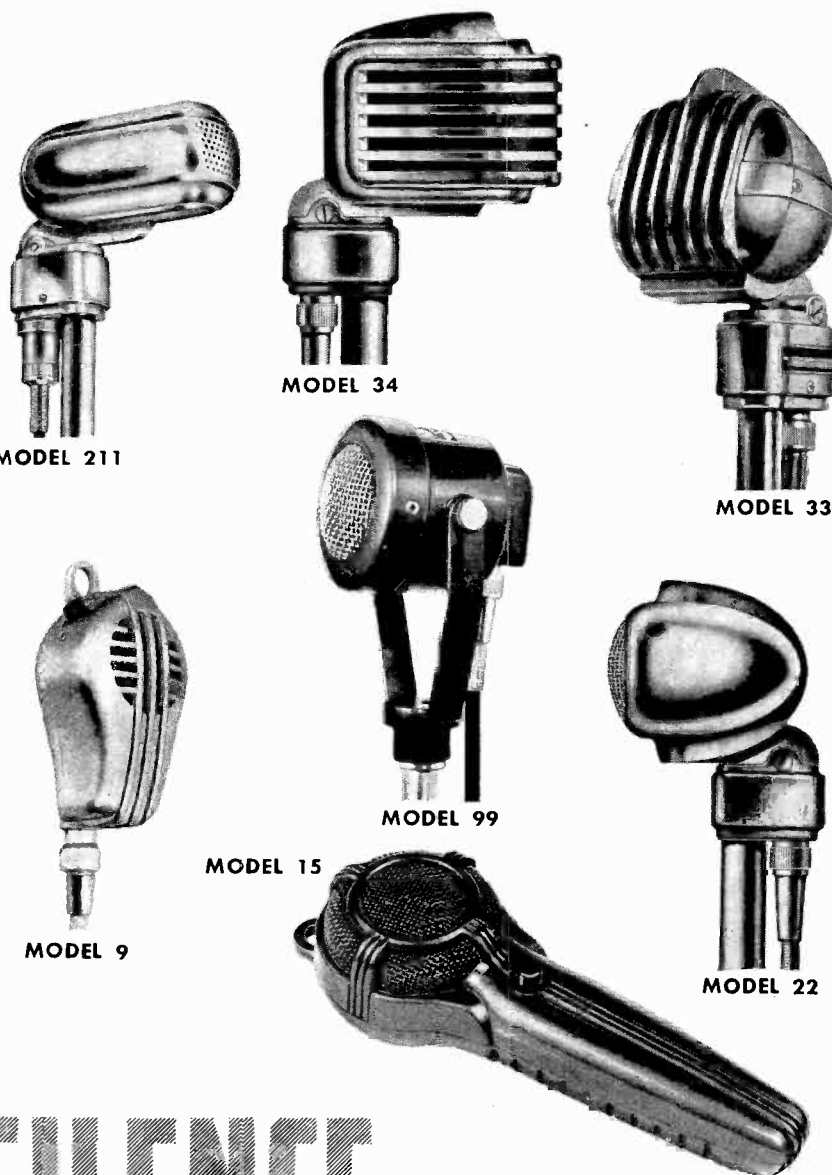

SILENCE IS GOLDEN

WITH MICROPHONES BY TURNER

The smooth performance and rugged dependability of Turner Microphones are the result of sound engineering, highest quality materials, and faultless workmanship.

For voice and music, for voice alone, or for any special sound application rely on Turner for greater satisfaction. Turner engineers will be glad to make impartial suggestions as to the right type microphone for your particular job.

ASK YOUR DEALER OR WRITE

THE TURNER COMPANY

903 17th Street N. E. • Cedar Rapids, Iowa

TURN TO TURNER—THE PASSWORD TO SOUND PERFORMANCE

LICENSED UNDER U. S. PATENTS OF THE AMERICAN TELEPHONE AND TELEGRAPH COMPANY, AND WESTERN ELECTRIC COMPANY, INCORPORATED. CRYSTALS LICENSED UNDER PATENTS OF THE BRUSH DEVELOPMENT CO.

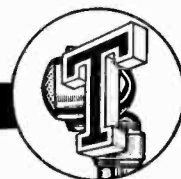



THE NEW

ELECTRONIC
AMPLICALL
INTERCOMMUNICATION

With the Exclusive Features that Sell for You!

America's Finest Business Communication System is a selling sensation! Overnight, businessmen everywhere are asking about, *buying* the New AMPLICALL. The reasons are obvious: Irresistible plastic styling—exclusive new advantages—simon-simple operation—incomparably natural speech. Add them up, and you get an exclusive selling appeal that puts profits in your pocket. The New AMPLICALL gives you "selling horizons unlimited"—a complete line with systems available for every conceivable requirement—exclusive features never before made available. Here's your opportunity to sell Intercommunication as you've never sold before!

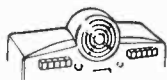

Striking Plastic Beauty—a "hit" on sight—because it creates an immediate desire for possession.



"Busy" Signal—neon bulb visual signal—indicates instantly when station being called is busy.



Handset—professional type for complete privacy—optional with Master Stations.



Translucent Volume Control—lighted to indicate that Master Station is turned "on."



Balanced Line Cable—cuts wiring costs—eliminates shielded line to Remote units.

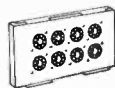

Plug-in Type Masters—allows quick transfer or exchange of Masters—cuts installation wiring costs by one-third.

SEE YOUR AUTHORIZED AMPLICALL DISTRIBUTOR. Get the complete selling story on the New AMPLICALL! Ask your Authorized AMPLICALL Distributor for full details and descriptive catalog. There's a New AMPLICALL System for every business prospect—a system that sells on sight and superior performance. Don't miss out on the biggest profit opportunity ever to come your way in the Intercommunication field.

Electroneering is our business

RADIO • RADAR
SOUND

Rauland

COMMUNICATIONS
TELEVISION

THE RAULAND CORP. • 4247 N. KNOX AVE. • CHICAGO 41, ILL.

Radio and Appliance Dealers Low Prices—Fast Delivery

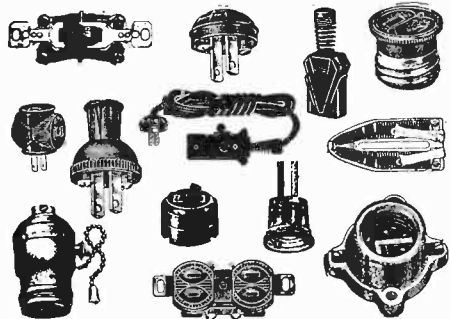

We are in a position to supply you with everything you need in the electrical and radio fields. We can supply many hard-to-get products, such as Plugs, Switches, Sockets, Elements, etc.

FREE—Send for our complete catalog showing Electrical Wiring Devices, Portable Electric Stoves, Fluorescent Equipment, etc.

TRUTONE PRODUCTS COMPANY

Dept. RC

303 West 42nd St., New York 18, N. Y.

Crosley Sales Manager



Lee Stratton is now the domestic sales manager of Crosley Division, Avco Mfg. Corp. He thus heads all field selling and domestic merchandising of Crosley products. He has extensive merchandising experience both here and abroad.

Insurance Protection

(Continued from page 39)

other fluid to any property resulting from the breakage or leakage of sprinklers or resulting from water entering through leaks or openings in the buildings, and includes coverage against accidental injury to sprinklers and other fire apparatus.

With regard to plate glass the standard policy provides that the insurance company will replace any glass described in the schedule, accidentally broken and any lettering or ornamentation thereon insured under the policy, or will pay for the replacement in cash if it so elects. Breakage is present when the break extends through the entire thickness of the glass.

Coverage by Bonds

Another coverage is that of Fidelity or Surety Bonds. Businesses often ask the difference between Fidelity and Surety Bonds. Strictly speaking, every bond is a Surety bond. However, a bond guaranteeing a small business against loss through defaults by his employes is referred to as a Fidelity bond. A bond assuming some other financial obligation is referred to as a Surety bond. You may be required by Federal, State or local government to file a License, Franchise or Permit bond. They are required to guarantee compliance with regulations, laws or local ordinances. Most business men are influenced in effecting those coverages which have been fairly common by usage.

In a discussion of the overall matter of insurance needs of a retail business Life Insurance is important. Its benefits are avail-

able to the business be it a sole owner type, partnership or corporation. If the business is a sole owner type the success of it is entirely dependent on him.

Since the Social Security Act does not apply to him, he must provide his own retirement program, from the business earnings and a Special Retirement Income Policy is available in varying amounts to provide these benefits.

Also to be considered is the disposition of the business in the event of death—should it be left to a son or relative—or should it be turned over to the employes either as a gift or under a buy and sell arrangement. If under the latter, Life Insurance on the life of the owner, purchased by himself or employes will provide at his death the necessary cash to effect whatever arrangement has been previously agreed upon.

In addition, cash at the time of the death of the sole owner will also provide cash for his executor to help administer his estate.

Similarly in partnership, Life Insurance can be utilized. Death terminates the partnership, and if the partners are insured, upon the death of either, the survivor can get the proceeds of the policy with which to buy out the deceased's interest

Best Window in New Jersey Display Contest



First prize winner in the window display contest sponsored by Proctor Electric Co. in 9 counties of New Jersey was this layout at Collora Home Appliance, Plainfield, N. J. The competition was directed by Carl McLoughlin, Proctor rep in New Jersey, and drew entries from 72 dealers.

and continue the business alone.

The heirs of the deceased will be guaranteed immediate cash in liquidation of the business interest. Further, if each contributes an unusual ability to the partnership they can insure each other in favor of the partnership so that cash will be available to compensate for the loss of ability which also dies with the death of a partner.

A similar program may also be adopted in small close corporations,

any or all stockholders and officers may be insured, as in the case of the partnership. The payment of the proceeds of a life insurance policy on the life of a stockholder provides immediate cash to retire his stock.

In summary, it should be borne in mind that in adopting an insurance plan the services of a competent and qualified adviser is essential, since he will not only be able to formulate a program but coordinate it in a comprehensive program.

NEW! SENSATIONAL!

Outsells Everything
IN RADIO WHEREVER
INTRODUCED

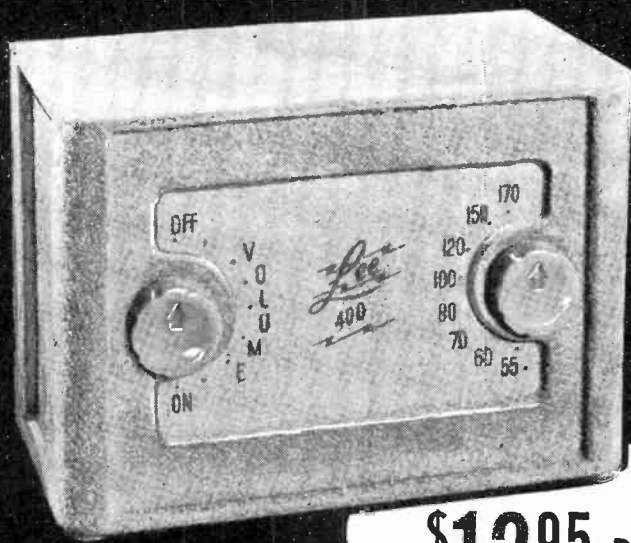

**AN ANSWER TO THE
PRESIDENT'S PLEA**

\$12⁹⁵ RETAIL

the

Lee
400

**WOOD
CONSTRUCTED
CABINET**

A NEW NOTE IN LOW PRICES SELLS ON SIGHT!

It's here! The Lee 400.

Designed and packaged for fast over-the-counter selling.

Only 5" High.

Its wood cabinet construction and its colorful suede-like finish makes it the biggest little package of radio power to hit the market at such a low price.

Not Distressed Merchandise!

Tops in engineering! And it can't be beat for price, quality and attractiveness.

A Variety of Colors!

Gold • Red • Emerald • Pastel Pink
Blue • Silver-Grey • Brown

Be the first in your territory. Wire or write now for a sample case of 12 assorted colors at \$9.75 each.

LEE RADIO COMPANY
1331 HALSEY ST., BROOKLYN, N. Y.



Fills a Long-Felt Need

New Improved JFD REMOTE-O-CABLE REPLACER

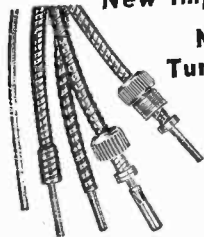

Control Shattering & Casing

• Available in coils, or cut to length. Exact duplicate cables for Philco, Arvin, Delco, Motorola. Also, standard shaft and casing assemblies.

Most Efficient Auto Radio Tuning Cable-Servicing Machine in Use Today!

1. SWEDGES SHAFTING TO PREVENT UNRAVELLING.
2. CUTS SHAFTING TO EXACT LENGTH.
3. REPLACES OLD FITTINGS ON SHAFTING.
4. CASING GROOVE MAKES CUTTING EASY.

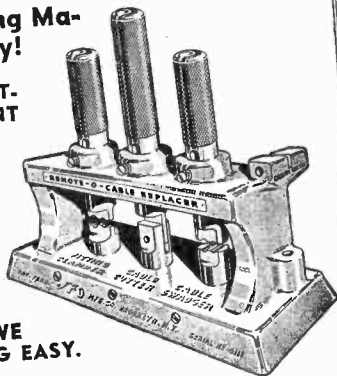

SERVICEMEN'S COMPLETE COMBINATION KIT OF CABLE, HOUSING and FITTINGS

30 different types of fittings — 120 assorted pieces. 50 ft. of cable, 50 ft. of housing. A single compact kit that fills all servicemen's needs for cable, housing, and fittings. Used in Philco, Motorola, RCA, United Motors, Bosch, Crosley, Sparton, Atwater-Kent, Stewart-Warner, Arvin, Zenith, Emerson, and other auto radio sets. All compactly packed in a FREE durable steel box. Model CK200.

EVERY SERVICEMAN MUST OWN ONE!

WRITE FOR LITERATURE

J.F.D. MANUFACTURING CO.
4109-4123 FORT HAMILTON PARKWAY, BROOKLYN 19, N. Y.

Now Small Size, Heavy Duty, Trouble-Free

5-WATT VITROHM

Wire Wound Fixed Resistors

Now . . . for extra reliability in many installations . . . for longer service and steadier performance . . . you can use this compact, low-wattage Type 5F resistor. Resistance wire is insulated and protected by WARD LEONARD'S own Green Vitreous Enamel of exclusive formula developed in the WL laboratories. Tough, hard, moisture and acid resistant. Quickly conducts away generated heat. Easily mounted by its wire leads.

Radio and Electronic Distributor Division
WARD LEONARD ELECTRIC CO.
53-H West Jackson Blvd., Chicago 4, U.S.A.

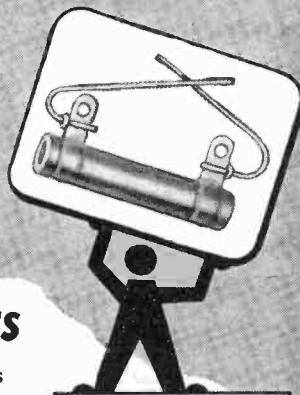

TYPE 5F • 5 WATTS

1" long x 5/16" diam.
Available from stock in resistances from 1 ohm to 5000 ohms.

Made available only by
WARD LEONARD thru
Authorized Distributors
everywhere

WARD LEONARD RELAYS • RESISTORS • RHEOSTATS

Electric control devices since 1892

Send for Catalog D-2 Give helpful data and information on the wide variety of WARD LEONARD Resistors and Rheostats.



Airfreighter for Lee Sets



Inaugural flight of American Airlines' new DC-4 airfreighter service coast-to-coast, takes 150 of the new Lee 400 radios from Jason Electronics Co., Brooklyn, N. Y., to the Kielson Co., Cincinnati distributors. Jean Director helps out with the loading of the \$12.95 sets.

Showroom Selling

(Continued from page 69)

uct, or to suggest a place where he feels certain the would-be buyer can get a discount.

In addition, if the prospect refuses to buy the product, or even if he does buy, and wants a "new one—not a demonstrator—" or a different type, then the retailer finds himself with a "used" product on his hands instead of a new one.

Too, he finds that lots of valuable time has been devoted to demonstrating, delivery, etc.

From the customer's standpoint, a thorough-going explanation in the store, followed by free after-sale demonstration in the home, is much more satisfactory than the business of being bewildered by neighbors and competitive salesmen in the home.

The dealer should not expect to be able to get out from under the responsibility and necessity for after-sale demonstration in the home, but he certainly should do all in his power to make as many sales in his showroom as he can.

Fada-Lucent in 5 Colors

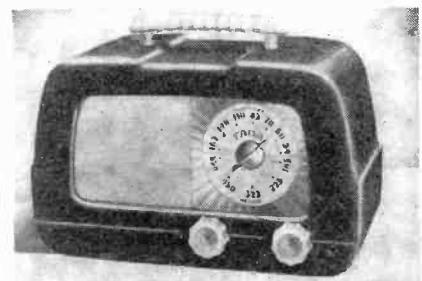

The Model 711 ac-dc superhet, made by Fada Radio & Electric Co., Inc., 525 Main St., Belleville, N. J., comes in "Fada-Lucent" cabinet, choice of 5 decorator colors. The 5-tube unit tunes standard broadcast and some state police; beam power output system, avc, 6 tuned circuits, Alnico 5 speaker.

Headquarters Honors New Refrigerator Feature

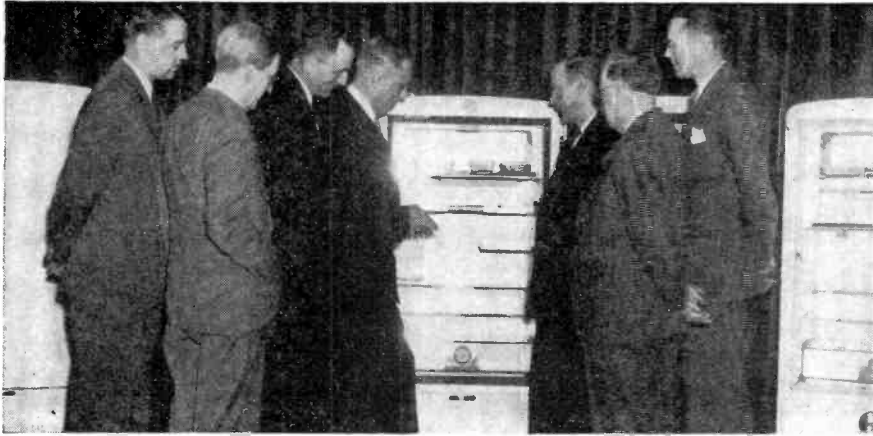

Viewing the extended frozen storage (Freezer Locker) compartment of the new Gibson Model F-787 box are these sales executives of the firm, at big division sales managers' meeting. Left to right, E. J. Byrne, sales promotion; Gregory V. Drumm, market development manager; Donald D. Shonn, sales dept.; J. L. Johnson, sales manager; John L. Stephens, sales promotion manager; J. B. Croskey, market development dept.; J. F. Klintworth, assistant to sales manager.

Sales Contests

(Continued from page 71)

of profit-reducing inducements must be banned. All contestants should be thoroughly familiar with the rules, and the rules should be based on clean selling.

The other pitfall to be anticipated has to do with salesman-customer relations concerning the contest. Salesmen must not be permitted to work the "contest angle" to death with the prospective purchaser. All references made to the contest by the salesman in using such subject to needle a sale must be done in a considered and appropriate manner. Utmost care must be exercised lest the introduction of the contest topic prove obnoxious to the customer.

Actually, the prospective buyer shouldn't care one way or another whether Salesman Jones is trying to win a prize. The customer is out to get the best buy for his money. However, the salesman can often use

Stripper News



Now available to jobbers is this new metal display for "Speedex" wire strippers—a 3-color unit with pocket for circulars. It is offered with orders, by General Cement Mfg. Co., Rockford, Ill.

the contest angle with those of his following with whom he is quite well acquainted. A personable salesperson can suggest to a would-be buyer the fact that an order placed now will mean a lot to him, provided he uses tact and none of the "working-my-way-through-college" stuff.

The sales contest should not be run at too frequent intervals, but when it is to be staged, it should be carefully-planned and meticulously administered. It must be based upon fairness to the salesmen. Also, it must be operated so that there will be no attempts made to "blackjack" customers into buying.

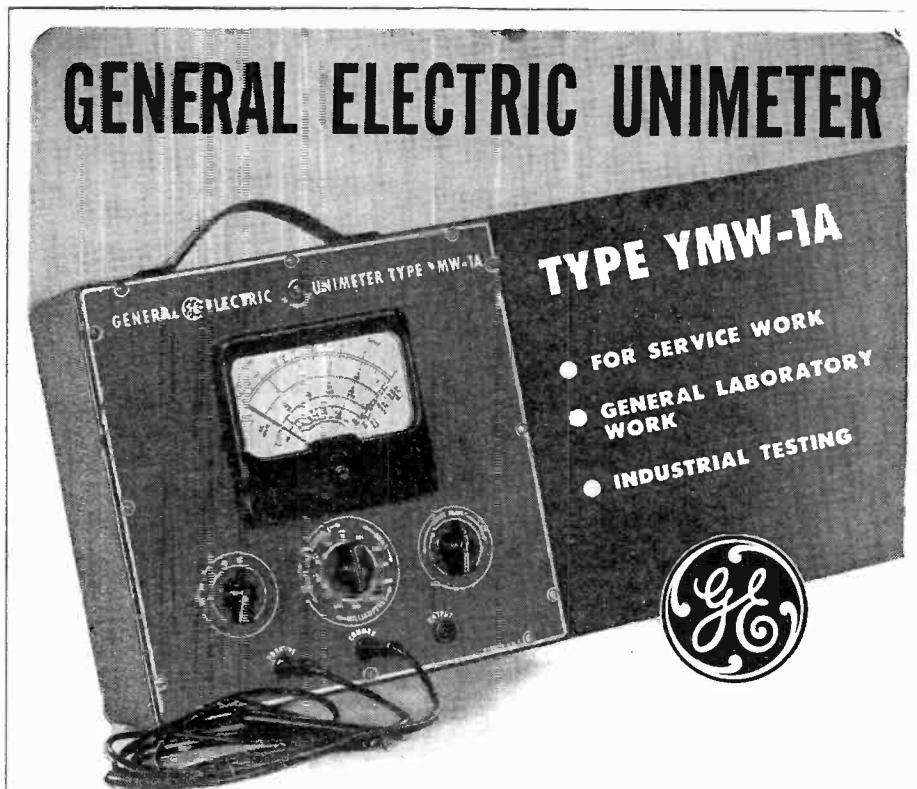

ACCURATE

Rapid, correct measurements of ohms, volts, current and decibels. Meter and terminal resistance accurate to within $\pm 2\%$; precision resistors accurate to within $\pm 1\%$.

EASY TO READ

4 1/2" meter with clear graduations shows readings at a glance.

SIMPLE TO OPERATE

All functions available without

changing test leads, except 50 microamps and output meter capacitor. Single rotary selector switch controls all functions and ranges. Two position switch used to select AC or DC volt ranges.

COMPLETELY PORTABLE

Weighs only nine pounds, gray wrinkle finish. Dimensions 10 1/4" x 9 3/4" x 4".

NEW FREE BOOKLET ON
FM SERVICING AVAILABLE

For complete information, write: General Electric Company,
Electronics Department, Syracuse 1, New York.

GENERAL ELECTRIC

164-F5

Gibson Shows New Models at Big Sales Meeting

At a meeting of the divisional sales managers of the Gibson Refrigerator Co., held at the firm's plant at Greenville, Mich., the company announced three revised "Freez'r Shelf" refrigerator models. (See "New Appliances" section of this issue.) Features of the new units are enlarged frozen food storage compartments, called Freez'r Lockers, each with space for nearly forty pounds of frozen foods. Net capacities of all are 7 cu. ft.

Pilot runs have been completed and production schedules provide for initial shipments into all distributors' territories. Average retail prices (zone system) are as follows: No. SF-797 is \$322.75; No.

Division Sales Managers in Coast-to-Coast Campaign

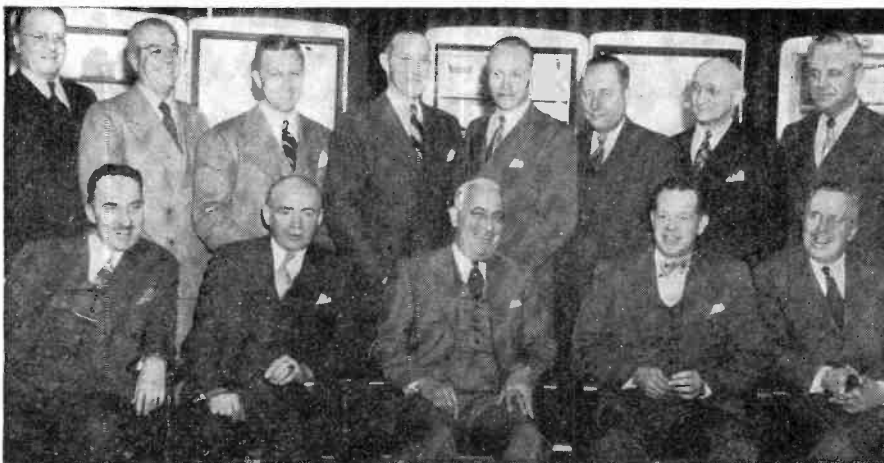

Vigorous sales plans were previewed by these division sales managers for Gibson Refrigerator Co., at a meeting where three revised 1947 model Freezer Shelf refrigerators were shown. They charted coast-to-coast dealer meetings, and reviewed sales angles of Kaokall range line as well as Gibson home freezer. Left to right, seated, George H. Jaud, Cleveland; Frank A. Dewey, Boston; E. D. Jacobs, Greenville, Mich.; Edwin F. Edsall, Portland; William H. Dennison, Dallas. Standing, Earl S. Nobles, St. Louis; F. E. Basler, Las Angeles; W. J. Browne, Chicago; Arnold C. Baldwin, Newark; Floyd H. Aarvig, Omaha; Herbert W. Lincoln, Wayne, Pa.; Charles I. Horowitz, export manager, Chicago; Brower Murphy, Atlanta.

F-787 is \$274.00; No. F-777 is \$234.00.

The revised models include a still further expansion of the basic Freez'r Shelf wall-to-wall design which Gibson has featured for twelve years. Freezing coils surround the new Freez'r locker compartment on sides, top and bottom, thus providing frozen storage in more than a cubic foot of space. Just below the Freez'r locker, Gibson places a Fresh'ner locker (Fresh'ner shelf in Models F-787 and F-777) which provides very high humidity with just-above-freezing temperature.

Other use features include a fifteen-position cold control, glass shelves, moist cold drawer, seamless and crackless all-poreclained interior and easy-out ice cube trays with ejecting lever. A dry crisper tilt bin, with wide opening, is provided with all three models. This bin (non-refrigerated) furnishes more than a bushel of space for dry cereals, crackers, etc.

Emerson Guarantees Prices, Ups Promotion

Distributors of Emerson Radio & Phonograph Corp. have been informed that existing prices on Emerson radios were guaranteed for the remainder of the year. Benjamin Abrams, president, said that "although no price changes are contemplated at this time, should any downward revisions in price occur the trade is guaranteed to be rebated for the difference."

Emerson also announced the most extensive advertising and sales promotion campaign in its history. Eighteen leading national magazines have been scheduled to carry the advertising until the end of 1947. Each of the advertisements to appear will cover some unique phase of the Emerson Radio business and feature one or more Emerson Radio "Sets of the Month."



OLSON RADIO WAREHOUSE, INC. AKRON 8, O.

Free Gifts



MARLIN RIFLE
.22 Caliber



EASTMAN
KODAKS



BULOVA
Wrist Watch



REMINGTON
Electric Shaver

Free Gifts for Olson customers

Why not buy your Radio Parts where you get a FREE BONUS? Here's just a few of the big selection of nationally known articles you can get free. Olson sends you a free "Pointer" for every dollar's worth of Parts you order, and you get your gifts by saving up Olson Pointers. No catch to it . . . no limit to the number of free gifts you can get. Start saving those Olson Pointers NOW!



Paste the coupon on a Postcard-
GET THIS FREE BARGAIN BOOK

This is our big new book of Olson Bargains, containing 60 pages of real money-saving values in Radio Parts, Sound and Testing Equipment. It also has a section of GIFT PREMIUMS you can get by saving Olson Pointers. Mail the coupon TODAY for this valuable Free Book!

OLSON RADIO WAREHOUSE, INC.

73 E. MILL ST., DEPT. 90, AKRON, OHIO

I want to get Olson's Free Gifts. Send me your new FREE Premium Book and Price Guide right away.

NAME _____

COMPANY _____

ADDRESS _____

CITY _____ STATE _____

Graybar Gets First Planeload of Automatic Coffee Brewers



First shipment of Cory Corp.'s new automatic coffee brewers arrives via Delta Air Freight at Graybar Electric Co., Atlanta, Ga. Taking delivery, left to right, O. L. Congdon, area manager for Cory; L. A. Crenshaw, Delta Air cargo rep; E. L. Lawrence, field freight agent; H. E. Giles, district merchandise manager for Graybar; and A. D. Hammond, southern district manager for Graybar.

Radio Executive Says Price Cuts Are Unsound

The slashing of prices by scattered dealers is only adding to the danger of a recession, declared S. W. Gross, president of Tele-tone Radio Corp., at a sales conference held at the firm's headquarters.

"Spasmodic marking down of high or overpriced items is seriously undermining the public's confidence and is encouraging stiff consumer resistance and the postponement of purchasing," Mr. Gross stated. He also said this reluctance to buy was even beginning to affect still scarce commodities.

"We have been playing cat-and-mouse with the consumer through eyewash measures like the Newburyport Plan which are doomed to eventual failure because they merely scratch the surface of the whole price-wage problem," Mr. Gross said.

"Certainly, there is a tremendous grass-roots rebellion right now against retail prices," he continued, "but any manufacturer or supplier who thinks this is merely a retailer's problem is indulging himself in an airy fantasy. Substantial



Tele-tone president S. W. Gross.

and lasting price reductions cannot be effected unless all of these groups seek and determine what the fair price levels should be."

Urging that immediate corrective action be taken particularly by suppliers and manufacturers, Mr. Gross affirmed that they must cooperate within the framework of the law to insure that goods are produced and sold to retail outlets at fairly reckoned prices.

"Instead of coming out with a highly marked-up item and then slashing repeatedly, manufacturers must bring their products out 'priced right' at the start. Tele-tone has already taken this type of action."

"This system has already paid high dividends in our business, and our sales have been holding up firmly," Mr. Gross stated.

MASCO DARES to issue a PRICE GUARANTEE

The following is quoted from our letter of May 26, 1947 to all Masco distributors:

MASCO PRICE GUARANTEE

We see no price changes at this time. Should any downward revisions in price occur, we will guarantee the difference between old and such new prices as may be established.

This guarantee covers inventory on hand December 31, 1947, which was purchased after May 31, 1947. We urge that you, in turn, extend the same guarantee of price protection to all MASCO dealers in your territory.

Mark Simpson

Now Masco's moral leadership in this industry is again accented. Our price guarantee, added to Masco quality, styling and value, is one more reason why DEALERS LIKE TO SELL MASCO.

MASCO

MARK SIMPSON MANUFACTURING CO., Inc.
32-28 49th Street, Long Island City 3, N.Y.

SOUND SYSTEMS and Accessories

RAvenswood 8-5810-1-2-3-4

**LOOK
to
WARD**

Ward FM antennas stand head and shoulders above the field for value. Available in straight or folded dipole types (with or without reflector kit), they adapt easily to varying individual requirements. Providing the maximum electrical efficiency needed for finest FM reception, they are easy to install securely. Their trouble-free operation assures you extra profits. Write for free catalog today.

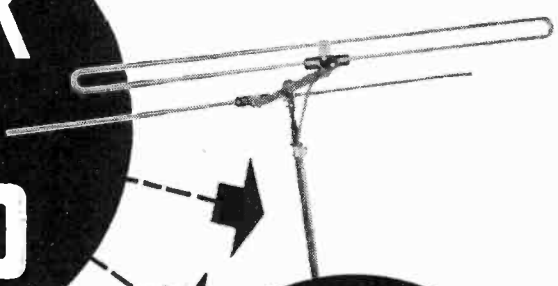

for
**OUTSTANDING
FM
Antennas**

WARD

THE WARD PRODUCTS CORPORATION
1523 EAST 45th STREET, CLEVELAND 3, OHIO

Aerials

EXPORT DEPARTMENT: C. W. Brandes, Manager, 4900 Euclid Ave., Cleveland 3, Ohio
IN CANADA: Atlas Radio Corp., 560 King Street W., Toronto 1, Ontario, Canada

Permoflux SPEAKERS



AN OLD NAME IN SPEAKERS
FOR YEARS A MAJOR SUPPLIER TO THE INDUSTRY
A NEW HIGH IN PERFORMANCE*

Announces... a COMPLETE JOBBER LINE of standard replacement and hi-fidelity de luxe loud speakers with both permanent and electro-magnet fields. These quality speakers, together with matching output transformers, embody the same skillfully engineered features as used in the units that PERMOFLUX now supplies to the radio set manufacturers.

*A two-to-one preference for use by radio set manufacturers. Sound room laboratory tests show greater uniformity and frequency response than other comparable makes.

• WRITE FOR FREE BULLETIN •

PERMOFLUX

TWO COMPLETE FACTORIES TO SERVE YOU

PERMOFLUX CORPORATION
4900 WEST GRAND AVE., CHICAGO 39, ILLINOIS
236 SOUTH VERDUGO ROAD, GLENDALE 5, CALIFORNIA

PIONEER MANUFACTURERS OF PERMANENT MAGNET DYNAMIC TRANSDUCERS

Detecto Sales Head



Charles O'Neill is the new sales manager for Lord-Taber Co., Canandaigua, N. Y., makers of the "Detecto" electric alarm system for fire and cold.

"Pilotuner" Is Subject of Big FM Sales Drive

To be placed on the market this July 15th, is a new low-priced "FM Pilotuner" offered by Pilot Radio Corp., Long Island City 1, N. Y. Dealer conventions and demonstrations will be held on that date in from 100 to 140 key localities, and retailer commitments will be filled immediately.

Teaser ads will appear during the week of July 7th in the key cities, followed by detailed ads in the same papers, and trade ads are running in all major radio dealer and broadcasting magazines. Complete promotional material, including window displays and a Pilotone vinylite demonstration disc, will also be available.

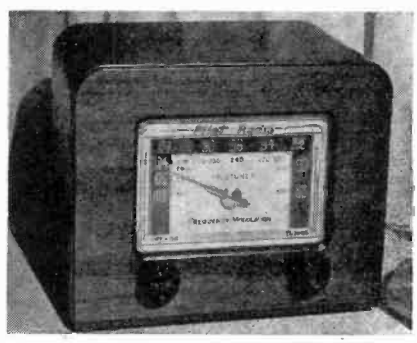

The new Model 601 Pilotuner, available July 15.

The tuner, which is easily adapted for use with any AM receiver, including those prewar AM-FM sets on the low band FM range, is priced at \$29.95 and is marketed by Pilot "to create a national interest in the benefits of FM broadcasting and FM reception." It has 5 tubes plus selenium rectifier, 3-gang copper plate tuning condensers, tuned rf range, FM ratio detector circuit, with both megacycles and channel designations of the dial for the new FM frequency band. The set has shielded cable to hook up to any set, phonograph or amplifier unit with an audio system. Also there's a built-in antenna for FM, plus provision for attachment to outside aerial, and provisions have been made for attachment

of a phono circuit into the tuner.
 "Pilotuner" is housed in a small wood cabinet, walnut finish, measuring 8¾" long by 6¾" high by 5½" wide.

Pilot points out that "from the dealer's viewpoint the tuner will be of considerable help in allowing him to move any large stocks of AM merchandise . . . from the FM broadcaster's point of view it will hike the available listening audience and help to secure high quality advertising on the standard previously set by AM broadcasters." The firm says that the low price is possible only through close cooperation with parts makers, the efforts of the company itself, and the cooperation of the retailers and reps throughout the U. S. who will merchandise the item.

Named by Sylvania



Terry P. Cunningham has been named as advertising manager of the radio tube, electronics and international divisions of Sylvania Electric Products, Inc. He has been with Sylvania for 5 years and has 21 years' experience in radio sales promotion for dealers and jobbers.

Tri-Core Solder in Counter Merchandiser

One dozen colorful lithographed "handycans" of triple-rosin-cored solder for the less-than-a-pound user have been packaged for counter selling by the Tri-Core & Core Solder division of Alpha Metals, Inc., 363 Hudson Ave., Brooklyn 1, N. Y.

The metal reinforced display cartons



feature the fast melting and positive fluxing action which the company's advertising has been stressing since the Tri-Core solder was introduced a year ago.

Another MASCO

PRIZE WINNING PACKAGE OF PROFIT

Dual Speed PORTABLE DISC RECORDER With Single Play-Back

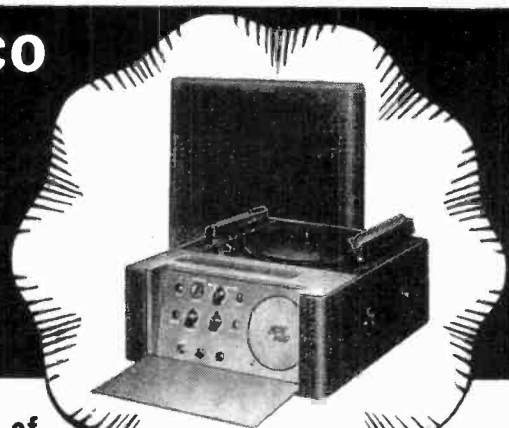

NEW! With Every Facility of the Professional Type Recorder

Sensation of the Chicago Show . . . because distributors and dealers recognized the big market for this disc recorder and play back . . . broadcast stations, talent agents, schools, churches, lecture halls, night clubs and people who entertain at home.

It has 3 separate input jacks, providing for 1. direct recording from microphone, 2. direct recording electronically from a phonograph (dubbing), 3. direct recording from radio to record. Selector switch on panel allows for simple change of function.

Volume level indicator eye assures accurate recording level. Separate volume and tone controls allow for any desired volume or tone setting.

Complete with heavy duty 6 in. P.M. Alnico V Speaker and kit of 5 matched tubes
 List Price \$135.00

Add 5% West of Rockies

Contact your local Masco distributor for immediate delivery. For descriptive literature or other information write directly to factory, Dept. D

COMPLETE SELF-CONTAINED DISC RECORDER . . . AND PLAY-BACK WITH BUILT-IN AMPLIFIER AND SPEAKER

FEATURES

- Combined recorder and P.A. system.
- Recording and play-back both 78 and 33½ RPM.
- Electronic volume level indicator.
- Heavy duty 6 in. Alnico V Speaker.
- Separate volume and tone controls.
- Five tubes including rectifier.
- Separate jack for external speaker.
- Adjustable cutting head.
- Separate motor switch.
- Fused circuit.

MASCO

MARK SIMPSON MANUFACTURING CO., Inc.
 32-28 49th Street, Long Island City 3, N.Y.



SOUND SYSTEMS and Accessories

RAvenswood 8-5810-1-2-3-4

WORK WANTED

BY WOOD WORKING PLANT THOROUGHLY EQUIPPED TO MANUFACTURE COMPONENT WOOD PARTS FOR ALL TYPES OF PRODUCTION SPECIALTIES.

UNITED WOOD PRODUCTS, INC.

11 SIMONDS ROAD

Fitchburg, Mass.

Telephone 4598

26,000* SERVICEMEN READ



EVERY MONTH

* Paid circulation, March 1947 issue

RADIO MAINTENANCE today fills a breach that has existed in the radio field for a long time. Already 26,000 servicemen read RADIO MAINTENANCE every month because it is devoted entirely to the radio serviceman.

The RADIO MAINTENANCE staff specializes in the preparation of articles on every phase of Radio Maintenance in series form which may be filed and used for reference. The leading articles cover everything for the radio serviceman on Television, FM and AM; Test Equipment; Electronic Appliances; Tools; Antennas; Alignment; Troubleshooting; Repair; Construction; Pick Ups and Sound Amplification and Reproduction Equipment. Also, in RADIO MAINTENANCE each month there are departments on hints and kinks, the latest news of the trade, review of trade literature, radiomen's opinions, new products and news from the organizations. All articles are presented in a step-by-step precision style, clearly illustrated, with schematics, accurate photographs, specially prepared drawings, white on black charts, color diagrams, isometric projections and exploded views.

Tear off coupon below and mail today.

Tear off coupon below and mail today.

Your first issue will be mailed immediately on receipt of this coupon.

One issue FREE if payment is enclosed.



RADIO MAINTENANCE MAGAZINE
460 Bloomfield Avenue, Montclair, N. J.

Please send me RADIO MAINTENANCE every month for

- 1 year at \$2.50 Payment enclosed
 2 years at \$4.00 Bill me later

Name

Address

City-State

*Occupation

Title

Employed by

*Independent Serviceman - Dealer Serviceman -
Service Manager - Dealer - Distributor - Jobber

Joins Hotpoint



Edward R. Taylor, formerly with Zenith, has joined Hotpoint, Inc., as merchandising manager. The new executive position was created to coordinate marketing service functions in Hotpoint's expansion program by which the firm's output will be tripled, according to vice-president L. C. Truesdell.

New Sales Department

W. L. Hasemeier, vice-president in charge of sales to the Wilcox-Gay Corp., has announced the establishment of a sales traffic department functioning as a separate department of the sales division. M. L. Ware has been appointed sales traffic manager and will be in charge of

New Antennas for FM and Television

JFD Mfg. Co. Inc., has announced its new 1947 line of FM and television antennas and accessories.

The units feature (1) the multi-position bracket which enables the antennas to be mounted anywhere—on walls, on window sills, on angular gable roofs, on flat parapets, etc., and (2) the "Snap-

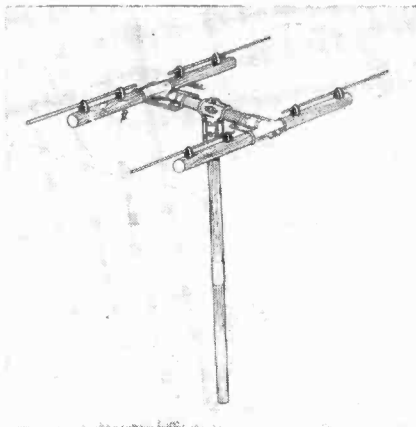

JFD standard dipole with reflector.

Lock" wall insulator which securely holds transmission leads in place in all adverse weather conditions.

A complete folder on the line may be had upon request to Dept. F, JFD Mfg. Co., Inc., 4117 Ft. Hamilton Parkway, Brooklyn 19, N. Y.

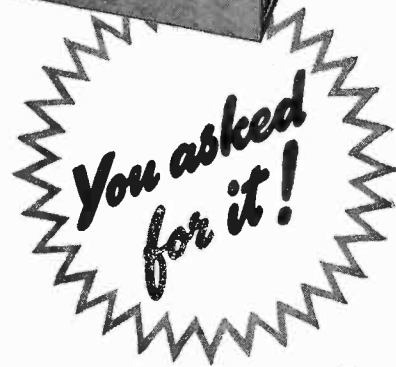
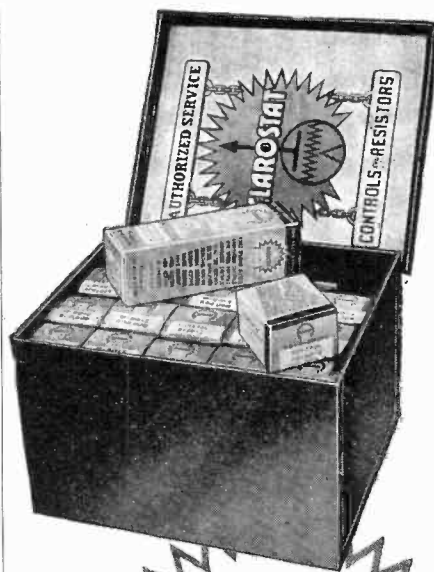

**SERVICEMAN'S
KIT No. 4**

★ With this kit you're ready to service upwards of 95% of the standard radios. And you can keep the kit complete by re-ordering individual items.

CONTROLS and SWITCHES

Kit contains 17 selected volume and tone controls. Most popular ohmages and taps. Also 8 Ad-A-Switches—both s.p. and d.p. types. Plus 4 Glasohms (glass-insulated flexible resistors).

PLUS—DATA and PLAQUE

Packed in a neat, sturdy, green-lacquered steel cabinet (no advertising or outside label). Kit includes Clarostat Volume Control Selector and Authorized Service plaque. A big \$32.15 value; "special" to you at only \$17.79!

★ Ask Our Jobber . . .

Ask for this "special"—get yours before the supply runs out. If you're not acquainted with the nearest Clarostat jobber, write us and we'll bring you together.



CLAROSTAT MFG. CO., Inc. • 285-7 N. 6th St., Brooklyn, N. Y.

Motorola Promotion



Howard C. Handweg has been appointed assistant sales manager for Motorola, Inc., home radio, car radio and car heaters. He's been with the firm for 7 years, recently was regional sales manager for North Central area.

New Hytron Guide for All Miniature Tubes

All miniature tube types, regardless of brand name or make have been included in the new free reference guide for miniature tubes published by Hytron Radio & Electronics Corp., Salem, Mass. The second edition, revised this year, carries complete data on 72 types, including numerous operating conditions for individual tubes.

Aside from listings of typical operation and characteristics of the tubes in given circuit applications, all basing connection diagrams are illustrated, while a special feature of the guide is a comparative listing of the corresponding tube prototype in larger envelopes.

Zenith Will Show One New Model at a Time

Introducing a policy by which "no dealer can get hurt on the obsolescence of one model," Commander McDonald, president of Zenith Radio Corp., has announced to the firm's 20,000 dealers that Zenith will bring out new models only as they come from the lab and are properly field tested.

Merchandise Manager



J. J. Clune has been appointed merchandise manager for Air King Products Co., Inc., division of Hytron Radio & Electronics Corp. Mr. Clune was with National Union for 17 years, where he had become the firm's director of sales.

IT'S *Signal* FOR SALES . . . FOR FINE PORTABLES

It's the *Signal* EMPRESS!

Handsome, fast-selling, 3-way light-weight portable—AC, DC and battery! Features the SIGNALLOOP—picks up weakest stations with least amount of noise.

- Powerful 5" Alnico No. 5—1.47 oz. Speaker
- Uses 5 Flashlight Cells and 67½ V. Batteries
- 4 Tubes, Plus Selenium Rectifier
- No Warm-up Time—Plays Immediately (no rectifier tube to heat up)
- Full Vision Slide Rule Dial
- Weighs Only 5½ lbs. . . . With Batteries that will last an average of 100 hours.
- Size—10"x3½"x5¾"
- Handsome Covered Carrying Case—Looks Like Fine Leather
- Finger-Tip Lift Carrying Handle & Fine Shoulder Strap



\$29.95 List price, less batteries

SEE OUR OTHER
NEW PORTABLES
FOR SIGNAL SALES!

SOME TERRITORIES STILL OPEN FOR DISTRIBUTORS

Signal Electronics, Inc.

Domestic:
SIGNAL SALES CORP.
114 E. 16th St., New York 3, N. Y.

3 WAYS TO BE AHEAD in Buying Test Equipment

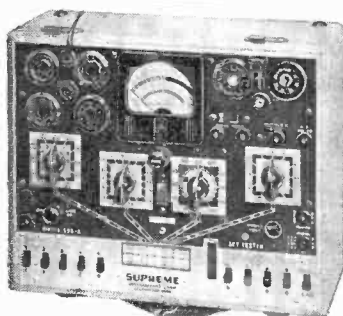

Model 599-A Tube and Set Tester

SPECIFICATIONS
DC Volts — 5 ranges 0/6/15/150/600/1500 volts, 1000 ohms per volt.
AC Volts — 3 ranges 0/15/150/600 volts.
DC Current — 3 ranges 0/6/60/600 milliamps.
Output Volts—0/15/150/600 volts.
Ohmmeter — 4 ranges 0/200/20,000 ohms and 0/2/20 megohms.

Condenser Checker—Ohmmeter provides fast method of checking leakage of both paper and electrolytic condensers.
Battery Tester — Tests most commonly used dry portable batteries of 1.5/4.5/6.0/45/90 volts. English reading "Replace-Good" scale.

- 1 BUY ACCURACY
- 2 BUY DEPENDABILITY
- 3 BUY SUPREME-ACY

Ask your nearest SUPREME jobber for a demonstration of Model 599-A Tube and Set Tester (above), Model 561-AF & RF Oscillator, Model 546-A Oscilloscope, Model 592 Speed Tester. Ask to see the complete line of SUPREME equipment.

SUPREME

Tube Testing — Circuit incorporates proven and modernized emission circuit. Checks for short, leakage, and noise tests between elements.
Power Supply—100-133 volts—50/60 cycles. Special voltages and frequencies on request.



WRITE FOR
NEW
CATALOG

SUPREME INSTRUMENTS CORP., Greenwood, Miss., U.S.A.

Export Department: THE AMERICAN STEEL EXPORT CO., Inc.,
1347 Madison Ave., New York 17, N. Y., U.S.A.

Thousands of
Satisfied
Users!



TRANSVISION

**TELEVISION
KIT... A High Quality
TELEVISION RECEIVER**
ready for Easy,
Rapid Assembly
Features the Brilliant
LECTROVISION Picture Tube!

ENGINEERED
BY
TELEVISION
SPECIALISTS



Easy-to-Assemble: No knowledge of television required. COMPLETE easy-to-follow INSTRUCTION SHEET gives you all the knowledge you need.

This kit INCLUDES SOUND, all component parts, and the following:—

Specially designed Television Antenna
... A \$30.00 Brilliant LECTROVISION seven-inch Picture Tube, plus ALL other tubes ... Pre-tuned R-F unit ... Finished front panel ... All solder, wire, and 60 ft. of low loss lead-in cable.

Operates on 110V.; 50-60 cycles A. C. Price: complete with ALL tubes, \$159.50 (fair traded)

IMMEDIATE DELIVERY!

We believe that the comparative quality of this set is superior to other available sets. It has been acclaimed by major television schools.



CABINET for
TRANSVISION
Television Kit

Made of selected grain wood, with beautiful hand-rubbed walnut finish. Accessory Kit for Mounting Included at No

Extra Charge. Overall size: 17 1/8" deep; 19 1/4" wide; 15 3/8" high. Price \$29.95

DEALERS! Cash in on this Kit! Ideal for making your own Custom-Built Television Receiver.

See your local distributor, or for further information write to

TRANSVISION, INC. Dept.
R.T.R.
385 North Ave.—New Rochelle, N.Y.

Appointed by ACA



Sidney Karr is the new advertising and publicity assistant to N. M. Haynes, vice-president of Amplifier Corp. of America. He was formerly with Templeone; he will now assist in ACA's expanded promotional program on the firm's newly designed line of amplifiers.

**Cosgrove Makes Report;
Balcom Heads RMA**

In his annual report to the Radio Manufacturers Association, given at the luncheon meeting of the 23rd annual RMA convention at the Stevens Hotel, Chicago, president R. C. Cosgrove said that "the radio manufacturing industry is back to normal . . . all of the elements of normality in the radio business are here—very much so."

Mr. Cosgrove, who is general manager of the Crosley Division, of Cincinnati, has retired as RMA president after three years' service.

Max F. Balcom, a vice-president of Sylvania Electric Products, Inc., was elected to the post of RMA president.

Overproduction, unbalanced inventories, cut prices and leader models were specified by Mr. Cosgrove as being indicative of the radio industry's return to normalcy. Commenting on set production, Mr. Cosgrove said: "The guidance and dissemination of information by RMA are partially responsible at least for the fact that in 1946 over 15 million radio receivers were produced, and in the early months of 1947 the average production rate is still higher."

"We claim in these RMA committees to have helped in normalizing of the business and in making of a great contribution to the purchasing public who, after all, should have been considered first."

**Cushway Named
Executive Vice-President**

Charles P. Cushway, widely known as an executive in the radio and electronics industry, has been elected executive vice-president and a director of Webster-Chicago, Corp. President R. F. Blash also announced other appointments in the expanding W-C program. W. S. Hartford was appointed general sales manager and E. R. Johnson was elected treasurer. Norman Conrad continues as chief engineer.

You satisfy every
COMMERCIAL
and
INDUSTRIAL
SOUND NEED
with the
complete line of

**BELL SOUND
EQUIPMENT**

and at the same time

- Simplify Your Inventory
- Increase Stock Turnover
- Boost Your Profits



Ask your
nearby Bell
distributor
for details

**BELL SOUND
SYSTEMS, INC.**

1186 Essex Avenue
Columbus 3, Ohio

SENSATIONAL SELLER!

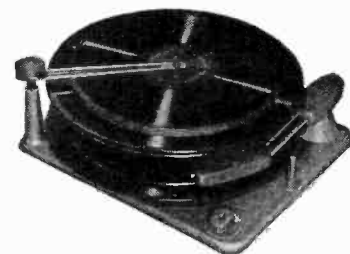

LAKE DELUXE CHANGER

Revolutionizes the Industry!
An Excellent Seller!

11 Outstanding Features:

- Positive Intermix Service Adjustments. Eliminated
- Minimizes Record Wear
- Single Knob Control
- Plays ALL Records
- Pick-up arm may be grasped at any time and changer will not be thrown out of adjustment
- Resonance-free ball bearing tone arm
- Easily operated—any child can do it
- Completely Jam-proof
- Records Gently Lowered on Spindle—not dropped
- Automatic Shut-off on last record

Dimensions: 13 13/16" W x 12 1/4" D x 7 3/8" H. No. 116A.....YOUR NET **\$28.73**

SERVICEMEN—RETAILERS Write for our new, illustrated 16-page catalog NR-116. It's free. Get on our mailing list!

Write for our Special Catalog on Microphones, Amplifiers and Sound Equipment!

Lake Radio Sales Co.

615 W. Randolph Street
Dept. B
Chicago 6, Ill.

SPECIALS for JULY

3 CONDUCTOR FLAT RUBBER COVERED AC CORD

An ideal cord for replacement purposes on AC-DC Radios, etc., where third lead is used for antenna. Has many other uses. Priced very special for this month only.

Per 1000 Ft. Spools \$30.00
Per 100 Ft. Coils \$ 3.38

SIX FOOT 3 CONDUCTOR CORD SET

A six foot cord set of the above material with molded unbreakable rubber plug and open end of cord stripped and tinned ready for attaching.

Per each 38c

AC-DC AERIAL WIRE

An extra flexible rubber covered wire, excellent for replacement aerial wire on small radios. A real value.

Per 1000 Ft. Spool \$ 4.13
Per 100—20 Ft. Hanks \$11.25

BARE AND TINNED AERIAL WIRE

Columbia's finest aerial wire. Guaranteed as to gauge and length. Stock up on these scarce items at this low price.

19 Ga. 7x27 Bare
Per 100 Ft. Coil 36c
18 Ga. 7x26 Tinned
Per 100 Ft. Coil 49c
15 Ga. 7x23 Tinned
Per 100 Ft. Coil 66c

TWISTED PAIR INTERCOM WIRE

Here is a 22 Ga. Solid Twisted Pair with plastic insulation at rock bottom prices. This is a never to be duplicated value.

Per 1000 Ft. Spools \$7.35

We carry in stock for immediate delivery many types of wire and cable in gauges of from 23 to 2, in addition to various types of multi-conductor cable for many uses. We also manufacture cord sets and cables to specifications. Send us your inquiries for prompt attention.

Our new catalog is now ready for distribution. Send for your copy today.

COLUMBIA WIRE & SUPPLY CO.

5734 ELSTON AVE., CHICAGO 30, ILLINOIS

NEW HAVEN QUILT & PAD CO.'S PADDED COVERS ELIMINATE DAMAGE CLAIMS

Completely covers all standard floor models. Waterproof canvas outside, mole-skin lined. Send for catalog of all appliance covers.

RADIO COVERS

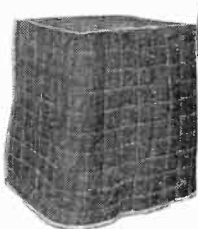

One-Piece
Padded Range
and Stove Covers

NEW HAVEN QUILT & PAD CO.
86-88 Franklin St., New Haven 11, Conn.

For Originality

LOOK TO

XCELITE



Look to XCELITE for heads-up tool developments that KEEP them on your top-selling list! The tough, snug-gripping, fast-action XCELITE Nut Driver above—and the whole XCELITE line—are engineered from the shop-man's point of view.

Write us now for full details. Make sure your line includes profit-building XCELITE tools!

PARK METALWARE CO., INC.

Dept. M Orchard Park, New York

Quality Tools

PREFERRED BY EXPERTS

RIDER Radio Publications

Builders of Successful Servicing

YOU HAVE TO KEEP UP-TO-DATE IF YOU WANT TO KEEP AHEAD

New fields of activity and profit are constantly being opened to radio men who are equipped with the knowledge to take advantage of the opportunities.

THREE OF RIDER'S LATEST!

"Inside The Vacuum Tube"

Theory and operation of basic types of tubes \$4.50

"Understanding Microwaves"

Foundation for understanding developments \$6.00

"Radar"

Explains fundamentals \$1.00

RIDER CLASSICS

The Meter at Work \$2.00
The Oscillator at Work 2.50
Vacuum Tube Voltmeters 2.50
Automatic Frequency Control Systems 1.75
A-C Calculation Charts 7.50
The Cathode Ray Tube at Work 4.00
Frequency Modulation 2.00
Servicing by Signal Tracing 4.00

ORDER TODAY!

By The Publisher
of
RIDER MANUALS

Hour-A-Day-with-Rider Series—

On "Alternating Currents in Radio Receivers"
On "Resonance & Alignment"
On "Automatic Volume Control"
On "D-C Voltage Distribution" 1.25 each

JOHN F. RIDER PUBLISHER, INC.

404 FOURTH AVENUE, NEW YORK 16, N.Y.

Electro

ELECTRICAL AND RADIO EQUIPMENT

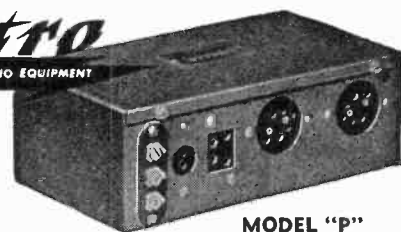

BATTERY ELIMINATORS

MODEL "P"

A Complete Line for Every Requirement!

Models to convert dry battery radios to efficient AC receivers. Other models to convert dry battery radio for use only with 6 volt storage battery.

Cost but a few cents per hundred hours of operation. Completely filtered—hum free—silent and efficient. Sturdily constructed—no liquids or moving parts—operate in any position.

MODEL "Q"—Operates any 1.4 volt 4, 5 or 6 tube radio from 6 volt storage or dry battery, or Wincharger. Ideal for farms, camps, autos, boats, etc.

MODEL "R"—Operates 2 volt 4, 5, 6 or 7 tube radio from 6 volt storage or dry battery, or Wincharger. (0.5 Amp. filament max.)

MODEL "P"—Operates any 1.4 volt 4, 5 or 6 tube radio from 110 volt 60 cy. source. Cuts down current use and saves batteries for portable use.

MODEL "F"—Operates any 2 volt 4, 5, 6 or 7 tube radio from 110 volt, 60 cy. source. (0.5 Amp. filament max.)

Canadian representative, **ATLAS RADIO CORP.**, Toronto, Canada

ELECTRO PRODUCTS LABORATORIES

Pioneer Manufacturers of Battery Eliminators
549 WEST RANDOLPH STREET CHICAGO 6, ILL.



BURGESS Builds Flashlight Battery Profits

Expertly merchandised in colorful, buy-appealing packs. Nationally advertised to 40,000,000 buyers every month . . . Burgess quality is known to millions. Order These Merchandising Displays Today.

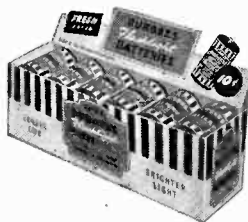

(Left) Twelve Size 2 flashlight batteries in small size carton move quickly on busy counters.

(Right) Forty-eight Size 2 flashlight batteries in sturdy, buy-inviting, two-color carton for quick turnover.

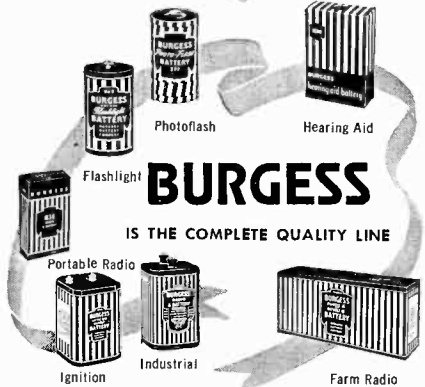

BURGESS
IS THE COMPLETE QUALITY LINE

BURGESS BATTERIES

DATES AHEAD

- July 7-13: Store Modernization Show, Grand Central Palace, New York City.
- July 7-19: Summer Furniture Show, Furniture and Merchandise Mart, Chicago, Ill.
- Oct. 7-9: National Farm Electrification Conference, Claypool Hotel, Indianapolis, Ind.
- Oct. 26-Nov. 1: National Radio Week.
- Nov. 3-5: National Electronics Conference, Edgewater Beach Hotel, Chicago.
- Nov. 23-30: Second Annual National Crafts & Hobby Show, Madison Square Garden, N. Y.

Rider Manual Contestants Rush Jobbers for Entries

A short delay in the issuance of official entry blanks at the start of the "Rider Manuals Mean Successful Servicing" contest, during June resulted in a deluge of letters from servicers, according to John F. Rider, publisher, and sponsor of the contest.

Announcing that immediate steps had been taken to correct the situation, which had come about through no fault of the more than 700 jobbers distributing the blanks, Rider drew a moral from the incident.

"I believe that this indicates," he said, "that dealers will start becoming aware of what they have, for a good part of their lives, taken for granted: the regular publication of Rider manuals. Like a right arm, our manuals are so important for successful servicing, and so regularly used, that only when one is mislaid, or missing, does the servicer realize his dependence upon them. To correct this state of affairs, our 100-word contest asks each contestant to think about why Rider manuals mean successful servicing. Aside from the possibility of winning one of the 224 prizes, worth \$4,325, the servicer will learn how to increase his profits and save his own time."

Dealers and Jobbers In Meeting on FM

A meeting on how to understand, demonstrate and sell FM was held at the Engineering Societies Auditorium in New York on June 19th, sponsored by the Dealers Group of the Electrical & Gas Association of New York, in cooperation with FM distributors of the area.

On the program were speeches by FM experts, exhibits by distributors, special demonstrations and broadcasts. H. C. Calahan, president of EGANY, said that the meeting was the forerunner of "a series of product meetings held by our Dealers Group in cooperation with manufacturer and distributor members."

Alexander Saybell, chairman of the retailers group, was chairman of the meeting, and the prominent retailer, Mortimer Fogel, a member of the dealers group management committee, was master of ceremonies.



REPAIR KIT SPRAY KIT

PHONO TURNTABLE STAND

G-C DELUXE CABINET REPAIR KIT

Comes in handy black leatherette finish box. Contains shellac sticks, stain, varnish, polish, alcohol lamp, spatula, brushes, wiping cloth, directions, etc.



No. 901—List \$4.50

G-C PHONO TURNTABLE SERVICE STAND

Steel stand on which to place any phono turntable; ideal for repairman, easily adjusted, sturdy steel construction.

No. 5205
List \$6.65



G-C FELT-KOAT FLOCK FINISH SPRAY KIT

For phono-turntables, cabinets, etc. Produces scratch-proof, velvet-like coat. Contains two colors, brown and ivory, easy to apply.



No. 180-2 blower kit complete
List \$10.75

Write for Catalog
G-C PRODUCTS are available at leading distributors.

RADIO DIVISION DEPT. G

GENERAL CEMENT Mfg. Co., Rockford, Ill., U.S.A.
Manufacturers of over 3,000 products
Sales offices in principal cities

SCOTCH TAPE, 3/8" wide, standard 1296" roll. Printed with numeral or letter (our choice):
Per Roll29
10 Rolls for 2.49

TUBE SPECIALS

All in perfect condition, but not in sealed cartons. Every tube guaranteed 90 days.
#20, 26, 27, 48 or 5829
#41, 42, 45, 75, 77, 78, 80, 89, 5Y3,39
#6H6 or 6K739
#35, 37, 39, 50L6, 84, 5Y4, 6A8, 6C5, 6D6, 6F5, 6J7, 6N7, 6SA7, 6SK7, 6U7, 12SA7 or 12SK749
#1A7, 1H5, 1N5, 1R5, 6A3, 6U5, 6X5, 7A7, 7C5, 7C6, 7Y4 or 5059
TUBE CARTONS: Plain white. Gt size (1 1/4" sq, 3 1/4" L). Per 100 1.25
Medium size (1 1/2" sq, 4 3/8" L). Per 100 1.49

"OUNCER" INPUT TRANSFORMERS (3/4" x 1 3/16"), Dynamic mike or low-impedance pick-up to grid49
12 for 5.00

PHONO MOTORS—Twin-coil 110 V. AC, quiet rim-drive. Constant 78 RPM. With 9" heavy duty turntable 2.95
20 mfd/200 V Tubular Electrolytics, 6 for 1.00
Victor Power Transformer for models R-32, 45, 52 or 75. Unshielded 5.95

SERVICEMEN'S KITS

#2—Speaker Cones; 12 asstd. 4" to 12" moulded & free-edge (magnetic incl.). Less voice coils 2.00
#3—BAKELITE MOULDED CONDENSERS: 50 asstd. .00001 to .2 mfd. 200-600 WV. Clearly marked 2.95
#4—TUBULAR BY-PASS CONDENSERS: 50 asstd. .001 to .25 mfd. 200-600 WV. Standard brands 2.49
#6—Dial Scales; 25 asstd. airplane & slide-rule (acetate & glass included) 2.98
#7—Escutcheon Plates; 25 asstd. airplane, slide-rule & full-vision types 2.95
#17—Dial Windows; 12 asstd. incl. flat & moulded acetate & glass 1.29
#20—SPEAKER REPAIR KIT. A real money & time saver. Contains: 25 asstd. paper rings, 10 spiders, 25 asstd. voice coil forms, 3 yds. felt strips, 20 chamois leather segments, kit of 16 shims & tube of speaker cement 2.49
#23—RADIO CEMENT & SOLVENT; 3 oz. each of all-purpose cement & thinner. With applicator brush69

PROMPT SERVICE ON ALL SPEAKER & PHONO PICK-UP REPAIRS
Minimum Order \$2.00—20% Deposit Required on All Orders. Please Add Sufficient Postage.

LEOTONE RADIO COMPANY
67 DEY STREET, NEW YORK 7, N. Y.

INDEX To Advertisers

JULY 1947

	Page		Page
Admiral Corp.	5	New Haven Quilt & Pad Co.	125
American Magazine	44	Noblitt-Sparks Industries, Inc.	47
Audak Co.	67	Norge Div., Borg-Warner Corp.	81
Bell Sound Systems, Inc.	124	Olson Radio Warehouse, Inc.	118
Bendix Radio Div., Bendix Aviation Corp.	43	Park Metalware Co., Inc.	125
Burgess Battery Co.	126	Permo, Inc.	61
Chicago Tribune	10	Permoflux Corp.	120
Clarostat Mfg. Co., Inc.	122	Philco Corp.	2, 3, 18
Collier's	8, 9	Pilot Radio Corp.	128
Columbia Records, Inc.	57	Presto Recording Corp.	59
Columbia Wire & Supply Co.	125	Radio Corp. of America:	
Crosley Div., Avco Mfg. Corp.	20, 21	RCA Victor Div.	30, 31
Delco Radio Div., General Motors Corp.	22	RCA Victor Records	52
DuMont Laboratories, Inc., Allen B.	23	Tube Div.	88, Cover 4
Duotone Co.	65	Radio Maintenance Magazine	122
Electro Products Laboratories	125	Rainbow Records, Inc.	68
Franklin Corp., L. K.	70	Rauland Corp.	114
General Cement Mfg. Co.	126	Rider Publisher Inc., John F.	97, 125
General Electric Co.	7, 11, 117, 127	Sams & Co., Inc., Howard W.	103
General Industries Co.	64	Seeburg Corp., J. P.	Cover 3
Graybar Electric Co.	85	Signal Electronic Corp.	123
Howard Radio Corp.	111	Simpson Mfg. Co., Inc., Mark	119, 121
Hytron Radio & Electronics Corp.	13	SNC Mfg. Co., Inc.	101
Jensen Mfg. Co.	16	Sporks-Withington Co.	14, 15
J. F. D. Mfg. Co.	116	Stewart-Warner Corp.	6
Keynote Recordings, Inc.	68	Stromberg-Carlson Co.	26
Lake Radio Sales Co.	124	Sun Recording Corp.	62
Landers, Frary & Clark	78, 79	Supreme Instruments Corp.	123
Lee Radio Co.	115	Sylvania Electric Products, Inc.	98, 99
Leotone Radio Co.	126	Transvision, Inc.	124
Maguire Industries, Inc.	95	Triplett Electrical Instrument Co.	107
Mallory & Co., Inc., P. R.	86, Cover 2	Trutone Products Co.	114
Meissner Mfg. Div., Maguire Industries, Inc.	12	Turner Co.	113
Merit Coil & Transformer Corp.	4	United States Television Mfg. Corp.	17
M-G-M Records Div., Loew's, Inc.	50	United Wood Products, Inc.	121
Milwaukee Stamping Co.	63	Ward Leonord Electric Co.	116
		Ward Products Corp.	120
		Webster Chicago Corp.	66
		Webster Electric Co.	109
		Westinghouse Radio Corp.	24, 25
		Weston Electrical Instrument Corp.	105
		Wilcox-Gay Corp.	19
		Winsted Hardware Mfg. Co.	83
		Zenith Radio Corp.	49

While every precaution is taken to insure accuracy, we cannot guarantee against the possibility of an occasional change or omission in the preparation of this index.

"HOT"
ON THE JOB BUT
COOL
TO HANDLE...



SOLDERING IRONS

FOR service men, mechanics of all types and "handy" men who want quality tools... G-E Calrod Soldering Irons meet every requirement.

CALROD ELEMENT

Cartridge type, insulated with highly compacted magnesium oxide which maintains full insulation properties and dependably protects against grounding. The Calrod element conducts heat so rapidly that there is little temperature drop from the resistance wire. High efficiency and quick recovery permit fast work with minimum loss of time.

CALORIZATION

Much longer life can be expected from the calorized tip. Calorization also makes tip removal easy and prevents "freezing in". Corrosion of the tip is greatly retarded by calorization.

HEAT RESERVOIR

An ample heat reservoir is provided by a calorized copper heat conductor which also serves as the tip holder.

STAINLESS STEEL BARREL

There is very low heat loss through the barrel because stainless steel has less than half the conductivity of plain steel. The barrel will withstand extremely hard usage without ill effects.

COOL HANDLE

The smooth, plastic handle remains cool to the touch. The heat is in the working tip where it belongs.

For complete information write:
General Electric Company, Electronics Department, Syracuse 1, N. Y.

169-F6

GENERAL ELECTRIC

THIS IS NOT A RADIO!



What is it?

**It is Pilot Radio's
amazing new FM**

8¾" wide, 6¾" high, 5¼" deep

For AC only

PILOTUNER

the new wonder-worker that adds glorious Frequency Modulation to any regular AM set. PILOTUNER retails at only **29⁹⁵**

WHAT DOES IT DO FOR YOU, MR. RADIO DEALER?

PILOTUNER is truly the answer to your prayers! It works for you **THREE WAYS**:

1. PILOTUNER modernizes your present AM stock! Did previous planning overload you with AM sets, now nearly obsolete? Has the bounding demand for FM caught you with your plans down? **FORGET IT!** WELCOME FM! PILOTUNER makes EVERY set a superior AM-FM radio. Sets you couldn't "give away" immediately become live, hot, fast-selling . . . when combined with FM PILOTUNER!

2. PILOTUNER gives you a sensational new best-seller! FM for the Millions . . . at a history-making low price! EVERY family will want PILOTUNER—to enjoy the *finest* FM reception from their own radio—or phonograph! America's FM stations, newspapers and radio dealers are joined in a great cooperative campaign to tell all America about PILOTUNER. John and Jane Q. Public will go for it with Open Arms . . . and Open Purses!

3. PILOTUNER rescues you from FM "BOOMERANGS" . . . It brings obsolete AM-FM sets up-to-date. Are the FM "pre-war babies" you sold bouncing back to you, accompanied by customer squawks? Hitch PILOTUNER to ANY of those "orphans" and PRESTO! . . . it's giving the pure, perfect FM reception your customer HOPED for. No drifting! No fading! Hair-fine selectivity!

PILOTUNERS ARE AVAILABLE FOR IMMEDIATE DELIVERY!

To assure fair distribution — maximum initial order is limited to 96 PILOTUNERS.

(Minimum order — 12 pieces.)

DEALER CONVENTIONS in honor of PILOTUNER are being held throughout America, in conjunction with FM stations. Watch for the convention in YOUR area.

PILOT RADIO CORP. 37-06 36th ST., LONG ISLAND CITY, N.Y.

MAKERS OF PILOTONE RECORDS • PIONEERS IN SHORT WAVE — FM — TELEVISION

WARNING!

There can be no compromise on quality of parts for FM tuners or receivers.

PILOTUNER is built up to the highest known standards!

- 3 gang copper condensers
- 5 tubes, plus selenium rectifiers
- Heavy duty transformer
- Own power supply
- Tuned R-F stage
- Handsome Walnut Cabinet

With these unsurpassed specifications, the amazingly low price of \$29.95 is possible **ONLY** through the closest cooperation and profit-sharing by Pilot Radio and parts suppliers.



Changer Performance
**TO MATCH THE PERFECTION
 OF THE INSTRUMENT**

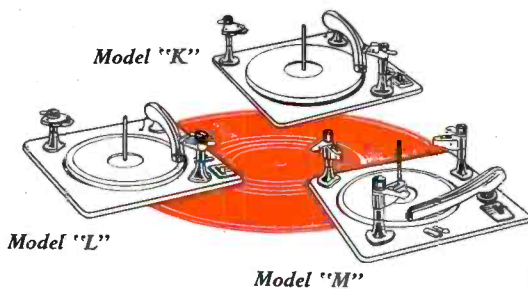

Fine combination instruments are judged—and sold—by their over-all excellence of performance. It's important, then, that you select record changers to match the precision and beauty of your radio-phonograph combinations.

Seeburg builds three such changers. While each is designed for use in sets of varying price ranges, all are engineered to give simple, trouble-free operation.

Back of every Seeburg changer is a broad, successful experience in the development and manufacture of all types of changing mechanisms—this is your assurance of dependable, gratifying performance.

Seeburg
 RECORD CHANGERS ★ MUSIC SYSTEMS
 J. P. SEEBURG CORPORATION
 1500 N. Dayton St., Chicago 22

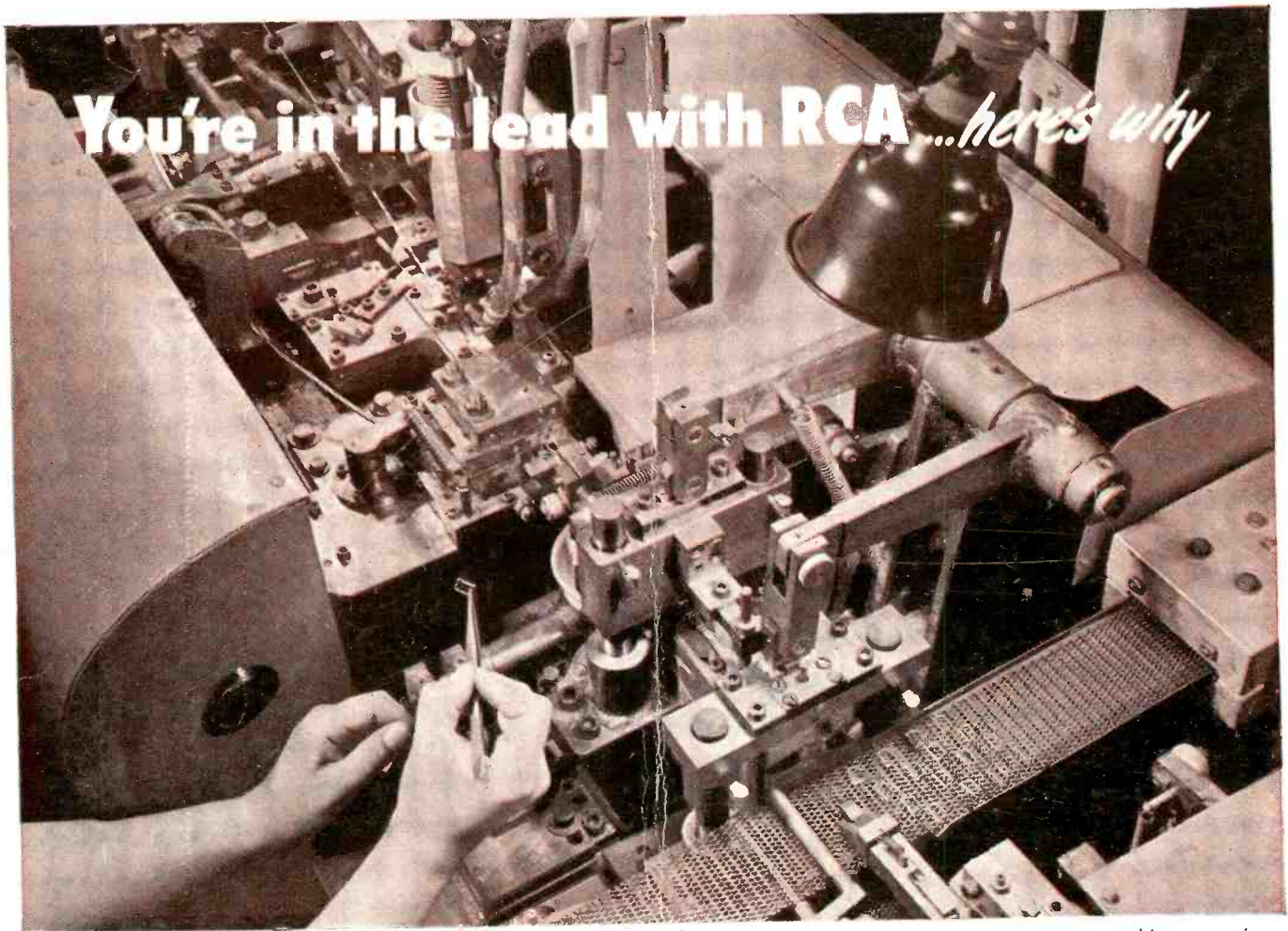

You're in the lead with RCA... *here's why*

*Automatic high-speed getter machine operation—
a tube manufacturing technique pioneered by RCA.*

Manufacturing...



millions of tubes with uniform, dependable quality

The ultra-modern RCA tube plants produce millions of tubes, hundreds of types . . . and this tremendous production is maintained day in and day out with standards of uniform quality that have always been a byword in the industry.

The secret? RCA's engineers are constantly designing ingenious new tube-making machinery, and improving manufacturing techniques to set the pace in this fast-moving radio-electronics industry. Hundreds of precision, mass-production machines, such as that shown above . . .

RCA designed throughout . . . perform near miracles of intricate manufacturing.

RCA's manufacturing "know-how" works constantly to your advantage. It is backed by the engineering leadership of the greatest name in radio. It accounts for the buying confidence and preference so universally accorded RCA tubes.

Manufacturing "know-how" is still another of the many reasons why you're in the lead with RCA.

So push RCA tubes and watch your business grow!

THE FOUNTAINHEAD OF MODERN TUBE DEVELOPMENT IS RCA



TUBE DEPARTMENT

RADIO CORPORATION of AMERICA

HARRISON, N. J.