

Operation Manual

Benutzerhandbuch

Fonctions Détaillées

Manual de Operaciones

Manuale Operativo

オペレーションマニュアル

USB AUDIO INTERFACE **UR 824**



EN
DE
FR
ES
IT
JA



Contents

Introduction.....	3
Contents in this Operation Manual.....	3
Features	3
Panel Controls and Terminals (Details).....	5
Rear Panel.....	5
Front Panel.....	6
Panel Controls for the Software Programs	8
Introduction	8
Control Panel of the Audio Driver.....	8
dspMixFx UR824.....	9
Dedicated Windows for Cubase Series	15
Sweet Spot Morphing Channel Strip (Channel Strip).	20
REV-X	22
Guitar Amp Classics	24
Usage Examples	26
Introduction	26
Recording with the Channel Strip and REV-X.....	26
Connecting the Mic Preamp	28
Using the Device Without a Computer.....	28
Using the Device with an iPad	29
Appendix	31
Glossary	31
Contents of the Getting Started Section	32
Signal Flow.....	33
Block Diagrams.....	35

Introduction

Contents in this Operation Manual

This Operation Manual explains how to use the device. The explanations in this manual assume that you've set up the device and prepared it for use according to the Getting Started document. If you haven't done that yet, refer to the Getting Started document and complete the setup before reading this manual.

Features

High-resolution Microphone Preamplifiers (D-PRE)

Discrete microphone preamps featuring a high-performance inverted Darlington circuit configuration achieve low distortion and noise while delivering sound with eminently musical balance and character.

Supports a Variety of Inputs

Switchable phantom power is provided for condenser microphones, electric guitars and basses can be directly connected via a HI-Z (high impedance) input, and a PAD is provided for input matching with high-level signals from electronic instruments. Optical input connectors enable direct digital input in ADAT or S/PDIF format from a variety of digital audio devices, while a BNC-connector for word clock input and output allows precise synchronization with other digital equipment.

Powerful DSP Mixer (dspMixFx)

A DSP mixer that can mix up to 24 input channels to four stereo outputs is built in. Two of those stereo mixes can be independently assigned to separate headphone outputs. It is also possible to directly route a stereo input to any specified stereo output. A number of DSP effects that can be applied to input signals are also provided, and since it is a hardware mix with there is no monitoring latency.

DSP Effect: Sweet Spot Morphing Channel Strip

The Sweet Spot Morphing Channel Strip ("Channel Strip" for short) is a multi-effect that combines compression and EQ. Advanced sound engineering know-how is condensed into a number of presets that can simply be recalled as required for professional results. Up to eight channel strips can be used at a time, and it can be assigned either to the monitor sound only, or to both the monitor and recorded sound.

DSP Effect: REV-X Reverb

REV-X is a digital reverb platform developed by Yamaha for pro audio applications. One REV-X effect is included in this unit. Input signals can be sent to the REV-X effect, and the REV-X effect is applied only to the monitor outputs.

DSP Effect: Guitar Amp Classics

Guitar Amp Classics are guitar amp effects that make extensive use of advanced Yamaha modeling technology. One Guitar Amp Classics effect can be used at a time, and it can be assigned either to the monitor sound only, or to both the monitor and recorded sound.

The maximum number of Channel Strip and Guitar Amp Classics iterations which can be used simultaneously has restrictions. Refer to the "Limitations on the use of effects" (page 34).

DSP Effect VST3/AU Plug-in Included

The DSP effects "Channel Strip," "REV-X" and "Guitar Amp Classics" of three VST3/AU plug-ins (page 31) are included. These can be used with Cubase series or similar VST-compatible DAW software and AU-compatible DAW software.

Free Download of Cubase AI

Steinberg's Cubase AI digital audio workstation (DAW, page 31) is available free for downloading via our website, specifically for customers who have purchased the UR824. Cubase AI is the entry-level version of the Cubase series DAW products, providing the basic functionality you need for music production and editing.

Class Compliant mode

In Class Compliant mode, the UR824 works with the iPad through the Apple iPad Camera Connection Kit. It can be used with iOS compatible music production applications such as Steinberg Cubasis for convenient high-quality recording anywhere, at any time. A computer can also be used in CC mode.

Loopback function

Loopback function facilitates video delivery and other Internet related activities. This function mixes the input audio signals (LINE, Guitar, Mic, etc) and the audio signals playing back in the software into two channels in the UR824, and back to the computer for live broadcasting via the Internet.

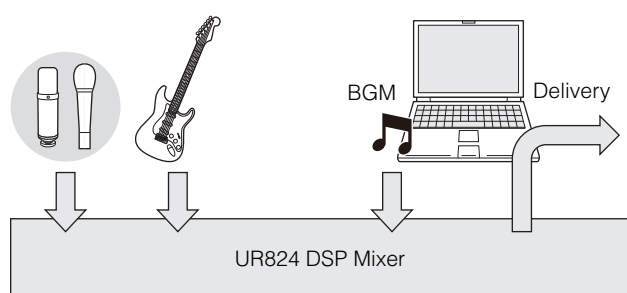

Panel Controls and Terminals (Details)

Rear Panel

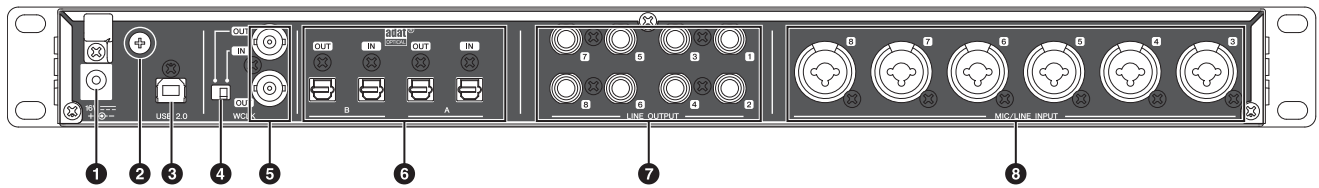

1 DC IN 16V

For connection to the AC power adaptor.

2 Grounding screw

For connection to a ground wire.

If you have a problem with hum or noise, use this terminal to connect to ground. The noise may be reduced.

3 USB2.0 (USB port)

For connection to a computer or iPad. Apple iPad Camera Connection Kit or Lightning to USB Camera Adapter are required when connecting the UR824 with an iPad.

USB Port Precautions

NOTICE

Be sure to observe the following points when connecting to the computer's USB interface. Failing to do so may result in the computer freezing or shutting down, as well as corruption or even loss of data. If the device or computer does freeze, restart the application or computer.

- Be sure to wake the computer from sleep/suspended/stand by mode before making a connection to the computer's USB port.
- Before turning on the power to the device, connect the computer to the USB port.
- Before turning on/off the device or plugging/unplugging the USB cable, quit any open application software on the computer.
- When connecting or disconnecting the USB cable, be sure to set all output level controls to the minimum.
- Wait at least six seconds between connecting or disconnecting the USB cable.

4 WCLK switch

Switches between IN and OUT for the upper WCLK terminal.

5 WCLK IN (OUT)/OUT (BNC connector)

For connection to the device which transmits and receives the word clock.

6 OPTICAL A/B IN/OUT (optical)

For connection to a digital audio device.

You can select the format of the OPTICAL A/B between ADAT and S/PDIF. To select the format, use the "Setup Window" (page 13) in the section "dspMixFx UR824" or the "Settings Window" (page 19) in the section "Dedicated Windows for Cubase Series."

You can select the output signal of the OPTICAL A/B OUT. To select the output signal, use the "Setup Window" (page 13) in the section "dspMixFx UR824" or the "Output Routing Window" (page 18) in the section "Dedicated Windows for Cubase Series."

7 LINE OUTPUT 1-8 (phone type, balanced/unbalanced)

For connection to monitor speakers. When the monitor speakers have a balanced input, connect them with a balanced cable.

You can select the output signal of LINE OUTPUT 1-8. To select the output signal, use the "Setup Window" (page 13) in the section "dspMixFx UR824" or the "Output Routing Window" (page 18) in the section "Dedicated Windows for Cubase Series."

8 MIC/LINE INPUT 3-8 (XLR/phone type, balanced/unbalanced)

For connection to a microphone or digital instrument.

Front Panel

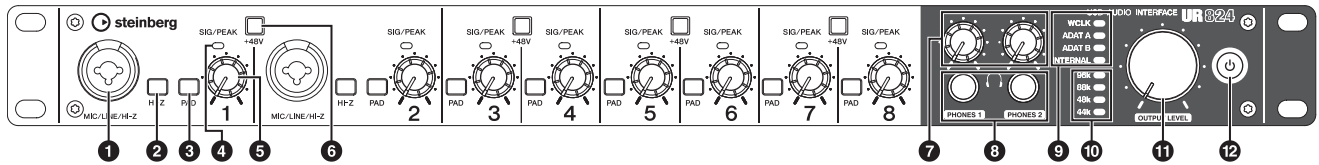

1 MIC/LINE/Hi-Z (XLR/phone type, balanced/unbalanced)

For connection to a microphone, digital instrument, electric guitar, or electric bass.

2 HI-Z switch

Turns on (☐) and off (■) the HI-Z of the MIC/LINE/Hi-Z.

Turn this switch on when connecting high impedance instruments, such as an electric guitar or electric bass, directly to the MIC/LINE/Hi-Z.

When you turn this switch on, use an unbalanced phone type cable for connection between the instrument and the MIC/LINE/Hi-Z. If you use a balanced cable or an XLR cable, this device will not work correctly.

⚠ CAUTION

- Do not connect or disconnect a device while turning on the HI-Z switch. Doing so can damage the connected device and/or the unit itself.
- To protect your speaker system, leave the monitor speakers turned off when turning the HI-Z switch on/off. It's also a good idea to turn all output volume controls down to their minimum. Neglect of these precautions may result in large noise bursts that may damage your equipment, your ears, or both.

3 PAD switch

Turns on (☐) and off (■) the PAD of the analog input jacks (MIC/LINE/Hi-Z and MIC/LINE INPUT).

When you turn this switch on, the input signal level of the analog input jacks will be attenuated by 26 dB. Turn this switch on when connecting high output equipment, such as a synthesizer, to the analog input jacks.

4 SIG/PEAK lamp

Indicates the input signal level of the analog input jacks (MIC/LINE/Hi-Z and MIC/LINE INPUT).

Lamp status	Description
Red	-3 dB or more
Green	40 dB or more – less than -3 dB
Dark	Less than -40 dB

5 INPUT GAIN knob

Adjusts the input signal level of the analog input jacks (MIC/LINE/Hi-Z and MIC/LINE INPUT). The adjustable range varies depending on the on/off setting of the PAD switch.

PAD	Range
On	-34 dB – +10 dB
Off	-60 dB – -16 dB

6 +48V button

Turns on (lit) and off (dark) the phantom power of XLR type connections on analog input jacks (MIC/LINE/Hi-Z and MIC/LINE INPUT).

When you turn on this button, phantom power will be supplied to the two adjacent analog input jacks. Turn on this button when connecting phantom powered devices, such as a condenser microphone, to the analog input jacks.

⚠ CAUTION

- Make sure that phantom power is turned OFF unless it is needed.
- When turning phantom power ON, make sure that no equipment other than phantom-powered devices such as condenser microphones are connected. Devices other than condenser microphones may be damaged if connected to the phantom power supply. Note, however, that the switch may be left on when connecting to balanced dynamic microphones. When connecting an unbalanced device to the MIC/LINE/Hi-Z and MIC/LINE INPUT and phantom power is turned on, hum or noise may result; this is not a malfunction or failure in the device.

- **Do not connect or disconnect a device while phantom power is applied. Doing so can damage the connected device and/or the unit itself.**
- **To protect your speaker system, leave the monitor speakers turned off when switching the phantom power on/off. It's also a good idea to turn all output volume controls down to their minimum. Neglect of these precautions may result in large noise bursts that may damage your equipment, your ears, or both.**

7 PHONES knob 1/2

Adjusts the output signal level of PHONES 1/2. This output signal level is not affected by the OUTPUT LEVEL knob.

PHONES 1/2 output one of the MIX 1–4 signals. To select the output signal, use the “Headphone Area” (page 13) in the section “dspMixFx UR824” or the “Headphones Window” (page 18) in the section “Dedicated Windows for Cubase Series.”

8 PHONES 1/2 (phone type, stereo)

For connection to a set of headphones.

PHONES 1/2 output one of the MIX 1–4 signals. To select the output signal, use the “Headphone Area” (page 13) in the section “dspMixFx UR824” or the “Headphones Window” (page 18) in the section “Dedicated Windows for Cubase Series.”

9 Word clock source lamp

Indicates the word clock (page 31) source of the device.

Lamp	Clock Source
WCLK	The word clock signal input to the WCLK IN.
ADAT A	The word clock signal input to the OPTICAL A IN.
ADAT B	The word clock signal input to the OPTICAL B IN.
INTERNAL	The internal word clock signal.

Lamp status Description

Lit	Synchronized with the clock source.
Flash	Not synchronized with the clock source.

To select the clock source of the device, use the “(device name) Window” (page 8) in the section “Control Panel of the Audio Driver” in Windows or Audio MIDI Setup in Mac.

10 Sample rate lamp

Indicates the sample rate of the device.

Lamp	Sample Rate
96k and 48k	192 kHz
88k and 44k	176.4 kHz
96k	96 kHz
88k	88.2 kHz
48k	48 kHz
44k	44.1 kHz

To select the sample rate of the device, use the “(device name) Window” (page 8) in the section “Control Panel of the Audio Driver” in Windows or Audio MIDI Setup in Mac.

11 OUTPUT LEVEL knob

Adjusts the output level of the LINE OUTPUT 1–8 signals.

To select the LINE OUTPUT for adjusting the output signal level, use the “Setup Window” (page 13) in the section “dspMixFx UR824” or the “Master Levels Window” (page 19) in the section “Dedicated Windows for Cubase Series.”

12 Power button

Turn the power on and off.

Power on	Press the power button (⏻). The power button will light.
Power off	Hold down the power button (⏻) for over two seconds. The power button will light dimly.

Panel Controls for the Software Programs

Introduction

This section explains software operations for using the UR824 with a computer.

NOTE

The software programs below do not apply to iPad.

Control Panel of the Audio Driver

This is the control panel for selecting the general settings of the audio driver. Click the upper tabs to select the desired window.

Screenshot

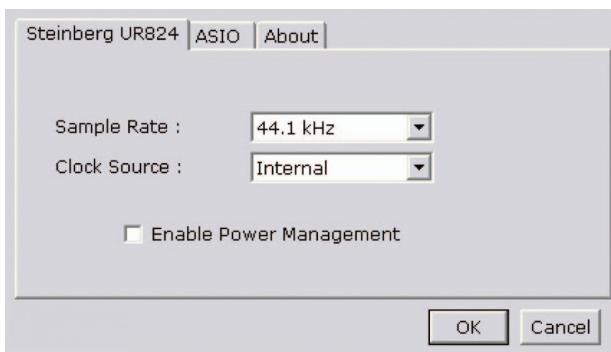

How to Open the Window

Windows

- [Control Panel] → [Hardware and Sound] or [Sounds, Speech, and Audio Devices] → [Yamaha Steinberg USB Driver]
- From the Cubase series menu, [Studio] → [Studio Setup...] → [Yamaha Steinberg USB ASIO] → [Control Panel]

Mac

- [System Preferences] → [Yamaha Steinberg USB]
- From the Cubase series menu, [Studio] → [Studio Setup...] → [Steinberg UR824] → [Control Panel] → [Open Config App]

Panel Controls

(Device name) Window

This is the window for selecting the sample rate or word clock source of the device.

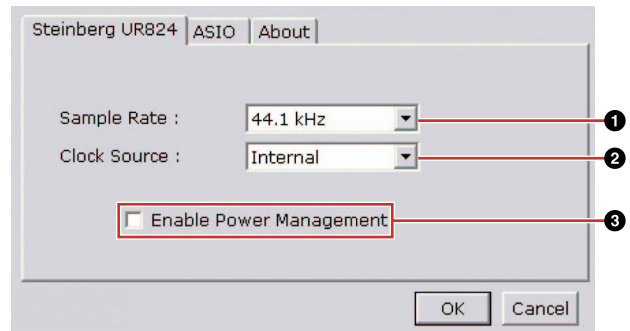

① Sample Rate (Windows only)

Selects the sample rate of the device.

Option: 44.1 kHz, 48 kHz, 88.2 kHz, 96 kHz, 176.4 kHz, 192 kHz

NOTE

For Mac, select the sample rate of the device via the Audio MIDI Setup.

② Clock Source (Windows only)

Selects the word clock source of the device.

Option	Clock Source
WCLK	The word clock signal input to the WCLK IN.
ADAT A	The word clock signal input to the OPTICAL A IN.
ADAT B	The word clock signal input to the OPTICAL B IN.
Internal	The internal word clock signal.

NOTE

For Mac, select the word clock source of the device via the Audio MIDI Setup.

3 Enable Power Management

Select enable (checkmark) and disable (no checkmark) for automatic power off.

The device is equipped with an automatic power off function. When this function is enabled, the power of the device will turn off automatically (after thirty minutes) when one of the following actions is performed. The power button will flash during the thirty-minute interval.

- Turning off the computer.
- Disconnecting the USB cable between the device and the computer.

ASIO Window (Windows only)

This is the window for selecting the ASIO driver settings.

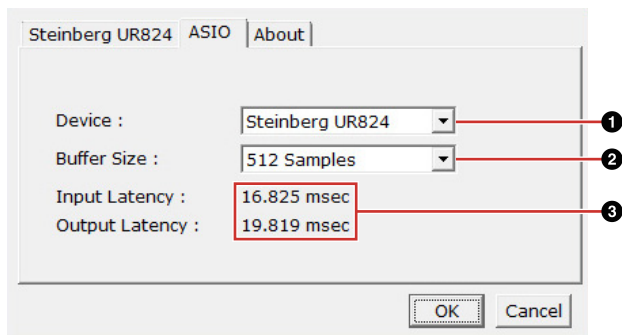

1 Device

Selects the device that will be using the ASIO driver. This function is available when connecting to the computer two or more devices compatible with the Yamaha Steinberg USB Driver.

2 Buffer Size

Selects the buffer size (page 31) for the ASIO driver. The range varies depending on the sample rate.

Sample Rate	Range
44.1 kHz/44.8 kHz	32 samples – 2048 samples
88.2 kHz/96 kHz	64 samples – 4096 samples
176.4 kHz/192 kHz	128 Samples – 8192 Samples

NOTE

For Mac, select the buffer size in the buffer size selecting window, which is opened from an application such as DAW software.

3 Input Latency/Output Latency

Indicates the delay time for the audio input and output in millisecond units.

Audio latency varies depending on the value of the ASIO buffer size. The lower the value of the ASIO buffer size, the lower the value of Audio latency.

About Window

This window indicates information about the audio driver.



1 About

Indicates the version and copyright of the audio driver. The letters “x.x.x” indicate the version number.

dspMixFx UR824

This is the window for configuring the DSP mixer and DSP effect equipped with the device. The signals flow top-to-down and left-to-right. The dspMixFx UR824 provides stand-alone operation.

NOTE

You cannot operate the dspMixFx UR824 while a Cubase series DAW is running. When Cubase is running, configure the DSP mixer and DSP effect from “Dedicated Windows for Cubase Series” (page 15).

Screenshot



How to Open the Window

Windows

[All Programs] or [All apps] → [Steinberg UR824] → [dspMixFx UR824]

Mac

[Applications] → [dspMixFx UR824]

Panel Controls

Tool Area

This is the area for configuring the common settings of the dspMixFx UR824.

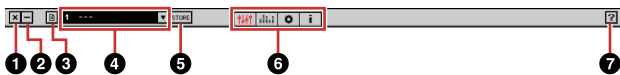

1 Quit

Quits the dspMixFx UR824.

2 Minimize

Minimizes the dspMixFx UR824 window.

3 Menu

Provides four menus, including Save the settings file of the dspMixFx UR824 (page 31) and Import Scene (page 31).

Menu	Description
Open	Opens the settings file of the dspMixFx UR824.
Save	Saves the settings file of the dspMixFx UR824 to a computer.
Import Scene	Imports a scene from the settings file of the dspMixFx UR824. Select the settings file of the dspMixFx UR824 and import scene on the left side of the IMPORT SCENE window. Select the destination for importing on the right side of the window. Click [OK] to import it.
Initialize All Scenes	Deletes all the saved scenes.

4 Scene

Indicates the scene name. You can change the scene name by clicking on it.

When you click the button on the right side, the window for calling up the scene will open. You can call up the scene by clicking it. To cancel calling up the scene, click outside of the window.

5 STORE

Opens the scene store window. Enter the desired scene name into the STORE NAME field. Select the destination for storing the scene in the No. NAME field. Click [OK] to store the scene.

6 Selecting the window

Selects the dspMixFx UR824 window. The selected window icon will light in red.

Icon	Description
	Main window (page 10)
	Level Meter window (page 13)
	Setup window (page 13)
	Information window (page 15)

7 Help

Opens the Operation Manual (this manual).

Main Window

This is the window for configuring the entire signal flow.

Channel Area (page 11) MIX Area (page 13)



DAW Area (page 12)
Master Area (page 12)
Headphone Area (page 13)

Channel Area

This is the area for configuring the input channel settings.

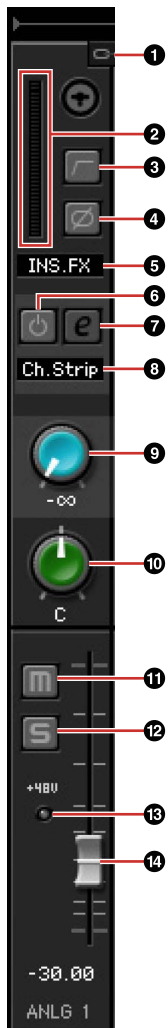

1 Channel Link

Turns on (lit) and off (dark) the channel link of two adjacent channels. When you turn this on, two mono channels will become one stereo channel.

2 Level Meter

Indicates the signal level.

3 High Pass Filter

Turns on (lit) and off (dark) the high pass filter.

To select the cutoff frequency of the high pass filter, use the “Setup Window” (page 13) in the section “dspMixFx UR824.”

4 Phase

Turns on (lit) and off (dark) the phase inversion of the signal.

5 Effect Insertion Location

Selects the insertion location of an effect.

Option	Description
MON.FX	Applies an effect to only the monitor signal (sent to the device).
INS.FX	Applies an effect to both the monitor signal (sent to the device) and the recording signal (sent to the DAW software).

6 Effect On/Off

Turns the effect on (lit) and off (dark).

7 Effect Edit

Opens (lit) and closes (dark) the selected effect setup window.

8 Effect Type

Selects the effect. The maximum number of Channel Strip and Guitar Amp Classics iterations which can be used simultaneously has restrictions. Refer to the “Limitations on the use of effects” (page 34).

9 REV-X Send

Adjusts the signal level which is sent to the REV-X.

Range: $-\infty$ dB – +6.00 dB

10 Pan

Adjusts the pan.

Range: L16 – C – R16

11 Mute

Turns the mute on (lit) and off (dark).

12 Solo

Turns the solo on (lit) and off (dark).

13 +48V

Indicates the on/off status of the phantom power function of the device.

14 Fader

Adjusts the signal level.

Range: $-\infty$ dB – +6.00 dB

DAW Area

This is the area for configuring the DAW channel settings.

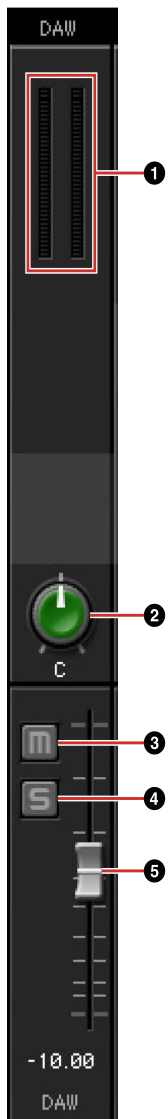

1 Level Meter

Indicates the signal level.

2 Pan

Adjusts the pan.

Range: L16 – C – R16

3 Mute

Turns the mute on (lit) and off (dark).

4 Solo

Turns the solo on (lit) and off (dark).

5 Fader

Adjusts the signal level.

Range: -∞ dB – +6.00 dB

Master Area

This is the area for configuring the master channel settings.

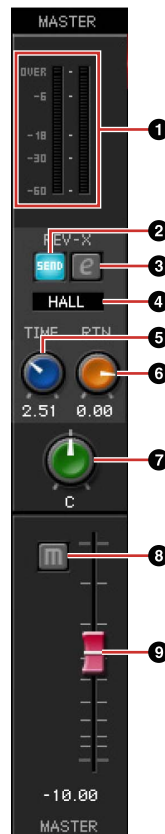

1 Level Meter

Indicates the signal level.

2 REV-X Send On/Off

Turns the REV-X on (lit) and off (dark).

You can turn this on for one of MIX 1–4.

3 REV-X Edit

Opens (lit) and closes (dark) the “REV-X” (page 22) setup window.

4 REV-X Type

Selects the REV-X type.

Option: Hall, Room, Plate

5 REV-X Time

Adjusts the reverb time of the REV-X. This parameter links to Room Size. The adjustable range varies depending on the REV-X type.

REV-X type	Range
Hall	0.103 sec – 31.0 sec
Room	0.152 sec – 45.3 sec
Plate	0.176 sec – 52.0 sec

6 REV-X Return Level

Adjusts the return level of the REV-X.

Range: -∞ dB – +6.00 dB

7 Pan

Adjusts the pan.

Range: L16 – C – R16

8 Mute

Turns the mute on (lit) and off (dark).

9 Fader

Adjusts the signal level.

Range: -∞ dB – +6.00 dB

MIX Area

This is the area for selecting the MIX you want to configure.



1 MIX

Selects the MIX you want to configure.

You can copy the Main window settings of the MIX by dragging and dropping.

Headphone Area

This is the area for selecting the output signal of the headphone.



1 PHONES On/Off

Turns on (lit) and off (dark) the headphone. You can output the MIX selected in the MIX area to the PHONES by turning this on.

Level Meter Window

This is the window for indicating the level meter of all channels on the upper part of the window. Also, this window indicates the controls of some channels on the lower part of the window. The function of the controls are the same as those described in the section “Main Window” (page 10).

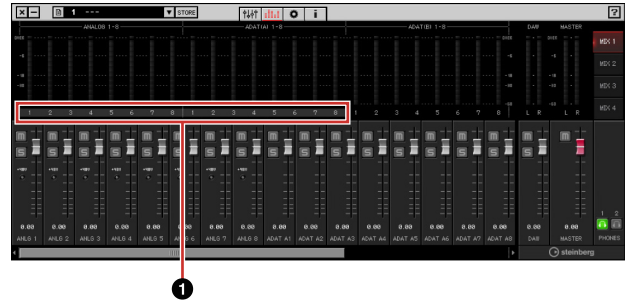

1 Range

Indicates the displayed range of the controls on the lower part of the window.

Setup Window

This is the window for configuring the common settings of the device.

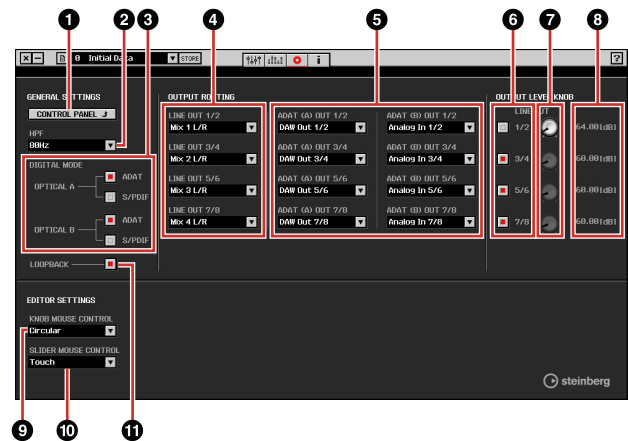

1 CONTROL PANEL

For Windows, this opens the “Control Panel of the Audio Driver” (page 8). For Mac, this opens the Audio MIDI Setup.

2 HPF

Selects the cutoff frequency of the high pass filter.

Option: 120 Hz, 100 Hz, 80 Hz, 60 Hz, 40 Hz

3 DIGITAL MODE

Selects the input and output signal format of the OPTICAL A/B.

Option	Description
ADAT	This is an input and output signal format supporting up to 8 channels.
S/PDIF	This is a 2-channel input and output signal format.

When ADAT is selected, the OPTICAL A/B terminals input and output signals of up to eight channels at 44.1 kHz and 48 kHz, or up to four channels at 88.2 kHz and 96 kHz, or up to two channels at 176.4 kHz and 192 kHz. When S/PDIF is selected, the OPTICAL A/B terminals input and output signals of up to two channels at any available sample rate.

4 LINE OUT

Selects the output signal of the LINE OUTPUT.

5 OPTICAL A/B OUT

Selects the output signal of the OPTICAL A/B OUT.

The number of OUT selections displayed here varies depending on the sample rate or DIGITAL MODE setting.

6 Knob Control

Selects which LINE OUTPUT signal level is to be adjusted by the OUTPUT LEVEL knob on the device. You can select more than one LINE OUTPUT at the same time. Checkmarks indicate the selected LINE OUTPUT signals.

7 Master Level Knob

Adjusts the output signal level of the LINE OUTPUT. Please note that this Master Level knob is disabled for the LINE OUTPUT with a checkmark on the Knob Control.

8 Master Level

Indicates the output signal level of the LINE OUTPUT.

9 KNOB MOUSE CONTROL

Selects the method of operating the knobs on the dspMixFx UR824.

Option	Description
Circular	Drag in a circular motion to increase and decrease the parameter. Drag in a dial clockwise to increase, and counterclockwise to decrease. If you click any point on the knob, the parameter will jump there instantly.
Linear	Drag in a linear motion to increase and decrease the parameter. Drag to the upward or rightward to increase, and downward or leftward to decrease. Even if you click any point on the knob, the parameter will not jump there.

10 SLIDER MOUSE CONTROL

Selects the method of operating the sliders and faders on the dspMixFx UR824.

Option	Description
Jump	Click any point on the slider and fader to increase and decrease the parameter. If you click any point on the slider and fader, the parameter will jump there instantly.
Touch	Drag the handle of the slider and fader to increase and decrease the parameter. Even if you click any point on the slider and fader, the parameter will not jump there.

11 LOOPBACK

Turns the Loopback function on (lit) and off (dark). When the Loopback function is set to ON, the audio signals output from MIX 1 in the DSP mixer (dspMix FX) in the device are returned to the computer for actual broadcasting. Refer to the section "Signal Flow" (page 33). When using multi-track recording in audio recording software, set the Loopback function to OFF.

Information Window

This window indicates information about the dspMixFx UR824 and the device.



Dedicated Windows for Cubase Series

These are the windows for configuring the device settings from Cubase series. The Dedicated Windows for Cubase series allow you to configure the parameters which are configured by the dspMixFx UR824. from Cubase series. Two types of windows are available: Input Settings and Hardware Setup.

Input Settings Window

This is the window for configuring the input settings of the device. The signal flow is from top to bottom. The settings on this window are saved to the Cubase project file, except for the +48V indicator.

Hardware Setup Window

This is the window for configuring the general settings of the device. Click the upper tabs to select the window. Only the settings on the Reverb Routing window are saved to the Cubase project file.

Screenshot

Input Settings Window



Hardware Setup Window

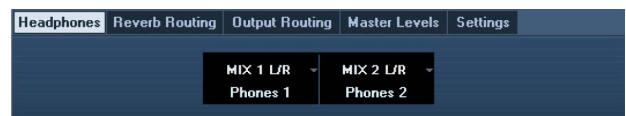

How to Open the Window

The Input Settings window appears in the Mixer window

1. [Studio] → [MixConsole] to open the Mixer window.
2. Click [Racks] to open the rack selector.

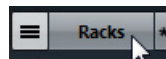

The rack selector appears.

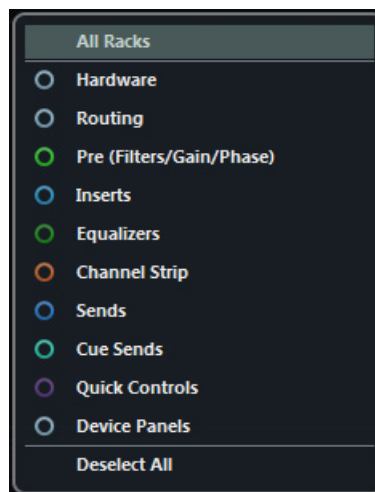

3. Click next to the [Hardware] to show [HARDWARE] in the Mixer window.

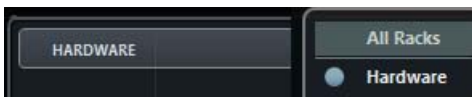
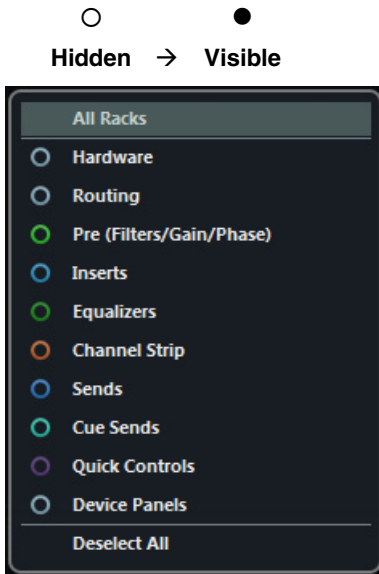

4. Click [HARDWARE].

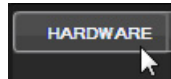

The Input Settings window appears in the Mixer window as shown below.



Panel Controls

Input Settings Window

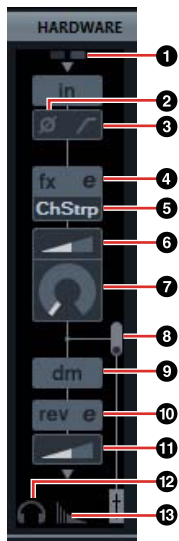

1 +48V

Indicates the on/off status of the phantom power function of the device.

2 Phase

Turns on (lit) and off (dark) the phase inversion of the signal.

3 High Pass Filter

Turns on (lit) and off (dark) the high pass filter.

To select the cutoff frequency of the high pass filter, use the “Settings Window” (page 19) in the section “Dedicated Windows for Cubase Series.”

4 Effect Edit

Opens the selected effect setup window.

5 Effect Type

Selects the effect. The maximum number of Channel Strip and Guitar Amp Classics iterations which can be used simultaneously has restrictions. Refer to the “Limitations on the use of effects” (page 34).

6 DRIVE / Output Level

When Channel Strip is selected, this adjusts the degree to which the compressor is applied. The higher the value, the greater the effect.

Range: 0.00 – 10.00

When Guitar Amp Classics is selected, this adjusts the output level.

Range: 0.00 - 1.00

7 MORPH

Adjusts the Channel Strip Sweet Spot Data. (Refer to the “MORPH” in the section “Channel Strip” on page 20.)

When Guitar Amp Classics is selected, MORPH is not displayed.

8 Effect Insertion Location

Selects the insertion location of an effect.

Insertion location	Description
Upper (OFF)	Turns the effect off.
Middle (MON.FX)	Applies an effect to only the monitor signal (sent to the device).
Lower (INS.FX)	Applies an effect to both the monitor signal (sent to the device) and the recording signal (sent to the DAW software).

9 Output Position of the Direct Monitoring Signal

Indicates the position from which the audio signals for monitoring will be output when turning on Direct Monitoring in the studio settings on Cubase.

10 REV-X Edit

Opens the “REV-X” (page 22) setup window.

11 REV-X Send

Adjusts the signal level which is sent to the REV-X.

Range: -∞ dB – +6.00 dB

12 Headphones Edit

Opens the “Headphones Window” (page 18) in the section “Dedicated Windows for Cubase Series.”

13 Reverb Routing Edit

Opens the “Reverb Routing Window” (page 18) in the section “Dedicated Windows for Cubase Series.”

Hardware Setup Window

How to Open the Window

[Studio] → [Audio Hardware Setup]

Headphones Window

This is the window for selecting the output signal of the PHONES on the device.

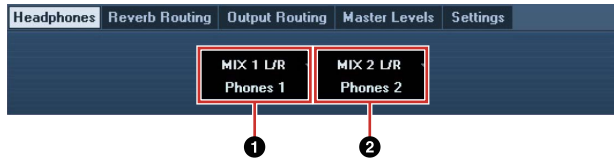

1 Phones 1

Selects the output signal of PHONES 1.

2 Phones 2

Selects the output signal of PHONES 2.

Reverb Routing Window

This is the window for configuring the “REV-X” (page 22) settings.

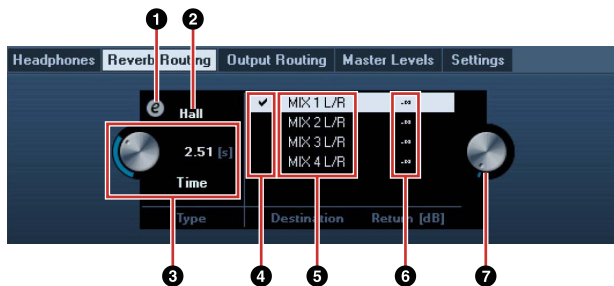

1 REV-X Edit

Opens the “REV-X” (page 22) setup window.

2 REV-X Type

Selects the REV-X type.

Option: Hall, Room, Plate

3 REV-X Time

Adjusts the reverb time of the REV-X. This parameter links to Room Size. The adjustable range varies depending on the REV-X type.

REV-X type	Range
Hall	0.103 sec – 31.0 sec
Room	0.152 sec – 45.3 sec
Plate	0.176 sec – 52.0 sec

4 REV-X Send Source Select

Selects the send source signal which is sent to the REV-X. You can select one signal at a time. The checkmark will be on the selected signal.

5 REV-X Return Signals

Selects the signal for which the return level is adjusted.

6 REV-X Return Level

Indicates the return level of the REV-X.

7 REV-X Return Level knob

Adjusts the return level of the selected (highlighted) signal.

Range: -∞ dB – +6.00 dB

Output Routing Window

This is the window for selecting the output signal of the output jacks on the device.

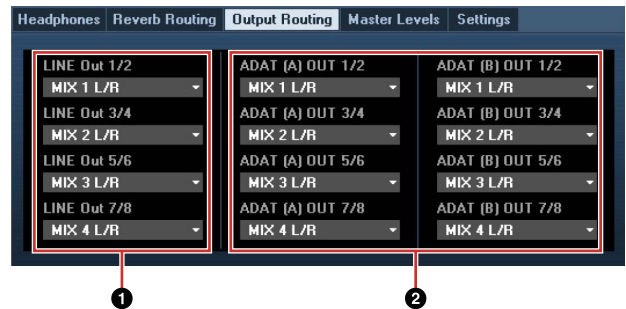

1 LINE OUT

Selects the output signal of the LINE OUTPUT.

2 OPTICAL A/B OUT

Selects the output signal of the OPTICAL A/B OUT.

The number of OUT selections displayed here varies depending on the sample rate or DIGITAL MODE setting.

Master Levels Window

This is the window for configuring the master level of the output jacks on the device.

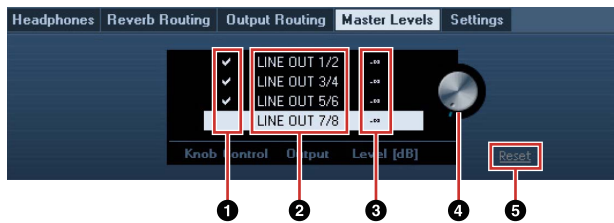

1 Knob Control

Selects which LINE OUTPUT signal level is to be adjusted by the OUTPUT LEVEL knob on the device. You can select more than one LINE OUTPUT at the same time. Checkmarks indicate the selected LINE OUTPUT signals.

2 Master Source

Indicates the LINE OUTPUT.

3 Master Level

Indicates the output signal level of the LINE OUTPUT.

4 Master Level knob

Adjusts the output signal level of the selected (highlighted) LINE OUTPUT signal. Please note that this Master Level Knob will not appear when selecting a LINE OUTPUT with a checkmark on the Knob Control.

5 Reset

Sets the output signal level of all LINE OUTPUT signals not selected in the Knob Control to $-\infty$ dB.

Settings Window

This is the window for configuring the device settings.

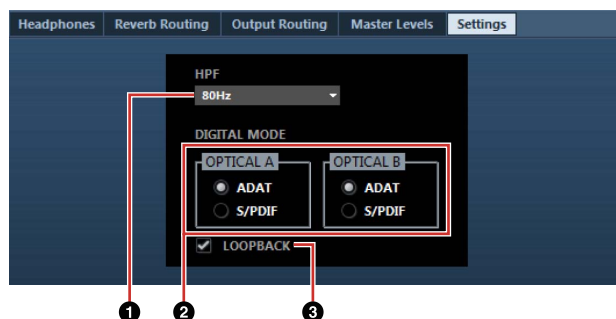

1 HPF

Selects the cutoff frequency of the high pass filter.

Option: 120 Hz, 100 Hz, 80 Hz, 60 Hz, 40 Hz

2 DIGITAL MODE

Selects the input and output signal format of the OPTICAL A/B.

Option	Description
ADAT	This is an input and output signal format supporting up to 8 channels.
S/PDIF	This is a 2-channel input and output signal format.

When ADAT is selected, the OPTICAL A/B terminals input and output signals of up to eight channels at 44.1 kHz and 48 kHz, or up to four channels at 88.2 kHz and 96 kHz, or up to two channels at 176.4 kHz and 192 kHz. When S/PDIF is selected, the OPTICAL A/B terminals input and output signals of up to two channels at any available sample rate.

3 LOOPBACK

Turns the Loopback function on (lit) and off (dark). Refer to the "LOOPBACK" in the section "dspMixFx UR824" (page 14).

Sweet Spot Morphing Channel Strip (Channel Strip)

Overview

The Sweet Spot Morphing Channel Strip (“Channel Strip” for short) is a multi-effect that combines compression and EQ. Advanced sound engineering know-how is condensed into a number of convenient presets that can be simply and instantly recalled, for professional results.

Eight channel strips can be used at a time, and it can be assigned either to the monitor sound only, or to both the monitor and recorded sound.

The Channel Strip equipped with the device and the Channel Strip of the Plug-in version have the same parameters. When using the Channel Strip on Cubase series programs, you can share the settings between the built-in Channel Strip and the Channel Strip of the VST3 Plug-in version as a preset file.

When using the built-in Channel Strip on Cubase series programs, turn on the “Direct Monitoring” setting in the program. Also, when assigning the Channel Strip of the VST3 Plug-in version to the effect slot on Cubase series programs, select it from the “Dynamics” category (in the case of the default settings). Please note that you cannot use the builtin Channel Strip when the sample rate is set to 176.4 kHz or 192 kHz.

How to Open the Window

From Dedicated Windows for Cubase Series

Select the “Channel Strip” from the “Effect Type”, then click “Channel Strip Edit” in the section “Input Settings Window” (page 15).

From the dspMixFx UR824

Select the “Channel Strip” from the “Effect Type”, then click “Channel Strip Edit” in the section “Channel Area” (page 11).

Panel Controls

Common to Compressor and Equalizer

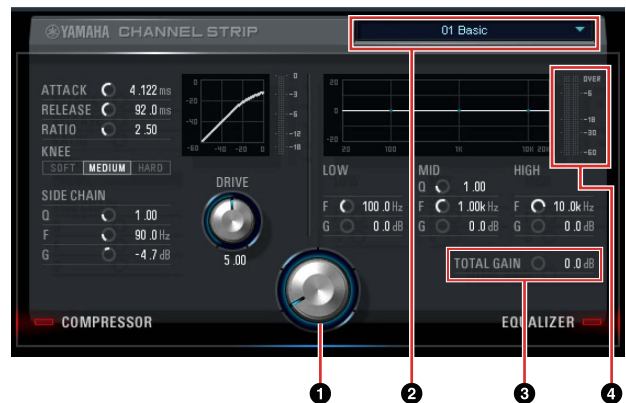

1 MORPH

Adjusts the parameter of the Sweet Spot Data.

You can simultaneously adjust the compressor and equalizer settings which are set to five points around this knob by turning this knob. When you set the knob to the middle of adjacent two points, the compressor and equalizer settings will be set to an intermediate value.

2 Sweet Spot Data

Selects the Sweet Spot Data (page 31).

3 TOTAL GAIN

Adjusts the total gain of the Channel Strip.

Range: -18.0 dB – +18.0 dB

4 Level Meter

Indicates the output level of the Channel Strip.

Compressor



1 ATTACK

Adjusts the attack time of the compressor.

Range: 0.092 msec – 80.00 msec

2 RELEASE

Adjusts the release time of the compressor.

Range: 9.3 msec – 999.0 msec

3 RATIO

Adjusts the ratio of the compressor.

Range: 1.00 – ∞

4 KNEE

Selects the knee type of the compressor.

Option	Description
SOFT	Produces the most gradual change.
MEDIUM	Middle setting between SOFT and HARD.
HARD	Produces the sharpest change.

5 SIDE CHAIN Q

Adjusts the band width of the side chain filter (page 31).

Range: 0.50 – 16.00

6 SIDE CHAIN F

Adjusts the center frequency of the side chain filter.

Range: 20.0 Hz – 20.0 kHz

7 SIDE CHAIN G

Adjusts the gain of the side chain filter.

Range: -18.0 dB – +18.0 dB

8 COMPRESSOR On/Off

Turns the compressor on (lit) and off (dark).

9 Compressor Curve

This graph indicates the approximate compressor response. The vertical axis indicates the output signal level, and the horizontal axis indicates the input signal level.

10 Gain Reduction Meter

Indicates the gain reduction.

11 DRIVE

Adjusts the degree to which the compressor is applied. The higher the value, the greater the effect.

Range: 0.00 – 10.00

Equalizer

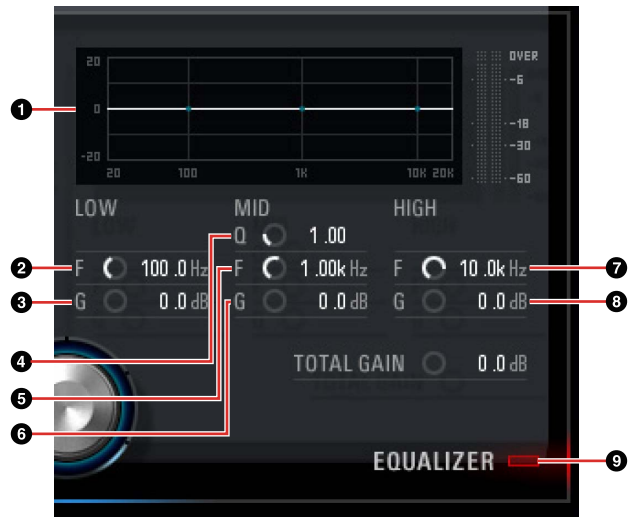

1 Equalizer Curve

This graph indicates the characteristics of the 3-band equalizer. The vertical axis indicates the gain, and the horizontal axis indicates the frequency. You can adjust LOW, MID, and HIGH by dragging each handle in the graph.

2 LOW F

Adjusts the center frequency of the low band.

Range: 20.0 Hz – 1.00 kHz

3 LOW G

Adjusts the gain of the low band.

Range: -18.0 dB – +18.0 dB

4 MID Q

Adjusts the band width of the middle band.

Range: 0.50 – 16.00

5 MID F

Adjusts the center frequency of the middle band.

Range: 20.0 Hz – 20.0 kHz

6 MID G

Adjusts the gain of the middle band.

Range: -18.0 dB – +18.0 dB

7 HIGH F

Adjusts the center frequency of the high band.

Range: 500.0 Hz – 20.0 kHz

8 HIGH G

Adjusts the gain of the high band.

Range: -18.0 dB – +18.0 dB

9 EQUALIZER On/Off

Turns the equalizer on (lit) and off (dark).

REV-X

Overview

REV-X is a digital reverb platform developed by Yamaha for pro audio applications.

One REV-X effect is included in this unit. Input signals can be sent to the REV-X effect, and the REV-X effect is applied only to the monitor outputs.

Three types of REV-X are available: Hall, Room, and Plate.

The hardware REV-X equipped with the device and REV-X of the Plug-in version have essentially the same parameters. However, the [OUTPUT] and [MIX] parameters are only available in the Plug-in version. When using REV-X on Cubase series programs, you can share the settings between the built-in REV-X and REV-X of the VST3 Plug-in version as a preset file. When using the built-in REV-X on Cubase series programs, turn on the “Direct Monitoring” setting in the program. Also, when assigning REV-X of the VST3 Plug-in version to the effect slot on Cubase series programs, select it from the “Reverb” category (in the case of the default settings).

The built-in REV-X is equipped with an “FX Bus” which is used for sending the signal from DAW software to REV-X. For example, to send the recorded audio data to REV-X, you can check the sound with REV-X, which is used for monitoring during the recording.

How to Open the Window

From Dedicated Windows for Cubase Series

- Click “REV-X Edit” (page 17) in the section “Input Settings Window.”
- Click “REV-X Edit” (page 17) in the section “Reverb Routing Window.”

From the dspMixFx UR824

Click “REV-X Edit” (page 12) in the section “Master Area.”

Panel Controls

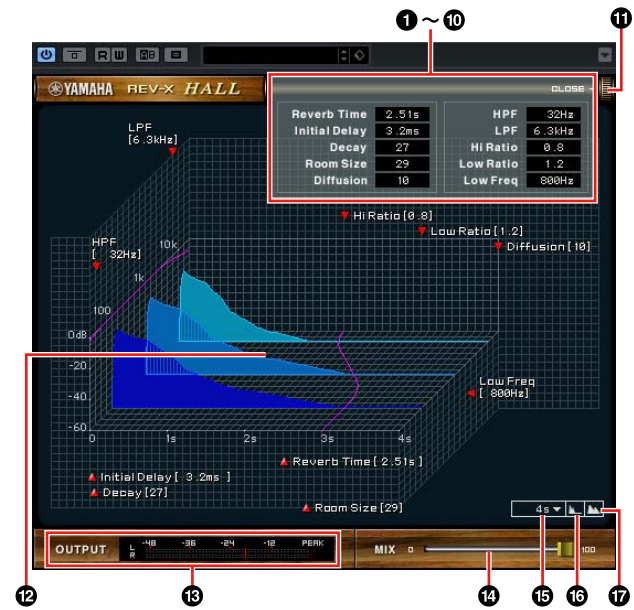

NOTE

This section uses the Hall type of REV-X as an example.

1 Reverb Time

Adjusts the reverb time. This parameter links to Room Size. The adjustable range varies depending on the REV-X type.

REV-X type Range

Hall	0.103 sec – 31.0 sec
Room	0.152 sec – 45.3 sec
Plate	0.176 sec – 52.0 sec

2 Initial Delay

Adjusts the time that elapses between the direct, original sound and the initial reflections that follow it.

Range: 0.1 msec – 200.0 msec

3 Decay

Adjusts the characteristic of the envelope from the moment the reverberation starts to the moment it attenuates and stops.

Range: 0 – 63

4 Room Size

Adjusts the size of the simulated room. This parameter links to Reverb Time.

Range: 0 – 31

5 Diffusion

Adjusts the spread of the reverberation.

Range: 0 – 10

6 HPF

Adjusts the cutoff frequency of the high pass filter.

Range: 20 Hz – 8.0 kHz

7 LPF

Adjusts the cutoff frequency of the low pass filter.

Range: 1.0 kHz – 20.0 kHz

8 Hi Ratio

Adjusts the duration of reverberation in the high frequency range by using a ratio relative to the Reverb Time. When you set this parameter to 1, the actual specified Reverb Time is fully applied to the sound. The lower the value, the shorter the duration of reverberation in the high frequency range.

Range: 0.1 – 1.0

9 Low Ratio

Adjusts the duration of reverberation in the low frequency range by using a ratio relative to the Reverb Time. When you set this parameter to 1, the actual specified Reverb Time is fully applied to the sound. The lower the value, the shorter the duration of reverberation in the low frequency range.

Range: 0.1 – 1.4

10 Low Freq

Adjusts the frequency of the Low Ratio.

Range: 22.0 Hz – 18.0 kHz

11 OPEN/CLOSE

Opens and closes the window which adjusts the reverb settings.

12 Graph

Indicates the characteristics of reverberation. The vertical axis indicates the signal level, the horizontal axis indicates the time, and the Z-axis indicates the frequency. You can adjust the characteristics of reverberation by dragging the handles in the graph.

13 OUTPUT (Plug-in version only)

Indicates the output level of the REV-X.

14 MIX (Plug-in version only)

Adjusts the output level balance between the original sound and effect sound.

Range: 0% – 100%

15 Time Axis Setting

Select the display range of the time (horizontal axis) on the graph.

Display range: 500 msec – 50 sec

16 Zoom Out

Zooms out the display range of the time (horizontal axis) on the graph.

17 Zoom In

Zooms in the display range of the time (horizontal axis) on the graph.

TIPS

- You can reset some parameters to the default value by holding the [Ctrl]/[command] key while you click on the knobs, sliders, and faders.
- You can adjust the parameters more finely by holding the [SHIFT] key while you drag on the knobs, sliders, and faders.

Guitar Amp Classics

Overview

Guitar Amp Classics are guitar amp effects that make extensive use of advanced Yamaha modeling technology. Four amp types with different sonic characteristics are provided.

Please note that you cannot use the Guitar Amp Classics when the sample rate is set to 176.4 kHz or 192 kHz. The maximum number of Channel Strip and Guitar Amp Classics iterations which can be used simultaneously has restrictions. Refer to the “Limitations on the use of effects” (page 34).

How to Open the Window

From Dedicated Windows for Cubase Series

Select the “Guitar Amp Classics” from the “Effect Type”, then click “Channel Strip Edit” in the section “Input Settings Window” (page 15).

From the dspMixFx UR824

Select the “Guitar Amp Classics” from the “Effect Type”, then click “Channel Strip Edit” in the section “Channel Area” (page 11).

Controls and Functions

CLEAN



This amp type is optimized for clean tones, effectively simulating the tight brilliance of transistor amplifiers. The tonal character of this amp model provides an ideal platform for recording with multi-effects. It also features built-in chorus and vibrato effects.

1 VOLUME

Adjusts the amplifier’s input level.

2 DISTORTION

Adjusts the depth of distortion produced.

3 TREBLE/MIDDLE/BASS

These three controls adjust the amplifier’s tonal response in the high, middle, and low frequency ranges.

4 PRESENCE

Can be adjusted to emphasize the high frequencies and overtones.

5 Cho/OFF/Vib

Turns the Chorus or Vibrato effect on or off. Set to [Cho] to turn the Chorus effect on, or to [Vib] to turn the Vibrato effect on.

6 SPEED/DEPTH

These controls adjust the speed and depth of the Vibrato effect when it is on.

The SPEED and DEPTH controls only work with the Vibrato effect, and are disengaged when the Cho/OFF/Vib control, above, is set to “Cho” or “OFF.”

7 BLEND

Adjusts the balance between the direct and effect sound.

8 OUTPUT

Adjusts the final output level.

CRUNCH



This is the amp type to use when you want lightly overdriven crunch tones. The CRUNCH model simulates the type of vintage tube amplifiers that are favored for blues, rock, soul, R&B, and similar styles.

1 Normal/Bright

Selects a normal or bright tonal character. The [Bright] setting emphasizes the high-frequency overtones.

2 GAIN

Adjusts the input level applied to the preamp stage. Rotate clockwise to increase the amount of overdrive produced.

3 TREBLE/MIDDLE/BASS

These three controls adjust the amplifier’s tonal response in the high, middle, and low frequency ranges.

4 PRESENCE

Can be adjusted to emphasize the high frequencies and overtones.

5 OUTPUT

Adjusts the final output level.

DRIVE

The DRIVE amp type provides a selection of distortion sounds that simulate the tonal character or several high-gain tube amplifiers. From mildly overdriven crunch to heavy distortion suitable for hard rock, heavy metal, or hardcore styles, this model offers a wide range of sonic capabilities.

1 AMP TYPE

Six amplifier types are provided. Types 1 and 2 feature relatively mild distortion that allows picking nuances to come through naturally. Types 3 and 4 have more pronounced overtones, resulting in a fat, soft tone. Types 5 and 6 deliver wild, aggressive distortion with a tight attack. The even-numbered amp types have greater presence and range than the odd-numbered types.

2 GAIN

Adjusts the input level applied to the preamp stage. Rotate clockwise to increase the amount of distortion produced.

3 MASTER

Adjusts the output level from the preamp stage.

4 TREBLE/MIDDLE/BASS

These three controls adjust the amplifier's tonal response in the high, middle, and low frequency ranges.

5 PRESENCE

Can be adjusted to emphasize the high frequencies and overtones.

6 OUTPUT

Adjusts the final output level.

LEAD

The LEAD amp type simulates a high-gain tube amp that is rich in overtones. It is ideally suited to playing lead guitar lines that will project well in an ensemble, but it can also be set up for crisp accompaniment tones as well.

1 High/Low

Selects the amp output type. The [High] setting simulates a high-output amp, and allows the creation of more distorted tones.

2 GAIN

Adjusts the input level applied to the preamp stage. Rotate clockwise to increase the amount of distortion produced.

3 MASTER

Adjusts the output level from the preamp stage.

4 TREBLE/MIDDLE/BASS

These three controls adjust the amplifier's tonal response in the high, middle, and low frequency ranges.

5 PRESENCE

Can be adjusted to emphasize the high frequencies and overtones.

6 OUTPUT

Adjusts the final output level.

HINT**Using the GAIN, MASTER, and OUTPUT Controls**

The tonal character of the DRIVE and LEAD amp types can be adjusted over a wide range via the GAIN, MASTER, and OUTPUT controls. GAIN adjusts the level of the signal applied to the preamp stage, affecting the amount of distortion produced. MASTER adjusts the output level from the preamp stage that is then fed to power amp stage. The GAIN and MASTER control settings have a large effect on the final sound, and the MASTER control may need to be turned up fairly high in order to drive the power stage sufficiently for optimum tone. The OUTPUT control adjusts the final output level from the amp model without affecting the distortion or tone, and is useful for adjusting the guitar's volume without changing any other aspects of the sound.

Usage Examples

Introduction

This section introduces some usage examples of the device. It is assumed that the audio driver settings on the DAW software have been properly configured according to the “Basic Operation” section in the Getting Started manual. If you have not configured them yet, refer to the section “Basic Operation” to complete the configuration.

Recording with the Channel Strip and REV-X

This section shows how to record a vocal to DAW software using the built-in Channel Strip and REV-X on the device. When using Cubase series programs, it is handy to use the project template. These project templates include the settings of the Channel Strip and REV-X. You can start recording instantly by opening the project template. When using programs other than the Cubase series, use the dspMixFx UR824.

NOTE

You cannot use the built-in Channel Strip when the sample rate is set to 176.4 kHz or 192 kHz. When you follow the steps in this section, set the sample rate to 96 kHz or less. To select the sample rate of the device, use the “(device name) Window” (page 8) in the “Control Panel of the Audio Driver” section in Windows or Audio MIDI Setup in Mac.

Connection Example

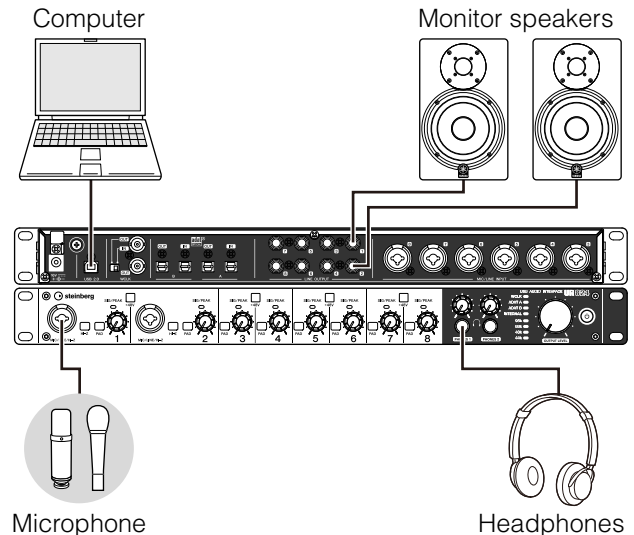

Operation

Cubase Series Programs

- 1. Launch the Cubase series DAW.**
The Project Assistant window appears.
- 2. Select the project template “Steinberg UR824 Vocal-Inst Recording 1” in “Recording” on the Project Assistant window, then click [Create].**
- 3. Turn on Direct Monitoring as follows.**
[Studio] → [Studio Setup...] → [Yamaha Steinberg USB ASIO] (Windows) or [Steinberg UR824] (Mac) → enter checkmark to “Direct Monitoring” → [OK]
- 4. Confirm that the “Record Enable” and “Monitor” indicators are turned on (lit) for the audio track.**



- 5. While singing into the microphone, adjust the input signal level of the microphone by the INPUT GAIN knob on the device.**
Adjust the input signal level so that the SIG/PEAK lamp flashes dimly in red.
- 6. While singing into the microphone, adjust the output signal level of the headphones by the PHONES knob on the device.**

7. Set the Channel Strip settings and REV-X settings on the Input Settings window.

Select the Channel Strip Insertion Location depending on the desired insert point. The default setting is “Lower” (applied to both the monitor signal and the recording signal). For details on the Insertion Location, refer to the “Effect Insertion Location” (page 17) in the section “Dedicated Windows for Cubase Series.”



8. Click “Record” to start the recording.



9. After finishing the recording, click “Stop” to stop it.



10. Turn “Monitor” off (dark) for the audio track.



11. Click the Ruler to move the project cursor to the desired point for starting playback.



12. Click “Play” to check the recorded sound.



When listening to the sound over monitor speakers, adjust the output signal level by the OUTPUT LEVEL knob on the device.

Operation is now completed.

Programs Other Than Cubase Series

1. Launch your DAW software.

2. Open the dspMixFx UR824.

For instructions on how to open the dspMixFx UR824, refer to the section “How to Open the Window” (page 10).

3. Adjust the input signal level of the microphone by the INPUT GAIN knob on the device.

Adjust the input signal level so that the SIG/PEAK lamp flashes dimly in red.

4. Adjust the output signal level of the headphone by the PHONES knob on the device.

5. Set the Channel Strip settings and REV-X settings on the dspMixFx UR824.



6. Start recording on your DAW software.

7. After finishing recording, stop it.

8. Playback the newly recorded sound to check it.

Operation is now completed.

Connecting the Mic Preamp

This section shows how to increase the number of analog input channels you can record by connecting an eight-channel mic preamp. In this example, you can record via up to sixteen channels by connecting up to sixteen mics to the devices. Use the OPTICAL A IN (ADAT) on the device to input the audio signal, and use the WCLK OUT on the device to output the word clock signal to the mic preamp.

Connection Example

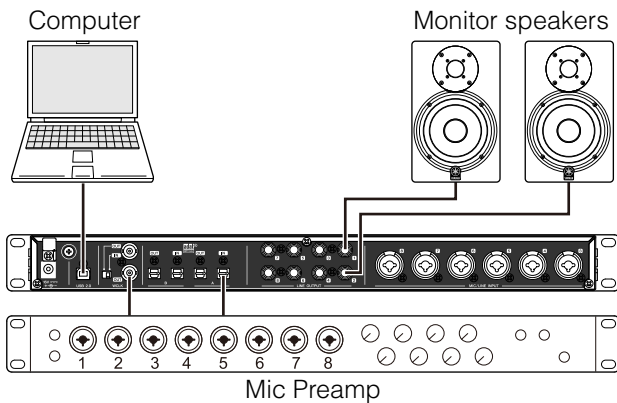

Operation

1. Connect the optical output terminal (ADAT) of the mic preamp to the OPTICAL A IN on the device.
2. Connect the WCLK OUT on the device to the word clock input terminal on the mic preamp.
3. Switch the clock source in the device to "Internal" by using the following window.

Windows

"(device name) Window" (page 8) in the section "Control Panel of the Audio Driver."

Mac

Audio MIDI Setup

4. Switch the clock source of the mic preamp to the word clock input terminal.

For switching the clock source of the mic preamp, refer to the owner's manual of your particular mic preamp.

5. Switch the DIGITAL MODE of the OPTICAL A on the device to the "ADAT" by using the "Setup Window" (page 13) in the section "dspMixFx UR824" or the "Settings Window" (page 19) in the section "Dedicated Windows for Cubase Series."

The operation is now complete.

Using the Device Without a Computer

This section shows how to use the device without a computer, allowing you to use it as a standalone mixer or A/D - D/A converter. You can save the DSP mixer and DSP effect settings configured by the dspMixFx UR824 to the device. These settings are maintained even if you turn off the power of the device.

Connection Example

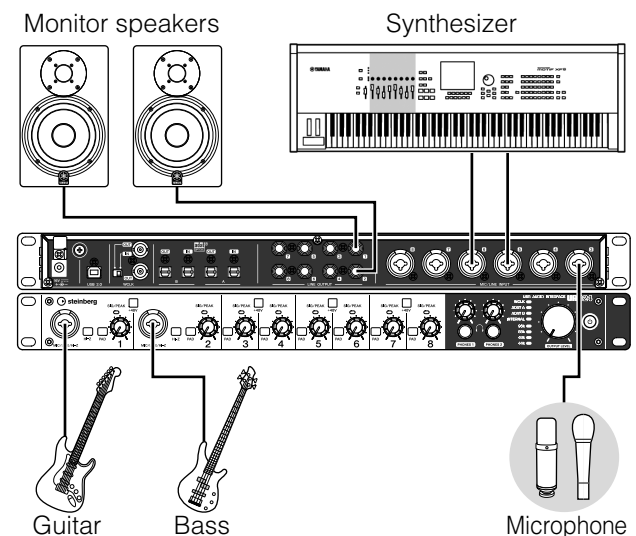

Using the Device with an iPad

Introduction

This section covers basic instructions for operating with Cubasis (an iPad app sold by Apple).

For the latest Cubasis information, see the Steinberg web site below.

<http://www.steinberg.net/>

NOTE

iOS applications may not be supported in your area. Please check with your Yamaha dealer.

Connection Example

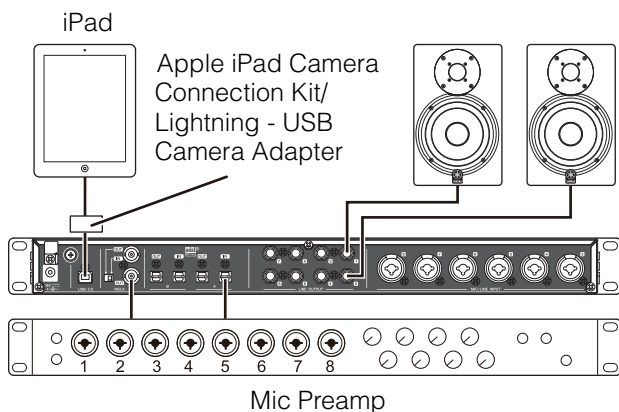

CAUTION

Make sure to set all volume levels to minimum before connecting or disconnecting the external device. Otherwise, high-volume output may damage your hearing or the equipment.

Recording/Playback

1. Turn on the device while holding down [+48V] button of the channel 7/8, and keep pressing the [+48V] button until a SIG/PEAK lamp flashes.

The UR824 enters Class Compliant mode for Apple iPad connectivity. While in the Class Compliant mode, the power button flashes several times by pressing the power button. To turn off the Class Compliant mode, turn on the power while holding down [+48V] button of the channel 7/8 again.

2. Open Cubasis.
3. Double-tap the Project [Template].

4. Enter a project name and tap [OK] in the [New project] window.

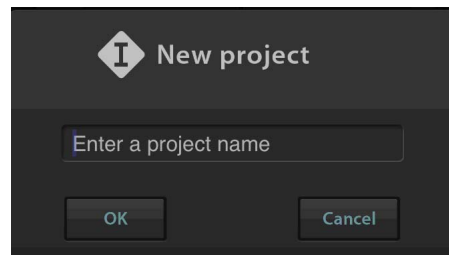

5. Tap [+AUDIO] to add an AUDIO track.



6. Tap [▶] on the far left of your screen to show the track menu, with [Audio input] at the top.



7. Tap  to show the details window and set the input bus for the track by tapping a number.



8. Tap  to turn monitoring on (lit).
9. Adjust the input signal level of the microphone with the [INPUT GAIN] knob on the device.
- To achieve optimum recording levels, increase the input level with the [INPUT GAIN] knob until the [PEAK] indicator lights in red, then slowly bring the level down until the indicator lights slightly when the input level is maximum.
10. While singing into the microphone, adjust the output signal level of the headphones by the [PHONES] knob on the device.

11. Tap  to start the recording.

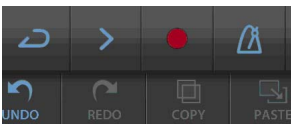

12. Tap  to stop the recording.

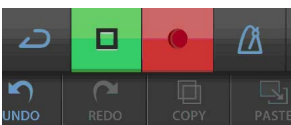

13. Tap and slide on the ruler to move the playback position.

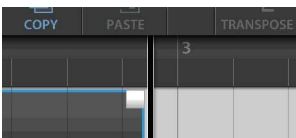

You can also tap  to return to the beginning of the recording.

14. Tap  to playback the recorded sound.

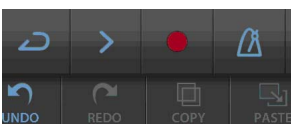

dspMixFx for iPad

From your iPad, you conveniently control built-in DSP mixer functions and DSP effects by using dspMixFx for iPad.

For details on dspMixFx for iPad, see the Steinberg web site below.

<http://www.steinberg.net/>

Appendix

Glossary

MIX

MIX refers to the stereo output signals which flow in the device. The input signals to the device flow to each MIX. You can assign any MIX to any analog output jack or any digital output jack.

VST Plug-in

VST (Virtual Studio Technology) is a technology developed by Steinberg which allows the integration of virtual effect processors and instruments into your digital audio environment. VST Plug-ins are instrument- and effect-based software of VST format. When you install a VST Plug-in to your computer, it will work on any DAW software compatible with VST Plug-ins, such as Cubase series.

DAW (Digital Audio Workstation)

DAW is an integrative system of music production, which lets you record and edit digital audio data. DAW software programs are applications which allow you to build such comprehensive systems on a computer.

Word Clock

Word clock synchronizes the process timing of audio signals when transferring digital audio data between multiple devices. Normally, one device transmits a reference word clock signal, and the other devices receive this word clock signal and synchronize to it. If the word clock signal is not transferred correctly, click noise may occur or recording may not be successful, even if the sample rates of the various devices are set to the same value.

Buffer Size

Buffer size refers to the amount of memory used to temporarily hold data during playback and recording. It is recommended to adjust the buffer size depending on the situation. Normally, a higher buffer size reduces load to the computer CPU but produces latency (time lag). Smaller buffer sizes reduce latency but produce greater load to the computer CPU. This high load to the computer CPU may result in noise or the sound cutting off.

Scene

A Scene is stored data which maintains the settings on the Main window of dspMixFx UR824. You can recall the stored Scene in dspMixFx UR824, and up to 20 Scenes can be stored.

Settings file of the dspMixFx UR824

The settings file of the dspMixFx UR824 is a data file including up to 20 scenes which can be saved to your computer. You can load the dspMixFx UR824 settings file to the dspMixFx UR824.

Sweet Spot Data

Sweet Spot Data are preset settings data of the Sweet Spot Morphing Channel Strip created by top-class engineers. This data includes the settings for the compressor and equalizer which are saved to each five points around the MORPH knob.

Side Chain Filter

The side chain filter is a peaking filter which adjusts the frequency range to which the compressor is applied. It features Q (band width), F (center frequency), and G (gain) parameters. For example, if the compressor reduces the audio signal level excessively because only the specified frequency of the audio signal is at a high level (and other frequencies are lower), you can selectively lower the level of the specified frequency by using this peaking filter. This will prevent the compressor from excessive level reduction.

Contents of the Getting Started Section

PRECAUTIONS

Introduction

- A Message from the Development Team
- Included Accessories
- How to Read the Manual

Panel Controls and Terminals

- Rear Panel
- Front Panel

Setup

- Setting up the Power Supply
- Installing TOOLS for UR824
- Downloading the Licenses (Activation)

Basic Operations

- Introduction
- Connection Example
- Configuring Audio Driver Settings on the DAW Software

Troubleshooting

Appendix

- Contents of the UR824 Operation Manual
- Uninstalling TOOLS for UR824
- Specifications

Signal Flow

The following chart indicates the signal flow in the device.

NOTE

- The controllers on the device, such as the HI-Z switch, INPUT GAIN knob, and OUTPUT LEVEL knob, are not included in this chart.
- To configure each parameter, use the “dspMixFx UR824” (page 9) or “Dedicated Windows for Cubase Series” (page 15).
- Please note that you cannot use the built-in Channel Strip (Ch. Strip) and Guitar Amp Classics when the sample rate is set to 176.4 kHz or 192 kHz.
- Some parts of the following signal flow may differ depending on the routing settings in the device.

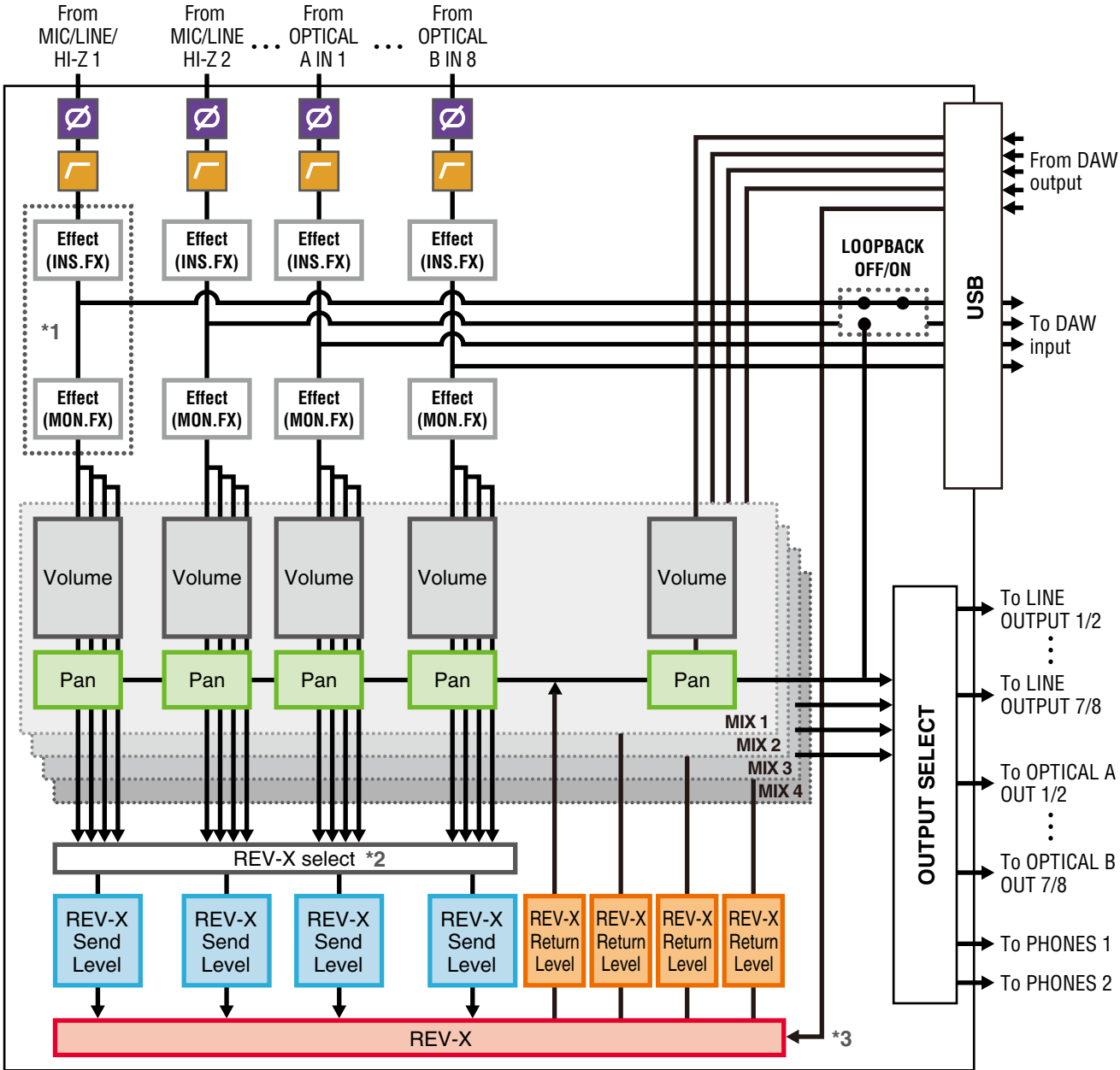

*1The following chart indicates an effect insertion location.

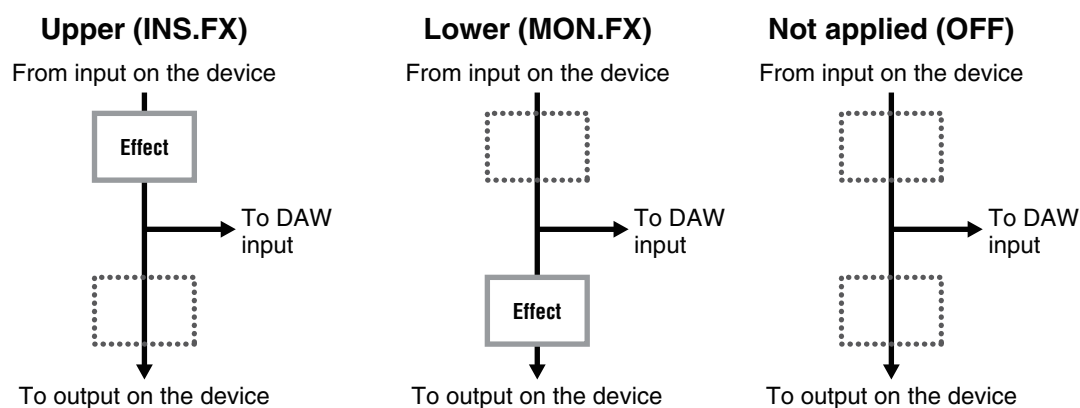

*2 One of the MIX 1–4 signals can be sent to the REV-X.

*3 The built-in REV-X is equipped with an “FX Bus” which is used for sending the signal from DAW software to the REV-X. For example, to send the recorded audio data to the REV-X, you can check the sound with the REV-X, which is used for monitoring during the recording.

Limitations on the use of effects

The maximum number of Channel Strip and Guitar Amp Classics iterations which can be used simultaneously are limited to the following. For example, Channel Strip can be used for four mono channels and two stereo channels, while Guitar Amp Classics can be used for one mono channel simultaneously.

Channel Strip		Guitar Amp Classics	
Mono	Stereo	Mono	Stereo
8	0	1	-
6	1	1	-
4	2	1	-
2	3	1	-
0	4	1	-

Please note that you cannot use the effect when the sample rate is set to 176.4 kHz or 192 kHz.

Block Diagrams

UR824 – 44.1/48 kHz

8 Analog In/Out, 16 Digital In/Out, 26 DAW In/24 DAW Out, 8+2 BUS

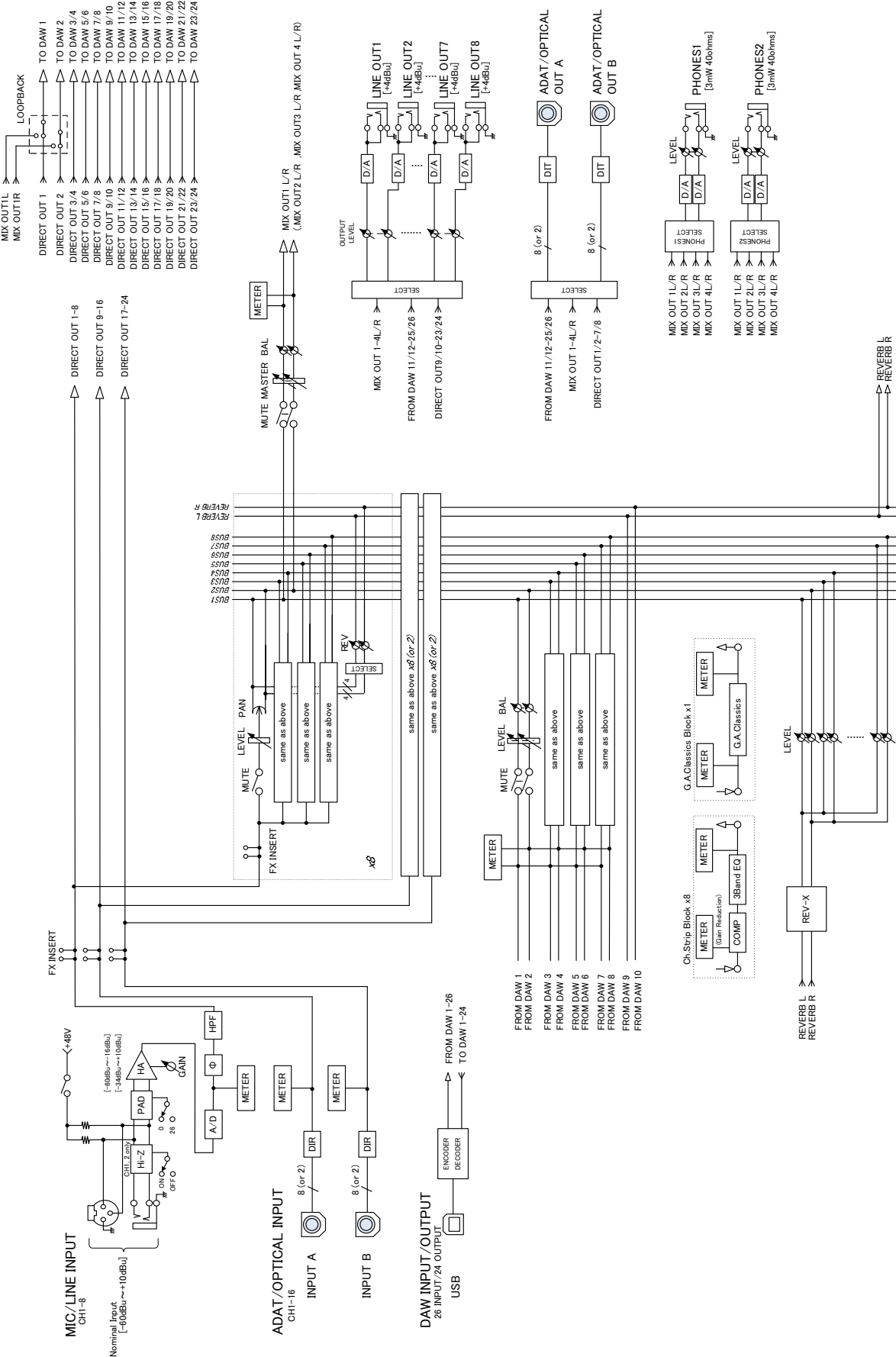

UR824 – 88.2/96 kHz

8 Analog In/Out, 8 Digital In/Out, 18 DAW In/16 DAW Out, 8+2BUS

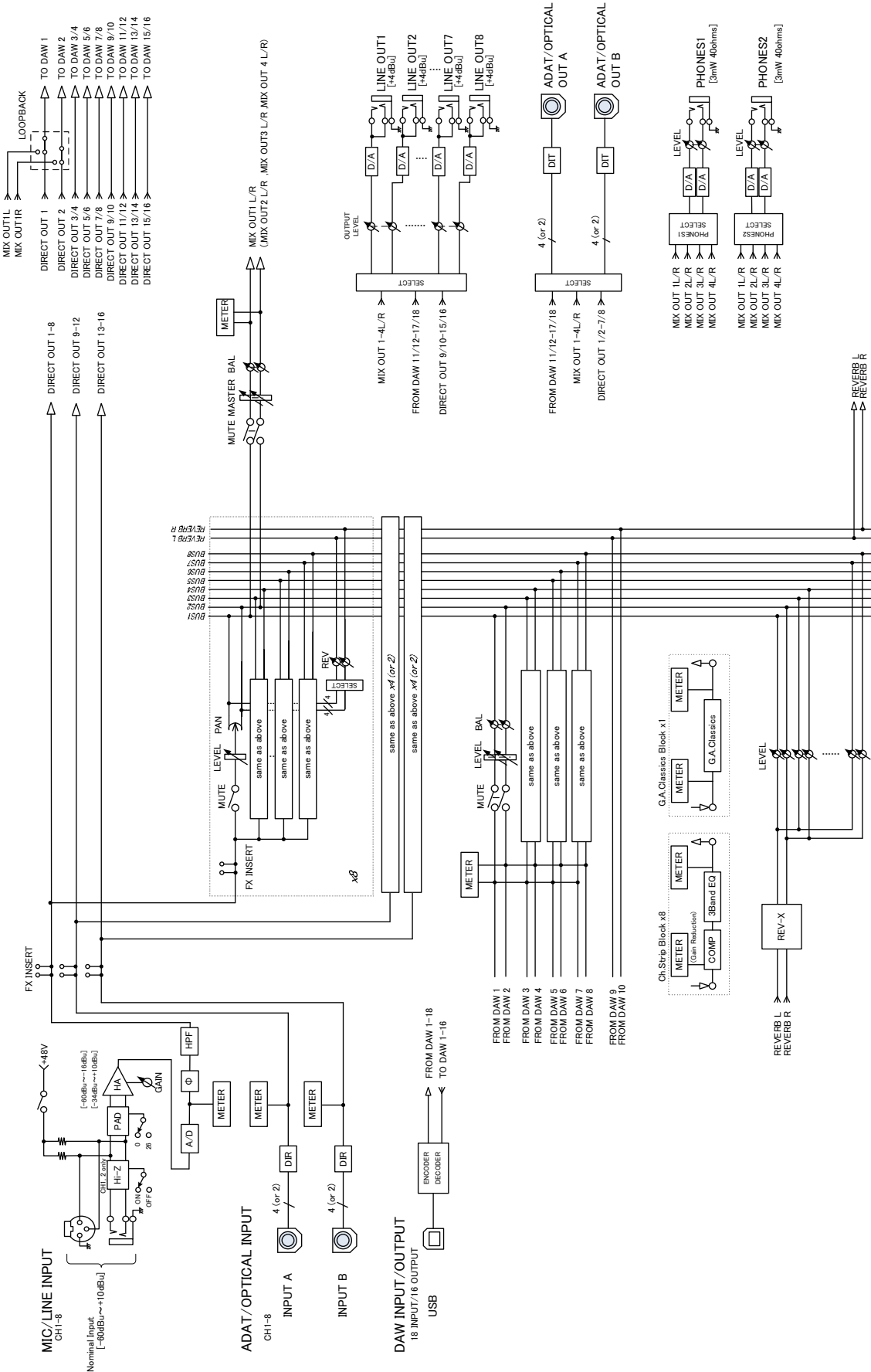

UR824 – 176.4/192 kHz

8 Analog In/Out, 4 Digital In/Out, 12 DAW In/12 DAW Out, 8+2 BUS

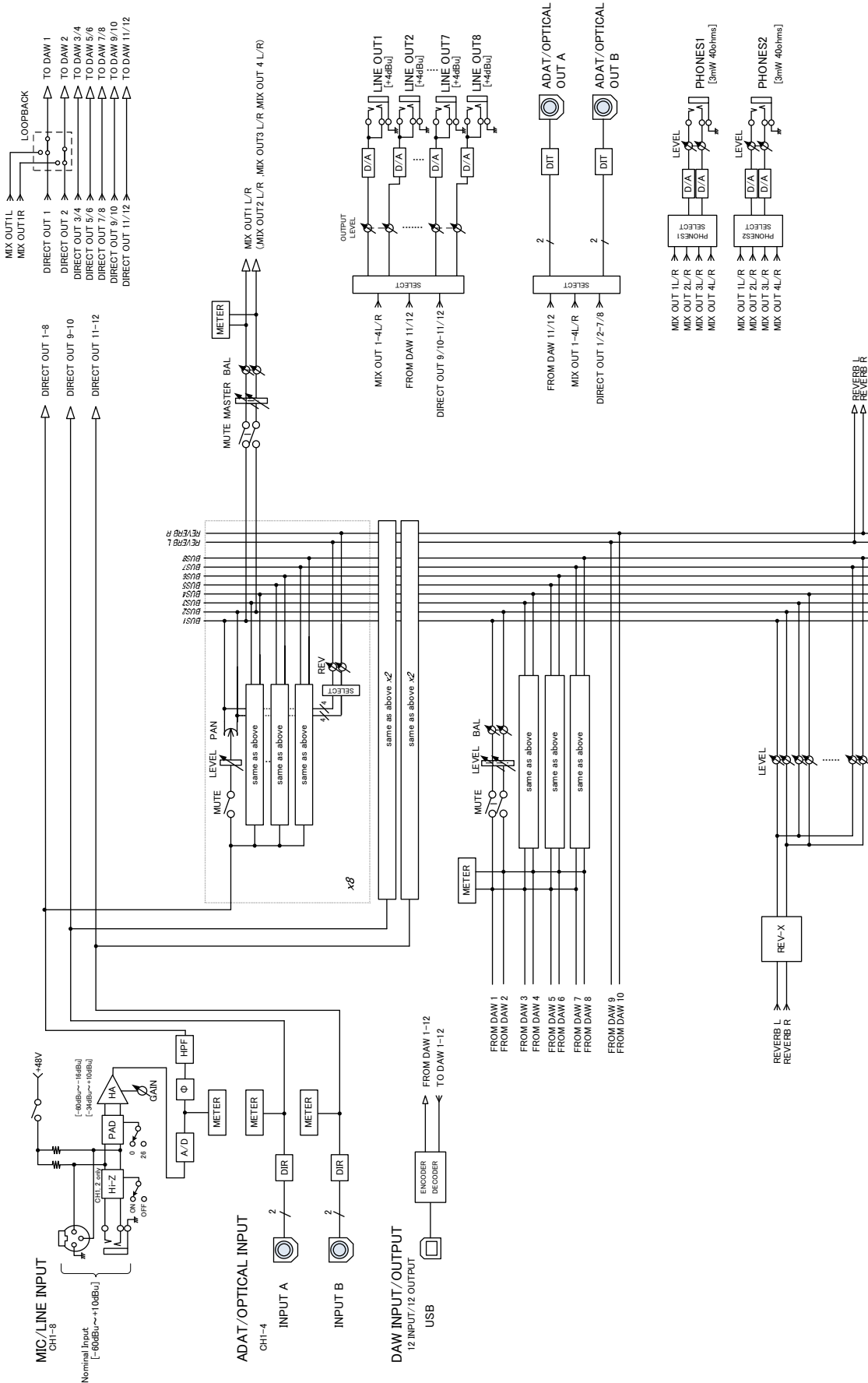

UR824 – 44.1/48/88.2/96 kHz - iPad

8 Analog In/Out, 8 DAW In/Out 8+2 BUS

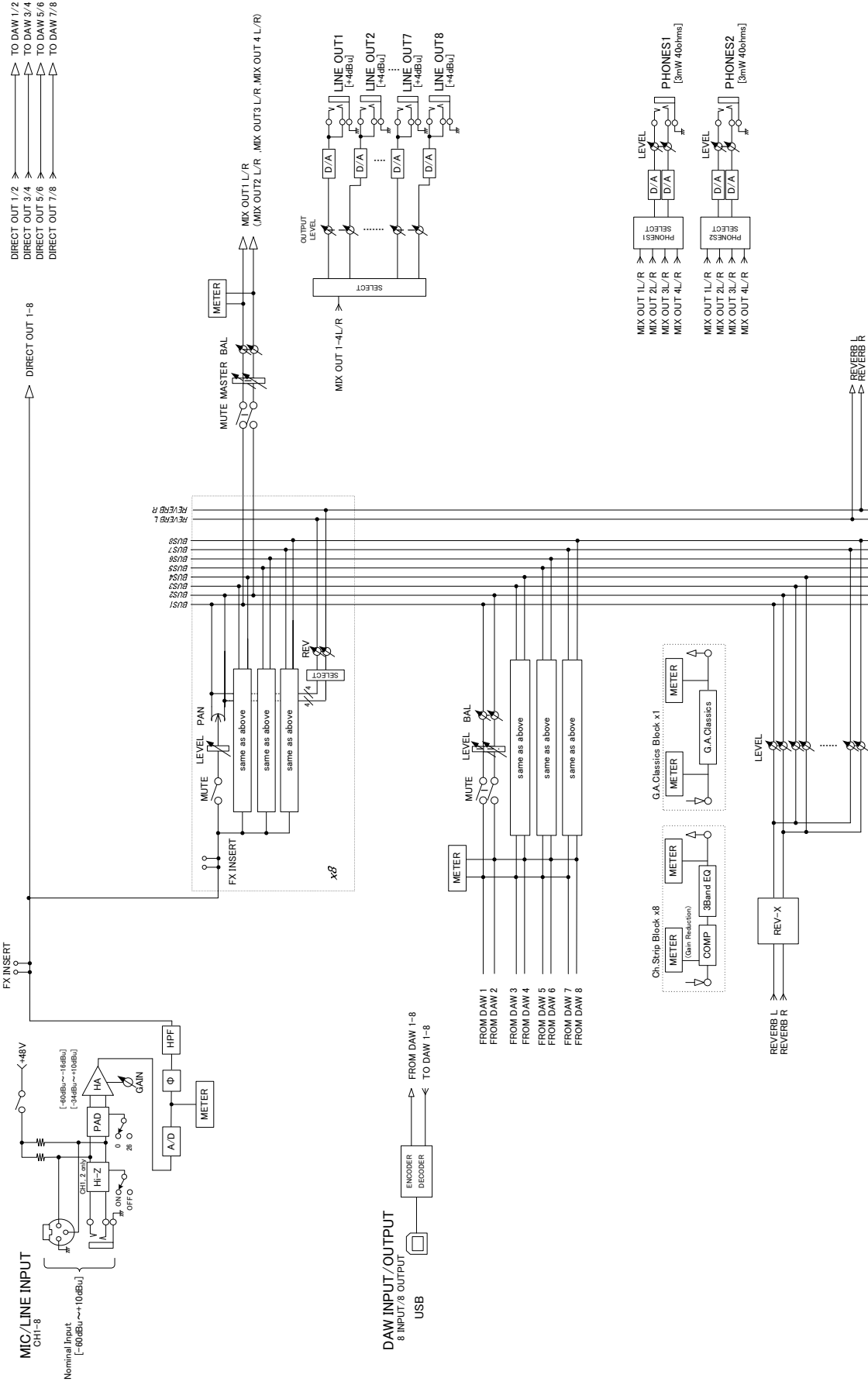

UR824 - 176.4/192 kHz - iPad

8 Analog In/Out, 8 DAW In/Out 8+2 BUS

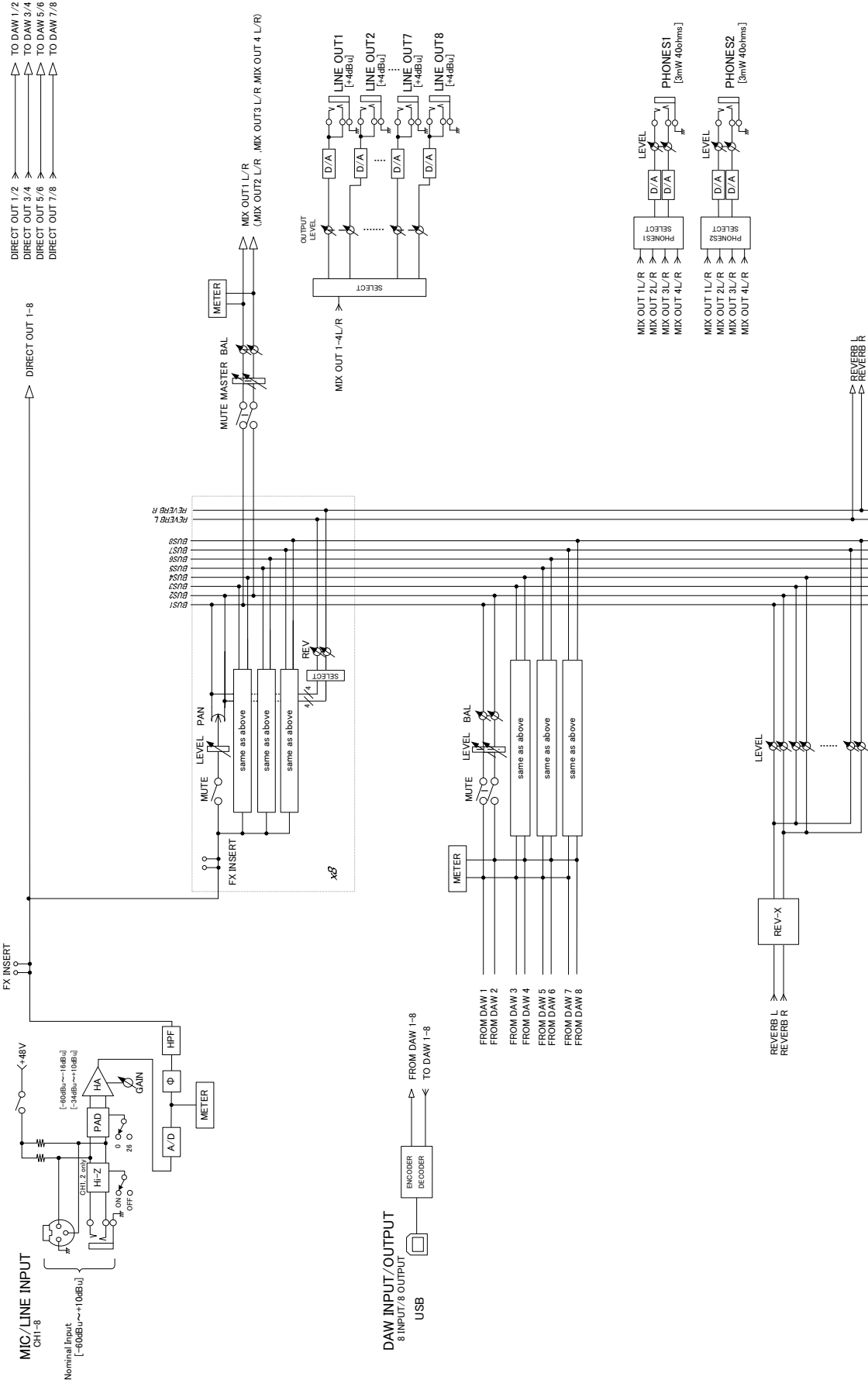

Steinberg Web Site
<http://www.steinberg.net/>

Manual Development Group
© 2011 Yamaha Corporation
Published 11/2018
2018年11月 发行
MW-F0

